Engineer Memoirs

MAJOR GENERAL RICHARD S. KEM

U.S.A. Retired

Office of History
Headquarters, U.S. Army Corps of Engineers
Alexandria, Virginia

Library of Congress Cataloging-in-Publication Data

Kem, Richard S., 1934-

Major General Richard S. Kem, U.S.A. retired.

p. cm. -- (Engineer memoirs)

Includes index.

1. Kem, Richard S., 1934- 2. Generals--United States--Biography. 3. Military engineers--United States--Biography.

I. Baldwin, William C. II. Walker, Paul K. III. Greenwood, John T. IV. Title. V. Series.

UG128.K45 A3 2002

EP 870-1-65

Foreword

This is the thirteenth publication in the *Engineer Memoirs* series of career oral history interviews. The series contains the selected recollections of major figures in recent Corps history. These memoirs lend important perspective to decision-making, now and in the future. By making these recollections available, the series preserves and shares the knowledge and experience of retired Corps officers and civilians.

Richard S. “Sam” Kem had a distinguished career in the United States Army, which culminated with his tenure as Deputy Chief of Engineers and Deputy Commanding General of the U.S. Army Corps of Engineers. Earlier in his career, General Kem served as a battalion commander in South Vietnam, a group commander in Europe, commander of the Ohio River Division, Commanding General of the U.S. Army Engineer Center and Fort Belvoir, Commandant of the U.S. Army Engineer School, Deputy Chief of Staff, Engineer, and Chief of Staff of the U.S. Army Europe. I recommend this interview to the soldiers and civilians of the Engineer family.

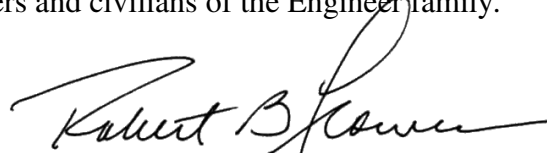

ROBERT B. FLOWERS

Lieutenant General

Commanding

Interviewers

Dr. William C. Baldwin is a historian in the Office of History, Headquarters, U.S. Army Corps of Engineers. He is a graduate of the College of William and Mary and received his doctorate in military history from the University of Michigan. He is the author of *The Engineer Studies Center and Army Analysis: A History of the U.S. Army Engineer Studies Center, 1943-1982*, and he was the interviewer and editor of the *Engineer Memoirs* of Lieutenant General John W. Morris.

Dr. Paul K. Walker is Chief of the Office of History, Headquarters, U.S. Army Corps of Engineers. Dr. Walker is a graduate of The George Washington University and received his doctorate in history from the University of North Carolina at Chapel Hill. He is the author of *Engineers of Independence: A Documentary History of the Army Engineers in the American Revolution, 1775-1783* and *The Corps Responds: A History of the Susquehanna Engineer District and Tropical Storm Agnes* and coauthor of *Financing Water Resources: A Brief History*. He has written articles on the Battle of Yorktown and canals in early American history.

Dr. John T. Greenwood is Chief of the Office of Medical History of the Office of the Surgeon General, U.S. Army Medical Command. He is a graduate of the University of Colorado and received his doctorate in history from Kansas State University. After serving as a historian for the Air Force, he was Chief of the Office of History, Headquarters, U.S. Army Corps of Engineers, from 1978 to 1988. He was Director of Field Programs and International Programs and then Chief of Field Programs and Historical Services Division at the U.S. Army Center of Military History until he joined the Surgeon General's office in October 1998.

Acknowledgements

Marilyn Hunter, Susan Carroll, and Jean Diaz edited this interview at various stages in its production. The Publishing Group of the Engineer Research and Development Center also edited and prepared the interview for publication.

Contents

Foreword	iii
Interviewers	iv
Acknowledgements.....	iv
Introduction	ix
Career Summary	xi
Promotion History	xiii
Education.....	xiii
Decorations.....	xiii
Interview.....	1
Early Years and West Point	3
23d Engineers, 3d Armored Division.....	24
62d Engineer Battalion (Construction).....	47
University of Illinois	49
Engineer Advisor in South Vietnam	55
Chicago District	74
Alaska Earthquake	82
Advanced Course, U.S. Army Engineer School.....	88
307th Engineer Battalion, 82d Airborne Division.....	91
Command and General Staff College.....	96
Commander, 577th Engineer Battalion (Construction).....	99
Staff, U.S. Military Academy.....	132
Naval War College.....	140
Military Personnel Center	143
Office of the Chief of Staff of the Army	166
Chief of Public Affairs, Office of the Chief of Engineers	172
Commander, 7th Engineer Brigade.....	185
Office of the Deputy Chief of Staff, Engineer, USAREUR	224
Deputy Assistant Chief of Engineers	248
Deputy Director of Civil Works	263
Commanding General, Ohio River Division	268
Commanding General, U.S. Army Engineer Center and Fort Belvoir	327
Deputy Chief of Staff, Engineer, USAREUR	382
Chief of Staff, USAREUR.....	414
Deputy Chief of Engineers.....	433
Acronyms	488
Index.....	492
Appendix A: Centralized Command Selection Paper.....	A-1
Appendix B: Engineers - A "Corps" in the Army's Regimental System	B-1
Appendix C: E-Force, Army of Excellence, Combat Engineers.....	C-1
Appendix D: Corps of Engineers Automation Plan (CEAP) Briefing for Assistant Secretary of the Army (Civil Works).....	D-1

Photographs

Major General R. S. “Sam” Kem, Deputy Chief of Engineers, 13 July 1990.....	2
Cadet Kem met with Congressman Ralph Harvey, who had appointed him to West Point, in the Hotel Willard after marching in the Eisenhower inauguration parade in January 1953.....	4
Cadet “Sam” Kem	10
Cadet Kem showed his parents and brothers the “sammy” (syrup) pitcher on the dining table in Washington Hall during his plebe Christmas at West Point in 1952	17
First Lieutenant R. S. “Sam” Kem.....	30
First Lieutenant Kem watched a motor pool vehicle inspection in West Germany in November 1958.....	33
Captain Kem was an advisor with the 201st Engineer Battalion of the Army of the Republic of Vietnam in 1962.	58
In May 1962 Company B of the 201st Engineer Battalion was rebuilding the French airfield at An Khe.	59
In May 1962 Company C of the 201st Engineer Battalion was constructing a road north from An Khe to Kannack.	59
Cantonment of Headquarters and B and C Companies of the 201st Engineer Battalion, Army of the Republic of Vietnam.....	61
Captain Kem as an Engineer advisor talking with a local inhabitant near Pleiku in South Vietnam in April 1962.	62
In August 1962 the 20th Engineer Group of the Army of the Republic of Vietnam was opening a road from Cheo Reo to Cung Son.....	67
Captain Kem, Deputy District Engineer, Chicago District, and Ann Kem in 1965.....	75
Brigadier General Raymond J. Harvey, Assistant Commandant of the Engineer School, presented the Army Commendation Medal to Captain Kem for his work during the Alaska earthquake in October 1965.	87
Lieutenant Colonel Kem commanded the 577th Engineer Battalion from July 1968 to July 1969.	101
Army Engineer bridges over the Ban Thach River in South Vietnam	105
The 577th Engineer Battalion quarry operations at Chop Chai Mountain near Tuy Hoa, South Vietnam, in January 1969.....	106
The 577th Engineer Battalion (Construction) built the Ban Thach River bridge from pre-cast elements in 1968.....	108
Reviewing stand of Headquarters, 577th Engineer Battalion (Construction), at Phu Hiep, South Vietnam, in September 1968	110
U.S. Army helicopters leapfrogged M4T6 trestles along the route from Tuy Hoa to Cung Son in February 1969.....	114
The completed Ban Thach bridge was dedicated on 7 December 1968.	116
Lieutenant Colonel Kem spoke at the dedication of the Ban Thach bridge.	117
Lieutenant Colonel Kem with Brigadier General John W. Morris, Commander of the 18th Engineer Brigade, at Don Duong, South Vietnam, in May 1969.....	118
Colonel Kem received the colors of the 7th Engineer Brigade from Lieutenant General Frederick J. Kroesen, Commanding General, VII Corps, in July 1976	185

Colonel Kem, Commander of the 7th Engineer Brigade, addressed soldiers of the 78th Engineer Battalion on 30 November 1977.....	191
Colonel Kem inspected the bridging exercises on the Rhine River conducted by the labor service companies and the 565th Engineer Battalion in the spring of 1977	203
Colonel Kem reviewed the 20th Engineer Battalion’s plans to destroy bridges on the Iller River in Exercise Carbon Edge, REFORGER 77, in September 1977.....	212
Lieutenant General David Ott, Commander of the VII Corps, and Colonel Kem as Kem left his assignment as Commander of the 7th Engineer Brigade in July 1978.....	223
Ann Kem and Lieutenant General John W. Morris, Chief of Engineers, pin brigadier general’s stars on General Kem’s uniform during his promotion ceremony in November 1979.....	252
General Kem’s wife, children, and parents at his promotion to brigadier general in November 1979.	253
General Kem with Mr. William R. Gianelli, who was Assistant Secretary of the Army for Civil Works from 1981 to 1984.....	277
General Kem at his promotion to major general in July 1984	328
General Kem received the school colors from General Carl Vuono, Commanding General, Training and Doctrine Command, when he became Commander of the U.S. Army Engineer Center and Fort Belvoir, Virginia.	329
General Kem and Major General James N. Ellis, departing Commander of the U.S. Army Engineer Center and Fort Belvoir, Virginia, at the change of command ceremonies on 21 August 1984.	329
General Kem, Commandant of the Engineer School, congratulated his son, Second Lieutenant John Kem, on his graduation from the Engineer Officer Basic Course on 27 November 1985.....	335
General Kem and Lieutenant General Elvin R. Heiberg III, Chief of Engineers, observed a test of the M9 ACE during the summer of 1985.	342
General Kem with Brigadier Roland Zedler, Commandant of the West German engineers, during a visit to a German engineer river crossing in 1986	348
General Kem greeted Lieutenant Colonel Garth Hewish, British Liaison Officer, and his wife Sheila when he was Commander of the Engineer School.....	355
General Kem met with Israeli Defense Force officers during a visit to Israel while he was Commander of the Engineer School.....	361
The first Honorary Colonel of the newly established Engineer regiment, called the Corps of Engineers, Lieutenant General Frederick J. Clarke (Retired), former Chief of Engineers, passed the colors of the regiment to General Kem, Commandant of the Engineer School, at the unfurling of the new colors at Fort Belvoir, Virginia, on 23 June 1986.....	370
Lieutenant General Elvin R. Heiberg III, Chief of Engineers and Colonel of the Engineer Regiment; Lieutenant General Frederick J. Clarke, Honorary Colonel of the Regiment and former Chief of Engineers; and General Kem at the ceremony establishing the regiment.....	371
General Kem presented a commemorative painting from the Engineer School to General Bruce C. Clarke (Retired), a prominent Engineer officer, on 10 March 1987	376
General Kem received the Distinguished Service Medal from the Commander of the Training and Doctrine Command, General Maxwell Thurman, at the Change of Command Ceremony at the Engineer School on 6 July 1987	382

General Kem, Deputy Chief of Staff, Engineer (DCSENG), U.S. Army Europe, with Mr. Korte of the West German Ministry of Defense, Dr. Fischer, Ministry of Finance, and Jorge Fuentes, Chief of the Real Estate Division, DCSENG..... 396

Commander-in-Chief to Commander-in-Chief meeting in Heidelberg, West Germany, in 1989 426

General Kem, Chief of Staff, U.S. Army Europe, and Major General Fursin, Chief of Staff of the Group of Soviet Forces Germany, at a 1989 celebration of the meeting of American and Soviet forces on the Elbe River in 1945 427

Major General Kem escorted Major General Fursin, Chief of Staff of the Group of Soviet Forces Germany, on a visit to Grafenwöhr in 1989 during the CINC to CINC visit..... 428

General Kem toured the Pineville, Kentucky, project as the Nashville District prepared to drill tunnels 436

General Kem with leaders from the Nashville District at the Divide Cut of the Tennessee-Tombigbee Waterway in 1990..... 445

General Kem, Deputy Chief of Engineers, inspected the chemical demilitarization facility on Johnston Island during a visit to the Pacific in 1990 454

General Kem with members of the Headquarters, U.S. Army Corps of Engineers staff..... 468

Groundbreaking Ceremony at the new Winfield Lock 478

In a ceremony at Fort Leonard Wood, Missouri, on 3 May 2002, Major General Richard S. Kem, USA (Ret.), received the Gold Order of the deFleury Medal from Lieutenant General Robert B. Flowers, Chief of Engineers and Colonel of the Army Engineer Regiment. The Gold Order of the deFleury Medal is the most prestigious individual recognition award presented by the Army Engineer Regiment. Only one such medal is presented each year. General Kem also is wearing the Silver Order of the deFleury Medal, which he received in May 1989..... 487

Introduction
by
William C. Baldwin

Major General Richard Samuel “Sam” Kem’s distinguished Army career culminated in two prominent senior positions: Chief of Staff of the U.S. Army Europe and Deputy Chief of Engineers. For two years at the end of the Cold War he was one of the senior leaders of the Army’s most important front line combat force, and in his last assignment he helped lead the U.S. Army Corps of Engineers during a critical transition period in its modern history. As General Kem thoughtfully describes in this interview, his earlier assignments had well prepared him for his senior positions.

After graduating from West Point in 1956 and attending Ranger, Airborne, and Engineer training, General Kem went to a junior officer assignment in America’s most important potential theater of operations, Europe, in one of the key units in that theater, an armored division. His experiences in the 3d Armored Division and the lessons he learned would serve him well for the next 30 years of his career. In just a few years, however, while still a junior officer, he saw early the challenges that would confront the United States in its next combat operations in Southeast Asia, as an engineer advisor assigned to South Vietnamese engineer units in 1962. After honing his combat engineering skills with the 307th Engineer Battalion, 82d Airborne Division, he returned to South Vietnam in 1968 in the middle of the war as commander of the 577th Engineer Battalion. After seven years as a student, teacher, and staff officer, he returned to troop command in America’s front line army in Europe as commander of the 7th Engineer Brigade. His experience in combat and command culminated in General Kem’s tour as commandant of the Engineer School where he oversaw the training of young officers, the reorganization and strengthening of engineer combat units, and the development of new and vital engineer doctrine and equipment. He then returned to Europe to apply his skills and implement the lessons he had learned as Deputy Chief of Staff, Engineer, and Chief of Staff of the U.S. Army Europe at the peak of Reagan Administration defense buildup and on the eve of the collapse of the Soviet Union. From his earliest military training and assignments, General Kem’s experiences prepared him well for his culminating positions in America’s senior overseas theater.

His service in the U.S. Army Corps of Engineers also prepared him for assignment to senior positions in the organization that would become a major Army command (MACOM) in 1979. After earning a master’s degree in civil engineering at the University of Illinois, General Kem was assigned to the Chicago District, at that time a large district with both civil works and military construction responsibilities. In addition to learning about the activities of an engineer district, General Kem experienced firsthand the Corps’ important role in helping communities recover from natural disasters. In 1964 the district sent him to Alaska to help with the cleanup following the devastating earthquake. Later General Kem served as Chief of Public Affairs in Corps headquarters as the agency struggled with its new environmental missions and the many controversies they produced. In his next Corps assignment as Deputy Assistant Chief of Engineers in the Pentagon, Kem was a key player in the Army’s programming and budgeting cycles and in relations with Congress. As Deputy Director of Civil Works, he learned more about the Corps’ water resources program. With this varied Corps background, General Kem was named commander of the important Ohio River Division (ORD) headquartered in Cincinnati, Ohio. ORD’s diverse civil and military responsibilities required careful management, especially in the early years of a new presidential administration committed to bolstering the nation’s defenses and finding new approaches to the Corps’ water resources program. These varied Corps assignments culminated in General Kem’s

becoming the Deputy Chief of Engineers and Deputy Commanding General of the U.S. Army Corps of Engineers in 1989. He assisted the Chief of Engineers, LTG Henry Hatch, in confronting the many difficult issues facing the Corps, including research and development, automation, and strategic planning. After a distinguished career of 34 years, General Kem retired in the fall of 1990.

This oral history interview contains General Kem's recollections and reflections on his background and his career in the U.S. Army Corps of Engineers. Like all oral history interviews, the transcript includes General Kem's personal thoughts and perspectives. Neither his views nor those of the interviewer necessarily reflect those of the Department of Defense or the Corps of Engineers. The strength of oral history is that it captures the unique perspectives and interpretations of individuals who witnessed or participated in historical events. Oral history can supplement and enrich the official record but never replace it. Interviews are often not objective nor are they expected to be. Their value is contained in the unique personal perspective they provide.

The interviews in this publication were conducted by three historians who were members of the Office of History, Headquarters, U.S. Army Corps of Engineers, when they taped the interviews. Dr. Paul K. Walker conducted the session on General Kem's tenure as Deputy Chief of Engineers and Deputy Commanding General of the U.S. Army Corps of Engineers on 19 October 1990, shortly after General Kem retired from the Army. Dr. John T. Greenwood conducted two sessions on General Kem's three years as Commanding General of the Engineer Center and Commandant of the Engineer School at Fort Belvoir, Virginia, on 29 June and 13 July 1987, as the general was leaving that position. Dr. William C. Baldwin and Dr. Walker conducted the remainder of the interview on 22, 24, and 29 October 1990; 13 August, 12 September, 11 October, and 5 November 1991; and 6 February 1992.

The interviews concerning command of the Engineer School and deputy command of the Corps of Engineers capture events shortly after they occurred and have an immediacy that comes from being close to events. Inevitably, however, they lack the perspective brought by the passage of time. That perspective informs the rest of the interview that ranges over General Kem's life and career from childhood to his retirement from the Army. General Kem and the interviewers reviewed and edited the transcripts, and Marilyn Hunter, Susan Carroll, and Jean Diaz edited the interview for publication. The original tapes of the interview are in the Research Collections of the Office of History, Headquarters, U.S. Army Corps of Engineers. The photographs in this publication are from General Kem's personal collection.

Conducting, transcribing, reviewing, editing, and publishing an oral history takes a long time. The Office of History thanks General Kem for the sizable amount of time he devoted to this project and for his support and patience during the lengthy publication process. His time is especially valuable because of his busy schedule as Director of the Department of Public Works for Arlington County, Virginia, a position he has occupied for more than a decade. While the production of these *Engineer Memoirs*, a series that began more than two decades ago, is time-consuming for all participants, the Office of History believes it is time well invested because of the unique and valuable historical information and perspective the *Memoirs* preserve and make available to those who read and benefit from them.

Career Summary

Engineer Officer Basic Course U.S. Army Engineer School	Sep 56	Oct 56
Ranger and Airborne Courses U.S. Army Infantry School	Oct 56	Feb 57
Platoon Leader, then Executive Officer, Bridge Company, then Assistant Battalion S-3 23d Engineer Battalion, 3d Armored Division U.S. Army Europe	Mar 57	Nov 59
Platoon Leader, 62d Engineer Battalion (Construction) Ft. Leonard Wood, MO	Nov 59	May 60
Graduate Student, University of Illinois	May 60	Feb 62
Engineer Battalion and then Group Advisor, Military Assistance Advisory Group, Vietnam	Mar 62	Mar 63
Executive Officer and then Deputy Commander, U.S. Army Engineer District, Chicago	Mar 63	Mar 65
Engineer Officer Advanced Course U.S. Army Engineer School	Mar 65	Oct 65
Assistant Division Engineer and then Executive Officer, 307th Engineer Battalion, 82d Airborne Division Ft. Bragg, NC	Oct 65	Jul 67
Student, U.S. Army Command and General Staff College	Aug 67	Jun 68
Commander, 577th Engineer Battalion (Construction) U.S. Army Vietnam	Jul 68	Jul 69
Regimental Executive Officer and then Director of Logistics, Department of Tactics, U.S. Military Academy	Jul 69	Jul 71
Student, U.S. Naval War College	Aug 71	Jun 72

Engineer Memoirs

Engineer Assignment Officer, Colonels Division, Military Personnel Center	Jul 72	Jun 74
Assistant to the Director of the Army Staff, Office of the Chief of Staff, U.S. Army	Jun 74	Jun 75
Chief of Public Affairs, Office of the Chief of Engineers	Jun 75	Jun 76
Commander, 7th Engineer Brigade and Ludwigsburg-Kornwestheim Military Community, U.S. Army Europe	Jul 76	Jul 78
Chief, Installations and Construction Division and then Assistant Deputy Chief of Staff, Engineer, Office of the DCSENG, U.S. Army Europe	Jul 78	Jul 79
Deputy Assistant Chief of Engineers, U.S. Army Corps of Engineers	Aug 79	Sep 80
Deputy Director of Civil Works, U.S. Army Corps of Engineers	Sep 80	Jan 81
Commanding General, U.S. Army Engineer Division, Ohio River	Jan 81	Aug 84
Commanding General, U.S. Army Engineer Center and Fort Belvoir/Commandant, U.S. Army Engineer School	Aug 84	Jul 87
Deputy Chief of Staff, Engineer, U.S. Army Europe and Seventh Army	Jul 87	Jul 88
Chief of Staff, U.S. Army Europe and Seventh Army	Jul 88	Aug 89
Deputy Chief of Engineers and Deputy Commanding General, U.S. Army Corps of Engineers	Aug 89	Oct 90

Promotion History

<u>Promotion</u>	<u>Temporary</u>	<u>Permanent</u>
2d Lieutenant		1 Jun 56
1st Lieutenant	1 Dec 57	1 Jun 59
Captain	25 Jul 61	1 Jun 63
Major	28 Jul 65	1 Jun 70
Lieutenant Colonel	12 Aug 68	1 Jun 77
Colonel	1 Nov 75	1 Jun 80
Brigadier General	1 Nov 79	22 Jan 82
Major General		1 Jul 84

Education

Military Schools

- U.S. Military Academy
- U.S. Army Engineer School
- U.S. Army Command and General Staff College
- U.S. Naval War College

Civilian Schools

- University of Illinois, M.S. in Civil Engineering
- George Washington University, M.S. in International Affairs
- Northwestern University-Kellogg, Advanced Management Program
- Harvard University, Senior Managers in Government Program

Decorations

- Distinguished Service Medal (with Oak Leaf Cluster)
- Legion of Merit (with Oak Leaf Cluster)
- Bronze Star Medal
- Meritorious Service Medal (with Oak Leaf Cluster)
- Air Medal
- Army Commendation Medal (with Oak Leaf Cluster)

- Gold deFleury Medal
- Silver deFleury Medal

Engineer Memoirs

MAJOR GENERAL R. S. KEM

U.S.A. Retired



Major General R. S. "Sam" Kem, Deputy Chief of Engineers, 13 July 1990.

Engineer Memoirs
Major General R.S. Kem

Early Years and West Point

Q: I'd like to start at the beginning—when you were born, where, and something about your parents.

A: Well, I was born 9 August 1934 in Richmond, Indiana. My parents, Charles and Janice Kem, had grown up in the vicinity of Richmond, Indiana, which is in Wayne County. They lived in Williamsburg, Indiana, which is five, six miles north of Richmond. My father had gone to Indiana University Dental School; my mother to Earlham College, which is in Richmond. When he began his dental practice, it was just across the Ohio line in New Paris, Ohio; and so they were living in New Paris at the time, but that community used the Richmond hospitals, which is why I was born in Richmond.

So, that was 1934, and we lived there—I don't know how long, two or three years, and then my parents moved to Richmond and lived at 25 Southwest Fourth Street, and Dad practiced dentistry in Richmond. He had practiced before in New Paris and a little bit in Richmond. Then he moved all of it to Richmond. In about 1941 we built a home, or we were building it in '41, and we moved in '42 into a home on the outskirts of Richmond, 1000 Henley Road, and I really spent the rest of my boyhood growing up in that home. It was just outside the city limits, so we went to county schools. I went to Riley School and Riley Junior High School.

Q: Is that James Whitcomb Riley?

A: I think so.

Q: I know he's a Hoosier, but I wasn't sure where he was from.

A: I'm sure it is. He may be from Greencastle. I'm not sure.

But then, come the tenth grade, Riley School students went on to Richmond Senior High School. I then spent my three years in Richmond Senior High School, graduating in 1952.

Q: How did you get interested in going to West Point?

A: Well, I didn't really know a lot about West Point, knew very little. One day my father suggested that perhaps I should consider it, about the time I was beginning to look toward college, two years away. I guess he suggested it because I really wasn't yet into that mode of looking on to colleges, but for West Point you need to do that earlier than you do for other colleges. He indicated that I had to go through the congressional process, so I wrote my congressman, Ralph Harvey.

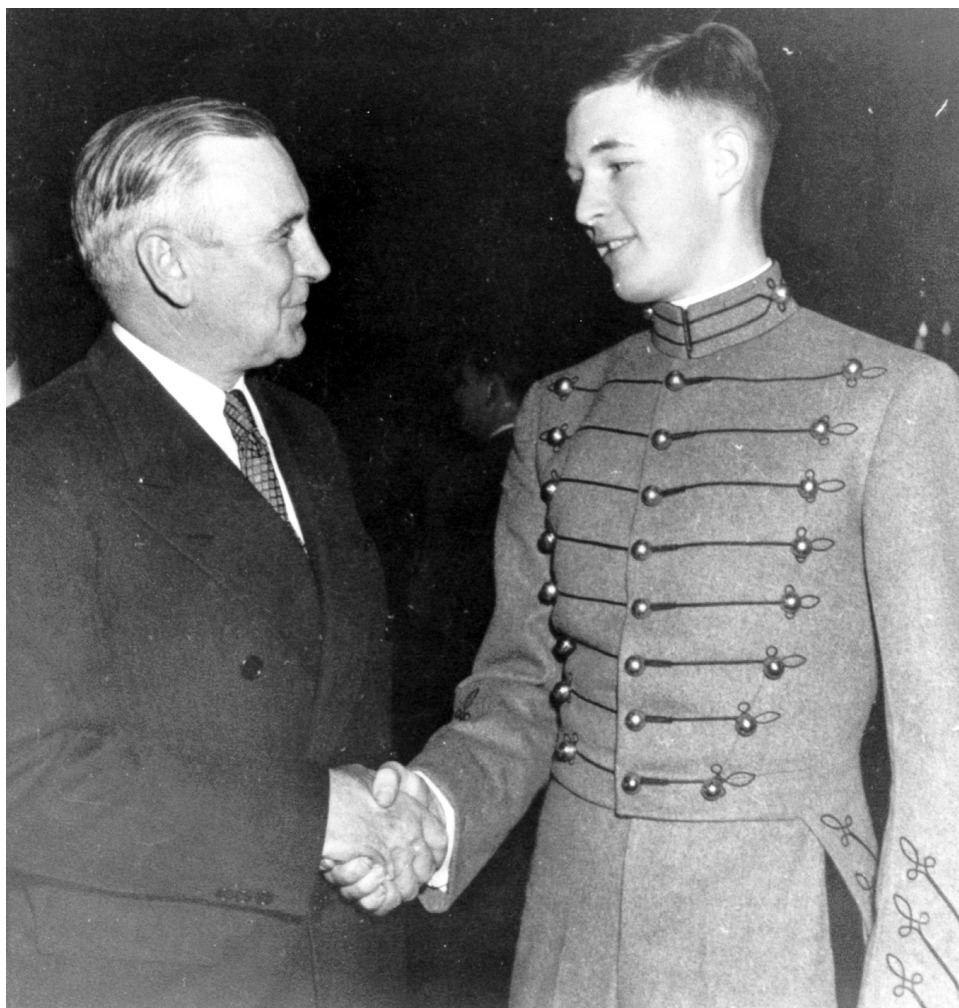

Cadet Kem met with Congressman Ralph Harvey, who had appointed him to West Point, in the Hotel Willard after marching in the Eisenhower inauguration parade in January 1953. Harvey represented Indiana's 10th Congressional District.

He was 10th District congressman. I told him I was interested and he sent me a note, told me what the process was. It started off with an exam at the post office in Richmond during the summer of 1951, and that would have been between my junior and senior year in high school. I took the exam. I still wasn't necessarily motivated for West Point, but now I was starting my senior year where I would start looking toward college and universities. I applied to Purdue and to Indiana and continued the process toward West Point.

Sometime, perhaps the fall, I was notified by him that I would receive his second alternate appointment. Later that fall, probably around December, he told me that I was now his first alternate, that one of the two had for some reason declined, so I should plan to take the official entrance examination now. The previous exam at the post office was only for assisting Congressman Harvey to rank order his people.

I went to Fort Knox, Kentucky, in the late February or March time frame of '52 and took the entrance examination. That includes both medical exam, physical aptitude test, and academic tests.

Meanwhile, I was going to continue pointing toward either Purdue or Indiana. I went to the rush parties for the fraternities during the appropriate weekends during that year at both universities. Somewhere around April I had a call at the high school. In the middle of an afternoon class someone came to the door and asked for me and said Congressman Harvey was on the phone. So, I left the class and went down to the main offices and took his call. He said he wanted to know my decision as to whether I wanted to go or not because I was now his principal nominee. The other one had fallen out somehow. I told him I'd call him back the next day and give him my decision. So, I went home, thought it over, called him back the next day, and told him I would accept the appointment.

Q: Let's go back just a minute. Do you know why your father suggested the idea of going to West Point. Did he have a military background at all?

A: No, he didn't, and I don't know why.

Q: Were you the only child? Did you have siblings?

A: I had three brothers.

Q: Three brothers—younger?

A: Next one three years away, then two and two. Four boys. All grew up together. We lived just outside town, so it was rural. We had a three-acre place with a big field in the front yard. It was a gathering place for the 18 or 20 kids in the neighborhood for whatever sport was in season.

Q: None of your younger brothers decided to go to West Point too?

A: No. My father was a dentist and later specialized in oral surgery. He wanted one of us to be a dentist; none of us were. Two of us eventually became engineers—me, a military engineer, and my brother Jan, who is a civil engineer and currently working in his own practice up in Newark, New York. He was the third son. So, one and three became engineers, two and four went into medicine. My brother David, the second oldest, is now a teaching and research physician at the University of Oklahoma Medical School and Chief of the Department of Endocrinology. My brother Bill, the youngest, does research and teaches as a professor of pharmacology at the University of Florida.

Q: This is another question out of order. Perhaps I should have asked earlier. The origin of your last name, "Kem." Is it an old English name?

A: Well, we really don't know, but I'll tell you as briefly as I can what we know. My father really did a lot of research into the area. We know what happened within the United States, which was not the origin of the name. But Kems came to the United States, to America, from England early on in Revolutionary times. They settled in Virginia and North Carolina, and then later made the trek to the west and settled in Richmond, Indiana, and went on to Missouri. Senator James Kem from Missouri, who was in office I guess in the late '40s, early '50s, was from the Missouri branch.

My parents were Quaker, and I grew up inside the Society of Friends. Richmond is the home of the Quaker Five-Year Meeting, thus the central home. So, part of the Kem migration west was with the Quakers when they came to Richmond.

How we came to this country from England has been put together, and it seems plausible, but I'm not sure it's certain. In the research that my father had done, it seems that most short names are either shortened from something else, though we have no indication of that, or come from Asia. It's thought that perhaps the Mongols' move north into Russia was part of that. We do know, up in the northwestern parts of Russia, White Russia, that there's a town named Kem. Then Dad suspected a migration across into Finland. There's a river and a town named Kemi in Finland. Then, supposedly followed a migration down into northern Germany. There was, as I found out later when talking to German Army counterparts in Germany, such a migration into the northern parts of Germany in what was called the Dettmarshes. From there, we believe the Kems followed historical migration to England.

We don't know that we were part of each of those migrations. We just know that there was a pattern established and that we've only found the name existing in that one particular region. So, it sounds plausible, but it's not certain. It's not a very common name. You don't find many in this country. As we traveled around the United States, which we did quite a bit after World War II, my father would always look in the phone books in each of the big towns we'd go to, and maybe in Denver we'd find one, and maybe here or there we'd find the name, but seldom did we find many.

There was one other Kem in the United States Army in my earlier years—of course, there's another one now because my son John is in. We came together one night, but I didn't even go to meet him. That sounds pretty bad, but I had just arrived in Vietnam on my second tour and was sent to the replacement depot down in Long Binh. At that point in 1968 you were herded there like cattle when you arrived. I was a major (P) [promotable], and I was supposed to go command a battalion. We arrived late in the evening, about nine o'clock, after a very long, tiring ride from the United States. We were told, "Go find yourself a bunk," and they were three deep all over those buildings. I mean, it was really like a corral. We were told, "Nothing will happen with you tonight. Your records will go into our screen tomorrow morning, so go enjoy the evening. Can't call anybody, can't do anything, can't leave, and we'll call you when we need you in the morning after we start the replacement processing stream."

So, about one o'clock in the morning, after I'd really conked out, I was awakened and told, "Get up. You're going to deploy this morning. Your orders are through."

I said, "I'm not; it can't be me. You know my records aren't going to go to the processing center until the morning, so I'm going to go back to sleep."

"No, you've got to get ready. You've got to catch the airplane in an hour and a half."

I said, "Well, who do I talk to?"

He said, "You can't talk to anybody. You turn in all your bedding."

So, I got up, and I was really groggy. I got all my gear together. There were no lights, and there were all these bunks and people and bags all over the floor. I'd stumble, trip, fall, cuss, and others were doing the same thing. I finally stumbled out, went in, and said, "Okay, what's going on? I mean, it must be a mistake."

They said, "You're on your way to Pleiku." My first thought was, "Oh, no, I've spent one tour at Pleiku already. I'd really like to see some other place in this country than go back to Pleiku." He said, "Nope; your name's Kem, isn't it?"

I said, "Right."

He said, "Well, here it is." Gave me my orders, and it was for Captain—I was a major at the time—it was for Captain Kem, Chemical Corps. So, there was another Kem in the Army. I turned back to the person and said, "You better go find him. He's only got about 30 minutes left."

I had turned my bedding in, and I was also still groggy. I only wanted to go back to sleep. That's why the other Captain Kem and I never met. I did luck out in that. Since they were sending people out, there were some field grade billets available with four or five to a room rather than a hundred.

Q: It's interesting, for the later migration to this country, the Quakers suffered some religious persecution in England, I think, didn't they? I think maybe even later on the East Coast, so that may have helped propel the family over this way.

Well, back to your decision to go to West Point. In the interim, from the time when you first applied until you got this telephone call and had to make your decision, had you learned any more about West Point? Or was everything still up in the air in terms of what decision you would make?

A: Well, it was all very much up in the air. I had learned more about it. I'd read the catalog by this time and seen one of the old Hollywood movies. In fact, I didn't know a great deal about West Point. I knew it was a very good education. So, I was still weighing all of my opportunities. Since I'd only been an alternate to West Point, I thought that was never going to jell as the principal, and I would probably pick between Indiana and Purdue. My inclination had been, because I seemed to be better at math and the sciences, to go to Purdue and be an engineer. Yet, I really liked the Indiana campus and what was going on there. So, I

was still kicking it around, but I would have probably ended up at Purdue had the principal appointment not come through.

Q: Were you in athletics in high school? As far as on a team?

A: No, I never made any of the varsity teams. I was always very interested in athletics, and that was the center of my activities in grade school and junior high school. I was always with all the folks at recess or after school and played baseball or football. Those activities took place in our front yard, so I was very much into it. Basketball was always a big sport with me. Riley never had a football team, just had basketball and baseball, and I always played with those teams.

When I went to high school, I never made the cuts. So, I didn't make the basketball team or the baseball team. I ran cross-country my first year, primarily because I was told that would give me a leg up on basketball because I'd be in better shape.

Q: That's what you really wanted to do?

A: Right. What I really wanted to do was make the basketball team.

Q: That's right. In Indiana basketball is a sport to aspire to, right?

A: We had the hoops everywhere—our backyard, the next-door neighbor's barn. So, just wherever the game was that night, we'd go one-on-one, two-on-two, three-on-three, or whatever the game was.

Q: One of the reasons I ask that question is to lead up to the next one. It's about what some interviewees have described as the shock of the plebe year at West Point. How was it that first year?

A: It was a shock, just as you said. The cultural change was rather significant, and as much as I thought I was aware of things, I was unprepared for how shocking it would be. My uncle had been in the Navy. He called me and gave me counsel that I needed to be ready for the change and be prepared to "keep a stiff upper lip and not get too emotional and to take it," and that sort of thing. It was a shock from day one.

There's an interesting anecdote that a lot of people have enjoyed, so I might as well tell it here. When you go up to West Point, on the very first day, you're lined up until some firstclassman comes to get you and leads you over to the company to which you've been assigned. There they start the in-processing, which includes getting your uniforms issued, getting you to the barber shop for your first haircut, and teaching you how to march a little bit so you can at least march that afternoon down to Trophy Point and take the commissioning oath.

So, to start that process you're with whomever you're lined up with. About eight of us were marched off to Fifth New Cadet Company with our suitcases. I happened to be first in line when we stopped, and he gave us a right face. So, he said, "Drop that bag," and of course we

didn't drop it fast enough, so we all got a little chewing. He started the process of understanding discipline and immediate obeying of orders and that sort of thing. After a little of that, he came and stood in front of me. Well, as my uncle had said, "You want to start off right, and keep a low profile and go along with the game," so I was mentally prepared to do that. He took one look at me with his chin inches in front of mine and said, "So, what's your name?"

And I said, "Sam Kem, Sir."

And he said, "From now on, you are New Cadet Kem, Sir. You understand that?"

"Yes, Sir."

"So, what's your name?"

Well, he had spoken so quickly, it had all slurred together, so I thought he said "Newcadumpsir." So, I said, "My name is Newcadumpsir."

Looking astonished, he said, "What did you say?"

I said, "Newcadumpsir."

He said, "Say that again," looking agitated.

"Newcadumpsir."

And he says, "Now, let's go over that one more time. Your name is New Cadet Kem, Sir. You understand that?" Only he still slurred it together. It sounded the same to me.

So, I came back with, "Newcadumpsir"—because I knew, having been to some of those fraternity things down at Indiana University, that you play these kinds of games. Certainly I knew one of your best principles is to never deviate from your position.

So, the more he tried to correct me, the more I hung fast to Newcadumpsir. Finally, after two or three minutes of this, he—rolling his eyes in frustration—moved two steps to the left to the next new cadet in line, Mario Nicolais. Mario was of Italian background, olive skinned, Mediterranean looking, where I'm very fair. He looked at Mario Nicolais—we were great friends later, having just met moments before—and said, "All right, Mister, what's your name?"

Mario Nicolais was no dummy. He knew that to stay out of trouble, you played along, and he said, "Newcadumpsir." The firstie looked at him, then looked back to me—my very fair skin—looked back at the olive-skinned Mario and said, "You two brothers?"

"No, Sir."

"Then what's your name?"

“Newcadumpsir,” Mario said without flinching. The firstie finally sorted it all out after that.

I have told that story, with encouragement from my wife, Ann, a thousand times, and Mario has told it. We met up at a reunion 10 years ago and he said to his kids, “He’s the one that was part of the Newcadump story.”

Q: Well, you develop some strong friendships in that first year, generally, and I noticed there are a number of engineers in your class. Every class has a number of engineers. Could you talk about some of them?

A: You do develop strong friendships—because of the cultural shock. They work to get rid of the civilian in you and your upbringing and start the remolding process from a common base. Because you endure with others the same kind of pains, deprivations, and challenges, you do start a bonding process that carries on for a lifetime. Now, there are friends and nonfriends, and the people you like and don’t like, like every other place; but because you have gone through a common experience, you start developing those kinds of friendships.

So, yes, plebe year you start that, but it really goes over all four years and continues beyond. I don’t know that my plebe year friendships necessarily have been the most enduring. Surely, some of my classmates, those who have gotten out of the Army over time, we’ve lost contact. Throughout the four years there were other friendships that we developed, other contacts with other people. Jim Ellis, now retired, was in the other regiment across the way. Somehow we met on the steps of the mess hall one time, started talking, and developed a start of a friendship. We have been assigned together many times, gone to civil school at the same time, been in 3d Armored Division together, and later I followed him. I followed him in the 82d Airborne Division; I followed him into Fort Belvoir. I don’t know if we met plebe year or not, but it was early on there that we met.

Another classmate, Jim McNulty—whom I don’t recall meeting as a cadet—went engineers, and I went engineers. We met at Fort Belvoir in the basic course and went on to the Ranger School where we were buddies. That is another place where you have the bond of enduring and going through a tough experience very closely, and so we have been fast friends over the years.

As a group, our class has remained close. We still meet quarterly for lunch at Fort McNair. I went to the last one a week ago. There were 30 classmates there. We must have 80 to 100 in the area. So, those kinds of bonds remain.

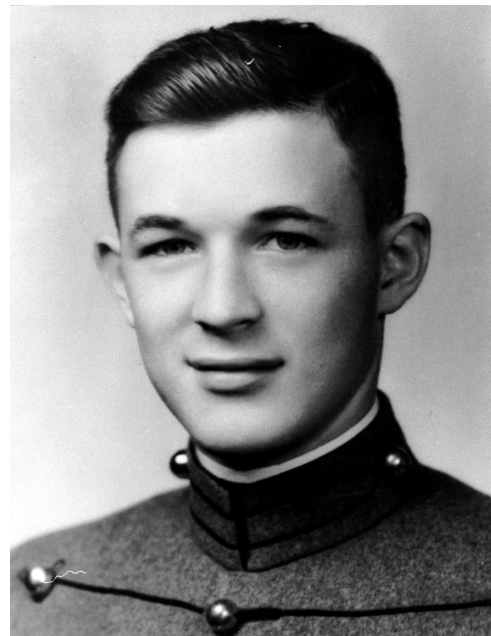

Cadet “Sam” Kem

Q: Well, there were a number of well-known—to me, at least—engineer general officers in your class.

A: Eight.

Q: I was looking down the list. A name that's prominent in the news today, General [Norman] Schwarzkopf, was in your class.

A: When I said eight, I meant eight engineer general officers. We always felt we were a good class. We were brought up well. We started at West Point during the Korean War. We went in on the 1st of July 1952, so Korea ended while we were there. We had tactical officers who had reached some relatively high rank during World War II, like General Mike Davison who had been class of '39—not too far out, let's see, 13, 14 years out of the academy. He was a colonel and had been a brigade commander in the war. Later he went on to get his fourth star and command USAREUR [U.S. Army, Europe]. He was our regimental commander.

Most of the company-level tactical officers and many of the other staff had returned from Korea where they'd spent a year or more. For example, my company, which was Company I-1—we had two regiments in those days, companies A through M, in each of the two regiments—lived in the South Area, which was horseshoe-shaped. Across the quadrangle the Company M-1 tactical officer was Captain Al Haig. Captain George Patton had another company, and Captain Bob Haldane came in to be our tactical officer. All of these folks, who later rose to stars and fame, had been in Korea already, so they were back to take care of us.

That wasn't your question. Your question had to do with, I guess, Norm Schwarzkopf, and I was talking about the class in general. We, as I mentioned, had a very cohesive class, and we maintained that. I don't know what the number is—something like 25, 27 made general officer. Ten of the class were killed in Vietnam; we all served there in our captain, major, and lieutenant colonel years. I served there as a captain and lieutenant colonel. Norm Schwarzkopf now commands our Central Command in our Middle East forces. Classmate John Foss commands TRADOC [Training and Doctrine Command]; we were fellow commandants together when he was at the Infantry School and I was at the Engineer School.

At that time, as it had been true for Jim Ellis, too—I followed Jim Ellis as commandant of the Engineer School—you could go to meetings at TRADOC or CAC [Combined Arms Center] and find many classmates there. There'd be John Foss from the Infantry School; Dave Palmer, now the superintendent of West Point, was at that time the commandant of the Command and General Staff College at Fort Leavenworth; Tom Weinstein had the Intelligence School; Rick Brown had the Armor School. So, we had Engineer, Infantry, Armor, Fort Leavenworth, Military Intelligence, so there are five commandants.

So, we've always had that interaction of classmates. You see people here and there. Even back in Germany, in the 3d Armored Division on a Winter Shield exercise, I was driving down the road near Schweinfurt and there was a Jeep off in the ditch. I pulled over to see if I could help, and it was my good friend Jim Ellis, infantry platoon leader. I helped pull him out, and he went on his way. So, those things happen again and again throughout a career.

Q: General Gar Davidson was the superintendent when you were there?

A: No. Let me see. General Frederick Irving was there when I arrived. General Blackshear Bryan's the one that I remember the most. Gar Davidson probably took over from Bryan the summer following our graduation.

Q: I interviewed him. I didn't go back and check my notes to see exactly the time frame he was there, but it was at some point.

A: General Mike Michaelis was one of the commandants. General Edwin Messinger replaced him.

Q: It's the tactical officers who probably had more influence over cadets, isn't it?

A: They had and have a very close relationship and influence. You're influenced by the instructors too. Certainly one of my reasons for going engineers was because some of the instructors that I thought the most of were engineers. I can't probably pull all the names back, but Captains Rank, McConnell, and Rochefort were some of them. Captain McAdoo was another. Their general demeanor, approach, and professionalism was attractive. I don't recall going up and talking to them so much as just observing them.

My intent when I went there was probably never to make it a career. I was not fixed on a military career as an outcome. I went there still having thoughts about Purdue University and being an engineer, with an inclination towards military engineering. I didn't know much about the other branches.

As I carried through until my final week, I more or less maintained that inclination. In the final week before branch drawing, as often happened—I went back later as a tactical officer, so I observed this in the cadets at that time—in my final week I started having second thoughts. “Am I making the right choice? Maybe I should go infantry or armor” because I liked the leadership aspects and I liked the unit aspects of troop duty. Was I going to get sufficient troop kind of time in the engineers, because I enjoyed that part of what we had done up there? So, I then went to various folks and did a lot of hard talking on infantry and armor. The armor folks in the Office of Military Instruction took me under wing, and I had quite a conversation with them. The night before branch selection I came to grips with myself and decided, “You don't think one way for a lot of months and then, quick knee-jerk, make a change.”

Some years later, I was the acting regimental tactical officer because Bob Haldane—I was lieutenant colonel at that time, and the executive officer/S-3 of the 2d Regiment, my regimental commander, was the same Colonel Bob Haldane who as a captain had been my Company I-1 tactical officer—was off to Harvard for the advanced management course. So, I was the acting regimental commander at the time of branch choice for the class of '70. The cadet regimental commander, who had been going infantry for all these years, on the next to the last night came in to me and said he thought he'd go engineers instead. I went back to my own experiences, told him the story. I said, “You know, you don't have an inclination for a

lot of months and then make a knee-jerk reaction. You're probably wrong. You might be happy both places. Why is it that you think that you've been wrong all this time? Better think about this one." So, he went infantry.

Q: Everyone realizes that that's an important decision. Well, maybe not everyone, but lots of cadets realize they're making an important decision when they make this branch decision and try to give it some careful thought.

A: Well, you always hope so. I know I did. I thought everybody was doing it the same way. When you're acting as the tactical officer, you begin to wonder about some folks. As much as you're working on it because some of the questions you get asked—"Well, would I be more likely to get Fort Carson if I go air defense or armor?"—make you begin to wonder if they're really motivated by the right kinds of things.

So, I say it's probably a mixed bag out there as to what's driving them, what's motivating them. It is a big decision, and although you can change things down the line a couple of years—and a lot of folks do—nevertheless, it's nice if you get it right the first time, which I fortunately did.

Q: Well, I've seen a lot of interviews with officers who went to West Point in the '30s and into the '40s. During that time it was difficult to get into the engineers. You made your choice based on class standing, and those slots went early. I think that was still the case when you were making your decision.

A: Yes. As I recall, I was something like 63 out of our class of about 480. I don't know where engineers went out, somewhere on the order of 120 or 140, I believe. About 34 classmates went engineers.

At that time we still had 25 percent of our class who went into the Air Force. So, of the 480, about 360 went Army and 120 went Air Force.

Q: I guess the big competing choices were Air Force and armor out of the top half of the class?

A: Yes, armor was, but engineers went out first. Air Force because the numbers went down quite a ways. You basically had to want to be Air Force—people made their pick one way or the other, Army or Air Force.

Within the Army, though, armor was a strong choice because there were such strong armor personalities at West Point in the tactical department. General [James F.] Hollingsworth, later a major commander in Vietnam, Korea, all around, was very flamboyant. The stories he would tell of armor and cavalry! When we'd go into our military training, he really ignited the class and really brought out this feeling of mobility and fire power of armor. This was the branch that knew how to do things. I remember two instances still vividly today.

One of them was an evening lecture. There were dialogues going on in our nation then about the future and, of course, we're talking '55, '56, we're talking about McCarthy hearings of the Secretary of the Army, and we're talking the Cold War and the Soviet Union. I still

remember Hollingsworth, who was then a lieutenant colonel, standing in front of us saying he knew what to do about the Soviet Union. What he'd do was just get some tanks, put the class of '56 in those tanks, and roar off toward Russia, and they could probably take care of anything. So, he got a hoorah out of the class because he was that kind of a person.

I remember a couple of years before, we were at Camp Buckner in summer training, sitting in the bleachers. We were receiving artillery instruction from one of the artillery cadre, a captain. The instructor was telling us, "Now, when those tanks come around, we're just going to bring in artillery and ring it in on those tanks." Hollingsworth then just stepped around the side of the bleachers and gave a wary eye at the instructor for preaching this kind of stuff, which obviously was heresy to him. Everybody really took from that that you went with Hollingsworth.

We had some crusty veterans who had fought in World War II and Korea and airborne types, like Colonel Julian Ewell, who still maxed the physical training test. The kinds like Colonel [William J.] McCaffrey, deputy commandant, and later Generals Mike Davison, Hollingsworth, Haig, Haldane, [Thomas M.] Rienzi, and all of those caliber of folks really instilled a lot of things into us.

I'd just say one more thing about our class, that I meant to say before, that consistently through the years we've been a group that has stayed on. From the first window that we could get out—three years was our obligation—and every year up to 20, if you look at the retention rates for classes, we were always above the curve. So, someone did something right in instilling in us that sense of duty, to keep us aboard and serving through all those years; we all enjoyed it so much that we stayed on. With that combination of things, a large number have stayed throughout in the service and been around to continue that kind of cohesiveness and bonding that started us all.

Q: This goes back a little bit earlier, but were you prepared for the academic rigor of West Point? How was it academically?

A: I was prepared, but my transition was difficult. To explain that, Beast Barracks is difficult as you make the changeover. By the end of that seven-, eight-week period of Beast Barracks, you're really getting under control. Then you go back into academics, and it's like starting all over again. There are about five or six plebes for every firstclassman in Beast Barracks, and all of a sudden, when you start the academic year, the rest of the upper class comes back. There are now about three upperclassmen for every plebe. There are plebe duties, and those duties are rigorous and time consuming.

Then there is the new cadet chain of command, some of whom want to exercise that command and that control. The first class is taking you through, and they've gotten used to running plebes around. Now you also have the second class, some of whom are squad leaders and cadet corporals for the first time, exercising their obligations as they see them. Then you have the new yearlings, who just before were plebes and some of whom take it very easy and some of whom are very tough to begin with. So, it's almost overwhelming to the plebe, and meeting the requirements of academics and the fourth-class system together is very difficult.

You now find yourself at a table of ten folks. There used to be eight plebes, two upperclassmen. Now there are three plebes and seven upperclassmen, all of whom ask questions. The plebe has duties that used to be for just the two upperclassmen at the end of the table and now there are only three plebes, so you're the water corporal or you're the coffee corporal or you're the gunner—taking the stuff from the waiter and passing it down. You're responding to upperclass questions, and each time you screw up you pay in some form, either in further recitation of the many thousands of facts you're supposed to know or something else.

The same goes for your squad leader. My squad leader was very demanding, and when you didn't know the President's cabinet, you might get the opportunity to write it out 30 times that evening. Well, then you have a choice: you can study math, you can study French, you can study English, or you can try to keep off your squad leader's bad list by writing the cabinet down 30 times. So, you do the latter.

I was very high in my high school class in math, did very well in English, and was high in relative class standing. So, I would take one look at those subjects and say, "Well, I know that math, I know that English," and hardly touch the book in either of those subjects. I was really having difficulty with French. I mean, I just didn't understand because we started out totally in French at the outset. From the first day, we did not speak English in the classroom. So, the transition was very abrupt for somebody who'd never had French before. Consequently, I was floundering in French, floundering with my squad leader, and just wouldn't touch math and English.

After six weeks, I was deficient in French, deficient in English, and deficient in math. I still wasn't doing too well with my squad leader. It was almost a self-fulfilling prophecy of things. For example, the max grade was 3.0; 2.0 was passing. In three straight lessons on the slide rule I went 1.0, 1.2, and 0.8. That meant that I was three units deficient on a cumulative scale in just those three lessons. That takes a lot to make up when you can only make it up with grades between 2.0 and 3.0.

So, things were not going well, and I was discouraged and even had my parents' permission to resign because of the duress I was getting from the squad leader and all of this. I didn't want to resign. Then several others left. Out of that there was a table reshuffling. My squad leader had also been my table commandant, so I mean I was getting from him twice. He moved off, and I was moved out of that squad to more reasonable leaders who maybe thought Theory Y was as good as Theory X. I then got the kind of breathing space I needed to get things going.

We were re-sectioned in our classes too. At West Point at that time, you were sectioned into classes according to where you stood in the class in that particular subject at that time. So, in math I was sent to the 20th section of 24—that's how far down I was in math. There I met Lieutenant Colonel Jessie Fishback, Corps of Engineers, and he was a patient, fatherly, mentoring kind of person. Later on, his son would be a cadet, assistant S-3 for the second regiment when I was a Tac in the regiment, the exec/S-3. The saying goes, what goes around, comes around.

Lieutenant Colonel Jessie Fishback and his manner and the fact that I was catching up with the fourth-class system and getting along there with my squad leader allowed me the time to now understand I did need to pick up a math book, did need to look at it, needed to do the exercises and do the homework. When taps played at 2015, our lights went out. So, I would go out in the hall where there was a 50-watt bulb at the ceiling. I could sit there and try to squint at the text, and thus be up for another hour and a half and then be tired the next day. I mean, it was a self-unraveling kind of thing. All that began to go away, and I started to get my act together. By the end of the year I had moved up to the 1st section in mathematics.

So, to finally answer your question, the math I had in high school prepared me for math there, but I still had to do the homework and do the work for it. English was a similar situation. French I was never prepared for. I had taken Latin in high school. Everybody had said that was wonderful upbringing, got you ready for anything. It didn't get me ready for French. By the end of the two years, I finished about 100 out of 101 in French. Several of my classmates who'd stood higher than I were found deficient in French and left West Point. The 101st was a roommate of mine, Bob Blocher. The two of us worked together and got ourselves through, primarily by memorizing everything we could possibly memorize and going into the final exam, oral or written, with passages committed to memory. We could pull out parts of our memory if the right question came along and replicate the answer or give a very short oral talk about some aspects.

Q: Did you have to stay at West Point for the first 8 or 10 months, or did you get a chance to go home?

A: At that time we had no time to go home from the day we entered, 1 July, until the following year when we could leave for our summer vacation as a new yearling or thirdclassman. We had then what was called "Plebe Parent Christmas." My folks and brothers came to West Point to spend the Christmas holidays.

Q: So, there's a real break with civilian life in lots of different ways.

A: Oh, yes.

Q: Including a break with your family, at least for that first year. So, the second year and after, then, things are pretty dramatically different, I take it. Once you get through that first year.

A: They remained austere. At that time we still had very few weekends away; we got 2, I think, the second year; 4 the third year; 12 in the senior year. Those have been liberalized considerably today. Academics remained as tough. I mean, I had French the second year, and it was just as bad the second year as the first year.

So, it remained rigorous and austere, but we didn't have to grapple with the fourth-class system. It was a happy day when I stood there for the recognition ceremony during graduation week and all the upperclassmen that had me up against the wall all year came by and shook my hand and introduced themselves with a first name and—



Cadet Kem showed his parents and brothers the “sammy” (syrup) pitcher on the dining table in Washington Hall during his plebe Christmas at West Point in 1952. On the left were his brothers, David, Jan, and Bill. On the right, his parents, Dr. Charles E. and Janice Kem.

- Q: Released you from the bondage of the first year.
- A: Released me from bondage, that’s right, and tried to assure me there was nothing personal that they’d done all year.
- Q: Then, of course, later you’re going to be on the other side?
- A: That’s right.
- Q: Not like your squad leader the first year, I’m sure. That was an unusual—you think that was a really unusual situation? You said there were others that had a real problem with the same squad leader that you did.
- A: He remained an S.O.B. throughout his military career.
- Q: He’s also even nameless, which is fine.
- A: He hounded me even years later.
- Q: Really? So, you keep running into people, negative and positive, in the rest of your career.
- A: Right. Fortunately, most all are positive.

Q: I have one other thought that I don't think applies so much in the '50s. Again, going back to people I've interviewed who graduated in the '30s, they seemed to find Engineer Branch attractive because of the civil works activities, that if there were a long peacetime period, as there was in the '30s, the engineer officers still had interesting work to do. Was that a consideration at all in the '50s or had things changed quite a bit by then?

A: We didn't know much about the civil works. I didn't know much about it. I understood there was a bigger variety of things and opportunities in the Corps of Engineers. In our summer training at Camp Buckner we had three weeks of infantry training, a week of armor training, four days of artillery training, and three days of engineer training. Our class went down to Benning during one of our summers and spent a month at Fort Benning in a part of the basic infantry course.

Even though there were most enjoyable parts of that training, there was some thought that there must be something more than going down to the bottom of the hill and practice training going to the top of the hill, practice the attack and then digging in and defending. So, even with the troops having all the emphasis, as it should be, there was always the feeling there was a greater variety in the Corps of Engineers. Building dams, operating the locks along the Ohio River like I did later, those weren't obvious and weren't apparent to me in that branch decision-making process.

Later on, the Army brought in cadets for summer training to expose them to some of those missions to try to make the point that there is that kind of variety of experience later on in a career. Some of those cadets would go on to be armor officers and artillerymen, some would come to the Corps. I think there's a very big influence on a cadet in what he's exposed to and who he's exposed to, and those exposures can be positive or negative. For example, during my command of the 7th Engineer Brigade in Germany, we would get 20 to 22 cadets a summer. We would try to match those with battalions when they were going through a cycle of doing something. You wouldn't want to put the cadet in the company that was standing down for a month's maintenance, for example. You would like to put him or her in the battalion that's going into Grafenwöhr for its training, construction cycle. The experience they would have would be one of leading engineer troops in doing things of an operational training mission mode, rather than a housekeeping mode.

If a cadet did that in an engineer outfit, he'd be positively motivated. If he did that in an armor outfit, he'd be positively motivated. If he was in a housekeeping engineer mode or in a maintenance mode in an armor outfit, he could be very much turned off. Yet, that's part of the annual cycle, too, so those were realities.

The people were important. Where the people treat them like grown human beings, allow them to do something, where the kind of command atmosphere that's prevalent in that place is positive, the experience is positive. If the other company officers are all married and run off to their wives at night and don't try to assimilate the cadet, he or she may have a bad experience. If there are a couple of bachelors in the company or a married couple that brings the cadet under their wing and take him or her around and do whatever they're doing—in Germany, for instance, where we were—then it's going to be a very positive experience.

Q: Sounds a little like fraternity rush. I suppose there's a positive side to that too. People need to be given positive experiences.

Okay, any other things about the West Point years that we should cover?

A: Well, I should tell you one other anecdote, and that was one of the first "missions" that I undertook. It involved one other classmate that went into engineers later, John Wall. Several of us in Company I-1 decided that just before the Army-Navy football game we ought to have a foray down to the banks of the Severn (Annapolis) and be mischievous—professionally mischievous in keeping with the spirit of competition and all that. We cooked up a mission. Bob Speiser, Dick Sylvester, and I were the ones who did it, and we used John Wall as an intelligence source because he had spent a plebe year at Annapolis before he came to West Point—and spent a second plebe year there.

We wanted to go into the Naval Academy and paint Tecumseh, the Indian statue that sits right in the courtyard of Bancroft Hall where the middies live. We wanted to paint Tecumseh black, gray, and gold—Army's colors. So, we talked to John Wall to figure what's the best way: do you go in by sea by rowboat; go over the wall and infiltrate in? He was our advance eyes and ears and helped us come up with our battle plan.

We drove down one Saturday morning after taking a weekend of leave in late October, stopping off at Sylvester's house in Cherry Hill, New Jersey. His father was assigned at Fort Dix. We picked up the paint and so forth, which had been procured and left there for us. We then set forth and came on down to Annapolis. We arrived early, unfortunately, and went into one of the local diners in town, awaiting lights out and taps, all the things that would close shop at the academy, which I suppose was one o'clock but might have been midnight.

Then the waiter came over because we had gone past the hour, and said, "Psst, you guys are really middies, snuck out, aren't you?" We said, "Oh, no, we're not that." We then left and we were all in our cadet black parkas, but without the numbers and "USMA" showing. We were wearing just jeans, so we were dark. We then drove to a back fence; climbed over the wall; took with us the paint and some stencils and some spray cans of paint and some rock salt; and began our infiltration across academy grounds. We moved in leaps and bounds and very tactically as we moved across the dark areas—all of this not yet in the built-up area.

Then we came to a bridge that was lit; we had to dash across that. There was little traffic. We could see a car here or there. Got across the bridge and went to the parade field. We used the salt to put a big "A" right in front of the reviewing stand, trying to kill the grass so that in the spring there would be a new brilliant "A" sitting there. Never did find out if that worked or not.

Then we moved on in close to Bancroft Hall where we could see Tecumseh and everything else. We met our first obstacle. As in any kind of battle, things aren't always quite the way you expect them. So, it turned out to be both a disadvantage and an advantage—Tecumseh had already been painted in all of its war paint, ready to go. He had not been unveiled; the scaffolding and canvas were still around him. So, then we're sitting there in the shadows, just

away from the lights because Tecumseh can be seen easily with the lights coming out of Bancroft Hall, and it was really lit fairly well. We contemplated for a minute, and then it was apparent, after we checked it out, that we could get up inside the canvas. That was the advantage; we could work without being seen.

We matched out, and I came up with the first draw, which meant I got to paint first. I crawled up inside the canvas, pushed it away, and we then spray-painted Tecumseh black, gold, and gray from top to bottom. Meanwhile, while one painted the other two stood watch plus took the stencils and spray cans and painted “Go Army, Beat Navy” on some of the benches and other things around the area.

We finished painting Tecumseh and then exfiltrated back out the way we came, by leaps and bounds, back up over the wall. Before leaving town we drove back to the restaurant and walked in to speak to the same guy, this time sporting paint splattered all over our parkas, and said, “We just wanted to let you know we are not midshipmen. We’re really cadets from West Point. We just painted the Indian.” Then we took off and made our way out. We then sent a message back to the first captain, to be read at the mess hall at dinner, saying, “Sighted Indian. Sank same. Tecumseh now clad in war paint of Army.” And signed it “I-1 firsties.”

Well, we thought we’d come home heroes. Instead, we had to quietly sneak aboard because Lieutenant General Blackshear Bryan, the superintendent, thought that our actions were really bad. He’d promised the superintendent of the Naval Academy there wouldn’t be any of this messing around that year, and he was looking for those people who had done this dastardly deed. Everybody was quiet, and our names were not revealed.

We’d always known if we’d been caught on the grounds we’d probably have gotten a haircut, been made to clean it up, been exposed to ridicule and such, but little did we know that we would have to sneak back into our own academy grounds and keep it quiet. We had only our great sense of satisfaction from that mission accomplished.

Q: The Army–Navy game seems to be a perennial as a memory of West Point years, a really big event. You graduated, then, in June of ’56.

A: Yes.

Q: What was your next assignment after that?

A: My first assignment, of course, after schooling, was with the 3d Armored Division, 23d Engineers, in Hanau, Germany. To get there, we went to the basic engineer course at Fort Belvoir, reporting in there at the end of August, and then on to Ranger and Airborne Schools.

Of note, the Army was changing uniforms to Army green. We were fitted for pinks and greens when we left the academy. I was in the brown shoe army for a couple of months. Brown shoes went out the 1st of October and black shoes came in. Pinks and greens carried on yet another year. So, I entered the Army in a brown shoe era, and I leave now two months into the black epaulet era.

Q: Since you were at the Engineer School as commandant later, how would you compare the basic course you went through with the basic course of the Army in the late '80s?

A: Well, that's difficult to say. I would think we thought we did a better job later, but I'd have to say I thought they did a pretty good job on me as a new lieutenant. We probably had more practical experience later when I was commandant in the course than when I went through.

There was a thought, which was probably erroneous, back in our day that since we had been at West Point, we'd had all that field duty, we didn't need all that field duty at Fort Belvoir. The ROTC [Reserve Officers Training Corps] cadets did need it, it must have been decided, and so they went to a thing called a "BOMOP," which was an extra couple of weeks to get them caught up. I know in our cadet command these days, the "can-do" in the ROTC summer camps have taken on a whole different mission orientation. I don't know what it was in those days, so whether that was right or wrong I don't know. In any event, we didn't have much of that kind of field duty in the basic course. Later, when I was commandant, we sent everybody in the basic course, regardless of source of commission, out to Camp A. P. Hill to get the same kind of hands-on experience.

I thought in those days that we covered an awful lot of subjects and learned a lot about things. Some things that we didn't have later at Belvoir—couldn't teach them because of available hours—we got then. That now should pick up again with the school relocated to Fort Leonard Wood. I always thought as commandant that there ought to be a tracking at the end of the course, a couple of weeks devoted to the new assignment of the officer. For example, devoted to expectations in a division assignment or Corps combat battalion, or combat heavy battalions, and a topo track.

Our engineer basic course was pointed toward a bit more of the career aspects back in the '50s, whereas when I was commandant, it was oriented to being a platoon leader. In both cases you were going to be a platoon leader. In neither case did we have the armored personnel carriers at Fort Belvoir so that we could practice for someone like me and others who were going to armored or mech divisions. So, everything we did of a practical nature was wheeled. At Fort Leonard Wood the idea would be to teach the lieutenant the kinds of things to expect generally, and in a couple of weeks, if he was going to a mech division, let him go through some heavy division kind of exercises. If he was going to a light division, light division kind of drills. If he or she was going topo, a specific orientation there. If he or she was going to a combat heavy battalion, then put him/her into the "million dollar hole" [construction equipment training] at Leonard Wood and have that experience.

When I was a lieutenant at Belvoir, we had the "mech and tech" department with all the construction equipment where we got to see and operate that equipment. By the time I was back as commandant, the mech and tech department had already moved to Leonard Wood, so we didn't have that. As a lieutenant I drove a grader, I drove a dozer, I operated all these kinds of things, but we couldn't do that for lieutenants when I was commandant. You can now do them again at Fort Leonard Wood.

Nevertheless, I thought that in combination, West Point and the Engineer School and Airborne and Ranger Schools prepared me very well for my first duty assignment.

Q: The basic course was longer then, wasn't it?

A: I believe so. Two and a half months then. It was the 1st of August we arrived. We left about middle of October. Of course, now a lot of cadets go to airborne during their time in ROTC or at West Point. Then, you did not do that. We left Belvoir to go straight to Ranger School. Thought we had two days to make it, but when we reported in on Sunday night we found out we were already two days late. Our infantry brethren were in the basic infantry course, and so we would be running through the Harmony Church area doing our physical training, and we'd find the Tom Griffins and Norm Schwarzkopfs all sitting over there on the ground taking a break from their instruction and taunting us as we did this. Of course, their time was going to come.

Q: Now, did you all go to airborne and ranger?

A: No, you had to volunteer if you wanted to do that, but essentially most folks went airborne. We also had our Army aviation as a choice. You could go to two of the three.

Q: Two of the three.

A: People opted for one or two. There were different combinations, but certainly not so many went ranger. Most, as I mentioned, went airborne.

Q: So, that was the influence of the World War II airborne generals, Maxwell Taylor and a couple of other people of the '50s. I've heard it commented that there was a lot of airborne influence in the Army in the '50s.

A: Well, there always has been.

Q: So, those schools were shorter than the basic course?

A: Yes. Airborne at that time was three weeks long, but then you stayed for a week of jumpmaster. Now you don't get the jumpmaster at Benning; you get it back at Bragg if you go to the 82d. The ranger course at that time was seven weeks long. We didn't have the desert phase as they do now. We had two weeks at Fort Benning, followed by two and a half weeks in the swamps out of Eglin Air Force Base, and two and a half weeks in the mountains out of Dahlonega, Georgia.

Q: So, you went to the airborne course—that would be about the 1st of the year, January?

A: I was in Ranger School from mid-October till mid-December. I spent a week at Benning attached to the airborne department, then home for Christmas leave. I came back and started airborne on the order of 4, 5, 6 January. Airborne lasted through January. I took leave after that. My recollection is reporting to Germany on 2 March.

I should say one more thing about Ranger School. Ranger School was one of the experiences that left its mark on me for what came later. You learn a lot in Ranger School about yourself, about when the going gets tough how you still keep going. No matter how tired, how hungry, you can marshal some extra reserve. There were those days when you hadn't been to sleep for a day and you hadn't had a meal for 18, 19 hours, when you still had to exert yourself. There were the times when you just finished an exhausting two-day problem and you knew you were ready for and were going to get a good meal, a good breakfast, and they said before that, though, you've got to climb a telephone pole, walk across a telephone pole mounted horizontally above a stream. Getting there, you'd notice that there was a flat board on the pole, but then the board stopped and you still had about 6 feet of just rounded log to cross, and this is 25 feet in the air. Crossing that, you then had to climb a slack rope up to a taut line that was coming back toward the start. After having that explained, all of a sudden, the instructor pointed to me and I was the first to go.

Then when I was just about to approach the end of the flat board 25 feet up—and this, remember, is after two days with hardly any sleep, paddling down the river—I thought I had nothing left. As I was about to cross the rounded part of the log they threw artillery simulators into the water and plumes of water shot up with noise. It was distracting and they were hollering at me, and all of a sudden they said to hang from the taut line, then said, “drop” and I went into the water.

When that was accomplished as a group, then we got breakfast. The point was just teaching self-confidence, no matter where you are and what the circumstances. Another strong message was that the mission needs to be accomplished. Focus on the mission; accomplish the mission.

Another lesson, and one that's really stayed with me through the years—and one that we preach in the Army in recent years—is that you can have very good realistic training but you should simulate as little as possible. So, there's a great benefit to realistic training, and in Ranger School they work hard at realistic training. If you want to take a boat and you want to paddle a river, you do it. You don't assume the river doesn't exist or the bridge will come forward. If you have to get across the river, you either have to bridge it or wade it or something. I mean, you've got to do the real thing with what you've got.

So, that stayed with me as I tried to create training throughout the rest of my career. That is, you want to make it tough, you want to make it realistic, and you ought not to let somebody assume the problem away or simulate the problem away because certain things aren't available. Make those things available. Make training realistic.

When I ran platoon tests three years later when I was assistant S-3 of the 23d Engineers, 3d Armored Division, we built the simulators and manufactured explosives even though they didn't exist in training stocks so we could give somebody a device and say, “You must tie these to the bridge and you must pull the lighter and you must go and set off the explosive, and you must do it before you're interdicted by the aggressor. Only then do you pass.” It would have been very easy to say, “Well, you just go out there and explain how you would

do it.” Not realistic; so we had devices there so you had to go do the job and the unit had to be trained to do it.

So, Ranger School taught me that you don’t need to compromise with training. You can make it realistic and then you get full value from it. So, don’t compromise; keep your standards high for training, and then the unit will benefit from that.

23d Engineers, 3d Armored Division

Q: So, you reported as a platoon leader?

A: Yes, I reported to Germany to be a platoon leader in C Company of the 23d Engineer Battalion.

Q: 23d Engineers. Who was your company commander?

A: Tommy G. Smith was my company commander. Started off with a bang.

Q: What was it like being a platoon leader?

A: Well, it’s something you look forward to with some relish. It was a super experience. I have to say once again how Ranger School and West Point, the sense of duty, the sense of mission that you got out of those places, make you ready and confident in what you can do.

The day I arrived in Germany was Rose Monday. It was the last celebrating day of Fasching. Germans go bonkers celebrating the pre-Lenten season. My classmate, Chuck Brinkley, had gone straight to airborne and come over. Another classmate, Ernie Ruffner, was also in the battalion with me. Chuck was a bachelor and already well at home. He said, “Come on out, we’re going to a party tonight. It’s the last night of Fasching.” So, I spent my very first night in Germany out till three o’clock in the morning at a big Fasching party at the Stadthalle, got up the next day to meet the battalion commander for the first time, and luckily he was out with the mumps.

They told me I was assigned to C Company. I went there and the company commander wasn’t there either. He was off. Nor were there any platoon leaders or an executive officer around, just the first sergeant. He was really ill at ease because the division sent down a no-notice first aid inspection team that morning to check out C Company. The company was to turn out 1 officer and 3 to 4 noncommissioned officers and 20 to 25 soldiers to take this first aid test.

I was the only officer available and I had just arrived; should they or should they not include me? So, the first sergeant asked me, “Well, what do you think?” I said, “Well, yeah, let’s go

do it.” So, I took the first aid exam, and I surely didn’t max it, but I did all right—80 percent or 85, something reasonable for a no-notice kind of thing.

That evening my company commander came back. We went to dinner together and that’s how I got to meet him. Two days later I was on the way to the field because the battalion that my platoon supported, the 37th Armored Infantry Battalion, Mechanized Infantry Battalion, out of Friedberg, was in the field on a command post exercise. He wanted me to have that experience right off. So, I headed out, and they gave me the best map-reading noncommissioned officer in the platoon, the assistant platoon sergeant, so I would get there. We struck off by jeep and went down to find the coordinates of the 37th Infantry Battalion command post.

After the assistant platoon sergeant got lost, I took the map and, based on what I’d been taught at Belvoir and at West Point, we found our way there. From a standing start, I remember walking in to meet the battalion commander. He said, “Well you’re just in time. In half an hour we’re getting all the company commanders together and laying out the duties for tomorrow.” I still remember that vividly. We entered his command van and he said, “Okay, men, I want you to meet Lieutenant Kem. He’s my engineer, my task force engineer.” Here were a couple of armor guys and a couple of infantry captains, his company commanders. It was a cross-reinforced task force. They were talking about the next day’s reconnaissance; they were going to set up a defensive position. We were terrain-walking the general defense plan on the terrain.

After laying out his concept of operations, he said, “Okay, now, Lieutenant, I’m concerned about the tank approach; I want to know what you can do for me.” So, the next day I did my recon with the others and, holy cow, they were defending on a table top. I mean, you couldn’t do much more than interdict a road here or there. There were gentle slopes and terrain that tanks could roll across easily. You just couldn’t put in enough mines to close a gap or do something worthwhile.

So, we got back together, and he asked for each company commander’s report, and they all mentioned how they would occupy their position. Then he turned to me and said, “Well, Lieutenant, what are you engineers going to do for me?” I thought, “Boy, how am I going to tell him I can’t do much?” So, I said, “Well, Sir, there’s not very much we can do to give you a very cohesive, strong defense, so we can do a little bit about breaking up the cohesion of the attack here and there.” He said, “Well, that’s just what I thought. I saw that big bunch of terrain out there and I didn’t think you would be able to do very much.”

Wow! He accepted my view. I thought of my inexperience. Here was a place where I’m in my first week, I’m still living out of the place where I threw my suitcases, and I’m out on a two-day exercise and having to produce quickly. Later, when I was commandant at the Engineer School, I used those kinds of instances to emphasize, “You’ve got to be prepared.”

To finish that week, I came back from those two days in the field and my company commander said, “While you were gone, division wants to open up this training area [later to become the Friedberg Training Area and today a major local training area for one of the

brigades of the 3d Armored Division]. We're going to send your platoon to Friedberg for six weeks on temporary duty to build the entrance road into the area."

So, at the end of that week—I've been in the country now seven days, hardly seen my platoon because I've been out at the command post exercise—I'm with the platoon sergeant and we're moving out to go build a road. So, I spent my next six weeks away from home station. Still didn't have a car, still didn't have a final BOQ [bachelor officers quarters] room, and I'm up making arrangements as the engineer company officer in charge in the area of Combat Command C—we were still organized as combat commands at those times—located in Friedberg. Arranging for billet space for my troops, mess hall, maintenance facilities, moving all of our equipment up. Happened quickly. We had to do the design. Nobody had done a design of the road. Nobody had yet found a quarry; they thought there was one around. All of that befell me to put together the entire operation to build that road.

So, the challenges came very quickly for me as a new platoon leader in C Company.

Q: I sense from your description that the 3d Armored put a lot of emphasis on training. Is that the case? Was that generally true of armored divisions?

A: Oh yes. We trained, trained, trained. I spent at least six months of every year that I was there that first three years away from my BOQ. My particular platoon supported two different battalions, the 37th Mech Infantry and the 32d Tank Battalion, also at Friedberg. Each time they took the Army training test, my platoon went out with them. Each time they went to Grafenwöhr or Wildflecken, my platoon went with them. Each time they had a pre-test, which they always did, my platoon went with them. Each time they had a pre-test command post exercise, which they always did, I'd always go and participate. So, having two different battalions to support, I'd go through all those cycles. Then we'd go to the field for our own 23d Engineer Battalion training or bridging exercises. We were fortunate to have Campo Pond right there in Hanau. This was a big, local training area and we did a lot of training there. So, it was a continuum of field training—combined arms, primarily.

It was a very good place for a young officer to learn about the Army, troops, units, and how engineers are part of the combined arms team. I've always felt that Germany provided the best vehicle for that because you could get combined arms training at the field training installations like Grafenwöhr or Wildflecken. Also, they had the bigger exercises such as the REFORGERS and the winter FTXs [field training exercises] where you could put Corps against Corps, division against division, and get the whole unit chain operating.

In addition, the 3d Armored Division was a particularly good place to start for me because in the heavy division, speed of action characterizes what they do. You really have to learn to think at the speed of your weapons systems. We were just, in 1957, 12 years out of World War II. There was still rubble in some of the cities. There was still that armor mentality carryover that we had. You and I talked earlier about Hollingsworth and all preaching at West Point that armor was firepower, mobility, and shock action. In this 3d Armored Division they would just drum that in all the time.

An engaging thing about it was that it was in the mind. It was preached in the 3d Armored Division that we were all armored; there were armored engineers, armored infantrymen, armored tankers—tankers weren't the only ones in the armored force. So, it was a state of mind of how you did things, and that was mobility, quickly developing your shock action, and using your firepower. We were taught how to do things by frag order, and how to move and go. The alert systems of those days turned us out into our local assembly area, ready to move forward. Sometimes we did move forward to general defense plan positions and then had terrain exercises so we would know the terrain on which we would fight.

I remember later we started having the big movement exercises, probably when [Creighton W.] Abrams was there. He put the entire division on the move after one of the alerts. Division would come out with an order that basically would take division units from wherever they were and put them in a long road march. Of course everybody was joining and leaving at different places, so you could get quite an exercise on road movement, hitting the starting point on time. It was drummed into all of us lieutenants that, boy, you made the starting point—not a minute late, not five seconds early, you did it right on time. Then we made our march intervals on the autobahns, before all of today's German traffic was there.

So, the mind-set of mobility and marshaling your force and delivering your firepower was endemic to the whole division. Those were good lessons for me that carried forth into the future when I commanded the 7th Engineer Brigade—how VII Corps operated and how engineers provided support to divisions who operate that way. I had learned the need to stress the engineer mind-set that has to support that kind of hard-hitting mobile action. Those things led eventually into the thinking that went into the force structure analysis that became E-Force. I mean, the lessons from those days in the 23d Engineers were a genesis for what came later.

As a platoon leader supporting my two battalions, my platoon and I would go to Grafenwöhr and would spend the month or six-week rotation at Grafenwöhr with them, living out in the barracks with them and supporting them on the exercises. Grafenwöhr at that time hadn't been turned into the major range complex that it is today, the live-fire range. It was more of a maneuver place. Now you do less unit maneuver and more live-fire training. Typically during a maneuver battalion training test, one part of it was attacking as an objective the Hoefenohe Church area, and that was tactically moving many kilometers over rough terrain to get to Hoefenohe Church. I'd come up with an engineer plan. I'd take my platoon out in our armored personnel carriers, M-59s. I had difficulty keeping up with two M-59s and one truck—only two of my squads had an M-59.

Then there was the problem of the dozer. I mean, why do we have the M9 ACE [armored combat earthmover] today? Because we had the problem of the roadbound dozer. What to do about the platoon's dozer that couldn't keep up? We would have to give it to the assistant platoon sergeant and say, "Here's where I'm going to be en route to Hoefenohe Church, here's the objective, and we'll be following this route. You need to follow generally this route, and at the end of the day we'll be there. You go to that intersection and we'll police you up."

He wouldn't have radio contact because we had no radio for him. So, we would have to go back later and find him. I'd have to tell my jeep driver that too. I'd have to ride an M-59 because we were going across country. The jeep couldn't keep up. So, I would have to go find my jeep at the end of the period. Then we'd have to go find the tractor-trailer and dozer and bring them in to where we were. At the same time, we're busy preparing to go on to a defensive mission or set up for the obstacle work we needed to do.

The M-59 had an engine on the right and left sides. We had one very sick, lemon M-59. It always managed to break down on every exercise. So, we had to shuffle to make things work, but, having been taught mission accomplished is paramount, you have to make do and find the way to still accomplish the mission even though there are all these kinds of obstacles.

Q: So, you learned things for the future about engineer equipment?

A: Organization and combined arms. The emphasis in the armored division was always combined arms. It was obvious then that engineers were an integral necessity in the combined arms team, and we really were maneuver. We worked with maneuver all the time. It was standard procedure when the 32d Tank Battalion marched that there would be seven tanks and then my engineer platoon, then the rest of the battalion. Many a road march I made on the tank trails of Grafenwöhr in the black of night, watching the cat eyes of the tank in front of me with my M-59s behind my jeep, hoping we'd stop in time before we would run up under the tank ahead. Squinting through the dust, in the dark, we would roam those trails at night and we'd turn off and we'd assemble. I mean, we really practiced moving tanks. The standard procedure always was that my platoon would follow the lead platoon plus the extra two command vehicles of the company in the column.

Q: At this time the engineer equipment hadn't kept up? Wasn't quite adequate for the movement required? For the speed?

A: Well, what wasn't adequate were things that have always gone wrong. Even then we needed the M9 ACE because, although the bulldozer could do the job on the objective when we wanted to push dirt, it couldn't go cross-country. So, it could run in a road convoy but it couldn't go across country. Therefore, we had to find a place to put it. We didn't have enough radios so that everybody could have one, which was why we later insisted the M9 ACE have a radio when some people wanted to cut it out.

I mean, the experience that I had there as an engineer platoon leader armed me with the ability to articulate later why we still had to have the radio, because in the M9 tests at Fort Hood, the location of the radio was a problem because of overheating. One easy solution would have been to take the radio out; then we wouldn't have a problem. I insisted we keep the radio and relocate it because of my experiences of years before and since you want to talk to that M9 guy and be able to move him and have him in the communications net.

The fact that our platoon leader was mounted in a quarter-ton jeep rather than a tracked vehicle was a problem that I've already mentioned. The fact that we only had two instead of

three M-59s was an allocation problem. We eventually got the third M-59 so every squad was track mounted.

Then our M-59, though, was not less capable than the infantry because they were in M-59s. Today, engineers are in M-113s while the infantry is in Bradleys, so we have a capability differential on the move that we did not have then. The basic things that the engineers need to move so they can be responsive to maneuver commander's needs were as evident then as they are today.

Q: It's almost a stereotype. You see it in the movies and you read about it—the amount of reliance a new lieutenant has to place on his sergeants and the importance of getting along with the sergeants. Did you have any experience along those lines? Is that true?

A: Yes and no. Once again, this early experience was something that influenced me in addressing how we try to teach our new lieutenants at Belvoir when I later was the Engineer School commandant. Let me jump ahead from my lieutenant days to my commander, 7th Engineer Brigade in Germany days, which is in between the time that I'm having the experiences I have been discussing and the time I'm commandant.

I was rather disappointed in the understanding of our lieutenants at that time as they came into the 7th Engineer Brigade on what they needed to do “to take charge.” As one example, one night I was on a bridge exercise. I found the lieutenant over at the side of the M4T6 bridge construction action. I went over and talked to him and I said, “How's it going?”

“We're going well. The old sergeant's got it really kicking along.”

I said, “Well, what are you doing?”

He answered, “Well, I don't have anything to do.”

I thought, “Oh my, we've come a long way” because, obviously, he did have something to do. I remembered my own days, building bridges and being in the midst of things, trying to make sure it was all going, and anticipating and everything else. So, I felt there, in the mid-'70s, that we had a lot of problems in the Army.

Just bringing up a new lieutenant to understand what Max Thurman later really brought to the fore in his “Rule 14” that, “When you're in charge, take charge” had a meaning. I felt I had that because we were all taught that back at West Point, Ranger School, and the Engineer School when I was a lieutenant. The example I gave of my first command post exercise, the first aid example, and the example of going up to build the road a week after my arrival. I mean, there was no doubt in my mind that I was in charge and I had a responsibility to be in charge.

So, now to your question, what does that do to your platoon sergeant relationship? Well, you need that person to help your transition and understand what it really is to lead troops, especially in those days because we did not, at West Point, have the third lieutenant program

or the program where in one of your summers you spent a month out with an active unit. We didn't have that but for a few cadets, and I never had that experience.

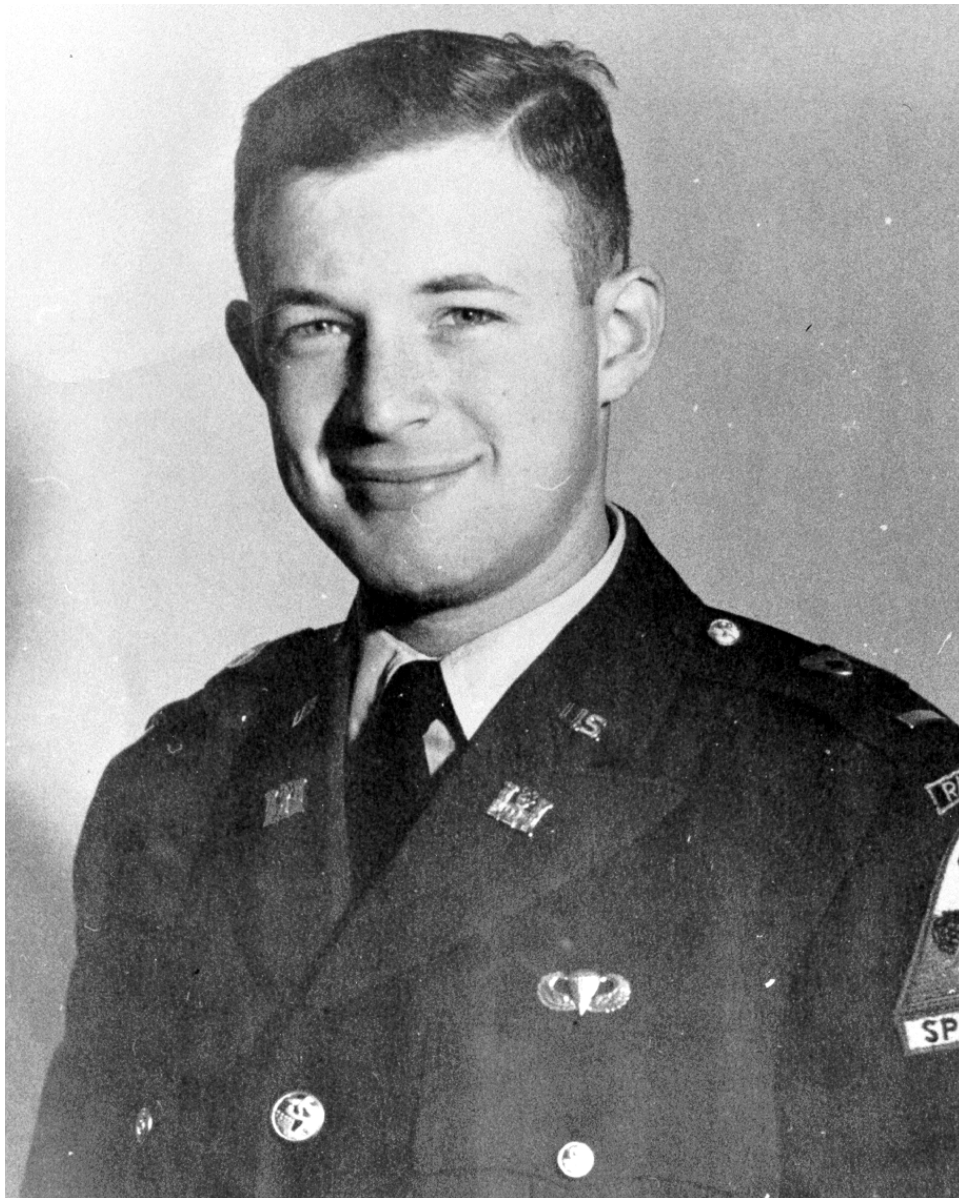

First Lieutenant R. S. "Sam" Kem

You also have the human nature factor, and I had a platoon sergeant that was very strong-willed. He had always been allowed to run a platoon when there were only two platoon leaders, and he'd been running this platoon for a year. He basically didn't want me there. I was hardheaded also, and so our relationship really deteriorated quickly when he vied with me for who was in command, who was leading that platoon.

It came to the point where the company commander had to do something with one of us three or four months down the way. The platoon would go out to build an expedient M4T6 bridge,

for instance, and I'd want to try it one way and he countermanded the instructions and did it the same way they'd always done it. So, he was moved to another position and I was given a new platoon sergeant.

So, I guess my answer to your question is that I learned things from that platoon sergeant. By the same token, it wasn't the all-enduring, supporting relationship that it could have been and should have been. I would attribute that to him. Human nature was a prime factor. He took that position because he had been a platoon leader time and time again.

Q: Who was the battalion commander?

A: Lieutenant Colonel Howard B. Kaufman was the first. He later was the Rock Island District Engineer. I liked him very much.

Q: This was '56 to '59, I believe.

A: March '57 to November '59.

Q: Yes. Is this about the time that the Army was experimenting with or trying to deal with tactical nuclear weapons? General Taylor, I think, during this period introduced the concept of the pentomic division? How did that affect you?

A: Thank goodness I was spared that because I was in an armored division. The other divisions in Germany were organized pentomic with five battle groups. We were in the old armored division concept with three combat commands. Unlike World War II, where there was a Combat Command Reserve, which was mainly a headquarters that would take elements of the six maneuver battalions and put them together when committed and they'd plan the counterattacks. Now the Third Combat Command was Command C to go along with Commands A and B, and it had maneuver units assigned.

So, I really didn't participate in the pentomic concept. Of course, when we went into the Reorganization Objective Army Division concept later, it was modeled after the armored division. Later, under the reorganization, the mech infantry divisions formed much like the armored divisions with a different mix of tank and mech infantry battalions. They trained the same, fought the same, and had the brigade-to-battalion task force relationship about the same. So, I think I was fortunate in starting off with what was going to be an enduring thing. Again, when I came back as the VII Corps engineer and 7th Engineer Brigade commander later on, we were in a Corps and supporting divisions that were similar to the ones I had been in as a lieutenant.

Q: Did your training place a lot of emphasis on tactical nuclear weapons and dealing with that possibility?

A: We had some. We'd draw curves for fallout, do certain things, but there was not a great emphasis on it. Most of it was because, even then, the feeling in the armored division was, "We'll survive because we can move, and we'll always keep moving."

Now, this is not the tactical nuclear weapon, of course, but we had the atomic demolition munition [ADM] in the 3d Armored Division at that time, and so I did get involved with that and trained in ADM while I was in Germany in that first assignment.

Q: That's a weapon whose fortunes have waxed and waned.

A: Well, I mean, it really wasn't a weapon. It was a demolition munition. To put it in the context of what it could do to destroy something, it had a real purpose. I was very involved in that later in the 7th Engineer Brigade because of the different way it had moved over time, which I can comment on right now—probably the best time to do it.

The standards for the ADM or other nuclear weapons are always very high, and the rules and regulations almost go to the ridiculous when you're training with it, some of them for good reason—safety. Some of them for another good reason—release authority and the need to use it in the right places. Some for good reason like you want to make sure it goes off at the right time and the right place to give you the right obstacle. Other procedures, like make sure you've wiped it 13 seconds after something else happened with the right kind of tissue and all of these kinds of things, were almost laboratory in approach.

So, back when I was trained in this, we were actually handling and inserting the ball. And, as a consequence, we did certain things with a lot of safety in mind. To go through the step-by-step procedure, with tissues and all, I mean, we would fail the training test if anything was amiss—awfully rigorous for the field, for training for combat.

I thought that ridiculous nature was brought to extremes when I was an umpire on an Army training test with another engineer battalion. We were in the field environment at Wildflecken, and they were responsible for putting an ADM in to blow a pass to create an obstacle. As I got out there to evaluate them, the lieutenant came up and wanted to make sure that I approved his substitution list, that they didn't have real Kleenex to wipe the ball with and they were just going to simulate that with something else. I was thinking, "How does that affect mission accomplishment?" I said, "Look, once you get that thing slapped home, if you back off the right distance and you set the right number of things in your timer and it goes click, you pass. If it doesn't go click, you don't pass. I don't care what kind of tissue you have." I mean, that's for the IG [Inspector General] teams. So, higher-ups could descend upon you for that, but here we're talking tactical.

Now, what's that a reflection of? I reflect back to my Ranger School experience, still worried about too much simulation, train realistic, have the right standard, and it's pass or fail depending on whether your operation accomplished the mission. There was that kind of IG environment prevalent then. So, because of that, everything done with ADMs was very rigorously looked upon by the whole battalion staff.

Consequently, we had one company in the battalion that was working the ADM mission, and invariably you had to give the best platoon leader to that company. When it came time for inspection everybody sent a truck over there so they had the best trucks. They didn't leak because you couldn't have anybody leaking any axle grease. So, because of the rigorous

nature of the tests, almost like rotations to the National Training Center today, everything stopped to make sure that the ADM platoon made it unscathed through this rigorous inspection.



First Lieutenant Kem (right) watched a motor pool vehicle inspection in West Germany in November 1958.

So, that's the way it was in every engineer battalion in Europe. Then one day someone had the bright idea, "If we could put all this back in one location, we'd probably provide better support. Oh, by the way, get all these battalion commanders off the hook." So, they made an ADM company in each engineer brigade. Thus, when I arrived to command the 7th Engineer Brigade later, I had the 275th ADM Company. I don't remember the numbers, but we had something like six platoons, 300 people, and I don't know how many ADM teams. Lots.

Inspections were an every-week occurrence. I think we counted up that we had an inspection of one kind 48 of the 52 weeks a year, somewhere, involving one of the ADM platoons and some infantry task force that had to provide the security. So, whereas we used to have an

engineer battalion commander's whole staff and the maintenance capability being able to help get that ADM platoon ready to go, now I had one company and one overworked maintenance warrant who had to get some platoon ready to go every week. Thus, we carried a high vulnerability for failure, which before had been spread to all battalions, but they also could provide a lot of resources to help.

We had a major commanding that ADM company. When this poor guy left I got a new one in there, and all of a sudden we started failing inspections. It all came home when I saw my own tail on the line, frankly. I tried to get into and understand the systemic problems. It became obvious that what I had had in the previous company commander was somebody whose strengths carried the day and who did all those things that all those other battalion commanders already had done to pass—switching trucks from one platoon to another, repainting the bumper numbers, taking all the best trucks, but after a while they too wear out. We were really living on the margin of risk of accomplishing the mission because we were so thin. We were short people so he would have to move people from one platoon to another. We weren't ready for wartime but we were accomplishing a lot of different tasks.

So, in the middle of 1977 I went to General Dave Ott, the 7th Corps commander, who had recently called down and said, "What's going on?" I briefed him and proposed major changes of how we in the Corps would employ ADM. This became the new *modus operandi*.

Basically, we needed to cut out some of the ADM teams. In the 7th Brigade at that time we had gone to the point that, no matter how many people we were short, we'd still field every required team. Yet, a soldier had to have certain clearances before he could handle the release material, and you couldn't get those clearances unless you'd been in the Army so long. So, as the personnel system delivered us fewer people and more junior people who hadn't been there long enough, we were down to the margin where there was only the absolute minimum number. Thus, the threshold for failure was really reduced, and nobody wants to fail. I didn't want them to fail—that's not good for their morale. I mean, we all wanted to succeed.

So, we changed the philosophy. If the system could not provide us the resources, we would stand down teams, but we would field teams that met minimum base requirements. I mean, if we were authorized a five-man team we'd never go with less than four, even though we've been previously going with three. We actually stood down the teams, and the Corps put it into their operational plans that we only had so many operational teams at that moment. Thus, the pressure was on the system to improve, much like readiness reporting is supposed to do for other units.

We also got priority from the Corps to get 30 new trucks because our trucks were worn out. Thus, we didn't have to take the old wire-and-shoestring vehicles back again and again, but had some vehicles that might pass inspection.

Then, significantly, we changed the whole concept of operations from taking the ADM forward all the way to delivering it on call, much like artillery. Thus, once someone wanted to employ a demolition munition, they, the infantry, wouldn't have to go all the way back to the depot, vicinity of Kaiserslautern, to pick it up. It seemed absurd that you would fly an

infantry outfit all the way back there from the forward area. That's what really rankled the infantry types, and I thought so too. So, I sold the concept that ADMs would be delivered to the brigade's rear boundary by Corps assets. We engineers would do the pickup; someone else would provide the essential security. Aviation would fly it. We would no longer drive it. I mean, it was absurd to think we were really going to put a vehicle on the road to go all those miles back to Kaiserslautern and then back to the front and make it in any kind of responsive time.

So, we modernized the whole concept of operations. If it's a Corps' mission and if the Corps has a priority for the use of it, the Corps must provide the resources to get it there. Aviation or Corps engineer assets would deliver it to the brigade's rear boundary, where then the employing maneuver commander with his engineers would pick it up, take it forward, and do all the necessary things as before.

When you put ADM operations on that basis, you needed fewer of them. They were more flexible because you didn't have to have ADMs out in many places. Now they would be provided forward. We had fewer people involved. The number of training inspections each year was reduced. You didn't have so many infantrymen and infantry battalions that had to be involved. We reduced our inspection requirements from 48 of the 52 weeks a year down to something like 22 of the 52 weeks a year. That was still a sizable number compared to previously when the battalion commander had it once or twice a year, but at least down to something that made a lot more sense.

We really reconstructed the entire ADM approach, I think, rewriting doctrine in a rather reasonable, logical way. That became the way until General [Bernard W.] Rogers, then the Supreme Allied Commander, Europe, got rid of all ADMs in the theater in the mid-'80s, primarily because of, I believe, concern for their availability to terrorists. We now had gone from what was, in my earlier day, a huge contraption down to a rather nice-sized backpack-sized munition.

Q: Storage security wasn't such a big concern in the '50s, but by the '70s, the security of the weapon had become a matter of substantial concern to us.

Wasn't there always the problem of the release authority too? You referred to that. It was a nuclear weapon so it did require rather complicated procedures.

A: Yes, it was always complicated. The problem there, that we also sorted out, was that engineers had to have ADM release handed down to platoon and team level, whereas in the artillery that was at battalion and battery level. So, we engineers had to be training sergeants, Spec-4s, in an arena where artillery could be training captains and majors. That was one of those things that heightened the risk of failure.

The change we made was to ask, "Why do we have to do release there at team level." The people in charge, the employing maneuver unit, ought to have that sort of responsibility. So, we sorted out release authorities and when and where it was to happen. We didn't change the basic release items. We changed who had to handle them.

Q: Let's turn a minute to talk about what it was like to be stationed in Germany during this time.

A: From '57 to '59.

Q: You were at Hanau.

A: Yes.

Q: What were the facilities like in the late '50s? For the BOQs?

A: The 23d Engineer Battalion was in Hessen Homburg Kaserne. Just two years ago [1988], we started fixing up Hessen Homburg for the first time since then. It was an old German kaserne. It still had the rifle racks in the hall in an alcove. It was adequate for our need then, barely. We had a motor pool that was down at the far end of Hutier Kaserne. You had to climb over a bridge over a street between Hessen Homburg and Hutier, and then walk to the motor pool for the tracked vehicles at the far end of Hutier.

We had a cinder courtyard in the middle of all our kasernes where we could have company formations. Typically physical training in the morning was out there, and we could fall out formations for morning work call and that sort of thing. The battalion commander ran the kaserne, where we had our own company messes and luckily our own theater where we could get large numbers of people together.

Years later they put a headquarters and a medical battalion in that same kaserne. They parked tracked vehicles on the middle quadrangle, which really made it awfully tight. I would have thought it would be very difficult to have lived under those conditions.

As a lieutenant living in Germany at that time, my BOQ was near Campo Pond. I had a single room, shared a bath. I ate all of my meals at the officers mess located in old Argonner Kaserne just two blocks from the BOQ. The facilities that are Hanau's today, basic kasernes, were there then. The family housing areas were nearby, so when you were invited to another lieutenant's home in the evening for dinner, as you were from time to time, they were usually within walking distance.

A bachelor's life was spent, when not in the field, out looking for girls, like any other place. You met them in the American community or at the movie, or you could go out and meet German girls. We had one lieutenant in the battalion who was engaged to a German girl, so dates could be arranged through her and her friends for others. There were also the special service girls who operated the rec centers, and the teachers in the Hanau schools lived in a women's quarters nearby. Thus, much of the social interaction was around that.

Garmisch existed as a recreation center, so you could go there to ski in the winter. Then you could book your own travel, either tours or on your own, driving to various places. That was the era of not many German cars on the road and the era of 4.2 marks to the dollar. You know, you could go down the street and get a rump steak for \$1.50 or \$2.00. A lot of the German cars on the road were the little Messerschmidt three-wheelers, more like the cockpit

of an airplane, or another one that was a little more buglike. As I mentioned, there were still city blocks in Hanau that had rubble in them.

The populace was very friendly. There was not the kind of mix between the populace and the military as there was later when I was a brigade commander, as I think about it. Then, I really don't know how much interaction there was between my battalion commander—the higher-ranking folks at that time—and the Germans. I do remember one very interesting experience I had when I was selected as the junior officer to accompany the battalion commander to Koblenz to meet with a newly forming engineer battalion of the new Bundeswehr. Germany had just reformed the Bundeswehr that same year. We had a very nice evening out, drank a lot of beer, and ate a lot of good soup—interacting with a bunch of very fine German officers who were just forming this new battalion.

Q: Yes, this isn't that long after the war. Germany's still recovering during this period.

A: That's right, it was still a recovery period. I did a lot of personal travel around because I was interested in the area. We could drive to the Taunus Mountains nearby and we could drive down to Würzburg and see the very nice bridges and castles down there. Later we could drive up to—I think it's the Hartz Mountains—and take my new Porsche and run it around the Nurburgring. You could make a 14-kilometer spin around the Nurburgring for two marks. You might be doing that and a Formula-one car would come up behind you, or maybe you would pass a tour bus. Pay your money, and you get a chance to go around Nurburgring.

Q: I wanted to turn back to your experience in the unit as a platoon leader, but I think you referred to the fact that then you went on to be part of the company commander's staff?

A: I was a platoon leader for a year and a half, and one of the interesting things at that time was that the 3d Armored Division was a gyroscope division. It had come to Germany in the summer of '56, and I joined in March of '57. There were only a few of us that came in as individual replacements. After two years I was still one of the five most junior officers in the battalion because it had gyroscoped over with a full complement of officers. Hardly anybody left and it stayed with almost the same group of people for two and a half years. They then left together in the summer of '59. So, opportunities didn't open up very well.

It was so much so that the battalion commander was even thinking of having some people who had been pulled up to be company executive officers go back to be platoon leaders to give other platoon leaders the opportunity to be company executive officers.

I was fortunate that I was picked to be a company executive officer, and I moved to E Company, the bridge company, after about a year and a half in the platoon. I was ready to move. I then spent about nine months as E Company's executive officer.

Of interest at that time in E Company, we did the field tests on a new equipment item called the armored vehicle launched bridge [AVLB]. This had just arrived—the first time the scissor bridge had been in a field unit. We did the field tests on the AVLB, which identified

massive hydraulic leaks that we experienced. It then had to go back and be fixed before it came back.

We also had the great experience of being the first to have an AVLB slide sideways in a small German town on slick cobblestones and wipe out half a building, and the other experiences that happen when you get something new for the first time. My classmate at West Point, Ernie Ruffner, was the bridge platoon leader who conducted those tests.

After having spent that time as bridge company exec, I moved to be the assistant S-3 on the battalion staff, and I finished my tour there. My tour was actually curtailed from a three-year tour ending in March 1960 to November 1959 because it had been decided that bachelors ought to only have a two-year tour; married officers would continue to have a three-year tour. Those of us who were already there had their tours curtailed according to a schedule, so I left in November.

Q: Did your experiences with the bridge company or at battalion have the same impact on you that your platoon leader assignment had? Were there any particular lessons you learned?

A: Sure, every tour you have in the Army builds on another. We have an Army that's already prepared for a mission that we hope never comes, but in getting prepared at any one particular day, you have new people in the job who are learning that job as others move off and up. So, you're always into a job—as you got to know the job, then you'd go to one of greater responsibilities, and so you're always continuing to grow and develop.

I guess the bridge company position gave me a chance to look across the whole battalion. I was pretty accomplished, I thought, by that time in combined arms and in training because I'd been involved with infantry and armor so very much in all their exercises. Now, because of the armored division and the Corps as they thought about their mobility requirements, the training mission was getting across rivers, like the Main River and the Rhine. We practiced a lot of combined arms bridging, much more than was done later when I was in 7th Engineer Brigade or even today. Our major exercises would have bridge crossings. I remember several times being at bridge crossings where the Seventh Army commander and the USAREUR commander would be there watching it.

So, the bridge company was an opportunity to once again learn a lot. The thing I really learned was the value of an exceptional first sergeant. Just working in the company command post with him, watching his ability to handle people and how he organized the company of his day, were good experiences for me. When I'd been in C Company, there was no platoon leader's room. There was no desk; I mean, you had no place to go. You were out leading your platoon. So, the company orderly room was a little godlike place that even platoon leaders didn't go into. The company commander worked out of there and the company exec, and it was the domain of the first sergeant.

So, as a platoon leader—I'm backing up a little bit—when you did your lesson plans and met with your noncommissioned officers you found your own place to do them. When I became a company exec, then, it broadened the perspective of how things operate. We had a relatively

easy going company commander, but a very strong first sergeant. It was a period where I learned about how multiple things bigger than a platoon go together and fit, and how you support multiple different operations. Good experience.

I moved up to be the assistant S-3. It was really a battalion to maximize learning, for a couple of different reasons. I knew a lot about maintenance. That was another thing the 3d Armored Division and 23d Engineers did a lot of. I mean, motor pools and maintenance were ingrained. You took care of your stuff—I knew that from being a platoon leader and the company exec in a bridge company where we had all those trucks and the M4T6 bridge and the new AVLB platoon and all of that.

Colonel Howard B. Coffman was my first battalion commander; Colonel John Frasrand was the second. Then Colonel Nick Carter came in and took command in the early summer of '59. Anyway, I became the S-3, as I recall, about March of 1959. This was now the time, if you recall my talking about the gyro rotation, that this group of people were leaving. For the first time we were getting a turnover of people—new people, new company commanders, and in all the staff activities.

I ought to make a comment about the company commanders we had back in '59. During my first couple of years in the battalion, our company commanders were old—that's a relative term—grizzled veterans. I think John Pick, when he was my company commander, was on about his fifth company. T.G. Smith was my first company commander. He was followed by Larry Smith. T.G. was short, Larry was tall. T.G. was initially the company commander, Larry Smith was the S-1, and Larry Smith came down and took the company, and T.G. went up to be the assistant 3, replacing Jack Campbell, who became the executive officer of D Company. All were good officers and taught me a lot.

Here was this group of folks who had been over there together, knew each other well, and all interacted with each other, all competed with each other, and a lot of them had Korea experience and multiple companies. Now in 1959 we were making this turnover, and the Smiths went home and the senior lieutenants went home, and now all of a sudden there was an opportunity to move up. Major Jim Foster had come in to be the S-3, and he was my S-3 boss to start off with. Then he left and Major Vern Pinky came in to be the S-3. There was all this change that summer, and that was during the rotation time I was the assistant S-3. The leadership of the division changed, too, and General Frederick Brown came in to be the division commander and Brigadier General Abrams came in to be the assistant division commander.

With Nick Carter, we had a can-do operator. He had an outward flair, very oriented to operations. Lieutenant Colonel Frasrand had been more methodical and middle ground. So, there was a new spirit in the battalion, I think, because we'd been alike so long, and in the people's last few months of all being together, we hadn't had much change. Carter ignited a whole new thinking of things. Pinky came in to be the S-3 and it was all new. So, it was kind of exciting for me as an assistant S-3, and I was a bridge between the two. Having been the assistant S-3 three months under Foster, the old S-3, and Frasrand, the battalion commander,

and now with the arrival of the new group I was part of the transition, and I could really watch that and enjoy it.

We had our engineer battalion Army training test that fall in October. It was very exciting as we prepared for that, going up with a whole bunch of new people to take the pre-test at Wildflecken, and having gone through many of those in years past with the same old group, good as they were. This was exciting because we did things differently with a new flare and with a more aggressive operational mode. They were good tests, and so very enjoyable.

Carter's idea was that the engineer battalion companies and platoons had to be able to move like armor because we were an armored division. We had to be able to move off the road into a quick holding area and then move back on the road and move. So, we were practicing those kinds of operations.

We took our Army training test as an engineer battalion. Even though we would normally support infantry and armor—that's how we were going to fight—in those days for some reason we would take a training test as an integrated battalion. We would have missions in which a company would go out to support somebody but that somebody wasn't there. So, that part of it was a little bit off-line, but then we practiced other things we couldn't do otherwise. So, we had a lot of big moves and heavy moves.

Now, as I mentioned, I was in the S-3 section. We put on platoon tests that spring for every platoon in the battalion, and we got to design the tests out of the S-3 section. I could design it based upon what I had learned being out on command post exercises with the kind of experiences I had when I had to be "in charge," the kind of things that came out of my going out with the 32d Tank and 37th Mech Infantry in combined-arms training, and the things I learned in Ranger School—that you shouldn't simulate anything if you can make it realistic.

So, we put together some rather realistic tests in which I operated as the maneuver task force S-3. We set up a maneuver task force tactical operations center in the field that I operated from to include a night shift. We would bring the platoon leaders into the operations center to see me, the infantry task force S-3, and we would give them "eyeball-to-eyeball" the missions in a playacting mode much as I had received missions as a platoon leader in years past. We had an S-4 and the materials and the supplies needed, trying to replicate real-life things as they did their various missions. We tried to never put them in the same place a second time, and they never had to stop after having tactically put in a bridge and administratively take out that bridge. They never went admin during the five days. We kept them always in a training mode, all of which were outgrowths of my Ranger School experience.

The kinds of things that the 3d Division was doing at that time, I thought, really prompted our thinking and made for rather good training. For example, in our last day of the Army training test at Wildflecken, after we'd been doing all of these kinds of various operating support activities and engineer missions, we were given a mission in the middle of one defensive scenario to move, say 55 kilometers back to the Main River in the vicinity of Hanau. This was a tactical march, moving the whole battalion. When we got there, we were

to conduct a river crossing across the Main River, building bridges in support of the division (simulated) who was making this crossing.

We pulled our various companies back out of the missions they were doing. Once they'd finish a mission, we'd put them on the road, and so it was all staggered. It was not a nice clean move, like moving out of bivouac. I mean, they were all out doing operational missions. We wrote that order, got the battalion on the move, and we were to meet our bridge company and other bridge elements from V Corps at the crossing location.

It was complicated—both sending and meeting—as well as thinking and operating on the move. Running down the road in our armored personnel carrier from Wildflecken, we got the word by message that so much of our bridges had been destroyed that we must be prepared to link an M4T6 bridge with a Class 60 bridge. We had never done that before—never had practiced it. Now, here we were already on the road, halfway to the place we're going to do it, we're meeting the folks who had the Class 60, and we now had the rather interesting task of determining how to put them together.

Gerry Galloway, later a brigadier general and the dean at West Point, was B Company commander at that time. With the M4T6 bridge at that time, the E Company provided the bridge to a line company who did the building. Basically, Gerry was on the ground with B Company, and we figured out a way of putting it together. Then we were there on the river bank all morning, conjecturing about whether it was going to work and how we were going to make it work. Essentially the proceeding was what was in the field manuals, at least later. I certainly had never read it before that day.

B Company took what M4T6 was not destroyed, built it from the near shore, balk after balk after balk. Then the Class 60 was assembled at another site on the near shore and you moved across to the far shore. The joining section was constructed at another site on the near shore, with M4T6 balk at one end, Class 60 on the other end, and B Company lashed them together with cables because they didn't join naturally. Then an AVLB was overlaid over that joint and lashed in. Then that completed link raft was moved into place, married it up with the Class 60, and then closed with the M4T6 to make the complete bridge.

So, this was certainly an interesting technical problem, but also an interesting management problem since we received the mission while on the move and had to figure it out on the move. I mean, people's thinking power was put to the test. Folks went to work to accomplish parts of the mission. Other folks were trying to figure out how we'd make the marriage work. I use that as an example of the kinds of challenges and opportunities that were thrown down to ensure we were thinking, capable, and able to move and accomplish our mission in armored style.

Q: That's interesting. You mentioned earlier training, preparing for what you hoped would never come. In Europe at this time and in the '57-'60 time frame—you arrived in March of '57, not too long after the Hungarian revolution and repression. What was that situation like? The tensions that were experienced in terms of what might happen.

A: There was nothing in my recall concerning the Hungarian affair. I guess that it was all over by my arrival.

Q: That's okay.

A: We were all very cognizant of the fact that we might have to fight, and the Soviet military mission was always around. We would see them continuously going around checking our training. So, we were very attuned that we were at the forward edge of freedom, and operations security and preparations were paramount. We practiced the general defense plan all the time. We had target folders for all of our targets; we did terrain walks with our supported maneuver units, as I mentioned before, on the actual terrain. The exercises were all oriented toward the same kind of mobility and combined-arms action. So, the threat was something that we all anticipated. We were proud the 3d Armored Division was astride the Fulda Gap, and that was drummed into us all the time, and we knew we'd be ready.

Another thing that happened during one particular period of tension, there was an alert for the division to be prepared to move up and move along the Helmsted Corridor to Berlin, a forced entry. The Russians had threatened to close all access to Berlin. Bridging was required, and I was detailed as the commander of the bridge unit. I was the executive officer of the bridge company at that time, and I was going to go as the commander of this bridge element, which had more than a platoon. We never moved north, but we were within what we thought might be hours of a mission to move with one of the battalion's line companies to go along with a division maneuver element in a show of force to Berlin. So, we were all very cognizant of our mission at the "frontier of freedom"—always.

Q: Did you have the feeling when you were there in the late '50s that there was more a sense that war might be imminent than there was when you were back in the '70s? Was the Army in Germany more finely honed, more on edge in terms of the possibility of war than when you went back later?

A: No, I don't think so. I think that kind of mission cognizance was present throughout the Army's whole time in Europe. One of the great things about that is—as a leader you can point to the Soviet threat as a real *raison d'être* for our being there, for our training.

Because USAREUR got the dollars, you could go out and train, and train the mission and use the general defense plan for the mission training. It gave training a real credibility and reality that my battalion's Army training test at another time at Fort Leonard Wood never had. When I was in the 82d Airborne Division later, the 307 Engineers, Vietnam was current and provided that same emphasis. We went out to Camp McCall and took an exercise where we were training the counterinsurgency Vietnam mode kind of thing. There was a *raison d'être* too. Certainly whenever you're in Germany that realistic threat and mission has always been a paramount thing to drive your training.

Now, I think there were some years in Germany—at the end of the Vietnam period and before I arrived in '76, the downtime in Germany—in which there were a lot of problems, a lot of leadership and discipline problems. With this low ebb of the Army in the early '70s,

there were a lot of things on our leaders' minds that drove them to think about other things too. They probably had difficulty getting the message across. I don't think the mission emphasis was ever gone, but they may have had such other problems—discipline, riots, racial tension, not the least a lack of training funds—that there were other things on the platter.

One of the things, while I was there in the later '70s, that helped us get out of that situation was, first of all, the new rules on drugs were in effect where you didn't have to tolerate drugs; you could throw a person out right away. Then there was the great sense of bonding with the community that General [George S.] Blanchard, CINCUSAREUR [Commander in Chief, U.S. Army, Europe] really got into when he was in Europe, that "We are citizens of the German community, interactive German neighbors." So, the whole thing of the Army really coming to grips with our multiracial dimension and working so that blacks and whites understood and appreciated each other and the defusing of the tensions that had been going on went on further while I was there.

That then allowed a new commander like Lieutenant General Dave Ott, who came in as VII Corps commander, to focus on, "Let's get back to training." This accelerated as our whole general defense plan changed then because we moved to the "forward defense concept." We were moving forward and changing all general defense plans, which prompted a change in the thinking of everybody. So, leadership turned to rethinking and pushed other leadership levels into action. Now we all had to go out and reestablish and walk the new terrain—new positions, new avenues, new obstacles, and we had to redo new target folders.

Continuing my leap-ahead at that point when I was in the VII Corps, 7th Brigade, I changed whole support relationships just to charge new thinking by commanders and staffs. Our 9th Engineer Battalion had always supported the 3d Infantry Division (Mech). I really thought they were stale. We were doing things the same old ways we had done them for years. We had something new in the Corps—the 12th Panzer Division, a German unit, would be the Corps to fight in our sector. I hooked up the 9th Engineer Battalion to support the 12th Panzers and let the 237th Engineer Battalion take over the support role of the 3d Infantry Division—not popular with my 9th Engineer Battalion commander, who liked his relationship with the 3d.

One of the major reasons I did that was because I thought things were stale. I wanted new thinking. So, when the new battalion commander, Ted Vander Els, arrived, he had a new challenge to support a Panzer division, which he never had before. That really stirred the juices of the 9th.

The 237th now had a division to support, the 3d. We broke all the old relationships and had to establish new ones. This stirred all the creative juices of both the commander of the 10th Engineer Battalion in the 3d Mech Division and the commander of the 237th because they had to work out new things. I thought it was all for the good. I took the 78th Engineer Battalion and had them start working with the 1st Armored Division, whereas before, just the 82d Engineer Battalion supported them and the 2d Armored Cavalry Regiment. Again, I had stirred the creativity of the leadership thinking in the 78th. So, I really was able to use that for good motivational and training cause. As we moved to forward defense, everything was

being rethought. Missions changed, as did relationships, and we had everybody doing some creative thinking, not just hanging with the old.

I don't know how I got into that.

Q: Comparing the two.

A: So, I always think that the Warsaw Pact threat has been the paramount thing driving training and the Army in Europe. I think there have probably been some years where other things were also high on the platter because they had to be dealt with.

Q: I think we may be at the point to wrap up the 3d Armored Division, unless there are other things that you can think of about your experiences there that we should talk about.

A: I'd like to say one more thing about my first assignment. I mentioned it before. USAREUR was a great place to start. I've always thought, as I mentioned, that starting off as a junior officer in Europe with a heavy division—where you had the mission, general defense plan, “Frontier of Freedom,” an orientation away from post, thinking, training, and being able to fight over a big mass of terrain—was a tremendous beginning. You couldn't just fall out to train on post or, say, the far side of Fort Riley, for instance, or even the western side of Fort Hood, as big as that is. You had to think in terms of real geography and terrain and real fighting. You had to deal with the problems of a deployed Army, that is, soldiers and families away from home, and a populace.

With all those ingredients, you also had the cultural aspects of being over there, which were fun. The whole thinking of the heavy division was something that I think is awfully important for an engineer officer who has to know that we do our job in combined arms. Combined arms in the context of the heavy division in Germany is movement, working on frag orders, being able to be flexible enough to change in midstream, and it's not a set piece at all.

So, even later in an airborne division—which is strategic in its rapidity of deployment but methodical after it hits the ground—my experience was prompted by that same kind of thinking that we ought to be able to operate by the frag order; we have to be flexible enough to change; we have to be mobile and act decisively. Then later, when I went back to Germany and the VII Corps, 7th Engineer Brigade, those same kinds of things were there.

Being in an armored division at the start meant I really learned combined arms, that our reason to be is not “engineer” but our reason to be is to ensure that the division's major weapons systems, the tank and the Bradley, get to where the mission is. The very key role that the engineer has—dual-hatted—both leading engineer troops and also providing engineer counsel and guidance to his commander, is paramount. We put a lot on our engineer platoon leaders and company commanders but nothing more than what you get in that experience in Europe.

That ability to think on the move, the ability to understand that you do it that way by combined arms, really is something you learn best in Europe in an armored division.

Another experience just came to mind that I ought to recount, which really speaks to the engineer's role in giving advice and counsel to the maneuver task force commander. I gave the one example earlier where I was introduced by the task force commander who said, "Meet *my* engineer." Later on, I was out on a field exercise with the 32d Tank Battalion, again a reinforced task force. A mission had been given to seize an objective. The interesting part of the objective was that two-thirds of it was on the right side of a river and one-third on the left side, and this was not a little stream. I mean, we're talking about, you know, 8 to 10 floats of M4T6 to cross it.

We moved out to do our recons and then came back in to talk to the battalion task force S-3 and commander so the commander could develop his commander's concept of the operation. I was one of the first back, and I went up to the battalion commander and he said, "Hey, now, that stream, that's no problem, is it? You can probably get across that in a matter of minutes."

I thought, "Oh, my God, where's he coming from?" I mean, that's unrealistic in the sense of here's the objective and you don't attempt a bridge crossing in the middle of assaulting your final objective. So, I suggested to him that, obviously, his force could take the right two-thirds part of the objective but he needed a force on the other side, much before reaching the objective, to make that assault.

Because I'd been in the pre-briefs, the options available seemed to show that there were a few companies from another battalion available on the other side of the river. Probably this was the teaching point that brigade or division was trying to make. I suggested that he should request them to be attached to him so they could assault the other side of the river and take that one-third of the objective. The light bulb came on, they made that request to brigade, they were given those assets, and they conducted the attack like this lowly lieutenant had suggested was probably the right answer. He looked like a champ. [Laughter]

So, I think the engineer officer on the battlefield has an opportunity at the earliest point in his career of anyone to get a perspective of combined arms in fighting the battle. To be successful, he must do that. I mean, the engineer must be able to see things like the battalion S-3 that he is supporting because he is contributing to him and he is influencing across the whole unit. When I would go out on the field exercises, my peer lieutenants of infantry were sitting in their foxholes waiting for the company commander to come back from his recon and tell them what their mission was for the next day. I, as an engineer platoon leader, was out there with those company commanders surveying the terrain, trying to figure out what was going on so we could make recommendations to the maneuver commander and his S-3 that would contribute to the molding of that commander's concept for the operation. So, we were contributing to his paragraph 3(a) "Concept of Operation" of the order. The others were waiting to be told what they were going to do the next day so they could execute. So, the engineer lieutenant has a higher level of experience and insight about combined arms than his peers.

By the same token, you see, that's another ingredient of E-Force because of that experience. The problem is that the platoon leader or company commander can't be planning and also

supervising execution at the same time. So, the lieutenant in the everyday battle that goes on just isn't capable of doing sufficient recon for the next operation while executing something that may be going on at the same time, such as putting in a minefield, getting prepared for breaching operations, and the rest of it. You can turn some of that over to the platoon sergeant, but what we need really is a kind of leadership comparable to what the infantry and armor have—that is, a captain supporting that task force. So, it would be a captain company commander doing those recons with the other infantry and armored captain company commanders while the lieutenants—and the sergeants—are preparing the platoons or off executing their missions.

So, once again, my experience back then in the 23d Engineer Battalion, as well as broadening for me, also proved to me that you really can't get it done in sustained battle day after day with that engineer organization. There was a void in capability, and we needed to correct it by putting the same level of leadership planning staff capability in this maneuver element. Mind what I said before, engineers maneuver like armor and infantry. To do that, we had to be comparable to the speed of the heavy division battle. So, those lessons were ingredients that later on became input to E-Force.

Q: Just one other issue about being platoon leader. You were talking about discipline and morale problems in the '70s. What about during this period of working with troops? Any lessons you learned there about morale, discipline, working in a foreign country, cultural problems?

A: Well, for the young lieutenant, this is his first hands-on leadership experience. It is where you really find out about yourself and whether you can put it together. How you work that platoon sergeant and three squad leaders and your 27 people makes you learn a lot about yourself. You learn what works and what doesn't work, and whom you can trust and whom you can't trust, what you need to check and what you don't need to check, and you learn about people and their foibles and the fact they're humans and they respond to different things.

So, I had a platoon made up of common, ordinary folks. There were some good folks, some bad folks. They were not the caliber of folks we have today in our all-recruited Army, without doubt. We had our racial problems back then too. We had the black bars and the white bars. One of the banes of a lieutenant's existence in those days was courtesy patrol. My, did we hate to be on courtesy patrol! The concept was in the 3d Armored Division that if we had people out getting drunk, getting in a fight, we would find them and bring them home before the military police brought them home. I think I pulled courtesy patrol every—it seemed like every fourth or fifth weekend. I was given a jeep and went out with a noncommissioned officer. Typically I would take a black noncommissioned officer so that we would go together into either black bars or white bars. We would try to walk around and be present. When we found somebody who'd already had too much to drink, we would get him back to his unit—that is, turn him into his unit with no report to the military police—take care of our own that way.

So, you really did learn about life, people, what motivates people, what turns them on or turns them off, and yourself in those days. It was a great leadership laboratory, if you will.

We had folks in those days that the judge said, “Either you go to jail or you join the Army.” So, how do you get them motivated? And, you know, I was the guy who came out of Ranger and Airborne Schools, and we did the chants and we did our runs, and that was new and different for an armored division. Nowadays, this happens all over the Army. It was a real developing experience.

62d Engineer Battalion (Construction)

Q: You left the 23d Engineer Battalion about November of 1959, I think, right? Then you went to the 62d Engineer Battalion (Construction) at Fort Leonard Wood. What position did you go into in the 62d?

A: I went back to being a platoon leader again. That was one of the real problems of the period, a real morale breaker. You have to be cognizant of such things when you’re doing reorganization things to force structure like we are today. I went from all the excitement of being on the frontier of freedom and all the missions in Europe, back to a unit in the continental United States that was well down the priority curve—short of officers, among other things. The officer they had deleted was the company exec out of every company. You were either the company commander or you were a platoon leader.

Now, you need to know, I guess it’s pertinent, how I arrived there because, in fact, I didn’t want to leave Germany, and I had written the Seventh Army Engineer and asked to extend my tour and stay. It turns out the commanding general of Fort Leonard Wood of that day, who was also the commander of the 18th Engineer Brigade, which was located there, had just complained to his personnel boss. This happened to be the Chief of Engineers at that time because an engineer personnel officer was in the Office of the Chief. He complained that he was always getting shortchanged and never got any Regular Army officers. So, they decided to fix that and thus sent 12 Regular Army lieutenants to Fort Leonard Wood beginning in the summer of ’59.

I was the 12th to arrive. I needed to be a company commander and I wanted to be a company commander. I was told, “You can be a company commander in March, but all those positions are filled for now.” They really were, by all of those other 12 who had arrived. We were all peers from peer groups ’55, ’56, ’57, coming back from many places, most of them from Germany. So, I begrudgingly became a platoon leader again.

The other interesting point about all of that is, having got his 12 Regular Army lieutenants the summer of ’59, they were all gone by the summer of ’60. So, the longest one there lasted a year. I was the last to arrive, in November. I was gone by May 1960. Almost all 12 were selected for civil schooling, and we moved off to go to our civil schools that summer. So, I arrived at Leonard Wood, and they told me that they’d give me a company command in March. One week later my orders came out for civil schooling in June, and they said, “Forget

it.” So, I spent a cold winter as a platoon leader, building the runway extension on the airfield at Fort Leonard Wood.

Q: I was going to ask you what sorts of projects the 62d was involved in there.

A: Well, we had a couple but the airfield was principally mine. We were involved, as was a lot of the 18th Engineer Brigade, in building the golf course that’s there today.

We had regular training and took an Army training test there, but to do the right thing to allow aviation at the airfield, they needed to extend the runway 1,000 feet. To extend it, we either had to put in a big fill on one end or cut off a hillside on the other end. They elected to cut off the hillside at the end near post. That was my platoon’s job, and we worked on it through those months in the cold winter of Missouri. I had most of the equipment assets of the battalion—that is, the dozers, the tractor-scrapers.

In addition, because we had quite a hillside to cut away, I was given, on detail, the assets of the tractor-scraper school. That is, they’d come out and use that hillside as their practical experience. So, there were many days when my platoon sergeant and I would be out there with 20 to 25 tractor-scrapers roaring about. We were not only trying to guide them, we were trying to stay out of their way. There were always, of course, four or five that were changing tires. These were not trained troops; these were troops having their first experience on a tractor-scraper.

To finish that experience—we did all the grade work, took the hill down and then did the shaping necessary with base course so that it could then be paved. Then a contractor paved it.

Q: So, the Army engineer enlisted training was done at Fort Leonard Wood at that time, was it, or a lot of it?

A: Well, yes, a lot of it. Maybe all of it.

Q: Equipment operation?

A: I just don’t really know. I know that the tractor-scraper school was there, but I was on the troop side so I knew very little about what else went on at the installation. We had four or five battalions at Fort Leonard Wood at that time. The 18th Brigade was a very substantial brigade-level headquarters.

Q: You referred to this earlier. Do you want to expand on the comparison you were making between the 23d in Germany and the 62d at Fort Leonard Wood—perhaps a bit of an unfair comparison, but it’s interesting in terms of at least what’s going to come later with Vietnam.

A: It is a point of one unit, the 23d, which has a really cohesive mission and a high priority versus a unit, the 62d, which did not have a focused mission that prompted much get up and go and enthusiasm and also suffered from a low priority. I just mentioned the number of officers as an example, but it also was reflected in the kind of equipment we had. The Army has its priority list now. It was the same priority thing then.

It was really a comedown for me to have participated in realistic Army training tests in Europe over many miles, exemplified by the example of the challenge of planning a bridge operation on the go, figuring out how you were going to fix the bridge before it went in, compared to taking Army training tests at Fort Leonard Wood, a very small installation where we couldn't roam very far and where we did not even have Army maps. We took that Army training test on Texaco maps because the regular ones weren't available. We were short so much and the standards of training were just so far lower than in Europe that it was a substantial change. It just made me think that we should never let a unit of the Army get into this kind of a situation if we can affect it.

Q: Now, you started out, I think, indicating that we should keep these things in mind with what we're doing with the force structure today. Right? The effect on morale when we're changing, we ought to keep that in mind with what we're doing now with reducing the military. I wonder if you could comment on that.

A: Yes, what I meant by that was, as we start making decisions on the build-down of the Army, we're planning to take out 35,000 annually. We've decided that's the ramp we could do considering the impact on the Army with all the personnel policies that will impinge on promotions, selections, and job satisfaction. We need to make sure we don't do something like, say, eliminating the company exec, because there's a building block that says after you've been a platoon leader so long, you should be given another development opportunity. I felt very little satisfaction, having been a platoon leader, having been a company exec, having been an assistant S-3, then going back and driving a platoon after three years of service. So, what I meant was, let's don't set up some scheme that fits the bean-counter notions but that really adversely impacts on a person's self-esteem, job satisfaction, and development. That's what I was referring to.

University of Illinois

Q: You indicated that all of your peers were getting ready to go back for civil schooling at that time, so you must have been doing some thinking during this period about where you'd like to go, what you'd like to do. How did you arrive at those decisions?

A: Well, in those days we received a form from Engineer Branch that said that I was selected for civil school, pick where I wanted to go. I submitted my desires by university choice and by discipline choice, and then the powers that be decided who was going where. Then I was told in December of '59 that I was going to go to the University of Illinois to study civil engineering with a physics minor for 20 months. So, that's the way it came back to me. I'd indicated Illinois as a choice and I'd indicated civil engineering. I don't recall if I'd indicated physics as a minor or some other program as a choice, but it was a one, two, three kind of choice indication.

Q: Most of your peers went to civil schooling during that period?

A: By most, I mean the number of engineer lieutenants that were going to stay on. I don't know what percentage it was. I think most of the Regular Army lieutenants who were going to stay on active duty that I had associated with went to civil school. The ones I knew seemed to. A lot of people got out after three years, four years too. You'd have to go back and look the numbers up to be accurate.

Q: I guess what I'm really getting at is that was more common then than it would become later on?

A: I don't know. They still sent a sizable number to school. There may have only been 35 or 40 then. I don't really know.

Q: Okay. For those people thinking about staying in, this was a step up their career ladder.

A: Yes, a significant and desired opportunity.

Q: How many fellow engineer officers were with you during the time at Illinois?

A: I don't know; we had quite a number. We had a number of Army officers there, to begin with. They weren't all engineers. For instance, General Lou Wagner, armor officer then a captain, later commander of AMC [Army Materiel Command], was there taking statics and that sort of thing because he was going back to teach in the department of mechanics at West Point. So, I think, as I recall, we had about 25 Army officers, of which the greater number were engineers. But that could be wrong too. There were quite a number.

Q: Was that a good experience for you? An interesting experience, going back to school, going back to graduate school?

A: Yes, I was ready to go back to school and it was a good experience. I very much did not want to go straight out of the Military Academy. Later on, they had a program whereby you could go direct, if you stood in the upper 5 percent of the class. I highly disagreed with that, thinking you should go out and be grounded in the field before going back to graduate school. I had done that and now it was time—I was in a good mental attitude to study and do academic work. I was married just a week before I reported there, so my wife, Ann, and I spent our first tour together at the University of Illinois. We had a lot of friends there that stayed friends for the rest of our careers.

Q: How did you meet your wife?

A: Well, back in the 23d Engineers, I was the date arranged for "Cousin Ann" when she came over to visit her cousin, Paula Campbell, and Lieutenant Jack Campbell who was a fellow lieutenant in the battalion. There were very few bachelors in the 23d Engineers, just three or four. Through this period, as I mentioned, there was not a great turnover, and so I'd become very friendly with the Campbells, and at all the battalion functions I would dance with Paula

Campbell. So, evidently she liked me enough and she fixed me up with Cousin Ann when she came over.

Q: Where's your wife from originally?

A: From Waukegan, Illinois.

Q: Illinois?

A: Paula Campbell was from Spring Valley and their mothers were sisters, spent a lot of time together during their youth.

Q: So, they had married student housing at the University of Illinois?

A: No. We bought our first house. We thought it was grossly expensive at, I think it was \$9,000. A car costs more than that now. In fact, we were so worried about the price that we got a guaranteed buy-back so we could sell it back to the builder-developer when we left two years later.

Q: Wouldn't be stuck with that heavy financial burden?

A: I wouldn't be stuck with that burden.

Q: Any other things about that almost—well, a little over a year and a half that you were at civil school?

A: No, it was a nice change from the rigors of troops, but it was also very rigorous. At that time we were accepted for full graduate work out of the Military Academy except for two courses taken the first summer, two undergraduate courses. One of those was in concrete and the other one, I believe, was in advanced calculus.

Other than that, we went straight into graduate work, and it was very rigorous and, in fact, I really wasn't prepared for it. The military officers there, the engineer officers, knew how to approach the task, but in fact our background at West Point at the time was not strong in civil engineering, and that's what I was taking. So, most of our civil colleagues were well ahead of us, some of them in industry architect/engineer firms, towns, communities, and were well ahead of us at the start. However, by the end of the period we Army engineers were making grades as good as or even beyond them, primarily because of our work habits and motivation and ability to go in and do the homework to catch up. At the start it was very difficult.

Q: You did a thesis?

A: No. They no longer required a thesis.

Q: Okay.

A: I should say one other thing, and that was I dropped out of the physics minor while I was there. That also was most difficult, and it was well beyond any preparation I had. The other

person who had signed up for the physics minor, then Lieutenant William “Herc” Carrol, also dropped the physics minor. He later got a Ph.D. in civil engineering and went back to be a deputy head of a department at West Point.

The two of us were sitting there one day at the start of a physics class when we looked around. It was a very small class but in a large teaching auditorium. I guess there must have been about 25 people there, and about half of them had Westinghouse notebooks and the other half had General Electric notebooks. Then there was Herc Carrol and me. The instructor came in and started writing formulas. He wrote them all the way around the room, all long physics formulas. Then he looked and pointed up at this thing hanging over our head on the wall, like at the Aerospace Museum here in Washington. It was the first betatron. He said, “Well, of course, I invented that.”

After he started writing formulas all around the room, both Herc and I felt that we were in a league that we weren’t prepared for, nor were we really interested in being in that league, being rather pragmatically oriented toward Army engineering that we had known in the field. So, we each at separate points, but within the month, marched down to see our faculty adviser, Dr. Nathan Newmark, and asked him if we couldn’t drop the physics minor.

So, I stayed on and got extra civil courses. Herc Carrol received approval to stay on and get his Ph.D.

Q: Do you think that physics minor might have come from the postwar engineer work in atomic weapons?

A: I think so. I think it had to do with nuclear effects.

Q: That’s what they were thinking about?

A: That was the reason they established that as a discipline.

Q: You didn’t sound earlier like you thought you had picked that as your minor.

A: I don’t remember picking it, no. The people going there for civil masters were going for a year. I was going for 20 months—that is, two summers, two fall semesters, and a single spring semester for the physics minor. Because I didn’t take that course until the first spring semester—I’d already finished the summer and the fall—and then dropped the physics minor, then we were able to ask to stay on. I really needed to stay on to finish the rest of the work because of what I’d been taking. So, I added other civil courses like hydrology, which was a help later when I got into the water resources business, and further geotech courses.

Illinois had some real heavyweights on their staff. Newmark was famous for dynamic structures and earthquake loading. He was my faculty adviser. Interestingly, at that time the Army told him, “Look, we’re sending you a lot of engineer officers every year to Illinois, more than any other university, but you’re not giving them any of your own personal class time. We’d like them to have some association with you.” I took the structure course that he invented in summer school, in the summer of ’61, and he taught it so he could catch up with

his credit with the Army. That was certainly a mixed blessing for me. First of all, there was the expedited nature of summer school, but second, we had an instructor who certainly knew his subject but was not interested in the basics. He was interested on the margins of where it worked and didn't work exactly according to his theory. So, we once again were jumped ahead beyond a basic foundation start into the midst of his interests.

[Richard S.] Englebrecht was there on the sanitary engineering side of the house, as were Ven Te Chow in hydrology; Dr. Ralph Peck, one of the greats in soil mechanics; and Don Deere in geology. One of the really interesting courses I took was with Peck and Deere, sharing case studies of things that worked and things that didn't work, where they had been called in as professors at Illinois to be consultants. Peck at this time was such a giant in his field that he only took jobs that interested him, that were a new challenge to him, something that intrigued him and piqued his interest. It was really interesting, interacting with those folks in those case studies.

Another new thing that happened that time—we had this huge box in a room that we went in to see one day, and it was called a computer. I mean, it was room-sized. Illinois had one of the first, supposedly, of these computers. So, I took a computer course with Steve Fenves, who later was big in that business at the University of Pittsburgh, in the department of engineering applications in automation. Ours was basically a programming course at that time, and we learned to program and operate the computers and run engineering solutions. Fenves was an assistant professor of engineering.

I ran into another assistant professor when I got into the construction management arena. First of all, I took an operations research/systems analysis course, a decision-making kind of approach. Then I took an elective with another professor by the name of Dick Schafer, who, of course, later was instrumental as the University of Illinois tied together its proposal to the Corps that became the Construction Engineering Research Laboratory. He then became the tech director of the laboratory. So, Dick Schafer and I can get together all the time and tell war stories about my captain days and his assistant professor days at Illinois.

Q: When were you promoted to captain?

A: It was in July of '61, while I was at the University of Illinois.

Q: To go back, I don't know exactly how to phrase this question, and I don't want to phrase it negatively, but you were talking about your West Point preparation. I can't think of any way to phrase it but negatively. Would you fault West Point for not having prepared you better in engineering, or that's not really the purpose of West Point?

A: No, it wasn't the purpose of West Point, and that was why—I guess it was recognition by the Army or the university that they were putting me into a course of study for which I really didn't have all the concrete, all the structures, all the soils that they thought I had. In other words, I was being credited with a full undergraduate civil engineering background, and I certainly didn't have that.

So, they recognized that in terms of the concrete, and I had to take an undergraduate concrete design course before I could move ahead. It was not recognized in other subjects. Certainly, I was heavily into soils, and when I hit Dr. Roy Olson's soils class and we were into clays and all the properties of clays and the basics, I had had little—a few days of soils at the Military Academy, a little bit at the Engineer School—but certainly was not prepared for the kind of things he had us into immediately.

I remember his derisive remarks that he had all these military folks who didn't know what they were talking about coming into his class, and he also had one of his students who had worked 12 years in subways in Canada or somewhere who really knew clays. On the first exam, all of us in the military went deficient—got "F"s. This guy was a shining light with his "A."

By the end of the semester most of us in the military had passed that guy in overall grades. We did not start up where the rest of them started. So, I don't fault the Military Academy on that because that wasn't the reason for the Military Academy. We all knew what we took when we were there. Now, the Military Academy has changed. They now have majors. You can now major in civil engineering, and I would suppose that today's graduate is better prepared in the kind of terms that I described than I was then.

Q: I suppose a part of it is the West Point legacy as beginning and being so heavily engineering for so long, and that reputation persists even after the curriculum may have changed.

A: Yes, I'm not sure the curriculum ever changed. I think what happened was that West Point was established as the first engineering school in the United States and then most of the other early engineer schools spun off of West Point and a lot of the instructors at them were West Point graduates. Then we settled the West, and Army engineers did all those things. Engineering at that point was rudimentary compared to what it was years later, certainly by the time I went to University of Illinois. So, engineers back then were across the board in disciplines.

Now we have one discipline oriented toward sanitary, another one toward structures, another one toward highways, another one toward soils. I mean, the subdivisions were all there and you really couldn't, nor did I at Illinois, concentrate in particular subdivisions. So, I think the whole development of civil engineering and engineering across the board has developed so extensively that it just encompassed a bigger environment.

Q: So, you finished your degree work, I think you mentioned the other day, in February 1962?

A: February '62.

Engineer Advisor in South Vietnam

Q: Your next assignment was in Vietnam. How did you get that assignment?

A: Well, that's another story. You can lay it on General Maxwell Taylor. Vietnam was just starting to get into the news, and in the late part of 1961 President John F. Kennedy sent General Taylor to Vietnam on a fact-finding tour. He came back and made a recommendation that we needed to have more advisers there at a lower level with the Vietnamese Army.

As I put it together in reading some other stories, his recommendation included that we should send some engineers over there to do development in the country. Certainly, when I was given my alert, which I suppose was in the fall of '61, it was to be part of forty engineer officers who were going over there supposedly with the mission of harnessing the Mekong River. I don't think anybody was going to harness the Mekong River, but it may have been a good cover story. Certainly that's not what I did when I arrived.

Another point was Vietnam didn't have any kind of stature like it later had, and I knew darn well I didn't want to go over and be an engineer doing design work on something to harness the Mekong River. I knew I needed to get back to troops and command an engineer company. So, I wrote to Engineer Branch and said, "I really want to go to Korea instead"—because I knew I was due a hardship tour and I thought the best thing to do was go to Korea and get that company. So, I wrote and said, "Look, I'm not fighting going to a hardship tour, I know I need to do that, but you don't have companies in Vietnam. Send me to Korea."

So, Engineer Branch wrote back and said, "No, it's essential. You've been selected, one of these key people to fill General Taylor's requirement, really help the nation of Vietnam and the Mekong." So, in March 1962, I went to Vietnam. I arrived in Saigon and was assigned as a battalion-level adviser to the 41st—later redesignated the 201st—ARVN [Army of the Republic of Vietnam] Engineer Battalion, with duty station Pleiku. So, we flew into Saigon. I had a room in the Hotel Majestic right near the waterfront. I checked in at the desk at the hotel and shared a room with Ted Bishop, who had come over with me, plus a Marine who was already there. He'd go out and patrol during the day and come back and stick his carbine up against the corner of the hotel room overnight, then go out the next morning to do something else.

In March of '62—this was very early, you have to understand, in the war effort—we would go up to the top of the Brink Hotel to the cocktail lounge, and we would sit there having a gin and tonic and watch the artillery fire on the horizon.

A couple of days later our orders came through. Everyone said, "Stay away from II Corps because the senior adviser to II Corps is Colonel Wilbur 'Coalbin Willy' Wilson." There were four engineers in the group as the orders were announced. One of them was to stay in Saigon, the next one was announced to go to III Corps, the next one was announced to go to I Corps, and I had a feeling that when I got mine it would be to II Corps. We were being dealt with individually. Captain Ted Bishop had come over with me and he stayed down in III

Corps. Mine was II Corps, and so the next day I flew north on a Vietnamese Air Force aircraft to Pleiku to be assigned to “Coalbin Willy” Wilson.

So, it was a very interesting time. That C-47 landed on the airstrip at Pleiku, which later was to become Camp Holloway, where the Americans came in full force a couple of years later. I remember well the landing. First of all, the airplane had all kinds of pigs and chickens and everything else on it. We landed, and there’s a big whirr as we rolled over the pierced steel planking and you could see the ends of the planks flipping up outside the aircraft. We moved down to the end of the runway, the plane did a quick spin around, and we noticed a little wood hut off the corner of the runway.

So, I got off, one other soldier got off, and we started walking toward the hut. There was no sign of any activity and nobody came out to meet the plane. We heard the engines rev and the plane took off behind us. Then there were only the two of us. We walked in the hut, and it was absolutely empty, no people, except for one little stool on which was an Army field telephone.

Now, we were outside the town of Pleiku—Pleiku is a very small town. It must have had a couple of thousand people, oh, 200 or 300 little shacks at a crossroads in the red laterite soil. We couldn’t even see it. We were on top of a plateau. There was nothing within vision above the horizon except that hut we were in.

We had no weapons. We began to wonder what was going on here. So, we rang the telephone, and rang it, and we must have rung that telephone for four or five minutes before an American voice answered at the other end. We identified ourselves as Americans who had just landed at an airfield that we thought was Pleiku and said, “We’re here.” He said, “That’s fine; we’ll pick you up in about 25 minutes” because that’s how long it took to drive from the then MAAG [Military Assistance Advisory Group], later MACV [Military Assistance Command, Vietnam], compound to pick us up. So, we hopped in his jeep and roared off to our new home, MAAG, Pleiku with the II Corps headquarters.

Q: You’ve referred to this, but did you have any orientation or training before you left the States or when you first arrived?

A: No, absolutely none. They had some kind of a course people went to at Bragg, which gave an orientation to the area. Engineers were among the first to go over. I think when Taylor had come back it was easier to say, “Let’s send forty engineers.” That gave a cover for why we were being alerted. We had no orientations, no language training, and didn’t come by Washington, Belvoir, or anywhere.

Q: From Illinois to the—

A: Flew from Illinois to San Francisco, where we incidentally had a second honeymoon along with Ted Bishop and his wife. Ted had been at the University of Illinois with me, and they were friends. Then the wives flew home and we went to Travis Air Force Base, checked in, got on the plane, and deployed.

When I arrived at Pleiku, there had been an advisory detachment at the II Corps headquarters for some time. I don't know how long that time was, but it'd been staffed at about twelve people. There was a small horseshoe-shaped compound of eighteen rooms, motel-like. It had no security fence on the outside of it. It was a nice little area. Colonel "Coalbin Willy" Wilson occupied two of those rooms as commander.

There were mostly colonels, lieutenant colonels, and majors. I was the eighteenth person to arrive. When I left a year later, there were 600 Americans in Pleiku, so that's how early it was in the build-up. When I left, it was still advisory; we didn't have units. We had some aviation detachments but not combat units. We had basically two fixed-wing aircraft, Otters, to service the entire II Corps tactical zone, which was the central highlands. One of them was a command aircraft for Colonel Wilson; the other was used to fly shuttle from one major MAAG installation to another. We had the major cities of Pleiku, Qui Nhon, Nha Trang, Ban Me Thuot and Kon Tum in our sector. That sort of framed the Corps area.

Q: There were how many engineers out of that original eighteen?

A: Well, I don't know how many of the original twelve, but in the eighteen there were three engineers. There were two majors; one of them was promotable. He was the Corps engineer. The other major was acting as the deputy Corps engineer and was the engineer group adviser. The group consisted of three engineer battalions and a light equipment company, maybe a bridge company. I was the first of the battalion advisers to arrive. So, previously, that 2d Engineer Group adviser had been the adviser for everything in the group. At the point of my arrival was the beginning of pushing American advisers down to the battalion level in the Army, and so I was one of the first of those.

Q: Do you remember who the major was or the major P?

A: The major was Sadayo Nagata.

Q: Okay.

A: The major P's name was [John A., Jr.] Hughes.

Q: This is a really interesting period. What did you do on the day-to-day level? What were your activities like, being an adviser at the battalion level? How did it work?

A: Well, I think I need to get into that by getting me into the job because everything we did was freewheeling. I mean, we really created and did what we thought was right without really being told. It was an interesting time. There was not a lot of guidance. There was also a feeling that we Americans were going to make it happen. Without doubt we understood that "Coalbin Willy" Wilson wanted things to happen. He also did not like engineers or signal officers.

When I had my first interview with him, the Corps engineer, Major (P) Hughes, took me in and Wilson said, "Welcome," rather gruffly, and "Glad you're here." We just chatted, a very short, terse meeting. We walked back out and my boss was ecstatic because I was the first

engineer that Colonel Wilson hadn't just thrown out of the office. He thought engineers might finally be making some headway.

There was real pressure on engineers everywhere at that time. We were really there as advisers, but because you were an engineer you were expected to make everything run in the facility compound. So, Major Hughes, the senior Corps engineer, never went out and advised. He was trying to keep the generators running, and when the generator would cut off in the middle of the movie, I mean that poor guy was under the gun.

When they decided to expand the compound, he was supposed to design it and then contract out for it and make it happen. There were no divisions, districts, or command; I mean, there was nothing. So, it befell to the engineer on the spot in every MAAG detachment to do all those things.

So, with the advent of the battalion adviser, his point was, "Best to get out into the field. You're going to be doing the advice out there on the ground. I'll check with you periodically. Come back in and see me; I'll try to keep the compound generators operating."

On the second day after I arrived I went out on an operation. Major Nagata said he'd take me over to meet my battalion counterpart, and it turned out to be one of the more exciting days in my year there. We drove down Route 19 from Pleiku to An Khe through the Mang Yang Pass. You have to know from reading, as we all did back in those days, *Street Without Joy* by Bernard Fall that it was between An Khe and the Mang Yang Pass that the French Mobile Group 100 had been ambushed and decimated by the Viet Minh. So, we were driving that route, and there were still a couple of tank hulks off to the side of the road from Mobile Group 100's demise.

We drove up to the An Khe airfield, and there were several H-21 helicopters, which was the other aviation asset we had in the Corps, one company of H-21s. They were ready to lift off because there was an operation ongoing, and there was to be an infantry sweep north of An Khe. My battalion, the 41st Engineers, had two missions. One was to rehabilitate and expand and improve the old French airfield at An Khe. Second, to build a road north from there to a town called Kannack. I don't recall exactly, but I think it's probably about 40 kilometers north of An Khe.

The infantry sweep was a sweep up into this area, and my battalion sent a survey party along to survey the road that we were going to be building over the next several months. Both of those projects figured heavily into my daily activities over the next year.



Captain Kem was an advisor with the 201st Engineer Battalion of the Army of the Republic of Vietnam in 1962.



In May 1962 Company B of the 201st Engineer Battalion was rebuilding the French airfield at An Khe.



In May 1962 Company C of the 201st Engineer Battalion was constructing a road north from An Khe to Kannack.

We took off in the helicopters. Later we came into a hot landing zone. A firefight was just finishing. There were a lot of bodies on the ground, a lot of smoke in the air, and a lot of jabbering in Vietnamese. A bunch of folks hopped out. I was aboard with my Vietnamese battalion commander, Captain Le Viet Tri, that I met just before we took off. He didn't take to flying, had been sick at his stomach the entire flight, and we hadn't communicated. As I found out later, we wouldn't have anyway because he didn't speak any English and I didn't speak any Vietnamese. We later got along on my broken French—after my finishing 100 out of 101 at the Military Academy in French.

Then we started flying back, and I thought, "Routine, mission over." Then we started circling in the air and the other helicopter flew down and entered another landing zone. We kept circling and circling, and then our pilot was looking back to us and hollering at me—I mean, this is an American pilot. With all the noise and everything else, and two or three bodies they'd thrown on the floor of the H-21 to take back from the landing zone, we really weren't communicating.

Meanwhile, the other helicopter had lifted off and we flew back to the airfield. Our pilot jumped out of the helicopter and ran to the other helicopter. There began a huge argument between some Vietnamese officers and the Americans. Well, it turned out my pilot had been the commander of the unit, so the other helicopter was his. Piecing it together when it was all over with, there had been a grand misunderstanding. My Vietnamese battalion, that I just met that morning, had sent about seven people aboard the two helicopters, five in the other helicopter and way too many for what was needed. They were basically going up to resupply their survey team and maybe get some papers back and deliver some supplies. The American pilots thought they were delivering the officers to join the survey party in the field.

When they settled down into this landing zone, there was a Vietcong prisoner who was wounded and they wanted to extricate him. When they put him aboard, it overloaded the aircraft and they couldn't take off. As long as the Vietnamese got off that was fine, but these Vietnamese weren't getting out. So, there followed a standoff in that helicopter in which the

pilot came back and pulled out his pistol and said, “Off you go,” after which a Vietnamese picked up his Thompson submachine gun and said, “No, we won’t.”

So, all of this was taking place in the other helicopter on the ground while we’re up circling around. This was a very antagonistic affair, and the aviation people thought we advisers were at fault because we hadn’t properly advised them. Of course, I had started that morning by meeting them outside the helicopter about 10 minutes before take-off. Anyway, this was my baptism to being an adviser.

We then drove back to Pleiku. Next day, I drove back to An Khe, right down that same Route 19. It was obvious I couldn’t go to work that way. I mean, I’m driving this route where Mobile Group 100 had been decimated and there’s jungle close to the roads and it’s not safe. They were sending squads to pick me up at the Mang Yang Pass and secure me on the way back, but it was pretty obvious to me that to do my duty I had to move out with the Vietnamese.

And, again, there was nothing said, there was no plan. It was just obvious to me that that was where I needed to be to accomplish the mission. There were no tents; there really wasn’t field gear. As a matter of fact, as one of the most junior members of the compound the only thing they could arm me with was an M-1 carbine—didn’t even have M-2s. Colonels and majors at headquarters kept those. Nor was there a way of getting food. There weren’t C-rations. They bought food in large cans to use in the mess hall, purchased off the shelf. So, I moved to An Khe and moved in with my battalion commander counterpart in his mud hut with a thatched roof. It was sitting on a hilltop where there’d been an old culvert factory. He had two companies there, B and C Companies, and their perimeter was around this culvert factory. His troops had built him this mud hut with saplings for re-bar and so forth. So, I lived with him for several months.

You asked what my daily activities were. At this time my daily activities really followed his. We got up in the morning and had breakfast. I was bringing my food from Pleiku but I had no refrigeration. So, I’d have to open the can of peas and eat those, say, for breakfast. Then I’d open the can of meat and have that for lunch, and then the can of peaches for dinner that night. I wouldn’t have three balanced meals.

So, the day would start with breakfast and then we’d go out and visit all the projects. One company had the airfield. Lieutenant Can commanded that company, and we’d go over and check construction and follow up earthwork on the airfield. The other company—I don’t remember the commander’s name of that one—was working on the road north, and they were clearing and grubbing, moving north. So, we’d go over and check on that. Then Captain Tri would say, “It’s time for lunch,” and maybe I’d have that can of meat or maybe he’d stop down at An Khe and we’d go into a restaurant down there, four or five tables, and have a small beefsteak and big orange drink with all the beads at the door trying to keep the flies out.



Cantonment of Headquarters and B and C Companies of the 201st Engineer Battalion, Army of the Republic of Vietnam. Captain Kem lived in a mud hut with a thatched roof with Battalion Commander, Captain Tri.

Typically after that it was siesta time for the Vietnamese. I didn't want a siesta so I'd try to read a pocket book or do something, but usually there was nothing to do because they all stopped. So, after a couple of hours of siesta, Captain Tri, the battalion commander, would get up. He really was a pretty nice guy, but perennially he'd have a headache after a midday nap. It's pretty warm there—we're talking 90, 95 degrees with fairly high humidity during the hot season. He'd really take a long time recovering from that nap, and he'd decide probably the best thing to do would be to go down to bathe or take a swim, so we'd go down to the river, the Song Ba, which ran through An Khe, and we'd jump in there with the liver flukes and all and have our afternoon bath. Meanwhile, on down the stream 100, 150 meters would be the women of the town beating their laundry out on the rocks at the side of the stream.

Then in the evening we'd have either a meal in our mud hut or we'd run back down to the little restaurant downtown. We had no lights, so come nightfall we went to bed. Then we would hear the rats running in the thatched roof or running on the false ceiling under the thatched roof throughout the evening.

That was a time where you made your own work. As you started out you found that you couldn't dictate to them. So, you started then figuring out the way that you could recommend and suggest things and then make it their idea so that they would want to accomplish it. You'd try to work a productivity kind of thing, "Well, now, guys, I guess, you know, by the

end of the week we ought to be able to get so far, get this done.” Well, when the week went by and about half of it was done, it wasn’t something like, “Come on, tell me why you didn’t do it.” I might suggest to Tri, “Lieutenant Can really didn’t progress very well this week.” I would get that, “Well, you know, that’s the way it is. He did his best,” or something like that. I’d suggest, “Well, maybe you could tell him go do this, go do that.”

Meanwhile, once or twice a week I’d go back into the MAAG headquarters, and the questions would be, “How much did *you* accomplish this week?” After a few weeks of this, this was really getting tough for me to live with because it just wasn’t ever enough. You can’t be on the Vietnamese’ backs every minute, every day, doing things. You needed some space for the Vietnamese to accomplish something without looking over their shoulder, although they did things best when you were looking over their shoulder. Nevertheless, you needed some back-away time, and I had none because I was always with them. About that time came the big push on reducing the deadline rate.

We had a deadline rate, which must have been on the order of 45 percent of our equipment. I mean, it was terrible. The battalion had just finished a project down near Dalat. It was the Camly Airfield, and a lot of the equipment on the deadline list was down in the city of Nha Trang and some still at Camly—at Nha Trang because that was the maintenance depot, and they’d never been brought forward. I mean, I’m talking about 12 to 14 items of the battalion. So, I started trying to figure out what I could do about reducing the equipment deadline. I began to move, then, around the Corps’ tactical area to find the problem, and I talked to my boss, Major Nagata, to try to attack the problem.

The battalion headquarters company, the battalion’s rear of the 41st Engineer Battalion, was in Ban Me Thuot, and they had their other line company there also. Then the equipment, a lot of it was still strung out in the maintenance chain. So, I started going to Ban Me Thuot, first with Captain Tri and later I’d just go alone, then on to Nha Trang, trying to get stuff out. We probably reduced the deadline rate by getting stuff turned in and off the books down to maybe 15, 16 percent by the time I left.

The other thing I was doing, though, was standing over the battalion maintenance sergeant as he typed up requisitions. That seemed to be the only way—and then we’d almost have to



Captain Kem as an Engineer advisor talking with a local inhabitant near Pleiku in South Vietnam in April 1962.

hand-carry them through the system to make sure the interaction between the Vietnamese system and the American system would deliver a part.

The next major event was rather interesting. We started—"Coalbin Willy" Wilson's concept—a clear and hold operation. We would move into an area, first clear and then put in a security structure and a civil affairs structure to hold it. Like an oil blot, you know, start the blot and then as it moves outward you bring under control more and more of the population. So, he started a clear and hold operation in Phu Yen Province, a coastal province with the province seat being Tuy Hoa. They needed engineers. So, the 41st Engineer Battalion sent its third line company, the one that'd been in Ban Me Thuot, to Tuy Hoa. Then they wanted an engineer adviser almost permanently in Tuy Hoa. As this was my battalion, that was me. So, I flew to Tuy Hoa and joined the advisory team there of eleven to twelve folks, which began and operated this clear and hold operation.

That was a really interesting experience. We moved into Phu Yen, into Tuy Hoa, and lived on the beach, oh, three or four kilometers from the main part of downtown Tuy Hoa. We had a compound there near an old French masonry building. We put a couple of tents outside and tent frames and that was our compound. When we first went there, the Vietcong were in the town at night and the town was dark. With the arrival of the 42d Infantry Regiment to be the operational entity, and then my engineer company from the 41st, the town opened up and the lights came on at night. The Vietcong weren't there and it was friendly again.

Then we moved out from Tuy Hoa to the various other villages. My infantry battalion adviser, compatriots, were taking these sweeps out and going into the various villages with the loudspeakers and interacting with the locals. We were trying to open up the roads and access and fix bridges and do that kind of work with the engineer company. So, it was a very interesting kind of operation. It had some real challenges. How to fix a bridge? I mean, I got out my old engineering handbook from West Point and tried to figure out how many rails out of a railroad you would use to be stringers for a bridge. You look at a cross section of a rail and you don't get much. It's not much of an I-beam—takes an awful lot of them.

Then we could build a bridge for a jeep or maybe a small truck, and so we'd find a lot of bent rails where the tracks had been blown and we'd cut sections. I'd also go down to Nha Trang and scrounge the welding rod so my battalion could use it to cut the rails. You can see the kind of push the American adviser was giving. I mean, I was figuring out what needed to be done—that bridge needs to be fixed; figuring out how many rails we'd need; giving them the design; scrounging the welding rods; and then matching their welder with the steel with the rest to get the job done. This was going on in all branches and MAAG detachments. I mean, everybody was ad-libbing, creating and putting these kinds of things together.

So, now my activities had changed, you see. You started asking about activities. At one point my activities were, on a daily basis, awfully boring day in and day out. Now, my opportunities changed so I would fly from Tuy Hoa back to An Khe, spend a day or day and a half there checking up on the airfield and the road, then I'd fly down to Ban Me Thuot at the battalion's rear, figure out where they were with all their records and maintenance at the headquarters, then I'd fly to Nha Trang, go into the maintenance depot or the supply depot

and try to facilitate the moving of supplies or maintenance, then I'd fly back to Tuy Hoa. I was spending most of the time in Tuy Hoa because it was more operational there.

I would make that round robin at least once a week, maybe twice, always trying to hitch a ride on the Corps' shuttle of the Otter, or maybe with the H-21 helicopters when they would be flying. So, I was always hitching my own ride to make all that happen, even though I did have a jeep and a Montagnard driver that were either at An Khe or Pleiku. He didn't speak English or Vietnamese or French. We spoke with sign language. It was difficult to tell him I had to be back here at eight o'clock Monday in sign language. So, I was expected to work out the schedule, the activities to do them, and to report periodically to the major or colonel—but do it. Without doubt, within the American advisory chain there was a feeling of chain of command and “make it happen.”

Q: That was your responsibility, then, to get things moving.

A: When things didn't happen, then they were highly critical. So, it was a very interesting time. Every night I'd go back into that compound, and it was growing now in size, maybe it was up to 40. One of my roommates back there at that time was Robert Shaplen, who was writing a lot of articles for the *New Yorker*. We kept getting bigger, but for a captain, the headquarters was not the place to be. Once I got back there then maybe the generator failed, and they'd look to me as the engineer present. So, you were really better off out in the field—that was pretty apparent. You had to do your mission in the field. So, I came back to Pleiku less and less.

Q: So, most of your time was with Vietnamese engineers, not very much time with even American advisers, other American advisers.

A: That's true. Well, in Tuy Hoa, of course, I was with other American advisers, so we were in that advisory compound, and when we were there I would participate with the group. Our leader was a major, and so here's a major and maybe another major and five or six captains and four or five sergeants. Most of the time the infantry advisers would have a sergeant in the system. Engineers didn't. We engineers were doing our own creating of the plans and putting together what we were going to do, but it was rudimentary by the standards of command and control and everything else.

For example, at Tuy Hoa our basic way of communicating to the outside was a single side-band radio, and we couldn't contact a whole lot of folks. The Otter aircraft flying the regular shuttle route around from II Corps headquarters would fly over our compound, waggle its wings if it was going to land, and we'd have to drive to the airfield near Chop Chai Mountain to meet it. This was because no one lived at the airstrip. If you wanted that airplane to land when it came over and gave a low buzz, you had to throw out a smoke grenade. Otherwise it would go on if it didn't have anything for you. I mean, we're doing smoke signals for communication about whether you needed it to land or not.

Q: The advisory role with the battalion, the Vietnamese battalion commander, must have, as you've indicated, a lot of tact and skill at interpersonal relations with limited language

abilities on both sides. It must have been a difficult job because you didn't want to take command of the battalion, I presume, you wanted the Vietnamese captain to. But you had some very definite ideas about how he was doing things and some goals in your mind about how to work, so all of that required a lot of initiative and skill from a captain, I would think.

A: Well, without doubt. You described it very well. I came out of the 23d Engineers, which I've described—a can-do, mobile, heavy warfare, think on your feet, on the move, kind of operation. That's what I had been taught. Now I still had the same kind of can-do thing and wanted the battalion to do all of those things—but I had to bring it out of somebody else; it had to be their idea.

Not only that. We were there for seven days a week, and the Vietnamese didn't work the weekend or didn't fight the weekend. I mean, war to them had been going on for a long time. If you never took a day off you were never going to get a day off, so when a war lasts 20 years, I mean, you look at it differently than when you're there for a year and you want to accomplish something. So, I had the sense of wanting to accomplish the mission, but the accomplishment had to be through my cajoling, persuasion, break down the obstacles, and that sort of thing. So, it was a rather sporty course.

Q: How would you rate the Vietnamese officers? How would you rate the enlisted men in terms of training and initiative at this stage of the war?

A: Well, the officers were certainly in the higher class. They were very well educated, seemed to be well motivated, seemed to know basically what they were doing. There was no obvious noncommissioned officer Corps as we know it here. There were noncommissioned officers but they weren't take-charge people, and the soldiers didn't have any particular skills. They were put there and they did the kinds of jobs—they'd been maybe taught to run a dozer, but the rest of them were really laborers.

They spent their day, a lot of it, just in basic housekeeping. Up at the culvert factory, when we woke in the morning, soldiers had to do their own breakfast. There was no mess hall that'd been up for an hour and a half getting it ready so you could go in, eat, head out for physical training, and then hit the job site. The first thing they did was start the fire and then go figure out what they were going to eat for breakfast and then cook it. In the middle of the day they had to knock off the job for lunch, then the siesta. At night they had to knock off early enough to be sure they could eat before darkness fell. So, there weren't many productive days in that garrison kind of atmosphere.

The troops got their rations by getting doled out rice. The commander would be given money to buy chickens and pigs or something and issue that out to the troops, who'd have to carve it up, issue it, and cook it on their own. So, there was an awful lot of motion spent in just living, without being productive on the job. When your upbringing is "can-do," knowing what the 23d Engineer Battalion could do, you get a little frustrated with that.

I should move from there to say that after about eight months, more advisers had arrived, things were maturing, and we had a lot more people over there. There were some

reorganizations. Major Nagata came back to the United States and I replaced him as adviser to the 20th Engineer Group. The 41st now had changed its designation to become the 201st Battalion, and we had a 202d Battalion and a light equipment company.

My motivation was not to get caught up like Nagata had by being the assistant Corps post engineer in the main compound, which by now was up to 400, 450 people. It was getting to be a sizable responsibility, and I didn't want to get captured by the headquarters. I figured I'd better stay out with the troops, so we established a compound near the engineer group headquarters at a place called Suoi Doi. That was at a crossroads that was about one-third of the way from Pleiku toward An Khe.

We operated from Suoi Doi. The group commander was Major Chan, and that was an interesting four months because, as much as I had to cajole before, I now had a completely different kind of person to deal with. I now had a very political counterpart who spoke relatively good English, but it wasn't just a matter of persuading and making it seem his idea. There were these agendas and intrigue because he was tied into the Vietnamese political chain. He was tied close enough that he could follow what the Vietnamese command wanted to do, and it was not always easy to decipher what that was. There were lots of "I agree," and then lots of nonaction.

What became apparent was that maybe some of the nonaction I'd seen down in the battalion earlier had been because his instructions to the battalion commander were, "Don't do that." So, this was a period where we were often arguing, often persuading—very interesting kind of period.

It also marked another episode that had historical ties to what later happened when the country collapsed because, if you remember, the collapse was precipitated when the II Corps commander decided to withdraw his Corps to Nha Trang. They started overland, down toward Cheo Reo, then Cung Son and down to Tuy Hoa. Years later when I read that was happening, my comment was, "They'll never make it." They didn't. They were really carved up by the Vietcong as they made that withdrawal. In the late fall of '62 when I was an engineer group adviser, we were told to open that road, the same road that the Corps was going to try to withdraw on later on.

I made the initial recons. It was not bad as far as Cheo Reo. From Cheo Reo on to Cung Son, though, it was basically a trail, and then we had the Song Ba River, which came south from An Khe and flowed through Phu Ban Province. The Song Ba was quite wide and flooded considerably in the spring and needed a lot of bridging. Beyond the Song Ba River on the way to Cung Son—this is where I said I knew they'd never make it, later on—the old road was no longer even two beaten wheel tracks. It had overgrown down to one sandy path. As we cut the road, we would have to send people in to clear and grub by hand and by dozer as we would try to just scrape away the tremendous growth that happens in the highlands during the rainy season.



In August 1962 the 20th Engineer Group of the Army of the Republic of Vietnam was opening a road from Cheo Reo to Cung Son.

You know, there are two different monsoons, and so you'd have six months of dry season where all the foliage would almost go away it'd be so dry and hot, and then six months where, at least for the middle four months of the six, you'd really have almost a constant mist with a rain squall moving past about every five minutes for a duration of five minutes. So, it was almost constant rain. Then the foliage would just grow up to overhead height, just like that. Now we were cutting a path through the jungle, a plateau kind of jungle, not triple canopy but heavy foliage, to restore this road—really, really heavy work.

It overgrew at least twice more after I left and before that Corps commander decided to withdraw down that road. So, to think that he was going to pull out his Corps headquarters, all of his combatants and all of their families, down that road and make it in quick time—there's no way. When I read about it, it was obvious the Vietcong just chopped them apart, came in close and hit them from the side again and again, and just kept picking away at them all the way down that road until, by the time they got to Tuy Hoa, there were just elements remaining.

We did a lot of ad hoc engineering on that route in our time. On another river, not so wide, we found old French pontons. We sank them, filled them with rock ballast, and built a combination M4T6 and timber trestle bridge over the top to restore the road.

One other thing that occurred at this time was the thing I mentioned about their other agendas. We really needed to get some rock on this road. They had a rock crusher in the 20th Engineer Group. The United States had bought it, the same kind we had in U.S. engineer units, 75 tons per hour. I wanted that rock crusher down at Cheo Reo to produce rock for the road. They were producing rock for the road by hiring a contractor who put about 50 women and children up on the hillside who would chuck the stones down to the base of the hill. Then they'd squat on them with these little ball peen hammers and break them up into the right size. So, we'd get enough rock to do a few hundred meters every now and then. My American can-do approach caused me to figure out how we could do it faster. I wanted to move the rock crusher and the trucks that the United States government had bought and give them to this engineer battalion down there to operate and build that road—get it finished and get out. Mission accomplished.

I was really being stonewalled. So, I tried at the battalion level. I tried at the group level with Major Chan. It was always, "No." We finally came to the conclusion that the Vietnamese goal was not to use that rock crusher and wear it out, but to keep it for that day when Americans might be gone and all they would have left were these things. There also may have been the goal of, "Let's keep the contractor out to deploy the locals to build the road."

We worked that at every extreme. We had the senior Corps adviser, now Colonel Wilson's successor, Colonel Hal McCown, who, interestingly enough in your readings of *The Damned Engineers* and MacDonald's book, was captured at La Gleize during the Battle of the Bulge by Joachim Peiper and held as a hostage and taken with him when Peiper pulled out and abandoned his equipment at La Gleize. Anyway, this Hal McCown was our senior adviser, and Major General [Nguyen] Khanh arrived to be the II Corps commander. We all knew things were going to be better because he spoke wonderful English. Later he briefly became Chief of State, you may recall. Now we really had some folks who spoke wonderful English, and they were interesting, but they all had their own agendas. Trying to figure out just what those were and dice them all together was sporty work for those of us who were advisers. Anyway, I had Colonel McCown working on Khanh to tell my group commander he had to take that rock crusher to Cheo Reo.

Then we turned to Saigon and the senior advisers there on the engineer side of the house to work with the ARVN's Chief of Engineers. We tried every way to get that rock crusher down to Cheo Reo and never did succeed. The senior Corps engineer had changed about halfway through my tour, about the time that I went to the 20th Group. Major Casper Bisping came in to be the senior engineer adviser, a fine gentleman and good officer. He was one of those that I was appealing to for help and he was very helpful in trying to make all these things happen. So, my final delivery to him, as I walked out of the Five Oceans BOQ in Saigon to come home, was a six- or seven-page missive on why Major Chan was not supportive of the war effort and should be relieved. That was the American viewpoint; that wasn't necessarily the Vietnamese viewpoint.

Q: I know there was a variety of attitudes, but how would you characterize the attitude of the Vietnamese officers and the soldiers you encountered? Had they seen it before with the

French and this was simply another group of people they had to deal with, or do you think they felt differently about the Americans, responded differently during this period?

A: No, we weren't just another group they had to deal with, certainly not. First, they were strongly anticommunist and strongly supportive of their government. Of course, I'm talking about the officers now, and they're part of the government. They appreciated the Americans being there. They liked the French, though, too. I mean, there wasn't an anti-French thing. Captain Tri liked the French, and he spoke fluent French, taught by the French. He was strongly nationalistic; Lieutenant Can spoke the same way. I ran into Lieutenant Can on my later tour. I'd say they were Vietnamese—make it South Vietnamese—patriots.

The kind of negative aspects I mentioned were probably due to the cultural differences between the East and the West. They looked at things more for the long haul, "We're going to be doing this day in, day out. Yes, I know that we need to do this; however, I don't necessarily need to do it today."

Second, they had to win in their own environment. They didn't want to lose. They didn't want to fail in their structure. If we recommended something that put them at risk, then they in a rather human nature kind of way would push that aside. They might not tell you, "No," but they wouldn't do it because they knew it was against "policy." They would be at risk for something in their own hierarchy.

I got along famously with Captain Tri and Lieutenant Can. I thought we saw eye-to-eye on the world and doing things. Their understanding of what could be done over a period of time and mine were quite different because I had been places and I had seen what equipment and troops could do. They hadn't been places where they could see that same kind of thing. So, that's why I was there to advise them. "If we give you this amount of equipment, we ought to be able to achieve this result." They didn't have that perspective.

So, as long as I remembered that they had their own chain of command that was giving them orders too, then I could keep things in perspective. I thought with Tri and Can that I was respected for what I brought them. Certainly when Lieutenant Can, years later, came back to me and gave me a plaque, he was disturbed that they had never done such a thing for me when I left the battalion. So, I think we had the kind of professional rapport that you would have with soldiers anywhere.

The group commander, though, was as sinister as you could get. I think he respected me for whatever talent I had and more respected me because I represented the Americans and was the source of the money that came in to his arena and the wherewithal they had. He wanted to use my position to help what he wanted done, and then keep me out of the way of things that he wanted to meet their agenda. The higher levels, Major General Khanh, the Corps commander, I think certainly had his own aspirations for the country. But, yes he was a pretty good Corps commander and got around in all kinds of ways, thinking, providing leadership, and was certainly more dynamic and made decisions where others hadn't.

Now, what the Vietnamese soldier thought? I never could really talk to soldiers. I would see them around working, but with the language problem and everything else, everything I had was filtered by the officers. They'd do their jobs, they'd go into the face of fire, they'd do all kinds of things, but what they were thinking got lost in the translation.

Q: When did you leave Pleiku?

A: March of '63. So, I was there from March '62 to March '63.

Q: How had your perspective on Vietnam and the war changed or developed in that time, from, like most Americans, not knowing much about the country or the effort there, and it was a very small effort at that time. By the time you left in March of '63 it was a much bigger effort. Getting to be, I guess, a more complicated political situation in South Vietnam, though that may not have come down to—

A: It hadn't developed yet. All of the things later—self-immolations and the Buddhist uprisings—were not apparent to me up in Pleiku if they were starting. Those were Saigon phenomena. We didn't yet have all the coups—[Ngo Dinh] Diem was still in power. We didn't even sense negative feelings or know things that the folks who were in the senior advisory positions would. We saw some of our senior advisers out in the field. General [Paul D.] Harkins came up two or three times when I was there, sat down and was briefed by everybody.

Once, when I was in Tuy Hoa, a plane came over and waggled its wings and we went to the other airfield, the big airfield, because it was a Caribou. It was General Harkins and the Chief of Naval Operations. We saw four stars on each shoulder of two people, sixteen stars looking at us when we roared up in three jeeps. The Caribou had got off the runway, nosed over and buried its nose wheel into the sand. We took them back to our compound and started briefing them. General Harkins said, "Go get me an airplane." Well, I described to you earlier how we communicated. You just couldn't go out, radio, and get an airplane. Luckily, after about a half an hour of briefing, our regular shuttle came in. I ran out and I threw about eight smoke grenades to make sure that pilot knew that we needed him to land. We drove out to the little airfield and General Harkins says, "I'm commandeering this aircraft." The pilot said, "Yes, Sir, by all means." The two of them flew off and we said, "Phew." Big relief. We didn't need all those stars around our little compound.

So, then I made some trips down to Saigon here and there. It was very interesting. I got to see friends like Jim Ellis, who had arrived by that time. I mentioned to you before that we had interacted several times. We'd been together in Germany in the 23d Engineers, when he transferred from infantry to engineer, and been together in Illinois at graduate school. He had arrived at the University of Illinois a little later than I had, so I went to Vietnam first. He'd come over that summer when he'd finished his degree and was a battalion adviser down in the Saigon area.

Even my wife came over once during that period. Her mother had died and her father had brought her on a round-the-world trip. I got leave to go to the Philippines, Tokyo, Hong

Kong, and Bangkok with her for about three weeks. She had come in advance, so I'd flown down, and then we spent one or two nights in Saigon before we caught the rest of the party in the Philippines. So, there were other opportunities to get to see things.

I did manage to get around in the II Corps area. Nha Trang was certainly a lovely town with a great bay. I always thought that our hotel corporations would make that a great resort after the war because you could wake up in the morning and there was the beautiful lagoon and the islands off to the side. Of course, I was often at Nha Trang Airport too, flying out. I mentioned I flew the shuttle, but also I would fly the Air Vietnam commercial plane from Nha Trang to Pleiku. Often we'd be sitting on the runway, or in the terminal up on the second floor having an orange drink, and we could watch T-28s strafing Vietcong positions on a hillside down at the end of the runway. The T-28s were probably piloted by Vietnamese with American advisers. There were a lot of interesting things so early in this phase of the war.

We could go on an operations sweep out of Tuy Hoa, going out into the rice paddies southwest of the city, and we could see the columns of smoke rising from village to village announcing that we were approaching. We would get into the thicker jungle and come on a Vietcong training facility, a rather well-developed training facility.

Now, all this was additionally interesting because years later, when I went back to Vietnam, I went back to Phu Yen Province and back to Tuy Hoa. So, when we get to that point there'll be references back to these same kind of things.

It was a very interesting tour of duty. Many things I had to develop on my own initiative. I learned a lot about people and myself. I also just about had to arrange flights myself on my own initiative to get from one place to another to make things happen.

I remember our dismay at the Air Force at that time because as C-123s would come in to Pleiku, although we badly needed to hitch rides someplace, we couldn't fly on a C-123 unless they had parachutes. They invariably didn't have extra parachutes. When the Army Caribou came in, we could hook a ride anywhere they were going and they'd be happy to take us without a parachute. So, my way of life really depended on deciding where I was going, and then trying to figure out what flights were going and when, and then hitching a ride and making it happen. I would hitch around the area of operation so that I could be at the right place to influence and make an action happen.

Q: When you left there, were you optimistic about the situation in Vietnam? Did you think things were looking pretty good?

A: Yes, I'd been involved personally in one of the clear and hold operations that was being touted as the way the new pacification program was to work—more strategic hamlets. That's what we were doing, establishing strategic hamlets in Phu Yen. We felt that we were seeing the effort expand. After all, we turned on the lights in Tuy Hoa and we were turning on the lights in the villages, and people seemed to be responding. We knew there were still Vietcong around because of the columns of smoke out on the fringe, but we were pushing

influence outward. We didn't have any U.S. units and little of the aviation had arrived. All that was to come later.

When I left, I thought I was leaving something that was on the right course. By the way, I wrote an article for the *Military Engineer* on "Engineers in Clear and Hold Operations," which was published, I guess, in November or December '63. The article recounted briefly my experience and how you'd use engineers in the kind of operation we had in Phu Yen Province.

Q: Were you solicited to do that or did you write it up and send it to them?

A: I wanted to write it because I felt I'd been in something unique and it was early. Now all kinds of my friends were going over there to have this same experience of being an engineer battalion adviser, so that was my motivation. I submitted it to the Society for American Military Engineers and the editor sent it back, greatly edited. So, I wrote a strong letter back saying, "You've really edited so much, you've taken out the context. So, either we put a lot of it back in or I don't publish it." I suggested some things to go back in. Obviously, he also had some good points in what he said. I got to expand the article again. He gave me another half a page, took out a picture, and I re-edited his editing. Then we came to a satisfactory agreement as to what should be in the magazine.

Q: That's interesting because it's in this period of the early '60s that the Army's trying to come to terms with the concept of counterinsurgency as a method of warfare, how to do it and the engineer's role in that.

A: That's right. We were all reading the books. Bernard Fall's book, *Street Without Joy* was sort of a bedside table bible. Later I got into John Thompson's book on Malaysia, and we had a lot of the novels that I really enjoyed coming out of the French Vietnamese experience. Jean Larteguy's book, *The Centurions*, described the French airborne at Dien Bien Phu and the bitterness of the lessons that they took out of that. This was followed by his book, *The Praetorians*. There was another book too that described their thoughts about operations over there. So, I did a lot of reading before, while there, and afterwards concerning all of this kind of period and how you put it all together.

Q: What was the attitude towards the French on the part of the young American officers who were there? Was it their feeling that, "We can see how they messed the situation up and we can do better," or—but you said you also were interested in the lessons learned from the French experience, which had been pretty negative.

A: No, I don't think it was negative. I certainly didn't have a negative feeling, nor do I recall that sort of reaction on anybody's part. I guess I felt they were led to an experience in which they never had the wherewithal to succeed. I mean, you have to figure the lessons we had later, that they covered twice the area, all the north too, with many fewer capabilities. It was only when you sit there and evaluate the task that you understand the futility of their task. You see, Phu Yen Province is where Navarre's Operation Atlantis came ashore. He put people ashore in an amphibious assault, but if you look at the areas on the map of what they

attempted to achieve, they go way inland. Then when you get a feel for the terrain you say, “My goodness, how could anybody anticipate doing that?” I mean, you don’t do sweeps of whole units in the World War II mode in Vietnam.

They didn’t have the helicopters. Ours were still fairly rudimentary when we were there. The best we had to start with was the H-21, a pretty nice helicopter, but just a few of them. They had less than that trying to sustain things as deep as Dien Bien Phu. Figure out how far Dien Bien Phu is from Tuy Hoa—they really were extended. Look at Mobile Group 100. That was just one mobile group, and a pretty good one, but it didn’t have the air cover like we have today or the helicopters or the ability to reinforce. When they were caught at Kilometer 15 on Route 19 it was their own battle—how they fought their way out of that ambush or not. There was no help to be gotten.

So, my feelings toward the French were not negative at all at the local tactical arena. Maybe the lesson there was that nationally they never put into it what was needed to go at it and everyone lost faith. That was our own experience later on when the country turned down the war. We never had done enough across the border to assure a win.

So, to answer your question, there was never a negative feeling toward the French. They had their situation. They were more austere, less prepared. We were better prepared in a smaller area, and we knew more about it because we had their experience. So our typical can-do approach was, “We’re smart enough to figure this thing out, so let’s figure it out and go at it.”

Q: Anything else about the Vietnam advisory period? It’s a very interesting period because it’s so early.

A: I guess I could mention one other thing. We had a senior engineer adviser in Saigon, and at least toward the latter part of that period that officer had developed more influence. He pulled people in from all over the country to try to come to grips with engineer issues: “What else can we do? What more can we do?” He convened a senior leaders conference where he pulled people in to get their ideas. I remember, as the deputy Corps engineer and the 20th Engineer Group adviser, going down to Saigon and participating in one of those. We tried to bring the best of our ideas to bear, and so we would share information about our experiences. I think I needed to make that point, that it wasn’t all just Corps on down in the engineer advisory business. That was certainly our emphasis. We were in an executing kind of mode, but there was this attempt to pull out lessons learned, and determine how we could do things better and what else was needed.

Q: Another question. At the time did you consider this a good assignment? Was this considered a good assignment?

A: I certainly didn’t go there thinking it was a good assignment. Like I mentioned, I thought I should go to Korea because I knew I needed to have a company command. It was a frustrating assignment but it was satisfying. By the time I left, it was pretty obvious this was where the action was. So, I came back from having been one of the early officers there where

the action was. That manifested itself in a couple of ways. One was the fact that I never did get to be a company commander. I came back from Vietnam and they asked me what I wanted do and I said, "I want to go somewhere and be a company commander." Even then you understood you needed to be a company commander. Then they sent me to the Chicago District. I said, "There's nothing wrong with the Chicago District but, guys, I need to be a company commander." They said, "No, you have plenty of time for that."

So, my friend Jim Ellis, who, as I mentioned, had almost a comparable career to this point, got ready to come back and they said, "You need to be a company commander." Wait a minute! So, classmates at West Point, 3d Armored Division together, Vietnam together, civil school together, I mean, how can what you've "got to do" be so different? Besides that, though, they were correct with him, but not with me. So, anyway, I went to the Chicago District. He went to company command.

The second manifestation was that it was okay and a good assignment because after I'd been in the Chicago District for a couple of years, the promotion list to major came out and I was on it, below the zone, as was Jim Ellis. So, you say, "Well, what about company command?" The answer *was*, I was an adviser in Vietnam, and so there was a recognition of that experience at that time. I'm not recommending that today—not commanding a company is a very precarious position to be in. It is that important. In those days, with Vietnam being what it was and because the battalion adviser was recognized as a very close to the action kind of role, it was a good assignment. As I mentioned earlier, it was a good assignment from the standpoint of satisfaction and feeling of contribution.

Chicago District

Q: The Chicago District was your first civil works assignment?

A: Yes, as I mentioned before, I met my wife Ann when she was coming from Illinois to Germany. So, we met in Europe. "Join the Army, see the world," the saying goes. Then she spent our first three assignments back in Illinois, her home state, that being the University of Illinois, then she stayed at home in Waukegan the year I was in Vietnam, and then we were reassigned to the Chicago District. So, her first three assignments were right in Illinois.

Q: So, you got there, then, in March or April?

A: I think it was still March when we reported in.

Q: Of 1963. Went in as executive officer?

A: Yes.

Q: Colonel Joe Smedle was the district engineer.

A: He left that summer. Most of my time there was under Colonel John Mattina. Lieutenant Colonel Ken Hartung was the deputy district engineer. Brigadier General Rogers was the North Central Division Engineer.

That's where I again learned it's not good to be too close to the flagpole. I'd go down for a routine bid opening and there would be General Rogers in the back of the room, ready to critique how I opened bids.

Q: Everything right there at Chicago. So, this is your first civil works assignment?



*Captain Kem, Deputy District Engineer, Chicago District,
and Ann Kem in 1965.*

A: That's right, first district assignment. I should explain, the Chicago District at that time was not the very small Chicago District of today. It had some 1,400 people as opposed to, I believe, about 130 today. We had military construction responsibilities and we also had procurement responsibilities. This was before the Defense Logistics Agency was established, and we bought all kinds of things for the Army that later were to be procured by either the Army Materiel Command or the Defense Logistics Agency. We also had sizable civil works responsibilities: the entire Wisconsin coast of Lake Michigan, the Illinois Waterway, and over in Indiana we had the Dunes State Park, with the "Save the Dunes" issue, and Indiana Harbor. We had the Cal-Sag Waterway, the connection between the Great Lakes and the Illinois Waterway leading to the Mississippi. Thus, we had the lakes level issue, where the

water level has gone up and down several times during the years. I was there during a down period. So, it was a very interesting time for me.

Q: That was quite a transition, engineer adviser in Vietnam to exec in the Chicago District.

A: Sure, after you live in a mud hut for a while—

Q: Went swimming with the liver flukes.

Q: Liver flukes, and had the creatures running over the mat ceiling.

A: You got to have a balanced meal too.

Q: That's right, no peas for breakfast.

Q: So, there was a lot of boning up needed pretty quickly, I guess, when you got to Chicago, the district itself?

A: No, the executive officer position was one where you're working in the command group and it's paper flow, and they did that on purpose. It was supposed to be, as the Corps was doing back then, a developmental assignment. The Corps really did a pretty good job back then of trying to get all engineer captains, especially out of civil school, back in the districts to have that experience. They had not done it in Chicago for some years before I arrived because they thought the area was too expensive.

Why I got to be the guinea pig, I don't know, because it was still too expensive when I was there. Since it cost a lot, I lived far out, in Park Forest. I commuted in by the Illinois Central Railroad, about an hour and a half commute every day. The idea was that I'd spend a year in the office and then a year in the field somewhere. It could have started the other way. I don't quite know why the district engineer did it that way except I guess he thought that was the best way. The idea was his that I would be the executive officer. I didn't replace anybody. I became one extra part of the paper flow so I could get the breadth and the perspective of what was going on. I would sit in when the deputy and the district engineer did their things and I could pick up the flavor of what was going on. So, it really was not a dramatic, difficult transition, but designed to move me onto a ramp of learning.

Q: What sorts of problems was the district facing when you got there? Deepening some of the harbors and waterways, I guess, was a concern with the anticipated new generation of ships on the Great Lakes.

A: Well, it's like all district engineers face. They're at some point in the cycle for a whole bunch of general projects. They're either in early planning, finishing plan formulation, in design, or in construction, so some are in all those realms. We were doing a lot of work on the Calumet Saginaw Channel as a connector. We were widening it. So, that included real estate acquisition, widening the channel—that's dredging, plus replacing something like 31 bridges that had to be reconstructed to make longer spans. They were mostly railroad in an industrial

area. So, that was a major ongoing design, construct, and real estate acquisition mission over several years.

Then there were the early planning things, such as deepening and providing breakwaters at ports, like at Indiana Harbor. This one was really enmeshed in the process because there was a threat to the beautiful dunes of northern Indiana on Lake Michigan. This was far in advance of the kind of environmental consciousness in the Corps as today. There was a “Save the Dunes” committee that said, “Don’t let the steel companies come in and build steel mills there,” but the companies owned the land. They were going to do a lot of construction. The Corps project was to deepen the harbor and build the breakwater. The strategy of the “Save the Dunes” people was to prohibit us from deepening the harbor and building the breakwater; then they could prohibit the steel mills from coming in. The steel company already owned the dune in question and could have carved it down. The nation and the Corps weren’t talking environment in those days, and “environment” wasn’t the word used. It was “Save the Dunes.” Put in today’s vernacular, we were talking environment, keeping our quality of life, the things that we think are good for us. We shouldn’t just throw something away in a cause of development.

So, I went to a couple of hearings. I didn’t preside at those hearings, but I was a participant. It was a real eye-opener. So, that was one of the major things the district was doing.

We also had a project to provide safe haven harbors for small boats all up the coast of Lake Michigan on the Wisconsin shoreline. That was a considerable endeavor with many town meetings and planning sessions.

After I’d been there a while the district engineer tried to get me out and involved in doing other things. However, Colonel Ken Hartung, the deputy district engineer, was alerted to go to Vietnam and all of a sudden it was decided that the deputy position would not be filled. We would only get two officers per district. So, John Mattina was left with this captain to be his deputy district engineer. That’s how I got to be a deputy. What that also meant, though, was I was not going to get that second year of experience in the field. My one year in the office was going to become two, executive officer, then deputy. It had both good points and bad.

I didn’t get to go to the field—I’ll talk about that in a minute—but I did get to be the deputy with that substantive kind of role and greater responsibilities and understanding. I now was dealing with resources and allocations and all the rest, rather than just being an exec and passing papers.

To cover this loss of the field experience, before Lieutenant Colonel Hartung left, they sent me for a month on the Illinois Waterway to get a feel for waterway operations. So, I worked at Joliet Lock and Dam. On the lock wall I was passing tows through—handling the lines and working the buoys, and then the machinery as we’d lock the boats through. Then I went out for a week with a maintenance crew as they repaired tainter gates and sent divers down to go through the lock culverts. That was a pretty neat blue-collar experience that later on, when I

was division engineer in the Ohio River Division, the operations folks would come up to talk about the need for maintenance, and I had a first-hand feeling for it.

I was also sent out to be the district's representative on the master planning board down at the Granite City Army Depot in the St. Louis area. I was sent out not only to show the green-suit side of the district, but also for my development, to give me some experience in that arena.

I also spent a month with real estate, working two ways. First, we had a relatively weak Real Estate Division and the district engineer wanted to get an extra set of eyes and ears down there to figure out what was wrong. Second, I went down to help them, too, with trying to come to grips with some of the acquisitions along the Cal-Sag Waterway.

They sent me to the Savannah Army Depot in Illinois on the Missouri River. There was a housing project over there, and I became the project manager, in the Engineering Division, to get that design under way. We had a cost limitation and I was—my salary was paid by OMA [Operations and Maintenance, Army]—I was free to the project. That was a separate motivation, but for me it was an extra valuable experience.

Because I was going to be the deputy and not have the opportunity now to go out for field experience the second year, the district engineer put me into each of these experiences so I'd have a broader feel for district operations.

I should mention that General Rogers was replaced by a person at that time who really became a long-term mentor for me, a person I greatly respected. That was Brigadier General Bill Gribble. He came out to be the North Central Division Engineer but spent, I guess, only several months there and then was pulled back to be the Deputy Chief of Research and Development for the Army. He certainly was to figure in my successive career numerous times.

Q: That's quite an assignment, to be 28 years old, and a captain, to be a deputy in a district of 1,400 people. Pretty unusual.

A: I had an accelerated learning experience, there's no doubt about it.

Q: In Chicago?

A: In Chicago, right.

Q: Did you learn about Chicago politics as well?

A: No.

Q: Not so, hanging around the head office?

A: No, I didn't get involved too much with Chicago politics, nor did the district engineer in those days. We were all active in the Society for American Military Engineers. I remember getting really involved there. On the home front, our second child John was born.

Q: You mentioned earlier doing quite a bit of military construction work in the Chicago District during this time. What sort of projects were going on there?

A: I don't recall many of the military construction projects. The Savannah Depot one I mentioned. I remember another big real estate activity we had at the time was at Camp Atterbury, Indiana. This was where I really became involved in the politics of things and sensitivities. There was an outfit called the Amateur Rocketeers of America. They wanted to build model rockets and have a firing range at Camp Atterbury and set them off. They had a very aggressive entrepreneur who was heading that organization. He had written to ask for these approvals, and he had been denied repeatedly by us because of safety problems. He had called upon political friends to bring pressure on us to yield to his wishes. I was designated—this is when I was deputy—to be the point of contact to deal with him. The district engineer would not talk to him, and each time I talked to him we had the district counsel in the office.

We started referring to this person, in jest, as the “Amateur Rocketeer of America” because he really was fleecing a lot of people. He published a magazine, supposedly monthly, which came out about every time he felt that he needed more contributions. We were very concerned with safety. He was going to take kids out on Army property and going to fire rockets—I mean, we're not talking about your everyday model airplane club.

We had asked him to submit plans on how he intended to take care of safety, and he would submit plans for a block house. We would evaluate the engineering and come back and say, “No, that's inadequate. You need glass ports. Viewing ports need to be this size and this thickness,” and all these other things. He would argue back and then he would advertise that there's going to be a great rocket firing on X date. There was no way we were going to give them permission to build before that date. Then he'd bring pressure on us to let them fire anyway in spite of the fact that safety construction hadn't been done. It was really tempestuous, and he was really trying to put the Army out on a limb. He wasn't so worried about his own limbs or the limbs of the youths that he was going to bring out there. So, he advertised and marketed a greater game than the operation that he followed up with. It just happened to be on a military installation, inactive as it was, but a problem for us.

I'm trying to think of what other military projects we had.

Q: An ordnance facility at Joliet during this time?

A: I don't recall work there.

Q: What about work for others? Were you working for any other agencies?

A: Not that I know of.

Q: Not any other work.

A: We really didn't use that term, work for others, back then like we've picked up in the lexicon since then. We may well have.

Q: Would you have had much contact with state agencies, Illinois, or other federal agencies?

A: No, I didn't because, I guess, the Chief of Planning would do those kinds of interactions, like now. Colonel Mattina would do those kinds of things, but I was not involved. We would know that the state of Indiana was at the public meetings we had at Indiana Harbor and for the dunes issue, but I didn't have personal interaction with them.

Q: The Corps ran the public meetings.

A: Yes.

Q: Were you involved much with those in terms of—

A: Yes, I helped put them up, sat at the front table, and helped put them on. I did not preside; the district engineer presided.

Q: Before we move on, maybe we could talk just a little bit more about the public meetings. I've noted later that the Corps' role in that kind of activity in the federal government is kind of a pioneering one, and I think maybe this is a very early example of that kind of thing, and so that's kind of what I'd like if you could address that.

A: Sure. Now, mind you, I was just coming into the civil work business, so as far as I know what we were doing was old hat. I didn't know that we were doing these public meetings for the first time or a second time. I recall that about that time there were Corps publications—I think developed by what's probably now the Institute of Water Resources—on how to conduct public meetings. We had that kind of document and I read it because I was involved with doing it.

For instance, the big one, the famous one at the time because it was such a *cause célèbre*, was the Indiana Harbor, "Save the Dunes" affair. There were strong antidevelopment forces, and there were strong development forces. Our planning folks, who ran the public meeting with great help from Public Affairs, put on what was to be a very contentious public meeting. We were going with the rudiments, and so I was learning. We approached it in a rather structured way. We'd try to take the contentiousness out of it and make sure everyone had a chance to be heard so the district engineer wouldn't be backed into a corner. We were looking for options; we were developing a way and an approach. There were media there; there were people for both sides of the question; and there were other interests, without doubt to include federal and state.

I think we probably ran a textbook public meeting, looking back on it, I would say. What I observed my district engineer run that day, with his staff, was a textbook public meeting.

I went to several others. I remember one incident that had a note of humor to it. We were looking for harbors of refuge for the small boats that would go out and ply Lake Michigan on

the weekend. We went into one Wisconsin town and held a public meeting, and there really were a lot of attendees. A few people got up and said things, but not many.

I remember the Fish and Wildlife fellow, a crusty local. He didn't bring any national or regional or state perspective; he brought the local perspective. To remind you, our district engineer's name was John Mattina. After two hours of meeting, Colonel Mattina said, "Well, now, is there anything else? Anybody else who wants to be heard?" The fellow stood and said, "Colonel Martini, I'm from Fish and Wildlife, and I don't know what I think about this project, but I want to reserve the right to say that whatever it is, when we figure it out, we'll let you know."

So, we all smiled inwardly that we were down here at grassroots America. It was his right to say that, and he certainly put a caveat onto the system in his own way.

Now, there are some who say that Fish and Wildlife hasn't changed to this day, that, in fact, there is no chain, that there isn't a national perspective. Well-meaning as this fellow was, and they all are, there isn't a national Fish and Wildlife perspective that influences them all. It will vary here and there, and there's not a cohesive kind of thought.

Q: At the time, did you see this controversy as anything different? As portending anything for the future?

A: Just to save the dunes?

Q: The dunes, as portending the future environmental movement.

A: No. I'm from Indiana and I've been up to the dunes area on vacations, and so I knew there was a very valuable tract and a lot of people enjoyed the area. I tried to rationalize my position then, but now, today, I'd probably be more adamant on the side of, "Hey, we're talking environment here. We've got to have sustainable development. How can we save the best of all of this stuff? Why can't we do something different?" I think my feeling at the time was, "This is property owned by the steel mill. The steel mill has every right to do what they want with the property." They didn't need the hearing to raze the dune. They could have scraped the dune down from the start, and then there would have been nothing left to debate.

We were trying to talk about, "Do we proceed with the harbor?" The antimill, the "Save the Dunes" folks, probably rightfully, saw that their only hope at stopping steel development was to stop federal funds for a harbor development, which would make it more economically justifiable for the steel mill to build a mill and thereby take down the dunes. If they could stop the harbor, they could stop the steel company and save the dunes.

So, much like today in our Corps permit process, the district engineer is caught in the middle and responsible to make important decisions. Back then, the district engineer did not have quite the same regulatory function, but was caught in his own dilemma of trying to find a solution that would make everybody happy.

Alaska Earthquake

Q: Let's talk for a few minutes about the Alaska earthquake, 27 March 1964, a huge earthquake in south-central Alaska. The Corps of Engineers became involved. How did you become involved in events there?

A: Not initially; it was about six weeks later. Initially, after the earthquake, the Corps responded by sending a bunch of folks up for damage assessment, much like we did recently in Loma Prieta, the San Francisco earthquake. After the damage assessment phase was over, people were put out to do various things and take various parts of the renovation. It was decided, I suppose here in USACE [U.S. Army Corps of Engineers] headquarters, on the request of the North Pacific Division Engineer, that we ought to send some people up there to augment the force. The assessors had probably gone home, at least for the most part. So, five captains were alerted. I was told, I guess maybe Wednesday, Thursday of one week, that "I think we're going to send you to Alaska for a couple of months to participate in the work there as a follow-up to the earthquake."

So, five of us were sent from various parts of the Corps. I met Captain Jack Sullivan, who came out of Tulsa District, in the Seattle Airport as we boarded the same plane to fly to Anchorage. Later Captains Al Hight, Joe Yore, and Jim Scott, all assigned somewhere in the Corps, came up. Colonel Trev Sawyer was the district engineer. What followed over the next two, two and a half months was really one of the most interesting experiences I've had in the Corps.

Q: What was your assignment there?

A: Colonel Trev Sawyer was a great gent, one of the great leaders. He was helpful as a mentor to me, even from a distance, because this was my most direct interaction with him. He started our experience right. Jack Sullivan and I arrived in Anchorage, I think it was a Friday evening. Colonel Sawyer made a car available to us and put us up in the Elmendorf Air Force Base BOQ there. Also, there was a district person to take us out to see the damage in the Turnagain housing area, which was one of the well-pictured things. We'd all seen pictures of the houses that disappeared down the slope, with the great chunks of earth rising and falling.

So, we toured around; we had a real feel for the town of Anchorage and the damage that occurred. We saw the buildings where the slabs fell to the ground and saw the holes where some of them had already been demolished even before we arrived.

Then we were assigned out to various places, and I went to Kodiak Island. The others stayed on the mainland, so I was out the farthest distance. There followed an experience for me that almost could be out of a Bret Harte story.

Now, to set the stage, what happened in Kodiak was that the island dipped about six or seven feet on an angle. On the side of the island where the town of Kodiak is located, a town of about 3,000 population, it dropped about six or seven feet. Then the tsunami, the tidal wave, came roaring in, breached a breakwater, and roared into the middle of town, going six or

seven blocks up into the town, wiping out buildings and carrying the small craft that were in the middle of that harbor into town and depositing them. Some of them were big fishing boats. Even when I arrived six weeks later, there was a huge boat—I hate to guess, 40 feet, 50 feet long—sitting in the middle of the town.

Then the wave went back out, breaching the other breakwater. So, there was no longer a harbor; that is, the breakwaters were down, and all the moorings in the interior of the harbor were gone. I think there were something like 39 lives lost on Kodiak Island itself.

The channel between the town of Kodiak and the island next door had actually gone dry with the pull-back of the water before the tsunami came in. Boats had dropped and hit the bottom of the channel before they were then picked up and swept into town. So, it was a pretty violent bit of energy that hit Kodiak.

My job in Kodiak was to rebuild the harbor. The Corps had a project under our PL-99 responsibilities, which similarly exist today, to rehabilitate work that we'd built originally. So, I was there as the project engineer for the contract to rebuild the breakwaters. The contract provided for the construction company to bring in huge rock and rebuild the breakwaters. That was really the job, but there were other aspects too.

First of all, Colonel Sawyer was piqued at the Navy because the Kodiak Naval Station, maybe Naval Air, was just a few miles away down the coast. Right after the earthquake he called the Navy folks and said, "Look, we've got all these damage assessment people coming up. They're available to come out if you want them." They said, "Sure, send them out." He put them on a commercial aircraft, flew them into Kodiak, and the Navy met the airplane and said, "We don't need you; go home now." They wouldn't even let them get off the aircraft. So, he was really piqued by that because he'd acted in good faith.

So, he said to me, "Oh, by the way, when you go out there, I want you to know you represent the Corps of Engineers. So, we're going to do a bang-up job." I recognized that he wanted to put a little competition into this atmosphere.

So, when I arrived I found out that to get the job started, the contractor had to develop a quarry on the back side of the island to bring the rock down to the harbor. But, as mentioned, my duties were being the Corps of Engineers rep on Kodiak as well.

Now, in the downtown area the damage was being taken care of by other federal agencies: the Federal Emergency Management Agency of its day; the Small Business Administration to provide monies to rebuild homes. Because the Navy was on the island, the Navy was given overall defense responsibility for all of that, not the Corps. When all of these folks would come to town, the fact-finding teams and the architect/engineer firm doing master planning for developing the new central business district—I'd go to all the meetings and participate with them representing the Corps.

I wore my fatigues and my hard hat with "Corps of Engineers" on it. We put up our project sign downtown as we built the harbor right by what had been the main street, so everybody

could see the project we were responsible for. I lived at the local Kodiak Hotel, which had 11 rooms, 3 with baths—I had one of those.

I would get missions from the district like, “We are now designing the new moorings, floating moorings. Go out and survey the harbor.” Now, how am I going to survey the harbor? Well, you heard what happened in Vietnam—piece of cake once you’ve been over advising Vietnamese and trying to make things happen. So, I went to the contractor and borrowed the level and rigged up a sounding weight. By this time the Corps had sent two civilian inspectors out to work for me, so we had two shift inspectors. We set up a weigh station down the main road to weigh the rock when it came in because we were paying by weight. So, we borrowed a small boat and set out and sounded and surveyed that harbor. We then sent the survey back in to the district so they could design the harbor.

This was really a tremendous cultural experience as well because we really were on the fringe of frontier America. The people that were there on Kodiak Island had once been in the West and then migrated up to Portland and Seattle. Then when that became too civilized for them, they moved on up to Anchorage. That became too civilized so they moved on out to Kodiak. It was like reading characters out of Bret Harte’s stories of the Old West. I mean, they were salt-of-the-earth kind of people. The people who ran the Red Cross operation in the immediate aftermath of the tsunami, with its loss of life—the blankets, the donuts, the coffee, the blood—I mean, they did this stuff, and were common, ordinary folks. The volunteer head of the Red Cross drove a truck for the construction company. They picked him up as a truck driver after things calmed. Really neat people. I really liked talking to them.

I would go down to the main bar on Saturday night, which is where the whole town went for their Saturday evening entertainment. Everybody would be in there dancing and sitting at the bar and cutting up, but it was not ventilated. I mean, the smoke, cigarette smoke, was so thick you could cut it. Today, half of our folks couldn’t tolerate it. It was not even tolerable then, and I was a smoker then. Everybody in town was there and you’d see all these people. Then you would walk out of this club at 1:00 or 2:00 in the morning and it’d be light because it was summer and the midnight sun.

I’d take my meals at various different restaurants. One of them was called the B and B, for Booze and Beer. Another one was across the street. I don’t remember the name of it, but I remember it had a sawdust floor. On the one side there was a counter and stools and a few booths, and on the other side there was the bar. Out front on benches would be men who were out of work. During the right season they worked the crab boats—king crab was big on the island. They’d get paid, come in at night and buy everyone a round at the bar. For the other several months of the year they’d sit out there hoping somebody would come by and remember and buy them a drink at the bar. They had great fish to eat there so that’s where I’d have my evening meal, and then I’d walk back to the hotel two blocks away.

It really was like I was living in the Old West. I remember a discussion one night. This one group of folks that I was talking to were so irate because the town had just passed a city ordinance that you could no longer abandon your refrigerator or stove in your front yard. This

infringement on their rights was felt so strongly—civilization was taking over the town; it was time to move on again. So, it really was a neat experience.

Anyway, my job for about six weeks was to work this project, and we did. About the end of my time, Colonel Sawyer asked me to extend another couple of weeks because the Chief of Engineers, Walter “Weary” Wilson, was coming up to visit the projects. Colonel Sawyer thought maybe I wouldn’t mind being there to show my project off to the Chief when he came. So, I elected to stay. We had it all arranged that day. I’d borrowed a bus from my friends at the Naval station, a school bus, the best way to take people around. We were sitting on the runway waiting for him to come in, and then the plane pulled up from its landing approach and took off again. We had a radio call that said they had developed a hydraulic leak and were going back to Anchorage and weren’t going to come in.

I released the school bus, jumped into my little pickup truck, and headed back into town. As I hit the ridge road I looked around, and here comes that airplane in a landing pattern again. So, I whipped around and turned back and roared back to the airfield. By the time I got there the plane had landed, come to a stop, and so I whipped on up to the airplane. What had happened was they were losing hydraulic fluid so quickly they figured they had to come back. They blew all the tires on the landing and skidded to a stop. They were sitting right in the middle of the runway when we pulled up.

So, I didn’t know what to do now. The Navy had sent their officer of the day back, but he was coming back now. He at least had a radio so we could call and get the school bus back. Colonel Sawyer was aboard. As I pulled up, they were all standing around the airplane already, just looking at it, wondering what was going on. So, we conferred and decided we’d go ahead with the inspection trip—somebody better try to get another airplane.

There was a lot of anxiety and people were, you know, a little up-tight. “We’ve got the Chief of Engineers on our hands; what are we going to do with him?” The most calm, nonplussed person about was General “Weary” Wilson, who sat there puffing on his pipe and taking things all in stride like he’d been through it many times before. So, we all got in the school bus and took a tour around.

Two other things had to take place. One was that we had to load all of the luggage, his luggage, onto the school bus. I thought, “Well, this is kind of weird. We’re just going to run around for a couple of hours, he’ll get another plane and then—.” Some years before, he’d been separated from his luggage, and so his standard procedure was, “My luggage stays with me. So, they might fix this plane and take it away and then where am I going to be?” So, we took time for the luggage.

Then there were the fish on board because they’d come from King Salmon and they had a lot of fish in the hold. So, before we moved, we had to do something with the fish, and there were a lot of fish. The Navy scrambled a pickup truck and we chucked the fish into the back of the pickup truck. It was driven into a big drive-in freezer where it stayed while we toured the island.

So, we made our tour, came back, and General Wilson went on his way, and I had an interesting experience.

After that, then, I closed out. We finished the project and it was time to go. One other nice thing happened to me then. Colonel Sawyer said, "You know, if you just stay one more week, now, my new deputy district engineer's arrived and we're going to send him on his introductory tour around Alaska. Since you've been stuck off in Kodiak all along and since you stayed those extra couple of weeks for General Wilson, you know, I'll give you a slot on that airplane and you'll get to see a bit of Alaska you wouldn't otherwise."

That sounded like an awful good idea, and so I did and had a tremendous trip. We went up to Fort Greeley and into Galena Air Force Base, saw those permafrost piles that the Cold Regions Research and Engineering Laboratory had developed years before, that I had read about. It was right out in the middle of nowhere. I mean, absolutely nowhere. From Galena we went to Unalakleet and then to Kotzebue up north beyond the Arctic Circle where they had early warning radar stations that had been built by the Corps. We came south and landed at Nome, thinking of all that I'd ever read about Nome. We saw the old gold dredges still sitting out in the lakes around there. We flew down to King Salmon, flying a little amphibious airplane the whole way through fog, for hours. We landed there, then flew on back into Anchorage. So, I had a really nice trip around, got to see a lot of Alaska, got to see a lot of Corps projects, and got to see the kinds of things you do when you send people out in small groups, out at the end of the supply line to do good work. It was a very nice experience.

Then I flew back to Chicago and finished up my tour as deputy district engineer.

Q: Did you have to do any kind of an after-action on your project or experience?

A: I don't recall. I'm sure I had to write something up to send to the Alaska District. Usually I keep something of everything, and I didn't keep anything from there. So, maybe it was just project notes.

Q: Was the work pretty routine, restoring the harbor? Did you have any particular problems or difficulties?

A: We had difficulties because the contractor was trying to do it on a shoestring. He tried to do the project too quickly. He got into the quarry and pushed his overburden down and then he loaded his shot and dropped the rock right on top of the overburden. Then he put his crane shovel in on top of that, and the shovel sank down into the overburden that he had pushed down there. So, he had a mess and he fell behind schedule. Then his trucks were supposed to be equipped for safety with a secondary brake system. He drug his feet on doing that and kept putting it off day by day till I stopped his project. Four days later he had them all done so he could finish up his project.

I learned a lot about dealing with contractors and working with them. We had to reject many loads of rock because he was throwing in some of the overburden. So, we had to play a little hardball with him here and there.



Brigadier General Raymond J. Harvey (left), Assistant Commandant of the Engineer School, presented the Army Commendation Medal to Captain Kem for his work during the Alaska earthquake in October 1965. Ann Kem is on the right.

Q: In Alaska you got some of the field experience that you might not have gotten in Chicago if you had—

A: That's right. That was the construction piece I did not get in Chicago.

Q: Sometimes there's talk about, for emergency situations like this, identifying key people with experience that could be pulled in to work on recovery. That wasn't part of your going to Alaska, I guess, because you didn't have that experience and you were all captains. Do you think that would be a good idea? I'm not really aware that we've really done that in practice too often later on. I worked on Agnes in '72, our history of that, and they talked about having a "ready district," you know, for people at all levels, and just how it would work. Then when it happened they could go here and go there and people would have the experience.

So, based on this, what would you think about the value of that kind of thing, or does it matter?

A: Well, I'm not sure it really matters. I think it does from the standpoint of knowing, but I think the Corps has got such a great bunch of professionals that, certainly to do the job I was doing, you can take the basic professional and make it work. You're going to go to each district to do that and ask them to identify, as I was identified, five captains. I mean, that doesn't mention all of the civilian professionals that had already gone as part of the Alaska earthquake recovery. I suppose those were done through the system by asking folks to nominate and look for volunteers or look for certain skills just as we do today. So, I think we have the capability to do that very well.

I'm not so sure that any one experience then qualifies you for the next experience. Yes, I'd been through it, but would I know beforehand that you've got to deal with these folks in Public Affairs? It was easily identifiable wherever I was later that I had those kinds of experiences. I think we have the ability to communicate and find out these things. I don't think you can have a ready district or a ready team that's on standby ready to go. I think, as we demonstrated in Loma Prieta by mobilizing 350 Corps folks over a weekend, we can get the right people there in almost no time at all, if somebody alerts us and tells us what they want.

Advanced Course, U.S. Army Engineer School

Q: Around March of 1965, then, I guess you go back to Fort Belvoir for the advanced course, is that correct?

A: Yes.

Q: After having company command, or the equivalent, really.

A: I had not had company command.

Q: Had been an adviser in Vietnam.

A: Yes. Well, by this time I'd come out on the majors list, like I mentioned. Actually, I returned from Alaska and somebody said, "We saw your name on the majors list." I said, "I don't think so." I certainly wasn't aware of lists or eligibility or even what "below the zone" meant at that time, as opposed to today. I guess you get the feeling today like everybody knows where they stand, but that wasn't on my screen at the moment.

So, we got the list and looked it up and I was. I called to verify it, and sure enough that was me. So, then I said, "Well, look, guys, you better get me the company command quickly. I mean, first of all, here I am in my ninth year, I'm just going the advanced course. I'm already late. I really ought to go to company command." They said, "Nope. You've got to go to

Belvoir now, not company command. You've been selected for major, so don't worry about it." So, I went on to Belvoir.

Then, at the advanced course, Engineer Branch came down and my assignment officer said, "You're never going to Leavenworth because you've never had company command."

I said, "Wait a minute. Let's do a little math. We send 50 percent of our officers to Leavenworth and I got selected at below the zone, which is a 5 percent selection. Doesn't that really say that I probably will go?"

He said, "No, that's it. You're not going to Leavenworth."

So, luckily, I did.

Q: Well, I asked this before about the basic course and I'll ask it again, to compare your experience in the advanced course down at Belvoir with what you were familiar with later when you were commandant at the Engineer School. It was longer, I think, to start with, wasn't it? A longer course?

A: Yes. I really enjoyed the advanced course at Belvoir. It was a nice time with my family. We lived in Fairfax Village. There were a bunch of our friends there, folks we would see time and time again, like the Ken Withers, the Bunkers who lived next door, the Barneys. I mean, here was a great bunch of peers, all there at the same time. Chris Allaire sat next to me in class. There was a whole bunch of folks we knew that were all there, so it was a very enjoyable six months. We had two children now and it was an enjoyable time with them.

The course was not overly rigorous, but the course was very good, I thought. I learned some things. I also learned to play golf there. Chris Allaire got me on the golf course, and it was the first place I really took to golf because we had afternoons to be able to do that sort of thing. It didn't have the rigor of the course that was there later when I was commandant. When I was commandant, Jim Ellis had just been commandant and they'd just gone through this whole revamping of the advanced course. He put a lot of effort into it with a lot of people, like "Stretch" Dunn, and really created a dynamic but not easy course that challenged folks—because they said they really wanted to be challenged.

The course that Jim Ellis had developed was in place and I just provided a little fine-tuning and add-ons. We completed the execution that was well under way when I arrived as commandant. It was a much better course than the one I took in 1965. But, once again, I learned a lot of things from that advanced course. The pace was more leisurely; it might even have been more enjoyable.

Q: Did the course at that time include material on the civil works mission of the Corps? Or was it mostly or entirely military?

A: The course at that time included a lot of engineering—I mean drainage, how you design things for drainage. Now it would be TO&E [table of organization and equipment] kind of construction, you know, construction for the theater of operations and that kind of thing. It

had bridge design. It was really preparing you for the theater of operations kind of construction.

It was a lot more engineering than what our course evolved to later, which was the engineers' contribution to combined arms and the overall theater. We had some of both in the more recent designed course. There was just no place that I ever learned civil works from the standpoint of designing dams. You might design buildings, but you wouldn't design dams. Nor did you talk about the planning process that we have now, or operating locks and dams in a system, or anything like that.

Q: I think I've read or heard people talk about there being some of that, but probably not a great deal, in the '30s, in the advanced course in the '30s. I haven't read directly about that, but I think that's interesting, an interesting difference that might be explained by the role of civil works in the Corps in the '30s as opposed to the role in the '60s.

You mentioned several of your classmates were there also in the advanced course?

A: My West Point classmates in that case, or—

Q: Yes. Sounds like there were several of you that were a little out of sync.

A: Yes, Ken Withers, Chris Allaire were both there. Well, you didn't have to go as long as I did. We had people there with four or five years of service. The big driver at that point, in '65, was that we were really starting the buildup in Vietnam, and so people were starting to go and return with the one-year change. So, you might have gone to the advanced course before you went to Vietnam or you might have been delayed going because you went to Vietnam and then came back.

Q: Were you one of the few of your classmates who'd been to Vietnam?

A: Yes. I was one of the few who had been there.

Q: So, you must have been consulted about those—

A: Consulted by a lot of folks who were going there.

Q: Because it's in the summer or fall '65 that some of the engineer units came through—

A: That's right, the big buildup was in '65. Before that time it had primarily been an advisory effort.

Q: I remember reading in some of the Vietnam engineer books about commanders looking around Belvoir for refrigerators to take over. They realized that they probably wouldn't go with enough refrigerators, so they were trying to see if they could find something.

A: Yes, well, when I was at Bragg later, when the engineering units were forming, or other units, they would pack all of those kinds of things in addition to the regular TO&E because

of their recognition that you had to take it when you could. You couldn't expect it at the end of the supply chain.

Q: Anything else about the advanced course that we should talk about here?

A: I was promoted to major there, and we finished up a very nice, but very quick, six months. In October '65 I then went off to the 82d Airborne Division.

307th Engineer Battalion, 82d Airborne Division

Q: How did that assignment come about?

A: Well, my old friend, Jim Ellis, as you recognize by now, had gone back and forth with me here and there. I was before him in Vietnam, then he came in. When I went to the district, he went to company command, then went to the advanced course and then to the 307th Engineers where he was the S-3. He was now selected for Leavenworth because he had done those things and was moving off in the summer of '65 to go to Fort Leavenworth for Command and General Staff College. He gave my name to the battalion commander, who had asked for me as a by-name select to the Office of Personnel Operations. They saw fit to give me that assignment.

So, I went down to be the S-3 of the 307th. That was my supposed assignment. Max Noah was to be the exec. The 82d had deployed to the Dominican Republic, and Jim Ellis had been down there with them, had deployed with them. When I arrived in October they were still there, so I processed in at Fort Bragg and then flew on down to join the 307th in Santo Domingo. I was assigned initially as the assistant division engineer.

That's where I've been so very helpful to—I say in jest, and keep reminding him all the time—to Barry Frankel in the real estate business because my duties at that time were with the Real Estate Office of Jacksonville District. That was headed by Dave Gray, who later was our Chief of Real Estate here in USACE headquarters. I didn't know him at that time, but when I went back as the Ohio River Division Engineer, he was Chief of Real Estate before he moved up here to the headquarters.

As assistant division engineer, one of my duties was to be the point of contact to Jacksonville's Real Estate Office. As real estate requirements came up, we would turn to that office for accomplishment.

When I arrived, there was still a no man's land with barbed wire, sandbags, weapons pointed in anger on both sides, and sniping rounds across the divide in the center of Santo Domingo.

Our 82d Airborne Division headquarters was located at the Dominican Military Academy. The engineer battalion headquarters was in the Trujillo estate, a small villa outside of Santo

Domingo, not far from the military academy. It was probably an 8- to 10-kilometer drive from the academy to the Trujillo villa. It was a pretty nice building with a fountain in front. We put some plywood around the fountain and it became the shower for the troops. There was a small swimming pool on the second floor. It had a huge master bedroom that became the operations center, with a couple of walk-in closets off that where the S-3 and assistant S-3 kept their bunks. It made a really nice command post for the battalion headquarters.

As assistant division engineer, I lived down at the military academy with the rest of the 82d headquarters staff.

My point was there still were hostilities, and 32 lives were lost during the fighting. Consequently, company commanders were changing their command posts constantly. After all, U.S. doctrine says you've got to change command posts routinely, daily, so you don't take artillery fire. So, the way it worked was the company commander of A Company, 2d Battalion, 325th Infantry, would decide he needed an apartment. He would roust the occupants out and he'd take it over and he'd occupy it for two or three days. He'd call the coordinates into the brigade and on up to the division. We reported it to the Jacksonville District, and the district would go over and pay the claim when it was all over with. Now, that was a sort of a hell of a way to run a railroad. So, I got the division commander to put out the edict that, although it was still a hostile period, we really weren't having artillery fire and most folks were probably in command posts that didn't have to move every couple of days to avoid rounds.

The division and engineer battalion were transitioning then. While I was there we had an operation one morning to clear the hostile downtown area. We pulled down our wire, marched our folks forward all the way to the sea, restored all the no man's land, and restored the town to a single whole instead of two sides. With that the 82d started to pull out, leaving the 1st Brigade and our 307th Engineer Battalion A Company. Captain Howard Graves, now assistant to the Chairman of the Joint Chiefs of Staff, was the A Company commander. Lieutenant Colonel John G. Waggener was the battalion commander. We then left the A Company with the brigade, and deployed back to Fort Bragg. So, I was down there about three months.

Q: Were things pretty much—you referred to this, most of the fighting had stopped?

A: That's right. There was still a period of hostilities but actual fire fights—there'd be reports of fire at night and that sort of thing—most of the action, maneuver and fire, had ceased. There was a lot of patrolling around the various areas where Colonel [Francisco] Caamaño [Deño] was located. This was a time when Lieutenant General Bruce Palmer, XVIII Airborne Corps commander, was trying, with Ambassador [Elsworth] Bunker, to bring a rightful government into power.

Q: There were troops from other Latin American countries there too?

A: Some.

- Q: Probably not extensive, not very. The 82d at that time was like today, it remained sort of the force for immediate readiness for movement and deployment.
- A: That's right. America's guard of honor, first to go.
- Q: Was this during the period of Strike Command?
- A: Yes.
- Q: So, that Strike Command was the rapid deployment force?
- A: Yes. I recall going out to Texas, to Amarillo Air Force Base, and a Simulation, Training, and Instrumentation Command exercise with General Paul Adams in charge, for a huge war game exercise. As assistant division engineer I was in the division headquarters cell, in one of the rooms playing the 82d's role.
- Q: Were you assistant division engineer the whole two years you were there?
- A: No, I was for about six months and then Major Max Noah came in to be the exec. I was to become the S-3. Then, with the buildup for Vietnam, he was pulled out to be a part of the newly forming 45th Engineer Group, which was to deploy weeks later to Vietnam. So, then rather than my moving to be the S-3 I became exec, and Major Al Rowe, who'd been commanding the 618th Engineer Company, moved up to be the S-3.
- Q: So, there was a lot of emphasis during this period on training and getting ready, although there would have been all along, but particularly now in training and readiness and being in the immediate state to deploy?
- A: Oh, yes, we were always ready to deploy, always had the immediate reaction force and all of those things. We turned also to start considering how we would operate in the Vietnam kind of environment. The Air Assault Division was then going through its paces down at Fort Benning. It was later to become the 1st Cav Division and deploy to Vietnam. So, all of us were thinking helicopters and thinking how to occupy fire bases. I remember we would parachute into Camp McCall and then set up a typical fire base and operate from it.
- Q: So, as an example of what we were talking about earlier, the counterinsurgency war situation doctrine, trying to determine what a unit would do, how it would respond to—
- A: Well, we weren't in the clear and hold kind of thing. We were now talking deploying troop units because that's what we were doing. So, we were setting up for fire base security. We'd build the bunkers at Camp McCall and then we'd put up radars and sensing devices to see if we could spot penetrations into the perimeter at night, and we would organize that way.
- Q: So, the situation here was more like it had been in the 3d Armored Division, I guess, in terms of what the unit was doing.

A: Professionally trained, professionally on the go, with a very high degree of mission orientation and a reality of our role.

Q: Well, during this period, and this relates to the unit's thinking about deployment, and some of the work I've done in World War II and the Southwest Pacific at least, they found that the airborne engineer battalions' equipment was fairly light for some of the jobs that they were given to do in the Pacific in the World War II period. What about the equipment of the 307th during this period?

A: Well, without doubt it was light. You don't send a D-6 dozer to do a D-7's kind of work. You have to remember the role of the airborne division. Its role is to force the airhead as a strategic projection. It allows us to project Army forces strategically, and its mobility is strategic. It does not have great tactical mobility but it has great strategic mobility. So, you can project force like we did in Panama, like we did in Grenada, and like we did in the Dominican Republic years earlier.

The 82d had gone down to jump into Santo Domingo but did not jump, which turned out to be a lesson learned. The first elements got word that they could land at San Isidro Airfield unmolested, and so they landed. The equipment was all rigged for air drop. Once they landed the troops got out and they could throw their gear off, but the equipment was sitting in the airplanes on honeycomb and pallets. Now, how do you get it out? I mean, it comes out of the plane via the drag chute in the air and it comes down, hits, and the honeycomb collapses. You unrig it, and it drives off. Sitting in the airplane with nothing to drag it out, on pallets and honeycomb, suspended, where its own power can't take care of it, then what do you do? Then there were these aircraft all around the airfield, not in one location. You couldn't taxi them in and pull the equipment out. So, it was really a problem. The lesson learned was if you're rigged for drop, then you're better off dropping, not landing.

Now, we did have, as it remains today, attached to the 307th, the 618th Light Equipment Company, which is a Corps-type company. It has always been attached to the 307th; they wear the division patch, they're known as part of the 307th. The 618th has a considerable amount of engineer equipment. Again, it is the same light equipment, except there is more of it—graders, dozers, and so forth.

We practiced the 618th Engineer Company again and again in doing its mission. Its mission was to jump into an area and build an air strip so that the follow-on forces could air land. The division would jump in with a brigade or two brigades, surround the area and secure the airhead, and keep bringing people in and expanding it. The 618th's job was to build an airfield so that the follow-on forces could air land and more rapidly build up. For example, B and C Companies of the 307th worked on an airfield right outside Saint Mere-Eglise at Normandy. So, we practiced the same mission at Fort Bragg. The mission for the 618th was air drop engineering. I remember we did this down near Darlington—drop into an area and build an airfield out of virgin terrain to accommodate C-130 traffic. Three days after the drop, C-130s came in to land on the completed airstrip. So, it was a realistic kind of mission.

Now, when you build such an airfield you don't start with mountains; thus, you don't have to cleave off great amounts of earth. There should be enough work expected to do a lot of grading and to have tractor-scrappers to be dropped in. The concept is that you go with the light engineer equipment that you can drop in, and then you bring in bigger equipment when you want bigger tasks to be performed.

Q: What sorts of lessons learned did you get out of this assignment in the sense that we talked earlier that helped you later with your career? What did you see as the most prominent benefits of this assignment?

A: Well, I moved now up from company level to battalion level. Of course, I'd been an adviser at battalion level so I already had a perspective in battalion operations, but now I was the executive officer. The executive officer really operates both as a deputy to the commander and as a chief of staff, really directing the staff in the battalion.

So, now I was putting together all those aspects for the commander. Different commanders work things different ways. Some commanders are interested primarily in their S-3 operations, so the S-3 and the commander are always together, focused on operations, and the executive officer worries about the S-4, maintenance kinds of things. That was not so in the 307th with Lieutenant Colonel Jack Waggener. He put them all under me and I directed and integrated all staff activities: S-1, S-2, S-3, S-4, maintenance, chaplain, surgeon, and so forth.

So, I guess that was a period where I found how you work all of those things. I found out how you balance operations versus training versus maintenance. I learned about what General Shy [Edward C.] Meyer talked about later when he was Chief of Staff, "keeping all those balls in the air and making sure the glass balls don't drop and break." I told you I'd learned a lot about maintenance as a lieutenant in the 23d Engineers. Now I was learning about maintenance as a battalion exec because the 82d had very stringent, no-notice maintenance inspections from division. They would descend upon us with notification in the night and the next morning we'd be up against it with the maintenance inspection.

There was also learning as a field grade officer, being one notch up in the executive level of trying to manage these many things and interact with other levels. My six months as assistant division engineer gave me experience on a division staff with a requirement to work with the G-3 and the G-4 and the assistant division commanders and chief of staff. I also gained experience and knowledge with the XVIII Airborne Corps headquarters right there. We were always interacting with them. So, I really experienced a perspective of things from the company level up to how you run engineer companies within the context of supporting brigades and supporting divisions.

Then the helicopter had advanced by this time too. Thus, the H-13 bubble we had in Germany just for reconnaissance and a little command and control had given way to Hueys. With the lessons from Vietnam coming back, we'd go on Army tests using the mobile concepts with the Hueys. I still remember one day when Captain Jack Grubbs' B Company was reorganized as infantry and working with the task forces of the 2d Brigade. I was up in

the brigade commander's helicopter, and we were directing operations on the ground much like the Vietnam model. For me, that was my first experience in an airborne command and control helicopter. Now we were using helicopters that cut distances to deliver troops to battle, to leap over obstacles, and for command and control.

Q: Who was the XVIII Airborne Corps engineer then, do you remember?

A: I don't remember who it was when we were in the Dominican Republic my first year. During my second year, Lieutenant Colonel Jack Cox came in. He was relatively junior; before that it had primarily been colonels. I believe Jack Cox came in as the Corps engineer, not the deputy. Then later, about three months before I left the battalion, Jack Waggener left as the battalion commander to become the division G-3 and Jack Cox came down and replaced him as the 307th Engineer Battalion commander.

Command and General Staff College

Q: In 1967, then, at about the right time, I guess, you went to the Command and General Staff College at Leavenworth. Was that when the bulk of your classmates and peers were headed off for Leavenworth?

A: I think so. It was certainly the right time for me because I'd just come out of this tremendous two years with the 82d, where I had both a division perspective, which is the basic thing they taught at Leavenworth, and became well-grounded with troops. So, I went to Leavenworth fresh with understanding of how S-1s and G-1s and S-3s and G-3s and S-4s and G-4s operated. When it came time to role play in each of these tasks, developing orders for divisions in the attack or for divisions in the defense, then I'd had that experience in the 82d. For example, I was part of the division staff on a Strike Command command post exercise as part of a deployed Corps in the Dominican Republic. I had worked with the staff of the division working under the XVIII Airborne Corps and had been a battalion exec seeing how we played engineers in support of theater operations.

So, I was well-grounded by now, having been on the battalion staff, close to the operating battalions and brigades, well-grounded in how U.S. Army troops, doctrine, force structure, and procedures all went together at the division level. So, when I went to Leavenworth, I was in a good position to study and learn what I'd been doing the previous two years.

Q: Did you find it as satisfying as you'd found the advanced course?

A: I found Leavenworth a lot more satisfying. I mean, it was satisfying from all aspects. I thought it was a super course, interesting because they had a lot of variety of things to look at. It had its slower moments when we got into the department of larger unit operations. Some of the instructors weren't the very best, but all in all a very good professional course. Now there were friends from previous assignments, and I got to know a lot more. I had

friends there from the staff of the 82d, fellow majors in the 82d, plus just a whole bunch of others. This was the first year of the doubling of the course from 600 to 1,200. This meant we didn't get housing on the post and lived nearby in the town of Leavenworth. We experienced again the bonding of people going through the same experience, and it was a super course. There was a lot of interaction and a lot of socializing off post because we had so many friends around. It was very professionally done.

Q: Was a lot of material feeding back from Vietnam into the course at this time, a lot of integration of that experience? This was two years, roughly, after the introduction of a lot of the Army forces.

A: Yes.

Q: So, this is looking a little bit ahead, but do you think—you've been in Vietnam, but do you think Leavenworth funneled some of the more current lessons back to you in an effective way for what would come later when you were reassigned?

A: Well, yes. They were still teaching the basic Leavenworth things. We were moving armored divisions across Kansas and doing similar things. They did not depart from the overall general nature of the course. By the same token, they focused certain things on Vietnam, and with more people having been there by then, that was a continual topic of conversation. We always kept up with the papers, and a lot of the speakers that came back would talk current items from Vietnam. They had a very active speakers program. So, we were all very much in tune with Vietnam and what was happening there.

Q: Yes. There were more of your fellows who'd been there by the time you got to Leavenworth.

A: I would say almost everybody had been there once and we were all contemplating our next tour.

Q: Well, why was it doubled from 600 to 1,200?

A: We were increasing the size of the Army, and the thought was that more folks needed that educational experience. Now, before that there had been two courses. There had been a long course, full-year course, and there'd been two half-year courses. So, there existed a distinguishing feature: who were the folks that got selected for the long one and who were the ones that got selected for the two five-month courses? So, the thought was that we really ought to have a single long course. So, to do that, the right size was determined to be about 1,200. Then they did away with the short courses.

Q: Okay. Well, the next assignment was in Vietnam.

A: We ought to talk about how I got assigned to Vietnam because there is an anecdote having to do with that.

First of all, I volunteered to go to Vietnam. I wanted to make sure this time that I went back to Vietnam because, obviously, that's where the action was and you've got to march to the

sound of guns. I still remember a friend coming up and saying, “I wonder why I’m going to Korea when I’ve been to Korea and never Vietnam, and you’re going back to Vietnam and you’ve already been there.” I said, “It’s very simple. I wanted to make sure I went to Vietnam so I sent in a volunteer statement. That’s why.”

The day came when the Officer Personnel Directorate was to send their assignment officers out to deliver the assignment envelopes and be available to answer questions. I was a major at that time, on the lieutenant colonels list. Major Ernie Edgar was the assignment guy that flew out with all of the engineer assignment envelopes. I had met him but didn’t know him too well at that time. Anyway, he said, “Well, here’s the good news, but there’s something else.” The good news was that I was being assigned to Vietnam and recommended for command of the 577th Engineer Battalion. So, I mean, that was really neat because I was going back and I was going to get a command.

Then I said, “Well, what’s the something else?” He said, “You’ll receive a letter this afternoon from the Chief of Staff of the Army that nominates you to be one of the first in the Province Senior Advisers Program.” General Harold K. Johnson had been out and talked to us about six weeks before and introduced this new program where they were going to take people who had been to Vietnam before, who had experience as advisers, bring them back and put them in the key job of province senior adviser. They would stay there for two years so we’d have continuity in the program. To sweeten the pot, the wives were going to be given orders to the Philippines. You were going to be able to get flights back and forth and certain extra leave and that sort of thing.

I thought at the time that General Johnson was explaining the program that because I was a major and they were looking for lieutenant colonels I would not be involved. “Wow, that’s really an important job,” I thought. Because of my experience in Vietnam operations, I really thought that this was a very important job and program and we were on the right path. I also thought, “Boy, that’d really be a tough decision.” So, anyway, my letter arrived that afternoon. Now I had two nice jobs: province senior adviser and battalion commander. Everybody at happy hour was in the dialogue of, “What are you doing? What have you got? Where are you going?” The comments to me were, “Wow, you have a tough decision. You cannot turn down province senior adviser since you have been personally selected. You cannot turn down the Chief of Staff of the Army.” Then they also said, “Wow, command, battalion command, that’s really super” because I was one of the first of my year group to be selected for command. I had about two or three weeks to answer with my acceptance of the province senior adviser job. Battalion command was there but, I mean, obviously what the Officer Personnel Directorate wanted to know was whether I was going to take this other job. So, I really warred with myself, thought it over with a lot of deep thought and a lot of advice from a lot of people, and it sort of came down to 50–50 on either side of the question.

Some said, “Well, you know, your career is over if you turn down province senior adviser because the black mark will be in your file forever.” So, I warred with myself and grappled with the decision. I called Major General Bill Gribble, who had been one of my mentors, one night at home and asked, “What do you think?” and he gave me his views.

I finally came down to the fact that I'd always been taught that what you ought to do is command in combat. So, here I'd been selected for battalion command in combat and what am I turning down? If I tell the Chief of Staff I'd rather do that than be a province senior adviser, with all my training—I mean, what's negative about that? Being province senior adviser was awfully important, but so was commanding in combat.

So, I came down to a decision that what I really wanted to do, had always wanted to do, was go command a battalion in combat. I'd already been an adviser. That was okay too. What did I really want to do? So, I wrote a letter to the Chief of Staff of the Army, General Johnson, that I couldn't accept the nomination because I really wanted to go command in combat. I got a nice letter back from the Adjutant General of the United States saying the Chief of Staff understood. So, I went off to Vietnam.

I left Leavenworth a week early so I could go take command because it was becoming available early. Took my family to Green Cove Springs, Florida, south of Jacksonville. A waiting-wives community had been forming in an old Air Force installation there. I missed the graduation ceremony where I would have had the opportunity to be in the picture with such stalwart folks as Gerry Galloway, Colin Powell, and Don Whalen, who were there also at that time. My experience I mentioned while with the 82d had managed somehow to get me past all the exams so that I finished in the top five of the class with those other illustrious folks. So, in the graduation picture of the class of 1968 were four people, and I was on the way to Vietnam.

Q: That's a good story.

Commander, 577th Engineer Battalion (Construction)

Q: In July 1968, I believe it was, you became battalion commander of the 577th Engineer Battalion (Construction) your second tour in Vietnam. Were you familiar with that unit before you went over? Did you have any input into that command assignment?

A: No. As I mentioned, Major Ernie Edgar told me that I was going to command and told me that was the battalion I was slated for. He also advised that many times when people came into the country their assignments were changed, but that I was certainly going over on the command recommended list.

So, I moved my family to Green Cove Springs, Florida, and then reported back into the system. I flew out to Travis Air Force Base, then on to Vietnam and into the replacement depot at Long Binh upon arrival.

I spent a couple of days there, and then I was told I was going to the 20th Engineer Brigade. I tried to intercede and say, "No, I am supposed to go to the 18th Engineer Brigade and battalion command." They said, "No, the 20th it is."

The 20th sent over a jeep, and I jumped in and we were on our way to the headquarters, where I met with a Colonel [James A.] Vivian, who was the deputy commander of the 20th Engineer Brigade.

He said, “Wow, this is wonderful. We have an unprogrammed major.” I said, “Well, Sir, I’m unprogrammed to you because I’m programmed to the 18th Engineer Brigade, your cousins up north. So, I’d really like to go up there and take that battalion command.”

He said, “Don’t worry about that. We’ve got lots of battalions down here. You haven’t been promoted yet”—which was true. I was a promotable major at the time, and they had delayed promotions that year beyond the end of the fiscal year to save a few bucks.

So, he said, “We’re going to assign you to the 159th Engineer Group. If you really hurry up you can make their change of command ceremony because Colonel Bates Burnell is going to take over that group this afternoon in about an hour and a half. So, you ought to hustle on over there.”

They put me in a jeep, took me to the 159th Group, and I was taken right in to Colonel Burnell and his predecessor—I don’t remember his name. Colonel Burnell said, “Glad you’re here. You’re my new S-3.” So, I went out and watched the ceremony, and then started figuring out how I became the S-3 very quickly and the old S-3 packed his bags and headed for one of the battalions.

This was the 3d of July in 1968. I spent the next day, the 4th of July, getting organized, getting uniforms and gear and sewing patches on and doing all of those things required on moving in. I went to the S-3 shop to get started because the next day, the 5th, we were to start Colonel Burnell’s—and now my—orientation. We were to visit two battalions.

We flew the next morning, the 5th, down to the Y Bridge in Cholon, which was a place that had a lot of action in the Tet attacks—we’re talking 1968, of course. Tet had occurred about four months prior. There was a lot of rehab work being done around the Y bridge, and one of the battalions was doing that work—the 92d.

After that, we flew over to another battalion at Long Thanh North, and I think that was the 46th. The chopper landed, and then we were taken from the air strip over to battalion headquarters. As we pulled up, the battalion commander came out and said to Colonel Burnell, “Sir, you’re wanted on the phone right away. It’s Colonel Vivian from brigade.”

Now I, of course, had told Colonel Burnell the story when I first came in that I really wanted to go to the 18th Brigade and be a battalion commander. After taking the phone call, he came back and said, “Well, Sam, you were right. You are going to the 18th Engineer Brigade and take a battalion. In fact, General [Harry M.] Roper is so unhappy that the 20th Brigade has tried to squirrel you away that he’s flying in here personally in one hour and a half to seize control of you and take you back. So, you’ve got an hour and a half to get all of your gear and be back to Long Thanh North when he flies in here.”

So, I jumped in a jeep and drove to Long Binh. I got the headquarters to get me a supply sergeant, and I pushed to him all the gear I'd been issued and said, "It's all there because I haven't done anything with it."

I went to the laundry and got my clothes out, wet. Got my uniforms back from the tailor shop where they were sewing 20th Brigade patches on it. The only thing that saved me was that I brought a parachute kit bag with me. So, I just opened it and crammed everything in it and jumped back in the jeep and drove back to the airstrip. Then General Roper landed and said, "I've got you. Where have you been?" Well, he didn't really want to hear the story. He just knew I was in his possession.

He turned me over to Colonel [Douglas K.] Blue, his deputy brigade commander, and we flew north to Pleiku, thence to Tuy Hoa. I was dropped off at the headquarters of the 577th Engineer Battalion at Tuy Hoa. Lieutenant Colonel Bob McDonald was the commander. He'd been trying to get home, and they'd kept him there until his replacement arrived. He had his goodbye thing with the battalion officers that night, and the next day we had the change of command, with General Roper flying in to preside along with the 35th Engineer Group commander, Colonel Del Fowler. Then they flew off with Bob McDonald, and I was the 577th Engineer Battalion commander.



Lieutenant Colonel Kem commanded the 577th Engineer Battalion from July 1968 to July 1969.

So, it was an interesting start. I really had nothing to do with the assignment, to go back to your question, to the 577th, other than the fact that, once I'd been designated, I kept trying to make sure I got there. I was also back in an area that I had served in previously—back in Tuy Hoa and Phu Yen Province.

The battalion was located in several Southeast Asia huts that had been built in the Army Phu Hiep compound next to the Army airfield. It was the logistics subbase of Qui Nhon, and the commander was the lieutenant colonel who reported to Qui Nhon in the logistical chain. The air base had a separate commander, also a lieutenant colonel. There was a large field hospital there that had a colonel commander. Periodically one battalion of the 173d Airborne would come in. Phu Yen was the 173d's area of operations, but they weren't always there. The lieutenant colonel was the senior person there in the operational chain.

So, the next morning I walked into my office, and I looked around and I didn't see any activity. There was one specialist sitting out there. Major Bob Tener had been the battalion executive officer. He left that morning, early.

So, Bob McDonald, the battalion commander, had left; Tener, the executive officer, had left. I was told my new executive officer wouldn't be in for another couple of weeks.

I'd seen a major out there as the commander of troops during the ceremony. He was the new S-3. The command sergeant major had left the week before. The S-1 was on leave in Honolulu, so there wasn't anybody around.

I told the specialist sitting out in front, the legal clerk in the S-1 section, to go find me that major. So, Major Pat Cummings came in and introduced himself. He'd been there about four days. He really didn't know much.

Bob McDonald and I had had about 45 minutes to an hour of talking about what the battalion was doing. He gave me some warnings, such as don't let yourself get trapped into paving that airfield; the matting is good enough. He warned that, "They're going to try to have you clear Vung Ro Bay of all jungle brush. Don't let them get you trapped into that. That's not engineer work."

He also evaluated the company commanders, all of whom were very junior. I think I had one first lieutenant and the other five were second lieutenants. Remember, you made first lieutenant in one year at that time, so this was, rankwise, a very junior battalion with little experience. So, I found myself right in the middle of that big summer rotational hump that we always read so much about.

Anyway, Pat Cummings did know that there was a meeting that afternoon at the sector headquarters—sector being the U.S. counterpart of the Vietnamese province headquarters. I said, "Great. Let's go."

He said, "Okay, but I don't know where it is." So, I said, "Well, let's go find the driver. He'll know where it is."

So, we got Bob McDonald's driver, and he had just changed three days before, and he didn't know where it was. So, we had nobody around who knew any of these things because they'd all rotated.

I knew where the headquarters had been during my last tour when I was there on the beach at Tuy Hoa in my first tour, that I have described already, '62 to '63. So, I said, "Let's jump in the jeep. We'll go back there and see if it's not the same provincial headquarters." Sure enough, it was. So, from day one we started going on dead reckoning. So, that's how I got started in the 577th.

Q: The 577th itself had been there a while, though; the unit had.

A: Yes, it had. I can't tell you how long, but I'd say about three years, and had been involved in the Cam Ranh Bay area and then Phu Yen for over a year. Maybe I should just go ahead and talk about the missions in the Phu Yen area of operations.

Q: Yes.

A: Basically, the 577th's area of operations extended from south of Vung Ro Bay to where it intersected with the area of the 84th Engineer Battalion in Nha Trang, to the north about halfway to Qui Nhon, where we intersected, or matched up with, the 84th Engineer Battalion stationed at Qui Nhon. Then we extended west, out past Cung Son, up that same road that I had helped open years before in Phu Bon Province.

Our basic mission was to provide combat engineer support to operational units in the area, which included the 4th Battalion of the 173d Airborne, as I mentioned. The 28th ROK [Republic of Korea] Division had a regiment there. The 47th ARVN had a regiment. The 47th was the same regiment that had been there years before when I had been an adviser.

Second, we were to maintain and clear the roads in our particular area of operation, which were primarily Route 1 from our southern boundary south of Vung Ro all the way up to the north about halfway to Qui Nhon, and then Route 7B, heading out west to Cung Son, and then on towards Cheo Reo.

Third, we were to build and upgrade QL-1 to a MACV standard from Vung Ro Bay to Tuy Hoa as a first priority, and that construction was under way.

Fourth, we were to support operations out of Vung Ro Bay, which was by now a thriving port that had been constructed and was a growing concern, run by the 1st Logistics Command.

Fifth, we were to support logistical operations around Phu Hiep Army compound. That involved building a POL [petroleum, oils and lubricants] tank farm, building a bunker for an ammunition depot, and other projects like that. Along with that were operations in support of Phu Hiep Army Airfield, where most of the construction had been finished. The runway was matted, and hangars were constructed. There was a chapel that we were working on. Also, the roofs had blown off two hangars in high winds, and we were reroofing them.

As part of the QL-1 upgrade, a very major project was constructing an 840-foot bridge over the Ban Thach River. Design and planning were under way, and the first piles had just been driven in the week or so before I arrived. So, that project was just getting started.

So, that was the 577th's mission there. Things from the past—Lieutenant Colonel Tom Lane had been killed in a recon of that part of QL-1 south of the bridge toward Vung Ro Bay earlier. I think he was the commander of the 39th Engineer Battalion at the time. He was flying along in a helicopter and took a round in the chest from the hillside when they were making their low-level recon.

Phu Hiep was a well-developed compound. We had built Southeast Asia huts for almost everyone. We had built a very large hospital there, which had quite a number of facilities and heliports where they could medevac folks into, and all the barracks where all the doctors, corpsmen, and nurses lived.

Tuy Hoa Air Force Base was about three kilometers away and located at the site of the former air strip that I mentioned earlier in the anecdote about when General Harkins and Chief of Naval Operations [George W., Jr.] Anderson had landed and buried their Caribou's nose wheel into the sand. On my earlier tour there was nothing there but the runway. Nobody secured it. Nobody occupied it. Now it was a full-fledged Air Force base with wire around it, operational facilities, officers club, pilots in white scarves there on Saturday night at the bar. A going concern in every way.

That was the layout of things at Tuy Hoa. It was a relatively mature buildup of the logistical base and Air Force base.

Q: That's a pretty big mission for a battalion, the things you were talking about there. It's a long list of responsibilities.

A: Well, it was. It was a big battalion. We had attached to it a float bridge company because while we were building the Ban Thach bridge we were also operating and maintaining an M4T6 float bridge over the Ban Thach River that had been in there a couple of years. So, the 553d Float Bridge Company (M4T6) was attached to the 577th.

We had attached an engineer light equipment company. We also had attached a concrete detachment and an asphalt platoon with its own Barber Green asphalt plant because we were to asphalt pave the highway we were constructing. That operation had started as well. So, we had about 30 kilometers of national highway QL-1 to build. We had a major quarry operation up at Chop Chai Mountain, north of the big Tuy Hoa bridge.



Army Engineer bridges over the Ban Thach River in South Vietnam. In the foreground was an M4T6 bridge and the background an 840-foot, 13-pier bridge.

The terrain that we lived on, though, the Air Force base and the Phu Hiep Army installation and airfield, were south of the Song Ba River. Where the river opened to the sea was wide. Route QL-1 passed over the river on a huge rail bridge that was decked. There was one-way vehicle traffic over this very long, very big rail bridge. So, we really had a constraint and bottleneck when we went north into the town. Tuy Hoa was just north of this river. We were building the other bridge, the Ban Thach, at another outlet to the south. Thus, anytime we went north we had to plan on the one-way traffic at the Song Ba bridge.

As I mentioned, our first priority was to upgrade the road from QL-1 from Vung Ro north to Tuy Hoa. Once we finished that, we were then to move north of the town and work on upgrading that road on the way to Qui Nhon. That road was in much better shape. The road from Vung Ro Bay was the main supply route to Phu Hiep Army installation and Tuy Hoa Air Force Base.

So, we did have a big battalion. We had a big area of operations and a lot of activities ongoing. We were later given yet another light equipment company, a dump truck company, and then a pipeline platoon, the latter because we also built a pipeline along the road from Vung Ro to Tuy Hoa.

We upgraded our crushers at the Chop Chai quarry operation from 75 tons per hour to 225 tons per hour. We got the extra trucks to haul so we could try to finish up the paving of that 30 kilometers of road and get out of there. Essentially, we did that while I was there over about the next eight to nine months. When I arrived, I suppose we'd probably paved about a kilometer and a half of the 30.



The 577th Engineer Battalion quarry operations at Chop Chai Mountain near Tuy Hoa, South Vietnam, in January 1969.

QL-1 was a very interesting project because it was so different in places. We had all kinds of construction. Down near Vung Ro Bay the road rose up from the deep port through rather high hills with steep grades. Then we had cuts down through the hills coming back down to the flatlands, the rice paddies along the coastline. So, we had six to seven kilometers of steep grades of side hill cuts and switchbacks to deal with.

Then we had 15 kilometers of rice paddy, where the highway was basically a ribbon of road with rice paddies on either side. Anytime you wanted to construct something, you really had to muck out a bunch of stuff and then get stabilized material into it.

The final eight kilometers were through sand, beach sands up near the Tuy Hoa Air Force Base and Phu Hiep. There construction was a matter of sand confinement and building upon it. So, we really had quite different kinds of construction facing us.

You left the paddy area and went to sand at about the Ban Thach bridge. So, we had three major different kinds of construction, and we'd go at them different ways. We had this huge Ban Thach bridge, which took a considerable amount of activity and effort.

I had assigned one company responsibilities for Vung Ro Bay and the area south of Ban Thach bridge. One company spent its time building the Ban Thach bridge, and one company worked north and at Phu Hiep. The equipment support folks were running the quarry operation, along with my equipment company. The asphalt platoon was out doing the paving operations and manufacturing the asphalt, which we did in our own Barber Green plant, which was located at the Phu Hiep compound. That was all under headquarters company.

The concrete detachment worked to place the concrete and form the precast concrete slabs that were used for the deck of the bridge. It was assigned to the line company that was building the bridge.

The other operations, the pipeline, the POL tank farm, and such, all were being done by various parts of the companies, and always at a lesser priority. Daily, we would have an operations meeting headed by the S-3—often I would participate—where we would try to shift equipment around on a priority basis to make sure we maintained production schedules.

Very definitely we kept things so that we continued to pave QL-1 and we continued to push bridge construction. If we needed a dozer because one was down, the one that was shaping the berms in the ammunition point might not make it to the project that next day because it would be diverted. We continually had to make operational kinds of decisions like that on the allocation of equipment.

Q: So, it was a big construction management job.

A: Yes, it really was. We finished the chapel at Phu Hiep Army Air Base and put the roofs back on the hangars. We did get the mission to clear and grub all the jungle around Vung Ro Bay that Bob McDonald had said stay away from. We had our hands full on a whole bunch of different kinds of things.

Q: Maybe we can talk a little bit more about the Ban Thach bridge project. That seems like a pretty sophisticated project for an engineer construction battalion.

A: It was a very sophisticated project. We had—my recollection—13 spans with five 50-foot, 36-inch-wide flange steel stringers. We were precasting the concrete deck, hauling the slabs to the site, and then welding them—we had weld plates cast into the slab—onto the stringers. Something like that hadn't been done over there before. A big construction menu in operation. It involved a lot of different things, a lot of priorities.

The pile bents were seven piles to a bent. There were three driven vertically on the center line and four on the corners, each driven to a double batter, which is more complicated. They were 18-inch steel piles filled with concrete. I think the deepest we drove was to 134 feet. So, yes, it was a rather sophisticated project.

We had a Vietnamese village on one side of the bridge. We continued to have to worry about security because it was out in the countryside. We had a couple of Quad-50 “dusters” at either end of the bridge that would cover up and down the river.

During low water we could approach the piers on sand bars, and we actually built in the dry. We would build out with sand and then drive piles through the sand, then excavate it and work the other end so we always were driving piles in the dry.

It was really quite an operation. All the while downstream we had the M4T6 bridge and constant monitoring of one-way traffic, all the low-beds or stake and platform logistic vehicles working their way up to the Army airfield and the Air Force base from Vung Ro Bay and returning.

So, it really was a complex, sophisticated thing. We had to maintain our concrete pours back in the Army compound. We set up a batch plant and a concrete batching operation and a precast yard. We had to set up routines to change the forms, place rebar, and pour the new panels. Then we moved them over to the side to cure, and all well in advance of when we’d need them. They were moved out to the bridge site sitting on rubber tires on low-beds. We had to be particularly careful picking them up and placing them before we welded them down. Then we checked the welds to make sure they were welded correctly. It really was a very good project.

Q: Was the company assigned to that still under a lieutenant?

A: Well, the company commanders changed from time to time. We got some captains in because you made captain in two years. Later on Captain Sam Champi was commander of C Company and finished the bridge.

Q: Again, that’s quite a bit of responsibility for a young officer.



The 577th Engineer Battalion (Construction) built the Ban Thach River bridge from pre-cast elements in 1968.

A: Yes, it was. Well, we maintained also rather tight battalion control. That was the priority project. Production priority was there because that was the one that, if you lost time, you couldn't make it up. At different parts of the highway and projects like the POL tank farm and the ammunition depot there were things you could do when you couldn't do other things because equipment had been diverted.

Out on the bridge, if you lost a day driving piles, then that was a day you weren't going to be able to pour the pile cap, or start putting stringers down, or eventually place the concrete deck panels.

We would have all those operations going at once. We'd be driving batter piles and we'd be forming for the pile cap on others that had been driven. We'd be placing stringers, and we would be bringing out deck panels, and then later on we'd be putting on railings and finishing the deck.

So, there was always something going on on that bridge. We were building it from both ends, all the time, and so we never wanted to let it slip behind schedule.

Q: Were you under a pretty tight schedule to complete it?

A: Well, not initially. Like anything, you made a projection of when you were going to complete, and you wanted to make that projection. Our jobs were so comprehensive and the responsibilities changed so often that basically we weren't fixed with any hard and fast date that it had to be done. That changed when Colonel Bill Barnes replaced Colonel Del Fowler as the 35th Engineer Group commander about halfway through my tour. I was there six months under each, basically.

Just before that was happening, Brigadier General John Elder, the brigade commander, had been thinking about how to change operations over time. The work was changing, and in response he was relooking the responsibilities of his three groups: the 45th Group in the north, the 937th located in the center, and the 35th in the south.

For instance, the 937th was in the center, but it really was operating along the highlands in the interior. It was centered out of Pleiku and went down to Ban Me Thuot. The 35th had been located in Qui Nhon and had the coastal area along the coastline of the South China Sea.

The change that John Elder was considering and working with his three group commanders was to make an east-west horizontal slice in the area of operations so the 45th would continue in the north; the 937th would take the center, both coast and inland, along Route 19 from Qui Nhon to Pleiku; and the 35th would move south to Cam Ranh Bay and take the things it already had at Cam Ranh Bay and the 577th in Phu Yen, but give up the 84th Engineer Battalion at Qui Nhon, which would go to the 937th. Then the 35th would take responsibility for the 70th Engineer Battalion, which was moving down to Ban Me Thuot. Then the 35th would go along the east-west highway from Nha Trang to Ban Me Thuot. The brigade's new plan really oriented along the main supply routes.



Reviewing stand of Headquarters, 577th Engineer Battalion (Construction), at Phu Hiep, South Vietnam, in September 1968. From left to right, Major General David S. Parker, U.S. Army Vietnam Engineer; Major (P) Kem, Commander of the 577th; Brigadier General John Elder, Commanding General, 18th Engineer Brigade; and Colonel Delbert M. Fowler, Commander, 35th Engineer Group.

The idea was to put greater emphasis down in the south, so there was going to be a shift of responsibilities southward, the idea being that the major traffic came up through QL-21 from the Saigon area, up to Dalat, cut down to Phan Rang, and then cut north on QL-1.

Major logistics traffic didn't follow the coast all the way up. By doing this, you avoided the Vietcong strongholds near Phan Thiet and south of Phan Rang.

There was to be a change of emphasis. We would finish up the QL-1 project we had been working on in Phu Yen and then move down and start working QL-21 in the sector just south of Dalat.

The thought was, let the 84th Engineer Battalion slide south from Qui Nhon to replace the 577th in Phu Yen; then we would finish up the work I've already described south of Tuy Hoa. Instead of us moving north to take the road north to Qui Nhon, the 84th would slide south and take that responsibility.

This would free us, then, to deploy down to the Dalat area, where we would move into that region, and then we would construct QL-21 going south and also 21 Alpha. QL-21A was a short cut-off that allowed you to cut from Duc Trong, where there was an airfield, over to Don Duong, where there was a reservoir, and avoid going up to Dalat. This was a travel saving in time and also avoided the grades and switchbacks to get up to the elevation of Dalat.

So, you could avoid going from Duc Trong to Dalat and then Dalat back to Don Duong. That was 21 Alpha. It was about 20 kilometers of highway through a river valley and very subject to flooding. In the rainy season, 21A was a big problem.

The idea was to keep 21A open during the year. Move the 577th there and we would have a mission to keep 21 Alpha open during the upcoming '69 wet season, and then get postured to start operations to upgrade the highway, 21 Alpha, and then 21 south from Duc Trong. Then go back down the highway toward Phan Rang, which was a bunch of switchbacks down the major mountainside to the coastal plain and to Phan Rang. That road from Don Duong to Phan Rang had been the responsibility of the 589th Engineer Battalion under the command of Lieutenant Colonel Al Costanzo, who had his headquarters at Phan Rang.

That was the general concept. So, I got into all of this, and I need to come back to those operations later. You asked if we had a schedule to get out of Phu Yen Province.

All of this thinking at brigade and in the groups was going on, and it really came to a head about the time Colonel Bill Barnes took over the 35th Group. He was the one that told me, "We are going to move the 577th south, and therefore you need to finish all of QL-1 and the Ban Thach bridge as soon as possible, and then begin moving your battalion down to the Dalat area." He asked me to put together a plan that would indicate when all of that would happen.

We used the critical path method throughout for all of our projects. We then had to come to grips with a schedule that was going to be hard and fast when we set it.

Now, I should say about this time we had been progressing pretty well through the cuts down at Vung Ro Bay. During the rainy season we would have a lot of erosion down hillsides and washing things out because we couldn't keep it stabilized. Once you broke the foliage when you cut it back, then you had a real problem. We brought in hydroseeders to try to seed the area, but it was steep and done with great difficulty.

During the rainy season in the rice paddies, road construction also was very difficult. We went through one hurricane in which QL-1 really looked like just a path through water. The only thing dry was that road. We really labored through some tough construction conditions.

We were also rebuilding four smaller bridges along QL-1. By that I mean two span bridges of about 35 feet of span. It made a pretty good bridge project, but smaller than the Ban Thach bridge.

We had really upgraded by now. We got the new 225-tons-per-hour rock crushers in, so we were really producing aggregate. We now had the dump truck company, so we were really hauling aggregate down to our Barber Green asphalt plant, to our concrete plant, and for the base course throughout the area.

Our plan for completing operations was to finish the area through the sand in the north. First of all, that was the easiest to do.

All three parts of this operation were quite different, as I mentioned. In the north, in the sand, we were using tractor-scrappers to maintain high production, to shape the subgrade and confine it. We would put on the base course, then come in and pave.

In the middle, through the rice paddy area, there was an existing laterite road that we had to widen. There, it was a matter of excavating out paddy bottom to the side of the road and then bring in lateritic kind of soil.

We had a mountain in the area that we had opened as a laterite borrow pit right next to the road. So, we didn't have to haul the sand way down that far, which would have been a real problem because the Ban Thach bridge divided the sand area from the paddy area. The complicator was that the heavily loaded tractor-scrappers would fail the existing road. We would then have to come back in and shovel out vertical chunks of existing road, bring it back up with rock, and stabilize it before we finished.

In the south, the cuts through the mountains were primarily dozer work.

So, we had tractor-scrappers in the sand. We had tractor-scrappers doing the haul in the lateritic center part, plus cranes and draglines mucking stuff out. Down in the hilly sections we had dozers working. Of course, we had graders working throughout.

We found a great opportunity to use Bangalore torpedoes while we were there to great advantage. When we were given the initial mission for clearance of the Vung Ro Bay jungle areas, we took Bangalores in there and set them off. They would strip through the jungle vines and cut them just like they would barbed wire. They left a very distinguishable area cleared. We also used chain saws, doing it by hand. You really couldn't get a dozer into most of the Vung Ro area because of the steepness of the hillside.

The problem was the hillsides around Vung Ro were shaped in concave fashion, and so the sound and shock waves focused toward the middle. Thus, using Bangalores we would rattle the shelves in the small post exchange and dump the merchandise into the aisle. So, that couldn't go on. Bangalores could only be used in a few places. Anyway, that experience sparked our interest in Bangalores.

Later on we were trying to clear and grub along the stretch of highway going through the paddies. There was a lot of rice and grasses. We found that by putting a Bangalore down beside the road along the shoulder—there was no ditch—and setting it off, we could blow grass and water and everything out. So, we would grub using the Bangalores so we could then bring in a dragline, clear out the soft paddy mud, and then bring laterite and rock in and dump it into what remained.

As we were progressing and trying to complete projects to inch on down to the Dalat area—I still have to come back to explain our plan to move out—we were given an additional mission. Even after we'd established a move date, we were given a mission to clear the highway from Tuy Hoa west to Cung Son, about 30 kilometers away. We were to use Rome plows to clear all foliage back 100 meters from the road.

This was a complicated operation. First of all, I had set the dates we were going to move, and this was a new mission. Second, we were told we would not get a Rome plow company or platoon. We'd be given about three Rome plow kits to put on our own dozers. This meant I had to take three dozers off production somewhere else.

Q: If I could get you to go through the Texas ball again. I believe we missed a little of that.

A: The Texas ball was a huge metal sphere used in land-clearing operations in Texas. I guess it must have been 8 to 10 feet in diameter, with chains that came out either end. You'd hook those chains with dozers, and the chains would cut the undergrowth while the ball rolled around. It wouldn't knock down large trees. It might knock out some smaller trees.

Now, the brush we were clearing along QL-7 really wasn't jungle. It was heavy brush and scrub kinds of trees with some bigger trees, but this wasn't thick jungle we were trying to clear away.

So, we embarked on that operation, and it was really difficult—difficult from the standpoint that, first of all, for the first several kilometers out from Tuy Hoa there was an irrigation canal lying right next to the roadway. The roadway was only about a lane and a half wide for one of our trucks, and there was the steep canal bank next to the road. We had to go over to the other side of the canal to get to the hillside to clear and cut away the foliage.

You really couldn't turn a low-bed on that roadway. To move back and forth across the canal was very difficult. It had to be almost a 90-degree turn. So, we built M4T6 trestle spans, and we would lift that in by Chinook helicopter, lower it into the canal, bring the trucks up, drop the balk in place on the trestles. The dozer would come down and make a 90-degree turn on the road, go across that completed bridge, then move up the hillside.

We had a company of armor—and I say armor because it was a tank company—but they were in armored personnel carriers with mounted .50-caliber machine guns from the 173d Airborne. They were our security out there; they went with our work party. The force stayed out in the field every night as they made their way west from Tuy Hoa.

So, then, when that bridge was no longer in position to be useful for resupply, we would bring a truck out, pull the balk off, and load the truck. We would run the truck down the road two kilometers, bring in another Chinook, leapfrog the trestle span down and put it in place in the new location. By keeping two of these bridges leapfrogged, we then kept ahead of our operation for resupply. So, that was rather an original way for keeping production going.



U.S. Army helicopters leapfrogged M4T6 trestles along the route from Tuy Hoa to Cung Son in February 1969.

Now, the hillsides were pretty steep, and so there were two ways we cleared them. First, we used Bangalore torpedoes, remembering how they had worked in Vung Ro Bay. Well, now we no longer had the concave problem, so we would use the tankers' armored personnel carriers to run the Bangalores from the road up the hill. Then we would fire the Bangalores and they would strip away the foliage—really do a great job.

The problem was that there weren't a lot of Bangalores being used in-country. So, during the briefings down in Saigon, when they presented the rate of use of various Class V stocks and other materials on charts, all of a sudden one week there was a spike on the use of Bangalore torpedoes. In the second week that spike continued too.

Meanwhile, we'd exhausted all the Bangalores in Qui Nhon and Tuy Hoa depots, and we were now flying them in from Danang. The loggers were very supportive. We put a demand on the system, and they'd load those Bangalores up in Danang, fly them down to Tuy Hoa, we'd offload them, and off they'd go.

I guess someone in the higher headquarters asked, “Why are we all of a sudden using all of those Bangalores?” They came down to understand they were all being used by one engineer battalion, the 577th. So, the whistle was blown, and our supply was cut off for not being used for what they were intended. They were certainly being used for high productivity in keeping the job going. We were both clearing and grubbing on rice paddy highways at the same time we were clearing along this road from Tuy Hoa to Cung Son. So, for about three weeks we had a field day, but then we were stopped.

Then we had to come up with something else on the roadway into Cung Son, and it was too steep, really, for dozers to operate safely. So, we came up with what we called the yo-yo technique. One dozer would stay at the top of the hill and put another on a winch that would work down from the top, scraping away, come back up, go down another path and scrape it away.

This area was too steep for the Texas ball or for normal kinds of clearing operations. Mostly there we used straight-blade dozing, not the Rome plow and stinger. In other areas where we had trees we used the Rome plow and stinger.

That operation continued for several weeks until we finished. That gets us back to the schedule for echeloning the battalion from the Tuy Hoa area to the vicinity of Dalat.

When we developed the concept of how we would move the battalion, we first had to come to grips with the schedule for completing the construction of QL-1, leaving it paved from Vung Ro to Tuy Hoa. Second, we were to finish the Ban Thach bridge. Third, we were trying to wrap up all of the other projects in Phu Hiep, but the ammo depot, which had been last priority, had been slipped and slipped and slipped. The berming for that and other projects could be turned over to the 84th Engineer Battalion.

We needed to be in the new area so we could work on QL-21A before the rainy season began. The concept was that we would switch flags of Delta Company's with the 589th Engineer Battalion. Delta Company had finished the northern part of the work on QL-1 and had moved down to the vicinity of Cam Ranh Bay, at Dong Ba Thin, to do some work there that the group wanted done.

So, I gave my Delta Company to the 589th out of Phan Rang. The 589th gave their Delta Company, already in place at Don Duong, up just below the reservoir, to me. So, we just switched guidons.

Of course we didn't need the float bridge company once the Ban Thach bridge was finished. The bridge company went back to group and brigade control down in the Dong Ba Thin area. We gave up the light equipment company and the dump truck company once we'd finished the paving. So, that meant really, then, we would echelon A, B, and C Companies and the headquarters and headquarters company on down to the new area.

The last to arrive was B Company. They were doing the last bit of work on QL-1. I put B and C Companies down at Duc Trong, at the other end of the triangle. We left one platoon up at

Dalat to do work up there at Camly Airfield. Then the Delta Company we'd taken over from the 589th, along with A Company and the headquarters, were at Don Duong. So, the 577th was going to be at three points of a triangle, Dalat, Don Duong, Duc Trong, with the headquarters at Don Duong.

So, we computed when we thought we would finish the Tuy Hoa jobs and set up the schedule to try to start moving folks down to the new area of operation. That really, then, was the time when we had a schedule that was fixed and one we wanted to meet. We always had a source of pride in the battalion that we met that schedule. We finished the Ban Thach bridge on the final schedule that we had developed.



The completed Ban Thach bridge was dedicated on 7 December 1968.



Lieutenant Colonel Kem spoke at the dedication of the Ban Thach bridge.

We completed the QL-1 paving and dedicated it one week late. Not bad, considering we had the Cung Son clearance mission put on top of us, and that was the job most impacted by that. We basically made the move on schedule.

So, we echeloned out. I started with a tactical command post down in the new area but stayed back mostly in the old area. Then more and more of our operations were down in the new area, and I would fly back and forth between the two, which were about 200 kilometers apart.

Another complicating thing was that we had been in place for a number of months. We really had a lot of supplies stacked up, and we wanted very much to take them down to Don Duong so we could use them. We had a large number of large steel stringers for bridges, and we had a lot of bridges to build. We already had been down there doing recons for the work. As soon as we took responsibility down there, we were on the road doing work, using the 589th's D Company, now under our operational control pending the flag change and reassignment.

So, we started bringing LSTs [landing ship, tank] into the beaches at Tuy Hoa. We would take our materiel down there, like the steel stringers, and we'd use dozers to winch them aboard the LSTs. Then run down the coast to Phan Rang, offload them, and haul them up the hill to our new base camp.

After a while the 18th Engineer Brigade got wind of all of that and put a stop to our materiel movement, and said we should leave all that there for the 84th. So, when we began to turn over to the 84th, we left a large Class II and IV stock of all kinds of things. We left a huge yard full of asphalt in drums we'd been using to pave QL-1.

This became a *cause célèbre* 16 months later when General [John W.] Morris went into Tuy Hoa and saw all the stocks lying around in the depot. He was the 18th Engineer Brigade commander by this time. There had been a mission change. They decided not to bring the 84th down to Tuy Hoa and the 84th didn't come in as they originally planned, but we had arranged materiel transfer, S-4 to S-4, when we left.

Now, they hadn't physically completed the move, but we were gone and were unaware of that. So, there were no engineers in Tuy Hoa when General Morris went up there and found all those asphalt drums sitting out there in this huge yard and all of the other equipment. He decided that the 577th and I had abandoned all this stuff and left it there, which wasn't true. We'd turned it over to the 84th.

He also found a rock crusher down at Vung Ro Bay that he said we'd abandoned and left there. That also wasn't true because we had turned it in to a log command property disposal company. This rock crusher was about 200 meters from the DeLong pier where we brought in all the ships. The idea was leave it there. They inspected it. They took it off our books. Then they were going to make the arrangements to put it on whatever ship was going to take it away.

The trouble was, they deactivated that property disposal outfit about six months later, after we already left the area and before they shipped out the crusher. When General Morris came up, he saw this rock crusher there, saw the 577th's numbers on it, and said, "Find out who left this here." He then ordered the 577th, by then commanded by Lieutenant Colonel Ernie Edgar, to send a detail north to clean up the mess they supposedly left in Phu Yen Province.



Lieutenant Colonel Kem (left) with Brigadier General John W. Morris, Commander of the 18th Engineer Brigade, at Don Duong, South Vietnam, in May 1969.

Q: So, you and General Edgar did interact quite a number of times.

A: Ernie Edgar and I have interacted a lot. General Morris and I have interacted a lot. Now, that's the other side of the story, as Paul Harvey would put it. [Laughter]

Q: Let me ask you a couple of things before we move south. What about the equipment that you had there? Obviously, with the attachments, you had a lot of equipment. Was it pretty much appropriate to the job? Did you have any trouble maintaining it, keeping it going, spare parts, problems along those lines?

A: Yes. I have to talk about it from several different aspects. First of all, when I arrived, our quarry operation really wasn't doing well at all. We had a few wheel-mounted drills, and we could not drill fast enough to provide the blast rock in quantities to feed the crushers. We badly needed crawler drills that we could move around on the slopes and really keep up drilling production.

We were borrowing drills from the Air Force and then having to give them rock. It was fairly torturous, but finally, through some support from my group and brigade headquarters, we got the right kinds of drills so we could really up the production of rock. That helped immeasurably.

The 75-tons-per-hour crushers were often down. They were old, and they didn't produce enough. Once we got the drilling up to feed them, they weren't producing enough to do the job that needed to be done down the road.

This need had been well known by theater engineers already, and so they were already procuring the 225-tons-per-hour crushers. I was fortunate enough to be there when they came in. That greatly increased capability and production. That was a godsend from the standpoint of getting the job done.

The Barber Green asphalt plant was yet another story. When I arrived, it had a history of always breaking down. So, I took it on myself to try to flag attention to get it fixed. We had about 4 percent of the replacement parts on hand. After fighting that problem for eight months, we left and left the Barber Green plant there when we went down to Don Duong. When we left, we still only had about 4 percent of the replacement parts on hand. So, the parts system never changed and never accommodated the needs for getting the Barber Green taken care of.

The huge main drive shaft, in fact, was about four to five inches in diameter and about 30 inches long. It would break after about 26 hours of operation.

So, the way that we fixed that problem was to go over to the Air Force and give them C-rations. They then would let our machinists work with their bar stock through the night shift. They worked the day shift; they didn't want to work the night shift. They'd let our guy work the night shift, and he'd turn out another shaft. He could turn one out in about 12 hours.

So, we basically just kept even. You figure 24 hours of operation, having to work only night shifts to rebuild. So, we had a guy who was continually building a new shaft so when it failed somebody else could install it, and he was making another. We tried to stay one shaft ahead.

We spent the whole eight months that way on the Barber Green plant. We brought in tech reps to look and advise. We brought in mechanics to work the problem, but it was never solved. We just kept trading off C-rations for time on the Air Force's machinery.

The other engineer equipment we had was all right. We could keep it operating. I'm talking now the basic tractors, scrapers, dozers, graders, cranes, the rest of that. People worked hard on maintenance, but we had to change our mode of operations. The old operator morning maintenance followed by during-operations maintenance followed by end-of-operations maintenance, with quarterlies and manuals and hourly periodic maintenance by mechanics as they became due, didn't work.

It didn't work because we only had a limited number of hours to work when we were in a hostile area. Base camp at night, full days on the job. We didn't work in the dark in those hostile areas strung out and vulnerable along the road. When we worked that way, it meant we had to take advantage of all of the daylight hours to operate. When you put an operator out there and bang him around all day, he's not going to be too fit to do the after-operation maintenance in the evening. He needs to be fit to start off the next day. We were cheating on

time or you're cheating on strength, energy, and capability of our operators. So, we changed to operate more like a construction firm, where we would bring our tractor-scrappers, for example, in at night after being run all day. Then nighttime maintenance teams would service them all. When that operator had a good night's sleep and came out the next morning, he could hop on his mechanic-maintained tractor-scraper, head out, and operate.

So, we modified by getting teams of mechanics who pored over the equipment every night. We maintained on the night shift, and we operated during the day shift. That was our accommodation for that kind of equipment and that kind of operation.

I guess that addresses most of the types of special actions we took.

Q: Did you find the training of the engineer soldiers pretty good, your operators and others? Did you have a lot of turnover—well, you did, I guess, while you were there.

A: We had a lot of turnover. I thought we had skilled noncommissioned officers who really knew what they were doing. The maintenance ones were very good. The people in the asphalt platoon were very good, really knew their stuff.

The people that came with the concrete detachment didn't know anything. The Army just formed the detachments, assigned lieutenants and folks to it, and sent it. Those detachments don't exist in the peacetime Army. We also used tech reps, civilians hired by USARV [U.S. Army, Vietnam] engineers to come out and help train folks. We had a tech rep who assisted us well on the concrete batch plant and the precast panel operations. He spent six weeks with us getting that operation going. We had tech reps for other things as well here and there, who would help out.

I thought our soldiers with basic training and advanced skill training, such as the equipment operators, knew the rudiments and got a lot better once they'd been operating for a little time. Except for dozing up in the pass near Vung Ro Bay, most of the terrain was flat, so they got to operating pretty well.

Q: What about discipline and morale in the '68, '69 period. Any particular problems?

A: Well, it was before the big problems, but we had some incidents. We had a terrible incident about three weeks after I arrived. In the asphalt platoon, one of our people who was on drugs was out on the perimeter one night, and his noncommissioned officers and his officers had been giving him some grief over time. We were sitting there that night watching movies in the officers rec area when we heard a burst of M-16 fire within our compound. This one soldier had just gone over the top; he had come back into the compound and was after his company leadership.

It was really tragic. He killed his platoon sergeant, the one person in the battalion who really knew asphalt and the one that we really were counting on. He maimed his company commander, the A Company commander, who eventually lost his hand from the gunfire and was never back to duty with us. He was medevacked right from there. The platoon leader escaped by ducking down between some sandbags and got away. Basically, this soldier holed

up then for the next hour in the barracks until he was talked out by a couple of his friends and surrendered.

That was rather shocking to everyone. It was probably our first knowledge that there were drugs around and they were to be a problem. Drugs were not a major thing, like they came to be a couple of years later. There were very few drug incidents.

We got some captains in, as I mentioned, and put them into company command positions in places where discipline was a little ragged. For instance, we put Captain Sam Champi in as company commander of C Company. He had been an all-East lineman for Army—West Point. He was a huge guy; I mean, he was just intimidating to look at.

Captains Kurt Rhymers, Dave Pierce, and Bob Lowry came in, also class of '66, and some others, and so we got stronger leadership. Once the summer changeover finished up, when we got those other people in, I put the more senior ones in the company commands. We had a battalion executive officer and S-3, both majors. Dick Copeland came in to be the S-3. Pat Cummings moved up to be the executive officer.

We got a new command sergeant major but he didn't work out and, after three or four months, I took the B Company first sergeant, First Sergeant Benini, and made him the command sergeant major, and he was superb. So, we applied a lot of leadership by assignment and by the sergeant major's and my getting around often to the various units in the battalion.

When we moved down to the Don Duong area, we moved into the three locations that I mentioned. Previously in Phu Yen we had been splintered, with some people living at Vung Ro Bay, some people living halfway down Route 1, some people living at the airfield at Tuy Hoa, and most of us working south.

So, we worked at it, but didn't have major problems, other than that one bad incident.

Q: That's an important function of a battalion commander, isn't it, to take his personnel, his officers, and assign them where they're needed to correct problems.

A: Absolutely. You've got to really know your people, and pick people to go to the right place, and change them when necessary. I relieved the concrete detachment commander while he was there because he just wasn't functioning; he just didn't have what it takes.

We had to work at it. It was such a big battalion, 1,400-some folks with all of the extra companies. When the second engineer light equipment company came in, they were from the Vermont National Guard. We kept them for a couple of months while they worked, trained, and acclimatized in-country. Then they moved off to Ban Me Thuot to join the 70th Engineer Battalion for the upcoming work there just as we were moving on down to the south to work on QL-21A.

That assignment of the Vermont National Guard brought its own particular problems. There were people who'd left civilian jobs who weren't sure they knew why they were in Vietnam

or why they ended up in Tuy Hoa. One platoon leader's driver was his boss back in civilian life. So, we just had a few interesting little things to work out.

Q: That's an interesting challenge, I think, to bring a National Guard unit in. It was, to some degree, done in World War II. That's interesting.

What about racial tension and racial problems? Were there any particular signs of those this early?

A: Not really. In the 577th we didn't have much problem with that. I wasn't cognizant of any problem, and I was alert for any.

Q: The other area that you mentioned earlier, one of the missions you had was combat support. What sorts of activities were you involved in; how much did that involve?

A: We didn't have too much of that, but it always took the priority. We dropped the other things when it came up.

The 173d was engaged up at Landing Zone English, north of Qui Nhon, so they spent little time down in our area. Every now and then they'd come down for a while. As I mentioned, they sent the one company down for us to secure the land clearing for special forces out of Cung Son. We were out mutually supporting them in that operation.

We did some mine clearing for various folks. The Koreans pretty much spent time to themselves and used their own engineers. We did, as I said, some mine clearing and sent teams out often with various people depending on the mission.

A typical operation came about when we were given the mission to open the road to Cung Son for a major supply convoy that was going through to the special forces detachment there. This was a big convoy, and they felt it would be interdicted, and they didn't want it to be ambushed on the road.

Our mission was to clear the road in the morning and put the convoy on the road by early afternoon so they could close at Cung Son by nightfall. The operation started slowly and was really dragging. Our 577th team was very conservative as they moved out on their first mine-clearing mission.

By eleven o'clock we'd gone only about 3 kilometers of 30. I was back in my command post monitoring that operation by radio. Finally I directed that the engineer team take five-ton dump trucks, loaded with earth in the back and sandbagged, and back them down the road.

They did that, and I flew out to visit them on the highway. We hit two mines with those five-ton dump trucks—destroyed the trucks, but didn't hurt the operators. I think one of them had a slight scratch, an elbow or something. We opened the road and did it quickly and pushed the convoy through by that evening.

Q: Was that a technique you'd heard about before, or you'd devised on your own?

A: I don't remember. I don't remember hearing about it. We typically had the bottoms of our trucks sandbagged, so that was ready. We went out with trucks in the column filled with earth in case they had to patch anyplace, but I don't know what prompted me to think of that.

So, I still get a mental picture of a truck with a wheel flying up in the air.

We did not have a horrendous lot of combat operations down in that area, but we had enough. We had a mounted reconnaissance patrol coming back from the road-clearing operation ambushed—killed the driver but the others got away.

We were mortared several times. Our team down in Vung Ro Bay was mortared one night, killing the squad leader and at least one other, and several were wounded even though we were bunkered in sandbagged culverts.

We had an incident one day where the Vietcong came down the hillside above the laterite pit where our tractor-scrappers picked up the material to be taken to the highway. They fired an RPG [Rocket-Propelled Grenade] into the cab of one of the tractors. The operator, taken under fire, spotted another tractor-scraper coming around the outside of his that had stopped. The driver jumped into the one coming around the side just as an RPG came into the cab. His own tractor burned in place.

Down in the Don Duong, Duc Trong area, we had several instances on the highway. One night vehicles moving from Don Duong to Duc Trong, even as the USARV inspector general came into our area, were stopped at a toll station. We were out later that night than usual; it was getting towards dusk. The Vietcong had already set up their toll station along the highway when the convoy came along. A short firefight ensued.

Another incident that happened was almost amusing, considering the circumstances. We did have IG inspections over there; even though we were fighting the war, we had to be ready for inspections.

B Company, our last to move, knowing they were going to go through this IG inspection a week and a half after they arrived, had meticulously fixed up their prescribed load list in an express container. They had all the right bins and markings and everything else, had loaded the container on a tractor-trailer and moved it down to their new location, offloaded it, and were ready to go for inspection.

They were located with C Company at Duc Trong, and our engineer compound was on the back side of the compound of the headquarters of the province chief. Well, the Vietcong had decided to attack the province chief's headquarters. They came around to our engineer side with their secondary attack. It was a feint, really, just to hold our people in place while they assaulted the ARVN facilities on the other side. The Vietcong put an RPG right into that B Company's express container and spewed all over the place the load that had so meticulously been taken care of and hauled all that way from Tuy Hoa.

Q: Now, this is not long after the Tet offensive, so, I'm sure people were still alert, on edge, or whatever from that sort of thing. In some areas, I guess, in the aftermath of Tet there was

actually a sort of slackening of the pace of enemy operations. They suffered so heavily during that period. Could you see the impact of Tet, or the aftermath, while you were there?

A: No, not really where we were. I think the thing you're referring to is in areas like Hue, Phan Rang, Saigon, the others where there were big engagements. Up in our area we were never mainstream with large, hard-core units.

Tet happened before I got there. Phu Hiep came under fire attack during Tet, and the 577th and others on the perimeter had fought them off. The Vietcong had occupied a school just outside the perimeter, and we had basically destroyed the school with fire. While I was there, we came back in and rebuilt that school for the Vietnamese.

The Vietcong didn't take a huge toll in the Phu Yen, Tuy Hoa area. Nor did the counterattacks take a big toll of the Vietcong, so they really weren't destroyed in the province. They were around and they kept things going, like those incidents I talked about. There were not large numbers of Vietcong or incidents.

The Korean regiment was very aggressive. They were always taking operations to the periphery areas around Tuy Hoa and really kept the Vietcong on the move. The Vietcong incidents we'd have would be planned skirmishes, planned firefights, basically by very small units.

Q: Did you have much contact with Korean engineers?

A: No, very little. I visited the Korean regiment early on to try to make contact with the commander. He really wanted to be autonomous, and he didn't want anybody messing with his engineers. We would invite them over in the evenings, and we would have some contact, but not a really professional kind of contact.

Q: Well, maybe we can turn to the activities in the Dalat area, if there isn't any more about the early period that you'd like to cover.

A: Well, I talked to you a lot about Dalat already. We continued our echelonment and moved into the new area. Either the USARV engineers or the brigade had come up with a study that said, for all of Vietnam, that building revetments and base camps out of sand bags was not smart nor cost effective because they wore out and a lot of effort was spent rebuilding them. There was a design to use plywood for revetments. You could build one very quickly, put on plywood, brace it, and put the sand in between, as opposed to stacking individual sandbags.

When we went into Don Duong, we decided to move in with Delta Company of the 589th, now our Delta Company. We built the base camp at the base of a large dam. The dam had been built there for hydroelectric purposes. There were large penstocks that ran down the hillside toward Phan Rang. The penstocks had been destroyed.

We built our compound right at the base of the dam. It was a nice flat area, away from the village, where we could immediately start down the switchbacks towards Phan Rang or run

down 21 Alpha. This was the intersection or the meeting point of the roads from Dalat and from Duc Trong, QL-21 Alpha.

Now, that was controversial later when General Morris arrived. He challenged why would we build our base camp right below the dam, from the standpoint of concern that the Vietcong could blow the dam with a large loss of life. One of the things I had to do early on was show him why we weren't in great jeopardy. I did this by demonstrating the amount of work that would have to happen for them to be able to provide a demolition charge large enough to have a catastrophic failure or breach of the dams so the water would pour on us below in the base camp.

We had our artillery at both ends of the dam, and it was secured. The kind of effort that would be required to breach the dam would take such a number of hours, or such noise, that it would be very obvious, and counteraction would be taken.

Further, no matter what happened with the breach where we were, we were so close that the entire river valley below us, along 21 Alpha, would be inundated. Because it was very populated with Vietnamese sympathetic to the Vietcong, any kind of warning for them to get out of the way would be certainly noticeable to us as we were going about our operations.

With that, General Morris acceded to the point that we were okay.

Q: So, one of your missions down there was to keep the road open during the rainy season, I think?

A: To get ready for the upcoming rainy season.

Q: To get ready for it.

A: When I departed, we were just getting into the first weeks of the rainy season. The mission was to keep 21 Alpha open. We were then to prepare to widen QL-21 south of Duc Trong.

We were also to look for a quarry site for rock to support further construction and paving operations. Finally, we were to take charge of the rest of the area and to build the switchback roadway down the mountain. That was a real challenge because it had severe high grades and switchbacks up a rather precipitous hillside.

We had three incidents during that time. One of them was natural. There was a tremendous rainstorm just before I left that breached a roadway where we had just put in three culverts. I mean, that's how quickly, in this narrow valley, the water came up. So, there was reason for us to be there to keep that road open.

Second, the Vietcong blew out part of the roadway leading up the mountain through the switchbacks. They did it very skillfully at a bend, so skillfully that the small Vietnamese buses that were typical of the area, loaded with folks, could get around the crater. Yet, our 1st Log Command stake and platform trucks couldn't get around it.

So, the Vietcong had kept the populace in mind, but had done something to thwart the Americans. It was a real challenge to get the road back in, and we solved it by building what we called the “band-aid.” We drilled straight down in the rock, put steel rails in vertically, then used vertical anchors to tie cable to horizontal steel rails that would hold a wood frame onto the mountainside. We then filled behind the frame to grade with rock and resurfaced the road. We bound that “band-aid” to the side of the hill, which dropped off 100 feet or so—patched it. That took about two days.

The last incident of the three was on the day before my change of command. The Vietcong blew a bridge down Route 21, just at the boundary of our area of operations where we met up with 116th Engineer Battalion to our south. Route 21 was the main supply route and we needed to open it quickly.

We had a panel bridge at our location in Don Duong, which was across the outlet from the dam and spillway. That bridge facilitated movement right after coming up the hill from Phan Rang and led straight into our base camp, rather than going around through the village.

I’d already asked that our people pull the bridge and then put it up again, just for some training, and that was ongoing. We sent a recon party down to quickly recon the blown bridge site, and we needed more Bailey bridge.

We started one company immediately to pulling out that Bailey bridge. There was another Bailey bridge down in Phan Thiet, and that bridge was moved overland, under command of some other engineer battalion, to the bridge site. Then we moved our Bailey bridge south on 21 Alpha, then 21 down to the bridge site, and the overall operation was my responsibility and under my control.

Through the next afternoon and evening we put the bridge in. One morning we found out it had been blown. That day the recon was made, and then we put things into motion to pull out our bridge and bring up the other bridge, so they were moved the second day to the bridge site to be put in that afternoon and evening. It was finished in the early morning of my last day—change of command and departure.

Colonel Barnes, the 35th Engineer Group commander, and Lieutenant Colonel Jim McKnight, the incoming battalion commander who had just come in that morning, arrived. Jim McKnight’s postponed arrival prohibited any overlap with me. Our overlap was a couple of hours after Colonel Barnes arrived. I jumped into the helicopter, and we flew down and looked at the bridge site. We returned to Don Duong, talked for a few minutes, and then we went out for the change of command ceremony. General Morris presided.

We flew down and saw that the bridge was in and the operation was complete. I could now leave. We’d had a few wounded down there by mortar fire and some mines left in the area.

Q: Maybe this is a good place to ask you to compare and contrast what it had been like, what you’d seen, what it had been like in Vietnam in your first tour, ’62–’63, and what it was like

now in '68-'69. How did the war look different? How did you view things that were going on there.

There are obvious differences, and I suppose, in my view, obvious similarities, but it's interesting to be there in the two time periods, earlier and then sort of mid-war, five years apart.

A: To go back to the same area.

Q: Yes, back to the same area. Right.

A: Well, there was quite a difference. During the first one, of course, I was an adviser in an era when there weren't many Americans and no operational troops, other than aviation. Everything then was oriented toward the Vietnamese doing it, and our energies were spent trying to make that happen.

When I came back, I was in the American chain. We still had advisers who were out doing the same, but now we in U.S. troop units were all very much oriented to our own particular missions and how they supported the whole. So, I was caught up in the operational activities associated with U.S. units.

We were everywhere; every place you went there were helicopters flying, operations going. We were reading about them in *Stars and Stripes*, and participating in them, and the activity level was high.

It was very much, from my viewpoint, a U.S. operation by that time. We dealt with the province chief and with the province advisers, but the whole context was different from when I operated there before. If I'd gone back to be another adviser, I'm sure that context would have been a lot closer to my earlier one.

Going back into Tuy Hoa and trying to reconstruct where we were when I left and where we were when I came back, I guess I would say we were about at the same place. We certainly hadn't "pacified" or made any other inroads to extend our areas of control. I guess I was amazed when I put together all that happened in the interim. When Diem had been assassinated, all the province chiefs had gone out, including the one in Phu Yen Province. Whereas, as I told you before, when we moved into Tuy Hoa, the lights came back on because the Vietcong moved out, well, after Diem's overthrow the Vietcong moved back into Tuy Hoa.

So, once again, then, when the Americans came back—the 4th Infantry Division had come in there, and then the 173d Airborne Brigade had operated in there aggressively—the Vietcong had been pushed back to the jungle and mountainous fringes once again.

So, there were indications that progress had been lost and things had not been put in place to stay. Control appeared to be about like it was—no better, no worse. The Vietcong still went to a lot of places at night and then wouldn't show themselves during the day. We still operated out and around, went after them in the fringes now, which we could do much more

aggressively because we had more units: the Koreans, the Vietnamese, and the 173d, as opposed to only the 47th ARVN Regiment when I was there earlier.

Q: Was battalion command what you expected it would be like?

A: Yes, very much so. I was ready for it and enjoyed it. I really enjoyed it because we had great missions, doing super work, and I had area responsibility. I mean, my responsibility was for anything and all that came into that area that needed engineer support. It was up to me, and it was my decision. I could always be second guessed, but it was my decision as to what went and what didn't go. When somebody needed engineer support, then that got the priority and we would slow down something else.

What got slowed down was my decision. I knew they wanted me out of QL-1 construction, which also meant the Ban Thach bridge. That was construction, and that could take second seat to combat engineer operations.

So, all of those responsibilities were mine. For about six weeks straight during that period I never talked to my group commander.

I was promoted to lieutenant colonel on the 12th of August. I'd been there now in command since the 6th of July. Colonel Fowler called me on the telephone at the end of the day and said, "Well, I suppose you thought I was going to fly in and pin them on you." I said, "Yes, Sir, I really thought so." He said, "No, just pin them on. I'm not coming." [Laughter]

Q: That's interesting. So, the group commander left the initiative, the leeway, to you?

A: Del Fowler's modus operandi was just that. He used to tell people that his group did so well because he "turned on" his battalion commanders and didn't mess with them unless they wanted to be helped.

Bill Barnes was not that way. He stayed in much closer contact. By the same token, though, he didn't take away my responsibility or accountability and I made the decisions. He might tell me that I hadn't paved enough, that the 864th Engineer Battalion under Lieutenant Colonel Art Daolis had paved a kilometer that day, and "Why didn't you pave like the 864th could?"

I got together with Art Daolis at a commanders conference three weeks later, and over a beer in Bill Barnes' little club at the 35th Group headquarters he said, "Boy, you 577th guys are really good. We just can't keep up with you. Barnes calls me every day and tells me how much the 577th has paved." So, after that, we knew. [Laughter]

Q: A technique, that.

A: A technique. I enjoyed both of my group commanders, and I really enjoyed John Elder, the brigade commander. I enjoyed being there in command at that time because I had an awful lot of autonomy. You knew you were responsible.

You know, it's sort of what General Max Thurman later called Rule 14. "When in charge, take charge." In Vietnam then you knew you were in charge. There wasn't any question about it. We would design something and then the 18th Brigade would say, "Well, who's approved your design?" "Well, no one. You want to approve it? Come on up and approve it. Don't tarry."

So, it was a bunch of can-do, move-out kind of folks, and we all had good missions. There were construction projects, which were finite. I know my company commander that had responsibility for that ammo supply point day in and day out got his equipment taken away from him. I mean, I had to console him every now and then by saying, "Now, look, you recognize that's just one of your many projects. That's not the battalion priority, so it's always going to be delayed."

I made the decisions as to how we used the resources to do the missions we were given. I made the decision to change our way of doing maintenance. I didn't have to ask for permission for those things.

We learned to operate so that we could make things happen. We would get the LSTs to take our supplies down to our new location. We knew the responsibility for security was ours, and for patrolling, and all those kinds of things, so we just took charge. A very satisfying period.

Q: Any other thoughts you have on the Vietnam period, '68 and '69?

A: Yes, I should say one more thing. It just occurred to me. You asked how the equipment was, and it occurred to me I didn't comment on getting supplies. The supply system where we were was very tenuous. You could order something for a particular project, like certain stringers and certain lumber, or your equipment replacements, and when they came into the depot they probably would get diverted.

So, early on it was apparent that we needed our guy at the depot. So, I put a specialist 5 at both the depot at Cam Ranh Bay and the one at Qui Nhon. His job was to go find our stuff, or available stuff. If it was available and we needed it, he would make out the requisitions for it and put it in "lot 16, bed 8," and we would go get the item. Then we would scramble the vehicles or the aircraft to bring it from wherever it was.

So, to make the system work, we really had to have our own expediter, maybe even protector.

Q: That's interesting. I've heard of a similar technique used during the World War II period too.

A: I'm sure.

Q: Perennial problem. [Laughter]

A: Right.

Q: This might not be a fair question, but let me throw it out to you. Shortly before this you were in the 307th Engineer Battalion, 82d Airborne. How would you compare the two battalions,

the 577th and the 307th, in terms of readiness, training? They were different situations, of course.

A: Well, they were absolutely different. In the 307th Engineer Battalion (Airborne), I joined a battalion that always had a high priority. The 82d Airborne Division always has had a high priority. The 307th had a very high caliber group of officers.

A lot of noncommissioned officers had been in and out of that battalion for years, so they really knew what they were doing. The officers were very high caliber, and senior. You didn't have lieutenant company commanders. In the 307th, we had captains. So, it was just a higher caliber of folks to begin with.

Second, the 82d works very hard on motivation and the "can-do" thing. We'd just been in the Dominican Republic and everybody felt good about that operation. We knew how to make things happen.

By the same token, the jobs we had to do, the training—I mean, there were high standards for training. You had to do it right. We didn't have to produce things and build things on the order of what we had to do in Vietnam.

The 577th Engineer Battalion (Construction) was altogether different. It was a battalion with very lean leadership from the standpoint of experience. We had company commanders who had less than a year of commissioned service. Even when we replaced them, the replacements would have less than three years of commissioned service. I would say some of our commanders in the 307th were in their fourth, fifth, and sixth years of commissioned service.

So, you had people in the 577th who were very junior. They never had an opportunity to really find themselves as platoon leaders and company execs before they were thrust into company command. They had great heart, all well motivated, but they just didn't have experience and maturity. We didn't have that cohesive drive on motivation that we had in the 82d. We did have the kind of motivation that professionals possess when they want to do a good job.

We had good noncommissioned officers for construction, and, as I mentioned before, I think they really knew their job of vertical construction and horizontal construction and that sort of thing.

Both battalions had maintenance soldiers and leaders who really knew their jobs, but certainly the job in the 577th was a lot more difficult than the 307th with its small amount of equipment and the small hand-operated stuff in the 82d. The 82d's standards of having to meet a roadside vehicle spot check were a lot higher than when we were operational in Vietnam.

So, there was a big difference, and I think the people that I served with in the 307th, 82d, could have fallen into the 577th and done a superb job. My commander in the 307th was Lieutenant Colonel Jack Waggener. He'd come over and was now commanding the 45th

Engineer Group in the north, while I was in the 577th in the 35th Group. Al Rowe, S-3 in the 307th, was at this time also in Vietnam. Chuck Henry, who'd been maintenance officer in the 307th, was up with Jack Waggener in the 45th Group.

I would say that by the time I got the 577th we had expanded the Army considerably. I arrived in the 307th about the time of the first deployments to Vietnam. By the time I got there post-Tet, the big deployments were over and we were at about max size. We had thinned out the professional leadership of the Army and spread it into all the units, so it had to be thinner in any one place. Then there was the turnover, the 6-month, 12-month turnover.

Q: Interesting. That rotation is coming up again as a subject in Saudi Arabia. What did you think of the one-year rotation? Was it too short? Did it serve a valuable purpose?

A: Well, I think so. I mean, in the heat and stress of what went on in Vietnam, one year was about as much as a lot of people could take. If somebody wanted more of it, they could get more of it by extending. A lot of soldiers from World War II slogged through the whole war, and a lot of them were also only in units with that kind of intensity for short periods of time.

I was the benefactor of a change in command tour over there. When I went over, it was a six-month command tour. Certainly I thought that was too short. I guess about my third or fourth month there, they were thinking about leaving at least some folks in for a full year tour as commander. I think I was among the first to get that opportunity. I had been told I'd probably move down to be the executive officer of the 35th Engineer Group, and I'd be replaced in six months.

I didn't really want to do that, so I asked Colonel Jack Waggener, as I just mentioned, the commander of the 45th Group, if he had any battalions available and that I was available. He'd mentioned that to Major General Dave Parker, the USARV engineer, who was at this time considering leaving commanders in place for a full year.

So, he asked Jack Waggener, "Where is Kem going?" Jack told him. Then General Parker said, "No, we'll leave him right where he is." So, I got to stay a full year in command.

Certainly six months weren't enough. I would say a year in command over there was a pretty long time to continue under that kind of load and stress. I think I was—I hate to use the word—burnt out; I certainly could have probably used some fresh ideas by the time I finished my one year.

So, your question really had to do with one-year tours overall, but I gave you an answer that indicates that the six-month command tour, in my mind, was a more important parameter and too short.

Q: Okay. Should we turn away from Vietnam? Any other thoughts?

A: Let me see. I guess not. I guess we can come back to them if necessary.

Staff, U.S. Military Academy

Q: The summer of 1969, then, you headed back to the United States, and then eventually back to West Point. How soon did you know you were headed back to the academy?

A: I don't know, probably April or May. I came home in July. It was a couple of months before I came back.

Q: Was this an assignment you were looking forward to? Was it sort of the thing you would like to do next?

A: I hadn't really thought about it. I'd been told I was going to Washington to the Office of the Chief of Engineers to be the executive to the Director of Military Programs. At that time the Corps headquarters was still at the old location near National Airport, and one of my first responsibilities, I was told, would be to move into the Forrestal Building, into the new digs.

I'm not sure when I was told that. I was sort of planning on an assignment in the Office of the Chief of Engineers when all of a sudden I was called and they said, "We would like to send you to West Point to be a tactical officer, a regimental executive officer, and would you like to do that?" I said, "Yep," so I did.

I didn't go up to teach. I'd always been trying to get back up to the department of engineering to teach. So, when you say, would I like to have done that next, I really never thought about it. The tactical officer assignment came up, and the opportunities sounded good because I'd be dealing with cadets. Here I'd just come out of a leadership role, battalion commander, and they wanted those kinds of people up at West Point. Just like, as I mentioned, when I was a cadet, the Al Haigs were across the quadrangle, the Colonel Mike Davisons were regimental commanders, and the Haldanes and Pattons were about—recent combat leadership experience.

So, in 1969 they were looking for recent Vietnam experience and battalion commanders to come back and be the number two person in each of the regiments in the tactical department. It was a lieutenant colonel position, a combined regimental executive officer/S-3. So, that's what I did.

Q: Tell me a little bit more about what that job entails, what the responsibility is like?

A: Well, the tactical department has a normal military organization. The commandant is the senior guy, and he has a staff, S-1, S-3, S-4, the cadet activities officer, four staff officers, and he has four regiments in the brigade he commands. Each regiment, at that time, was commanded by a colonel, and he would have two on his staff. One would be the lieutenant colonel, my position, who would be his exec/S-3. The other one would be a major, the S-1/S-4, then George Lawton.

There were nine company tactical officers who were typically captains, maybe a major here or there. That was the assigned chain of command. Then there was a cadet chain of command made up of cadet captains, the regimental commanders, regimental executive officers, and

regimental S-3, S-1, S-4, and all the rest. Company commanders were also cadet captains. We tried to let the cadets run the command, although the colonel was actually “in command” of the regiment.

The tactical officer then had the combined role of running things through the cadets and being a counselor, adviser, teacher in the military ways of things, but not academics. The academic departments taught the various subjects. We were located in the vicinity of the barracks. Since then, the academy has actually moved company Tac offices into the barracks. That was not true at that time. We were in Washington Hall with offices contiguous to the barracks.

I was in the 2d Regiment. As mentioned, I was the 2d Regiment executive officer. We didn't use the term “exec/S-3,” we just used “executive officer,” but I did the S-3 part too.

So, that meant that I reported to my boss, Colonel Robert Haldane, the regimental commander. That's the same Captain Haldane who was my company Tac when I was a cadet 14 years earlier. Later on, when I was in the DCSENGR [Deputy Chief of Staff, Engineer] in Europe as a colonel, Lieutenant General Haldane was Chief of Staff, USAREUR, a job that I held later in 1988-'89.

I would interact with both the cadet captain regimental executive officer and the cadet captain regimental S-3 in doing those things that had to do with cadet operations. Additionally, we took responsibility for planning summer training. As the academic year approached, we first would get organized for the year and would pick the cadet chain of command, based on their previous performance, experience, and their cadet performance reports. When the academic year started, we would get the cadets started off in the leadership positions doing the various kinds of things that were their responsibility.

We would monitor their performance through the year, and then start working with the first class (seniors) towards their branch choice as they prepared to move off and start their commissioned service.

In the spring we would begin to plan for one of the summer training activities. For the 2d Regiment that year, our mission was to be second summer training at Camp Buckner. The cadets, just now becoming yearlings (second year), would go out to Camp Buckner and undergo combined arms and support services training in the field for 60 days.

So, the responsibility during spring 1970 befell to Colonel Haldane and his staff to plan the Buckner operation for that summer. Then he would be in command at Buckner during the period.

Q: How long were you there? I have a couple of conflicting dates.

A: I spent one year in the 2d Regiment and two total years in the tactical department. In the second year I moved to become the S-4, Corps of Cadets, that is, the commandant's S-4.

Q: What did that involve?

A: It involved almost all activities in logistical support of cadets. I was the budget officer for the Corps of Cadets. I maintained the program and budget. I was the supply officer for the Corps of Cadets. We operated the supply room with all the khaki uniforms, the bayonets, and so forth that were issued for them.

I was the transportation officer for the Corps of Cadets. I arranged air transportation to fly to the Notre Dame football game. I would figure out what airplanes were needed for when. I wasn't the contracting officer, but my office would get the contract and make the arrangement for the treasurer to withdraw the money from cadet accounts. We would then contract for the commercial aircraft to fly the cadets to the football game, or lay on the buses to take them down to Philadelphia for the Army–Navy game.

We were in charge of cadet uniforms. Therefore, we would work with the uniform manufacturers, who were right there at West Point. The crew that makes the cadet uniforms didn't work for me, they worked for the quartermaster, United States Military Academy. I was the commandant's rep that worked with them for all the fittings to get them right and so forth. We coordinated all of the uniform manufacturers who came to West Point to sell the graduating class their first Army uniforms.

I did not operate the cadet mess because there was another quartermaster officer, Major Tom Arwood, who worked for the Military Academy, who operated it, but I was the commandant's point of contact with him on all operations of the cadet mess.

Likewise, I was the point of contact for the commandant for everything having to do with facilities for the cadets. The barracks police worked for me—that is, the janitor on each floor and each stairwell of barracks worked in an organization of about 130 that reported to me.

Parts of the new barracks at that time were under construction by the North Atlantic Division, New York District. The district had an area office at West Point. I was the commandant's point of contact for everything having to do with construction requirements, for policing of the area so that we could simultaneously conduct operations, for closing off certain things so certain construction could take place.

Q: Did you like being back at West Point at this stage of your career? Did you enjoy working with cadets?

A: I enjoyed it very much, and I enjoyed very much the interaction with cadets. It was a nice time for my family too. It was, having just been in Vietnam on a hardship tour, a chance to get to know my children.

I left Steven at age two and came back at age three. He was three, John was six, and Michelle was eight. That was a nice period for them, getting started with school and all the activities at West Point. We met an awful lot of nice people and interacted with them. A lot of people had just come from Vietnam; some were just going back.

Q: Harking back to what you said earlier about your branch choice, when you were at West Point; they gave you a chance to have some influence, hopefully, over cadets who were facing branch choice questions.

A: Well, yes. I mentioned the anecdote before, I believe, where the cadet regimental commander wanted to change his mind at the last minute and go engineers. I basically talked him out of it. I think what was important was to make sure people made a right choice.

There's always the interest in your own branch, and you really like to talk it up to people who are interested or undecided, but, by the same token, you're really looking for the right match for the Army, for the right people to do something that's going to keep them motivated throughout a career. If you put a guy who should be infantry at an engineer post, he's probably not going to be motivated to stay the route, and vice versa.

There was a tremendous interaction with the cadets. For instance, the brigade supply officer, my counterpart when I was the S-4, was Cadet Captain Rick Capka. Later on, when I signed in at Fort Belvoir to become commandant, there was Major Rick Capka. Then later on he became General Heiberg's aide here in the USACE headquarters.

So, you do have those kinds of interactions that continue throughout a career.

Major General Dan Schroeder, now commandant of the Engineer School, was a company tactical officer at that time. Brigadier General Roger Yankoupe, now at South Pacific Division, was another company tactical officer at that time. I didn't really know him there, but Major General Pat Kelly, Director of Civil Works, was teaching physics. Major General Tom Fields and Brigadier General Bill Fitzgerald were company Tacs with me in the 2d Regiment. Lieutenant General Tom Griffin was exec in the 4th Regiment. Major General Jim Ellis taught earth space and graphics, and Colonel Jim McNulty was a permanent assistant professor of mathematics. There are just a lot of people that came in and out of my assignment at any one particular time.

Q: West Point does bring together a fairly high concentration of officers, I guess, in the faculty and staff positions—people who have a lot of interactions. That's quite a few engineers to be there at one time. Maybe that's usual. I don't know.

A: Well, there always are quite a number of engineers. Colonel Bob Ayers had just been in the tactical department and was now in Engineer Branch, Office of Personnel Operations, and he was trying to get engineers in some of those tactical department leadership positions. Later on, Generals Mark Sisinyak and Hugh Robinson were regimental commanders.

Q: We've talked about your positions at West Point. I don't have any further questions. I wasn't sure if you had any more thoughts about it.

A: Well, about the S-4 job, that was one job I really didn't want to take. I argued that I ought to stay in the 2d Regiment. Colonel Dick Tallman, the assistant commandant, called me in one day and said I'd used all the good logic and made a lot of great points about why I should not go be the S-4, and therefore I should report Monday.

I did, and that place had a lot of problems. Dick Tallman's charge to me was to put it back on an operational footing. For example, I found out the budget was prepared by the same guy who approved all the purchases against that budget. I walked down to the supply room and found out that he ordered the same number of the various sizes of khaki uniforms. So, we're out of 32 medium, but we had a whole shelf full of 38 extra longs.

There was a lot of dissension in the ranks. The janitors wanted to be an operational entity. A lot of things just weren't being taken care of. So, it was my job to clean house and get it straightened out.

I did that by adding a second deputy position. I had two; I had a major that worked for me as assistant and added a second one. Major Bob Oliver, an engineer, had been there as assistant S-4 over the last year and was doing a good job. There was way more to do than he could take care of, so I brought in Major Gary Brown, a field artilleryman, to fill the other position.

During that year we straightened out a lot of those things, and we rewrote the logistics manual for the Corps of Cadets, which addressed how to do everything from rooms to uniforms. We did quite a number of things to put supply, logistics, and transportation activities into a better condition.

We also worked to review the cadet accounts. Our interaction with the academy treasurer was on the cadet accounts—what moneys went into which part of the account. We reworked all of those and worked very hard with now Major General Tom Arwood, who was then a major and head of the West Point mess in Washington Hall. We fought a lot of problems together that year.

For example, a couple of our United States senators decided that cadets should wait on their own tables because, after all, when they went to college they had waited on tables in their fraternities. So, in typical fashion, as I was to find out later when I came down to the Army Staff, we got a message tasker from the Department of the Army, Office of the Chief Legislative Liaison on Friday evening about five o'clock. The requirement was to provide them a paper by eight o'clock Monday morning on the issue.

As the staffer responsible, I got that weekend mission and worked with Tom Arwood to prepare our response—why things were different between a fraternity's and West Point's meal operation. Why taking away from cadets' already full schedules, when we were paying to get certain things accomplished, just wasn't smart. We submitted our paper back to the Office of the Chief Legislative Liaison on Monday. Evidently, it worked.

Q: How would you characterize the mood at West Point in the '69-'71 time period, as opposed to what you remembered when you'd been there before in the mid-50s. The Vietnam War is still going on. Was it a lot different? Did it seem a lot different to you?

A: Well, it's pretty hard to characterize because your view as a cadet is much different than your view as a Tac officer at any time. I mean, often, when I was a cadet, what I wanted to do least

was go to parades. I wanted to do my things, be independent, had a little rebellious nature, and often tried to beat the system. In the tactical department you think that everyone is trying to support the team, to get ahead, to be a winner in the endeavor, not recognizing that everyone is human.

So, there are two different views. Certainly, as a Tac I worked at the cadet captain level, that is, interacting with the brigade staff, regimental commanders and staff, positions far higher than I ever had attained as a cadet. I was a cadet sergeant my first class year. I was working now with people who came with more motivation and a higher level of motivation in their class, and they'd proven that throughout all of their years there.

So, the people I dealt with, the cadets I dealt with day in and day out, were an extremely high cut of caliber, motivation, and potential for the future. Not that cadet sergeants can't find motivation and over a career amount to something. That's not the point. I mean, the point is that what I saw day in, day out, with my working relationships didn't necessarily reflect that everybody up there was motivated to do that same kind of job, and there were an awful lot of the rebellious kind of folks, just like I had been earlier during my yearling and second class years.

This was also a time where there were antiwar feelings throughout the campuses of the United States. I didn't notice it at West Point, although in the previous year before I arrived, the class of '69, under General Rogers, then the commandant, had had some difficulties with several cadets. Some of them were either canned or otherwise disciplined. There were just a lot of problems.

I didn't see that. I thought most of the cadets that I saw were motivated, and they were very interested in wartime activities in Vietnam because they were going to go there when commissioned and paid attention. They had a good motive.

That didn't mean that cadets didn't have a lot of horseplay and didn't mean there wasn't a lot of other things that went on. For example, in one incident, Vassar students decided that they would come down and circulate petitions to get cadets to sign up for antiwar activities. It was said that they would come down and trade their bodies for a cadet signature on the petition. That was the word passed around the Corps one week.

On Saturday morning, as we got ready for the football weekend, we looked out upon the plain, and there was a single cadet bunk with a sign that said "Welcome Vassar." [Laughter] So, throughout all of this, there's always a bit of horseplay and humor.

Then another incident was more serious. Cadet Michael D. Anderson, who had been the assistant S-3 in the first detail—the academic year was divided into two leadership details—and thereby worked under the cadet regimental S-3, joined the legal suit against mandatory chapel at the service academies. This was quite a *cause célèbre* at the time.

Now, Cadet Anderson had missed chapel formation one Sunday, and he'd been reported absent by the cadet in charge of his chapel marching unit. He had argued that he wasn't a

member of that Protestant chapel squad that he was marked absent from because he was really on the Catholic chapel squad.

Well, when you got right down to it, it was found that he missed chapel, and so he was written up for punishment. There was an ongoing legal action by five midshipmen at Annapolis who had sued the federal government to get out of mandatory chapel. Anderson joined that suit and was the only cadet as part of that suit.

At this time, Colonel Haldane, the regimental commander, was at Harvard at an advanced management program, so I was the acting regimental commander. It befell on me to handle this situation over the coming weeks.

There was a strong reaction from Anderson's classmates, and there was a great deal of discussion and talk, a buzz of activity and dialogue about this at West Point. It was manifested a little bit later in an incident in which Anderson, in a classroom, had used some profanity in a social studies class in answer to a question. The cadet section marcher reported Anderson for conduct unbecoming a cadet, using profanity in a classroom. The instructor took issue with this because of his feeling that in the classroom he was in charge, and he wanted to have freedom of expression.

This, then, became a bit of an issue between the academic department involved, social sciences, and the tactical department. Now, you must understand that often there's some differences in opinion between the tactical department and the academic departments. The tactical department feels that they do important things; the academic side needs to understand how important those things are. The academic departments think the cadets are up here for an education; if the tactical department would quit taking up all their time, they'd be able to study better and be more prepared.

That puts it very simplistically, but that's the rudiments of this divide. There were always efforts to bring the two together for the common cause.

Well, in this case, Colonel Amos Jordan, who had been the head of the department of social sciences for some years, quite a well-known figure in United States national security circles, called me, the acting commander. He said basically that what happened was well within norms and met the standards of the department of social sciences and certainly we shouldn't do anything to punish Cadet Anderson.

Now I had a dilemma. As I looked at the situation, it seemed to me that I should let it play out its course and see how it was going to work. I didn't want to stop anything at any one particular time because if I stopped it, then it was going to be a situation in which no one was going to be happy.

Our normal protocol in the tactical department was that if a cadet reported an offense we sent it to a cadet board. I'm talking here about an offense that reached a certain threshold, we would send it to a cadet board and let them pass judgment on their fellow cadet and assess the punishment. If it was reported by a tactical officer, we would send it to a tactical officer

board to go through the same process. Since the cadet section marcher wrote him up, I decided to send it to a cadet board.

I well remember the report of the board, which was some two or three pages in length and signed by Cadet Captain Steve Wesbrook, who was the deputy regimental commander. The board found Anderson guilty of the offense and recommended punishment. Part of Wesbrook's articulation because the academic departments had talked about standards, was to the effect that academic departments may have their standards, but cadets had their standards too. Cadet Anderson didn't meet them, and so he was assessed the punishment.

I thought this was an appropriate solution to the episode. Colonel Jordan may not have agreed, but the process had worked. The punishment was approved, only to be stopped when the plaintiffs went to the judge and got an injunction against any punishment of Cadet Anderson or others during the period.

In the end, of course, that suit is the one that caused mandatory chapel to be dropped at our service academies.

Q: So, the era had its effect on West Point, but perhaps not in the same ways that it might have affected some other parts of society, but a sort of rebelliousness against rules and regulations.

A: Well, you put that in a little different tone, in a different mode from what I answered. You asked, did I see things as different. Your conclusion about the era may've not been the same thing.

I think you'd have to go in and do an analysis of a whole bunch of things, such as retention rates, for one. You know, I think the numbers of applicants per position were down in those years compared to later years when the number of applicants had grown considerably after the war was over.

I don't know whether the graduates of '67, '68, '69, '70 stayed in or got out in any different proclivity from other classes. I don't think my answers can lead you in any kind of overall conclusions on the impacts of those wartime things on the graduates of West Point.

What I was trying to suggest was that daily activities at West Point weren't embroiled in war operations, that we went about the daily business. The daily business for a cadet is very time-consuming. He or she has got a lot to take care of, and their schedules are very packed full of academics and other activities. So, there's not a lot of extra time to do other things.

What I'm suggesting is, from my interactions with the cadets of that time versus the old, the tactical department of my day as a cadet and me, I'm not so sure the interactions weren't about the same, and things that went on weren't about the same. Certainly a different external climate that we were all aware of and all very interested in, and probably all more in tune with than many of the people on the rest of the campuses, many of whom seemed to be in the streets but with their ears tuned off to anything of logic and only tuned into things with their own already preconceived biases.

Q: You did point out, and I thought that was interesting—and I've heard this from people over at West Point during World War II—that there is a sort of urgency, perhaps, being there in a wartime situation. The cadets know that soon thereafter they'll probably go to the theater, and that's given an emphasis.

A: Sure. When we interacted with them, they wanted to know about what was it like, and what's happening, and I'm able to provide their answers as the recent battalion commander of the 577th Engineer Battalion. A cadet who wanted to go engineers could talk to me, and I could talk about the kinds of things we did in the engineers.

Q: Anything else about West Point, before we turn to your next assignment?

A: No. I worked with some fine folks there. Colonel Bob Haldane, I've already mentioned, was the 2d Regiment commander. Colonel Bill Webb commanded the next regiment over, the 4th Regiment, and my classmate Lieutenant Colonel Tom Griffin was their executive officer.

Later I was to work with Major General Bill Webb when he took command of the 1st Armored Division and I was the 7th Engineer Brigade commander in Germany. Then, as I mentioned earlier, Colonel Haldane came back to be the Chief of Staff, USAREUR, when I was in the Office of the DCSENGR.

Then Colonel Dick Tallman, who was selected for brigadier general, went to Vietnam and unfortunately caught an artillery shell and was one of the few general officers killed there. He was a fine gentleman and a terrific leader.

I also enjoyed working with the commandant, Brigadier General Sam Walker, who, I thought, was a superb commander and individual. General Bill Knowlton came in as superintendent, and I enjoyed his time there.

I should say early on there was one other thing that did cause a lot of conversation and thoughts throughout the faculty and cadets. When I first arrived, General [Samuel W.] Koster was the superintendent. He, of course, was involved as the Americal Division commander with the My Lai affair, and so I was there when he was removed as superintendent and watched him leave and General Knowlton come aboard. I guess that happened just a couple to three months after I arrived.

Naval War College

Q: Shall we turn to your next assignment, then? I guess the obvious question is, why did you go to the Naval War College?

A: I went to the Naval War College in 1971. I was due to stay at West Point for another year. I had a call from Engineer Branch and was told I was on the alternate list for the War College.

This was my first year of eligibility, so I had thought I hadn't been selected. They don't reveal names on the alternate list.

This was right at graduation time, so I'm talking about like the 3d to 5th of June in 1971. He said, "You've just been activated as an alternate and slated against the Naval War College. Our question is, do you wish to accept?"

I thought, "Well, I'd really rather go to the Army War College." So, I said, "Well, what about the Army War College. Do I have a choice?" He said, "You have no choice. You can go to the Naval now, or you can turn it down and go back into the competition for next year."

So, I decided that it was the right time; a rather abrupt change but I probably ought to go. So, I went on to the Naval War College.

Q: How many Army officers were there at the Naval War College?

A: Out of about 300 students, there were 26 Army; about the same number of Air Force officers.

Q: The Army War College also has Navy officers and Air Force officers, don't they? That's a deliberate policy?

A: Well, yes. I'd say there were about 26 Air Force and the balance were Navy and Marines.

Q: At the Army War College, there would be also Naval officers?

A: Yes. The number was supposedly 22 our year, as it had been for a couple of years. The Navy hadn't filled its own share and offered additional slots to the Army, so we had 26 rather than 22.

Q: What was the curriculum like?

A: It was basically much like that at our other War Colleges, oriented on national security. The course was divided into segments. Only one segment was maritime in nature and rather focused on the Navy and national security operations. The others were all national, Washington, geopolitical in aspect, and quite a broad well-structured course, I thought.

We had a lot of wonderful speakers who came up. Typically we would be in seminar groups, work sessions in the morning, and then in the late morning we'd have a very well-known speaker of some sort, either from academics or Washington or the services. Then we had a question and answer period, and some smaller group of students, maybe 8 to 12, would go to lunch with the speaker with another question and answer period. Then in the afternoon the speaker would interact with another group in a seminar kind of session.

We signed up for those lunches and seminars we wished to attend. I thought it was a really great, broadening kind of thing, plus an opportunity for exposure to a lot of nationally known folks.

In addition, we had to write a thesis and had considerable interaction with a faculty adviser. Mine was Professor Fred Hartman, who had written several books on national security.

We had a good faculty up there and a lot of activities. In addition, there was another program where, with George Washington University, you get certain credits for the work done within the Naval War College. At the same time, I took other courses in the evenings for credits towards an M.S. degree in international affairs. So, I did that, as well.

China was big at that time with Nixon opening the door to China, so courses on China were big, both at the War College and as an elective with the George Washington University faculty.

Q: So, you completed the course work for your master's degree at about the same time?

A: That's right. My War College thesis, by expanding it and meeting a more rigorous requirement, passed for the George Washington thesis as well.

Q: So, you completed the master's degree in '72, then? About the same time you completed the Naval War College.

A: That's right.

Q: Did you find the interaction with a lot of Naval officers interesting and different, or at this level is everyone focused at a fairly strategic level?

A: No, the Navy works differently. That was very obvious at the time. Just walk around Washington and hear people talk about the various services and how they approach things, or dodge things, or ignore things even with the Office of the Secretary of Defense. You could see some of that independent feeling up there as well.

That is a very fine college. I really enjoyed it. At the time the Navy had a thought that if you were good, you were at sea. In the Navy you didn't have to go to the War College, whereas in the Army and in the Air Force certainly going to a War College was a stepping stone to bigger responsibilities in the future. The whole thought and culture of the Navy was different than the other services.

Q: I hadn't known that. In the Navy you were supposed to be on a ship.

A: That's right, and that came out in the work ethic of the people there. When we got to group things, the people who got together and came up with the solutions in the group activity were Marine, Air Force, or Army, typically—and I know this is a generalization.

I remember that the Navy, the fleet, said, "We've got to have our folks know how to write a staff study." So, it came to the War College that "shouldn't we teach, and have our folks do, staff studies?" The answer that came back from the Army and Air Force liaison officers—both services had senior faculty members there—was, "No, we teach that at Fort

Leavenworth or Maxwell in the staff level course. It isn't appropriate for the senior course, the War College."

You need to understand that at the Naval War College there was both the staff level course, the Leavenworth level, and the senior course, the Army War College level course. Both were there at the same location.

So, nevertheless, it was decided they would require a staff study. Then the faculty decided that rather than individual staff studies, they would make it part of the next group effort. Why they thought that provided a great teaching and learning experience for individuals I don't know, but anyway, it was required in the next task. Then in all the work groups the strawman staff study was put together by either Air Force, Army, or Marine students. The Navy folks would look it over and say, "Well, that really looks good." So much for Navy officers needing to experience putting together a staff study. [Laughter]

Q: Were there any other engineer officers when you were there?

A: No.

Military Personnel Center

Q: So, the next assignment, from 1972 to 1974, was as staff officer, Personnel Management Directorate, Military Personnel Center in Alexandria.

Did you find out about that assignment right at the end of your time at the Naval War College? Was it something you expected? How did that develop?

A: It was during the period when I was at the Naval War College, probably around the January time frame or so, that Lieutenant Colonel Bob Ayers, who was in the Engineer Branch of the Officer Personnel Directorate at the time, called me to see if I'd be interested in that position.

Chuck Fiala was in the position, the engineer colonels assignment officer, in the Colonels Division. It was really then still the Office of Personnel Operations and still located in the Tempo Building beside Fort McNair.

The Colonels Division basically had a single officer for each branch, with two for artillery and three for infantry because of size. Bob Ayers called to say this position was always selected with the concurrence of both the commander of the Office of Personnel Operations and also the Chief of Engineers.

I thought that it was a good position and said I'd like to do it—and so the nomination was made. I knew in February or March of that year that I would be going there.

Q: What were your duties in that position?

A: The assignment duties for anybody in officer assignments are much the same from the standpoint of being interested in career development, taking care of the person, putting the “P” in personnel, so to speak; managing requirements, fitting the right person to the right job, and making the whole personnel reassignment system work.

This also has to do with being able to build and have data and people’s records at your fingertips, plus a lot of time on the telephone in dialoguing with people, plus doing your own analysis trying to figure out who the right person is for the right job.

Then there was the nonroutine, when something happened, and that happened a lot, where somebody might be relieved or somebody got ill or was in an accident or the things that cause a person to be curtailed, to go off to school or selection for a certain nominative job.

When any of those kinds of things come up—then you have to break the routine and go address that situation. Then there are ripple effects back on the rest of the system.

Now those duties are shared by everyone, whether assigning lieutenants, captains, majors, lieutenant colonels, or colonels. The farther you go up the ladder, the smaller the number of folks you manage. So, in the Colonels Division, very specifically, we were talking about 300 engineer colonels. I was their personnel manager, and that’s a rather small sample compared to many others.

I was a lieutenant colonel at the time, so unlike many places where you have a major handling a major or a lieutenant colonel handling a major, here was a lieutenant colonel handling colonels.

That was done by design. The idea was that the colonel in the United States Army is a very important person, has risen up high in rank to where most folks finish their careers. The idea was that they wanted the colonels to be given a personal touch as far as addressing their personnel actions. Very definitely the Army did not want them to be treated like “part of the pack,” as in “all lieutenants are going to have to do this.”

At the end of 19, 20 to 30 years of service, first of all, there’s not much more development that takes place. People all still do develop individually, but basically formal education development has been completed and it is now the period of maximum contribution.

There aren’t many colonels, so most of them are in very responsible charge and by themselves, so they are the senior executives of the Army. By that token the system—the Army—wanted them to feel very personally taken care of by the system. So, all of the assignment officers, except for the Chief of the Colonels Division, were lieutenant colonels.

Our business was still really one of matching the right person to the job, but there was a lot more dialogue and a lot more interaction, almost like somebody who works at a headhunter agency, who is working for the firm and for the individual too, trying to make a match. You really have to convince both of them that it’s the right kind of assignment.

So, there was a lot of interaction, a lot of telephone calls—typically every assignment would be 5, 6, 7, 8 telephone calls, calling around to find a person's interest; coming back with two or three "what do you think's?" Then moving on to say, "This is coming open, are you interested?" No, he's not, for whatever reasons. Then trying to find other matches.

At the same time, we had Army requirements. We still had Vietnam going on, and it was drawing down, so no one wanted to go for their second or third tour; some people still hadn't been there for a first tour.

There were some things where Army policy would be, "so and so should go next," so there were a few "have to's." The job of the Colonels Division assignment officer was to facilitate that process, make it work, and make everybody happy.

Another factor in all this was the fact that with colonels' very high level responsible charge, oftentimes I would only have one engineer colonel at a place. It's not like you would have eight or nine majors on a post and certain ones could gravitate to certain jobs and others slip to others, or you could cross over.

Typically, the colonel succeeded or didn't succeed in the position. There was no backstop there, no flexibility at the post, and everything was then a permanent change of station move to someplace else. So, that complicated things.

Also, colonels work for generals, and a lot of generals had very decided viewpoints on who ought to do what and where, what their colonels were worth and not worth, and who should be selected. They were always willing to provide a little extra help to the assignment officer.

So, that's what an assignment officer did, and the differences between, say, the Engineer Branch or Artillery Branch, and the Colonels Division.

Q: So, there were fewer Vietnam slots, but there still was a requirement for a number of colonels?

A: Yes. By that time, I think, we were down to three or four engineer colonels in Vietnam.

Q: Was there any feeling on the part of men who hadn't been there that this was something they needed to do, they needed to go ahead and have an assignment there? Or was it too late for that?

A: I don't believe by this time that people who hadn't been there felt that they had to go; those people who hadn't been there basically could have gone if they'd really understood and had asked. There may be some exceptions to that, and certainly some people who hadn't been there for some number of years could go back or not go back. By this point in time, we're talking 1972, we were definitely pulling back and down, so it was seen that the heyday of Vietnam service was over.

It was still a very important place. There were people advising the Vietnamese and still trying to make it a go. Certainly on a ramp down.

Q: Well, it was the sort of position that gave you a lot of high-level contacts throughout the Corps of Engineers, wasn't it, at the general level and with the colonels there at the time? A pretty delicate position for a lieutenant colonel.

A: It was a delicate position. A lot of folks really interacted, and some not so positively. Remember, that's with the Chief of Colonels Division there. I had a very good one, Colonel Lou Tixier (Too-shay, a French pronunciation), who was a grizzled old veteran. Most of his peers, his West Point classmates, were generals long ago, so he knew all of them on a first-name basis.

He was the decision maker. I made no final decisions on policy as to an assignment. I would send up my recommendations and he would put the final approval on them. So, when somebody really wanted to object, I could dialogue with the person, but ultimately it came back to Colonel Tixier.

I remember well dealing with Korea and the difference in hours and the nominative process, getting calls at home three nights in a row, just beating me up one side and down the other about someone's disagreement with the way things were going. So, dutifully, I would go in the next day and say, "Well, I had a call from colonel so and so last night"—this wasn't the person being assigned, this was a person representing the command—"and he was really irate and really worked me over. It's not getting any more pleasant. Here's the facts—and I still think my recommendation and your decision is the right way to go."

Lou Tixier would say, "Well, you tell so and so to quit climbing on your butt and tell him to call me next time. He talks to you no more." That was sort of the way we were. We would try to work it out, but sometimes things get to the point of not being able to be worked out. Then he was there, and he was of the vintage and the point in life where he could stand up and call it like it was and take it.

Meanwhile, those of us more junior were sitting there working with folks a grade up, trying to do the best we could to do it the right way. I thought the system worked pretty well. I mean, I'm calling everybody "Sir" when I'm talking to them and trying to work it out. I knew all these other communication links existed, and I knew also that a lot of folks would be communicating back to the Chief of Engineers. A lot of those went to the exec at the time, Colonel Ed Peel, or the deputy at the time, Major General Andy Rollins.

I got calls from the Chief's office. I would say, invariably, those calls—and I just want to make that clear now—invariably, those calls from either Ed Peel or Andy Rollins started with "So and so called about this situation. What's going on?" They were not calling and saying, "I want you to make this happen." So, it was put in the right context. Typically, I would explain what was happening and they'd say, "Well, it sounds right to me," or "You know, you really ought to consider so and so," and that would be some other factor that maybe I needed to throw into the equation as I worked it out. I thought the system worked pretty well from that aspect.

Q: Well, that leads in to an interesting topic, since I guess around 1962 was when the Chief of Engineers lost a lot of his input into the officer personnel selection procedures for Corps officers. It created a situation in which the Chief has a role in these personnel assignments, but they do come from another part of the Army. Could you talk some more about how that system worked and how the Office of the Chief of Engineers interacted with the Officer Personnel Directorate to make the critical assignments for the Corps, which are the district engineers?

A: During my time there, Lieutenant General Fred Clarke was Chief of Engineers, followed by Lieutenant General Gribble. The deputy was initially Major General Rollins, followed by Major General Dan Raymond. In all those instances, I had access to them because we're talking colonels and because they were interested. The Chief of Engineers has the responsibility for providing engineer support for the Army, and he was very interested in his executive-level assignments. With the exception of the selection of district engineers and commanders, I would guess it was basically up to me as to when I wanted to call to inquire, or when I wanted to make them aware of something.

If something came up with them, they could call me. Sometimes they went through their Chief of Military Personnel, Colonel Jim Bunch.

Back then, a military colonel was the Military Personnel Chief, separate from the Chief of Civilian Personnel, rather than later when it became a military lieutenant colonel position, and then later still a civilian position, now Ed Gibson.

We had quite a routine interaction with Colonel Bunch. We had up until this point a very rigorous screening process for district engineers, which I'll go into in a minute. For anybody within the Corps of Engineers family, then, I would deal with Jim Bunch as a natural business. If you take out district engineers and you take out everybody that was part of what is now USACE, that still left quite a number of folks. They might or might not be interested in the routine reassignment of the post engineer at Fort Campbell or the ROTC instructor or anyone else.

They were generally interested in where everybody was going, but it wasn't something I would call up to dialogue with them. Typically, the conversations weren't much. I never, for those others, floated a paper to the Office of the Chief of Engineers saying "please approve." So, it was all in terms of dialogue—are we getting it right; is it happening the right way?

Oftentimes, of course, there are so many people in the USACE part of it, they had to be released from USACE to go somewhere else. So, this caused a very natural dialogue with Colonel Jim Bunch and his folks. For example, "I'm thinking of so and so, who is right now the deputy division engineer at the Missouri River Division, to go out and be the post engineer at Fort Campbell. He normally finishes a tour there in December; I really need him in August. Could we get him early? I talked to the individual, and he wants the job."

Then Jim Bunch would be the one who would call the division engineer and say, "What do you think?"—and coordinate that sort of thing.

I also had other division engineers who would call me and say, “Sam, what are you thinking about for my new deputy?”

So, concerning your original point, there was a lot of interaction between me and the others. I’d get called by and talk to all engineer colonels and almost every engineer general in the Army, plus a whole bunch of others.

I said later on, and I told him this, that one person that I never did meet or dialogue with during that time was Joe Bratton. He, of course, later became Chief. He made brigadier the summer that I reported to the Colonels Division and left my “client” list. He was assigned to SHAPE [Supreme Headquarters Allied Powers, Europe], and was over there really out of the realm of dealing with me, so we never had any dealings. So, it was one important exception to that comment you made.

Q: It sounds like it’s sort of brokerage; there’s a lot of input and the people in the Colonels Division are the central point where this information comes together and gets massaged into decisions.

A: I think that’s a good term; I think I was doing a lot of brokering. I was the person. It was, to start off with, almost frightening. Chuck Fiala, my predecessor, told me that in the first four or five weeks he would wake up in the middle of the night in cold sweats and wonder how he would ever get through the day. In fact, that happened to me. I would just wake up at three or four in the morning wondering how I was going to come up with the names of those three folks needed today to nominate to somebody.

Starting out I hadn’t started an interaction with anyone. My knowledge base was only as good as my personnel roster, and I didn’t yet really have a feel for it.

In my first week we had an engineer colonel who was kicked out of Vietnam for alcoholism. He’d only been there 10 days. So, we got a blistering back-channel from General [John E.] Murray in Vietnam to the Chief of Colonels Division, about three pages long, talking about how inept we were to submit a name like that—“please don’t do any more and send over a real water walker immediately.”

So, here I am wondering how am I going to get a real water walker, so we would at least have a name to send him in a couple of days, and one that we could break free and send over in two or three weeks. How was I ever going to do that? I mean, this was two or three days into the job.

Then, about the third day in the job, I was called down to General Gene Forrester’s office—he was the Director of Officer Personnel. He said General Sid Berry, who was the commander of the Office of Personnel Operations at the time, was establishing a new thing called the Military Personnel Center [MILPERCEN] and we were going to move from the tempos to the Hoffman Buildings. We were going to reorganize into the new command the next Monday, and General Berry had selected Joe Jansen, the Engineer Branch chief, as his chief of staff. Would I hurry up and pick the right guy to be the next Engineer Branch chief.

Gene Forrester would like to have a name in two or three days. That's, again, in the first week.

Then General Rollins called me up and said, "Sam, we have this new thing, it was effective on the 1st of July." I had reported in on the 3rd; I believe he called on the 5th and said we have this new thing called the Officer Personnel Management System [OPMS]. "How about coming over in a couple of weeks and briefing the Chief of Engineers and tell him what it's all about and its impact on the Corps?"

We had just driven down from Newport, had a brand-new home we had just purchased, and we were trying to get the house set up for the kids in a new neighborhood and everything else. I mean, I was sort of overwhelmed with the expectations of folks for me. I was still trying to find my way down George Washington Parkway, across the 14th Street Bridge, to get to the tempo buildings and make things go.

Then it wasn't long thereafter that there was a lieutenant colonel standing in front of my desk saying he wanted the files of the best engineer colonels I had because General [William E.] DePuy was forming this new thing called TRADOC, splitting up the Continental Army Command into TRADOC and FORSCOM [Forces Command]. General DePuy was going to get the best officers in the Army to serve for him, and "I'm here as his stalking horse to find out who they are so I can recommend them. So, give me your best files. I'll be back in 20 minutes for them." So, the officer left, went down and accosted another assignment officer. I went over to Colonel Church Matthews, who was the ordnance colonels assignment officer, and I said, "Who was THAT? We give things away like that? Who is this guy?" Church said, "Well, that was Colonel Max Thurman. He's going to set up the new TRADOC and he's going to get them anyway, so you might as well identify who they are."

So, as I said, the job had a lot of things about it. I guess that's why, ever since, every time we had a new Colonels Division engineer assignment officer, I've tried to call them up the first week he was on the job and say, "Congratulations. You have a very important job, but it's difficult. Anytime you feel that you're in the cold sweats or you want to talk about anything, give me a call. I'm not in touch with the database any more, but if you would just like to pursue anything, just keep your cool and I'll be happy to help you out."

The assignment duties for anybody in officer assignments are much the same from the standpoint of being interested in career development, taking care of the person, but I remember well a call from General Carroll LeTellier. He called me my first week in the job. He was commanding the Engineer Command in Europe. Later, of course, parts of it became the 18th Brigade. He called up and said, "Sam, I'm commanding a big outfit and use a lot of your colonels in very important positions. Chuck Fiala always did a fair job by us, and I want you to know that we really need good people over here because we're in Europe, and they're all out by themselves doing important work. Just one thing: I'll always wait and take an underlap for the better man."

That was reassuring to hear because so many people call up and say, "I want your perfect man and I want him with a two-week overlap." When you're dealing with colonels, one

replacing one, it's hard to have overlaps. So, I always appreciated those comments by Carroll LeTellier. Thereafter, as I rotated into different positions I would try to convey that same thought to personnel assignment folks too. I was really interested in a quality kind of person that could do the job. If that meant waiting some period of time, let's talk because I was not insistent on the overlap but, rather, a tradeoff and a little time to get the quality.

Q: Well, along those lines, this is really the beginning of the time period at the end of the Vietnam War when the size of the Army went down, I believe, and the size of the officer Corps decreased, so that must have placed additional pressures on you to match the man with the job.

Was there a shortage of colonels? Were there more positions than colonels available, or did it stay pretty much in sync?

A: I think the colonel level stayed fairly well in sync; we didn't have a shortage of positions nor a shortage of colonels. It seemed to be fairly well in balance. We had the normal people leaving through the retirement system.

This was unlike in the company grades, where we were going through a reduction in force in that same time frame, especially year groups '66-'67. The branches were dealing with those reductions but we in Colonels Division weren't dealing with those. We still had turbulence, but the turbulence was starting to abate; we were trying to get back to leaving people in place longer. And, of course, everybody wanted to be left in place longer because we had had such turbulence.

Q: From looking at the other people working in the branch, did you have a different relationship with the Chief's office than—well, the Chief being one of the few branch chiefs left, that makes it a little different. Did you work differently than your infantry counterpart or your artillery counterpart?

A: Yes, I think so from that standpoint. Then there were other places, too, such as the intelligence assignment officer who was certainly tied to the Deputy Chief of Staff, Intelligence, and talked the same kind of way. It was different from infantry and armor and artillery, but it wasn't singular. Ordnance, transportation, and quartermaster assignment officers got help from the AMC community, the DCSLOG [Deputy Chief of Staff for Logistics] and so forth.

Now I would say that has changed somewhat. Of course, I was at the other end of that scheme later with the advent of TRADOC and the school commandants being the proponent for their branch. So, now the branch school commandant is a person who plays in assignments quite considerably. Whereas when I was assigning engineer colonels, the school commandant was contacted for his own assignments, but we didn't interact for others.

Later I became the commandant and Engineer Branch "proponent." I then participated in the dialogue on which troop commands folks go to, and with the Chief of Engineers on district engineer assignments.

As commandant I took a proponenty role in trying to work with the engineer colonels assignment officer as to what kind of needs there were and so forth. I often got calls from the assignment officer saying, "I'd like to check one out with you; what do you think of this one?" I think he was also calling the Chief of Engineers doing the same kind of thing.

Q: So, do you think, from your perspective, that was an advantage of having this input that, say, your infantry or artillery counterpart didn't have? Was he sort of—struggling in the dark is too strong—but operating without those sorts of contacts?

A: They always seemed to manage. I guess you always had a commander of the Officer Personnel Directorate who was infantry, armor, and artillery, so they got their help there. All the generals who wanted help were calling him, so they had a lot more interaction there.

Also it depended on the branch chief. Lou Tixier knew the Chiefs of Engineers. He knew them from having served with them; he respected them; and he said, "Sam, you've got a special relationship with the Chiefs of Engineers. I expect you to make that relationship work. You got any problems, call me, but don't feel reluctant to dialogue with them to make it work."

So, I really had his mandate—and really it all followed common sense. I mean, everybody—the Chief of Engineers, the Deputy Chief of Engineers, the Chief of Colonels Division, me, and the individual were all trying to make sure we got a round peg in a round hole and square pegs in square holes and did the right kind of thing.

Now certain people had views; they'd say, "Well, so and so doesn't seem right to me." I'd say, "How come?" They'd tell me how come, and then it would usually be obvious—it didn't seem right.

Before centralized command selection, it was different; of course, this is a little hearsay from me because I was at the end of that period. Oftentimes generals and colonels would want their favorite person to go command one of the top engineer troop units, even though he was not the best qualified person. So, our recommendation would go forward. The messages would come back saying, "How come him? So and so was certainly a better commander than the one you're nominating. I don't understand you guys; you just don't know what you're doing."

However, we had the personnel file, and it might show that same person he insisted upon having as his colonel commander was relieved from battalion command as a lieutenant colonel. It was a matter of principle—you don't reveal that stuff. So, we were saying, "No, he is not recommended for command and can't go in to command." Now later on, the centralized command selection basically took care of that problem, though a lot of people, of course, would say, "So and so is not selected. We don't understand it."

Over time, we basically have an understanding of how it goes. That was a phenomenon that occurred back early on, and one of the reasons why centralized command selection came about.

After the Vietnam War, with a reduced number of commands, it was felt that the Army ought to pick officers who were the best they had to command troops and not count on the old boy net to arrange whom our troops were going to be commanded by. The old boy net sometimes seemed to go on personal likes and dislikes, as opposed to what the record said. Not that the records were always 100 percent. When you got something as strong as officer efficiency reports that talked about a person's inability to command troops, you don't share efficiency reports with people, and thus you could have abuses like that. So, that was one great reason for centralized command selection.

Q: Were there some of your counterparts on the staff who didn't seem suited to this sort of job or didn't like it? It strikes me that this takes a particular type of individual for this sort of job. Is it something people would adapt to and work towards?

A: Well, everybody was pretty well hand picked; they were all recommended by somebody. Lou Tixier, however he did it, went out and checked everybody's pedigree, not just from a file, but how they interacted with people and the rest of it. So, I think that it was pretty well done.

I'm sure there were one or two who didn't like it so well. We had one who left after a year. I don't remember his ever really voicing dislike for what was going on, or maybe he just had another opportunity. I don't know. Basically, we were a pretty congenial group. We'd go down to lunch together and lament our various problems of the moment and question how we were ever going to come up with so and so, and that sort of thing.

One difference in duties was managing requirements. In Colonels Division we tracked colonel requirements, and we had three or four officers who had smaller branches, who would be the requirements person for TRADOC, for instance. TRADOC would say, "We need an officer." This officer would have the TRADOC books, and he would know how many they were authorized to fill, and he would say, "Yeah, that is a valid requirement; send it to me." It might be a branch-immaterial position, and he, the TRADOC guy, would send it to four or five assignment officers and say, "This seems suitable to anybody in a branch on an immaterial basis. Please provide me a person if you have a name."

We would fill it. Sometimes those queries would be from Tixier: "You must nominate a name." I would sit there and question, "Is this a good kind of position for an engineer to fill? Is it going to be enhancing for one of my people to do, or is it really not going to be enhancing and I'd really rather save the officer for another position?" Oftentimes we'd throw four or five names to the Chief of Assignments, who then would pick one to be the nominee for the division.

Q: Maybe this would be a good time to talk about the paper on colonels' assignments that you had during this period.

A: Well, OPMS was very new, as I mentioned. It became effective 1 July 1972. Now it had been approved, I don't even know when—probably the previous November or December. So, folks had been working on the principles and all the rest of it for some time. However, on

July 1st, I would guess a lot of people out in the Army didn't know a lot about OPMS, even though there had been *Army Times* articles and so forth.

Within the Corps of Engineers there had not been a lot of discussion about it. I know up at the Naval War College, there were only 26 of us in the Army there, and it had some very minor kind of exposure. It really hadn't crossed my mind when they said, "Hey, you know, OPMS started last week." I said, "Oh, what's it all about?"

As I mentioned earlier, I had this phone call from Major General Andy Rollins who said, "Sam, come brief the Chief of Engineers on this thing called OPMS and tell him what the impact is on his Corps of Engineers and his engineer officers, on his colonels."

So, I did a lot of research; I had to learn about OPMS. Out of that, I put together a briefing and I went up to brief General Fred Clarke. Andy Rollins was present and probably Ed Peel.

The essence of that briefing was that much of the rudiments of OPMS was in general terms, but the focus was on centralized command selection. That first year only troop commanders were being selected centrally by boards.

My recollection is that we had about twelve troop commands that engineer officers commanded, and about seven of them would rotate that year. So, the board was to meet and pick seven commanders to go to troop command the following July.

He asked what impacts were involved. One of the things I told him was that, first of all, I thought there was going to be a big change in engineer commanders. We had some good people commanding engineer troops in the Army, and we had an awful lot of district engineers who were all very good. You need to know that district engineers at this time were "slated." Maybe I better back up a moment and say that the process for selecting district engineers at that time was that the engineer assignment officer in Colonels Division would develop a slate of officers, recommending them to be district engineers, meeting the criteria of the Chief, year groups, and that sort of thing. We would take the twelve or thirteen districts becoming available and open that next summer, and then I would go over to sit down with the Chief of Engineers and typically his staff general officers present that day, and go through a "slating" session. At that slating session the Chief would then approve those who would be district engineers for the coming year.

The assignment officer would go back to the Colonels Division, write up the assignment sheet, send it in, and the Chief of Colonels Division, Lou Tixier, would approve the assignment.

In other words, we had a work group, face-to-face nominating process working. The assignment officer would take over that list, plus some alternates or potential substitutes. At that time we in the Officer Personnel Directorate worked with something called an order of merit list, a ranking by branch of how people stood.

The assignment officer would present, “Here’s the Portland District, my recommendation is…” and give a resume of the person, show them a picture, and be able to answer any questions concerning the recommendation.

The Chief of Engineers would ask his assembled generals, “What do you think?” If it was an all civil works district, he’d ask the Director of Civil Works, “What do you think?” If it was a military construction and civil works district, he would get both of their comments.

It was really the Chief’s “board of directors” giving him advice, and then typically he would say, “Well, I’d like so and so to go to the Portland District.” That was the process.

When I went to my OPMS briefing for General Fred Clarke, I told him that I felt that one of the things that was going to change was that, whereas all of the previous secondary zone selections to colonels had gone to districts and none to troop command, they were now all going to go to troop command and would be unavailable to him as district engineers until later. The Army was saying our troops deserve the best; their new system was going to get the better commands because they were going to send the first cut of folks to troops and not districts.

My comment to the Chief of Engineers was that we had the potential for setting up two classes of citizens based on this situation.

Whereas the Army had some suspicion, especially coming out of the Vietnam War, as to the relative worthiness of district engineers, in the greater scheme of things, as opposed to warfighters and troops, we had a real potential of having that differentiation work to the detriment of the Corps of Engineers.

So, having said that to the Chief of Engineers, my recommendation to him was that he should consider very strongly the idea of putting his engineer districts into the centralized command selection system.

He asked that I brief the three new engineer brigadier general selectees. The selection board had just met, and I briefed two of them, Bill Read and Jim Kelly. I briefed them to get their viewpoints, and I think they generally went along, had some views, and conveyed their thoughts back to General Clarke.

Anyway, I was told by General Clarke that he’d like to proceed in that light—do what I needed to do to make it happen. So, I started really working on it then to try to flesh out the concept and come up with the ideas of how we wanted to do it. I floated a paper that made the recommendation to do it. The paper I’m just giving you now, the 30 March 1973 paper, is the culmination of that. [See Appendix A.] Colonel Paul Suplizio had a study group that was working on changes to OPMS; they were pretty well tied to what they already had going. By this time they were not really looking to make changes other than the ones they thought about themselves. Colonel Tixier was very supportive because we were emphasizing the Army’s concept that we want key positions and we want to get the right people into them.

Our engineer point was that districts are really command. We want success in that very important position that happens to command more civilians than troops, so it's really not troop command, but it *is* command. So, we had a lot of dialogues and a lot of different people dialoguing.

Anyway, the 30 March memo was written just to set down thoughts as opposed to being the typical staff study. That gave me a little freedom in providing analysis and dialoguing and talking about it, but it did have advantages and disadvantages and so forth.

We started the coordinating process off, went on up the tape. Then I had to go back over and brief the Chief of Engineers and his assembled staff and general officers on kind of a "what do I want to buy in on?" discussion. Before that, General Clarke had *really* said, "Let's go in concept," but he hadn't said, "Let's do it."

So, I had to go back and brief. The last paragraph or last couple of paragraphs of the paper really put it into perspective. It said, "If board selection for engineer troop commanders is valid, it would appear that it'd be valid as well for district engineers." Whether you pick from a slate of candidates or by centralized board selection appears to rest on three issues.

First of all, could the Chief of Engineers live with his loss of flexibility? That is, you would have to buy in to the Army's peer groups and system; you couldn't have it all separate. The Corps would be part of it. The Chief of Engineers had had all kinds of flexibility, as I described before.

We also had a feeling that we liked a longer eligibility span and longer deferments. Would officers be able to be used in both positions? Could you be a troop commander and then a district engineer? How many years would that take them away from other things like key staff positions and the rest? So, that important issue depended on the question, "What were the rules?"

A second issue would be, are eligibility and selection criteria compatible in relation to available engineer colonels?

Third was the issue, would OPMS be adaptable to meet branch differences? Of course, that could be an arguing point. Everyone, we thought, who had the goal to do the right thing by the individual and the Army should be able to accommodate differences within the OPMS system.

So, my summary said a district is not a troop command, but it is a command. Elimination of commander "shopping lists" had been a driving force behind centralized troop command selection. It had not been such a severe problem in engineers as for other combat arms since we were spread thinly.

Consequently, the real drive was to provide board credibility in the selection process, and in that case the same argument would prompt me to believe it would be valid for district engineer selection.

So, my preference, my recommendation to the Chief of Colonels Division and the Chief of Engineers would be to see that the OPMS system show its adaptability by providing a board-selected list of commanders from which assignments would be made to both district and command positions.

I said, "Further, I would seek a four-year period for consideration [originally OPMS called for a two-year window], thus permitting greater stability in assignments and schools." Then I said, "I think the question of length of eligibility for selection needs to be answered first and then redirect the question to Chief of Engineers."

Anyway, we went through the process of briefing the Chief and the rest, and so General Clarke then addressed his request to the DCSPER [Deputy Chief of Staff for Personnel] of the Army.

Anyway, Lieutenant General Sid Berry, former commander of MILPERCEN and now the DCSPER, did not concur. So, ultimately it went to General Abrams, Chief of Staff, U.S. Army, for resolution with a recommendation from the Chief of Engineers to include centralized selection of district engineers within the Army's centralized command selection process, nonconcurring in by the DCSPER. There was a Chief of Staff's office showdown one day, to which I was not invited. Colonel Lou Tixier attended as Chief of Colonels Division. I pre-briefed him beforehand.

As a result of that meeting General Abrams approved command selection for district engineers over the objection of the DCSPER. Then he turned to Colonel Tixier and said, "What's your recommendation? Should a person be able to do both; that is, be selected for one one time and one another and serve sequentially, or should they be selected for one or the other?"

My recommendation at the time was to do only one, so that that person would have his command, other people would have the opportunity for command, and that person would be available to go to other important positions. Thus, he would not be out of the net as a commander two years, then three years—total time as a colonel five years and all in command. Who were going to be the guys filling all those other positions?

Lou Tixier then told me, "I didn't remember what you said, so I said, yeah, let them do both." So, as it first came down, a person could do both. That's the way it was for the first two or three cycles, and then later it was changed so that you would go to only one of the two. One colonel-level command per person was it. That's basically how it happened.

Q: Why was there opposition to this program?

A: Are you talking about Sid Berry's opposition? I never talked with him, so I'm just supposing, but generally it came from the standpoint of why is it that the engineers got to do something different? He might have thought, "We're trying to emphasize troop command and we got OPMS." Like so many things in the Army, it had been thought out in terms of the

infantryman, the artilleryman, the tanker—I mean, the people in those combat arms as opposed to all the other combat arms and the other services.

So, I think there was a resistance to see a break in the model they had created, thinking there would be further “erosion.”

And, in fact, there was. AMC came in and wanted the project managers centrally selected—later approved; wanted the lab commanders centrally selected—later approved. Others came in, I believe in the intelligence arena, and wanted certain positions where not only military but a lot of civilians were involved centrally selected—later approved. In my viewpoint, those things were good for the Army.

With a list of 25 selected commanders when we needed 15 district engineers and 10 troop commanders, I could still work and prescribe a fit of a round peg in a round hole, square peg in a square hole, and sort the selectees by where their druthers were, where they best fit, and where their experience was.

Some people move very decidedly in one direction or another; others are in the middle, on the margin. So, there is some back and forth. If you look at what OPMS was touted to be—and that is, get the right person in the right job because the Army deserves that—we should let people specialize and we should get the right people to command troops and the right people in all those jobs. That is what we were just talking about, sticking the right people in the jobs.

Now we would have a system for all branches to do what was best. For the engineers, we’d have a system whereby a board would meet, and that board would recommend the best 25 officers to go to command that year from their review of the records. It was no longer the old boy network and no longer just assigning an officer how he views his opportunities. Now we’re talking about a board independent of those influences that recommends the top 25.

Then when Colonels Division goes to assign them, there is still the ability to work the system and the officer’s druthers, using the Chief of Engineers’ slating system to determine which one is the right one to go to which position. So, it seemed like we were better off.

Your question was, why did people oppose it. I think it is because they were thinking simplistically of a narrow model that had been derived, and they didn’t want to have exceptions to it.

Q: So, those other people weren’t really involved in originally developing this? The ones that now were objecting to it?

A: I don’t know. See, the Suplizio work group were lieutenant colonels and majors, at my level, which were always engaged in dialogue as to what’s right or not. Yet, they were pressured to put together their briefing charts and go brief directors of the Officer Personnel Directorate and the Deputy Chief of Staff, Personnel. I’d never been assigned to the Pentagon at that time, so how that worked was a mystery.

I remember a couple of things from the dialogues. I was in a meeting before the Abrams meeting with Lieutenant Generals Sid Berry and Fred Clarke. Berry had not opposed it yet, but he was listening as Fred Clarke was trying to bring him about. I remember one of his questions. Sid Berry's question was, "Well, Fred, aren't you really looking for something special in your district engineers?" Well, I could see it was kind of a loaded question: If you want something special, then you're not talking about "my" centralized selection, you don't want to buy in to the rules. You want something different, so you go run your own system to handle that.

"You know," General Berry said, "something like professional registration or certain special or technical kinds of capabilities." Well, we engineers had professed we wanted professional registration in the Corps among our engineers. It had always been a desired thing, not a "have to" thing.

So, Fred Clarke's answer was very direct and really fine. It was, "You know, Sid, I really want the same thing that you say the Army wants when it selects its commanders. The most important thing to me for selecting a district engineer would be success in the previous level of command. I want somebody who succeeded as a battalion commander, who shows he can take resources and face problems and tight timelines and stress and work through people, work it all together and make it turn out and produce a quality product." He continued, "That's the same thing you're telling a troop command selection board. So, no, I don't want anything special; I'd be very satisfied when your board sits down and picks the best guy, and I can live with that best guy."

"As far as professional registration, I'd still like it. I think we're still going to encourage our folks to get it. We'll be ahead of the game when almost all of those folks have professional registration. To say that's a 'have to' or the final kicker, no; the thing I really want is knowing we've got the best people going to the command."

Even after that, Sid Berry nonconcurred, but I think that was probably a telling argument when General Clarke went up to see General Abrams.

Q: That's an interesting path for a program to follow, personnel programs nonconcurred by DCSPER, but approved by the Chief of Staff.

A: Well, General Abrams had a real, down-to-earth knack for solving things that way; that is, if there is an issue, work it to the end and then bring everybody in and everybody give it their best shot, and then he'd decide. So, he did it.

Q: So, would one way of looking at this be that in order to prevent a two-tiered system that might not be favorable to the district engineers, the Chief was willing to give up a little of the input that he had under the old system in selecting district engineers. Is that one way of looking at it? You give a little and you get a little?

A: Well, I think I saw it that way when I first started off. Seeing how things were working, I think you'd have to ask him. I believe General Clarke would have said that he recognized

that he was going to have this list given to him of folks who had been sorted out, and he really wasn't going to have to give up much at all because he was going to have identified for him the right people. After that, he still had the ability to put a person that was seen as broadly capable with experience, say with troops and military construction and civil works, all three, in a district like Savannah, one of our very large districts. Or if he had another person who had served in the district with civil works only and really had shown a knack for dealing with outsiders, then he could put him in a civil works only district. Or a person who had spent all his time with troops could be put in a troop command.

I think he felt that he really wasn't giving up anything, and would have this new opportunity, and there would certainly not be any two-tiered system of haves and have-nots from the standpoint of how the Army was going to look at them. Promotion boards and the way people look at things are Army run, and so it's important to be in the Army system from that standpoint.

I think he felt maybe, as I had, that perhaps district engineers would not compete for general officer as well on future boards if the Army saw only troop commands being anointed by the centralized command selection process. The Army system was to select the best. Therefore, if you hadn't been to troop command, you weren't going to be, by the Army definition, part of the "best."

The first year of my two years in the job, engineer troop commands were centrally selected, and then I slated district engineers for the districts just like had been done previously. My second year then was the first year that we had a centralized selected slate, and that year then I took a slate over to the Chief of Engineers. It recommended for his district engineers only people who had been picked by the centralized command selection board.

There was one minor point of flexibility the Chief lost. As I mentioned before, if there were twelve districts, we would take over twelve slates and three or four alternates. He had total flexibility to leave somebody off and put in an alternate. Under the OPMS system, the Army system, when you were identified as a command selectee, you would go. A new alternate would not come in until all selectees were in position.

Now the way the system worked was the board selected a number larger than the positions available. Then it wasn't very difficult to figure out how we did the rest. They would come and ask me how many engineer troop positions were to be open in the coming year, and I would say seven. They took their list of twelve names and then drew a line after seven, and published those seven names as the selectees. The remaining five all became alternates.

So, that was the drawing of the line. The announcement in the *Army Times* to the Army was only selectees, those people above the line that we knew there were commands opening for. Thus, the Chief of Engineers could not get down to alternates until all the command selectees were done.

That second year we went over just like the year before. I stood at the end of the table with General Gribble now on the right, and all of his general officers who were there that day, three or four, sitting at the table, and we went through the slating process.

Like before, I'd say "Portland District is coming open this year, and I recommend so and so." The only difference was, the only ones I had on my slate for all districts were those who had been selected by the command selection board rather than selected by me.

That selection board that first year had five members. We had two engineers on that board. Following the board, we went through the same slating process. Colonel Tixier, the Chief of Colonels Division, went with me that year, sat there and watched the process and never said a word. We went through the whole thing, and there was a lot of discussion. In the end General Gribble said, "Well, I'll buy the list as presented." So, we didn't change a thing from the basic recommendation we went in with.

I did not take the troop commanders over to propose those as a slate because the troop commanders worked for the CINCUSAREUR, and other commands. So, I did not slate those to the Chief of Engineers. I had met with General Gribble and basically brought him up to date on what we were doing and who we were going to nominate to those other places, so he'd have a feel for it and an opportunity to input.

That particular year, as I mentioned, an officer was selected and designated for troop command or for district. Because they decided you could do both, they had to have two selection lists. You could not appear on both, but having been on one, later you could be selected for the other.

So, there were two discrete lists, which meant there was no movement from one to the other. The thing I described before is a condition now, where there is one list and there is the ability to put people in the right spot.

That first year, if the people on the board decided an officer should go to troop command, then he received a troop command. If they decided an officer was to go to be a district engineer, then he had to go to be a district engineer.

When the day came that the lists were announced to the Army, there was the list of command selectees. The same day that list was announced, it went to the commanders, like the CINCUSAREUR, with the names of which officer was nominated for which command in Germany. There were only three engineer commands there at that time, but many more infantry, armor, artillery, and others.

So, CINCUSAREUR had a slate, and he had the ability to say, "No, I really want this one up in Bamberg and this one back in Babenhausen because both are artillery commands. I got family problems here, and to my knowledge this fellow might be better doing the community bit." So, CINCUSAREUR had the ability to do that kind of shift around. At the same time, the Chief of Engineers had his slating session to line his commanders in the right place.

I have one more thing to mention. It really ties to something that becomes very emotional each year, and that was brigadier general selection because when the lists are announced, everybody has their analysis of why everybody was selected or not selected.

While I was in the Colonels Division, I watched that process. A lot of people called me up and lamented their own nonselection or wondered why so and so had been selected. So, there were many opportunities for dialogue along this line. I remember this particular year that we had a lot of engineers selected—five.

I remember at least two calls afterwards; one of them said, “Well, enough of this OPMS selection business. Obviously you have to be a troop commander to be selected for brigadier general.”

Then another called up and said, “Obviously you have to be a district engineer to get selected.”

It turned out that that year the selectees included a couple of district engineers, a few who had been troop commanders, and Ernie Peixotto, who had done neither but commanded an engineer lab, the Waterways Experiment Station, which was not then centralized command selected.

So, much for everyone’s reading of the tea leaves.

Q: You didn’t become involved in the brigadier general selection except to get this feedback from the colonels you had contact with?

A: No. Our drill each year was to go through the files before we sent them to the board to make sure that they were straight. We all knew those that we felt were very strong candidates and we knew who the top fifteen or twenty were—who could end up being a top four or five. We would do our own analysis of the files that were to compete.

We would look at their picture and make our own analysis of whether that picture represented what that individual thought he would be seen as.

We’d call him up and say, “You really don’t want to go in with a picture like that. You really ought to get your picture retaken.” So, this was the same kind of thing that the Engineer Branch does at all levels.

We basically just tried to make sure the file was correct before it went to the board.

Then, once we got the names of those selected, we’d dash out and read the file and copy whatever we needed out of it—because it was gone immediately to the General Office Management office. So, any residual analysis we wanted to do, we had to do it quickly.

Q: Did that include any attempt to make the files better another time, based on the outcome from the file?

A: We were always advising people of improvement things. It was a good feeling because people were interesting. Oftentimes their discussion was whether to retire or not or to stay competitive, or where they were competitive, to stay or not—so we were always in that kind of a dialogue with people. Even though we knew those fifteen or twenty people that were competitive, we'd want to go back and look at the selectee's file and say, "Why was it the board selected this person rather than another one?"—for purposes of understanding.

We really couldn't make the files better, other than, as I mentioned before, correcting a mistake that was obvious or didn't come out right or that sort of thing. A person had to make his own file better by his performance, and that was in the officer efficiency reports.

Q: Were there ever any studies done of that information in the Army that you know? I know there have been historical studies done. In fact, it's interesting to look at the careers of general officers, World War II commanders—but at the time nothing formal was done. The people in the branch had this information in the field, but nothing formal in terms of studying the characteristics of men promoted?

A: I don't know of any formal kind of thing. We were all convinced—with the things that I heard before—that number one is that performance counts. The officer establishes his mark by performance.

Second was the job—what job you're in. There are no "have to's," but I think General Morris put it right after he'd served on a brigadier general board. He said, "The thing we were all looking for was how many times did the person have an opportunity to fail, but he didn't?" as reflecting that a person had tough jobs. A lot of people might have good performance records, but in jobs that were seen to be more mundane or routine, and hadn't had the tough jobs where a person was really putting his ability on the line, and had had multiple opportunities to fail in doing that, but carried the day and brought things about so there was success.

That's why I think command has always been such an important factor. Some people say, "Well, you've got to be a commander." Well, I don't know that you've got to be a commander. Nevertheless, command positions, for the most part, are seen as an assignment where a person has multiple opportunities to fail. If the record as written up in performance reports shows that it was a tough job and he performed well and did these kinds of things, then it would stand out.

Subsequent to all this, I sat on a brigadier general selection board and on a colonel selection board—and I think "selection" comes out of a file. By "file" I mean not an individual officer efficiency report, but when you read ten or twelve or twenty, there will be a common pattern there of strength, of taking tough jobs, of doing things always at a notch above base expectations—or not.

So, when people start to score out files, it almost comes off the page at you. When you do a bunch of them, you can see certainly who definitely should not make it and who definitely should make it.

The tough part comes when you start working the margin just above and just below the “cut” line. How difficult that is, comparing a couple of different people, because now you’re really in the middle of it.

I believe the Army system is such that we make each individual make his/her own record. That is, their personnel file really does have a word picture of them. The system works pretty well—especially when you take a board that has twenty-five different people looking at individuals’ files and doing all that kind of scoring. The other thing I found was there was pretty darn good unanimity in the way things were.

I mean, it’s not that one board member puts a person in the top group, and another puts him in the bottom group. They’ll all put him in the top group or maybe one will have him at the bottom of the top group and the other one will have him at the top of the middle group.

When a board member looks at a file, he starts having that image of the baseline. Even though we come from the engineers, infantry, military intelligence, ordnance—we sit down in a group thinking of the common good of the Army and start scoring records. It comes out and it works out.

Q: Was battalion commander seen as one of those tough jobs that was important?

A: Yes. Of course, the time frame that I’m talking about, ’72–’74, was right after the Vietnam War period, so that was definitely seen as one of those kinds of tough jobs. A command anywhere—I mean, there was a recognition that command in Europe might have been tougher than command in Vietnam because the resources had been reduced so. We had battalion commanders in Europe with one major, maybe, and one captain, most of the folks being lieutenants commanding companies.

That’s what I had when I commanded Vietnam, too; I had two majors, but at one time I had five lieutenants. That was when you made captain in two years.

I mean, that growing Army had had a lot of that, but certainly the resources were toward me in Vietnam and not toward Europe. I had my own things to deal with in command in Vietnam, particular problems and folks shooting. The person in Europe was sitting there, too, with people who had come out of the Vietnam culture, some of them with the problems they brought with them, and then went back into a disciplined arena and really fought that.

So, the folks commanding in Europe were without the money to keep the troops out training, keeping everybody occupied. Some of them would have bad habits such as alcohol and drugs and were not worried about a mundane training day. Always working on a surge basis, the commanders in Europe had to deal with some very difficult problems.

I think the system recognized that command in Europe was tough. The Army does have a way of looking at what went on, and over all those years, so many people had been to Vietnam that that had to be a very significant point—commanding at battalion level for purposes of selection to colonel, or commanding at colonel level for purposes of selection to brigadier general.

Q: Was there a sense, and this is going a little bit beyond the assignment, but your comments made me think about it—was there a sense at the beginning or did that sense grow, of which engineer commands, engineer districts, were tough jobs or tougher jobs than some others? Or did the board depend on the engineer generals there to give them that input? Were some engineer districts more controversial, with harder jobs perhaps than others were?

A: You're talking about brigadier general selection.

Q: Yes, that's going a little beyond there.

A: I think perennially that has been a question and perennially one that people have dialogued and discussed. Often the engineer board member has been asked to explain just what is a district.

I sat as a member of a brigadier general board. As we met together, as a full board, before we broke down into three panels, they asked me to comment on districts, just as the board president asked people to comment on project managers, depot commanders, and others. Even during the board, people would come up to me and say, "Now that I read the files, I'm starting to see this. What really is a district, anyway? It really looks like a tough job."

You know, when we engineers wrote a job description, we really wanted to make sure we threw in all the stakes a person had, worry about the fact that they had this watershed or that watershed—I mean, that's pretty tough for a board person to decipher in the short amount of time that he had to look at a file.

So, it was an important discussion point. That's why we changed the title to district commanders as opposed to district engineers, to make sure that the command was plain to everyone. That's why there has been a continued emphasis to describe the command in short terms that really make the point.

Everybody in the Army knows what infantry brigade command is, and everybody knows what division artillery command is because everybody's been stationed where there is a division that has all these components.

On a board many don't know about an engineer brigade because we haven't got many of those. So, you might have to explain that too. You talk about engineer command, district engineer command, and what that really means. Being able to describe it in terms of being responsible for people, being responsible for duress, stress, large contract amounts, and those important characteristics is essential for the engineer board member.

I think an engineer on a board does have to explain that. The board I was on, having had that discussion, selected five engineers. A couple were selected who had been district engineers—not a question and the troop commander selectees—not a question.

I think it fell between the strength of their overall reports. The district engineer was seen throughout his jobs, and he had served in other important jobs, as having had a lot of tough jobs. One of them, his command job, was with a district. He was seen as a person who really

had it all together, certainly general officer capability, and he stood very high. The other district engineer selectee was not a matter of differentiation between type of command so much as his file was strong.

I think General [John W.] Vessey is the one who said, talking to a bunch of new brigadiers at their charm school session, "You know, if we were flying you out to Fort Sill this afternoon and the plane went down, we'd just take the next 50 on the list, and they would do just as well as you will."

My session on the board would validate that. We only got to pick 50. There was another 50 and then some who were certainly qualified and capable.

Q: Any other questions we need to cover in the '72-'74 assignment?

A: I can't think of anything.

Q: Who succeeded you?

A: Tom Sands, and he was followed by Mark Sisinyak.

Q: When you mentioned General Fiala, I was struck by the fact that we had people in that position who were all generals later, right? I guess it was an important assignment.

A: It was and is. Now, there has been a change since then. Not in the quality of people, but it used to be that the person selected was right out of the War College.

Q: Okay.

A: At some point thereafter it changed so that the person selected was just finishing battalion command but not yet going to the War College. I don't remember when that point was.

Typically, the colonels assignment officer, when finished, went off to a district after that assignment. Chuck Fiala left and went on to Louisville District. Because he was now past War College, he would be selected for colonel while in Colonels Division, then left to go off to command an engineer district.

I broke the scheme because, having convinced the Chief of Engineers to have centralized command selection, when I was ready to leave I was not yet a colonel and could not be considered for centralized command selection. So, I didn't, as an irony, get to follow my predecessors, based on my own recommendation.

One other irony of that is, and I had no insight but just note it as an irony, that, as I mentioned to you, I had recommended a person only go to one command. Yet, General Abrams' decision was to let them do both sequentially. Thus, I watched all my friends and peers, Hank Hatch, Ken Withers, John Wall, Scott Smith, and others, go do both, one after another. I went off to command the 7th Engineer Brigade, later, with the potential opportunity of being selected for district engineer as a following assignment. The policy

switched during my brigade command, so then I didn't get the opportunity to go two back to back.

Of course my recommendation had been not to let people do that, so the irony being that the system had worked for a number of years, and about the time when I might have the good fortune of doing both, the system changed. So, I got the opportunity to go to Heidelberg for a year to work as a staff engineer, and then come back to the Pentagon in the Office of the Assistant Chief of Engineers for a year instead.

In the end, if anything made the difference between my selection for brigadier later on, which happened just after I arrived in the Deputy ACE's [Assistant Chief of Engineers] job, it was probably the fact that I did not go off to a second command job but went instead to Heidelberg. There I worked on some very tough issues that were visible Armywide. So, I would suppose that when the board looked at my file, they saw that I had had those tough jobs I had mentioned, not only command, but also in Heidelberg doing a tough job. Well, the irony might be that I didn't get the opportunity to do two in a row, but from the standpoint of potential for selection, it probably worked out better for me.

Office of the Chief of Staff of the Army

Q: Your next assignment in '74-'75 was assistant to the Director of the Army Staff, Office of the Chief of Staff of the Army. What did that position involve, and how did you get to that position?

A: Well, that was an interesting period. The bottom line of all this was that I was completing two years as an assignment officer, and you get a certain burnout feeling when you're doing the same things over again. I had changed, or helped change, the system, and that was exciting, but I wasn't going to go off and be a district engineer in the next assignment like Chuck Fiala and all my predecessors had done. So, I felt it was time to seek a change in responsibility here in town while I was here. It was time for something new.

You know, when you're in the Army, you maybe get addicted to change. That is, you enjoy the new challenge every couple of years or so in a new position. Maybe you don't always enjoy the physical move, but you get a sense when you've sort of maxed out in your professional development in a particular area, your juices aren't as charged as they were before, and you really need to seek something different. So, that's about where I was as we ended that time. Nobody else had ever been there more than a couple of years—that was about the right tour—and I knew there was a board meeting and I was in the primary zone for colonel and thought I would be selected.

So, if I stayed in MILPERCEN another year I'd be doing the same kind of things over again, so I ought to seek to do something in the Office of the Chief of Engineers or in the Pentagon.

I had a West Point classmate, Dave Palmer (who has just retired as superintendent of West Point), who was in the Office of the Chief of Staff of the Army, working in an office called the Office of the Deputy Director of the Army Staff for Coordination, Analysis and Reports. Another classmate, Mike Conrad, was also working there. They had some changes coming up in that office, and so Mike and Dave asked me to come over and interview with some people.

So, I did, and was then selected to join that office. They were changing leadership; the fellow coming in was supposed to be Colonel Bob Sennewald, who did not come in but was picked for brigadier that same week. Later, of course, he ended up as a four-star commander of Forces Command.

This office had been part of the old Secretary of the General Staff's office, but under the Army reorganization it was now the Director of the Army Staff. The director had two or three subelements under him, one of which was the Staff Action Control Office, in which they had the so-called "Seven Dwarfs." These were the people who were actually running the actions. When papers come in to the Office of the Chief of Staff of the Army from throughout the Army Staff, they would come to that office. Those action officers would make a quick review. If it was all right, everybody had signed off on it, they sent it on to the Director of the Army Staff and on to the Vice Chief or the Chief of Staff for action. They processed and controlled staff actions.

Then there was our office—CAR (Coordination, Analysis, and Reports). There were four elements to it. One was the Chief of Staff's speech writer, one person sometimes augmented to two. Second were the Chief of Staff's legislative assistants. They would put together all the issue papers and sit behind him when he'd go over to testify on the Hill. When he wanted to talk about a subject he was questioned on, they'd pull out the right paper and set it before him. They were the keepers of the testimony books in that respect. Third were the people who put out the *Weekly Summary* from the Office of the Chief of Staff to all Army general officers every two weeks. Finally, there was the special action team. I was part of the team.

I can't remember how many of us there were; I guess there were five plus Colonel Doug Smith, who was the chief of the special action team. Colonel Vic Hugo was the Deputy Director of the Army Staff for Coordination, Analysis, and Reports.

Our job was to assist the command group—the Chief of Staff, the Vice Chief of Staff, and the Director of the Army Staff—in any way in which we were needed. I really mean that in the full sense of it. You could say we were almost "gofers" in this respect because our jobs weren't specifically diagramed. If there was a need, we were there to go and try to answer that need.

We had areas that we were assigned to monitor. The Army Staff was divided up into functional areas, and we were each given several offices and areas to monitor. My recollection is that I had the Office of the Chief of Engineers, rather naturally, and the DCSLOG, the Inspector General, and some others—six or eight.

Papers were sent to us from the Staff Action Control Office to keep us apprised of what was happening on the Army Staff. A paper might come over that they would say was ready to go to the Vice Chief of Staff of the Army, and if they thought it was an important issue they'd send us a copy. Or if a paper came in which they were bothered by or felt something was amiss—they only had about three minutes to review any particular paper because they had so many of them—and a more thorough review was needed, it would be given to us. Then we would go down and try to talk with the staff officers involved from the sending office to make sure it was straight, so we could recommend basically to the Chief of Staff that he ought to sign it or not sign it, or perhaps he ought to call a meeting.

I would suppose that process was followed back on the command selection for district engineers issue. The DCSPER sent a paper up saying the Chief of Engineers wants this thing to happen, and I nonconcur. It was reviewed; it was sent to the special action team; and the officer who was monitoring DCSPER or the Chief of Engineers actions looked at it and determined there were a lot of issues and disagreement and recommended the Chief of Staff of the Army call a meeting, bring them both in for a discussion, and make a decision.

Within the Office of the Chief of Staff we would write what we called a “BOM,” which stood for blue office memorandum—it had a blue border on it. That would go on top of the Chief of Engineers' action paper or the DCSLOG's action paper or the others. On it we would write our analysis and recommendation. Say, for example, the Staff Action Control Office sent a paper over and thought it needed more review, and when we got into it, we took issue with it or we felt it really wasn't complete. We would prepare a BOM to the Director of the Army Staff or the Vice Chief or the Chief of Staff giving our views. “So and so sent up a paper; he recommends this. However, in looking it over, there are several questions that arise. We don't think it really answers this or that. Recommend the paper be returned with the following questions to be asked....” Then we would sign our name as the action officer making that recommendation. Then my boss, the chief of the special action team, and the Director of the Army Staff for Coordination, Analysis and Reports would initial it and send it on up.

Thus, the Chief of Staff would have the paper and he had his own inner staff comments on top of it. When the paper came back out, the Chief of Staff would have written his decision. Then the blue office memorandum would be pulled off—it would not go back to the DCSLOG identifying this lieutenant colonel had taken issue with the lieutenant general's recommendation. The Chief of Staff's decision would be written on the DCSLOG's paper. So, what we really provided was a way for the Chief of Staff to have his own thoughts, and also somebody to do a second independent analysis of an issue.

The Chief of Staff didn't have the time to do it all; somebody else could chase down the issues. A paper might go in to him that everybody thought was clean, and he might say, “I'd like CAR to look into the following....” So, we might then have to go look into an issue that he initiated.

It was a very interesting assignment in that I might track certain things, but there was always something going on where we were probing into various kinds of things to try to “do right for

the Army,” and allow the Chief of Staff or Vice Chief of Staff to make the right kind of decision.

Several interesting things came up. I remember one issue that came out followed General Abrams saying, “We have got too many reports of survey and we never find anybody responsible. Why can’t we simplify the procedure where we just hold somebody responsible if he loses something, and don’t have to go through all this paperwork?”

He sent the Army’s Inspector General around the Army to check. The Inspector General came back and said, “We just got all kinds of stuff missing and we’ve got all kinds of paperwork out there, and it takes forever to get it processed before we get the missing items replaced.”

So, the DCSLOG was asked to take a look at the issue. The answer that came back up said basically that the fix was too tough because the Judge Advocate General [JAG] says we’ve got to do all this stuff. The JAG was saying we’ve got to follow the law, and all that.

So, it came down to us in the special action team. I was the one who got the action, but there were two or three of us who sat around and jawboned the issue so we would know what was going on in the field. What it came down to was that we really ought to have a simple process that, if a soldier loses something, that’s simple negligence. You shouldn’t have to go through all the paperwork, but the soldier ought to pay for it through a simplified procedure.

So, I took the paper back to the DCSLOG and the JAG and nobody was happy with that. I mean, it was sort of, “This is the way we do things and we should continue doing it the same old way.” By dialoguing things and by forcing the issue under the signature of the Director of the Army Staff, people were required to relook the issue. Questions were asked back to the DCSLOG and the JAG, “Why can’t we do this?”

By going back and forth to the lieutenant general, Director of the Army Staff, we drove a process whereby people relooked the issue, challenged the unthinkable, and came up with new ideas, and we overcame the obstacles to change the system. So, that process was operated by CAR, and specifically the special action team, so that was a value to the Chief of Staff of the Army. We would get questions coming down from the Joint Chiefs: “What about...; I heard about this...” and we would develop answers. Books and articles would come out. We had a lot of them at that time right after Vietnam and My Lai, different kinds of things where we would do an analysis and send it up in an executive summary so that the Chief of Staff or the Vice Chief of Staff could get a feeling for what it was and have some sense of what’s in the book or paper and could send other questions out and get more into it if they wanted to.

One project I did involved the Center of Military History. After General Abrams died in office from cancer, General [Frederick C.] Weyand was selected to replace him. General Weyand wanted to bring in former Chiefs of Staff and talk to them about the Army of the day and the issues we faced.

The project was to take current issues and link them back to issues his predecessors had faced. I guess it was like, “I’m now going through this drill much like you had to go through a similar drill,” or “I’m doing these things, which are different from what you did.” The issues addressed the size of the Army, where research and development funds were focused, the roles and missions between the Air Force and the Army, and a whole bunch of different things.

About two weeks before the session, the Chief of Staff said, “I’d really like to know about the issues they faced during their days.” So, that was sort of a typical task, and it came down the way to CAR, and I was the available special action team member unassigned with a mission at the moment. So, I was given the task of, “How about analyzing these eight Chiefs of Staff that are going to be here and their periods?” The periods went all the way back to the end of World War II. “List out what were their issues and what they thought.”

The problem was that I only had about four days to do it. So, an advance call went over to the Center of Military History that said, “We’ve got to do all this, and this Lieutenant Colonel Kem will come over and lead the effort.”

So, I went over there and sat around and jawboned it for a while, and basically picked different periods and different chiefs, and several historians pulled in the stuff. The Chief of Military History assigned who was to do what, and they wrote it up and sent it in to me. I was the collator, bringer together in a format, editor, and that kind of thing.

Once we had it, then I boiled it down into a two- or three-page executive summary of all of those things, and then developed a matrix with the names of the Chiefs of Staff across the top and the issues down the side—an issue like Army versus Air Force roles; you know, we had to decide who gets the Caribou, who gets the helicopter and so forth. Another was the size of the Army, how many divisions did each have and that sort of thing.

Then we filled in the matrix with words; it was a word picture, not just numbers, to say “here it is,” and it was a triple foldout. So, a week after that, each was given a copy of this matrix representing the analysis of the Army and its important issues in each period.

It was a tremendous surge of effort—evenings and weekend. It was a pretty fair product, but not so rigorous. That was a typical requirement. When the Chief of Staff or Vice Chief of Staff of the Army had a need to do something—we would provide that need.

It could also be assisting speech writers, as speech writing requirements were heavy at the time, or analyzing a book and what was said, or analyzing various items like the one I mentioned. We also worked up trip books for the Chief of Staff and the Vice Chief of Staff when they went out to visit places—pulling issue papers together.

So, it was a year of doing that, really being an extension of the thinking and actions for the Office of the Chief of Staff.

Q: Did you enjoy that?

A: I did.

Q: It seems like it offers the possibility for a lot of surge jobs, a lot of things.

A: There were. Somebody was surging every week. That meant we also helped each other out. That was the job of the chief of the special action team, to put together a team effort.

When it came to be legislative time, we all helped in reviewing the papers that the legislative guy would keep in his big black briefcase. We would all, in our particular areas, review those papers and work on issue completeness. Our capability was to call straight to an action officer; I could call the Office of the DCSLOG and say, “What’s all this really about? What do you really think? What did you mean to say here?” So, we could fill in the blanks a lot of times without having to send some paper back down needing to come back up, or we could augment the paper. So, we helped facilitate how things ran.

I always thought if I was ever in a senior position *any place*, I’d really want to have a special action team. In fact, in a budget crunch, FTE [full time equivalent] crunch times, they’re hard to justify.

One of the things I did that year was write a paper justifying why CAR and the special action team should be kept. It carried the day and CAR was kept. Since then it’s gone away.

Q: So, is it that nobody is doing that kind of thing, or did they just give it to someone else?

A: It happens some other way now.

Q: Some other way they do it. About how many people were involved in that office, roughly?

A: I remember that the special action team had five. There was probably one fulltime speech writer, one fulltime legislative person, two people doing the weekly summary—those were all uniformed. Then there were probably four secretaries plus the chief of the special action team and the director.

Q: That’s still a pretty small group.

A: The speech writer was totally dedicated to speeches and never got involved in the rest of the stuff, other than to participate in discussions about issues, because he had more direct interaction with the Chief of Staff than many of us. He would hear things as he was writing the speeches and he would share them.

For me, that position, being my first in the Pentagon, gave me, from the start, a broad perspective of the Army Staff and the secretariat. So, it was really a perspective broadener on the inner workings and functions of Army leadership and on the thinking of the day. We were trying to write things that would become Chief of Staff policy statements. He would say, “I really think we ought to have a policy on so and so. I’d like to move in this direction.”

Often CAR was the group that actually wrote the sentence or two of the policy, put in the words, put in the direction, and then send it in to him and he would fine-tune it, change it, throw it out, start over, or refine it where appropriate.

Q: Well, it would give you a sense of inner workings and the paper flow at that critical juncture.

A: I was happy to work there rather than in with the Seven Dwarfs, who were in the paper flow tracking actions—get it in, wait for a signature, get it back, send it on back with the right kind of decision, and get it all filed and recorded appropriately. So, they were really in the flow; we were just off the flow—

Q: Watching it.

A: Available to provide some capability to address substance.

Chief of Public Affairs, Office of the Chief of Engineers

Q: Do you know the month when you went to your new assignment in Public Affairs in 1975? Your next assignment was Chief of Public Affairs in the headquarters of the U.S. Corps of Engineers.

Can you say a little bit about how that particular assignment became your next one?

A: Yes. First of all, in November 1974, after I'd been in CAR, I came out on the colonels list. I was in a lieutenant colonel position, so there was a push to have me move to another colonel's position. It was a matter of finding another position. While working with the engineer colonels assignment officer, a position as Chief of Public Affairs for the Corps of Engineers came up.

I don't know if the name was recommended to him or he came up with my name, but General Gribble, through the system, asked for me to be his Chief of Public Affairs. Of course I'd known him earlier when I was at the North Central Division and in work when I was in the Colonels Division and he had been Chief.

He knew I was on the colonels list. The Corps had a real public image problem at that time and was coming to a head with environmentalists thinking we weren't in the forefront of the environmental movement as we'd been trying to tell people we really were. Fred Clarke had put out his policy to implement the National Environmental Policy Act of, I think, 1969.

We in the Corps were doing pretty well in changing our paradigm internally, but this was a time when the environmentalists were really teeing off on the Corps, and a lot of high-visibility things were happening. Articles in the papers and the magazines were harpooning the Corps. The Chief's Environmental Advisory Group had been established.

The 404 wetlands program was beginning. Trying to come up with the rules and regulations for that, the Corps was seen as having not been interested because definitions had initially been to apply the Corps' 404 responsibility to navigable waters only. The courts said, "No, it's broader than that. You have to move into these other areas." A bunch of folks jumped on that and said, "Well, it shows the Corps is not really with it." In fact, the Corps was trying to let the system define itself. Anyway, General Morris was Director of Civil Works, and he felt that we needed to do more. The Public Affairs Office in the Office of the Chief of Engineers was not held in the highest regard at the time for whatever factors. The person in that job was leaving and it was a colonel's position. Typically, at that time, it had always been filled by an engineer and not a public affairs professional, as it is today, the thought being at the time that the civilians provided the professional skills, but the Chief wanted somebody who understood the Corps so the combination together would work.

So, it was sort of a natural thing for me, looking for another job, recognizing that once again it was going to give me the same kind of broad perspective of the Corps of Engineers that I had just gotten on the Army Staff being right outside the command group. It would let me interact in a new, challenging arena that I had not been associated with before. So, that's how I became Chief of Public Affairs for the Corps.

Q: Maybe we could talk a little bit more specifically about some of the major issues that you just alluded to. One of the questions, though, would have to do with trying to set the time when you went there. There was a lawsuit involving a natural resources defense counsel versus the Army on the wetlands regulations and the definition of those, which were being worked out. That was in the early spring of 1975. Do you recall that as being one of the first kinds of things that you confronted?

A: As I mentioned, there was disagreement on the extent of Corps responsibilities, and that court case expanded Corps responsibilities as we viewed them. The aftermath was active after I arrived.

The way things worked was that the Director of Civil Works ran the 404 regulatory program, and we in Public Affairs provided support as needed. By the time of my arrival, General Morris had moved in to be the Deputy Chief, and General Ernie Graves had come in to be the Director of Civil Works.

From my stand, I was trying to do what we could to improve our public affairs capabilities, and I was taking an across-the-board approach.

Very early on I'd gone out to the annual get-together of the public affairs folks in Chicago. General Morris came out and really laid some tough challenges down. It was almost brutal. He said, "You guys gotta get your acts together," and things like that. So, it wasn't all just the outside versus the inside; a lot of it was within the family.

Victor Veysey was now the Assistant Secretary of the Army for Civil Works. He was the first to hold that position. He had very decided feelings that the Corps wasn't doing the right kind of job in many arenas, and one of them was public affairs. He felt we didn't know how to do

public affairs. He had some public relations background, and he was always saying, “Let’s turn over Corps Public Affairs to the Army Chief of Information.”

Part of that, I think, was that he was right down the hall from the Army Chief of Information and he felt that he’d have his man doing it. Other assistant secretaries have had similar thoughts, like, “Maybe I really ought to run everything. If I had it over here, then I could run it. If I have it over there, with the Chief, then I’ve got to work through the Chief and his staff.”

When I first came over, General Gribble gave me several items of guidance. One was, he said, “Sam, we don’t have a very good reputation, Corpswide, for our environmental actions, so I want you to work on that, but I’m not so sure we can really change everybody’s perceptions. We ought to work on trying to do better and we ought to do it right and then maybe it’ll eventually come out right.”

Second, he said, “All we seem to talk about out of this office is the civil works part. I’d really like to see more awareness on the part of the Army of those things we engineers bring to the table. So, although you’re seeing everything defined about our bad image being civil works, I came out of the Army Staff research and development to this job. You have just been through the district engineer selection process in MILPERCEN. We know that not everybody in the Army understands us or appreciates us, so I want you to work on that line—that’s one reason I selected you.” He continued, “Pretty soon we’re going to have to address what’s going on, I mean the flaps that come up. You’re going to have to figure out your time between solving flaps and getting us better.”

So, I approached my new position from that standpoint. I dialogued with people in the field and developed a public affairs action plan that had a lot of parts. Part of that plan was to get our capabilities better aligned and focused on the right kind of things. That meant more capability in our office in the Forrestal Building.

We had some folks who were wedded to their old ways. We didn’t have anybody who could write anything concerning contributions to the Army, that aspect. In fact, we did speech writing for the Chief of Engineers, and I did the Army part of the speeches thereafter. We were at a place where the Civil Works Director, General Morris, had become so unhappy with the Public Affairs Office that he had set up his own communications presentations branch office. There was almost a nonspeaking relationship between that office and the Public Affairs Office that I inherited.

At the same time, out in the field, we had offices that had some really capable people, but they could never get in to see their district or division engineer with their ideas. They weren’t part of the team when the division engineer got his team together. In many respects these people had good ideas and couldn’t get the ear of the commander. Many others were comfortable doing just what they had been doing and didn’t want to have any more responsibility or visibility because that meant more work to be done.

So, my evaluation was, “I’ve really got a mess here, and quite different in its aspects—some strengths and some weaknesses, certainly nothing cohesive, and no strong stovepipe like what existed everywhere else in USACE.”

Not that I really wanted a strong stovepipe but, as it was, I couldn’t help anybody. So, the public affairs plan really had in it several components. One important one was get the public affairs person to be part of the commander’s team.

I worked that by trying to jawbone with the division engineers, trying to convince them to raise grades. Our division public affairs person was always a grade lower than the other federal regional office representatives, whatever they were.

You look at our public affairs people, and they were always a grade lower. I tried to get more people in the Public Affairs Office so they could do more than just putting out a newsletter for the division office telling who got this recognition or who had the new baby.

I mean, we really needed to provide some help to the division engineer. So, I tried to encourage appropriate staffing. Meanwhile, at the headquarters I tried to do the same thing—to add a couple of people, hire the right kind of talent so we could get involved in the right things, and maybe over time make some change. Then, over time, maybe I could cut back as some of the folks who weren’t pulling their weight retired and moved on.

So, I did get a couple of extra positions, and we hired folks like Warren Pappin, John Jones, Gil Gilchrist, and Bob Hume. We brought in some young blood—people who had been out in our divisions and districts and who understood things out there, and who weren’t so very happy with how things were and wanted to do better. I was really trying to attract to Headquarters, USACE, the motivated people who wanted it better. I wanted to enlist them in my campaign to get it better for Public Affairs and thus for the Corps.

Then I tried to work a raise in the grade levels of division public affairs officers. That was a tough fight. We started with the Lower Mississippi Valley Division, then the South Atlantic Division. I remember well being opposed by the personnel classification system for raising the grades of our division public affairs officers. Ralph Loschialpo’s deputy at the time was the one that carried the ball for personnel.

Anyway, it came to a showdown in which the personnel classification person and I went up to see the Deputy Chief of Engineers, General Morris, because personnel was nonconcurring with what I was trying to do. I made the point about the level of the work and the importance to the Corps. We were so decentralized. The divisions were where the work was happening and the place where we were getting harpooned on this TV channel and that channel. Nobody was putting together a counteraction. We could clip newspaper articles and tell the division engineer what was happening, but nobody could or would put together a program to go out and take the offensive and tell the story of the Corps.

The fact was that our people are always a grade below everybody else in the federal regional system. I was arguing all of the reasons why they should be elevated a grade to be like their

regional peers. General Morris was hearing both sides. I think I won when I said that not only are public affairs officers down a grade, but the top personnel guy in every one of these places is one grade higher than the public affairs officer, and I didn't understand that, either.

General Morris turned to the deputy personnel person there, whose name I don't remember, and said, "Why is that?" The personnel guy said, "Well, probably because the personnel position is more important to the Corps." He was saying that, of course, to General Morris, who was the one who had been lampooning Public Affairs for not doing the job—that the Corps' public image was so bad; we ought to do something to get it right.

He now had a public affairs program that we had developed, that he was aware of, and we were trying to get it right. He understood that one thing was that you really ought to staff at a grade level that is representative of the kind of people you deal with.

So, General Morris stood up and said to him, "You said what?" So, it was repeated, and General Morris said, "We need to raise the grade level." The one being considered at that time was the Lower Mississippi Valley Division, Herb Kassner's position. Gene Brown at the South Atlantic Division and others followed here and there. We never thought that necessarily they'd all be equal across the board, as we do have differences in divisional responsibility. That was the start. I would guess, the way things go, that where they are today is where people wished it to be and made it happen. Where they're not today, those particular bosses didn't feel strongly, and the issue went away.

Q: When you brought in some new people, did you make organizational changes in how the office was structured in the headquarters to address public affairs?

A: Oh, not really; we changed a few assignments. One of the things I wanted to do was to bring somebody in who could speak "Army speak" so they could take over the speech writing bit that I was doing and have a sense for tracking Army issues.

General [Walter] Bachus at that time headed our Facility Engineer Directorate, and we had a great focus on doing facility engineering better. In Public Affairs, we had nobody to interact with it. Thus, we needed to have somebody deal with him. Military Construction had been there all along. Major General Bates Burnell was doing that and it was ongoing.

I pointed some public affairs folks so they were oriented to service, that is, a point of contact to service certain arenas. Ed Green was still working with Civil Works, but I had somebody now, Gil Gilchrist, who was to be the Facilities person. I could turn to him and say, "Run down there and find out what General Bachus wants with these."

Q: Was that Warren Pappin? Or the other person?

A: No, it wasn't Warren Pappin. Gil Gilchrist, who came from the Army Chief of Information.

Anyway, it was that kind of an orientation. Locke Mouton was the deputy director. He was a very strong person, very set in his ways, and contributed greatly to the Corps over the years. He was also very set in what he would do. He did some things well, and some things he

wouldn't do. So, that left me to do those—mainly Army-oriented activities. So, part of my challenge was organizing around those kinds of things.

We did have a few things that happened of major significance, and one was the decision on Marco Island.

Q: Oh yes, in Florida.

A: Deltona was the developer, and this had become quite a *cause célèbre*, and rightfully so. It was a major test of whether the Corps was really interested in preserving wetlands.

There were great analyses made of the cypress swamps and what was going to be cleared away to make room for this major home development. The Jacksonville District Engineer was very much involved, and the South Atlantic Division Engineer, Major General LeTellier, was very much involved.

There was a lot of dialogue all the way up to now the Director of Civil Works, General Graves. He became very personally involved in that decision and spent hours working it. He made the final decision. In the end, we held a press conference, which we had not done often at Headquarters, Office of the Chief of Engineers, now Headquarters, USACE. So, we had the chance to support General Graves in conducting his press conference. We invited the press in, and representatives attended from many of the environmental organizations that had been vociferous in their objections to the Marco Island development. General Graves announced his decision at the press conference, and we worked the press releases and orchestrated all those kinds of things.

Q: That was kind of a new thing, or at least not that common.

A: Not common at headquarters at the Office of the Chief of Engineers to have a press conference.

Q: You had to get up to speed pretty much on the public affairs arena as well, didn't you? Press conferences hadn't been something you had a lot of experience with prior to that.

A: No, but I had people to run those. I had the capability to provide the understanding of the Corps of Engineers, which I had served in at the district level. I had served on the troop side.

I knew that I didn't know about press conferences, so I would get our civilians to take care of that aspect of it. I tried to facilitate the communications problems that the Public Affairs Office had had before with the Director of Civil Works and the Chief.

The Chief at that time went to each of his directors for one-on-ones once each week. When he went to a one-on-one, he would take his deputy, the executive director—that was Russ Lamp at the time—and the Chief of Public Affairs—me. For example, the four of us would go tromping down to Civil Works and meet with General Graves. He'd go through his three-by-five cards and bring the Chief of Engineers up to date. Or we'd go to the Chief Counsel, or we'd go to Director of Military Construction, or the Postal Program, or down with General

Bachus in Facilities. So, once again, I was really getting a great overview and perspective of all the things that were going on in the Corps and the engineer side of the Army.

I could take back information in anticipation of certain things and tell my public affairs folks to follow up or see if we could take an initiative to help.

I knew I was not an expert in the technical aspects of public affairs, but I had a pretty good feeling of how things worked and of communications. I learned a lot that year—I learned a lot of things that held me in good stead ever thereafter.

For example, the fact that you have to deal with perceptions, not only reality, when you deal with people. Also, that public affairs is really communications, and there are a lot of different audiences that you need to communicate with—external, internal, your own staff, the Army external, the environmental external, the Corps employees in the field, the employees in the office. I mean there are just a lot of different audiences. I learned that if you want communications to succeed, you have to target the audience and design communications for that audience.

Sometimes there can be more than one target audience, but you really have to know what messages are intended, and you have to change the design of your communication to target each audience. I can't tell you how much that understanding has helped me. I rely on that now in talking with folks.

When you prepare a briefing, you need to develop your boilerplate briefing on how you communicate your intended information, issue, solution. When you go to brief General X, you need to sit back and make sure you know what you want General X to come away with and what you want to convince him of. You need them to redesign your briefing, be prepared to throw out charts, change charts, change words on charts so that you're targeting General X for that briefing.

Or if you want to take it out to the outside media, you can't just go with your standard pack of charts. If you go with your standard package to every audience, not stand back and look at it critically, then you're going to have something in there that's going to turn them off, irritate them, or cause you to lose. So, you really need to redesign your brief for the audience.

Now you might have two people you want to target. Then you've got to make sure that even though you're speaking to General X, you know that Colonel Y is looking at it from a different angle and agenda. You want to convince him, so you're going to have to put the things essential to his perspective in there to convince him, but making sure they don't kill you with General X.

Just understanding the reality that you have to design a communication or a briefing for a particular audience and target them is invaluable. We in the world so often don't do that. You always know because you get burned by the result when it happens.

Some people don't understand why they got burned. That's why I've never liked slides and Vu-Graphs printed up so nice and clean and beautiful—because then you're reluctant to

change them. I'd rather have the old type Vu-Graph—running it through the copy machine, black on yellow. If all of a sudden I determine, “Hmm, those words are going to turn somebody off and it really doesn't say it the way I want to say it,” then it's very easy to change that chart. So, the key is to really convey the message you want to convey, rather than look pretty.

So, I learned a lot from that year, from all those kinds of aspects, and in dealing with people and trying to deal with a whole bunch of different kinds of issues from organization to the media.

Q: Again, it was an assignment that exposed you to the whole Office of the Chief of Engineers staff, I mean, at various levels throughout the organization.

A: Yes. The Office of the Chief of Engineers staff and the field, too, because I went out to a lot of different things and went with General Gribble on several trips. The Tennessee–Tombigbee Waterway was an issue that year because costs were higher than projected. I accompanied General Morris down to visit South Atlantic Division headquarters for General LeTellier to explain why projections were different from what was being experienced.

So, I did get to participate at a pretty high level, in what was a very intense year of education.

Q: Lock and Dam 26 was—

A: Lock and Dam 26 was really up there as a hot issue and a very high visibility.

Q: The wetlands regulations.

A: The wetlands regulations, right. All those were things that were moving along. So, it was a good time to watch all those hot Corps issues. Hardly anybody got to mess with Lock and Dam 26 besides General Morris. He really was orchestrating it, pulling things together, and it was fairly well pulled together as far as the game plan at that time.

Q: You already mentioned the fact of Victor Veysey becoming the first assistant secretary at that point. Is there anything else in that relationship—I mean, did the strength of the Corps organization improve sufficiently then? I don't recall right now how long he was in.

A: In terms of public affairs, whereas the Director of Civil Works went to see him on the civil works program, I went over to see him initially on the public affairs program and had him explain to me what he thought we needed. Then I went back to brief our public affairs plan to get the Corps up on public affairs.

General Gribble wanted me to do that. He wanted a dialogue between me trying to show Secretary Veysey what we were doing in the Corps and that we had a proactive plan to try to make things better.

Victor Veysey, like many others since then, had a feeling that if you didn't read good news about the Corps in the *Washington Post* then it wasn't good news. That's really a fallacy. I

mean, there were lots of words printed out in the hinterlands about the Corps—giving them credit for good works and harpooning them for different kinds of things that were going on. In this town of Washington, though, what the Corps of Engineers does or doesn't do is not always first-rate news as far as the *Washington Post* is concerned. When you go home and watch your news channel at night, that's national news, not the locals, and they're not always interested.

I mean, the five o'clock local news, before the national news, might cover Four Mile Run flooding back when it was flooding south Arlington, but now that the Corps has built Four Mile Run, there are no longer floods. I mean, it's not news any more, so you don't get the positive story in the *Post*.

Q: Yes.

A: Victor Veysey felt—and of course he had Marco Island and all these things up on the screen— “Why isn't the Corps getting inches of news space showing that we really are for the environment?”

It was a very difficult thing. I was going back and forth to see him for a while until he must have figured we were at least working at it—and lost interest in dealing with me, so I stopped going. He would never say we were really there in Public Affairs, but he at least wasn't fussing at us for not trying.

Q: Did you get involved in the public meetings that were going on in the field?

A: That's handled by the field. I did that when I was in the Chicago District, as I mentioned.

Q: Then as Chief of Public Affairs you didn't really need to—

A: No. We would know and would be kept advised of major things, and we always knew when the meetings were going on in Marco Island, for instance, and that sort of thing. In our decentralized USACE organization, that's really a division and district thing.

Q: Did you find the suspicion of Public Affairs in the Office of the Chief of Engineers? Sometimes an organization that's under attack from all sides sort of closes in on itself.

A: I think it was that way. There was a suspicion of that. The organization closed in on itself, didn't stand up to be counted, and did a few things like saying “We can't support you, Civil Works, with speeches.” That had caused General Morris to set up his own communications. They then became competitors with Public Affairs.

Q: It still exists.

A: They then became competitors, and thereafter it was vogue to say bad things about Public Affairs, whether you wanted to or not.

So, there really was a suspicion, a feeling that Public Affairs doesn't cut it, they don't understand the Corps, and why should I spend time making them understand? It was not a very good atmosphere.

Q: Although this happened later, what do you think about the change to career public affairs persons being the Chief of Public Affairs instead of engineer officers. That happened maybe around the late '70s, I think?

A: I guess I was always suspicious of that, but I only spent a year there. I guess it's a matter of how fast a person can learn about the Corps and how receptive are they to understand that you do have to understand a decentralized organization like the Corps, as opposed to where the Army has been. We've had some good ones; in particular Bill Garber, I thought, was superb.

When I was Deputy Chief and working with Bill, he didn't have a qualm about coming up and saying, "I don't understand this; tell me about it" or "I think we ought to do this." His aggressiveness and assertiveness and ability was just right for the position—and he had then all those technical capabilities that I didn't have. I mean, he could set up editorial boards and he could get things done that I was not trained to do. He had a sense for having a game plan. That's what we never had before my arrival and what I tried to start—but we couldn't just have a game plan at the headquarters; we had to have a game plan in each division, in each district.

Bill Garber came up and had the capability to formulate with his assistants a game plan to use Chief of Engineers Hank Hatch's strengths to go out and interact, to get him involved here and there, and to communicate the "Corps." It really depends, to answer your question, on getting the right person for the job. So, if you get the right public affairs specialist, that's better than having the right engineer in that position. The right engineer in the position might be better than having the wrong public affairs specialist.

So, I think it's fine.

Q: We just have a new one now, the last couple of weeks; who I don't know.

A: Who is it?

Q: I haven't met him yet. Colonel Monteverde, but he's called "Monty." He came from the Pentagon.

To follow up on something—I heard you speak to the public affairs officers in Louisville when they had one of their meetings. I remember one of the things from your remarks, and I also remember it provoked some discussion in the hallways.

A: When they tried to throw me out afterwards, you mean?

Q: I may not even be remembering the right thing, but I remember that you were talking about placing, I think, and this is my interpretation, less emphasis on command information, less

emphasis on the newsletter and those kinds of things, and a more aggressive approach to dealing with external media sources. Is this something that also reflects back to your experience at this time?

A: Absolutely. I really have already commented on it. It's not necessarily a reflection that they in the Public Affairs Office should not emphasize the command information component; what I was suggesting was that they overemphasized their newsletters. My feeling was that in an organization that's still austere staffed, where there were only two or three people in the Public Affairs Office, with one of them spending almost full time keeping the newsletter up to date—that, I said, was not putting our effort where it should be. A newsletter is easy to do, it's fun to do, and as long as you fill the time with something easy and fun you might not ever get around to doing the more important things.

That comment in Louisville was a reflection of my feeling that way, having been a division engineer since my Public Affairs days, having watched it and having tried to convert my folks. Newsletters were all right as long as they did everything else that was needed.

Now, I wasn't against command information; what I was saying was, "If your newsletter informs the command about policies and functions and things that are happening and things they need to know, okay; spend your effort on that, but not on new babies, retirements, and the list of things that you find in most of them."

In fact, my whole emphasis was that they, the public affairs professionals, ought to be focusing on programs for making their external audiences understand what the Corps was all about. That takes a lot more work because you've got to get out of the office and you've got to go visit editorial offices and papers in various places.

Back then it seemed like we were dividing up things 50 percent external and 50 percent internal, and the Corps' focus ought to be 25 percent internal and 75 percent external. Further, our division and district commanders know how to communicate motivation to their subordinates; you don't need a person in Public Affairs cranking stuff out, especially when it's easy. Therefore, I felt we ought to extend ourselves in getting higher caliber people who could do more than just crank out a newsletter—that would use their full talents better.

So, that was it. What I did was tell my views to a lot of people in the audience that day who were persons who really took pride in their newsletters and who spent their efforts on it—and they knew just exactly what I was talking about. It wasn't that we had bad newsletters, but in a zero sum game can you afford to have people that are so proud of the newsletter, they spend every moment of their day getting it even better when the rest of the mission goes awry? So, there was very considerable debate that spilled over into the halls.

Q: That was probably part of the intent, right?

It got people's attention.

A: Sure did.

Q: Do you have any other things that we haven't asked you about, directly related to this assignment?

A: Well, that was the year we also had the towboat *Sergeant Floyd* motoring about our waterways.

Q: Okay.

A: It was part of the bicentennial celebration. It was certainly a good time. The Corps won the Silver Anvil award for the *Sergeant Floyd*, which carried Corps exhibitions from inland port to inland port.

Q: This is a little different than some of the questions we've asked from your other assignments, but could you take a few minutes to give an assessment of General Gribble as Chief?

A: Yes. General Gribble was the epitome of a person, in my estimation, who had very quick capability to understand what was going on. He was truly a nice person who dealt with people in a most personal manner. It was not that he wasn't tough—and he had a toughness that was as tough as anybody—but his way of dealing with people was personable. He was not one to be out talking up something, not an external kind of person, but a more internal, get to the heart of the matter, interact with those needed, show them we're together, get the job done, solid type of person. He was very well respected in the previous position he held as Chief of Research and Development for the Army.

He had an interactive spirit with people on the Army Staff, the Chief of Staff and the Vice Chief of Staff, during that time. He would call them and dialogue things.

He was a quick learner, one who quickly received information and could hand back guidance or counsel to General Graves or someone else as to what the situation was or how it was developing.

I enjoyed very much working for him in the Chicago District. Although he was at division headquarters, we were both in the same town, Chicago. I didn't see him often. I enjoyed very much coming back to work for him my years in Public Affairs.

I had a personal relationship with him and I saw him as my mentor. From the time in Chicago that I first met him, I respected him. I was a captain and enjoyed working for him. I didn't have too many interactions with him, but I saw him as a person I could approach and talk with.

There were occasions after Chicago that I would call him at home and ask him about things. He was always very forthright, down to earth, and helpful. One example of that—I believe I covered this earlier—was when I was at Fort Leavenworth and Ernie Edgar came out and told me I was going to Vietnam for my next assignment and would go to battalion command. That was the good news. Then he said this same afternoon I'd get a letter from General Harold K. Johnson, the Chief of Staff, saying that the Army had set up this new province

senior adviser program and was hand selecting people to go back, based on their having served their previous tour.

The sector adviser would serve for two years, leaving his family in the Philippines, with trips back and forth. The Army needed continuity in that very important program.

General Johnson had just been out to talk to us as a class about three weeks before about how he was going to set this program up. I thought then, “Boy, I’m glad I don’t have to worry about that one”—because he was talking about lieutenant colonels and I was still a major. Of course I was on a promotion list, but the way he described it, I really didn’t think it applied to me.

Anyway, I got that letter that afternoon. So, there I was, selected for command and selected for the province senior adviser program. General Johnson, the Chief of Staff of the Army, said he’d really like to have a response from me in a couple of weeks as to whether I’d accept the program or not.

Immediately, all of my compatriots at Leavenworth divided into two camps; one was, “You can’t tell the Chief of Staff no; you must take it,” and the other was, “You ought to go to command.”

There were four or five of us who were on the list from out there. I was in a quandary because I believed we really needed an important province senior adviser program. One of the calls I made was to General Gribble, and I asked him, “What do you think?” At that time I believe he was Deputy to the Assistant Chief of Staff for Force Development. He was certainly at the Pentagon and on the Army Staff, and a two star by this time. He thought it over for a while, and he said, “Well, it really is a very important program; we really need it. I think you ought to just do what you want; if you want to do that, go do it; if you want to command, go do that.” Then he said, “In the end, I don’t think the Army will credit that senior advisory position like they say they will—that is, the equivalent to command. So, although I believe it, and the Army is sincere about it, I think when push comes to shove for future selection boards for command and things like that, it won’t stand up in lieu of command. So, if you really have your heart set on command, which is what you really told me, you probably ought to go to command.”

So, with that, I sat down and wrote General Johnson my letter. Here it was coming from my mentor—it validated where I was in my own thinking. I had been taught through all our schooling that a soldier, officer, should aspire to command in combat. Here I had the opportunity to command an engineer battalion in combat. Yes, this was an important job too. It was what I aspired to do. So, that’s how I expressed it in my letter—that I really wanted to follow my long-term aspirations to go command in combat since I had that opportunity.

Back to General Gribble. That was an instance where he was available as a mentor and very approachable and easy to talk with.

Q: Did he retire while you were Chief of Public Affairs or was that slightly thereafter?

A: No, afterwards.

Commander, 7th Engineer Brigade

Q: From '76 until '78 you were commander of the 7th Engineer Brigade and the Ludwigsburg–Kornwestheim military community commander. I wonder if we could start with discussing how you got that position and how you got that job.

A: Well, basically I came out on the engineer troop command list from the OPMS centralized board selection process, and through that process I was programmed to the 20th Engineer Brigade at Fort Bragg, I think because I had had airborne experience in the past. Colonel Herc Carrol had been programmed to go overseas as commander, 7th Engineer Brigade. His wife, Sue, became very ill, later died of cancer, and so he removed himself from the command list that year. So, it was a consideration on how to rework the list—what to do about it. Because I was in the position as a public affairs officer, I was programmed after a two-year tour for the 20th Brigade a summer later, '77. When this came up I spoke with General Gribble, the Chief, and asked to be released early from my position so I could go to the 7th Engineer Brigade and take command. He approved that request and MILPERCEN, Colonels Division, processed the change, and so I was assigned to command the 7th Engineer Brigade in summer 1976.

Q: Before we start talking about that position and its responsibilities, could you give me a sort of overview of the engineer troop organization in USAREUR at that time, how the 7th Engineer Brigade fit into the engineer structure in USAREUR.

A: Surely. It had been for years in about the same mode. Basically there were and are two Corps, the V and the VII Corps. Each Corps had two divisions and some other combat elements. In each of those divisions there was the divisional engineer battalion. In the other combat elements that I referred to, which might be a cavalry regiment or



Colonel Kem received the colors of the 7th Engineer Brigade from Lieutenant General Frederick J. Kroesen, Commanding General, VII Corps, in July 1976. The departing commander was Colonel Harry Lombard (right).

something like the 1st Infantry Division (Forward) Brigade, which was located there, there would be an engineer company that was organic to that combat element.

In addition to those engineers assigned to larger combatant elements—doctrine calls for, and our force structure provided for—there was in fact, an engineer combat brigade with each Corps. That was the 130th Engineer Brigade in V Corps, and the 7th Engineer Brigade in VII Corps.

Now, in addition, our doctrine and structure calls for a brigade at echelons above Corps; that is, that would be part of the communications zone or rear combat zone as portrayed in Europe. In Europe that was the 18th Engineer Brigade, which was composed of four combat heavy battalions and the topo battalion.

So, then, and until recently when the drawdowns began, the 18th Engineer Brigade had the four combat heavy engineer battalions plus the topo battalion. The 130th Brigade supporting V Corps had three engineer combat battalions (Corps) and some number of bridge companies and combat support equipment companies. The 7th Engineer Brigade had at that time four combat engineer battalions (Corps), plus three float bridge companies, plus a panel bridge company, plus two combat support equipment companies. At that time both Corps engineer brigades had an atomic demolition munition company. The one with the 7th Engineer Brigade was the 275th ADM Company. So, the 7th Brigade had about 6,000 or 7,000 folks and provided engineer support from the Corps' rear boundary forward into the division in support of the division elements and backing up the divisional engineer battalion.

Q: Now, you said in another interview that in this position you really were wearing three hats. Could you talk just in an overview way about that, and maybe then we could talk about each hat a little more.

A: Certainly. Well, you identified that I was assigned as the engineer brigade commander and as the commander of the Ludwigsburg–Kornwestheim community, and that sounds like two hats. In effect the first one, brigade commander, has two within that position. So, let me first address the other one, and that is the commander of the Ludwigsburg–Kornwestheim community.

In Germany, all U.S. forces are assigned in communities, and there are 40-plus major communities with subcommunities under them. A troop commander, usually a ranking person in a community or subcommunity, is made the commander of that community. That was done to make a single commander responsible for both the troops in it and the community structure—that is, the support structure, the organization that takes care of the schools, the facilities engineer, and all the other aspects of community life. This was done in the '70s, I think, by General Blanchard, so that we didn't have a we–they kind of set-up where the troops always felt, "We're combat; we don't have to bother ourselves with support," and the support folks had to try to provide the support but had not the wherewithal to make it happen. By having one commander who had both the troops and the community responsibilities, there was somebody there who could mind the store for all aspects of military life and would have everybody pulling together.

Now, not everybody had just their own troops in their community, so there had to be a lot of cooperation. There certainly was a great understanding that everyone had a duty to contribute to the whole. I'll come back to that, but let me say that the 7th Engineer Brigade headquarters was located in the town of Kornwestheim, which is just south and contiguous to the town of Ludwigsburg. It had been there for years, and before that there had been an engineer group there. This was a sizable subcommunity of the greater Stuttgart military community.

The greater Stuttgart military community had six subcommunities of various sizes, to include Patch Barracks, where the EUCOM [European Command] headquarters was located; Kelly Barracks, where the VII Corps headquarters was located; and Nellingen, where the Corps support command was located. Each of those was commanded by a general officer: EUCOM by a four-star, VII Corps by a three-star, and 2d SUPCOM [Support Command] by a one-star. The deputy community commander was a colonel who was the effective everyday operating official for the community. He also commanded the subcommunity at Robinson Barracks. Then there were two—the Ludwigsburg–Kornwestheim and Böeblingen—subcommunities that were commanded by colonels. I was the ranking person as a colonel in the Ludwigsburg–Kornwestheim community.

It was a community composed of seven battalions and many separate companies from all over the Corps. In fact, I only had one of my battalions there and the atomic demolition company. We had an infantry battalion, a transportation battalion, maintenance battalion, signal battalion, and so forth. It was a very large subcommunity and the northernmost in the greater Stuttgart area. We had a very large family housing area, Pattonville, where people lived who worked all over Stuttgart—at Patch Barracks, Kelly Barracks, and Nellingen, south of Stuttgart.

My first hat, then, was to run the subcommunity, but we never used the term “subcommunity” in the greater Stuttgart community because our subcommunities were bigger than a lot of other communities. Therefore, we commonly used the term “community.” So, I commanded the Ludwigsburg–Kornwestheim military community, with support and logistic responsibilities for how we Americans lived there in Germany.

Now, then, to go on, the commander of the 7th Engineer Brigade carried two hats, as I mentioned. First of all, the command of the brigade as we traditionally view it—all the aspects of commanding an engineer brigade of four battalions, an atomic demolition company, and six separate companies.

Now, I said four battalions, but we really had six battalions because the separate companies—bridge and combat support equipment companies—were formed into what were then called “composite” battalions. The battalion commander was selected off the battalion command list and had a small staff. Thus, in essence, we had six battalions, which included the normally separate companies and the ADM company. Those battalions were located throughout Germany, so time and distance was a big situation for me and for operations command and control, but we can get into that later.

The other so-called hat comes from the fact that doctrinally and by organization the Corps engineer brigade commander operates also as the Corps engineer—that is, the senior engineer staff officer of the Corps commander. It was similar to a division, where the engineer battalion commander is the division engineer and has at the division staff a major, the assistant division engineer major. The Corps engineer, the brigade commander, has on the Corps' staff a colonel, the assistant Corps engineer. So, that was my third hat—Corps engineer. I was the Corps commander's engineer staff officer. For that role there were about ten to twelve people who worked at Kelly Barracks with a lieutenant colonel or a colonel, the assistant Corps engineer, who was the day-by-day operator in that position.

So, those were the three hats—brigade commander, Corps engineer, and military community commander.

Q: Let's talk a minute, again maybe with some questions on the command of the 7th Engineer Brigade. This is in the late '70s, in the post-Vietnam period. I wonder if you could comment on the several aspects of the battalion under you—training, discipline, morale, these sorts of issues. What shape was the Army in during this period in terms of combat readiness, training, and these sorts of things?

A: I'd say at that time the Army's position was one of emerging from the bottom of its depths after Vietnam. Certainly it's been well-written of the many problems in Europe during Vietnam where commanders had few resources and few people to work with and also had many troops who had come out of Vietnam, out of combat, many bringing with them drug problems. There were racial tensions and all kinds of problems in the early '70s. That had bottomed out by the time I arrived and was on an up trend. There are others who certainly get credit for this, but General Blanchard gets a great share of the credit. He had made the community commander and troop commander the same person so that morale, discipline, order, and support kinds of things could all be addressed.

Some regulations were being changed so the Army could deal more effectively with druggies; that is, urinalysis testing was starting and we were modifying the rules for discharges, so it was easier for commanders to deal with and discharge the misfits and the malcontents. We were starting to emerge from Vietnam, and there was a little more stability, and people were starting to work to train noncommissioned officers and this sort of thing.

I heard an awful lot of stories from folks who had been recent company commanders and were still in the brigade's battalions about how bad it had been just the year before or just two years before. That is why I'm saying it was emerging because there were some conditions that weren't the best, but it certainly wasn't as it had been, for example, where in Bamberg an officer just had difficulty walking the streets safely. You know, garbage cans thrown out of windows nearly missing somebody entering the building, tires slashed repeatedly, things like that—really representative of a low state of discipline. Those kinds of events were in the past by the time I arrived.

I found within the command leadership structure a really positive attempt to recognize and deal with that. General Blanchard was a very positive person, just was ebullient about

everything, and that enthusiasm drifted down through the ranks. General [Frederick] Kroesen was the VII Corps commander, later to be the Army Vice Chief of Staff and come back as the USAREUR commander. They had people oriented back to making things better, making them right, establishing good order and discipline, getting people into the field so we could train. Money and resources were coming so people were back in field training, learning their combat tasks and working as teams. They were addressing the personnel problems, trying to put money into the housing so that families were happier, thus the soldiers with families were happier; trying to get rid of the malcontents, isolate the druggie from the good folks, and all of that.

So, there was certainly a positive command structure and climate that had started things on the up trend, and we were emerging from the post-Vietnam doldrums. I don't think it was there yet. We continued on beyond that to improve to the point of a kind of ebullience you have about the Army of DESERT STORM. We were just then a few years into the all-volunteer force, and we were starting out and had not yet got to the great recruiting years of "Be all you can be" that started about 1980. I mean, this was still pre-'80. You recognize in 1980 still only 54 percent of the recruits were high school graduates, later to rise in '93-'94 to over 90 percent.

This period I'm talking about, 1976, still had us recruiting a lot of category-4s. We still had noncommissioned officers that had not gone through the kind of training and improvements that we had later when we recruited the more positive folks of the early '80s, took them through basic leadership training and made them noncommissioned officers of a bunch of other high-quality recruits. So, I guess that would be my comments as to the general climate.

We were back into training. We were going to the field, and REFORGER [Return of Forces to Germany] exercises were happening regularly, and there was an orientation that—well, General Blanchard had it throughout the command, but I'm really speaking of VII Corps. I mean, there was that feeling that you wanted to be training combined arms and that you wanted to be in the field with infantry, armor, engineers, artillery, and doing things to improve our combat readiness. The things that service in Europe has always provided, back when I was a lieutenant, and then now in this particular period when I returned—the fact that we had a real mission. I mean, there was the Warsaw Pact across the border. The Cav always was doing border patrols. We fell out and had alerts. There was always the significance that you knew you were there in a forward deployed posture and you had a real mission. Therefore you went out and trained the mission. So, we were spending many days in the field.

As for the state of combat readiness, I think, for its time, it was pretty good. It was certainly better later when all of the positive things after the pullout from post-Vietnam came together—that is, the better recruits, the new items of equipment, better facilities, and the resources for training. Considering the equipment we had at the time and the people, we went out and trained and I think we did a great job.

The 7th Engineer Brigade had a lot of deficiencies that were really based on the fact that the engineer force had remained basically unfixed since World War II—that is, we were still a

wheeled brigade. We ran around in trucks trying to support tank and mechanized divisions who were in tanks and armored personnel carriers. We couldn't go cross-country like they could—we were an all-wheeled force.

We were also lacking total communications. I did not have a signal node assigned. Corps signal provided communications nodes to the other major subordinate commands of the Corps—that is, the two divisions, the Corps artillery, the Corps support command. All those other major support elements had a signal node in the field that really tied them into the Corps communications net. I didn't have one of those that came with us, and we were often out of contact with the great distances in VII Corps. You have to recognize how big VII Corps was even compared to V Corps in land area, stretching all the way from the Czech border back to Stuttgart and then its width between II German Corps in the south and V Corps to the north—quite large. That's also why we had the 1st Infantry Division (Forward) as another combat element besides the two divisions that V Corps also had.

In combat capability I think with what we had we were capable, but we lagged and lacked critical things that inhibited our capability to go to war as engineers to properly support the Corps.

At the time I arrived, we still had the M4T6 bridge and the Bailey bridge; all vehicles were wheeled; and we had dozers and so forth—so we've come a long way since then.

In the Army of its day, within the capability of the rest of the Army, we were probably commensurate with it except for the fact that engineers had never been fixed—doctrinally, organizationally, or properly equipped—really since after the war until then. These would later be the things that prompted E-Force and were never fixed until E-Force was implemented.

Q: So, you could see some similarities with your first tour there when you were a young officer? Some of the problems you saw the first time around still were evident?

A: I think my ability to start running in the 7th Brigade really went back to my good upbringing and initiation in the 23d Engineer Battalion, 3d Armor Division, V Corps, years before. That experience, being part of the combined arms team, was ingrained in me. I was back on the German terrain and we were back doing the things I knew. I knew what the platoon leaders were doing trying to support their mech infantry or tank cross-reinforced task forces. I had just moved up a couple of echelons but, in essence, the divisions and the Corps were doing the same things. The kind of REFORGER exercise we had in '76 and '77 were not dissimilar from the basic things that we had in the FTX Winter Shields and Sabre Knots of '58 and '59 in terms of being in the field, interacting, part of the combined arms team, and that sort of thing.

So, both the good things and the bad things related back. Yes, we were wheeled back then, and we were still wheeled in terms of the Corps battalions.

Q: What about troop construction projects? Was there much use of troop labor for construction projects while you were there?

A: Yes, there was, quite a bit. Now, the 18th Brigade had as its mission, of course, to do troop construction, but Corps engineer brigades had considerable activity doing that as well. Specifically—this is a good place to put it in—one of the things about the 7th Engineer Brigade was its very large geographical spread.

With six battalions and all of those companies, we really were spread all over the southern German map. As I mentioned, we had a composite battalion in Kornwestheim with us and the ADM company. We had a combat battalion at Aschaffenburg, the 9th. We had the 82d Engineer Battalion (Combat) in Bamberg, the 237th Engineer Battalion (Combat) at Heilbronn, and we had another composite battalion in Karlsruhe, which had the bridge companies. When I started off, there was a float bridge company down in Nellingen all by itself. The other battalion was the 78th Engineer Battalion (Combat), which was located at Ettlingen, which is right outside Karlsruhe.

Then there was a combat support equipment company located at Grafenwöhr. V Corps had a combat support equipment company located at Wildflecken. The two companies were there to do range maintenance and construction at the training areas, so they had their equipment out on the tank trails all the time doing work.

We had summer construction programs where we would rotate combat battalions through the major training areas—that is, Wildflecken and Grafenwöhr. We would send a combat battalion for six weeks to do construction projects and training at the major training areas. They would get in range time and required training, things like that, and they would work on building ranges, knocking down ranges, fixing things, and that sort of thing. Hohenfels was part of that program as well, along with Grafenwöhr. So, we basically supported Graf, Hohenfels, and V Corps



Colonel Kem, Commander of the 7th Engineer Brigade, addressed soldiers of the 78th Engineer Battalion on 30 November 1977.

basically did Wildflecken. Of course, they had the 54th Engineer Battalion at Wildflecken all the time also.

Q: This will probably be more appropriate later on, but did you have much contact with people from EUD [Europe Division] when you were at 7th Brigade?

A: No, almost none. They had an area office in Stuttgart, and we would see each other at the Society for American Military Engineers meetings and that was about it.

Q: Anything else about the 7th Brigade command that we should discuss?

A: Oh, well, surely. Lots. [Laughter] Where do we start?

Q: I thought before we went to the VII Corps engineer I was interested in—

A: Well, maybe we ought to talk about VII Corps engineer and then come back and do the two together because things that happened track together because I'd be commanding the brigade and then I'd be doing the Corps engineer part. I might be sending a message from the Corps down for all engineers in the Corps to include the brigade, so I might be sending myself a message about doing certain things. There was always an interaction between the two, and so we ought to talk first about the general aspects of the Corps engineer position.

Q: Okay.

A: Then we can talk about how things happened because if we want to talk about REFORGER '76, we'd want to talk about both brigade and Corps engineer aspects of it. So, what would you like to know about the Corps engineer?

Q: You had a role in the war planning, planning for combat operations. What's the role of the engineer in dealing with war planning?

A: The Corps engineer really has responsibility at the Corps headquarters for all things engineer, which means he deals quite a bit with the G-3 in terms of planning and operations, and quite a bit with the G-4 as a logistician in terms of planning and operations because we really support across the board those activities.

During peacetime, planning for wartime is one of the major functions that happens there at Corps headquarters. Whenever the G-3 was reworking a plan, mission plan, real-live contingency plan, or if the G-3 was preparing a training exercise, like REFORGER, where there was a scenario similar to a wartime plan, whichever G-3 element was working it—maybe the wartime planners or the training planners—would call on us, the Corps engineer section, to provide the Corps engineer input. We had quite an interaction in developing, recommending, making estimates of the situation, recommending action to the Corps commander, to the G-3 or the G-4, chief of staff, as to what the engineer application should be to support this contingency or that contingency. Then, once decisions were made, the Corps engineers section would write the engineer part of the operations order or war plan that

delineated how that was to be executed. So, in all war planning, the Corps engineer was the major player in terms of the engineer applications.

In 1976, there was the political decision to “fight forward” in NATO [North Atlantic Treaty Organization]. So, in fact, our general defense plan was being revised to reflect this doctrinal shift of fighting forward. This came about from the standpoint of the German government that basically the thought that we would trade space for time, which had been the strategy before—that we would pull back until reinforced and then regain the border—was no longer sellable to the German populace; that is, that NATO would give up portions of Germany.

So, within the NATO countries the decision was made that NATO would fight forward. “Forward defense” became the new operating words and that, in fact, required us to change some things, especially within VII Corps with our great depth. Just look at the map and look how far east the Czech border is from, say, what V Corps faced at Fulda. Certainly, V Corps had the shorter distance, but we had the depth, which meant if we were going to fight forward we had to move forward.

So, we had a lot of things to do, and when you revise wartime operating plans it’s not just a paper exercise. It means terrain walks, picking positions—those typical steps you go through for any kind of a military operation. The Corps concept of the operation goes down to the division commanders, who would develop their concept and then brief it back. Once it’s decided on a forward position kind of thing, then division commanders pass down to the brigade commander to pass down to battalion commanders and to the company commanders who pick the actual fighting positions and kill zones on the actual terrain for how you wish to fight. After that you sort of roll the process back upward by putting on paper all those aspects at each level so that it’s a cogent war plan. That was the process that was going on in 1976–’77. We were really redoing operating plans and redoing them in terms of not only forward defense concepts but down to the actual terrain.

There were some other changes too at that time, most of them reflecting on the great size of the VII Corps area. For the first time a German division was given to an American Corps. The 12th Panzer Division was assigned to VII Corps for the warfight. We now had three divisions plus the 1st Infantry Division (Forward) and the 2d Armored Cav Regiment as major combat elements to fight the battle.

There is great initiative and vigor caused by change. So, there was a lot of thought, a lot of meetings, a lot of people throwing out their ideas, and it germinated quite a bit of good kind of tactical thinking. It was a real positive for me to arrive at this time because in the midst of change you can make things happen. Over the next year the war plan for VII Corps to support the new forward defense doctrine was developed.

Q: There would have been engineer input at all stages of that roll-down and roll-up.

A: That’s right. So, what that meant for engineers was that we would participate at the Corps staff level and the initial Corps concept of operation to include troop lists. For example, we would put a Corps combat battalion, as was then doctrine, in direct support of a division. So,

the battalion that we would put in direct support of the 1st Armored Division we would designate. When the Corps commander said, “1st Armored Division, I want you to plan a defense on this line,” the 78th Engineer Battalion that I put in direct support tied in with division engineer, the commander of the division’s organic battalion, the 16th Engineer Battalion. As division engineer he was doing the engineer planning in the division sector, and so my 78th Battalion commander was then tied in with that planning, also.

When the maneuver and engineer units were picking positions, they would be deciding which engineer company would support which maneuver unit, et cetera. All that detail was going on, coordinated with part of the 7th Engineer Brigade.

Meanwhile, back at brigade headquarters we were doing our planning also. We at the time really didn’t know what the 78th was going to do when they were up in the division sector. We were responsible for everything behind the division’s rear boundary or the “engineer support line,” which might be forward of the division’s rear boundary. As brigade commander I had responsibility for the Corps’ rear and how we were going to take care of our missions, to include what we were going to do with our panel bridge companies, float bridge companies, where they would fit into the war plan, and how we would move them to where they ought to be. You have to remember that the 3d Infantry Division was fighting forward of the Main River, so very quickly the Main River was at their backs. Consequently, we might well be called to put in a float bridge rapidly for a potential retrograde or counterattack mission for the 3d Infantry Division.

We would have to coordinate that kind of planning with the division engineer of the 3d Infantry Division, who was also the 10th Engineer Battalion commander and had his own float bridge company. We were doing all that kind of intricate planning down at brigade and battalion level. So, throughout the structure everybody was out on the ground planning the forward defense.

I found at this time that it was an ideal opportunity for change, and so we did several things. I felt that things had been the same for so many years that our approaches to combat engineer support were relatively sterile. I would go to a division engineer battalion and their supporting Corps battalion, and I was getting routine answers and comments that didn’t reflect much new thought but really a response that, “this is the way we’ve always done it and so we’ll continue to do it this way.”

At this time, with the many new parameters thrown into the picture—that is, we were fighting forward and the new 12th Panzer Division was serving in the sector—there was an opportunity to change the relationships. The 9th Engineer Battalion had been supporting the 3d Infantry Division and the 10th Engineers. So, I split the 9th away from 3d Infantry and assigned them the engineer mission to support the 12th Panzer Division. We now had a U.S. engineer battalion who provided direct engineer support for a Panzer division, and that’s the way we were supposed to fight, combined operations. We didn’t get extra engineers with the 12th Panzers, so we had a gap within our Corps engineer capabilities.

The 237th Engineer Battalion, which had previously been left to the rear area, I assigned to be the new battalion in direct support of the 3d Infantry Division. The 82d Engineer Battalion, which had supported both the 2d Armored Cav and the 1st Armored Division, I assigned just to the Cav because of its very large border and forward area responsibilities. Then I had the 78th Engineer Battalion take up direct support to the 1st Armored Division. So, with the exception of the 82d, which had supported the Cav and was still supporting the Cav, I had a new challenge for each battalion. There was nothing old, nothing routine remaining. They each had a whole new mission area and combat unit to support. They had to go out and generate all of the things they needed to do to provide that support, and nobody could sit back on their heels and do business as usual. They all had to go out and create it new. I thought that was a rather opportune thing for me to have—to be able to have them all out doing that kind of invigorating change.

Q: As this new planning went along, how did engineer capabilities measure up to the requirements that were being placed on them?

A: Well, we were quite short in terms of capabilities. Of course, the entire warfight is predicated on reinforcement from the United States, and so you get into the entire reinforcement picture—that is, how much do you have, how much is in POMCUS [pre-positioning of materiel configured to unit sets], fighting capability, and on back to the capability of reserve forces and the issue of activating the reserves. So, it's pretty difficult to describe things like shortfalls except in terms of the first day of the fight, second day of the fight, tenth day of the fight, first day of reinforcement, or however that comes about, because it's an over-time kind of thing. Even as we drew the war plans up for that time frame, we put contingencies in the war plans. In the VII Corps plan we called for the return of engineer battalions to be released by a division on order. That was a recognition that we really had placed all of our Corps combat elements forward in the divisional areas and had relatively little in the Corps' rear.

I remember well we told General Webb of the 1st Armored Division that he got the 78th Engineer Battalion initially, but on order, Corps would pull them from him. He said, "No, I have to have that engineer battalion all the time. Everybody knows you have got to have a divisional battalion plus one more—you can't pull them away." So, in the strong debates that followed about that, my pitch to the Corps commander was, "That's true, everything he says is true, and we want to give it to him, but we do have a Corps' rear area. You may have difficulty, as Corps commander, ensuring your other folks are supported, and I may have difficulty in keeping the main supply route open to the divisions without some capability." We needed a string to be able to pull back capability if need be.

We were right in putting them forward initially. War plans would dictate we might have so many days' advance notice, which means we may well have so many days of putting in obstacles. Then our capability should be forward, putting in those obstacles, and then after the fight begins, once other engineer missions in the rear area—that's not engineer missions just as engineer missions, but our engineer missions derived out of cut main supply routes and damages in the Corps' rear—become critical, then you have to divert capability. That's the time then you would pull it back and balance capabilities against requirements.

Q: Well, much of this planning went on in the context of the post-Arab–Israeli 1973 war, I think. It was expected there were going to be violent encounters that would cost a lot of equipment, a lot of manpower, in the first few days of the war. So, the whole idea of reinforcements from the United States, how quickly that would get there and how much destruction there would be in this initial confrontation between Soviet and U.S. forces, put a lot of pressure on the troops that were there planning to hold out for the first few days, I guess.

I mean, there are a lot of changes in thinking going on during this period, aren't there, like forward defense?

A: Oh, there was considerable thinking. It was at this time that the administration was, because of the agreed-upon strategy of forward defense, thinking about how they could, would meet the U.S. commitment. The echelons higher than us at VII Corps, that is at USAREUR and EUCOM or at SHAPE and NATO, were thinking about how to improve our capability more rapidly. The administration adopted the strategy of rapid reinforcement of NATO. This became a State Department, Defense Department item to take to NATO. The Carter administration pushed for each country within NATO to increase by 3 percent its defense budget over the next several years to improve NATO's capability to fight. Out of that came the American initiative to provide NATO more rapid deployment of three more divisions. This became a requirement to build warehouses of equipment for those three extra divisions in Europe. This is what I became so involved in after I left 7th Brigade.

So, there was considerable activity being addressed because of recognition of what you mentioned, the '73 Arab–Israeli war. It's going to be violent, it's going to be sudden, we're now fighting forward, and what's all that mean in terms of improving our capability to fight and win. We're no longer going to trade space for time. We better reduce the time it takes reinforcing folks over there so they can be part of the fight. That's been every year an issue for the U.S. Army in Europe, I guess, since we started NATO and thinking about those kinds of things.

For us in the field it meant recognition that we were on the margin and we needed to figure out how we were going to take care of those kinds of things.

When you talk about the Arab–Israeli war, you prompted another thought, and that was we were at that time reading the books on the lessons from that war. I remember carrying around a super book that described the violence of the fight of the Israeli 7th Brigade, an armor brigade, and the Barak Brigade in the Golan Heights. It was violent, and their tanks were just destroyed one after another. Also, we were getting interested again in the antitank ditch as an obstacle because of its success in the Golan Heights, where the Israelis had used an antitank ditch quite successfully in spoiling Syrian attacks. I remember pictures of Syrian vehicles in the ditch and their AVLBs rolled over in the ditch. So, we stepped up our interest in trying to figure out how we could do antitank ditches more quickly and how we could effectively use them. As in the Golan Heights, you're talking about something dug prior to battle because it is an equipment-intensive thing to build an antitank ditch.

We then were trying to reduce the antitank ditch down to doctrinally fit us and to a size that was capable of stopping the enemy—or not stopping them but having them present targets to our gunners because our concept was bring them into a killing zone, hold them to present good targets, and then kill them. Recognizing the mass formations of their kinds of attack, we had to be able to service many targets in only so much time because of the mass of what was coming at us in terms of armor. So, recognizing an obstacle not covered by fire is ineffective, then any obstacle to be effective had to provide some kind of delay to improve the capability of our gunners to get the target. So, with the antitank ditch, what we were looking for was having a ditch of such minimal dimensions that it could be dug with as much ease as possible and yet present the kind of an obstacle that would break up the flow of this massive armor down an avenue of approach, cause them to be stopped to get into the sights of our gunners, our gunners meaning in the combined arms context.

We had our 563d Engineer Battalion (Composite), with two combat support equipment companies, run tests at Grafenwöhr on various sized antitank ditches to see what could happen. It came out with, as I recall, that a 1.8-meter-high ditch, dozer width, with a spoiler berm on the friendly side, would disrupt the enemy tank. The tank would have to move forward, go down a ditch, and then when it came up it would have to rock back and forth, trying to obtain an ability to work its way through the ditch. When it did that, it would provide opportunities for belly shots—exposing the lesser protected belly of the tank to our TOW [tube launched, optically tracked, wire guided] gunners and tank gunners. That was the concept and design of the antitank ditch.

With a lot of experimentation with that, we then built that into our war plans. Some were up in the Meiningen Gap, which was a broad plain to the west of Würzburg, and a high-speed, massed armor approach. We planned some rather extensive antitank ditches that would require some days to put in. The extent of the obstacles was dependent on the number of days of before-battle prep available. In other places, in narrow valley defiles, the antitank ditches would be relatively shorter. We were doing a lot of this kind of thinking.

The other point at that time was that we still had massive stocks of the mines left over from World War II. We did not have a good new modern mine. All of these became things I later took on when I commanded the Engineer School at Fort Belvoir. We were trying to solve the problems of that day in the field, but these weren't newly discovered; they were old, existing problems.

We didn't have a new modern mine but we had lots of the old kind, so the idea was how do you put the old one in more rapidly? There had been developed mine plows with chutes. Engineers would pull this behind a truck and slide the mines down the chute. The plow would open the ground and just let one slide underneath before it closed. We also started just leaving mines on top of the ground, armed, recognizing they were exposed. In the smoke of battle, with all kinds of lead flying, a person's eyes might well not be fixed to the ground as they, in their mass of armor, are churning forward. Again, it wasn't always a stop we needed. We wanted to delay, we wanted disruption of the formations.

As we engineers, meaning divisional and Corps battalions supporting, did our thinking, it was always in terms of the combined arms. How do we better the capability of all arms to fight the battle and how do engineers emplace obstacles to prepare the battlefield in advance of the fight so that tank and infantry TOW gunners can get a better sight and a better shot? We planned multiple obstacles and then commanders, maneuver and engineer, had to be flexible with all the obstacles planned to know where to implement and execute. By that I mean—this was a major change from my day as a platoon leader, where even though we planned withdrawal, retrograde operations, and delay operations, it was never quite in the same terms as the warfighters were now thinking, that is, in terms of positions, alternate positions, killing grounds, and moving in thrusts and counterthrusts at the speed of armor. That was a big change.

During general defense planning down at the lower levels, the maneuver commanders would be saying, “I intend to fight from here and here and here. I want my tank guns here. I want my TOW gunners there. I want the artillery to focus in this area.” Engineers would then sit with those commanders, figure out that with our assets available we couldn’t build every obstacle, so prioritize to build the obstacles effectively, say, to delay them coming up a high-speed avenue, or plan one in a location that would cause them to move around that obstacle, which say allows them to no longer use a hill mass as a hide position but pushes them out in the open ground where our gunners could take them under fire.

It had to be a coordinated ground maneuver and fire power oriented thought process that the engineer, with the maneuver commander and the artillery gunner, had to think out all together. So, we used our limited assets to focus on the primary killing area. That would be the first constructed position and obstacle. Then the maneuver commander would have another position or an alternate that would then prompt other obstacle combinations. What we had to get to was a capability, for example, that if we were pulling back at this particular time, or moving laterally to set up a new kill zone, the maneuver commander would indicate his intent, “I intend to occupy this position. Once forced out of that, I would occupy over here but I might change to occupy here a third position.” Having declared that intent and then “on order” during the battle he makes the call that all—maneuver, engineers, artillery—execute.

Engineers couldn’t deliver needed support in those days without remotely projecting mines, without modern tools—couldn’t deliver on call like artillery could. So, the engineer would have to be predicting which operational concept was going to be and work out with the maneuver commander, “Okay, while you’re fighting this fight and I’m fighting it with you, I’ll have some people back preparing this alternate obstacle to support your alternate fighting positions. You need to know that I need so many hours to do that, and so if you want to pull back to that one, I’ll work on that as your first priority. If you want to go to your second priority, I won’t have that done, so you’ll be fighting without the obstacle.”

That kind of thought process, you know, magnified by every fire team and battalion out there, means a lot of those kinds of interactions are going on. That also means there was lots to be done every day in training and in preparing for the general defense plan.

All that, also, was a good prompter for people to train well. I mean, the general defense plan in Germany becomes a great vehicle for training, a great motivator, and for keeping sharp the senses of the leaders, noncommissioned officers and officers, oriented toward that mission. That mission keeps reminding everybody of why we are there. So, that's always been a great thing about service in Germany over all these years—you're always working on a general defense plan that always keeps you sharp and keeps you trained.

Q: That also requires an appreciation by the maneuver commanders of the role and capability of engineers, and also the ability of the engineer to sell those commanders on what he can and can't do. This is a broad generalization, but how well was that going over there? Did the maneuver commanders have a good sense of what engineers could and could not do? Were they wanting too much? Were they impatient?

A: Well, that's a question that's always germane, and the first part of your question really established the essence of it. There has to be a real interaction between maneuver commanders and their engineer. The engineer cannot wait for the commander to call for him. The commander needs to have an appreciation for what this element of the combined arms team can do for him. A lot of them don't have that; they don't get that training. I mean, at the TRADOC schools, as I learned when I was there later at Fort Belvoir, when you're told to cut back your curriculum here and there and you start paring things out, you find out that in the other service schools your part seems to get pared a little bit more. I found in the Armor School, for instance, that we'd put engineer instructors there—I've really now jumped ahead to my Fort Belvoir time, but it's pertinent to your question—that our instructors were basically just teaching wiring diagrams. "This is an engineer company; this is an engineer battalion. When you're here you can expect this." After that hour and a half of that, then—"we've had *Engineer*."

We found graduates—captains, advanced course graduates at the Armor School—that thought the combined arms team was when you had infantrymen with tankers, as opposed to having engineers, military police, artillerymen, et cetera, as the combined arms team. They thought the hasty breach was the one tankers did by themselves and the deliberate breach was the one where you called the engineers—as opposed to the entire combined arms team moving forward so when it hits an obstacle everybody ought to be operating to get across it and the commander uses his engineers as his main breach element. This later became the reason at the Engineer School that we rewrote the manual for breaching and we set up different definitions. We called the tanker-only concept the "bull through" operation. This was not defined as a doctrinal breach operation but an act by a desperate commander who found himself in the middle of a minefield, taking fire, and who had to decide whether to go forward or backward. If he decides to go forward, it becomes a "bull through," and he must expect to take great losses. He would never decide to do that if he didn't have to in a desperate situation.

We also changed the name of the hasty breach to the "in-stride breach," which identified the connotation that a combined arms fighting unit on the move, once it comes across an obstacle identified by scouts, would like to cross that obstacle "in stride" without losing momentum. The unit doesn't want to get bogged down and allow enemy gunners to bring fire in on it,

sitting behind the obstacle even one or two kilometers. This certainly was not a breach done by tankers only, but a combined arms breach using all maneuver and fire support arms.

A deliberate breach, then, was that breach in which you are stopped, facing a formidable defense line that you must plan for, send out scouts, recon, assemble, use diversions and whatever else you can to have surprise and make the deliberate breach—much like in DESERT STORM when we made our first assault. That was certainly a deliberate breach. We had time for photos, ground recons, figuring out all we needed to do in each unit and place and detailed planning and preparation on how the breach would be executed.

So, back to the essence of the question. When an officer comes out of the advanced course, as I found out later, the person is a product of his experiences. So, we found many commanders knew quite well what engineers should do and were receptive to advice and were comfortable with all of this being worked. Others really didn't understand where they were, thought almost simplistically, like engineers should be along for the ride. "When I have a problem, I'll send for the engineers." Of course, in today's modern armor operations you don't have time to send for them.

That brings to mind the movie *A Bridge Too Far*. When the British Corps was strung out on a single road and came upon a major river obstacle, the commander radioed, "Send back for the bridge." It took hours for the bridge to come forward. The commander has to know the water obstacle is out there and have the bridge in formation with him when he needs it. It is part of the commander's concept translated into operational plans and executed if you're going to fight in today's armor and heavy battle operations.

What I found then was that some commanders were quite attuned to what's going on; some were tuned so that wasn't their prime thing. I also found everybody was receptive to ideas to make things better and to fight better.

General Kroesen as a commander was well attuned to fighting the battle and the necessity for complete interaction of combined arms. General Ott, who followed him, likewise was really attuned to the need for a combined arms fight, not just a single branch or service kind of fight. As a major subordinate commander in the Corps, I felt my job, the senior engineer commander, was to meet with the division commanders and create initiatives for us to work well together.

Combined arms and battle preparations were major motivators for me. A major thing I took on was to move the 7th Engineer Brigade to the field more often. As I went around the Corps, I would tell each and every maneuver commander that when they went to the field on an exercise, we wanted to be with them and we would contribute to their operation, their training exercise, and support it with engineers. If they were in the field, we wanted to be in the field with them. That meant we increased our field time considerably, and it paid dividends.

When I arrived in July of '76, the FTX for REFORGER '76 was to occur in September. I found the 7th Engineer Brigade headquarters was not going to the field as part of the Corps.

That the brigade headquarters was not going, not being a part of the Corps FTX, was shocking to me. The brigade battalions, certain ones, were going. Some were already constructing the many kinds of facilities needed—an umpire headquarters and a Corps headquarters, and a visitor headquarters because REFORGER FTXs draw visitors from all over the world. So, we had a lot of responsibilities, but we were not going out there to be a tactical headquarters. I was told by my staff, when I asked why, “Well, we just never do that. We don’t need to be out there. The Corps engineer section can run the engineer part. They don’t need us out there.”

I said, “Well, gang, we’re going.” They said, “Well, you know, we can’t. All that planning goes on months ahead of time, and the troop lists and all that are finalized and there’s no money and there’s no place to go.” There was only a month and a half left before the FTX. I said, “Sorry about that, but we’re going!”

I had them rustle rations, use our own training money, go find us a place to set up, called the Corps commander and G-3 and said, “We’re going.” They said, “Fine.” It was only within our own brigade kind of thinking that had us not going. So, we went out on the REFORGER ’76 FTX.

Frankly, it was not a very successful exercise from my standpoint. It certainly led to our preparing for REFORGER ’77, which turned out to be a most significant exercise and one that was a culmination of a lot of planning. The seeds for success in ’77 were set in REFORGER ’76. For example, in REFORGER ’76 engineers only built two bridges in 10 days of FTX. One of those bridges came about because we sent a message from Corps headquarters out to the orange forces and told them to build a bridge at this location by such and such a time. Otherwise, they’d have never built it.

In the ’76 FTX we engineers really weren’t integrated into the operations. So, out of that, and because I lived through that frustration, I had a feeling for how we needed to be prepared for the next year. Our prep for REFORGER ’77 was significantly different.

To answer your question, commanders were receptive, but if you, the engineer, really wanted to be integrated, you needed to take the initiative to ensure the integration. I met with the commander of the 3d Infantry Division, who was a bit skeptical when I told him we wanted to be in the field with him on his training exercises. He was taking the whole division out for a January–February winter exercise, and I knew there’d be great training opportunities. He was taking the 10th Engineer Battalion out, and I wanted him to take others from his expected engineer support slice. So, I developed a plan with the staff to piggyback on his exercise. I mean, the U.S. Army’s exercises always focus on a brigade and the fight at the line of contact, and the things that happen in front or behind of it never get any emphasis.

I mean, if the scenario had a blown bridge, we’d come in and replace that bridge, the brigade fight moves on beyond it, and it’s now in your rear area. Now everybody’s using the old bridge all the time and nobody ever blows a bridge in the rear. It’s always just the ones right up front. So, for Corps troops on a typical maneuver FTX, there could be a point where there’s not much to do in a moving forward operation. So, when we were piggybacking, what

we would do was to develop our own scenario within their scenario, so we would track the basic plans of the division, and our units would responsively support whatever the division engineer and G-3 came up with for support requirements.

In the meantime, we would develop requirements in the rear area that would cause another engineer battalion to be doing realistic training things, and the bridge companies and the combat support equipment companies would likewise be doing things. As an example, we'd be out in the field. The maneuver brigade has this particular tactical problem; the division engineer wants one more company of his supporting Corps engineer battalion to be direct support to the brigade. So, having taken that second battalion to the field with us, we would send the company forward in direct support so it would help with his tactical situation.

In the meantime, we would cause a bridge in the rear, or something else to happen in the rear, which would have the other two companies of the engineer battalion busy. When the other company comes back, as part of the scenario, then we would move it out as the situation dictated. We always had things being done that would require coordination by the line company commander and by the bridge company. We were putting in bridges because we had our own scenario. It would have to blend with the maneuver division's overall scenario and never interfere. By our presence we could then talk them into recognizing that cutting a main supply route was a good realistic exercise for their logistic troops. They would have to bypass around the obstacle because we had the supply route cut, and then when we restored it, shifting the main supply route back would be coordinated.

By this mechanism we provided a depth to the exercise that was not only realistic but to our advantage for training. We took full advantage of it. Initially there was a little skepticism, but once they saw it work, that we weren't taking over their exercise or inhibiting it because we had so many obstacles, they recognized it could work to everybody's advantage—and we then maximized our training opportunities.

Another thing that had started before I arrived was to sponsor bridging exercises. That was another super tool to integrate engineers with maneuver elements. The brigade staff would obtain maneuver rights in a particular area that happened to straddle a river, would coordinate river crossing closures with the Germans, would even call up and submit a plan, as was necessary, many months in advance to get Air Force air sorties to support a training exercise in that maneuver box. Then we would go to the divisions and their brigades and say, "Wouldn't you like to have a good training exercise? We can give you a super combined arms training exercise. We have the maneuver box and the river crossings and sorties, and here's what we propose. We propose you bring your brigade or two battalions of your brigade to this site, and we'll give you one day of training just to get your people to run across the bridge and rafts and get used to driving on them—hands-on river training. After you get everybody up to speed, then we'll run a tactical exercise for three days in which you can, your choice, attack across the river, move forward, and then delay back and cross it again; or you can start forward, delay back to cross the river, and then attack back across the river and go forward."



Colonel Kem inspected the bridging exercises on the Rhine River conducted by the labor service companies and the 565th Engineer Battalion in the spring of 1977.

A most difficult combined arms operation is one where you have to bring the maneuver elements from a spread formation down to constraining points, process them through constraint, and then let them maneuver out and be ready to go again, whether that is a minefield, complex obstacle, or river line. So, we would use this mechanism to convince them that “your commanders would be aptly tested in their ability to communicate, coordinate, write plans, and your noncommissioned officers, company grade officers, and everybody will get a good exercise trying to cross this river—because it’s tough. You will really understand yourself better. Not only that, you get a two- or three-day realistic field training exercise. You can attack; you pick the objectives. Here’s the way we see it.” Let them actually develop the exercise to their needs.

Just as later we got into mission essential task lists, commanders could pick out their training objectives, which ways they wanted to train, write the scenario to get the maximum amount of training the way they wanted it, and we had already done a lot of the early staff work for them. All they really had to do was provide their own training money for fuel and that sort of thing.

In essence, for somebody who thought, “Gosh, I really wish I could get out and train,” that hadn’t thought about it enough in advance, to have that kind of opportunity was helpful. We’re not talking small maneuver boxes, either. It was a ready-made FTX. We would then move the engineer brigade headquarters and one of our bridge battalion headquarters to the field and we’d stay there for a month and we’d do bridge training on our own and then move a maneuver brigade or a couple of brigades through an FTX with supporting engineers.

This provided a great point of integration of engineers into the other combined arms from the standpoint of training activities.

Q: You mentioned the significance of the REFORGER ’77 exercise. You were probably referring to the fact that the brigade was better prepared and participated more fully, but were there other significances to that exercise over the one in ’76?

A: Yes. To put it all in context, REFORGER ’77 provided the impetus for a lot of things that have since happened in the engineer force. If you will go back and read the after-action report for exercise Carbon Edge, the FTX part of REFORGER ’77, you’ll find that after-action report refers to a lot of things that are now in the engineer force today.

When I came out of the ’76 experience, it was obvious that we had to prepare for an exercise. Later on, people like Generals Carl Vuono and William Richardson were talking that up in TRADOC too. That’s what we were teaching later at the Engineer School—that leaders have to prepare a training exercise so it’s effective.

At the end of REFORGER ’76, to go back to that just for a second, on the last day of the battle a tank went across a thousand-year-old bridge that wasn’t quite wide enough and kicked out many stones of the bridge. I mean, it was a major German–American issue because some tanker ruined a historic bridge. The bridge was closed and General Kroesen sent out an order saying, “7th Engineer Brigade, go down and put in a bridge overnight so normal traffic can be ready to cross in the morning.”

So, we got this about seven o’clock in the evening and our bridge—the second bridge that I mentioned—was in the ground. We started pulling it out and pointing people in the direction of the damaged bridge. We made a quick recon and found out that we didn’t have enough bridge, and it was a very difficult site with one bank very high above the waterline. The permanent bridge was high enough to hit that bank, but when we put in a float bridge, you then have to come up the bank, so we would have to do major carving away at the bank. This would require major coordination with German highway and political authorities.

So, I told General Kroesen that we should not build this bridge. First of all, it would be great training over time, but it couldn’t be done as part of the exercise. It really needed to be thought out and coordinated with all these other authorities, and we needed to get the right kind of equipment to the site. If we started that night, in the morning it would be unfinished, and we would have people upset again because we went ahead and did this without coordination. He said, “Okay, but I was just trying to find you something to do. I just knew you didn’t feel that you had a very good exercise out here.”

So, we talked about that a little bit right there—sort of our own after-action review at about eleven o'clock at night on the last day of the exercise, and it was just General Kroesen and me. I said, "I think we didn't come out here prepared, and I need to do a lot of work with the divisions to get it to where we can be better integrated and realistically do all these things. We just have to do better next year." Well, remember, six weeks before that we weren't even going to go to and be in the exercise, and he knew that.

His comment was telling, though. He said, "No," he said, "you know, it's my fault. This is my second REFORGER. Last year I made every commander—division, Corps artillery, engineer brigade, Corps support command—come in and tell me what their objectives were for the exercise and how they intended to meet those training objectives and how they had laid it out so that we planned our training so we got out of it what we wanted to." Then he said, "This year, I didn't do that. I figured with all of that last year they'd know how to do it. So, we came in here and so-and-so really didn't do this and so-and-so didn't do that, and I never caused you to have to come up and show and tell so you could say you were concerned about bridging and this and that and everything else."

That was certainly an eye-opener for me because it was obvious that we had to plan and prepare for REFORGER '77 and have our own training objectives if we wanted it to work out right. I won't say we started that same month, but as we looked toward REFORGER the next year, we did a lot of different things to prepare for that exercise. We started with the troop list. I wanted to put everybody possible on that troop list. I mentioned before we had been revising the general defense plan, so we had all that thinking about how people would be employed, so we used that. I wanted to portray our engineer capabilities—strengths and weaknesses—as a part of Corps combined arms on the doctrinal battlefield during the FTX of REFORGER '77.

On the doctrinal battlefield, if you have a division, you have a Corps engineer battalion in direct support of that division and another general support battalion behind that. Too often, on a training exercise, you know, the engineers are going forward and find a bridge out. Being track mobile, the tankers and division engineers say, "I'll bypass this. The engineers behind us will put one in." Then later when the truck convoys come up that would need that bridge that would have been put in, they just go across the original bridge because everybody's forgotten it was knocked out (simulated), and they move forward.

I wanted to put in the doctrinal slice and avoid that kind of unreality. I wanted to take out sufficient troops to really have two battalions for each division and an appropriate slice of the separate companies—panel bridge, fixed bridge, float bridge, combat support equipment, and ADM—atomic demolition munition.

In addition, typically on an exercise, engineers put in a bridge. Then they're just going to pull it out. When you don't have bridges there in an exercise, it is easy to say, "Well, I'd call up the bridge, and when it gets here I'd wait three hours and then the bridge is in—so then we'll use the original bridge." Or maneuver guys go up to a minefield and say, "Well, no engineers here, so we're going to cross."

So, we did several things that could happen. First, we got the troop list fixed so we had two battalions for every division, plus separate companies. To get that, Corps asked USAREUR for, and I talked with Colonel Ed Keiser of the 18th Engineer Brigade, actually the 24th Engineer Group at that time, to have the 79th Engineer Battalion (Combat Heavy) to come to the field with us. Parts of the 79th would come to us in the general defense plan for doing those antitank ditches I mentioned earlier.

So, on the one side, that is the orange forces, in addition to the 3d Infantry Division and its organic 10th Engineer Battalion, we had the 78th Engineer Battalion available as the Corps battalion in direct support of the division and then we had the 79th Battalion (Combat Heavy) as the one providing general support behind the division.

On the blue forces side, which were going to be the 1st Infantry Division coming over from the States as part of the reinforcement package, we had behind them the 9th Engineer Battalion, which would be the Corps battalion in direct support, and then also coming from the States as part of the reinforcement was the 20th Engineer Battalion (Combat), a Corps-type battalion from Fort Campbell. So, we would have the divisional battalion, plus two supporting battalions, or three engineer battalions on each side. Then we'd put a composite battalion, since I had two composite engineer battalions, on either side with a mix of companies—float and combat support equipment. We took out a full complement. Later on, they decided to run the 2d Armored Cavalry Regiment in to screen in front of the arriving 1st Infantry Division as an extra, so I had the 82d Engineer Battalion, which had not planned to play in the exercise because they were constructing the many required Corps facilities, come aboard for the first two days of the exercise to participate while the Cav was a participant.

So, one early important thing was getting the force structure organized. A second thing was ensuring rules of realistic engagement. We worked hard on umpire rules and we asked for lots of umpires. We took the initiative to work with USAREUR to get V Corps to provide additional engineer umpires so we could try to come to grips with realistic obstacles and really not let people bypass obstacles. That's why engineers don't get battlefield credit—because the maneuver team roars up to an obstacle, soon as nobody's looking, they rip down the engineer tape or whatever that identifies the obstacle and they roar on. We wanted to come to grips with that, so we did it by writing the rules, by having engagement rules that required a unit to do the realistic kind of thing—he had to get the right engineers there with the right equipment if he was going to build a bridge to get across that obstacle that you really couldn't construct because of maneuver damage. Maneuver damage was a factor. He had to have the bridge and the engineers on site before waiting the construction time, and we had enough engineer umpires to enforce that.

Then we talked with the Corps commander and the chief umpire, who was General Webb, who'd been through the previous year's exercise as the commanding general, 1st Armored Division. Consequently, the umpire system knew that obstacles were supposed to be realistically obeyed. At the last briefing of all of the maneuver commanders, battalion and up, the day before the exercise, Lieutenant General Ott emphasized, "I want you all to play obstacles correctly. We don't gain anything by moving them aside. We gain with a realistic

exercise.” So, then, at the Corps commander’s emphasis, did that mean that there wasn’t an obstacle or two bypassed? No, but it meant that we did better than other times.

Another thing we did was to bring adequate bridging to the battlefield. We wanted it there so it could be used when needed. We pulled bridging out of bridge storage parks and moved it down and set up a bridge depot, or bridge park, which would represent where we normally stocked bridging in various parts of the Corps’ rear and at storage depots. We did that behind each division, in the Corps’ rear of both blue and orange forces. We brought some people down from V Corps and some of our people who weren’t in the playing units to run the parks. So, they had bridging available, panel bridge and other bridging that they could issue. So, when X knew they were going to need to put in a bridge, they could draw that bridge and go put it in—no saying if it was available we would put it in. It was available.

Then we played the scenario so we had crews who could go up and take out a bridge and bring it back to the park. So, a unit who was on the advance didn’t have to stop, administratively pull down a bridge they had put in tactically, and thus be out of the flow of the tactical combined arms operation.

We tried to play damaged rear areas with interrupted main supply routes. Now, if I can jump ahead again, for example, on one of the days of the exercise we destroyed a major bridge in the rear of the 3d Infantry Division. I’m talking major. The 79th Engineer Battalion got the responsibility to replace the bridge. They ended up putting in a double–triple Bailey—big—over quite a gap. It took them two and a half days to do it. They had to bring in major equipment items to carve down one of the bank approaches. I mean, it was a major undertaking. During the time they were building that bridge, the destroyed bridge (simulated) was closed and not used as a main supply route. There was at that point a 14-kilometer logistic detour for 3d Infantry Division logistic troops to go around.

We effectively, within the FTX, broke the main supply route and caused it to be fixed. The real bridge was used by all the German citizens that needed to cross and that came to watch all the activity building the bridge, but it was not used as the main supply route—realistic in terms of battlefield requirements. So, we worked hard on making realism happen.

Corps’ general defense planning had been completed; we had new battalion commanders in; the relationships with the divisions were jelling that we have been talking about. We really had a bright bunch of commanders aboard who worked together well, and so another thing we did was we started anticipating the FTX and how we would interact and support the Corps.

We sent a lot of people down to recon the maneuver area that was south of the autobahn between Stuttgart and Augsburg. We reconned bridge crossing sites so we could try to make sure things happened. There were major autobahns down there and there was a section where the Iller river was bermed and we could not cross there. We were going to have to have rules to realistically simulate a river crossing in that section. We tried to find ways so things didn’t have to be simulated. As much as possible, we wanted to make things have to happen. That was ingrained into our approach.

Everybody, all engineer units, went down on a recon. We already had a technique that started long before I got there of having engineer map exercises where all of the engineer battalion commanders in the Corps—and there were eight plus the Corps engineer and brigade staffs—would come to Kornwestheim. The commanders would bring their S-3s and S-4s. Our headquarters had its own small airfield right outside the Pattonville housing area. It had a hangar and was quite convenient. We'd move all our helicopters out of the hangar and then we'd move in tables. We would set up all of the engineers from the Corps in the hangar—that included the divisional ones. We'd set up bleachers and we would run map exercises to run through the general defense plan.

While we had been revising the general defense plan and planning how we were going to fight in the forward defense, we would come in and exercise our plans. We would say, "Okay, now it's D minus 2; where's the 9th Engineer Battalion?" The 9th Engineer Battalion commander or S-3 would come up and tell everyone what they were doing and what they would be expecting to do over the next day and a half. Then we would have others present similarly. We were map-thinking it out, as we withdrew along certain lines, as we attacked back of a line or took various Corps kinds of actions that we would anticipate and describe. So, the S-3, the S-4, and the commander were able to think on the ground how they expected to be employed in the battle.

Our staff, both brigade and Corps, could then think out how that interacted with things that were going on. That kind of exercise was very useful in our general defense planning.

As we approached REFORGER '77, we conducted engineer map exercises on the terrain that we were going to train on. We anticipated the exercise maneuver. We knew that orange forces were to attack initially and they were going to attack up to the Iller River line. Meanwhile, blue forces, with reinforcements coming from the States, would be ordered in to defend the Iller River line with a Cav screen in front of the arriving 1st Infantry Division. After that, there would be a fight between orange and blue. Orange would cross the river and attack, pushing blue back to a certain point. Then blue would counterattack, restore the ground before the river, recross the Iller River, and move forward.

Having that concept, we could then do our own map exercise. The battalions on the orange side would describe what they anticipated during a particular phase; then the blue forces would also. We were able to pretty well war-game out the exercise day by day with expected maneuver and supporting engineer interactions.

Now, we knew there were a lot of problems in the engineer force, things I've talked about. We knew that one major problem was that we were wheeled Corps engineers trying to support mechanized forces. We had certain objectives that we thought and wanted to make sure that our exercise validated the point. So, we sort of scoped out the after-action report in advance—with the objectives that we thought would be proven. Because they were such obvious shortcomings, they ought to be recorded when they came out. One thing we knew we would be able to show was that Corps engineers need to be mechanized on the modern battlefield. Everybody had that in mind.

We knew that the relationships of the Corps engineer company and the divisional engineer company both supporting a maneuver brigade were troublesome and difficult. With a direct support battalion and a divisional battalion, how do you integrate them with maneuver to fight the battle? It's difficult. Today it is solved by E-Force, you see. We wanted to point out those kinds of difficulties on the training and doctrinal battlefield that the REFORGER exercise provided—a great forum.

We felt that engineers could greatly help in the combined arms fight if we could prepare terrain and use obstacles to improve the fires—tank, infantry, artillery.

Another point, we knew it was difficult to move a tactical bridge to be available when you need it. If you have your bridging on the roads, exposed, enemy air is going to attack it. If you have it so far back where it's not exposed, then it's not going to be there when you need it. Remember the example in *A Bridge Too Far*. We knew that it was difficult and so we wanted to work on that. How do you do it? Did we need to rewrite our doctrine or what to solve that question?

We had the new medium girder bridge on that training battlefield for the first time ever. We didn't have it in the brigade yet, but V Corps had it and we brought it down for this exercise. We also had the ribbon bridge available, which we had received since the last REFORGER—also a first time on a REFORGER exercise. So, we were taking out some new stuff, and we knew we wanted to say, “Hey, that's an improvement, but we need more of it. Field it faster.” We also knew that the dozer on its tractor-trailer was not the right thing for forward brigade engineer elements and we badly needed the M9 ACE. We knew that because we had been to the field with maneuver elements so many times. We knew that whenever we went to the field, engineer company commanders always left the tractor-trailer and dozer back to the rear. They'd never take it up into the forward brigade area because you couldn't turn it around fast enough on German roads to beat it out of there. It just wasn't sufficiently maneuverable, so it was kept back.

We had this nice list of things we knew were shortcomings. So, we taught our people, as they were going through day-by-day actions, to keep an after-action log—jotting down instances and anecdotes, real-life things that happened to prove the points. As we did our map exercise, we would say, “Hey, we think that's going to happen there. We think this is going to happen here. This would be a good point to emphasize.” So, we really framed and scoped out the major elements of our after-action report—what we thought we'd be commenting on and were looking to have identified in the exercise.

Ground recons—people were really familiar with what was going on. We really prepped to try to make sure it was realistic and we did it right. We took out more engineers than have been on a large Corps exercise for I don't know how long. There were 6,340 combat engineers, over 11 percent of the total force of 56,000 in the field.

We had a great exercise. I think we put in something like thirty-one bridges over a 10-day period as compared to the two the year before. People didn't stop action to take out the

bridges they put in. Engineers conducted eight river crossings and installed over 2,000 obstacles.

We were able to say that because of the way we were watching the battle, that the difference in approach of the three different brigades of the 3d Mech Infantry Division, the orange force, reflected the interaction of brigade commander and the engineer. In one case the brigade commander didn't do anything without his engineer's input—close integration. In another case the brigade commander would listen when the engineer could get the door open. In the third case the brigade commander just kept his engineer away. The success of the three in terms of what happened in the battle reflected their relative interaction. The first brigade commander was able to maneuver and did better in his obstacle plans and coordination compared to the other two.

The Corps commander made a statement at the end of the battle. One of his observations, unsolicited—that means he didn't get it from me—was that he felt that the relative ability of blue forces in the defensive phases as opposed to the orange forces was because the blue forces did a better job of reinforcing terrain, combining obstacles and fires.

In one notable instance, the 1st Infantry Division developed an effective killing zone. They called engineers together with their maneuver folks, established a fire trap across from where orange would cross the river. The next morning as that orange brigade moved forward, they were caught in the fire trap—they ran into many obstacles and were caught in the cross-fires of 1st Infantry's tanks, TOW missiles, and artillery and were annihilated.

The G-3 of 1st Infantry Division was Colonel Bill Reno, who had left command of the engineer battalion and moved to be the G-3. He had an engineer's understanding of using terrain, maneuver, and fires. Ted Vander Els was commanding the 9th Engineer Battalion in direct support of the 1st Division. Ted was the commander who spent the night down there with a couple of his companies putting in the obstacles that were the hold-ups, the stoppers, that would spring that fire trap. So, that was the Felheim fire trap.

We had several interesting things happen, all of which carried teaching points. As orange ran for the river, the covering force on the east side of the river, which was expected to delay about 18 hours, collapsed. Orange moved over the terrain quickly and reached the river line in 4 or 5 hours, instead of the 18. Then, when orange pulled up to the river and called up their bridges and follow-on forces, they didn't bother to tell them where the mine fields were that the tanks and infantry had bypassed or breached. So, the bridging, which would have facilitated an early, quick crossing, got caught up in the obstacles and couldn't get through to the river. So, although the combatant force moved and reached the river line early, its capability to cross was not brought up commensurate with it and got caught up in the obstacles that had been bypassed, once again making my point that training to be realistic must cover the depth of the battlefield.

On the other side, the Corps commander did an interesting thing for us. I've got to back up a minute and say we took the 7th Engineer Brigade headquarters to the field, unlike the year before. We rented a village and were established in buildings with our communications

masked in the buildings typical of the way we did our general defense plan. We didn't tent in the woods, we went into buildings where we would be camouflaged within the German countryside. Also, the brigade, like the Corps headquarters, played both orange and blue. Thus, I was both the orange engineer and the blue engineer. Within my own headquarters, my S-2 and S-3 shops had both an orange segment and a blue segment, and they weren't permitted to see the other's side of the maps.

At the Corps headquarters they played the same way. There was a G-3 orange and G-3 blue. The Corps headquarters and the Corps engineer operated on both sides, but it was a control thing too. I mean, the Corps ran the exercise so they were there making sure the training objectives were met. So, I would do the same thing down in my headquarters for engineers. We would play each side—play orange and blue. So, if you wanted to call the engineer brigade for support for something and you were orange forces, then you had an engineer brigade to call to. If you wanted to call the Corps for something, you had a Corps to call to. There was always somebody to call to.

I also wore the white controller/umpire stripe on my helmet. I would go back and forth—I could be blue one day and I could be orange another day. I would go visit the forces in each of those modes. One day I might be helping the 1st Engineer Battalion commander find one of his long-lost companies with my helicopter because he couldn't get one from division. The next day I might be over with the 10th Engineers of the orange force doing something or back with the 79th on their big bridge.

This allowed me then to see both sides and pull all of the engineer things together—to get the most from our training.

I diverted to tell you that, but back to the first day of the exercise when orange had attacked and the 1st Division was in-country but physically on the move from POMCUS sites and staging areas and not yet in the maneuver box—a rather realistic situation. The Corps commander decided to give me and the 7th Engineer Brigade responsibility for the river line, knowing we didn't have forces to defend them but were, in fact, preparing the bridges to be blown. The concept was that the 1st Infantry Division would come in and take over responsibility for the bridges and the river line from me. I had no forces to defend with but had the 9th Engineer Battalion, which had not yet passed to the control of the 1st Infantry Division. The 20th Engineer Battalion had arrived, too, so it was also attached to me. So, in effect, I now had the blue force responsibility for the river line, and we had some fourteen or fifteen bridges.

As I mentioned, the covering force collapsed quickly. Instead of being relieved by the 1st Division early enough so they could fight the river line battle, I was still owning bridges when orange forces were approaching those bridges. So, the 9th and 20th Engineer Battalions, working for me, started destroying the bridges without exposing that there was really little force on the near bank. It was a dicey time as I was flying about trying to figure out who and what and where. I got a real appreciation for the difficulty.



Colonel Kem (front left) reviewed the 20th Engineer Battalion's plans to destroy bridges on the Iller River in Exercise Carbon Edge, REFORGER 77, in September 1977.

That experience addressed a real doctrinal issue: which bridges, then, do you retain for Corps responsibility? Answer: the fewest possible—those that are significant and critical to that level of commander. Thereafter, in our general defense plan, we pushed a bunch more down to division commanders while we kept a few for Corps. For those, we said, “You’ve got to call me before you blow these; the others are yours.” So, we modified our general defense plan from that FTX experience.

One exercise we almost didn’t get to run because the FTX was terminated early was deployment of the ribbon bridge by CH-47s. Blue forces were counterattacking back and were about to cross the Iller River. We had tactically planned the first helicopter delivery of the ribbon bridge. We’d never tried it in training before. We’d figured out how we wanted to do it. We had a good operations plan with the Corps aviation folks and our own 502d Ribbon Bridge Company. The aviators would deliver the bridge by helicopter, and the bridge company would put it together, and we’d get our maneuver teams across. The idea being that as the force is moving forward, you want to cross the river in stride, that is, without delay. The commander doesn’t know which of his tactical units is going to have success, which one won’t be opposed at the river line. So, he doesn’t want to commit his bridge assets to a road that binds it to one crossing if that turns out to not be his best opportunity.

By keeping the bridge back with multiple roads or paths to the river line as opportunities dictate, he can then decide which one to move on with success—catch one where he can get

forces across the river more rapidly before the enemy has an opportunity to oppose the crossing. We rigged each ribbon bridge section so that a CH-47 Chinook could pick it up, move it down to the river, and deploy it in the water. The CH-47s would remain back in defilade, back behind hill masses until they were needed.

Unfortunately, the exercise was terminated early because the Canadians went into a town that was off limits, crossed an existing bridge that was supposedly blown—because they were not supposed to be in the town. The Iller River had been crossed, and then people got in a verbal fracas as to who was right or wrong. So, Lieutenant General Ott, the Corps commander, said, “This is probably a good time to stop the exercise.” We huddled together quickly with the aviation folks and immediately—I mean, within the hour—put the bridge in on the Donau River in the same manner of operation we had planned for the Iller.

The first CH-47 brought in an assault boat and the operator and some crews. They dropped the assault boat in the water and the crews on the bank. The crews captured the boat, hopped aboard as the next CH-47 came around with an interior float unit of the ribbon bridge. After that was put in the water, the assault boat moved up and triggered the release, and the bridge section unfolded right there in the water. Meanwhile, as that CH-47 flew off, the next one rounded the hill and came in with the next float. He put it in next to the growing raft and the crews hooked it up. One after another those CH-47s came in, dropped one float at a time, until we built the bridge. We felt we really had proven a really good principle right there—even though it was moments after, rather than part of, the exercise.

So, I guess I described basically what happened on FTX Carbon Edge. It was very successful. There were a lot of folks in that exercise of note—Paul Cerjan was commander of the 10th Engineers at that time, is now Deputy Commander in Chief in Europe. I mentioned General Reno. Brigadier General Ted Vander Els, then commanding the 9th Engineer Battalion, later was Director of Combat Developments at the Engineer School at Belvoir with me. A lot of good folks contributed a lot of good time and effort to making things happen.

Fred Parker was there as the assistant Corps engineer. He later on also became Director of Combat Developments for me at Belvoir.

Out of the Carbon Edge FTX came several things in the after-action report. We really made the case that you had to have mechanized engineers in the Corps. Now, for the last three or four years, all but one of the engineer battalions in Europe have been mechanized. It came out of Carbon Edge. The following year, as Corps engineer on the Corps staff, I fought the battle to make sure mechanization was in the Corps’ program analysis and resource review, which leads to the POM [preparation for overseas movement], which leads eventually through the Army system. USAREUR prioritized it high on the command’s needs. We found the armored personnel carriers, once infantry turned them in to get Bradleys, M-113s came to the engineers and we were mechanized at Corps level.

The after-action report of the REFORGER before ’76 from the 7th Engineer Brigade had said, in a rather self-serving manner, “I think that this exercise has proven that wheeled engineers belong on the same battlefield as tanks.” I thought that somebody was fooling

somebody, namely themselves. It was important that the '77 after-action report say just the opposite and make the point so they could be brought on later. We also made the point that we had to have the M9 ACE quickly in today's battle; the dozer and tractor-trailer combination did not fit the heavy force battle.

We also made the point that engineers needed to have remotely delivered mines. Hand-emplaced mines just took too long to put in. We made the point that our breaching capabilities were inadequate and engineers in the heavy force critically needed a breaching capability. We made the point that we had to have modern float bridges throughout the force. We wanted to get them totally converted from the M4T6 and Bailey. We made the point that the mix of Corps battalions and divisional battalions was only ad hoc and they really didn't fit together. As we needed to operate to support heavy forces, what we really needed was something like an engineer group or something like that within the division so there would be an engineer battalion per maneuver brigade. That was the first statement at that time of what would become the concept for E-Force later. We made the point that we needed to have more rapid terrain analysis capability from the topo folks available forward at Corps and in the divisions.

As you can see, we made quite a number of telling points that were to improve the combat engineers of today.

We made the point that we needed a permanent engineer at brigade level on the brigade staff. We were doing things ad hoc by necessity. For instance, in the 3d Infantry Division, the organic 10th Engineer Battalion headquarters would basically support one maneuver brigade plus the commander would do his division responsibilities. Its direct support battalion, the 237th in wartime, would have its battalion headquarters support another maneuver brigade, again with a mix of either the 237th or the 10th companies. Then they would take the remaining companies and put them with the third maneuver brigade with a field grade officer from each engineer battalion and set them up as an ad hoc battalion headquarters. That's how they were trying to achieve, ad hoc, the requirement to support all three maneuver brigades with a field grade headquarters and multiple companies. So, we made the point that that was bad; we needed the engineers throughout—thus, this later became E-Force.

We also made the point that we had to have an engineer at maneuver brigade headquarters all the time, so the brigade commander would always get the engineer contribution into his planning, his estimate of the situation, his concept of the operations, and the brigade's execution. Later on, that became the brigade engineer position filled by a major.

So, out of the REFORGER '77 Carbon Edge field came the brigade engineer. Mechanization took a step to the plus side instead of the minus side and became a happenstance several years later. The M9 ACE picked up valuable field support that was later turned into messages from Corps headquarters and USAREUR back to the Engineer School and the Army system with high-level commanders saying, "I got to have the M9 ACE." Breaching was listed as a critical heavy force inadequacy and the strong message was sent that things were amiss when engineers had to ad hoc things between two battalions supporting a division.

Q: Well, this exercise was important, then, in setting your agenda for your next several assignments, at least when you were commandant in the Engineer School.

A: That's right.

Q: Highlighting the things that you wanted to concentrate on.

A: We concentrated on writing a good after-action report, moving it along, and trying to support that at the Engineer School. I was in contact with Major General Jim Kelly, who was then commandant at the Engineer School, and Colonel Roger Peterson, who headed Combat Developments. We were trying to support their initiatives and communicate with them—we were trying to provide field experience and write-ups to support what the school was trying to do for us in the TRADOC arena. When I came back and briefed the Engineer Center team and wrote the after-action report, I asked General Kelly if we couldn't write an entire issue of *Engineer Magazine* about Carbon Edge, and we did. There were contributing articles by all of our battalion commanders on their various experiences. The 79th commander wrote about Elmer, his big double-triple Bailey bridge; Ted Vander Els, of the 9th, wrote about the Felheim fire trap; and so forth. We had people put together articles of interest for communication throughout the engineer force. It did become a real resource—as commandant at the Engineer School, Fort Belvoir, I could refer back to “REFORGER exercises have proven...,” and use that Carbon Edge FTX experience as a basis for justification and rationale for taking certain actions.

Q: So, you were in this position, then, for—

A: Two years.

Q: —for two years. You weren't there for REFORGER '78—was there a '78?

A: There was a winter REFORGER in early '79.

Q: You had already moved on since then, probably?

A: I think the REFORGER exercise was in January or February of '79. I'd moved up to USAREUR headquarters by that time. I was fortunate that when I arrived, brigade command was an 18-month tour, but then the Army changed to a two-year tour for commanders. My request to stay an extra six months was on the Corps commander's desk the next morning and was approved.

Q: So, you were there from—

A: July '76 to July '78.

Q: Let's talk about your third hat as community commander of the Ludwigsburg–Kornwestheim military community. Before we talk about particular aspects of that, maybe you could talk, just in general terms, about what are the community commander's

responsibilities. These are a little different than your other two hats that you were wearing. In general terms, what role does the community commander play?

A: Within the U.S. forces in Germany context of that time and existing today, the community commander really operated as the mayor or city manager of the town or group of villages that made up what was called a community—a jurisdiction in terms of our civilian populace, where we have counties and cities. It was a geographical jurisdiction that brought together all of the—I'll use the term “support relationships”—having to do with taking care of our forces, soldiers, civilians, and dependents in Germany.

In other words, we put a division there to fight, but that division has to live in barracks and have motor pools. Then we bring the families over and so you need housing, both bachelor and family housing. Then you need recreation services and also logistic services to provide necessary supplies and services. That means you need POL tank farms and ammunition depots and pretty soon you have a very large infrastructure and a very large component of people in addition to those in the infantry division.

We, of course, were living within the German populace and Germany, and the U.S. Army in Europe had some 800 different installations and was organized into 39 communities. Those 39 communities, then, were the way the organization was geographically organized and provided the jurisdictions to manage the support tail that goes with the fighting force.

To run that, then, were a lot of staff people of many different kinds of talents. Back when I first served in Germany in the '50s, there were organizations called the Northern Area Command, Southern Area Command, et cetera. I guess there was somebody who was the installation commander, in the terms of, if I were using the United States, say Fort Knox. The commander of Fort Knox is the installation commander. In Germany, the difference was that it was not just one place with a fenced community around it of many different parts like Fort Knox. So, back in the '50s there was an installation commander who worked for that area commander, but that commander and support elements were completely separate from V Corps, VII Corps, the divisions, and all of the fighting forces. There were two separate chains of command.

Somewhere after that, it was decided to merge the two chains. I think it was in the Blanchard era that the senior tactical commander in one of those geographical jurisdictions was made the community commander. The idea was that now the same person was responsible for support of the families, the logistics, and for his units and his troops. He was the right one to interact with the populace; he was the right one to balance the priorities of time, effort, and resources between different missions; and they would work out better than separate commanders.

So, the community commander then was in charge of a jurisdiction that had some geographical boundaries to it. The job varied because the size of the communities varied. Some were small communities; some were very large. I happened to be part of a very large community, the Stuttgart greater military community. The Corps commander, General Ott, was the community commander. I was really a subcommunity commander. In the greater

Stuttgart military community we didn't use the term "subcommunity" because many of our subcommunities were bigger than some other communities, so we just used the term "community commander."

The support structure a community commander had would also vary considerably. Some of them had full service: full facility engineer and housing offices, logistics functions, public affairs functions, and all the rest. Others did not. In Stuttgart there was only a single facility engineer for the whole greater community of six subcommunities, so I didn't have a separate facility engineer that worked directly for me.

There was another major function—that was the interaction with the German populace, and the German mayors, the *Burgermeisters*, and county commissioners, the *Landrats*. That varied by community too. Some commanders would deal with a single county or a single town. Although I didn't have any facility engineer, I had numerous political contacts across the northern edge of Stuttgart. General Ott left to me all dealings with my *Länder Landrat* and also with the *Burgermeisters* and city councils and staffs in Ludwigsburg and Kornwestheim, and about five other smaller communities where my different military kasernes were located. I had some fourteen separate small installations that were located in and among these various towns.

Q: About how many people were in the Ludwigsburg–Kornwestheim community? Dependents and soldiers?

A: There were eight battalions of about 4,100 soldiers. There were about 6,500 dependents—some 1,340 plus families. Pattonville was a very large housing area that served all of the greater Stuttgart military community, not just those in the north. So, you see the cross lines of this held. I had soldiers living in Pattonville that worked south of the town in Headquarters, VII Corps, or Headquarters, European Command, or for the Second Support Command or the 1st Infantry Division (Forward). We also, of course, housed the soldiers and families who worked in the various battalions in my community. Those soldiers had responsibilities with me to help take care of the families. Yet, I would go to Robinson Barracks, another subcommunity, for facility engineer support, and we took direction from VII Corps.

The schools all varied too. The senior high school for all of Stuttgart was in my community. Students bused from all over to come to that senior high school. So, I was the person in the greater Stuttgart community directly responsible for supporting the senior high school. I also had a middle school and a couple of grade schools. We also ran the youth programs—the youth soccer, basketball, football, et cetera. We had a library.

There was a small snack shop. We didn't have many services there. Most of our people went to the big post exchange in Robinson Barracks. We ran buses back and forth. The major hospital was in Bad Constadt, which was 20 to 25 minutes away, and we'd also run buses over there. U.S. forces living in so many different parts in a huge military community like Stuttgart have just all kinds of interrelationships and problem areas and things that need to be worked out.

Thus, there was a staff that addressed those kinds of things and also a community commander who was responsible for both the tactical side and the support, community side. I couldn't say, "That's another's responsibility, go do it." I had the responsibility to get it done and make sure it was done for both sides of the house.

Q: Well, I want to talk about some particular subissues that you've been talking about, but obviously a lot of those issues had to be handled by your staff. What sort of issues reached your desk? What sort in that two-year time period?

A: From the community side of the house?

Q: From the community side that occupied more of your attention than others.

A: Well, just the whole host of things pertinent to a city. There were the streets that weren't getting fixed; the budget issues—trying to figure out where we needed things. For instance, we had a theater that only had a men's room, didn't have a women's room. So, we had to work that through the facility engineer to try to get that accomplished—so that was a facilities kind of thing.

There were traffic issues. The Germans wanted to change a highway and change access/egress to our facilities. There were many problems in the school. We had a big concern about drugs and drug availability around the high school. Although I didn't have a provost marshal working directly for me—the provost marshal worked for the greater community—nevertheless, the provost marshal always had people out in my community area. We had one plainclothes policeman who worked around the school. He would report in to me as the community commander involved as well as make his normal reports for the blotter back to the provost marshal. That didn't go to the community commander, General Ott, except as reported by the provost marshal, but every day it came to me so that I could do something about it. General Ott's expectation was that I would do something about the incidents.

There were a lot of issues that were morale and discipline issues. Families would play loud music. Families were inconsiderate of others. Families had children who were truants, who ran away from school, or who would pick on other people. When you live in such close proximity as we did over there, there are a lot of those family kinds of issues. There was a staff structure to try to deal with those at a low level, but ultimately some of them came to me. Through our procedures they might come to me with a recommendation that the family be sent home—that extreme—or the family would be denied certain privileges.

There were all kinds of dealings with the local mayors and governing officials. Oftentimes, they were meetings—their staff and ours—so we understood each other better, talked with each other. There was a lot of that kind of activity, and we would always invite the local officials to our changes of command and receptions, and we would get invited over there. Each side was trying to keep a dialogue going so that when the sticky things came up, such as a bunch of soldier hoodlums who damaged some cars downtown and got thrown in jail, that

we could then try to address, justly, the image impact of Americans living in the German populace.

There were things like, for example, when I arrived we were operating a Sunday stock car race out at the trash dump on the other side of the airfield. This was very obtrusive to the Germans because the dust clouds and the noise on a Sunday afternoon were abhorrent to them. The noise was very annoying. The roar, roar, roar as twelve to fourteen cars roared around a tight circle and the cloud of red dust that rose—you could see it for miles—drifted over and settled in their homes. The mayor brought that issue to me, with petitions. So, I would have to deal with that kind of issue, as well.

There was a continuum of things that had to be addressed. Another was that I sat on the school board for all the military schools along with the other community commanders. I tried to be personally present in and about the school, to be helpful. We had community budget meetings, and we had community commander meetings of the greater community. I mean, there were all kinds of things that any mayor or community manager would get involved in.

So, which ones surfaced to me? Most of them. The contact with the *Landrat* or with the mayor was always me, not the deputy—because that's who they wanted to talk to. I wouldn't start the process of the discipline problems—we'd try to work them down at a lower command level and save me to be the review authority and final determinant so those things didn't have to go up to VII Corps commander. On those things I would become involved only at the threshold level where they passed somebody else's authority.

Q: What about facilities? By this time in the late '70s, I know, there were a lot of problems with the state of the facilities in Germany, particularly barracks and family housing. A lot of problems with quality and maintenance. Were those beginning to be addressed?

A: Well, some of the programs were already started, such as the Modernization of U.S. Facilities Program to fix barracks. That was ongoing and might have reached this community or that, even my community, one set of barracks but not yet another. We would have some undergoing the change because we couldn't do all of them at once. So, that was starting to be taken care of.

The housing areas had had some general upgrades, but they weren't in the best of shape. There was not a great deal of funding available. We were coming out of the Vietnam War and, like everything, we all wanted certain things to make the community whole.

One of the problems in my large community was having a place where I could bring people in to meet, a community meeting, so to speak. Then, when I'd been there four or five months, the gym and auditorium at the elementary school burned down, so we lost that large meeting facility. We wanted to get volunteers to contribute their time and draw together a community feeling but we really were inhibited by limited space. How can you bring people together, talk to them together, develop activities that get them all involved during long winter months, with so little available inside space?

Since then, I've returned and feel rather good about what has happened in Ludwigsburg–Kornwestheim. They now have rebuilt the auditorium at the elementary school and they have built a new middle school on the same grounds, which provides extra community capabilities. They have also built a bowling alley in the community, which provides another outlet for people's energies, improved the branch post exchange, and renovated the theater. So, some things have improved over time.

Q: What about facilities engineering support? I think by the time you got there in 1976—prior to '74 I think the facilities engineers had reported to the Engineer Command. That had been disestablished in '74 and the facilities engineers made responsible to the community commanders—in this case it would be the community commander at the level above you. I know that was a pretty difficult transition. What did you see as the quality or the problems with facilities engineering support while you were there?

A: Well, most of it had to do with money. Funding was still, as I mentioned before, austere. So, you couldn't do everything you wanted to do. The facilities engineer worked at the greater Stuttgart military community. I had no feeling for how it'd been before, when it was under the Engineer Command, so I had nothing to compare it with. There was no reflection back. I just don't recall it being said, "We used to do it this way; now we have to do it this way." So, I just lived with what we had, which was a normal relationship like you'd find in any post, camp, or station in the United States.

The maintenance folks were mostly German nationals and they worked the work orders we submitted. We had many more things that needed to be done than could be done by those folks—there was always a backlog. I can't really make a judgment that that was due to the organization or management. I think it was primarily a resourcing issue with a lot of valid needs beyond what could be met with dollars available and people available.

I have to say that my understanding of this was perceptibly better later when I went to the headquarters in '78–'79 and was involved in the programming of monies at USAREUR headquarters for allocation for facilities and then when I returned a year after that to work in the Office of the Assistant Chief of Engineers. As the Deputy Assistant Chief of Engineers, I was involved in the Army's Program Budget Committee's and the Select Committee's infighting for funds. One of the things we fought for in the '82 budget was an additional \$200 million for Europe for the backlog of facilities maintenance. I remember that well because on the last day we worked with the Vice Chief of Staff, General Vessey, to get those funds reinserted into the Army program—certainly my understanding, having lived in Germany, was helpful in articulating the need.

That number reflected the fact that we had been living at a lower level for some time and only in this particular budget year was it being really addressed and money to correct the deficit being added.

Q: The term "facilities engineer" is still being used at this time rather than "DEH" [Director of Engineering and Housing]. That term comes in a little later, I guess.

A: I believe so. That's my recollection.

Q: Were there any problems with the facilities engineers reporting to General Ott rather than to you? Did that create difficulties in getting the work done or did you not perceive that as a problem?

A: Oh, some, but it's like everywhere else. There's a chain of command and he was my boss both on the troop side and on the community side, and so I had access to my boss to work the problems. He had a deputy community commander who did most of the legwork in the Stuttgart community, and that was Colonel Bob McDonald, Corps of Engineers. Bob had once been in the 7th Brigade and in the Ludwigsburg–Kornwestheim community, so he was familiar with us.

He didn't bend over backwards to help us because he also was subcommunity commander for Robinson Barracks in addition to being the overall deputy. We would have our arguments and discussions on allocation of resources and priorities and that sort of thing, but he was very professional in working these out. We'd make our case and he'd make his case and we'd work out a lot of them. Very few of them went up to the community commander for resolution. I mean, most of them Bob McDonald resolved for all six subcommunities. When you don't have enough money to go around, everybody feels a little short, so we had some very interesting meetings.

Q: I didn't realize that General Ott would have a deputy particularly assigned for the community—

A: So did I. I should state that as I wore the three hats, I had three deputies or assistants, one for each. I had a deputy community commander, a deputy brigade commander, and an assistant Corps engineer, each one a lieutenant colonel. Otherwise I couldn't have pulled off my responsibilities. In each case they were the person there daily. I was the one trying to provide focus, direction, resolution, and carried the accountability and responsibility. They would go down and interact with the staff. I didn't have to be at every staff meeting in the community. The deputy community commander would work that staff every day and do the follow-up. He was the one who would take those family disciplinary cases I talked about, and they would focus up to him, hopefully for his resolution, prior to getting me involved.

But, again, the mayors didn't want to talk with him. They would include him in, but when they sat down they wanted to talk to the boss, so then I would get involved. So, it worked much like anything else. You try to work at the staff level where possible. Some things rise up and have to be dealt with by the boss, and the boss in every case has to give direction, set standards, articulate needs, fight the battles for resources and that sort of thing after the staff's done their homework.

Q: You talked about the relationships with the German community. I suppose it would be inevitable that most of those issues would focus on the sort of rough edges of the interaction between the American community and the German community. Is that the case? You

mentioned the one example—I think the Germans have fairly strict noise regulations, don't they?

A: Yes, they do.

Q: Sort of working the rough edges and maybe the cross-cultural conflicts, things perhaps that Americans aren't used to that the Germans would be more sensitive to, or vice versa.

A: I guess I'd have to answer that yes and no. Certainly the example I gave was on the rough edge of where we were doing something that was counter to not only their noise standards but their culture that Sunday afternoon's a quiet afternoon. They felt that not only were we violating that, but that we were insensitive to their sovereignty because we wouldn't do something about it. That's the situation that I found myself.

Not everything was on the rough edge. What we tried to do in the community business from the top at USAREUR on down was to be proactive. General Blanchard started the German–American clubs and pushed the interactions. He started all commanders going to the Defense Language School at Monterey, taking German before they went over to take command. Every soldier that came in took a “gateway” class in German language within the first month or so of arrival. Everyone would have a better understanding of culture, a general familiarity with language, and an ability to be sensitive to things about Germany.

We had German–American clubs, and German–American youth clubs. Part of our community structure would have a person who was the facilitator for German–American youth clubs, and he would try to pull people together, go to meetings, work up transportation to make positive interactions happen.

Then we'd have our fests. We, together with the local communities, put on a German–American folksfest. We would have certain booths and they'd have booths, and we'd hire a carnival and try to bring German citizens and American citizens together to this fest, so we would be doing things together. We weren't one community and they another community—we tried to pull them together. We tried to be very proactive in articulating these kinds of things so as to avoid the rough edges. When things were coming up, we'd be very sensitive to them. They would warn us if a certain holiday was coming up and they felt a certain element might be out—and then we would acquaint our populace.

If something happened, like a group of soldiers who came out of a bar one night and broke car antennas and so forth, we'd get on to that quickly and try to figure out who it was so we could get them to pay back the people whose cars were damaged. If we couldn't do that, then we would send a U.S. claims person down to process their claims to get them hands-on service so they felt that we weren't pushing them away—insensitive to their needs. Yes, it happened. Yes, Americans did it. We're sorry about that. I can't correct it but I can address it from the perspective of the claim relatively quickly.

So, there was a lot of work on avoiding rough spots, and then we had to address them when they came up.

Q: On the disciplinary side, you just mentioned some examples of families. What sort of disciplinary legal responsibilities did the community commander have, or was that handled within the individual units, or did it mostly concern families for the community commander?

A: Well, the general court martial authority was at the Corps headquarters. We had special court martial authority then where we were. We were pooling judges by that time and pooled prosecuting attorneys, and so those all came out of the Corps headquarters. We had one JAG officer who normally worked all the cases for us. He was always about and had access to me—we would invite him in to staff meetings and that sort of thing.

So, we had the U.S. Army's court martial system, which wasn't applicable to dependents, even for capital cases. So, many of those the German authorities would make the arrest and they would be incarcerated in a German jail. Then the procedures would be through the JAG folks as to how that was dealt with, and they were advising me, or General Ott, the Corps commander.

Q: So, you would possibly get involved in some dependents' legal problems, personal problems with—

A: Yes, we were involved with dependents' legal and personal problems and with the German authorities.

Q: I guess what sort of impresses me about this is what you started out talking about—the enormous range of issues that a community commander is involved with, particularly in a foreign country with a lot of different sorts of people, not just soldiers in green suits but kids and wives and husbands.

A: Civilians who worked there, the complete range.

Q: Any other issues about this community commander's job you'd like to talk about?

A: No. Can't think of any.



*Lieutenant General David Ott (left),
Commander of the VII Corps, and
Colonel Kem as Kem left his assignment as
Commander of the 7th Engineer Brigade in
July 1978.*

Office of the Deputy Chief of Staff, Engineer, USAREUR

Q: Well, let's turn to your next assignment, '78-'79. You were, at the beginning of the period, Chief of the Installations and Construction Division in the Office of the Deputy Chief of Staff, Engineer, at Headquarters, USAREUR. I'll begin the way we've begun these other assignments. How did you get that job? How did it come about that you went to Heidelberg and to the Office of the DCSENGR.

A: I guess in the great scheme of things that people at Headquarters, USAREUR, look around, see what positions are going to be open the next year, and figure out how they're going to fill those positions and with whom. They have available those people coming out of command, as in my case, and then whichever they can't fill from within theater, they get from the replacement stream from the Military Personnel Center. That's how it worked, and I was picked, I suppose, by General Lou Prentiss, the then DCSENGR, and General Dick Groves, who was the Chief of Staff. I'm sure they laid the slate before General Blanchard for final approval of many different positions with me in that position. That's how I got it.

Q: So, the two years down as commander, 7th Engineer Brigade, was a pretty standard two-year command tour at that level?

A: It changed while I was there. When I went over, the command tour was a year and a half. The Army changed that, for longer continuity, to a two-year tour. The day that policy came out, I petitioned General Ott for an extension. He sent a message back to the States asking that I be extended for the full 24-month tour, and it was approved.

Q: That was pretty good timing for your assignment, wasn't it?

A: Good timing.

Q: Got to stay on six more months.

A: That's right.

Q: Well, the Office of the Deputy Chief of Staff, Engineer, had just undergone some changes in staff in '77. I guess the year before you got there, there was a reorganization of the whole USAREUR staff as well as the DCSENGR staff. Maybe you could talk a little bit about how the DCSENGR staff worked and how the Installations and Construction Division fit into the DCSENGR organization.

A: Well, like all organizations, the USAREUR headquarters keeps changing over time. The basic changes from Staff '77 were in place, at least structurally, when I arrived. Now, as part of that, it was felt that policy, programming, budgeting should be in the headquarters at Campbell Barracks—that is, Headquarters, USAREUR. Execution and implementation should be in the field and at the USAREUR level for facilities that would be vested in a new organization called ISAE, the Installation Support Activity, Europe. Colonel Charlie McNeill was assigned as the first ISAE commander.

His organization was up, functional and running but not fully staffed, and there were still a lot of rough edges between what they were to do and what remained at Campbell Barracks. By that I mean some people were reluctant to let some things go out of Campbell Barracks. The people out at ISAE were putting together an organization and picking up the ball and weren't all quite sure they wanted all these various missions and issues because they were trying to manage what they could handle and add to it.

I don't remember any major problem. I just give that rundown as the place where we were in the maturity of the organization transition.

To get the colonel position to command ISAE, two separate divisions of the headquarters were combined. DCSSENGR previously had an Installations Division and a Construction Division. They were combined into one division called Installations and Construction Division. That's the one that I took over. Jim Van Loben Sels was my predecessor.

In addition, there was a Facility Engineering Division, which was responsible for those kinds of activities. There was also a Programming, Budgeting Office. When I said the Facility Engineering Division, I meant the Engineering and Housing Division. Colonel Fred Wegley had that, and he had two hats, one for engineering, one for housing.

There was a Real Estate Division. George Fuentes had been there for years, a civilian and a great person.

When I mentioned the Programming and Budgeting Office, I meant the Management Division, which is what we called it, which had a programming side and a budgeting side. In addition, with that also was a Military Engineering Office. They worked with the DCSOPS [Deputy Chief of Staff for Operations and Plans] on engineering troop matters. All that was under the Management Division, Lieutenant Colonel Bob Vermillion, and then Lieutenant Colonel Bob Lee had it at the time.

In the Deputy Chief of Staff, Engineer's office, besides Major General Vald Heiberg there was the Assistant Deputy Chief of Staff, Ed Keiser. Charley McNeill, who commanded ISAE, also acted as Assistant Deputy Chief of Staff, Engineer. Within the province of the way Headquarters, USAREUR, acted, and acts today, great power is vested in the assistant deputy chiefs of staff, as they're called. There are the deputy chiefs and the assistant deputy chiefs who carry the stick for the boss and usually had sign-off authority the way General Groves ran things then, continuing to today.

So, that's basically the organization.

Q: Now, what were the responsibilities of your Installations and Construction Division?

A: Well, as I related, I brought two different parts together, so let me talk about them. Our construction mission was focused on new construction, not execution. That is, if European Division was designing it and was going to go out and be construction, ISAE, the Installation Support Activity, Europe, would have the interaction with EUD. That was one of those things where staff responsibility was divided. We in Installations and Construction Division

would work the program five or six years out, putting together the MCA [Military Construction, Army] program for USAREUR, and we would ship that to the Department of the Army.

We also had the NATO infrastructure program. We'd work all those details, which was taken care of within NATO locally with Headquarters, EUCOM, a big player but involving the whole NATO organization. There was a separate branch in Installations and Construction Division for NATO infrastructure because it was complex. They had all their own interworkings and a whole different set of rules.

That basically was the construction part of the division, focused on putting construction programs together. We interacted with EUD, EUCOM, Department of the Army, with our own Real Estate Division, and with the entire USAREUR staff, and we went down to the Corps and the Corps' Director of Engineering and Housing, now, to get the Corps program built together. That meant we brought programs together; we had a lot of prioritizing sessions in-house; and we'd come back and participate here in the Pentagon with Department of the Army and the Office of the Assistant Chief of Engineers. There were a lot of faxes going back and forth, trading messages as we tried to work the priorities as the Army went through its annual building the program, building the POM, and building the budgets process.

On the installations side, we really were the keeper of the books on those 800 different installations that I talked about earlier in 39 communities. We were the keeper of policies having to do with installations—whether you can have this, don't have that, how many of them, what the standards would be, and that sort of thing.

We were also the stationer. You know, with stationing there's a big operations component and there's a big engineer facilities component. Over time it has gone back and forth as to who is the stationer, DCSOPS or DCSSENGR? Well, obviously it's operations who has the call. I mean, DCSOPS takes it to the commander for approval of which unit should be where, but we were the ones who kept the books and would say, "If you want that unit there, you're going to take up all the facilities and you still will have a shortfall." So, we knew how much and we kept all those kinds of facts. So, if you ever wanted to move a unit or change a force structure, DCSOPS and the Installations Branch of the Installations and Construction Division would have to get together and work all those details.

That was a very big comprehensive kind of thing, not so routine a process as every year putting together a construction program.

Also involved with stationing was something that had come up as a special initiative at that time—the master restationing plan for Europe. General Groves, I think, had been the initiator of the program initiative to try to determine the way of refitting where we were located so that we better fit the mission and installations in Germany—maybe to be able to move out of some of the U.S. installations, which were right in the middle of downtown German communities; move them out to the periphery to avoid some of the interaction problems and to get us out of some of the older, hard-to-keep-up facilities. After all, the kasernes we were living in, for the most part, were those captured during the war.

Once the Bundeswehr was established, they built new kasernes. So, they were living in fairly modern kasernes, and our soldiers were living in older, patched-up kasernes. The idea of the master restationing plan for Europe was to allow us to potentially build new, better facilities. Garlstedt, a newly constructed community that had just been built up in the north when we wanted to move a brigade to the northern area, was heralded as a novel approach. General Groves, as DCSENGR, had gotten German funding and built a facility out and away from a city. It was modern. Our folks were in it. By restationing, we could get away from the downtown Stuttgarts, Frankfurts, and so forth.

In DCSENGR, as Chief of the Installations and Construction Division, I was responsible for USAREUR action on the master restationing plan.

Q: Now, is this also related to the forward stationing idea that had begun to be talked about? I think we talked about it earlier, moving U.S. troops closer to the front?

A: It became that because the DCSENGR is responsible for all infrastructure and facilities. If the command was to do something new or different requiring restationing or building new—part of that would be obtaining the real estate, part would be facilities engineering and housing those other divisions in the DCSENGR—but the kind of focused things, the up-front things, really came to “installations” first to figure out the where and how and the what, and then to the “construction” part of the Installations and Construction Division to program the necessary construction.

President Jimmy Carter had brought to the NATO countries, through his defense staff and the State Department, an American initiative for rapid reinforcement of NATO. His initiative was to get every country to increase its defense budget by 3 percent, so everybody was contributing more to a better NATO defense. His point was that if every country did that, the United States would commit its 3 percent to adding forces for reinforcement of NATO. That is, we would build more POMCUS sites. In other words, if you want a more capable force, we would commit to building sites and storing the equipment forward for three more reinforcing divisions from the United States to come forward to fight in NATO. That would reduce the time to move three divisions to be able to fight because they would just have to fly troops over; the weapons and equipment would be there. That was the initiative.

Like most initiatives, the decision makers wanted it done in a very short time. As I arrived in DCSENGR to be the Chief of the Installations and Construction Division, execution of that initiative was on my desk. Sites had been picked for the first division set of POMCUS in northern Germany at Moenchen–Gladbach, Herongen, and Twistaden—three different sites.

It had been determined that we were not going to use the usual controlled humidity warehouses but adopt something else—individual covers for tanks with separate dehumidifier elements, which had come to be called, in the vernacular, “baggies.”

That was the point where we were when I arrived. EUD was now the design agent, through the Germans, to try to construct the first division set of facilities. That wasn’t going very quickly, certainly not quickly enough for those at the Pentagon who were involved. We still

had not picked sites for the other two division sets. So, very quickly this became a major personal effort for me. I spent the next year in that office, and it was the most intense year of my career. Another major item, of course, was the master restationing plan. Both of these had major Chief of Staff and command interest. A third major one was the collocation of CENTAG [Central Army Group, Central Europe] headquarters and Fourth Allied Tactical Air Force headquarters with USAREUR headquarters in Campbell Barracks.

Both Fourth Allied Tactical Air Force and CENTAG were NATO commands. Of course, General Blanchard then was the CENTAG commander. The two commands were located nearby, but not within Campbell Barracks. His thought was, "If we're going to have this greater cooperation and interaction, we ought to have the three headquarters living together in Campbell Barracks." As part of the USAREUR staff reorganization, discussed earlier, people were moved out of Campbell Barracks, and the new space was to provide for the two headquarters. There was a relocation plan that had been drawn up to relocate different USAREUR staff people from one barracks to another, rehabilitate the buildings, and then at the end of all of that, Headquarters, CENTAG, and Fourth Allied Tactical Air Force would move in. That program was also my responsibility in the Installations and Construction Division.

So, over and above the annual construction program, I found myself with those three major initiatives that I was the point of contact on, or, really, the division chief responsible to deliver the results.

Q: What were the problems with the POMCUS storage program? Was it new technology, new design principles? What had slowed the program?

A: There weren't great new technologies. There were just a mass of things involved and a lot of different people across international boundaries that had to be involved, and they all had to be driven through to conclusion. There were a lot of players; I mean, it got so that I spent most of my time networking. The networking included people in SHAPE headquarters, in the Office of the Secretary of Defense, people in the Army Staff, and people in EUCOM headquarters. There were people contacts and phone calls trying to smooth the way so that papers got addressed in three days, not two weeks. We were dealing across so many lines.

We didn't have, as I mentioned, the sites for the fifth and sixth POMCUS sites. General Groves called me in and said, "Well, what are you going to do about it?"

I asked, "Where are we?"

He said, "Nobody's even decided where they should be. There's been one thought that they should all be in Germany, but the Germans say the impact should be shared, probably."

I asked, "Well, has anybody figured that out? Has somebody made a decision?"

"No, nobody has made a decision."

So, in the first couple of weeks in the job I really found out that my action ramp had to accelerate. I wasn't going to have a nice glide path into understanding what was required in my new job. General Groves wanted answers now—and he was looking down the table at me directly. It was one of those things where it was pretty plain that I had to seize the responsibility and do it and pull it all together. So, I became the focal point for making things happen for the USAREUR implementation of the rapid reinforcement of NATO initiative.

Probably the only way that worked was that I had direct access to General Groves, the Chief of Staff. I could call his secretary, Marian O'Donnell, and say, "I really need to see General Groves." I'd get five minutes, and I'd go in and say, "This is this and this is that," and I'd get it—he'd say, "Drive on," or "Change direction," or "Go." I was involved in the thinking and strategizing, and I had a validator. I had a high-placed somebody that could give the blessing and I didn't have to wait a long time for that blessing.

I should back up here and give you an incident there that happened soon after I first arrived. Major General Lou Prentiss was the DCSENGR and he changed out just six weeks later. Major General Vald Heiberg replaced him. I remember after about the second week, after one of my trips up to see General Groves in one of our private sessions, General Heiberg, who had been out flying around, learning, visiting some of the people like you do when you first arrive at a job, came back and said, "Well, don't you think you could come see me before you go see General Groves?"

In sort of a flip response, but being sincere, I said, "We do need to succeed, and I don't think we have the time to wait on your availability for these things, so, I mean, I'll keep you informed, we'll let you know, but there will be times when, to keep things going, we're going to have to get up there and get the Chief's blessing. I suggest we better have that modus operandi." So, that continued and he didn't object and we had a great working relationship. I believe I kept him informed.

Now, back to the example I was giving—where were division sets five and six to go? As mentioned, I'd been up to General Groves and found out nobody had made a decision. Not only that, no decision was pending. There was nothing operating to get a decision. So, I went back to the office and wrote a message basically to the world, to the Supreme Allied Commander, Secretary of Defense, EUCOM, to all the players, and said, "We've determined that one set ought to be in Belgium and one set ought to be in the Netherlands in addition to the set in Germany for the following reason: basically to share the pain. Need your decision and coordinated positions. If you don't object by so-and-so date, we're going to go with it."

I walked that back up to General Groves. He signed it out, and the message went to the world, and within a week it was the decision. I don't know if we ever got a message back from anybody. It was just understood that that was the right way to do it. That was an example of how we just had to make things happen.

Then the question came, "Well, where in the Netherlands?" I didn't have anybody to turn to. So, we called up the defense staff in The Hague and said, "We want to meet with you and pick sites." In the meantime, once the global site message had gone, we solicited SHAPE and

the Department of Defense to send messages to Belgium and the Netherlands saying we had decided on sites in all three countries.

Once the decision was made, then I called and set up a meeting date and said, "We're coming up. How about nominating 8 or 10 sites." Then we would fly to The Hague or wherever they wanted to meet us; they would send a lieutenant colonel or major, and we'd go walking sites. I'd take two or three people. We'd say, "That one, that one, that one," and would rank-order them in priority. They'd come back and say, "No, there's too many communists in that area; that'll be a major problem," or, "No, not in that place; too environmentally sensitive." We'd maybe say, "Not in that place; the road network or rail network is not good enough."

Through that process we would winnow down the sites, oftentimes not having enough at the end. We'd say, "Go back and get us some more." That's how we picked the sites, back and forth, mostly dialoguing in my office, getting approvals and ratification. That was our modus operandi. We'd try to go wrap it all up, and when people objected, we'd go get some higher-up to break the objection or put pressure on them to make things happen.

Meanwhile, we're back trying to figure out with EUD how we're going to get the Germans to build the division first set more quickly because they were dragging their feet. They were saying, "Well, we'll get to it next year," and so we would then network around for pressure to come down saying, "No, Germany, you've got to do it more quickly." We would call a meeting in Bonn, fly up to Bonn with EUD, and we'd sit there and play the bad guys, saying, "No, that's unsatisfactory, you've got to deliver it more quickly."

The German defense staff would say, "No, we can't. We've got to do this and this and this, and you haven't done it." Then we'd do our part. We played that back and forth just to get construction of the first POMCUS set going.

So, there was a lot of focused activity. Why did it go slowly? It was going slowly because there was a lot of this kind of interaction necessary to make things happen. I mentioned my organization at the start—I established a new Storage Branch. I got approval for eight more positions, put two people in it, and got started right away so I could have somebody just to keep the books on all of this.

I was now involved not only with the POMCUS sites but also with all the theater reserve storage sites. Because we were increasing the number of divisions, we were also going to have to have more theater reserve in the country to back them up with additional days of supply. We were also going to have to have more ammunition, so we had to add ammunition sites. So, I had a theater reserve program, an ammunition program, and the POMCUS program, all having to do with storage—and I found our books floated.

By this, I mean, we would go to briefings and a DCSLOG staffer would brief and there would be this requirement on this day, and two weeks later the requirement changed. I set up the Storage Branch in the Office of the DCSSENGR just to have our own focal point, to become the bible, so to speak, of requirements that you could audit back to. DCSLOG was still responsible for logistics materiel and ammunition procurement, but I kept the books on

facility requirements. If the DCSLOG wanted to change something and it had to do with facilities, the facilities inventory didn't float, but changed only by our Storage Branch inventory.

So, it came that there were several of us at the colonel level who began to network in the USAREUR headquarters considerably. Four of us were almost always at these many different meetings involved with trying to sort out these operational enhancements. One of those was Bob Dacey, an engineer who was then the plans officer in the Office of the DCSOPS. Another, Rod Ferguson, was in the Office of the DCSRM [Deputy Chief of Staff for Resource Management], a money, budget, and program guy. I was in the Office of the DCSENGR, and Colonel Walt Kastenmayer was with the Office of the DCSLOG, the colonel responsible for the supply and maintenance division.

When we went to a decision briefing over in the Keys Building conference room, all four of us would be there. We would have to all basically talk, agree that it was "This amount of things that needed to be stored, this amount of facilities required," and "Yes, it fit the operations stationing plan" and "Yes, we had money in the program to do it." We were always talking, networking. I'll bet I talked to those other three guys twice a day throughout this period as we tried to work the many issues involved.

I should go on to say our work evolved to the point of many trips back to the United States to brief at the Pentagon. There were doubts that we were proceeding fast enough. I guess there's always been some sort of a great understanding and credibility problem between USAREUR and the Department of the Army. Really, there shouldn't be; we're all pulling the same way. Often it's, "Those guys said," or "They don't understand over here in the Pentagon," or "It's the Imperial Seventh Army over there, always got to have it their way."

Actually, many things were different in Europe—quite a number, as a matter of fact, like the NATO construction program. We were using other money, different sets of rules, not Department of the Army's rules. We had to do construction through German agencies. We really had to go by certain other rules, not the same rules we had back here in the Army for military construction. When you're crossing international boundaries, there are other things, conventions, agreements, rules.

General Blanchard, Commander in Chief, wanted to send a team back to brief the Army Staff on how we were proceeding, basically to say, "We really do have our act together over here. We are proceeding on POMCUS sites four, five, and six. We do know what ammunition we want, we do know what theater reserve we want, and this is the whole program."

We were called to the Chief of Staff's office one afternoon. At that meeting were the DCSLOG, DCSRM, DCSOPS, and DCSENGR. General Groves wanted to decide how we were going to address this credibility problem with the Department of the Army. He indicated that General Blanchard had decided to send back this team and asked who should head it. Every Deputy Chief of Staff looked at every other one, and by and by I got picked. I was in the back row and had not said anything.

We put together a good team, but unfortunately it was advertised as “The Truth Squad.” Now, if you tell somebody that we’re sending this team back to bring you the truth, it raises certain hackles on the part of those who are to receive that message. So, we walked back into a veritable lion’s den of growling folks ready for, “What is this truth you’re bringing us?”

Now, the nice thing about it was that General Blanchard did call General Shy Meyer, who was then the DCSOPS, and asked that he sponsor us, so we at least had somebody to be a long-range protector.

In any event, we came back, after putting together a rather long briefing of, I don’t know, 70 to 80 Vu-Graphs, and briefed. At the staff level, the majors and lieutenant colonels from all over the Army Staff just had question after question. We dealt with all kinds of their questions, and then we briefed up the line, the next level. Finally, we had our major briefing to a dozen Army Staff generals, co-chaired by Lieutenant General Meyer, the DCSOPS, and Lieutenant General William R. Johansen, the DCSLOG at the time. They co-chaired the meeting. It was a two-and-a-half-hour briefing. That is, I was on my feet at the end of the table briefing for two and a half hours. There were a lot of questions and answers and challenges and dialogue. This briefing was a major point, I think, in which we moved to a place where everybody understood where everybody else was. We portrayed the difficulty of doing all the things required and the fact we had to have decisions. Somebody needed to be figuring out where they were going to get all the trucks, tanks, and Bradleys to put in the warehouses we were going to build.

We now had the basic mark on the wall for how we would proceed. Henceforth, after that day, the Department of the Army and Headquarters, USAREUR, had a plan that called for so many warehouses, so many theater reserves, so many ammunition storage sites, the number of places we intended to put those warehouses, and that sort of thing. This was the mark that any other change could be measured against. We now, at least, had something on paper we could dialogue against. That was a major point in time.

A second most interesting trip back to Washington came a couple of months later. Brigadier General Drake Wilson was commander of EUD at the time. He came down, sat with me, and said, “I think we’ve got a big problem in constructing the first site in Moenchen–Gladbach using the baggies, the humidity-controlled cover for individual tank storage.” His point was twofold: First, instead of having one big, cleared area where you construct a warehouse, you had to have a bigger area to put all the individual baggies. Second, each one of them had to have a prepared platform, which meant there was a lot more construction required, and therefore it was going to be a lot more costly. Yes, the individual bag may not be too much, but for the construction to have a pad, an entrance, and then the wiring to get electricity to each of the dehumidifiers was going to be more. Additionally, we were in wooded areas, so we were going to have to take out a lot more trees, and EUD was getting adverse reactions from the Germans.

Drake felt we really had a problem, and he ran out some numbers that showed EUD felt they could build controlled-humidity warehouses for about the same price. With that, General Groves, the Chief of Staff, dispatched General Heiberg and me back to brief the Army Staff

on the change; that is, don't use the baggies, and go back to controlled-humidity warehouses. The problem was that General Prentiss had been quite wedded to the baggies, and the British had used some smaller number in their area before and had sold the program to the Department of the Army. General [William] Wray had been the ACE at the time. He had testified to Congress extolling the virtues of this great new idea, the baggie. It was one of those occasions where what had been extolled previously didn't appear to be so virtuous any more, but a lot of people had put their credibility on the line and felt strongly about it.

General Heiberg and I stopped in to brief General Wray to begin with. General Read was now the ACE; General Wray had moved up to be Director of Military Programs. General Wray, was really quite irate that USAREUR was changing its mind, saying, "How come you new guys don't buy what the old guys did?" We had some time trying to lay out the rationale. We were trying to do it, not to harpoon anybody—but because Drake Wilson, the EUD commander, who, of course, worked for General Wray, had brought to us the facts that feasibility and the dollars said that maybe this wasn't the way to go.

With that, we scheduled a meeting with the Army Staff. As a follow-on to our previous briefing before Generals Meyer and Johansen, they had set up a rapid reinforcement of NATO steering committee. Henceforth, when we came back, that was the group we addressed.

That group was called together and we briefed them, and they concurred. Then we went to see General Kroesen, who was the Vice Chief of Staff, in an office meeting of, oh, five or six of us. I remember it included General Heiberg and me; General Read, the Assistant Chief of Engineers; and General Max Thurman, Director of Program Analysis and Evaluation at the time; and maybe one or two others. There was another person from the Army Materiel Command, who were asked to procure the baggies. They had come up with concerns of their own as to how they were going to put those things together and procure them and get a kit and have to maintain airtightness during dehumidified periods. We came down on the fact that the British didn't take their equipment in and out of the individual storage shelters quite as often in the amounts that we were going to do. During REFORGER exercises we were going to be moving whole brigades' worth of stuff out of the shelters. Once your soldiers go in and take the baggie off, they leave the area and are focused on other things. After the FTX they come back and have to put the tank back in the baggie, seal it up, and reestablish the dehumidified state. There had just begun to be a real question as to how viable that was for maintainability over the long run.

So, we made our presentation to General Kroesen. The AMC guy made his presentation from the procurement situation, and we all recommended change. The Vice Chief of Staff made the decision that we would not proceed further with the concept of individual humidity-controlled wraps or baggies, but we would go back to the controlled-humidity warehouse concept. We were back in business.

Q: Can you give me a rough date on when this meeting took place?

A: Late January or February of '79.

Q: So, the baggie concept, then, was sort of an open area and then the tank or piece of equipment would be on the hard stand, wrapped in this plastic or whatever the material was.

A: Yes. It was all in a separate shelter with a separate dehumidifying device that would operate for that bag.

Q: I suppose the idea was, on first blush, that you don't have to build walls and a roof and all that, so it must be cheaper, I mean, until you think about how costly the bag is, I guess.

A: You would have to talk to those who thought it up.

Q: This is really an interesting evolution of an idea here. So, the POMCUS storage sites, then, were probably more elaborate and more expensive than the theater reserves or the ammunition storage sites, is that right?

A: Well, it's hard for me to say because for ammunition you need bunkers with concrete walls, metal doors—you'd really have to run a cost analysis. A theater reserve site often had controlled-humidity warehouses. Some of them had open areas. Even POMCUS sites had some things stored in the open, like trailers. You would have to run out the cost to see, and it would vary by site.

On a POMCUS site you had the complexity of having different things. You had the tank and then you had the radios, which we'd pull off the tank and store in a separate area. The weapons systems were stored in another area secured just for that. Then there was fuel. The vehicles were topped off on the way out. There was a whole bunch of these different kinds of things. In the controlled-humidity warehouses, the vehicles park side by side, bumper to bumper.

I should mention one other thing. We didn't build just the controlled-humidity warehouses. There was another idea that was retained to be tried. This was something called the stress tension structure. The structure was a rather large fabric-over-frame kind of structure for multiple vehicles that had cost benefits. We were going ahead to procure six of them to try out. The 18th Engineer Brigade did a good job of constructing the six stress tension structures.

Q: Do you remember if there were different program terms for POMCUS, theater reserve storage, and ammunition storage? Were they considered different programs or were they sort of folded into the general POMCUS facilities program?

A: No, they were separate programs. There was another panel run by the DCSLOG that was addressing ammunition. Ammunition is a very complex problem because you're always upgrading guns, systems, and ammunition. Ammunition items you don't need any more because you have a modernized kind of gun, are still in tons in ammunition bunkers, taking up space. We also didn't have space necessarily where we wanted it. We wanted so much of it forward, so much of it back, for flexibility. So, the Army had a separate steering committee, run by the DCSLOG's assistant for supply and maintenance, for ammunition. He was involved not just with facilities, but for procurement—how much do you buy of this

round versus that round to meet projections of when various tubes are going to be available and storage is going to be available, and how much shipping are you going to have? Whether you have a facility or don't, which is the chick and which is the egg when you make all those determinations? It becomes very involved and complex.

I also began to be involved with ammunition, with Walt Kastenmayer from the Office of the DCSLOG, USAREUR, being the principal person. He would take me back to the Department of the Army committee meetings to talk the facilities part of ammunition.

I think one of the things we accomplished during this period was to bring discipline to the process by keeping the books in USAREUR, as the person responsible for the facilities. When I arrived, DCSLOG would brief the facilities part and the ammunition and everything else. We wouldn't brief facilities; they would. They had no feeling for how long it would take. They would say, "We need one here in this town, so we'll just start calling it an ammunition supply point."

Next thing you know, it'd start getting used in the conversations like there was one there. There wasn't a program and nobody had done a feasibility check. So, by our taking responsibility, saying, "Look, we own the books on facilities and we will share information with you, but the facilities you're going to use are going to be on our inventory, and our books are it. If you have got something out there, it better be on this set of books." Then we started presenting the facilities part in all the briefings. I think that helped sort things out over time and got us all dialoguing better. Then when General Groves, the Chief of Staff, looked down the table, the logger didn't feel obligated to speak about facilities. He could turn to the engineer to speak for himself. The engineer would have to speak and say, "I have it" or "I don't." "It's not in the program" or "It is." "If we do it, it'll take this long." Or whatever the aspects were.

Q: The funding for the POMCUS program, was it in MCA or NATO funding? Were there funding problems with POMCUS, NATO reserves, ammunition, and storage?

A: All the above. NATO infrastructure was a very complicated thing. One of the other complicators was the requirement to run our programs through all the other countries. All the countries had to agree on various things. There's a formula by which various countries contribute to the NATO infrastructure fund. The United States is the greatest contributor, something like 27 percent back in that time. Germany was second greatest, 26 percent or so.

Everyone wanted to get all they could for their country. This influenced their vote, whether something was or wasn't eligible for NATO funding. Remember the obligation to contribute an additional 3 percent. The United States was going to contribute its 3 percent and do it, in part, through NATO infrastructure. If a country wasn't eager to push forward on its contributions, it could delay the whole process and might help its own national budget. One way to do that was not to proceed too quickly in approving the part that the proponent country, the United States, was pushing for its 3 percent. So, if we couldn't get ours implemented then maybe they would not have to match it. So, it became very complicated if we tried to push through that maze. NATO infrastructure funds funded some aspects of our

rapid reinforcement of NATO program, and some new categories were established to take care of that.

Some other things, though, had to be built with MCA kind of funds because NATO wouldn't cover those items. We had difficulties making our pitch to Congress on things over and above NATO funding. "We are contributing to NATO infrastructure," was the congressional view; "why don't they cover it all?" There was almost a continuous dialogue about whether it should be this way or that way. We would have an opinion on how it should be. Both places where we were addressing them—NATO countries and Congress—would disagree and want to pare down their part. This meant another reason for a lot of the networking of whether we in USAREUR were on top of things. USAREUR was always getting blamed by EUCOM, the Department of the Army, and the Office of the Secretary of Defense that we weren't proceeding fast enough.

I used to say that, "Look, USAREUR is at the bottom end of this noodle. You push a noodle, it collapses. We need a pull from the top and then the noodle will come straight." In effect, we were at the bottom of the NATO infrastructure system. We had to send things to EUCOM, then to AFCENT [Allied Forces, Central], with a German commander, before it went to SHAPE. Then we, if we wanted to do things through MCA, had to go to the Department of the Army. We just had a lot of players, and we really tried to succeed through networking.

So, I would call people—Colonel Bill Keach, Corps of Engineers, worked in the Office of the Assistant Secretary of Defense for Policy. General Groves had left USAREUR and gone back to that office. I would call Bill Keach and say, "It'd be awfully helpful if the Secretary of Defense would put out a message saying this and this and this." He would work it from there to make it happen. I would call Colonel Vern Ebert, a friend of mine who was one of General Haig's SPACOS—U.S. action type. Vern worked on U.S. problems at SHAPE headquarters, and I'd say, "We're really having trouble getting into The Hague. Can you have somebody call down and tell them to get with it?" He'd have someone call down, and they would be more responsive to us.

We just tried to anticipate obstacles and somehow push the obstacles or go around and had somebody pull it through that obstacle. I might even call Vern Ebert and have him say, "We need General Haig to ask the AFCENT commander to get that stuff on up here. He's interested" because, from the German national perspective, it might well have been advisable to hold the thing down. After all, the Germans wouldn't have to start delivering on the more rapid schedule in Moenchengladbach if we didn't have approvals. We were beating on them to execute, but we didn't yet have all of our approvals through—delay in the approval process took the pressure off of them.

So, within the scope of things, our plans just might get hung up at AFCENT for a few weeks, so I would call up to ask Lieutenant Colonel Ebert to have SHAPE pull them up, pull that "noodle" through AFCENT. I did an awful lot of networking, just trying to make it happen. We in USAREUR were at the bottom of all of the approval totem poles, but we were the ones who were being looked at to produce.

Q: Was there any resistance in Belgium or the Netherlands to building these storage sites in their countries? Was that a sensitive issue?

A: From the governmental and NATO perspective, I saw none at all. There may have been late—I left before all things were wrapped.

There were some community folks who had the old NIMBY—“not in my back yard”—feeling, that local community reaction to some of the planned storage sites. Many of them were at places, though, that had low employment and out-of-the-way areas. I think nationally they recognized the obvious: that if they were going to be for this rapid reinforcement initiative, they each ought to take one division set of storage sites.

Now, at the end of this time frame, about April or so, General Haig asked us to come lay out the whole program for him. He invited senior SHAPE staffers and Air Force types, and we laid out the whole program—that is, theater reserve, ammunition, and rapid reinforcement. We were planning to use some airfields in Belgium that were being given up by SHAPE’s air component. I was the briefer. General Heiberg, Walt Kastenmayer, and I had flown up. It went over pretty well, but I recall one Belgian general from the NATO air component standing up, saying, “I don’t think we should use those airfields. We might want to have them available for standbys, for extra airfields.” General Haig turned and rather pointedly said, “That was my thought a year ago, and I asked you all if there was a reason to keep them. No one had a reason, so we exceded them. Where were you then? Now they’re exceded. We’re going to use them for this.” It was a rather decisive moment.

Q: Was EUD going to be responsible for the construction of the facilities for all of these programs at all of these sites?

A: Yes. I say that, recognizing that we used EUD as our agent either to construct or as our pass through to the German construction agency. Almost all of the construction in Germany was done by German construction agencies, but EUD was our contact and agent.

Q: So, that was a big program for EUD—or at least the prospect for them during the late ’70s, early ’80s. Quite a few storage facilities.

A: Yes.

Q: Maybe we could turn to another program that I’m not sure that your office would have been responsible for—the long-range security program that was going on at this time. Was this in your area of responsibility?

A: Yes and no. What I mean is that, as I described before, certain things were in the policy, programming, budgeting stage, and then there was the execution stage. The long-range security program had passed out of the first part, was now a program being executed. So, ISAE was really monitoring and working with EUD on the construction at the various sites. I did attend some meetings. There was a lot of consternation, some policy issues and everything else, but it was basically ISAE from the standpoint of USAREUR headquarters that was managing the program with EUD.

Q: There were some problems, I think, with the long-range security program at this point. So, you didn't have too much relationship with those problems or knowledge about them?

A: I went to a meeting where there was a lot of hollering and cussing back and forth between EUCOM and EUD. My recollection of that was thinking that people from EUCOM at that time were rather unrealistic in their expectations and demands. They had a responsibility as the user and they were reflecting narrow user views without accommodating practicalities and changes. In other words, if something wasn't going to work, they had a requirement to sit down and interact with EUD as part of the modifications to the concept so that it would be something that would work, as opposed to just staying out of the issue and then criticizing EUD for something that wasn't going to work. That was a very complicated arena with lots of different issues, many of which were site specific. So, there was EUD and EUCOM and ISAE who would go site-by-site and look at the problems and try to work out solutions.

Q: Was that program, the security program, primarily for nuclear weapons, or did it have other components as well?

A: I think the answer is yes, primarily for nuclear weapons. It may have had other components as well, but I'm really not positive.

Q: Of course, this had a lot of visibility because of the German terrorists during that time and the anxieties about storage of U.S. nuclear and conventional weapons too. There's another program I've run into called the Facilities Modernization Program. Are you familiar with that program?

A: That was a program that, I believe, if I have the right label, started with using facilities modernization funds, German funds, and put them into barracks to fix them up. We had talked about a facilities modernization program from the standpoint of rolling all things in just to focus on modernizing everything that needed to be modernized, and we tied that in with the master restationing plan, as well. So, we tried to package everything that had been there before and to call it the Facilities Modernization Program.

With the way you're using the term, I'm not sure if you're really addressing the earliest attempts called Modernization of U.S. Facilities, which was a program of its own, or how modernization programs later were amalgamated and brought together. By the time I had gone back as DCSENGR in '87, facilities modernization had many components—had a maintenance shed component, had a “get the tanks out of the mud” component—that is, pave motor pool areas. So, it was a way of addressing what was a number of programs and deficiencies, trying to allocate funds against them, so much each year, so that we could be working against the backlog.

We could always represent to our higher-ups in the Department of the Army and then to Congress that, “We have so many square meters of motor pool space that need to be paved. Right now, it's on gravel and mud. We are programming this next year for this many at this many million dollars, so we will accomplish 3 percent of it,” or whatever. Then we would be able to show progress against a backlog, whereas before we were just out saying, “We got to

have this, got to have that.” With the Facilities Modernization Program, with all their various components, we could say, “In this component, using the tank motor pool example, this is how much we have as backlog. Here’s how much we’ll accomplish with your money this year. We need this amount of money that will bring us, say, to 6 percent, and it’ll take so many years to finish.”

That is how the Facilities Modernization Program grew over time from the Modernization of U.S. Facilities Program to really having something—it was really a way of articulating need and requirement in terms of kinds of things—amount done and amount remaining—for the decision makers.

Q: I read somewhere the program allowed the use of MCA as well as OMA funds, but it brought more funds to bear on some of the backlog problems. Is that the way you remember it?

A: Well, yes. MCA funds were used on the MCA things; OMA on OMA things. It was a reflection that for many things you could use different kinds of funds to solve a broad-based kind of problem area. You might use maintenance funds to fix up certain motor pools; you might build new ones under MCA, which takes part of the backlog away. Both of them can be used to address a backlog. It’s not that you’re using MCA for OMA kind of things or OMA for MCA kind of things. It’s you’re addressing a backlog in that category, using both kinds of funds.

Q: Okay.

A: You were able, then, to be able to let everybody focus on a category, “Hey, that’s a good idea. Yeah, we can do that. So, let’s do it.”

I’m not sure when—I suppose it happened between when I left and when I arrived back in ’87—somewhere in that time frame, I think, that it fleshed out to be the program given the label, “Facilities Modernization Program.” There was a set of facilities books, much like probably my earlier storage set of books, that was the bible. It was an inventory of facilities and requirements. You could say to VII Corps when they came in for a motor pool, “Is that on your backlog in the Facilities Modernization Program? Yes or no? Yes? Okay, then you can tie it in there.”

Q: Any other particular programs? It sounds like the POMCUS, theater reserve, and ammunition storage programs were the ones that took up most of your time during that time.

A: The rapid reinforcement of NATO program took a considerable amount of it. Then we’d also have the meetings for prioritizing military construction and we’d have the NATO infrastructure meetings. We’d fly off with many of the same players from SHAPE, AFCENT, and people would come over from the Secretary of Defense’s office, and they would all sit and wonder why USAREUR wasn’t spending money fast enough. That was right back to my shop too, and so we had to interact there too. We were actively involved with the master restationing plan because that had passed from where it had been under DCSOPS the year before about, “Where do you want to have your tactical units?” to the point of coming over to

DCSENGR where we had to fit them to facilities, determine where we wanted those facilities, and come up with a game plan to do that.

That year we also put together a strategy for how we wanted to relocate and position Europe in terms of facilities. We derived that in my shop. Steve Rutz put it all together and recommended it to CINCUSAREUR. The strategy concept was to build a new brigade encampment at Vilseck, one at Wildflecken, and one at Giessen. We could then start the master restationing by moving a brigade forward to each of those new areas, thus releasing some space to the rear. We could then move some folks about, thus freeing other space. General Groves was the catalyst for this and all the thought processes that brought this together, based on his experience before as the DCSENGR in Garlstedt, as I mentioned before.

Through the trickle-down we would free up some space, say in the middle of my community in Ludwigsburg when I was at 7th Brigade, where in the middle of town we had old warehouses and old beat-up facilities that weren't very good. We could then turn those back to the Germans, where they had some value because they were downtown. The Germans could put something commercial in that location, some kind of a hotel or something of value. The sites certainly had more value to them than us. The Germans should then be willing to put up funds for that, and we would then get approval through the system back to Congress to use those funds to build yet another new installation. Then we could move some more U.S. troops out—that was why it was called the master restationing plan. It was not conceived as a quick fix. It was conceived as working over time so we would move forward, closer to the border, out in the rural areas away from the towns. Thus, our forces would be in better locations where we wanted to be. We could improve our war-fighting posture at the same time we were improving our location with the Germans posture. We would give up facilities that they would take and use the money back in the loop.

It was a rotating cost concept. That year we fixed locations where we would like to have major brigade areas. We wanted to start the process, and so we picked the first three. Those were, as I mentioned, Vilseck, Wildflecken, and Giessen. That became, then, the USAREUR program.

Jumping ahead to my next year, I went back in the Office of the ACE. There, I'm receiving military construction programs that I sent from USAREUR the year before, and we had the master restationing plan presented by Europe to the Department of the Army for action. We also had General Groves, the architect of the plan, who's graduated up to the Office of the Secretary of Defense, who wants it pulled up to him. During this second year—and I'm really ahead of myself now—General Groves arranged to brief congressional staffers. I was the briefer, now from the ACE's shop, that in the Pentagon briefed staffers from the House and Senate Armed Services and Appropriations Committees, under General Groves' sponsorship from the Assistant Secretary of Defense for Policy.

A lot of effort went into all that, with a lot of interaction, and we engaged in a lot of dialogue with the Germans. Eventually Congress approved Vilseck as a new brigade location without committing to the master restationing plan. So, the new brigade location in Vilseck is that

same brigade location conceived of back then as the first increment of the master restationing plan. Very obviously, the rest will not now follow with the fall of the Berlin Wall. We had initiated the first move under the master restationing plan while I was still there, to get started. We moved an armored battalion of the 8th Infantry Division forward to Wildflecken. So, here's the 8th Division basically behind the Rhine and one battalion up at Wildflecken. The concept had been to build this brigade base whereby you could put a brigade of the 8th Division with its associated battalions and artillery battalion and forward support battalion and engineer company up there to be forward deployed. One battalion was about as far as we got.

Q: I noticed in your bio here it said that you spent some time as assistant DCSENGR, too, during the time you were over there?

A: Yes. Ed Keiser had been the assistant DCSENGR. He had left command of the 18th Brigade shortly before I left 7th Brigade and came down to USAREUR. He was the assistant DCSENGR when in April or May the brigadier generals list came out. He was on it and immediately rotated back for a new position in the States. Once he did that, I moved up to be the assistant DCSENGR. I only had two or three months left to go myself, and I was already on orders back to the ACE's shop.

Neil Saling, who had been my deputy in the Installations and Construction Division, took over as chief when I moved up.

Q: You've talked about ISAE a little bit before, but I've seen references to it in some of my reading. I know that as a result of Staff '77 it did combine a lot of previously separate elements that reported to DCSENGR, but maybe I could get you to talk a little bit more about the variety of functions it actually performed. It seems to have done quite a few different things. You talked about how it had worked more closely with EUD during the actual construction stage, I think, so it did have sort of coordinating responsibility during the actual construction. It seemed to include a lot of activities there.

A: Oh, it did. As you look at the name, the Installation Support Activity, Europe, it brought together those things that supported the installation engineer throughout all the communities. It was supposed to be that point of contact that would support the facility engineer or the housing guy, although there wasn't so much of that. It also brought together other things that were out there in the execution mode. Once again, remember, this was for USAREUR headquarters under Staff '77 to separate policy, programming, and budgeting staff functions from execution. The execution functions were to leave Campbell Barracks and go elsewhere. ISAE did that for engineer execution functions.

If you look at the ISAE organization chart, they were the Power Procurement Office—they procured the power and did all the interactions with the German agencies for that. They procured the coal from all over that went to the various installations.

In the Supply Maintenance Division, those folks were supporting facility engineers with supply and maintenance support and data. The DEH in VII Corps had its own supply and maintenance activity, ordering various kinds of things.

When a community facility engineer had a problem, they could call Charlie McNeill and he'd send somebody out to help them. He was designated to be that kind of person. I wouldn't send anyone from the USAREUR staff, Campbell Barracks, because Charlie McNeill would do that. I would deal primarily with the Corps DEH on programming or policy or funding issues, but not on the execution. Well, you say, it sounds like with TR-1, ammunition and POMCUS, I was doing a lot of execution. We were. That was a special kind of thing. ISAE was involved in that, too, but we were the drivers of that rapid reinforcement of NATO initiative and we were at the early point in a program where driving and pushing and articulating and networking was really the thing getting it off the ground and moving.

Also within ISAE was the U.S. Army Real Estate Agency, Europe, which had been a separate entity before that. They didn't move from Frankfurt. Charlie McNeill was now responsible for it.

So, as an operating activity there was somebody there who could be concerned with helping the facility engineer and a focal point for all of those things that didn't have to be in Campbell Barracks. It was the prototype for the Engineering and Housing Support Center under the Office of the Chief of Engineers. It was determined that we ought to have an organization for the Army to do what ISAE did for Europe. It's the irony that the Engineering and Housing Support Center happened about the time that ISAE went into demise.

Q: During even deeper staff cuts at USAREUR, I guess.

A: Well, that happened before I arrived back at USAREUR in '87. It took place during Major General Scott Smith's time as the DCSENGR. Just as Generals Blanchard and Groves had driven certain approaches in Staff '77 to separate execution from policy planning, General Glen Otis's drive was, "We've become bloated. We need to streamline. We ought to stop doing things." Okay, so earlier we had separated planning, programming, and budgeting from execution, maybe we shouldn't execute anything at USAREUR headquarters. Maybe we don't need an ISAE that sends people down to help facility engineers. Maybe they don't get any help. Maybe we can't afford to have folks that only get around to a facility engineer every 9 to 10 months. Maybe that's not helpful enough. Maybe we better take those 90 people and send 2 out to each community and get 2 more warm bodies down there to work, or do it from Corps. Let's don't necessarily expect that we have to support.

Now, I'm giving you that from what somebody's told me because I didn't go through the experience. Scott Smith would have to tell you that or Major General Chuck Fiala, who was Chief of Staff in USAREUR at the time. Those were the driving notions, I believe, that then made the ISAE demise happen. Some functions and activities, though, still had to exist, like the Real Estate Agency, Europe. So, it returned to the Real Estate Division located in DCSENGR USAREUR. The direct link was to George Fuentes, the Chief of Real Estate. He no longer had to go through Charlie McNeill, an independent arm. Which is better? Probably

a few different views on that, but it evolved back to a more direct link. We had no middle person, no middle line in there, but yes, we now had a headquarters back with some executing responsibilities, at least within the organization box. Now, the Real Estate Agency, Europe, that was part of ISAE did not move back into Campbell Barracks. It's just that it reported to the Chief of the Real Estate Division instead of the commander, ISAE.

We also still had to procure energy, and we still had to have people who were interested in engineering and housing management. So, some of those kinds of things moved back, but mostly spaces were saved that were distributed to the field.

Q: Well, in more general terms, when you got there in the '78-'79 time period, EUD as an organization was just about four or five years old. What was your perspective on how EUD was doing at that time, in general terms, with its mission?

A: I thought EUD was struggling. It had some good people. It also had a lot of people taking shots at it. Just as we felt that everybody blamed us at USAREUR because those high-visibility national programs weren't getting executed as quickly as everyone thought they should be, EUD was at the focus of all of the shots on the long-range security program that you mentioned before. They were understaffed to address things. We had many new rules, like you had to have 35 percent design by 1 January before a project could make the year's MCA program. They worked hard, applied themselves to the program, and worked the issues. I know they had a big program to recruit back in the States to get people to come over. They were sending out teams from EUD to go back and visit our divisions and districts. These efforts were starting to show promise; people were arriving. I remember Joe Higgs arrived that year to take over the Engineering Division. I thought that was really a break because he brought concepts of how to run things and project management into the Engineering Division.

I give that example because I was made aware of the new rule that you had to have 35 percent by 1 January or it didn't make the program. As the Chief of Construction, Headquarters, USAREUR, I called my supporting USACE engineer at EUD and said, "Send me a team to tell me where you are with all our projects because I want to be assured that you are going to make 35 percent. I don't want to lose a single project in our program because they're not at 35 percent by 1 January."

A couple of young folks came down from EUD and we compared lists and we went down 30 projects. I think they were going to make 35 percent on just one or two of them. This was going to be a terrible blow to the program if we couldn't get some relief. So, I started marching down the projects one at a time, saying, "Why can't we do this? You're just going to site adapt, you've got plans, why don't you get it out on the street and do this and that and everything else and by this time you'll be at 35 percent. You've really got to get moving. I mean, you can't wait two more months to do that. On this one you can check it off, you're going to be at 35 percent."

I was really concerned that the understanding of necessity and how to "get it done" wasn't there. I put a phone call in to Drake Wilson and he understood. Joe Higgs came in at that

time. He understood those things and jumped on the problem, and so I saw things getting better even as we watched. So, I'm just trying to frankly answer your question, which was, how did I see them when I arrived. I saw them not yet fully there, a situation recognized by their leadership who had set up these recruiting teams. USACE had agreed to more personnel spaces, and so the build-up was still happening when I arrived. When I left, it wasn't well but I saw things happening that made it look like the fixes were coming and in place. The right people, like Joe, were there to put things together and make it happen. When I returned in '87, eight years later, there was an obvious improvement in capability.

Part of the problem of the long-range security program, too, was the right kind of people. I mean, not just people who could do the technical engineering, but people who could work with the user. I'm speaking of the philosophy of working with the user and getting him to work out solutions. If he doesn't, go back to him and push him into working with you rather than let him say something, you go back and fuss with it a long time and come back with something, and then he beats you over the head because you'd taken so long and he still doesn't like it even though he'd never helped contribute to the solution.

So, that organizational maturity had happened by '87; they were a growing organization in '79. I'm sure that it had happened by some intervening time, probably closer to '79 than '87.

Q: You mentioned Joe Higgs. Had you worked with him before or known him?

A: Never had.

Q: Just the way you said it, it was like maybe you had experience with him. You're saying he came and then afterwards you saw what happened.

A: Yes. He came and I saw what happened. Then when I came back here, I really found out about his reputation and that sort of thing. He was just Joe Higgs to me, senior Corps kind of person, when he came over.

Q: Yes.

A: He's the kind of person who deals straight up. I mean, you sit with him and immediately he conveys to you, "I'm here to solve the problem; let's work it out." And, "Yes, that's my responsibility; I'll take care of it; I need this from you." I mean, you could immediately work with him on a straightaway basis. John Blake's the same kind of person. He might have been there in '79—I don't remember when he came in to be Chief of Construction.

Q: A little later, I think.

A: Again, in '79, execution was in the ISAE part of the organization. I wouldn't deal with the construction side of the house. I was dealing with getting the projects from program into design so we could have something to construct.

Q: The relationships between your office and EUD wouldn't have been as extensive, I guess, as ISAE's, but did you see those developing and maturing while you were there, as well, that everyone was having to learn to work with EUD still as a relatively new player?

A: Well, no, I don't want to leave you with the wrong impression. I think our office maybe had more extensive interrelationships with EUD than ISAE, but I just didn't do it on the actual construction side. I mean, we would be more involved in the programs as the programs continue through congressional approval for construction. We were responsible for the NATO infrastructure program, and we had parts of the execution part of that too. So, we had quite an involvement with EUD. I can't comment on the ISAE side, but remember, ISAE also was just organized at this time.

Q: That's right.

A: So, EUD was maturing and ISAE was probably at a lesser stage than even EUD at that point in time. So, we often had meetings where there was a little finger pointing back and forth and everybody was trying to grapple with just who is the interactor with us. General Heiberg, the DCSENGR, and Drake Wilson, commander, EUD, had a good working relationship and they moved that down through their subordinates—Charlie McNeill and me on Heiberg's side. It was a matter of working it out. The leadership was compelled to the right kind of working relationships. It's just when there is a lot of work and organizations are maturing, there are apt to be some rough edges and maybe even a gap now and then.

I thought during that year we had good relationships with EUD. My comments had to do with the fact they were still growing their capability to produce with that one very specific example.

Q: That's about all I have on the DCSENGR job. Are there any other areas we should cover?

A: Well, I just want to make one comment on Army assignments to a major Army command headquarters. You asked how I got the job. I really went kicking and screaming. I wanted to stay down with Lieutenant General Ott and his VII Corps staff. He had asked for me to be the G-4.

There's always a perspective, I guess, as of the next higher headquarters. I've always told folks who've come for assignment advice since that a MACOM [major Army command] headquarters provides anyone who wants to really understand how things work in the Army a very good experience. You really learn it there. The MACOM headquarters is that place that interacts both upward and downward—downward to the BDU [battle dress uniform] army, upward to the green suit army. The MACOM headquarters is that place that has to translate needs from below and sell them to all the higher decision makers. The MACOM headquarters has to translate the allocation of resources from above downward—recognize they're usually in terms of shortages from that desired—into real terms for those below. So, a MACOM headquarters is a pivotal point in our system of planning, programming, budgeting, and execution.

At Headquarters, USAREUR, we did theater planning and theater programming to try to relate the needs in our 800 installations and for training and all the many other aspects of living and training in Europe. We had to balance, then, the desires of the community commanders and the Corps commanders and all those BDU folks that are the real Army into some kind of terms, package them, and sell the program to the Department of the Army. First of all, so they would understand it, appreciate it, buy it, and second so they'd be prepared to use that kind of justification to carry it to Defense and Congress. So, the success of our efforts would be how well we'd be able to support our folks in the field.

On the other side, once Congress had decided and the budget trickled back down and we got an amount of money, which was always short of what we wanted, then we had to reallocate it, once again balancing so everything could get done. In fact, the doors of the installation open every day, the front gate opens, and people come—you have to have electricity, you have to have water, you have to have motor pools, you need training to keep the troops going and combat-ready so you have to have fuel and track pads. You needed to have logistics flying things over, and you have to take tanks back for maintenance. So, we had to repackage the budget allocations the best possible way we could to do the job of the command.

Then we had to sell it once again back down, saying, "Division commander, I know you don't get what you want, but you can still do your job and here's how we figure it. Do this and do that, and yeah, I know you can't accomplish this, but...." We had a selling job back down to keep them motivated even when under-resourced to get the job in the command done. Headquarters, USAREUR, was a very pivotal point. We would wear our BDUs, go down to the Corps and sit there in the meetings and figure out what they wanted. We would fly back to the United States in our greens, back to walking the Pentagon halls or going over and visiting the staffs on the Hill, to try to justify what we wanted for our BDU folks in the field. Again, a MACOM headquarters is a very pivotal place in the system.

If you serve only at Corps and below, you don't understand. All you understand is that you never get enough. If you're at the Department of the Army level and have not been down to the MACOM level, you don't understand things are different. You may think of the Seventh Imperial Army because it's different. You don't think they understand that we're the boss back here at the Department of the Army and when we say this is the policy, damn it, that's the policy—even though it really can't be implemented in Europe because there's a German law that precludes it. Once you've been at this MACOM level, you really have your sharp edges rubbed off and you recognize you really have to make peace upward and downward, and you have to make the translations. I wanted to cap my discussion of Headquarters, USAREUR, with that.

Q: Where's that intersection in USACE? Is that the division level? I was thinking about some things that you hear inside the Corps in terms of the model you were setting up. The field does what they want; they don't pay any attention to headquarters. Then from the field the question of the standards there.

A: Well, districts don't believe there is any necessity for divisions—I know that. [Laughter]

When I was Deputy Chief, and that idea was being advanced, I argued that districts really do need divisions, they just don't understand that they need them. They need them because their perspective is so narrow that they'll always be in trouble unless there's a division engineer there to help bail them out, do some of the interactions with certain congressional folks, and provide that level of review that keeps them out of trouble. When we get to the Ohio River Division, if you want me to give example after example, I don't know if I'll give it or not, but I mean there are cases where we really do need divisions—and the Corps' one-up review policies are a given.

That's not just reviewing an engineer design, but ideas. I mean, things need to be buffered to get them right. Sometimes you don't get a buffering if one person's the only god. So, the fact that they have to show and tell, other ideas come to play, products usually get better. That's where I think we are in USACE. Divisions come testify to Congress and then with the assistant secretary's policy-making function, which is separate from USACE, and so that sort of clouds a nice clean line of comparison with my MACOM example.

I think basically the fact that the Chief of Engineers wants his regional commanders—the division commander—to take charge of that region is much like the Chief of Staff of the Army looks to his USAREUR commander to be the guy who's calling the shots. That's who I want to tell me, the Chief of Staff, how it's to be in USAREUR. That's the one I want to tell me, the Chief of Engineers, how it should be in the Ohio River Division.

Then you have the executing arms below, the districts. We allow them a little freedom to go out and talk with the locals, and we're talking governors, mayors, and congressmen, so that's where it gets a little confused. Those people don't have any problems with that. Sometimes people do have problems with that. Without doubt, the division is needed to take a very myopic perception of a district and broaden it. So, the Lower Mississippi Valley Division can talk about the whole lower Mississippi, not just the reach up around Memphis.

Q: Well, at this point, after three years in Germany, you're getting ready to head back to the United States. Do you have any reflections about what it was like going back, what you felt like headed back to Washington? Were you reluctant to leave Germany?

A: Well, I have to say that I mentioned that year in USAREUR headquarters was the most intense year of my career. Literally, with all of those things I mentioned, I worked every Saturday and I believe every Sunday but three during that year. It was a most intense period. I think I was approaching burnout and needed a change. I think, in retrospect, the decision to combine Installations and Construction into one single division overloaded one colonel. Later, the Installations and Construction Division was divided and re-established as separate divisions in the Office of the DCSENGR.

At the same time, it was a very satisfying year because I thought things were rolling now in our rapid reinforcement of NATO program. I left with a Storage Branch established. We now knew the facilitization status of where things were and the DCSENGR was fixed as the, quote, "expert" on what should happen, where. Incidentally, over the years that Storage Branch went away.

The master restationing plan was well developed as a concept. We were nearing the end of the relocation of the three headquarters in Campbell Barracks. That was well on the way and most of the arguments had gone by the wayside. So, I had a good feeling of satisfaction, but it had been a long, tiring year.

Also, I really enjoyed my two years in command of the 7th Engineer Brigade. That was just a top-drawer assignment, working with super people. I really liked General Ott and interacting with the division commanders and assistant division commanders and all the colonels and others that over the years I interacted with more and more. I mean, Colonel Butch [Crosbie E.] Saint, later CINCUSAREUR, was commander of the 11th Armored Cav, then on the USAREUR staff at that time. Major General Bob Dacey was on the USAREUR staff as a colonel. Walt Kastenmayer, in DCSLOG, was later to make brigadier. When I first arrived, the Chief of Staff, 3d Mech Division, was Colonel Jack Galvin [later the Supreme Allied Commander, Europe]; Bob Elton was the Assistant Deputy Chief of Staff; and Glenn Otis [later the Commander in Chief, U.S. Army, Europe] came over at that time as a major general to command the 1st Armored Division. Lieutenant Colonel Ed Leland was G-3, 3d Mech Division, and is a three star at EUCOM now. You just go on and on of people who we were involved with. Of course, I worked for Major General Vald Heiberg and Major General Dick Groves, people that I came back and worked with and for later on. It was a superb experience and I really enjoyed it.

My family really enjoyed Europe. I still managed to get away for a skiing vacation here or there and to take advantage of space A travel and the Air Force's C-130s to England and Spain during those three years. So, it was a very enjoyable experience. I've always enjoyed assignment to Europe, and that certainly was a measure of why I sought the assignment leaving Fort Belvoir later to go back as the DCSENGR.

Deputy Assistant Chief of Engineers

Q: You mentioned about finding out about your next assignment while you were still in Europe, and I wondered if you could reflect a little bit on your selection for the Deputy ACE job and the factors that you see in getting the assignment.

A: With every assignment there's some negotiations with the assignment officer. By the time you reach colonel, many people get involved and the assignment officer's working with various folks. I don't quite know how it happened or what came first, really. As I mentioned, it was such an intense year, and years are very short in terms of assignments. I reported to the job in DCSENGR, Europe, in the summer of '78 and knew already in January, February of '79 that they were putting together the slate for the coming year of assignments. So, I'd only been there five or six months and already somebody's thinking about where I was going to be reassigned. I knew I was coming back to the States and was not going to stay in Europe another year.

I really don't recall how it happened, but it was rather a natural progression because, having been the Chief of Installations and Construction in Europe, dealing with Military Programs and all of the major activities going on, all the trips I was making back to the Army Staff to brief them on various activities for which the ACE is one of the major players, the fact that I could go in and be the Deputy ACE was a very natural progression.

So, now whether Major General Bill Read asked for me, Major General Vald Heiberg volunteered me sometime when they were talking, or what, I don't know. I don't know which one of them mentioned it to me first, but I had known I wanted to come back to the Washington area.

We owned a house in northern Virginia and I knew that's where I wanted to serve, in the Pentagon somewhere or in USACE. It seemed to be the natural step, that I certainly had something to offer Major General Bill Read, the ACE and our point man for a lot of things on the Army Staff. He would be able to get somebody who was involved in some of the high-visibility things, like rapid reinforcement of NATO, the master restationing plan, a lot of the initiatives that I talked about before, and that Lieutenant General Groves was pushing now that he was back in the Office of the Secretary of Defense. Those initiatives were going to the Hill and the committees were talking about things, and General Bill Read, as the ACE, was the testifier for those committees. So, I would certainly bring some on-the-ground, hands-on experience with many high-visibility initiatives plus knowledge of the regular programming responsibility for construction and the construction program in Europe.

So, I really don't know who mentioned it to me first or how. It just all happened because it was natural. It might have been the assignment officer; it might have been Bill Read; it might have been Vald Heiberg.

Q: You hadn't worked with Read before, had you?

A: No, I never had. I had first met him when, as a colonel assignment officer, I made that very first briefing for General Clarke on OPMS, and he had asked me to brief a couple of the new brigadiers that were in town. One of them was Jim Kelly, another one was Bill Read. So, I met him there, and I hadn't seen him, really, since my year in the Office of the DCSENGR. Each time we'd come back, we'd go in and brief the ACE.

Q: I have an organization chart. Maybe a good place to start would be to talk about exactly what you did as Deputy ACE, the various things that you got involved in. I have some specifics to bring out. One of the things—well, one of the things would be your role with testifying on the Military Construction, Army, program.

A: Okay. Well, let me just first say that I started off very rapid fire because I reported in on the date that Bill Read had said would be acceptable, and when I reported in he said, "Well, I'm going on leave to Europe for 30 days, starting tomorrow." So, that's how I started—being the acting ACE for a month. That certainly does accelerate your learning curve because you're now the principal at all the meetings. Let me just talk about my duties, and I'll start off with

the one mentioned. There really was not much involvement for me in testifying before the committees as the Deputy ACE.

Now, having made that statement, I think I went over only once or twice to appear before a committee and testify. The reason for that is that the ACE job is a rather high-intensity job because you're always in the middle of the PPBES [planning, programming, budgeting, and execution system] process. The ACE is always preparing, contributing to defense guidance, working the POM, or working the budget. There are just an intense number of meetings to go to as you're wrestling with new budgets or the cuts. A new cut comes down, new bogies need to be met, and the ACE, as part of the Army Staff, meets with others as they sort all those out. There are regular procedures for all of this that I should get to.

In the meantime, the ACE has four committees that he's the principal Army officer for testifying before—the Appropriations and the Military Construction Subcommittees of both the House and Senate. The ACE has more testifying days than any other officer on the Army Staff. Bill Read described my job responsibilities—he would basically take the testimony to the Congress side of the ACE house, and he would leave me to work the programming and budgeting issues on the Army Staff.

I don't know if that's a "Mr. Inside/Mr. Outside" because you're not traveling far when you just go over the river to the Hill. He described the problem he faced in his first year as ACE, that he found himself coming and going daily. He would be returning from the Hill, having testified, and someone would push papers at him so that he could attend a Program Budget Committee meeting for which he'd have to be voting on Army Staff issues. That meeting would be over at 6:30 or 7:00 p.m., and then he would have to go back to a prep session then and again early the next morning before going back to the Hill at 10:00 a.m. or so to testify to another committee. He said, "You can't prepare and go to Hill meetings and prepare and go to Army Staff meetings while they're all going on concurrently." So, he was going to take the former, I was going to take the latter, and that's how he divided things up, basically.

He would attend Select Committee meetings, often with General Morris, the Chief of Engineers, when our issues got to that level, and he'd carry the ball. I carried the prep in those sessions and was the principal ACE member at the Program Budget Committee. Now, the way it works on the Department of the Army Staff is that the Program Budget Committee is a committee co-chaired by the Director of Programming Analysis and Evaluation and the Director of the Army Budget. I say co-chaired because they'd each take the lead depending on whether it was a programming session or a budgeting session. If you were addressing the program, then the Director of Programming would take the lead, and that was Major General Max Thurman and then Major General Pat Roddy that year. If it was a budgeting session then it was chaired by the Director of the Budget, and that was an engineer general, later Comptroller of the Army, Major General Peixotto.

The voting members were the Army Staff proponents' budget persons. I certainly get to meet a lot of good people up there when we're wrestling with all those issues. Everybody brings their agencies' agenda to the table. I'd sit next to Larry Skibbie, who then was a brigadier working in the Office of the Deputy Chief of Staff, Research and Development. He later

became a deputy commander of AMC. Brigadier General Herb Temple, later a National Guard Bureau Chief, was the National Guard Bureau's action person, and so forth.

We would meet to try to put together the Army's position on the program or the budget. From there, the two principals would take the results to the Select Committee, which was co-chaired by the Vice Chief of Staff and the Under Secretary of the Army and consisted of all the Army Staff principals. That would be the final wrestling area before the program or budget was presented to the Chief of Staff and Secretary of the Army. So, we tried to wrestle with all the issues at the brigadier/two-star level to come up with recommendations to the Select Committee. We tried to get it—POM or budget—focused and molded into some sort of shape, ready for the committee. We would highlight issues that couldn't be resolved at our level, which would then be presented to the committee for their action.

That year, '79 to '80, I typically was our rep on the Program Budget Committee, and then at Select Committee time I often would go with the Chief, General Morris, as the back-up person, or General Read attended for General Morris and I'd go as the back-up person, or sometimes General Read went as the back-up person to General Morris. That's how we covered the committee.

Then, as you asked what did I do, what was my job during the year—it was principally focused around putting the program together and putting all those kinds of initiatives together, doing the Program Budget Committee actions and related things. It also broadened out as Bill Read's deputy to cover other activities that went on in the ACE's shop across the board. General Read left most of the military engineering items to me. I'd been a commander in Europe, more recently in touch with things than he was, and so he left that to me. We both were involved in the Environmental Office headed by Colonel Charlie Sell. That was really coming into its own at that time. Lot of things were happening, so we worked that, whoever was there.

In the Installations Planning Division, both of us worked that, although the master restationing plan that I'd worked on in Europe was now big in the ACE's shop because General Groves was trying to get the Army to push it up to defense and was really active on it. Since I brought that experience with me, I worked the master restationing plan issues.

In addition, emergency planning was starting to get a big play on the Army Staff toward the end of that year. Al Carton had Programming Division and, of course, he was so well-experienced and had that all on-line. He was dealing with the congressional committees and dealing with the Office of the Secretary of Defense. I would often be a participant in our internal preparations for testimony, putting it together, but he and General Read really did the prep sessions. I didn't get involved in the hours going over the testimony books. I'd be tracking along so I could be a filler, if necessary.

One time I did get involved in testifying was toward the end of the year when General Read was out of town. We had to testify before the House Appropriations Subcommittee pertaining to cost overruns, in particular the Army's project, the new Walter Reed Hospital.

The question was, “Why did it cost \$10 million more than had initially been estimated?” I was designated to go over and testify about that.

Q: That’s a really hot-seat position, I think, to testify on overruns.

A: Well, yes. I hadn’t even taken my seat when the committee chairman said, “Well, General, what are we going to do about an Army that has a \$10 million cost overrun.” It was my first time before a committee. I was trying to put my thoughts together. I mean, I was still walking from my back seat to the table. Somebody else in the Air Force had been up and now they were leaving, and here we are approaching and the chairman was already asking a question. I didn’t have my books out or anything, I’m just moving forward and trying to key my mind too. So, I just blurted out what came to mind, which was, “I don’t know, Sir, but just remember it’s the only Army we’ve got.” [Laughter] It seemed to keep the day going. I won’t say it carried the day because there were a lot of questions that followed—but at least I didn’t get thrown out.

Q: Let’s talk a minute, maybe, about the organization of the office and how it functioned. Before we started actually taping, we were talking about the executive assistant position, I guess it’s called now, and the lack of it at that time. That’s one issue that you might want to address. Let’s start with that, and I have a couple of others to follow.



Ann Kem and Lieutenant General John W. Morris (right), Chief of Engineers, pin brigadier general’s stars on General Kem’s uniform during his promotion ceremony in November 1979.



General Kem's wife, children, and parents at his promotion to brigadier general in November 1979. From left to right, John S. Kem, Ann Kem, Steven E. Kem, General Kem, Mrs. Charles E. (Janice) Kem, Dr. Charles E. Kem, and Michelle Kem.

A: Well, the Deputy ACE was a colonel's position. The fact was that the ACE really needed two general officers to do the kind of high-level things that I've just described and to be on a par with other deputy chiefs up there who all had four or five generals. They could always be covered at a meeting by a general; the ACE was always short. I came in as a colonel and that's what I was expected to be. I brought the experience with me, but as luck would have it, about a month after I arrived I was on the brigadiers list. I was toward the top of the list, so I was promoted the first part of November. Therefore, we now had two general officers, and so we just had more clout. I mean, the way the Army Staff works is you sit by date of rank around the table. The more rank you have, the closer to the front of the table where the action is. When you have a table with 12 generals at it, and the colonels fill the end of the table or the back rows, then it's nice to have two generals there to do the job.

We had a major as the executive officer for the office. The DCSOPS and DCSLOG were much bigger and had colonel executive directors. They each had a deputy director who was a two-star and then they'd have several other major general directorate heads. So, we were really undergunned by only having a major. A major could run the office. He could be a senior admin type, but not an executive officer in the sense of the way the Pentagon runs.

That's somebody that the Director of the Army Staff could call down to, a colonel-level person, and work the whole organization. You didn't have to have the generals present in those other places—their executive officer fielded the ball and pulled in whichever director was responsible. Whereas, with a major, typically you're going to get a good professional and the best kind of person, but he can't be directing a bunch of higher level people. So, we were short in that regard. That's been corrected over the years now that the ACE has a colonel.

Q: Was there any effort at that time to push for a change, or did that not really come up?

A: Well, I was clamoring for it. I think General Read was just happy that he now had a second general and things were happening to keep him happy. You should recognize one other thing. At that time, Military Programs was a directorate within USACE. General Wray headed that, and General Read was listed as Deputy Director for Requirements and Programs as the ACE. General Sisinyak was Deputy Director for Facilities Engineering—the old separate Directorate of Facilities Engineering had been placed under Military Programs to provide a stem-to-stern Army facilities directorate. Military Programs Directorate would take facilities from original concept, installation planning in the ACE's shop, through programming and budgeting for the construction, then construction, and then over to facilities engineering and housing. The Military Programs Directorate would do the construction through its military construction districts. Thus, General Wray had two deputies, but he was not the rater of the ACE. The ACE was rated by the Chief of Engineers directly. Whereas General Sisinyak was with Military Programs in Headquarters, USACE, of course the ACE was in the Pentagon.

I don't know how I got on to that, but I was trying to make a point.

Q: Well, the interaction between the ACE and Military Programs.

A: Yes, you have to keep that in mind to understand then how the ACE operated because the ACE was, and I was, as mentioned, the person who went to the Program Budget Committee and brought the programs together. Yet, the people who did the facility engineering and the housing components of the program worked over in the Forrestal Building. So, we would have to pull them over to meet with us so we could put all the numbers together. We weren't doing that too well back at that time. We worked a lot that year to try to make that program wrap up better.

Later organizational changes sought to bring those facilities components and housing components to the ACE so we would have a better tie. There were some thoughts of moving them. Later, there was a facilities programmer and a housing programmer added to Al Carton's Programming Division shop, trying to make the ACE more effective in the programming business.

Anyway, I was the deputy. After me and the changes, Jerry Hilmes had come in to replace Sisinyak, who had replaced John Wall. After I left the ACE, it was decided to take the brigadier general facility engineer position out of Military Programs and bring it over to be the Deputy ACE. This formalized the position—I was there in a colonel position but a serving brigadier—to give it the clout of the two generals. Brigadier General Jerry Hilmes

moved over in that position, so you had the two general officers in the ACE's shop. Then Major General Norm Delbridge, when he was ACE, brought Al Carton up to be a second deputy, so there were two deputy ACEs. Then the Army did the normal kind of expected thing when they ever find two deputies: they cut one out, and the easy one to cut was the general officer. So, the Department of the Army took away that second general position, leaving, then, just the major general ACE and the civilian deputy. So, that's how that migration happened, and somewhere in there is when the executive officer became an executive director and a colonel.

Q: So, now at this point that we're looking at, when you were the Deputy ACE, the Programming Division and the Installations Planning Division have the dotted line in the ACE organization because they're actually in Military Programs, right?

A: That's right because the Corps wanted to represent Military Programs as a stem-to-stern organization. Read across the divisions of the Military Program Directorate—installations planning, programming, engineering, construction, operations, and maintenance—you recognize the life cycle, leaving out real estate acquisition and disposition, in the Real Estate Directorate. General Read then was listed as a deputy, double starred. Then on the ACE chart the solid lines are to Military Engineering and the Environmental Office, under the ACE alone and not part of Military Programs. The ACE had staff supervision over those two.

In reality, we operated as two separate organizations. We did participate in, and I often attended—but not General Read—the Military Programs staff meeting that General Wray would hold to keep the continuity of information flowing back and forth between the two.

Q: That is a sort of complicated link-up there, isn't it? In 1979, I believe, the Corps became a MACOM, recognized as a major Army command. So, distinguishing the Chief of Engineers' Army Staff responsibilities, which the ACE carries out, the MACOM responsibilities, which come under the new MACOM, made a complex mixing of responsibilities there, didn't it? Was it difficult for the people involved to sort these things out, or is this something that is more complex from the outside than it is from the inside?

A: No, it's only complex if you try to believe that it operated like the line diagrams. I mean, the dotted lines versus the solid lines on here really reflect who ran things. The dotted lines really ran those shops that are dotted, not the solid. What's even more confusing—you have Brigadier General Mark Sisinyak then as Deputy Director for Facilities Engineering. That was not, you see, principally a MACOM function. It was principally an Army Staff function.

Yet, he was the deputy that stayed over in Military Programs and the Army Housing Management Office stayed over there and worked for the Military Programs, and all the programmers, so we really hadn't separated out O&M [Operations and Maintenance] from Construction Engineering.

In reality, General Wray never came over to the ACE's shop—he concentrated on Military Programs. Don't read that absolutely; what I mean to say is that he'd come over often to sit in for the Chief of Engineers in the Select Committee and we'd pre-brief him and all the rest,

but we didn't routinely have him because he left it to General Read to run the installation planning and the program budgeting functions and to testify on the Hill.

Of course, he had been the ACE before Major General Read. When one has such a seat-of-the-pants feel for something—he and General Read could talk on the phone, and he would understand immediately where things were and how things were running. So, he didn't pay attention to the nitty-gritty or hold the meetings to develop things involving installation planning and the programming aspects. At the same time, General Read really didn't get involved with running the MACOM aspects of the Corps—that is, design and construction or the facility engineering execution—even though we did the programming.

It was difficult for me to get the facilities and housing program people over. I could go right outside my office and there were the construction programmers. When we had four hours to prepare for a change or present something to the Program Budget Committee the next day that we'd just found out about, I'd have to get on the phone and call over. Hopefully, we'd find out before five o'clock because people bailed out of the Forrestal Building with their carpools and the people I needed might already be on their way home. It was difficult not having all programmers in the ACE.

General Read had John Sheehey, who worked between the two offices. He was the one who was always filling in the data and the projects and maintaining the books that Al Carton used for programming and which engineering and construction were going to design and build to—the designers, most specifically.

Thus, Generals Wray and Read ran two separate organizations and both were fully employed, I can assure you, with the many things happening in the Army. The next organization change brought facilities engineering and Jerry Hilmes over to be under the ACE. Now the Army Staff included both installation planning and programming and the installation support of facility engineers under one head. Then the USACE execution part, design and construction, were under another head.

We were living through a point of transition when I was there; that is, we were understanding what next needed to be fixed, and at the time of the next change, they were fixed.

Q: When I talked to you on your assignment when you were a Deputy Chief of Engineers, you referred to the situation as one in which there were tensions between Military Programs and the ACE. You didn't really use that word today, but I mean, was it causing real problems in the operations that that word might indicate?

A: We had some tensions involved really with what I've already subtly described as trying to get the programming folks together, trying to get the people back when they've gone home at 5:00 and you have the pressure of a meeting the next morning at 7:30 and you have no one to work the facility engineering programming issue or the housing programming issue, and somebody to build the case. On the one hand, Al Carton, who'd been there so long, and his organization was right down the hall, and when somebody said, "You've got to cut \$40 million out of MCA," they would fall in, do some what-ifs, get on the phone and call

commands, and would put together the ACE's position. I mean, we just couldn't call all these shots without touching base with others. Some of them required other people to be coordinated with and to contribute. Al's team was there to work that.

The same call would say, "We need the Chief of Engineers' recommendation on where to take a \$60 million cut out of facilities operations and maintenance—O&M money." We'd have to get on the phone, call over to the Military Programs shop, and there were no vice presidents in charge of facilities other than the executive director. We'd be working directly with individual action officer programmers. We'd have to almost barter for their time, depending on the other agenda items they might have gotten from their direct bosses. So, in a sense, it may have been a matrix organization in which we had not defined well our horizontal matrix line. We spent the year trying to better define that. I mean, General Wray was very cooperative in dealing with it. It's just that with the rapid-fire turnaround of things and the intensity on the Army Staff when you're in those budget and program cycles, the calendar dictates on certain days that you do various things. If somebody has another new idea, he'd have to wedge it in the same time frame.

One thing I hadn't mentioned before is that typically I would go into a Program Budget Committee meeting and it'd be chaos. They'd line up a priority of things in a program and draw the line about the number to be funded, and everybody's pet project or program would be sitting in the unfunded area. So, they'd all—and me, too—would insist that one had to be funded. We'd stuff it back in the program and then others would bubble out, as the expression goes. Then you'd have to stuff those back in. After three hours of this in that hot, humid room, sitting all cramped in, everybody's tempers get a little tight and you're not winning. Then the chairs would say, "Well, let's run another printout and let the council of colonels deal with this one."

Well, I mean, that was really a no deal for the council of colonels. I mean, what that meant was they'd have to take—now 6:30 at night—another couple, three hours to run the computer printout and then they'd meet at 9:00 that night and do some more wrestling with the issues, trying to come up with something. Their tempers were probably frayed, too, because they'd been sitting in listening to all this other stuff in the afternoon. Then they would try to work out some sort of agreements that could be presented the next morning at 9:00 to the same Program Budget Committee. So, they would stay up half the night and they'd run another computer printout in the morning. They would all meet with their general officer principals and convince them that the solution was the right kind of solution, that they shouldn't argue so hard at the Program Budget Committee meeting, or they should, or we're still getting screwed on this one so we better go in and make the case, or try to make a couple of phone calls to get some other support before going back to meet again.

Well, when you've got that kind of intensity and all of a sudden you need some fact in the facilities side and it's after 5:00 and the council of colonels is going to meet in two hours, and you're dealing with Europe, Korea, in other time zones—nothing meshes. It's not like putting together, say, a research and development program. That's very complex too, though, as I found out later at Fort Belvoir. You've got to deal with a lot of people there, but at least

most of them are in the continental United States. So, we in the Office of the Assistant Chief of Engineers were really at a disadvantage.

So, the tensions I was talking about largely came from a running tempo—like we just weren't getting supported with timely responsiveness and facts and prep. By "prep" I mean developing the chart that articulates what we want to say that will win the argument with the Program Budget Committee—without my having to do it. We just didn't have that process greased. We hadn't operated this way before with two generals, one doing the Hill and one being able to concentrate on the Program Budget Committee. I had some time now to concentrate and try to get this one right—because before we just tried to ad hoc it and get the best we could. That's what I meant by the tensions.

There might have been some others, which is almost a perennial thing on trading information—whether a project's going to make 35 percent design by a certain date because they had to deliver that or adversely affect the program—before congressional testimony. There were no tensions between Read and Wray. It was really—I think as I mentioned, just the fact that we were transitioning. We were trying to be a more responsive, a bigger hitter on the Army Staff.

Now, the ACE was always a big hitter in the program arena, but these many initiatives that have been happening in Europe that I described before which came out of the administration, the master restationing plan in Europe, more construction in Europe, the ammo program, the rapid reinforcement of NATO program, plus Korea construction, all these kinds of things were initiatives and the ACE was to be the facilities player for these things. If you want to be a player, you have to go to the meetings. The meetings take a lot of time and you're there for a long time. So, I think we were a little more austere manned in the ACE's shop than the fellow deputies of operations, log, personnel, and the rest. They were really burgeoning bureaucracies in comparison to the austerity found in Al Carton's Programming Office and our tiny Environmental Office. We were at the point where, you know, a couple of absences because of sickness or vacation could really leave us in a void.

So, we were building and the tensions came. Bill Read brought me in to up-gun our contribution to these Army programs, I believe, raise the level of contribution and participation. To do that required staff work so that we could input and have the homework complete. Those were the kinds of catalysts that contributed to the reorganization that occurred one or two years later.

Q: What about testifying before Congress? Would the Military Programs Office have responsibility for the committees dealing with issues of O&M and housing, for example? The question is, is there a problem in the relationship with congressional committees related to the Corps' organization?

A: I don't think so. I believe General Read did the testimony on all those aspects. They, of course, contributed design status and those kinds of things. Well, for example, I was the one testifying on the cost overruns at Walter Reed rather than the Director of Military Programs. General Read was the Deputy Director of Military Programs, so he was the person to testify,

whether he testified as the ACE or for General Wray on the execution side. It works on the basis that you need to build up any kind of relationship with congressmen and their staffs—and there were an awful lot of meetings, you know, where General Read would go over one-on-one with staffers and talk with them about things or call on a congressman to work things out in addition to testifying. General Read had working relationships with the staffers and the committee chairmen, so he was the right person to carry over the cards.

Q: What about—this is a little different issue—within the secretariat? What about relations, for example, with the Assistant Secretary for Installations and Logistics at that point? You know, in the interim it has been an issue, and so what was it like at the time you were there?

A: I guess Paul Johnson must have been there.

Q: Okay.

A: Same crew. They were there and we interacted with them; I don't sense with quite the same degree of specificity that goes on now. Perhaps I'm wrong. Perhaps I just wasn't involved with that, and perhaps General Read, in carrying something to the Hill, touched all those bases. Later, when I was in Europe as DCSENGR, I knew many things that the ACE was telling me that he had to get secretariat approval on this. I had the feeling that we went to the secretary a lot more than we used to—maybe we always did.

Certainly the environment wasn't a big issue thing then, and Dee Walker's position didn't exist, so when that came about there was a whole new arena for contact between the two offices.

Q: Okay. One of the things that, in talking with General Hatch—I've been interviewing him over the last year—we talked about the level of participation, direct participation by the Chief on the Select Committee. You referred earlier to, I think, the ACE at times attending that meeting. General Hatch was making a point, which was something that General Heiberg also observed when he was Chief about the importance of the Chief actually attending those meetings.

Do you have any comments on that from your period of time? Did it seem like it was fairly routine for the Chief not to attend, or what? I had a sense that General Heiberg had identified this as something that he wished he had done more of. He thought it was a more important thing to have happened and it didn't.

A: Yes. I think General Hatch has done extremely well in carving out the time to make sure he's present there when the Army's senior leadership gets together, either the General Policy Group or Select Committee. When the Army wants to get its collective leadership together to advise the Chief of Staff and Secretary of the Army, it's an important time. I think that it is an important time for the Chief of Engineers to be present so that he's seen as a contributing member of the Army and not just "that civil works guy." Hank Hatch has done it very well. Others may have too, but I had more visibility of how Hank Hatch did it.

With his predecessors, I think oftentimes their schedule called them away to do other things. I almost put them back to a parallel experience as when we discussed my being the community commander in Germany as well as the brigade commander. I think I suggested at the time the community could always schedule something earlier than the troop command side. So, if I let the schedule just happen and be filled up by the one who asked first, the community would fill the schedule and I wouldn't have any quality time to command the brigade or go to Corps meetings. So, I learned that I had to be in charge of my schedule. Not that I'd take over from the secretary, but I couldn't accept everything that somebody wanted to put on my schedule. I had to save important times and things, give tentative okays but not finals. I would caveat things—I may have to send a rep, and that sort of thing. Otherwise, I would have been totally consumed by community activities and never have had time to do the troop side.

I think the same thing happens to the Chief of Engineers. He really needs to be there when the Army's senior leadership is getting together over things. Yet, you don't always know when that will be. The Chief can certainly fill up his schedule with visits to the Far East, going along to the good old Missouri River Division, paying a semiannual visit to the Southwest Division, dropping into the Lower Mississippi Valley—the good folks in the Delta are always happy to see you down there. Those are pretty easy to accept, and the Chief can really fill up the schedule before important things are scheduled.

Q: Same?

A: That's right. The Chief has to weigh his time. The Army Staff's PPBES calendar is all laid out at the start of the year, so it is known generally when the senior leadership's going to be getting together for purposes of deciding their response to defense guidance, or final approval of the POM, or sending the budget out. I think the Chief can ensure that certain areas of time are left open for that. He would be there at those key kinds of events. They schedule four-star conferences well in advance, so he can always be involved in that, and I think most Chiefs made themselves available, but not always.

So, from my experience back in those days, General Morris was often gone and he also often attended. When he wasn't there, General Read attended or I attended. Now, that's a pretty sobering thing when you're a brand-new brigadier and you walk into a general policy council meeting and you're sitting next to the Vice Chief of Staff of the Army because they sit by rank and he's the four star and is sitting in the middle of the table. General Morris was the ranking three-star in the Army and so that's where I would sit—in General Morris's seat. So, here's all these three-stars around the table and one or two brigadiers, one of them right next to the Vice Chief of Staff. Does keep you awake for the meeting! [Laughter]

But, you know, I was always wondering, were they looking down at me wondering where General Morris was? So, I think it is important for the Chief to pick his shots and make himself available for key times when the Army leadership wants to make weighty decisions and they're looking for collective advice. I know the last year before I retired, I had a couple of people on the Army Staff comment on how Hank Hatch was appreciated for his contributions, not just in subjects of Army engineering interest, but his contribution as part of

the collective leadership in bringing up issues or commenting on things on the wide variety of subjects that might be entertained. It's certainly a forum that one has to stand up and be counted if it's your issue or it's an issue you're interested in or might go against you. It's one where your ability at those crucial times might depend upon the credibility you have established during other times and your willingness to be a part of and contribute to the collective leadership there.

Q: Earlier, when you were talking about the organization and referred to the Environmental Office, we didn't really talk about specific issues during the period. I think from a couple of sources that I was looking at—for example, air and water pollution—did you have enough involvement with this to comment on some of these things?

A: Not really. It was an office—I think bureaucratically the Army was trying to figure out where it was on the environment. The Corps on the water resources, civil works side, was way out in front, with General Clarke having said, "Let's get involved with the National Environmental Policy Act and get out doing those kinds of things." From the standpoint of an Army program, this was an embryo stage. We had an office, we were writing regulations, but they were really early regulations from what you would find there now. We were trying to figure out how the Army Staff could communicate with all of its installations in the field, tell them what needs to be done, and what should our involvement be, and who should be doing that involvement, and that sort of thing.

Q: If I could go back to something I mentioned earlier, in 1979 did becoming a MACOM have much immediate impact—was it seen as fairly important? Was it seen as a possible way of helping with some of the ACE's military programs functional responsibilities at the time?

A: I always thought it was important—wherever I was when it came about, I thought it was an ideal move and would be important.

I don't recall any major strategies, I think, because the ACE's shop itself hadn't changed much in its operating entity. From the standpoint that we had an overworked major general and a colonel who operated then as his deputy but not having any executive director, we moved to have two general officers and we'd get more involved, but we didn't have the staffing to support us and had to pool our programming activity. We still were doing essentially the same things—that is, the Army Staff part of things—as before the MACOM. The MACOM was running the design and construction activities that had always been done by those folks across the river. The fact that they were in a MACOM cleaned up the lines from the standpoint of the Army. There were other aspects—it got the Chief of Engineers to go to commanders meetings, and now he was a commander at the four-star conference. So, it had those kinds of benefits, but in day-by-day operations it was not something that we spent a lot of time on.

General Wray may have over in his Military Construction shop, but in the Office of the ACE that was not a big ticket item. We were basically trying to sort out staff functions, whether it was Army Staff or USACE staff, and not worrying about the rest of the command structure.

Q: We had said your description when you were in the Pentagon earlier, that to an officer or a civilian, I guess, certainly on the Army Staff, life is a hectic one, with long, unpredictable days, middle-of-the-night sorts of meetings. I'm sure it's worse for a green suiter perhaps than for a civilian, but pretty frenetic.

A: Well, Al Carton always used to put in those same kind of hours.

Q: Same kind of hours?

A: Yes, and John Sheehey put in long, tough hours, and then others too, so it wasn't just green-suit types. You're right; you're driven by a process and decisions and that calendar that keeps grinding on. The PPBES system says the Office of the Secretary of Defense is going to do something on a date and the services have to answer if they want to count by that date. You get certain actions and you have so many hours—36 hours or 48 hours—to answer, and that's a window that has to be made to include all the coordination, getting every other Deputy Chief of Staff to sign up all the way up through the Vice Chief and Chief of Staff. I mean, a lot of wickets in there for 36 hours.

Q: When you were promoted, you still were in a colonel's slot, weren't you?

A: Yes.

Q: So, they didn't make that a brigadier general slot at the time—so you were sort of beginning to look for a job pretty early on while you were in the ACE's slot, I guess. Or were other people looking for a job for you, maybe?

A: General Morris told me early after my selection for brigadier general that he was going to leave me for the year, and I think he said that in the sense that I ought to complain if I wanted to. I really wanted to stay. I had come to the ACE knowing what was there and knew I was a natural because of the Europe job we've talked about before. I thought I had things to contribute, and it would have been a shame for everybody if I had left in midyear. I mean, that would have just been more turmoil for the organization. They wouldn't have been able to take the value of my contribution—what I brought to the organization from Europe.

I certainly learned an awful lot that year on how the Army system worked, the ins and outs of fighting the battles in the Pentagon and the programming and budgeting system. That helped me immeasurably later on when I was Engineer School commandant at Fort Belvoir. I mean, as the Deputy ACE I had participated and fought the battles on the mine program and UET [universal engineer tractor —later the M9 ACE] funding. From the ACE's perspective, I watched those working in the Office of the Deputy Chief of Staff, Research and Development, and how they worked issues. I sat next to the Research and Development guy when he did his thing at the Program Budget Committee meetings. I didn't throw on the table issues on funding for mine programs or the UET; the Research and Development guy covered those. Those were his bailiwicks, not mine to mess with. I could always educate people, make sure they understood what was right or wrong about an engineer issue, or be able to receive intelligence that they were planning a cut in those kinds of programs so that

Major General Read or Lieutenant General Morris could talk to the commandant at Belvoir, or to the commanding general of TRADOC, or the Deputy Chief of Staff, Research, Development, and Acquisition.

So, I needed to stay for that year. Then General Morris in October or November called me and we talked about my future. He said at the end of that year he wanted to know what I'd like to do and we'd go from there. So, I told him I'd like to stay in the Washington area, and if they didn't have a brigadier position for the ACE, I'd like to be the Deputy Director of Civil Works.

Deputy Director of Civil Works

Q: So, that's what happened? October '80?

A: That's when I became the Deputy Director of Civil Works, right. That conversation took place the year before, or over the intervening months.

Q: Why did you want to be the Deputy Director of Civil Works as your next assignment?

A: Well, I wanted to stay in Washington. I'd just been there a year. I thought, having had a year of experience on the ACE part of the Army Staff, that if I could take a year in the Directorate of Civil Works prior to being a division commander, it would be beneficial. Not having been a district engineer, I thought that position would help me lean into division commander responsibilities. Understanding things from the headquarters, I'd be more capable when I went out to a division.

Q: So, the division command would inevitably happen regardless, probably, whether you—

A: Probably.

Q: Okay, that was actually in the fall, then, of 1980 that you went over to Civil Works.

A: My reporting date was delayed. General Norm Delbridge was coming in to be the ACE and I stayed on as the acting ACE for a short time. I don't know if it was a month or six weeks between General Read and General Delbridge, but there was some interim period because General Read had to get on to the Lower Mississippi Valley Division, and General Delbridge could not yet leave South Pacific Division. So, I stayed on as acting ACE.

Q: So, at the time you went over to Civil Works, General Heiberg was the director, is that right?

A: That's right. He had come back earlier from USAREUR, had been pulled back to be the Director of Civil Works in summer '79. He'd been the director for a year. We had talked, and so I was going back to be his deputy again. One day before I reported to Civil Works, the

Deputy Chief, General Johnson, said, “General Morris has told you you’re going to the Ohio River Division, now, hasn’t he?” I said, “No.” He said, “Oh, well, maybe he better tell you. I’ll let him talk to you on Monday.” So, on Monday General Morris called and said, “Yeah, you’re going to the Ohio River Division. I mean, Harry Griffith’s leaving, and you get to be the new commander out there, you’re up.”

Now we were into the fall, other things had happened, and that was really kind of an unwanted surprise. Much as I wanted to go to command a division, the timing with respect to my family was poor. My son John was into his senior year in high school. Then I hadn’t had the opportunity to get into civil works to do the headquarters aspect too. So, anyway, I went over to Civil Works for a relatively short period, four months, and then went on to the Ohio River Division in January ’81.

Q: Did you leave your family, then, in Washington, until—

A: I left them here until the summer of ’81 and then moved them to Cincinnati. I commuted back whenever I could to see them, which is often when you’re in the middle of testimony time and getting to meet your congressmen and that sort of thing. Division engineers come to Washington often enough, but especially during the first months you can find yourself back here quite often.

Q: In your short stay in Civil Works, what things would you recall as being the hot issues at that time?

A: To put the perspective on the time, the fall of ’80 was the end of the Carter administration, to include the election, so the first couple of my months there were filled with things pertaining to programs that the Carter administration wanted to put forth as initiatives. Private hydropower development of public dams was a big issue. Certain federal dams were to be made available for private interests to develop the hydropower potential. That had really come to a focal point, and the Carter administration was portraying this as an initiative for returning things to the private sector. It had a lot of visibility.

There were other things, such as trying to open up the U.S. ports to facilitate coal sales to the Japanese and other folks. I found myself at the White House three or four times at these things that oftentimes became “events.” The administration was calling folks in for a high-visibility presentation and event.

Q: Another thing that happened in December was the so-called “Stockman Manifesto” by President-elect Reagan’s soon-to-be budget director. There were some memos in the Civil Works files from December 1980 from Programming Division related to what they saw as the coming problems with the new administration’s plans in cuts, for example. Do you recall getting into that?

A: No, what I recall is that we were very interested in hooking up with a transition team for the new Reagan administration and eager to learn who would be our new assistant secretary. Mike Blumenfeld was assistant secretary in the Carter administration. He and General

Heiberg had a very good working relationship, and I think we all respected him as an individual and how he ran the office. My own personal experiences were with Victor Veysey. He was the first Assistant Secretary for Civil Works, when I was in Public Affairs, and it was a rather vitriolic kind of early start that I witnessed then.

Like everyone is in any transition when you're with a federal agency, we were looking forward with some anxiety as to what it is we're going to have to do. We're going to have to bring aboard and educate that person as to who we are and what we are. There was some feeling that we might have to fight all the old battles all over again because anybody who wants to make a cut would look around and certain things seem to be obvious things to cut whether they've been disproven over and over again or not. Also, there was the Corps' positive can-do attitude. We wanted to get on with getting our guy, the Assistant Secretary for Civil Works, and making sure he had the opportunity to know us and understand us so that he would be our best representative.

So, with all of that, we were really looking forward to the new administration. The Reagan transition folks were well advised in all the papers as to what was going on—only we couldn't find ours. No one seemed to be interested in these early days about the Army Corps of Engineers and what was going on. We kept waiting for the phone to ring, for somebody to come get briefed about us and what we were doing because we wanted to get in early and we had a lot of staff work done and we had everybody prepared—Bory Steinberg and others—all ready to make the necessary contacts. Nobody called for the longest time.

Now, you have to remember that my last duty day was in December because I reported to work in the Ohio River Division in January. The time between the first week in November and the end of December is about seven weeks long, so there's only a short period in there. What might have been happening with transition teams toward the end of December and January might have missed me.

The other major things that were happening during my period in Civil Works were the National Waterways Study and the National Hydropower Study. Even in the short four months' time I was there, I got very involved in them, to include going out on the road with the Institute of Water Resources folks and being a front person for public meetings in various parts of the country on the hydropower study and the waterways study. We would take testimony and listen to the talk, give talks, that sort of thing.

To get back to what started all this, I don't remember a Stockman Manifesto stated in those kinds of terms.

Q: Okay. That might have been late in December, I think.

A: If it was dated December, at that point, that's about when we were starting to have some contacts and maybe looking to see something happening.

Q: Well, you were only in that Deputy Director of Civil Works job a short time, but do you have any comments or feelings about how it was to be Deputy ACE and how it was to be Deputy Director of Civil Works? Similar? Two very different jobs?

A: Some of both, I guess. Anytime you're deputy, of course, you're number two, and number one calls the shots. So, you fall in with the style of the principal and you're taking on those things the principal wants you to take on. It was rather specific the way General Read divided things up. That is, he took the congressional side and dealt with the Army senior leadership; I took the Programming Budget Committee "put it all together" side.

Then you have to be able to cover in the absence of the principal. That's not always the easiest thing to do when you have to step in because number one is very comfortable where he is, knowing what he knows. Then he steps out for a couple of days or a week and number two steps in knowing the basic business but maybe not knowing all the nuances that the principal was dealing in. So, there's always a little bit of anxiety, "Do I know everything I need to know to carry it like he would have wanted it carried?" Not just the rudimentary stuff, but to play the nuances. So, in the ACE's shop I was very much involved in the processes, ongoing, intense kind of processes.

The Civil Works shop was quite different. First of all, I'd been General Heiberg's deputy once before so I knew him and he knew me. It was a brand-new arena. That is, I went to the ACE's shop right out of Europe, where I was dealing with the same things, so I mean I really had a feel for the issues. The environment was different only in that it was the Army Staff environment. When I went into Civil Works, many of the people I knew from my days in Public Affairs—Bory Steinberg, Alex Shwaiko—I knew them from that time frame, but now the issues were different and I would be dealing on a higher level. Tenn-Tom was a big issue, you know, with lots of articles in the newspapers, environmental programs, hydropower, private development. I mean, here were macro issues and I was coming in at the highest level of policy formulation and yet I had not been down at the bottom coming up like I had just moved from Europe to the ACE.

You know, it was working with people, the familiarity was there, the easy kind of way General Heiberg has, his daily sunrise service meeting. George Robertson had been the Executive Director in Civil Works. Once I was announced to go to the Ohio River Division, General Heiberg made George a deputy as well, so he was working with two deputies. We'd have a sunrise service, as he called it, every morning at 7:30. We would sit around and talk about things for the day for 20 to 25 minutes, then we'd all go off on our separate ways.

In the ACE, the Army Staff was intense and you knew you were going to come in and be engaged in combat all day long on issues. In Civil Works, since I was new and learning and getting involved, I had time to advance my learning, but yet I might get a flash assignment with little warning.

For instance, one day I participated with the then Chairman of the Council of Economic Advisors and a whole bunch of folks at the White House. The Carter administration had invited all the hydropower people to come over and have a meeting at 10:00 that would be

followed by a reception and that afternoon with a big press conference in the East Room where various cabinet folks would talk about what the administration was doing in hydropower. It was at the sunrise service that morning, 7:30, that General Heiberg said, “I don’t think I’ll go to the White House meeting today. Why don’t you go for me?” I had about two hours to prepare to go to that meeting. So, I mean, there are challenges and then there are *challenges*. [Laughter]

So, I went over to the meeting chaired by, I believe, Alfred Kahn, Chairman of the Council of Economic Advisors. He really was a sharp individual, good wit, obviously a top-flight guy in command of the situation. He had a command presence as he ran the meeting, was really in charge, could put himself down, had a sense of humor and everything else. I remember at this meeting I didn’t make the table—I was sitting in a row of chairs on the wall. After Alfred Kahn had given a short briefing, the first question came up. Now, the administration had identified something like 94 to 96 federal dams, almost all in the Corps of Engineers, which could be made available for private development. We had a bigger list, up to maybe a thousand, with various stages of difficulty. The 95 were the ones that could be done without too much problem, and we were not hot on allowing development of the rest of them. There’s a lot of practical problems when you do this.

The question was, “Well, Mr. Chairman, tell me, is this going to be the only list? Are there going to be more of these made available? What I really want to know is, is this just a Carter administration ploy for the upcoming election, or do you really mean it and is this going to be an ongoing program?”

That was the hot question. So, Chairman Kahn said, “No, of course not, we really mean to make this an ongoing program. General (pointing to me), I want you to tell him about what’s coming next.” [Laughter]

Since I knew what the answer was—I had met briefly one of the executive people for this committee as we started and knew he had been the coordinating person—so I said, “Well, that’s correct, and so-and-so over there has the list of those also being considered, so why don’t you take it from there?” [Laughter]

Q: That’s an iffy time to be at the White House, isn’t it, right before an election.

A: Well, so we went down to the reception afterwards where we had cookies and sweetened iced tea. I was standing there when one of the staff came up and said, “Here’s a couple of Carter supporters from the White House, General. Why don’t you tell them what you’re doing for Texas?” I was happy to get back to the headquarters!

Commanding General, Ohio River Division

Q: So, in January of '81 it was off to Cincinnati and the Ohio River Division, and a rather quick change from your previous assignment. What kind of preparation, transition, were you able to have in going to the Ohio River Division?

A: Well, I don't know how much anyone ever has. I think I probably had as much and as good as anybody could. First of all, the four months in Civil Works were helpful in digging into that arena and knowing things. Since I knew I was going to the Ohio River Division, of course, I listened more intently to those items wherever that was mentioned, or I could note, you know, a particular policy having to do with large dams. When involved with budget issues, I would always note where the Ohio River Division stood relative to others. Although I didn't really spend time focused on the division, I nevertheless could look for perceptions of the Ohio River Division, and I could go around and talk with Alex Shwaiko, Lew Blakey, and Bory Steinberg, and others to get their insights on what was ahead.

In addition, Tenn-Tom was a big item at the time. I'm not sure when General Heiberg made the famous testimony before the Senate committee, but I remember a roomful of people. I think it was during that time frame, but maybe when I was still in the ACE. I knew I was going to the Ohio River Division so I went to hear the testimony.

Also, because I was going to have to testify in the fourth or fifth week after I arrived in the Ohio River Division before the House committee, I flew out to the division and had an early get-acquainted briefing session, but primarily oriented toward the budget. Thus, when I arrived out there, we could immediately go into final budget preparation. I mean, the budget was all prepared; it wasn't a matter of putting the budget together but preparing me to defend the budget. At the Ohio River Division we used mock hearings to prepare; that is, the district engineers and their staffs came in and the division engineer and his staff would then be the committee hearing the testimony of the district. We would do that with our own testimony books before us with the projects that I was later going to have to be able to defend before the congressional committee. That first several-week period in the division was rather intensely devoted to the budget, and so going out there in advance one time to get a pre-brief was helpful.

Q: At that point General Griffith was gone, right?

A: He had left that summer.

Q: Did you really have any interface?

A: There was a six-month underlap. Colonel Rich Gell, the deputy, had been the acting division commander. I talked with General Griffith here in town briefly and he filled me in on some of the main people involved and his evaluation of them.

Q: Anything from the Chief of Engineers, instructions or advice? Or General Heiberg?

A: Well, I guess time erases most of this. I'm sure they had some things to say. General Heiberg, I know, was helpful. We talked a lot in just looking forward. He had been the division engineer out there. He liked the people. I'm sure he commented on them, and had a few insights that he passed on.

I guess the one I'm sure they all mentioned was the Tennessee–Tombigbee because it was a major issue that required focus because it was continually under attack. Every year the coalition of environmentalists and railroads would gather their supporting congressmen, and they would prepare to do battle in the annual budget process. Congressmen [Jamie] Whitten and [Thomas] Beville and their staffs were fighting the “pro” fight to keep it going. There was almost a siege mentality in that the votes were closer than people wanted them to be, and you just never could be sure that something wouldn't happen to tip it another way. So, they wanted to make darn sure that we were proceeding with the construction as fast as possible.

Q: Was there much interaction when you were first getting ready for your testimony, taking a project like Tenn–Tom, for example, with the South Atlantic Division, which had more of the Tenn–Tom work, I believe, than your division did? What kind of interaction did you have on that particular project?

A: Oh, considerable. First of all, the South Atlantic Division had the lead role—they were the lead division, no question about it. Major General Jim Ellis was the South Atlantic Division Engineer at that time—an old friend and West Point classmate. We had talked before my arrival in the Ohio River Division, and we got together early on to ensure we were coordinated. We met quarterly with our staffs at various places, to ensure we were all locked in and moving along. We did our independent work but we submitted all matters through the South Atlantic Division with respect to the Tenn–Tom budget and program. They really had the overall responsibility, which was right, not just because they had the major part of the project in their geographic area.

To answer your question, we stayed coordinated throughout and we were coordinated on our testimony. That particular year, 1981, we both testified before the Senate, which typically hadn't held hearings. In all the hearings, the South Atlantic Division would go first and we would follow. We'd always be locked together—General Ellis would cover the overall aspects of the Tenn–Tom plus give the update on Mobile District's part of the actual construction. Then I would follow with Nashville District's part, which was the very significant divide cut, which always had a high focus. Although there were many different aspects and parts to the project, some had to do with cutting out bends and oxbows and weren't so dramatic as cutting 175 feet through the divide—so a big budget item, big ticket item, always something to measure, something to see, and really a significant thing. You could build all kinds of parts of the waterway, but till you cut through the divide, you couldn't pass the water from the Ohio River basin to the Gulf.

The divide cut plus Bay Springs Lock and Dam, the largest lock chamber (84 feet) in the system, were rather significant components of the whole. I would follow the South Atlantic Division and report on those aspects of the waterway project.

Q: Did those have every bit as much environmental attention as any other part of the overall project? In other words, you had a significant environmental opposition component to your piece of it, as well?

A: Yes. The divide cut being so large a cut, we had 38 different disposal areas that had to be environmentally engineered. Also, the South Atlantic Division changed the location of the proposed channel in their area to avoid some historical and archaeological finds. We were very much concerned, for example, that we were bringing to the surface materials that had been at some depth. These weren't topsoil, but sands with a high mineral content, and their ability to grow things was doubtful. So, how we would position and place them was important, so we in effect very specifically designed 33 disposal areas.

These were not just ravines and depressions that we hauled to. They had to be designed, material brought in the right way and compacted the right way. We had to design for flows and we had to build retention ponds to catch the flows, so the waters flowing over these interior sandstones would have a chance to percolate and clean up before they reached the streams again. So, there was considerable environmental work through the divide cut.

Q: Would you say, then, that overall, the Tenn-Tom project maybe occupied the majority of your time in the civil works area when you were at the Ohio River Division?

A: No. I'd say that in the first year the Tenn-Tom occupied a significant part, maybe 7 or 8 percent. Compared to other projects, which might have had a quarter of a percent or something like that, it occupied 7, 8 percent of my time. We did an awful lot of work in preparation for testimony and those things. We often flew tours of the Tenn-Tom to educate various congressmen on the project. Congressmen Bevill and John Myers, as well as the Senate side, would identify members and talk them into taking a trip down to see the project. Typically, General Ellis would be in one helicopter with three or four congressmen and a staffer or two, and I would be in the second helicopter with three or four other congressmen and a staffer or two. I'd have one of his, the South Atlantic Division, people with me and he'd have one of my Ohio River Division people so we would talk about all aspects of the project.

We typically started at the northern end, the divide cut end because we could come in to the airfields at Muscle Shoals and helicopter over to the project. We would then fly the divide cut, which was very dramatic when you observed the massive cut, and then hit Bay Springs Lock and Dam, which was rising up out of the ground. Then we would fly down over the next five locks and dams immediately below Bay Springs. They were in various degrees of construction. The northernmost were just getting started, and then as we flew south they were in different stages of construction. When you got down to the last one, which was completed, we would stop there and tour the lock and have lunch. Then we would either fly back from there or continue on down to Mobile. The trip on to Mobile was flying over that part of the project that was straightening out bends and oxbows and widening and dredging—not so dramatic to look at.

We did that quite often. It might be for folks wanting to be updated or it might be people who'd come down to look at concerns. I remember Congressman [Louis] Stokes came down from Ohio. He had been most concerned that people had said we weren't really doing our job in hiring minorities. The antiproject groups had attacked the project from that standpoint. I think we had done a pretty fair job of minority emphasis and it had been a part of the project all along. As a consequence, Congressman Bevill knew that, and he invited Congressman Stokes to come down and see for himself. So, he brought him down. During that trip we broke out the facts and figures and briefed him on them. I believe that convinced him that we were on the right track and doing the very best we could in the area and doing pretty well. Thereafter, he supported the project.

On the opposing side, Congressman Bob Edgar came down from Pennsylvania. He had been a very outspoken critic of the project before that. He asked a lot of tough questions, and we gave him all straight answers, but he remained a very outspoken critic of the project after that. So, we had folks of all ilk down there, showing them the project. Typically, we would make that helicopter run so they could see the immensity of the project, and we'd also land at our area office in the divide cut where our area and resident engineers would talk about the project and where they were that day, how much was already done, and how much remained. We could then talk budget issues or percentages and that sort of thing.

South Atlantic Division had put together an intercom setup that they would bring to the helicopters because when you get different helicopters from different people you never know how many headsets you're going to get or what works. Their setup had something like eight headphones so we could give everybody a headset. Thus, we always had communications so that we could talk in the air and point out features as we flew along.

Q: Were the costs of the project one of the big issues—probably the biggest issue outside of the environmental?

A: Yes and no. The overall cost of the project was always featured when people would attack it. Years earlier, costs had been a factor in the early construction of some of the first of the dams. I know the South Atlantic Division and General LeTellier had been involved with early cost estimates. By my time frame, that was history. We had already spent about half of the project. We were certainly doing big ticket items up where we were. There was a lot left to be spent, and I think that increased the zeal of the folks against the project. They figured they really needed to get it stopped immediately. Of course, it made the point for those who wanted to continue the project too—there was an investment on the ground.

Even the environmental issues were typically used as an opportunistic way to oppose the project. I mean, the people against the project were primarily brought together by the railroads, who were trying to avoid the competition of the waterways. They led the fight and they signed up the environmentalists to aid their actions. Certainly there were valid environmental considerations, but in the end, I'm pretty proud of the way the Corps addressed the environment, did things the right way—used good engineering practices to solve environmental problems.

As a matter of fact, I later on had been asked by a professor at Miami University at Oxford, Ohio, to come up and talk to his class on environmental engineering two straight years. I used the Tenn–Tom as an example of how an engineer deals with environmental issues and construction development. You see, I could make the point that although there was a channel where there was not a channel before, certain things were seen by some as improvements—bass fishing was superb the very next year after we opened Bay Springs Lock and Dam. We protected against wash of any kind of nonnatural flow into the stream during construction. We avoided with well systems and dewatering systems, sloughing off of the banks of the 175-foot-high cut—we pulled the water table way down there. We worked hard to design against environmental injuries and for environmental improvements.

We took great care in building the disposal areas and shaping them so they would drain properly. We put topsoil on them, and lime, and other things, and we tested them. Some of the soils were very acidic from coming from the subterranean sands. It would be difficult to support any vegetation on them. We would treat the surface and put on the lime and then we'd sow grasses. Then we'd come back and monitor the systems for draining and settling particles before the water percolated back into the stream. We really took a lot of care to make the disposal areas be a positive, not negative, environmental feature. Even shortly after finishing, we would go down there and people were talking about what a great duck flyway we had built—because they now had all the ponds along the way where we left them up in the disposal areas—and how good the hunting was, and the fishing, and things like that. So, I think we really did do it in the best environmental way possible.

I think you have to remember that the main advocates against proceeding were the railroads, who put together a coalition of opposition.

Q: Did you have occasion to have direct interaction with railroad executives during your time?

A: No.

Q: Okay. I don't know if you have any other Tenn–Tom observations or comments at this point. It might come up again.

A: Well, of course, it continued throughout the period that I was division engineer. We had the opening of a dedication of Bay Springs Lock and the divide cut just before I left, so I got to be the division engineer that finished the project. I did leave a few claims for Pete Offringa to take care of later on, but the clamor during that time was to finish. Oftentimes we came to Washington to brief Hunter Spillan and Congressmen Bevill and Whitten where we were on the project. The idea was: don't let the schedule slip, deliver on time, and don't let costs increase.

We were held closely accountable for progress, not that we weren't always accountable, but maybe with some sense of skepticism on their part that we really were going to finish when we said we would. So, we picked a date and said we're going to finish by that date—if you keep getting us the money we need—and we met those time frames. That was something, then, that the congressional supporters of the project didn't have to go back and say to their

colleagues, “We need to give them so much more money”—whenever they would go back to the well for a revote, which they had to do every year. The system provided that the project could have been killed every year if the money was not appropriated to finish it. So, it had to meet the test, I don’t know, 12 or 13 different years, to be continued, to include the very last year. It seems kind of preposterous that when you have \$1.2 billion invested in a project and for the last \$100 million Congress might scuttle their big investment to date—but that was the legislative system.

So, I spent many hours going down there, inspecting construction and following up, in addition to quarterly meetings with the South Atlantic Division, just making sure the project stayed on track, then coming up to Washington and reporting the project was on track. In fact, it stayed on track and we made our schedule.

Q: Who was your district engineer in Nashville during this period?

A: Colonel Lee Tucker was the first two years. Then Colonel Terry Kirkpatrick came in my last year and was the one there at the finish.

We had some just tremendous people working there on the project. The team put together to work the Tenn–Tom was just super. Euc Moore was the Chief of Engineering in Nashville District, and Charlie Hooper was the Chief of Real Estate. The Chief of Construction was Dan Hall, and Jerry Rainer, the area engineer, had three residents underneath him, such as J. C. McDaniels, who had the divide cut. All were top drawer, salt of the earth, Corps of Engineers kind of folks that you just felt good about. You know, I’d go into the area office and turn everything over to them and they would brief the congressmen straight on. I mean, you know, every day they’re out there in their construction boots and hard hats, chasing the contractor and making sure all went well. When you’re sitting there with a massive project—you have to recognize, now, the claim that Morrison–Knudsen put in on the divide cut project was \$50 million, so it had to be a pretty big project. They didn’t get that, by the way; that was what they claimed for costs associated with unknown conditions.

We had great folks down there working on the Tenn–Tom. They were just great to be with. From the district office—the care that the Chief of Real Estate and Construction and Engineering and Planning put into the project—down to the area and resident engineers and their inspectors.

Q: What was it like taking these congressional groups on tour? Was it a fairly routine business sort of thing? It must have been something of a strain if you had a helicopter full of critics of the project—really put you on the front lines.

A: Well, it was, but—I don’t know. By this point in time I was used to doing it—I mean, having testified and being used to senior Washington people by this time. You can’t do much else but deal with them directly. When you get a question, you answer it truthfully and factually, whether it’s coming from a supporter or a critic. So, when Congressman Bob Edgar would throw tough questions out, we’d answer them straightforward. He might be throwing soft curve balls, so we’d better be answering those straightforward too. I mean, he sounded

almost like a supporter sometimes when he was down there, he was so smooth—but he got it straight from us just like the rest.

By the same token, Congressman Bevill, a supporter, would throw out tough questions, which would be making certain points to other people or really wanting to make sure we were staying abreast of the issues. The only way was dealing with it all straight. We didn't participate in getting them there or getting them home. They would usually fly in on the Chief's plane to, say, Muscle Shoals. We would have flown down from the Ohio River Division and Nashville in a chartered aircraft—the division didn't have an aircraft. I'd bring some of my staff and we would fly into the same airfield. General Ellis would fly up from Atlanta the same way and then the district engineer from Mobile would be in charge of all the logistics.

He would bring the helicopters and the headsets and everything else. We would assemble there an hour or a half an hour before the Chief's plane arrived. They'd typically be running late because they got off late from Andrews, so we'd pile them all in and we'd roar down the Tenn-Tom Waterway talking about the project. Then we'd land and visit the area office and handle all these questions very directly, then fly on down to the other office, have probably a box lunch or something like that. We'd be tossed questions, and we'd all be sitting with our area engineers and the party in a group. Then we would hustle them out to the airplane so they could fly back to Washington. It was a rapid-fire day. Then we would hop aboard our charter aircraft and fly back to Cincinnati—so it was just another day in the life of a division engineer. [Laughter]

I mean, we would prepare our notebooks, you know, so that we could flip to pages and have the right map to show whoever wanted them, with the facts at the right place, anticipating questions and that sort of thing, but most of the time we got so we could wing it because we'd done it so many times pointing out the project features.

Q: It's a lot of high visibility. It probably means that the congressmen know more of the names on the lists of generals to be promoted from the Corps than they know from any other branch, probably. They knew you personally.

A: Well, probably, but we're talking about a few handfuls of congressmen total that went down through all that. I mean, certainly Bevill and Whitten, and John Myers from Indiana, the ranking minority member, were perennials. They knew the Corps' generals from all of this, from their testimony and the other contacts.

Q: Does congressional testimony get to be routine too? Or is that different?

A: No, it never got routine. I think I got better at it, but I don't believe it ever got routine. Of course, we were dealing with a tough staff. I mean, Hunter Spillan's not the easiest person to deal with, but I think he was pretty straightforward. As long as we were dealing with him straightforward, things were all right. So, it was like anything else. I mean, you just ought to be forthright and straightforward. You really want to do your homework. You can't go in there blind.

From the first year, where I really had to take what was there for testimony, I always tried to develop really a story line and to say something, not just review projects, not just a catalog of, “Here’s what we’ve done,” but to point out what it meant in terms of the budget. I worked hard on my budget statement every year. Of course, it was printed in the record and it’s all sitting there. It was really a “Here’s what we’re doing and what we need and why” kind of a statement for the division. There was a longer written statement, and we would cut that down for the oral briefing statement for whatever minutes they gave us. We would then try to anticipate questions and answers. I would call on the various congressmen and their staffs prior to testimony to ensure I was ready. I would call on Hunter Spillan to identify issues, make the connections, and ferret out potential areas that he wanted to make sure were answered.

We could usually be prepared to address what would come up, but it was never routine. The first year, besides the Tenn–Tom, we had another most significant project because it was a controversial one—the Section 202 flood control program in West Virginia, Kentucky, and Virginia.

The event that led to that was a very large flood in April 1977 that wiped out portions of those three states and inundated the Tug Fork and the Levisa Fork valleys of West Virginia and the upper Cumberland River in Kentucky.

Five cities were named in the legislation, which was widely pushed by Senator Robert Byrd. I only mention his name—there were others—because he was the one who was most visible in our connections thereafter. That legislation mentioned Williamson and Matewan, West Virginia; Pineville and Barbourville, Kentucky; and Grundy, Virginia, as the five cities. It basically said that regardless of all weather policies and normal ways of doing things, we would provide measures to alleviate the flood conditions of the standard project flood for the area. The specific language is important because when Secretary Bill Gianelli later got involved—he was not yet there at the time—he thought the language was too *carte blanche*, and so he opposed the project. Senator Byrd had been a writer of the legislative language, along with Senator [John] Cooper from Kentucky and others. He knew what he intended it to mean, and so we in the Ohio River Division and Huntington District found ourselves in between two giants, Gianelli and Byrd, and their different interpretations of what was meant by the project. That remained a ticklish situation throughout my tenure as the division engineer.

This very first year of testimony for me also coincided with the Senate’s wanting to have testimony on the Tenn–Tom. Senator Byrd also wanted to hear about his Section 202 project. I remember it well because the hearing was held in a very small room in the Senate. We really had to crowd in. General Ellis was at the table because the South Atlantic Division always testified first on the Tenn–Tom. I was standing in the back and could hardly get through to my seat when it came time to swap. Ellis got up and I came in. Everybody was looking around, and the committee chairman looked around for the majority leader, who wasn’t there. Someone said, “He’s not coming.” So, everyone got up to leave and then all of a sudden somebody says, “Senator Byrd’s on his way,” so everybody scampered to get back in their seats. He really was very pointed and direct in his questions to me. I mean, it was

almost like a prosecutor and I was on the stand. He was nailing down where we were to make sure we were moving out and implementing that project as conceived and on a responsive timetable.

We had anticipated this, knowing his interest, and I had flown out to Williamson. I had been with Senator Byrd earlier on the R. D. Bailey Dam dedication before I had even become the division engineer. When it came time to dedicate R. D. Bailey Dam, which was in southern West Virginia, the Chief of Engineers couldn't go, General Heiberg, the Civil Works Director couldn't go, and so they asked me to represent them and fly out there with Senator Byrd and back and give the remarks. They told him that, although not yet announced officially, I was the future division engineer in the Ohio River Division, so the person he was going to be working with would be there.

Senator Byrd really wanted to pin down where we were—and the 202 project was large and not yet to the point of designing so we could start building something physically. What he really wanted to tie down, like I guess any congressman wants, was something on the ground, some visible action that things were happening. So, I was telling him at that point about when we were going to start the first increment, a pumping station, at West Williamson—as part of that project. He was interested when we were going to build the flood wall at Williamson—we're talking about a 40-foot high wall—but we were still doing the engineering on that project.

We laid out the program as we saw it. His questions really nailed us to the wall—he meant that program to proceed rapidly, and he meant for us to deliver that program as it was. So, it was a pretty strenuous 30, 35 minutes of questioning by Senator Byrd after only five weeks in the job.

Q: Some of those questions were probably actually directed at Gianelli, at the administration.

A: He wasn't there.

Q: He wasn't there?

A: I don't know that he'd even been named by February or March. I just don't remember. He didn't participate in that first year's testimony, so we didn't really know of his antipathy to the project at that point in time. I mean, this was straight-on. We read the language, we interpreted it the way we thought it was meant to be, and we testified as to how we were going to proceed. It was later on that Secretary Gianelli interpreted it differently, when the administration came up with the cost-sharing proposals that they wished to apply and Senator Byrd didn't think they should apply because of the way the language was written. Gianelli wanted to reduce the project, to be designed at standard project flood, back to a hundred years' storm.

Q: I think that level was perhaps even less than the big flood that this had all been in response to, or it was pretty close. That was one of the issues, I think, that they wanted to bring you back from standard project to something that was the original cause of all this.

A: The fact was that we had testified one way. Secretary Gianelli sought not to take on Senator Byrd directly, but sought to see if he couldn't have us change our ways. Well, we were part of the administration and, of course, had to do things in accordance with administration policy. Nevertheless, we also had responsibility to call a shot a shot. If this was a standard project flood design, it's a standard project flood. The secretary had some consternation with us because we kept sending him plans and designs and programs that he didn't want. Yet, it represented the way you solve that particular problem, given what we were given.



General Kem with Mr. William R. Gianelli, who was Assistant Secretary of the Army for Civil Works from 1981 to 1984.

Then he would get calls from Senator Byrd, "Where is it now?" He told me that he didn't understand why Senator Byrd's office was always pressuring him to give him things that he didn't even know about yet, insinuating that we were calling Senator Byrd and telling him to call. The facts were that Senator Byrd's staff was very good and he was very personally attuned to this project. In fact, they were calling us weekly, sometimes daily, asking where

something was. So, if we had just had returned to us something from the Secretary for Civil Works to redo, then we would tell him we just got it back to redo. Then if he would take umbrage to that, he'd call Secretary Gianelli's office and say, "How come you returned it?" So, he'd get an answer. Then we would send it back up, and he would know we sent it back up because he would have called and asked, "Where is it, have you sent it back up? Haven't you finished it yet?" We'd say, "No, we haven't finished it yet, we're still working on it." Then it would go up.

We could be passive from our standpoint because he was very actively engaged. Senator Byrd had a very sharp staff operation that always stayed in tune. He knew the value of staying in tune and intelligence, and so when the report would go back up they'd know it. It would stay three weeks in Civil Works, Planning, Lew Blakey's shop. Senator Byrd would know it was there so he'd be calling them, "Where is it?"

When they'd ship it over to Secretary Gianelli's shop, they would call them and ask, "What are you going to do with it? When?" So, the secretary could not escape dealing with Senator Byrd on this issue. I believe he thought he could by burying it with us, but it was not to be buried because it was so active. So, this put us right in the middle.

In this first episode that I was talking about, in the testimony in February 1981, Gianelli was not yet aboard, had not yet visited the site, and so this was a very straightforward testimony about what we planned for the project.

Of course, in the years afterwards, Senator Byrd used the figures and milestones that we had given that year to say, "You said you were going to do this by this date; where are you now?"

We took Secretary Gianelli to the Tug Fork Valley on a first visit some months later. We thought it would be straightforward; we would just show him how important this project was, why it was necessary and all of that. As we flew up the Tug Fork, his disdain for the project was apparent. We got to Davy, West Virginia, a coal mining community that was really down and out, with a lot of poverty. It was a place that then Senator Kennedy had visited during his campaign in '60 and had received a lot of TV coverage. We almost had to land vertically in the town's softball field to get in there by helicopter. We then got in a panel truck to drive around through the town. We passed over a stream. The stream was littered with car bodies, and a couple of diapers were floating down the stream. Seeing this, Secretary Gianelli said, "These people don't deserve to be helped." We knew we were facing a critic of the project right there.

Q: So, was a lot of it a question of definition on his part, do you think? That is to say, you know, what are you talking about, define it, and then what is the legitimate federal role in that? Is that more where he was coming, or how much money the federal government should spend on such things?

A: I think so. I think there was a legitimate federal role, part of it, and he was carrying the administration's banner, which was cutting back the amount of federal participation in things. Plus, there was talk of cutting budgets back and there was the money question. Those

were basic involvements of his. We tried to suggest that the legislation as passed, signed by the President and everything else, said certain of the normal things were overcome by the words of the legislation and, “Therefore, Mr. Secretary, you really need to deal with those issues with the Congress straight up—that is your role as the secretary. If you deal with those issues straight up at the top, then it’ll be clearer to us about how we proceed. If you don’t deal with them at the top and only talk to us about your misgivings—and don’t talk with the man who wrote the legislation—then we are probably going to be having a lot of stress because the legislation says we should be doing something, and we have a person holding us and you accountable for it, and so we’ve got to deal with it. So, who best to deal with that—us at the bottom or you at the top?”

He chose not to deal with it till later and tried to go by these other means and stretch it out, so that made for some touchy times in dealing with the Section 202 program.

Q: How far had that gone by the time you left in 1984? Was the project still ongoing?

A: Yes.

Q: Gianelli was still there, I think.

A: Yes.

Q: So, was it still that this guerrilla warfare hadn’t really been resolved?

A: Well, it was resolving. It was resolved shortly after I left, as I recall. Secretary Gianelli and Senator Byrd finally did come to grips with what the legislation meant. The resolution was that the most liberal interpretation would apply to the five named communities, but not for the others. That was helpful and that would have been helpful to us early on because we had to study the whole watershed areas to find other places to determine what we needed to do to protect these areas. We had community concepts all over to bring protection to this same kind of high standard. The new agreed-to resolution greatly reduced the number of communities to be protected.

The problem at Matewan was how to protect a town that had almost been completely destroyed by flood and almost didn’t exist any more. We practically had to rebuild a site for the town and then protect that site from the flood while the town was rebuilt. Now, that’s pretty important in West Virginia. See, that’s one of the social issues involved in determining what is the federal interest. What’s a social interest; how much should people do; what’s right—in that almost everything in West Virginia along the rivers is vertical and communities exist on narrow floodplains alongside the rivers in the deep valleys?

Q: In the floodplain?

A: In the floodplain—that’s right. So, what do you do? Even people living up the hollows and those who were doing the coal mining would come into their community seat for their dime store, supermarket, and movies, et cetera. For that country seat to exist, you had to protect something. So, should you have a Matewan or not? So, that’s where the gut issue was, and

certainly with Senator Byrd. In the Section 202 authorizing legislation, they had come to grips with that question and decided, “Yeah, these communities we ought to have.” Secretary Gianelli, from his viewpoint, didn’t see it that way.

Another issue in the Section 202 project was providing alternate housing. We thought we had developed a pretty creative approach for a nonstructural solution. The Corps was always being criticized, “You always only find structural solutions. Why don’t you look for nonstructural solutions to some of these flood control problems?” We found, near Williamson, one rather large draw that we thought would support a new community. Our intent was to build a housing community—I forget the number, some 65 units would fit in there. Not many, but a lot considering the size of communities we were dealing with. Then people could move to that new housing and give up areas of the floodplain. We then would remove the vacated houses and that area wouldn’t have to be protected at the high cost of floodwalls. It was a cheaper solution—a nonstructural solution. Also, not a normal solution, so we very excitedly briefed the secretary that we’d found something that we thought would hold down costs. We also had arranged for the West Virginia housing folks to take care of running it so it would not be federally maintained. We were just going to deliver the project. We thought he would find this approach desirable, and he was absolutely opposed to it.

So, in the meantime, we still had mayors calling us every week and Senator Byrd calling us concerning the project. That took place in the Kentucky part of the project, although we just never had the congressional visibility or interest there. We were progressing in Pineville and Barbourville on projects. Pineville, very specifically, had a loop in the river where the river leaves the mountains and the river flow makes a big bend away from the mountains. That was just enough space for people to build a town. Trouble was, when the floodwaters came up, they inundated everything below that mountain in the valley, to include the whole town. That was Pineville.

Finding innovative solutions for Matewan was a challenge and involved the whole town, which made it costly. This was also a program—the 202 program—that took a lot of my personal time. Maybe this one took more time than the Tenn–Tom because there was so much consternation in the secretary’s office. They were always returning stuff to be retooled and arguing against our budget projections and insisting we couldn’t do certain things.

Basically, I took the position not to compromise our ethical position. When told that something couldn’t be accomplished because we weren’t ready, then I would correct that misrepresentation.

Secretary Gianelli perhaps felt he would lose on the Section 202 affair with Senator Byrd and tried to make it not work through us by claiming we were unable to deliver. We knew we could deliver and had testified to Senator Byrd that we could deliver. The senator, in fact, believed us from the start and knew from past experience that we could deliver. So, the secretary’s working 202 the way he did was not creditable to Senator Byrd; that’s why he kept putting the pressure on the secretary.

The senator's office was smart enough to know that he couldn't just pick on us to keep us in the middle. Gianelli was putting us in the middle but Senator Byrd's office knew we didn't belong in the middle, so he would focus attention back on Gianelli. He knew to deal directly at the top, knowing that's where the deal had to be made. The secretary chose not to engage there for the longest time, until after I left.

Q: Did you have other projects during your time in the Ohio River Division that the assistant secretary's office got involved in to that degree, had that strong feelings about it, or was this really the major one for the division? How about the recreational areas closing in Pittsburgh and Louisville Districts and reduction of locking services?

A: Oh, yes, those were other raw spots.

Q: Let's see, were they tied together as issues?

A: No, they were really separate issues. They did focus on the same thing, and that was on the administration's goal to cut back federal expenditures. Secretary Gianelli was the administration's responsible man in the water resources arena, and he was trying to make it happen. The problem was in all of those things, there would be a pronouncement of the policy and then the facts would be requested. When we'd present the facts, they weren't always supportive of what had ever been in the secretary's mind when he made the policy. So, the statement might be made, "We need to close recreation areas and you can do this without any problem and save so much." Then we would be asked to go through the drill to evaluate our recreation areas, address potential savings and how we would do it. Our Corps recreation areas, for the most part, are very austere manned. A lot of times they're contracted out. A lot of times the only people we have at a dam are the people required to operate the dam for purposes of safety, and then they check, as our contracting representative, the contractor who would operate the associated recreation area.

If you only have two people at a dam and recreation site, you can't really cut them—so you don't really have a saving. The idea, then, would move on to, "Well, then contract more out." Contractors only contract places where they think they can make a buck and have a going organization. So, the good ones were already taken over and the other ones they didn't want. Then what remains of our responsibility? We have a lot of roadside pull-offs, which we didn't particularly care for either. Maintain those? A motorcycle gang could trash one in a matter of a few hours, chuck stuff out, rip stuff up, throw all the beer cans around. I mean, these were not all fun responsibilities to have, but we'd build the recreation areas of every type under some kind of program. So, do we have a responsibility or don't we? How do we get out of that responsibility?

The states said they didn't want to take them over because they didn't want to clean up after those motorcycle gangs either. So, can we just walk away from it or can't we? I'm saying this to highlight the kind of issues we faced. Once you then add up all of those things, those we think we can do, the things we think we shouldn't do because of low levels of use, and the things we know no other state or contractor wants, when the answer is not satisfactory to a secretary who has decided it is all a pretty simple matter—you just have to close down this

program or cut it in half, or whatever. The policy maker would write a policy that he thought was going to save X amount of money. The policy was tough to write in executable terms and the money never seemed to get saved.

Our problem was that by presenting the facts, we would be looked at askance with statements being made like, “You’re not supporting what I’m trying to do.” Well, we were trying to be very supportive. The problem was that that policy maker hadn’t sought out the right information in advance of his decision to get an understanding for what was achievable. After you’ve been scrubbed several times by successive administrations, what’s left to be scrubbed? So, to make wise policy he ought to do his homework and then not shoot the messenger when he brings the facts later. Homework is only effective when completed before the answer is stated. Most people learn that in school.

The other issue had to do with tow traffic on our waterways. As part of the fiscal year 1983 budget drill, the administration said they could no longer afford to operate the waterways at the same level of service without approval of cost recovery legislation—a drill to get the barge industry to agree to user charges. As stated, the position was that without user fees there were insufficient federal dollars, so we could only operate part of the system and would close down certain parts of the system.

That was the drill, and it came about as the budget was being put together in the fall of ’81 and then became part of the President’s budget submitted to Congress in January of ’82. To us in the division—the USACE Civil Works staff may have had more direct involvement in this beforehand—it came as a blast of frosty air on a warm night—a surprise, in other words. It was just a pronouncement, “We’re going to close these parts of the system.”

We had had some staff input to verify numbers and that sort of thing, but it came out as an abrupt announcement that, “We’re going to stop and close down the navigation operations on the upper Allegheny, the Monongahela, the Kanawha, the Cumberland, the Tennessee, and the Kentucky Rivers.” Basically, in the Ohio River Division they were only going to leave the main stem Ohio River locks operating.

After his announcement, the secretary asked us to prepare impacts and be prepared for congressional testimony with impacts. We really did a lot of work addressing impacts. They were sizeable—a millions of dollars hit to the economy. The decision reflected a not very real understanding of the integral nature of the waterway infrastructure and the life and economy in the Ohio Valley, for example. It’s interwoven, and the Corps’ role in operating those systems is very integral to what’s going on in all the river basins and the national economy.

For example, closing the Allegheny River system as had been announced. Above Lock 4 or 5 on the Allegheny is a power station that supplies a great amount of power to part of Pittsburgh and the area to the north of Pittsburgh. There’s not a lot of coal goes through those locks, but when you turn down that power station and you compute out how many trucks have to go across the highways to get that coal up there, it’s impractical.

Now, what the decision means is that you turn off power to a very large number of people and a large number of industries. You do the economics and you find out this has a very high dollar impact. We did the same analysis for the Monongahela River and all the others. We did our homework and we could say, “We think it’ll cost this number of jobs,” and that was the impact we submitted.

Now, the problem I had was that in the secretary’s opening testimony to Congress in February 1982 he stated that it was the Corps’ idea to do all these cuts and that he was going to require us to relook the cost and impacts. I’m sitting in the back of the room, knowing that he, Gianelli, had directed us to do that and we’d already made all those impacts and submitted them to his office. He knew they were catastrophic.

Over the following weeks, then, we had to grapple with this issue. Congressman Carrol Hubbard, from Paducah, responding to his constituents who ran a lot of towboats out of Paducah, asked Gianelli to come out to a meeting. He said he’d come. I was with him, and at the meeting he said, “Well, those Corps of Engineers, you know how they are. They try to do these kinds of things but I’m going to relook at how they answer your needs.” I’m sitting there beside him and I know full well that for six weeks he’s had the facts about the impacts of his river system closures and knows that and what to do with them.

So, in the end, those waterways weren’t cut back because the impacts were too great.

Q: Should we turn to the Green and Kentucky Rivers?

A: There were two locks at the far end of the Green River that weren’t getting much commercial use. We already had been looking to try to pull locks out of the system that didn’t have a commercial role. We had closed the Muskingum River in Ohio and given the locks to the state years before. Ohio was now unhappy because it had all these locks and they weren’t commercially viable.

It’s not always a great deal to get stuff back from the feds, the Corps because it usually represents something no longer worth having. Otherwise, we probably wouldn’t get rid of it.

The Kentucky River was an issue, and continued operation of the locks had been challenged by the Corps headquarters. We were looking at the Kentucky and had the Louisville District Engineer, Colonel Gene Eastburn, come up and brief. The first four locks carried commercial tonnage, almost all of it being sand and gravel, a small operation of 10,000 to 12,000 tons per year. Above those four, there was no commercial traffic—Locks 5 to 14. Therefore, I deduced there was no federal interest in maintaining them so we ought to close them. We began working with the district to make that happen.

During 1982 we basically closed the system by taking the operators off, leaving a skeleton crew for maintenance, to the point where if we had a tow, we would send somebody there to operate the locks. As a practical matter, that basically closed the Kentucky River system above Lock 4.

The Kentucky River locks were ancient. Some of the dams still had saplings used for reinforcement of concrete—an ancient way of construction. They were really late last century, early this century construction. They were also very small. To really be a modern waterway you'd really have to invest some bucks in the system. To do it right, we were going to have to start replacing dams and locks, so it really was not in the best interest of anyone to continue. The problem was that between Locks 8 and 9 there were some very pretty palisades. There was a scenic boat operator just above Lock 9. He would board people there and they would have a very nice sojourn down the river, lock through, see the palisades, and return. You could not enter the river between the locks because of the bank heights. The palisades were especially nice during the fall of the year. He had a small, but nice, commercial enterprise there.

Opposition to our closing the river developed, with congressional help. We persisted, and Gene Eastburn spent many nights in various meetings. I think it went on to his successor, Colonel Dwayne Lee, who was the final person to put this issue to bed. He met with governor's representatives. There were hearings and then they changed governors and the state's position reversed. Then we offered it to the state. It didn't have a federal interest, but if the state wished a commercial tourist operation there, the state could pick up the locks and operate them. Many of the arguments advanced had to do with the responsibility for water supply for local communities, and safety, and so forth. Well, we really determined that there was not a safety problem. If one of them should breach during a heavy flood, the flood itself would have already damaged all the things that the breach would do because they were not large ponds.

We welded the lock gates closed and stopped operating them. My recommendation to the Director of Civil Works was to allow the state the opportunity to take over the Kentucky River if they chose, or sell it off to commercial interests if somebody wanted to buy portions such as Lock 8 and operate it. When we thought we had the state ready to go, and they were organizing to do it, then they would change their mind. Somebody came in and said the Corps must restore it to the right levels of service. Since we hadn't spent the million dollars a year in maintenance for a couple of years, we should then spend a couple of million dollars to fix it back to the right condition before they would take it over. Anyway, that was the issue on Locks 5 through 14 of the Kentucky River. We basically closed it of our own volition.

Q: You went from the position of Deputy Director of Civil Works to the Ohio River Division in January of 1981. Could you say a little bit about how the assignment came about and your transition into the division?

A: Well, I was selected for promotion to brigadier in November 1979 while the Deputy Assistant Chief of Engineers. General Morris, the Chief, planned to leave me in the ACE until summer 1980. Over the year, it had been discussed with General Morris that I would move to be the Deputy for Civil Works in summer of 1979. General Heiberg was the Director of Civil Works, and he'd concurred.

As I moved to Civil Works, all of a sudden the new Chief—Joe Bratton—was announced and Harry Griffith was chosen to be the Director of the Defense Nuclear Agency. That left a

position in the Ohio River Division, and so General Morris chose me to move there. Those actions took place in, I guess, about the August–September time frame of 1980. Therefore, I only stayed a short time in Civil Works as the deputy director and moved in January of '81 to Cincinnati and took command.

My transition was rather steep because our testimony before the House Energy and Water Resources Committee took place about three weeks after I took command and I was faced early on with the requirement to testify before the committee in February.

Of course, I knew about it in advance, so I had flown to Cincinnati twice on brief, get-acquainted visits. We had talked a little bit about the testimony process and how they were laying it out. Testimony preparation was the intensive part of my first three weeks in the Ohio River Division.

In addition, another important thing for a new division commander is to get around to meet various congressional and other state interests that you support. Before I left Washington, I called on the ones who were pertinent to the upcoming testimony. They were Congressman Bevill, Congressman Whitten, and Congressman Myers from Indiana, who was always interested because his district was in the division area.

Because we had responsibilities for the Tenn–Tom, both Bevill and Whitten were very key and interested in those activities. In addition, I called on Senator Byrd because of his interest in the Section 202 program and all our projects in West Virginia.

Within the division, I had initial meetings with my district engineers, but I don't recall getting out very much the first three weeks because of the intensity of the testimony preparation. Basically, the testimony statement and backups had already been prepared. I had some input into the statement of that, but not so much as in the years to come where I could take charge of the process earlier.

I was basically taking what there was and becoming acquainted with it. In the Ohio River Division there were district mock hearings, which they had done for years. Each district engineer would come in to the division headquarters with staff and testify to us, the division staff and me, on their programs.

They would use slides, and we would go through our budget book with all of the things we had submitted up through USACE and on over to Hunter Spillan and the committee staff. We would go through the pages; the division staff would ask questions of the district engineer and the district staff. We would try to ask the tough questions that we anticipated we would get during the congressional hearing.

That was a very valuable process and gave me a good stem-to-stern view of everything that was going on in the Ohio River Division. Of course, there were a lot of details. There were five or six pages for each project, and so a lot of it I couldn't absorb for the long term, but I did get used to the process and how to find things in the book. I also got to meet the district

engineer and his chiefs of construction, real estate, programming, engineering, and operations and a good overview of their activities.

Each one of those sessions lasted three or four hours, and it was a good prep session for me. So, basically, my first three weeks were involved with testimony preparation.

After that testimony in early February, I was on the road quite a bit, both back in Washington making contact with other congressional interests that I needed to call on and then going around to our four districts. I would then go out with them on their projects for a firsthand understanding. Included in that was the Tennessee–Tombigbee project, which was a maximum interest kind of thing at that time, as I discussed before. Because of its particular nature, under siege from the railroads and environmental groups, under siege in the Congress with close votes and great concern with our completing the project on time, it remained a high-interest project throughout my period as division engineer.

So, early on, then, I toured Tenn–Tom for my own benefit, got to meet our folks out there, and got down and familiar with the project in its nitty-gritty detail. The Ohio River Division’s portion of the project, the northern 39 miles of the waterway, was a complex undertaking. It included the 27-mile-long cut through the divide—175 feet deep at the divide—and the Bay Springs Lock and Dam. At a lift of 84 feet, Bay Springs was the third highest lock east of the Mississippi. In the divide cut, 150 million cubic yards of material were removed to 38 disposal areas, creating a 5,000-acre wildlife management area. In addition, four highway and two railroad bridges were relocated. Over 40 prime contractors were involved with the \$270 million contract for the divide cut, the largest in the history of the Corps.

Q: How did that testimony go the first year?

A: It went pretty well. They put me toward the last so that I could watch others. Congressman Myers had always been a very active participant, and the committee yielded to those who had states within a particular division area to focus the questions. John Myers did that for us.

In the past, he had been unhappy that one of his favorite projects had never been recommended by the Louisville District or the Ohio River Division, and thereby had been very tough in his questioning of Ohio River Division Engineers. Two of the persons who were involved in the division at the time his project—making the Wabash River a navigable waterway—was not recommended were present. The district engineer of the Louisville District at the time was Jim Ellis, who now was South Atlantic Division Engineer. The division engineer at that time was General Vald Heiberg, who now was the Director of Civil Works.

So, with both of them in the room, John Myers asked a few questions. Knowing all of this background, I had gone by to meet him and introduce myself beforehand, hopefully talk to him as a fellow Hoosier. I don’t think that did me much good.

Q: It was worth a try, right?

A: It was worth a try.

Q: Was this testimony an occasion for opponents of the Tenn–Tom to get a forum, or was the committee sympathetic enough until it didn't come up so much?

A: It wasn't a debate before the committee during the testimony. Basically the committee set aside times for people to testify, and so we were scheduled—the Secretary of the Army, the Chief of Engineers, and the Director of Civil Works would lead off the series of hearings and then each of the division engineers would follow with their testimony, two or three a session, morning and afternoon.

There was no interspersing of other folks during that particular period. Later, they would hear from waterway association interests, other interests, and so there were opportunities for people to come up and talk, but it was not a debate. For us it was reporting of status on programs and projects, and then addressing issues that we knew about concerning division programs and budget.

In addition to calling on the congressmen, I had made a point of going over to meet Hunter Spillan beforehand. I got to know him and basically began an interaction with him as the staff Director for the Energy and Water Resources Committee. I asked him what kind of questions to anticipate, what did he see as issues, and that sort of thing. It was plain that stewardship on the Tenn–Tom would be an item that they would be looking at, not only in testimony but in times to come.

I think the testimony went pretty well. I didn't get too many questions, and I think we handled them all right.

Q: Getting back to your selection, was there something about the Ohio River Division and its projects, or politics, or whatever, that was part of that or not, that you know of? You mentioned that it was a vacancy and you were a person to be put in there, but maybe sometimes that is a consideration. Was it, in this case, that you know of?

A: I think that Chiefs of Engineers, when they go about making their selection of who goes where, think about people's backgrounds and experience and put them in different places based on their anticipation of the kind of work being done and experience and background of the individual. Certainly, if a person has been a district engineer in both a military and civil works kind of district, that might prepare them better for divisions that have both missions.

However, in this particular instance, the assignments had already been made for the year. Then Harry Griffith was selected for promotion to lieutenant general and to take over the Defense Nuclear Agency, so, a vacancy in the Ohio River Division existed. I thought I'd be going to a division the following summer, so I was probably next up and certainly available from the standpoint that I was on the USACE staff. I was replaced by George Robertson, then a colonel, who filled in as the deputy director for the rest of that year. I think that probably, in this case, it was an issue of availability.

Q: So, your going to the Ohio River Division also coincided with a new administration coming into office in January of 1981.

A: Yes.

Q: It seems in looking at the issues and things that would be happening over your term in the Ohio River Division, it has very much to do with some—perhaps some continuities, but also some rather new policies and initiatives of the Reagan administration. So, maybe one way to look at some of the things is to approach it first as a general thing, and then I'd like to look specifically, for example, at regulatory reform and the decline in the civil works mission, the buildup of the defense budget.

I guess one area we could look at would have to do with the area of planning in the civil area. This is an area for construction that budgets would be going down. In other areas, advances would be under way—regulatory, for example.

How would you address that, in terms of impact of policies on the division and what you had to accomplish? I know it's a rather big thing. Maybe we can get more specific.

A: Well, it's a very good question. I guess my only problem in answering it would be trying to pinpoint any kind of day or month anything happened in this time frame, but it happened slowly.

I think I mentioned when I was talking about leaving the office as Deputy Director of Civil Works that it was in the waning months of the Carter administration. Then the Reagan transition teams were active, but we didn't have one.

So, I left USACE at a point when General Heiberg and Alex Shwaiko and others involved were awaiting the newcomer.

Then we had a secretary named Bill Gianelli, in the March–April time frame. He arrived and we got to know him as he was sorting out his role in what and how the administration wanted to play, and the cards they wanted to play, through talks he gave to various associations who were all very eager to have him come talk as to the future of the civil works program—what was he planning to do—because every association wants to get the new guy up on their dais for their meetings.

Of course, he was also dialoguing with General Heiberg, the Civil Works Director, and the Chief of Engineers, General Bratton, and we started getting some feedback downstream. What I'm really saying, I guess, is that there was a long period of development of what his role was going to be. So, it was not a very abrupt apparent change that identified that this was the new wave.

It manifested itself in questions that would come out. "Why are you doing this? Why is it we're doing it this way?" So, we would provide answers, but we wouldn't get immediate feedback like, "That's going to change." That caused our antenna to be sensitive to identify the meaning of the questions and statements. It was, "Shouldn't we do it this way, my way?"

Q: Okay.

A: It was not only the regulatory mission. It had to do with some other policies for issues that we thought were pretty cut and dried. It evolved over quite a period of time—maybe two years of evolution before we really got to the point where Secretary Gianelli was saying, “This is the way it’s going to be.”

So, we had a lot of things that we’d send up and would get back with a statement, “No, that’s not quite right,” but the guidance back wasn’t really specific on what was right or what was wrong.

We didn’t have many regulatory problems in the Ohio River Division. We weren’t big in that business. We had, navigationwise, a rather well-defined river. In the 404 program we didn’t have a lot of things going on. We were basically tracking along with other’s experiences and keeping abreast of the dialogues.

We did have a lot of navigation, and we started having that dialogue because we were very involved with the navigation associations—the Ohio River Improvement Association, initially, then DINAMO [Development of Inland Navigation in America’s Ohio Valley] started out in this era. User fees were already an issue, largely put aside. The waterway folks were, of course, very interested that the new administration stay with them, since they all felt they were good businessmen and Republican administration kind of folks. They were more than a little dismayed later on when their administration pushed for cost recovery and waterway user fees.

We were watching that dialogue. This then became the “creative financing” initiative. Cost-sharing came out of that period, but again, down the line. Early it was mostly the question, “Shouldn’t so and so pay for this?” My answer, when I was asked that question, was, “Well, we’re doing it the way the laws call for. This would be a change in policy, so I guess I’m not the person to ask that question.”

I think it was during all of those times when the secretary would be traveling around and have those kinds of conversations with many different people that I suppose it jelled in his own mind. I think it was jelled to begin with on direction, but specifics and how to write the policies and all of the implementing kinds of things took a long time to come out. So, it was a long period where things were indirect and, even in the field, rather confusing if you were concerned about really getting things done.

Now we in the Ohio River Division started to see, in particular, our own instances of that change in a couple of areas. One was the Section 202 flood control project, which I talked about already.

Another area was up in the Muskingum area of Ohio where there were several dams constructed for flood control. A lot of them were dry reservoirs, and there were encroachments into the reservoir and the backwater areas by developers who built houses. We had gone to court trying to evict people because we felt we couldn’t tolerate a house in

the flood pool because, should it disintegrate and pass on downstream, it would then threaten the system.

They were very clear encroachments. We submitted a plan of how we'd take care of eliminating them, and the local developers went straight to the secretary, who intervened and started challenging us on why we were doing it. We made the typical arguments of upstream versus downstream interests. We had a federal project that is designed to prevent certain flooding levels downstream. If we can't use the pool designed for it, how can we deliver the lower levels downstream to avoid the flooding?

It was the perennial argument of whose interests come first, downstream or upstream? In our view, this had been decided when Congress approved a federal project and we spent federal taxpayer money to build the project. The encroachers were not letting us use the full value of the project, and so to us it was pretty clear. To the secretary, it was not so clear.

Over some time period, the issue went back and forth. There was a lot of interaction in order to come up with an acceptable policy position.

At this time, we were beginning to feel that we were in a bit of quagmire of—I won't say indecision—but of a process that was not very precise. On day one you put out an order. Then things changed, certainly, but how they changed evolved slowly, over time. We worked that over an eight-month period—visits to Washington, visits to Ohio, back and forth, this actor and that actor, different interpretations as it evolved. The division staff, most particularly, was comfortable interpreting things cleanly according to a set of statutes and regulations—rather precisely. In a changing policy period, they were unsettled and had difficulty in knowing how to work things.

In the end, Gianelli more or less gave the issue to his new deputy who had come aboard. Bob Dawson and I spent a lot of days on the telephone dialoguing the wordings and meanings of sentences. "Would this be acceptable, or not acceptable, and why?" We negotiated a position in the middle, something certainly less than what we were asking, but it didn't quite give away the farm. We felt we could live with it based on the small probabilities that certain events would happen. Maybe the absolute condition we were seeking didn't need to be.

So, in answer to your question about how did things happen with the change in administration, I'd say they evolved rather slowly. The people who probably had an understanding of the compass direction in which they wanted to go nevertheless were faced with the reality of dealing with real situations, real policies, real reaction from interest groups, real reactions from Congress. They learned—in a couple of instances probably painfully—that you just don't put out an edict and it happens. You have to work it out over time.

Then we were the ones trying to execute, and we were the ones that had fed the realities to them when they'd asked the questions. Sometimes they asked the right questions early enough; sometimes they didn't. Because they weren't always free in identifying where they

were going, it was difficult sometimes to anticipate what they really wanted to know. So, it was a long, evolving process.

Q: I'm interested in that particular case with the encroachment. What was Gianelli's position on that? I mean, it sounds like a clear violation of federal property.

A: Well, it was never precisely stated, other than we were being too strict, and we were demanding too much, and we weren't realistic. It stayed the same way, and we found out we weren't getting anywhere. Bob Dawson came aboard, and he was a little more reasonable in at least having a dialogue, so we could try to work a solution.

So, I'm not quite sure what Gianelli's position was other than it should be less than what we were trying to execute. He never did state his bottom line. It was just his approach to unravel it from where it was to an easier position.

Q: This was recreational use, or were they residents?

A: They were residents. There were houses on a street in the authorized flood pool.

Q: Wow.

A: There was also a trailer park and some barns. So, it was difficult; people did have money invested. I mean, like most of the problems we dealt with, they were real, live problems because real, live people had investments.

It might have been a nickel compared to the budget of the United States, but it might have been their life savings. So, when you put real flesh and issues together, then they have to be looked at that way.

Q: Just while you were getting these visits and these questions, other divisions were getting similar visits and similar questions.

A: Yes.

Q: So, at the headquarters level, then, for the whole Corps—I'm trying to tie this together—how was that being handled? Or was it?

A: You'd have to ask General Heiberg that because he and Alex Shwaiko, Lew Blakey, and Bory Steinberg were the ones who were involved at the headquarters. My feeling was that Gianelli also didn't start off by seeking any kind of a working understanding with Congressmen Whitten or Bevill and his committee. As a consequence, he portrayed that since he was the administration, he could establish certain policies, and that's the way it would be. Of course, that's not the way it is in our government. There was some abruptness in the interactions between the two, and you could get caught in the crossfire if you weren't judicious. By judicious, I mean when somebody spoke to you about something, you had to recognize that this was part of an issue, and we all, of course, were part of the administration. Policies were policies and established procedures.

We were typically responding to the congressional side, “This is the new policy of the administration and we follow it.” It was pretty obvious that they needed to deal with the person in the administration who knew something about the policy formulation, that being Secretary Gianelli.

Later on—as I explained when I talked about Section 202 before—that project became distasteful to Secretary Gianelli, and he felt he was being put under too much pressure by the Congress, in this case Senator Byrd. He felt we ought to have deflated Senator Byrd’s expectations and taken the pressure off of him.

Well, that was a rather unrealistic expectation of the secretary. Senator Byrd certainly knew that he couldn’t drill us to change administration policy, so, being a very astute senator, he was going right to the point of influence. He wasn’t even putting pressure on the Director of Civil Works or the Chief of Engineers because he knew the place he had to go was the place where the policy was made, that being Assistant Secretary Gianelli. So, the secretary got a lot of phone calls from Senator Byrd.

Q: Well, it’s really a case of a new administration that is pretty confrontational with Congress, or at least the House of Representatives, but also a new assistant secretary who is a little more assertive than some other assistant secretaries had been, I think too. It was a period of adjustment in lots of dimensions there. A lot of that, I guess, had impact at headquarters, but it obviously had impact in the field as well, on particular projects.

A: I guess we always felt that Secretary Gianelli never had a feel for a very large organization or for the people part of it. He was an engineer with a lot of activity in water resources. The fact was that large organizations move slowly, not always by edict but by consensus and by passing ideas down and by bringing people aboard and that sort of thing. Valuing people and their views seemed to escape him.

So, it got to where he was saying things about the Corps in a negative sense, and he would say things about Corps people in a negative sense, and they heard about it and didn’t like it. They were proud of what they were doing.

He somehow put all these things in his manner in the sense of, “These folks are disloyal because I’m not getting what I want (by edict),” even though he had this problem with the Congress. The Corps was still following the law and regulation as existing. He wasn’t changing them, the laws or regulations. He was just talking, but he was talking about, and against, the Corps and still had to achieve what he had to achieve: that was the political reckoning, the changing of policies at the top.

I think the people in the Corps felt ill-served by him, that he owed some loyalty downward as well as upward. He was always speaking of loyalty, but it was always in the negative sense. He asked me once specifically, “Why aren’t you loyal to me?” It had to do with the Section 202 project. He was always speaking of loyalty in the sense that we weren’t giving it to him. By the same token, though, he was besmirching and smacking down the people that he was expecting loyalty from as he expressed it to other people.

Q: Well, one of the ways you felt the impact at the Ohio River Division and throughout the Corps was budget cutting and personnel cuts during the early years of the Reagan administration. The size of the work force was cut back. According to the division history, there were 301 O&M cuts in personnel by the end of 1982 and 157 the two years following in engineering and support services areas.

A: Oh, really.

Q: Of course, divisionwide, that includes all the districts, I guess, which led you to speak out about the problem or the need for retaining in-house capabilities for design as you were getting more and more contracting. What was that doing to your ability?

A: Those were focused—and this is by the end of '82 already?

Q: Well, with O&M, in the O&M area. That's what it says.

A: Again, it's how difficult it is to put what into what time frame as to when events happened. One of the things that happened—there are several—was the Grace Commission. The administration set the Grace Commission up to go investigate how things could be done better throughout government. Then there were our own initiatives started down through the secretary's office, and they sort of all blend together.

One of the things that we addressed was the notion that we needed to cut down the number of folks in our recreation and parks area. By the time that surfaced, there also surfaced the administration's feeling that there ought to be user fees, in some way, for the towing industry to pay for navigation improvements. The administration's tactic was to put pressure on the bottom end by just stating, "We're just not going to do all the things we used to do." So, they cut funding in the O&M arena and in the recreation and parks arena.

These were programs where we had to submit ways we would cut back. There was always the notion, common in the administration, that we should contract everything out instead of doing it in-house. We had an ongoing dialogue as to how we could best do that, and we approached all of those things from the standpoint of, with the new direction, how can we do it?

The problem was that we always came up, rather abruptly, against numbers. The Corps is not a big, overstaffed organization. When it comes to navigation, repairing locks and dams, there aren't people out there that you just contract to come in and repair a lock. You can order a new miter gate—there are some people who'll be happy to make you one over the next five or six months.

However, the people who had the big barge derricks, the heavy-duty kind that could lift heavy gates, was us—the Corps of Engineers. When a tow rams a gate, it is a time-sensitive repair, and they were all different. You go out and dewater the lock. The Chief of Operations gets down there and does a quick triage and really figures out what is needed to be done. Then they manufacture and cut the steel, or bring another gate in, or do what's necessary. Meanwhile, there is great pressure from the towing industry because we're talking hundreds

of thousands of dollars a day for every delay when they can't get through a lock and the system shuts down.

We went through all kinds of numbers drills. "You need four crews, one for each district. Can't you get by with just one in the whole Ohio? What's the right answer? Can't you cut them down? Justify each and every last person."

Once we had gone through that drill, we started to come to the conclusion that we were about where we needed to be. We could cut a few people out of the grass-cutting crew and let that be contracted out—if there were grass-cutting crews.

With the parks and recreation mission, our rangers, it was a little different. It varied by state. Some states, like Indiana, the state's Department of Natural Resources ran all of our areas and we didn't have rangers there doing the recreation part. In other places, like Ohio or down in Tennessee, we would have them and we would staff all aspects of the mission.

So, when you want to cut in a place like Indiana's Brookfield Lake, we would only have two or three people on site who really were there to operate the flood control project and had nothing to do with the multirecreational facilities at the lake. The state took care of that. When you only have three people there for a round-the-clock operation, then how do you cut? All areas got lumped together and seemed to be a lucrative opportunity. With two or three per site, how do you cut?

We developed a list of things we could cut, and we tried to close places. Of course, for every closure we ran into the realities. There would be a public reaction through local and congressional interests about not cutting back, which would come swinging around the loop. Our expression would be, "The recreation area is not well-used. We need to cut the budget, and we can't afford to run them all. We're going to operate the ones that are most effective and serve the most people."

Out of that kind of process came the cut in the operations personnel that you mentioned. We did get quite a number of cuts and parceled them around as best we could.

My concern about cutting into our professional capability came later. It was always difficult to say who was cutting what. We knew the Office of Management and Budget passed cut numbers down to USACE, and there the Director of Civil Works really figured out, based on workload levels, what the allocation should be to different organizations.

Q: Right.

A: So, a lot of our debate was with Bory Steinberg, who ran civil works programs at the time—how they analyzed our work versus somebody else's. Our thoughts were that certain things were not being computed correctly. So, it was hard for me to determine if all of those might be administration driven, except for the ongoing drills to reduce navigation and recreation.

Of course, Bory Steinberg's answer was, "I get the numbers from the Office of Management and Budget, so I have to pass the shortages and cuts somewhere." My response to them was,

“Then we’d better address the fact that we can’t salami slice away because I have to keep those three people at that Brookfield Lake because I have a flood control project there. I can’t walk away from a dam that’s preventing floods, and I’ve got lots of these flood control dams in the Ohio River Division.” When we had my people out at 76 lakes, two to three each, we didn’t have any flexibility.

So, the next thing we would have to cut was an engineer or a planner. We didn’t have many of those, either. Now you’re cutting into the capability to do the Tenn–Tom, to engineer and construct the other projects and the other missions, and that’s the heart of what we were to do. As much as I’d like to turn some operational stuff over, I couldn’t until someone eliminated the mandate that we operate that mission.

That was the reason for my comment. I was trying to build a backfire to carve out what our responsibilities were. My feeling was that oftentimes the easy way for Gianelli was to cut a number and make us sort it out as to where they fell. His feeling was that if he couldn’t get it implemented through his initiatives, he would implement it through cuts because we wouldn’t have enough people to get the missions accomplished.

My response, as I said, was, “Well, you may think we’re going to be closing park areas and stop navigation, but you can’t have a catastrophic failure on the Ohio River or a flood control dam. As long as we’ve got those responsibilities, we have to maintain them. What’s going to hurt is our capability to do the other things we need to do.”

Q: Now, I think, by the year after you left the division, 40 percent of the civil works engineering was being done on contract, according to the statistic that’s provided here.

A: When I was there it was about 25 percent.

Q: It doesn’t say, but it had grown to that, and 90 percent in military construction.

A: Military was always about 90, but civil works was basically down at 20 to 25 percent. That’s what it had been when I was there. I didn’t think that was necessarily bad. I mean, I thought we could pass some more of the civil engineering out. In military construction, I didn’t see that as necessarily bad. The problem was, and is, even to supervise engineering contracts you have to—with the professional integrity of the Corps in doing the job right on the line—have a professional force. I mean, the concept of a one-up review of engineering is essential. One has to have capability to do a one-up review. We did have the expertise in locks and dams design. Who else has designed those over time?

Different parts of the Corps had expertise in certain things. Nashville District had helped St. Louis District out on design of Lock and Dam 26. Civil works at that time went to a center of expertise approach and directed that, for certain type projects, there ought to be a district that would have the expertise and engineering capability to assist others.

For example, if you’re not building much hydropower across the Corps, then you can’t afford to have every district with a hydropower capability, so maybe the biggie in hydropower, North Pacific Division, ought to be that center of expertise. We had hydropower experience

down in Nashville, and they always thought they were a center of expertise. In this case, they couldn't hold a candle in numbers of hydropower facilities to North Pacific Division—nor could Little Rock.

Come navigation, however, the Ohio River Division was the largest builder of systems with locks in them. The division had 20 locks and dams on the Ohio River and 41 on its tributaries.

Q: Yes.

A: The Mississippi Valley Division, of course, had the open river expertise, but the Ohio River Division had certainly built many more locks and dams of different varieties than they had.

When we got into the environmental mission, centers of expertise became a big thing because we couldn't afford to put everyone into business. So, in Superfund the Corps started with designated centers of expertise.

Another center of expertise that had begun five years before was for medical facilities construction because of the longstanding problem of rapidly changing technology during the time of design and construction. Design would be for a certain set of cabinets or items of equipment, and by the time you were ready during construction to order the machine, technology had leaped ahead a couple of years and the Medical Corps no longer wanted the designed one. They had a new one. It would come with right-hand this instead of left-hand that and different size so there had to be modifications to fit it into construction. Having someone who was really up on medical facility design as a center of expertise was important.

Q: Now, when you talk about the discussions with Civil Works' Program Division about how to allocate cuts, then you, in turn, were having the same discussions with your districts, right, who were waiting from you their particular required allocations.

A: Yes.

Q: That's what led you to do some of these things that you're talking about, I think.

A: It was on the division level; we called the shots on that. Basically, what we would do was our Chief of Programs, Lou Listerman, would put together the "program" from the districts, working with their chiefs of programs. This included desired levels of staffing and funding for levels of activity in the various mission areas and projects. Then the division would send that forward, and we would have to justify it to Headquarters, USACE. Then cuts would come, or other levels would be anticipated, or we would get an allocation that would say, "This is all you're going to get." We would then go through the drills and analysis at division headquarters, send it down to the district, get their viewpoint back of what this meant in terms of impact, put those pieces together, and then dialogue back with USACE's Chief of Programs in Civil Works.

Q: One area that you tried to set up a design center in but weren't successful was in the Superfund area. I wondered if you could talk a little bit about that. It was Huntington and Nashville that you wanted. This was something you were leading, right?

A: Yes.

Q: Okay. The division didn't get it.

A: Military construction was another mission that came in. Chronologically, the military mission came before the environmental, but we can talk environmental first.

Q: All right.

A: When Superfund came about, the Corps approached it with great eagerness, like we do everything, and it appeared that we were going to have a rather good program. The newspapers and magazines at the time were covering quite a bit of the hazardous waste problem in the United States, the river in Cleveland that burned and others of a sensational nature.

A national top 10 list was created. One of the sites on the top 10 list was Chemdyne in Hamilton, Ohio, just north of Cincinnati. So, when the Chief put the Corps forward in getting involved, we offered, or were offered, to EPA [Environmental Protection Agency] for our abilities as executors.

In the Ohio River Division we saw it as an opportunity too. Because of our location, with Chemdyne, we would, without a doubt, have an early start on things, and so therefore should develop an expertise and capability to do it. It was also apparent that not every division and district was going to be able to do it.

The Chief started off in the beginning by saying, "I don't know how it will be working out, but we will want to establish expertise centers. We're not sure how we're going to manage this, but we might have one, two, five, some number of centers, depending on what develops."

So, we in the division jumped, and I think Missouri River had a very early start. We did Chemdyne using Huntington District. We went to school, sent some people off to be trained, and used the Missouri River Division to help us. We did most of the design work, and then they reviewed it, so we weren't sure what kind of help they were providing.

Out of that, though, when the call came that, "We're thinking about two centers. Who'd like to be one?" we submitted our proposal to be a center.

Dick Armstrong was Chief of Engineering and Jack Kiper was Chief of Construction. Jimmy Bates arrived to be Chief of Planning. We felt we were really in a good position from the standpoint of being central, within shooting distance of many of the nation's problems, considering our area included Pittsburgh, Cleveland, near Chicago, over to St. Louis, and down to Tennessee.

When we looked at the next list of 100 problem sites, there were quite a number of them in our general area. We thought, locationwise, that we would be pretty logical folks to be a center. So, we put in our pitch for the mission.

At the same time, EPA was really not pushing a very aggressive program. My own view was that the administration at the time wanted to talk a good game but move out methodically. They weren't in the business of rapidly addressing all of these problems, but in the business of not having large budgets and being able to methodically move after them at a slower pace.

The Corps, being a can-do outfit, presented EPA a problem. We were ready to go; we could execute. It became very apparent that they didn't want us to execute as fast as we were executing. It was almost like you'd go to a meeting and they'd say, "You're here ready to go already?" Of course we asked, "Where's your next two projects? Next time, we don't need to handle them one at a time. Give us three or four. We can clean this up."

We did Chemdyne almost without a hitch, to include bringing people in and handling the public participation. We told people what was happening and did all the newspaper work. We did all the right testing and did it all through contracts. We built a platform overlooking the fence so people could come and watch, take out their binoculars and look into the area with signs that told what was happening and the procedures. I think we did a pretty fair job of the whole site cleanup in rather rapid fashion.

I think the Corps—looking at it from the USACE perspective—could have established more centers, but there wasn't immediate work out there for centers to do. What had been anticipated as work for two, three, or four centers really was work for one center. Working through the districts involved in each place could very easily take care of the mission for the first couple of years.

That's why we didn't get to be a center. The Corp's great enthusiasm for cleaning up the country's hazardous waste depended upon an EPA program developing to provide us the work. We weren't in charge of the program; we were only providing a service to a customer, that being EPA.

Q: The Missouri River Division in Omaha?

A: The division in Omaha became the Corps' center for environmental cleanup. They had been asked to start certain things to begin with, and so they always were a lead. We were always seeking to be the second. We knew we never could displace the North Central Division. We were seeking to be the second division and the logical second one to add. Let the Missouri River Division concentrate westward, and we'd concentrate on the east coast. We thought that would be an ideal thing. The level of activity didn't develop.

Q: Of course, the division did carry out construction management for several toxic waste sites and continued the program.

A: Yes.

Q: It was just not at the level that the Corps was ready to undertake.

A: Right.

Q: I had listed—back in the regulatory area—some specific changes maybe that happened in the division. For example, a section in the division organization, like a section devoted to regulatory that hadn't been there before. I don't know if that's really worth exploring.

A: You say we did that?

Q: Yes, the history says you did it.

A: Did it, really?

Q: Well, it talked about things such as using project managers for permits, speeding up the permit process, and maybe these are not necessarily things that were going on divisionwide or at the division level.

A: I'm thinking of the division level perhaps. The divisions are lean affairs.

Q: Well, you did mention specifically a section at the division office for regulatory.

A: Divisions are very lean affairs. There was a Construction–Operations Division, probably of 15 to 19 people. We had a navigation section that might have had two people. We had a regulatory section that might have had two people in it. The recreation section might have had just one person in it. It was very difficult to look at sections as being much different than responsible action officers. This was because of our role at the division level. I mean, the doers were in the districts. Down at the district level, certainly there were regulatory sections. The way permits were handled was to assign a project manager to one because it did move over sometimes a lengthy time frame.

Q: The administration was trying to speed up the permits process? I mean, that was another administration initiative. How far did that get during your period there?

A: The question was, "How come it takes so long?"

Q: Right.

A: That was a good question, but it was put in a punitive style that didn't seek to differentiate between the norm and the complex. We hadn't bothered to break out the statistics at the headquarters between the norm and the complex. Sometimes things were complex because people objected to them, whether they had reasonable reasons to object or not. When a district was leanly staffed, they couldn't always have a meeting each and every night to wrap it up quickly. So, things stand in a queue for action sometimes.

We tracked permits, as I recall, on a 30-, 60-, 90-day basis, and worked on them. My recollection was that we weren't too bad in the Ohio River Division. Not the worst, not the

best in terms of processing time, but closer to the shorter time frames than the longer, although we had two or three or four that hung out there, too, because they were complex and involved a lot of different things.

Q: Maybe before we move into military construction, another point that was made was that you had an opportunity to make several personnel selections, that maybe every division engineer doesn't necessarily get to do. One of them—you mentioned Listerman a little while ago—was the deputy, I guess, and then became the Chief of Programming. Also Jimmy Bates came in as Chief of Planning. Do you have any observations on that opportunity that you had and how you approached it?

A: It was an opportunity to really mold a team, and I think that's the way I approached it too. When I arrived, we had a single SES [Senior Executive Service]—Dick Armstrong, a very strong-willed, very capable, talented individual. He was certainly the dominant voice on the staff, so much so that some staffers just fell into the background, so I often got just a single voice. Dave Click was a stalwart executive assistant who always provided good counsel and was most effective.

It was my feeling that, with our great operational responsibilities, with all those locks and dams on the Ohio navigation system and those 76 flood control dams on the tributaries, and with the large number of park visitors annually—I think we were second or third in the Corps—that we had very large operational responsibilities and the Ohio River Division ought to have another SES position. From that I was able to argue for, justify, and get approved that the Chief of Operations Division would be an SES position. Then Jack Kiper moved up to be the SES in that position, providing additional clout to operations.

Planning had been split off in previous years by General Heiberg, and we were doing that throughout the Corps. When my Chief of Planning retired in the fourth or fifth month after I arrived, there was an opportunity to go for another SES, which is quite a long and deliberative process. There were quite a number of very qualified candidates, and from them I selected Jimmy Bates, who had been in the division before in Nashville District.

Also, then, as mentioned, the Chief of Programs retired, and Lou Listerman as deputy had a good handle on programs, so I selected him. The Chief of Real Estate when I was there, Dave Gray, became the Chief of Real Estate for the Corps. I was very happy to nominate him and support him to the Chief. I then had an opportunity to select a new Chief of Real Estate and Dave Perkins as Chief of Procurement.

I also selected a new Chief of Public Affairs, Bob Hume, during that time frame. So, I did have quite an opportunity to put people in and build the organization.

Q: Armstrong and Bates are now in the headquarters, and the public affairs officer is still there.

A: Right.

Q: Joe Higgs is now at the Ohio River Division in the planning and engineering slot, I guess.

A: Yes. The positions were combined back together, and he's come back.

Q: Whom you knew from Europe?

A: That's right, we knew each other in Europe.

Q: Before we leave civil works, what about Yatesville Lake?

A: Yatesville was a very interesting story, and I think a compliment to how the Corps can make things happen.

Carl Perkins was the congressman from eastern Kentucky and was the sponsor for Yatesville Lake. He already had five Corps lakes in his district. I say that just because a lot of people brought that up from time to time.

There were environmental problems with building Yatesville Lake. When General Heiberg was division engineer, he didn't particularly want to proceed with Yatesville Lake. He'd come to the determination that it was not a good project, that we should not proceed, that it was environmentally damaging and we shouldn't do it.

When I arrived, I found myself faced with a lot of pressure from Congressman Perkins to get started on building 18-mile-long Yatesville Lake. At the same time, there were the questions on the environment. Huntington District came in one day and said, "We have a major problem. We've tested the waters of the river, and it has an extremely high brine content because the Martha Oil Field is located just above it."

Ashland Oil was operating this oil field, and they had a low-level extraction procedure going on. Long ago the wells were basically finished, and now they were pumping brine into the wells to force out oil. They were reaping very little, like a barrel a week, from some of them.

They were running that brine straight down the hillside into the streams, heading towards the creek that became the river that was going to become the lake behind Yatesville Dam. Huntington District said, "We're going to have Dead Sea II here if we build this lake. It will be too briny; it will not support fishing or anything else."

When that had been passed to Congressman Perkins, he said, "It's all false. Best bass fishing in the world is right there where those two tributaries come together and where we were going to build that dam. I catch bass there all the time. Best bass fishing in the world."

When you reviewed the brine content of samples measured by Huntington District, you knew that we had two views of the world here. [Laughter]

Meanwhile, trying to determine how we could proceed, we had to do the right thing, which means we couldn't build a dam that's going to be Dead Sea II. At the same time there were the pressures to get on with the congressionally approved project. The question was, "How do we work this thing and do the right thing?"

I asked for further analysis to be done on where the flows were coming from. Meanwhile, I'd gone down to the Martha Oil Field and walked it, and I was appalled—absolutely appalled—to see what Ashland Oil was dumping down those hillsides. I mean, you'd go up there and you'd see this eroded ditch coming out of a wellhead, running down the hill toward a stream, and it would be brown-orange colored from the stuff that had come out of there over time. It was just running raw down the hillside—an absolute disregard for the environment. I was really appalled.

When I analyzed how I was going to get a project like this done—no matter how much Congressman Perkins wanted it or the legislation authorized it—the fact is that you have to go through a process that ensures the environmental impacts are acceptable. If it's wrong, impacts are unacceptable, then you shouldn't do it. We had the environmental impact process with EPA, Fish and Wildlife, and everyone else participating.

We made contact with the EPA regional office in Atlanta and started talking to them about all these problems. We found out that the commonwealth's laws weren't sufficient to prohibit Ashland Oil from their harmful actions, and they didn't follow the EPA federal mandates—they had not adopted those as standards. Thus, statutes wouldn't provide us any way to solve the problem with Ashland Oil, and we'd never get through the environmental process to be able to do the project.

Meanwhile, as mentioned, we had Huntington District doing further studies as to how the stuff got to the Big Sandy River and to the potential lake and what would happen. What we discovered was that there were two components, surface runoff and ground water. We also found a fault area through there, so we traced that.

What we found was that the way the fault lay, the subsurface water, the ground water, would be cut off before it got to the lake area and would go elsewhere. Where the aquifers came in, they met up against an impervious wall area, and they were diverted elsewhere. An important find—the briny ground water was cut off from going into the lake project area.

That was very important because it takes something like 60 or 70 years for ground water contamination to clean up naturally. Surface runoff can be stopped, and it's an almost immediate cleanup.

So, once we found that we had cut off the ground water, then we felt we could come up with a solution preventing the lake from being a Dead Sea. Ground water was taken care of; all we had now to do was take care of the surface runoff from the Martha Oil Field. To take care of the surface runoff, we needed to have the Commonwealth of Kentucky adopt laws that would prohibit Ashland Oil from its irresponsible discharge of brine into the streams.

So, with this, we developed a scheme that said we would design the lake, and we would isolate the lake from the Martha Oil Field by closing down discharges and the brine source. Huntington District had come back with a proposal that we buy out the Martha Oil Field from Ashland for \$50 million. I thought that was not a worthwhile expenditure of federal funds. We really ought to get Ashland to do what the nation had mandated, and that was to

clean up the environment. We needed to get the Commonwealth of Kentucky to act. Being good responsible citizens, they would obviously want to do that same thing.

So, Huntington District approached the governor's office and found that there was not great interest at the moment in cleaning it up. Consequently, we went into a briefing one day for Congressman Perkins. I was going to lay out for him how we were going to proceed because he was badgering Chairman Bevill to get money for the project in that year's budget to get started. We did have components of the project that we could start—the tunnel for carrying the waters through the dam and the intake tower. We could start that component, but we wouldn't want to start it unless we knew we could finish the rest of the project. In our meetings with EPA, we felt that we could go into the environmental impact process and demonstrate that if Kentucky cleaned up their law so Ashland Oil would stop contaminating, we could move it through EPA and Fish and Wildlife and show we were doing a good thing for the environment. We were going to come up with the right kind of lake.

That process was what we took to Congressman Perkins. "We can get started, but we need your assistance with your state government to clean up the laws."

Basically, he threw us out of the office at that point. He told General John Wall, the Director of Civil Works, who was with us, that he wanted some of those combat generals, not all these environmental generals to talk to him. [Laughter]

Someone who'd go out there and build it, not sit there and talk about how to fix it environmentally.

Anyway, he basically threw us out of the office because he didn't want to hear about going to the state to force Ashland Oil into compliance. All he wanted to do was build the dam and lake. So, we left his office and went back and told Hunter Spillan the outcome of the conversation. We were getting close to budget time, so they put some words in the budget that told us to proceed.

Meanwhile, we knew we had to do the right thing by the environment, and so we began to work with EPA and go through the process, keeping at it, and working against the state, telling them they really ought to clean up their act. We got EPA to tell them the same.

Sure enough, a few years after I left the division, the commonwealth passed new laws that effectively closed down Ashland Oil's ability to use that antiquated method of brine extraction and dumping stuff irresponsibly down hillsides. So, the surface runoff was now taken care of. Thereby Yatesville Dam was built, we didn't spend \$50 million to buy out the oil field, and we got some good state laws that helped the environment.

The day I left the Ohio River Division and crossed over the Ohio border into West Virginia, I heard on the radio that Congressman Perkins had died of a heart attack, so he never came to see it finished. That's the story of Yatesville.

Q: Is there fishing for bass?

A: I was there a year and a half ago, and they had not yet raised the pool. I guess it's raised now. Anyway, it's a good story of how good things do turn out, and with a good outcome for the environment. There was the lucky happenstance of the fault cutting off the groundwater, or we'd never been able to proceed. Second, though, we stuck to our guns that we could do it, but if we're going to do it, it had to be done environmentally correctly. Then we figured out the ways, no longer a technical solution—we had the technical design all done—but figuring out the ways through the political process to get the laws fixed so we took care of the environment.

Q: I mean, it sounds like you had support for this position from headquarters and from the assistant secretary's office. Is that the case?

A: We brought it up to Washington and we briefed General Heiberg. I think he was basically skeptical from his own experience in the Ohio River Division. John Wall, the Director of Civil Works, supported us, went with us over to see Congressman Perkins and took the gaff, as I mentioned, so certainly we had support from him.

As for the secretary's office, if there was a buck to be saved, they would rather save it than spend it, but I believe this just was a battle they didn't want to join. They had several others going and probably thought Yatesville would die of its own weight, the state would never come through, and so Gianelli never participated and allowed the process to continue.

Q: What about the Big South Fork?

A: The Big South Fork National River and Recreation area was on the border of Tennessee and Kentucky. It was a neat project, not well known by many folks, even today. You ask people about the Yellowstone of the East, or the Big South Fork, and you get a blank stare.

Down in Oneida, Tennessee, they know about it. It is a National Park Service park of some considerable size, 103,000 acres. It involves the upper gorge of the Cumberland River and is quite a nice area, a lot of palisades and caves—very rustic. There are old coal mines in the area, deep gorges, a lot of hills, and white water rafting and canoeing. It is very rustic.

The whole idea of the park was to provide an outdoor experience for people. It's not a "Yellowstone of the East" where you can go find geysers. What you find is the real outdoors. If you want to hike, if you want to ride horseback into the wilderness, if you want to do those kinds of things, or raft down a river, or canoe down a river, it's there. The concept was to leave it wild and rustic, not make it glitzy.

What Nashville District did to develop it was to procure the land, build a bridge over the river at the base of the valley, and construct two major public use areas—Bandy Creek in Tennessee and Blue Heron in Kentucky—and some other facilities. The existing bridge was just a low-level bridge that flooded over during high water. When the water goes down, you use it again. Nashville constructed a high bridge up and over the valley so all year long you could get from one rim to the other rim.

We also built some canoe access points and two or three campgrounds. There were places where National Park Service rangers would have a station. At Bandy Creek the Park Service would contract out to livery men who would have the horses so that people who wanted to come up and rent a horse could take one out from there. You could also rent canoes, and there were some shops to buy some basic grub and that sort of thing. Big South Fork retained its very rustic setting, and there was not a lot of construction.

Early on, Big South Fork became one of the administration's targets for reducing the budget. Originally the recreation area project was to include something like 173,000 acres. The administration objected to the total \$258 million project and cut it back. It was cut back in one of the early budget exercises to about 103,000 acres. One of the early things we had to do was submit a proposal for reducing the project. That was relatively easy to do in that certain real estate had already been procured and we could draw a line around that and clean up the borders.

There were some unhappy supporters of the project, like Senator Howard Baker from Tennessee, who had sponsored the project. He was also part of the administration, and yielded. So, about one-third of the planned area was set aside for later acquisitions. We then completed the reduced project. I visited there since it's been completed, and there are very nice facilities but maintained in its rustic atmosphere. In addition, at Blue Heron there was a coal tipple that has been restored. It was not completely rebuilt, but for the camp they put up steel frameworks to represent where houses had been. Various buildings provide pictorials of how it was back in coal-mining days. Nearby, maybe six or eight miles away, there is a town, and there is a railroad link—the old railroad for taking coal out. They now run tourist trains from the town to the restored tipple. After the train excursion in, you walk through the coal town and then come on back out. In addition, there's a couple of overlooks from the rim that you can look down into the deep gorge. It's a nice experience.

Q: How did the Corps get that project in the first place? Are you familiar with the history of it before you got there?

A: No, not really. After all, Army engineers were the early saviors and developers of Yellowstone and Yosemite in years past. We have those capabilities to build things and procure real estate, so I think we were a natural to do the Big South Fork. The legislation was written that the Corps would build it and then turn it over to the Park Service.

Q: Okay.

A: The trips down there were always interesting. Initially, when we went down there it was treacherous getting down to the river level during a rainy day. There were many switchbacks as the road cut down from the hills. When muddy, it was easy to slide off the road. It was essential, then, that we build a road down to a high bridge across and a road up on the other side if there was ever to be an all-weather access. Thus, we constructed Leatherwood Ford bridge. This bridge also provided a nice link from one side to the other. People didn't have to go the long way around.

We always had interesting times down there because it's such a very rustic area. Oneida, Tennessee, was 10 or 12 miles away. I remember the groundbreaking for Leatherwood Ford bridge. Senator Baker came down. We were to have the groundbreaking down at the bridge. It rained heavily the night before and we couldn't get to the bridge by auto, so we had it up in a local high school auditorium. They put up the flags and everything else. It was cascading rain outside, the auditorium was full, and Senator Baker and I gave our talks. We took our spades outside of the school for the groundbreaking—the bridge site was two or three miles away.

Another interesting time was the groundbreaking for the Bandy Creek visitor site, the ranger station and so forth. The locals brought a mule with a plow. The local congressman and I were to stand behind the mule and the plow, and we would break ground that way.

I remember getting behind the mule, whose name was Sam also, and the congressman looked over to me with all these photographers and people around him and said, "What do we do, anyway? How do we get this mule moving?" I said, quietly, "Congressman, I don't know, but then, the people here don't expect *me* to know." [Laughter]

So, he had a problem. I don't think he was elected at the next election. I'm not sure if it was because people recognized he didn't know how to drive a mule.

Q: That could have been part of it, though. [Laughter]

A: I always enjoyed going back there because our Corps folks there really loved the land and the project. It was just a wonderful project for anybody who really liked nature and the environment.

I remember Jim Spears was there with Nashville District working on the project, and he was quite an artist. He did paintings of birds that were lovely, really terrific. This was his country. It was a labor of love for all those people, where they were acquiring real estate, working the project, or whatever. I mean, they were doing something for their world, and they really loved it.

Q: Are there other civil works projects of note?

A: Yes, I ought to talk some about the Gallipolis Locks and Dam project. Gallipolis, located in the middle Ohio, with one 600-foot- and one 360-foot-long lock was the biggest bottleneck for barge traffic on the river. Located on a bend, it was also the most hazardous. During my time in the Ohio River Division there was considerable activity—planning, design, model testing at the Waterways Experiment Station, testimony, congressional visits—revolving about modernizing Gallipolis to provide new 1,200-foot and 600-foot lock chambers. A new organization, DINAMO, came into being.

DINAMO brought many leaders, government and political representatives, to Gallipolis to view firsthand the problem and to solicit support for the preferred solution. I rather thought there was an effective partnership of private industry and government in this endeavor. It led to authorization and construction of the badly needed replacement locks.

Q: Ready to shift gears here a little bit? In June of 1981, General Bratton—I'm sure there was a little background to this—requested you to plan for a full-scale resumption of military construction in the Ohio River Division, which then was undertaken—not too long a period before it was actually resumed. So, this, I think, is a reflection of increased funding in the military area and some other things. How would you start in describing this process of bringing in military construction?

A: It was in that time frame that several of us had approached General Bratton and said, “We think you ought to expand the number of Corps divisions and districts with military construction.”

Q: Several division engineers?

A: I certainly was one of them. As I had traveled around initially to various places, I would get the question, “How come you're right here in Cincinnati, and I'm here in Dayton, Ohio, 50 miles away at Wright–Patterson Air Force Base, and my facilities are being built by the Baltimore District?”

Or, “How come I'm over here in Rock Island, and there's a Rock Island District right here, but Omaha District does my construction?” Fort Campbell, Kentucky, was the same way. Fort Benjamin Harrison, Indiana—same way.

So, I, for one, approached General Bratton, and there were others, and said, “I think dollars are up, the Reagan budget, there's a lot of construction out there. I think we need to get back in the military construction business.”

The Baltimore District had excellent people. They really wanted to do a good job. The district engineer came out every six months just to see the commanders at Wright–Patterson and make sure that they felt loved. However, he wasn't to feel loved for another five months. The customers just didn't feel that they were getting enough hand touching. I thought that we could do that better, and we should be in the military construction business.

So, General Bratton told the Director of Military Construction, Major General Drake Wilson at the time, to open the question, come back and tell him how we might adjust our military construction boundaries.

We put together a team to analyze how we'd want to do it in the Ohio River Division. We came to the conclusion that we couldn't afford to have more than one district in the military construction business, and every one of our districts wanted to be it. We had to concentrate in one district.

As a parameter, we knew we couldn't win getting back military construction if we were profligate in the amount of people the Ohio River Division needed to do the job. We had to constrain resources, do it the right way but do it austerely, and we had to focus on customer service. The thing we were hearing from customers was it wasn't being done right.

About that time there was to be a project in Rock Island called REARM [renovation of armament manufacturing], which was a major redoing of the factory up there, which cast the breaches for our Army howitzers. They brought in the howitzer tubes from Watervliet Arsenal. Then they did the assembly for certain of our weapons—the 155-mm and 8-inch howitzers. It was almost a Civil War operation, when I saw how they were doing it—pouring the molds and machining the breach and everything else. I thought of all the old black and white blurry pictures of ancient days. Now the world was moving into new ways of drilling things out and using modern machinery to do things. So, the Army Materiel Command [AMC] and the Armaments Command had a plan to redo that whole factory complex in a three-phase operation.

We thought that an appropriate dividing line for military construction boundaries would give us Illinois, Indiana, Ohio, Tennessee, Kentucky, and West Virginia. There weren't any military construction activities in West Virginia, maybe some future reserve centers.

Q: Michigan?

A: Michigan because there was one of our tank plants, and there were some Air Force installations in Michigan as well. We were also doing real estate in some places, so we really felt that that would be an appropriate thing.

So, we carved out that as our desired area of operation for military construction. Then we went to school to figure out how everyone else did their military construction mission. That meant, how does Omaha do project management? How does Baltimore do it, and how does everybody else do it? We more or less put together a package—you might call it a bid proposal—on how we thought it was in the best interests of the Corps that the Ohio River Division get back in the military construction business, with Louisville its executing district to take care of military construction and real estate in the area described above.

After that came quite an internal debate facilitated by Drake Wilson. You might have called it a fight, with “losing divisions” arguing not to lose their areas and, of course, us saying, “Well, we really ought to do it because it's in the best interests of the Corps.”

Eventually, then, the decision was made to give us military construction.

Q: One of the things that was said—I don't know if this is part of the bargaining or whatever because it would have happened anyway, no doubt—was that you placed an area office at Rock Island specifically because of concerns that came out in this debate from the Missouri River Division that you couldn't handle the project, that they had the expertise for the complex construction that was going on there. Does that sound about right?

A: Yes, but let me put it in context.

Q: Okay.

A: We had a professional disagreement with Baltimore District, North Atlantic Division, and with Mobile District, South Atlantic Division, on mission transfers of Fort Campbell and

Wright–Patterson Air Force Base, respectively. We all made our arguments and left it up to decision by Drake Wilson, the Director of Military Construction.

The Missouri River Division didn't do it that way, though. The division called General Wilson and asked to basically have a showdown at an upcoming DEH conference we were going to have in Nashville. They wanted to meet with him and lay down why the Ohio River Division shouldn't be given military construction responsibility, and specifically the REARM project at Rock Island. REARM was a \$91 million, three-phase, multiyear project to modernize the arsenal's major weapons facility. The Missouri River Division had said publicly to AMC that we in the Ohio River Division didn't have the professional capability to do REARM. Now, there's nothing that gets your dander up quicker than having your professional qualifications called into question.

So, we showed up at the meeting and were very surprised to find that the Missouri River Division had brought AMC to the meeting with Major General Drake Wilson. We thought we were coming to a meeting to dialogue why we ought to have it, and they would say why they thought they ought to keep it, and then Drake Wilson would mull it all over and give us a decision at the right time, after conferring with the Chief. The Missouri River Division brought in AMC to participate in our internal dialogue, and then they said, "The Ohio River Division doesn't have the capability to do this project. Isn't that right, AMC?" I really thought that was not the right kind of way to work things. Since AMC was there, Drake Wilson let them have their say, and he made no decisions that day.

We countered by going up to AMC and challenged them, "What do you mean, we don't have any capability? Do you realize we've done this project and this project and this? We understand the Missouri River Division's point. They don't want to lose the business. We don't understand your point, AMC, in that the Missouri River Division hasn't done any REARM before. So, what is your point?"

AMC said, "Well, we don't know. We just want to support our good friends from the Missouri River Division."

I said, "Well, just what is it they're providing for you now? You know, we've been up here, and we hear your Rock Island Arsenal folks griping about the fact that they only have an inspector and a clerk there from Omaha District, Missouri River Division. When they go over to their office, they can't ever find anybody. The arsenal doesn't really feel served. So, why don't you talk to your DEH who is doing this and come back and tell us?"

So, they said, "Well, I guess that's right." I said, "Well, look. The way we analyze this, this project is big. It's going to last. We're going to move a major office in there. It will be headed by a GS—whatever, and he'll have his inspectors, an office of four to five people compared to the two people you have now. He'll report straight to the district; he will not report to another area office and then to the district. So, now, tell us again why you don't think you're going to be well-served with the Ohio River Division coming to do this job for you? Or why do you think it ought to be the other way?"

They said, “Well, geez, we didn’t think of it that way.”

We didn’t do that as a ploy. We figured out how we would staff various places, and we did our numbers because we knew we had to go back in and show Drake Wilson and his programming people that we weren’t padding and building an empire that couldn’t be afforded. We were really scrimping and saving on each FTE. Nevertheless, that was the plan that came in for staffing at Rock Island.

We presented our plan to Drake Wilson, and eventually a decision was made that we’d get military construction to include the REARM project at Rock Island.

One other interesting issue—and we did adapt the Missouri River Division’s basic solution in this area. We wanted to get into project management, for the question was, how do you best manage the military construction projects? Where do you put that focus, the people who are handling the money and doing project management?

Now, this is pertinent now to what the Corps later came to in terms of project management. We found out that project management was implemented differently all over the Corps. For some, the engineers managed the project while it was in design, and then the construction folks managed it when it was in construction. In several districts, though, project management was an integral part of construction. Construction folks all thought they ought to manage projects because the big bucks are there, and they could do change orders more quickly.

When we called the Missouri River Division, Brigadier General Mark Sisinyak, the division engineer, told me that he had put project management in engineering because the problems are all up front—in making milestones, getting the design done, and interacting with the user. At the time the project is passed on to the construction management folks, they’re interacting with the contractor and the user, but the potential for time loss is up front. Engineering folks with project management can still manage the money. The construction manager comes to the project manager to get a release, and he may be coming to him for design changes too.

Anyway, it’s easier to close that communication gap than it is to transfer and have a break in project management or give construction folks the responsibility up early when the engineering folks have to deliver.

So, we adopted the Missouri River Division model for project management when we started the military construction mission in the Ohio River Division. We set it up and thought it worked very well because we had project managers from the start each taking part in the process.

Q: Well, in addition to the Rock Island, there was the complex hospital project at Wright–Patterson Air Force Base that you either got or took over. I’m not sure which it was. Could you comment on that? Hospital projects—I know the ones in Germany—tend to be complicated.

A: All of them are complicated. We took over two hospital projects. One was at Fort Campbell. The design and construction had been completed by Mobile District. We really took over the project at closeout and punch list time.

I felt that Mobile District should continue and finish the project, but the South Atlantic Division said, "If you're going to take Campbell, you've got to take it all now." USACE Military Programs backed them up, and so I guess we had little choice and said, "Okay. We'll clean up your project and close it out."

In the case of Wright-Patterson, that was key to the timing of the whole transfer process because that project was about to start. It was a big project. There was consternation on the part of Wright-Patterson for the project. That had great visibility in the Air Force, all the way to the Secretary of the Air Force's office. There was all kinds of detailed guidance coming down as to how the project was to be accomplished.

The \$106 million medical center project had been designed by Baltimore District, so we took it over for construction. One key part of that project was the hyperbaric chamber. That became an issue unto itself because this was a big, regional teaching hospital. It was an Air Force medical center with a lot of instruction and teaching. They wanted a hyperbaric chamber there so that they could do research and take advantage of having a center for treatment under pressure. It's very helpful for burn cases, for one.

The Assistant Secretary of the Air Force for Installations and Construction took personal interest in the hyperbaric chamber construction. He put out a directive that the Air Force wanted the Navy's expertise, having to do with diving bells and submarines, to be involved with and pass on (certify) construction of the hyperbaric chamber.

This issue came right out of the woodwork in the 11th hour. We had been dealing with the AFRCE [Air Force Regional Civil Engineer] in Atlanta, headed by an individual who was always carping at the Corps and how we needed to be sure to meet cost goals, meet milestones. He wasn't going to tolerate any slips or any extra claims. Now we had a very late decision that said the Navy is going to be involved in the approval and design of the hyperbaric chamber, which had already been designed and we were now on the street for a contract to build it.

The late decision presented us a dilemma in how to proceed rapidly and at the same time recognize that we have a new player. How would we integrate that new player? With a lot of assistance from the Chief's office, Military Programs, we got the Navy in quickly. There were two different players from the Navy too. They had to choose which one was to be the best expert on hyperbaric chambers.

We submitted our design and asked, "Don't design us one; approve this design quickly, please." We promised to integrate their testing program and visitations so they could do what the Air Force wanted, which was to certify that the hyperbaric chamber was okay.

We had great apprehensions, and it was a lot of work on a lot of people's part to make it happen. In the end, I suppose it worked out all right. I wasn't there at the end, but that was my understanding.

The project was complex from the standpoint that we were building a major new medical center facility, after which we would gut the old 144-bed hospital and rehabilitate it. As part of the new facility, we had to take away all of the close-in parking, plus do all of the utilities work, heating and air conditioning, for the whole. There was also a large glass atrium in front.

It was a complex, ticklish project that was programmed to last over five years, in the two phases.

Q: I know some of the European medical centers got complicated also because they were partly OMA funded and partly MCA funded. I don't know whether the Air Force was involved in any of those complications.

A: Certain equipment was OMA funded.

Q: I have one question that we ought to have asked earlier that's sort of out of order, but, just so I won't miss it, but why did you choose the Louisville District to be the military construction district?

A: It was basically because the center of mass of their civil works area was in the area that best represented the military area too. We had little activity in eastern Ohio, Pennsylvania, West Virginia—the Pittsburgh and Huntington District areas. Nashville District certainly had Fort Campbell. It basically seemed to fit best for Louisville District, with Indiana, eastern Ohio, Illinois, Kentucky, and with Fort Knox right there and Fort Campbell on the Kentucky–Tennessee border.

Q: Didn't Louisville have military construction earlier? I think they did.

A: I think they had it earlier too.

Q: Ten years earlier. Not that that would necessarily—

A: Probably the reason they had it earlier was for the same basic reasons. Louisville was a large district, and Wright–Patterson was in their area. It just seemed to be the natural fit.

Q: Was the type of infighting, or whatever, that you encountered in this process of getting military construction unusual in your experience?

A: The Missouri River Division part was.

Q: Not the other part?

A: No. I thought the rest—I mean, we’re two folks who each wanted something and would make their case, and the decision makers would decide.

Q: Now, what do you think accounted for that? Was it the severity of their cuts in their civil program that maybe made the Missouri River Division sort of desperate to hold on?

A: I don’t know. The Missouri River Division has always been a strong, strong division. Not many districts, but Omaha District was the one involved here, and they had that very special arrangement with Strategic Air Command and all the Air Force work. They also had the center of expertise for Superfund. So, I don’t know.

I think their attentions were everywhere else but Rock Island. That’s why Rock Island folks would say, “Hey. We never see anybody but this GS—whatever.” One of the lessons we learned from these dialogues was that our chief of construction and district engineer had to get in a car and drive around and drop in on folks every now and then to show that there was great care coming from Louisville.

Q: Of course, Rock Island has a district engineer, but he’s in the North Central Division.

A: That’s right. He was up there, and so there was still that dichotomy. Even their people would ask. Louisville District turned work over to Rock Island District to do because we had the one-stop services program to support installation DEHs, which was coming on about at that time.

Q: Yes.

A: We took it on as a philosophy to begin with that we would turn over to Rock Island District things that they could better take care of. Not the big REARM project because those kinds of projects take great tracking back through the whole system. For the small projects, servicing with design to the local DEH. The DEH would call us and say, “We have this project we’d like you to take on. We need design, and get us a contractor to do this project, like a parking lot or some kind of a thing, on the one-stop basis.”

Louisville would say, “Fine. You’ve come to your one-stop person, and we’re going to deal it to the Rock Island District Engineer and he’ll call you.” Louisville would pass the project to Rock Island, and thereafter all contact would be between the arsenal and the Rock Island District Engineer for the design and construction. Louisville was a pass through—they were the one-stop call. The idea was that an installation would not have to call around and figure out which district will do a project. Just call Louisville, and they would take care of the rest, arranging it with Rock Island District. That way, Louisville wouldn’t have to send another person up there to be handled by their folks on a chargeback basis.

It really worked out rather well. At the time, Drake Wilson wasn’t just considering which districts to put back in military construction, but also which divisions too.

An early comment was, “I don’t plan to put the North Central Division back, I can’t afford to put it and the Ohio River Division both back in.”

- Q: I don't think the North Central Division had maybe ever had much, if any, military construction.
- A: Yes. When I was deputy district engineer as a captain in Chicago, we had military construction.
- Q: Okay.
- A: We also had supply and procurement, a huge operation. That went to AMC.
- Q: We talked about some of the challenges of REARM and Wright-Patterson. How about in the tank area at Lima, Ohio, or in Detroit.
- A: Lima? We had some projects coming up there.
- Q: The Abrams tank was—
- A: Yes. It was in production.
- Q: Okay.
- A: At Lima, there was a \$26.5 million expansion of the plant to add 330,000 square feet. There were also projects for improvement of the existing plant in Detroit.
- Q: Organizationally, within the division office, the Military Construction Branch was in Engineering with Carl Betterton the chief. That was a change, I guess, that resulted from taking back the military construction responsibility.
- A: That branch was the one I set up in Engineering Division modeled after the the Missouri River Division's approach. Once we did that, then we gave Jack Kiper's Construction Division one or two more people to help out in construction management. That was about it, I think, from the standpoint of division staffing increases.
- Q: How about military accounting? Maybe that was in finance and accounting.
- A: There might have been a requirement for four or five people. I don't remember. We had a centralized finance and accounting, you see.
- Q: That was in the division?
- A: At the division level. We separated support when we talked about division. We would talk about the 115 or so folks that were in the headquarters downtown in the division office. The centralized support, like finance and accounting, would be accorded to the districts as if they were districts. We would do the breakout of how we charged project support and put the finance and accounting part on the districts, even though they were collocated at a site in Cincinnati.

Later on, when we reorganized the personnel function and went to a centralized shop there, we did a similar kind of thing. In the Corps' sense of accounting for personnel, there are those in districts that are charged out certain ways and those in divisions that are overhead. So, we always had to be careful to ensure that we were addressing FTEs that were really district level work, collocated for efficiency as district kind of FTEs.

Q: Different from overhead?

A: Different from overhead, which was the division.

Q: How about in the military real estate function, which came at the same time, the recruiting stations, for example. I think this was one of the biggest areas that any division had.

A: Yes, it was.

Q: I think you were the lead in that.

A: Yes. I think in numbers of activities we were very big, I guess, because of Chicago and Detroit and Indianapolis, Nashville and Louisville. I mean, those kinds of places, including Columbus, had large numbers of recruiting centers.

Recruiters were always changing centers. I mean, it was endemic to that business that each year they would decide that they could improve recruiting if they could just have that better location down the street. So, there was a high turnover business.

So, our people in Louisville were very active in that business, and there was a lot of road time spent doing that.

Q: Now, was that handled out of the Real Estate Division, Louisville District?

A: Out of Louisville District.

Q: Those were probably leased, weren't they?

A: Yes, leased.

Q: For recruiting?

A: Yes.

Q: In terms of land acquisition for military bases, there probably wasn't a whole lot of activity.

A: No. Our real estaters also handled installation contract property use. If there were contracts, like at the Indiana Ammunition Plant for farmers to graze cattle, then that was handled by Real Estate. If there were timbering contracts, that was handled out of Real Estate as well. There was a large amount of activity in that respect at the various installations.

Q: I am interested in a couple of different types of questions, if we can change subjects.

A: Yes, sure.

Q: You were also, as division engineer of the Ohio River Division, a member of the Mississippi River Commission.

A: Yes.

Q: What sort of activities were you involved in with the Mississippi River Commission?

A: I knew very little about the Mississippi River Commission until I became a commissioner and found that it was a very interesting part of my job. I enjoyed it professionally because it opened new vistas of understanding of our nation, and an important component of the Corps' contribution to the nation.

Forty-one percent of the 48 continental states of the United States drains out past New Orleans into the Gulf of Mexico, and it goes down that waterway. When people talk about the Lower Mississippi Valley Division being the premiere division in our system, they do it with some reason. There are other competitors, like the South Atlantic Division with its multiple responsibilities in South America and now in the Middle East. The South Atlantic Division has major military installations—Bragg, Stewart, Benning—and during my time had responsibility for the large Tenn–Tom project. The responsibilities that befall the division engineer in Vicksburg in time of crisis can be as big as anybody's. He has to make decisions based on what's tumbling down the Mississippi in cascading amounts of water.

So, I always appreciated Major General Bill Read's job. He was the division engineer at the time and the president of the Mississippi River Commission. Of course, I had worked for him in the ACE's shop, where I'd been his deputy.

The Mississippi River system is operated by the Mississippi River Commission—the Lower Mississippi Valley Division less the St. Louis District—that is Memphis, Vicksburg, and New Orleans Districts. It is an open river—no locks—and they have engineered it and trained it to keep the flows available for navigation and to be able to fight flood flows. The Mississippi River tributaries project has all types of systems—levees, floodways, tributary dams—the Morganza Floodway, Bonnet Carré Spillway, the Old River control structure, and the Atchafalaya River are the measures by which they do it.

The key reason for my being on the commission or, say, the position of the division engineer of the Ohio River Division, is the fact that the Ohio River can be the biggest contributor to floods in the lower Mississippi. The Missouri has a component. The upper Mississippi certainly has a component. I mean, you can get rains anywhere, but the real design storms for the catastrophic flood on the lower Mississippi is a major storm centered over the Ohio basin, and basically centered over the main stem of the Ohio.

Recognize that the flood control apparatus, the 76 dams that I mentioned earlier, are up the tributaries. So, if you get a storm centered over the main stem below the tributaries, you're getting water that hits directly into the Ohio. Not well known to the layman is the fact that

the Ohio River locks and dams are not there for flood control. They are there for navigation—to maintain a nine-foot pool for navigation.

Those main stem dams don't have a flood control component; they don't back up water and hold it for flood control. When floods occur, the gates are opened, and natural flows occur. So, you get a lot of water coming from the Ohio into the Mississippi system.

Within the Ohio River Division there's a tremendous system established for reservoir control, centered out of the reservoir control room in Cincinnati. It uses measuring gauges at all of the various tributaries and lakes, connected by satellite. The satellite retrieves the data day and night as it's going over these places and feeds the computer system in Cincinnati, which links to Vicksburg. Our division reservoir control folks talk to the ones in Vicksburg who are measuring the lower Mississippi. They make a determination as to what the flows are and what they expect it to be at the gauge at Cairo and on downstream.

Cairo is where the Ohio comes into the Mississippi. With the Missouri and upper Mississippi already there, that becomes a pretty important point for gauging. Our ability, then, to control flows into the Mississippi might or might not be limited, depending on where the waters are and what we've done on these upstream dams.

Within the the Ohio River Division area is the Tennessee River, which is operated by the Tennessee Valley Authority. The division is supposed to give the Tennessee Valley Authority instructions as to what to do on the Tennessee, and they're supposed to abide by our instructions.

Basically, in Vicksburg they're watching the curves of the water and communicating to us, and we're communicating to them. We're saying when the next Ohio rise is expected to arrive at Cairo hours and days in advance. They're reading from the North Central Division and the Missouri River Division what the flows are coming out of the upper Mississippi and Missouri, and they can predict stages. They can then say, "We expect the Missouri to reach Cairo at such and such a time three days hence. If you can hold anything back and prevent your rise from either getting there before or after, please do so."

So, in Vicksburg they try to work out those kinds of things to take care of the flooding. It's important at Cairo because of the New Madrid Floodway. If needed, the New Madrid Floodway is opened by blowing the levee and letting the water divert down that floodway, which wipes out a lot of farmers and their properties and their investments. That became an issue when I was on the commission. The local farmers in the floodway were seeking to find some way to prevent the Lower Mississippi Valley Division from blowing the levee to make the floodway happen. That was one of the things Bill Read had to wrestle with, so I can't expand on that much more.

When I was at Belvoir, we were developing the TEXS [Tactical Explosive System], the liquid explosive system that we never were able to bring into the combat engineer inventory. However, the Lower Mississippi Valley Division used that principle, preparing the pipes and

having them ready for liquid explosives, to prepare the levees for emergency demolition to make the floodway.

Well, anyway, my joining the Mississippi River Commission had the additional value of my better understanding my responsibilities upstream.

The Mississippi River Commission has multiple events, two of them being the annual low water and high water trips. Taking the motor vessel *Mississippi*, the president of the commission, his staff, and the other commissioners make an inspection trip down the Mississippi to New Orleans on one trip, and down the Atchafalaya to Morgan City on the other.

During that trip the commission holds hearings daily aboard the vessel tied up at Memphis or Vicksburg or other ports. People come aboard, especially from the levee districts, and report on status or concerns with the project. The district engineer, in each case, gives his report so all can hear his report. Then the others come up and provide comment and thus develop issues that will be addressed later by the commission and commission staff. General Read, as president of the Mississippi River Commission, presided at the hearings.

This was an interesting time because of several things. One was the New Madrid Floodway issue that was controversial. People were coming aboard addressing the commission and arguing the fact that the floodway was obsolete and shouldn't be continued. They later carried that argument to the Congress and to the administration and to the courts.

Second, the whole issue of the Atchafalaya was still in question. That was, what is the right thing to do to protect the environment of the Atchafalaya? We were embarked in planning for starting with the construction of the second control structure where the Atchafalaya left the Mississippi. The first one had been badly damaged in previous floods. There was always a tension about whether the new one would be built in time before the next flood came down and threatened it.

Finally, there were the arguments down at Morgan City on the floodwall project. This project was being opposed by environmentalists and the oyster fishermen. They were saying that the lack of fresh water was allowing saltwater encroachments and thereby destroying the oyster beds and that we were destroying the whole Louisiana coast down there.

Finally, there was the question of saltwater intrusion up the Mississippi during flow regimes and the viability of the New Orleans water supply.

Open channel engineering was not something we were involved with in the Ohio River Division, so this was a whole new component for me, and very educational and very enjoyable to participate in.

Q: I'm glad you remembered that because I had it on my list.

A: Beside the annual trips, we also had meetings from time to time, typically in Vicksburg. That would be run much like our Board of Engineers for Rivers and Harbors meetings because

projects in that area were passed on by the Mississippi River Commission, not by the Board of Engineers, and then would come to the Chief of Engineers directly. The Morgan City flood wall project was one of those, with its many controversies.

There would be hearings in the hearing room at Vicksburg in the commission offices, presided over by General Read. The commission would meet, and we'd all vote on the projects. Some of those votes were quite close, like four to three.

Q: Humh. You would later be on the Board of Engineers?

A: Right.

Q: When we were doing our interview on your time as Deputy Chief, you referred a couple of times back to your experience in the Ohio River Division, and you were doing this in the context of the relationship and as ACE headquarters from your perspective—now in the headquarters, but back then as division engineer—and the things you remembered about that experience that were troublesome, I guess is the word to use.

One of the things that you said is that getting guidance and decisions out of the headquarters took too long to make things happen. I wonder if you would say a little bit more about that, now that we're talking about your Ohio River Division time. How much of a problem was it really—resources you mentioned. I think what you were getting at was that there were some pretty critical things sometimes that took too long.

A: Well, I think resources was a prime one and a thing that we never have solved at the headquarters, even now. Even when I was deputy there was a question as to who really controls the resources. There was always an argument—does the Director of Resource Management control the FTEs, or does the Program Manager, Director of Civil Works, or Director of Military Programs control them?

Sometime when we asked questions from the Ohio River Division—and I'm going back to that point—we would get the view, "Well, the comptroller or resource manager did that." We'd call that office, and the finger would point back, "No, that was Civil Works who did that." So, part of the issue was trying to find where the buck stopped so we could grapple with it at the staff level. Now, you could always get Bory Steinberg, and I don't remember who the resource manager was in that day.

Q: It was Colonel [Clarence] Gilkey.

A: Basically, Bory would get aggressive at the staff level. It was just tedious to work through. You had to raise it to a Bory level to really get a direct answer, and he wouldn't always agree, but that was all right too. I mean, that's what people are supposed to do, stand up and be counted. Then we would raise the issue up to the director level.

There was a continual resource issue thing. It was annual, but came more often because there was a midyear review, and then somebody decides to cut something. One rather famous issue was when, in midyear, Bory's people decided that we weren't using our civil works

operations FTE allocation that year. Therefore, they were going to give us a midyear cut—I mean, some sizable number, like 60 FTEs.

We answered, after doing the homework, “Wait a minute. You’re not reading the charts right.” It was not a linear chart. We are talking about a chart line that is flat at the beginning and then ramps up come spring and summer when we use most of these funds. Figure out when the fiscal years are and recognize that we start bringing on temps to work in our recreation areas in the late spring time frame. We start bringing on people to augment our work crews out doing summer work on the locks, the dams, during that same time frame.

It was not a linear relationship. That is, you don’t plot that we use everybody straight-lined, one for one all year long. The fact that the USACE staff was measuring in January says that they should not be measuring up at the straight part of the curve. It would be down on our projection. Our argument was, “Don’t measure against what *you* thought we should do, which we think was erroneous. Measure against what *we* thought we would do when *we* asked you for those FTEs and *you* gave them to us.”

The answer came back, “You will never, ever use them.” We said, “Oh, yes, we will use them. We’ve got plans to use them. They’re right in our projection.”

I mean, we diddled with them at the staff level for weeks. Then we got to Bory, and Bory didn’t support us, and John Wall, the director, brought me in and said, parroting what Bory’d said, “You’ll never use them.” I said, “Oh, yeah, we will.” He finally said, “I’ll bet you you’ll never use them,” and I said, “I’ll take that bet.”

So, at the end of the fiscal year, turns out we used them. Except they never changed their numbers. [Laughter]

The interesting thing was that the Office of Management and Budget called the Corps on the carpet for overusing their spaces that year. I don’t remember what the numbers specifically were, but it might be on the order of 10 over. We’d used 60, so the other folks had fallen short and not used theirs, and therefore we’d used basically the rest of the Corps’ allocation. So, Civil Works had responded through Gianelli as to why USACE had gone over.

About the same time there was some sort of a personnel newsletter that goes out to all federal agencies, and it basically said: “Use them or lose them. Only four agencies used their allocation this year. Plaudits to X, Y, Z, and the Corps of Engineers for fully using their capability.” Then it listed all those other agencies that shot way below their number.

So, I called up John Wall and told him, “You received the compliments of the newsletter. I hope you accept that. When you write Gianelli back, just say we didn’t count very well, or whatever. [Laughter]

Nevertheless, you received compliments for having the foresight to plan and be very close.” I mean, what’s the difference between 10 over versus not using to serve your country 200 man-years of effort? In the Ohio River Division we used the man-years of effort to good avail in

serving the folks in the Ohio Valley. Anyway, I got my hand smacked, but I accepted the bottle of Scotch he had bet me. [Laughter]

Q: Were there other areas of that relationship of the headquarters with division headquarters?

A: I think part of that we talked about before. You have to recognize the headquarters at that time was deeply involved, especially toward the last, in changing policy developments with the secretary's office. There were lots of times where they were trying to sort out things, not knowing how they would sort. So, there were time delays because of that.

Frankly, I think, in some cases, some of the things we had to send over to the secretary's office, he would sit on because if he would sit on them, then the Corps wasn't spending money, and that was a goal of the administration—to hold down federal expenditures. If he could keep it in suspension, then action wasn't being taken and so one can't necessarily fault the Director of Civil Works for not prosecuting these things. He had the problem of trying to work out the issues and the process.

Now, where that befell us was, again, my comments that I thought the secretary did not respect the Congress and their staffs who really knew how the process worked and knew they had to keep the pressure on the office of the secretary for answers. They always knew where projects were because they'd call and say, "Where is this?" The answer would be, "Well, we sent it to USACE on such and such a date." Then they'd call headquarters, and they'd say, "Yes, that's correct, and we sent it on to the secretary's office on such and such a date."

So, then they'd call over to the secretary and put the pressure on getting it out. Then it might come back down, back up and back down, as we all sorted out the policy kinds of things.

I think my comment that it took too long is really answered in those two kinds of things—the fact that it just seemed too often that we had to call up and get answers that should have already been developed and sent back.

On the military side of the house we were just getting into that, and on the resources side I know that we felt that we had convinced Drake Wilson and his folks, and they'd tell us they agreed on those numbers. But then it would go over to the resource manager, Colonel Gilkey, who would want to work it, but he didn't have time to work it.

So, it would take a while to get him to verify, validate, or disagree with what we already thought we had through the Director of Military Programs. If he validated it, that was fine and we got it, eventually. If he disagreed, then we'd have to go through the whole process again, back to Drake Wilson, get those two together to come to grips with each other as to the right answer.

I think those were the sense of my comments.

Q: How would we relate another comment that you made about, "We need a higher headquarters that acts like a higher headquarters?" I mean, does that pull in some different kinds of things as well?

I forget the context in which we were talking at the time. This came out of our discussions when you were deputy.

A: Interesting comment. While I was at USACE headquarters, sometimes some people wanted to get into execution, which basically should be down at division and district level. At USACE we've had difficulty really coming to grips with what is our role, and what is policy, and making the program decisions, and coming to be definitive in a responsive time frame in the fact that resources have to go up and down hill, as I've described—that is, from USACE back to divisions, and then reallocated and impacts developed from below, and then communicated back up. I mean, you shouldn't dawdle over that kind of a process because you forget, and then it all has to be re-explained, and then that's lost effort.

So, the more disciplined—precise is not the right word—you can make the process so that each level is doing the right thing and have to address the realities, then the better off you are. This really means for resources you want to allocate bogies, get the impacts back in, get a decision at the top, communicate that decision back, ask for impacts, get the impacts back up, adjust your staff level decision recommendation, send it to the decision maker—the Chief of Engineers or deputy, whoever it is—to make the decision.

Dragging out the process doesn't usually make the inputs any better. What you really need to do is to make sure you coalesce the folks to make the decision in a time frame that's right. I think, as complex and difficult as the Army Staff process is, they do it right with Program Analysis and Evaluation who puts it together, and they meet time frames because they get a program/budget schedule from the Department of Defense and have to go back up in a certain way and time frame.

So, Program Analysis and Evaluation gets the people together and they make their decisions, ask for input, and have to meet certain windows. You don't mess with the process. If you want to play the game, you'd better sit up and have a program and playbook and do it because the defense process will leave you behind.

With the Corps, I think we have the capability of being a little more flexible in our process, but then probably we get too sloppy at it and say, "Well, okay, so we didn't get it Tuesday; we'll get it on Thursday." Then at the headquarters there is not the recognition that that has an impact downstream in the division. When you do go back, then, on Thursday, maybe that doesn't give the division enough time to develop their impact and turn it around.

So, the Army/defense system takes care of that by putting the whole calendar out and staying disciplined to it. Everyone knows the key dates from the start. We're a little more informal in the way we've done it in the Corps, and that leads to not always doing it in a good, disciplined way.

Q: Compared to other assignments that you had—not just Ohio River, but being a division engineer—how did that measure up?

A: I enjoyed it a great deal. How does that stack up against other assignments? I don't know. I've never had a bad one. Some are better than others. The Ohio River Division was better than a lot. I really enjoyed the great professional challenge, great people, a lot of friends. I enjoyed the interactions, worked hard, and enjoyed it.

Q: Okay. I don't know if you want, at this point, to say anything about—I guess you know some of this was going on before you retired in terms of reorganization, and the plan that got shot down included closing some divisions—not Ohio River, but some divisions and districts. The new approach that's being taken now is to look first at the divisions, not with any—you know, it's like going in tabula rasa, the secretary says.

A: What does that mean?

Q: Well, that means without much reference to the previous plan. In other words, they don't have a plan. There were some things they liked about the earlier plan, and there is a lot that isn't very popular about the earlier plan, but that the Corps clearly needs to reorganize and clearly needs to get more efficient.

If you see any perspective that you could provide to that in terms of just not a specific division but the overall issues that are involved. If you want to say something about that now, fine.

A: Sure.

Q: It might be a good way to close out here on the division.

A: Well, while I was in the Ohio River Division, you know, we had a very quiet look at reorganizing the divisions in the middle of the United States. The people that were involved in that were the commanders of the Lower Mississippi Valley Division, the Missouri River Division, the North Central Division, and the Ohio River Division, under General Read who was the head of the study effort.

Our charge from General Heiberg, Deputy Chief, to General Bratton was to get a look to see if we could come up with some plan to do something in the middle. We met several times without staffs but involved staffs on our own when we went home.

In our meetings, typically, we'd fly to St. Louis and rent a room in a hotel near the airport. General Read would preside with the three of us, and he'd have a person there take notes and run the Vu-Graph projector. We'd try to carve out a rationale for what might change and why.

I don't know if we ever recommended anything specifically, other than we looked at some alternatives and gave the pros and cons of each and addressed them forthrightly. We came pretty close to what the last reorganization group came up with.

For example, it was clear that we didn't need all three divisions—the North Central Division, the Missouri River Division, and the Ohio River Division. Certainly something could go

there. We tried to play with what we would do with districts and that sort of thing at the same time.

We tried to take a special focus on the Missouri River Division and the responsibilities of the Air Force and how we'd address that. The North Central Division, we came down to, was the most vulnerable. The problem was, "What do you do with the responsibilities of the commander, North Central Division, with respect to Canada and the Great Lakes?"

One of the schemes we came up with basically took the Ohio River Division and the North Central Division, Detroit and Buffalo Districts, and put them together. The problem was, I felt fully employed at the time as the Ohio River Division Engineer, and didn't know whether I would get time to go do the Canadian. That was a sticky wicket there.

Then the thought was that St. Paul and Rock Island could go to the Missouri River Division. So, we might end up with the Lower Mississippi Valley Division and then two at the top. Of course, the more recent plan came up with a single at the top—the Ohio River Division.

Out of all that, and having thought about it a lot from my time in Civil Works and as deputy, and down in the Ohio River Division, and having participated in this study of the center, and being in the Mississippi River Commission, I thought that the plan the Williams group came up with was brilliant. It really addressed a lot of things and kept things about the right balance.

First of all, there are some folks who say, "Why do we have to have the division level?" I say, "You really need divisions. I mean, our districts' perspective is, frankly, pretty narrow. They bring a very local bias. Now, the locality might be as big as a state and a half, but their bias is much more local."

You start confronting ideas with ideas at the division level, and you need that one-up review that comes not only in engineering design but other things too. The pressure put on the regulatory program came from me at division. The pressure put on closing Kentucky River came from me to Louisville District, who didn't want to do it.

Huntington District would never have solved the Yatesville Dam situation because they just would have thrown up their hands and said, "We can't do it. You go tell Congressman Perkins." Or, "All we could see is go buy it for \$50 million." Neither of which was really a responsible position.

It took the division to guide district solutions. Now, when I say division—I don't mean just me. I'm talking about my strong staff—Dick Armstrong, Jack Kiper, and Jimmy Bates and their staffs who worked out all the details, who'd come up with alternatives and challenge with the "what ifs." I mean, you need that mature, experienced-level kind of thing to develop comprehensive regional solutions.

I don't think Huntington could have done the EPA job with Chemdyne without the division. There was another case where Huntington District would not give a permit to the developer of a privately developed power site at one of our main stem dams on the Ohio—an

administration initiative, if you'll recall, for the nonfederal development of hydropower. The district would not permit the developer to bring high-tension lines across the locks.

In fact, Huntington had a good rationale, but, also in fact, they'd taken a lot of weeks messing with it, not solving it. The people pushed them, wrongfully so, and had even ordered the steel that was now on site. So, here was the dilemma: "You [Huntington District] are thwarting us from doing what's necessary."

We, meaning the division staff, worked out the solution to that problem, not the district staff. They did their level work, but we forced the tough engineering analysis and questions and answers that brought about a rational solution.

There's another example: the Tishomingo County roads. We were asked by Congressman Whitten to look at the roads we were destroying in Tishomingo County near the upper part of the Tenn-Tom project. Congressman Whitten's point was that Mobile District was not doing that down in their area. "They're taking care of the roads and paying for the damage. Why aren't you?"

Nashville District was adamant that there was no federal interest in doing that. So, I had our staff look into it. When you come right down to it, we had fixed up a contract that was different from Mobile's. Mobile was running their haul road right down the middle of the project, so that's why their roads were not damaged. We were hauling huge stone in mammoth trucks over county roads for some distance. The roads weren't designed for that load, and we were destroying them as a result of our activity.

Did we have a responsibility? I thought so. So, once again, we worked the solution to come up with how those things could be taken care of and the county reimbursed for the damage we were causing. It would never have happened at the district level. It would have just remained an issue.

So, I think divisions are an important and responsible level. We should not get rid of divisions. They need to be there. The USACE headquarters should not be in the execution mode. The translation point between policy and planning and programming and execution is appropriately at the division level. So, we need to have them.

Do we need to have as many as we have? No. I think the solution the recent task group came up with—the Lower Mississippi Valley Division and having divisions in the southwest and northwest, southeast and northeast, and then in the upper middle, is the right kind of solution.

I also thought that the way they split Southwest Division was brilliant. I mean, I'd never thought about their going away. It was always a very strong division, but when you really come down to the numbers crunch, that does make a logical kind of split.

Also, I think keeping one in Cincinnati makes sense. I mean, everybody will say, "Well, you were there," but in essence, with the prime role the Ohio River system has and the biggest lock system that we've got on the waterways, that says that's going to remain an integral thing that needs to work.

Omaha District would certainly remain to do that in a diminishing era for the Strategic Air Command, but they could get their oversight from somebody else.

So, if the Ohio River is the one with the largest number of locks, then running the Illinois system and the upper Mississippi system of locks falls within that framework too. I wouldn't have guessed all those components—Little Rock has always wanted to be part of the Lower Mississippi Valley Division—but I really thought it was a good plan.

Q: I wonder if it will be politically easier to sell the division reorganization than go back and sell the district? If the district is more sensitive? You don't think so?

A: Well, I don't know how you can do the two parts.

Q: Well, I don't know that they're going to implement anything. They've got \$5 million in the '93 budget.

A: To study?

Q: To work towards it.

A: I mean, part of the division is supervising districts, the point of delivery.

Q: Yes.

A: The real question is, "In how many places?" What do you need at the point of delivery of services, and then what layers do you need to provide support to that point of delivery? Point of delivery is area offices, and parks, and locks and dams. I mean, really, subdistrict offices. Then where are the logical places you need to put districts that have to service them?

Like on the Ohio, we figured we had to have two repair fleets, one to serve Louisville District and one to serve Huntington and Pittsburgh. I don't think they, the districts, ever came to that conclusion. So, then, how many engineering and construction offices do you need to take care of the activity generated in terms of construction and design in an area? Then what's your level of review over that? Then tie them together, do the Canadian interaction, do the testimonial interaction, and pull that all together on a regional basis.

What you come down to is six or seven divisions in the continental United States, so they probably had that right.

If you don't talk about what districts to close or contract, then you're maintaining folks down there that you don't really need. You have to address districts somewhere.

When we did our study, one of the factors always was taking down a Corps flag. As long as you take down a Corps flag, somebody will object. The people in that office will write their congressman, and that mayor, that governor, or that congressman will object that you're doing something to their flag.

You know, when you pass laws like Senator [Pete] Domenici did that say you can't close an office so close to someplace else, or Senator [Fritz] Hollings, South Carolina, did for the Charleston folks, or [Dan] Rostenkowski in Chicago—I mean, there's a big guy everywhere.

Q: Right.

A: At one time, in the Ohio River Division, we had both the Senate majority leader and the Senate minority leader in our area of operations, Senators Howard Baker and Robert Byrd. Congressman Whitten was there with the Tenn-Tom in Mississippi. We had some good folks.

So, if anybody wants to make sure nobody objects, you're never going to get there. So, the Corps had a plan, and it was in the base realignment and closure plan and the right place, and I think the Bush and Clinton administrations and Congress lost an opportunity. It had been done right.

Q: They lost the appetite to implement it?

A: Yes.

Q: One quick question. When the Central Division study with the division engineers was ongoing, about what's the time frame on that?

A: I would suppose it was—I left in the summer of '84—in the winter of '83-'84. I might be wrong.

Q: We might not find any record of that. You said it was a quiet one.

A: It's probably in General Heiberg's personal files.

Commanding General, U.S. Army Engineer Center and Fort Belvoir¹

Q: In the summer of 1984 you became commanding general of the Army Engineer Center and Fort Belvoir. Could you have been better prepared for the job?

A: I don't really think so. I believe my background of assignments, experience, the fact that I had come up through the ranks and served in almost all kinds of engineer battalions, had served in both heavy divisions and light airborne divisions, had served at Corps and at division, commanded a combat heavy battalion in Vietnam, and worked at not only a troop unit level but also at major Army command level and Department of the Army level on staffs, that I really knew how the Army worked, how units worked, and how things needed to be done, knew a lot about engineers and training and professional development, and therefore

¹Interview conducted by Dr. John T. Greenwood on 29 June and 13 July 1987 at Fort Belvoir, Virginia.

was appropriately prepared. I don't think I could have done more to be better prepared. Although I will say I didn't really fully understand the breadth or the scope of my duties when I arrived, but it only took me about one week to find out how broad those were. I think my preparation for that was there. I just wasn't quite aware of the position responsibilities in total.



General Kem (center) at his promotion to major general in July 1984. On the left is Lieutenant General Joseph K. Bratton, Chief of Engineers, and on the right is Ann Kem.

Q: Which is pretty normal, wouldn't you think?

A: It might be normal, but I think there has been a change in the role of the commandant over these past several years, that General William R. Richardson at TRADOC and General Carl Vuono at the Combined Arms Center really put into place—that is those things having to do with the word “proponent.” I had thought from outside and other assignments in the Corps that the word “proponency” had to do with personnel proponency only. I found out that it meant responsibility for the engineer force and the total Army in all aspects of doctrine; force modernization, that is both force design and materiel modernization; training, both individual and unit; and in personnel policy. General Richardson always said, “I want the commandant of the Infantry School to be chief of his branch, Chief of Infantry. Well, we have a Chief of

Engineers; nevertheless, for the engineer force, those same connotations of what he ascribed to the commandant of the Infantry School pertained to me as the proponent for engineers.

One of those other things that I did not understand was the fact that we are responsible here at Fort Belvoir, as engineer proponent, for the programs of instruction that are taught at Fort Leonard Wood. We have here those kinds of responsibilities and have, in fact, a field team permanently located at Leonard Wood to exercise those responsibilities.

Q: What guidance did you receive at the beginning of your tour?

A: Well, I met with my two major bosses. General Vuono, who was the commander of the Combined Arms Center, wanted me to be proactive, wanted me to absolutely ensure the integration of engineers into the combined arms team, told me if he was the Corps commander, I was his Corps engineer and we ought to make things fit that way. He wanted me to focus on AirLand Battle doctrine and ensure we embedded the tenets of AirLand Battle doctrine in all things we do. Basically, he emphasized that we set the standards for the Army in TRADOC and CAC and I should be the standard setter for the engineer force and I should actively pursue bettering that force through TRADOC and throughout the Army. That meant working things through the Pentagon and working things through CAC.

General Richardson actually was probably more specific describing the proponent's role. He specifically laid that out in the terms that I used for the last question. He expected me, as the engineer proponent, to take charge, make sure we did everything possible to improve the effectiveness of engineers. He told me he didn't think we engineers were very effective and we were badly broken and we needed a lot of work to be repaired. He said, "Your job is to go



General Kem (second from left) received the school colors from General Carl Vuono, Commanding General, Training and Doctrine Command, when he became Commander of the U.S. Army Engineer Center and Fort Belvoir, Virginia.



General Kem (right) and Major General James N. Ellis, departing Commander of the U.S. Army Engineer Center and Fort Belvoir, Virginia, at the change of command ceremonies on 21 August 1984.

out and do that, and that means working not only at Belvoir.” The way he put it was, “You’re not responsible for just engineers and how combat engineers are taught at Fort Belvoir. You’re responsible for engineers in the total force and how the commandant of the Armored School instructs in the use of engineers at Knox and the same at the Infantry School at Fort Benning and at the Combined Arms Center at Fort Leavenworth and so forth.”

In other words, I was and am responsible as proponent not only for engineers in the total force, but the engineer functional areas as they are taken care of by the rest of the Army—mobility, countermobility, survivability, sustainment engineering, and topography. His challenge to me was to work within the system. He felt that engineers needed to be fixed, I should go do the fixes, and I should work within the TRADOC context.

I did have one other call and that was with General John A. Wickham, who was Chief of Staff of the Army at the time. His challenge on a broader scale was, “You’re now in charge. I expect you to set the standards within the engineer force. TRADOC has an important mission, preparing the Army for war, and thus you’ll be doing your part of that. You should look to try to lighten the force. Seek ways, materiel systems, by which one could lighten things.” He was speaking mostly materiel systems, but also other things.

Q: Now, did you accept General Richardson’s viewpoint that the engineers were broken and had to be fixed, or did you analyze that and see that that may not have completely been the case and adjust your reactions?

A: No, I absolutely believed it to be so. From my experience in the past, I felt that we were the weak link in the combined arms team; that we had been left behind by the Army in the modernization efforts; that people did not fully understand, respect, and value the engineers’ role to the combined arms team, primarily because throughout the many places we trained, like Europe and our REFORGER exercises, we simulated so very much. The white engineer tape simulates a mine field and simple rules of obstacle engagement provide a nonrealistic scenario—too short a delay, for example, in front of an obstacle. That takes away the credence of the contribution of the engineer. Obstacles don’t seem like such a battlefield factor when you simulate it and do away with it so easily. So, I felt that engineers had not kept pace with the rest of the Army. We were woefully deficient in organization design and equipment, primarily. We had great esprit—all of our troops were doing their damndest—but we really had not kept pace. The Army had not allowed the engineers to keep pace with the rest of the combined arms team.

So, I agreed with General Richardson. Importantly, when he was talking to me, I recognized that he also understood those things.

Q: Did you set yourself a series of specific goals or objectives, then, to try to remove these problems?

A: No, I didn’t establish any series of objectives or goals. I really worked within the rather macro objectives and goals that were already established, but it all blended together rather nicely. First of all, the TRADOC mission—prepare the Army for war; be an architect for the

future. Second, the fact that my two bosses said, “Take charge. It’s broken. Go fix it and do it in terms of integrated combined arms.” Third, my own background experience and very recent experience in Europe where I could see that during REFORGER training exercises that we just were falling farther behind and couldn’t keep pace. All of those ideas blended to fit the agenda that I came in with and the feeling that we had to get it fixed. Now I was being given a position whereby I had the responsibility to get it fixed. I couldn’t watch or send letters to somebody else; I now had that responsibility.

That, then, was accompanied by the massive lessons learned that were coming out of the National Training Center [NTC] with each rotation. There the simulations went by the board. The value of the engineer to the combined arms team was really being represented at the NTC most often by units failing because the engineers were the broken part of the team. We were finding all these ways the maneuver units and engineers were trying to create band-aid solutions to the problems out there. That became a fourth catalyst, and all that came together and met very nicely my inkling and desire to fix it—the combat engineer system. Consequently, I then established a game plan, a strategy for analysis, assessed the parts, and developed a strategy to approach how we could go about fixing it.

I didn’t set, in answer to your question, specific goals and objectives. I recognized that we had to address the engineer system across the entire spectrum of proponenty—that is, doctrine, organization design, equipment, training, and personnel. You couldn’t do just any one or the other, although some of them are easier to work on than others. That is, doctrine, training, and personnel are soft things that you can tend to work on within resources. The problems with force structure and materiel solutions are that you are now having to work within the whole Army and you now compete for approvals and time and bucks and so they become more difficult.

Q: So, what was your strategy, then? Obviously your two bosses were supportive of your efforts.

A: The strategy really came about to address combat engineers across all of those functions. We began to put together an analysis and coalesce maneuver opinion and maneuver commander support for the recognition of the engineers’ role and capability—realistically. See, I’ve maintained for some time that very often engineers have been their own worst enemies because we tell people things are great when, in fact, they aren’t great.

Our maneuver folks know, however, in the realistic situations we provide them on the realistic battlefield environment, like at the NTC, that we engineers don’t provide the combat support they need—in their terms. We may provide what we engineers talk about as great support, but it’s in our terms, like with a five-ton dump truck, like breaching with bayonets, but it’s not in the terms of guys who talk mobility and maneuver, like General Saint or General Bob RisCassi. When they talk maneuver, they talk about moving out.

Maybe my background, starting off in the 3d Armored Division’s 23d Engineers years ago, gave me a feeling for the thinking of the armor maneuver commander and today’s battlefield. Even tailored by my subsequent time in the 82d Airborne with can-do folks down there, it was apparent to me that we weren’t talking the same language. Some engineers think we’re

okay, but they're defining things in their terms. So, what I did was to define the engineers' role in maneuver-commander terms.

So, my focus throughout my time here has been on engineer warfighting as an integrated part of the combined arms team on today's AirLand battlefield. When you do that, then engineers can't support that maneuver commander in the terms of how he intends to fight. So, what Vuono was describing at the Combined Arms Center as the AirLand Battle and what RisCassi and Saint were describing as how they were going to fight, engineers were not going to be able to do the job they expected of us in real time.

So, what I did then was put together in that first year an analysis of the engineer contribution to the combined arms team and, by visiting many different places, assembled the feelings of many different maneuver commanders and put that together in a briefing that really said, "Engineers have been left behind in modernization. We are now the weak link in the combined arms team." I briefed that around to the four stars and others and received a wide acceptance of that viewpoint. Only General Glenn Otis of all the four stars I briefed—and I did not brief Chief of Staff General Wickham; it was all below the Chief of Staff—only General Otis said that he thought we were tied at the bottom with air defense. Then I pointed out that air defense was on the way to climbing out of the hole based on the Army's creating a \$11 billion forward area air defense program. So, my strategy really was to lay it out on the table for what it was. In terms of the maneuver commander, we engineers were broken in the forward part of the battle area. Putting it in their terms and using experiences gained at the NTC, I was able to get a very broad understanding of that view. That was my first year.

As we ended the first year, I was looking across the board of the proponentry functions trying to determine what could be done. We spent a lot of time that first year trying to save the M9 ACE, which was going into extinction based on a report by the Operational Test and Evaluation Agency. That challenge then became a field test and evaluation to be held in 1985 down at Fort Hood. So, I spent a lot of time that first year, 1984–1985, in working toward that important test of the M9 ACE.

By visiting the NTC, by assimilating the lessons learned, by interacting with people all over, by working that first year on the redesign of the echelons above Corps part of the Army, which was a TRADOC/CAC initiative, there were plenty of things keeping us busy. It was not always easy to carve out time for independent thought analysis. We put all of our thoughts together and started fleshing out the game plan of where we wanted to go.

So, at the end of that first year, then, what had been analysis plus articulation of the problem then turned to addressing what to do about it. Out of that came the concept of E-Force [or engineer force] with the redesign of the engineer part of the Army as a refinement of the Army of Excellence design. See, the Army had just gone through a whole new organizational initiative called the Army of Excellence in which all of the organizations had been changed and redesigned. I maintained that although we had done engineers too, and some parts of the engineer team were all right, specifically in the communications zone where we'd gotten new equipment because it was commercially produced and we could use commercial equipment, that part of the engineer portion was all right. Where we were broken was in the forward

battle area. The National Training Center and the lessons we were learning out of there showed that our Army of Excellence designs were flawed. We had to consider a near-term refinement; we couldn't wait another 15 years. Then we developed the concept of E-Force, which addressed the communications zone and the echelons above Corps in our first year and then we addressed the light forces in the second year because the Army and TRADOC were focused on that.

Then we focused on the close combat heavy part of the engineer force—that is, the engineers in support of our armored and mechanized infantry divisions in the NATO environment—as the place where we were most broken. Out of that, then, developed our new concept for the division engineer, the regimental-sized organization, in the close combat heavy force. So, all of that developed and was coming to a culmination in late 1985. Want me to go on?

Q: Yes, take it on. That's exactly what we want you to do.

A: So, in 1985 General Vuono left to become the DCSOPS of the Army and General RisCassi came in to command CAC. General Richardson stayed as commander of TRADOC, and he, of course, had told me to come back with a fix. In the fall of 1985 at the TRADOC commanders conference, I briefed the engineers in AirLand Battle, a briefing I had taken to all the four stars. Then I began briefing the E-Force concept to General RisCassi and then on up to General Richardson and TRADOC, specifically the remaining piece—engineers in the mech and armored divisions, the division engineer organization of three battalions, three line companies each. This was a revolutionary concept, in some aspects, of how we should do things.

It was really evolutionary. It's only revolutionary because some people seem to think you can get by with only the single divisional engineer battalion in a division. However, we know from the history of World War II that throughout the European campaigns, Corps engineer battalions were attached and stayed with divisions throughout the fight. A post-World War II study group looked at that experience and said, "We ought to put more engineers into the division." Over the years that idea has just been kept away. So, it's only revolutionary if you think that one battalion is all the heavy division needs.

It's really evolutionary when you see that what we're trying to do is take the divisional engineer battalion and the Corps engineer battalion that's typically, normally, almost always OPCON [operational control] or attached to that division—like currently in Germany, just take those assets and reorganize them so they really can do the job of that maneuver commander in the time frame that he wants it. So, we took that sort of a bastardized organization, what I call ad hoc, and all the ad hoc arrangements we engineers had to put together to try to make our World War II system work for the maneuver commander, and tried to bring it to a new organization that was tailored to the demands of the AirLand battlefield and the demands of that maneuver commander who's got the problem of synchronizing all of his combat power. From that standpoint it's evolutionary because we don't require more spaces and we use the same equipment, although we want modern equipment to get into today's age. It really puts the right kind of command and control in an

organization to get the engineers at the point of battle when they're needed and not to have to be called up and not have to send back for what was needed.

It was revolutionary from the standpoint of people changing their thinking, if they were academicians. It's evolutionary when you've been out there on that battlefield and you know what you need as a maneuver commander and you know when you don't get it. You know it's available back there somewhere, but you just can't quite get it.

In about October 1985, Colonel Chris Conrad, who had been a brigade commander in the 4th Infantry Division with a lot of NTC experience, wrote a two- or three-page think piece that really hit home on what was wrong with the engineer part of the combined arms team. He said things like, "Engineers could be the most valuable contributor to combat power in the brigade, but we seldom use their full potential." He said things like, "We've got enough engineers, we just don't have them put together right." He initially said, "What I want is that engineer company attached to me." His thinking was, "Give it to me; I can make it work."

We had him out along with some other armor and infantry commanders because we were putting together our concept or fleshing out our thinking on how this division engineer should be organized. We had all of them to Fort Belvoir and did a lot of talking around. He said, "No, I recognize my paper was at fault. I really want that company for every task force. I want them to tie in together at the brigade. That's what I should have, and it just doesn't work the way it is. I've gone out to the NTC with a Corps type of company along with my divisional company. I want all engineers organic to the division, and I need a battalion element for my brigade."

So, with that and with his help and the help of these other maneuver commanders, we then fleshed out our concept and began briefing that throughout the Army to division commanders, to the Combined Arms Center, and to General Richardson. [See Appendix C.]

It was widely accepted by those we briefed. Anybody who had been to the NTC knew it was right. We had lieutenant colonels and colonels with NTC experience tell us—when asked the question, "Can you use it now or do we wait until we get the modern equipment to go with it?"—"Give it to me now. I'd go to the NTC and do a lot better right now with today's equipment. It'll be even better with the modernized equipment; don't give up on that either." We briefed around and never had a maneuver commander who did not agree with the concept.

I took it back to General Richardson, who wanted us to evaluate the other alternatives. First, address all the other alternatives from other staffers who thought you could do it this way or that. We did that, and in every case E-Force was the most effective option against all other options measured in terms of effectiveness to the maneuver team. He asked us also, though, to consider a fourth battalion in the division engineer organization. It was a regimental-sized organization, but we didn't call it a regiment. I lost my train of thought.



General Kem (left), Commandant of the Engineer School, congratulated his son, Second Lieutenant John Kem, on his graduation from the Engineer Officer Basic Course on 27 November 1985.

Q: You were talking about having talked to other people about the concept and getting opinions.

A: The fourth battalion. As we put the concept together, we had kept it to just the three battalions that would be with a maneuver element forward. General Richardson felt that we ought to consider a battalion who'd work in the division's rear as well. We put together an option that did that, took that up to him and recommended that we not proceed that way, that we felt that there was no flexibility forward. When you were committed in the forward brigade area, you were committed. We could retain some battalions at Corps who would work in the division area, rear area, on line of communication work, and that would provide that kind of flexibility.

Forward in the brigade area we needed that habitually OPCON association of engineers. We needed the ability to be agile like our infantry and armor counterparts and we had to have units that were fully agile and could move with them. We saw two different kinds of effort,

and we convinced him that we should keep the original design. So, we proceeded with that design after that. However, time with General Richardson on deck as TRADOC commander ran out, and we did not proceed with the concept to the Chief of Staff of the Army at that time.

General Vuono then came back to be TRADOC commander. Basically, with the many changes of personnel throughout the year, we had to start over briefing a new Forces Command commander; a new Combined Arms commander, General [Gerald T.] Bartlett; a new Armor School commandant, General [Thomas H.] Tait. Therefore, we went back on the road to go around and touch the bases again and brief the E-Force concept. General Bartlett became a very solid supporter, as did General Tait. Throughout, those TRADOC commandants associated with maneuver gave E-Force strong support; that is, RisCassi and Bartlett at the Combined Arms Center, Tait at the Armor School, [Edwin H.] Burba at the Infantry School, [Frederick M., Jr.] Franks at the Command and General Staff College—in other words, the doctrine guy at Fort Leavenworth—and Charlie Ottstott, the new commander at CACDA [Combined Arms Combat Development Activity].

In February I talked with General Vuono, who then felt that in the waning months of General Wickham's time as Chief of Staff, it was inappropriate to take other new things forward. So, it continues now with one remaining piece of E-Force not implemented. That is, we've done the echelons above Corps, those engineers who work in the communications zone. We've done the light force. The heavy force engineers part of the E-Force remains to be taken forward under, once again, a new regime—General Reno, General Max Thurman, General Bartlett's still a strong supporter—back up to the Chief of Staff.

Q: Should things like that be held back because of those changes or should they go forward anyway? I mean, it's a significant, very significant change to take place, isn't it?

A: I think they should go forward anyway, but the realities are that to make things work, you've got to sign folks up. We needed a consensus, and so consensus building was a great part of the effort. It was not difficult because the consensus was already there: the engineer part of the combined arms team was broken. I found that the maneuver folks were looking for an engineer who agreed that it was broken and would come up with a plan to fix it, and fix it in their terms—maneuver terms. Having done that, then the many comments we got back from infantrymen, the tankers, and the artillery as we went about in the combined arms arena allowed us to refine the concept so that we got a package that everybody solidly felt was needed at the levels we work in—that is, divisions, TRADOC, FORSCOM, USAREUR.

Yet, when you approach the Department of the Army level, you approach people who worry in terms of dollars and bigger agendas and how things work in the bigger arena. So, it's easy to say, "Yes, they should proceed right ahead," but you do have to keep your consensus together and ensure that you are going to be receptive at the top. The feeling was that General Wickham, like a lot of people, very naturally had a plate full of agenda items he was trying to wrestle to the ground before he left, and there wasn't time for new ones.

Q: Do you think it's going to have a favorable reading, though, to the new Chief of Staff, who himself has been involved with it before, when it gets there?

A: I think so. I think General Vuono commanded a mech infantry division; he's the architect of combined arms integration; he talks of initiative and synchronization and AirLand Battle; he recognizes that this engineer piece is broken, and because of the fact it does not cause more manpower spaces, it's not a big bill payer requirement for the Army. What we badly need is concept approval so we can go work out the details of stationing the rest of it, which will have some minor bills, certainly minor in terms of force modernization paid for in other battlefield systems. So, I think he will. We still have some staff detractors here and about, but I emphasize once again, the leaders who understand maneuver all solidly support it. People with NTC experience know we've got to have it. So, the places where we have the pockets of resistance are typically those who don't understand maneuver or have problems with not having been at the NTC.

Q: So, the real problem would arise in staff or with, say, materiel development, new equipment, where the Army budget's going to have to be sliced differently for research and development and acquisition, and somebody's going to have to lose something?

A: Well, anytime you put something together like this, you always have the difficulty in boiling down the number of Vu-Graphs or slides for the high level of person you're briefing while still putting in enough slides so that you have the level of detail necessary for all the questions. We've analyzed E-Force from every dimension. Nevertheless, you'll find people out there who can't believe we don't need more people for this concept. Most of those people are staff level; they haven't served in a division or were in a division who once again believe that the only engineers you get are the ones in the organic divisional engineer battalion and who don't understand today's concept of Corps battalions coming in OPCON to support.

The fact is, even with this concept, we're keeping 50 percent of our engineers at Corps and we're still rolling one Corps battalion into the division. So, we've analyzed it to show there is no force structure gain, no more spaces gained, no officer gain. And, in fact, in terms of modernization, taking things that are already in the Army program, we require less modernized equipment for E-Force than we do for today's force because our today's concept that says we're going to have two Corps battalions that may at any time go fight in that division, you have to modernize all of them. We're only converting one of the Corps battalions and rolling it into the division, so we need less equipment. Key to that is the fact that we see everything in the divisional engineers forward of the brigade's rear boundary being totally mechanized like its infantry/armor counterparts. Behind the brigade's rear boundary we'll have all wheeled engineers. Consequently, in fact, we need less equipment and modernization.

There is one exception to that, and that is the Army's glaring weakness in countermine. We don't have a heavy force breacher. We still, after all these years, rely on bayonets and are getting the mine-clearing line charge. We badly need a breacher—that is, something with a full-width plow that can go out under fire and move the mines aside. We don't have that in the Army program. We would like to have that in E-Force. We right now have the combat

engineer vehicle [CEV] in our divisions, which satisfies most of the E-Force requirement for a vehicle, but it is not the counterobstacle vehicle or the full-width breacher we talk about. So, we need a breacher, but we could reorganize today's force with the modernization improvements in the stream—things like Volcano, the M9 ACE, the small emplacement excavator. They aren't here but are in production, are in the program and coming. We can get E-Force for the heavy force right now. The one thing we'd like to add to that is that heavy breacher. We can separate that out and say that is the Army's countermine problem; we need to solve that problem. That is the strategy by which we're attacking that issue.

Q: Do you see that countermine breacher as an attachment, like a plow, or a new vehicle altogether?

A: Well, our counterobstacle vehicle is a prototype right now. It has a full-width plow on it, but it is a full vehicle. The fact is that we've tried plows, and we're developing plows for our M-1 tank, but we're developing track-width plows. Track-width plows have great problems. First of all, they protect really only the tank they're on because of the width of the plow blade and the tracks and the difference in the tracks of following systems, like the Bradleys and M-113s. What happens is that you strip engineers and infantry in that forward maneuver element out of your team—only the tanks can proceed. So, although we're getting track-width rollers and track-width plows, they really are only a 25 percent solution. We need a full-width plow.

To do the full-width plow, you need a powerful machine, more powerful than the tank. Not only that, you put that blade up there with the M-1 and with the operator in the reclining position like he is, he can't see. You then have problems with tube depression. You have to turn the tube to the rear while you're plowing, even with the track width. So, what the Army really needs is a dedicated breaching vehicle that can do other things too. That's why our counterobstacle vehicle has a couple of digging arms, and it can dig with that blade as well, but it is a dedicated vehicle. We see that as a replacement for today's combat engineer vehicle, which has a blade but it is a blade that can't plow away mines. We need something that can go down to a full-width, 12-inch-deep mine removal.

Q: You'd take that whole lane out of there?

A: Take the whole lane out, that's right. That's what the counterobstacle vehicle does. We've got a prototype right now. We developed it with the Israelis. During the Gramm-Rudman cuts it was taken out of the Army program. So, to get that back in, we now have to find the bucks in some other program. That's a materiel modernization need and we think that need is there and we think that's the Army's "most broke" arena. We can do E-Force with the CEV and have a better organization than we have now; it'd be better yet if we could get the breachers.

Q: Your maneuver commanders generally support this kind of thing.

A: The maneuver commanders all support E-Force. I have not briefed a maneuver commander yet who didn't say, "Long overdue. Got to have it."

Q: Do you see, as the Bradleys get finished and the M-1s get in place, that there'll be more support for the procurement of these breachers?

A: Well, there's a lot of support there now. Whether you go out to the NTC with a M-113/M-60 force or a Bradley/M-1 force, the facts are that when you run into an obstacle, you stop. Certainly the speed of the Bradleys and the speed of the M-1s on that battlefield are wonderful, but if we're going to hit an obstacle every three or four kilometers—and we have mission area analyses that say that we will hit it even more often than that in some arenas—then we're just not going to realize the capability of those vehicles unless we solve that countermine problem and the ability to get through an obstacle.

Q: Our friends in the East are very good at mines, aren't they?

A: They're very good. We talk competitive strategies now in great detail, you know. The question would be, "What can we use as our strengths against their vulnerabilities?" We would say that we know they have vulnerabilities. If they intend to succeed through mechanized columns and mass and they want to push through our defense, then we are going to succeed against that by employing good defenses at the forward line of our own troops and in depth. In other words, we use our countermobility mines, obstacles, defenses to break up their formations, slow them down, to attack their second echelons by fire to slow them down, disrupt their formations, and then use maneuver, the highly mobile character of our weapons systems, to maneuver to achieve our advantage.

The Soviets, practicing competitive strategies, also look to us and say, "They, because of lesser forces in the face of our coming forward, are going to have to use maneuver. They preach it; they have an AirLand Battle doctrine that says they're going to use maneuver, so we are now going to organize for, equip for, and train for flank mining to protect our flanks so we can thwart their maneuver so we can keep going in our mass thrust." I think we can see that in how they've reacted to our AirLand Battle doctrine, which means we very badly need to solve our countermine initiative, which brings me to another thing.

That is, we've been talking countermine as a spinoff of E-Force, but in effect, the countermine problem was a separate issue that we started working on way back. The Defense Science Board in 1985 took on the task of looking at mine warfare and countermine as an issue.

Looking at the counterobstacle vehicle, General [Richard H.] Thompson, then commanding AMC, wrote General [William R.] Richardson, commanding TRADOC, and said, "I think we need an initiative to fix countermine." As part of that we established a general officer steering committee that I was given responsibility to chair to address, in General Richardson's words, "Our countermine deficiencies across the entire spectrum of conflict in all mission areas, all elements of performance"—that is, doctrine, organization, equipment, training—and to work with AMC. We set up that steering committee and began to work.

As we talk at this moment, we are hoping to get back from the printer the countermine initiative study. We had work groups and addressed the countermine problem and put

together an action plan that we will mail out and begin briefing around shortly. Part of that study is an addressable threat. I think one of the things we have to do is ensure that those in the United States Army and those who are concerned with our ability to fight integrated combined arms understand that threat to our ability to maneuver.

Q: Do you think that that is generally true, that they do understand the Soviet threat as far as its capabilities in the engineer area?

A: No, I don't think that is true. I think that part of the threat is not well understood. That's come out as we briefed during the countermine initiative. We had people on the general officer steering committee who represented the major TRADOC schools—Infantry, Armor, Artillery, Aviation were all there. General Tait, Armor School, came several times. We had the Combined Arms Center represented. We had the Army Staff and General [John W.] Woodmansee from Operations and Plans and General [Robert] Molinelli from Research, Development, and Acquisition. We had field units—General Andy Cooley from the 24th Division, light division folks, and the 5th Mech Division sent an assistant deputy chief. We had quite a number of people addressing the problem, and typically many were surprised with what threat was still there.

We find as the “threat” is briefed about the Army, it typically focuses on weapons systems that kill by direct fire and doesn't really address the threat in terms of our ability to maneuver against it. You won't find many statements or briefings on the threat that address their capabilities for mine warfare. So, as part of our countermine initiative, one of the things proposed by the general officers steering committee is that we get the Army to adopt and validate the threat in this arena. One of the chapters in the study we're putting together addresses threat capabilities, and we will seek to have that be incorporated as part of the threat, to improve overall understanding. So, the answer to your question is, “No, I don't think the Army understands the threat to maneuver, really understands our Soviet threat's capability of thwarting our ability to maneuver.”

Q: That's really critical to operations on the battlefield, isn't it?

A: Absolutely.

Q: We're sitting there and don't understand what he can do.

A: Absolutely.

Q: You mentioned the M9 ACE earlier. Describe your involvement with it while you were commandant.

A: The M9 ACE was a major focus of my activity from the day I became commandant until the end of my tour and afterward. At the 1984 Engineers Functional Review, Major General Ellis pitched the need to continue the M9 program in spite of a challenge by the Operational Test and Evaluation Agency that it did not meet requirements for fielding. At a lunch showdown that day General Thurman directed a follow-on field evaluation of the M9 versus the D-7 dozer tractor-trailer system. That started weeks of hassling with the Operational Test and

Evaluation Agency and others to set up field evaluations that would be truly an evaluation of the value the M9 ACE brought to the combined arms team on the battlefield. The tests were to be conducted at Fort Hood under realistic battlefield conditions.

What I could not understand was the out-and-out adversarial approach the Operational Test and Evaluation Agency was taking. Colonel John Burlingame led that effort, and it was as if he asserted the M9 was no good and that he would ensure the tests came out that way. Many times in the field, he would make certain assumptions that would eliminate the D-7 tractor-trailer shortcomings. Major Tim Wynn, our Engineer School project officer, did an exceptional job of fighting off killer assumptions and ensuring realistic field relationships were maintained. I made five trips to Fort Hood myself during this period to ensure the M9 was not killed by evaluator zealots who seemed to think their measures of success would be to kill a system rather than to try to field a system to the battlefield troops that badly needed it.

There were many other challenges in the Pentagon with many armchair tacticians trying to kill the M9 ACE. Mr. [Walter W.] Hollis set out one challenge—that providing armor plate to protect the D-7 operator would suffice. A full laydown of the issues to him removed that obstacle. Colonel Ted Vander Els worked very effectively in all these skirmishes, pulling together all the facts.

Each budget cycle found another challenge from the Department of Defense, mostly out of Program Analysis and Evaluation. They were usually deterred by senior commanders' messages from the field and the Army's making M9 ACE funding a priority issue to defend.

One bizarre challenge came in 1986 when a Marine lieutenant colonel told the Department of Defense, Program Analysis and Evaluation, that the M9 was inferior to the British combat engineer tractor. We made a full direct comparison of the two and the M9 was superior across the board. I met with Major Generals [Ray M.] Franklin and [Carl E.] Mundy of the Marine Corps and they agreed not to stand in the way of our procurement. Oddly, the Marine lieutenant colonel, who was then retiring, later went to work for Royal Ordnance, the producer of the combat engineer tractor. Max Noah and I then briefed David Chu in the Department of Defense on the comparability issues and the M9 advantages, and the M9 stayed in the program again that year.

The evaluation at Fort Hood was a success, and the M9 ACE proved itself in a combined arms FTX at Fort Hood in May. Lieutenant Colonel Pete Sowa [commander, 17th Engineer Battalion, 2d Armored Division] did a superb job of supporting the tests and employing the M9 ACE in the FTX.

The final Army Systems Acquisition Review Council process was held in early September 1985. At the Army program review with Mr. [James R.] Ambrose, the Under Secretary of the Army, and attended by General Thurman and a host of others, the decision was made to go ahead with the M9—with fixes of some minor items that had been identified during the follow-on evaluation. I can tell you that was a happy day for a lot of engineers that had devoted countless hours to that effort.



General Kem (center, right) and Lieutenant General Elvin R. Heiberg III, Chief of Engineers, observed a test of the M9 ACE during the summer of 1985.

Q: Okay, to proceed then, want to talk about your role in evolving the engineers' role in AirLand Battle during your time here as a commandant, how that's evolved?

A: Well, I think we have really defined the engineers' role on the AirLand battlefield in the last three years. The process had started. People were working on manuals; people were doing some of the doctrinal thinking. In many cases I think we were wedded too much to looking at things, again, from engineer eyes.

Part of the problem with engineers and how we look at things is that we bring up our brood from many different directions. We've got light engineers and heavy engineers, but so does infantry. We have divisional engineers and nondivisional Corps engineers, and infantry doesn't really do that. I mean, they may have a separate infantry brigade that might find a rear area mission at Corps, but basically they're all doing the same general thing, and all the tankers are found forward. We also have combat heavy engineers. If we put people out in all those arenas and they do things in those different environments, you can get different engineer mindsets as to what engineers "do" and how they "do it."

One engineer may think the world is construction and building ranges at Grafenwöhr during peacetime. One may be in a place where he or she is in a combat heavy engineer battalion on a divisional post and you run out and build antitank ditches with tractor-scrappers and think

that's the way you're going to do it in wartime. We need to try to put all those things into the context of how it's going to be on the battlefield, and you're not just trying to make do with the combination you're given. Now, we are always going to make do with the combination we're given, even on the battlefield. If we can define the battlefield and define the force the way we want it, we're not going to put that combat heavy battalion, like at Fort Carson, with the 4th Division and let that be the expected combat support relationship. That combat heavy battalion in time of war goes somewhere else and is not attached to the 4th Division. There's a Corps battalion that's going to be supporting that division. The engineer may go to Europe and may be in a Corps battalion there, and because of the general defense plan, maybe understand a little bit better combat relationships.

The point I was getting to was that when you get a bunch of engineers with six or seven years of experience in maybe two assignments, you really can have different views of battlefield missions and what engineers do. Even within the division experience category, one might have light division experience and another might have heavy division experience, which causes different views. So, from the terms of what we're talking about—the heavy NATO battlefield and the division and the way guys like General Saint, commanding general of III Corps, thinks today with his shoot, move, and communicate, let's move out, shock action, audacity, move, synchronize combat power—you don't have time to sit back and do an engineer estimate. I mean, you're talking about frag orders, action, rapid change, violence—so we have to put things in that kind of context. So, part of our problem, then, is this inability of engineers to focus often until very late in a career, once they have had a bunch of those experiences.

As I mentioned early on, I've had those experiences—have been in armored division, very formative years; been in airborne division; been in a Corps engineer battalion; been with a combat heavy engineer battalion. So, my perspective is a lot broader, but it takes a lot of years to get that breadth of perspective. The people we have working down teaching and doing things at captain and major level do not have that breadth. So, our problem is that we have to look beyond the boundary of our own experience and put things in the terms of what's being described by the Combined Arms Center and by thinkers like Vuono, RisCassi, Saint, Burba, and Franks on how we're going to operate on that battlefield. If people don't have that ability to think that way, or are chained to an old doctrinal manual just to be modified and make do, then it's difficult.

So, back to your original question, one of the things we've tried to do is bring our engineer thinking to their maneuver level. Back to a point I made earlier, my focus here has been warfighting in terms of the maneuver commander on his battlefield, being responsive to him, for his needs that he defines. Now, I can help him define those needs, but I don't say, "This is what I'm going to give you and that's all you get." I say, "What do you need, and let's figure out what we can do to make your battle team more effective."

If we then unchain ourselves from "all we've got is this, and this is the way we've always done it" and cross that boundary—I call it "looking beyond the discontinuity," the "discontinuity" being our thinking versus theirs—get into their thinking, put it in that framework, and then describing those terms, then we can do it. So, I think we really have

defined here at the Engineer School, in the past couple of years, the real engineers' role on the AirLand battlefield, and we've done it in a couple of documents that are just about to come out. FM 90-13 is a new field manual on counterobstacle and river crossing operations that definitely crosses that boundary. FM 90-13-1, which is coming out tomorrow, is going to redefine counterobstacle operations at the maneuver task force in terms of combined arms. It's going to have an interactive infantry-armor-engineer forward maneuver element with all the rest of the combined arms included—air defense, aviation, all of them. It's going to describe how we get through an obstacle in terms of the maneuver commander, that is, in stride with minimum loss of momentum, and provide the doctrinal basis for that. I think that is what has been lacking: thinking and putting it in maneuver kind of terms. I think we've done that.

I think we've done it also by obtaining approval throughout the Army of taking to the NTC a full brigade engineer slice. When NTC first started they said, "One engineer company is what a maneuver brigade gets normally and that's what it gets at the NTC and that's all in that division." That's not what doctrine says is going to fight with that brigade. By doctrine you're going to give that brigade assets that will probably amount to about one company per task force. They go out to the NTC with two maneuver task forces in a brigade, so they now have approval to take out two engineer companies. We also have approval for a permanent engineer company in the opposing force at the NTC, which is now forming.

Our focus at the NTC is making that training environment very realistic, to simulate as little as possible to make it fully realistic. I think, in fact, we have really not fully defined the engineer in the combined arms teams in the AirLand Battle. I think we've put a higher resolution in that definition, and that resolution has been pitched toward putting it in terms of the maneuver commander on the AirLand Battlefield and thus it's become a much better definition.

Q: Is this going to require some retooling of engineer career patterns to get the kind of experience that you're talking about into these people so that we remove that segmented experience?

A: E-Force does that too. Our problem in the engineers, besides our thinking problem, is that we've never addressed this big sore that prevents us from being truly effective, that sore being that we have an archaic organizational design that was found lacking in World War II and has never been fixed and is totally inadequate today—that being this thing that causes us to say that we're going to move battalions in to join the division as needed. That "flexibility" from Corps is an "apparent" flexibility only; it's not real in terms of today's battlefield. It was not real in terms of the World War II battlefield, but people have said it was for years.

Q: Except engineers.

A: Except engineers. Now with the NTC experience, maneuver people really recognize that. What was your question again?

Q: Career patterns and how they'll change?

A: E-Force fixes a lot of things. It's going to put the right kind of stuff in the division. It's going to allow us to write doctrine now with the kind of association to really follow METT-T [mission, enemy, terrain, troops and time available] without all the "ad hocricies" that are required under current doctrine to make it work. We're going to solve the maintenance and the supply problems that have always plagued us. We're going to solve the communications problems because no longer are you going to have 70 kilometers between engineer company and battalion; we're going to shorten those distances. We need less communications equipment. All of that gets solved.

In addition, back to your question, we're going to have more engineers, now, who grow up in divisions because we'll find that much of our active force will be in divisions or combat heavy battalions and most of the Corps battalions are going to be in the reserve components, which, I say, is exactly the way it should be. Now the reserve components have four heavy divisions, too; they'll still have engineers. The reserve component engineers, Corps battalions, with their limited training time do not have to try to be up close and personal with heavy divisions because, in fact, they will seldom be asked to go up in the forward brigade area. They don't have time to really learn close combat support of the heavy divisions, as we learned last year in our REFORGER training exercise.

Reserve engineer units will be able to focus their mission-essential task list back of the brigade's rear boundary. Those folks in the E-Force divisional battalions can focus on the forward area for their training because, then, most of the Corps battalions are reserve. More of the active force will be in divisions or the combat heavy battalions. Now, we'll still have some Corps battalions and we'll still have the light engineer battalions, but we'll have double the number of people going through divisions with E-Force than we had before.

We're also going to have a colonel in that division commanding the division engineer element. General Vuono said he badly wants that in the division, the colonel. We're going to have three engineer battalion commanders, lieutenant colonels, commanding in that division. So, we're going to have more people with the mindset that I think is so valuable—that is, how you think, how you operate on the move in that AirLand Battle situation. I think E-Force itself corrects the problem, and so I don't think it will change career patterns. I think the guy will still have about the same amount of time with troops and time in an engineer district or a DEH or on a staff or at school. However, because of E-Force, more of that time with troops will be in a division, more than it was before. Since we're doing that, then we can make sure more of the combat heavy folks have an opportunity to be in a division and vice versa.

Q: Now, every time you talk about the regiment, I always come back to the old engineers I've interviewed and asked them what happened in 1940, 1941, when General Leslie McNair decided that they didn't need that engineer regiment in there, they just needed the battalion. And, of course, their answer to it was, "Flexibility, hell! There was no flexibility. You still had all this stuff attached to you anyway. You just didn't command it really." They universally said it was to prevent there being an engineer colonel in that division who could become the brigade commander. It goes back to a jealousy factor. Every one of them said the same thing, "It never worked, could never work, and was recommended against."

A: Well, I don't think engineer colonels today are going to become maneuver brigade commanders.

Q: Well, not anymore.

A: There are going to be a few of them become Chiefs of Staff, and that's good and we've had a few as Chiefs of Staff. We have an engineer Chief of Staff of an airborne Corps now. General Reno, who's replacing me here, was G-3 of the 1st Infantry Division and an assistant deputy chief. There'll be more of that. General Vuono, you see, is one guy who says, "I really want that colonel in the division," because the guys he's relied on for understanding terrain have been his engineers. The trouble is, if the engineer of today is out executing with his battalion, he's not up at division doing that for his division commander. So, E-Force really solves a lot of problems.

You find a few staffers opposed, most at the major or maybe even the lieutenant colonel level, people who don't understand who offer that, but guys who've been there say, "I want the colonel in the division."

Q: Well, you know, you think of the engineer officers that came up in World War II and became division commanders. All of them came out of that system you're talking about basically, the regimental system where they served in an engineer regiment serving in a division. I mean, they knew the inner workings of a division very much more than they probably do now. I'm just thinking that maybe there is a new day, like you say.

Is there anything more you want to discuss on that particular subject, AirLand Battle, anything key that you think that we didn't cover? It's a large subject so it's very difficult to do it in a short time.

A: Well, I think I've really discussed it.

Q: Okay. Could you describe your personal philosophy of leadership, command, and management?

A: Well, yes, I will. I come from the school that says people are basically well motivated. I think the Army does a pretty good job of growing them up through the system at whatever level they are—I'm talking about all the grades—to be ready for that particular time for the requirements of their position. So, I think that it's my responsibility, as commander or commandant, to set the vision of what needs to be, to build a framework for getting there, to allow the subordinate elements of the organizational structure to move to accomplish that. I believe I recognize that people make mistakes on the way, and we don't have a perfect organization, or perfect people, especially in an Army where we're always preparing for something that we hope never to do—that is, fight—and thus we're putting people continually into a growth position to grow to the next level of expertise. Consequently, I believe in establishing an environment where a person can charge on with his own initiatives and not be afraid of being dashed by me and has the capabilities to grow and develop.

I believe in the worth of people and their desire to do the right thing and their ability to do it. I think we can get a lot more for the whole if we let all the individual initiatives drive on. So, I guess philosophically I've always felt that if I can get the right people in the job and give them a charge and let them drive forward and try to bend them in directions to fit the long term, I'm a lot better off. We obtain more, on the whole, than if we sit on people and try to very specifically prescribe what they should do and the product they are to produce.

So, philosophically, I guess, I'd probably put it all together as setting up an organization, put a vision out there that we ought to achieve, and then point people in that direction and let their individual drive and initiative work toward that, ensuring that we establish an environment where people feel the freedom to strive and the freedom to contribute.

I guess what I've done here at Fort Belvoir has been to try to work to ensure that the many different parts of the Engineer School doing it that way stay together. In other words, if we're developing a new system, are the trainers staying up with that development so they will train and set up the training processes to train the people, maybe at Fort Leonard Wood or here, to use that piece of equipment? Are the doctrine people over in the Department of Combined Arms working the doctrine so it's all coming along in tandem? People driving on don't necessarily look outward to the broader scope other than their own to ensure that it is all proceeding for the better.

Second, I guess, as a style thing I feel that I do need some checks on how we're moving. Are we pulling along toward solutions? Typically, I do that not on a one-on-one with somebody, but trying to have them come in and brief an in-process review of where we are on something. That accomplishes two things: I know where we are and can add guidance or give what I know people feel that I owe them—that is, perspective and guidance. At the same time, others are hearing it, so we begin to ensure the perspective is carried throughout the organization.

Q: Do you think engineer command is a little different than, say, infantry or armored?

A: I guess I have to ask what you're describing by engineer command? Do you mean command of an engineer company, battalion, or you mean command of the Engineer Center at Fort Belvoir?

Q: No, more of the line type of command. Is there a different problem because of the customer you serve?

A: In its essence, there is no difference in commanding an engineer element or an infantry element if you take it on a comparable basis, platoon for platoon, company for company. The problem that comes up, and the thing that makes the job of that level commander more difficult for the engineer in some cases, is the additional part of being the task force engineer or the brigade engineer or the division engineer. In other words, there's a second half of the job.

I'm really describing now something that's really part of the divisional engineer battalion. The fact is that if you only accept the divisional battalion as contributing to the division, then the platoon supports a task force and the platoon leader is so overextended with his duties with serving that task force S-3 and the commander that he has difficulty in commanding his platoon. His infantry counterpart is only commanding his platoon, working for a company commander who's got just three or four of these companies working in a tight-knit element. The engineer platoon is working throughout the task force, a much broader area, and yet he has that other responsibility to the staff—in the command element of the maneuver task force. So, it's that extra addition that makes the engineer platoon leader's task more difficult. That same thing happens at battalion level when that engineer commander has to operate his companies throughout the division area and has division engineer staff responsibilities. That engineer battalion commander also has the biggest battalion in the division, with all the headaches of maintenance and systems.



General Kem (left) with Brigadier Roland Zedler, Commandant of the West German engineers, during a visit to a German engineer river crossing in 1986.

So, I think the engineer battalion commander does have a bigger command problem than his counterparts. I think the company commander and the platoon leader have a battlefield operations problem more difficult than their counterparts, but it may not be a command problem. That is what I was asking when I first started because of the word “command.” If command comes with responsibilities as the task force engineer or the brigade engineer, then

the engineer commander has bigger battlefield problems than his peers that he has to wrestle with.

Q: That requires different training?

A: It requires us to concentrate, like in our basic course, on a module that trains a maneuver task force engineer. Now E-Force solves those things because it puts people at the right commensurate level. The maneuver task force will be supported by an engineer company, so the task force commander will look down to infantry, armor, artillery, and engineer company commanders as his next command element. So, now we have raised the engineer working at that level from platoon leader to company commander. We would now say that his problems and his requirements are commensurate with his maneuver brother. The brigade commander looks down to a lieutenant colonel battalion commander and staff of infantry, armor, artillery, and logistics but an engineer captain, company commander, divisional, and maybe a couple of Corps type engineer company commanders with no battalion commander or staff. In the future, E-Force will be commensurate as well, with a lieutenant colonel engineer battalion with staff—the same as armor, infantry, artillery. So, our current archaic structure affects command capability as well. E-Force then becomes the solution to that problem. We'll now have a commensurate level at all battlefield command levels.

Q: It's been a long time coming to solve that problem.

A: That's why we say E-Force is not magic. It solves "ad hoc" and solves a whole lot of battlefield problems; what it does is bring together organization, materiel, and command and control. The major changes are really command and control when you look at it because you've taken the over 1,700 engineer folks in the current divisional engineer battalion and Corps engineer battalion and reorganized them into this division engineer regimental structure, and with fewer people. They're now in groups that can be command and controlled to have the right piece of materiel or the right organization to be responsive to the maneuver commander at the right place on the battlefield.

Q: How would you contrast this command here at Fort Belvoir with your most recent command at Ohio River Division?

A: Well, before I contrast it, let me talk about some things that are probably the same, and that is high-level responsibility, a requirement to make things happen—I'm speaking about my personal position in that command—the ability to work with a lot of good people. What I think was similar was a charge to make things happen from my bosses in either case and an arena where, in either case, I could let the status quo continue and not succeed from the standpoint of the engineer force here or programs in the Ohio River Division there, or things could be improved and get better.

In contrast, I would say the pace and scope of TRADOC is much faster. The fact is that geographically I have total force responsibilities throughout the world as opposed to one very large river basin, which was very big in those days. My travel requirements as commandant take me to Korea, to Germany, to Israel, and to Honduras. I work in an arena of a much more

centralized major Army command. TRADOC, with its subordinate integrating centers, does a lot of things in integration and is much more centrally controlled, although they want me to make it happen in my particular arena.

USACE is much more decentralized. I probably had much more individual authority as a division engineer than I do as a commandant, although I can write doctrine that is Army doctrine as a commandant. I'm not sure I could do that in USACE. I have to sell programs to a lot more layers here in TRADOC than I did in USACE. I have my hands in many more different functional arenas here than I did in USACE. That is, doctrine is one arena, force structure is one arena, materiel modernization is a very difficult arena involving the whole Army Materiel Command and the Army Staff in the Pentagon. Then training is a whole different arena, from officer development here at Fort Belvoir to soldier development at Fort Leonard Wood and unit training everywhere. Personnel policies involve all the engineer force worldwide. So, I have many more different actors in all of those functional arenas than I did in my last position as the Ohio River Division Engineer. I guess that's the basic contrast.

Again I would just say, though, that both have been very challenging and both very rewarding from the standpoint of satisfaction in knowing that the responsibilities there in the Ohio River Division and here at the Engineer School have each been an opportunity to create a vision of what should be to make things better and an opportunity to have people and the wherewithal and the resources to make that happen.

Q: Both great challenges. There seems to be a much greater challenge here and a much more significant outcome.

A: I think so, from the standpoint of "proponency" of the total engineer force. You're talking about national security and the engineer force part of the overall team—I think that's right. We're talking about professional development of the entire future of the engineer officer Corps plus the noncommissioned officer Corps. So, I think that's right. I'm sure you'd have difficulty explaining that to somebody like Senator Byrd when the Tug Fork project wasn't proceeding on schedule.

Q: Just going to a different arena of combat, right? [Laughter]

A: Well, at least in some respects.

Q: Leave that behind.

A: As I said from the outset, I really didn't understand initially the full scope of the responsibilities here at the Engineer School. It's much broader and much more encompassing of the total than I ever expected. I think many people don't understand that because we have a serving Chief of Engineers. Many people think he has all these responsibilities when, in fact, for a lot of these things, the arena is the TRADOC arena. We play here; he can't affect them like I can. He can support things when they get to the Department of the Army or he can dash them when they get to the Department of the Army. He can influence them, but a lot

of things I have to start here or he can't influence there. So, it was certainly something, as I mentioned, that I didn't fully understand at the start. Even now we have people writing the Chief letters asking him to get certain things done or complaining that something hasn't been done quickly enough when it should be more properly directed here because I'm the one that has that responsibility.

Q: I realize this is a touchy question, but how is it being the commandant of the Engineer School, sitting 20 miles south of a three-star Chief of Engineers? That present problems for you, or him?

A: Well, you'd have to ask him about problems for him, but I would guess his answer is probably close to mine. I don't think it's been any problem for me at all. General Richardson's first charge to me was, "You've got the responsibility to make all this happen for the engineer force. You have to work out a relationship with the Chief of Engineers." That was pretty clear to me. I'd been General Heiberg's deputy twice; I understood what I needed to do to work with him. My own feeling was, "If it's right, we'll all buy it. If it's wrong, then what am I trying to do to push it forward if it's not going to be acceptable to him?" I mean, logic should prevail, and we should be doing the logical thing. It ought to be able to be accepted by everybody.

Way back, when proponentcy was thought out and when people were talking about, early on, the Chief of Engineers' role versus the commandants', I was in the ACE's office. I guess I said at the time that I supposed the success of that arrangement would be partly due to the personalities involved, but it should work because it was logical. In the past, personalities have been a factor in some cases.

I don't think it's been a factor at all in this case, and I think General Heiberg has been most supportive. He has sent down questions every now and then that he'd like to have answers for so that he's well informed in his arena. He's suggested things that we ought to look at and we've looked at them. He's had a lot of good ideas; that's been an influence here. By the same token, when we've gone up there to seek his support, he's been very supportive.

The key to all that is recognizing the different arenas we play in, and TRADOC and AMC do an awful lot at our level before it ever gets to the Department of the Army. It's very difficult for the Chief of Engineers to play down at our level. When it gets up to the Department of the Army, he has the opportunity to play in the arena and to support the programs or not support them depending on whether he's there at the meetings or not there at the meetings or gets involved. That's where he's got the ACE to take care of that.

Commandants do also play in the Department of the Army arena. That is, we're asked to take our systems forward. I was present for the decision brief of the Under Secretary and the Vice Chief of Staff for the M9 ACE. It's not that I don't go to the Department of the Army, but I'm not there working on a day-by-day basis, and the Chief should be. So, long as we sort out the two arenas then I think it should be a supportive relationship.

Q: It's a relationship you have to handle that none of your other commandants have to worry about, isn't it? Presents you a little more of a challenge in that respect?

A: Well, yes, it's a relationship we have to handle. Whether it's a challenge or not depends. It almost implies that if you've got to work hard at it, then it's a challenge, and I haven't had to work hard at it. I mean, it's been natural as far as my feeling goes. I worked as the Deputy ACE before, and I worked directly for him in two positions, and so I think I understood the different relationships. Every now and then I find somebody who doesn't, so they want us to do certain things. Usually, after a little discussion, we can figure out that that's in the other arena and they ought to take care of it or it's down here. Or they get something in that we should work on and they'll feed it to us. We get something in that is really above our level, we'll pass it back up.

There's maybe a little more discussion than other people have, but it's not been a challenge because it hasn't been difficult. We have things like the Engineer Center team meeting, and we typically invite General Bob Dacey's people out here for our meetings like we do our operations, force integration, and our people from Research, Development, and Acquisition.

Q: Now, what would you say was the greatest challenge you faced in this position?

A: Well, if I define that engineers were broken, then my greatest challenge was to try to get an Army understanding of that and develop a game plan to fix it and put that game plan on the path to getting fixed and hopefully accomplish that fix. Going with that, then, becomes the ability to marshal the forces and focus and keep doing the other things that are daily important that you can't drop to accomplish the major thrust.

Q: Did you make any major changes in the organizational structure, and why?

A: Yes, we made some changes. First of all, though, TRADOC had decided that there would be an organizational change to accommodate the fact that we have doctrinal responsibilities as well as teaching responsibilities. A thing they call School Model '83 had been approved when I came in. What I found out was that we had not implemented School Model '83 here, so during my early months I made the decision to implement it. That moved people out of the Training and Doctrine Development Directorate into the teaching departments so that we would be teaching and writing with the subject matter expert at the point of teaching instead of writing in the Directorate of Training and Doctrine Development and teaching in the Department of Combined Arms or the Department of Engineering. The decision had been made that that was the conceptual framework. We made an evaluation while I was here, decided we weren't in that mode, and made that mode change. So, that happened.

The other things have not been as dramatic; that is, we've done some fine tuning. I established an organization called the Engineer Force Modernization Office, and brought in Lieutenant Colonel Tom Farewell to head that to provide some ability to pull across all functional areas. I think I mentioned earlier the fact that different organizations could be pulling in one direction and not knowing what others were doing. I asked Tom Farewell to come in and provide that perspective and vision across all of our functional elements so we

could have an understanding and perspective in those elements of what all was going on. That allowed me, then, to have greater networking within the organization and out as we tried to focus on how we reach that vision of the future—that is, an effective engineer force. That office has been functioning for a year now, a very small, austere organization with Lieutenant Colonel Farewell, a major, a captain, and a clerk. It's provided a great input and synergism here.

Q: It's amazing. Basically, just implementation of School Model '83 and then this one office are your major organizational changes?

A: Well, of course, one thing we have to look at is down the line—the move of the school to Fort Leonard Wood. So, the things we've tried to do organizationally have been fine tuned here but pointed toward that. Part of the School Model '83 effort was that I reorganized the school secretary, which has gone away. There's some fine tuning along with that. We have focused toward Fort Leonard Wood and spent a lot of planning on that. As part of that there are other organizational things that have been approved which lead toward the move.

One of those is that we're doing away with atomic demolition munition instruction. We've pushed and worked throughout the Army to get us out of that mission area. Second, we are passing to the Ordnance School responsibility for training generator and environmental equipment repair. As part of that I have started an initiative, and it's now been approved, to pass total responsibility for generators smaller than 500 kW—that is, tactical generators—and environmental control equipment to the Ordnance School. In the past we've had one whole department here teaching ordnance kind of folks. In addition, we've had combat development responsibility for those generators.

In my mind, that has been a thing that's diverted us from primary attention on our combat engineer missions. That's why I asked that with the school move, and the fact that the department was going to stay here anyway—we conduct advanced individual training for 7,000 students a year for ordnance—that it be transferred to the Ordnance School. It was never going to go to Fort Leonard Wood anyway. We were going to retain responsibility for that instruction here with the Engineer School at Fort Leonard Wood. It would be a diversion. So, we got that responsibility transferred to Ordnance and got them to take the combat development responsibility too. That's effective the 1st of October 1988. That's been a major organizational change based on the future.

We've established a noncommissioned officer academy here as a prelude to moving it to Fort Leonard Wood to combine with their noncommissioned officer academy. We've also sold the idea of creating, at Fort Leonard Wood, a battalion to run the basic officers course so that the battalion commander and the company commanders become very involved in the training as opposed to now where we have a basic officer detachment that does the training under the Department of Combined Arms and we have a staff and faculty battalion that has them for command, administration, and discipline. That battalion commander's got a lot of other things to be involved with and a company commander who is very involved with them.

When we get out to Fort Leonard Wood, we'll have all that as a total entity so that the basic officer students will be operating in leadership positions in their platoons—platoon leader, squad leader—but that platoon will be part of a company and part of a battalion. We'll have the whole hierarchal perspective there, and that platoon leader won't now just be a platoon leader in a platoon working for part of a company. He'll be a platoon leader working for a company commander who's totally involved in his training and one of the trainers working for a battalion commander, who's totally involved in that training. We call that the "unit context," and that's a major organizational change as well.

Q: Want to continue with your discussion on looking back at the whole issue of the relocation of the school to Fort Leonard Wood and go into that?

A: Well, I arrived in the job, and the decision to relocate had basically been made. I forget when it was announced, but I think that in February 1985 it was officially announced. So, I didn't get involved at all in the decision about whether to go or not to go, but I immediately got caught up in a swell of people that said it was the wrong decision, a terrible thing, and so forth. I don't feel that way. I think that from the standpoint of training and keeping the engineer part of the force effective, that Fort Belvoir's just too tight. It's certainly a wonderful place and it's got a lot of tradition, but the fact is it's just going to be better when we get officer training and soldier and noncommissioned officer training all out at the same place so we all start from the same focal point. We're going to be able to do a lot of things out there we can't do right now here.

From my standpoint, we're also going to get rid of a lot of distractions that I have right now. Being an installation commander in the National Capital Region has a lot of other things that go along with it that cause you to sometimes wonder how you can maintain your focus on a mission like keeping the engineer force prepared for war. For example, the Secretary of the Army puts out a new smoking policy and all of the national TV networks with Washington offices come to the closest post wanting to interview soldiers about what they think about the secretary's policy.

We have a hospital here that serves a very large population that comes in for its share of public visibility as we do things here that others do. We have 39 different activities on post, each with its own individual things that require some effort. Yet, of all the major TRADOC posts, I don't have a brigadier general assistant commandant.

The Secretary of the Army hosted a dinner for all of his civilian aides when they came to town, some 250, at our officers club last Monday night. So, the post resources are used for a lot of other different kinds of functions not commensurate with the resources allocated to all TRADOC posts for the kind of jobs they do. Not only do we do them, but there are certainly things that cause me to commit time to.

All in all, what I was starting to talk about really was the fact that I think that the move's a good one and it'll have a lot of benefits, although it'll continue to take some emotional toll among many folks who don't want to go. At the same time, our real challenge is to maintain continuity and not to lose institutionally as we cross that transition period. That's always a

problem. Typically, people have found that, in moves of corporations and organizations, only some 15 percent of the work force will move, and our estimate here is less than that, 10 percent. So, that is a real potential institutional problem.



General Kem (right) greeted Lieutenant Colonel Garth Hewish (center), British Liaison Officer, and his wife Sheila when he was Commander of the Engineer School.

So, as a consequence, once the decision was made, I have tried to put our planning in focus and to ensure we do it the best possible way. We've done that by trying to ensure with Fort Leonard Wood that we'd think of all the things that need to be taken care of. We have redesigned our programs of instruction for two of our courses, the advanced noncommissioned officers course and the basic officers course, to take advantage of the fact that we'll be able to, so to speak, fall out the academic classroom door into the field as opposed to here doing so many weeks of classroom and then going down to A.P. Hill for field training.

We've tried to address the meaning of different kinds of operations and what we want in the new school building. We've incorporated some things that will make it a state of the art

facility for the Army. In June of 1985, I traveled to the French and British engineer schools and brought back some ideas that we're going to incorporate there. It was a very fortuitous visit. I found the French had built a tactical training center, a large room with bleachers and screens that you could project movies or slides or TV.

The significant part of that room was the fact that it had a lot of individual rooms, 14 of them, set up to look out to these scenes so you could put two students in each of the rooms. Each one of them would have only their map board and their radio telephone, and then they'd be able to work problems that way, real terrain problems. There was a central control room by which instructors could speak to each student module individually so they had independent work. It was an idea that I thought had great merit because one of the things we'll not have at Fort Leonard Wood, just as we don't have it here, is the rest of the combined arms team. We can do engineer things, but we need to replicate the rest. I thought by coming up with a facility, which we first called the Tactical Training Center but now call the Battalion Combat Training Center, was something that we ought to build that would follow that French concept.

I should add that after leaving the French school I went to Chatham, England, to visit the British school. They had in the center of their tactical training room a model on a terrain board, and they had built plywood armored personnel carrier modules. They would put their students in the armored personnel carrier where they would look out at the training board to do their work. We combined the two into a facility for Fort Leonard Wood that had the individual cells in which you could isolate two students at a time, hook them up by radio telephone so they could work and be talked to by an instructor or other students in a task force tactical operations center.

At the same time, we incorporated the terrain board into the Battlefield Command Training Center because we're talking about commanders, platoon leaders, company commanders, battalion commanders, group brigade commanders, and we want to focus on AirLand battlefield training there.

The idea is that we can bring folks in there, put up something on the training board, still project real scenes up on the screen if we want, and ask them to work a problem, work independently from their map board, independent solutions, call in reports, do different kind of things. We think that this will be valuable in many different respects. We also will put some elevated benches around the room, and all those benches will be wired for computers. That will tie in another initiative that I haven't really talked about yet, and that's the Engineer Command and Control System, which will be a battlefield system. We'll be able to bring that into the classroom, too, and they'll be able to work that from the other benches throughout the facility.

Another thing that General Vuono, while at the Combined Arms Center, started was that he wanted everybody to have a typical command post within their facility. We will fix one of our rooms up as a typical engineer battalion or brigade command post. People in the tactical operations center don't see the battlefield, so we'll not give them access and visibility out to the terrain board. It will be located so that people out seeing the training board—platoon

leaders and company commanders—can report back to the tactical operations center and replicate their battlefield roles.

What we see is the need to provide a combined arms team experience and context. We could, for example, be going to take the basic course out to see and practice the breaching operation—the close combat, heavy, in-stride breach as in FM 90–13–1, which goes to print tomorrow. We can teach that, the concept of the combined arms breaching operation, in the classroom. Then we can take them out into the field and have them actually go through the breaching operation from armored personnel carrier into the complex obstacle.

One thing we won't be able to provide at Leonard Wood is the perspective of what's happening at the larger element, the task force or the brigade. We think we could put on the terrain board a major layout with boundaries and everything else so the brigade is doing this part of a larger operation—AirLand Battle, deep attack, controlling the forward line, whatever. We could put the larger context of the maneuver element on the terrain board, understand it at all tactical levels, and then take one part of it, the combined arms breach, having made sure they understand the broader perspective, and send them out to execute it in the field.

That's what we see when we talk about Fort Leonard Wood. When I talk about it being the Army prototype training facility for combined arms, we're going to have a school that's wired for all of our automation and any other kind of way we want to present instruction, plus this Battlefield Command Training Center, plus all of the good terrain at Fort Leonard Wood to practice "hands on" in the field. That's what's going to be the great benefit there.

Q: How are the plans coming now?

A: Well, there are two things involved with the plans. One is building the facility, and that's one we have participated in, and we've contributed to very closely with Fort Leonard Wood. The Kansas City District has been doing things; we're way behind. Initial costs came in above projections and Kansas City District and Missouri River Division have been wrestling with that with Fort Leonard Wood, trying to get a facility under construction. We badly need to get that building under way. We were going to have a groundbreaking in March; already now, we're well into the summer construction period. That's part of our planning, the design and construction of the building.

In the meantime we have done our other planning, that is, to get into the budgets, into the programming, and talk about what moves where. We've taken that planning as of 31 March [1987] down to the "each"—each position, civilian, soldier, officer, in each element—and we've determined when we can phase in there and when we should not. We've worked with Fort Leonard Wood preparing the requirements to get some money from TRADOC to fix up the Noncommissioned Officers Academy so we can make an early move of the advanced noncommissioned officers course. That'll happen in April 1988, as currently scheduled. We've worked to move our 12 Charlie—that's the bridge specialist—basic noncommissioned officer course to Fort Leonard Wood early.

That'll be this summer. We've got detailed planning on how to phase our course so that we'll have some overlap in the advanced course. That is, we'll be finishing up a couple of advanced courses here at Belvoir while starting the successor ones out at Fort Leonard Wood. At the same time, we won't have to do that for the basic course. We'll be able to finish one and start one out there. We've taken the staff and faculty planning for each of those down to the eches—all of that based on an assumption of when we'll be able to get in at Fort Leonard Wood. That assumption, of course, still floats as long as we haven't started and got a fix on a beneficial occupancy date from the Kansas City District.

So, we've got our planning down to the details and we're comfortable with it. It's just that we'd like to have that assumption turn into a more fixed date. We know it's slipping as of this moment from 1 March 1989 to what we're told is in the order of October, but we'll know that better when we finally have a date. In the meantime, many of our civilians are already leaving the work force here. That's causing us some difficulty because, very naturally, they want to find security and a secure position if they have already made the determination they're not going to move. In our crucial combat developments arena, people are in an area where their type of jobs are plentiful, the Washington area, and they are moving when they get the opportunity. We're already losing some expertise. We had detailed planning to try to start building up our expertise and capability out there and we moved positions to Fort Leonard Wood. We've hired interns there to start building up. Hopefully we didn't want to take too great a dip in institutional knowledge and continuity during the time we're making the move.

Q: That's risky business, though, isn't it, all the uncertainty of when you're going to go because you can't move that fast, can you?

A: Well, we were very comfortable up until the first time the bids came in "over" because we felt everybody was plowing on and we were being assured that things looked pretty good and not to worry. So, we did our planning and felt a little under the gun to make sure we tied up all the loose ends. Having tied them up, it's been a little frustrating now to see them unraveling and the execution time extending. We had programmed a shift of the commanding general, that is my successor, General Reno, out about 1 October 1988, the idea being that he would be here for a year to understand how the school worked and know all of the environments and the functional arenas that I described. Then he would be able to move early and pull it to him, putting all that information to work as he made it happen at Fort Leonard Wood.

We had planned, as part of our transition, to move those things that are associated with engineer proponency with him—that is, part of the Combat Developments, part of Training and Doctrine, the Engineer Proponency Office, the TRADOC system manager, the Engineer Force Modernization Office, those things that are involved in the day-by-day proponency arena as opposed to teaching the advanced course and teaching the basic course.

Thus, we would have split Combat Developments. The computer would still be here because the building's not ready there to put the computer in, so people associated with the computer in Combat Developments—that is, the force designers, the TO&E designers—would stay

here. Materiel guys would move out there. That split causes inefficiencies. The idea was that he could leave an assistant commandant here; he'd have a deputy assistant commandant there, and that would make that work. Now that period that we planned for is stretching out because the difference between 1 October and 1 March is only six months. We could see how we could live under that kind of split office for that period. If that extends on through October or later, because we still don't have that fixed date, then we have to go back and challenge the assumptions that led to the terms of our detailed planning, and we will have to adjust that.

What we have not been able to do is make that movement. We've played a few what-if drills; we know what the considerations are, but until we can fix that date we're reluctant to change our plan and fix onto it. Otherwise we may be fixing and refixing the plan. So, yes, we think we're pretty firm, but we'd really like to firm up the rest of it.

Q: Somebody else, in this place, is calling the shot that affects everything you've got planned?

A: That's right. Kansas City District's construction.

Q: What happens if Congress is not going to allow reprogramming? I'm just giving you a what-if. What do you do then?

A: Well, my view is that we don't move. We need a school facility at Fort Leonard Wood.

Q: Would you think about rescoping the building or something?

A: The implications really are that we would have to redesign the building. We've scoped the current building. Things have been taken out that were in the original plan. The decision has been made to completely redesign the unaccompanied officers housing, so that will come later. If we build the academic building and the classroom facility, right now the first officers that go out there won't go into the unaccompanied officers quarters. They'll be billeted somewhere else, hotel or motel, for the first year or so. So, it's already not the optimum. We've scoped with Fort Leonard Wood the existing buildings.

If we don't get a reprogramming, we have to go back and redesign a new facility. Redesign is a year or two-year process, so we certainly will have a major break in the schedule. If that takes place, then the idea is we'd have to redesign the facility and then we'd pick a new date and do it all over again. Meanwhile, we're sitting down here with a lot of empty positions and it'd be a major disruption. I see no other alternative but to redesign the buildings.

Q: There's no way you can do anything else.

A: Philosophically and logically and the only way we should have it is that we shouldn't move until we've got facilities out there that are appropriate to the mission. Those facilities include an academic building and a headquarters building. Headquarters is not just the headquarters as we know it at Abbott Hall here. What we're going to do is put the other directorates that aren't teaching directorates—that is, Combat Developments, the Directorate of Training and Doctrine Development, the Directorate of Evaluation and Standardization—that are so spread

out here at Fort Belvoir in different buildings all in one building. Those facilities are needed before we move.

Q: And, of course, if you don't move then it just goes on back, doesn't it? Causes lots of problems.

A: That's right.

Q: How much time have you spent on this particular aspect of your function?

A: The school move?

Q: Yes.

A: Oh, I don't know, quite a bit of time. I guess I've never thought about that aspect. What I have said is that breaking down my time—I spend about 85 percent on proponenty-related functions. What I really say is that I wear three hats. I really wear two hats, commandant of the school and commander of the post. The commandant of the school has two connotations, and I break it into two parts. One is being the school principal, that is, operating the school and doing those training functions associated with the classes every day. The other one, still a school commandant function, is the engineer proponenty function, which involves a total force doctrine, force modernization, combat developments, and so forth.

That makes the three hats, with the commandant broken into two. I spend 85 percent of my time on the engineer proponent functions, 10 percent of my time on school principal functions, 5 percent of my time on running the Fort Belvoir installation functions. That's how I see the demands on my time. Now, I would put the school move into the proponent part of that 85 percent. What percentage that is, I don't know. We established a year ago the Engineer School Transition Office, as a functional element to do the direct liaison with Fort Leonard Wood, with Headquarters, TRADOC, and work with all the staff. I made the assistant commandant the principal guy for pulling all that together. He can coordinate directly with the chief of staff of Fort Leonard Wood and keep all those various things pulled together.

Q: Is there anything further you want to discuss about the move or planned move?

A: No, I can't think of anything at the moment.

Q: What is your evaluation of the strengths and weaknesses of your subordinates? That includes senior officers, junior officers, noncommissioned officers, soldiers, and civilians.

A: You're talking about in general?

Q: In general, right.

A: You're talking about the ones at the Engineer School here, rather than engineer force?

Q: School and Center, right. Now, if you want to talk about the engineer force, that would be perfectly acceptable.

A: Well, I think at the Engineer Center we've got probably our cut of Army talent. That is, I'd say we've got top third, middle third, and some bottom third kind of folks. We've got some folks who are very good, very talented, some of the best I've ever seen. We've got some who haven't pulled their weight, and they stay in the background while the first group does the work, like in many places.

I would make two specific points. I don't know if I talked about this last week; maybe I did. The fact is that we went out to MILPERCEN over the last couple of years and tried to bring in some very talented folks, not only high-quality officers—that's whom I'm speaking of in this instance—who had great credibility among their peers be they engineer or maneuver, but also people who had a broad perspective of combat engineering on the battlefield, specifically with regard to maneuver. We focused our efforts to get that kind of talent. We brought in lieutenant colonels who had been to the National Training Center with their battalions, lieutenant colonels who had commanded in Europe, a lieutenant colonel who had commanded in Korea, and one who had commanded in Hawaii. We went after talent based on reputation and demonstrated capabilities and potential, but also because of their perspective of how things were in the Army. That was a tight, small group, really, but in the amount of talent there it was a tremendous wellspring of capability that we hadn't had before. That was one aspect.



General Kem met with Israeli Defense Force officers during a visit to Israel while he was Commander of the Engineer School.

The second comment I would make is that we have some very good people but they're not fully effective in the jobs they are in because of the Army's continued movement to pull down the strength in the field grade level of the officer Corps within TRADOC. A specific example: we've decreased 30 to 35 percent in the number of majors we're authorized in

terms of officer distribution policy, that is strength support, to be replaced by captains. When you do that and you get a captain out of his first assignment plus advanced course, then you're getting a person who's got a very narrow perspective, a perspective of only one unit. With engineers that could be a combat heavy perspective, or it could be a divisional combat perspective, or a topography perspective, or a training perspective, or a divisional perspective. When we put somebody on that platform, we want somebody that has the broader perspective to be able to teach others. So, although there are some very good people here, because of their lack of breadth of experience, we don't get a full capability in effectiveness in the job they're supposed to do as a teacher and as a writer of doctrine. They're really too narrow in experience to be fully effective.

So, when you talk about kind of people, I'm putting it in terms of authorizations for people and making the point that we really need more majors at this place where we're training captains—not more than we're due, but our full share of what we're due in terms of what the structure people say we ought to have.

Q: So, the basic problem is one of authorizations; you don't have the authorizations?

A: That's right. It's the officer distribution policy. It's how the Army allocates the available officers to fill what's authorized worldwide. We're continually resourced at a level considerably less than what we're authorized in majors with captain substitutes, and that hurts very much at a training base.

Q: Nothing that can be done about that, though? That's set at the Department of the Army level?

A: Well, I think we could stop the downward spiral of staffing and officer cuts, which has lots of different parts. Congress has mandated an officer cut, I've heard. The Army has tried to establish new divisions, and to find the capabilities to do that has caused a down trend in officers elsewhere. I guess what bothers me is from time to time you hear that we can do these reductions without any hurt, and what I'm saying is, it does hurt. We tend to look at this year's cut against last year's numbers. If 20 was okay last year and you get cut 2 to 18, that shouldn't hurt too bad. That doesn't reflect that over the five years you've been cut from 30 to 20. So, now you measure 18 versus 30 rather than 18 versus 20. So, yes, something can be done about it, but it really takes a recognition throughout the Army. It's a recognition that we need people with the right kind of experience and perspective in TRADOC schools so that we can have that capability to develop our future leaders.

Q: What about enlisted soldiers?

A: The noncommissioned officers we have here at the Engineer School, I think, are superb. I've been impressed with the senior sergeants major in the battalions. I think we've got a fine engineer noncommissioned officer Corps that cares for their soldiers and knows a lot about what they're doing. I think once again we have a bottom third, a middle third, as well as a top third, and I don't begrudge that because you have to recognize I am talking about the whole installation.

We certainly handpick the captain who's going to be a team leader in our officers advanced course. He has to have a breadth of experience, he has to have proven leadership capabilities, he has to have the recommendation of a couple of former battalion commanders and a branch chief. They're all selected on their abilities as a leader, coach, potential mentor, and so forth. We try to put the right person in each different job. We have jobs here that get done and don't necessarily require brilliance. The better people you have, naturally, the better it's all going to be.

I would like to have more good junior officers with perspective to put in the Combat Developments Directorate because I think that's a weak area here as we've stretched out the numbers. In the combat development arena we bring this same person back to Fort Belvoir and we pick one to go to the advanced course and one to combat developments. When you're limited by number of majors and above and you get mostly captains, you're bringing here a person who's had one or two tours and the advanced course as his level of experience. He's been in troop units—that's what he knows, and probably did that very well—but now we're asking him to do work in a whole new field that he hasn't been trained for, combat developments—to write papers that will defend, win or lose, an engineer system, and they might be writing those papers for an Under Secretary of the Army or a congressional staffer. Now, I never did that until I was a lieutenant colonel assigned to the Pentagon. I wrote papers at lower levels but not to the degree of editing them down to be the hard-hitting, very high level things that you read in the Pentagon.

Then that becomes a burden to that officer's bosses because they now have to work harder to develop that person and let him know what's going on, and in what's a very supercharged, stressful arena anyway, combat developments, that extra burden for the bosses takes its toll. Once again we're talking about level of experience.

Now, the implication of your question might be that we're not getting good folks here. I want to dispel that. I know that in times past, people didn't want to come to the Engineer School. It was always said that infantrymen want to go serve at the Infantry School because that was felt to be career enhancement. I was always told that you don't want to go to the Engineer School because that's not career enhancing, *vis-à-vis* other things. I would like to think we've turned that around. I'm told by some that we have turned that around. I imagine there are others out there who still say the opposite, who aren't talking to me. Nevertheless, we are hand picking lieutenant colonels out of the War College, majors out of Fort Leavenworth, and people see the caliber of people we have here. People have seen that we've had three Engineer Branch chiefs—Paul Chinen, [Peter G.] O'Neill, [John Paul] Basilotto—all assigned here after leaving branch, and people have seen that we've had people selected for brigadier general out of here, for colonel below the zone out of here, for lieutenant colonel below the zone out of here. Hopefully the word is getting around that our selections for Fort Leavenworth and the War College are higher than the engineer average. People see that of last year's sixteen engineer colonel command selects, three were assigned here and one had just left; that's 25 percent. When those kinds of things get around and about, I think people see that if they come to the Engineer School, that it's not career damaging; it is probably, if they perform, career enhancing.

Second, you're going to work for good people here. So, when you come and you're going to be working with and for the Paul Chinens, the Ted Vander Els, the John Fesmires, the Paul DeVrieses, the Bob Whitleys, the John Schauffleburgers, the Russ Fuhrmans, the Tom Farewells, the Rick Capkas, the Al Carrolls, guys who are obviously right at the head of their peers in their respective year groups, then I think that we're getting good publicity. At the same time, I'm not sending a list to Engineer Branch saying, "I need your 40 best majors"—but I'd sure like to have 25 of them.

Q: It takes a long time to unmake those kinds of things, those myths or those things that used to be.

A: It does. That's why I caveated my response. I think we've turned the corner, but I know somebody out there still thinks that way. It's very difficult to communicate to the whole force. Just communicating to battalion commanders is difficult. I came here with the thought that we've got to do better as proponent communicating to battalions about our work. We sent messages to the field, messages to every active battalion commander, every total force engineer battalion commander. Yet, it's amazing to hear somebody stand up and say, "How come you never do this?" when I know it was the subject of a message six months before, fully laid out. We received responses from some people for communicating that, yet here are two or three people who never even heard of it. Because we turn over so rapidly in the field, we don't retain an institutional base of knowledge out in the units, and the myths are very difficult to turn around, even with facts.

Q: I guess a lot of it may be because of the division between the school and the Chief of Engineers' office. Would the infantry and armor and field artillery be much stronger in that area?

A: I don't know if I necessarily agree with that. I guess there's potential, but we should be better because we have at least two spokesmen now on the circuit talking, the Chief of Engineers and me when I go out as proponent. General Heiberg and I early on decided we would like to speak with one voice and recognized keeping each other informed was an important part of that. When he goes on trips, he has his people call down here and say, "What's the latest?" or "I'm going over there; any subjects I should know about?" We know when he's going. We try to prepare him with some papers, usually not a lot. We've both been in our positions long enough now to have a real feel for what each knows and so forth. If he gets a question thrown at him, he'll say, "I'll get you an answer." He comes back and bounces it to the Office of the ACE for an answer, copy to us so we can work with the ACE to get the answer. We should be more effective in communicating as long as we stay in one voice, and I think we've done that pretty fairly.

Q: To what degree did your position involve direct contact with the civilian community and what were the nature of those contacts?

A: You're talking about the surrounding civilian community from Fort Belvoir?

Q: I assume that's what this is, yes.

A: Considerable and yet not so much. I think it is like on any large Army post, we've got those kinds of contacts, but it may be different just because of our location. Fort Belvoir is in the National Capital Region and is the subject of considerable visibility. We are absolutely in a fishbowl here with everything we do. Also, then, we're small potatoes to the surrounding community. When something happens here, we have immediate visibility with all the national wire services and networks. When the Secretary of the Army and the Chief of Staff put out their no-smoking policy, all the networks came down here to interview soldiers as to what they thought of the secretary's policy. Now, as commander you might say, "Gosh, I wish they'd find somebody else," but I'm local and I have soldiers, and the networks don't want to go too far, so that's what happens. So, we make them available. When we court-martial a doctor in our hospital, then we have the national wire services sitting there in the courtroom with their cameras. The *Washington Post* runs a picture of a sergeant major whom I removed, with all kinds of accusations, later to be proved invalid.

So, we get a very high visibility from where we are located. By the same token, though, it's a big bustling metropolitan area with lots of things driving it, as opposed to a place like Fort Campbell, Kentucky, a huge division installation much bigger than us but with small surrounding towns where that commanding general knows congressmen and senators and all the rest of it. Around here we don't quite attract that kind of interest unless it's potentially something big.

My interaction with Fairfax County, which is the local jurisdiction around us, is a very pleasant one. We deal with them professionally at all levels. The Fairfax County school system runs our schools. We then interact with Hayfield secondary and middle schools as our schools. We have two Fairfax district supervisors, that's the governing body of the county, in our area. The greater part of the post, south post, has one supervisor. Another supervisor has the northern part of the post. We have often had meetings with them or their staffs concerning items of interest. On the one hand, one supervisor is very cordial, very much wants to have a professional relationship. The other one takes the more old-time politician's view that if you can hammer them, you get your news space and then work out the details after the noise has subsided.

Our military police deal with county and state police continually because we have open county and state highways that run through the installation. We have joint jurisdictions and we have great cooperation with them. In fact, when we have our receptions and get-togethers—there's a spring reception and fall reception—we typically invite the Fairfax supervisors, the school boards to include the Fairfax County school superintendent, and the police chief and his subordinate chiefs to those functions to maintain those kinds of relationships.

Q: You only get in somewhat hot water when you have things like the relocation to Fort Leonard Wood, the Springfield bypass issues?

A: That's right. At the congressional level, we got interest when we were potentially moving. There are too many other acorns around, I guess, from that standpoint.

Q: Well, in that case, once they were assured that there wasn't going to be any net loss of positions or something like that.

A: That's right. When we went to Congressman Stan Parris and demonstrated it was a net gain in people because of the relocation and other people would be moving to northern Virginia to offset these leaving, that issue died down. We never had any senatorial interest pro or con.

Q: Describe the efforts undertaken by your organization to promote the "Total Army" concept.

A: Well, engineers know total Army like no one else knows total Army because 70 percent of the combat engineers are in the reserve components. So, in fact, we pretty much do talk total force. We talk about doctrine, of course, and you don't talk about which kinds of units—who's going to fight that doctrine—but just talk units and how they fit into AirLand Battle. When we start talking force structure and manning the force, then we very much talk about and organize who's in the active force and who's in reserve components and who's going to be available to reenforce a NATO or one of the other contingency plans. We have reserve component advisers on our staff, one from the Army Reserve and one from the National Guard, who participate in everything we do.

Our annual commanders conference is a total force commanders conference. We invite from all three components. Most of the engineer general officers in the troop units are in the reserve or guard and support that conference very well. We put them on the program—usually Capstone, that is the interrelationship of units depending on mission theater for deployment. One other aspect, of course, is that the engineer force right now is sending many different battalions to Latin America, SOUTHCOM [Southern Command], to do engineer work down there. The Engineer School is involved in that effort in publishing lessons learned, making sure deploying units are prepared, and that sort of thing. FORSCOM's involved in all components: active, guard, and reserve. This last year at our commanders conference we had one session oriented on Latin America, headed by the active duty colonel SOUTHCOM engineer, which had had briefings by battalion commanders from all three components. We also had the USAREUR engineer talk, and then we had a session having to do with engineer operations in the communications zone given by the commander of the 412th Engineer Command (Army Reserve), which included subordinate units that were active, guard, and reserve. Then we followed it with another theater, southwest Asia, and the 416th Engineer Command (Army Reserve), which once again had subordinate active, guard, and reserve units. So, we basically deal across the board of the total Army.

As we went into the Army's regimental system, we from the school and General Heiberg always felt it should be total force. At the time the Army Reserve and the National Guard were holding back. The Guard said, "Don't call us; we'll call you if we're interested." We then went at the leadership of the Reserve and the National Guard in the person of Brigadier General Dick Dean, who was an engineer in the Army Reserve, and said, "I don't know what your problems are with the Army's regimental system when it comes to regiments." I think, potentially, the Guard and Reserve may have wanted to avoid the great changes of flags—all of that caused quite a commotion in the active force in the infantry, armor, and artillery. Once we explained how the engineer regiment would be a whole branch concept—emphasizing

both the Corps and the battalion, the concept fit very nicely, and it would be total force with 70 percent of the engineers in the reserve components—then both agreed.

Q: This is as good a time as any to talk about the regiment and your role in getting that established.

A: Well, I think it was probably a pivotal role. When I came into this job, my predecessor had, with the Proponency Office, tried to put together a regimental system of engineer regiments pretty well based like infantry, that would group battalions into a regiment with a regimental crest and that sort of thing. Combat heavies would be grouped together, lights grouped together, and the combat battalions (divisional) would be grouped. Then there was a try to work it out so a person could have reassignments between different places while serving in the regiment. For instance, in one regiment the person would rotate between Fort Polk and Germany, then back to Polk, and so forth. Another regimental rotation might be from Fort Sill to Korea and back to Sill.

Shortly after I came in, I attended a proponency meeting, in November of 1984. I found the Chief of Infantry, Major General John Foss, quite unhappy with the way the regimental system was working, and he felt like challenging the system from the standpoint of infantry. What he was saying coalesced with my own thoughts too. I didn't like what I saw. What I didn't like was the fact that already five of those engineer battalions had changed in the force structure. For example, one combat heavy battalion was now going to become a light battalion. So, in the regimental grouping within a group of combat heavies, then it wouldn't fit. More specifically, though, I didn't like the fact that with the officer Corps we were going to develop specialists who would only know Fort Polk and Germany, and somebody else who would only know Fort Sill and Korea. I felt that our officer Corps ought to develop and have a breadth of understanding that was across the board. We ought to know what combat heavies are like; we ought to know what Corps battalions and divisional battalions are like and how they interact. I felt strongly there was a real need for that. We don't want specialists—all light, all heavy, or all combat heavy—and that was exactly what John Foss was saying. He didn't want all Bradley infantrymen, or all airborne infantrymen; he wanted people who had more, not fewer, kinds of experience.

In the meantime, there was a lot of ongoing consternation about this new system. Lieutenant General Bob Elton, who chaired the meeting, held a roundtable about the new regimental system, and there was considerable discussion on what was involved and what should be done about it. The DCSPER folks went back and took a relook at it with the Chief of Staff and, basically, from that, disassociated the assignments part from the Army regimental system. In other words, no longer would you have to go between Fort Polk and Germany, but still the idea would be to affiliate with a regiment and have some volunteer kind of home basing. So, for noncommissioned officers and soldiers, you might well want to buy a home in the vicinity—voluntary home basing could get them back to Fort Polk if that's where they wanted to come home to.

As we addressed the engineer regimental system then, when that assignments plan was removed, our thinking continued to evolve. I'd been dialoguing with General Heiberg, and I

brought him my concerns first. We had several times discussed different kinds of options, different approaches. The whole branch concept was out there, but there was a connotation that this was not combat arms, that it was only for combat service support. So, there was a lot of emotion about it. Some people felt we had to be in regiments like infantry and artillery. Others felt we just had to be in something. Everybody else was now starting to wear regimental insignia and still engineers weren't. We'd get these messages from the field; we had to do something. So, General Heiberg convened a meeting of some retired senior officers. I can't recall specifically who was there, but I believe it included Clarke, Morris, [Frank] Camm, Bachus, and LeTellier.

General Heiberg and I were there, and after he kicked off the meeting I gave a little brief just to start to get the discussion moving. Our intent was really to get the counsel of these alumni to help us sort out where we were. We got the same crosscurrent of different thoughts—got to be like the other combat arms, got to be whole branch; can't we do something—we just had all kinds of things on the table. I came out of that meeting about as muddled as I went into it. I sat down just trying to figure it all out and wrote a think piece with some questions on the subject.

I tried to throw out a question, then answer the question and just let the logic come out. What I really did was to just put my own thinking to paper, and that brought me around to believe that we should have a whole branch concept—because our engineer allegiance, most specifically officer allegiance, is to the Corps as a whole and the history and the heritage of the Corps. Our noncommissioned officer allegiance, I felt, was to the unit. Because we have the soldiers and the noncommissioned officers trained at Fort Leonard Wood only coming to Fort Belvoir when they go to the advanced noncommissioned officers course and officers trained at Fort Belvoir maybe never going to Fort Leonard Wood, we never brought the two together. We are going to have that opportunity with the school coming together at Fort Leonard Wood in 1989. So, for officers, battalions and regiments as regimental focus would be artificial. I recognized there were general service regiments and regiments in World War II, but that kind of history is long gone. What I mean is that when we're starting to talk bonding and all the kind of thoughts that General Wickham was talking about, then we're talking about a more immediate, personal kind of thing, more allegiance than periodic adjustment. So, trying to set up put-together regiments, in my mind, was artificial.

I wrote the paper as a think piece, and it just seemed to come out that we ought not to have a regiment in the infantry regimental scheme of things, but we ought to find a solution that allowed us to keep the strong bonding that the Corps of Engineers has now to its people and at the same time emphasize where engineers serve, and that is in battalions. So, the paper came out that way and I sent it to General Heiberg. He wrote back and said he agreed, and we proceeded in that way. [See Appendix B.]

Now, there's one other aspect I think will be of particular interest to you about the engineer regiment. Early on, even before what I've just described, both General Heiberg and I had discussed, and both of us recognized because we both had served at both the headquarters and in the field in USACE, that the question comes up, "What about USACE? How does that fit?" Both of us had the feeling that we already had in USACE one of the strongest bonded

entities in the United States Army, that the strength of USACE is in that feeling within the Corps, civilian primarily, the basic work entity throughout the Corps of Engineers and all of its districts and labs and every place else. Whatever we did, we did not want to disrupt or take away from that bonded entity.

Note that I have used the word “bonding” several times because that’s what General Wickham emphasized we wanted. The system was to focus on bonding the unit. I know General Heiberg felt, and I feel, the obvious bonding of the Nashville District or the Huntington District in the Ohio River Division. There is a focused feeling that I had when I was there that I heard General Wickham describe when he was saying, “I want to achieve that elsewhere.” So, we said that we did not want to disrupt that. We did not want to take this Corps MACOM in and the USACE crest, for instance, and move it over to accompany a larger entity. We wanted to keep USACE and that crest, patch, all as one entity.

Then the question came in, “How about civilians? Are they part of the Corps and the regiment or are they not?” After really thinking about that a long time, we decided, no, they weren’t because that’s not the definition of the Army regimental system. Is that a problem? No, it shouldn’t be because we’ve still got USACE, this strong, bonded entity.

So, we looked at the two parts of that and we felt very comfortable with where we were going and the fact we were not taking away from USACE, nor were we trying put it under. It stood out there as a major Army command, and we’re talking the Corps and we’re talking battalions in the Army regimental system.

Out of all that, we took the think piece that General Heiberg agreed with, boiled it down into an action paper, and sent it to DCSPER for approval. DCSPER approved it.

Q: Now you’ve implemented it all?

A: Now we’ve implemented the regimental concept with several significant occasions. One was the unfurling of the flag. We picked former Chief of Engineers General Fred Clarke and Sergeant Major of the Army Leon Van Autreve as the first colonel and sergeant major of the Corps, respectively. We’ve converted all of the training brigades and battalions at Fort Leonard Wood and the Engineer School at Fort Belvoir to engineer numbered brigades and battalions, thereby bringing back the heritage that all of them can enjoy. We have a committee under the assistant commandant here that’s always trying to develop new ways to try to build in this. I’ve visited the British Royal Engineers’ institution at Chatham to learn from them. So, we have implemented the engineer regiment, and there are more things yet to happen, such as trying to emphasize engineer battalion heritage. The Corps is easy because it’s there, but battalions are individual.

I should say, there was one other thing we wanted to do. We wanted that engineer’s affiliation with his or her battalion to be like the infantryman’s association with his regiment. We felt we could not impose upon the battalion commander the same things we imposed upon the infantry regimental commander as far as maintaining rosters, having a museum, and doing all of those things. We felt it had to be a little looser than that because some battalions,

such as the 307th from the 82d Airborne Division, have a lot of tools and implements; they could put together a museum readily. They've played history and heritage for years and they've got quite a package, where others never have thought of it much.



The first Honorary Colonel of the newly established Engineer regiment, called the Corps of Engineers, Lieutenant General Frederick J. Clarke (Retired), former Chief of Engineers, passed the colors of the regiment to General Kem, Commandant of the Engineer School, at the unfurling of the new colors at Fort Belvoir, Virginia, on 23 June 1986. The colors remained at the ceremonial home of the new regiment, the Engineer School, then at Fort Belvoir, Virginia. Sergeant Major of the Army (Retired) Leon Van Autreve (second from the right) was the first Honorary Sergeant Major of the regiment.



From left to right, Lieutenant General Elvin R. Heiberg III, Chief of Engineers and Colonel of the Engineer Regiment; Lieutenant General Frederick J. Clarke, Honorary Colonel of the Regiment and former Chief of Engineers; and General Kem at the ceremony establishing the regiment.

We wanted our engineer battalion commanders to stay concentrated on leading, maintaining, training—those things he's got to do—without having this as a burden. So, we asked the Chief's historical folks to put together a package that will assist these battalion commanders in doing that sort of thing. That package is a short history, some capability to provide a card of basic highlights of the battalion's heritage to give the individual soldiers, and some kind of a thing to put beside a plate at a soldier dinner or a dining-in or something like that. We got a lot of good support from you in the Corps' Historical Office in putting that prototype together.

Q: We'll give you a running account of how well we did; keep you informed on that one.

A: I knew you knew all that; I just thought I'd put it on the tape, though.

Q: Good to have for the record. [Laughter] That's something we still have to work out. Probably I was remiss in not working with you more on that.

A: I told Paul Chinen, as the new assistant commandant, that he is to step in where Bob Whitley took off. Bob ought to debrief him on what his jobs are as part of this committee so he can take over, so there'll be some opportunities.

I guess there's one thing that's been very difficult, and that is to get people to stop using the term the "engineer regiment." Once again, it's sort of those myths, it's hard to put down. "Oh, we have an engineer regiment." No, we really don't. We really have the engineer Corps. Is it a new Corps? No, it's the same Corps of Engineers, but we're now organized as an official part of the Army's regimental system. So, we're not an engineer regiment; we're an engineer Corps in the Army's regimental system. That's consistently what is said, but it's very difficult to say and, too, we print programs and other things that continually talk about the engineer regiment.

Q: One of the things that we need to work out is to provide the Corps of Engineers, as part of the Army's regimental system, with historical support because you don't have it at Fort Leonard Wood.

A: It's interesting when you say that. The British have the institute. They have an organization that is all financed out of soldier pay. They take two and one-half days' pay from every officer every year and a certain amount from the soldier; I think it's half a day, it might be a day's pay. That is the income into the regiment to run what they can do, but out of that they do a lot of things. They publish their magazine, they maintain the rosters, they buy the regimental silver—and they have some wonderful silver that stays in the regimental mess at Chatham. They also run their own welfare system for hardships in later life; in other words like Army emergency relief. All of that is done by a small group; I don't think there's more than 30 or 34 folks in offices there. So, they carry support to a much higher degree than even ours.

I didn't mention that we have picked, of course, the home of the Corps in the regimental system is Fort Belvoir until we move the school. So, the home of the Corps is the school, wherever it's located.

Q: As it should be. The problem is with the Chief of Engineers and all of that. I don't know if it's ever going to be resolved. I guess a new generation.

Can you describe a typical day in your position? I know this'll probably be almost impossible.

A: No, I really can't because there are several kinds of days. They're the kind of days that I get so seldom, and that involves being able to get out and go visit training, advanced course students, or basic course students. A lot of my days are days where I go get on an airplane, first thing in the morning, and go flying off to Fort Leavenworth or Fort Monroe and come back two days later; so those days are completely away from this place. If you would want me to describe a typical day at Fort Belvoir and the realm of what kind of activities we have here, basically, I come in at 7:15 and at 8:00 we have a morning update for 30 minutes where I get the command group together—the assistant commandant, chief of staff, the command sergeant major, the public affairs officer, and the Secretary of the General Staff—and we would review the day to come, major events coming and so forth. It is a quick runaround, don't try to make decisions and solve things; it's not decision briefs. Basically we're looking to make sure we're all on-line and things are getting taken care of. It almost never went more

than 30 minutes. We invited the brigade commander, Colonel [Roger Charles] Strom, in on Mondays and any other day he felt that he ought to be there to talk about something.

After that we then very typically went through a busy day involved with decisions, decision briefs, or meetings. It may well involve a trip to the Pentagon to meet with an Army staffer. I would go over to the congressional staff to meet with them or it might be to AMC for a meeting there. It might well involve my going to the brigade or to the school to see training or a class. It would most certainly involve a couple of hours, at least, spent on combat developments, either by their coming here to talk over some issues and getting guidance or being on the phone talking to six or eight people about some materiel item that there were issues with.

Invariably, I did very little paperwork during the day. I would typically use that time for interaction with subordinates, be they base operations, school, combat developments, or training, so that we could keep the business of the school moving on. Typically I took home a briefcase or two in the evening; on weekends three or four. I did most of the paperwork in the evening until 11:00, primarily because the daytime was for subordinates, giving them guidance, hearing what they had to say, trying to lead them, giving them perspective, guiding them in what was going on.

Oftentimes, once a week, we'd have a reception in the evening for the officers advanced course.

Q: How much has the lack of a brigadier general as the assistant commandant hurt you?

A: I think it's hurt us considerably because a lot of times I go to meetings because I feel that we have to be there with a general officer, and I find the assistant commandant of the Infantry School or the assistant commandant of the Artillery School are covering that meeting. What that really means is that the commandant could be somewhere else, thus doing two things that require the presence of a general officer. I think what that means is our assistant commandant, being a colonel, is pushed down and does two tiers of things. At one tier, the lower tier, he's running the day-by-day activities of the school, which really should be done by a deputy assistant commandant. At the other tier, the upper tier, he has difficulty getting into some of those arenas just because he's a colonel; shouldn't be that way, but that's the way it is. So, when you look at the Aviation, Artillery, Air Defense, Signal, Infantry, Armor Schools—all have brigadier assistant commandants. You can see that that's a problem for us. We've got the National Capital Region; we've got the place where the Secretary of the Army decides to come down and plant a tree one day and other things that engage our time.

Q: How do you go about trying to restore that, or is it possible with the Army's general officer loss then?

A: Of course everybody wants general officers. The fact is that it will be solved when we move to Fort Leonard Wood. The brigadier general at Fort Leonard Wood now is an infantryman. After the school move, that will become an engineer brigadier and be additionally the assistant commandant.

Q: In the meantime, you lose a two-star engineer once you're out there so there is no net gain.

A: That's right. One of three positions goes away. We'll end up with one major general and one brigadier general of engineers. We will then, in fact, have an assistant commandant who will then be involved in the combat development side of the house and the training side of the house and all the rest. That brigadier will be able to speak for the commandant and represent the views of the proponent. That's where it really counts. We can send our current colonel assistant commandant down to talk to the Chief of Engineers, and he's as good as anybody else, fully acceptable. In some of those other arenas out there at meetings, you don't even get a seat at the table unless you're a general officer. The colonel finds himself in the back row and less effective.

Q: That's another positive thing to be gained from the relocation to Fort Leonard Wood, then, a little more subtle, not as much up front as the others.

A: Yes.

Q: What is the one area in which you did not make the progress you had hoped, and what do you attribute that to?

A: Well, I guess the most frustrating thing I've fought since I've been here is staffing for combat developments most specifically. We rank ninth in staffing in combat developments in TRADOC. We rank second, fourth, or fifth in all the items that you count, like numbers of systems, number of SRCs or type units, numbers of sets, kits, and outfits we manage. I look with a little envy at Knox who worries about armor and Cav, tanks and Cav vehicles, and about the same number of officers in the active force but many more folks in the Department of Combat Developments.

The job at Knox, from the standpoint of the Department of Combat Developments, has got to be more simple than somebody who's here working in the multiple mission areas where we are addressing countermobility, mobility, survivability, topography, and sustainment engineering, each with different sets of systems and tools. The engineer carries a bunch of different tools in today's battlefield so that others don't have to carry them. I mean, with the tankers we bring in the CEV, the AVLB, the digger—the M9 ACE or the D-7—and we need a breacher. We have all the different implements so they can have that single focus on direct fire kill. Artillery's got the indirect fire mission. So, we sit out there with an M-60 AVLB and an M-60 CEV trying to support a battalion task force that is equipped with M-1 tanks and the M-2 Bradley with the infantry component. That's four systems, three branches; we've got two of the systems. The other two are modernized.

So, we're playing catch-up across a lot more different kinds of systems, a lot more different kinds of units, more different sets, kits, and outfits than anybody else, and yet we're ninth in combat developments staffing. So, I mean, it's just vexing to me. Not only that, engineering modeling lags everybody else's because modelers look at total force, which replicates armor, infantry, aviation, and so we also have to play catch-up, yet we only rate ninth in staffing vis-à-vis all the rest of them. What we're talking about are turning out the documents, the

operational and organizational plans, the requirements documents, all that staffing stuff that gets you into the game to get one of these improvements. So, my most frustrating thing is I have not been able to solve the combat development staffing problem, although I've gone directly at it. We really get a wave off. They really say, "Well, yes, you've got a problem. We're working on it." Then it goes on and never gets solved because the system's too big. We're fighting a whole spaces bureaucracy, then a whole faces bureaucracy.

Q: So, that's something that really is, what? You attribute that to just pure personnel management and space management?

A: That's not personnel management; that is space management. That's convincing people that they ought to take away from other folks that have them now and put them here. In the past, whenever we've lost, it's difficult for them to give it back. If we're ninth in staffing, to get us up to, say, fifth in staffing, they've got to take spaces away from somewhere else in TRADOC. It might be the Armor School or Air Defense School, and all those people will scream. So, it's very difficult for those decision makers to do it, and so they don't do it. They just pass it off, and then the people change, and there we are.

Q: Back to square one again.

A: Back to square one. It's very vexing to me. The USACE system of staffing that I used to fight with all the time was much more amenable because it could change. USACE folks, especially in the construction arena, are used to stopping projects and starting projects, moving people, hiring up and closing down. I really became convinced that the construction arena was very mobile, and they know how to do that because they've had to do it so many times.

Q: Everything being project related?

A: That's right. If you're not earning, you can't hire against it. So, those chiefs of construction in all of our districts and divisions in the Corps know well that you've got to meet the bottom line and they do very well at that and make those tough decisions. The Army, with its insatiable appetite for more brand-new things, jumps out and resources a new thing, not recognizing that they might have been better off to spread those resources out on fixing the old things. By establishing the new things, then they have to go back and pare down all those old things once again. So, we're always chasing the new initiative. Us folks trying to play catch-up with the less sexy kinds of items just don't have the time or people to put on it. So, we're behind in our operational and organizational plans; we're behind in our required operational capability. It's very difficult.

So, your question was, "What's been the thing you haven't done most?" That's the one I would put on the table. It's the one I talked to my successor most about, and it's written up in my end-of-tour report.



General Kem (center) presented a commemorative painting from the Engineer School to General Bruce C. Clarke (Retired), a prominent Engineer officer, on 10 March 1987. On the right is Lieutenant General Frederick J. Clarke (Retired), who served as Chief of Engineers from 1969-1973.

Q: That answers the question very well. Do you see the time when that is going to be solved, when the rest of the combined arms team is going to realize that unless they help in this area, that the things they need aren't going to be there?

A: Well, something's got to give. We can't continue building a bureaucracy of paper within the combat developments realm that requires more effort to maintain than the current staff. Do I see any great number of folks out there? No. I see us moving to Fort Leonard Wood, getting established, starting a staff up there, getting stability, and then two by two, four by four, working out the appropriate level of staffing and at the same time trying to cut down on lost effort that's in our process now. Our process meaning the TRADOC process whereby we send things to CAC, it's sent back and redone and sent back to CAC who approves it and sends it to TRADOC where it's sent back to be redone, and part of what CAC did has to be redone and part of what we did has to be redone and then it goes back up. TRADOC is

finally ready to send it to the Department of the Army who sends it back to TRADOC saying, “Not quite right,” and yet we’re staffed for doing it just one time.

Q: It’s just a bunch of paper shuffling after a while.

A: We’ve got to find a way to coalesce the people, decide what it should be, and write it for us, CAC, and TRADOC all at once with a little fine tuning later on.

Q: That’s where a lot of the wasted man-hours are then. That’s familiar; we go through that exercise. Do you see that the work you’ve done with the combined arms commanders is going to have a beneficial effect on this kind of thing?

A: A beneficial effect to the engineer force, or beneficial effect to staffing?

Q: To solve such a problem like this because really it does affect their mission.

A: No, I don’t think so because we all compete for school staffing.

Q: No, I was looking at it in terms of the maneuver commanders’ interests, trying to say that these are things that they need and the perception that can they bring any influence to bear as a result of the whole mission area work you’ve done?

A: Well, I think they’re very supportive. In open forums they stand up and say we need E-Force. General Tait at the Armor School does that. General Burba, the Infantry School commandant, has said that. He said, “The thing I worry about most is my combat engineer support.” When you come down to combat development staffing, that’s a level that’s below their ability to have a view. They probably figure it’s going to come out of their hide and not the rest. They have been supportive, and General Tait’s included us in his mission areas and wants to jointly write things up. We still have to take the lead, and we’ve got to write the things and take the things to them, but they’ll support it when we do that. Our staffing problem is that it’s new, innovative work over and above trying to keep the mill going and all the routine things too. So, that kind of creative work takes more resources. So, my problem has been to find a way to do that. We’ve done the work, but our combat developments people are working long hours: 12, 14, 16, 17 hours a day.

Q: Will the relocation provide any relief or solution by combination of what’s here with Fort Leonard Wood?

A: It’s hard to say. From the first standpoint, we see only 10 percent of our people are going to move, civilianwise. Now, we’re talking faces, of course. We should accrue the same spaces. So, we’re obviously going to lose some institutional knowledge and have some transition problems. Already people are leaving us. See, it’s a year away and already people are starting to go elsewhere because they don’t want to move and because of job security; they want to make the move when they can.

At the same time, in the ones we are hiring out at Fort Leonard Wood, we’re getting some very good people. I think the number is something like this: We wanted to hire 17 interns, we

looked at 35 applicants and we hired 17, only one of which had a bachelor's degree; the others were higher degrees than bachelor's degree. That says we're getting a pretty good cut of folks. So, we think the people who will come to us out there will probably be pretty talented, and we may well be able to keep them better in the long term because here in the Washington area, where jobs are plentiful, there's considerable mobility. Because we are a very junior agency under the Department of the Army, we fall down so far on the position classification scale that most people start with us and move up.

Q: I know what you mean. We've got the same problem. We have the same, exact situation for our field. Lots more higher grades at other places.

A: Very close by.

Q: Very close by. Right. They don't even have to move. So, that's the greatest challenge you see facing General Reno, this one in combat developments, or is there something else that you think is more critical, such as maintaining the contacts and the progress that you have made?

A: I think his greatest challenge—let me put it, his greatest opportunity—I believe, is E-Force. Now, whether that becomes a great challenge because it's difficult to push it through, or he's going to be able to build on this wealth of support out among the maneuver commanders as he goes up into the tough arena of the Army Staff, remains to be seen. That's the great opportunity.

Q: We were talking about how General Reno's going to face the challenges.

A: I think that's the opportunity. Why I use the word "opportunity" instead of "challenge" is that E-Force solves so very much. It's an organizational thing that puts the right organizational framework, plus command and control, and the right engineer combat systems to ensure the right place for employing the new systems to best support the maneuver commander. So, it's going to help force modernization. It helps doctrine writing because it sorts out all these ad hoc relationships we've had in the past, so you can write doctrine easier. You write it so it's more understandable to the maneuver guy. Instead of his going out there and not understanding, he will understand, so he'll use his engineers better. He gets a higher level engineer leader to advise him, so the engineer support gets better from that standpoint.

It puts engineers at the right place on the battlefield. Plus, it helps training in peacetime because it reduces the mission-essential task list, where the reserves have such a, speaking total force, such a hard time and the engineers do so many different things. Right now that Corps battalion's got to work from the covering force all the way to the Corps' rear boundary. Now we're going to let the E-Force divisional battalions work from the covering force to the brigade's rear boundary; and then the Corps engineer battalions will be having a simplified mission and will be doing line of communication work, berming, survivability work, reserve targets, and that sort of thing. Because of that, the reserve components, which have that kind of battalion mostly, will be able to focus their training and not have to do things for combined arms integration, which they rarely see and rarely have the opportunity

to train with, so therefore they don't do it very well when they're there. So, they'll be able to focus on a different role now that'll help their training so they'll be more effective.

So, the opportunity is that E-Force solves so many things. It solves getting people broader experience, more people with division experience, more engineers knowing what's going on, solves doctrine, solves training, solves communications, and it works now. We've shortened distances from 70 kilometers to 20 kilometers between units. It solves maintenance because we allow the DCSRM the resources to take care of the engineer battalions. It solves supply because we provide for barrier hauls that've been a problem all along. So, it solves so much—that's the great opportunity.

Now, Bill Reno's challenge is going to be to continue to do all of these various things as I have, balancing the books so you can open the schoolhouse every day with quality people teaching and still get the Department of Combat Development to keep the systems going. We're trying to get this there. So, basically, I borrowed time to create and drive on with E-Force, but because I didn't sell it to final acceptance decision in a reasonable time and it's still there, that's become a burden because other things are still back burned that deserve time. So, it's becoming more and more painful every day we don't get that concept approved. So, his challenge will be to get it as quickly as possible.

Q: So, he's going to really be the one that has to take it now and sell it to the Department of the Army, to senior staff?

A: That's right.

Q: How much experience has he had with it? Being in TRADOC, he must have had a little bit.

A: He's been briefed by us several times. We had him in here and he was briefed thoroughly on it before. He's had a lot of troop experience, not only engineer, but he was the G-3 of the 1st Infantry Division when it came to REFORGER '77, which is the experience that is most vivid in my mind because I was the Corps engineer in VII Corps and the 7th Engineer Brigade commander in that REFORGER exercise, and that's when we wrote up that experience considerably in the *Engineer* magazine. So, he was there at that time too. He will have just been to the NTC this weekend, where he'll get a feeling for what's wrong with engineer support to maneuver in that realistic battlefield laboratory. I think he's well prepared by experience and background and has an intuitive feel for what's right and what's wrong. It'll be a matter of becoming comfortable with all the eases and how it is and that sort of thing.

Q: You would very much have loved to have seen this in place before you left, wouldn't you?

A: I would've loved to have concept approval before I left. It would've been nice to have done that.

Let me say that out of REFORGER '77 we pushed to do two things—mechanize the Corps engineer battalions and, second, to get the brigade engineer established as a position. That was in 1977. As we sit here today in 1987, the next to last battalion in Europe is

mechanizing. That is, the sixth battalion of seven is mechanizing right now; five are done, one more to come. That's 10 years. The brigade engineer has been established now for four years or so. Things don't happen just like that, but you've got to persist and go after them.

E-Force is going to succeed someday. If not now, someday these lieutenant colonels and colonels who had to fight their maneuver battalions and brigades at the NTC and have found their engineer support lacking are going to approve an E-Force because the alternative is not to have any engineers. If they're not able to do the job, might as well not have them. So, we've given them, the maneuver commanders, the solution, and they understand that solution, and they'll buy it when they get up in the ranks to positions of influence.²

Q: Is the work you've done on this one of the reasons you've been selected to go to become the DCSENGR in Europe?

A: I don't think so. You'd have to ask somebody else why I got selected, but, if I were to guess, it's because—well, first of all, the DCSENGR job is primarily facilities construction, maintenance, housing, plus, like the Chief of Engineers, senior staff member at the headquarters for the combat engineer. So, E-Force is only a small part of that. I would say it's more likely the fact that I have had Europe experience and I was in the DCSENGR shop before as the Chief of the Installations and Construction Division, and then subsequently the assistant DCSENGR. I have had that experience, so I have a feel for the arena. That's probably why I was selected.

Q: Thinking that the work you've done there is critical because if you go to war, you are the most important engineer officer, aren't you, in Europe, by far?

A: Well, I don't know. I'm the one that's got the most assets, thinking about it. Certainly, if we go to war, we ought to have E-Force in place if we intend to maneuver.

Q: Do you think you'll be able to influence it from the Europe perspective?

A: I don't know; I'll have to find that out. General Otis already has signed up for it, so it's to the point right here where it's ready to be carried forward and won. If we get concept approval, I'll certainly have the stationing all figured out in Europe to get it done.

Q: All set to go.

A: We'll facilitate the force modernization aspects because one would have to assume Europe would be high up on the priority list for doing it because it's already high up on the equipment list and all the rest of the priorities.

Q: Do you look forward to your new position?

²*Editor's note:* When Lieutenant General Fred Franks, commanding general of the VII Corps in Germany, was alerted to move his Corps to Saudi Arabia for DESERT SHIELD/DESERT STORM, he organized his engineers into E-Force configurations and fought the battle that way. Then on 31 March 1991, Army Chief of Staff Vuono approved the Engineer Restructure Initiative, which was a renamed E-Force with some refinements—for example, the bridge company was deleted. The approval established an engineer brigade of three engineer battalions in each armored and mechanized division.

A: Well, I do. I hate to leave this place because it is so challenging and so much in the middle of everything that's going on and I have total engineer force proponent responsibilities for that. But, as I mentioned, I've been in Europe before, so I know Heidelberg and I know Headquarters, USAREUR. I think it's a very important job. I think a lot of people in the United States Army don't appreciate the MACOM level, the major Army command level. I know I didn't until I was assigned to Headquarters, USAREUR, in 1978–1979.

The fact is that the Army Staff takes care of policy and programming and fights for resources. When you're in units, you're trying to lead and care for troops and do your mission. MACOM headquarters, like USAREUR headquarters, Forces Command, and TRADOC headquarters, is that place that translates between the two. It's the place where they talk upward to the Department of the Army about what the needs are and what resources we need and talks downward to the units about what your needs are, here are your resources, here's how you use them. So, MACOM is the point of translation where you go up and down. Therefore, it's a very important place from the standpoint of educating officers on how the Army works. If you work just at the Department of the Army, you could figure out that the people down below ought to get it all done a lot more quickly than is happening.

If you just work in the units, you might get the feeling that nothing ever comes down from above. When you're at Headquarters, USAREUR, or Headquarters, Forces Command, you understand that what you get from above is limited, that you've got to make the good case of what you're getting from below, package it together so you can make a case for more. Then when you allocate down below, you've got to explain why it's only this much or why you guys have got to do better with your limited perspectives in trying to make the better case to go back up. So, it's really an up/down flow kind of place, a very important echelon of how the Army works in peacetime.

Q: Another challenge.

A: Another challenge.

Q: I hope to be able to come over and do some things with you.

A: I'd like to do that.

Q: Definitely going to follow up on that. I've already talked to my two battalion commanders, who are ready and willing at any time to come over and go back to the Bulge, so we'll get that put together.

A: Good.

Q: Do you have any other conclusions, comments that you'd like to make?

A: Yes, I would like to identify some of the engineer officers that carried the load with me on the E-Force initiative—writing the papers, fleshing out the concepts, doing the numbers, preparing and giving the briefings, and talking to their counterparts at the other schools and in units and commands throughout the Army. Colonel Ted Vander Els and Majors Rick

Capka and Hounng Soo worked initially on developing the many inputs that formed the concept. As they moved on to other positions, Colonel Fred Parker along with Lieutenant Colonels Russ Fuhrman and Tom Farewell and Major Al Carroll, picked up the baton to push the concept on throughout the Army. They all did yeoman work over long hours.



General Kem (center) received the Distinguished Service Medal from the Commander of the Training and Doctrine Command, General Maxwell Thurman (left), at the Change of Command Ceremony at the Engineer School on 6 July 1987. Ann Kem is on the right.

Deputy Chief of Staff, Engineer, USAREUR

Q: You went to Europe to become Deputy Chief of Staff, Engineer, U.S. Army Europe. That was July or August 1987, after you'd finished your tour as commandant at Belvoir. How did you get that job, how did the opportunity come up, and how was it connected with your time as commandant at the Engineer School?

A: Well, while I was still commandant at the Engineer School, General Vuono, commander of TRADOC, asked me what I wanted to do next. Well, I told him I wasn't sure. I wanted to stay involved where things were going on, either in the Pentagon; Headquarters, USACE; or

back to Europe. This conversation was taking place in probably the January–February time frame.

At the same time, he asked me to suggest my replacement, and I told him I thought my replacement should be Dan Schroeder, who had a very strong combat engineer background. However, at the time he was only a brigadier general, and I also indicated then that General Reno, serving as a major general, would be appropriate too. I knew that General Reno had very strong bonds with General Vuono and General Thurman, and that would be helpful in our progressing and bringing to decision the E–Force concept because I thought all the groundwork had been laid. What we needed was to really get in with those two decision makers and push it through. I sensed that, having pushed it so hard, that my own credibility with the two of them was a little bit suspect, even though we had a lot of other nonengineers, combat arms types, speaking for E–Force. Nevertheless, they were being rather difficult to push the concept through. So, I thought General Reno was in a perfect position to do that.

As it turned out, General Reno was appointed my successor, but he only stayed a year, and General Schroeder, having been promoted, then followed him. So, that was an early conversation. Then, I suppose shortly thereafter, I talked with General Heiberg, the Chief of Engineers, and told him essentially the same thing. He indicated that he thought nothing would be changing at Headquarters, USACE, and thought he’d like to see me go over to Europe to be the DCSENGR. So, I told him that sounded fine to me, and then I let things happen.

How it happened, after that, must have been conversations between General Heiberg and the General Officer Management Office, or General Heiberg and the Commander in Chief in Europe. I was nominated and accepted, and that was it.

Then in July I replaced Major General Scott Smith, who was the DCSENGR in Europe.

Q: The USAREUR commander then was General Otis?

A: Yes, Glenn Otis. General Fiala was the Chief of Staff at the time, of course also with an engineer background.

Q: A sort of broad question, but how had DCSENGR changed since you’d been there in ’78, ’79? DCSENGR itself, I guess the USAREUR staff agency?

A: Well, I guess things had changed. Now that I think about it, there were several things that had changed. First of all, as mentioned, I had been the Chief of Installations and Construction Division as a colonel, and that certainly was a two-colonel job. Subsequently, after a year or so, it had gone back, and so there now was an Installations Division and a Construction Division. That better divided responsibilities so you could have the right amount of attention to each.

Next, the construction mission had grown considerably in that the program was so much bigger. I left there in ’79 and, as I mentioned, participated back in the Army Staff prior to the start of the Reagan administration. The Reagan defense buildups had led to much-increased

European construction programs. So, the construction side of DCSENGR responsibilities had really increased.

The things that I had been working on that had taken up most of my time earlier in '78-'79 was the rapid reinforcement of NATO initiative, getting the three divisions of POMCUS in, building the warehouses, getting them sited. All the infrastructure work from before had basically now been completed. Thus, the separate section that I had set up to handle that initiative had now gone away.

We were back to a more fundamental split. Installations Division was still working on stationing and those kinds of responsibilities. Stationing had, from when I was there in '79, moved from DCSOPS over to the DCSENGR. We had been part of the initial action, but now it was fundamentally locked into DCSENGR. Installations Division, then, were the ones who carried the ownership of the stationing requirement. Consequently, as we found out a year later, when I was Chief of Staff, when it came to starting planning the drawdowns from Europe, and what stationing changes would happen, Installations Division became a very integral player in that.

In addition, though, another thing that had just been established when I arrived at DCSENGR in 1979 was ISAE, the Installation Support Activity, Europe. In 1986, before I arrived in 1987 as the DCSENGR, General Otis had streamlined the headquarters, and he had abolished ISAE. Remember, I had arrived just after certain implementation and execution responsibilities were sent to ISAE, leaving only programming and so forth in the headquarters. I arrived back as DCSENGR in 1987 to have certain things under my responsibility that weren't there in '79. Primary among that was the support of the facility engineers in Europe that had been at ISAE.

In '79 General Heiberg, as the DCSENGR, could look down to Charlie McNeill as the colonel commanding ISAE who would take care of installation facility engineer support. He would look to the divisions in the headquarters in Heidelberg to take care of the other responsibilities.

Now, in 1987, I had a facilities engineer support directly under me. It was quite tailored down. Quite a bit of what had been ISAE was eliminated and not duplicated and pushed to the field, such as the technical support teams that would go out from ISAE and assist installations. We no longer had those at USAREUR level. We were to operate at a much higher kind of level.

We had the environmental expertise and those kinds of things where we would take care of the programming and policy responsibilities and provide some limited assistance in those special areas. So, there had been some considerable shift back.

Another change had been the strengthening, over time, of the combat engineer function, even though the DCSOPS maintained that overall responsibility. The military engineer function had grown, and we had a colonel in charge, and there was more activity. This was representative of the knowledge over time that—and this is a key point for all to understand

when one speaks of USAREUR—that in wartime it is not a fighting organization but the theater Army organization. CINCUSAREUR moves up and commands the Central Army Group, a NATO command, to fight the war. USAREUR headquarters, under command of the Deputy Commander in Chief, becomes the theater Army in support of all U.S. activities in theater.

Consequently, the 412th Engineer Command out of Vicksburg, a reserve brigade with multiple battalions all over the United States under various groups, was the theater engineer command element. Because they were a reserve activity and our planning was an active activity, over time, we had a larger military engineer section in the headquarters. The 412th Engineer Command had a liaison element in Europe, with a person from their headquarters, and we then set up rather good working relationships with the commander of the FORSCOM units and their staffs, so that when they'd come over for various exercises—and they were over there a lot with the annual REFORGER exercises—we had a link.

Q: Well, prior to your getting there, the USAREUR staff had been undergoing, and maybe continued to undergo, quite a few changes. I guess one of the pressures was to reduce the size of the USAREUR staff, coming from Congress or from Washington.

A: Yes, probably I could get into that a little later.

Q: Okay.

A: I mean, if we take it chronologically.

Q: Okay.

A: I had a year as DCSENGR, and then a year as Chief of Staff.

Q: Okay.

A: When I arrived in '87 as the DCSENGR, replacing Scott Smith, General Otis had made the decisions to reduce the staff, and ISAE elimination was one aspect of that. Scott Smith had already implemented that. So, although the bumps hadn't all been smoothed out, basically the people were in place in the new locations, or had been done away with, or moved, and responsibilities were shifted.

So, I really picked up an organization that was a going organization, albeit in its changed style from the Otis changes. During that year there were not more changes. I sense that Scott Smith acted quickly and maybe was ahead of some of the other staff agencies who were still changing, but from my viewpoint, in my year as DCSENGR, there were not more changes.

However, then, in the summer of '88, General Otis retired and General Fiala retired. General Saint came over as the new Commander in Chief, and I became the Chief of Staff. During that year we had had changes due to a couple of different things, the driving part of that being General Saint and his approach on how things were to be done. One other aspect of it was something that happened back in the last months of General Otis's and General Fiala's reign.

A team headed by the Deputy Inspector General of the Department of Defense, Derek Vander Shaaf, came over on a worldwide trip with the goal of cutting out spaces in Europe.

General Fiala had chaired those sessions where we all briefed the Vander Shaaf team on our responsibilities. The results of that effort weren't enacted until later, when I was Chief of Staff. That became the second factor driving changes in organization in the year '88-'89.

Q: Okay. Well, we'll probably come back to that.

A: Be sure and ask me about Vander Shaaf's methods later.

Q: Well, I'd like to go into the various elements you talked about: facilities engineering, construction, some of those things. What were the budget trends affecting USAREUR, affecting the engineers while you were DCSENGR?

A: Well, budgets were still up. We were fairly well funded, but it was beginning to turn. I guess we were executing a pretty good budget, but the budgets we were programming and planning for were on the downturn. So, that's always difficult.

Then my second year was even more difficult. There was a lot of talk at this time about the Germans and the NATO allies carrying more of the load. Congress was filled with people crying that they weren't carrying their share of the burden. That wasn't new because I heard it back when I was in the Office of the DCSENGR before, again in the years on the Army Staff, and it seemed just like a popular refrain—even though multitudes of words and statistics and graphs were displayed that showed who was carrying what load with respect to what. Nevertheless, it was just popular to say the United States was paying too much.

Well, it may be popular to say that, but then energetic staffers and other groups would form to try to make those kinds of things happen. So, there was always that business.

The essence of all that was that things were starting to turn down. I came back for a meeting about the construction program that Major General Bob Dacey, the ACE, had chaired, with all commands present, when he tried to grapple with the program. The numbers escape me for a moment, but it was something like we had all started by putting in 1,800 projects, and the last bit of guidance we received was that only about 600 projects would make the cut, and now we were trying to stuff it all down into 200 projects. Every command was there. I mean, here we were, USAREUR, a third of the United States Army, but also individual installations: West Point, Alaska. I mean, all sizes and shapes of commands were there. Of course, Bob Dacey had a difficult problem: how's he going to patch all this together in a cohesive program?

It was really not a very satisfactory affair, from our standpoint. It just couldn't happen logically. We also had, then, all of the have-tos: people at the the Department of the Army headquarters stuffing in their projects: a new headquarters for AMC; finish Fort Drum—it was well under way, so we had to finish that. All of these kinds of things were top down “drivers” and, of course, they would push out multiple projects of the rest of us.

Well, Fort Drum was understandable because we were just about wrapped up there. Army strategy, really, was to do that. Then to add an AMC headquarters into a pot already filled with a TRADOC headquarters—that is two headquarters in the same program—didn't seem like that would ever fly in the Congress. I didn't think we, basically, had a method of coming up with a capital investment strategy in the Army.

So, on return to Europe, I prepared a briefing for General Otis, and later to General Vuono, and sent it back to General Heiberg and General Dacey, which proposed a capital investment approach instead of the usual—everybody throw your projects through your headquarters to the ACE, who then had to grapple with such a large number of projects. This also included a lot of up-front executive time spent on developing the forums and everything to have the support for a project, when most of the projects wouldn't have a chance of making the program, and then all the late entries from the higher headquarters would stuff things out. Then came the annual, “Gotta cut it back,” and we would get a budget number from the ACE's shop to cut back the military construction program.

A better approach, I thought, would be to come up with a concept strategy over what the banding might be, have that portrayed to the senior Army commanders at the Army commanders conferences, get a buy in up front about how much should be spent for headquarters, how much should be spent to finish Fort Drum, how much should be spent for Patriot facilities worldwide, how much should be spent to take care of troops, how much should be spent for the Chapel of the Year program, et cetera.

The problem had been that anytime something got stuffed in, the things that fell out were the things that took care of troops. So, we in Europe were hollering, “Top priority.” In Korea, they were hollering, “Top priority.” Then when the budget pinches came, you had to finish Drum, you had to have the headquarters, and the chaplain had to have his chapel, and the troop projects fell out.

So, the thought was get the commanders to agree on what were the bounds. They could agree that we had room for two headquarters, AMC and TRADOC, or only one this year and one next year. They could make those kinds of decisions. Then the commands could stuff things in and compete for, in terms of justification, the right to fill up the bands with certain types of projects. Then, when the cutting came, or when another great new idea came, somebody could then look at that band and say, “If it is a new headquarters, it ought to compete in the headquarters band, and let it compete there, not over the whole program, knocking off the troop projects.”

It seemed like a better way to run the process. So, I proposed the change, yet it's never come about.

Q: It's still pretty much a large hopper with hundreds of projects in it.

A: Well, I don't know. I've been away from it too long to know, but I'd say that. Then there is this new thing called moratoriums. You put the whole construction program in a moratorium,

with approvals only for certain exceptions. Well, that sort of kills any thought of having a logical, appropriate capital investment program.

Nevertheless, the fact is that industry and others set aside so much for capital investment for the future and so much for current operations as a certain basis of understanding, and the board of directors and chief executives are the ones who participate in establishing those levels and the trade-offs between them, as opposed to the way we do it.

For example, Op Tempo for training is established as a budget entity. Op Tempo means so many flying hours per year and so many tank hours per year. That's an operating kind of function—training—and very important in the Army, no doubt about it.

Then when the division commander comes in and says, "I can't achieve that training tempo unless I buy more tread for my tanks because I'm wearing them out," then that would get funded. That would then pressure against the other accounts, either capital investment or within the OMA budget, and would come against the facility counts.

So, what I found in Europe, then, was not only the problem of establishing the appropriate level of capital investment but, as I was managing the operating programs for facilities and housing in Europe, I would want some bucks to finish fixing up some housing, I would be competing against Op Tempo. Op Tempo was key to aggressive maneuver commanders who really wanted to get out and train. I say again, that was our business in USAREUR, that was important. That kept people off the streets; that kept us ready to go.

Op Tempo could eat stuff up. It was hard for commanders to compete against Op Tempo for bucks for the other things they were responsible for, and that is taking care of the troops and barracks and so forth.

Q: Well, you mentioned this a couple of times, and maybe you could talk a little about this—the whole quality of life issue at USAREUR. I note that USAREUR since the early '80s had been making a real push to improve barracks and family housing and to do things to make life better for soldiers over there, after a long period of neglect of facilities. Was that program continued? Had it achieved a lot of success? You've already indicated it looked like it might lose priority in the budget crunch.

A: No, it had. There was a great deal of change, a great deal of improvement from my time in '79 because the dollars had been there overall, with the rising defense budgets in the Reagan administration, and I think that money had been used wisely and across the board.

At the same time, if you wanted to measure it as General Otis and Scott Smith had laid out the programs, on how much was done and how much was remaining to be done, you found that there were still tanks being maintained in the mud, and still troops living in barracks that still had to be renovated to a better standard. So, a lot had been done; there remained lots to be done. I think it was obvious that the money was running out faster than it was going to be done.

So, Europe's case for arguing and justifying its funding needs was based on pretty good things. We had books and charts and pictures to show the good things that had been funded and the things that remained to be done. The budgets turned down, and it was starting to run out.

We'll talk about this later, but to make the point, this became an essential part of Butch Saint's approach when it came to drawing up plans for any potential drawdown. That was to keep the best facilities—I should say the best installations, not facilities—in terms of providing for the needs of the command.

When we were picking a brigade location where we were going to stay, the fact that it had better facilities, better housing, better support facilities, and better local training areas became a very key factor for that decision. We would select locations out of what was there and thus, then, offset the reduced funding we were to receive. The funding would have been for other places, now no longer going to be needed.

Q: Well, that seems to have required lots of good current data on the facilities, the state of facilities, the backlog of maintenance and repair, all those sorts of issues. So, DCSENGR kept a lot of data, I presume. I mean, that was one of its responsibilities, to keep up with the state of facilities.

A: Yes. We also had the regional DEHs at the Corps levels—the XXII Corps Command, VII Corps, V Corps—who had input data, too, so that we could put together all the necessary data and analysis.

Speaking of quality of life, that was really an emphasis point and something that we needed to take care of. The command took that to heart, and it was across the board. I'm really not only speaking of the facilities, but in all elements there was a real attempt to provide a community life that was American in its aspects of providing for people and for our soldiers and their families who were uprooted from their home, from their home country, and brought over to Europe. We wanted to not only open them to the culture and things German and other nationalities but also provide for them the quality of life essentially equal to what they left behind.

One of the other organizational changes when ISAE disappeared was that the responsibility for furnishings and appliances came to DCSENGR. Now ISAE, of course, had worked for DCSENGR so, in a sense, it was there to begin with.

Let me depart, just to finish one other organizational change that comes to mind too. Previously, the Real Estate Offices had been brought under ISAE, back in the '79 time frame. Now, under the Otis-Smith reorganization, they had come back to report to George Fuentes, the Chief of Real Estate in the Office of the DCSENGR.

One of the things I think we did pretty well was in appliance change out. Our folks were able to order and bring in appliances to a central location and then feed them to all the other

installations in Europe as there was the need. So, that process had been streamlined quite considerably.

Lieutenant General Tom Griffin, Chief of Staff of Allied Forces, Southern Europe, NATO's command in Naples, found out that the Navy, who had command responsibility in the Naples area, would not provide facilities, furniture, or appliances to U.S. service members, even those renting apartments. You have to understand that in Europe it's different from the United States. When somebody leaves an apartment, they take with them the sink and the appliances. You don't rent it with the sinks in. So, for a young soldier to have to buy a sink, where he's never going to have a use for it anywhere else, that was really a hardship. So, appliances, refrigerators, those kinds of things we took care of out of the central office in Giessen, as I mentioned.

Well, anyway, Tom Griffin called up and asked if we couldn't take care of the Army and Air Force and Navy people down there. We did some quick staff work on that and agreed that we could support it from Giessen, now all the way to Naples, Italy. Allied Forces, Southern Europe, had to budget it and get the Navy to cough up some of their bucks to take care of the costs, but we were not going to let soldiers be on their own with respect to appliances. So, we then, as a priority, took things out of the stream and pushed it south to take care of our people in Naples.

Q: I thought we might go back and talk a little bit more about the director of engineering and housing issues, the facilities engineering sorts of issues. Now, the DEHs reported to the community commanders and to the Corps commanders and the 21st Support Command, I guess. So, DCSENGR had sort of technical supervision and support in relation—

A: It really wasn't supervision. We had program responsibility and the support activities that went with that. With the program responsibility, of course, we had the bucks, and we would have to be smart enough to know how to allocate them and that sort of thing. Then we had some special support activities that we provided for people.

But, in fact, the DEH worked for the community commander. The community commander reported to the Corps commander. The DCSENGR reported to the Commander in Chief, and the Corps commander had his own DEH colonel, with his regional staff, which had more intimate support and more support activities, and assistance teams, and that sort of thing to work with.

Q: So, the ISAE assistance teams had gone to the Corps support command?

A: No, the Corps activities already had them too.

Q: Oh, they already had them too.

A: It was seen as a duplication, so General Otis had figured it was not needed at the USAREUR headquarters level and left them down at the Corps level. So, that responsibility, then, was no longer USAREUR's; it was the Corps'.

Q: You might talk about some of the DEH issues that may have come up to DCSENGR, that DCSENGR may have been involved in. I understand one of the issues was heating conversion, coal to oil and district heating. Was that an issue that you got involved in?

A: Oh, a little bit, but not too much because it was well under way during my years there. It was nearly completed. My predecessors had laid all the groundwork, done all the things, and the procedures were well in place. They weren't all converted, but it was all happening. I spent next to no time on it because it was really essentially done.

We had a person on the staff who tracked it. We'd get briefed and we'd follow up the review of contracts and that sort of thing. It was not an issue, which is the way you posed the question.

Q: Right. What sorts of DEH issues tended to come to your attention at the USAREUR level?

A: Well, staffing of people, getting the right kind of people down into the key positions. Again, the Corps and the communities were involved in that because they had the people.

A lot of our interactions had to do with determining next year's construction program, where we could go with things, and the Corps would come up and try to justify their budget dollars to us. So, that was a lot of our interaction, and I would suppose some would call those issues. Others might call it everyday life.

Q: Standard interaction.

A: I think I mentioned earlier, about my other USAREUR experience, that a major Army command is a very interesting and important place to be. USAREUR headquarters was a very dynamic place, and a lot of good folks toiled to do the right thing. A MACOM headquarters is really a swing point in the Army's structure, especially in terms of USAREUR. FORSCOM and TRADOC had it as well, in the terms I'm going to describe, but I think being in a forward Army deployed, the separation of the ocean and the time difference seemed to make it different.

At the MACOM headquarters, we were the ones who interacted with the field, and we put together the programs for the command based on their input. So, the people in muddy boots, the BDUs, the folks in the trenches, the battalions, divisions, and their communities would then see a cut in their programs and their initiatives and would come up to us. Then we had to look downward and analyze and pull out things and package it for the Commander in Chief so that, then, he could take it forward, or we would take it forward and be able to sell it to the Army Staff.

So, we at USAREUR headquarters were really the swing from the BDU Army to the green suit Army, representing the Pentagon. We had to translate programs from the field, package them so they made sense and could attract the dollar in the Pentagon. At the same time, once the dollar was allocated from the Pentagon, we had to take back from the green suit Army and translate it and remold it into the working programs to send back to the field, both the pluses and to allocate the shortage. Some people's aspirations were not going to be met. Yet,

we had to put them into the right kind of packages so the command could be positive and moving ahead, and that sort of thing.

So, we in USAREUR were really at the swing point. We had to speak with the field and understand the field. We had to speak with the Pentagon, Army Staff, and understand the Army Staff.

So, we flew back and forth across the ocean a lot, and we were on the phone a lot as we tried to mold those kinds of packages. So, that's the essence of the whole headquarters, not just DCSENGR.

Q: Of course, going back to something you said earlier, another factor in that is that not only did the whole Army have to come up with its budgetary priorities, but in things like the military construction bill that come out of Congress, Congress also put its own priority sometimes on military construction projects, which might have been different from the Army and USAREUR. So, you were forced to deal with that, as well.

A: The Department of Defense too, of course. The Department of the Army basically addressed those things. We would, from time to time, come back and go with Army Legislative Liaison or the ACE people to visit Hill staffers on various things, or we would entertain congressional groups when they would come over. Basically, the Department of the Army molded that. They had to repackage too, you see, to represent all commands.

Q: As you mentioned earlier, there was a lot of construction. The construction budget was still high, and the Europe Division of the Corps was executing much of that construction program.

A: Yes.

Q: Maybe you could talk about some of the big construction programs, some of the types of facilities that were going on that got priority. I'm thinking of things like—I know EUD executed it, and it was a program that was ongoing—the attic conversion program. I think it caused some controversy with the German government.

A: The controversy happened before I came on—

Q: Before you were there.

A: —because we didn't have any when I was there. Attic conversions were under way when I came aboard. The program started getting frozen out, moneywise, when I was there. It was a very good program because it provided more housing for our soldiers and took care of them better. I don't know who thought it up, but it was a very good program.

Q: What other programs were ongoing to improve housing? I think there was a program probably already ongoing to bring U.S. manufactured housing to Europe and assemble it over there.

A: It was already going on when I arrived. We had the first dedication while I was there. I believe it was at Mainz. It was controversial with the Germans. Some others were put up at Wildflecken.

We visited the first ones. They looked pretty good. I guess people said they wouldn't hold up. I'd like to go over and see them today and see what really happened. Again, although USAREUR remained interested in the execution parts of these programs, it had passed beyond our programming window, you see. The big thing that we did was prepare for the next year. Then once it was in execution, we felt comfortable that EUD was going to execute it. We would then allow EUD to do the construction, and they were tied in very closely down at the installation level. Maybe every now and then there was something where somebody would have to go out and work something between the two, but basically, that was execution, and EUD took care of that very nicely.

Q: Was it during the time that you were there that the Armed Forces Recreation Center [AFRC] at Garmisch, the hotel, was that the controversy?

A: That's a big story, the recreation center and the hotel. Before I left to go over there, I was asked to come visit the Assistant Secretary of the Army for Financial Management of the Army, then Michael Stone [later Secretary of the Army]. He talked to me about the importance of the recreation center and a new hotel at Garmisch, and that there was some consternation about USAREUR fighting the problem. The thought was that when I got over there, I certainly ought to make sure things worked out all right. There weren't a lot of facts with that. Then I met also with Judy Miller, who worked in in the Office of the Assistant Secretary of the Army for Manpower and Reserve Affairs in the nonappropriated side of the house and was working on this issue. So, I had some advanced inkling that it was a sensitive subject.

When I got there, I found out two things. It was very sensitive and controversial, primarily in the interactions between the headquarters, that is, Department of the Army and USAREUR. That it was well under way, the hotel aspects of it, in that General Bill Ray, EUD, had already held a design competition, been out working through the German authorities with different architect/engineer firms, with models and everything else, trying to select a design. The parameters of how many rooms, and this and that, were already established, some being specified back here by the Army's Community and Family Support Center, the nonappropriated fund command that was headed by Major General Bob Joyce, who, incidentally, had been with me as a fellow action officer in Colonels Division, Officer Personnel Directorate, years before.

It was quite controversial, and it was a real tug-of-war between General Joyce, who wanted to run the AFRC, and General Otis, who had the feeling of any good commander that the person that can best take care of his troops is the person there with them, and Garmisch and Berchtesgaden and all the AFRC had always worked under the USAREUR commander. The implications were that it was going to be a direct chain back to Joyce and the Under Secretary of the Army.

So, I found that to be quite controversial. There had been a lot of messages back and forth, and people would speak ill of General Otis back in the Army secretariat. General Otis was really standing by his guns that the right way to do it was the commander on the spot, who has responsibilities for all kinds of other things. There was some recognition that General Otis had this responsibility, but the AFRC also served the Air Force, and the U.S. Air Force, Europe, commander also had a role.

So, what I found out was that it was long past me, as DCSENGR. It was being handled right out of the Office of the Chief of Staff and the Commander in Chief, from the standpoint of the interaction on command relationships. Meanwhile, EUD was driving on, with coordination with Bob Joyce and others as to what should be put into the new facility.

Well, subsequently, the decision was made that AFRC would belong to Bob Joyce and the Community and Family Support Command here in Washington and would not report to USAREUR. So, as bitter a pill as that is to a commander who feels the obligation to take care of his soldiers, that had now been established. General Otis, in his later days of command, and Butch Saint, when he picked up command, honored that and let the Community and Family Support Command here take charge. There was really a lot of bad blood and hard feelings over that.

When he came in, General Saint said: “Enough of that. We don’t speak of that anymore. It belongs to another command. The other command will take charge. They’ll make the decisions, and if they ask us, we’ll contribute.”

Later on, when there were problems in budget and support problems, the kind that naturally arise with any function, the AFRC commander would come to USAREUR asking for things, and he was respectfully asked to contact the Community and Family Support Command in Alexandria. The point that General Otis had been arguing was, “Responsibility comes with command, and I’m willing to exercise that responsibility. I think I should exercise it.” General Saint came in with the saying: “If you want to take in the receipts, be expecting to pay the bills.”

So, my year as Chief of Staff for General Saint, we had very little interaction with AFRC, Europe. We watched and heard how things were going. We heard back from our folks about their happiness or unhappiness with how things were. And, during that particular year, we also told them they might want to reconsider the size of the planned hotel because sometime in the future we might not have as many people in Europe.

However, I left before the Community and Family Support Command took down the old hotel. Then they did not proceed to build the new hotel, and left what’s there today—a hole in the ground.

Q: I heard about that when I was over there. At one place, I think, they actually have parking under the ground level.

A: Early on, the concept had been to demolish the old hotel and then build underground parking, two or three stories, in the first phase. Then above that you would raise the hotel and the rest of it.

Q: Well, I know that at some point—perhaps along the same time—that I think it was General Otis who raised some questions, generalized questions about stovepipe organizations in Europe, and asked questions about EUD as well.

A: Yes, he did.

Q: Was that while you were there?

A: I think it really happened before. He wrote back to the Chief of Staff of the Army and said he felt all stovepipe organizations should work for him, that is EUD and all the rest. I believe General Heiberg had communicated back to him.

While I was there, it came up a couple of times in conversations. General Otis might have reminded us of his feelings. There was no ongoing activity that I had to address one way or the other. There was no ongoing action. So, I sensed that all the shots had been fired before I arrived.

Q: Did troop construction play much of a role in the construction program in Europe, the 18th Engineer Brigade, or the civilian labor center?

A: Yes. Those were two very good organizations, and they played some role in supporting installations. The 18th Engineer Brigade's primary role was getting involved in the construction of the major tank ranges at Grafenwöhr and at Wildflecken. The real training key for tank gunnery was being able to identify and engage targets at considerable range before their guns got in range.

Now that we've seen what's happened in the Gulf War, DESERT STORM—our tankers could see Soviet tank rounds hitting in front of ours, not reaching our tanks. Then we were able to pick them off at that range—our Abrams capability and the wisdom of having ranges to train that capability were apparent.

There was a range atop a major hill complex at Wildflecken, and the idea was to convert that into an even longer range, extend it out, build lanes so that tanks could move and shoot on the run and move forward to other positions. So, that was quite an important range. There was another range at Wildflecken, which was to be a Bradley range for firing its weapons, which caused considerable controversy.

The two ranges were held up for a considerable amount of time and occupied a lot of my time in both positions, DCSENGR and Chief of Staff. The first range I mentioned, the tank range, actually was broken free more quickly, and the 18th Engineer Brigade did that construction, committing multiple battalions there over a two-year period. It was a major project, and they did a very nice job.

To continue on, the civilian labor folks—they were a part of and worked under the 18th Brigade and were very skilled folks. When we had inside jobs, drywall and doing that sort of thing, they were the people who really had that capability and skills. Being under the 18th Brigade commander, they were moved here and there and really fixed things up.

Moving back to the ranges, one of the DCSENGR's responsibilities is to be the point of contact with the Germans in the accommodations process.

That word “accommodations” has to do with activities of the United States forces in Europe. It's not real estate; it's that they're accommodating us in particular kasernes. It also had to do with environmental activities, training activities off post, maneuver damage, and a whole bunch of things.

The DCSENGR, because a lot of that is focused on facilities, had been, prior to me, and continued to be, the point of contact on the USAREUR staff to go up and interact with the Bonn government in the Ministries of Defense and Finance. Defense would have some aspects of that, and Finance would have other aspects of that. Major players in that were Ministerialdirector Dr. Shaefgen in Defense and Ministerialdirector Eberhard Hubrich in Finance.



General Kem, Deputy Chief of Staff, Engineer (DCSENG), U.S. Army Europe (third from left), with Mr. Korte of the West German Ministry of Defense (second from left), Dr. Fischer, Ministry of Finance (second from right), and Jorge Fuentes, Chief of the Real Estate Division, DCSENGR (right). The picture was taken in Bonn in the spring of 1988.

Underneath those two, who were at the three-star minister level, were Ministerialdirigent Dr. Korte from Defense and Ministerialdirigent Dr. Klaus Fischer from Finance. These division chiefs at the brigadier level—they're all civilians, mind you—focused on our particular activities. These were major interactors with the DCSSENGR. I had known Dr. Korte from my previous tour. The senior minister in Finance, Hubrich, had been a prisoner of war during World War II in Florida and spoke perfect English and was very pleasant to deal with. Dr. Shaefgen was also a very nice person and easy to deal with. Dr. Korte was slippery as an eel. You just really had to watch, and not necessarily believe what he said. Dr. Fischer seemed initially to be pretty pleasant; later on he really became a very difficult actor.

To get back to my story—there had been an injunction. Local citizens had gone to court to stop construction of the Bradley range in the north part of the Wildflecken training area. That part of Wildflecken was in the state of Hesse. The southern part of Wildflecken was in the state of Bavaria. The major tank range that I spoke of, that we actually got to start more quickly, was in Bavaria, which is probably why we got to start it.

So, we had to work with different regional entities in working these problems. The Hessians were always more difficult to deal with and were difficult about noise in and around Frankfurt, and so our dealings in Hesse had been a lot more strained and difficult. Here we were in court on the Bradley range. We badly wanted to start both ranges because the modern training of our soldiers, that they were getting elsewhere, needed those kinds of live fire, shoot on-the-move ranges to be able to properly train.

This was a high-priority item to push, and so I had many meetings with Defense and Finance officials in Bonn, trying to get them to move forward, and it was always very difficult. We got into noise, which was the big factor in both ranges. We got into measuring decibels of noise, and groups of citizens and officials would go out, and their experts and our experts would sit there and try to measure decibels. From our view, the decibel levels fell, once you measured them accurately out where the people were listening to them—fell below the standard the Germans were setting. Nevertheless, the people weren't satisfied with that and kept up the attack, trying to get us to close down and not build the range, period. So, we had many interesting times with that, trying to articulate the reasons.

The Germans had outlawed lawnmower use on Sunday in their towns. You couldn't cut your grass on Sunday because the noise would bother your neighbors. The noise we were talking about from our 20-millimeter Bradley weapons two miles away from the town was considerably less than that a neighbor would hear from a lawnmower.

When I left, that Bradley range project had never been started. I don't know if it has today, frankly.

Q: Well, on the German side, you had to deal with their federal system, I guess, the federal agencies, but then the state, and then even the localities. There might be a different perception from what level you were talking about on the German side.

A: Well, the ones I had just mentioned were at the federal level.

Q: The federal level. The lawsuits may have been brought by local people, though.

A: Well, they were, but it was the federal level that we dealt with in the accommodations process. The people who went to court to defend us were really the Defense Ministry. So, Dr. Korte would go to their Supreme Court to make the case for us because it was really the German government who'd invited us over there who were responsible for "accommodating" us. The German government would then say, "Yes, U.S. forces are here for our purpose: NATO, defend freedom. We want them here, and therefore we have to accommodate certain things. These are the rules we're putting out and have agreed to, and thereby we, the German nation, need to uphold those rules."

The next interesting thing that took place a bit while I was engineer, and carried over when I became Chief of Staff, was the caper on bringing the AH-64 Apache helicopters into Europe. The big confrontation took place in Wiesbaden, and it was a similar saga, involving all the same players. The mayor objected to our having aircraft there, and the people did not want the Apache helicopters to come. Apaches had come over for REFORGER in the fall of '87 with General Saint when he commanded III Corps and had been very successful in the FTX up in the north.

So, we wanted to accelerate their arrival down in the south because they were just a tremendous tank killer and such a great addition to our capabilities in NATO. We had a stationing plan that we worked out. We were to get, I remember, ten battalions and place them one in each division and three in each Corps.

The first place we desired to put them was in Wiesbaden, for V Corps, opposite the Fulda Gap. We already had the airfield there in Wiesbaden. We'd taken that over from the Air Force, and it had a lot of hardstands and aprons.

Now, the other thing that had happened in this time frame, technologywise and trainingwise, was the advent of the helicopter flight trainer. The Army has rather sophisticated trainers for Army aviators to use. So, we had wanted to build a flight simulator at Wiesbaden. We had one in Hanau, and we wanted to build one at Wiesbaden because that was going to be a major location for Apache helicopters.

This was being fought by the locals, and we were trying to get that construction under way. We were to the point where EUD was trying to get on with the ability to construct. So, again, I met several times with Dr. Korte and tried to get them to go on, and we were basically enjoined from proceeding. There were something like eighteen trees, mostly scrub ash, that had to come down, and people were using that as a reason not to do the project. These were the same people who didn't want any more helicopters there. They thought if the simulator arrived, then we'd have a reason to put more aircraft there.

The complexity of it was all the interaction with the state, federal, and locals. The Länder president—state president—was reluctant to commit. He waited on the fence. The mayor was

quite against it. The federal government was quite for us at the speaking level, but down at the Korte operational level, he would always seem to bring up a new obstacle—“Don’t worry; as soon as I solve this one, we can move.” Then when we’d solve that one, then there’d be another new thing that he had to take care of.

As for the eighteen trees, we offered to plant five for one. They were all scrub, a couple or three inches in diameter, maybe a few larger than that. We offered to plant wherever would make the best screen for the populace, and that wasn’t satisfactory. So, it just never got resolved.

Meanwhile, then, we wanted the Apache helicopters to come over, and they arrived and were coming down the Rhine by barge. We brought them into Mannheim, where we could have the aviation maintenance folks there assemble them, and then they were to fly to Wiesbaden.

However, we only got two to Wiesbaden before there was an injunction that enjoined us from moving more. This prompted several trips by me to Bonn, trying to elicit the assistance of our ambassador and trying to work with the ministries to try to get permission so that we could move the rest of our Apaches into Wiesbaden.

By now, I had moved up to be Chief of Staff and General Saint had taken over as the Commander in Chief. General [George A.] Joulwan, currently SOUTHCOM commander, was the V Corps commander. He had been the DCSOPS, and General Joulwan and I had come back to visit our Army Staff and the Joint staff, and over to the Department of State, trying to obtain high-level, high-ground kind of approaches to get the governments to allow us to get all of these modernizations completed. We were trying to break the logjam, get them out of the low staff level obstacles and get them up to the major political level for resolution.

So, by this time I’d become Chief of Staff; General Joulwan was now V Corps commander and was working with the Hesse state president. Because I’d been so involved as DCSENGR, I continued as the prime point of contact on the Wiesbaden issue, but we really now had the whole USAREUR staff involved. Jerry Moeller, a civilian who worked in the Host Nation Support Directorate of the headquarters, was an exceptionally talented person with political savvy and understanding. He’d been there for years. We had a lot of meetings trying to figure out ways to make it happen.

General Joulwan would work on the Länder. We would think we’d have an opening, then it would go away. We were enjoined by a court order, and this was a local, Wiesbaden-level court. So when we brought up the complexity of federal, state, and local, here we had a local court had kept us away; and the state government was abiding by that.

I would keep saying to Korte and Shaefgen, “Well, tell us we can go. We’ll go.” It was really disruptive. By this time, we’d finished putting the helicopters together and flown them to Hanau so they’d be up and in an operational element near maintenance facilities. Hanau had a nice runway at Fliegerhorst. We were going to put Apaches there one day, and at least they

were up in the V Corps area. Expanding Fliegerhorst was also being opposed by the Germans in that particular area.

We put them up there, and finally, at one point in time, it got so bad that we flew some other type of helicopters out of Wiesbaden and flew the AH-64 Apaches in—a one-for-one swap. General Saint made that decision so that we at least had the command working together because, as he found out, they weren't coming up to operational readiness, not being able to train together. Sitting there in Hanau and then flying the pilots from where they lived in Wiesbaden over to their aircraft in Hanau so they could go train just really wasn't working right. So, to maintain operational readiness, he made that swap, and we then had them there at Wiesbaden.

After I left, that issue continued. It was only with the advent of the drawdown and DESERT STORM—when they flew off to fight in the desert showing their worth and effectiveness—and with the concurrent disappearance of the Warsaw Pact that I suppose that issue and our restationing attempts were solved, by going away. I don't know. I'll have to ask General Saint one day.

Q: Did the communities find out that this was going on and protest that the Apaches were being brought in on a one-for-one swap, or did you not hear any outcry?

A: Well, they found out about it after the fact.

Q: After?

A: There were some protestations about it, about it not being straightforward, but our answer was, "We were limited." The argument was, "We shouldn't have any more helicopters at Wiesbaden."

Q: Right.

A: We don't. Operational need was that we needed all of the same kind together.

Q: Right.

A: So, there was a small furor that blew away.

Q: Well, what you've been talking about are some examples of the environmental issues that, I take it, were becoming more and more troublesome all over Germany.

A: Well, they were and they weren't. I mean, USAREUR had a rather aggressive environmental program. We were not environmentally insensitive. We really had put together a lot of things, such as the heating plant business, that not only saved energy but also reduced emissions. I was invited to speak to a symposium of German scientists and environmentalists in Mannheim. I gave about an hour talk, and I had chart after chart telling what we were doing to stop erosion in the training areas and to keep sod and ground cover. Also, the fact that we had converted our heating plants, and I had a chart that showed the great reduction in nitrous

and sulfurous oxides released into the air, based on our conversion of heating plants and based on our conversion of our vehicles to be more environmentally correct.

Oil spills. I mean, we aggressively worked against that. We had oil separators in our motor pools. We really were doing a lot of things and were very sensitive to the environment.

So, yes, there were those who said the reason for not having Apaches was environmental, and there were probably some other motivations tied in with that as well.

Q: Yes. There was the suspicion that some of the opponents didn't want the U.S. military, period, and for whatever reason that was being cited and it would be used.

A: There was some of that, yes. We were, in some areas, a very visible kind of thing, and this was a technique by which we could be opposed.

Q: The German environmental movement, I heard several people say, had developed more slowly and a little behind the U.S. environmental movement.

A: I believe so.

Q: Where they were in the '80s was perhaps where we had been ten years before.

A: Or fifteen. I think that, in the United States, we have gone away from the just cheerleading about the environment and complaining about it to the point of having rational programs, and environmentalists are seeing that rational approaches were being made.

In Germany, they were still in this rant-and-rave mode that nobody can be right. We really didn't get recognition for the kinds of things we were doing. There was a lot of selective listening.

Q: Well, before you went, USAREUR had already started the program of treating wastewater from, say, tank washing facilities and things like that.

A: Right.

Q: To lessen runoff of pollutants and oil and along those lines.

A: Right. Exactly. All those programs were under way.

Q: So, you had a pretty proactive program. You mentioned trees, and in a small country like that—I mean it may seem so strange to us since we have so many—but they're preoccupied with down to the last tree. In some cases to the point where the *forestmeisters* and citizens could really cause problems for projects.

A: Well, they have a lot of trees too. It's a pretty country. They've got a little more temperate, cooler climate than here, so some of them flourish even better. At that time, I think I heard it for the first time while I was there, there was evidence that the Black Forest was suffering from acid rain. It wasn't yet a big clamor, like I'd already experienced several years before

when I was in the Ohio River Division. We're talking about five years before, in the Ohio River basin, where it was very obvious with the people in the Northeast clamoring about the soft-coal-burning plants along the Ohio River that were causing acid rain. So, it was only starting in Germany, I think, during this time frame. From my reading, that's persisted since.

Q: Were there any other major projects held up by, if not environmental objections, other problems with the German government? I've read a little bit about the Rheinberg-Reichel project, and I'm not sure whether that was—was that a controversial issue while you were there?

A: Yes, Rheinberg was a controversy. I'm pretty vague about it, as a matter of fact. I guess time obliterates.

It started back while I was there in the '79 time frame. I remember Charlie McNeill of ISAE going out after the acquisition of the former rug factory because it was an existing building with all the utilities. Part of General Groves' overall thought about stationing in Europe was that if we were going to have people—that is, our operational reserves—potentially fight up in the NORTHAG [Northern Army Group] area, then we ought to have a reinforcing capability for the people who came over to build up the U.S. force. They ought to have a place where there could be a headquarters, and storage of certain things, and be a central place to do that in the NORTHAG area.

So, first was a lot of dialogue and issues about whether it should be NATO funded or not, and we had to go through the whole NATO process. As part of the NATO infrastructure program, the German AFCENT commander had to approve and the German government had to support the projects. Then there were rules in NATO about some part of it could be NATO funded, but if it was just for U.S. facilities, then it's not supposed to be. So, they went some years on that issue.

By the time I arrived in 1987, that was fairly well sorted out, but now there was an issue about whether we could reroute the highway or not, and how much would go where. I went up to visit the area and walked through the huge facility. EUD wanted to get on with the design, and what we put where was sort of conceptually laid out, but it was contingent upon our being able to solve the acquisition of the property and to relocate what was a major thoroughfare right in front of the factory.

The Germans wanted us to put the parking on the far side of the highway and then have our people walk across this thoroughfare to get to their work site. We didn't want that, thinking about terrorist activities. First of all, normal security for any kind of a U.S. installation and storage facility, where you have few people, lots of facilities, is sensitive. Second, then, the fact that terrorists were something to seriously consider in this time frame. Then finally, just the plain fact of having our people subject to having to cross a major thoroughfare. I'm talking, you know, about BMWs and Mercedes roaring by.

So, what we wanted to do was move the highway over several hundred feet. That would allow us to fence on this side, park our people inside the fence, and then they could go in and

out. We would also then have a standoff separation of the building from the fence, terroristwise. We'd also have a separation of our own parking lot from the rest. People wouldn't have to cross it.

Acquisition by the German government of the properties and solving those issues just went awfully slowly. Again, remember Dr. Korte, who found a new obstacle every time he solved the old one. So, that acquisition was going torturously slow.

Later, then, when General Saint came in and the appearance of who should go there was changed, we decided not to proceed further. We dropped it.

Q: You've been involved in the NATO infrastructure program. That was a slow way to get things built, for the most part, wasn't it? Very deliberative. It took a long time. One in which DCSENGR played a pretty key role, I think, in terms of programming.

A: Yes. The DCSENGR was the point of contact with the infrastructure program. I should mention that we did have a higher U.S. headquarters there, and that was EUCOM, located at Stuttgart, Patch Barracks. Many things were service oriented, so we went directly to the Army Staff for things that were service oriented.

Nevertheless, for our Army construction programs, we went through the EUCOM engineer and up to General Galvin. As the CINCUSAREUR, he would add his comments, and part of his annual statement to the Congress would include those aspects of it.

In the NATO infrastructure program, EUCOM had an even more direct role because they were the theater command who determined the theater position on issues. So, EUCOM would take the Navy, Europe; the Air Force, Europe; and the Army, Europe, positions and put them all together. So, our channel on NATO infrastructure projects was through EUCOM.

It was also through AFCENT because the NATO military tactical commander had to comment. Then it went to Brussels and went through the NATO potpourri of actions carried on by the U.S. mission representative.

So, the DCSENGR put together the USAREUR infrastructure program. We had a NATO Infrastructure Branch, and Fred Kishaba was still there, just like he'd been in '79 when he'd worked for me.

It did take a long time because you had to get all those approvals.

Q: I don't have a good sense of this. The Vilseck restationing, was that happening?

A: The Vilseck restationing was ongoing when I arrived and continued. During our annual construction program, each year while I was there, we had some more facilities to add to Vilseck. It had started. It was nice for me to see, having, as I mentioned earlier, been involved in 1978 and '79 in DCSENGR with the master restationing plan in Europe and having come back to the ACE's office and interacted with the Department of Defense,

General Groves, and congressional staffs. The fact that we had, at that time, proposed Vilseck be the first installation converted. It became, in reality, the only real installation converted.

So, Vilseck construction was well under way. They were building housing areas and that sort of thing at the time. Today, as we're drawing down in Europe, one of the brigade places remaining is Vilseck.

Q: To turn, for a minute, to another issue, the time when you were there is about the time, or perhaps a little after the time, when the dollar started to decline—pretty rapidly, I think. Currency fluctuations must have been a pretty major concern when dealing with a budgetary situation.

A: Yes, it was. It was certainly not down as far as it is now, but it was down from its high side, which had gotten up to 3.2 to the dollar earlier, when I'd been over visiting from Belvoir. It hovered between about 1.9 and 1.65, I think, while I was there.

We would always have to be worrying about that at the end of the budget year, having to get a fix from the defense pot to balance things up. So, it always became a factor.

Another one of the big changes in quality of life by this time was that they added an adjustable cost of living allowance and the housing allowance, which fluctuated with the dollar much more rapidly.

Back in my earlier time, you'd have to go so long, and then they'd reset it. Now, the allowance fluctuated as the dollar fluctuated. So, people who were renting on the economy were not hurt so bad in that they had adjustments that could only lag a month, not six months or a year.

Q: You've mentioned the exercises, particularly the REFORGER exercises that were ongoing. Would you like to talk some more about those, and the role of DCSENGR? Was it when you were at DCSENGR, or perhaps later, that there was an attempt, at least, to do a try at E-Force during one of those exercises?

A: Well, the saga of E-Force certainly continued, and I remained very interested in trying to make it all happen. I found that the people in Europe, General Otis, the Corps commanders—General Woodmansee in V Corps, General Ron Watts in VII Corps—were all aggressively for E-Force.

Nevertheless, we still couldn't seem to get it out of TRADOC, as I mentioned. General Thurman had taken over TRADOC, and General Reno's approach was to package it all up, you know, a complete study, and spend some time on it.

Colonel Russ Fuhrman—now a brigadier general—was in Combat Developments and was carrying the ball on E-Force. General Reno talked about it when he came over for the annual engineer conference. E-Force and the REFORGER FTXs were linked considerably during

that time, and throughout the period I retained my aggressive activity to try to make E-Force happen, networking throughout the Army.

At the same time, we were still fighting, I should also say, actions from there to support the M9 ACE. Let me just digress and address the ACE first. There's nothing like messages from the field, especially USAREUR, one-third of the Army, and the fighting part, to support things. I had a call one day from Lieutenant General Max Noah that the ACE was in trouble again and maybe I'd better get some message back. I was supposed to play racquetball at Campbell Barracks at 5:00, and I knew General Otis daily played handball next door. So, I ran over at 4:50 and caught him before he went onto the handball court, and said, "Sir, we need to get a message back supporting the ACE, get the Army leadership, the secretariat, behind it because it's on the cutting block again."

He said, "Fine, but I'm leaving here at about 6:15 and flying off. I'll be gone two days. So, if you can write the message, I'll sign it."

So, I gave up my game of racquetball and ran back to my building, which was only 300 or 400 feet away, and we dashed out a message and got it over to his quarters about 6:10 so he could sign it and send it on back.

In the meantime, I called up to try to get General Galvin to come on-line too. Brigadier General Paul Cerjan was his executive officer at the time, and when I called up to SHAPE, I found out that General Galvin was back in the Pentagon. So, I called back to the Pentagon and got Paul Cerjan on the line and told him what the problem was. He said, "We'll get a message from General Galvin if you can just get us a copy of General Otis's message."

So, we put General Galvin as another addressee on the message and got a copy to him so that he could add his comments to it. So, both went into the Army Staff to support the M9 ACE. I guess I just wish I had a nickel for every time that had to happen in my years at Belvoir and USAREUR, that General Noah and I hooked up communications and tried to make the right thing happen.

Back to E-Force. General Saint was coming over with his III Corps to participate in REFORGER in the fall of '87 up in the NORTHAG area, and I had talked with him before. We'd briefed him on E-Force. He was a solid supporter and really wanted to make it happen.

So, when III Corps came over, they brought the 2d Armored and the 1st Cavalry Divisions. They were supported by Corps engineer battalions from V Corps and VII Corps. We worked hard to get them both to work in the E-Force configuration.

The commander of the 17th Engineer Battalion, with the 2d Armored Division, was Jack O'Neil, and he made it happen in that division. The Corps engineer battalion supporting them, the 317th, supported one maneuver brigade. They were a two-brigade division then, and Jack O'Neil had his 17th Engineer Battalion with the other brigade. So, Jack O'Neil—although he was still the division engineer—put himself down at the brigade headquarters.

It worked magnificently, and the division leadership really extolled the virtues of E-Force. In their after-action reports, in their comments, the brigade commanders said, "Gosh, every time I wanted an engineer, there he was. I always had my lieutenant colonel in the headquarters. I was really getting the kind of support I needed."

So, Jack O'Neil and the 317th commander really made it happen, and I give the credit to Jack O'Neil, who worked with the division staff and talked them into doing it.

On the other hand, the 1st Cav didn't. I flew up to visit them one day, and it was a night and day difference from the 2d Armored. You'd fly out to the brigade headquarters in the 2d Armored and Jack O'Neil, tied in, was right there in the brigade. You'd go out to the bridge site, and there's the 2d Armored assistant division commander talking about how great things are and how much he really liked this new E-Force concept. I mean, everybody knew about it.

Then we visited the 8th Engineer Battalion commander, 1st Cav Division, and he wasn't even in the fight. He was far behind either of the brigades and so was his supporting Corps engineer battalion, the 82d. Neither one of them was tied in with the rest of the combined arms team. I mean, they were not a factor in the battle.

The 1st Cav had not gone to E-Force. I don't know whether it was that General John Yeosock, the division commander, thought it was unnecessary, or whether that engineer battalion commander had not carried the mantle, as had to happen for success. I mean, it took the division engineer to carry it in and say, "This is how we ought to do it." My thought was in the 8th, he was not a factor in the division.

Out of that experience, General Saint was even more convinced. With the 2d Armored really positive about E-Force, the words went back, and so we had positive support out of REFORGER '87.

We then began preparing for REFORGER in the fall of '88. By that time General Saint had arrived as the Commander in Chief and I was Chief of Staff. So, once again we were working to sell the Army leadership that E-Force was the way to go.

I had gone back to the engineer commanders conference in May at Belvoir, that General Reno hosted. General Thurman talked there and said, "What we're going to do with E-Force is have it go through the 7th Light Infantry Division validation process."

What had happened there was that, before they had established the 7th, they had developed the concept of the light infantry division. They then organized the division and took it to the National Training Center and tested their concept and then modified the organization according to what they'd found.

So, General Thurman said, "That's what we're going to have to do to have E-Force." Well, that was a big obstacle. It was an opportunity, but it was an obstacle. I mean, it was an opportunity because it sounded like now we had a path to succeed. Having been stymied here

and there because nobody really was sure, now at least there was established a way of moving it.

The obstacle part, though, was it's one thing when the Chief of Staff of the Army—Wickham, in the case of the 7th Light Infantry Division—puts everything behind it and says, “We’re going to reorganize.” Then all systems convert, and they document, and they send people in there, personnel systems, logistics systems. All the tapes that you requisition against, all the codes, all that took place so they could have a light division. That didn’t take place for E–Force. We couldn’t do that. We’re talking about an organization that didn’t really exist.

So, we went about to do that. Meantime, there were some other structural changes in Europe, starting the drawdown of the Pershing missiles. General Saint approved keeping certain spaces allocations from that to take care of the E–Force numbers. By this time, as an outgrowth of REFORGER ’77, the Corps engineer battalions had been mechanized. We had also moved from staffing level two to staffing level one, and so they were more robust at the Corps battalions and they could better interchange with divisional battalions.

So, we took it as an opportunity and said, “Well, we’re going to drive on, and for future REFORGERS, engineers are going to be in E–Force configuration.”

Meanwhile, then, General Reno left and General Schroeder came in as commandant of the Engineer School. It was too late to do the test during the REFORGER in the fall of ’88. General Woodmansee commanded the V Corps. Jay Braden commanded the 130th Brigade in V Corps. Colonel Clair Gill arrived to command 7th Engineer Brigade in VII Corps commanded by Lieutenant General Ron Watts.

Once again, VII Corps ad hocked it as best they could and put battalions together. We didn’t have the colonels to be the division brigade commander, but VII Corps still worked it and came up with solid lessons learned that E–Force was the kind of organization needed.

Up in the 130th Brigade they were not quite so precise and results weren’t so clear.

Meanwhile, then, we continued to push. General Saint, with a message to General Vuono, indicated he wanted to try to get E–Force in and said, “We want to organize and implement the E–Force organization so we can do General Thurman’s 7th Light Infantry Division test of the concept during REFORGER ’89.”

Now, to do that we needed to reorganize about January the year before so we could get people to put forward, and we could requisition a colonel and work in the personnel and logistics systems. We took to heart what General Thurman had said. An important part of that is documentation. You’ve got to get your computer tapes with all the right numbers and this and that, the equipment and people all in it, and bring it back.

Well, we reached an impasse in DCSOPS, and General [Wilson A.] Shoffner was an obstacle this time. We worked toward getting approval to document, and we were about to miss the window. We had to have a documented organization to requisition. “What’s wrong?” we

asked. “We’ve done everything General Thurman, the TRADOC commander, said we needed to do.” We had all the spaces. We had most of the right grades.

We were going to have more operator types, but if we got it done in January, we could be ready for the REFORGER FTX, which was to take place a year later. So, we had time to do it, if we could get it going.

Time moved on. February went by. March went by. They said, well, they would allow us to stuff in the documentation off-line once we got the rest of the approvals. General Saint was really pushing and trying, and we were just getting stiff-armed, I think, by the commander of TRADOC, the Chief of Staff, and the DCSOPS in the form of General Shoffner.

Then General Schroeder, trying to break the dam, had a briefing for General Thurman to try to push the E-Force organization for his approval so he could take it up to General Vuono so he could give the final approval, so we could get the documentation and proceed with the 7th Light Infantry Division type test.

General Thurman just blew the briefing apart. He evidently forgot his commitment and tasking at the engineer commanders conference that we would have to go through the 7th Light Infantry Division process. He said, “It’s not ready. You haven’t done your evaluation. You haven’t done your analysis.” This seemed to me just to be a way of throwing E-Force out and stiff-arming us—USAREUR and engineers—because we were proceeding along the path he had directed and because we had done those analysis things earlier that he said needed to be done.

This test during REFORGER was the next essential step. We had a major commander, General Saint in Europe, who was asking for it. General RisCassi, the Vice Chief, was supportive in facilitating the process.

So, it came down to a great culminating point, with messages from Saint and Thurman, back channels back and forth, and General Vuono decided that it would not be documented at that time and we would not go forward with it. Then General Saint said, “Well, I’m going to test it on my own, ad hoc.” General Vuono, the Chief of Staff, said, “Fine, go ahead. TRADOC will support your evaluation.”

With that, our plans to fully do it with a documented organization went away, but we proceeded to do it on our own. Within the Corps—and this was to be a V Corps versus VII Corps REFORGER FTX—plans were made to reorganize into E-Force configurations. Commanders were designated and S-3s for the engineer brigade headquarters and all of that. The headquarters elements were designated, and which battalions were going to support which brigades were designated, and REFORGER complements were tied in.

We asked the Engineer School to send over evaluators, and TRADOC sent over evaluators. General Schroeder, by this time, had people come in to do various analyses, and he had then recast E-Force into the terms of the Engineer Restructure Initiative. Now, see, we’re talking about a January ’90 REFORGER. By this time, I was back in Washington as Deputy Chief of

Engineers. Bill Ray was the DCSENGR. Now, I was networking from the Deputy Chief of Engineer's office to Dan Schroeder at Leonard Wood, to Bill Ray in Heidelberg, and Russ Fuhrman, who was now the 130th Brigade commander, having been the lieutenant colonel action guy at the Engineer School with me, trying to make it all work out.

General John Foss was now commanding general at TRADOC, and General Schroeder presented to him the Engineer Restructure Initiative, which had certain modifications toward the Army of the future concept. Certain of those modifications couldn't come about until the Army switched. For instance, under General Foss's concept, you wouldn't have mechanics in battalions. They'd be back in the division support command structure. So, the engineer battalions, likewise, shouldn't have mechanics.

Well, that's fine, to have that as the objective organization, but the tank battalions and infantry battalions at this time still had mechanics, and support command had not been restructured to have them, so therefore, the restructured engineer battalion needs to keep them.

So, when you lined it all up, the refinements and the put backs, the Engineer Restructure Initiative was very similar to E-Force. The bridge company was taken out of the division and put at Corps, which is something that we had thought of originally in E-Force but had kept it in the organization as a fallback, give up position if necessary to achieve spaces.

So, essentially, by the time you put back in today's needs—because the Army was that way today—we had what we needed: that is, an engineer battalion in each maneuver brigade and a brigade commander with a slimmed down headquarters at division.

Then that organization was tested in January during the REFORGER FTX. Colonel Joe Oder went over to be the chief evaluator out of the ACE's shop. The evaluations were all very positive. We had a bunch of new maneuver commanders, and it was, again, well received. Once again, it was shown to the maneuver elements that E-Force was the way the engineers needed to be as part of the heavy combined arms team.

The VII Corps commander at that time was Lieutenant General Fred Franks. Later, when DESERT SHIELD/DESERT STORM came about, General Franks called back to General Hatch and said, "I want to go with my engineers in an E-Force format. Give me some colonels." The system then provided the colonels to head the engineer brigades, and the E-Force concept was proven on DESERT STORM's very aggressive and lethal battlefield—and is being implemented today throughout the Army.

I guess the only other anecdote I would relate was that in the late spring of 1989 there was a senior leaders training conference at Grafenwöhr that General Vuono, General Thurman, General [Leonard P., III] Wishart, and others came to. It was hosted by General Saint and presided over by General Vuono. At lunch the last day, we were at the table with General Vuono on one side and General Thurman on the other. General Vuono looked over to me and said, "Well, Sam, I haven't heard much about E-Force. How's it coming?"

I responded, “Well, I don’t know. It’s not in my hands these days. I know that all the division and Corps commanders around here say it’s the only way to go.”

With that, General Thurman made a visible wince and commented that everyone at the conference had come up to tell him about the need for E-Force.

Q: Where did the major reservations lie about E-Force? Was it manpower?

A: Oh, it’s hard for me to say. I don’t know. It was always my frustration. I briefed General Vuono on it initially in May of ’85, just as he was leaving the Combined Arms Center, Fort Leavenworth, to go be the Army DCSOPS.

It was the May before he was supposed to leave in June or July. It was a new initiative, and it did all the things he had been challenging us commandants to do: looking forward, trying to make the combined arms team more effective, emphasizing productivity of equipment over people, slimming down, the combined arms team. I thought this was an opportunity for him to pick it up and see it as one of his things.

I think the problem was that I hit him in the last couple of months of his tour at the Combined Arms Center and he had no time to assimilate it, adopt it, and take it over. Thereafter he was fairly lukewarm.

The next year, General RisCassi came in. He bought the concept and was supportive. I briefed General Richardson, commanding general of TRADOC. He bought it and told me to go brief General Vuono in DCSOPS. I remember that General Thurman was the Vice then. General Vuono said, “Not the right time. General Wickham’s leaving. You shouldn’t hit him with anything in the last months of his command. Wait.”

So, we waited. General Richardson bought it and was very supportive. He was a tough man to convince—I mean, you’ve really got to lay it all out. We did, and he bought the E-Force concept.

General Vuono wanted to wait at that particular moment. So, then he came back to TRADOC and then challenged us to do certain things, which took some more time. By the time we had it ready to go, then he was saying it was too late for General Wickham. Then he graduated from TRADOC to replace Wickham as Chief of Staff.

So, I don’t know—E-Force just kept getting pushed aside. Other things had priority of their focus. It was just difficult for me to understand. I briefed General Thurman, then the Vice Chief of Staff of the Army, on it one other time—the initiative we were doing. It seemed to answer all the things he and others were saying that we ought to be doing: bring the engineers in closer to the combat Army, integrate engineers more into the combined arms team, train in peace like you will fight in war. Well, we always put a Corps engineer battalion with the heavy division in war, and they went to fight together, but they weren’t ready to work together.

We showed that E-Force at the National Training Center worked. We showed that E-Force worked on the REFORGER FTX battlefield. We did analytics. We did everything possible, and the briefings indicated that it really met their challenge as to every facet.

We did all the numbers on force structure that showed that we had it right and within space resources. We did all the equipment numbers, and we would be short something like, for the whole Army force, six or seven M-88s, nothing else.

So, to answer your question, I don't know why those three artillerymen didn't understand how the engineer fit the battle in that manner, integrated into the combined arms team, and that was the way it should be. Armor and infantry maneuver commanders agreed.

Well, I think that wrapped up E-Force, for the most part, but it prompts me to think of one other thing that we did in my year as DCSSENGR. There always seemed to be a little bit of 7th Engineer Brigade versus 130th Engineer Brigade kind of differences. They did not always agree on things.

Clair Gill and Jay Braden were the commanders. I thought we'd worked all that out, and I think they were fairly successful, but not totally. Jay had been the deputy in VII Corps—the 7th Engineer Brigade. Then he went to the 130th Engineer Brigade, so I would have thought those things would be worked out.

One of the things we did at that time was get the senior engineer colonels together. I'm talking about the three brigade commanders and the three Corps command DEHs, who along with the DCSSENGR and the assistant DCSSENGR would be sort of a board of directors kind of thing for engineers, as I saw it.

Even though they didn't work for me, we would work together and talk engineer issues and problems. One of the key aspects was trying to work a personnel system so that we had a way of progressing to put the right people in to be battalion S-3s and execs. Majors getting that experience was crucial to their development in the great scheme of things as it was coming out.

I thought that the “engineer board of directors” was rather successful and enjoyable. We got together quarterly, and we would include, when he was in town, the 412th Engineer Command commander too.

One other item that came up, that we haven't talked about yet, had to do with the soldiers' quality of life. It was something that we initiated when I was DCSSENGR, and I followed it later as Chief of Staff, and eventually we carried the day. It had to do with furniture.

The DCSSENGR had the responsibility—first through ISAE, now in DCSSENGR—for the furniture program in Europe. It was really managed in the commands, V Corps, VII Corps, and throughout where they maintained the warehouses that had the furniture in it to go into soldiers' quarters.

Some years before—I came over in '87, and so I'd say that would be in about '85 probably—it was decided that it was probably in the best interests of everyone if they brought their own furniture over. Rather than having this big inventory of government furniture to issue people, traded in and out, and having to have a maintenance activity and a refurbishing activity and that sort of thing, it was probably more economical to go ahead and let people bring their own things.

It had been tried at certain higher grade levels: senior sergeant and major and above, who then had the ability to bring the full complement of furniture over, and they called that “full JTR” [joint travel regulations].

Then it was decided to expand full JTR to everyone, not just the senior people. A briefing was prepared and taken to General Thurman proposing that that policy be approved.

He not only disapproved it at that time but decided that the people who had previously been able to bring their furniture over—the senior sergeants, the majors, and above—would no longer be permitted to bring their furniture over, and they would go back to the other policy, which had the acronym of “limited JTR.”

I was one of those impacted by that change of policy in that, whereas I thought when I was assigned as DCSSENGR I was going to take all my furniture over, I had to go over with my limited JTR allowance of 2,000 pounds and get government furniture. I found when I got there that the government furniture wasn't available, and some of it was ratty, and it took an awful long time to get it.

I was the DCSSENGR responsible for the whole program, so I figured if that's the kind of action I was getting, it must be not too good throughout the command. So, I looked around and found out it wasn't very good: a lot of complaints and a lot of unhappy wives and families.

It was very limiting. I mean, you could have only two end tables. You were really limited to what you could do. You couldn't bring your own over.

So, General Otis said, “Well, why don't we do something about it? Why don't we go back?” We did the numbers and found it was still more economical to do it the full JTR way.

Besides, now the Department of the Army was reneging on the program amounts of money that they had put in the program to buy the furniture to support giving everybody furniture rather than having them bring their own. So, on the one hand, they were reneging on the money available, and on the other hand, the policy had caused a lot of complaints and really lessened the quality of life for soldiers and their families.

We started doing the numbers, and we got some help from the analytic capability available in the headquarters to do a study and figure out what it should be. What we proposed was that we have a “flexible JTR,” and that is, people could bring what they wanted, and we would fill in the gaps around that.

Now, the idea was, a lot of young soldiers don't have a lot, so they really do need some furniture. Others have a lot, and the Army was paying to store it in the United States and, at the same time, paying to have furniture in Europe to give them, and didn't have enough to do both.

So, we had them both angry. We couldn't take care of the soldier and his needs; we didn't have enough. We couldn't replace what the senior people were needing when they left theirs in the United States.

We thought, based on our experience with appliances, refrigerators, and stoves, where we really had the inventory down, that we could operate the system centrally, get out of the ratty warehouses spread throughout the command, have fewer warehouses, and really get on a serve-the-people kind of basis.

So, we had a lot of talks, and back and forth messages, and that sort of thing. This carried on into my time as Chief of Staff. The study person—I don't remember her name—did a wonderful job on the study. She was sent by the Department of the Army over to intern in Europe and learn the trade and get experience in a working environment.

Anyway, she and I came back and briefed the Army Staff and the Vice Chief of Staff of the Army, General Art Brown, by this time, and sold them on the idea that we could then reverse the process one more time.

Q: That's a big operation for as many soldiers as are stationed in Europe, and as much movement back and forth as there is.

A: Oh, it was a big operation. It caused the hiring of a lot of Germans and it cost a lot of money.

Q: Interesting.

Let me ask a question that goes a little bit back to the construction issue. This may not be a fair question, but looking at EUD from the perspective you did at DCSSENGR, what kind of a job was it doing? Was it doing a big job at that point? Other than some of the issues you've talked about, were there any major construction issues or problems that came up, and how would you evaluate EUD at its peak, as we look back now, since construction dropped off and the size of the organization dropped off?

A: Well, you may recall from our earlier sessions, during my 1979 time at the Office of the DCSSENGR as Chief of Installations and Construction, that I was a harsh critic of EUD, but yet saw, at that time, that with the arrival of Joe Higgs and other folks they were really trying to make a change in engineering and project management.

I was very pleased to arrive back in DCSSENGR and find an altogether productive, top-flight European Division. So, I thought very highly of EUD during my year as DCSSENGR and a year as Chief of Staff. I thought Bill Ray was a super commander, and Joe Higgs and John Blake really were topflight SESs. They had a bunch of other top-flight people that interacted well. They were positive, can do, and had a feeling for being close to the people they served.

They were like other districts and divisions in the Corps, except they had a very large military customer and a very spread command. So, I thought they did a super job, and I thought they were most professional.

Q: Other DCSENGR issues that we need to talk about?

A: That kind of takes me out of the DCSENGR category, I think.

Chief of Staff, USAREUR

Q: In June, I think it was of 1988, you went from the position of DCSENGR to Chief of Staff, USAREUR. This is about the time of the change of commanders, right? About the same time.

A: It was exactly the time—

Q: Exactly?

A: —because General Otis and General Fiala retired at the same ceremony on the parade field there, and General Saint took command and I became Chief of Staff.

Q: General Ray came up?

A: General Ray came up to be the DCSENGR at that time. That's right.

Q: Well, new job, new commander. Was that a pretty tough transition, or was it, by virtue of your experience there, not so bad?

A: It was not too tough a transition for me because I'd been there a year and watched General Fiala and General Otis be involved in numerous issues facing the command—the Apache helicopters in Wiesbaden, the noise at Wildflecken, and the Vander Shaaf committee had just come through that we'll talk about in a minute. And, oh, a number of the major issues involved in the REFORGER exercises, all of those kinds of things. So, I really had a feeling for what was going on.

I also knew General Saint from the past. We had been in the same company at West Point, and we came to Europe in 1976 for our colonel commands, his the 11th Armored Cav Regiment and mine the 7th Engineer Brigade. Immediately before that we had gone to Monterey together for language school, and we'd been together there three weeks. We'd known each other here and there, and I'd seen him at Fort Hood when he commanded III Corps. A lot of our year at Headquarters, USAREUR, '78-'79, after the commands, we were there together.

So, I knew him well, and we had quite a personal interaction. I also knew most of the folks around the headquarters, so it really wasn't a major transition.

Now, the style changes from Otis to Saint were rather major to the command, as they adjusted to a new Commander in Chief. General Otis was a very "on top of things" person, but his method was really letting people do things—but he was always there at the sound of guns.

General Saint had a few things that he wanted to be sure happened, so he started putting out a few directives and changed the style around. Both of them worked through their Chief of Staff, and so I guess it was a fast, fast start out the gate for the horse, and so I had to grab the tail and pull the whole staff and coordinate a whole bunch of activities, so the intensity of the pace picked up. Transitionwise, as far as knowledge and everything else, it was not such a major change.

Q: Well, the Chief of Staff's position is—correct me if I'm wrong here—is a position that the commander has a large hand in filling. Isn't that the case?

A: I think so.

Q: You very much were handpicked by General Saint, in this case, for the job? It's a key job.

A: I would guess so. He always had a saying that he would let his subordinate Corps and division commanders pick three people: their chief of staff, their G-3, and their command sergeant major. After that, the folks were his to allocate to cross level and fill other positions.

Q: So, you would expect he would think that in terms of his Chief of Staff. Did you know several months in advance of the change, or was it pretty quick?

A: No, I think I probably only knew about 60 days in advance. The May time frame is my recollection.

Q: Give me a brief description of the USAREUR Chief of Staff's responsibilities. That could go on for a long time, but sort of characterize the job.

A: General Saint believed the Chief of Staff is supposed to run things. He provides the direction, the thrust, calls the shots, the policies, and that sort of thing, with the day-by-day activities of the command at the headquarters run by the Chief of Staff. That means coordinating all the many activities so things, as he would say, hum along, keep moving, and then prepare for new things and make recommendations—making sure everything happens.

He had a deputy commander that he put on to certain responsibilities, but he really expected that I would run the staff and thereby the command. His morning meetings were with me, the command sergeant major, and the deputy commander. Whereas General Otis used to have the DCSOPS, Major General George Joulwan, come in as part of those meetings, General Saint said, "No, the DCSOPS runs his staff. You're the Chief of Staff; he works for you. I'll tell you what I want the DCSOPS to be pushing, and you go make sure it happens."

So, with the Secretary of the General Staff, I ran all the papers in and out of the headquarters and tried to make sure things were coordinated. The functional chiefs—logistics, engineering, intelligence and operations—ran their functions, and the Chief of Staff made sure they were coordinated, integrated, and followed the thrusts of the Commander in Chief. When problems arose, they were brought to him for resolution. When he had things he wanted to initiate, we would get the right people in to get it started, and I would track with them that things were going along in accordance with the desires of the commander.

Q: Well, as you've mentioned before, one of the things that you had to tackle right away were the implications, or consequences, of the Vander Shaaf study.

A: Yes. I should drop back and say Vander Shaaf came over as part of a study effort, having decided that we ought to take some folks out of Europe. It wasn't just Europe; it was all around—avoid duplication. I forget the acronym for the study he was on.

He came into USAREUR headquarters like a blustery north wind—more like a hurricane, I guess. Chuck Fiala, the Chief of Staff, said he knew Vander Shaaf. He knew he was going to come in, and we ought to be prepared because it wasn't going to be pleasant.

In fact, we did great preparation for him. We were there to brief what USAREUR headquarters did with other headquarters, EUCOM, et cetera. I know I was on my feet for two hours briefing in my particular area, and all the other deputy chiefs were too. It was really thorough.

His approach was so shallow that he never, ever, I think, tuned in to listen. He was there to speak. His notions were preconceived. We were there to brief an organization chart. He disregarded that. He went with the phone chart that slips under the glass on your desk. That's what he thought was the bible.

So, he would ask, for instance, "Why do you have a topo officer in DCSSENGR whose responsibilities are to coordinate the topographic activities of all the Army in Europe, when European Command has the same thing?" I'd say, "Well, the European Command has to interrelate Air Force, Army, Navy, and the rest of it."

"Well, what does yours do?" I said, "Well, we have the active units here. We have the 649th Topo Battalion, and this officer's the interconnect between them and the States and makes all the topo kinds of things happen."

"Well, it says here you've got two people." I asked, "What do you mean, two people? I've only got one person." He'd say, "Well, look. The phone book has these two phone numbers here."

I'd say, "Well, disregard that. That doesn't mean anything. I mean, yes, we make up a phone list. This guy, that's a position that comes in from the 649th. We give him a phone and a desk, but, I mean, it's not a position on our staff. It's really a liaison position, a desk and a phone."

To Vander Shaaf it was a superfluous position because, obviously, it was in the phone book. I just gave one example. I mean, the whole thing was like that. His desk phone charts were what guided him, and he'd make up his mind based on them. We really spent an awful lot of time with some very good rationale for various things.

He'd ask, "Well, why does EUCOM have one?" I'd say, "Well, you've got to ask EUCOM that. I mean, I know what mine does, and the Army assets, but what the EUCOM guy does in coordinating the three, what do they need that for? Go ask them."

He asked what functions the DEHs did at the Corps headquarters versus USAREUR, and so we told him. We explained how General Otis had taken all of the assistance teams out of USAREUR. They now did that function at Corps. General Otis had already pulled out the duplication between the two headquarters.

I think it went right over the top of him, or he didn't want to hear it, or he had his numbers in his pockets and he had to come up with something. Everything that Chuck Fiala predicted would happen, happened. Vander Shaaf went home and wrote his report anyway, and the report said—I don't remember the number exactly—"take 420 spaces out of USAREUR headquarters."

Q: Out of the headquarters?

A: He called it duplication. Or out of command headquarters elements, was the way it was put. Not necessarily USAREUR headquarters, but the command headquarters offices. When it came over for USAREUR comment, we commented. It was a cheap shot—he never found a basis for his actions. I mean, we couldn't put his numbers together. There was no supporting rationale that would explain why or where the "duplication" was found to exist.

Even though we were backed up by EUCOM and by the Department of the Army on our position—I guess having advertised that he had come up with some cuts, Defense was bound that some cuts were going to be taken. Because they were overseas and that was where they wanted to make a point with Congress, the cuts were taken. So, we had to cut those people out of the headquarters offices. To do that, it fell now to General Saint and his Chief of Staff, me.

At the same time, General Saint had his own thoughts about duplication and the fact that certain layers ought to come out, specifically in nonappropriated fund activities. You need to remember that he had previously been the commander of the 1st Armored Division and the community commander of that region, reporting to VII Corps. So, he had the natural inclination of a division commander that the Corps was all screwed up and didn't quite have it right, and why were they between him and the great resourcer, USAREUR? He had a concept, that later has been implemented, for converting and getting rid of certain layers of things so commanders had regions that they were responsible for, and then they could go straight to the resourcer and get things, and they didn't need extra policy guidance from a Corps level headquarters, and maybe the Corps ought to be by themselves.

Now, I say that because that view carried on some activities over the year and led to many more after I departed, but that became a factor as we tried to address the Vander Shaaf cuts. We really went out with his guidance to the Corps commanders. When I say “Corps commanders,” I mean the 21st Support Command along with V and VII Corps, the three three-star commanders, and also to the Berlin commander and the Southern European Task Force commander in Italy.

Those five, plus the Commander in Chief, Deputy Commander, Chief of Staff, and the USAREUR Command Sergeant Major, met rather often together, and so we all had a sense of direction on where we were going, and we would address various kinds of major items going on.

We had the Corps and the other two commands submit potential cuts, focusing cuts to try to get rid of duplications, with quite a number to be in the nonappropriated fund management arena.

Based on that, we convened commandwide meetings. I chaired the first meeting, and we tried to identify certain areas for reduction. He established numbers for the Corps headquarters, and then they got to choose where the cuts came, but then he wanted to see some rationale for why things were different in similar Corps functional offices.

We held a great, big, all-afternoon meeting with the Corps chiefs of staff, with me presiding, and we tried to lay the groundwork for what would be presented to General Saint and the Corps commanders for final decision. Then we had another meeting where General Saint presided with the Corps commanders present, and the briefings laid out which cuts had been easy and were agreed upon and those that were still disagreements, and then the Corps commanders had a chance to say, “No, I don’t want to do that. I think we ought to do this instead,” and that sort of thing. Then General Saint would make the final decision.

It was a difficult process. There were two sessions, one presided over by me, one presided over by General Saint, to make the final decisions. With that we cut out the 420 spaces and sent them back.

Q: Did those come pretty heavily at the Corps level?

A: Yes.

Q: USAREUR is undergoing yet another round of staff reorganization and cuts, it seems to me.

A: Yes, and I think the idea was that General Otis had trimmed the USAREUR staff, and he had started to look at the Corps staffs and turned that task over to General Saint. That’s where the ax fell this particular time.

With General Saint’s predilection that Corps commanders may have intervened too often in his divisional community arena and they had certain other responsibilities they needed to put their attention to, that’s why that happened.

Q: Well, an issue like this probably took up a good proportion of your time as Chief of Staff.

A: Well, at that particular time this was a big issue. There were all kinds of different issues always coming along. It was a very intense period of my career, I guess the most intense. I was staying late at night, taking briefcases home at night and four briefcases on a weekend.

There were a lot of activities and interaction with the host nations.

Q: Why don't we turn to some of those host nation issues?

A: I think I really talked about them earlier. The Apache helicopters at Wiesbaden issue continued. The noise issues continued. They were the prime items.

I would say that in March of '89 things took another change. There had been a study two years before, actually before I arrived as DCSENGR, involving the ministries I've spoken of, Defense and Finance. It also involved the USAREUR Chief of Staff and Major General Scott Smith and other staffers from USAREUR, involving the use of our training areas and how the various nations train.

The basic thing the Germans were asking was, "Why doesn't the American Army train like the German Army?" We felt there were major differences and that we could not tolerate the reduced level of training of the German Army, both the manner of training and the level of proficiency. Also, our Army was deployed overseas and, having brought people over there, we wanted to keep them occupied.

The German Army needed to knock off on a Friday afternoon so their soldiers could go home because they had a home to go to. When our folks knocked off, they didn't have a home to go home to, and so they could go down into the town. Yet, downtown were some of the Germans who didn't want the Americans around. So, what kind of activities could one keep our soldiers involved in over these off periods?

We really wanted a high level of training intensity. We needed to train the combined arms team together, and that was our emphasis and not the German emphasis. We wanted to train live fire, and we wanted to do a lot of those kinds of things.

So, we made the case, and it had been a dormant issue for over a year. But, in that March of '89, we went up to a meeting where we were asked to come up and explain our need for live firing at Grafenwöhr.

Dr. Fischer, whom I mentioned before, really threw down the gauntlet. He basically said, "You must begin training like the Bundeswehr. Nothing else will be satisfactory. If you don't tell us in a week that you're willing to do that, then we will get your political masters to tell you to do that."

This was a very different tone and sense of interaction than I'd ever experienced. I'd been doing this for nearly two years with the Germans, and although we had some issues, I thought they were supportive and they were trying to accommodate us.

It changed at that meeting. It must have changed that they lost their willingness to stand up and say to their citizens, “Yes, it is right. They’re here as our partners and we’re doing a common thing, and for that, they need to do certain things, and we need to try to accommodate that.”

I’d seen that changing over—they weren’t now always quite so eager to be out front explaining why it was right for Americans to do this for the common cause. Now, here in March, we were being told, “You do it our way or we’re going to get your masters to make you change.”

I don’t know what prompted that. Eberhard Stoltenberg was, at that time, the finance minister, and he told Fischer to go and tell us this. I guess they felt from the political climate that they could obtain that kind of fix on us.

So, I really felt a change in atmosphere at that point in time. Of course, I left soon thereafter and started looking on from afar. Things became more difficult in terms of getting things done. They wanted us to knock off all firing at night with our artillery at Grafenwöhr. We wanted to fire at night because our purpose is to train in peace like we’re going to fight in war. You fire at night in war. So, we wanted opportunities to fire at night.

The United States made a rather formidable investment in Europe with these forces in the number of units and artillery battalions. If you just ran the math of trying to rotate our artillery battalions through the training area, they wouldn’t make it adhering to Bundeswehr timetables. You couldn’t get them around through there in a year’s time.

So, we told them we were developing concrete warheads and things to reduce the noise and that sort of thing. Basically, they just didn’t want to hear it. They just wanted us to change.

That was a very, very controversial and bitter meeting—a watershed meeting, I thought.

Q: So, did this lead, then, to a whole series of exchanges back and forth, or did they pull in the political authorities?

A: Well, we told all of our own political authorities beforehand, “Stand fast. Don’t let them do this.” During the time I was there—this is March, and I left the beginning of August—there wasn’t much time left for me in this. We had a new ambassador. Vernon “Dick” Walters came in and took over. There were several meetings with him, and they were quite open. We didn’t feel any, any of the political pressure from our side during the time I was there.

Q: So, possibly another example of the hardening attitude on the Germans’ part—given the events that are beginning to go on all over Eastern Europe and Germany as well—was the dramatic change in atmosphere over the last two or three years.

A: I think that was a watershed meeting and marked a change in attitude.

Q: Well, you were there—talking about a watershed—for the end of the Pershing IIs as well. Would you talk about that, and the INF [intermediate nuclear forces] treaty?

A: Well, we should all be proud of the Pershings, and we should be proud of the conviction of the Reagan administration that put them over there in the face of a lot of actions on the part of the German populace and others to not deploy them. Even the German government stood up and supported the deployment.

The Pershing II, I believe, was a major factor in causing change. Our ability to project farther into the hinterlands and threaten things the Soviet Union didn't think would be threatened was a motivator to them. I believe, also, it was a major factor in their seeing that they could not compete with us both in the arms race and economically. They were really bankrupting their nation economically in pushing the arms race. They weren't going to be able to beat us. That started the chain of events in leadership thinking, Gorbachev's thinking, that led to other things and the major changes that happened later.

The Pershing folks and the commanders there in the 56th Artillery Brigade did a super job in planning for and executing that rather difficult maneuver—taking things down, moving them out, moving people out, keeping morale up even while things are being taken apart. I think they all really deserve real plaudits for the work they did.

Q: Yes, that's a dramatic event for lots of different reasons. What about NATO issues while you were there? Major alliance issues that you were having to deal with, apart from the problems with the Germans?

A: I don't recall any. We had numerous major exercises with CENTAG and the rest. Our interactions with the other forces and with the other commanders, both NORTHAG and others, were strong. There was good interaction between General Saint and General Galvin.

So, I don't believe that there were major issues that came during my rather short time frame. In the great scope of things, one year is not very long.

Q: Right.

A: In those kinds of terms.

Q: Did you have quite a bit of contact with your NATO—counterparts is not the right word—officers in CENTAG, NORTHAG, German, British?

A: Not a whole lot really. Not me in particular. We did with CENTAG in that the CENTAG headquarters was collocated in the same building. The CENTAG Chief of Staff, a German major general, had his office immediately below mine. He would coordinate his staff from there, and I would coordinate the USAREUR staff, and we socialized together and did some things together.

When we went off in NATO field training exercises, General Saint would go off with CENTAG, and the Deputy Commander in Chief, General George R. Stotser, would come with us. We'd go out separately.

With NORTHAG—when I was DCSENGR, I have not mentioned that—we used to have home and home meetings with the BAOR [British Army of the Rhine] engineer where our staffs would get together.

As Chief of Staff, I went up at least once and hosted once the BAOR Chief of Staff to coordinate and have meetings on various kinds of issues and to keep each other up to date on things. We did not have a lot of that kind of activity. I think General Saint had much more interaction in the ways he traveled.

Now, one thing while I was Chief of Staff, we had a number of interchanges with the French Forces in Germany, located in Baden–Baden, and also with the French First Army, in Strasbourg. I took a delegation from USAREUR—our deputy chiefs: DCSOPS, DCSLOG, and so forth—down, and we met with the French First Army general staff in some briefings at their headquarters. That was very interesting. They very much wanted to establish a professional working relationship, even though they weren't participating in the military part of NATO. The probabilities were that, in case of conflict, a Warsaw Pact attack, that they would then join with us. So, we had that kind of interaction and common interest. They also participated in some of our exercises. Not every one, but on their choice.

The Chief of Staff of the French First Army was Brigadier General Quesnot, an engineer that had commanded the parachute regiment in Montauban that I had visited as commandant of the Engineer School at Belvoir when I went over to visit their engineer school in Angers. We had flown down to Montauban and visited them, so we had a little reunion in Strasbourg.

There was a liaison officer from the headquarters of the French Forces in Germany, at USAREUR in Heidelberg.

General Quesnot mentioned the fact that this was a great combination because it was the French First Army and the U.S. Seventh Army that had fought up through the southern part of France and southern Germany during the war.

Q: Yes.

A: Then we had the previous common personal bond.

Q: Yes. That's interesting. Did you have a sense, and this is still fairly early, by the summer of '89, a sense that there were such dramatic changes coming in Europe, or going on? Or was this too early?

A: No, we could not sense how far and how fast it was going to go. Gorbachev was there. He was just starting to make changes. He was talking *glasnost* and *perestroika* at that time.

We need to swing to that arena, the interactions we had with the Group of Soviet Forces, Germany.

I need to go back and say one other thing because this ties both to the Soviets and the Germans. When we had the French visits and talked with the commander of the French

Forces in Germany, having coffee with him before we went on to talk to the First Army folks, he said, “You know, it’s really important that we French and you Americans are seen together like this, not only from the standpoint of the Russians, but also from the standpoint of the Germans.” I thought that was an astute statement of the way things had worked out over time. That’s about the time frame that we got the ultimatum from the Germans: start training like the others.

With the status of forces agreements, the Germans were meeting with the French and the Brits and us, wanting to do it separately. We were all saying, “No, we’ve got to be in this together because sending forces have common kinds of issues.”

Well, then you swung to the Soviets and asked about our ability to predict. Other things were happening at this time. The thaw in relationships was happening.

The President had met with Gorbachev. The Secretary of Defense had met with the Soviet Defense Minister. The Chairman of the Joint Chiefs had met with his counterpart. The next in that increment of exchanges was to be CINCUSAREUR.

Q: Yes.

A: So, the door was opened by the administration, the State Department, that we ought to be facilitating and having this exchange. I need to backtrack a little bit, just to identify that the Chief of Staff was the point of contact in USAREUR for the Soviet military mission in Frankfurt. Also then was the point of contact for our own military missions in Potsdam and Berlin.

Now, our military mission would have a point of contact with the Chief of Staff, Group of Soviet Forces, Germany, as well.

I had a lot of interaction with the Soviet military mission at Frankfurt. I visited them there and had them down to the headquarters in USAREUR. Likewise, Brigadier General Greg Govan—he was a colonel then—was our chief of mission in Potsdam, and he did the same with them.

Out of all this came an invitation from General Snetkov to the CINCUSAREUR to come up and visit them at their headquarters. I flew up to Berlin, drove over to Potsdam to our military mission headquarters, and met with their Chief of Staff, Major General V. Fursin, to make the arrangements for this get-together.

That was a rather interesting meeting. At that meeting we made the arrangements for a USAREUR visit to their headquarters. We decided on a delegation of six principals, and they would match with six principals.

General Saint, of course, led our delegation. I went along. The DCSOPS went, along with two division commanders and the command sergeant major.

We flew up to Berlin and drove to Potsdam. They met us at the U.S. mission with a bus. We drove for about an hour to their headquarters at Wunsdorf.

There were numerous activities involving first an honor ceremony, then an introductions get-together with breakfast kind of goodies out and coffee. One of the significant things about the Russians in East Germany was that they didn't live like we did. They were all by themselves in East Germany. They allowed no Germans into their kasernes, whereas our workforce in support of the U.S. Army, Europe, was largely German. With them, there were no Germans, and that meant quite an isolation of their army from the German population. They maintained it that way, for whatever their purposes.

I guess there were eight waitresses that were there to take care of the tables, et cetera. We had a rather stiff opening, and then we started going around touring. They took us by a typical barracks, which was immaculate. Shined floor and not a thing out of place and not a coat in sight. Occupied? Didn't appear so.

Then we went to what they called their rec center tearoom. There were the same eight Soviet waitresses waiting to pass out something to eat.

So, then we went out to the field and observed field training activities at a large range complex. They had set up a huge tent for field mess, and we were to get a typical Russian soldier's meal. After walking in and being able to wash our hands, we went in to sit down at the tables, and surprise, there were those same eight Soviet waitresses—out in the field.

I'd have to say the meal was very good. I don't know if that was the typical meal, but the soup might have been typical soup, and it was very good. Then we went back out to the ranges and observed an exercise that afternoon. It was a live-fire exercise in which the Warsaw Pact forces took on an attack by NATO forces. We watched that live-fire exercise and then watched some other training.

Then we went back to the headquarters and freshened up for an evening in which we were going to have a meal and then watch a Soviet soldier show. This was a very professional series of acts. They had the families of the local garrison there and the wives of our hosts. That was our only activity with somebody besides our meeting group. At the meal, again, there were those same eight Soviet waitresses. Anyway, it was an interesting time.

On the bus back that evening, we were talking with the person who had picked us up and was escorting us back, the Deputy Commander in Chief. Someone on the bus asked him, "Well, do you think Gorbachev will succeed?"

His answer was very interesting because—now mind you, your question was, "Were we able to predict anything?" My answer was, "No." His answer was, "Well, he must succeed, you see, because we have too many millionaires in our government and in our society and we're not supposed to have any millionaires."

Q: Interesting.

A: So, that was the end of that visit.

Q: You said it was sort of stiff that morning. Did things loosen up as the day went on?

A: It loosened up a bit. General Snetkov was a very gregarious, outgoing person. I mean, he dominated the conversation. None of his people really said much except off to the side.

Q: Yes.

A: General Snetkov almost had a dialogue with General Saint while the rest of us sat there at the table because he was so dominant and the others yielded to him so much. Although General Saint would yield to us, he hardly had a chance to because he was sitting directly opposite General Snetkov and it was all directed over towards him.

There was one other interesting statement while we were standing around talking to one of their commanders who commanded a division that was being demobilized and sent back to the Soviet Union. One of our division commanders, I think maybe Cal Waller, said, "What's your biggest problem?"

The Russian said, "Well, my biggest problem is how to take care of my people and find them housing back in the Soviet Union. You see, they have been in the military all their lives, and they don't have houses. They're not from a city, and they don't want to go back to the farm."

Q: Right.

A: "There's no housing in the places they would like to go, Moscow or Leningrad and so forth. So, my problem is how to take care of the people and find them housing, those that are being mustered out."

Of course, we saw later on that this was a very big problem and continues now as they're trying to get out of the Baltic states.

Q: Yes.

A: Germany actually has negotiated with them for the extrication of the Group of Soviet Forces in Germany, and ended up paying for houses to be built in the Soviet Union to facilitate the process to get them back.

Q: Yes. Your description of the installation of the Soviet bases helps explain why Soviet troops could stay so long, and I guess some are still there in eastern Germany, that they are insulated from the rest of the society.

A: Very insulated. That's right.

Q: So, that is their home until they can get some place back in Russia.

A: Well, it could be, but, you see, their short period of service for the inductees means that they have a swap out annually.

Later on in the spring, we hosted General Snetkov and his delegation at Heidelberg for a return visit. In this case, it was an overnight affair, and they came down, spent a night with their mission in Frankfurt, and then came on to Heidelberg the next day.

Our focus for their visit was to prompt them to see lots of people, not to be insulated, and to see our Army as it was. We let a lot of the visit be handled by our noncommissioned officers. The Soviet Army did not have a noncommissioned officer Corps of substance that could do the kinds of things like the rock-hard sergeant noncommissioned officer that is the backbone of the American Army, that's always down there at the cutting edge, making things happen. It doesn't exist in the Soviet Army.



Commander-in-Chief to Commander-in-Chief meeting in Heidelberg, West Germany, in 1989. From left to right, Major General Foley, Deputy Chief of Staff, Operations; Lieutenant General Stotser, Deputy CINC; an interpreter; General Saint, CINC USAREUR; Major General Kem, Deputy Chief of Staff, Engineer; and Major General Joulwan, Commanding General, 3d Armored Division.

At every opportunity we allowed them to see how capable our noncommissioned officers were, so they'd see the strength of the American Army. You don't just look at an officer or look at a rifleman, but you recognize that noncommissioned officer strength and how substantive it is.

After we had an introductory meeting over the green felt table—somebody said you always had to have a green felt table—and had had a chance to dialogue a little bit, then General Snetkov and General Saint had a commander-to-commander private meeting with interpreters for about an hour.

Then we hopped aboard helicopters and flew down to the 3d Mech Division at Schweinfurt to observe them doing daily activities. There we were met by the command sergeant major of

the division and their noncommissioned officers who took them on tours of the barracks and briefed them. The noncommissioned officers did everything and the officers stood back.

We had the same delegation matchups we did before, and so we went along and watched. Then they went into the unit dining facility for lunch. Where at Wunsdorf we had always eaten with them in our tight group, we had our soldiers at the mess with them. There was a sergeant in charge of each table.

Since their Chief of Staff, Major General Fursin, was there, and I was his counterpart, the two of us went to the same table, but there was also a captain, a sergeant, a corporal, and so forth. Our whole principle was to let the troops talk to them and get an interaction.

Our core delegation was there to try to facilitate a dialogue between our soldiers and them. Our folks did very well. Our soldiers asked the questions, “Well, what do you do about this in your Army?” That sort of thing. It worked very well.

Then we went out on the range and saw our people operate on a weapons range right on the kaserne. Schweinfurt has one of our better facilities for training. Then we moved to the local training area and watched a combined arms exercise using MILES [multiple integrated laser engagement simulation system], the laser designator that we fit our weapons with so they can record training “kills.” The scenario had a Warsaw Pact tank–infantry company attacking and being taken under fire by a U.S. tank–infantry platoon in hull-down positions dug into the hillside and with a minefield in front.

Afterwards, we brought all the tanks and vehicles up and let General Snetkov and his folks walk down and talk to our crews. The rationale was there, again, to see the strength of our people. I mean, the well-trained, rock-hard element of our capabilities.

I took their chief up to one tank crew and let him do the talking—we had an interpreter there. He asked the tank commander, “How long have you been in the Army?” “Well, Sir, fourteen years.” “How long have you been over here in this outfit?” “Well, four years, Sir.”



General Kem (right), Chief of Staff, U.S. Army Europe, and Major General Fursin, Chief of Staff of the Group of Soviet Forces Germany, at a 1989 celebration of the meeting of American and Soviet forces on the Elbe River in 1945.

Then he asked, not understanding, “Well, what tank do you use when you go to the training areas?” The sergeant was a little perplexed with this. See, the Soviets have one tank at home and a different tank in the training area. The sergeant says, “No, I take my tank. This tank.”

It had a strap of MILES devices on the turret. You could see that was there. So, we explained. “No, that’s the tank he maintains with his crew in the motor pool; that’s the one he brings out here to the local training area; it is the one we put on a train and take to Grafenwöhr for live fire. So, he and his crew know how to shoot their tank; they know how to maneuver the tank. It’s theirs.”

Now, the tank commander was an Hispanic–American, and the Soviet Chief of Staff moved over to the next man, and there was a black gunner. He asked how long he’d been there. “Five years,” was the answer. He moved on down to the next soldier and talked with him, and he’d been a year and a half on the crew. The loader had been there about seven months. So, we had a rather cohesive crew there, recognizing their swap outs.

Q: It must have been interesting to observe them and see what they were interested in.



Major General Kem (left) escorted Major General Fursin, Chief of Staff of the Group of Soviet Forces Germany, on a visit to Grafenwöhr in 1989 during the CINC to CINC visit.

A: Oh, it was. That evening, whereas at Wunsdorf we only ate dinner with our officer hosts, we invited them to eat dinner with us and our wives.

The USAREUR chorus sang—not the professional actors that they had, but a very good bunch of soldiers. We explained to them they were soldiers in wartime, not professional entertainers.

The next day we flew down to Grafenwöhr and took them out to see artillery outfits set up to shoot and then took them out on our range and watched our tanks go down range, live fire. One of our tanks skipped a round up into the target, and the Chief of Staff picked up on that. “Ah, it just skipped.” Then we said, “Yeah,” and took him up into the control tower, and he found out that the person had not been credited for the hit on the scoring system. So, we had a good interaction with that.

Then they left from Grafenwöhr and drove back on up across the border at Hof.

So, that was our exchange of activities—very cordial and very professional with an understanding of each other.

Q: Itself something different, that probably had not happened often, if at all, had it? That sort of real, open exchange between Soviet and our forces?

A: No, not to that degree. I believe back in General Blanchard’s day, he told me there had been a meeting, I believe, between him and his senior counterpart. We had much acrimony in the interim. For instance, just before I got there, the killing of Major [Arthur D., Jr.] Nicholson of our military mission had been rather brutal, and there were a lot of hard feelings that went with that.

We had other meetings between me and their Chief of Staff, Major General Fursin, to try to ensure that the rules of engagement, or disengagement, working with each other’s mission people—ours over there, theirs here—did not lead to things that were threatening harm to those people.

Q: So, you worked with their Chief of Staff on that issue?

A: Yes. Those were formal. We met in Potsdam, and we’d have interactions through the missions in the interim.

Q: Well, along these same lines, I think you mentioned earlier this afternoon that USAREUR was giving some thought to restationing, to looking towards the future, some changes in stationing.

A: Yes. It seemed to General Saint that the writing was on the wall, that the clamor now in Congress—we’d had Senator [Sam] Nunn come over and talk with us, and several congressmen, and Senator Hollings had been over—that we’d best start the planning for contingent drawdowns. Yet, it needed to be a very close-hold kind of thing because we were really only talking contingency.

The problems were we'd get asked questions, even though decisions hadn't been made, and then if people know things are being thought, then that can become a self-propagating proposition. So, he, I think smartly, established a team to think out in matrix form what might happen—basically look at it from the standpoint of segments. We didn't know the final level, but it was going to be something more than just the 56th Artillery Brigade, Pershing. What if we had to start pulling things out by increments? What increments should those be? Where would we want to take them physically? If you're going to do that, you really ought to have a base case, an objective that you're going to end up with.

If you don't know where that line is, how can you have a really good objective? You'd better establish something. So, he picked a level of a single Corps, a couple of divisions, and associated support elements that might be a reduced-sized USAREUR.

Then we went through the thinking process of what that force might be, and then we went over to the stationers and the operators to say, "Well, look. That's where it's going to be. Where should they end up? What are the best places, in terms of location, U.S. facilities, housing, getting our people off of the economy as much as possible? We ought to move out enough and save the housing so our people can have it like we should have. We should give up the worst places and the places where we always had to accommodate a shortfall and where it wasn't working. Let those go and save the ones where we could be best positioned. We could tighten the force, but locally loosen up to accommodate all the needs, keep the quality of life and the ability to train in whatever force it was."

The effort came about to identify some segmented force slices—knowing what the objective force was assumed to be—and identify the objective facilities.

So, if somebody would come in and say, "This is the number," then we could go to the stack and say, "Okay. That means these segments go, these units go, these are the places that go, and these are the kind of moves we have to make to make all that happen." Then we could cost it out and identify all the other actions required to do it.

So, that thinking started at that particular time, and it was continually honed until such time as it was needed to be implemented.

Q: Well, that was, as things turned out, very good advanced planning.

A: I believe so.

Q: It may help to explain why some things have seemed to have gone smoothly, I guess, because they haven't hit the news. Maybe that's a bad definition of going smoothly, but you know, things started changing with USAREUR pretty quietly. You'd hear about the huge numbers of people coming back on the transatlantic flights, but you didn't hear about negative stories, you know.

A: Well, General Saint took a retired colonel who had spent a lot of time in DCSOPS and really intimately knew what went on in the command, and brought him back as a civilian, and put him in charge of the team. We allowed him to lock himself in the room and do the quiet

work—high-stress, high-intensity kind of work—because once somebody needed to know something, it had to come very fast.

General Saint was very smart, starting that process and setting it out in that manner, so the homework could be done early because always the questions came and they never included sufficient assumptions to provide a valid point to start. The people wanted the answer anyway, and you always knew you were going to be responsible for your answer, even though the context may not quite be right in the way the question was put.

Q: Right.

A: So, he set this up, and he set Darryl aside to work the problem. He was the expert, and he had straight line access to General Saint so that it could be kept rather close-hold so the whole world didn't know because that would have had implications to various communities and impacted the morale of our folks. Yet, the planning was done and packaged to be used.

Q: Can you say about what time that started? Not an exact day, of course, but spring of '89, summer? Spring of '89?

A: Spring of '89.

Q: Okay. Other issues you'd noted for your period as Chief of Staff?

A: I think we've hit most of them as we've talked through. I think another fine action that took place early on was also rather a good example of how General Saint worked, and that was the company level computer. It had long been an Army issue as to whether the company should have a computer or not. The opposing view was that with a computer the company administration would be tied to the orderly room, with the first sergeant supervising a clerk on the computer when the first sergeant was supposed to be out with the company training and not tied to administration. During General Wickham's time as Chief of Staff of the Army, it had been an issue that was debated at the highest levels, and he had said, "No company computer."

Well, General Saint was one who believed that the way the computer had evolved to the lap top, that there was benefit to have a company computer in order to help the first sergeant. He could take his clerk to the rifle range and they could enter the people's scores right there rather than having people doing pencil log work, keeping records, and then bringing that back to have it laboriously entered on a roster. He thought there was a value in having a computer to take out to training or whenever.

He also thought that to obtain the potential value of a company level computer, it shouldn't be something that was going to be dictated by computer experts in Washington or personnelists. We already had all kinds of automation with the personnel system and what was going to happen at battalion level, and the personnel team wasn't working—it was placing additional demands on the company.

So, as long as the battalion was putting demands on the company, giving them information, somebody had to stay in the orderly room and answer those demands. If we could make that work through a company computer, then that would be better.

General Saint, providing direction to this, told me to find a company commander coming out of command who knew something about this kind of business. He wanted company commanders to develop a tool that helped them, and he didn't want other people to meddle with that process, telling the company commander what he had to have. He really forbade people from screwing with the people developing this product.

We found a company commander coming out of command, and he became the guy who was told, "You go out and invent those software programs to do the jobs you need as a company commander to make your job easier and to get the first sergeant out of the orderly room, not keep him there."

General Saint didn't say, "You've got to have this, you've got to have that." He just said, "Let the company commander do it, and don't anybody mess with him."

The next thing he did was to give, out of the USAREUR budget, each Corps a bunch of money to buy the personal computers for the next budget year, so the seed money was there. It wasn't enough to do the whole command, but it was to be seed money. The Corps were to identify those units who should be the seeds of the project, and it was supposed to include different kinds of units—not all armor, or infantry, but to have artillery, engineer, quartermaster, ordnance as well, so we would seed the whole command, the idea being that everybody will see it work and want one. Then they will go out and buy their own through the system.

Then he talked to the commander of the 5th Signal, the communications staff officer for the command, and said, "You get your organization ready so that we can procure and put in the computer store the company computers necessary and reproduce and stock the software packages necessary that are developed to do that."

So, our company commander project officer went out and developed some things for personnel actions, for training, for logistics, whatever he felt would help him. General Watts' VII Corps said, "I would like to get it for all of my company commanders. I will pay the balance out of my budget." So, we got a bunch of folks oriented toward developing the company commander's computer by a company commander and tried it out on other company commanders. He was not messed with by the lieutenant colonels, colonels, and generals, but it was resourced by the generals—the Commander in Chief—who made it happen in a relatively short time.

Q: So, did it turn out to be popular?

A: Yes.

Q: All the companies saw it and wanted one?

A: Well, like hot cakes.

Q: Yes. Well, that's interesting. That pretty much goes through my questions.

A: Yes. I've checked off every one on my list.

Q: Well, were you ready to go, ready to come back to the States in the summer of '89? Two pretty intense years in Germany. Did you feel that it was time to come back?

A: Yes and no. I really liked USAREUR. I spent three tours over there, and I enjoyed all of it. I enjoyed the activities there and would have been happy to stay over there.

At the same time, it was obvious that I was not going to be selected to be the next Deputy Commander in Chief of Europe, the job that I would be most happy to stay in, so it seemed like time to look for something else.

I knew the Deputy Chief of Engineers position would be open, and I was in the twilight of my career—two possible years left on active duty. So, I thought that it was time, even though I'd really enjoyed my job as Chief of Staff, USAREUR, and I enjoyed working for General Saint, it was time to begin the transition back. To go back and work at another place I liked to work, that is, USACE, as the deputy supporting Hank Hatch, and that would put me in place for the final transition: that is, back to retirement in civilian life.

Deputy Chief of Engineers³

Q: In August of 1989 you became Deputy Chief of Engineers. I wonder if you could say something about your feelings at the time of the selection, and how that came about.

A: To be selected as the deputy?

Q: Yes.

A: I was serving as Chief of Staff in USAREUR, and was asked by the Commander in Chief, Butch Saint, whether I would like to stay on as Chief of Staff another year. I said, "No, I think I ought to return to the United States." He said, "What would you like to do?" I said, "I would like to be the Deputy Chief of Engineers."

So, he says, "Okay. I'll be going back in a few weeks. I'll probably see Hank Hatch back there." I said, "Well, I'm going to call him and tell him the same thing."

³Interview conducted by Dr. Paul K. Walker on 19 October 1990 at Washington, D.C.

So, I called Hank Hatch, told him I'd like to do that, and I called Colonel Steve Smith in the General Officer Management Office and told him the same thing. Another couple of months later they confirmed it and that was it.

Q: Now, would you say that is the usual way that would happen, or maybe there isn't a usual way?

A: For general officer assignments, that has been my experience. There's been a dialogue with the Chief of Engineers and your desires made known, and all those things go together. So, I think every assignment I have discussed with the Chief of Engineers has happened with my cognizance, except when I went to the Ohio River Division the first time. It was kind of a surprise because Harry Griffith had been pulled out very quickly, and the Chief, General Morris, had made up his mind before he talked with me.

Basically, there's been dialogue for most general officer positions. So, I'd say, yes, I thought that was rather normal.

Q: What you're saying then is that when General Saint brought the question up with you, you had already discussed this with General Hatch, at that point?

A: No. I think I called him right after that.

Q: Okay.

A: So, before General Saint went back, I had discussed it with General Hatch. My job in Europe was a great job, being in Europe, being Chief of Staff of USAREUR, and with all of the things going on. I would only have two years left before mandatory retirement, and normally, having been in the personnel assignment business, people aren't looking for a one-year person. They're looking for doing something when you have two years left. So, I felt if I stayed there another year, I would be putting someone in a box as for what I would do in my final year. I knew I wanted to return to the United States before I retired.

Of course, the deputy job is a super job, and you're right at the top of a great organization, so I really wanted to do that. That was certainly my prime choice. I would be hard-pressed to think of another choice.

Q: At that point.

A: At that point, right.

Q: In 1988, little more than a year earlier, you were mentioned as one of the top candidates for the Chief of Engineers at that time. Did you want to be Chief at that time?

A: Of course. I thought I was qualified and a good candidate, and my background actually was much like Hank Hatch's. We'd been a lot of the same places, in the ACE's shop, in Europe, at Belvoir, around the USACE divisions. So, I thought I was qualified and probably a pretty good competitor of his.

Q: Does that have any effect, maybe more from a personal point of view, then to later come in as deputy or not? Well, actually, you said you wanted the position.

A: No, I don't think so because, you know, when people grow up as peers, go through the ranks, you participate together, you contribute together, you serve together, and you also compete as the pyramid narrows to the top. So, we've always—we also went to Leavenworth together—we've always had a good professional relationship.

I always had thought that it would probably be between Hank Hatch and me, and he was the one guy that I would understand that, if he got it, the Army made a good choice. So, it wasn't difficult at all to come back and ask him to be his deputy. I think we've had a great year working together because we've brought our particular fortes to the table, and we've been able to operate with fairly good strength in the headquarters.

Q: I had a question to ask you about your past relationship with General Hatch. You were a year ahead of him in class at West Point, so that your careers fairly well paralleled in terms of—

A: Yes. We never were assigned closely together, but he was one of those folks I knew was out there, and around, and coming up, and getting assignments. We were doing different things about the same time, commanded battalions in Vietnam about the same time. We didn't run across each other over there but, I mean, when you're of the same peer group you're going through the various gates and organizations at about the same organizational level, so you know who they are and what they're doing.

Q: So, in talking to you, then, it seems—it's a lot different to want to be Deputy Chief of Engineers than the jokes that people make about being Vice President of the United States? I mean, it sounds like you felt that that was a genuine place where you could make a contribution at this point in your career?

A: Sure. I thought it was a very good, substantive job, and certainly not a figurehead. Now, one of my predecessors, Norm Delbridge, keeps wondering why I'm so busy—as if he wasn't. I keep asking him, "My goodness, Norm"—I mean, I leave the office at 6:00 every night and stay fully occupied every day chasing issues and working problems and things like that.

So, I don't know what was driving his thoughts, but to me, it's a very substantive, needed position that gets very involved when you have an organization as big as USACE—40,000 people worldwide, 13 divisions, 39 districts, the labs, and all of those kinds of things. There's plenty out there to keep a whole bunch of people occupied if we're going to really move ahead, move forward.

Q: Now, did you come into the position with any particular things, goals of your own that you wanted to see happen, implemented, at the beginning?

A: No, I had no particular agenda. As I mentioned, I had just left being Chief of Staff of USAREUR, a big headquarters doing all kinds of things, and I figured I'd be joining the USACE headquarters doing all kinds of things, albeit different.

I liked the Corps of Engineers so much. I've served at division level; I've served on the USACE staff as Deputy Director of Civil Works, Deputy ACE, and the Chief of Public Affairs. I may be getting into a little bit more of the career stuff here but, I mean, they're pertinent to the deputy job.

Q: Sure.



General Kem (second from left) toured the Pineville, Kentucky, project as the Nashville District prepared to drill tunnels.

A: So, I've had an awful lot of interaction time in the headquarters working with people. When I was at Belvoir, that's so close, so much interaction—I didn't need an agenda. I just knew a bunch of people that were very enjoyable to work with, and I knew so many people in USACE headquarters too—most of the SESs, plus the general officers and quite a number of the office chiefs—that it was almost like rejoining the family.

I was coming back to a place where I knew I'd be professionally challenged, rewarded, and satisfied and working with good people and doing the very interesting and very important work of the Corps.

Q: One of the end-of-tour standard questions has to do with preparation, and I think that's a little hard in terms of the deputy position to ask, but maybe there's some particular assignments—you've sort of been indicating that—that maybe now, looking back over the past year, would have helped with the perspective that you have to have.

A: No, I have some things to say about that.

Q: Okay.

A: Beyond the particular positions that I had that allowed me to interact, working in our headquarters, recognizing that the Chief of Engineers has two jobs: Chief of Engineers and Commander, U.S. Army Corps of Engineers. He's always moving between one and the other, and I, as deputy, move between one and the other—that is, the Deputy Chief in an Army Staff role, or the Deputy Commander, doing the major Army command kind of issues.

I think there are some things that are essential in that preparation, and I think any success I might have had comes from that, the experiences I have had. I think if anybody else comes without some of those experiences, they might be less effective or might have difficulty picking them up. Of course, that's also dependent on a person's nature, and not everybody has the same experiences.

One of those is on the other side of the house. On the Chief of Engineers' side of the house, the Army Staff side, I think a person really needs to have experience in the Pentagon, in fighting the battles of how the Army does business, and I'm talking about POMs and budgets, and dealing with the Director of Program Analysis and Evaluation, and getting down into the real, tough, infighting on issues. So, you know how to play to win; know you have to get deep down, do your homework, and be tough in the trenches if you're going to win those battles. At the same time, you also have to know how to deal and build credibility.

A person who plays in the Army Staff arena has to be credible, has to be smart, has to do things very timely, and has to have a sense for how to balance all those things so that you're there at the moment before the decision is going to be made, anticipate what's going to happen, figure out who the influencers are, and network those influencers before an action. Also you can even be tough and go for the jugular when necessary and somebody's picking on your people, to make sure your people aren't picked on, and you don't lose because of that.

So, a person needs to understand the Department of the Army's staff arena, and it's a tough arena. You can get overwhelmed and overrun if you're not playing it tough. I think my background, having come up from a major Army command—that is, Headquarters, USAREUR, in 1978-'79 where I was involved in working with the Army Staff—and then coming to the ACE's shop where I sat on the Program Budget Committee as the Deputy ACE and experienced all the infighting around those programs, gave me that preparation.

Then, subsequently, as commandant of the Engineer School at Fort Belvoir, where I fought Army force structures and systems battles—I mean a never-ending fight to sustain structure,

spaces, systems, and dollars—prepared me to have a sense so I could work with Hank Hatch. He'd also had those same kinds of experiences, having been at Belvoir in Combat Developments—not as commander, as I was, but certainly in that most intense combat developments part of it—and having served as the ACE and as DCSENGR in Europe, he also had those same kind of experiences.

So, we can almost talk to each other in shorthand, understanding what needs to be done almost immediately, based on the parameters that we see out there. I think that's been helpful, having the two of us. As he goes around a bunch of other places, the other one left here—that's me—or if I'm out places, he's here, somebody's always around that has a sense for that, to help provide perspective and guidance to the people in our Resource Management shop or the ACE's shop where we're fighting all those battles, or preparing for those battles.

So, I think that upbringing—a sense for how to play and win in the Washington and Pentagon arena—is an important ingredient to my job as deputy.

I would say, on the command side, I brought a sense to the job as Deputy Commander of USACE that came from those same jobs, understanding the Washington level—Deputy Director of Civil Works; Chief of Public Affairs—but also commander of the Ohio River Division, where I was there for three and a half years and had a feeling that we needed a higher headquarters that acted like a higher headquarters.

Some of my time in the Ohio River Division back then, I never felt that way. As I would grapple and seek to obtain guidance or decisions, a lot of them having to do with resources, and then having to dialogue with so many over time, it seemed never ending. It just took too long to make things happen. So, I brought that sensitivity in.

Now, I already told you, I didn't come with agendas. I didn't come with an agenda to change the headquarters. Having been here, I think I have a sensitivity for the next layer down, the division, that we in USACE communicate to, that was helpful.

Q: Okay. Did General Hatch, early on, seek a kind of definition of what your role would be?

A: We had a very early-on discussion, and it was specific in what the role would not be. It was not specific in what it would be. It was specific in what it would not be, from the standpoint that he said, "I do not want it to be I'm a Mr. Outside, you're a Mr. Inside—that is, I would go out and travel around and you stay here to do everything. I want yours to be a substantive role and across the board."

I think he probably asked me what I thought before he gave his views. I told him that I felt I could probably best help by using my background, which had been across the board. I didn't want to be a designated hitter, role player, take a part of the action and he'd take another part. I saw myself dealing with substance, not process. I'd served in the Chief of Staff of the Army's office before as Assistant Director of the Army Staff, and I saw how the Chief of Staff did some things, and the Vice Chief of Staff did other things, and they didn't try to

duplicate themselves, but they both dealt with substance, and the Director of the Army Staff took care of process.

I thought that was a pretty good arrangement and that they were maximizing both number one and number two to deal with substance. The whole rest of the Army Staff worked the process under the Director of the Army Staff. That's where the process works, but when you want to go to win, then you send somebody who'll fight the battle.

It shouldn't be Hatch and me together. He goes and fights some battles; I go fight some other battles. Or maybe, if he's off somewhere, I go fight that one, or if something I've been handling and I'm going to be gone, he comes in and he covers that one.

We often strategized together. I'm a contributor to his commander's guidance and how he formulated an approach to something, but we're both players of substance. We had that conversation, and he agreed that he wanted me to be in that substantive role.

I had been interested, when I looked at Ken Withers' 67-1A, that he had done an awful lot of work on automation and an awful lot of work on research and development. Specifically, I left those off my 67-1A when I submitted it because we'd had this conversation—that is, Hank Hatch and I—about staying broad across the board.

He asked me, when I sent it in to him, "What about automation and research and development," and I told him why I'd left them off. He said, "Well, I agree. However, those are places where we have an SES in Research and Development, surely, but we don't have one in the automation arena. So, I'd like you just to provide a little two-star oversight in both these arenas, especially since Bob Oswald [Director of Research and Development] has been off convalescing for a period of time."

So, I put them back in. So, I did carry those roles and, in fact, I was very busy in both roles this year, for reasons that developed over and above the fact that I was just going to be the oversight. It turned out that, in both arenas, there was a year of intense activity, and whether I had written that on my 67-1A or whether Hank Hatch had told me pay attention to those two arenas or not, I would have been fully engaged in them.

I was also fully engaged in military programs, and involved in Bill Robertson's strategic planning, got involved in civil works and some in real estate. So, I really was across the board in the various arenas. I've left out resource management. I did a lot in that arena too.

Q: Well, General Hatch spoke of his deputy as an alter ego that he saw there, your spheres intersecting, and that he was looking for a credible spokesman for him when he was not there. These are all the things that you've mentioned.

I asked him specifically about the inside and outside because I recalled that, at—I think it was at General Withers' retirement—there was reference made to that distinction by a previous Chief of Engineers. General Hatch got up and made a reference to the fact that that's not the way it was going to be under him.

So, you know, I was following up on that. He came in from the Director of Civil Works position, of course, under the previous Chief. So, I think he saw that aspect, and that was something that didn't suit how he wanted to operate.

A: Well, he's very comprehensive, and so he can handle a whole lot of things all at once. The Chief of Engineers, like a lot of people—like when I was at Fort Belvoir; like when I commanded in Germany—as the boss has demands on time from well-meaning people who like to have him come out and visit their organizations and show the flag because it makes them all feel good, and it's kind of important.

Sometimes the Chief, or his player, needs to be at the battle—moving toward the sound of guns. Sometimes it's more important, and you do more for the organization being at an Army Select Committee meeting than out visiting “Project X” or “District Y” and feeling good that we have the very best people in the federal government working on these jobs.

Q: It would seem, from what you said earlier, that you both have a sense of when you need to be at those kinds of things, and, you know, that that's the priority. It may not be the sexy things in terms of the people out there that want the flag shown and all that.

A: Right.

Q: In terms of attending Select Committee meetings and other meetings in the Pentagon, then, have you found yourself just doing that frequently? It seems that General Hatch does it a lot himself.

A: I've attended Select Committee meetings and I have attended general staff council meetings—all those meetings for him. Pete Offringa, the ACE, does also, as the guy over there in the Pentagon. General Hatch, if he's here, will go to them. So, whatever works best, that's what we try to do. Sometimes when he's here, but he has to go somewhere, I'll do it. Often we'll size up the subject matter and see who the players have been, and that will make our determination, as well.

Way back, when I wrote him a letter congratulating him on being chosen Chief, I gave him a couple of pages of friendly guidance and counsel that suggested that he needed to pay attention to the Army's POM schedule, the Select Committee schedule, and that he needed to play and win in Washington. Sometimes he ought to look at his schedule so that he doesn't get trapped away when he needs to be there, and be ready to break things.

I remember General Noah telling me once how he was supposed to fly out to somewhere, while he was Comptroller of the Army, and more than once called and canceled a half an hour before the flight was supposed to leave because of something critical that was happening.

I think Hank Hatch has done that. In fact, after he came in, he said, “Well, I got your letter out the other day, just before you came in, and I think you should be happy that most of the things you mentioned I've accommodated.” I said, “Yes, that's been obvious to me.”

Q: What about the whole scheduling process in the executive office. How is that handled? By the Chief of Staff, pretty much?

A: He runs the process of the staff. Scheduling, of course, is done with our respective secretaries, or the Chief's exec. Different people need us for different things, and they call the secretaries up directly. We interact with our secretaries to decide the priorities of who needs to be where and what might need to get slipped because something else has occurred that requires attention.

Travel is a place where each time you commit yourself to travel, then you're vulnerable to whatever happens during that period. So, we weren't Mr. Inside/Mr. Outside. I've traveled extensively—I haven't been to every division, but I've traveled to quite a number of them. One of them, a far-reaching trip out through Pacific Ocean Division, took over 10 to 12 days.

When you schedule a trip like that, you're blocking out time, you pretty well have to look within. At those points in time, the Chief of Staff, Al Genetti, who maintains a schedule of general officer travel, tries to assure that we're all covered. When Bob Page was our secretary, he wanted the Chief or me here, one or the other, and the Director of Civil Works or the Chief here, one or the other.

So, we were always looking to see where there are conflicts before we accept things, or before we lock the schedules. There is a lot of interactivity between the secretaries, the Chief's exec, and Al Genetti and his Secretary of the General Staff people.

Q: That sounds like you play a pretty active role in determining the schedule as well.

A: For a long time I've always looked at a six-month block calendar for programming and major things like leave and like trips. Then a two-week closer in focus, and then, of course, the day by day.

In my six-month block, I don't know what the day by days are going to fill up with, but Delores Green, my excellent secretary, takes care of filling those. If I'm in town, then she works who gets there and who doesn't.

We have master calendars of what events are coming, and so the Secretary of the General Staff folks tell her when the Monday staff meeting is going to be on Wednesday of this week, can we schedule it; or my Friday automation executive committee meeting that often meets on Monday or Tuesday. When we make all those changes, we call it around.

I found a long time ago that if you're in an executive position, you can't abrogate your own schedule to somebody else or you lose control of yourself and the ability to put your time where it needs to be put. So, every now and then I'm a little frustrated, and most of the time I remember that I have not paid attention for two or three days and let it get away from me.

But, you know, you don't get down to the details. I just sort of keep tracking and watching and knowing, and then trying to set aside days sufficiently in advance if I want to go and do something. For instance, if somebody would like me to come and talk, then I look around,

what else I would like to do to make it a two-day affair, and then I'll start the negotiation maybe three months in advance.

I'll participate in that process, so that when we lock it, it's of value. That participation may be one phone call, two phone calls, put it down and the details will come in later. I know generally what's there and what's going on, and to put it in the parlance we taught at Fort Belvoir, the commander's guidance has been given; now frame it, and flesh it out, and make it work.

I guess I learned that lesson—that's probably another contributor of the past—when I was commander of the 7th Engineer Brigade in Germany because I really had three hats. I have two hats here in this job; I had three hats there. I was a brigade commander, commanding the largest engineer brigade in the Army, six battalions and an atomic demolition munitions company. I was also the Corps engineer, responsible for all engineering activities in the VII Corps, to the Corps commander. I was community commander of the Ludwigsburg–Kornwestheim community during this time, subcommunity of the greater Stuttgart military community.

What I found out was that the community staff because I interacted with at least three mayors and county commissioners, the *Landrat* would ask for my attendance at things far in advance of either the Corps staff or the brigade. So, my first few months there I was always boxed because my calendar was filled.

My learning experience was that I had to take charge of my own calendar or I would lose my ability to influence things. So, I did it then, and that experience has been valuable ever since.

Q: Do you and General Hatch have regularly scheduled one-on-one time, or has it just happened irregularly, or how do you arrange for those kinds of meetings?

A: No. We have a door between our two offices, and we walk back and forth as needed but don't have a scheduled one-on-one. I go see him when I think something's burning, and he's the person who finally provides the direction, and that sort of thing.

So, if I've been handling something and I want to make sure he's aware of it and the direction I'm going, he's got a chance to tell me that. Or if I find out something he ought to know because he's working something and I want to make sure he has that influence and my input into what he's doing, I just walk next door and we chat.

So, it's been rather ad hoc, discussing things.

Q: Have you found yourself ever put in the position as the deliverer of bad news, as, you know, something has teed off the Chief, kind of thing?

A: Oh, you mean to deliver bad news from him to somebody else? Or are you talking about taking bad news to him?

Q: Well, I guess both. I was thinking of it as sort of a protective role to the Chief, he didn't have to do it, or for whatever reason. It doesn't sound like it was frequent.

A: I don't recall any of that. I do recall at Fort Belvoir it was nice to have a tough deputy so that I could be the nice guy.

Q: Yes, I think that's what I was getting at. Yes.

A: No, I don't think so. I've delivered some folks some bad news, but not because of protecting the Chief. I mean, I just felt that was my role to do it. I don't think, in particular, I was a deliverer because I can't recall any instance, as a matter of fact.

Q: Okay.

A: Usually when something like that happens, it is that somebody wants to save themselves for yet another communication. So, if you pull back once, then you can still play. If you're the deliverer, then there is no opportunity to perhaps work things out, other than be at this final resting place.

Q: Right.

A: So, sometimes you'd want to try to keep it down at a working deliberative level, rather than at any culminating point. I can't recall any occasions frankly.

Q: What kind of a feeling, if any, is there in the executive office of a sense of what's going on at the lower levels, in the directorates? I think General Edgar was saying something the other day about, you know, a lot is missed, and I think that's probably maybe just what happens because of the nature of the beast. Do you make a conscious effort to be regularly involved with the directorate heads and the issues they're working?

A: Yes, with the directorate heads, but I don't make a conscious effort to get down below them or talk with their people doing the job. I have to qualify that by saying it's different if it's something where I require the directorate head to come up. I would probably call the directorate head or his deputy or maybe his executive director on an issue. If they choose to solve it by sending up somebody, that's fine. I mean, I'm receptive to whomever they send, the expert. For example, in the recreation study I had a lot of interaction with Dave Wahus, even though Dan Mauldin, the Deputy Director of Civil Works, was the principal contact. So, I'd probably call Dan Mauldin; Dave Wahus would probably come up and tell me where we are, and that was certainly a good way to work.

In the automation line, I worked with the entire staff on that program that we had going this year, and so I really got down and got a feeling for that.

By understanding—if the comment by Edgar was we don't really understand what's going on down there in—

Q: No, I think what he meant was there's an awful lot happening, and you're going to miss it if you don't deal with it. Yes.

A: Well, there is a lot happening but, I guess, we're all put here and have a particular position to handle only what we can handle. So, I'm very happy with Pat Kelly handling his directorate, with my knowing enough to engage and that things are going in the direction that USACE wants it to go. When we need to know, we know how to get involved, and we can do it and work it. I don't have to walk around Civil Works office to office and find out how folks are doing. That's his job.

Q: Shortly after you came, you had a transition workshop over at Fort Belvoir. Was that your idea?

A: No, I was told by the staff I should have it.

Q: Okay. Did you find it helpful?

A: Yes, and I was surprised. I didn't think I would. I really kind of fought it for the first two or three times. I said, "Why do I need a transition? I know most of these folks; most of them know me. I mean, I'm not an unknown quantity, so why do I need to do it?"

Everybody said, "Yes, but there are a lot of questions out there. They want to know how you want to operate."

So, I more or less went along. Just to go on to your next question, I really found it valuable, and maybe not for what it started out to be, but for that too.

Anyway, it was prescribed that I ought to get to know the folks better, and that was true, and I did. Second, they ought to get to know me because now I'm in a different role, and they need to look at me in that role and hear me talk about that role.

So, with the questionnaire that was put out, I was trying to figure out from them what they sought—and you were one of them—

Q: Yes.

A: —sought from me, the deputy, a role definition kind of thing.

Now, I sensed there must be somehow growth from my predecessor and where he fit in with the Chief. Or maybe it wasn't. I don't know. But, for some reason, to me, there should be no question about role. I mean, you already heard what I said about Hank Hatch in my discussion, which seemed to be sort of typical of how I expect all Army activities to operate and how deputies and chiefs of staff and commanders operate. So, although it seemed plain to me because it was suggested, I went through it.

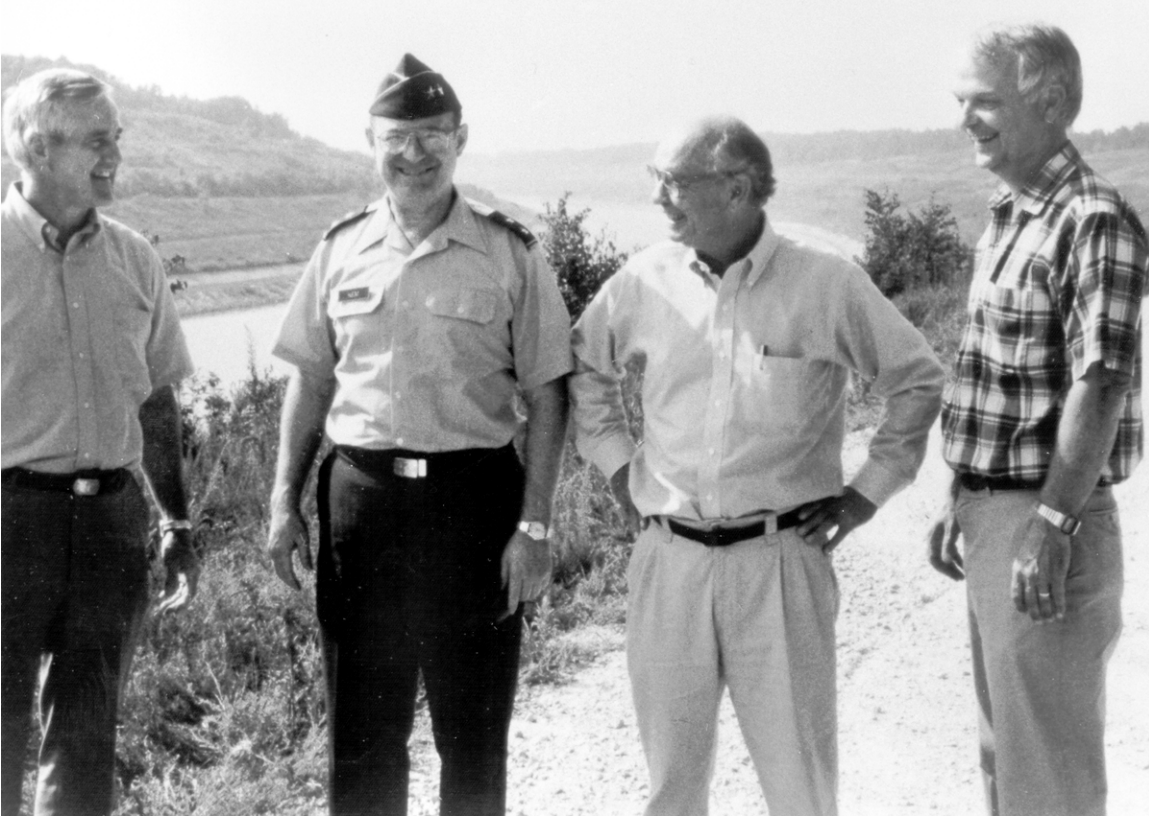

General Kem (second from left) with leaders from the Nashville District at the Divide Cut of the Tennessee-Tombigbee Waterway in 1990.

Now, with the questionnaire coming back, I was really kind of surprised because many of the answers suggested that everybody wanted me to be a “Super Chief of Staff.” I’ve always told you that I wanted to deal in substance and thought I should deal in substance, and we had a Chief of Staff who could handle the process. Well, he’s not a general officer, that’s true, but he’s pretty effective. At least I thought so. Having just been a Chief of Staff, I knew how one could operate a staff and deliver what the CINCUSAREUR needed, and how demanding he was in that instance, and how you have to keep a lot of activities going. I mean, there’s a lot involved in being Chief of Staff.

We had a deputy commander in Europe, so we had that same separation role over there—the two got together, but they also did their different things. So, there were two substantive persons, not one a mirror of the other.

So, when I read the results of the questionnaire I thought, “No, I can’t be a ‘Super Chief of Staff.’ We don’t need two of us; there really is enough work around here to be dealt with substantively for the Deputy.”

So, I used the session initially to sort out the issue: Isn’t there enough work at the Corps headquarters? What really is the problem?

I sort of came to understand that what people were saying was that our staff process didn't work fast enough, and I also sensed that it didn't work fast enough. I can talk about that some more, if you like.

The way I decided I could help the most is not messing with the process, but be this substantive person that can make decisions. The problem was, we never got around to making decisions. So, if Al Genetti, the Chief of Staff, could work the process and I could deliver somebody a more rapid decision, that's probably helping the organization better than my trying to also work the process.

So, I came to a different conclusion as to what the real problem was, and I was willing to let Al Genetti keep working the process.

When we got out of the workshop, with people talking all that morning, all of a sudden I was supposed to give feedback in the afternoon. I was ready to give feedback by eleven o'clock in the morning.

So, I sort of summed everything there and told everybody where I was coming out. It occurred to me, also, that perhaps we had an identity problem within our headquarters unto ourselves, and that identity problem—having worn two hats before and having sensed this before in our headquarters—is that we sometimes confuse whether we're doing things as staff for the Chief of Engineers or the staff for the Commander of USACE. Only one place does that occur in the Army, and that's with the Chief of Engineers and Commander of USACE.

By the way, the Army is about to put the Surgeon General back in that forum, where Health Services Command will go away and the Surgeon General will be the commander of whatever this new organization is called. So, he'll be two-hatted again.

Because of this, there was confusion in the headquarters—and certainly we had two letterheads. You can sign things “Chief of Engineers” or you can sign things “Commander, USACE.” A person might be working in the morning on one action, and in the afternoon on another action for the other side.

I thought, then, for the balance of that day we'd just have an exercise to figure out if people really knew where they were because I didn't know. You know, you ought to be able to construct a wiring diagram representing your organization. It always seems like you might be a little bit better if you knew who you are when you're doing what you are doing.

So, I asked folks to address that issue, and two different work groups came up with a scheme by which they would lay their functions down and then address whether they were Army Staff or USACE headquarters staff—that is, policy, programming, or operational in those aspects of the USACE headquarters. Then the work groups really got into it.

I mean, I watched it, and there was a lot of energy and enthusiasm, and it seemed like a pretty good exercise, to me. I had some disagreement with one, but I mean, that was part of the interaction of understanding.

For example, the disagreement was that the Inspector General said, “Well, of course, he’s about 50–50. He’s 50 percent Chief of Engineers staff things and 50 percent Commander, USACE, things.” Well, I took issue with Denny Bulger at the time and said, “No, I don’t think so because the only reason for the Inspector General is to be the Inspector General for a commander.”

That’s how it all started, way back with Von Steuben, and that’s a very good Inspector General’s role, to be there for the command and the commander, sensing the ability of the command.

Why would an Army Staffer need that? He said, “No, obviously I do.” I’d say, “Well, we’ve got a Department of the Army Inspector General. You might be called on to provide him some help, but he also gets command assistance from the FORSCOM Inspector General and the USAREUR Inspector General.”

Of course, I had just come from USAREUR where I was Chief of Staff. The Inspector General reported through me to the Commander in Chief.

Anyway, it was through that kind of a dialogue that I tried to heighten people’s sensibilities to roles, really come to grips with self. Are you really doing that because you are the expert MACOM guy, or is that really a staff function?

Of course, we had the deal with Civil Works, which is a staff function when they’re dealing through the Army Staff secretariat, so you’d count that the same as Army Staff.

So, they put out a tasker to everybody to go back and look at their organizations and come to grips with themselves and put down the number of people they have working both functions to just see where we come out.

We came back together 30 days later and had a report out. We had worked the various sheets in the meantime, and our discussion was, I think, illuminating in a couple of rather key instances. I think everybody understood themselves a little bit better, and I hope that process allowed them to influence some of their subordinate people into understanding the two very important roles.

The answer came out that, basically, about 17 percent of our activities here in Washington had to do with the Chief of Engineers’ role—that is, dealing with policy, programming, and things in both civil works, military construction, real estate, research and development from an Army Staff role. For the Chief of Engineers reporting to the Army Staff, the Assistant Secretary for Installation and Logistics, or the Chief of Engineers reporting to the Assistant Secretary for Civil Works, that is doing a staff role. About 83 percent of our activities were as the MACOM headquarters staff, dealing with how we work our divisions and districts—dealing downwards, in other words.

Now, the second thing—and this came from participants—was a statement that I thought was really interesting and most illuminating. Somebody said, “So, 83 percent of our time was

spent at Headquarters, USACE, but I would bet that's the part of the job we do less well than the other part of the job."

My reaction back was, "Now that you mention it, as I think back to my time as commander of the Ohio River Division, I would sense that's right. I felt then that your attention was on Washington level things, and I had difficulty attracting your attention to deal with me on things. You surely sent out a message saying, 'You only get this number of spaces; you will do this.' Trying to get a meaningful dialogue and influence was difficult."

So, it really is important to understand, you are the Headquarters, USACE. That's 83 percent of our role, that work. You need to work in putting out the right policy, doing the right programming, the right kind of resource allocation, the right kind of anticipation to direct, lead, manage this worldwide organization called USACE.

So, from all that, I thought the workshop accomplished what it was intended—that is, the interaction so that I get to know the chiefs better. I thought I got a big value out of that. Second, I thought we probably did some illuminating work that was of benefit to all of us.

Q: It was an approach that hadn't been taken before, in terms of sitting down and trying to look at that, and I think the comment that you made was that, you know, from below, we don't look like a corporate headquarters, or are we acting like a MACOM, and what does it mean, to act like a MACOM?

There's probably more to be done on that as an outgrowth of that session, I think. More sensitizing. Has there been an effort to carry on that kind of thinking in terms of attention to the MACOM headquarters' role in the months and the years ahead?

A: No, I don't think so. I have used the occasion to articulate that in the senior leaders conference and at other kinds of affairs. When I got into the automation business that I was involved with during the year, I figured that in that case we were definitely acting in the MACOM headquarters' role, and therefore we needed to do headquarters kinds of things for the command. Others may have not known or understood that aspect of it, but to me, having gone through the transition thing, my recognition was that this action would involve that part of the USACE world, and we've got to do those necessary actions, even though we were responding to Bob Page, of course, who was a staffer.

I was really doing Headquarters, USACE, things, but that would cross over the line to the Deputy Chief's role when I'd go see Bob Page to present.

Q: Did you share the results of that session with General Hatch?

A: Yes, much like I described to you before. I walked in and chatted with him and told him what we'd done.

Q: Maybe it helped. I think, from the questionnaire, the interviews that happened beforehand, and you were talking—there was a situation between the deputy and the Chief of Staff. That's one of the real things that came out, and perhaps that was a frustration over the feeling

that the process wasn't being managed as well as it should be, or could be. It may not have been a question of individuals in charge of that as much as how big the process is. I don't know.

A: Yes. Might be.

Q: I know there was some reference made to the time in the few years before you came in, in the mid-80s, when we had, like, four Chiefs of Staff in two years.

A: Yes.

Q: That was a problem. There was a sense from the staff that we needed some continuity. Of course, with Colonel Genetti we've had, certainly, a greater measure of continuity—

A: Sure.

Q: —because it's been almost two years; next month it will be two years. Compared to what we'd had, you know, we've had three in that same period before.

A: Well, that's a very key job, and the person has to be the right kind of person. He also needs a kind of anticipation and know-how to play and win in the Washington area for that position. Al Genetti had that because he'd been with the State and Regional Defense Airlift and been in and around a bunch of different places.

Q: He'd been in the Office of the Assistant Secretary of the Army for Civil Works.

A: Yes. So, he had a feeling for how people can get down on you when they don't understand, and how you may not even know that you're in trouble because the dialogue is going on, and you figured everything is wonderful, and over there, they're ready to carve you up because there's misinformation. How you have to stay tuned and be in constant contact and then mount a counteroffensive and do your homework and go do these things.

He also had a sense of organization. An organization's got to run. I've really been impressed with the way he's done things this year because I've seen how he gets the staff together. And, having gone through that transition thing, where I wasn't going to get involved in his business, he has done absolutely what I thought he would do. That is, he has run the staff.

In our USACE organization we have such powerhouse directors in our big, functional stovepipes, and they are the Directors of Civil Works, Military Programs, Real Estate, Research and Development. That's how they operate, as program directors. They run their programs.

You find at the AMCs, the Forces Commands and the USAREURs, the Chief of Staff is a two star, and he's maybe the senior guy. Then the directors of the staffs may not really be program directors and not as powerful. Staff activities are two and one stars, or SESs.

I was the USAREUR Chief of Staff and was the senior two star on that staff. The Commander in Chief says, "I don't want to talk to the DCSOPS every morning; I talk to the Chief of Staff every morning. The DCSOPS can talk to the Chief of Staff. I let the Chief of Staff run the staff. I don't interact, direct, one or the other, unless the Chief of Staff sends him in to see me." Here in USACE we have a colonel level Chief of Staff/executive director because he, too, is Chief of Staff of the headquarters element and also executive director for the Chief of Engineers in his staff role. He would funnel a lot of things through the ACE when they'd come through the Army Staff.

Then we have this direct relationship of the Director of Civil Works with the Assistant Secretary for Civil Works because of the way that works, it's so close to Congress. With these powerful, functional components and program directors, our colonel Chief of Staff starts from a position of weakness unless he's got guts and fortitude and a lot of ability.

Al Genetti really has operated as a Chief of Staff, and I think earned everybody's plaudits for that this year.

Q: The new Chief of Staff comes out of the Pentagon arena?

A: Yes, comes out of that arena. When I was in the ACE's shop, Bob Herndon was a lieutenant colonel action officer in DCSOPS trying to get the NTC under way. Thankless job. He did a great job. He won the Pace award as the outstanding action officer on the Army Staff there.

Now we have him. He knows our organization. He's been the Jacksonville District Engineer, so he knows what happens in the field. He knows how to make things happen on the Army Staff. He's been a very effective executive director to the ACE, so he knows the Program Budget Committee and Select Committee and what's important.

Now he's going to be here as Chief of Staff. I think he'll come in and there will be some differences. There always are, but he'll really know how things work. He'll be a good one.

Q: Is there anything more you'd like to say about the ACE's office and how that fits into the scheme of things? I know you mentioned the Director of Civil Works and the Assistant Secretary, but sometimes there seems to be tensions, or whatever, between Military Programs and the ACE's office, perhaps, or the headquarters elements and the ACE's office.

A: You say sometimes there seem to be tensions; there probably are. In a lot of things where good folks are operating, tensions occur at the staff level. They're trying to protect their boss, or isolate their boss, or do something.

Usually when you get boss to boss, reason and logic prevail. Sometimes below those levels, somebody's trying to make sure they keep it in a particular arena, as they see the world, but they're not the people with real perspective of how things are. The boss got to where he is because he'd been through all those major, lieutenant colonel gates, and now he's a major general, like Pete Offringa, the ACE, because he's done a lot of that stuff. He has a perspective. Some of his subordinates may not. So, I think most of it's that.

I served in the Office of the ACE from '79 to '80, as the Deputy ACE. I was the first of the brigadier Deputy ACEs before the job went away. I just happened to go there as the colonel deputy and was selected for brigadier general, and General Morris left me there for the year, so we had two flag officers playing in the arena.

Because that's really a tough job over there when you have to go up here before four committees, as the ACE does, and you have to attend all the Select Committee and Program Budget Committee meetings, the poor ACE finds himself coming and going.

So, it was awfully nice for General Bill Read at the time to go work the committees, and I would work the Program Budget Committee. Thus, he didn't have to be coming back from testimony to be handed a bunch of documents to go sit in the Program Budget Committee meeting until eight o'clock at night, whereby they'd hand him his testimony for the next morning for the next appearance before Congress.

There's plenty of work in the Office of the Assistant Chief of Engineers for two folks.

At that time, there was some tension between Military Programs and the ACE's office because, in fact, we in the ACE were carrying the programming ball for housing and for facility engineering. Those aspects both came under the then-Military Programs, who had their own brigadier general, and the people over in the Pulaski Building. The ACE was all over at the Pentagon.

So, there were tensions because we always had our own MCA programmers who had all the answers. Then we'd have this big, apparent void, you know, in housing. So, we weren't developing a full plate of answers or positions.

That was structurally fixed later when they moved programmers from those other offices over into the ACE programs. Certainly, our facilities funding understanding and ability to articulate issues is much better because of that.

There's a very separate difference between the ACE and his role as the Army's programmer and his installations staff role, and the Director of Military Programs, who is the Corps' executor of those missions the Army gives USACE for construction.

Now, over the last couple of years that has been broadened, of course, with the growth of our environmental programs and our defense effort to solve environmental problems. Maybe there's been a little tension grown there because we have the environmental office, which works for the ACE, as he did way back when. With Military Programs that environmental part has now grown.

So, there might be some tension there, as we work that out. We've been trying for some time now to make some organizational changes with regard to the environment, and that hasn't yet come out of the secretariat because some of the folks over there are working their own agendas. There are still some battles ahead to sort all that out.

Basically, the ACE, as I see it today, is much stronger than it was in my day in the ACE. They're a much more credible player on the Army Staff, I believe, respected by the operations community, and the Chief of Staff, and the Director of the Army Staff in ways they weren't back in my day. We seem to always be trying to clamor for recognition and credibility. I think, over the years, because of the things like I mentioned, of moving housing and the O&M programmers there, so the ACE had a more complete package. Those structural things were fixed. So, therefore, they're better.

Q: Yes.

A: Second, now, when I was there, it was the last of the Carter years and we were on low budgets. So, the second factor was that we went through the Reagan years' budgets and all of a sudden the ACE comes out as a bigger player on a bunch of things because of that.

Now, with the growth in the environment and the Chief of Engineers being given the role as the Army's chief environmentalist, the guy responsible for the Army's environmental programs, the ACE's role has grown. Finally, with all the base closures and the realignments and all those exercises that have to do with installation planning, the Installations Planning Office, which had all the books back when I was there and did some pretty good stuff, now is really involved in anything the Army tries to do in figuring out changes in installations.

So, I think the ACE is much stronger than it used to be and a very credible player. I don't see any problems or tensions in what's happening with respect to them. If there are, it's because somebody doesn't understand the respective roles.

I think, without doubt, with regard to Military Programs, we've got communications there better than ever before. I'm sure Bill Ray, having arrived and having come out of Europe as the DCSENGR and now having been previously in the ACE's shop in programming, that also will improve—just understanding of the leaders and how things are.

Now, as new people come in as action-oriented folks, they've got to provide their perspective to their organization, so that they respond and respond that way.

Q: I would like to ask you about—you said you might want to return to the issue of the process not working fast enough, since we were just talking about process a few minutes ago. Do you have more comments on that?

A: Yes. As a headquarters, we really don't do staff actions in a timely manner. Now, you know, I just got through saying Al Genetti really cranks these and does them right. What I'm really coming down to is I think we're so big that we don't have that Pentagon, Department of the Army sense of timeliness on doing things.

We almost have a MACOM of stovepipes. We're a very professional bunch, so we'll go at it very deliberately, and sometimes we're not ready with a decision when it needs to be made.

Now, you can say, you know, that maybe they want decisions too early. Well, in this environment, in this town, to win you have to have anticipated, done your homework, and be

ready to deliver because a quality product is only quality when it's delivered at a point in time that it influences the action. If it's delivered two weeks late, it's then overcome by events and doesn't mean anything.

So, just time and time again I find the action officer has come in on something, and I ask where are we, and he responds, "Well, we're still waiting for coordination chops out of this directorate or that directorate."

"Well, okay," I ask, "how long has it been?" "Well, it's been three weeks." "Three weeks?" You should never have to wait three weeks. You don't get it in three days, then they probably didn't want to comment, or you probably shouldn't have asked them, or something. I mean, there's some phenomenon that's apropos here.

So, two problems. One is we've gotten into this environment where it's all right to never give a person's paper back. Second, our action folks don't know how to get attention to get something back on a timely schedule.

We've sort of grown to that. That's become our thing now, I think, and we really need to get away from that, so when we have a paper, the action officer has talked it around enough to know that they're about to have a consensus or not. You get it there so you can get a concurrence or nonconcurrence quickly, walk it around or whatever. If we get the nonconcurrence, we write the statement of consideration rather quickly and get it up to a decision maker so that the problem hasn't festered and become worse, so the problem isn't overcome by events, so that it's more meaningful. So, that's what I mean.

Q: How do we get out of this problem?

A: We really need to work those faster. Today we assign ourselves deadlines that are too long.

Q: Yes?

A: I mean, the Secretary of the General Staff will assign a three-week deadline, which, in my view, usually means two weeks on the back burner, and then they pull it forward and work it.

So, if you really need something, then you ought to assign a week deadline so they work it right away instead of putting it on the back burner. Now, you can't do everything that way, you have to measure importance and figure out how you cut the amount of work. I think what we're doing is, our staff folks are putting a lot more work in some things than is really needed, so we're spinning wheels; that's really needed for the decision maker. As a measure of productivity, that's pretty bad because we're not getting any productivity.

So, we need to find the way by pushing the system so that we get the right, smart person to do the right thinking, to come up with the right conclusion, and we don't spend process time trying to get that right conclusion to whomever is going to make the decision.

If we study an issue and then restudy it and overstudy it, then that's not going to help. So, I think we've got a way to go to get that one squared away.



General Kem (second from right), Deputy Chief of Engineers, inspected the chemical demilitarization facility on Johnston Island during a visit to the Pacific in 1990.

Q: How would you do it? If you were going to be around for another year, whatever, would you devote more time to trying to clean that situation up? Can the Chief of Staff do that on his own, or is he going to need a higher emphasis on the whole?

A: Well, no. There are only two people higher than the Chief of Staff.

Q: Yes.

A: So, I have tried to work it out this year in the things I've done. I'm just trying to make those examples of something by saying, "If you want to get it coordinated in three days, give them three days. If they haven't answered by then, you just send it up to me and say they didn't answer, and we'll make the judgment." Or, "Why did you send it to all 20 people for coordination because you know that for 15 of them it doesn't apply and you don't need their comments? It's not going to be meaningful to you; it will not improve your paper. If you spend two days on each one of them coordinating it sequentially, you'll never get to the ones you really want. So, why don't you just take it to the five people that you need input from, get their input, incorporate it, and then go talk them into signing concurrence."

It becomes a training issue for every action officer. To do that requires mentoring and coaching and perspective from the executive directors and the bosses down the way. You're

not going to run a school and run everybody through it for 14 days at a time because those things don't come out.

Q: Of course, our staff action handbook, which was a product of the last couple of years, is trying to address some of these very issues.

A: Yes, that's helped.

Q: I'm sure it's helped, and I think there's been a great improvement.

A: Yes.

Q: You're saying we have a ways to go yet.

A: Yes, I think there has been improvement, even this year, but we still have a ways to go.

Q: Now, a frequent complaint we might hear is that everything has to go to counsel, and that this becomes a real bottleneck. Do you have any comment on that?

A: Well, in today's world—

Q: Today's world?

A: At the high level we deal with in civil works, in military programs, in real estate, in resource management, I mean, counsel's pretty important. And, in fact, our counsel is more than just a lawyers' shop. They provide counsel too.

You get a guy like Les Edelman, who's served on the committees of Congress, and with his great sense of Washington you get more than your money's worth. You're not just getting a legal check for dotting i's and crossing t's.

Q: Yes.

A: You're getting counsel. So, it's pretty hard to argue. Every individual item can be looked at on its own merit. Does this one need to go to counsel or not? It's pretty hard to argue that the sense of important kinds of things, that our counsel shouldn't have access—be able to be monitoring and have an opportunity to view an issue and say, "Chief, that's no problem with us," or "This seems to be not thought out," or "Somebody forgot that in 1884 somebody did this to that," and that sort of thing.

Q: There were three specific areas that I wanted to look at a little more closely, and one of those is the information management area. The CEAP [Corps of Engineers Automation Plan] seems to me to be one of the major areas that's occupied you in the last year. That was something that had started before, I believe before you came into the position. You were referring to the fact that General Withers had worked in the information management area a lot. You've already alluded to it in terms of dealing with it as a headquarters thing, but it

came out of congressional directive, and it came out of the Assistant Secretary for Civil Works. Correct?

A: Well, I will elaborate on that.

Q: I was wondering if you could explain a little bit about what it is and why, and the problems and considerations that have been involved for the last year.

A: Sure. The Corps of Engineers has been embarked for a number of years, like all corporations in America and all other government entities, in trying to figure out who handles all the information requirements they have, and how to automate it, and do all of those things at reasonable cost. Because there are big bucks involved and because the state of the art changes all the time, it's a very difficult arena.

It's hard to find anybody that's done it right, you know, in government. Certainly our airlines must have done theirs right because they can get all these tickets and do all that stuff so much better than they could fifteen, twenty years ago.

Way back, when I was here in the Public Affairs Office, '75 to '76, we were talking about CE80 [Corps of Engineers in 1980]. We were going to have this kind of architecture for automation, and we had people working on it back then.

Then when I got to the Ohio River Division, '81 to '84, we would get briefs at all the annual conferences about what the Corps' approach would be to do this and do that in automation.

Then, I arrived back last year as Ken Withers' replacement. He told me one of the things I would have to do right off was to consider whether I wanted to be the source selection authority for our CEAP contract. It had to do with a contract solicitation for firms to provide the hardware, software, and communications to provide for our Corps of Engineers' automation requirements in our MACOM role—that is, the headquarters, divisions, districts, labs, and other field activities.

When he talked about that, the first question was whether Bob Page should be the source selection authority, but he decided he did not want to be it. So, I inherited being the source selection authority. Now, that came up very early in my tenure, I would guess probably September of '89, which was my first or second month.

Q: The contract was awarded on the 6th of October.

A: Okay. It was immediately prior to that. The source selection really follows a process. Since you asked me to bring you up to date on this, the Corps had gone out a year and a half or so before that to ask for proposals to provide for Corps needs over eleven years in hardware, software, and communications. Several firms responded, and I guess this was winnowed down to a smaller number of three by the time I got into it.

Those three had gotten into doing certain show and tells, benchmarks, and other activities with our staff. We had an evaluation committee, which had met and gone through a rather

standard federal procurement approach of technical evaluation, where they would judge the three vendors and what they were going to do against the requirements. It involved both headquarters and field people, a rather rigorous system where they would be graded out on whether they fully met, partially met, or what in each of the categories of what we wanted.

The evaluation committee did the job on a raw score basis. There was no weighting to that, although we had previously weighted various arenas as being more important. Over a rather long period, the committee came up with a rather large volume of material, and it was pretty impressive. You take a lot of experts, put them down to evaluate others, and they really come to grips with things.

Then the advisory committee met. The advisory committee applies the weights and now brings in the cost bids for the first time. You see, the evaluation folks never saw costs. Then the advisory committee goes through a rather set routine also and comes up with a recommendation to the source selection authority—which was me.

We went through that process, and I had the advisory committee report. I went through the volumes of the evaluation board and the advisory committee and looked at all the factors. As the name implies, I was the final authority for the selection of Control Data Corporation as the winning vendor for that CEAP contract.

I thought that we had a good contract: eleven years of options, a minimum money guarantee. That is, we only had to spend some \$5.6 million or so to meet minimum requirements. I had all the evaluation criteria, and they scored out very well compared to the others, in some factors more than twice the others.

We had a good vendor and a good product in all three areas of hardware, communications, and software, also good training, good administrative capability, and the flexibility of eleven years of options, with the prices stated to buy certain things if we needed them.

Then there was to be a pilot test. Now, I sort of thought that was going to be the extent of my major responsibilities—selecting this vendor and that was that, and we'd go about going through pilot tests and then go about fielding it.

Congress and Bob Page, the Assistant Secretary of the Army for Civil Works, both had misgivings on the size of the contract. There was congressional language that pretty well said, "Okay, Corps, you can have your pilot tests and do it, but you don't need to spend more than the pilot test until you come back and tell us what went on."

Then I was asked to go brief Bob Page on where we were out of the source selection, so I did. I never had been made to understand how much he was against the CEAP program or his strong personal feelings that we were embarked on the wrong path—too much big computers, we didn't know what we were doing, we hadn't based the program on requirements, and so forth. He felt the technical people were driving the train; that our approach was to buy a computer, then figure out what to do with it. It costs way too much money, and we were never going to be able to afford it. We didn't need it, and we were really

on a binge. I mean, he was really strong about it. He had had his own experiences in the private sector, which put him in opposition to this direction.

We had a lot of others who influenced him on just the costs. He explained that every time we came over to brief him on CEAP, we sent somebody different over. So, he always saw a different bunch of people, and they were always the technical folks, and that didn't have much credibility with him. He felt the cost was just out of sight because he had seen an initial estimate that was up in the \$1 billion range, to do all of those things.

Now, the \$1 billion estimate was not \$1 billion. That was some early thing that had no credibility with us either. When you boiled it down to the kind of things being considered, we were talking \$120 million. I'm not saying that's not large; what I'm saying is the \$1 billion was grossly incorrect.

So, anyway, we had a rather testy meeting in which he was adamant that, when the pilot test was over, we'd better decide that was it. We weren't going to buy any more. I'm sitting there at the meeting saying to myself, "Wait a minute. What's all this? We're embarked on the thing."

I had thought it was all locked before I arrived. I thought we all had gone through it, processed it, and come to grips with what we wanted to do before we went out to the vendors. In fact, we had; but now we had different players. I responded to him that we did base CEAP on requirements. We were not going to buy hardware first and figure out what to do with it. We did know a lot of what we had to do. We did a lot of things in automation, and our other machines were wearing out. We absolutely had to buy something soon to replace our Harris-Honeywells because they were ancient, exhausted, and wearing out.

So, I promised him at that meeting that I would come back after the pilot test and lay out for him the direction the Corps wanted to go and answer all of his questions. I said, "We're going to show you how we based it on requirements. We'll show you how we fund it." He was also interested in charge-backs to the districts because he felt they couldn't afford it and we shouldn't put a system on them they couldn't afford.

So, I said, "We'll lay out the affordability situation in the districts. We'll make an economic analysis that shows you what we're going to get. We'll answer every one of your questions, and I'll bring it back to you."

He said, "Okay, well, you're going to have to do that before I approve it."

That took it from what I thought was going to be a nice source selection process and I would be done with this issue, to one where I took the lead because somebody had to, to sort it out over time. In fact, we did sort it out through a rather rigorous process that we set up.

There was nothing magic about it. It's, I guess, the way I've tried to approach things throughout my whole career. That is, when you have an elephant that's too hard to swallow in one gulp, you'd better break it down into bite-sized increments, attack each bite one at a time, and make it happen.

The problem was we had to do it all in a year.

Q: Which is the length of the test contract, the pilot?

A: The Harris–Honeywells had already worn out, and we needed to get out of them to start really saving money. We were spending big bucks each year on Harris–Honeywells, \$754,000 annually.

Q: \$754,000 a year?

A: \$754,000 a year per district Corpswide.

Q: That *is* big bucks. So, you had that very important time deadline for acting.

A: Right. So, what I was saying was the way I've always approached these kinds of things is to break it down in parts and then work each part. Because of the tight deadline, it could not be a sequential thing. We had to work them all concurrently.

What I'd promised him really was not that much different from my own viewpoint. I'd come out of Europe where we had just developed two or three different automation initiatives, starting down at the very bottom, at the work center, and doing something that made sense to the worker, and then amalgamating upwards.

For example, Butch Saint had always wanted a company-level computer. He thought that would save the time of the company commander and the first sergeant. The Chief of Staff of the Army, General Wickham, had said, "We will never have a company-level computer." His thought was you don't need the first sergeant tied to a desk in the orderly room. Two different views of the world.

Our approach in the Army—this is where our problems came from—had been to figure out what we needed at the top and then go down to the next level and the next level to the bottom level, so they had to provide all that information up.

Our approach in Europe then, as Butch Saint did it, was bring in a smart captain as commander of the company, have him design and build a laptop computer with the programs he needs to run his company. Then we would buy the laptop, give it to every company, and make each company commander able to pick up from our computer store the software packages to do that. It would be his. Nobody could meddle with him and change it.

Now, if something the company commander has on there is useful higher up, then they can pull it up and use it. It's his system. It was a pretty nice approach. Credit Butch Saint.

So, I brought those same biases into USACE. My bias was that CEAP ought to be requirements driven. There's probably too much information that we produce that doesn't really get used that ought to be scrubbed down. The biggest bias—because of the company automation experience where we put the company commander who knew what he needed in charge—was that we really needed a functional guy in charge, not the technical guy. So, you

see, I had an affinity for what Bob Page was saying because my own predilections were that you should do those things.

Then I remembered back, and all my years in USACE, in 1975, '76, I heard about CE80, my time in the Ohio River Division when I got briefed, who were the guys always talking about the automation? It was Information Management. Now, we've taken some people, given them the mission, come up with this Corps automation program, left them alone, really. In our own Army, Corps way, the staff and the agency in charge have got to run with the ball. That's true. In USACE it was really an Information Management-developed product, not a functional component-developed product.

So, he, the Chief of Information Management, goes in to the Director of Civil Works and says, "Let me have some time. What do you need?" The Civil Works guy says, "I'm too busy, you know. Go develop it; go talk to my underlings." So, we had an information management system that was developed, but it never had a buy-in by functional chiefs. So, we had to be able to tell Bob Page that, yes, we had based it on requirements, and we had to be able to solve his problem of our always sending somebody different over, and always a technical guy, rather than one of Bob Page's fellow engineers. I established a very quick principle. I put it under the "Let's make sure we win" principle, that we wouldn't send anybody over to Page's office anymore from our Information Management shop. I would go over. I would lead the team. I might take technical guys with me, but we were not going to send technicians over as messengers just to get shot because he would see who they were and shoot them just on sight.

I was doing a little damage control as I tried to grab hold of it to begin with so we could get organized and I could do my own thinking of how we could progress. Basically, the way we did it was, as I told Bob Page, I will accept the rose. I'll pin the rose to my chest to deliver to him all the things he asked for.

Having gotten the rose pinned on my chest, I went out to find some other rosette getters. That was to be the functional chief of each of the fifteen functional arenas in the headquarters.

The Director of Civil Works was really not the expert. He's got so many different parts, like project management, like engineering. I mean, those are the people in Civil Works who ran a stovepipe of activity who really were the Corps' experts on how you do that functional arena. Those were the people that I wanted in charge of that functional arena.

We set up a process. It started with them. The first thing was to put together the inventory, a list of the whole world of USACE automation, every program that we use, and match them against each of the functional arenas.

Having done that, then each of those functional leaders was charged with figuring out how people in that function do their work now and, second, how automation helps them do their work. Notice I was talking requirements. I didn't start with the automation; I started with work. That's requirements. So, the requirements are driving their automation needs rather than automation driving their requirements, from the Page comments.

I asked them to present that for now, the present, and then how they would like it to be in the future because every one of them would want to do their functional area better—how they'd like it to be in 1995. "Come back and tell me how you'd really like to do work in 1995 with automation helping you." They did that. Each one of them came back, and I had them brief our executive committee.

I need to stop, pause for a moment, and talk about our framework for dealing with our automation. It had to do with an Information Resource Management Steering Committee, high level, both headquarters and the field represented, and a senior level committee with a lot of SESs and general officers.

Underneath that we had some other committees because we had started data scrubs and we started considering configuration. We were going to have to get into configuration management once the pilot test was done.

Page wanted to influence the action down there, so he wanted his office represented on a users committee to represent the user. Now, I really took umbrage to that. I mean, we're going to put people from his office to represent the user? I mean, after all, we had users—the district level folks—who knew a lot more than his people about users. Why should somebody be telling us what users want? Why don't we find out ourselves?

The idea of the committee wasn't bad, but I thought the idea of his putting people on it was bad because—as they quickly turned out—they'd just be a quick channel to him and then the next thing you know I would be getting memos telling me how to proceed.

That certainly happened. After the first meeting of the users committee, I had a memo signed by him from Bob Sterns—he was Page's representative on the users committee—before I even had communication from the committee chairman, Art Denys, Southwestern Division.

So, I went to see Mr. Page and said, "Look, that's no way to operate. I mean, your guy's on there to contribute, to help find the right solutions, not to come back with his own agenda and, because he failed to get it in the committee, come back up here, get you all to sign a memo telling me I have to do that and tell the committee to do certain things. I mean, that's just not the right way to work."

Page understood and he agreed. He said, "Well, didn't he come through the chairman?" I said, "No. The chairman offered him the opportunity to write a minority opinion, but he didn't even do that."

He says, "You're right. They'll come through the chairman henceforth." So, we got that back in place.

I guess I started talking about our process structure. We used that structure, then, with the Information Resource Management Steering Committee as the overseer of the whole thing, and each of the subordinates had a role to play as we went through the yearlong process.

The steering committee had an executive committee. I met every Friday with that executive committee that consisted of John Wallace, our Resource Manager; Pat Kenney, our Information Manager; and the two project managers—that is, Ken Calabrese with CEAP and Dave Spivey with the software development effort. We also had Terry Wilmer, who was Deputy Director of Real Estate, and Don Cluff, out of Civil Works. We later added John Sheehey from Military Construction.

We would meet Fridays and just try to track the process and where we were going. That was my major sounding board. They really were helpful to me in developing my thoughts and helping drive the whole process.

Now that I've explained the organization, what we did was have each of these fifteen functional proponents brief on how they wanted to do business with automation now and in 1995—brief the executive committee.

Meanwhile, now, Information Management had gone to Joan Stolley and, using her as the point of contact, contracted out to a local firm for information technical expertise. They came in and listened to all the briefings. Each proponent briefed how he would like to be in 1995, and we had certain measurements of how many kinds of machines, what size memory, how many activities, how many connections they would need, so we got a real sensing of size.

I thought that was a good process. A lot of people learned a lot about their own functional arena. It was good for us because we had the boss involved. A lot of them learned how automation could support them, and it was a supportive thing in that our technical folks were available to them to help them understand what could be available.

Each one of the functional proponents developed its own way of doing business. Whether it was microprocessors or mainframe kinds of things, that kind of advice was there. Each one built the model of how he thought it would be in 1995.

Then the contractor and Joan put it together, integrated all of that. First of all, they converted all of the briefs to a common set approach. Then they integrated it all, thought it out, and came back and recommended to the executive committee an approach to set up an architecture to solve our problem.

We gave that a lot of deliberation. I don't want you to think it was an easy process. The executive committee went out to the Fusion Center and spent two days in a workshop. Now, you know, that was with shirt sleeves rolled up, really dialoguing and trying to figure out what's what and how we do things—and should do things.

We then fine-tuned a little bit, but essentially put together and brought the recommendation that we establish a core architecture, which was to have regional centers that everybody, meaning the headquarters activities or divisions or districts or labs, would connect to for communications. We at USACE would drive the system, the architecture, and we would provide the mainframe computers, serve the system, plus do central processing. We'd leave district organizations to themselves. However, we would buy their communications link.

We hammered all that out in, I think, a rather creative effort. So, you see now, what we had done is respond to Page's requirements. We let requirements drive. We built a requirement in each of the fifteen functional areas. We then integrated them, came up with a solution of how we would do that, specified the parts, left some things to the districts, which provided for that sense of decentralization we wanted. At the same time, we recognized that, out of that process—I'm a little ahead of the game—in the economic analysis, that they would really be spending a lot more money down in the districts to develop their individual things than we would if we did it centrally.

We knew we had to have discipline in our future approaches, and we just couldn't let everybody have free reign to drive on and develop on their own. That's the bad side of decentralization.

So, having done that, we took it up. I promised the division engineers we'd interact with them during the year. We had a briefing for them, and in the summer time frame we had all these things culminating together. The pilot test had been ongoing, and it was producing good results. We'd had to convert an awful lot of our programs and legacy systems into the database requirements and into the CEAP environment, and that had taken a lot of work.

The executive committee met on Fridays and monitored the entire process and tried to break down obstacles to make sure it all happened on time.

All of these events were coming to culmination about the 31st of July, and we programmed that we were going to come to grips with it on the 9th of August at our Information Resource Management Steering Committee meeting. I should say that all the other committees were doing their work too. The users committee was reviewing these things all along. We'd developed an economic analysis model with Doug Wiley's help, who was from the secretary's office, and he was very helpful in showing us how we could approach that.

Now, I was going off on leave for eighteen days to Europe in August, and then we were to brief the Chief of Engineers on the 5th of September and then Bob Page by the end of the month. We'd finish out the fiscal year with it all approved. Then Bob Page announced he was leaving and would be gone by the time I got back from vacation. So, we had to advance and culminate our process much earlier. We really couldn't extend the pilot tests. We really couldn't accelerate configuration management and all those things that were really coming to a head on 31 July. So, we really had no way of accelerating a decision before 31 July.

So, the period from 31 July to 9 August was very intense, as simultaneously the configuration management board met and determined the configuration. They chose to have two regional centers and not deploy hardware to each division location as we had originally envisioned. The users committee met, under Art Denys, and pored over all the issues.

We tried to pull together all the economic analysis and the numbers to fit the model. Mike Yeomans, out of Information Management, worked very diligently with his folks on that.

We went to the Information Management Resource Steering Committee, briefed the division engineers, and finally I went with General Hatch in the middle of the steering committee wrap-up to see Mr. Page and laid it out for him and received his approval. [See Appendix D.]

We had met his requirements. We had shown him, by this process, that requirements had driven our recommended system. We had taken those requirements and built the automation program for the Corps for 1995 that was needed, and we were going to accommodate project management—something new. We were going to do the work of the Corps in all the other areas. Also, the essential initial programs had to be, as a minimum, provided by '92; others could be judged on their own economic feasibility.

We showed him that the economic analysis showed we would save money in automation alone and we would increase productivity. That is, we could combine finance and accounting centers and do away with some positions. We would eliminate people doing stubby pencil jobs today and save other money in the future.

We talked affordability. We showed him, if I remember the number, \$164,000 a year per district would be saved in automation billbacks.

I told him that we needed to provide discipline in the system. We had to right some of that. We convinced him that—when I talk about the Information Management technocrat, I'm not really disparaging him, but he wasn't in charge—the leaders were in charge. I mean, the corporate management was now telling Page we wanted to do this because we had addressed our requirements in each of the functional areas. We'd integrated them and had them in a logical solution.

So, it was not the technicians bringing that solution to Page. It was Corps leaders, who now understood the corporation and how automation could help them, who had come to that decision. That was our recommendation.

He then approved it and wrote letters to the Office of Management and Budget, the congressional committees, and back to the Chief and said he was removing his office as the obstacle that he'd put himself in and now wanted the normal routine approval, budgeting, programming process to work.

So, with that, we have now given the second option year to Control Data, and we're figuring out what we want to buy with that. We will buy the communications equipment to provide every one of our field offices. We're paying for the redeployment of the hardware that was at our pilot site locations to our regional centers. We have to buy very little additional mainframe hardware—some—and we spend our effort really developing the software things that make it work.

So, that was the year of automation.

Q: It started out as what you thought was going to be a one-vendor selection. About how much of your total time do you think you might have given to that, if that's possible to estimate?

A: Oh, probably 8, 9 percent.

Q: Eight or nine?

A: Everybody thinks it was a lot smaller, but everybody in the time frame of 31 July to 9 August, I mean, it was probably nine straight days.

Q: At the end, yes.

A: We had an awful lot of good staff. I leaned very heavily on Pat Kenney and his staff, the project manager, Ken Calabrese, Dave Spivey, Mike Yeomans, Joan Stolley, Brenda Evans, Ed Huempfner, Pat Cobb. They're very good people.

The technicians really were great folks. Page's problem with them was, you know, that they came over and they really didn't understand his corporate level questions. We sent them out as messengers instead of taking them with us to provide technical advice as leaders carried the mail. We asked them to reflect management's view instead of the manager going over and saying, "I want this because I want it." So, I mean, that one little change of technique helped right there. We had great folks, and they were very helpful.

So, I presided, I facilitated, I showed up for all the meetings with the functional persons, and I required the function chiefs to brief personally because I wanted the bosses signed up. You see, the other thing we achieved during that process was a consensus because they were all involved.

By this process, one couldn't sit back and say, "Ah, the CEAP. I've heard it's going to do this, it's going to do that." Each was involved, so he had to buy in early. We got the division engineers early. We didn't have 100 percent coalescing of opinion on it, but we're a heck of a lot higher than we ever were before, and I think we have a good product, and we saved an awful lot of money.

We're only buying probably 50 percent as much as was estimated at one time—remembering that they were all option years. We never had to buy it all. If you projected that we would buy it all and put it all out in 13 places, it was to be about \$95 million. We're now going to invest about \$24 million and put it in two places.

Q: This is really the product of the last year?

A: That's right. In the last year we developed an architecture for doing the Corps' work. We really have an understanding of what all the boxes in these fifteen functional areas are. We really have an understanding of what ought to go in there. We really know what the key ones are that must interconnect—that's project management, financial management, program management, real estate—and we built a way to isolate an executive database to pull stuff up, just data we need at Headquarters, USACE.

We've figured out a way that we don't need a separate database for divisions and the headquarters. It will all be one database. From the division commander's staff viewpoint, it's his. From our headquarters viewpoint, it's ours.

We're getting to the point where we should be able to get where a person in the district can manage all of this data, for whatever his purposes are, and it's up to us to specify the details that we want. Then, when he plugs in the completion date of a particular project and the project name for his management purposes, or changes and updates, by his putting it in the system should update the corporate database used by the divisions and the headquarters with just those two entries at that one point.

Information is now available for the project manager of the Savannah District and to the project management division at Headquarters, USACE, and other people who want to see that same piece of data. He's only inputted it once, but it's available to all three.

The decision has been made. Now we've got to go execute all that, and most of the work's in the software. What we've done is we've boiled down the hardware requirements into something that is more palatable and makes more sense. Also, you can say, if you're the district guy and not wanting to pay for all of this, that now you're saving \$164,000 a year. If you're a Page, who said, "It costs way too much," we brought those numbers way down. It provides for what's needed now and it has growth potential.

If we find out we need more, we've set up the system that provides for an economic analysis to show and tell why it makes sense to do more. If we can show and tell and we save money, then we ought to be able to get the right decision to proceed. If it doesn't make money, we're not going to proceed. We're rewriting the discipline things for the whole Corps to say, "If you've got a bright idea, before you go around and spend money on your bright idea, you're going to have to check it off against our system. Does the solution already exist? If so, use it; don't develop a new one."

If you've got such a great new idea that the current system doesn't do it for you, then you do your economic analysis and show how what you want to do will be compatible, that it's exportable to the rest of the Corps, and that it's going to make money going off in your direction.

So, we've really put in a system of not only feasibility, but also economic feasibility. All in a year.

Q: A real accomplishment.

A: Well, we had a bunch of good people. I was the driver, and so you take it back to what we talked about earlier about the substantive role: How can I help the headquarters? Well, I drove the process to meet the requirements put on us by Bob Page.

Q: Okay.

A: I'm not an automator. I was a manager. You see, the managers had to be in charge. The managers had to listen and have their ears open to the technicians, but the manager had to make the decision. You see, I helped open the ears and the minds of the managers to receptivity to what the technicians were trying to tell them all along. Now he had to understand because he was going to have to come up and show and tell to the executive committee how he was to do his business.

So, he listened, and we got a lot of benefit out of the technician helping improve that data level that we never saw until it was presented. So, we had a lot smarter people and a lot smarter corporate body.

Q: So, the decision that General Hatch was to have made, he made that, obviously?

A: He just did.

Q: Oh, he did. Okay.

A: We sent in a regular decision paper a couple of weeks ago. It had a whole list of decisions on it. He approved them all, one of them with comment because just how these two regional centers will operate between centralized management, which you must have for that kind of operation, versus the day-by-day control of centers at the Waterways Experiment Station and NPD [North Pacific Division] has to be worked out in detail.

So, I suggested he might just want to leave that—because it's contentious between a couple of the field commanders—and just might want to have the details brought back to him for his final approval. So, he approved the concept, awaiting the details.

Q: Here's another area that I was going to ask you about. When I was talking to General Hatch last, he mentioned the CEAP area, of course, and another area he mentioned was that he had utilized you as his principal in working with the Army Staff on the E-Force structure. That, of course, is not something new to you, by any means, coming in as the deputy, having worked that issue at Fort Belvoir, and perhaps earlier and since as well.

At the time that you became the deputy last August, a year ago, where was E-Force; what was the status of that? Obviously some decisions had been made, but there were more yet to be made. Then we might look a little bit at how it's evolved over the last year.

A: Well, let me back off and just give a perspective right here and a little bit of the historical development in executive fashion.

E-Force was developed while I was at the Engineer School at Belvoir in 1984-'85, responding to my early education into TRADOC and how it works and the force structure fights of that fall.

My guidance from then-CAC commander General Vuono and TRADOC commander General Richardson was that they wanted the proponent, TRADOC's commandant—me in

the case of the engineers—to find new, creative ways to fix things, get it right for warfighting. My responsibility was to ensure the engineer system on the battlefield was right.

Well, from my long background in divisions, I knew that it wasn't right in Europe and knew what the answer was. We'd almost surfaced it in our REFORGER '77 FTX when I was VII Corps engineer and 7th Engineer Brigade commander in Germany. It was premature at the time, and so we worked then on mechanizing Corps engineers, getting APCs [Armored Personnel Carriers] for them, and doing other system things.

In my first year at Fort Belvoir, one of the things I put down was to fix all the engineer force structure while I was there. We were already under way in fixing and changing the combat heavy battalion. By the way, Bob Herndon, who had just finished commanding a combat heavy engineer battalion in Korea, was back, and for three or four months we used him to head the team to redesign the combat heavy battalion.



General Kem (second from right) with members of the Headquarters, U.S. Army Corps of Engineers staff, including Charles Schroer (third from left), Lieutenant Colonel Timothy Wynn, Commander of the Honolulu District (fourth from left), and Brigadier General Clair F. Gill, Commander of the Pacific Ocean Division (right).

We'd just redone the light division engineers as part of the new light division. The airborne engineer battalion and air assault engineer battalion had just been redone. We were in the midst of doing the topo battalion over with an all-new topo concept. So, the only one we hadn't touched was the heavy division engineer battalion.

So, I put a team together and started working with Colonel Ted Vander Els, the Combat Developments Chief, and Majors Rick Capka and Houg Soo. I was intimately down with them working the details, trying to design how it really should be. So, we developed a new organizational model for engineers in the heavy division. What we were trying to do was provide the right kind of command and control and the right kind of force where the work gets done at the brigade level.

The other thing that had happened at that time was that NTC was showing that the engineers were not doing the job during exercises at the NTC. They had to be augmented. They were failing. They even had armor command sergeant majors, quote, "in charge of" fleets of bulldozers to get the work done, rather than the engineer company and the engineer platoon.

What was identified, in spades, was that the engineer platoon was insufficient to support the maneuver task force, and the engineer company was insufficient to support the maneuver brigade.

Now, I'd known that all along because I'd been out there in the field as a platoon leader in the 23d Engineers, 3d Armored Division, years ago and then as commander of the 7th Engineer Brigade and Corps engineer in VII Corps, Germany.

We put all that together, and then, like everything, we had to sell the product. So, we started developing the briefing that would articulate the need and market it. Then we had to call the new structure something.

So, that's when I came up with E-Force, engineer force because we were doing the whole force. E-Force really wasn't just the heavy division. It's come to be thought of as just that one increment remaining. In fact, my responsibility to Vuono and Richardson was to do the whole engineer force to fight the whole engineer battle. So, we had done all of it.

Now, only this piece hadn't been wrapped up, the heavy division. Over time, that got to be known as E-Force, and you'll see that again and again.

Q: You were referring to the whole thing?

A: Well, initially, I was referring to the whole thing.

Q: Yes.

A: My briefing usually says, "Here's where we are. Now, let me return to what's left—the heavy division." You take the briefing, which is, you know, an hour long. Well, there's 10 minutes on the problem and the whole, and then the next 50 minutes deal with just the heavy division

part. So, the emphasis of the briefing makes you think that's all that we're talking about in E-Force.

That was the genesis of E-Force. It started at that point in time but, unfortunately, I briefed General Vuono in his last month in command, and he was not receptive to new ideas in his last month. Later he was to tell me it's like telling a brigade commander how to run training in his last month in command.

I mean, he was receptive to the need, but it was one more thing that he wasn't going to be able to follow through before he left. His plate was full in wrapping up what he was doing, and so I sort of got the cold shoulder on it at the time.

Over the next year we worked some more on it and brought it back up to his successor, Lieutenant General Bob RisCassi, and General Richardson. It had not been to Richardson earlier. RisCassi sent it on to the TRADOC commander, who liked it. He wanted to send it on up to the Army Staff.

At this point, it was toward the end of Richardson's last year. The DCSOPS of the Army now was General Vuono. General Wickham was shortly about to leave as Chief of Staff. Once again, it was not deemed opportune by General Vuono to send it up because General Wickham had just slam-dunked a cavalry reorganization in his and General Richardson's last days.

You know, one of the aspects of E-Force all along was that it was never just an engineer thing. We brought infantry in and armor in. A lot of folks with experience at the NTC, maneuver commanders, said, "We got to have something like this." All that combined arms input contributed to E-Force from the beginning.

Now, maneuver commanders, as they went to the NTC, began ad-hocking E-Force so they could use the concept. Now we were hearing maneuver people really saying, "Hey, this thing's really paying off." I mean, this from tankers and infantrymen. Pretty soon, as people were hearing about it around the Army and trying it out, those people had done it as battalion commanders and brigade commanders and then they were assistant deputy chiefs.

So, we had a whole wealth of maneuver people who said, "This E-Force is better. It works better. For the first time, I have the right level of engineer—a captain, not a second lieutenant, at task force level, or a lieutenant colonel, not a captain, at brigade level—doing engineer command and control. I have got enough engineer assets, and it's really tailored to what I need."

This was coming out of the NTC in published lessons learned. People were getting it all over the Army.

So, as General Vuono returned as the TRADOC commander, we continued working the details and worked it throughout that year. When I left the Engineer School, Major General Reno took it on the following year. When General Thurman came in as TRADOC

commander, he sort of backed it up, and Bill Reno developed the study that really fleshed out the writing to support the concept.

Major General Dan Schroeder replaced him—we had a quick turnover of commandants. Schroeder came in and General Thurman challenged him to put analytics with the concept. Meanwhile, the commanders who liked it moved up, like Lieutenant General Saint at III Corps, who'd seen it at NTC, all of a sudden became Commander in Chief, USAREUR.

Now he wanted to implement E-Force, and he started communicating back between the Army Staff and TRADOC, wanting to get on with it, wanting to test it. General Thurman had said we should test it at a REFORGER exercise.

Later, General Thurman reneged from that position after a Schroeder brief. Thurman had stated he wanted a test in the same manner that the Army had done the 7th Infantry Division at the NTC—put it together, take it to a major exercise, and test.

The only place you can do that is at a REFORGER where you've got the Corps level FTX. We already knew about the NTC—that the engineer company was better than a platoon at the maneuver task force level. What we wanted to do was put the rest of it out there.

So, Thurman had pushed for it to go on REFORGER, and then he backed off. General Saint came up on the net and said, "Chief, I want to test it myself. TRADOC withdrew Army sponsorship, and I want to test it." The Chief of Staff said, "Go ahead. You test it. I'll send some TRADOC people over to watch it."

Meanwhile, Schroeder did his analytics and got the TRADOC analysis center involved. Then USAREUR had a very good test a year ago [January-February 1990] during REFORGER. They actually put the E-Force organization together on the battlefield, set up an ad hoc division engineer, brought in Colonel John Morris, who was deputy commander of the 7th Engineer Brigade, to be that colonel, division engineer commander. Gave him a staff, an S-3 and a deputy. Then they brought three battalions in to work with each of the three maneuver brigades, and they worked it during the REFORGER FTX.

It really proved itself. I mean, the lessons learned that came out of that FTX were that E-Force was really the answer on the heavy battlefield.

So, that sort of brings you to where it was when I came in last year as deputy. As I left USAREUR, we were just getting ready for this REFORGER test. We had wanted to document the organization so they could organize. We were not permitted to do that, so they had to ad hoc the organization, as I've just mentioned, for the test.

My activity as Deputy Chief regarding E-Force has not been direct. It's been indirect, and I've gotten a lot of men working over the last year—involved with USAREUR, Forces Command, the Army Staff, TRADOC, and Major General Schroeder at the Engineer School—trying to move the decision along. That is, too often things sit and aren't brought to a head, so I networked and pushed to make things happen.

Meanwhile, General Schroeder really has the ball. He's the proponent now. He did the heavy work of discussing it within the TRADOC community. His analysis in TRADOC—the Engineer Restructure Study—showed that a battalion was right for the maneuver brigade and that we needed all the things called for in the new organization. Under the AirLand Battle future program the Army was downsizing the heavy division. That's a future model. So, Dan Schroeder built a future engineer component.

E-Force, as a name, really isn't the name of this new organization. I mean, I already told you how E-Force manifests itself to the heavy division. The new concept looks an awful lot like E-Force, but it has things that have changed to match the AirLand Battle future concept. The program name was changed to the Engineer Restructure Initiative, and that's what Dan Schroeder's pushing now.

The Army, the field knows it was E-Force because it looks like E-Force and has the major things that the E-Force design had when we first came out with it. So, that's still, I guess, the name that one attributes to what we're talking about.

Q: So, we're still awaiting another decision?

A: Well, where it is right now is that General Schroeder was successful in going to General Foss, commanding general at TRADOC. General Saint, from USAREUR, came up on the net along with General Burba, commanding general of Forces Command, who was a big supporter when he was commandant at the Infantry School. He was a fellow commandant with me. Both came up on the net and supported it strongly.

General RisCassi left being the Vice Chief of Staff of the Army where he was facilitating those things on the Army Staff and went to Korea. He was a buyer and reorganized his engineers in Korea to the E-Force concept.

So, where we stand right now is that it has been approved by General Vuono for implementation in Europe as the force draws down. That's what General Saint wanted.

After Conventional Forces, Europe, when General Saint reduces the size of his European force, he designed what he wanted that force to look like. He wanted that force to have all of its divisions with an E-Force kind of regimental organization, and the Chief of Staff approved that. With TRADOC now having to approve the TO&E documentation, the letter was provided. Europe now has the modified organizations and, with the drawdown, will organize the two E-Force brigades. They planned to do that in two divisions in '91.

Korea also wants to do E-Force, and they've already come in so that this year's command selection boards will select their centralized troop commanders. Europe is in the process of doing the same thing for their troop commanders.

What happens in Forces Command is unknown at the present time. General Schroeder's documentation provides for everybody. I think that DESERT SHIELD, now ongoing, and with Forces Command in the midst of a build-down—that is, the 2d Armored is going out—and

with our deployments, our minds are turned to other things at the moment. So, that's where it is.⁴

Q: Okay.

A: So, my role this year has been as an active networker, but not the proponent's role.

Q: Working with a lot of players that you've dealt with all along.

A: About 50 or 60 or so.

Q: Yes.

A: I haven't had the direct role recently that Schroeder's had. There are just a lot of people who understand it now and want it. General Vuono asked me when I was still in Europe where we were with E-Force over there, and I told him, you know, in some jest, but not all jest, that the division and Corps commanders had finally convinced me that E-Force was the right way to go.

In fact, they were E-Force's greatest proponents. They were the ones that knew the engineers weren't right on today's battlefield. With this design because they had practiced it and seen their engineers and maneuver brigades and maneuver task forces go to field with it, had seen it work better, they were all sold on it. So, the clamor for E-Force is basically coming from all over. It's not just coming from engineers.

So, for the last three years I've not had to be the marketing spokesman for this concept. I gave my briefing to thousands of folks back when I was at Belvoir and created a TV tape of the briefing and passed that tape to a lot of division commanders and a lot of people to explain the why. I haven't had the tape out for the last two years.

What I've been trying to do with the networking is to make sure, if there's a decision point coming, if we have an obstacle, then we get rid of the obstacle so that everybody's in agreement, so we can try to keep moving. That's what I've tried to do this year.

Q: I think, as far as the engineer commander goes, General Hatch has observed when we were talking about the relationship of the Chief with the Engineer School, and his not being in command—

A: He was not the proponent.

Q: Right.

A: General Schroeder is the proponent.

⁴*Editor's note:* Lieutenant General Franks, commander, VII Corps, deployed to Saudi Arabia with engineers organized as E-Force and fought in Iraq with the concept. Subsequently General Vuono approved the change so that armored and mechanized divisions would have an engineer brigade of three engineer battalions.

Q: Yes. General Hatch was talking about the importance of speaking the same language.

A: Yes.

Q: He said, “When we get E–Force, it will be because we all spoke the same language.”

A: Right. Exactly.

Q: I think that’s an important point.

A: It is, and my having been his deputy this year has allowed me to be a networker and help the whole process. Certainly, Colonel Tom Sheehy, over in the ACE’s office, has been very effective in working with DCSOPS in all the details of what’s going on.

Q: Is he in the Military Engineering and Topography Division?

A: Right. That division has had a bigger and more influential role this year than I’ve ever known in the past. I think, with his aggressive, can-do nature, he’s really taken on the correct context. That’s why I’ve stayed back and strategized and networked.

Q: Now, I want to turn to strategic initiatives a little bit. Of course, now General Hatch has just named an Associate Chief for Strategic Initiatives. What has been your role, then, in that area in the last year?

A: Well, I’ve been a very active player. Bill Robertson and I have talked lots of times. I’ve been involved with them. He carries the work basket of pushing things, and he’s networking and doing all of those very valuable things for USACE.

I think it was a very good stroke by the Chief in setting up that office and getting somebody who’s not burdened with an in-box of daily operational problems to be able to look ahead and try to articulate and network important things.

A long time ago, when I first became knowledgeable of the Office of the Chief of Engineers, he had, I’m not sure what it was called, a planning cell or strategic planning cell. I know Ernie Peixotto was in there at one time. During one of the position cutting drills, they did away with that office. It had just been a small office; I don’t know its size. It certainly wasn’t in the very aggressive, direct role that Bill Robertson plays today, but, I mean, it was the Chief’s ability to go out and do thinking and planning things.

I’d been in a similar kind of organization when I was in the Office of the Army Chief of Staff on what was called the Special Actions Team. We would do whatever the Chief of Staff or Vice Chief of Staff or Director of the Army Staff wanted. It was not specified. We could go out and chase various initiatives and try to help congeal staff thinking because they had to do all kinds of things every day and couldn’t spend time looking at a particular area. If the Chief or Vice Chief of Staff had something, we could go out and develop that issue for them and bring it back in.

Now, I always thought that if I was ever in such a position, I would want my own special actions team. I see Hank Hatch with the Office for Strategic Initiatives having been smart enough to establish his special actions team. He gave it the particular direction of strategic initiatives, but he has unencumbered it, just like we were unencumbered in the special actions team—from having a routine in-box. I mean, you do what seems to me to be done for the good of the corporation. When I first came in as deputy, I saw the Office for Strategic Initiatives and I thought, “Boy, that’s really a great stroke.” I’ve been very impressed with their work this year.

So, your question was, “What have I been doing with the Office for Strategic Initiatives?” Of course, Bill has direct access to the Chief and gets his guidance, and they interact together. I think I’ve been a sounding board for both. I think Bill’s come to see me to try things out beforehand. I’ve had the Chief ask me about various things.

So, I have played in a lot of these issues and initiatives enough to be counsel and sounding board. I’ve been involved very directly in putting together some of the things as we looked at things. Either we were going to go out and get together in the Senior Staff Group and dialogue on something, or, more specifically, on the space initiative, where I was the front person of the effort—going down to give the speech in Albuquerque during Space ’90 in February and meet with Dr. Aaron Cohen of the Johnson Space Center to start an interaction with NASA. I was making networking phone calls to the Space Systems Division and the Air Force staff to open the communications door there.

Q: Is that a new area for you?

A: Networking was not.

Q: No, no. The space initiative area.

A: Yes. I had not been involved in space before.

Q: Yes.

A: Then I know when they recently had a briefing of the General Staff Integrating Group, where the Chief is the member, I represented him because he was out at the senior leaders conference.

So, I’ve been involved most directly in that arena. I’ve been involved in the nation building mission push. As Bill and his folks put together the nation building piece, I was involved in suggesting folks to come in and be in the skunk works, involved out at the Fusion Center in some of the briefings and in the development of that initiative.

Later, as Colonel “Rock” [Terence C.] Salt became involved with taking on nation building, I went over to help brief Bob Page and the ambassador designee to Poland on how we could help in that arena. So, I’ve been a player both as part of the thinking and part of the doing.

Q: The decision on forming this office did have its people who had questions about it, were skeptical about it. One of the concerns that was raised at the time that this separate Office for Strategic Initiatives was established had to do with the very fact that you've looked on as a strength: the isolating of a strategic planning team. Originally some of this was handled out of the Resource Management office. Also, there was the involvement of, perhaps, a broader spectrum, or a deeper spectrum, of the staff, which maybe is not so much the case under the way things function now. Would you have a comment on that?

A: What you're suggesting is that when Resource Management had it, there was involvement of a broader, deeper spectrum of staff?

Q: I wouldn't necessarily tie it together to that. It's just the arrangement that existed before, another group that existed, was called the Strategic Planning Initiatives Group. That group involved a lot of less senior people, as well as senior people.

That is not so much the case now. It was said at the time that this strategic initiatives proposal—because that was worked through the staff and everything—it was said that doing this would, in effect, really destroy that old arrangement, and therefore strategic planning. All managers needed to think strategically, and there would be nothing left in place to get them to do that, in a sense, nor to take advantage, perhaps, of some of their contributions to the whole process.

A: Well, the latter one is the most important point. Back when there was Resource Management, and Kathy Thompson was involved with it—a very capable person—I was involved, I guess, when I was in the ACE.

Q: It's called Future Directions Branch, Resource Management, I think.

A: I don't know whether I was involved with the Strategic Planning Initiatives Group, or what it was called. I remember meeting, when I was Deputy ACE and Deputy Director of Civil Works, in future planning sessions that Kathy Thompson was getting off the ground. Maybe it developed deeper later.

Q: It was in Civil Works then, later.

A: Well, what I was going to say was I never had a feeling it really worked. I think the problem with it was—and I'm not really being fair, and I'm not castigating her under any circumstances because she is very capable—that it was all too structured. It was almost like the information management experience I have just talked about. The senior managers had only tuned in to the technical guys when they said, "Here's what we got." They never put their minds and thoughts really into CEAP to make it something, so that management never bought in. Senior managers participated every now and then, but they didn't buy into strategic planning. I'm talking about senior managers, director level. Although you might have had a lot of players, it might have been like some of those other staff activities I mentioned. We play in a lot of arenas in the Corps; we're a bunch of professionals and we talk and plan, but getting down to doing it, that's another question.

So, I think the value of what we have now in the Office for Strategic Initiatives is that you have an absolute buy-in of the Chief of Engineers. I mean, this is his thing. It's not Bill Robertson's thing. It's Hank Hatch's thing.

He's just not coming to a meeting and then pulling away. We now have a person in Bill Robertson who's higher up the pecking order and has an access to the Chief that Kathy Thompson never had. So, instead of working a process of strategic planning, talking about this and that as possibilities, and developing certain products, we now are developing the process and the vision and the products—developing the articulation for the Chief to use so the words are out on the table, then networking behind the scenes to open contacts, to make things happen, to hit points of influence.

It's much different now and much more active. Planning is not a very active thing. Planners just keep planning. I mean, it's sort of a truism. Army planners keep planning and planning and their product is a plan. Operators operate and accomplish the mission.

You get out into our divisions and districts, and our planners for years have turned out planning product after planning product. When I was in the Ohio River Division there was at least one district planning chief that every year budgeted the same studies. Just throw another little bit of money at it, hire a couple of people, and he would keep working, irrespective of whether the district ever came up with a product.

What a corporation needs in strategic planning is to find and establish a sense of direction and to follow that direction. Corporate America does that for several reasons: because a functional mission area goes away and they need a new one, or they've maximized their talents and they want to move into another area, or they see an opportunity, or they want to coalesce and find other opportunities because they've outgrown their wealth and are big enough to expand. Then they move, make decisions, and crank up.

What we in USACE were always doing was talking, but we were never doing in the process that I described of 10 years ago, in my view. What we have now with the Office for Strategic Initiatives is an ability to at least work in certain directions.

When I was in the Ohio River Division, the word was, "Yeah, we ought to be the federal engineer. You guys at the bottom go out and carve out your way of doing it." Well, some things you can do at the bottom, but to carve out a new mission area really is top team, top leadership stuff.

So, you don't approach NASA from the bottom, or even the Department of Energy—although we have, working the Hanfords and the Savannahs and all those other places. If you really want to carve out a mission area, that is doing the necessary things at the Washington level, and that means you have to get to influencers and decision makers and essentially get to the person who's got his hands on the resources.



Groundbreaking Ceremony at the new Winfield Lock. Left to right, Major General Kem, Deputy Chief of Engineers, Senator Robert C. Byrd of West Virginia, Neil Diehl, Chairman and Chief Executive Officer of Ingram Barge Company, Congressman Robert Wise of West Virginia, and West Virginia Governor Gaston Caperton.

To do that, the Chief's got to be in the lead. He has to have somebody who's paving the way, developing the contacts, setting it up, writing the articulations, and doing the networking. That's what we've got now with Bill Robertson and the Office for Strategic Initiatives.

With the Office for Strategic Initiatives, we have a very proactive element. They are not just strategic planners. I mean, the word is not strategic planning now, you see—it's strategic initiatives.

Q: Initiative. Which is the emphasis more on the action.

A: That's right. It's action.

Q: Uh-huh.

A: I arrived after the fact; it was all set up. When I walked in as the deputy and found out what it was, I just nodded to myself and said, "What a smart guy Hank Hatch is to do that."

Q: Now, you are on the Senior Staff Group that meets—I don't know if it's a regular schedule.

A: Periodically.

Q: Periodically. That is all the senior level people and general officers, basically?

A: Basically, yes, the SESs and general officers at the headquarters.

Q: Maybe you can say a little bit about how it works.

A: It's a forum that allows the Chief to dialogue firsthand with his senior staff, a so-called board of directors. Most of the time, the board of directors meet here. I think we're more effective if we always involve the great, strong leaders, our SESs and our general officers, at this level. There are so many of them in the headquarters, in our offices and Directorates of Military Programs and Civil Works. I don't even want to use their names because then I would leave somebody out.

Just run down the names, the division chiefs of those two directorates, and you've got a wealth of experience, hands-on in the field and at the headquarters. They have done all kinds of things. That is a tremendous assimilation of talent.

So, the Senior Staff Group is the Chief's way of interacting with them all—to dialogue with them. So, I say that's our board of directors. I mean, not a board in the sense of validating what the chief executive wants, but a board in the sense of contributing fully to the charting of direction.

The Senior Staff Group provides a great dialogue for the Chief of Engineers to work on anything important. Some of our sessions have been contentious. I mean, people let their hair down and say what they believe. That's really superb, that you've got a forum of such people, and an environment where people feel free to really say what they believe. It's got to be a positive thing when the Chief of Engineers can hear two of his top folks take different sides of an issue. Of course, the other thing goes with it too—when something is out on the table, you can't keep quiet if you have a thought and it affects you. I mean, you'd better stand and be counted because you were there. Silence means you buy in, so it causes people to have to talk.

A couple of those meetings of the Senior Staff Group that I've been at this year have had to do with program and project management, as we've sorted out what different interpretations of what those things mean. Our divisions have tried to reorganize project management to meet what they saw as the Chief's guidance, and their interpretations have been different.

So, it's been a way of coalescing a corporate position and a way for the Chief to hear straight up what his top people think and a way for the Chief to dialogue back. I mean, it's not a one-way, Chief telling them this. It's really a dialogue, and I've really been impressed with that. I've rather enjoyed the Senior Staff Group.

Q: I think having that type of forum was part of the original plan when the office was set up. That went along with it. General Hatch and I haven't gotten to this area yet in our interview, but—

A: Well, I don't know that specifically, but the two go hand in hand because if you've got an initiatives group charged—remember, they developed the vision first—and all of that to sort of set a course and how you work through things, then it is essential for the Chief to have a

way to bang things around among the senior folks for two purposes: To get it right, first of all, and, second so they have a buy in, so there's a consensus that this is the right way to go.

I guess also so the Chief hears different views, and when he makes up his mind, it's not just been Bill Robertson talking. Bill may have been the architect in putting all of this together, but it's been banged around by all the other good thinkers. He gets all the inputs, and we can better a good product, with a consensus buy in, and everybody feeling good because they participated.

Q: I don't know if you can answer this. As an institution, the Office for Strategic Initiatives—it's very clearly General Hatch's "thing." When a new Chief comes in, do you think it's likely to have proven itself and be the means that will continue, or is it really—

A: One can never predict those things.

Q: Yes.

A: I created my "thing" when I was at Fort Belvoir as commandant. It was a technique to create a matrix thinking, developing synergy. I called it my "mafia." I brought Tom Farewell in to head what I called the Engineer Force Modernization Office, my special actions team. I gave him two people, ensured they were not encumbered by an in-box, and used them as the focus of activities of the mafia and others to make things happen for the engineer force modernization efforts I was pushing.

They were big drivers in helping me work to establish E-Force. They did a lot of integrating work and networking, and I thought they were super and did significant work. Yet, my successor killed it in three months after he arrived because all the other folks, the colonels in the command, turned against it.

You see, the mafia folks were lieutenant colonels, and I thought I was taking care of the insecurities of the colonels by making them the oversight. They, the colonels, met with me and the mafia, and we always did things together. When I left, the colonels turned upon it, and Bill Reno did away with it.

So, I would say you can't be assured that the Office for Strategic Initiatives and Bill Robertson will continue like that, and if you get somebody other than Bill in there driving the Office for Strategic Initiatives, it may not be as effective and, you know, his interests may not stay there forever. If you get a guy of that ilk, his satisfactions come from creating and doing things. If he feels that it's no longer an opportunity for creativity, then he may well decide there are other places that he can get such satisfaction. Without him, there goes the chemistry because he and Hank Hatch right now have great chemistry.

Q: That's an important part of it.

A: It is.

Q: Like your group, you had the chemistry, I'm sure.

A: That's right. So, if either one of the next two don't have that chemistry, then it won't quite work. So, it could go away.

Q: Have you given your successor some advice from your last year as to his first months, or whatever?

A: I think so, but if you're going to ask me to say what they were now, I'm having difficulty in recounting it.

I've walked through a bunch of things. I've talked to him about many of the things I've talked about today, that is, process versus substance, inside–outside, how you have to play across the board, how you have to anticipate, how you have to try to influence the action, and the need for better timeliness on the part of our headquarters in coming to grips with issues. What I really mean in timing is coming to grips with what we need to do, whether it's a little thing or a big thing, also, the fact that the budgets of the coming years mean we have to find a way to do less with less.

Q: Not everyone states it that way, do they? Doing less with less?

A: No. A lot of people say more with less.

Q: More with less. Right.

A: I say that because we're going to have a 580,000-person Army. We cannot expect to continue USACE at this size for a 580,000-person Army. It has just come back to me in the last couple of weeks since Ernie Edgar's arrived, and I've had the opportunity to communicate that to him.

Way back when we were doing the command operating budget, it was obvious our funds were being cut. I laid down several markers, and we tried to not salami slice. I tried to put it out to people that we must look at a different way of doing business. We can no longer afford everything in the same manner.

So, for purposes of looking ahead to '91, we've got a 40 percent cut. You'd better find out how you're going to live within that. You hit a 30 percent cut, you'd better find out a way how to do it.

For example, the Engineering and Housing Support Center. We're going to have a 580,000-person Army and fewer installations. Since the center's job is engineering and housing support to the field, they had better find out how they can be smaller and do it. So, what's essential? To all—don't just salami slice. Figure out if there is something we're doing that we should not be doing, so you can cut it away.

Q: You know, you asked the same question at the transitions workshop a year ago too.

A: Did I, really?

Q: Yes.

A: Well, it will all come back to haunt me. [Laughter]

What has happened this month since I've returned from leave and while Ernie Edgar's been here, we crossed into the new fiscal year. All of a sudden we're in the year that the command operating budget is effective.

Each one of our offices has come back to Ernie and said, "He cut my budget. I can't live this year." So, I told Ernie, "You know, we're going to have to find a way." I mean, once you get your budget cut, there are two ways to work it.

One is, you find out what's really essential, and you reorganize and downsize to do the essential. Second, if your essential is more than that, then you find the way to better your articulation to go fight the battle back uphill, to show the Army why we need more money for that.

So, you ought to be able to win, one way or the other. You've gotten lean, and having gotten lean, if there's something still so essential that's important, you have a better argument to go back to the Department of the Army.

Now, six, seven months ago when they got their reduced markers, all these people didn't do that. They waited until now, and then they've thrown the marker back and said, "I can't get by this year because I don't have enough money." So, having not articulated a need for more, they are left to downsize.

In fact, at the Engineering and Housing Support Center now—they have a new commander—Ed Watling came in and said, "I need more people." I said, "Ed, the Army is not going to give you more people" because, as General Sullivan said the other day, if we don't cut some places in the Army, we're all going to be standing around watching our one division of people—because that's all we got out there doing the job.

So, one of the things I've told Ernie Edgar is that one of his big challenges this year—if we can get by this surge of Vanguards, Lab 21s, and all the rest of the studies—is to really bring our own selves to bear on our organization so that we find the way to change and get our people really to come to grips with trying to get leaner. Corporate America has gotten leaner. When I was in Europe, I arrived as DCSENGR, and the Commander in Chief, General Otis, had just eliminated ISAE from my organization.

Now, the Engineering and Housing Support Center is patterned after ISAE. It does for the Army what ISAE did for the U.S. Army in Europe. I was there when ISAE was started years ago, in '78, '79 in Europe, and it was a nice organization, provided support to the directors of engineering and housing in the field. Over time it got bigger and bigger, and more of its people supported each other in the field.

So, General Otis said, “We’re going to cut the headquarters. We’re going to do away with functions we don’t need. I’ll make the tough choices between what we have to do and what we’d like to do.”

Everybody said, “You can’t do away with ISAE. We have to do this. We have to provide staff assistance to our installations.” He said, “No, you don’t. You only get around to an installation about once every two years. What kind of assistance is that? You know, when installations call, they have to get in a queue, and you’ve got somebody required for the scheduling.” So, he did away with the whole outfit. Some of the things were moved to the DCSSENGR’s staff. I mean, different things moved different places, but ISAE as an entity went away.

When General Saint came in, we had to take the Vander Shaaf cuts. As Chief of Staff, as I mentioned earlier, I led the staff effort over there where we had to cut 450 spaces out of USAREUR and the Corps headquarters. We found a way to do it.

We cut a lot of sacred cows on the way, like 20 auditors. “You can’t cut auditors,” we were told, but we did. We did away with our MS-3 staffing study shop. “You’ve got to have an MS-3 shop,” they said. “No, we don’t,” and we really didn’t. We also eliminated 30 lie detector operators.

Now we’ve got to meet this new requirement in USACE, you know? We have to make tough choices. We all say you shouldn’t salami slice, but if you don’t make a choice between A and B, then you have to take the same percent off both of them.

We haven’t come to grips with that in USACE. So, I’ve told Ernie Edgar that I did not succeed this year. I tried to cut excess. I sent a marker to the Engineering and Housing Support Center, told them that they were going to have to figure it out. I sent a marker to the Engineer Automation Support Activity, told them they were going to have to figure it out. Sent one to the Engineer Studies Center, told them they would have to figure it out, and all of them stonewalled change.

Really, we are going to have to figure out how to cut somebody because you can’t continue doing everything at the same level when what you’re supporting is smaller.

Q: Is a lot of that going to come in the very next year, do you think, or spread out maybe over a few? I mean, is the next year going to be really the toughest, or might it be ’92 that’s even worse?

A: I think the work activity for addressing it is next year. See, the advantage of doing it on your own initiative is that you might well be able to program the ramp. If somebody else does it to you, you probably can’t program the ramp. There are a lot of reasons why you want to program the ramp.

You might be able to say, “I want an Engineering and Housing Support Center of this size. However, during the pullout from Europe and the base realignment and closure process for two years, I ought to take a little and take a little and then take some more in the fourth or

fifth year.” As opposed to saying, “We don’t need this. Cut them all now,” like General Otis did in Europe.

So, we really must come to grips with realities. That’s one item I’ve told Ernie that he’s going to have to focus on.

Q: There’s a lot of pain associated with that, of course.

A: Sure there is. I mean, it’s tough.

Q: This has been a not very usual situation in which there have been two deputies on duty concurrently for a period, even though short. It’s given you an opportunity for some overlap and some of this interaction that normally doesn’t occur.

We were joking about that the other day, but it’s only been maybe—what? It will end up being about six weeks of time.

A: Well, it’s really been fortuitous for a couple of reasons. He came in, I guess, around the latter part of July, and I was gone for eighteen, nineteen days in August. So, we had a couple of weeks of overlap, and then I turned it over to him, so he was able to operate and had to come to grips with things.

Part of the problem of any transition is that the issues don’t surface while you’re there overlapping so that you’ll have an opportunity to dialogue it while it is hot. So, by his early assignment, he was in the saddle and having to operate. Then when things came to his attention, he could ask about that. I may have not thought to tell him about it to begin with. So, we’re able to dialogue better from that standpoint.

Second, he then was able to get around and get acquainted while I was operating the store. When I was on leave, he was operating the store. I could finish up the automation, which is one of the big things to be completed, while he was there to mind the store. Plus, then the senior leaders conference came during the period. We always have to leave somebody in Washington, and I could stay back while he could go out and interact with all the leaders that he was going to associate with in the future. So, that worked nicely too.

It’s worked throughout. Like, even next week, I turn out to be the designated guy to stay home because both the Chief and he will be out of town. With our requirements to have generals in town, and before Bill Ray came back to be Director of Military Programs, we were one shy. I’m still behind in my officer efficiency reports, even after all that. I mean, that’s how fully employed I’ve been—all the Vanguards and all those other actions.

Q: When you commented earlier about the need to know the Army system and how the Washington scene works and everything and since you just mentioned the Vanguard study and all of the other things, there are some things that have been coming out recently from Vanguard and defense management reviews, I believe it is. Has the Corps been caught off balance by any of those, or were these all mostly things we anticipated coming along?

A: Yes, I think we've played in all of those activities. The problem is, in all those studies, you get people who really don't understand. They go crashing on in some great crusade to do something. They don't understand, and once they put a marker down that certain cuts seem appropriate, then they're unwilling to back off from their position. Remember the Vander Shaaf action I discussed in USAREUR?

So, the good guys—us—are always on the defensive to folks who really have some imbecilic ideas, and to deter them just takes an exorbitant amount of executive and staff time. It's really a lot of work, and some of the ideas are atrocious and unrealistic.

Q: Yes. Maybe what I was getting at was, wasn't there a way earlier to anticipate and do something so that they didn't get to this situation? I guess that is what I was looking for. Were there some missed opportunities, perhaps, or some things you could have paid more attention to?

A: Well, Vanguard, I mean, that's been an ongoing process. I'm really disappointed with their hardheadedness and misunderstanding of USACE and our labs and their apparent unwillingness to find out the facts.

Now, we know the process is growing. We've had them over. We've talked to them. So, I think we've participated. For some reasons, they don't understand facts, logic, and truth. So, it's just very difficult. I mean, we say certain things that meet their requirements and the principles they espouse, and then they produce a new paper that comes back with the very same original position, as if you'd never talked. So, how do you deal with that?

Certainly, we've been playing with them for weeks. I met just this afternoon on where we stand.

On the defense management reviews, those come down sometimes with a bit of surprise, sometimes not. Certainly, the big one going on now is who's the construction agent. We were participating with them. I think we were a little surprised by what they originally came out with.

Their numbers are also very wrong. So, how do you ever anticipate that somebody's going to use screwed-up numbers, then think it's the gospel and come up with a conclusion without even the other option that you had been led to believe was going to be in there to begin with.

Now, I don't know if that meant that we dropped our guard at an inopportune time. We were certainly surprised when they only came out with two options.

Q: I don't know if you've had any predictions on what might happen. For example, for the big one you were just talking about, do you know what the outcome of that defense management review might be?

A: No. Now they're talking about yet another study, going to April. Blows my mind. Everybody's got a better idea of how to do things.

Q: Yes.

A: We spent an exorbitant amount of time addressing all those ideas, and there's an awful lot of wheel spinning. For some reason, Defense puts people in positions of responsibility with a bean-counter mentality whose sole justification seems to be to achieve some level of cut.

“Goodness” is then defined, you know, as to whether you achieve the cut, rather than whether you've done the job that needs to be done for the Army.

Why people that have that outlook get picked to go into those jobs, I don't know. Certainly we teach in all of our schools that mission accomplishment is paramount, doing the Army's job. That really gets lost when people keep quoting, “We're doing this to meet the principles of Vanguard.”

The principles of Vanguard are fewer field operating agencies. Yet, you could have something like a subordinate operational activity; that's all right. Doesn't that sound like a field operating agency?

Q: Yes.

A: Only by another name?

Q: Yes.

A: Sure it does. So, I don't know. The original mark on the wall becomes the driver, and we have folks who see their measure of success as to whether they can achieve that number, irrespective of mission accomplishment or effectiveness, and that's absolutely wrong.

We ought to find out how to effectively accomplish the mission with fewer resources, or with the right number of resources, or articulate the cause if it's a threshold on a certain kind of resource, like AMHA [Army Management Headquarters Account] spaces, to get it right.

Part of the Vanguard problem is that it was good, in years past, to have subordinate activities do these kinds of jobs rather than headquarters. Now, “good” has been redefined. It's no longer good to have a field operating agency. It's better to have the function at the headquarters, but you can't have more spaces at headquarters—that is against another principle, which was the original problem that caused the field operating agencies to be established to meet the original “goodness.” So—it's bonkers.

Q: How do you feel at this point, now that you're about two weeks away from retirement?

A: Oh, I feel that I'd rather go back, start my career all over again, and do it all over.

Q: Sure.

A: I mean, if you asked me again, I might tell you the same thing. I feel pretty good. I've had 34 years, 5 months of great service, and I've enjoyed all of it—some days more than others.

We've just got great people and a great mission and a great opportunity to serve, and I feel that I have contributed more than my fair share and have some significant achievements that I'm proud of. So, it's been a wonderful time.

At the same time, they don't let you stay forever. I've always known that at least by June of next year I would be retired mandatorily. So, I started on a path to ensure that I was looking at opportunities should they come up in the final year and not stay until the very last day before I started looking.

Mentally, I'm prepared for that transition as well. So, I feel pretty good.

Q: Well, it's certainly been a pleasure talking about the last year.

A: Sure. Well, I've enjoyed this. It's been fun.



In a ceremony at Fort Leonard Wood, Missouri, on 3 May 2002, Major General Richard S. Kem, USA (Ret.) (center, right), received the Gold Order of the deFleury Medal from Lieutenant General Robert B. Flowers, Chief of Engineers and Colonel of the Army Engineer Regiment (center, left). The Gold Order of the deFleury Medal is the most prestigious individual recognition award presented by the Army Engineer Regiment. Only one such medal is presented each year. General Kem also is wearing the Silver Order of the deFleury Medal, which he received in May 1989. (Photos by F. T. Eyre, HQUSACE, and Michael Curtis, DPTM TSC, Fort Leonard Wood.)

Acronyms

ACE	Assistant Chief of Engineers
ACE (M9)	Armored Combat Earthmover
ADM	Atomic Demolition Munitions
AFCENT	Allied Forces, Central
AFRC	Armed Forces Recreation Center
AFRCE	Air Force Regional Civil Engineer
AH-64	Apache helicopter
AMHA	Army Management Headquarters Account
AMC	Army Materiel Command
APC	Armored Personnel Carrier
ARVN	Army of the Republic of Vietnam
AVLB	Armored Vehicle Launched Bridge
BAOR	British Army of the Rhine
BDU	Battle Dress Uniform
BOM	Blue Office Memorandum
BOQ	Bachelor Officers Quarters
CAC	Combined Arms Center
CACDA	Combined Arms Combat Development Activity
CAR	Coordination, Analysis, and Reports
CE80	Corps of Engineers in 1980
CEAP	Corps of Engineers Automation Plan
CENTAG	Central Army Group
CEV	Combat Engineer Vehicle

CINCUSAREUR	Commander in Chief, U.S. Army, Europe
CMH	U.S. Army Center of Military History
DCSENGR	Deputy Chief of Staff, Engineer
DCSLOG	Deputy Chief of Staff for Logistics
DCSOPS	Deputy Chief of Staff for Operations and Plans
DCSPER	Deputy Chief of Staff for Personnel
DCSRM	Deputy Chief of Staff for Resource Management
DEH	Director of Engineering and Housing
DINAMO	Development of Inland Navigation in America's Ohio Valley
EPA	Environmental Protection Agency
EUCOM	European Command
EUD	Europe Division
E-Force	Engineer Force
FM	Field Manual
FORSCOM	Forces Command
FTE	Full Time Equivalent
FTX	Field Training Exercise
G-1	Assistant Chief of Staff, Personnel
G-2	Assistant Chief of Staff, Intelligence
G-3	Assistant Chief of Staff, Operations and Plans
G-4	Assistant Chief of Staff, Logistics
IG	Inspector General
INF	Intermediate Nuclear Forces
ISAE	Installation Support Activity, Europe
JAG	Judge Advocate General

JTR	Joint Travel Regulations
LST	Landing Ship, Tank
M9 ACE	Armored Combat Earthmover
MAAG	Military Assistance Advisory Group
MACOM	Major Army Command
MACV	Military Assistance Command, Vietnam
MCA	Military Construction, Army
METT-T	Mission, Enemy, Terrain, Troops, and Time Available
MILES	Multiple Integrated Laser Engagement Simulation System
MILPERCEN	Military Personnel Center
NATO	North Atlantic Treaty Organization
NORTHAG	Northern Army Group
NPD	North Pacific Division
NTC	National Training Center
O&M	Operations and Maintenance
OMA	Operations and Maintenance, Army
OPCON	Operational Control
OPMS	Officer Personnel Management System
P	Promotable
POL	Petroleum, Oils, and Lubricants
POM	Preparation for Overseas Movement
POMCUS	Pre-Positioning of Materiel Configured to Unit Sets
PPBES	Planning, Programming, Budgeting, and Execution System
REARM	Renovation of Armament Manufacturing
REFORGER	Return of Forces to Germany

ROK	Republic of Korea
ROTC	Reserve Officers Training Corps
RPG	Rocket-Propelled Grenade
S-1	Adjutant
S-2	Intelligence Officer
S-3	Operations and Training Officer
S-4	Supply Officer
SES	Senior Executive Service
SHAPE	Supreme Headquarters Allied Powers, Europe
SOUTHCOM	Southern Command
SUPCOM	Support Command
TEXS	Tactical Explosive System
TO&E	Table of Organization and Equipment
TOW	Tube Launched, Optically Tracked, Wire Guided
TRADOC	Training and Doctrine Command
U.S.	United States
UET	Universal Engineer Tractor
USACE	U.S. Army Corps of Engineers
USAREUR	U.S. Army, Europe
USARV	U.S. Army, Vietnam

Index

- Abrams, Creighton W., 27, 39, 156, 158, 165, 169, 314, 395
- ACE. *See* Assistant Chief of Engineers
- ADM. *See* Atomic Demolition Munitions
- AFCENT. *See* Allied Forces, Central
- AFRC. *See* Armed Forces Recreation Center
- AH-64. *See* Apache helicopter
- Airborne School, 20, 47
- AirLand Battle, 329, 332, 333, 337, 339, 342, 344, 345, 346, 356, 357, 366, 472
- Alaska District, 86
- Alaska earthquake, vi, 82, 87, 88
- Allaire, Chris, 89, 90
- Allied Forces, Central, 236, 239, 402, 403, 489
- AMC. *See* Army Materiel Command
- An Khe, vi, 58, 60, 61, 63, 64, 66
- Anchorage, AK, 82, 84, 85, 86
- Anderson, Michael D., 137, 138, 139
- Apache helicopter, 398, 399, 414, 419, 489
- Armed Forces Recreation Center, 393, 394, 489
- Armored Combat Earthmover, 27, 28, 209, 214, 262, 332, 338, 340, 341, 342, 351, 374, 405, 489, 491
- Armored Vehicle Launched Bridge, 37, 38, 39, 41, 374, 489
- Armstrong, Dick, 297, 300, 324
- Army Materiel Command, 50, 75, 233, 308, 350, 489
- Army of the Republic of Vietnam, vi, 55, 61, 67, 489
- ARVN. *See* Army of the Republic of Vietnam
- Assistant Chief of Engineers, v, ix, xii, 166, 220, 226, 233, 248, 258, 284, 451, 489
- Atomic Demolition Munitions, 32, 33, 34, 35, 186, 187, 191, 205, 489
- AVLB. *See* Armored Vehicle Launched Bridge
- Ayers, Bob, 135, 143
- Bachelor Officers Quarters, 26, 36, 68, 82, 489
- Bachus, Walter, 176, 178, 368
- Baltimore District, 307, 308, 311
- Ban Me Thuot, 57, 62, 63, 109, 121
- Ban Thach River bridge, vi
- Barnes, Bill, 109, 111, 126, 128
- Bartlett, Gerald T., 336
- Bates, Jimmy, 297, 300, 324
- Battle Dress Uniform, 245, 246, 391, 489
- Bay Springs Lock and Dam, 269, 270, 272, 286
- BDU. *See* Battle Dress Uniform
- Berlin, 42, 241, 418, 423, 424
- Berry, Sid, 148, 156, 158
- Bevill, Thomas, 269, 270, 271, 272, 274, 285, 291, 303
- Big South Fork National River and Recreation Area, 304, 305
- Bishop, Ted, 55, 56
- Bisping, Casper, 68
- Blakey, Lew, 268, 278, 291
- Blanchard, George S., 43, 186, 188, 189, 216, 222, 224, 228, 231, 232, 242, 429
- Blocher, Bob, 16
- Blue Office Memorandum, 168, 489
- BOM. *See* Blue Office Memorandum
- BOQ. *See* Bachelor Officers Quarters
- Bradley Fighting Vehicle, 44, 339, 367, 374, 395, 397
- Bratton, Joe, 148, 284, 288, 307, 323, 328
- Brinkley, Chuck, 24
- Brown, Frederick, 39
- Brown, Rick, 11
- Bryan, Blackshear, 12, 20
- Bulldozer, 28
- Bunch, Jim, 147
- Burba, Edwin H., 336, 343, 377, 472
- Burnell, Bates, 100, 176
- Byrd, Senator Robert, 275, 276, 277, 278, 279, 280, 281, 285, 292, 327, 350, 478

- CAC. *See* Combined Arms Center
- Cal-Sag Waterway, 75, 78
- Camp A. P. Hill, 21
- Camp Buckner, 14, 18, 133
- Camp McCall, 42, 93
- Campbell, Jack, 39, 50
- Campbell, Paula, 50, 51
- Can, LT, 60, 62, 69
- Capka, Rick, 135, 382, 469
- Carbon Edge, vii, 204, 212, 213, 214, 215
- Carrol, William “Herc”, 52, 185
- Carter, Nick, 39
- Carton, Al, 251, 254, 255, 256, 258, 262
- CE80. *See* Corps of Engineers in 1980
- CEAP. *See* Corps of Engineers Automation Plan
- CENTAG. *See* Central Army Group
- Central Army Group, 228, 489
- Centurions, The, 72
- CEV. *See* Combat Engineer Vehicle
- Chan, MAJ, 66, 68
- Cheo Reo, Vietnam, vi, 66, 67, 68, 103
- Chicago District, v, vi, ix, 74, 75, 76, 79, 180, 183
- Chow, Ven Te, 53
- CINCUSAREUR. *See* Commander in Chief, U.S. Army, Europe
- Civil engineering, ix, 49, 51, 52, 53, 54, 295
- Clarke, Frederick, vii, 147, 153, 154, 155, 156, 158, 172, 249, 261, 368, 369, 370, 371, 376
- Coffman, Howard B., 39
- Colonels Division, xii, 143, 144, 145, 146, 148, 149, 150, 151, 152, 153, 156, 157, 160, 161, 165, 172, 185, 393, A1
- Combat Engineer Vehicle, 338, 374, 489
- Combined Arms Center, 11, 328, 329, 330, 332, 334, 336, 340, 343, 356, 410, 489
- Commander in Chief, U.S. Army, Europe, 43, 160, 240, 248, 385, 403, 423, 445, 490
- Controlled humidity warehouses, 227
- Corps of Engineers Automation Plan, v, 1, 455, 456, 457, 458, 459, 462, 463, 465, 467, 476, 489
- Corps of Engineers in 1980, 456, 489
- Cung Son, vi, 66, 67, 103, 113, 114, 115, 117, 122
- Dalat, 62, 110, 111, 113, 115, 116, 124, 125
- Davidson, Gar, 12
- Davison, Mike, 11, 14
- DCSENGR. *See* Deputy Chief of Staff, Engineer
- DCSLOG. *See* Deputy Chief of Staff for Logistics
- DCSOPS. *See* Deputy Chief of Staff for Operations and Plans
- DCSPER. *See* Deputy Chief of Staff for Personnel
- DCSRM. *See* Deputy Chief of Staff for Resource Management
- Deere, Don, 53
- DEH. *See* Director of Engineering and Housing
- Delbridge, Norm, 255, 263, 435
- Deputy Chief of Staff for Logistics, 150, 167, 168, 169, 171, 230, 231, 232, 234, 235, 248, 253, 422, 490
- Deputy Chief of Staff for Operations and Plans, 225, 226, 231, 232, 239, 253, 333, 384, 399, 407, 408, 410, 415, 422, 423, 430, 450, 470, 474, 490
- Deputy Chief of Staff for Personnel, 156, 158, 168, 367, 369, 490
- Deputy Chief of Staff for Resource Management, 231, 379, 490
- Deputy Chief of Staff, Engineer, iii, v, viii, ix, xii, 133, 224, 225, 382, 396, 426, 490
- Development of Inland Navigation in America's Ohio Valley, 289, 306, 490
- Diem, Ngo Dinh, 70, 127
- Dien Bien Phu, 72, 73
- DINAMO. *See* Development of Inland Navigation in America's Ohio Valley
- Director of Engineering and Housing, 220, 226, 242, 309, 313, 345, 390, 391, 490
- Divide cut, Tennessee-Tombigbee Waterway, 269, 270, 271, 272, 273, 286
- Dunes on Lake Michigan, 77, 80, 81
- Edgar, Earnest, 98, 99, 118, 183, 443, 481, 482, 483

- E-Force, v, 489, C1
 82d Airborne Division, v, ix, xi, 10, 42, 91, 130, 370
 Ellis, Jim, vii, 10, 11, 70, 74, 89, 91, 135, 269, 270, 274, 275, 286, 340
 Engineer Branch, 18, 49, 55, 89, 135, 140, 143, 145, 148, 150, 161, 363, 364
 Engineer regiment, vii, 370
 Englebrecht, Richard S., 53
 Environmental Protection Agency, 297, 298, 302, 303, 324, 490
 EPA. *See* Environmental Protection Agency
 EUCOM. *See* European Command
 EUD. *See* Europe Division
 Europe Division, 192, 392, 490
 European Command, 187, 217, 416, 490
 Ewell, Julian, 14
 Fall, Bernard, 58, 72
 Fasching, 24
 Fenves, Steve, 53
 Fiala, Chuck, 143, 148, 149, 165, 166, 242, 383, 385, 386, 414, 416, 417
 Field Training Exercise, 190, 200, 201, 204, 205, 207, 212, 213, 215, 233, 341, 398, 408, 309, 410, 468, 471, 490
 Fields, Tom, 135
 1st Armored Division, 43, 140, 194, 195, 206, 248, 417
 Fishback, Jessie, 15, 16
 Fischer, Klaus, viii, 396, 397, 419, 420
 Fitzgerald, Bill, 135
 Forces Command, 149, 167, 336, 366, 381, 385, 391, 447, 449, 471, 472, 490
 FORSCOM. *See* Forces Command
 Fort Belvoir, iii, v, vii, x, xii, 10, 20, 21, 88, 135, 197, 199, 215, 248, 257, 262, 327, 329, 330, 334, 347, 349, 350, 354, 360, 363, 364, 365, 368, 369, 370, 372, 437, 440, 442, 443, 444, 467, 468, 480
 Fort Campbell, 147, 206, 307, 308, 311, 312, 365
 Fort Leonard Wood, 21, 42, 47, 48, 49, 329, 347, 350, 353, 354, 355, 356, 357, 358, 359, 360, 365, 368, 369, 372, 373, 374, 376, 377, B3, B4
 Foss, John, 11, 367, 409, 472
 Foster, Jim, 39
 Fowler, Delbert M., 101, 109, 110, 128
 Franks, Frederick M., Jr., 336, 343, 380, 409, 473
 Frasrand, John, 39
 Friedberg, 25, 26
 FTE. *See* Full Time Equivalent
 FTX. *See* Field Training Exercise
 Fuentes, George, viii, 225, 242, 389, 396
 Full Time Equivalent, 171, 310, 320, 490
 Fursin, LTG V., viii, 423, 427, 428, 429
 Galloway, Gerry, 41, 99
 Gianelli, William, Assistant Secretary of the Army (Civil Works), vii, 275, 276, 277, 278, 279, 280, 281, 283, 288, 289, 290, 291, 292, 295, 304, 320
 Grafenwöhr, viii, 18, 26, 27, 28, 191, 197, 342, 395, 409, 419, 420, 428, 429
 Graves, Ernie, 173
 Graves, Howard, 92
 Gray, Dave, 91, 300
 Gribble, Bill, 78, 98, 147, 160, 172, 174, 179, 183, 184, 185
 Griffin, Tom, 135, 140, 390
 Groves, Richard, 224, 225, 226, 227, 228, 229, 231, 232, 235, 236, 240, 242, 248, 249, 251, 402, 403
 Haig, Alexander, 11, 14, 236, 237
 Haldane, Bob, 11, 12, 14, 133, 138, 140
 Hanau, Germany, 20
 Harkins, Paul D., 70, 104
 Hartung, Ken, 75, 77
 Harvey, Congressman Ralph, vi, 3, 4
 Hatch, Henry, 165, 181, 259, 260, 433, 434, 435, 438, 439, 440, 444, 475, 477, 478, 480
 Heiberg, Vald, vii, 135, 225, 229, 232, 233, 237, 245, 248, 249, 259, 263, 265, 266, 267, 268, 269, 276, 284, 286, 288, 291, 300, 301, 304, 323, 327, 342, 351, 364, 366, 367, 368, 369, 371, 383, 384, 387, 395
 Higgs, Joe, 243, 244, 300, 413
 Hollingsworth, James F., 13, 14, 26

- Hughes, John A., Jr., 57, 58
Huntington District, 275, 297, 301, 302, 303, 312, 324, 325, 369
IG. *See* Inspector General
Information Management, 460, 462, 463, 464
Inspector General, 32, 167, 169, 386, 447, 490
Installation Support Activity, Europe, 224, 225, 241, 384, 490
Intermediate Nuclear Forces, 490
Irving, Frederick, 12
ISAE. *See* Installation Support Activity, Europe
Jacksonville District, 91, 92, 177, 450
Joliet Lock and Dam, 77
Joulwan, George A., 399, 415, 426
Kansas City District, 357, 358, 359
Kaserne, 36
Kelly, Pat, 135, 444
Kem, Ann, vi, vii, 75, 87, 252, 253, 328, 382
Kem, Bill, 5
Kem, Charles, 17
Kem, David, 5
Kem, Jan, 5
Kem, Janice, 3, 17
Kem, John, vii, 6, 264, 335
Kem, Michelle, 134
Kem, origin of name, 5
Kem, Steven, 253
Khanh, Nguyen, 68, 69
Kiper, Jack, 297, 300, 314, 324
Knowlton, Bill, 140
Kodiak Island, 82, 83, 84
Korea, 11, 13, 14, 39, 55, 73, 98, 103, 146, 257, 258, 349, 361, 367, 387, 468, 472, 492
Korte, Dr., 397, 398, 399, 403
Koster, Samuel W., 140
Kroesen, Frederick, vi, 189, 200, 204, 205, 233
Larteguy, Jean, 72
LeTellier, Carroll, 149, 150, 177, 179, 271, 368
Louisville District, 165, 281, 283, 286, 312, 313, 315, 324, 326
Lower Mississippi Valley Division, 175, 176, 247, 263, 316, 317, 323, 324, 325, 326
Ludwigsburg–Kornwestheim, 185, 186, 187, 220, 221, 442
M–59, 27, 28, 29
M9 ACE. *See* Armored Combat Earthmover
MAAG. *See* Military Assistance Advisory Group
MACOM. *See* Major Army Command
Major Army Command, ix, 245, 255, 327, 350, 369, 381, 391, 437, 491
Matewan, West Virginia, 275
Mattina, John, 75, 77, 80, 81
MCA. *See* Military Construction, Army
McAdoo, CPT, 12
McConnell, Richard E., 12
McCown, Hal, 68
McDonald, Bob, 101, 102, 103, 107, 221
McNulty, Jim, 10, 135
Mekong River, 55
Messinger, Edwin, 12
Meyer, Edward C. "Shy", 95, 232, 233
Michaelis, Mike, 12
Military Assistance Advisory Group, xi, 56, 491
Military Construction, Army, 226, 249, 491
Military Personnel Center, v, xii, 143, 148, 224, 491
MILPERCEN. *See* Military Personnel Center
Mississippi River Commission, 316, 318, 319, 324
Missouri River Division, 147, 260, 297, 298, 308, 309, 310, 312, 313, 314, 317, 323, 324, 357
Mobile District, 269, 308, 311, 325
Mobile Group 100, 58, 60, 73
Morris, John W. "Jack", iv, vi, vii, 117, 118, 125, 126, 162, 173, 174, 175, 176, 179, 180, 250, 251, 252, 260, 262, 263, 264, 284, 285, 368, 434, 451, 471
My Lai, 140, 169

- Myers, Congressman John, 270, 274, 285, 286
- Nagata, Sadayo, 57, 58, 62, 66
- Nashville District, viii, 269, 273, 295, 300, 304, 306, 312, 325, 369, 436, 445
- National Training Center, 33, 331, 333, 361, 406, 410, 491
- NATO, 193, 196, 226, 227, 228, 229, 231, 233, 235, 236, 237, 239, 242, 245, 247, 249, 258, 333, 343, 366, 384, 385, 386, 390, 398, 402, 403, 421, 422, 424, 491
- Naval Academy, 19, 20
- New York District, 134
- Newmark, Dr. Nathan, 52
- Nha Trang, 57, 62, 63, 66, 71, 103, 109
- Nicolais, Mario, 9
- 9th Engineer Battalion, 43, 194, 206, 208, 210, 211, 213
- Noah, Max, 91, 93, 341, 405, 440
- North Atlantic Division, 134, 308
- North Central Division, 75, 78, 172, 298, 313, 314, 317, 323, 324
- North Pacific Division, 82, 295, 467, 491
- NORTHAG. *See* Northern Army Group
- Northern Army Group, 402, 405, 421, 422, 491
- NTC. *See* National Training Center
- O&M. *See* Operations and Maintenance
- Officer Personnel Management System, 149, 152, 153, 154, 155, 156, 157, 159, 161, 185, 249, 491, A1, A4, A5
- Ohio River Division, iii, v, ix, 78, 91, 247, 264, 265, 266, 268, 269, 270, 274, 275, 276, 281, 282, 284, 285, 286, 287, 288, 289, 293, 295, 296, 297, 299, 300, 303, 304, 306, 307, 308, 309, 310, 313, 316, 317, 318, 319, 320, 323, 324, 327, 349, 350, 369, 401, 434, 438, 448, 456, 460, 477
- OMA. *See* Operations and Maintenance, Army
- Omaha District, 307, 309, 313, 326
- Operations and Maintenance, 78, 255, 491
- Operations and Maintenance, Army, 78, 239, 312, 388, 491
- OPMS. *See* Officer Personnel Management System
- Otis, Glenn, 242, 248, 332, 380, 383, 384, 385, 387, 388, 389, 390, 393, 394, 395, 404, 405, 412, 414, 415, 417, 418, 482, 483, 484
- Ott, Dave, vii, 34, 43, 200, 206, 213, 216, 217, 218, 221, 223, 224, 245, 248
- Pacific Ocean Division, 441, 468
- Page, Robert W., Assistant Secretary of the Army (Civil Works), 441, 448, 456, 457, 460, 461, 463, 464, 465, 466, 475
- Palmer, Dave, 11, 167
- Patton, George, 11
- Peck, Dr. Ralph, 53
- Peel, Ed, 146, 153
- Pentomic division, 31
- Perkins, Congressman Carl, 301
- Pershing missiles, 407
- Phu Hiep, vi, 102, 103, 104, 105, 107, 110, 115, 124
- Pick, John, 39
- Pinky, Vern, 39
- Planning, Programming, Budgeting, and Execution System, 250, 491
- Pleiku, vi, 7, 55, 56, 57, 58, 60, 64, 66, 70, 71, 101, 109
- POM. *See* Preparation for Overseas Movement
- POMCUS. *See* Pre-Positioning of Materiel Configured to Unit Sets
- PPBES. *See* Planning, Programming, Budgeting, and Execution System
- Praetorians, The*, 72
- Preparation for Overseas Movement, 213, 226, 250, 251, 260, 440, 491
- Pre-Positioning of Materiel Configured to Unit Sets, 195, 211, 227, 228, 230, 231, 234, 235, 239, 242, 384, 491
- QL-1, highway, 104
- Qui Nhon, 57, 102, 103, 105, 109, 111, 114, 122, 129
- Ranger School, 10, 22, 23, 24, 29, 32, 40
- Rank, William A., 12

- Read, Bill, 154, 233, 249, 250, 251, 254, 255, 256, 258, 259, 260, 263, 266, 316, 317, 318, 319, 323, 451
- REARM. *See* Renovation of Armament Manufacturing
- REFORGER, vii, 189, 190, 192, 200, 201, 204, 205, 208, 209, 212, 213, 214, 215, 233, 330, 331, 345, 379, 385, 398, 404, 405, 406, 407, 408, 409, 410, 414, 468, 471, 491
- Reno, Bill, 210, 213, 336, 346, 358, 378, 379, 383, 404, 406, 407, 470, 471, 480
- Renovation of Armament Manufacturing, 308, 309, 310, 313, 314, 491
- Richardson, William R., 204, 328, 329, 330, 333, 334, 335, 336, 339, 351, 410, 467, 469, 470
- Rienzi, Thomas M., 14
- Robertson, Bill, 439, 474, 477, 478, 480
- Robinson, Hugh, 135
- Rochefort, Joseph J., 12
- Rock Island District, 31, 307, 313
- Rogers, Bernard W., 35, 75, 78, 137
- Rollins, Andy, 146, 147, 149, 153
- Ruffner, Ernie, 24, 38
- Russia. *See* Soviet Union
- Saint, Crosbie E. "Butch", 94, 248, 331, 332, 343, 385, 389, 394, 398, 399, 400, 403, 405, 406, 407, 408, 409, 414, 415, 417, 418, 421, 422, 423, 425, 426, 429, 430, 431, 432, 433, 434, 459, 471, 472, 483
- Santo Domingo, 91, 92, 94
- Sawyer, Trev, 82, 83, 85, 86
- Shaefgen, Dr., 396, 397, 399
- Schafer, Dick, 53
- Schroeder, Dan, 135, 383, 407, 408, 409, 471, 472, 473
- Schwarzkopf, Norman, 11
- Senior Executive Service, 300, 439, 492
- SES. *See* Senior Executive Service
- VII Corps, vi, vii, 27, 31, 43, 44, 185, 186, 187, 189, 190, 192, 193, 195, 196, 216, 217, 219, 239, 242, 245, 379, 380, 389, 404, 405, 407, 408, 409, 411, 417, 432, 442, 468, 469, 473
- 7th Engineer Brigade, v, vi, vii, ix, xii, 18, 27, 29, 31, 32, 33, 38, 44, 140, 165, 185, 186, 187, 188, 189, 191, 194, 200, 204, 210, 211, 213, 224, 248, 379, 407, 411, 414, 442, 468, 469, 471
- SHAPE. *See* Supreme Headquarters Allied Powers, Europe
- Sheehey, John, 256, 262, 462
- Shwaiko, Alex, 266, 268, 288, 291
- Sisinyak, Mark, 135, 165, 254, 255, 310
- 62d Engineer Battalion, v, xi, 47
- Smedle, Joe, 75
- Smith, Larry, 39
- Smith, Scott, 165, 242, 383, 385, 388, 419
- Smith, Tommy G., 24
- Snetkov, GEN, 423, 425, 426, 427
- Song Ba River, 66, 105
- Soo, Huong, 382, 469
- South Atlantic Division, 175, 176, 177, 179, 269, 270, 271, 273, 275, 286, 308, 311, 316
- Southwestern Division, 461
- Soviet Union, ix, 13, 421, 425
- Speiser, Bob, 19
- Steinberg, Bory, 265, 266, 268, 291, 294, 319
- Street Without Joy*, 58, 72
- Suplizio, Paul, 154, 157
- Supreme Headquarters Allied Powers, Europe, 148, 491
- Sylvester, Dick, 19
- Table of Organization and Equipment, 89, 90, 358, 472, 492
- Tactical nuclear weapons, 31
- Tait, Thomas H., 336, 340, 377
- Tallman, Dick, 135, 136, 140
- Taylor, Maxwell, 22, 31, 55, 56
- Tecumseh, 19, 20
- Tennessee-Tombigbee Waterway, viii, 179, 445
- Tenn-Tom. *See* Tennessee-Tombigbee Waterway
- 3d Armored Division, v, ix, xi, 10, 11, 20, 23, 24, 26, 27, 32, 37, 39, 42, 44, 46, 74, 93, 331, 426, 469

- 32d Tank Battalion, 26, 28, 45
 37th Armored Infantry Battalion, 25
 Thompson, John, 72
 Thurman, Max, vii, 29, 129, 149, 233, 250, 336, 340, 341, 382, 383, 404, 406, 407, 408, 409, 410, 412, 470, 471
 Tixier, Lou, 146, 151, 152, 153, 154, 156, 160
 TO&E. *See* Table of Organization and Equipment
 TRADOC. *See* Training and Doctrine Command
 Training and Doctrine Command, vii, 11, 149, 150, 152, 199, 204, 215, 263, 328, 329, 330, 332, 333, 336, 339, 340, 349, 350, 351, 352, 354, 357, 358, 360, 361, 362, 374, 375, 376, 377, 379, 381, 382, 387, 391, 404, 407, 408, 409, 410, 467, 470, 471, 472, 492
 Tri, Le Viet, 59, 60, 61, 62, 69
 Tug Fork Valley, 278
 Tuy Hoa, vi, 63, 64, 66, 67, 70, 71, 73, 101, 102, 103, 104, 105, 106, 107, 111, 113, 114, 115, 116, 117, 121, 122, 123, 124, 127
 23d Engineers, v, 20, 23, 24, 27, 39, 50, 65, 70, 95, 331, 469
 237th Engineer Battalion, 43, 191, 195
 U.S. Army, Europe, 11, 424, 492
 U.S. Military Academy, v, vi, ix, xi, xiii, 3, 4, 5, 7, 8, 11, 13, 14, 15, 16, 17, 19, 20, 21, 22, 24, 25, 26, 29, 38, 41, 50, 51, 52, 53, 54, 63, 74, 90, 121, 132, 134, 135, 136, 137, 138, 139, 140, 146, 167, 269, 386, 414, 435
 University of Illinois, v, ix, xi, xiii, 49, 50, 51, 53, 54, 56, 70, 74
 USAREUR. *See* U.S. Army, Europe
 Van Autreve, Leon, 369, 370
 Vander Els, Ted, 43, 210, 213, 215, 341, 364, 381, 469
 Vander Shaaf, Derek, 386, 414, 416, 417, 483, 485
 Veysey, Victor, 173, 179, 180, 265
 Vietcong, 59, 63, 66, 67, 71, 110, 123, 124, 125, 126, 127
 Vietnam, iii, v, vi, ix, xi, 6, 11, 13, 42, 48, 55, 56, 70, 71, 73, 74, 76, 77, 84, 88, 90, 91, 93, 95, 97, 98, 99, 105, 106, 110, 120, 121, 124, 126, 129, 130, 131, 132, 134, 136, 137, 140, 145, 148, 150, 152, 154, 163, 169, 183, 188, 189, 219, 327, 435, 491, 492
 Vung Ro Bay, 102, 103, 104, 105, 106, 107, 108, 111, 112, 114, 118, 120, 121, 123
 Vuono, Carl, vii, 204, 328, 329, 332, 333, 336, 337, 343, 345, 346, 356, 380, 382, 383, 387, 407, 408, 409, 410, 467, 469, 470, 472, 473
 Waggener, John G., 92, 95, 96, 130, 131
 Wagner, Lou, 50
 Walker, Sam, iv, x, 140, 259, 433
 Wall, John, 19, 165, 254, 303, 304, 320
 Webb, Bill, 140
 Weinstein, Tom, 11
 West Point. *See* U.S. Military Academy
 Whitten, Congressman Jamie, 269, 272, 274, 285, 291, 325, 327
 Wildflecken, 26, 32, 40, 41, 191, 240, 241, 393, 395, 397, 414
 Wilson, Wilbur "Coalbin Willy", 55, 57
 Wilson, Walter "Weary", 85
 Withers, Ken, 89, 90, 165, 439, 455, 456
 Woodmansee, John W., 340, 404, 407
 Wray, William, 233, 254, 255, 256, 257, 258, 259, 261
 Wright-Patterson Air Force Base, 307, 309, 310
 Yankoupe, Roger, 135
 Yatesville Lake, 301

Appendix A
Centralized Command Selection Paper
30 March 1973*

* Appendix A has been retyped. However, it retains the spelling, punctuation, and style of the original.

30 March 1973

MEMORANDUM FOR COL TIXIER

SUBJECT: OPMS Command Selection and Selection of District Engineers

1. The purpose of this memo is to set down my thoughts on the selection process for commanders and District Engineers—ideas that I have recently discussed with LTC Supplizio of the OPMS Study Group. I will do this by first providing in rough essay form my thoughts and follow this with a statement of options and advantages and disadvantages. Lack of time does not permit boiling it down to study format without important omissions.

2. OPMS Command Selection - the first year. The Combat Support Army Command Selection Board picked good officers for command this next year as can be expected. In failing to return to Colonels Division a longer list as we had requested (25), the board has limited assignment flexibility. At present the entire list of 12 has been exhausted—with three deferees, seven engineer commands, one aviation command and one support command commander, all alternates have been used. With possibilities for general officer selections, selection for key horseholder positions, and relief for cause or sickness, future boards should provide a larger number as was done for Artillery and Signal this year—we can still draw the line for principal and alternates at the appropriate points.

3. Impact of this year's OPMS command selection. Before board results were known, the Chief of Engineers determined that he would support OPMS fully. He determined that District Engineers completing two years would go to command—he would request that any District Engineer who would be completing but one year in a District be deferred a year. This resulted in three officers leaving their Districts after two years, with two officers, having served only one year being deferred for command until FY 75. One other officer, slated to be Regt Cmdr at USMA next year was also deferred. With but few available commands, the impact has been considerable. It meant increased turbulence this year as three District Engineers left early. For next year, it means that we already know that two District Engineers will leave after two years, and three of the five FY 75 command positions are taken by this year's deferees. Therefore, only two command positions will be open for new selectees next year.

4. Philosophy - Engineer Colonels, Troop Command, District Engineers. Like an officer of any other branch, an engineer officer worth his salt aspires to command. Within the Corps, for colonels that command is perceived as engineer troop command or engineer district command. This may not be fully understood by the combat arms officer who would view a district engineer—a civil function—as management or a technician's job. But the relation of the two and the perception of engineer officers is real and valid. It is valid because engineer districts really are command—requiring the same principles of leadership and management as does a troop command. A district is an operating element in a chain of command, reporting through engineer divisions to the Office, Chief of Engineers. It has subordinate operating elements and the district engineer has a staff to assist him. He is concerned with operations, planning, preparing resources, men, materiel, money and time to

accomplish missions. He must lead and motivate—different personalities require different techniques just as in troop units. He must handle the personnel problems of his command and since it consists of the whole spectrum from the lowest grade of wage-board employee to GS-15, this means: he is concerned with replacements and timing; he has discipline problems; equal opportunity problems, and congressionals; he is expected to produce results—through his operating elements, using his staff, and his own qualities of leadership. It is his command and he is responsible for the whole of it—he cannot delegate his responsibility. This doesn't establish that districts should or are perceived to rate a priority over troop command—there are large and small districts, more and less challenging and more or less desirable just as there are more and less challenging commands—e.g., an engineer bde in USAREUR with five combat battalions compared to an engineer group of one battalion at Ft. Riley.

5. The relationship is valid from the standpoint of force structure and offers professional development as well. In time of peace the Army logically seeks to retain the highest possible percentage of its combat forces in the residual force structure. Headquarters are opportune items for deletion. The few residual engineer battalions are spread about CONUS with little need for Engineer Group headquarters to pull together their efforts. As a consequence the Engineer troop unit structure is truncated at the top. That gap in command experience historically has been adequately filled by the engineer district. It provides the opportunity for the Army to train officer who can command the combat groups and brigades in an expanded wartime forces. It provides the opportunity for all engineer officers to see command running from platoon to company to battalion to group/district.

6. Alternatives for selecting troop commanders and district engineers.

a. Alternative I - Board selection of troop commander with District Engineers selected by the Chief of Engineers in a slating session for OPD. (Present System)

Advantages:

- (1) Chief of Engineers has maximum flexibility in selecting of District Engineers.
- (2) Eliminates possibility of board having more than a single set of selection criteria. (Assumes there would be different criteria. Present COE indicates he is looking for same criteria.)
- (3) Maintains a clear-cut distinction of troop command. (Assumes such distinction is desirable.)

Disadvantages:

- (1) Carries “halo” effect for engineers since there are so few positions.
- (2) Establishes District Engineer position as second class—not equivalent to troop command.

SUBJECT: OPMS Command Selection and Selection of District Engineers

- (3) Increases assignment turbulence by permitting premature rotation of officers from District Engineer positions for troop command.

b. Alternative II - Troop command selection board selects District Engineers with troop commanders on a single list.

Advantages:

- (1) District Engineer and Troop Command are recognized colonel commands.
- (2) Eliminates “halo” effect of few engineer command selectees.
- (3) Provides board credibility to selection process.
- (4) Permits engineer colonels to indicate an honest preference for district or troop command (not the experience this year).
- (5) Precludes premature rotation of officers from district engineer positions to troop command.

Disadvantages:

- (1) Precludes dual assignment of an officer as a District Engineer and Troop commander.
- (2) Could complicate eligibility and selection criteria (assumes there would be different criteria).
- (3) Clouds Army-wide clear-cut distinction of troop command. (Assumes distinction is desirable.)

c. Alternative III - Troop Command Selection Board selects separate lists of officers for troop command and for District Engineers.

Advantages:

Same as for Alternative II.

Disadvantages:

- (1) Could complicate eligibility and selection criteria (assumes there would be different criteria).
- (2) Clouds Army-wide clear-cut distinction of troop command. (Assumes distinction is desirable.)
- (3) Limits OPD assignment flexibility unnecessarily.

d. Alternative IV - Troop Commanders and District Engineers selected by independent boards.

Advantages:

- (1) Each board considers single set of criteria.
- (2) Improves visibility of district engineer positions in Army.
- (3) Provides board creditability to each selection.

Disadvantages:

- (1) Does not remove 2d class no-command stigma from District Engineers.
- (2) Creates “3d Class” citizens.
- (3) Complicates overall selection process—which board meets first?
- (4) Restricts assignment flexibility unnecessarily.
- (5) Requires another board.

7. Analysis of above factors.

a. Selection Criteria. The subject of different eligibility and selection criteria addressed in advantages and disadvantages assumes there will be different criteria. The current Chief of Engineers told the OPMS steering group that he was looking for the same type leader for district engineer as desired for troop commander. Considering the discussion in paragraph 4 above this appears valid—for an engineer the progression in command is platoon - company, battalion, and the group/district. For each of the latter two, the primary prerequisite is successful demonstration of performance in command.

b. “Maintain a clear cut distinction of troop command.” Apparently other command names on branch list from one board should not abuse the distinction. That distinction is set out by the adjective “troop.” District engineers are not troop commanders. Although some troop commands have more troops than some engineer districts. A common board list is adjusting OPMS command selection procedures to the peculiarities of a single branch. I believe that OPMS should be so adaptable to be right for any branch.

c. “Increases assignment turbulence by permitting premature rotation of officers from District Engineer positions to troop command.” This can be taken care of by other modifications to current procedures,—by increasing the year span of consideration and by permitting up to two year deferment. Both of these might contradict other objectives of the selection system.

d. Alternative II - “Permits Engineer colonels to indicate a preference for district or troop command.” —In answer to the 6 July 1972 message many colonels commented to me they preferred

SUBJECT: OPMS Command Selection and Selection of District Engineers

district assignment (because they perceived it is a tougher more demanding position than troop commands) to command but felt they had to opt for troop command. Likewise other colonels told me at this fall's slating session they preferred a troop command to a District. With this situation an officer really desiring a District may go to troop command thereby depriving another well qualified officer of his preference as well. It happened this year. This is aggravated by the extremely small number of command opportunities in the Corps of Engineers compared to other branches.

e. The "halo" effect—this is a problem in any branch but this is aggravated for engineers. There are so few positions that they equate roughly with the number of engineer general officers that might be chosen in any year. The existence of another demanding, quality position (district engineer) fed by the same manpower resources provides further artificial inequalities and perceptions affecting selection. For instance, roughly 5-6 troop command positions will be filled yearly along with 12-14 district engineer positions. Experience would also indicate roughly 4-5 engineer colonels would be selected for general officer as well. Thus roughly 20 engineer colonels are really competitive for general officer each year. Selection of six from a set of 20 with a previous board sort of five to six in that sort provides a ready environment for the "halo" effect. By selecting a larger set for command, 17-18 for district engineers and troop commanders, the two sets become more alike and the "halo" effect will be less likely to occur or be perceived.

f. Alternatives III and IV can be disposed of quickly. Both provide no further advantage than Alternative II and further complicates OPD assignments by designating officers for specific assignment. In addition, Alternative IV requires still another board.

8. If board selection for engineer troop commanders is valid, it would appear that it would be valid as well for district engineers. The final decision between the remaining alternatives and board selection of both district engineers appears to rest on three items —

a. Can the Chief of Engineers live with his loss of flexibility? Would year group and single command opportunity be a hindrance? If a longer eligibility span (3 - 5 years) is approved thereby permitting longer deferments and the ability to use officers in both positions—would this be more in keeping with his needs?

b. Are eligibility and selection criteria compatible in relation to available engineer colonels?

c. Is OPMS adaptable to meet branch differences?

9. In summary I would re-emphasize the following points. I don't see District Engineer selection by a central board as deprecating troop command in the engineers or the Army. A district is not "troop" command but it is command. The elimination of Commander "shopping lists" has been a driving force behind centralized troop command selection. This is not such a severe problem in engineers as it is for other combat arms officers since engineer troop commands are spread thinly and engineer districts provide the alternate high visibility assignment. Consequently I see no real drive to cause engineer troop commanders to be centrally selected but to provide board credibility to the selection process. In that case the same argument would prompt me to believe it would be valid for district engineer selection. So my preference would be to see the OPMS system show its adaptability by

SUBJECT: OPMS Command Selection and Selection of District Engineers

providing a board creditable list to OPD from which assignments would be made to both District and Command positions. It is more credible and provides a system very close to that in the past. Further I would seek a four-year period for consideration thus permitting greater stability in assignments—another of today's goals. I think the question of length of eligibility for selection needs to be answered first—then redirect the question to the Chief of Engineers.

RICHARD S. KEM
LTC, CE
Colonels Division, OPD

Appendix B
Engineers – A “Corps” in the Army’s Regimental System
2 August 1985*

* Appendix B has been retyped; however, it retains the spelling, punctuation, and style of the original.

ATZA-CG
2 Aug 85

SUBJECT: Engineers—A “Corps” in the Army’s Regimental System

The Army’s Regimental System Purpose—“To enhance combat effectiveness through a framework that provides the opportunity for affiliation, develops loyalty and commitment, fosters an extended sense of belonging, improves unit esprit and institutionalizes the warfighting ethos.

As one addresses potential ways the Army Corps of Engineers might seek to implement the above purpose the numerous pros and cons of each alternative seem inconclusive and each prompts as many opposing such an option as supporters. In analyzing the conflicting arguments in the endless debates that arise whenever the subject is addressed the conclusion obtains that there is no simple solution to meet all the design parameters of CSA and to obtain the very appropriate purposes articulated above. The questions then to be answered are:

—Why: What is different?

—Are our assumptions valid?

—What can be/should be done?

—How can the Corps of Engineers obtain the purposes of the Regimental System?

Let me address each of these, in turn—because the purposes are valid to the engineer force in today’s Army. The mission then is to determine in what form the engineer of that Army will participate in the Army’s system and obtain the purposes desired.

First, to answer the question of why can’t we develop for the engineer force a system of regiments like those of other combat arms. After considerable dialogue and thought—after observing how others grapple with the issues and their changing thoughts while thinking their way through the pros and cons—I conclude that the reason is that each attempt provides an organization scheme that is artificial. That is—each person recognizes that in fact the purposes will not be best obtained by artificial associations that do not provide the bonding or affiliation that such associations would be intended to produce.

In analyzing why each organizational scheme associating battalions in regimental groups provides an arrangement that is artificial it becomes readily apparent that engineers have their strongest feeling of association in two directions—to their branch and to their battalion or a past battalion, or in the case of separate engineer companies to a parent organization. Because engineers are organized in battalion entities for the most part and assigned to Divisions, or Engineer Brigades or Groups, or perhaps stationed as an independent battalion at a larger divisional installation, broader associations—other than existing combat association—do not provide real associations and are not perceived as appropriate. Where those broader associations exist, such as the 20th Engineer Brigade

or 2d Engineer Group, they are current force structure organizations, mission oriented and therefore do not fit design parameters. In addition, they provide no ready association for Divisional Engineer Battalions.

The Corps of Engineers' long history of battlefield action is maintained at two levels—overall Corps of Engineers and at battalion. Both lineage and heraldry tie the present to past battlefield exploits at battalion level. Because engineer contributions to battle have been in the past so extensive throughout the length and breadth of battle, those contributions embrace combat, combat support and combat service support functions on the battlefield. That total story is found only in the story of the engineers as a Corps—embracing all theatres, all campaigns, all construction and nation building and by engineer units in great numbers whose designation and individual lineage today rests often only in the U.S. Army Center of Military History (CMH) whose exploits are wrapped in the history of the whole “Corps of Engineers.”

Are our assumptions valid? In addressing this question, I believe the above identifies as invalid the assumption that we will obtain greater bonding or esprit in the developed regimental association based on ties to past lineage. The orientation of current serving soldiers to their battalion, and the strong history and ties of the Corps provide the greater opportunity for affiliation, for developing loyalty and commitment and further fostering a sense of belonging. Because we train and operate as battalions, unit esprit and the warfighting ethos will not be extended by regimental associations.

The second assumption to be addressed is the suggestion that we need to do something—that action is needed within the engineer force to further the purposes articulated above. I believe the strong identification of the Corps of Engineers as a “Corps” probably provides a more purposeful affiliation than that of many other branches. That is due in part to its long history but also the fact that it retains a serving “Chief” and has an additional bonding mission of historical significance in serving the nation. Certainly, the identification of soldiers for their serving and past battalions should not be broken by any action to be taken. The fact that the CSA has decoupled the personnel assignment system from the regimental system (and that homebasing remains a voluntary way soldiers can return to a desired CONUS base and unit) removes a requirement to associate battalions in a regiment to foster personnel assignments.

A third assumption offered is that engineers need to organize as regiments because other combat arms are organizing as regiments. That argument tends to be artificial as I addressed above and further avoids recognizing that infantry has in the past fought as regiments whereas engineers have typically fought as battalions and further dismisses the very large contribution of combat engineers throughout the battlefield—combat, combat support, and construction.

I would argue that there are reasons to not “stand fast”—that there are significant actions that can be taken within the Engineer force to obtain the purposes of the Regimental System enumerated by CSA.

What can be/should be done? Or stated in more direct form—in consideration of design parameters and the purposes intended, and the way engineers have been (history and lineage) and are (modern day realities) organized, what should be done to insure the purposes of the regimental system are obtained for the engineer force?

To answer that, I sought to further identify strengths and weaknesses of our current principal bonding affiliations—with the Corps of Engineers as a branch and with the engineer battalion.

—The Corps of Engineers is a significant bonding element for engineer officers. I perceive such a bond for the enlisted soldier at initial entry is not so strong yet develops as the soldier advances into NCO ranks. Thus, ways to the identification of the enlisted soldier with his “Corps” are appropriate. When one recognizes that most officers never serve at Fort Leonard Wood and most enlisted engineer soldiers never serve at Fort Belvoir (the first across the board opportunity at the SFC level advanced course), it is readily obvious that the collocation of engineer officer and NCO training at Fort Leonard Wood with the engineer enlisted training would provide opportunities to fortify common bonds and affiliation.

—Engineer battalions provide a significant point of pride in service and affiliation for the officer and NCO. Because of the wide geographical distribution of these units, repetitive assignments don't often occur for officers, and are more prevalent for enlisted soldiers in special type units such as airborne or topographic battalions. Within army engineer battalions, lineage, significance of historical contribution, and availability of museums vary widely. In seeking to further bonding that will live and grow—rather than be unwieldy and thus through erosion fail to obtain the purposes desired. That which can be done at battalion level to focus bonding I believe is currently being accomplished with leaders focusing on the unit, the mission, and emphasis on soldiers belonging to a first class outfit. To extend that battalion bonding to the future, to maintain bond/affiliation that is meaningful and continuing, is difficult to accomplish. One way would be to continue the identification by the continued wearing of that battalion crest. Can battalions feasibly maintain the rosters, establish the museums and maintain the constants that foster continued affiliation? What happens with force changes? My analysis is that, whereas engineers feel strong association with the battalions with those they serve, or have served, and would be happy to wear the crest, the purposes identified for the regimental system will for the most part not be obtained and will logistically be a problem.

How then to proceed? I believe the purposes of the regimental framework articulated by CSA are best captured in identification of the “Corps of Engineers” as a “Corps”—embodying the lineage of Corps of Engineer contributions to the Army in each battle and campaign since Bunker Hill in 1775; capturing the diversity of engineer contributions to all parts of the battlefield from close combat with armor and infantry in the forward brigade area to combat support and construction throughout the theatre; incorporating the contributions of all, eliminating none; providing a way to include all individuals in the Corps to include the training base; providing the potential to extend through the total Army. This would parallel similar designation in the British Army where the Corps of Royal Engineers is drawn from throughout the U.K. rather than the more narrow regiments (geographically associated) of other arms. It would identify the distribution of engineers throughout the U.S. Army—every echelon, in every theatre, on every battlefield, in every way.

Concept of execution: The establishment of the Corps of Engineers as the affiliation embodiment for engineers in the Army's Regimental system would entail several actions.

Ceremonial Home of the Corps. The home of the Corps would be at the location of the USAES, currently Fort Belvoir, passing to Fort Leonard Wood when the school and proponency moves in 1989. Location of the ceremonial home at the Engineer Center and School would maintain the tie to the active Army at the place where (after consolidation) each soldier, officer and enlisted, received his/her qualification training.

Colors. Corps of Engineers colors will be designated in coordination with the Institute of Heraldry and maintained at the ceremonial “Corps” home.

Crest. A crest for the Corps of Engineers as a “Corps” (as separate from MACOM) will be designated in coordination with the Institute of Heraldry. Affiliation—joining the “Corps”—would be recognized by presentation of the “Corps of Engineers” crest at AIT graduation, warrant officer appointment ceremony, and EOBC graduation. Persons entering the “Corps” by other means (branch transfer, reclassification) will have their crest presented at an appropriate ceremony. This is similar to the British presentation when the engineer becomes a “Royal” engineer.

Leaders of the Corps. The “Corps” ceremonial leaders would be the incumbent Chief of Engineers and the CSM to the Chief of Engineers. They would be assisted by Distinguished Members of the Regiment chosen from active and retired officers and noncommissioned officers chosen for that purpose.

Battalions. Battalions will be highlighted throughout “Corps of Engineers” museums, publications, and in the mess (e.g., Crests in the Castle Room, Fort Belvoir Officer Mess should go to Fort Leonard Wood). Battalions will be encouraged to develop ways to portray the battalions historical accomplishments through individual museums and literature. Battalion crests will be worn when serving in the battalion. In recognition of the strong battalion affiliation of engineers, engineer officer and enlisted soldiers would continue to wear branch collar insignia with battalion numerals after leaving a battalion (as permitted for regimental affiliation—would require exception to policy but appropros to the Engineer Force. Assigned battalion collar insignias will take precedence when serving in a battalion. Battalion leadership will foster that the strength of the “Corps” is to be found in its accomplishments by its many diverse battalions, historical lineage of the battalion and the significance of the battalion as part of its parent Division (or Brigade or other association).

Conclusion; By establishing the “Corps of Engineers” as the bonding affiliation entity for engineers yet retaining maximum identification of individuals with the “Corps” basic fighting unit, the battalion, we have a solution that

- maximizes historical ties
- is realistic to today’s Army
- provides affiliation opportunities
- is inclusive, no one is excluded

- provides for continued battalion identification and focus
- is not tied to personnel system but facilitates voluntary homebasing
- avails new resource problems at battalion level
- is not artificial

MG R. S. KEM
Commandant

Appendix C
E-Force
Army of Excellence
Combat Engineers
November 1985*

* Appendix C has been recreated. However, it retains the spelling, punctuation, and style of the original.

**E-FORCE
ARMY OF EXCELLENCE**



COMBAT ENGINEERS

**COMBAT ENGINEERS ... AT A
WATERSHED**

- Combat multiplier—adds strength, depth & flexibility
- Valued when needed ... but often viewed as cumbersome and deliberate
- Heavy resource reliance ... manpower, materiel & time
- Engineer improvements have previously been at a stutter step

THIS IS A TIME WHEN...

- The Army has fielded a new generation of combat vehicles
- New Doctrine—airland battle—places a premium on mobility and flexibility
- The Army is in major renovation—to the Army of excellence
 - New fighting structure
 - Trend to light forces
 - Resource constrained
- National training center experience highlights the importance of M-CM-S and the value of the engineer role to the combined arms team
 - The integration of maneuver, fire support, and terrain is imperative!

THE PROBLEM SIMPLY STATED:

We are supporting a rapidly modernizing battlefield combined arms team with a 1960's engineer force!

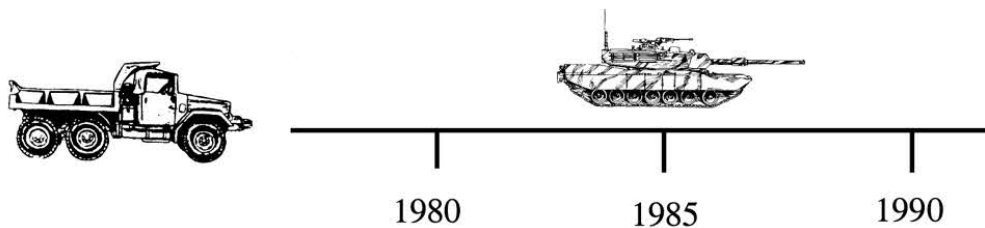

Today's combat engineers are the "weakest link" in the battlefield combined arms team!

AIRLAND BATTLE DOCTRINE

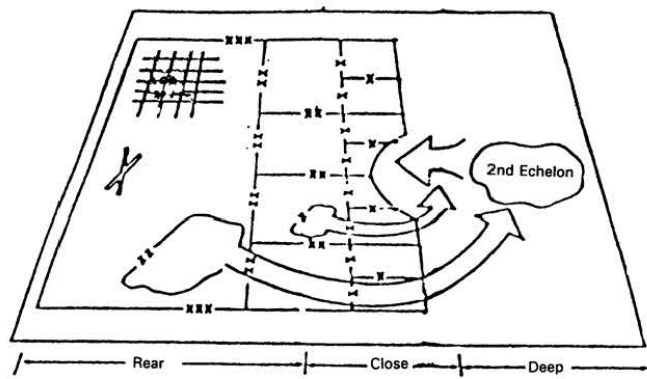

TENETS

- INITIATIVE
- AGILITY
- DEPTH
- SYNCHRONIZATION
- ENDURANCE

- | | | |
|-----------------------------------|----------------------|----------------------------|
| • RETAIN FREEDOM OF ACTION | • SHAPE THE FLOT | • FRUSTRATE TEMPO |
| • ENSURE CONTINUITY OF OPERATIONS | • DESTROY THE THREAT | • ISOLATE CLOSE BATTLE |
| • PROVIDE SUSTAINMENT | • PASS RESERVES | • CAUSE REACTION |
| • POSITION RESERVES | • DISRUPT COHERENCE | • INFLUENCE FUTURE BATTLES |
| | | • MANEUVER TO OBJECTIVES |

ENGINEERS ON THE AIRLAND BATTLEFIELD

- | | |
|-----------------------|--|
| • Mobility | — Increased emphasis on tactical mobility |
| | — Faster tempo |
| | — Greater distances |
| • Countermobility | — Need to shape battlefield |
| | — Rapid shifts in defensive/offensive operations |
| • Survivability | — Increased lethality |
| | — Broadened dimensions |
| | — Faster tempo |
| • General Engineering | — Greater emphasis on lines of communication |
| | — Shorter warning time |

Dimensioning the challenge—Engineers must be more responsive, accomplishing the tasks over a larger area in significantly less time!

THINKPIECE—ENGINEERS IN THE COMBINED ARMS TEAM

- In many battlefield situations combat engineers could be the combined arms task force's greatest combat multiplier.
- By measure of the NTC and our major exercise experience we are only obtaining a small fraction of engineer potential.
- The Task Force Engineer has been given an impossible mission...In no other 2LT do we entrust to such an extent the success or failure of the whole TF mission.
- An engineer unit arriving on the scene to do a job cannot be an instant member of a cohesive, well-drilled team. They don't know SOP's. The synergism that is necessary for the combined arms team is not there.
- We have sufficient engineers in the force—but C² and mobility become a tangled mess as we overlay Corps Bns on the Divisional structure. We need agility—but can't get it with this archaic architecture.
- The Maneuver Brigade needs an engineer battalion (one company per task force) to support it in almost all operations.

COL Conrad
Former Bde Cdr, 4th Mech Div
C/Army Studies Gp
31 Oct 85

THE COMBAT ENGINEER PART OF THE CCH COMBINED ARMS TEAM IS BROKEN!

**SEVERE BATTLEFIELD PROBLEMS
LIMIT ENGINEER CAPABILITIES
AND
COMBINED ARMS EFFECTIVENESS**

THE CHANGING BATTLEFIELD

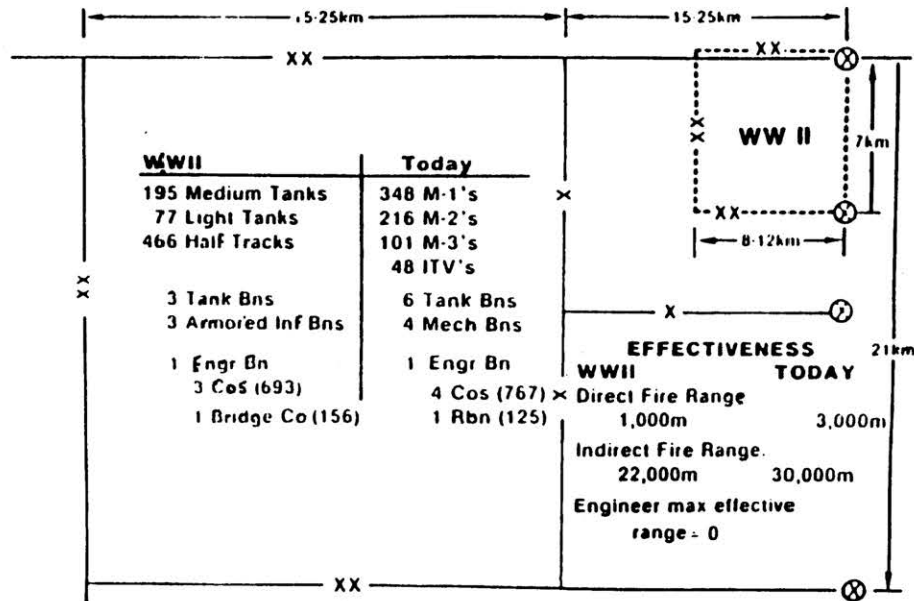

Combat Support: Unlike artillery and aviation which can project, engineers must be at the point of action.

CURRENT DIVISION ENGINEER PROBLEMS

- Insufficient organic engineer assets for mission
 - Corps Engineer Battalion (DS) required forward
 - Battlefield size, lethality, mobility
- Organization impedes integration with maneuver elements
 - AD HOC solutions not responsive
 - Equipment mix unbalances, complicate solution
 - Inefficient, wastes resources
 - Burdens commander, does not fulfill his needs
- Overloaded Platoon Leader, Engineer Commanders
- Maintenance, communications, Class V barrier supply don't work

Bottom line: Bandaid solutions will not support Airland Battle Doctrine— will not be responsive to maneuver commander's needs

NTC LESSONS LEARNED — THE OVERLOADED PLATOON LEADER

- The Task Force engineer has been given an impossible mission...in no other 2LT do we entrust to such an extent the success or failure of the whole TF mission.

COL Conrad
Bde Cdr, 4th Inf Div (Mech)
31 Oct 85

- The engineer platoon leader is unable to simultaneously plan, effectively supervise execution, coordinate logistics support, command and control of personnel, equipment, and materials, and coordinate with other combat elements...the motivated engineer lieutenant is often "overcome by events."

Rotation 86-1
1 Nov 85

- Maneuver units compensate by using the Task Force XO, CSM, or Asst S3 as a "Dozer CINC," to supervise the engineer platoon leader.

CAT: 1 Jan 86
Commander memo: 20 Nov 85

ENGINEER PLATOON LEADER'S RESPONSIBILITIES

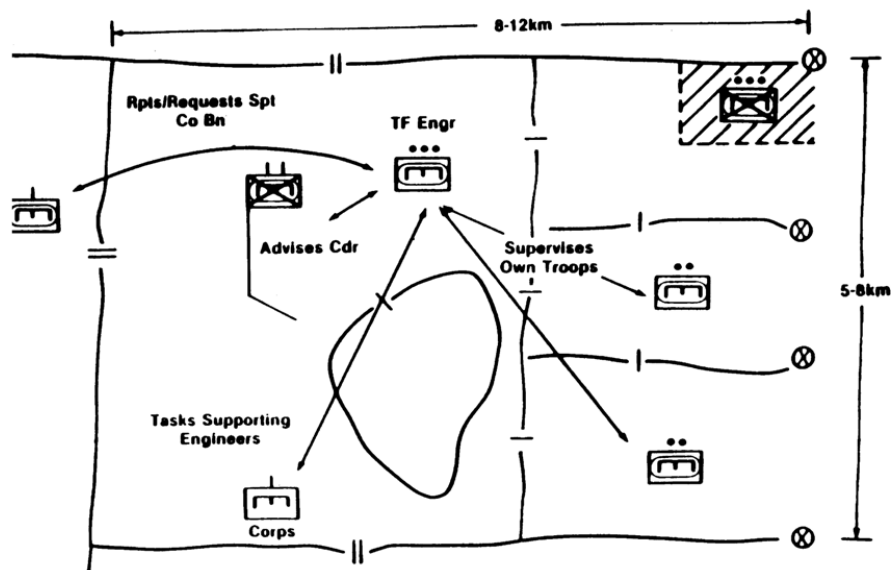

The Task Force Commander's engineer expert advisor,
planner, executor, coordinator

CURRENT ENGINEER C³, MAINTENANCE, SUPPLY BROKEN

- C³ — Inappropriate level of commanders, dual-hatted
Extended Distances
Multiple nets required, — frequency interference
CEOI, COMSEC keying material difficulties

- Maintenance — Support changes as command relationships change
COSCOM support pulled forward — or DISCOM supports
without resources
Extended distances inhibit support from parent battalion

- Supply — Engineer requirements spread throughout Division
System supporting Division/Corps mix changes as
command relationships change
Structure not parallel to supported maneuver units
Class V BARRIER haul always a problem

COMMUNICATIONS

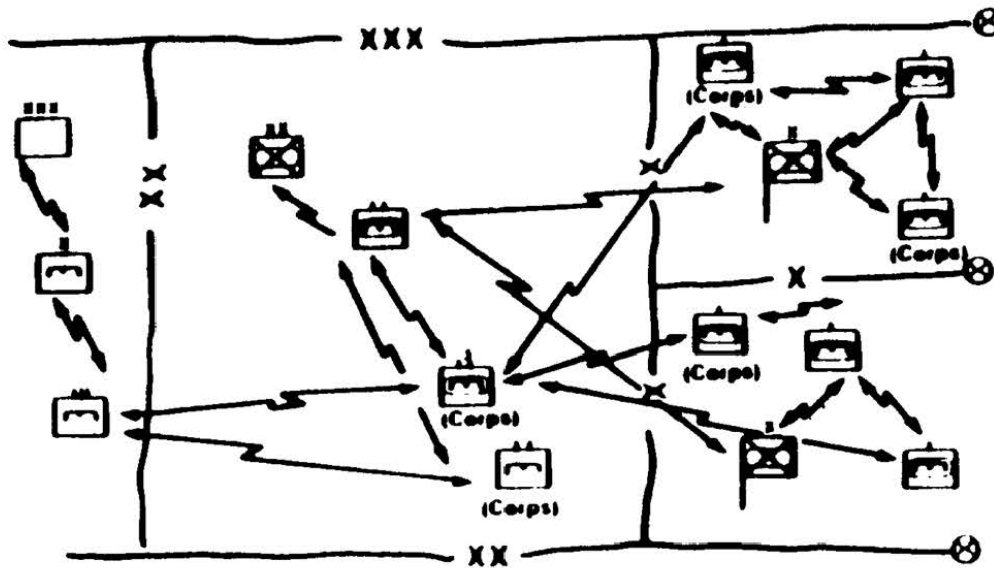

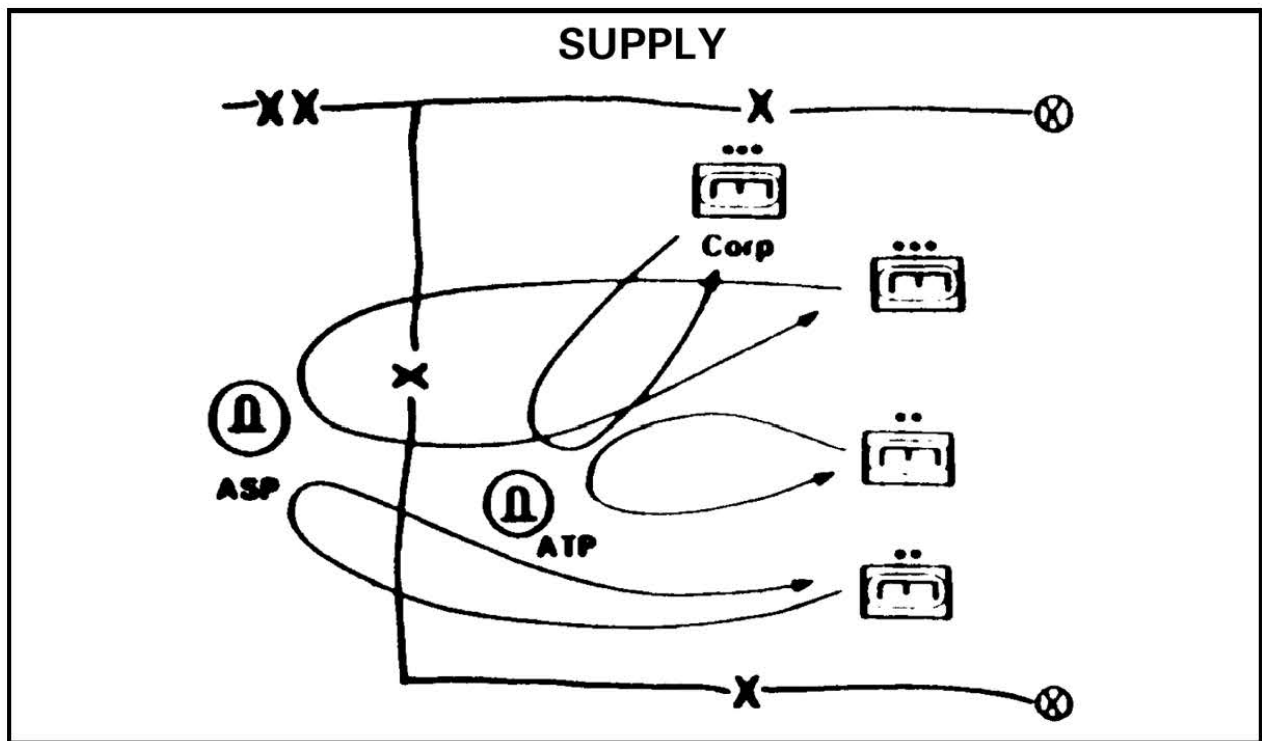
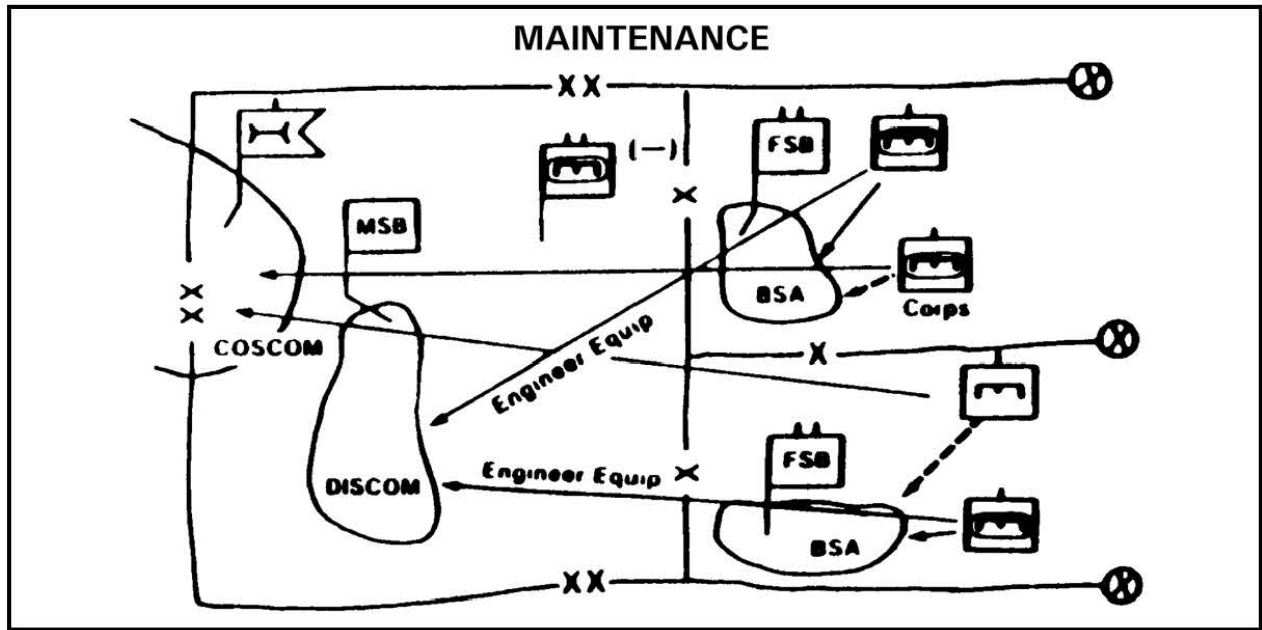

HOW WE FIX IT —

Build capable, responsive combat engineer organizations for the task force commander's requirements
and
Aggregate upward — ensuring integrated, capable, responsive combined arms support at each level

Airland Battle Doctrine
— The requirements basis for E-Force

WHAT DOES THE TASK FORCE COMMANDER NEED FROM HIS ENGINEERS?

Phase	Requirement	Engineer Action
Offense	<ul style="list-style-type: none"> • Complex Obstacle Breach • Short Gap Crossing • Flank Protection • Water Gap • Mines 	Breach Obstacle (Now!) AVLB/M9 (Now!) Volcano (Now!) Ribbon Bridge (Soon) Breach Mines (Now!)
Transition (Offense to Defense)	<ul style="list-style-type: none"> • Survivability Positions • Block Major Approaches 	M9Ace (Now!) Mines, Craters (Now!)
Defense	<ul style="list-style-type: none"> • Best Use of Terrain • Obstacles — Tied to Concept • Fighting Positions • Ability to Move • Resupply 	Continuous Terrain Reinforcement (Now!) Key Approaches (Now!) In Depth — Mines Craters, AT Ditches, Destroy Bridges (ASAP) Primary (Now!) Alternate (ASAP) Supplementary (ASAP) Combat Roads & Trails Open LOC
Transition (Defense to Offense)	<ul style="list-style-type: none"> • Ability to Move Rapidly 	Mobility Assets Positioned for Response

WHAT DOES THE TASK FORCE COMMANDER NEED FROM HIS ENGINEERS?

Phase	Requirement	Engineer Action
Continuous — All Phases	• Understand Commanders intent	TF Engr — Proximity to Cdr/Staff
	• Capability Positioned for Responsiveness	Battle Sense/Troop Leading/Organization
	• Timely Engineer Advice/ Recommendations/Reconnaissance Planning Status	Knowledgeable Integrated Engineer
	• Capability for Independent/ Integrated Action	Strong command and control
	• Sustainable	Systems Work
	• Ability to Rapidly Adjust to Mission Changes	Organization, Planning, Execution

In Sum: Cohesive, integrated, supportable organizations capable of rapid response to battlefield changes. The engineer structure must be responsive; on-site; integrated with the maneuver force at all times; ready, anticipating, and able to execute the commander's concept and requirements throughout the battle.

"E"-FORCE — DIV ENGR COMPANY

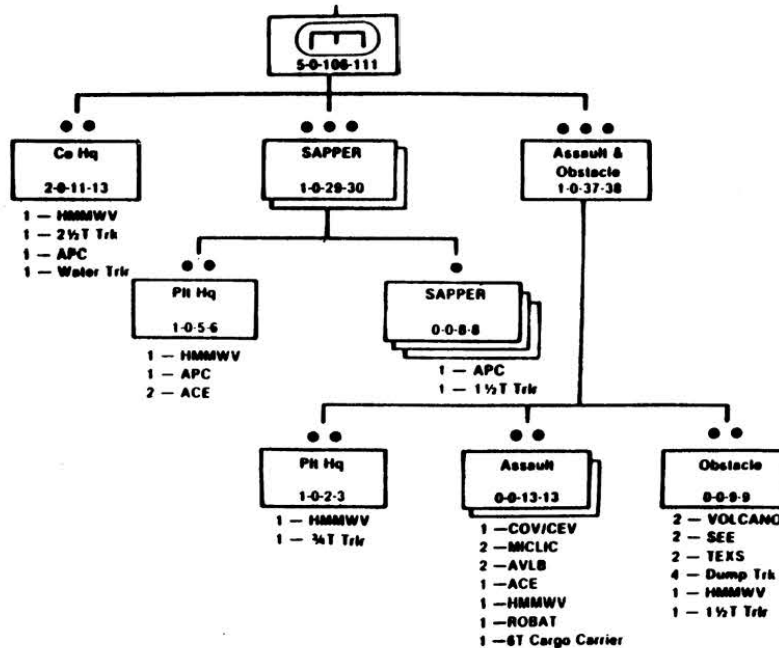

WHAT THE MANEUVER BRIGADE COMMANDER NEEDS FROM HIS ENGINEERS

- Timely Planning and Execution in context of Commander's intent
- Immediate responsiveness—Timely Engineering Capability where required
- Dedicated Sufficient Engineer Capability—Able to react, move, change promptly
- Integrated Combined Arms—Engineer self-aligning to mission requirements
- Simplified Command, Control and Communications
- Requisite level of Expertise and Commandership
- Absence of Distractors
- Sustainability –Not A Logistics Burden

E-FORCE — DIVISIONAL ENGR BN

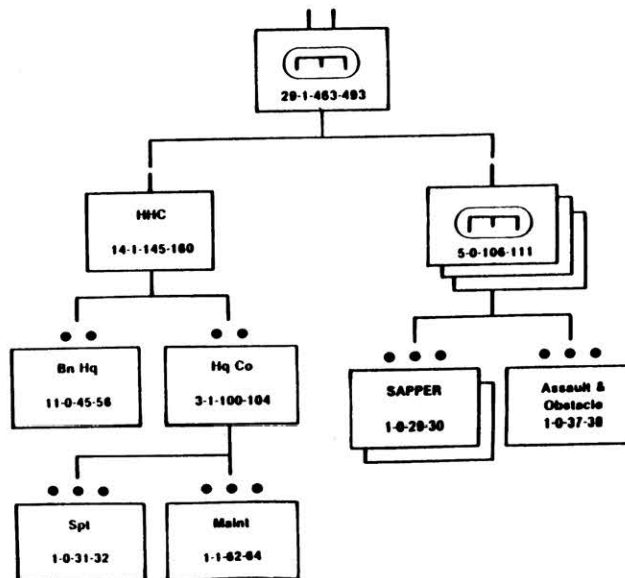

WHAT THE DIVISION COMMANDER NEEDS FROM HIS ENGINEERS

- Timely planning and execution in context of commander's intent
- Ability to rapidly focus combat power
- Support FLOT battle/free maneuver forces to strike
- Focus forward, not rearward
- Timely engineer capabilities where required
 - responsiveness
- Keep LOC's open
- Absence of distractors
- Division survivability
- Command/control of non organic engineers

E-FORCE – DIVISION ENGINEER

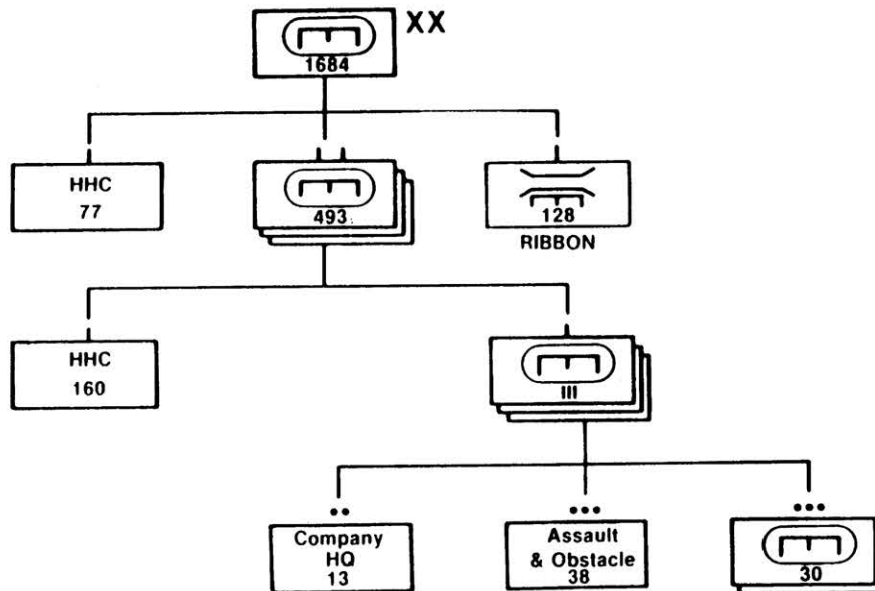

THIS PROVIDES:

Division Engineer (Div Eng)
of
3 Battalions (C² Moved Forward)
of
3 Companies (Close Support Forward, Protected)
of
3 Platoons
Forward
Equipment Responsive
Tailor to M, or CM/S



WHAT THE CORPS COMMANDER NEEDS FROM HIS ENGINEERS

- Timely planning and execution in context of commander's intent
- Expedite movement of operational level attacking divisions
- Flexible capabilities to weigh the battle or provide economy of force
- Priority of support to divisions
- Keep LOC's open
- Support corps units (ARTY, COSCOM, Aviation, etc.)
- Support rear operations

ENGINEER BATTLEFIELD LAYOUT – CURRENT

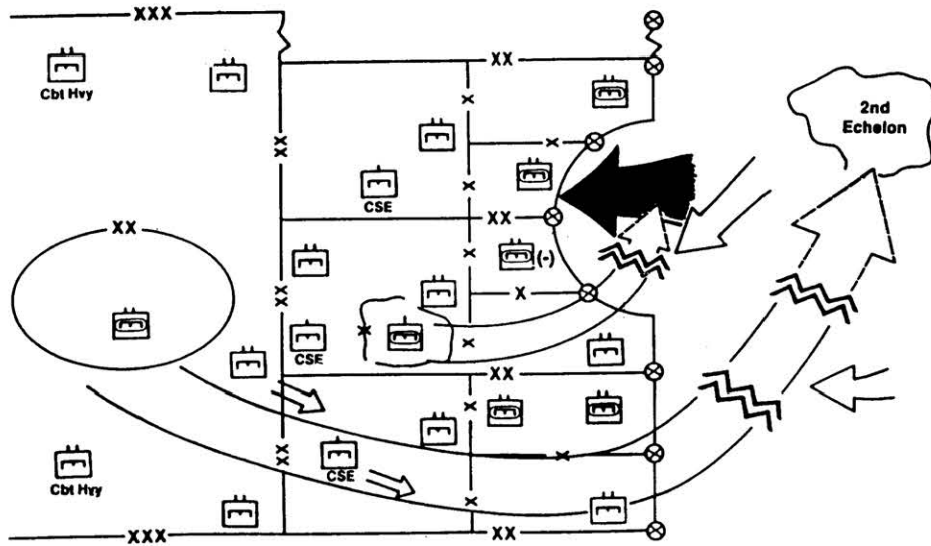

ENGINEER BATTLEFIELD LAYOUT – E-FORCE

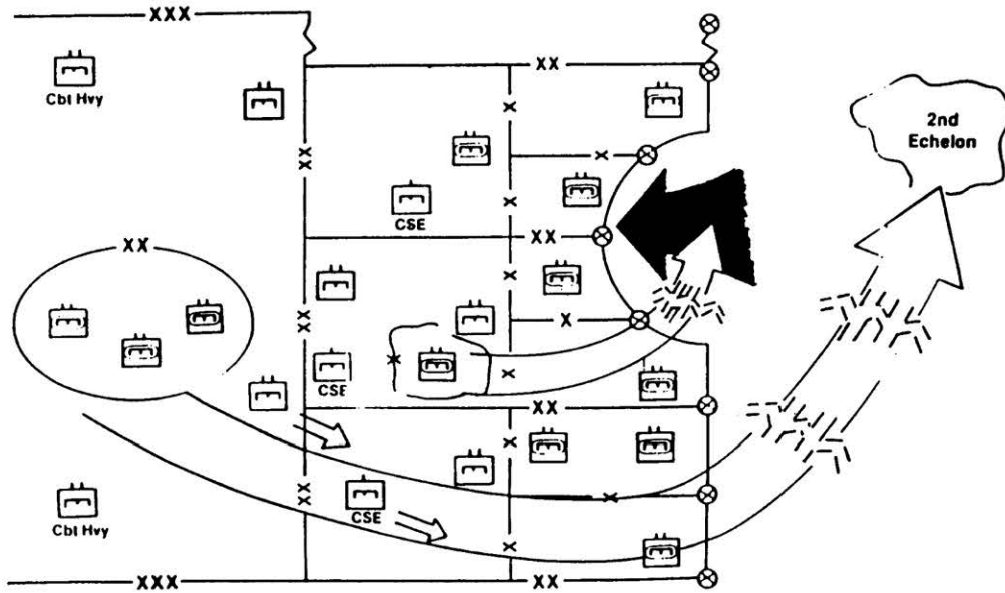

E-FORCE FIXES

- Responsive, capable organization for maneuver Commanders needs in Airland Battle at all echelons.
- Integrates engineer capability with maneuver forward where needed—more effective Combined Arms Team.
- Productive organizations
 - Compact units, reduced admin overhead
 - Increased equipment to labor ratio
 - Increased leader to lead ratio
 - Apply materiel/modernization efficiencies
- Shift C² forward—appropriate level to supported maneuver commander
- Solves battlefield problems—real today and aggravated in Airland Battle
 - Overloaded platoon leader
 - Communications
 - Maintenance
 - Supply (Class V—mines, breaching charges)

CURRENT C²

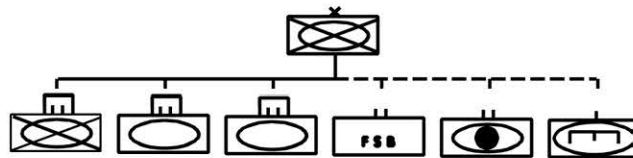

E-FORCE C²

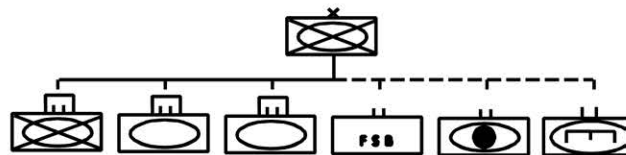

Comparable Command/Staff—Both Planning and Execution

**TODAY'S OVERLOADED PLATOON LEADER
"E"-FORCE REMEDY
TASK FORCE ENGINEER = COMPANY COMMANDER**

- More Experienced Leaders
- More Credibility
- More Assets

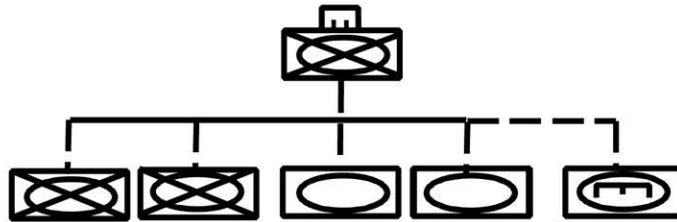

**COMMAND, CONTROL &
COMMUNICATIONS**

Current Deficiencies:

- Extended distances
- Multiple nets required to establish C² of engineer task force
- Frequency interference between Corps Engr Bn's and divisional units
- CEOI, COMSEC keying material distribution difficulty
- Ad hoc solutions

E-Force Fixes:

- Shortened lines of communication
- C² streamlined
- Frequency assignment, COMSEC material distribution more manageable
- Reduces requirements/increases flexibility
- Better coordination

Bottom line: Solves C³ problems which are not fixable by doctrinal changes

MAINTENANCE

Current Deficiencies:

- Support relationships change as command relationship changes
- COSCOM's support pulled into forward area or DISCOM overloaded
- Extended distances inhibit organizational support from battalion

E-Force Fixes:

- Consistent support relationships
- DISCOM structured to provide required support
- COSCOM units not in bde area
- Smaller area permits maintenance at battalion

Bottom line: Enhanced maintenance for battalion—improved capability for maneuver bde

LOGISTICS SUPPORT SYSTEMS

Current Deficiencies:

- Engineer bn requirements spread throughout division area
- System supporting divisional/corps engineer mix changes as command relationships change
- Structure not responsive—not parallel to supported maneuver units
- DISCOM required to provide support without resources

E-Force Fixes:

- Engineer bn area of responsibility reduced to bde area
- Support channels streamlined—parallels maneuver units
- Solves forward obstacle Class V distribution problem
- DISCOM structured to support engineer structure

In Conclusion, "E"-Force Provides:

**RESPONSIVENESS TO THE
MANEUVER COMMANDER**

- 3-battalion division engineer structure for optimal positioning
- "Tools of the Trade" in line with maneuver requirements
- Streamlined command, control, communications within division

In Conclusion, "E"-Force Provides:

**INTEGRATION INTO THE
COMBINED ARMS TEAM**

- Maneuver commander access to experienced engineer advice at all levels
- Ability to train as we will fight
- Integrated combined arms at all levels
- Engineer capability commensurate with requirements of maneuver partners

WHY BUY THE E-FORCE DIVISIONAL ENGINEER ORGANIZATION?

- Essential to win in airland battle
- Fixes battlefield problems
- Inexpensive—essentially within resources

Bottom Line: Current structure broke

— Doctrine can't fix

Appendix D
Corps of Engineers Automation Plan (CEAP) Briefing
for Assistant Secretary of the Army (Civil Works)
7 August 1990*

* Appendix D has been recreated. However, it retains the spelling, punctuation, and style of the original.

THE CHALLENGE

- Need must be demonstrated
- Based on Requirements—Work Corps must do
- Do Project Management
- Demonstrate Economic Justification
—CEAP vs Other
- Demonstrate Affordability to Districts

SOLUTIONS

(Hardware/Software/Comm)

Current Universe of Requirements	Functional Model (Now & Future)	Future Universe of Requirements			
Project Management Real Estate Design Research and Dev		Project Management Real Estate Design Research and Dev	Options		
			Main Frame	Mini	Cost
			Proj Mgt	0	\$
			Real Estate	0	\$
			Design	0	\$
			Res & Dev	0	0 \$

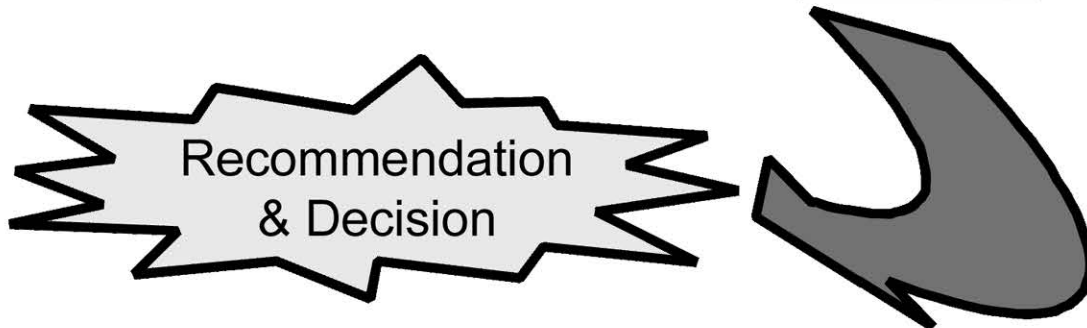

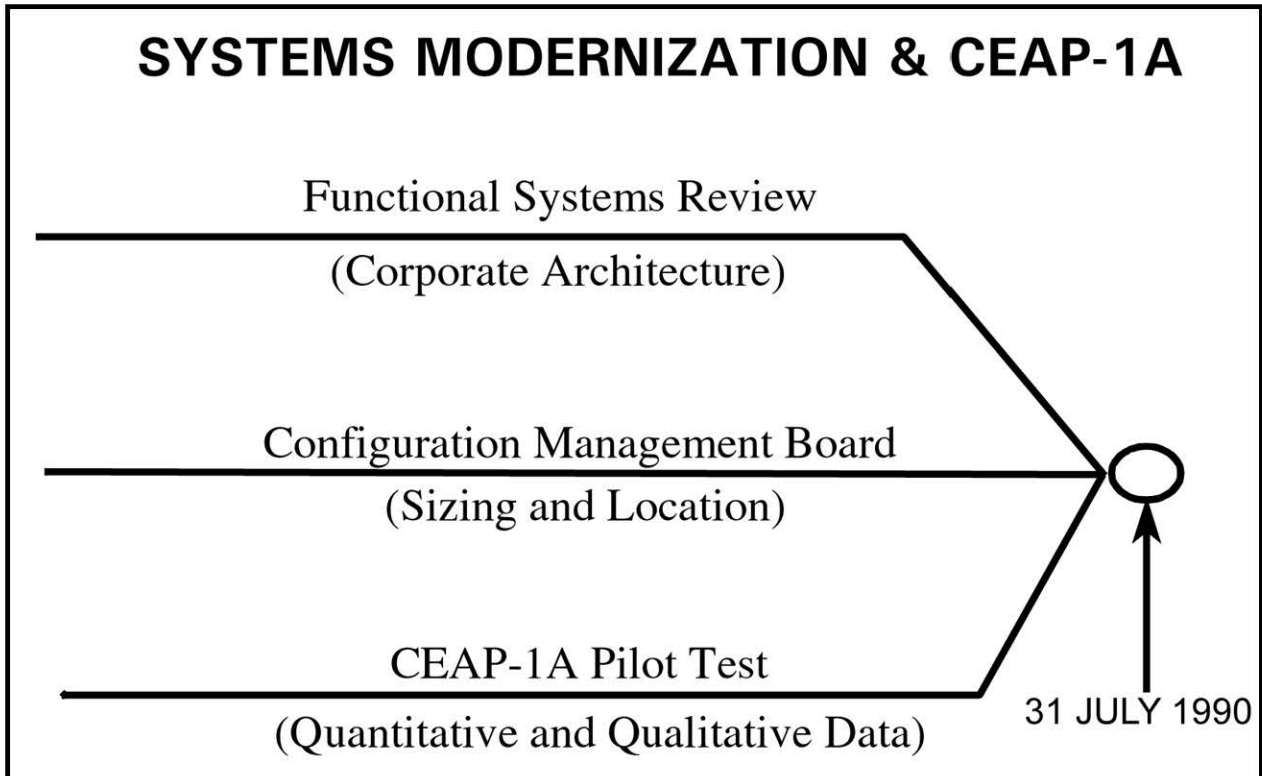

- ### USACE SYSTEM PROPONENTS "The Rose Getters"
- Directorate of Civil Works (MG Kelly)
 - Program Management - Mr. Cluff
 - Life Cycle Project Management - Dr. Steinberg
 - Planning - Mr. Bates
 - Operations and Maintenance - Mr. Elmore

 - Directorate of Military Programs (Mr. Carton)
 - Project Management - Mr. Dunnam
 - Environmental Restoration - Mr. Watling
 - Program and Execution Support - Mr. Sheehey
 - Construction - Mr. Hanson
 - Engineering - Mr. Kennon

 - Directorate of Real Estate - Dr. Wilmer

 - Directorate of Human Resources - Mr. Loschialpo

 - Directorate of Resource Management - Mr. Wallace

 - Directorate of Logistics Management - Mr. Thomas

INTEGRATING THE FUNCTIONAL SYSTEMS

- Assumptions
 - Management
 - Technical
- Evaluation Criteria
- Doing the Work
 - FOAs
 - HQUSACE and Divisions
- Determining “Drivers”
- Developing the Corps Architecture

DOING THE CORPS’ WORK

Key Strategies

- Match Automation to the Way We Do Business
- Define District Required Capabilities
(Process, Communications, Data Source Entry)
- Provide for HQS (USACE/Division) Requirements
- Define Requirements at Organizational Tiers
- Provide for Data Sharing
- Reduce Data Bases to Those Necessary
- Advantage Communications
- Provide Connectivity
- Use Existing Systems and Equipment
Wherever Feasible

THE 1995 CORPS ARCHITECTURE NETWORK PERSPECTIVE

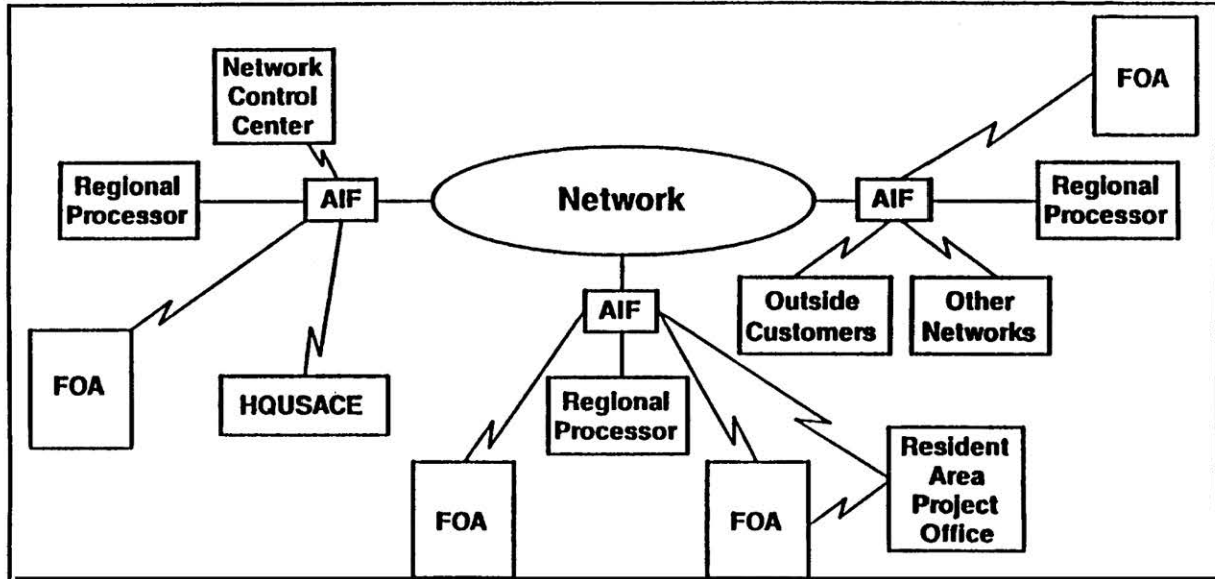

THE 1995 CORPS ARCHITECTURE FOA & RESIDENT OFFICE PERSPECTIVE

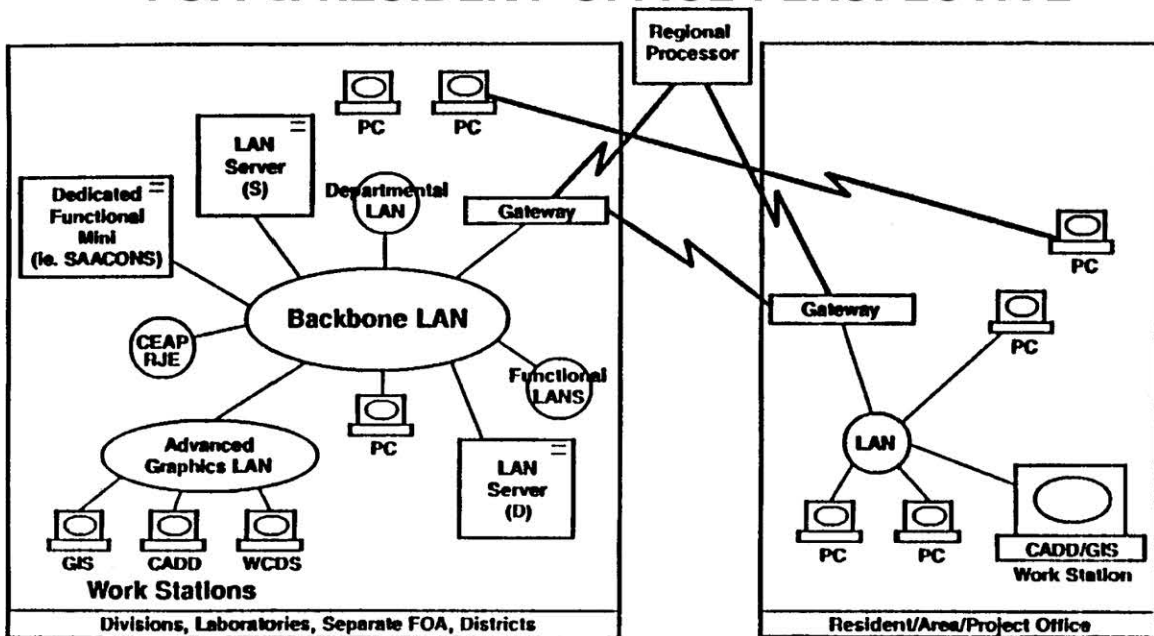

CONCLUSIONS

- Best Solution To Meet USACE Functional Requirements - 1995
- Reduces Data Bases and Maximizes Connectivity
- Maximizes Use of Existing Equipment and Systems (Don't Junk Anything)
- Meets Requirements of AR 25-3
- Provides Guidelines for Future Most Effective FOA Architecture (LANS)
- Basis for Identifying Requirements for Configuration Management

CEAP-1A PILOT TEST

Stress Test at WES

- Capacity Tests for F&A and AMPRS
- Functional Tests for Modernized Systems
- Tests of CYBER 962 and Minicomputer
- Capacity Tests for '95 Architecture
- Tests Completed

SOFTWARE TESTED

- F&A Civil, Military, and Revolving Fund
- AMPRS
- Payroll
- CETAL
- Funds Control
- Real Estate
- Personnel Reporting System
 - * Financial Management
 - * ARMS
 - * PCMIS

* New Systems

PILOT TEST RESULTS

CYBER Systems Match Corps Needs

Exceptional Performance and Reliability
Relative Performance Increase from 2 to 12

Performance Tuning Achieved and Continuing

Enhanced Technology
Air Vs Water Cooled—Cheaper to Buy/Operate
Communications—\$170,000 Device Replaced
with \$25,000—Savings Exceed \$9M

Hardware Tuning—Up to 18% Cost Reduction

High Degree of Confidence in Sizing/Capacity

Initial Deployment
7.8 "B" Systems vs 37 Original
\$33M vs \$111M

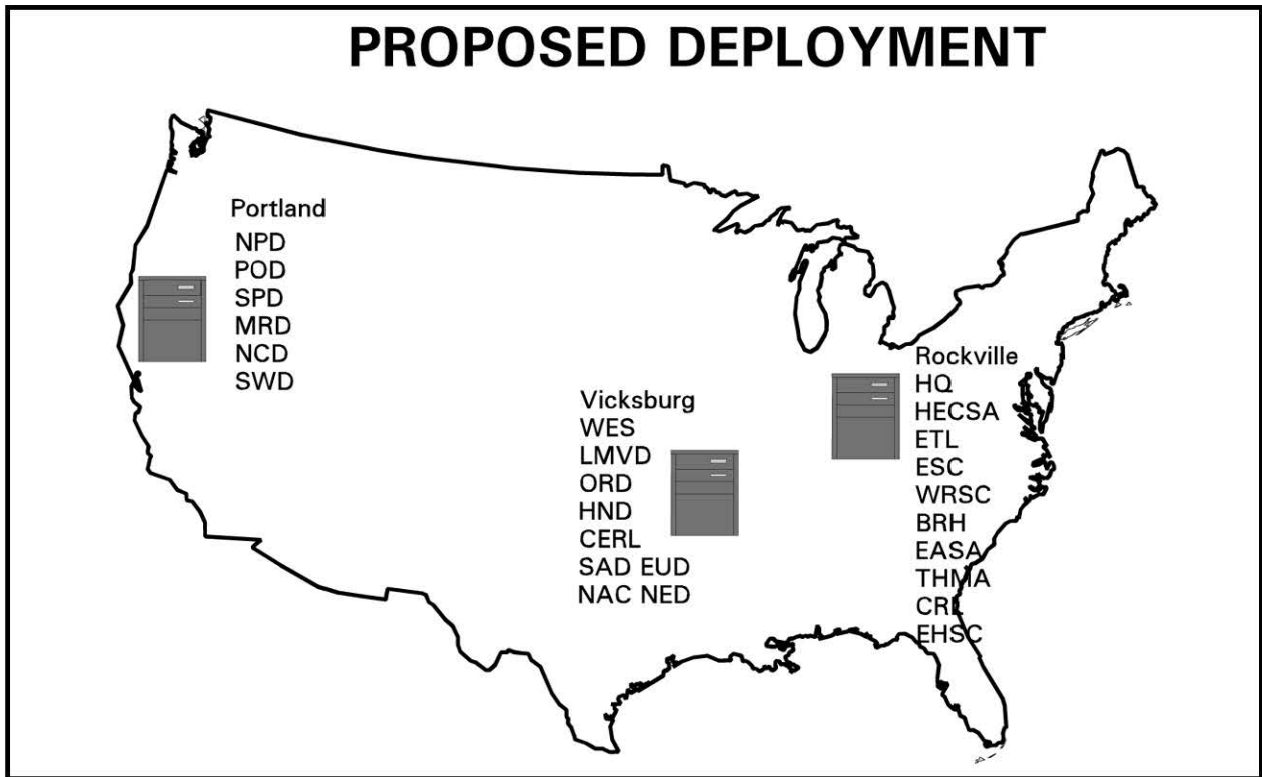
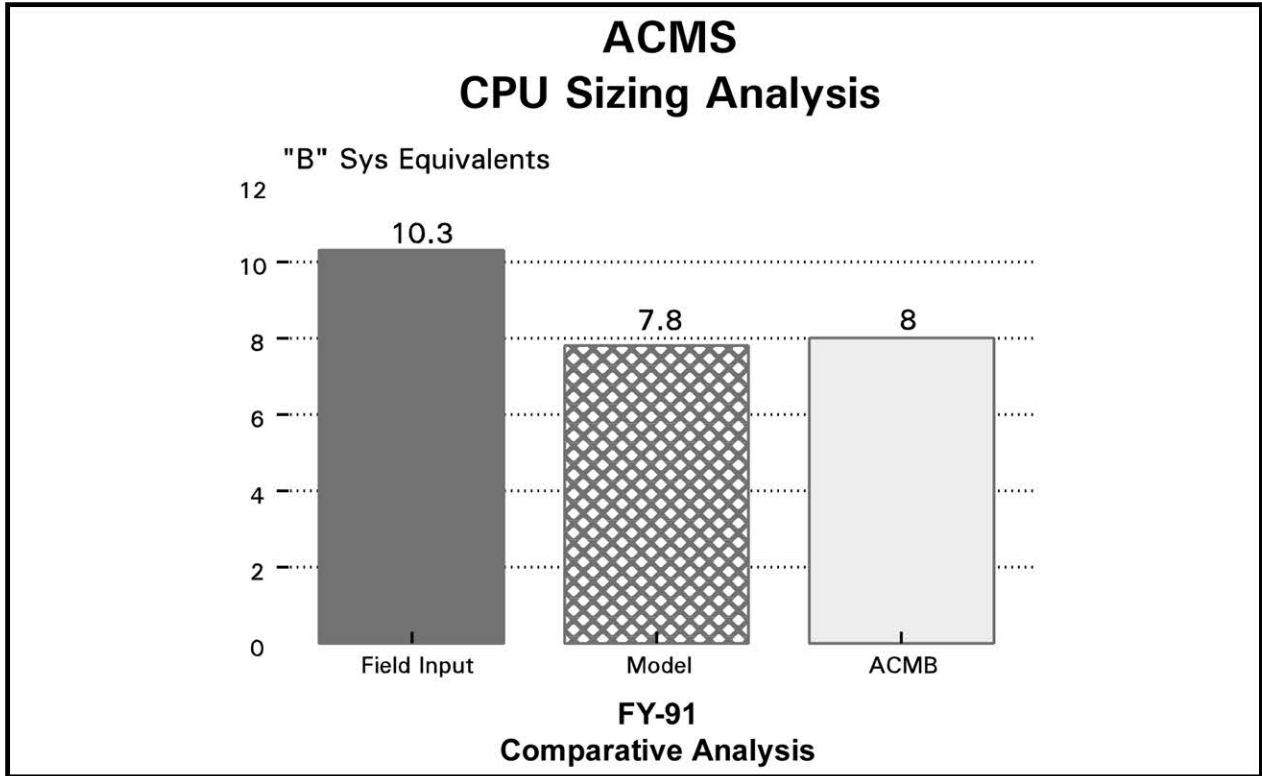

1995 USACE ARCHITECTURE

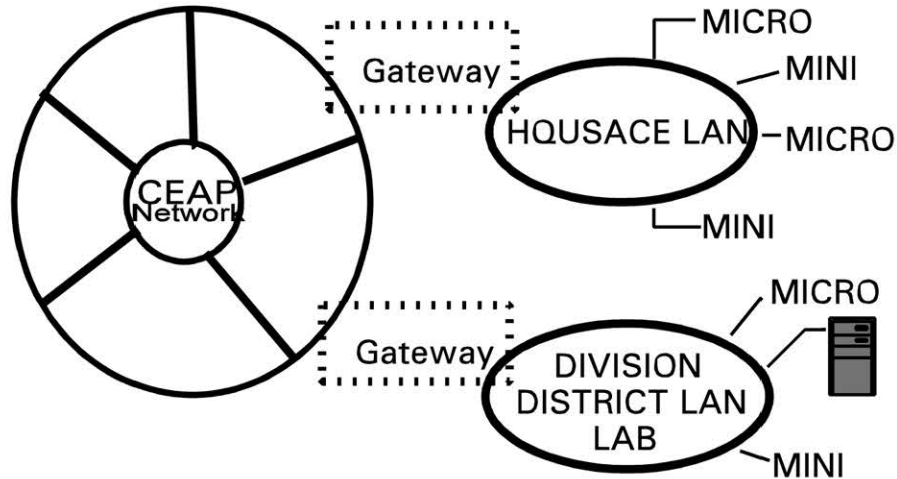

FOA OPTION AS TO
WHAT, WHERE, WHEN

EVOLUTION OF COST ESTIMATES

	<u>Initial Investment</u>
Estimate Prior to Contract Award	\$111M
Estimate Based Upon Awarded Contract	\$95M
Estimate for Recommended Deployment	\$43M

PRIP INVESTMENT PROGRAM USACE 1995 ARCHITECTURE

(\$M)

	<u>91</u>	<u>92</u>	<u>93</u>	<u>94</u>	<u>95</u>
Additional CPU	2.1	5.8	1.6	1.3	1.3
Disk Storage (One Time)	4.9	0	0	0	0
Peripherals/Printers	2.5	0	0	0	0
Communications	4.1	0	0	0	0
Total	13.6	5.8	1.6	1.3	1.3

ECONOMIC ANALYSIS FRAMEWORK

(000,000)

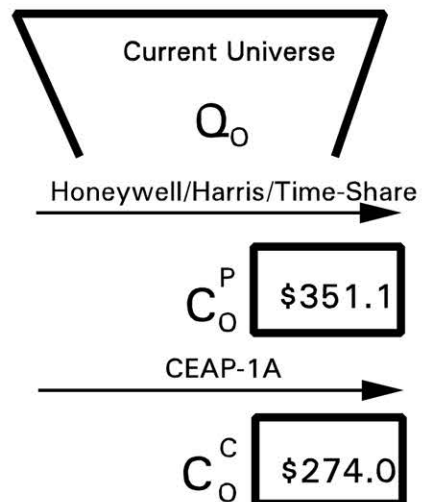

10-year life cycle

MODERNIZED WORKLOAD INCREMENTS

- Q1 Project Management
- Q2 Financial Management
- Q3 Real Estate
- Q4 Programs Management
- Q5 Email & Encyclopedia
- Q6 Contracts Data Bases
- Q7 Employee Data Base
- Q8 PAX Data Extract

Q1 thru Q8 are minimum essential to Corps operations—modernized PM & FM mode.

-
- Q9 Automated Review Mgmt
 - Q10 Integrated Logistics
 - Q11 R&D Management
 - Q12 Contract Performance
 - Q13 Water Control
 - Q14 CAE/GIS
 - Q15 Library, CEALS, Etc.
 - Q16 Safety Data Base

- Q18 Planning
- Q19 Career Program
- Q20 Frequency Mgmt
- Q21 Nat'l Invent Dams
- Q22 Land Mgmt
- Q23 HQ Automation
- Q24 Other EIS
- Q25 Local Uniques

ECONOMIC ANALYSIS FRAMEWORK 10-year life cycle

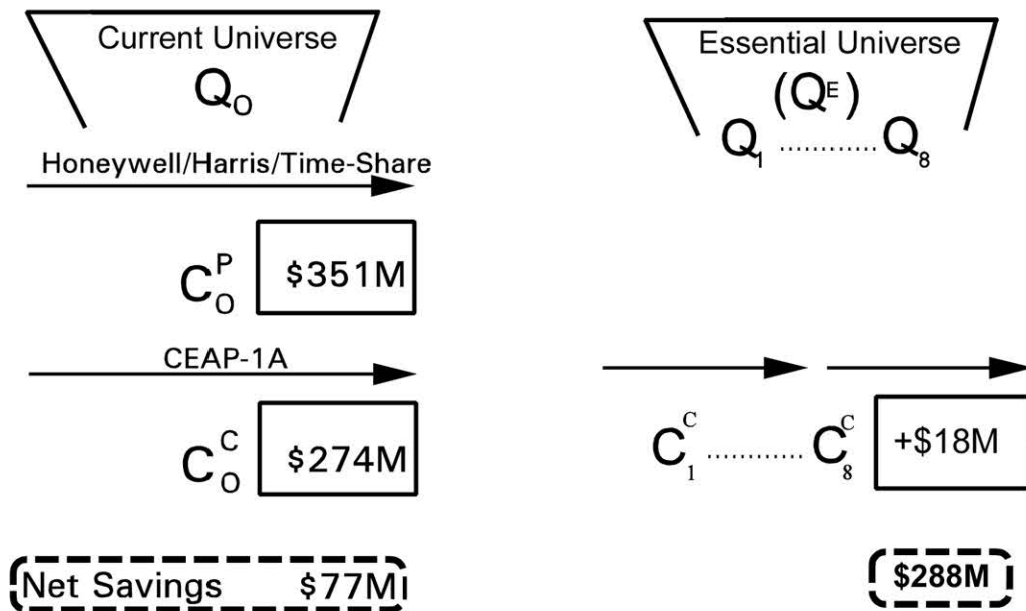

FOA CHARGES

(000)

	Annual
Current Honeywell/Harris Charges	\$754
Current CEAP Charges	\$586

Average \$164K Decrease per district

DOLLAR COMPARISONS

Total Corps Program = \$9 Billion

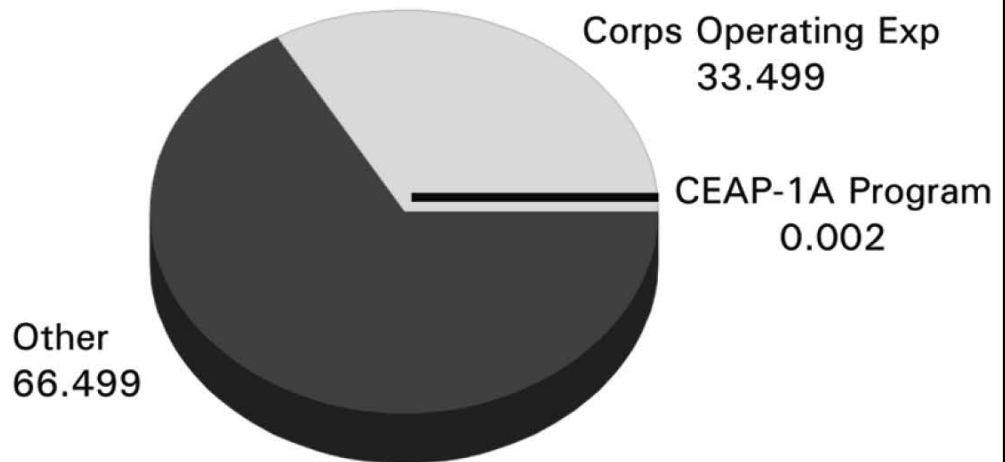

By Percent

INCREMENTAL ANALYSIS FUTURE SYSTEMS

I. Economic Justification for Software System to meet requirement.

II. In-house capacity available?

Yes.....No Purchase Decision

No..... Purchase Decision

III. Purchase Decision

$$C_9^C - C_9^{Other} = \Delta \langle \pm \rangle ?$$

*

CONCLUSIONS

- Architecture provides for USACE information management needs for 1995
 - Districts process most requirements on micros, minis, LANs
 - Regional processing centers provide network services and other processing
 - Districts feed Div/USACE requirements electronically
 - Minimized data base requirements single data base for Div/HQ
- Configuration selected appropriate
- CEAP-1A contract more economical than time share or leasing
- Investment plan affordable

NEED APPROVAL OF

EXTENSION OF CDC CONTRACT

FOLLOWING INVESTMENT PLAN

	<u>FY</u>	<u>91</u>	<u>92</u>	<u>93</u>	<u>94</u>	<u>95</u>
CEAP		13.6	5.8	1.6	1.3	1.3

\$ in Millions