

# MCMURDO STATION

MASTER PLAN 2.1  
DECEMBER 16, 2015





# TABLE OF CONTENTS

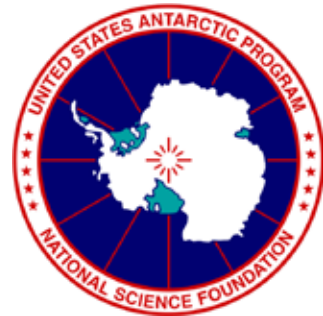

INTRODUCTION	4
GLOSSARY	14
ARCHITECTURAL DESIGN GUIDING PRINCIPLES	18
FACILITY CONSIDERATIONS	22
FACILITIES PROGRAM	38
MCMURDO STATION MASTER PLAN	42
SOCIAL SPACES	70
MASTER PLAN FLOW DIAGRAMS	72
CIVIL SITE & UTILITY PLAN	78
ENERGY	84
INFORMATION TECHNOLOGY & TELECOMMUNICATIONS	98
FIRE PROTECTION STRATEGY	110
CONCLUSION	116



# INTRODUCTION

---

The McMurdo Master Plan 1.0 was completed in March of 2013. The purpose of that original plan was to provide an in-depth first look at the current layout of McMurdo, identify both constraints and opportunities for future redevelopment, and create a basic plan to serve as a guide for that development. That initial plan was intended to serve as a Master Plan “starting point” to generate substantive discussion. Not only did it generate that discussion, it also resulted in a great deal of excitement. Since Master Plans are meant to be updated in light of evolving technologies and new requirements, this version was created.

The Master Plan 2.0 was published on December 26, 2014.

This version, Master Plan 2.1, reflects continued refinement with respect to, among other inputs, modified strategies for Traverse Operations, the IT&C Facility, as well as snow deposition modeling.



# GOALS OF MASTER PLAN 2.1

## MISSION STATEMENT

The infrastructure modernization will ensure that McMurdo Station remains a viable platform for supporting Antarctic science for the next 35 to 50 years, whereby this modernization will:

- Result in comprehensive redevelopment of McMurdo Station, Antarctica, into a more energy and operationally-efficient station, optimized for support of local and deep field science.
- Allow predictable operational costs, support personnel requirements, and improve operational efficiency.
- Improve energy consumption for facilities and operational support.
- Provide a reliable, safe and healthy working environment for USAP personnel and visitors.
- Provide the flexibility to adapt to the changing needs of U.S. science in Antarctica over a 35-50 year planning horizon.
- Reflect the “active and influential presence” in Antarctica in a manner consistent with U.S. stature in the international research community.
- Reflect the professional nature of the National Science Foundation and the scientific activities carried on within the station.

## OBJECTIVE

The primary objectives of this Master Plan are to respond to the valid recommendations stemming from earlier plans and to guide future development of McMurdo Station in an orderly and thoughtful way so it supports an evolving Antarctic Sciences mission.

## PURPOSE

This Master Plan will serve as a guide to future development of McMurdo. It will be a living document, adaptable through time to serve a dynamic set of needs.

Specific areas of focus include:

1. Site, including Fire Protection, Materials Storage and Distribution, Electrical Distribution, and Pedestrian/Vehicular circulation.
2. Buildings, to seek arrangements to increase operational efficiency and function.
3. Logistics Management, to optimize warehousing and delivery processes while reducing footprint.
4. Information Technologies, to decrease complexity and increase reliability and flexibility.
5. Energy Conservation, to increase facility efficiency and incorporate renewable energy sources.
6. Quality of Life, to improve both the living and working experience at McMurdo.

# DEFINING PARAMETERS

The following parameters are determinants of this Master Plan:

- To achieve overall operational efficiency using strategies such as appropriately sized building footprint, consolidation of similar work flows and effective logistics.
- Population limited up to 850 in austral summer with short term surge capacity to accommodate an extra 200 beds during contingencies. Population should be scalable based on approved science requirements.
- While the station can be operated at a reduced capacity during construction/development, uninterrupted operational supply to the South Pole station is required. Further, McMurdo will always be capable of supporting a baseline level of science activity.
- The Master Plan will be designed independent of funding phasing, however phasing needs to be realistic with what is achievable.
- It is possible that the fuel vessel will come every other year instead of yearly.
- South Pole Traverse frequency is assumed to continue to operate at two per Summer Season, with potential expansion of up to four per Summer Season.
- A station survivability strategy is to be considered when establishing building and functional layouts.
- Allow for expansion and contraction seasonally and over the decades. Program size may increase and/or decrease due to budget constraints and realization of program scope efficiencies.
- A limited variety of staff accommodation options should be considered. Accommodations for single and limited double occupancy rooms will be incorporated into the lodging mix. Re-use existing BL206-209 lodging, where possible.
- Existing structures and utilities will be demolished and retrograded when their replacement facilities are constructed.
- Fuel tanks will remain where currently located.
- Wastewater treatment facilities shall remain in place.
- The location of water and power plants can move if there is a compelling reason to do so.
- To support redundant (back-up) utility systems, utility distribution will be a looped/gridded system to the extent feasible. Utilities include power, water, firewater, waste-heat, information technologies, direct digital controls, and fuel.
- Existing buildings to remain may be repurposed to support a different function.
- Year round access to McMurdo is likely in the near future.
- The location of helicopter operations will be studied for possible relocation.
- Facilities should be designed to provide a reasonable level of adaptability to evolving needs.
- The amount of science to be supported at McMurdo will be determined by the National Science Foundation.
- While important, Arrival Heights, Black Island, Dry Valleys and other Field Areas are beyond the scope of this Master Plan.



# DEFINING PARAMETERS

To achieve the primary goals of improving: 1) logistical efficiency, 2) resource efficiency, and 3) quality of life, the following principles guide this Master Plan:

- Self-sufficiency in phasing - McMurdo must remain fully functional upon the completion of each phase, without reliance upon the implementation of subsequent phases.
- Simplicity and standardization - to promote ease of operations and maintenance.
- Reliability - to reduce maintenance staffing and associated costs.
- Walk-ability - to reduce the reliance upon vehicles, their associated staffing, maintenance and fuel consumption and to improve safety through reduced pedestrian/vehicular conflicts.
- Integrated social spaces - to support the collaboration and the sense of community within McMurdo.
- Flexibility and adaptability - to support the evolving nature of scientific inquiry in Antarctica.
- Reduced footprint - to increase logistical efficiency, resource efficiency and to reduce the reliance upon vehicular traffic.
- Strategic redundancy - to enhance both ongoing operations and disaster recovery.
- Design appropriately to respond to environment, terrain and weather conditions.
- Site is to be designed with final state orderliness in mind. In addition to building placement, site development must address the importance of site appearance, sensitively addressing the locations of shipping containers, recycling bins, dumpster enclosures and site utilities.
- Healthy environments, where indoor air quality is improved through non-toxic materials and ventilation.
- Conscientiously revisit the Master Plan as necessary, since it is a living document, to confirm it continues to reflect the needs of the Antarctic science community and asset management teams.

# HISTORY / BACKGROUND

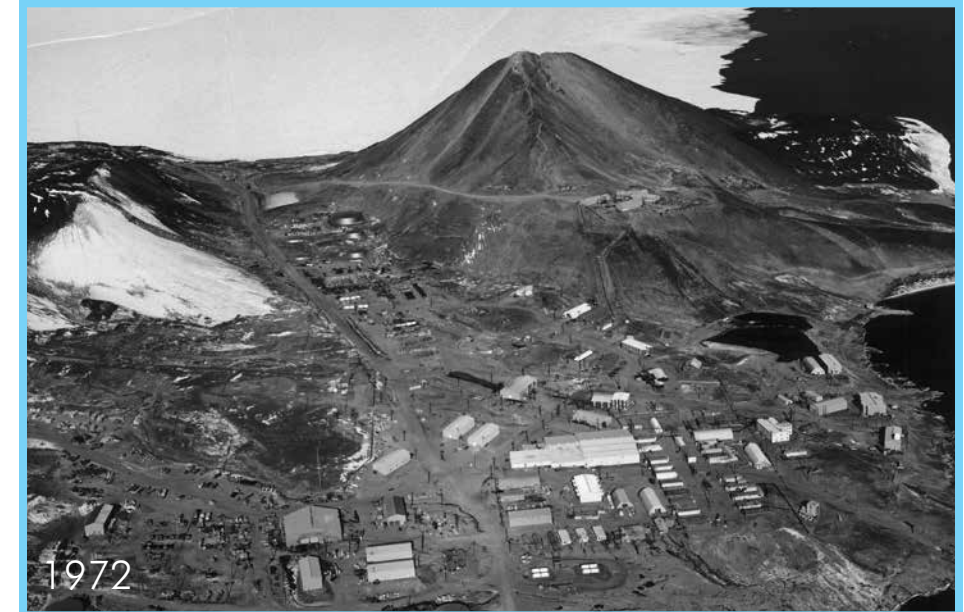

McMurdo Station is one of seven stations built by the United States Navy for the International Geophysical Year (IGY), which was an opportunity for global scientific cooperation during the peak of the Cold War. The IGY included research by 12 nations at more than 60 stations in Antarctica.

At the time, the US Navy was considered the only institution capable of large scale construction and support in remote and hostile conditions following World War II; the US Naval Mobile Construction Battalion (Seabees) was commissioned to build the stations. This group was known as "Task Force 43," which was part of the larger military Operation Deep Freeze. Deep Freeze included transportation, cargo movement, communications, maintenance, operations and other support functions.

Operation Deep Freeze arrived at the ice edge of Ross Island in December 1955. The sea ice edge extended more than 40 miles north of what is now McMurdo, so cargo was offloaded over the sides of the ships directly onto the ice and then transported by tractors and sleds to the site. The station was originally named "Williams Air Operating Facility" in honor of Richard T. Williams, the first casualty of the off-load. Today his name is still remembered with the Williams Field Ski-way located southeast of McMurdo.

During that first year, the name was changed to McMurdo Station, reflecting the name of McMurdo Sound, the surrounding body of water.

The first group of Seabees to arrive at Hut Point Peninsula erected tents around Scott's historical Discovery Hut in which to live while constructing the station. While most of the station was completed by March 1956, finishing touches continued through the 1956 austral winter. The main street was named Forrestal Avenue in honor of former Secretary of the Navy and first Secretary of Defense James Forrestal.

McMurdo, like all the IGY stations, was never intended to be a permanent station. They were to be built as quickly as possible, with few amenities, to allow military men and researchers to survive in hostile conditions for two years.



# HISTORY / BACKGROUND

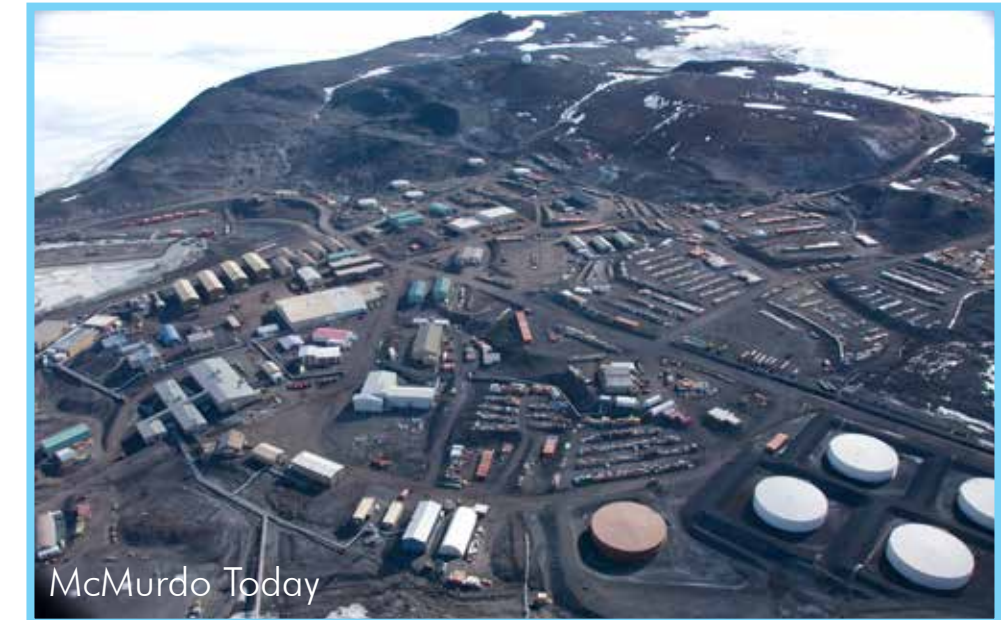

McMurdo Station was intended to serve solely as a base camp for the construction of the South Pole Station during the 1956-1957 austral summer. There were international political sensitivities at the time about which nation could conduct science in which locations around the continent and plans were already underway for New Zealand's scientific research to be done at Scott Base nearby. Therefore, the US planned to use McMurdo Station as a support camp only to supply the more strategically located South Pole Station.

The buildings were either canvas-covered Jamesways, corrugated metal Quonset huts, or 4'x8' insulated plywood boxes called Clements huts, all easy to assemble quickly. The Clements huts panels simply clipped together. There were 34 buildings comprising the original McMurdo Station, and in addition to berthing, administrative offices and the mess hall, there were buildings to house sled dogs, a photography lab, and a parachute loft where parachutes were packed.

During that first winter of 1956, the focus was building cargo pallets of construction materials to be air dropped at the South Pole during the 1956-1957 austral summer. South Pole Station construction was completed in January 1957, as planned, allowing the scientific work of the International Geophysical Year to proceed.

The IGY was to last 18 months, but because of the logistical difficulties of working in Antarctica, it effectively lasted two years. The original plan was to remove or abandon the stations after 1958, but the global scientific community considered the IGY such a success that they wanted to continue polar research, subsequently leading to the 1959 Antarctic Treaty. The original signatories of this treaty were the 12 countries active in Antarctica during the International Geophysical Year (IGY) of 1957–58. The twelve countries that had significant interests in Antarctica at the time were: Argentina, Australia, Belgium, Chile, France, Japan, New Zealand, Norway, South Africa, Soviet Union, United Kingdom, and United States. These countries had established over 50 Antarctic stations for the IGY. The treaty was a diplomatic expression of the operational and scientific cooperation that had been achieved "on the ice". McMurdo Station's "temporary" buildings lasted into the 1960s and 1970s, with modifications and new construction added as requirements grew.

Today, McMurdo Station has approximately 100 buildings covering an area of 49 acres, with some of the oldest buildings still in place after over 50 years. However, it is not just the age of the buildings that defines McMurdo Station today. The current configuration reflects six decades of limited planning, with science never having served as a focal point for the support facilities. While McMurdo Station remains a logistics hub and support center for deep field work, it is also a center for science and has a multi-discipline laboratory. The age of the station's facilities and infrastructure, coupled with a continued need for efficiencies in Antarctic Science and Support reinforces the need to develop a comprehensive Master Plan to guide both short and long term development.

THIS PAGE INTENTIONALLY LEFT BLANK.

# EXISTING CONDITIONS

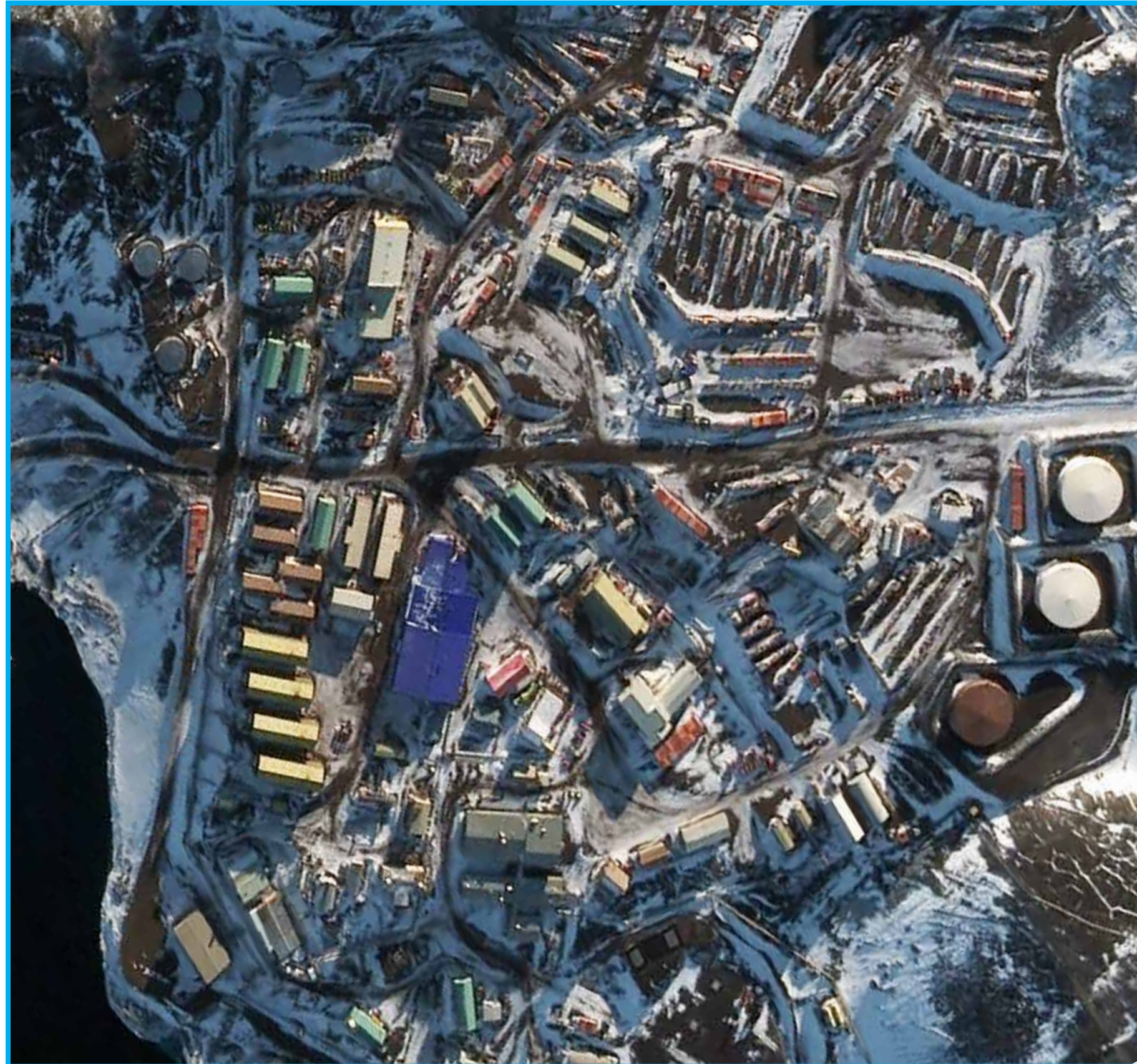

# EXISTING SITE PLAN

## BUILDING LEGEND

001	CRARY SCIENCE AND ENG CENTER	166	NSF BERTHING
002	CSEC EMERGENCY GENSET	167	NATIONAL SCIENCE FOUNDATION
003	CORE STORAGE	168	AUTO UNHEATED STORAGE WAREHOUSE
004	SCIENCE SUPPORT CENTER PHASE 1	174	FLAMMABLE STORAGE WAREHOUSE
007	CHAPEL OF THE SNOWS	175	FEMC/IT/NSF OFFICE
010	HUT TEN	176	COLD FOOD STORAGE
017	EQUIPMENT OPERATIONS	177	PAINT BARN/STORAGE
034	WARM-UP SHACK	182	FIRE HOUSE/TELEPHONE EXCHANGE
035	WARM-UP SHACK	185	WASTE MANAGEMENT
073	CARGO WAREHOUSE/BFC FOOD ROOM	188	NSF BERTHING
075	GYM	189	JOINT SPACECRAFT OPERATION CENTER (JSOC)
076	COFFEE HOUSE	191	LOGISTICS/MATERIAL/MAPCON
078	AEROBICS FACILITY	191A	CARPENTRY WORKSHOP/TOOL ROOM
085	RECOMPRESSION CHAMBER	191B	WORKSHOP
107	SOUTHERN EXPOSURE	191C	WORKSHOP
108	GALLAGHER'S CLUB	192	SAFETY/QUALITY ASSURANCE
120	INFOSYS/FOOD WAREHOUSE	196	POWER PLANT
121	ELECTRICAL WHSE (CMO BEER & SODA)	198	WATER DISTILLATION PLANT
122	SKUA CENTRAL	199	WASTE WATER TREATMENT PLANT
125	NSF BERTHING	201	BERTHING
129	HELICOPTER HANGER	202	BERTHING
132	SUPPLY WAREHOUSE (GSK AUTOMOTIVE)	203A	BERTHING
136	FEMC TRADE SHOP	203B	BERTHING
136A	MODULAR OFFICE	203C	BERTHING
136C	MODULAR OFFICE	206	BERTHING
140	MCC/POST OFFICE/CENTRAL SUPPLY	207	BERTHING
141	FUEL DEPARTMENT OFFICE/SHOP	208	BERTHING
142	MAC MEDICAL DISPENSARY	209	BERTHING
143	HEAVY VEHICLE MAINTENANCE FACILITY	210	BERTHING
144	DIVE SHACK	211	BERTHING
151	FIRE PUMP HOUSE (BERTHING)	340	UNHEATED STORAGE
155	GALLEY/BERTH/STORE/LAUNDRY/LIBRARY	341	UNHEATED STORAGE
156	AIR GUARD SUPPLY WAREHOUSE	342	UNHEATED STORAGE
157	COLD STORAGE WAREHOUSE	637	CONSTRUCTION STORAGE WAREHOUSE JAMESWAY
159	FM/AGE/COMMS WAREHOUSE	D2	DIESEL TANK
160	BERG FIELD CENTER	D12	DIESEL TANK
164	FROZEN FOOD STORAGE	D13	DIESEL TANK
165	MCMURDO OPERATIONS/AIR TRAFFIC/WEATHER	M1	MOGAS TANK
		M3	MOGAS TANK





SCALE 1:300





PREVAILING WIND

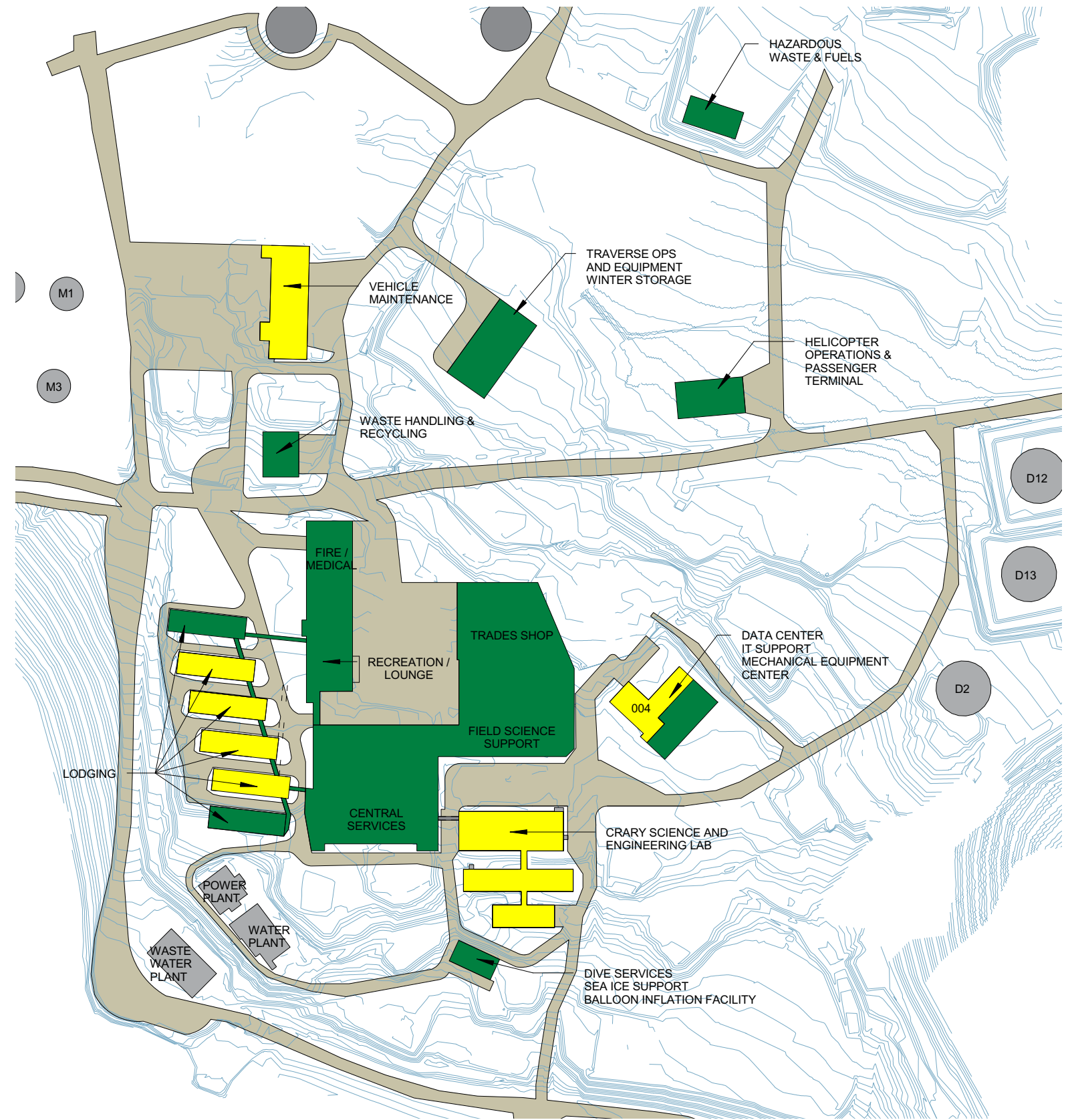

# PROPOSED MASTER PLAN

 EXISTING STRUCTURE TO REMAIN  
 NEW CONSTRUCTION  
 MAJOR RENOVATION



PREVAILING WIND   SCALE 1:300  
 0 75 150 300 600



# GLOSSARY

---



# GLOSSARY

- **AFRTS:** American Forces Radio and Television Service.
- **AGE:** Aircraft Ground Equipment. Department in McMurdo dealing primarily with maintenance activities for aircraft.
- **AHJ:** Authority Having Jurisdiction.
- **ANG:** Air National Guard, United States Air Force Reserve Component.
- **ASC:** Antarctic Support Contract. The primary logistical support contractor to the United States Antarctic Program, managed by Prime Contractor to National Science Foundation.
- **ASHRAE:** American Society of Heating, Refrigerating, and Air-Conditioning Engineers.
- **ATO:** Antarctic Terminal Operations. Division of Antarctic Support Contract that manages the movement of passengers and cargo.
- **Bag Drag:** Similar to check-in with commercial airlines. Passengers are weighed and checked for extreme cold weather gear, carry-on bags are approved, and bags are palletized for transport.
- **BICSI:** Building Industry Consulting Service International.
- **BL:** Building.
- **C-17:** A United States Air Force aircraft used for transporting cargo and personnel between New Zealand and McMurdo.
- **C-130:** A wheeled four-engine Lockheed Hercules turboprop airplane. LC-130 indicates a ski-equipped plane like those used in Antarctica.
- **CEP:** Central Energy Plant.
- **CHP:** Combined Heat/Power Microturbine.
- **CONUS:** Continental United States.
- **CRREL:** U.S. Army Corps of Engineers' Cold Regions Research and Engineering Laboratory.
- **CSEC:** Crary Science and Engineering Center. Laboratory at McMurdo Station. Also known as Building 001, or Crary Lab.
- **DDC:** Direct Digital Control.
- **DHW:** Domestic Hot Water.
- **DNF:** Do Not Freeze.
- **DV:** Distinguished Visitor.
- **ECM:** Electrically Commutated Motors.
- **EOC:** Emergency Operations Center. A dedicated space to use as an incident command center during emergencies.
- **FS&T:** Field Support and Training.
- **GEM:** SPAWAR GPS Embedded Module
- **Grantee:** A scientist who has received a grant from the National Science Foundation.
- **HVAC:** Heating, Ventilation, and Air Conditioning.
- **IBC:** International Building Code.
- **Ice Runway:** Runway built on the temporary sea ice; accommodates wheeled airplanes.
- **IFC:** International Fire Code.
- **IGY:** International Geophysical Year.
- **IT&C:** Information Technology and Communications. Antarctic Support Contract functional work group overseeing telecommunications and computers.
- **JPSS:** Joint Polar Satellite System; part of National Environmental Satellite, Data and Information Service of the United States.
- **JSOC:** Joint Space Operations Center. Also refers to a building in McMurdo that houses both National Aeronautical and Space Administration as well as Antarctic Support Contract Network Operations Center.
- **JTF-SFA:** Joint Task Force-Support Forces Antarctica, led by Pacific Air Forces at Joint Base Pearl Harbor-Hickam, Hawaii.
- **MCC:** Movement Control Center, McMurdo Station, Antarctica.
- **MCM or McM:** McMurdo Station.
- **MCI:** Mass Casualty Incident.
- **MEC:** Mechanical Equipment Center, McMurdo Station, Antarctica.
- **MEP:** Construction industry term standing for mechanical, electrical and plumbing.
- **Milvan:** - Military Van. Containers used for shipping and storage of goods.
- **MP 1.0:** Previous McMurdo Master Plan.



THIS PAGE INTENTIONALLY LEFT BLANK.



# GLOSSARY

- **MP 2.0:** Previous McMurdo Master Plan.
- **MP 2.1:** Current McMurdo Master Plan.
- **MP:** In Master Plan 2.1 refers to Multi-Purpose rooms. Specifically the Multi-Purpose Lecture Hall located in Central Services.
- **MV:** Medium Voltage.
- **NFPA:** National Fire Protection Association.
- **NSF:** National Science Foundation, an agency of the U.S. government.
- **NYANG:** New York Air National Guard.
- **OAS:** US Department of the Interior's Office of Aviation Services.
- **O&M:** Operations and Maintenance. Usually refers to cost burdens not construction.
- **ORP:** Oxidation Reduction Potential.
- **PAX:** Vernacular for passenger/s.
- **Pegasus:** A prepared runway on permanent ice near McMurdo Station that accommodates wheeled airplanes.
- **PFH:** Plate/Frame Heat Exchangers.
- **PIV:** Post Indicator Valve.
- **PV:** Photo Voltaic.
- **Redeployment:** Passenger transport from destination to origin.
- **Retrograde:** To return cargo from the field to McMurdo Station, or from McMurdo to destinations north. Usually in the reverse order of its initial deployment.
- **RO:** Reverse Osmosis. Refers to the water purification system used in McMurdo.
- **SATCOM:** Satellite Communications.
- **SG:** Smart Grid.
- **SOPP:** SPAWAR Space and Naval Warfare Office of Polar Programs. Agency that provides weather forecasting and air traffic control services for the United States Antarctic Program.
- **SPoT:** South Pole overland Traverse.
- **SSC:** Science Support Center, legacy building (building 004) in McMurdo currently containing the Mechanical Equipment Center and Field Safety Training Program.
- **STHX:** Shell and Tube Hyrdonic Heat Exchanger.
- **UL:** Underwriters Laboratories.
- **UPS:** Uninterrupted Power Supply.
- **U.S. Antarctic Program (USAP):** United States Antarctic Program. The United States governmental program, administered by the National Science Foundation, for Antarctic research and related activities.
- **VFD:** Variable Frequency Drives.
- **VMF:** Vehicle Maintenance Facility (Building 143).
- **WAN:** Wide Area Network.
- **WTE:** Waste to Energy. Current program initiative that uses cardboard, wood and paper as feedstock to operate a wood chip boiler.
- **WWTP:** Waste Water Treatment Plant.



# ARCHITECTURAL DESIGN GUIDING PRINCIPLES

The principles that follow are suggested to guide the specific architectural design of McMurdo Station. These principles should inform and drive all aspects of the building design, from layout and massing, to the organization and character of interior spaces, to the design of the building enclosure, from both technical and aesthetic points of view.

These guiding principles are primarily a reflection of the NSF/USAP Mission and the environment of McMurdo's Ross Island site.



## REFLECTION OF USAP MISSION

The primary intent of this document is to produce a long-range strategic plan that is a reflection of the NSF's USAP mission, one of progressive and dynamic scientific inquiry. To that end, appropriate materials are to be designed into and used during the execution and construction of the proposed station. The design must be adaptable and open ended affording NSF the ability to scale facilities and their use according to the velocity of science; scaling down to reduce utility and support personnel costs when support needs are lower and ramping up when science needs are greater. The exterior of the buildings must reflect the stature of the United States, and of the NSF as a premier scientific organization. It must convey strength and permanence, while reflecting the world-class and progressive science that it supports. It should also be indicative of the professional nature of the USAP mission. The interior of the buildings must also convey that message and should incorporate areas that highlight the history of the past missions as well as displaying current and ongoing scientific activities.

As many of McMurdo's work flows are logistical in nature, the Master Plan and eventual station build out need to reflect and promote an efficient and effective logistical hub. Roadways, utilities and buildings are designed to allow flexibility while supporting functional work flows and participant wellness. The consolidation and co-location of similar work functions creates efficiency and promotes safety as a result of fewer touch points of material. Locating materials near where they are used will improve productivity. Strategic redundancy for life safety offers constant operational support for a number of environmental and emergency situations.

## PROMOTE ENVIRONMENTAL STEWARDSHIP

The NSF and USAP go to great lengths to ensure environmental stewardship. Implementation of the Master Plan will further that commitment. Resource efficiency intended to reduce demand on fuels will be achieved by a number of efforts.

High volume-to-skin ratios of the building structures will increase energy efficiency and require less heating. A compact footprint will reduce reliance on vehicular transport of materials and people, and will reduce lengths of utility runs. High performance building envelopes will decrease heat loss and maintain residual interior temperatures with less reliance on heating sources. Proper building orientation to optimize day-lighting and to take advantage of the austral summer's 24 hours of sunlight will reduce reliance on electrical lighting systems and reduce reliance on generated power. High-performance mechanical systems will operate efficiently and use standardized equipment, thus reducing operations and maintenance requirements. Structural efficiencies gained by using repetitive bay, cross bracing and cantilevered elements will reduce construction costs and engineering effort. Improved monitoring and controls systems which will enable better management approaches to energy consuming systems, smart Grid technology which can contribute to better energy management, and increased public awareness can all further environmental stewardship which is a hallmark of the NSF.

The use or re-use of existing materials on site, including steel structures, along with waste heat capture and distribution, continued and further implementation of Combined Heat and Power (CHP) micro turbines and re-use and optimization of the Waste to Energy (WTE) system further promotes resource efficiency and capitalizes on previous NSF modernization efforts. The re-use and expansion of renewable energy sources will include solar and wind energy.



THIS PAGE INTENTIONALLY LEFT BLANK.

# ARCHITECTURAL DESIGN GUIDING PRINCIPLES

## PROMOTE WELLNESS

Developing a station that highlights its scientific mission as well as its past and continuing community support is a cornerstone of the Master Plan.

To promote individual well-being, this Master Plan recommends opportunities for physical activity, adequate rest, relaxation and recreation diverse enough to appeal to the interests of its population

To promote a sense of teamwork, cooperation, collaboration, and recognition of accomplishments, the Master Plan recommends the need for various venues for both formal and informal gatherings, social and professional activities, appropriately designed and sized to foster interactions of all kinds.

To acknowledge and pay respect to the important activities, events and all personnel that have played and continue to play a critical role in the evolution of the United States mission in Antarctica.

## PROJECT AN IMAGE OF STATURE, PERMANENCE AND DURABILITY

The McMurdo Station development, as a reflection of not only the National Science Foundation, but also of the United States of America, must project strength, organization, permanence, and professionalism in this part of the world. The design must be demonstrative of the stature of the United States in the global scientific community and must be world class in its function and appearance.

## IS OF ITS PLACE

The architecture must be responsibly designed to be responsive to its immediate environment, but must also reflect the United States of America's active and influential presence in Antarctica.

Buildings should respond to the local climate by using high-performance building envelopes, with form and structural systems to efficiently withstand elemental forces and ice and snow. Facilities will be oriented such that wind effects and snow drifts will be minimized. The optimization of views will be achieved while balancing energy efficiency and thermal comfort.



# FACILITY CONSIDERATIONS

---



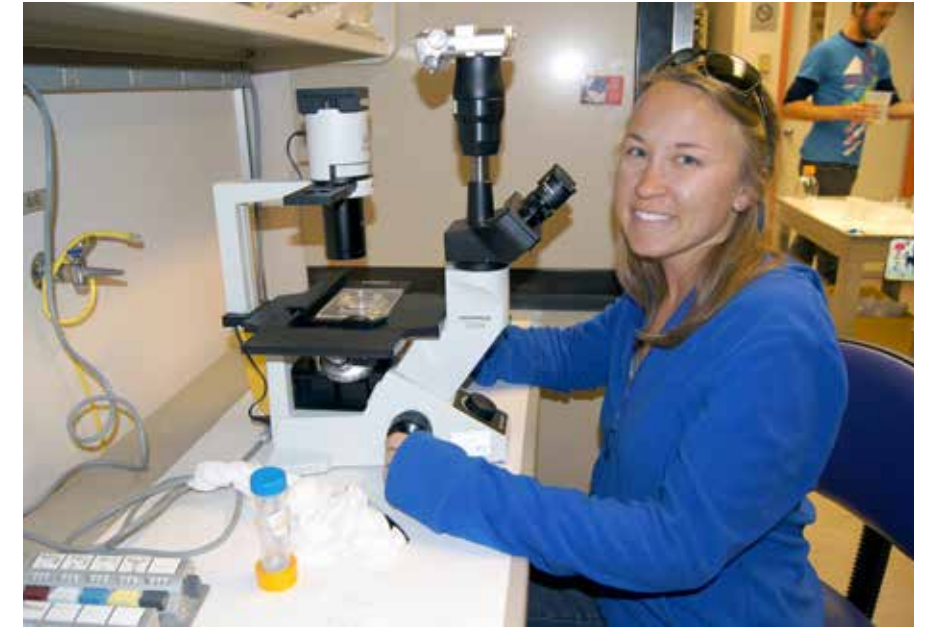

## CRARY SCIENCE AND ENGINEERING LAB

Crary Science and Engineering Lab is the premiere research facility located within the McMurdo Station. Almost every researcher who deploys to McMurdo or the deep field for the United States Antarctic Program has, at one time or another, worked in this facility. Crary is still a good and viable workplace within the McMurdo Station although its largest constraints are current layout, preparation and loading dock space especially when it comes to field science staging. This would be alleviated when the new proposed Science Support facility is completed and Crary Lab can return to its original design intent which is primarily office and lab space.

Under this Master Plan Crary Lab remains in its current location. A major renovation effort aimed toward the interior of the building as well as labs, mechanical, electrical, fire protection, direct digital controls (DDC), and information technologies/communications (IT/Comms) is proposed. Optimization of loading docks as well as existing interior staging space is recommended for all phases of the Crary remodel effort. To limit the amount of disruption to Crary's normal operations each of the existing phases of Crary Lab will be remodeled independently of one another.

The renovation effort for Crary is recommended to be constructed across from the current location of the aquariums on the lowest level. This addition will house mechanical, electrical, fire protection, DDC and IT upgrades that can be built independently of Crary's normal operations and allow for the simple extension of distribution lines as remodel phasing progresses. After construction of the mechanical room addition the aquarium will be remodeled. This remodel will include increased flow capacity to the aquarium tanks, an ability to provide ambient temperature water from the sea water intake, redundant piping for cleaning and isolation of tanks, and monitoring equipment for variables including flow rates, Oxygen, Oxidation Reduction Potential (ORP), pH, Nitrogen, Ammonia and Carbon Dioxide. The second phase remodel will include versatile and multi-purpose lab and office space, freezers for scientific samples, IT data room space for grantee specific project use, grantee collaborative work space, clean labs for trace level isotope work, as well as updated mechanical, electrical, fire protection and IT infrastructure. The third phase remodel recommends remodeled speciality labs and equipment storage, versatile chemistry labs, shared equipment labs, environmental rooms, NSF and administrative area office space, grantee conference rooms, grantee offices and multipurpose space, equipment and material supply room and facility management offices and storage space. Utility distribution will be completed and leave Crary with a thoroughly updated and modern utility infrastructure.

Despite a major, multi-phased renovation effort being proposed for Crary, it is the intent of this Master Plan to reduce organizational and spatial incongruities within the current Crary layout and to optimize efficiencies for the grantees to quickly and efficiently complete the work they are deployed to Antarctica to accomplish. The USAP exists to support scientific research and inquiry. The renovation and reconfiguration of Crary will assist in ensuring the viability and the work performed therein will continue for many years to come.



## WAREHOUSING

A fundamental strategy to increase efficiency at McMurdo is the co-location of material storage with the associated activities that require the material. Doing so reduces time, reliance on transport vehicles, and potential risks associated with re-location of material.

Current Situation: McMurdo (MCM) receives approximately 400 containers from the annual supply vessel. Of those 400 containers, approximately 250 are staged in Outside Storage Areas. The contents of these containers are not needed until later in the season and include items such as fuel barrels and Non-Do Not Freeze (DNF) material or equipment. The other 150 containers are currently staged and then unloaded as personnel are available throughout the winter season in preparation for the following summer season.

This Master Plan recommends a Central Warehouse be co-located with Central Services. In addition to this storage space, most buildings that will consume specific materials are suggested to be designed with loading docks and interior storage capacity to accommodate direct delivery from the ship offload. This will be comprised of materials that are used with such regularity that they can be considered “bench stock”. Bench stock is material that is used consistently on a monthly basis and is to be delivered directly to the satellite warehouses during ship off-load. This co-location is a departure from the current configuration and will result in a more efficient operation. Specific facilities to use this approach will be Vehicle Maintenance, Trades Shop and Science Support.

Material required for use within the Central Services function will be located in the Central Warehouse and distributed as necessary. Surplus material, and material used less frequently, yet intended for specific work groups, can be stored within the Central Warehouse and transferred to satellite warehouses as needed throughout the season.

This approach allows the appropriate amount of material to be ordered in the off season and creates a more efficient delivery system during ship off-load. It also provides an appropriate level of physical asset management including, in conjunction with appropriate management software, the ability to monitor frequency of material usage.





## CENTRAL SERVICES

The Central Services building is proposed as new construction under this Master Plan. It has been located outside the footprint of the existing Building 155 to facilitate ongoing operations. This facility is, where possible, connected by enclosed walkways to the various elements of the station.

This facility consolidates most administrative functions as well as most station support functions. Specifically the Central Services houses Dining, Food Warehousing (including dry, frozen and refrigerated storage), and multi-purpose lecture space.

In addition, it is recommended that Central Services will include the primary mission operations center for the station. Primary mission operations refers to those departments that receive, interpret and relay information critical to USAP operations. These functions include primary field and intercontinental communications, fixed wing aircraft service provider, Air Traffic Control and Fire Department Dispatch. The Command and Control features currently located in BL165 and BL167 are intended for this facility.

Secondary IT/Comms infrastructure will provide strategic redundancy and emergency back-up capabilities in Central Services to support the primary data centers for NSF, NASA and Joint Polar Satellite System (JPSS) in the event of a catastrophic failure in the primary IT/Communications facility, which is recommended to be located in the existing BL004. In addition to the data centers this facility will support backup station telephony, uninterrupted power supply (UPS), appropriate fire protection, HVAC and wiring closets to allow for efficient replacements and upgrades to critical IT infrastructure.



## EMERGENCY SERVICES/CONTINGENCY OPERATIONS

McMurdo is an isolated community. In the event of a fire or other catastrophic occurrence that would render most of the station services unavailable, the Contingency Operations function will be capable of supporting the station population. The New Emergency Services facilities (Firehouse and Medical) co-located with the recreation facilities, including a full size gymnasium that doubles as emergency sleeping quarters, will support the concept. As part of this concept, a small kitchen and access to the stores is included.

A new Firehouse that provides sheltered parking for fire trucks and ambulances is recommended along with berthing and a day room for fire fighters on shift, administration areas, training room, specialized storage capabilities for storing and servicing emergency breathing apparatus and storage for station fire extinguisher stock and bunker gear. The bays will include a drive through capability thus increasing safety, efficiency and preparedness.

A new Medical center will be co-located with the Firehouse. Medical center recommendations based on military medical facilities designed to accommodate and treat a deployed population similar to McMurdo. The Medical center will feature administration, exam rooms, hyperbaric oxygen chamber for treating altitude and decompression sickness, dental exam and procedure space and sick bay berthing rooms for patients requiring separation from the general population. The Medical Center design must be adjusted to meet current applicable criteria for such a unique mission.

Completing the Contingency Operations concept will be a recreation block that will include multi-purpose rooms whose primary function are skills development center, music practice rooms and exercise space. These rooms will be available during contingency operations to serve as functional areas as determined by management.

This concept creates a strategic redundancy that focuses on providing the support functions most critical to the population in case of emergency including warm shelter, potable water, and cooking facilities.

Warm shelter will be provided in all of the Contingency Operations buildings in the event of an emergency. The full-size gymnasium doubles as emergency sleeping quarters or other contingency function as needed. Cooking can take place in the Lounge's commercial kitchen facilities.

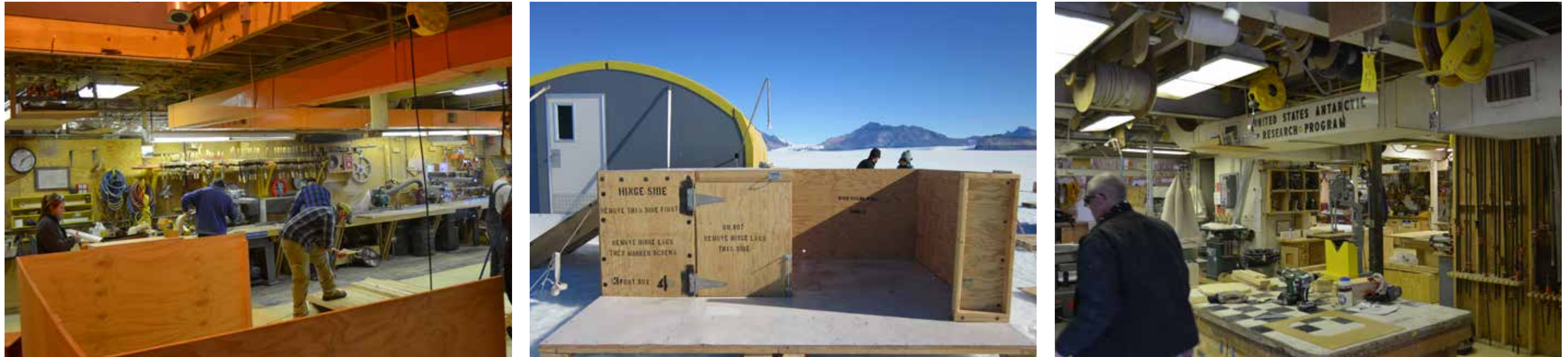

## TRADES SHOP

The light industrial Trades as well as the Carpenter's shop are intended to be co-located within a single new structure within this Master Plan. Light industrial Trades refers to non mechanical trades that primarily maintain station facilities, assemble minor scientific equipment and minor fabrication or repair of scientific components.

Satellite warehousing for bench stock is to be integrated into the building design. Both the light industrial Trades as well as the Carpentry shop will be designed to receive materials from a contiguous warehouse within the shop, move through the construction, assembly and finishing process before being sent to the loading dock for station distribution or entered into the cargo stream.

The Trades Shop is designed to be co-located with the proposed Field Science Support with a large covered area between the two buildings for assembly of items such as portable science facilities repair, construction or maintenance, assembly of large scientific apparatuses, etc. This staging area will have a concrete floor, ample lighting, electrical and mechanical components and a heating system if needed. It will be designed with large overhead doors to accommodate various sizes of equipment and structures.



## FIELD SCIENCE SUPPORT

This Master Plan proposes a new facility called Field Science Support. It is located across the road from the existing BL001 Crary Lab, will be connected to Central Services, co-located with the Trades Shop and featured prominently in the entry sequence of participants and visitors. This will reinforce the fact that Science and the support of Science is the primary purpose of McMurdo Station. This facility will include the majority of cargo functions relative to the USAP. Antarctic Terminal Operations, Cargo, Science Field Gear, Science Cargo, Field Communications Gear and the issuance of mechanical field gear will be operated from the first floor of this facility.

Field Science office space is severely lacking within the current McMurdo station. This facility will provide second floor office space, conference rooms and multi purpose space for field grantees. Providing this work space to grantees deploying to the field will alleviate the space constraints in the existing Crary Lab.

The 1st floor of this facility will house the field gear preparation area necessary to accommodate the voluminous amount of gear necessary for a grantee to deploy to deep field camps as well as helicopter supported camp facilities. The hundreds of tents, sleeping bags and other gear items issued to grantees and support staff to complete their work in the field will be returned here at the end of the season, cleaned, repaired by field staff and returned to “ready for issue” status. This area will include industrial laundry facilities, capabilities to dry gear returning from the field and kitchen facilities to properly clean and sanitize camp kitchen utensils for return to stock.

Science Support is seen as a “one stop shop” for grantees on their way to any of the various field sites within Antarctica including South Pole. Grantees will have easy access to field science work center personnel who will assist in preparing them for the field.

ATO and Cargo (departments responsible for the movement of participants and cargo both on and off continent) functions are also co-located within this facility. The intent is to accommodate the field science gear, South Pole material, in-bound and out-bound science cargo and cargo intended for consumption at McM that does not arrive on the vessel. It is sized appropriately to accommodate future winter flights and the cargo that could be expected on those flights. Science gear will already be located at the facility by virtue of it being the main drop point from either the airfield or the helicopter operations and material and equipment coming from the Trades Shop will be located in close proximity. There will be ample yard space for outdoor building of Air Force pallets at existing pads located at BL004, BL167, BL188 and BL166 as well as ample staging space within the facility.



## SCIENCE SUPPORT CENTER - EXISTING BUILDING 004

Science Support Center BL004 is an existing building that this Master Plan proposes as remaining albeit with an extensive remodel. An addition is recommended to be built on the south side of the building whose function will be the primary NSF data center including Network Operations Center as well as a primary NASA and JPSS data centers and Control Center offices. This is not to be confused with primary mission and operations and Command and Control that are to be located in Central Services.

Relocating the IT, NASA and JPSS functions from their current location early in the Master Plan phasing process allows uninterrupted station support services that are currently in buildings slated for early demolition.

In addition to the primary data centers there will also be backup mission operations/ strategic redundancy capabilities for essential support functions such as the Fire Department call center (Fire Dispatch), communications operations center (MacOps), meteorological services (Mac Weather), air traffic control (Mac Center), and Air National Guard Operations (Raven OPS). These secondary capabilities provide strategic IT and Comms redundancy should a tragedy befall Central Services, where the primary mission operations, communications and emergency mission operations are to be located .

The 1st floor of the existing BL004 is to be repurposed into office, warm storage and electronics shop space. This space will include IT&C and SPAWAR administrative office space and SPAWAR, IT&C Comms and Telco electronics shop and the IT&C PC electronics shop.

The 2nd floor of existing BL004 will house the Back-up Mission Comms and offices, the secondary Emergency Operations Center, the Network Operations offices, the Primary IT&C Data Center and IT&C administrative office space. The eastern portion of the building will house deployable geoscientific instrumentation.

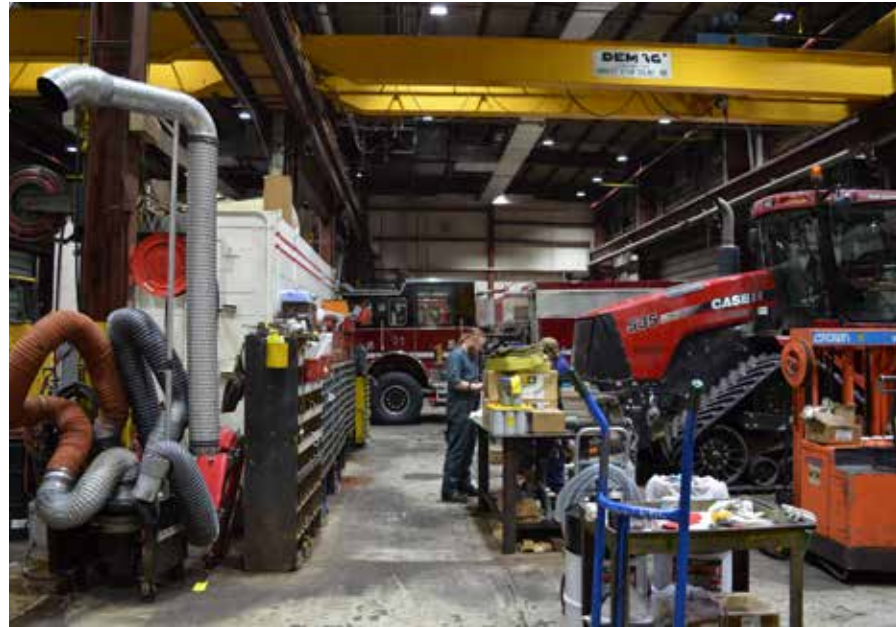

## EQUIPMENT OPERATIONS

---

Under the Master Plan the existing Vehicle Maintenance Facility (VMF) is shown to stay in the current location albeit with an extensive remodel.

With all heavy equipment maintenance activities, both Traverse vehicles as well as heavy equipment used for town and airfields, moving to the new Traverse OPS facility, the current VMF will be remodeled to service light vehicles and equipment.

The Mechanical Equipment Center, which currently services, repairs, maintains and issues science related field gear will be located to this facility along with the Aircraft Ground Equipment and Air National Guard storage facility.

The material needed for the maintenance and repair operations, as well as common bench stock, will be located in a high density warehouse located within the facility. Appropriately sized locker rooms as well as industrial laundry facilities would also be proposed for this facility to keep grease and fuel soaked work clothing out of the new Central Services and Lodging units.



## TRAVERSE AND EQUIPMENT WINTER STORAGE

The Traverse and Heavy Equipment facility is proposed as a new structure under this Master Plan. Traverse Operations is the common term for the material, cargo, equipment and personnel needed to deploy a train of tractors from McMurdo to South Pole Station to lessen the costs of delivering fuel to the South Pole Station via LC-130 aircraft. Heavy Equipment is the material, equipment and personnel needed to maintain all of McMurdo's heavy equipment fleet including bulldozers, graders, front end loaders, fork trucks, etc. that are used to maintain the town and airfield sites.

By co-locating these similar, yet distinct, functions numerous efficiencies can be gained and much material, personnel and equipment can be shared thus negating redundant expenditures.

Traverse Operations, Fleet Operations and Heavy Equipment mechanics, supply staff and administrative personnel will share administrative, meeting and training space. Appropriately sized locker rooms as well as industrial laundry facilities would also be proposed for this facility to keep grease and fuel soaked work clothing out of the new Central Services and Lodging units.



## HELICOPTER OPERATIONS

---

Under this Master Plan the Helicopter Hangar and Passenger (Pax) Terminal is shown as a new facility. However, the size feasibility and flight patterns still require further study.

Helicopter Operations in McMurdo are used to get grantees, material, equipment and support staff to field camps that are either inaccessible by ground transportation or not suited for delivery by a fixed wing aircraft. These locations include the Dry Valleys, Cape Crozier, Lower Erebus Hut, etc.

The facility's proposed location is being studied to ensure optimum siting. The NSF is conducting a feasibility study to determine the optimal location based on prevailing wind conditions and operational flight requirements.





## WASTE PROCESSING

A new waste processing facility is proposed under the Master Plan.

The new facility is located in the approximate location of MCC/Post Office/Central Supply BL140. As most of the non-hazardous waste on station is currently generated from Lodging and Food Services, waste is separate, but geographically co-located with these facilities to increase efficiency, reduce handling and decrease travel distance to its final deposition. Due to different building occupancy classifications, waste and hazardous waste must remain as separate facilities.

The waste processing facility will incorporate the Waste to Energy unit currently proposed for McMurdo. This unit will use the cardboard, wood and burnable waste streams as fuel. Other waste streams will be picked up from collection sites and deposited into Milvans backed up to loading docks. These Milvans will be switched out as necessary and ready for ship on-load for retrograde back to the U.S.



## LODGING

---

The Master Plan makes lodging provisions that are scalable, with the ability to add or subtract, based on the amount of supported science.

Depending upon a positive structural analysis of buildings 206 through 209, this Master Plan recommends using these buildings once again as lodging, by re-using the steel structure, and developing a new building envelope and floor plan. If the current facilities prove to be unusable, or not worth the investment, new lodging is proposed to be placed on the existing lodging footprints. Lodging is comprised of a mixture of single occupancy and double occupancy rooms.

This lodging will be designed to be mechanically isolated to accommodate reduced population, as in winter, or as the velocity of science and grantee support dictates. All lodging facilities are connected to Central Services as well as to Fire/Medical by way of enclosed pedestrian walkways.



## DIVE SERVICES AND SEA ICE STORAGE

The Dive Services and a small Sea Ice activity storage facility are proposed as new construction in the approximate location of the current dive services which is close to the sea ice.

The Sea Ice grantees begin their work early in the austral summer season and are necessarily complete with their work by late November due to sea ice beginning to melt and becoming unstable. This schedule squeezes a large amount of work into a short amount of time.

The USAP Divers assist grantees in collection of specimens which are often transported back to the aquarium at Crary Lab. There is often a large amount of gear, in addition to diving gear proper, which must be transported to the Sea Ice to accommodate these collection efforts.

Under this plan a new Dive Services is co-located with a small, conditioned Sea Ice Storage facility. Sea Ice grantees often share Pisten Bully tracked vehicles, which are best left closer to the sea ice. Gear, including cumbersome fishing equipment, monitoring, storage and measurement devices, often needs to be removed (only to be loaded again the following day) from the vehicle and the only place to store that gear currently is within the Crary Lab which is ill suited for this type of storage. The proposed facility would afford better coordination between divers and will give them a place to store equipment and gear. The facility will feature shelving space, fresh water showers to rinse gear and wet suits, and warm storage facilities. There will also be a decrease in associated maintenance costs from road damage caused by tracked vehicle traffic.

THIS PAGE INTENTIONALLY LEFT BLANK.



## HAZARDOUS WASTE AND FUELS PROCESSING

This Master Plan proposes a new hazardous waste processing facility. This facility is intentionally located away from town for physical safety separation standards and will feature the mechanical, electrical, and architectural controls necessary to safely process, store, package, and ship these waste streams.

Recently completed construction projects have provided the appropriate number and types of tanks for fuel storage but the Fuels Department remains viable and necessary for the operation of McMurdo's utilities such as the power plant as well as providing fuel for aircraft. The Fuels department is proposed to be co-located with Hazardous Waste as all of the by-products from Fuels is processed by Hazardous Waste.

Appropriate administrative functions will be located in the facility to allow for proper daily management and oversight.

# FACILITIES PROGRAM

The following pages compare the current facilities at McMurdo Station with the Master Plan. As a result of increased efficiencies through both consolidation and improved layout, this Master Plan results in a reduction in size across all program elements listed on the following pages. Along with this reduction, select additional program areas are included in the following program listing in response to evolving facility requirements. It is anticipated that due to the consolidation and improved layout, that additional reductions in personnel and fuel usage will be realized.

As the Master Plan is implemented through architectural design, this Program will be confirmed and further developed to reflect the specific functional requirements, adjacencies and supporting infrastructure.



<b>LEVEL 1 CENTRAL SERVICES</b>			
<b>EXISTING PROGRAM AREAS</b>	<b>SQUARE FOOTAGE</b>	<b>ADDED PROGRAM AREAS</b>	<b>SQUARE FOOTAGE</b>
BUILDING 155 LEVEL 1	30000	PAX / MULTI-PURPOSE ROOM	1550
INCLUDES: GALLEY, STORE, PUBLIC COMPUTER ROOM TV / RADIO, HAIR SALON RECREATION RENTAL		GROWTH CHAMBER	1000
		MULTI-PURPOSE / LECTURE	2300
		BACKUP DATA CENTER	8000
		CIRCULATION / GALLERY	14000
		<b>ADDED PROGRAM AREA</b>	<b>26,850</b>
EXCLUDES: LAUNDRY, HOUSING OFFICE FINANCE OFFICE, CRAFTS ROOM			
<b>EXISTING PROGRAM AREA</b>	<b>30,000</b>		
		<b>TOTAL PROGRAM AREA</b>	<b>56,850</b>
		<b>MASTER PLAN PROGRAM AREA</b>	<b>45,700</b>

<b>LEVEL 2 CENTRAL SERVICES</b>			
<b>EXISTING PROGRAM ADMINISTRATIVE AREAS</b>	<b>SQUARE FOOTAGE</b>	<b>ADDED PROGRAM AREAS</b>	<b>SQUARE FOOTAGE</b>
IOPS TRADES	3850	MULTI PURPOSE AREAS	4100
IT	3800	CIRCULATION	7700
HOUSING	200	<b>ADDED PROGRAM AREA</b>	<b>11,800</b>
LOGISTICS	1500		
FINANCE	400		
ENVIRONMENTAL	1800		
FLEET OPERATIONS	640		
ANG	500		
NSF	2250		
ASC	500		
NASA / NOAA / JPSS	2350		
MAC OPS + MAC RELAY	2500		
IT PREP & STAGING	4200		
LOCKHEED + SPAWAR	6500		
<b>EXISTING PROGRAM AREA</b>	<b>30,990</b>		
		<b>TOTAL PROGRAM AREA</b>	<b>42,790</b>
		<b>MASTER PLAN PROGRAM AREA</b>	<b>45,300</b>



<b>TRADES BUILDING</b>			
<b>EXISTING PROGRAM AREAS</b>		<b>SQUARE FOOTAGE</b>	
FEMC TRADES SHOP - B136		14900	
FEMC MODULAR OFFICES - B136A, B & C		1650	
CARPENTRY SHOP - B191 COMPLEX		12000	
CONSTRUCTION STORAGE J-WAY		640	
ELECTRICAL WAREHOUSE - B121 2ND FLOOR		3800	
ELECTRICAL WAREHOUSE - B141 2ND FLOOR		3800	
FIELD COMMUNICATIONS / AGE SHOPS		3800	
FEMC TRADES CONDENSED EXTERIOR STORAGE		3000	
UNHEATED STORAGE - B341		2000	
<b>TOTAL PROGRAM SF</b>		<b>45,590</b>	<b>MASTER PLAN PROGRAM AREA 40,940</b>

<b>FIELD SCIENCE SUPPORT</b>			
<b>EXISTING PROGRAM AREAS</b>		<b>SQUARE FOOTAGE</b>	
BERG FIELD CENTER - B160		7760	
MEC / FSTP - B004		22500	
CARGO / SUPPLY - B140 1ST FLOOR		5000	
SCIENCE CARGO / BFC FOOD - B73		7350	
BFC FREEZER		320	
BFC CONDENSED EXTERIOR STORAGE		7500	
REFRIGERATED/FREEZER STORAGE - B003		1590	
<b>TOTAL PROGRAM SF</b>		<b>52,020</b>	<b>MASTER PLAN PROGRAM AREA 47,450</b>

<b>OPERATIONS</b>							
<b>EXISTING PROGRAM AREAS</b>		<b>SQUARE FOOTAGE</b>		<b>ADDED PROGRAM AREAS</b>		<b>SQUARE FOOTAGE</b>	
VEHICLE MAINTENANCE FACILITY - B143		21,683		TRAVERSE OPERATIONS FACILITY		18000	
FUELS DEPARTMENT - B141		7760					
WASTE MANAGEMENT - B185		3066		<b>ADDED PROGRAM AREA</b>		<b>18,000</b>	
EQUIPMENT OPERATIONS - B017		640					
HAZ. WASTE FLAMMABLE STORAGE WHSE - B174		7840					
SUPPLY WAREHOUSE (GSK AUTO) - B132		7760					
AUTOMOTIVE WAREHOUSE UNHEATED - B168		7760		<b>TOTAL PROGRAM AREA</b>		<b>76,509</b>	
TRAVERSE OPERATIONS - B183		2000					
<b>TOTAL PROGRAM SF</b>		<b>58,509</b>		<b>MASTER PLAN PROGRAM AREA</b>		<b>76,368</b>	





<b>EMERGENCY SERVICES / CONTINGENCY OPERATIONS</b>				
<b>EXISTING PROGRAM AREAS</b>		<b>SQUARE FOOTAGE</b>	<b>ADDED PROGRAM AREAS</b>	
FIRE		7300	KITCHEN	1,920
MEDICAL		4900	SKILLS ENHANCEMENT CENTER	5,000
LAUNDRY		2100	MULTI PURPOSE ROOMS	1,800
AEROBICS GYM - B078		1,617	EXPANDED FIRE	11,260
CRAFTS ROOM - B155		350	EXPANDED MEDICAL	1,210
YOGA ROOM - B155		1,500	EXPANDED GYMNASIUM	4,720
LARGE GYM - B075		4,580	EXPANDED RECREATION FACILITIES	5,500
LIBRARY - B209		600	ENCLOSED CIRCULATION	4,770
BAR 1 - B107		1,900	<b>ADDED PROGRAM SF</b>	<b>36,180</b>
BAR 2 - B108		2,700		
COFFEE HOUSE - B076		2,650		
BUILDING 10		1,850		
BEVERAGE WAREHOUSE		3,880		
<b>EXISTING PROGRAM SF</b>		<b>35,927</b>		

**TOTAL PROGRAM SF 72,107**

**MASTER PLAN PROGRAM AREA 68,000**

<b>CENTRAL SERVICES WAREHOUSING</b>				
<b>EXISTING PROGRAM AREAS</b>		<b>SQUARE FOOTAGE</b>		
DO NOT FREEZE FOOD - B120 1ST FLOOR		3800		
COLD STORAGE WAREHOUSE - B157		7760		
FROZEN FOOD STORAGE - B164		5750		
DRY GOODS STORAGE - B176		7760		
UNHEATED STORAGE - B341		2000		
COLD STORAGE ANNEX - B341A		250		
CENTRAL SUPPLY - B140		5000		
UNHEATED STORAGE - B340		4000		
UNHEATED STORAGE - B342		4000		
AIR GUARD SUPPLY WAREHOUSE		7760		
<b>TOTAL PROGRAM SF</b>		<b>48,080</b>	<b>MASTER PLAN PROGRAM AREA</b>	<b>33,230</b>



# MCMURDO STATION MASTER PLAN

---



# SITE PLAN - FINAL STATE



# BIRDS EYE

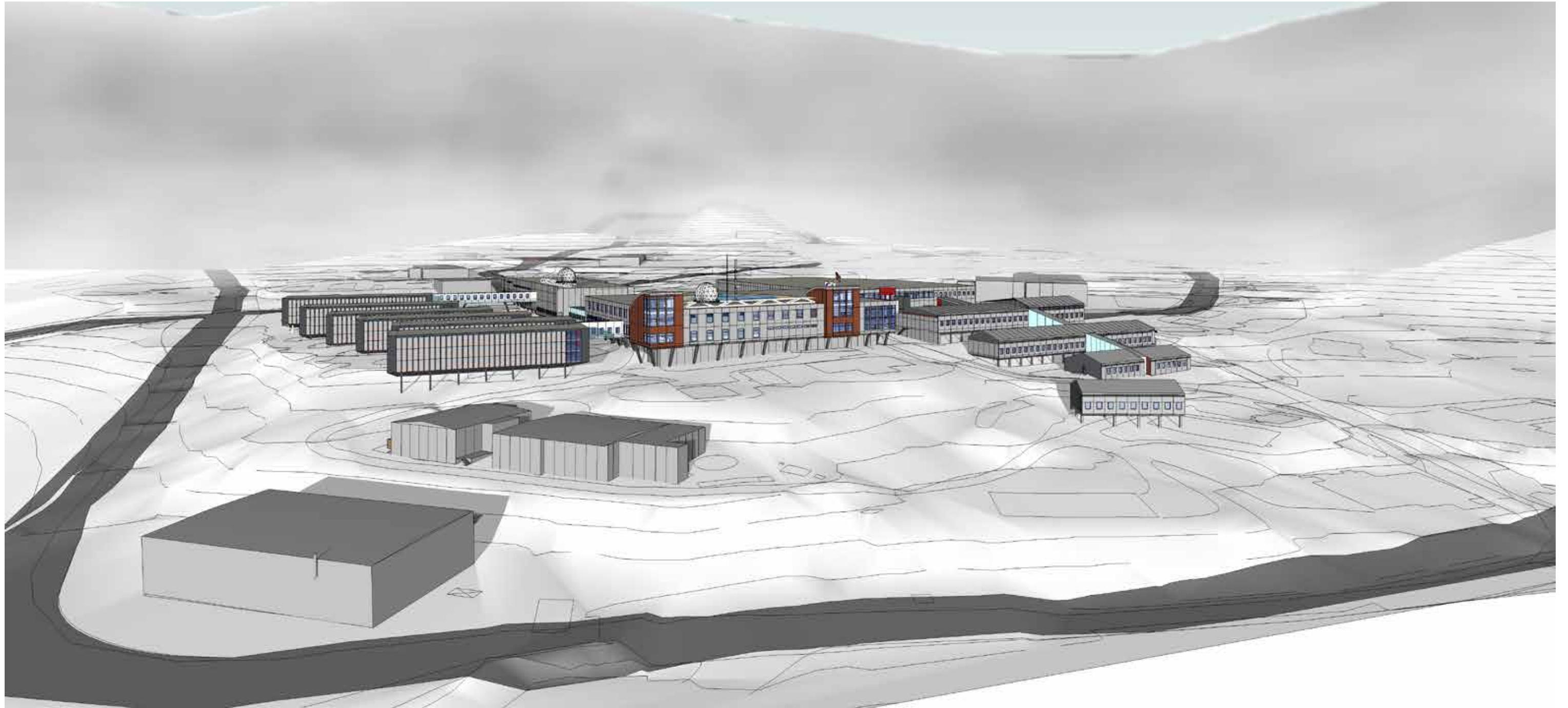

# BIRDS EYE FROM NORTH

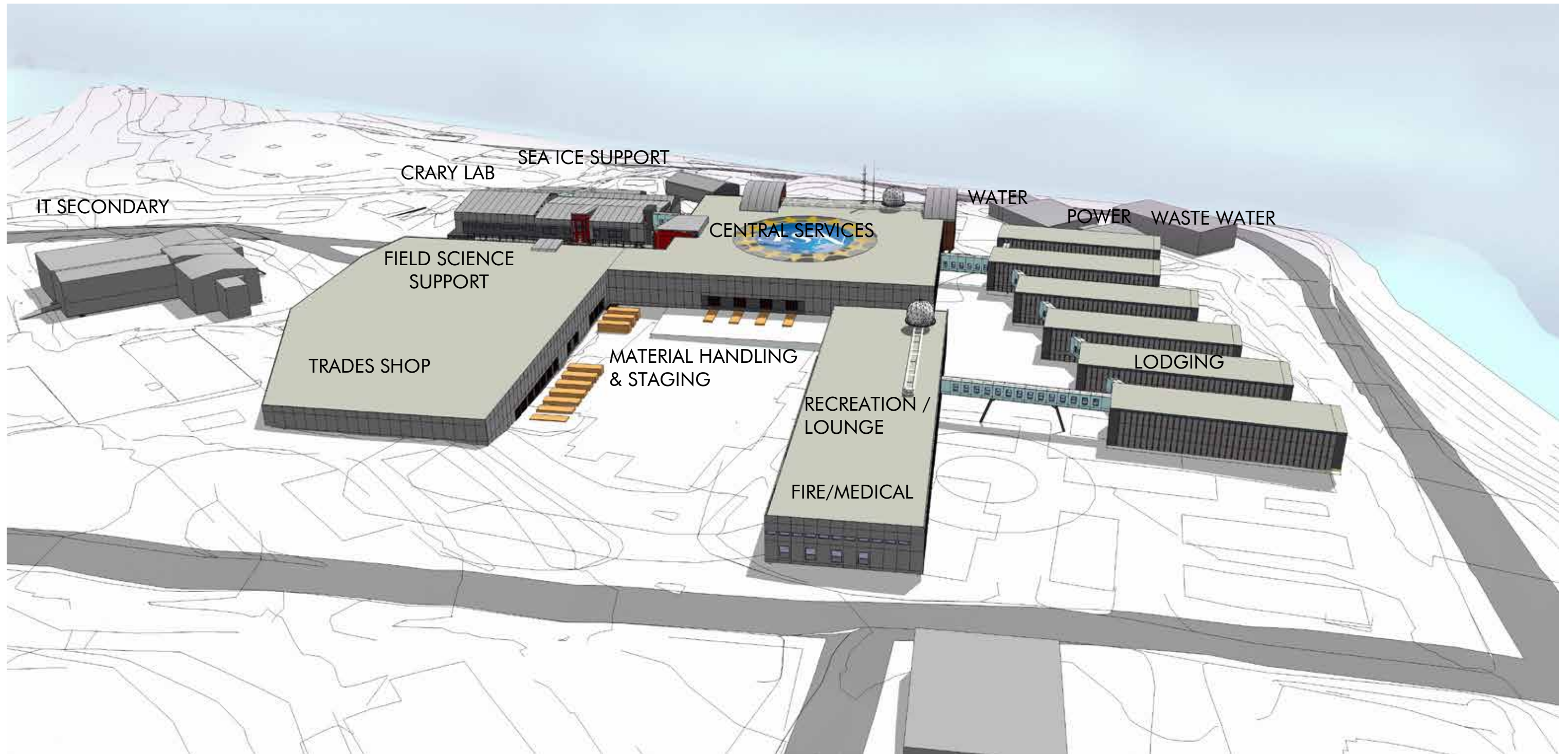

# VIEW FROM SEA ICE



# CENTRAL SERVICES - VIEW FROM SOUTHWEST



# ARRIVAL VIEW





# ENTRY



# ENTRY LEVEL GALLERY

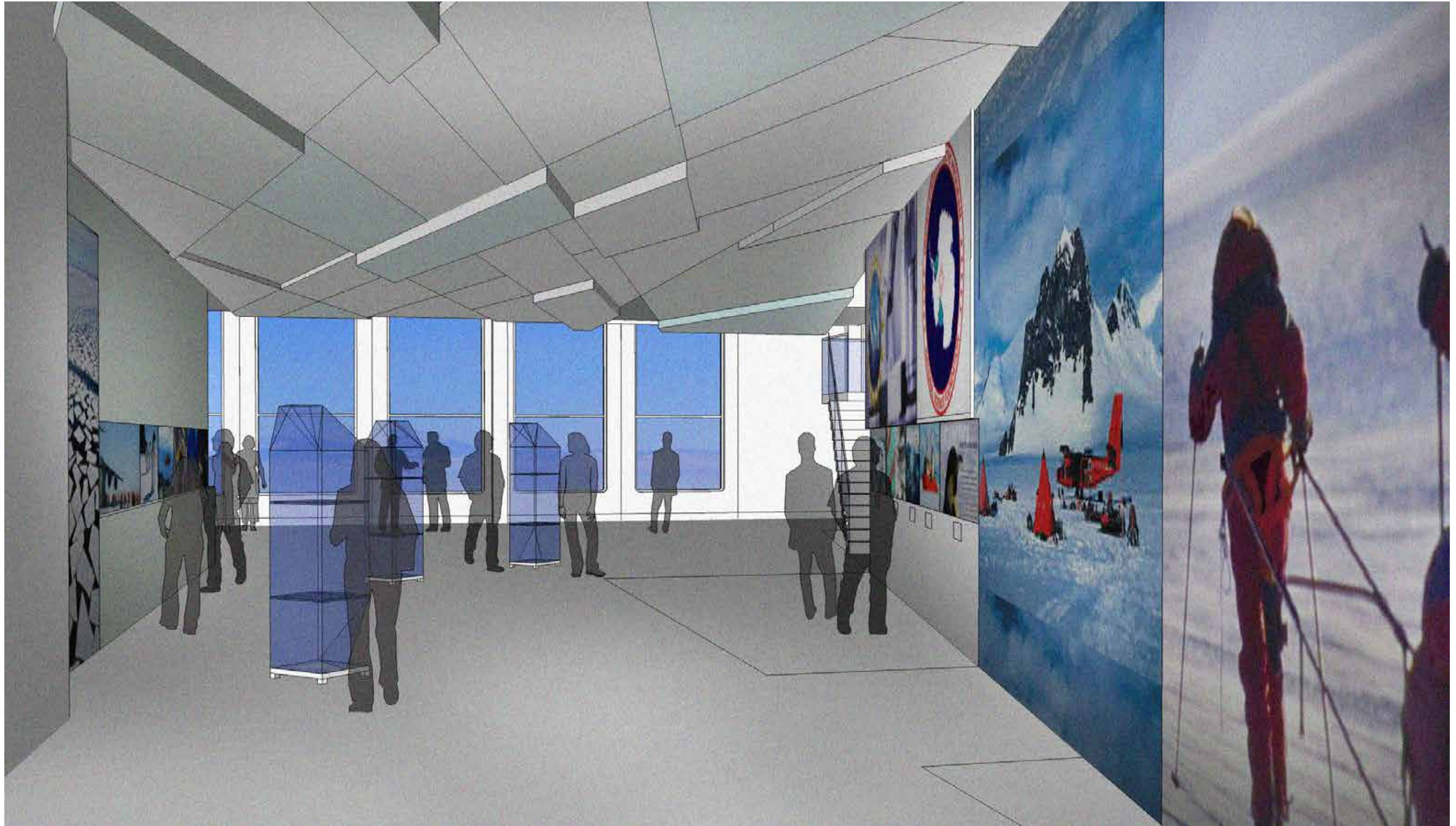

# MAIN LEVEL AT GALLERY OVERLOOK

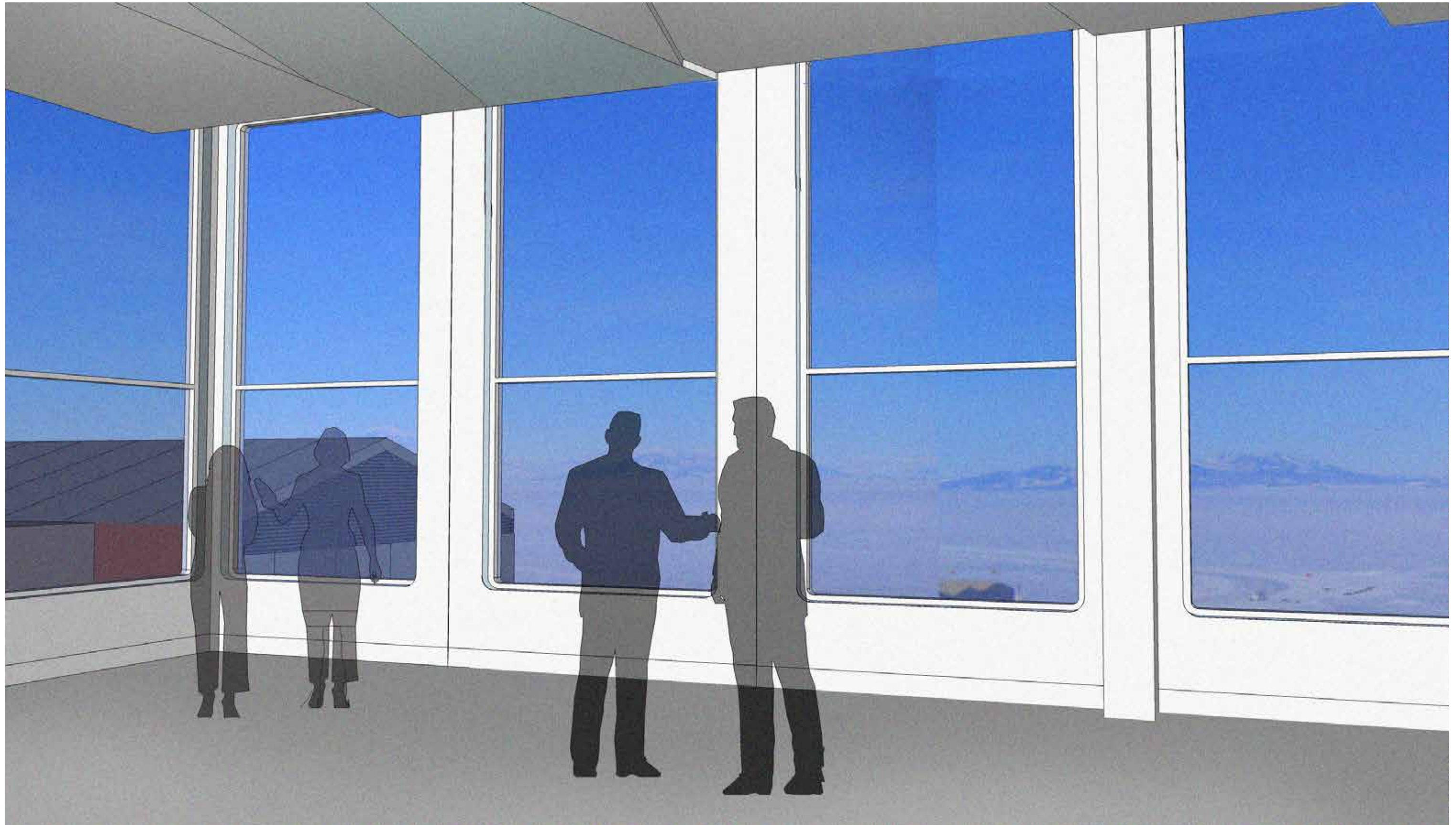

# MAIN LEVEL MULTI-PURPOSE



# MAIN LEVEL DINING

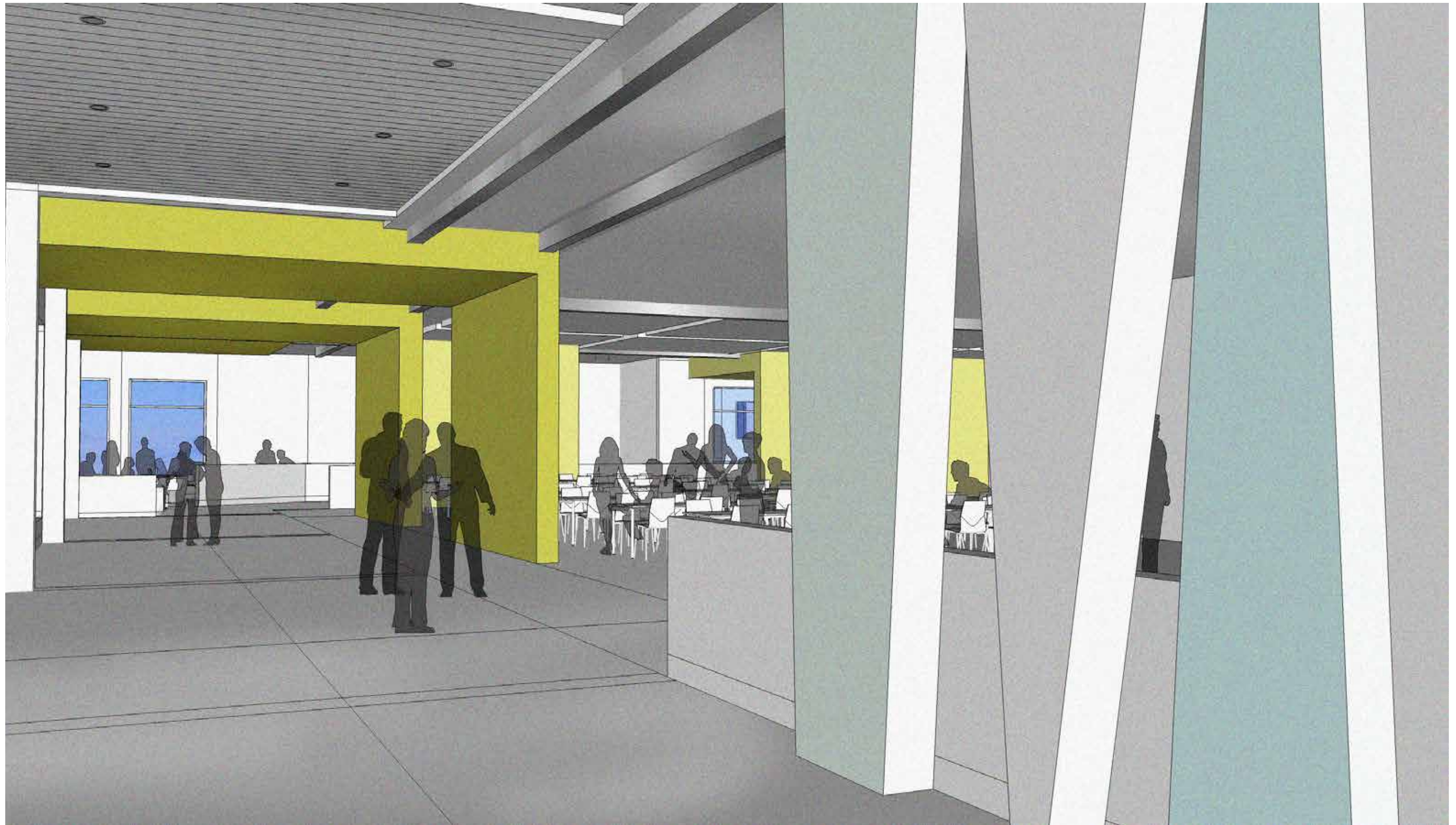

# MAIN LEVEL LOUNGE AREA



# UPPER LEVEL ADMINISTRATION & MULTI-PURPOSE OVERLOOK

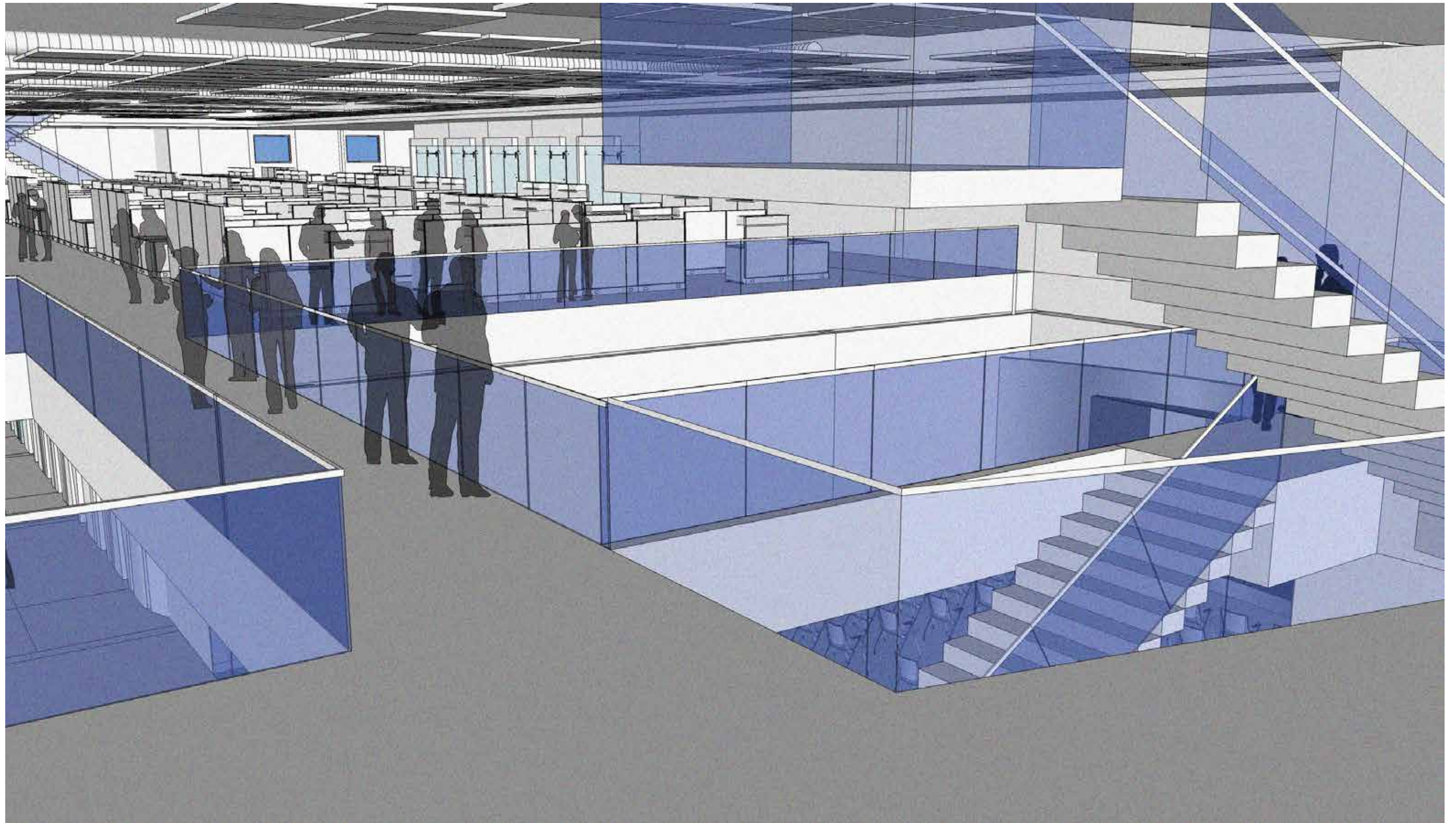

# UPPER LEVEL LOUNGE AREA





# UPPER LEVEL ADMINISTRATION



# LEVEL 1 BLOCKING DIAGRAM

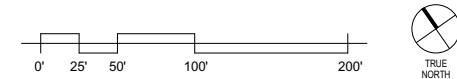
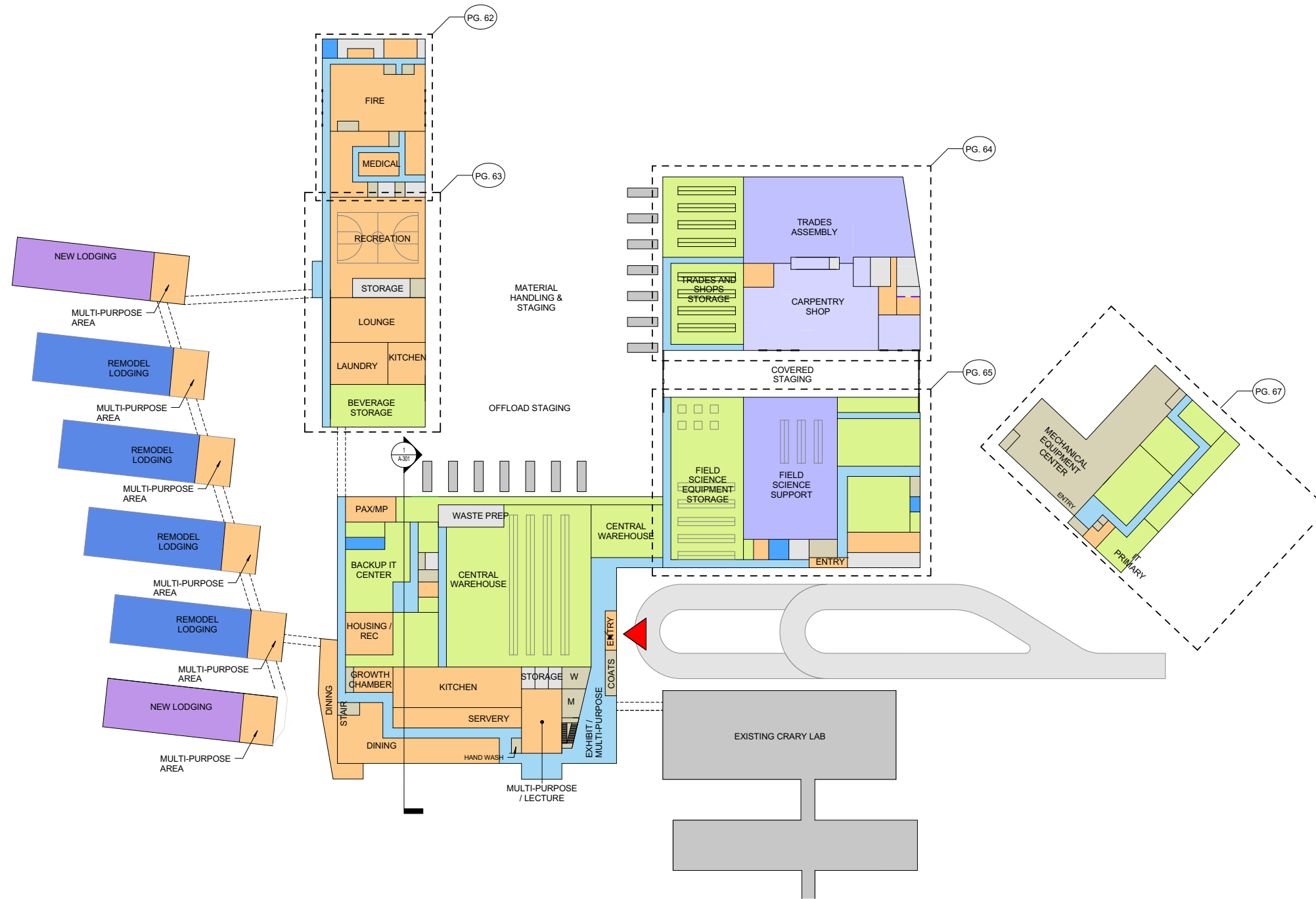

# LEVEL 2 BLOCKING DIAGRAM

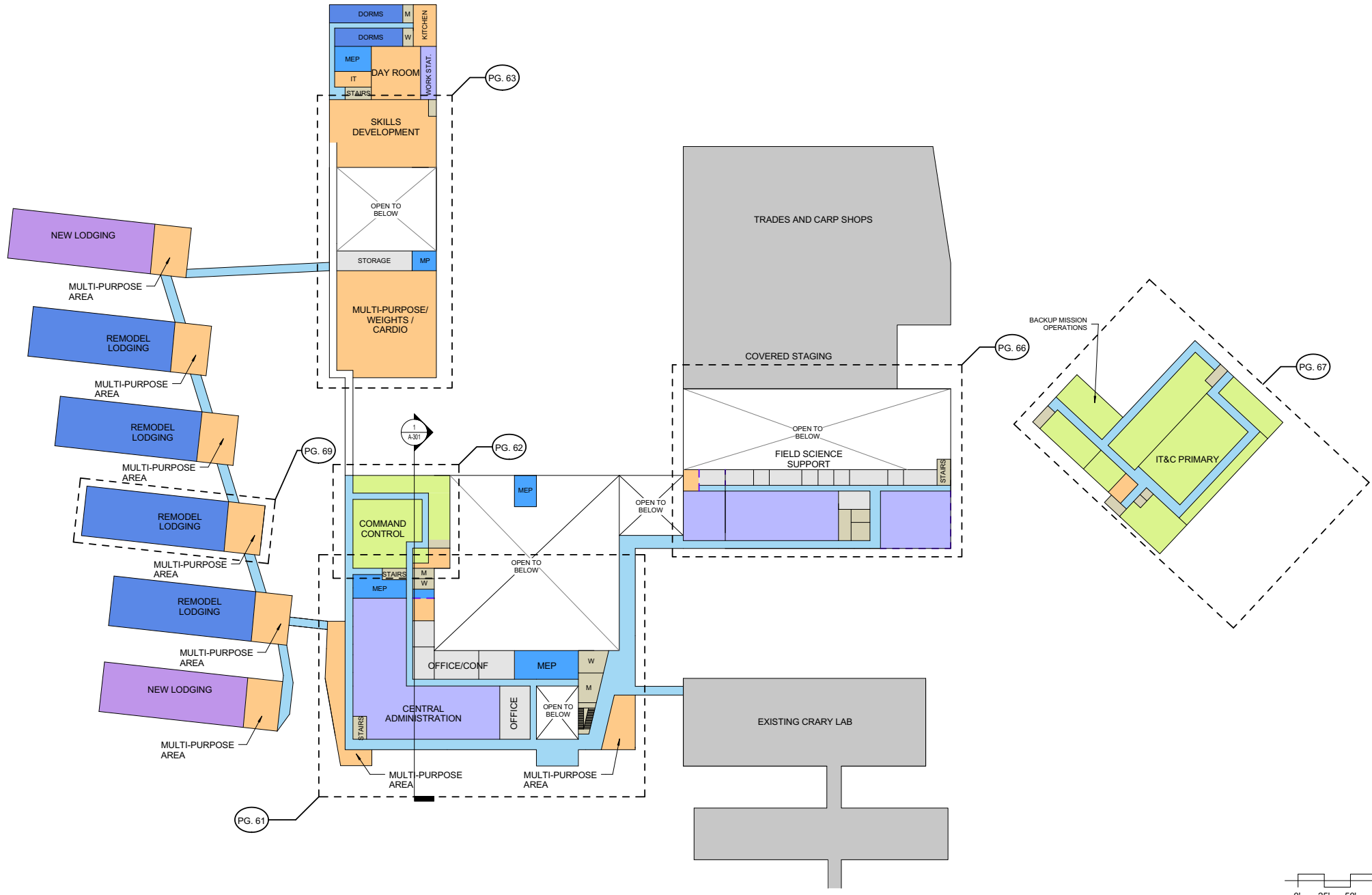

# LEVEL 3 BLOCKING DIAGRAM

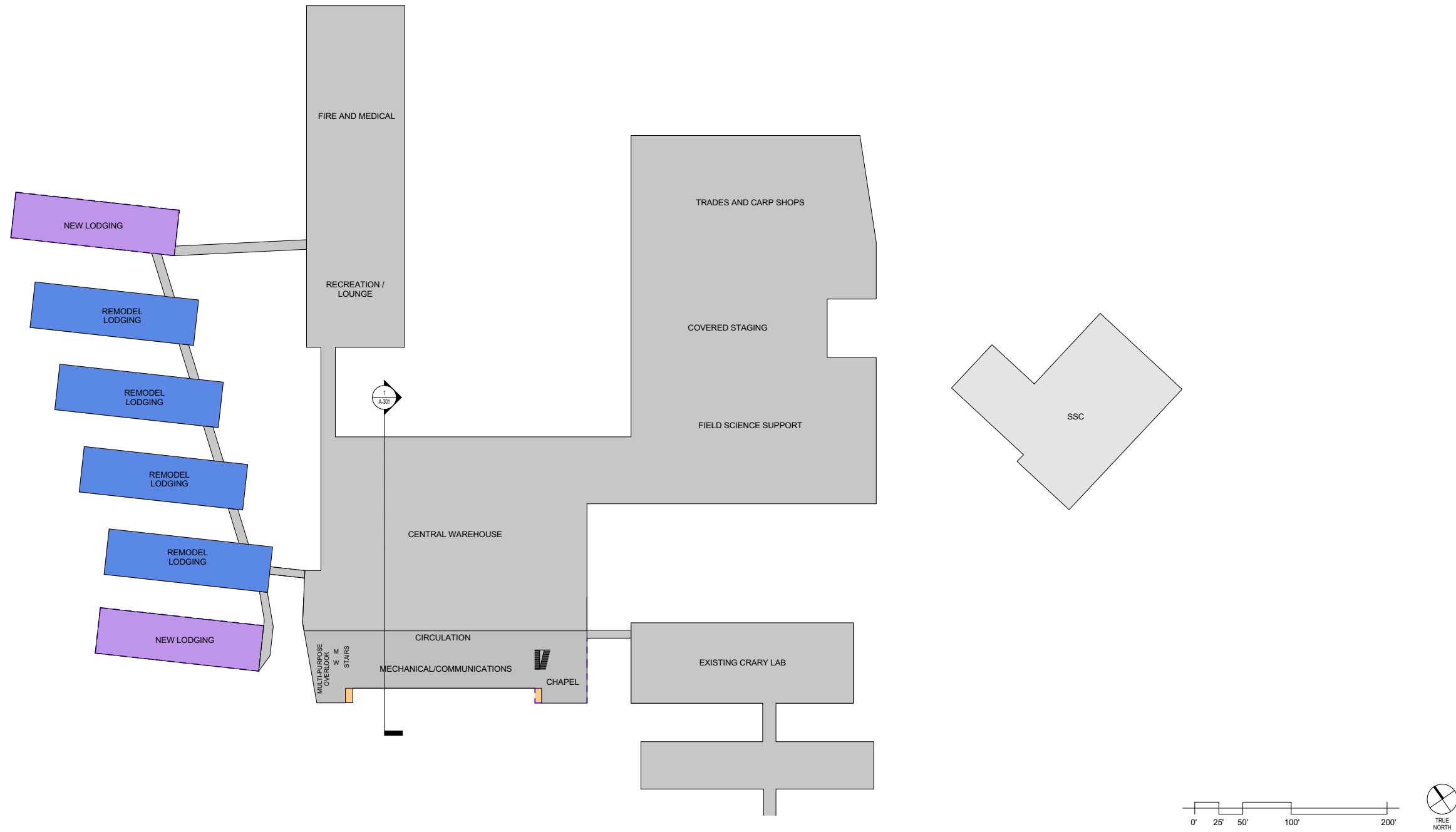

# ENLARGED BLOCKING DIAGRAMS

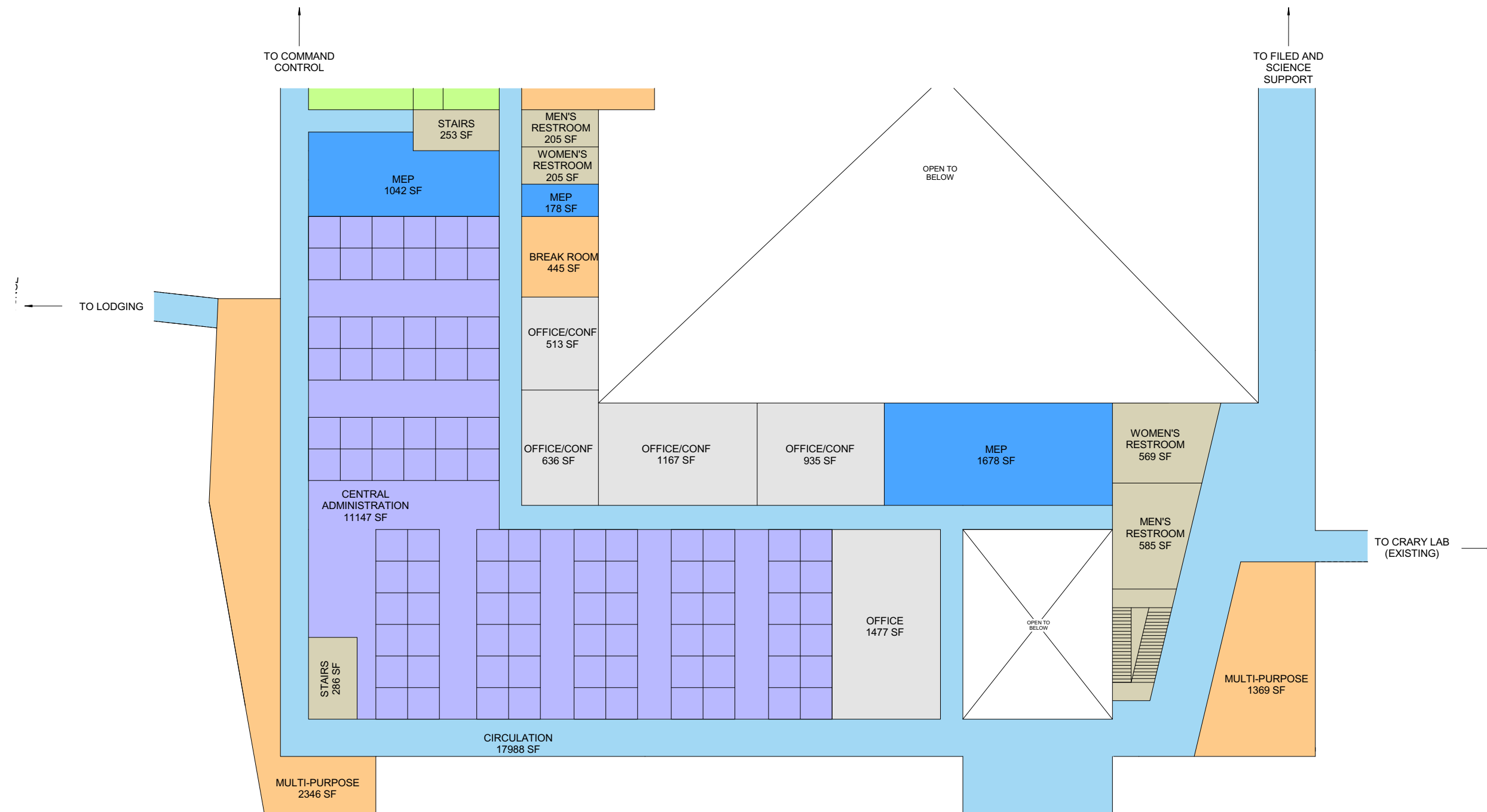

## ADMINISTRATION

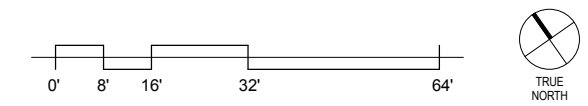

# ENLARGED BLOCKING DIAGRAMS

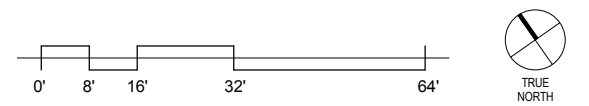
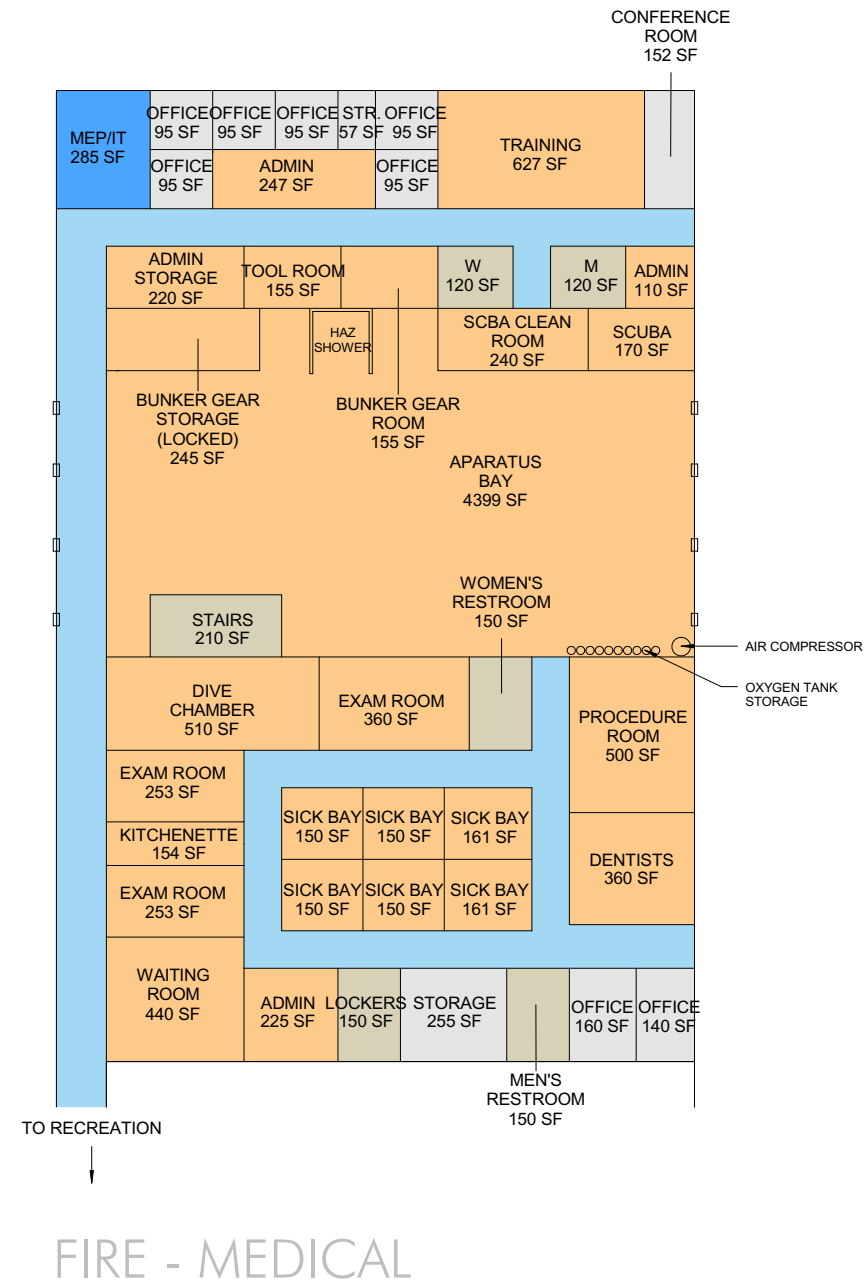
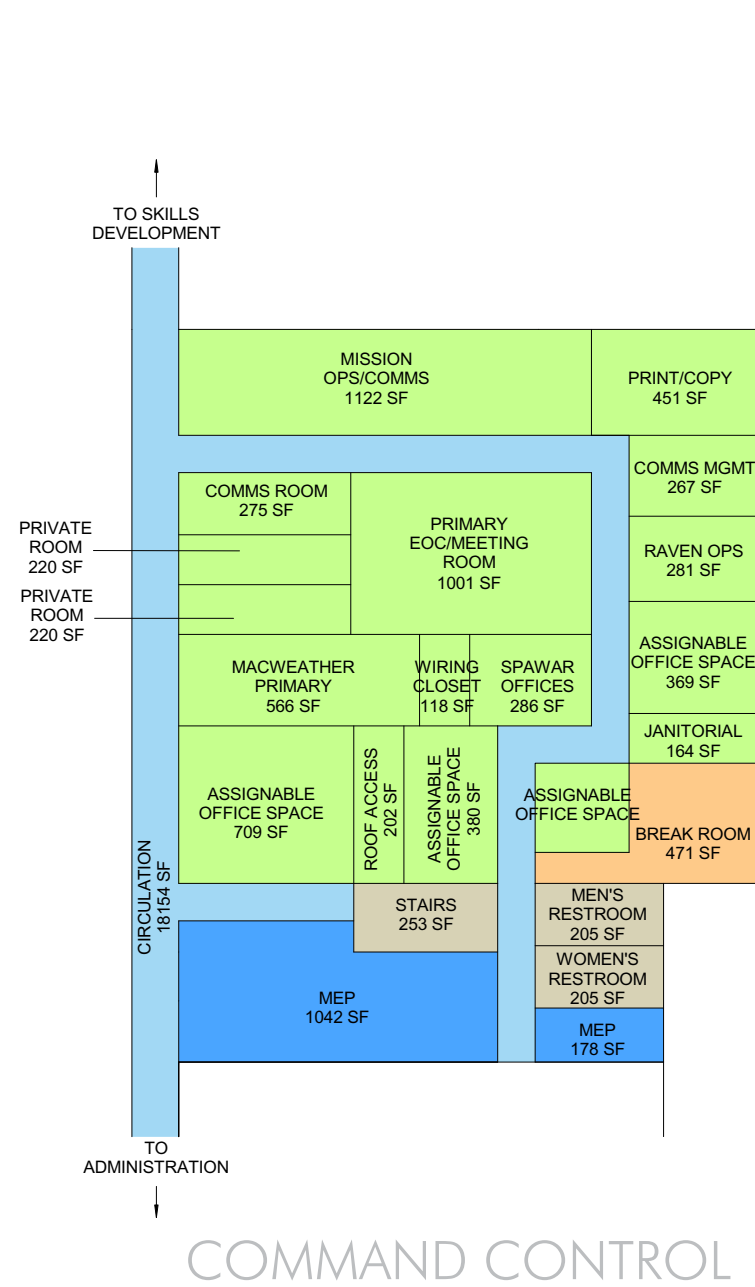

# ENLARGED BLOCKING DIAGRAMS

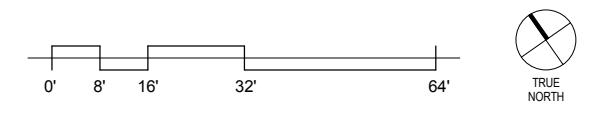
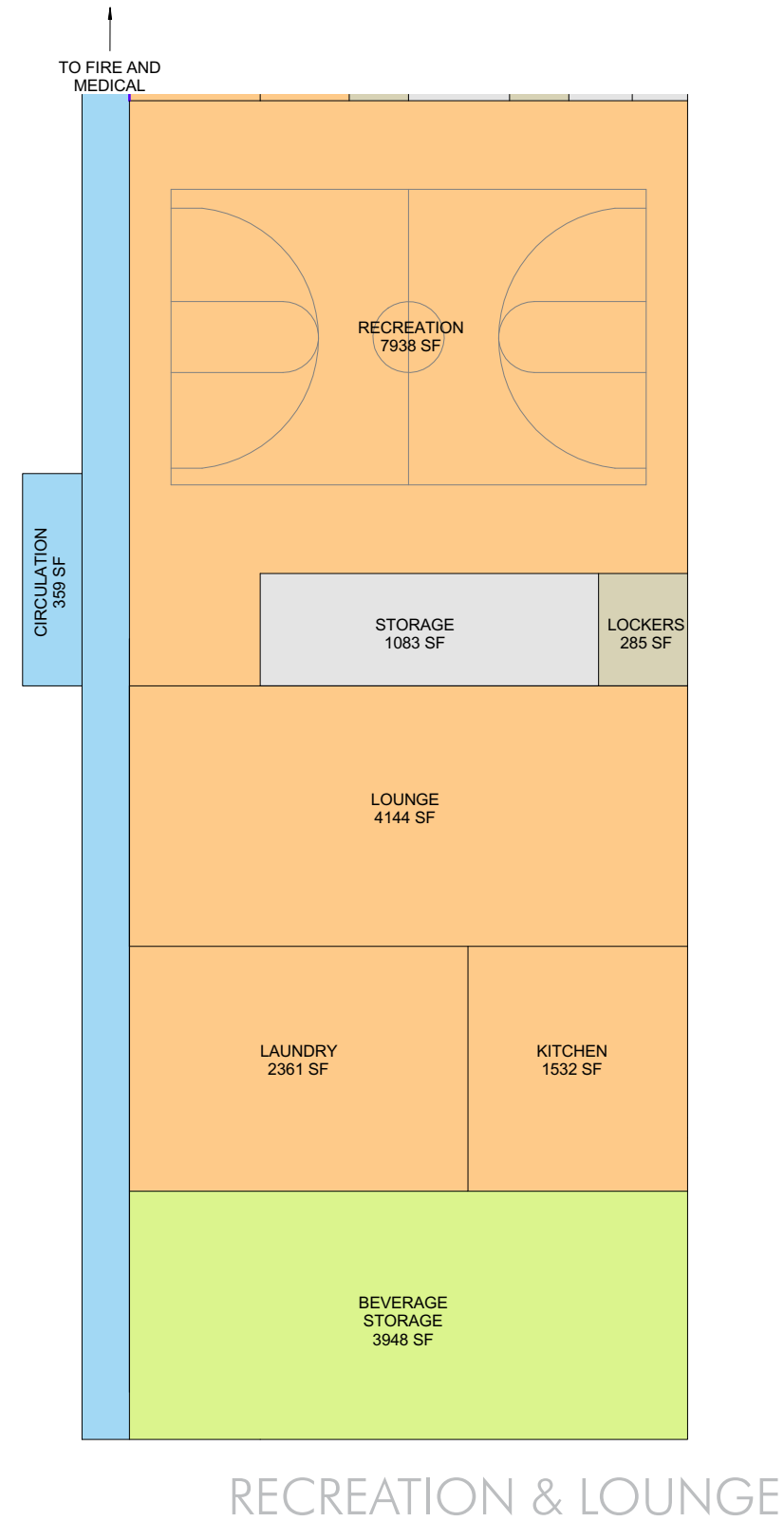
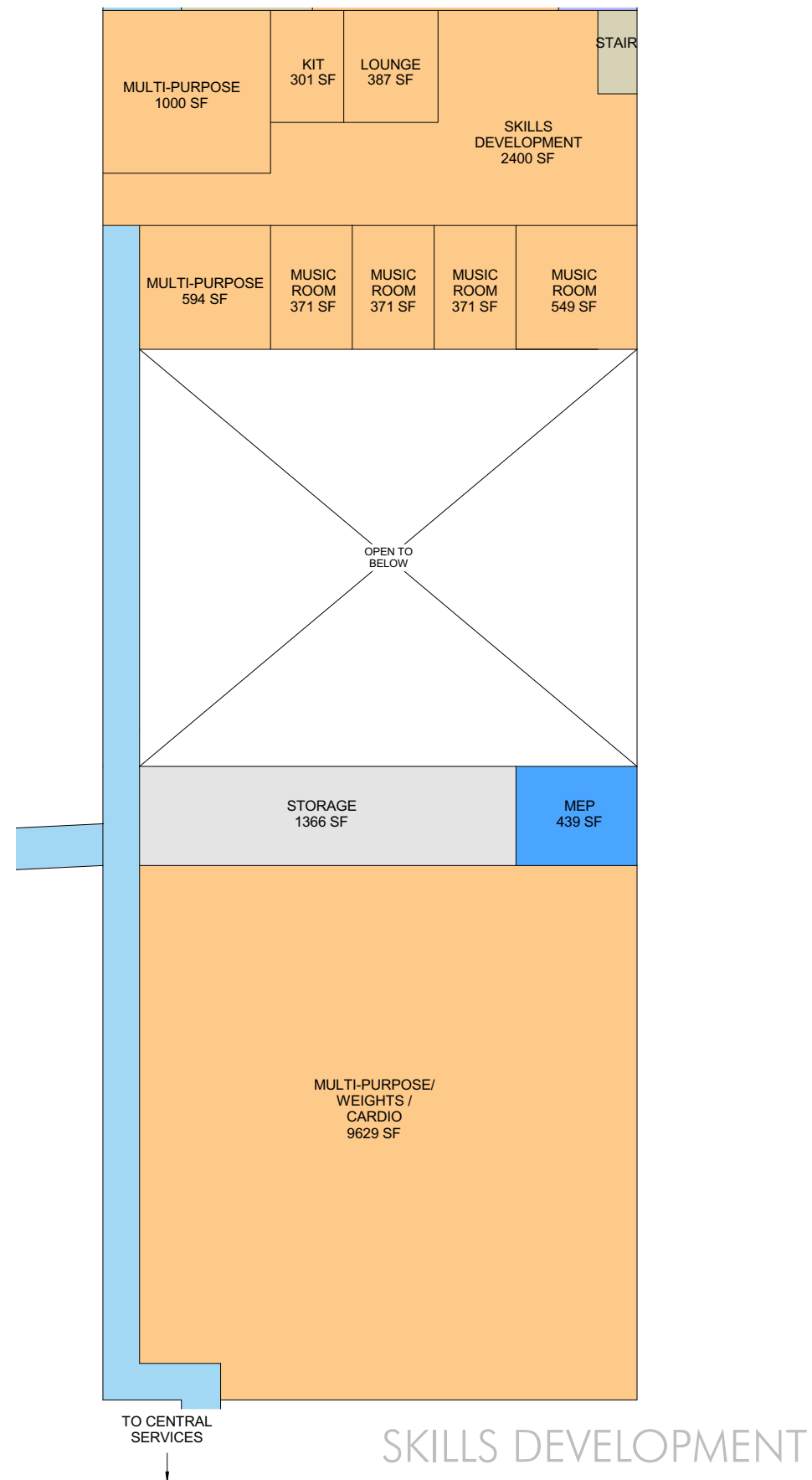

# ENLARGED BLOCKING DIAGRAMS

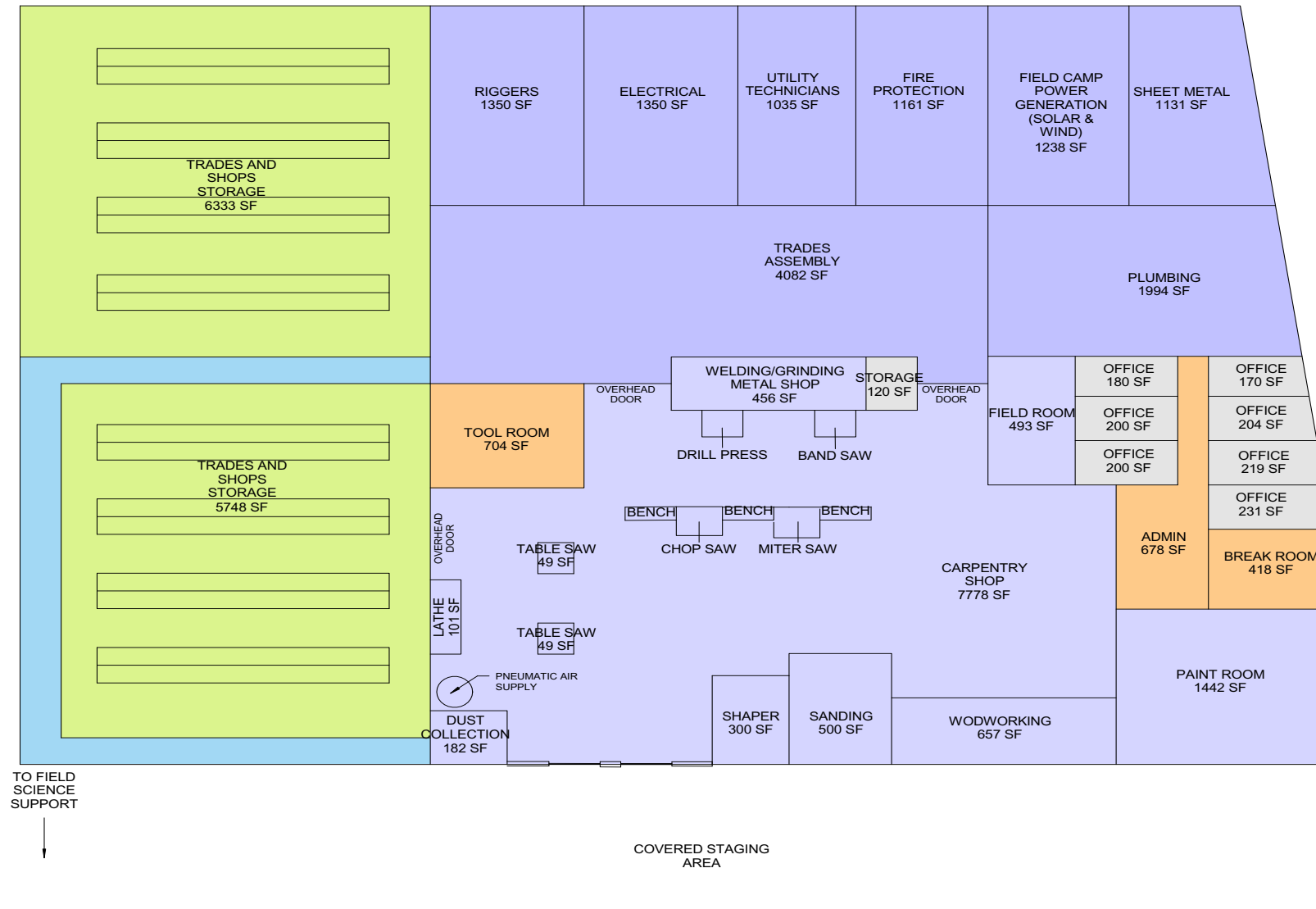

TRADES AND CARPENTRY SHOP

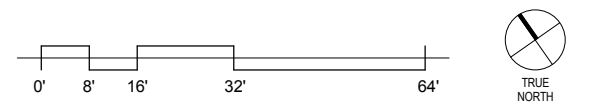



# ENLARGED BLOCKING DIAGRAMS

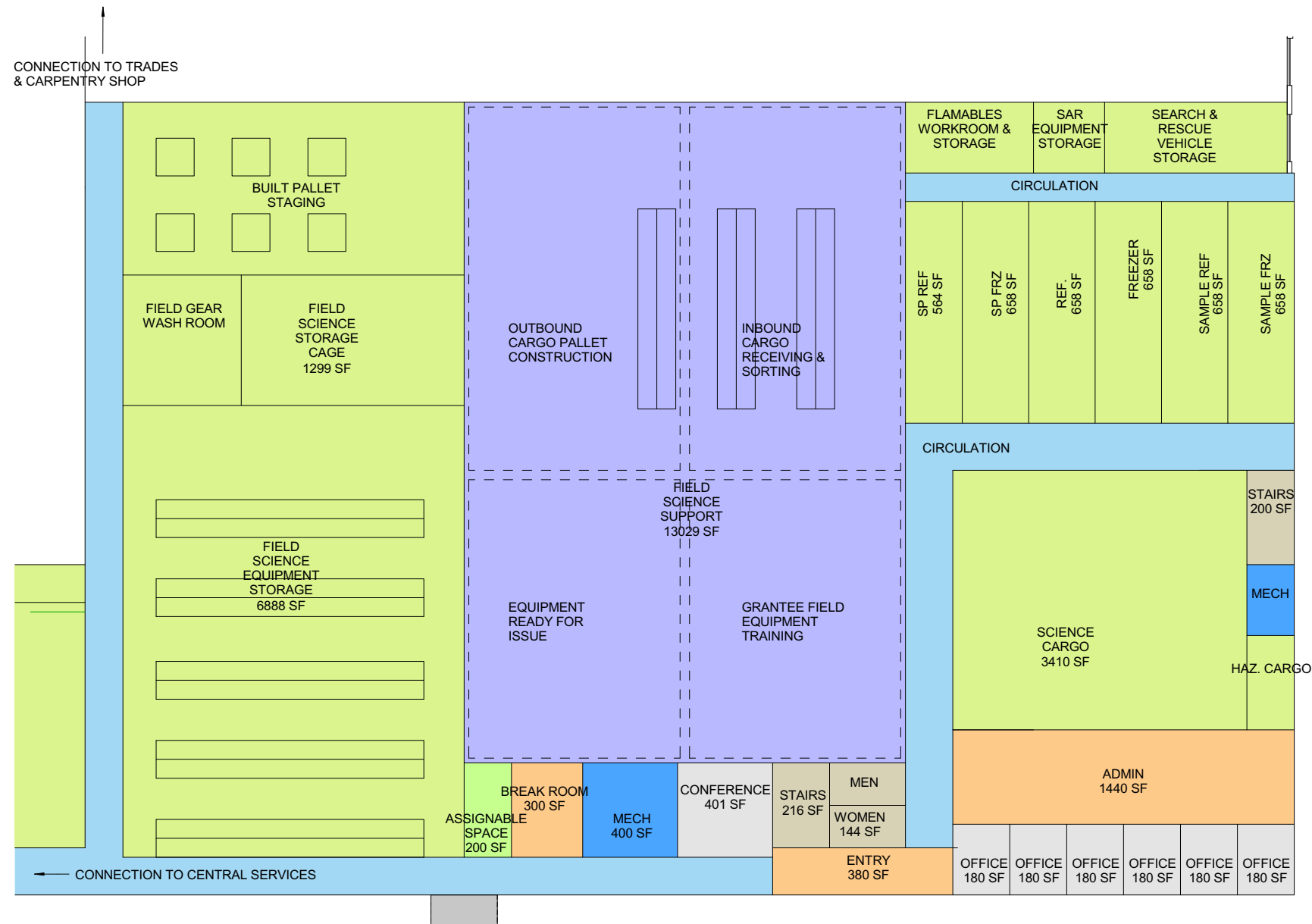

FIELD SCIENCE SUPPORT LEVEL 1

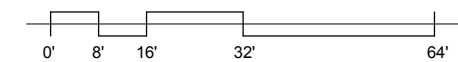

# ENLARGED BLOCKING DIAGRAMS

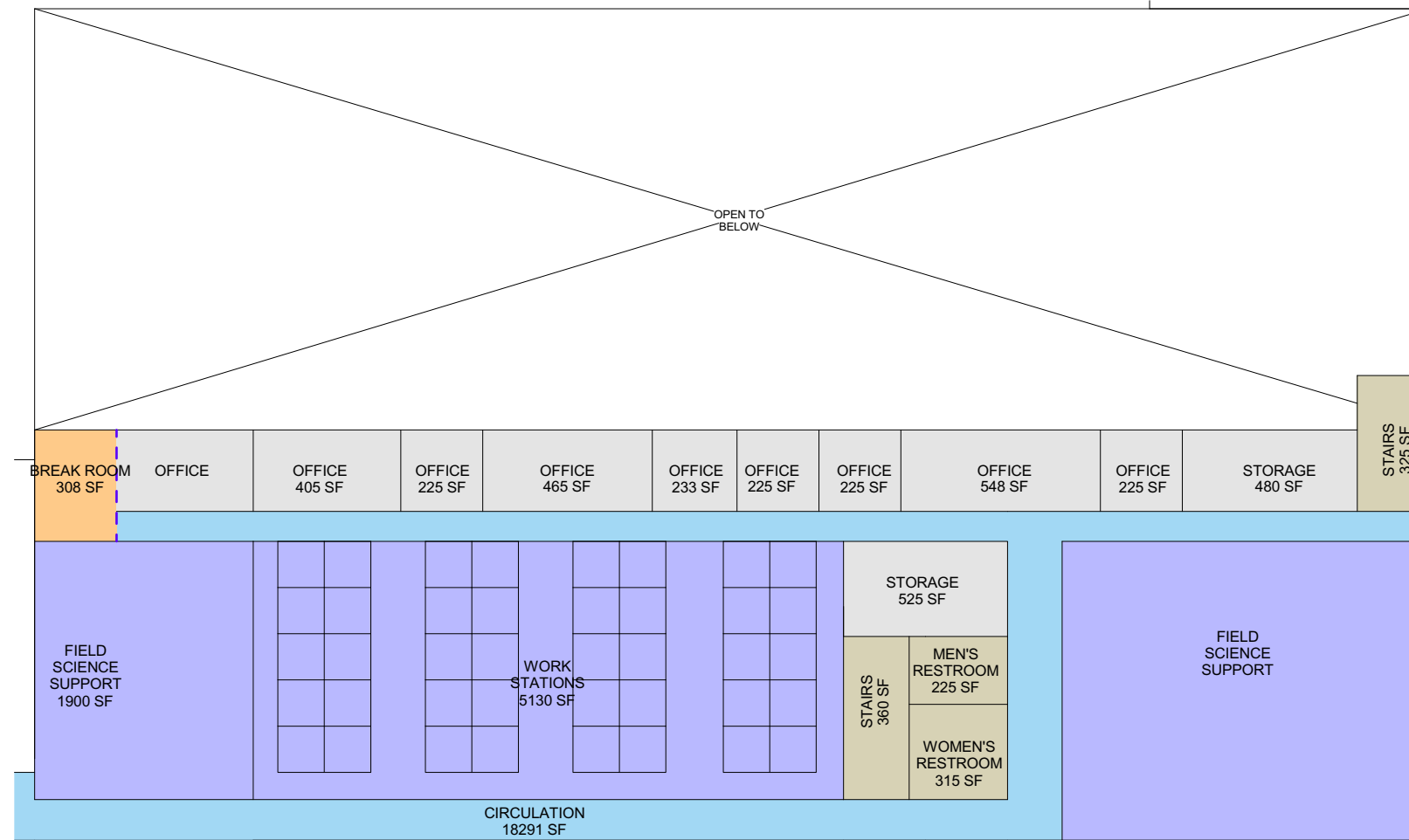

FIELD SCIENCE SUPPORT LEVEL 2

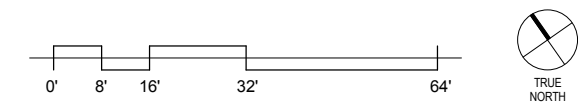

# ENLARGED BLOCKING DIAGRAMS

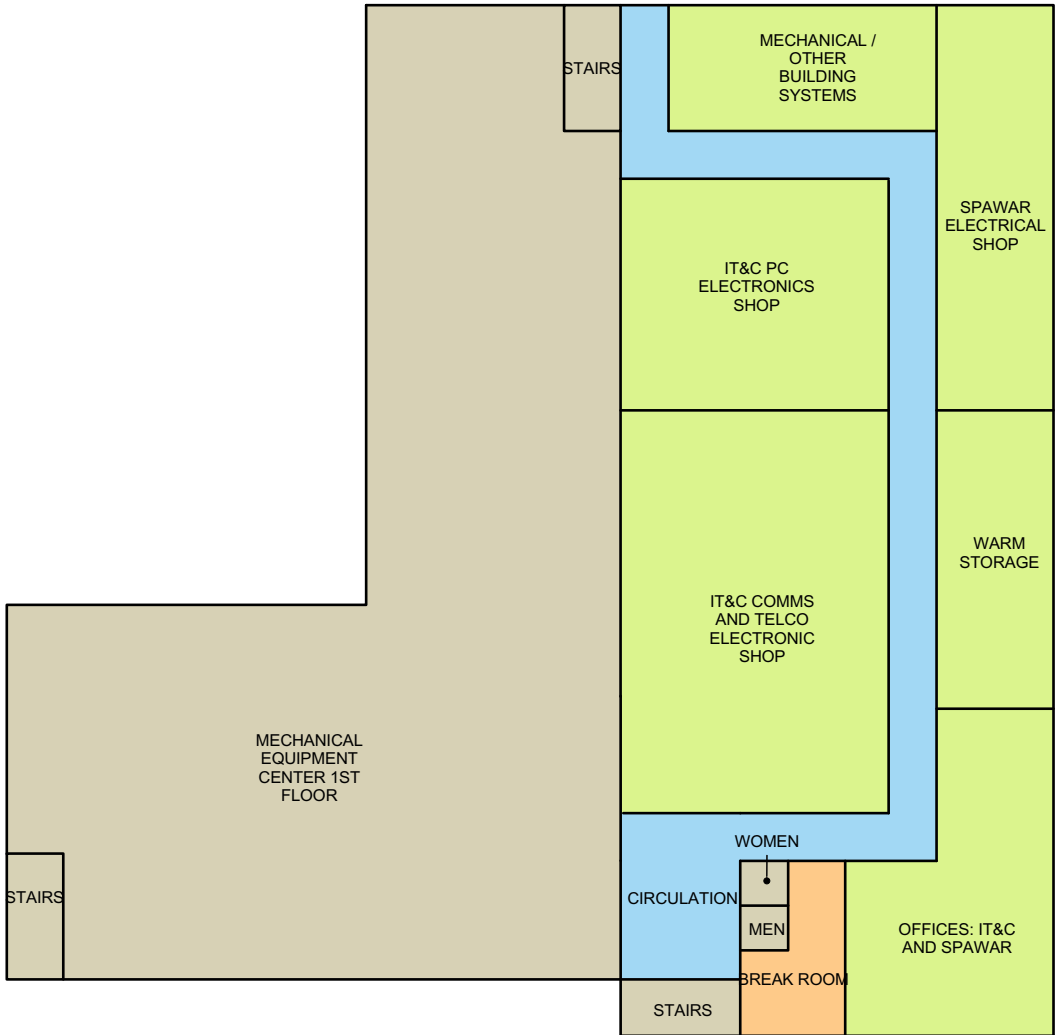

BLO04 LEVEL 1

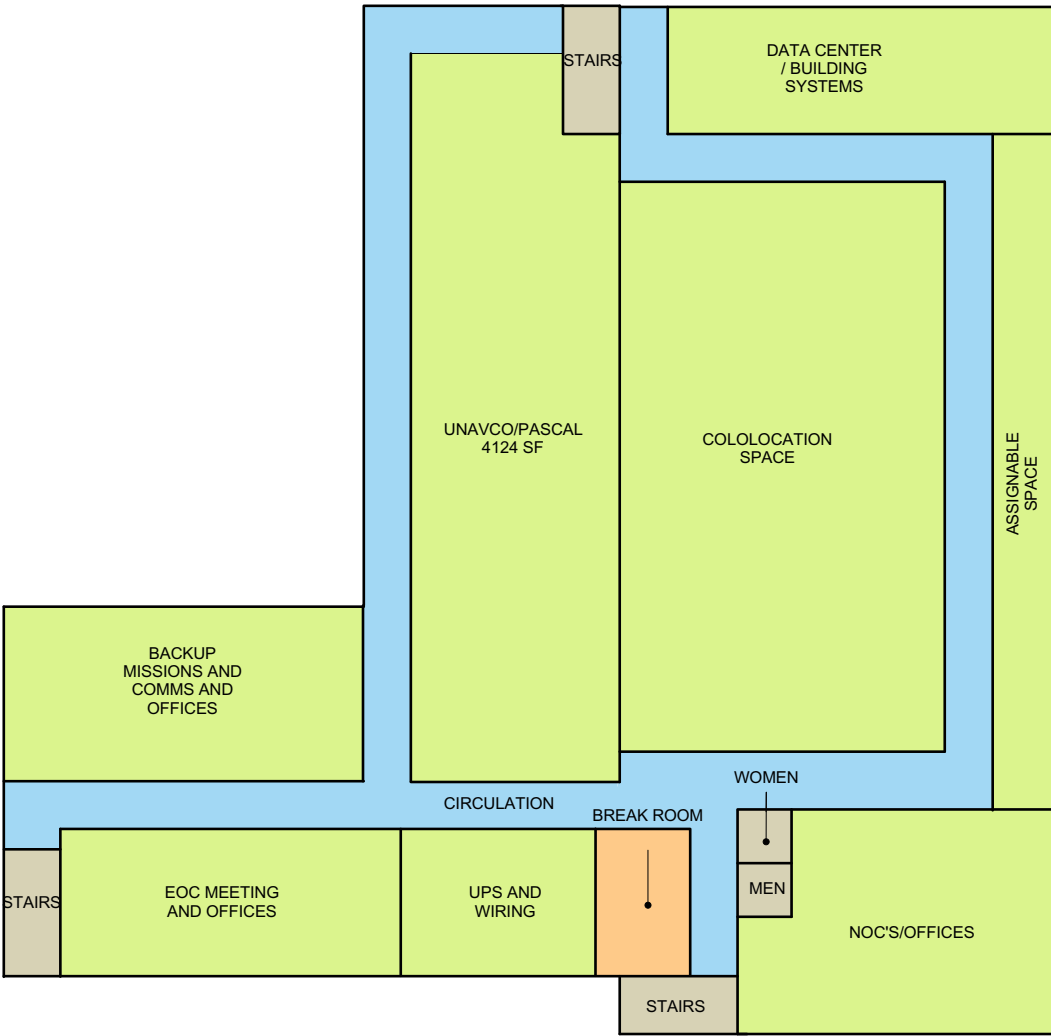

BLO04 LEVEL 2

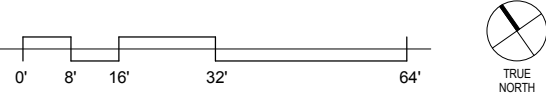

THIS PAGE INTENTIONALLY LEFT BLANK.

# ENLARGED BLOCKING DIAGRAMS

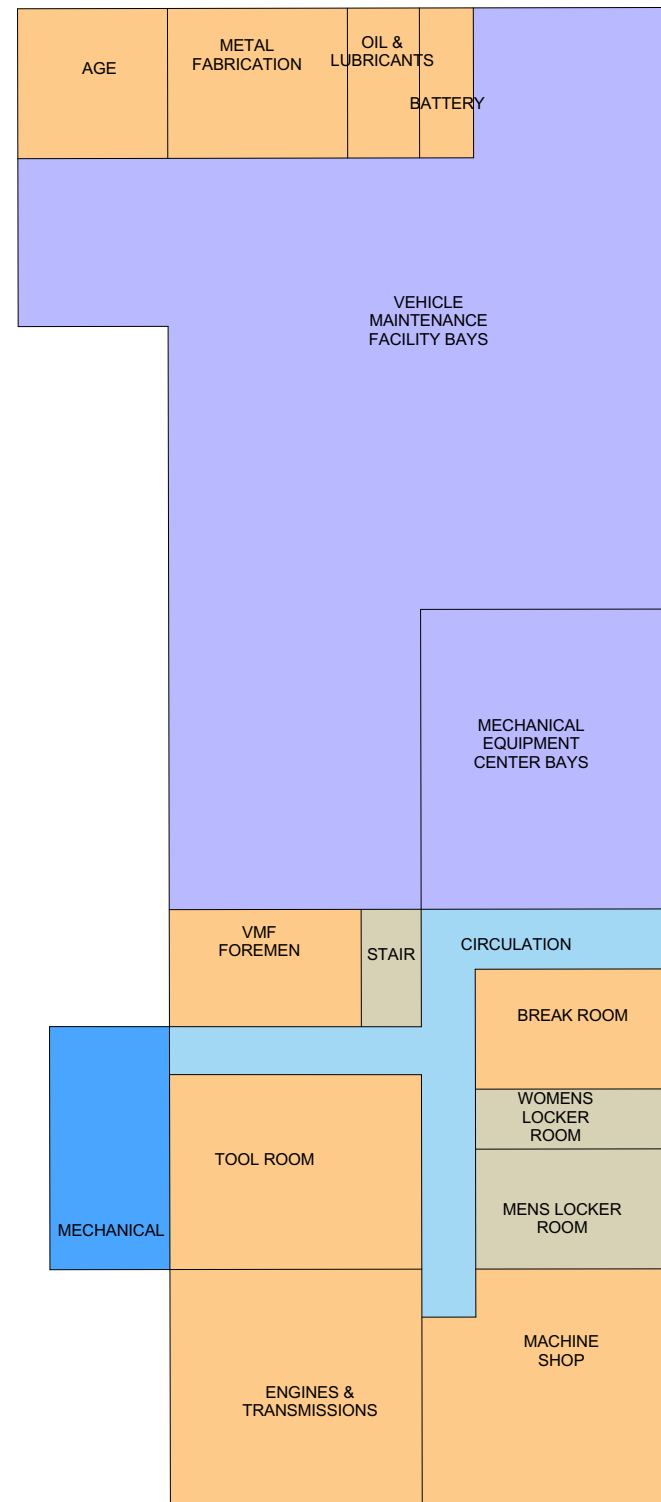

VEHICLE MAINTENANCE FACILITY

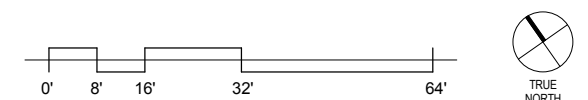

# SOCIAL SPACES

---

This Master Plan recognizes the importance of having pleasant spaces that provide the opportunity for collaboration and conversation to occur in a warm, relaxing environment. This plan recommends providing various areas throughout the development that support that important goal.

Designers must be keenly aware that size, location, volumes, lighting and materials all contribute to environments that support both personal and professional interaction. The images on the next page are examples of the character that can be achieved as a result of such detailed consideration.





# MASTER PLAN FLOW DIAGRAMS

---





# CONSOLIDATED FLOW DIAGRAM

A primary goal of this Master Plan is the efficient and safe routing of both materials and people at McMurdo. As a result, this plan strives to minimize the number of touch-points, reduce the distance between these touch-points, and separate pedestrian from vehicular circulation.

The following four pages describe this circulation of materials, personnel and waste through the proposed station.

This sheet indicates the flow of all three elements, while the following show each of the components separately.

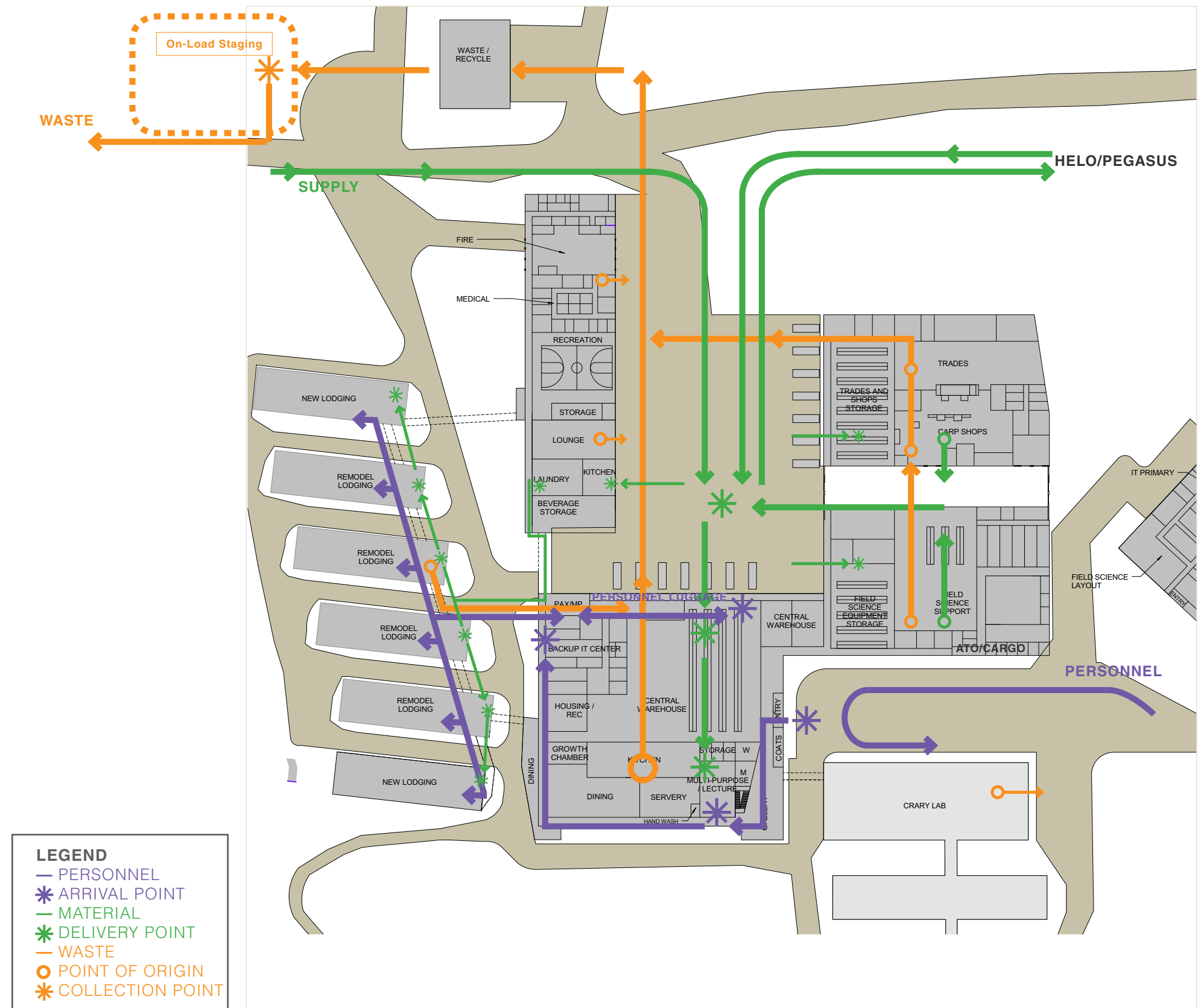

# FLOW DIAGRAM - PERSONNEL

The current McMurdo arrival experience can seem very disjointed to a new participant. This Master Plan arranges the station to establish an order that enhances an arrival's ability to quickly orient themselves. In doing so, the plan supports an arrival sequence that is clear and intuitive, while expressing the professional nature of the NSF.

Immediately upon arrival to Central Services, the first arrival point after aircraft arrival, the participant is dropped off at the main entrance which is flanked on either side by science facilities - Crary Lab to the south and the new Field Science Support facility to the north- to reinforce the fact that science is the core of McMurdo's mission.

This flow diagram represents the proposed personnel arrival sequence. Personnel are dropped off by the shuttle vehicle at the main entrance of Central Services, where they will be immediately welcomed by an exhibit space that reinforces the NSF mission in Antarctica. It is recommended that the volumes of these spaces and display material be carefully selected to represent not only the scientific mission, but also the history of this installation as well as the personnel who support and maintain this mission. This particular plan indicates the exhibit space terminating at a window wall that frames the dramatic view across the bay to the Royal Society Mountains. An adjacent 150 person multi-purpose room allows participants to receive orientation and safety briefs. The last stop prior to entering the lodging facilities will be the Passenger Support area where arrivals will receive their baggage and be assigned their rooms

Note that the departure sequence of personnel is essentially the reverse of this arrival sequence. Here, a participant will check in and drop their baggage off at the Passenger Support area, where it will then be transferred by staff to the ATO function within the Field Science Support facility. The departing passenger will then walk to the main entrance of the Central Services facility for final processing and boarding of the vehicle bound for the runway.

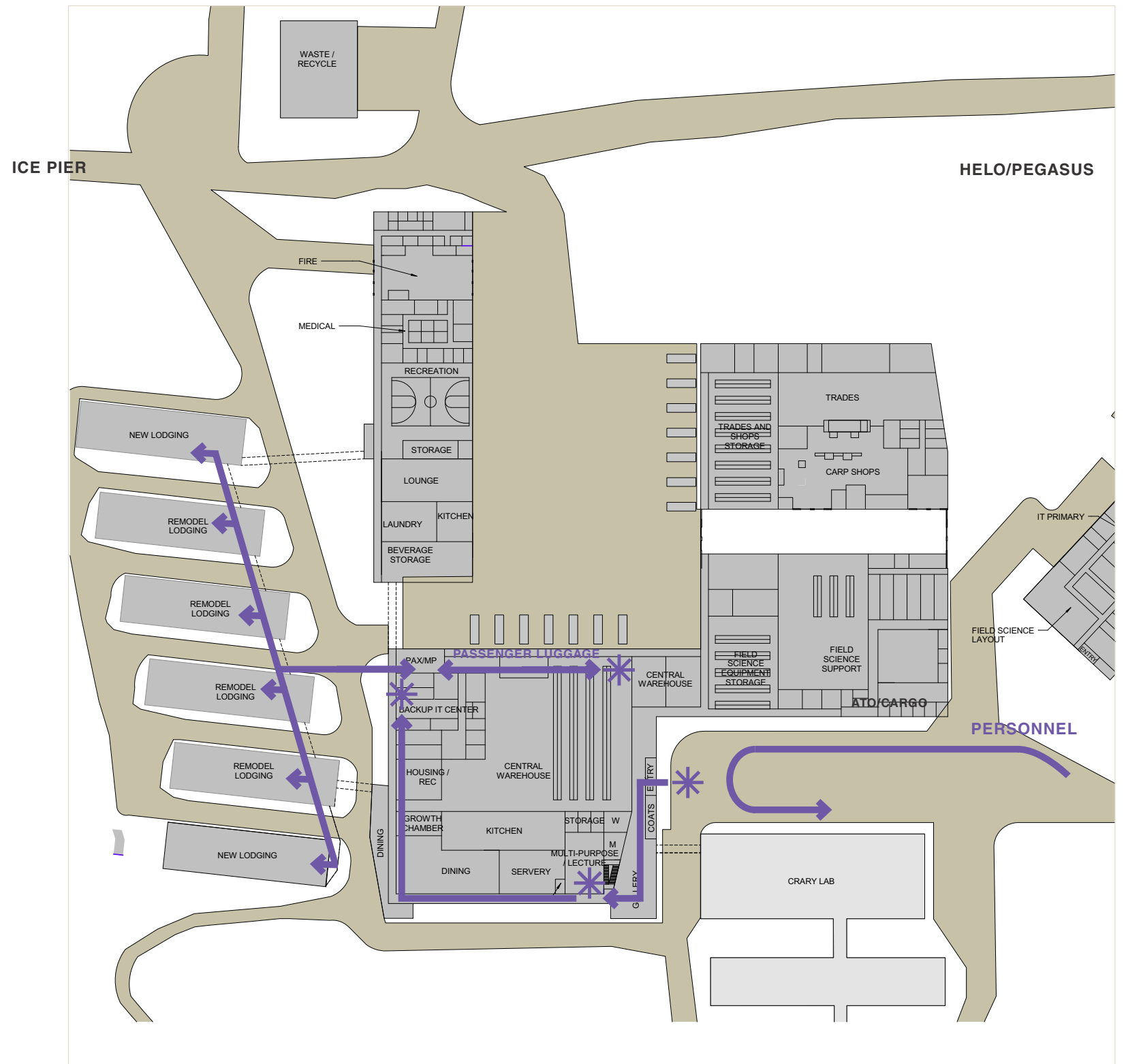

**LEGEND**  
 — PERSONNEL  
 \* ARRIVAL POINT

# FLOW DIAGRAM - MATERIALS

Logistical efficiency is a cornerstone of this Master Planning effort. Increased efficiency in delivery, handling, receipt and issuance of material are paramount to reducing the spatial and population footprint of McMurdo Station.

The current process, and its related inefficiencies, is dictated more by geographical locations of warehousing facilities than by any other one factor. There are currently 22 different warehousing spaces at McMurdo which creates more travel time, distance and number of times material is handled prior to its final disposition. Under this Master Plan those functions will be reduced to 4 main warehousing locations: Central Warehouse and Trades Shop, Science Support and Vehicle Maintenance satellite warehouses.

## In-Bound Cargo

Cargo arriving by annual Vessel will be brought to the material handling and storage space behind Central Warehouse or be sent directly to the Vehicle Maintenance, Science Support or Trades Shop satellite warehouse. Material intended for Central Warehouse will be offloaded directly to that facility. Loading docks and appropriate material handling equipment will be used to unload the Milvans (shipping containers in which most material is shipped to and from the continent) with the material going directly to its intended storage location where it will remain until it is issued for use. The interior space has also been sized for in-bound cargo not received on vessel (cargo arriving by aircraft) and accommodates winter cargo flights should that practice become normal operating procedure.

## Out-Bound Cargo

Out-bound cargo processing efficiency is greatly increased due to the collocation of ATO/ Cargo within the Science Support facility. The vast majority of gear needed for the field will be located within this facility and the distance that gear will travel between issuance and entrance into the cargo stream will be greatly reduced. Out-bound grantee-specific cargo headed to the field, Science Cargo in-bound and out-bound as well as Hazardous Cargo certification will all happen within this facility. 80% of Carpenter Shop cargo is destined for the field and the collocation with trades shop will increase the efficiency of this process.

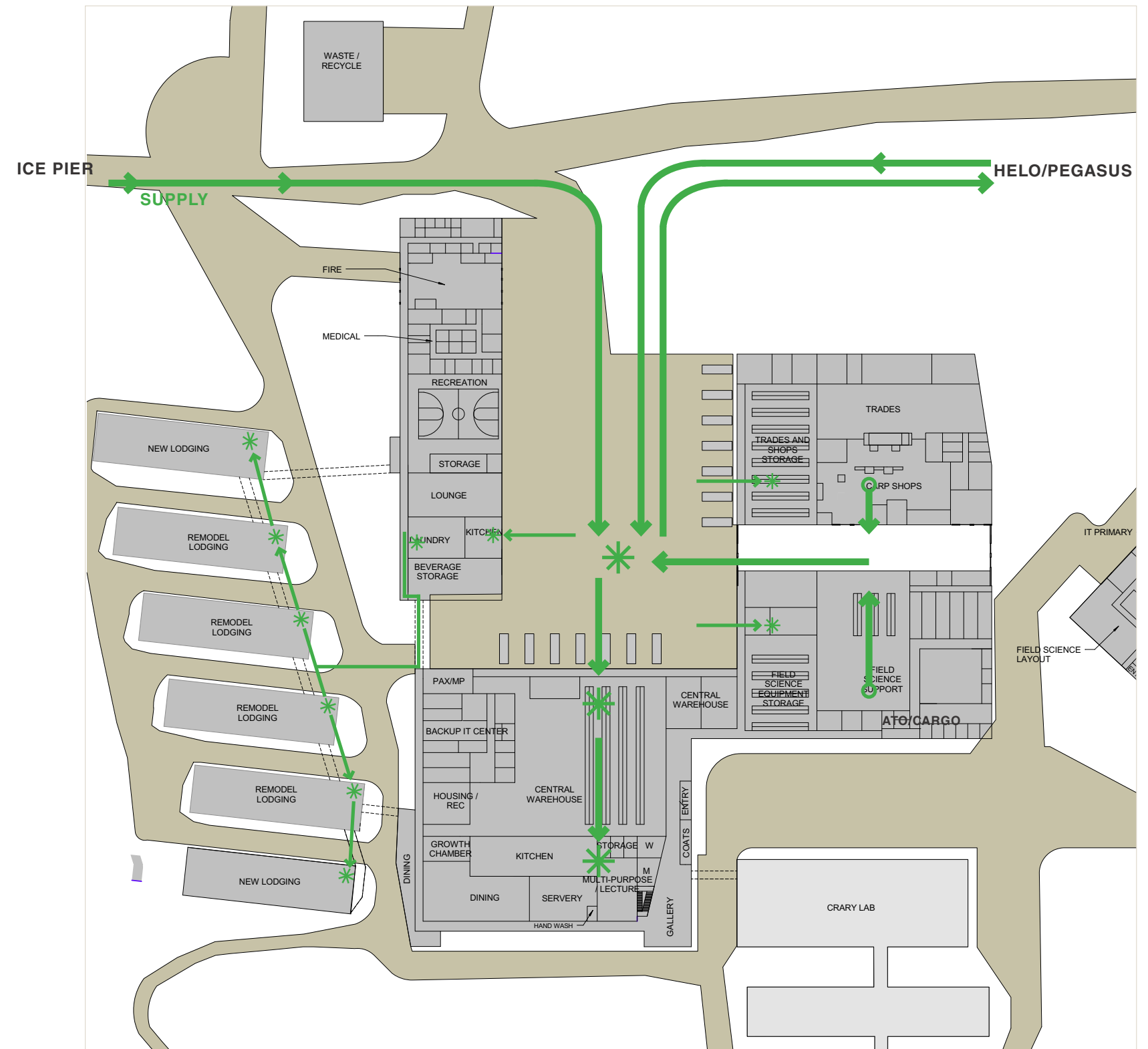

**LEGEND**  
 — MATERIAL  
 \* DELIVERY POINT



THIS PAGE INTENTIONALLY LEFT BLANK.

# FLOW DIAGRAM - WASTE

As a steward of the environment, the USAP maintains a robust waste processing and recycling program. As much material as possible that is recyclable is processed and returned to CONUS to be reused. Any material that is considered waste is also processed and returned for appropriate disposal. That process will continue with a reduced footprint, resulting in significant efficiencies gained in the amount of waste being handled, moved, and processed.

Waste stream processing within the McMurdo station will gain marked efficiency simply by the consolidation of the station structures as proposed in this Master Plan. Of the 104 buildings currently on station, approximately 45% of them produce waste in one form or another. This waste is intended to be sorted by the community as it is dropped off at the collection point but Waste personnel, after gathering the waste and transporting it to the sorting area, must ensure proper separation of waste into individual content components prior to loading the Milvans that will be retrograded back to the U.S. on the annual supply vessel.

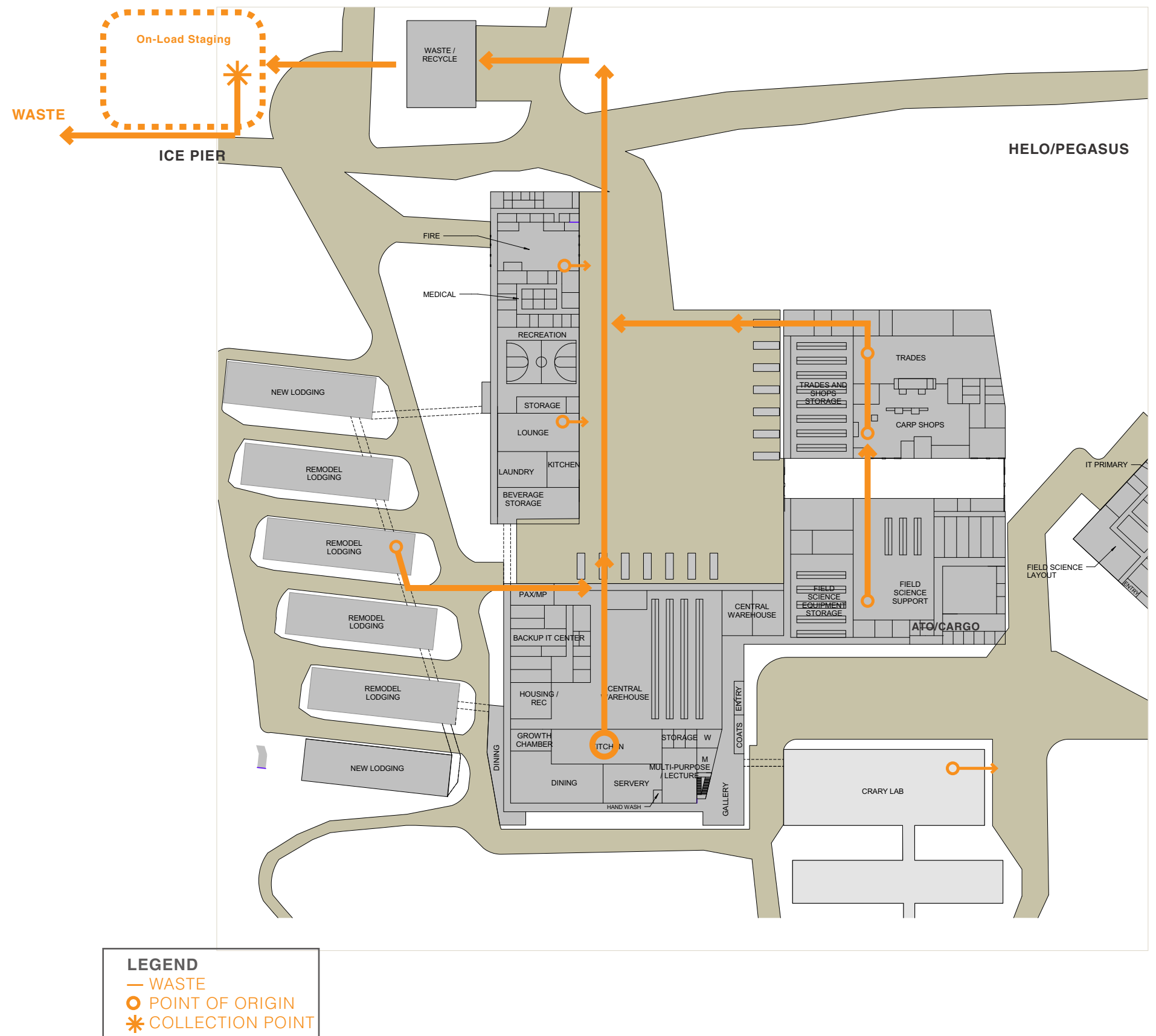

# CIVIL SITE & UTILITY PLAN

---



# CIVIL SITE & UTILITY PLAN

## UTILITY CORRIDOR

As a part of this McMurdo Station Master Plan, the existing utility corridors carrying domestic water, power distribution, communications, sanitary sewer and fuel will be removed as necessary and a new distribution system provided. The intent is to route station utilities as much as possible through the new buildings, allowing the utilities to be within conditioned spaces. This will provide easier access to utilities during inclement weather and reduce the amount of heat trace required for the utility systems. In locations where utilities cannot be placed within buildings, two other utilidor schemes are proposed. The first would be an above-ground utilidor system similar to the system in use at the station today. The second would be a pre-fabricated, below-grade tunnel system with vertical hatches on either end or access directly to buildings. The underground utilidor system will be used where needed to convey utilities beneath pedestrian and vehicle travel corridors. The use of direct-buried utilities is not desired since they are not accessible and are very difficult to service in the McMurdo Station climate.

Utilities, to the extent practicable, and as indicated in the drawings, will be looped to provide backfeed capabilities to facilities in case of maintenance or emergency shutdowns.

## WATER DISTRIBUTION

The existing water distribution system at McMurdo Station will be replaced as a part of this Master Plan. The fundamental change for the proposed system is to add water storage tanks topographically above the station. The ability to rely on gravity head from the tanks will reduce the size of pumps necessary to provide fire coverage for the station. Water storage tanks provide a level of redundancy as well as the ability to serve the station with fresh water in cases of emergency or equipment failure.

Two new tanks will be incorporated into the overall water distribution system for both domestic water and fire water supply. They will be filled with potable water. Refer to the fire protection section of this document for further information.

## SANITARY SEWER

The existing sanitary sewer distribution system at McMurdo Station will be replaced as a part of this Master Plan. The new sanitary sewer collection system will be routed with other utilities on the proposed utilidor system to the extent feasible. Where the sanitary sewer needs to deviate from the overall corridor, separate runs will be provided on ground-based utilidors. The sewer system, as much as practicable, will be a gravity-based system. Every effort will be made to reduce (or eliminate) the need for sanitary sewer lift stations. Sewage will ultimately remain tributary to the existing wastewater treatment plant.

## SITE PLANNING

The building layout presented in this Master Plan was based on the large amount of input the design team received from all stakeholders in the station's development. It is intended to increase efficiency for station personnel as well as to reduce (or eliminate) conflicts between pedestrians and vehicles. Elevated pedestrian walkways between buildings will assist in reducing pedestrian/vehicle conflicts as well as providing the opportunity for McMurdo Station inhabitants to circulate inside during inclement weather conditions. The Kress personnel transport vehicle was considered in the layout of the new facilities with provisions for turning radii and vehicle circulation. Fire department access will be provided in accordance with International Fire Code requirements and a minimum roadway width of 26 feet will be provided for fire apparatus access roads.

## GRADING & DRAINAGE CONCEPT

The drainage system at McMurdo Station is primarily active during the summer season when temperatures are high enough to create snowmelt runoff from the perennial ice and snow fields that are upstream of the station. As such, the system needs to be able to convey larger amounts of flow for short periods of time in the summer while remaining dormant or frozen for the remainder of the year. This creates maintenance concerns and large amounts of work in the spring to clean and clear the existing drainage ways for the summer snowmelt season.

Based on review of existing drainage studies (primarily the "CRREL Study") and conversations with station personnel, it appears that the larger snowmelt flows are coming from the north of the station through "man made swale" (existing roadside ditch/culvert system between BL143 and BL340-342) and through existing roadside ditch/culvert system along the roadway serving BL132, BL141 and BL168. These flows combine near BL192 and are then conveyed into the bay. From input gathered, it does not appear that these flows ever breach the ditches and contribute to runoff issues on the south side of the main road within the existing station. Thus, this snowmelt conveyance north of the main road will be kept in its general existing configuration. Improvements to this portion of the station drainage are proposed to consist of: (1) shaping existing drainage ditches consistently and of such size to convey the anticipated runoff, (2) providing check dams or drop structures to slow and control the runoff, (3) providing concrete trapezoidal channels in areas of erosion concern, (4) providing appropriately sized culverts to convey the anticipated runoff and, (5) providing an effective system to keep culverts and ditches free of ice and debris as feasible.

The main footprint of the new station will be re-shaped and re-graded as a part of this project. This will be an opportunity to fix existing areas of drainage concern and to provide positive drainage around new and existing buildings. The primary goal will be to keep runoff in defined drainage systems. The surrounding areas can then be routed to these systems via surface flow to get runoff away from the facilities.

These concepts are in agreement with the recommendations of the CRREL Drainage Study, which were (1) eliminating several existing flow paths and merging flow into one drainage path, (2) diverting flow away from the station, (3) controlling the runoff with the installation of flow controls and settlement ponds, and (4) upgrading the culverts to the proper sizes.





## FUEL DISTRIBUTION

When a Distributed or Hybrid CHP configuration is selected, fuel distribution will be co-located with the utilidor utilities to share routing, support and heating. The Fuel Distribution Loop will follow the same construction phasing used for the utilidor.

## WATER STORAGE

It is assumed that domestic water storage and fire system storage will be augmented by the new storage tanks approximately 100 feet in elevation above the main site. This storage strategy will aid in fire and domestic water throughout the station and will reduce pump energy demand. The addition of one million gallons storage capacity will provide adequate water for fire suppression system as required by code. Other, existing online storage tanks will satisfy the requirement for domestic water backup in case of emergency or equipment failure. Water storage tanks will be insulated and heated to prevent ice buildup. Because the domestic water and fire storage tanks are remotely located, in-tank hydronic heaters are not recommended. Either in-tank electric heaters or heated recirculation loops may be used to prevent ice buildup.

### **In-Tank Electric Heaters**

In-tank electric heaters are reliable, simple to operate, and inexpensive to replace. However, heat trace will still be required for the lines leading to and from the tanks.

### **Heated Recirculation Loop**

A heated recirculation loop consists of a small recirculating pump, heat exchanger and recirculation pipe leading to and from the tank. The advantage of this option is that the fill lines could double as the “heated supply” with the tank’s main supply line acting as the “return”. Because there are long lines feeding multiple remote tanks, this option is more reliable and cost effective than the heat trace/in-tank heater option.

## DISTRIBUTION FREEZE PROTECTION

The majority of the piping distribution systems are close to the facilities being supplied. During long portions of the day, system demand and fresh inflow of water will negate the need for freeze protection. However, overnight and during extreme climatic conditions, freeze protection will be required for the utilidor. Depending on utilidor configuration, freeze protection will consist of electric heat trace cable or small electric heating units. Utilidor heat tracing will be monitor and programmed by a central energy monitoring and control system. Small finned hydronic radiant heat was considered, but rejected, because it would be unable to function if a section of heating loop were disabled.

### **Heat Trace Cable**

Heat trace cable is self-regulating electric resistance cable that is typically wrapped around piping under the insulation. If the utilidor consists of a suspended piping rack with individual pipes exposed to the weather, heat trace cable must be used. In the past, heat trace failures have resulted in substantial piping damage and repairs. Therefore, it is recommended that parallel lengths of heat trace cable utilizing dual independent electrical circuits be used for each section of pipe. Heat trace operation will be monitored by the facility’s control system to ensure faulty heat trace cable is replaced quickly. Because the parallel heat trace cables provide redundancy, a faulty section of heat trace can be replaced without losing freeze protection.

### **Electric Heaters**

If the utilidor consists of an insulated conduit containing all of the utilities, independent electric heaters may be employed for freeze protection. Multiple redundant heating units utilizing independent electrical circuits will be used for each section of pipe. Heating unit operation will be monitored by the facility’s control system to ensure faulty equipment is replaced quickly.

# EXISTING & NEW UTILITY PLAN

## EXISTING UTILITY PLAN

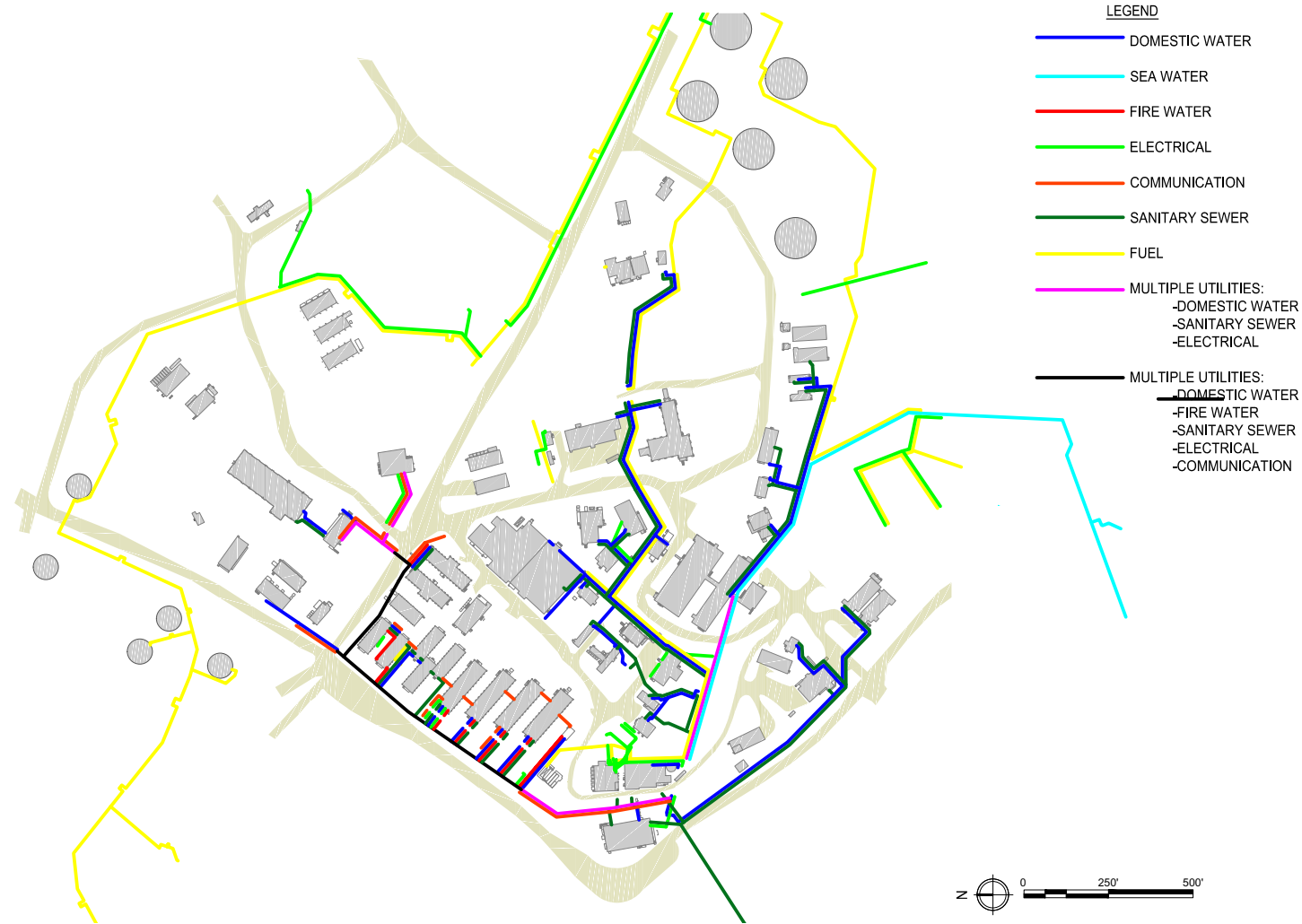

## NEW UTILITY PLAN

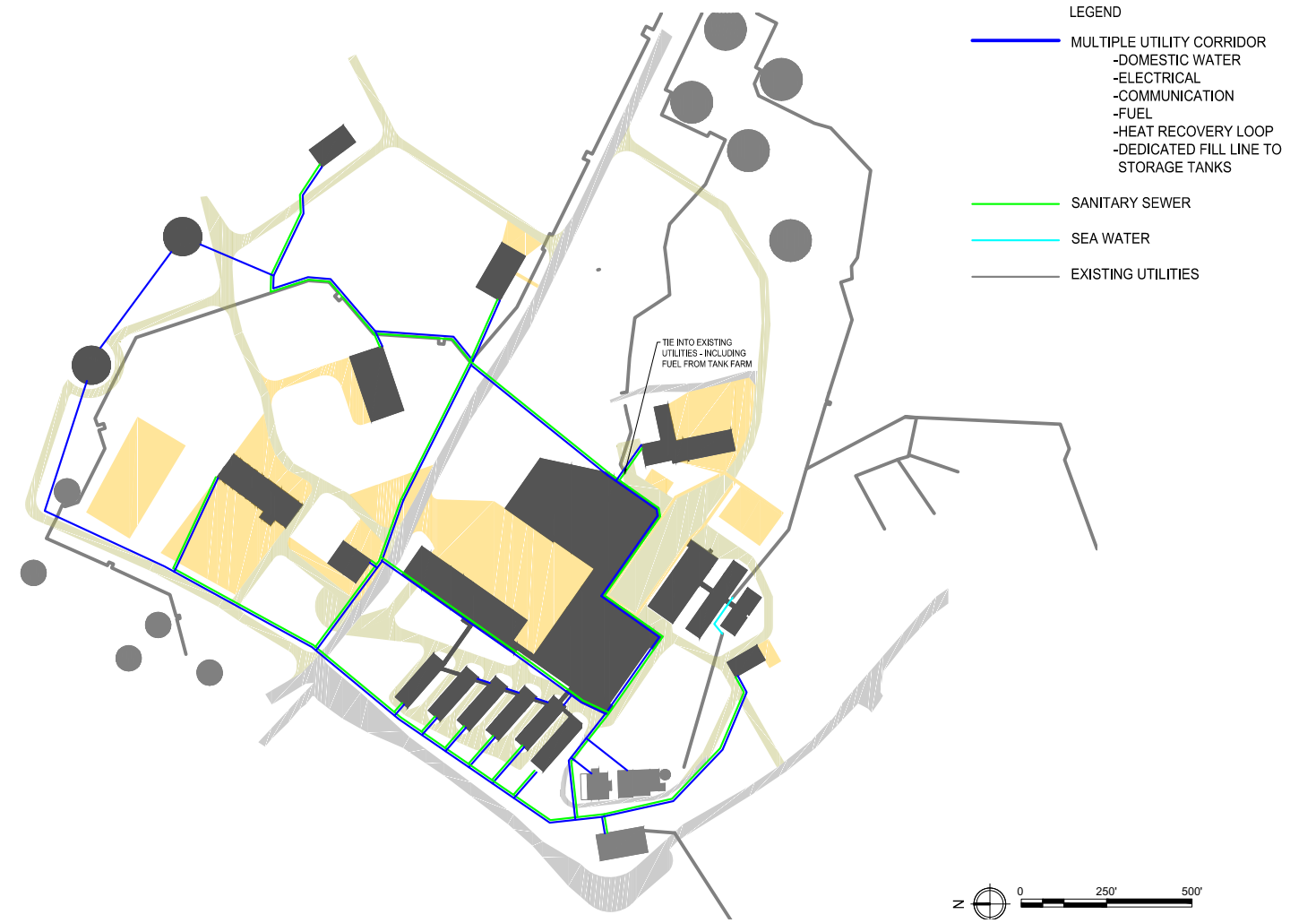

THIS PAGE INTENTIONALLY LEFT BLANK.

# ENERGY

---



# MCMURDO STATION ENERGY STRATEGIES

McMurdo Station requires 800,000 gallons of fuel to produce electricity and another 500,000 gallons of fuel to heat buildings per year. The vision for the McMurdo Station master plan utilities profile is to reduce this fuel dependency with new efficient modern building construction and renewable energy systems. The building heating, ventilation, and lighting are among the largest consumers of the total energy within McMurdo Station (ships and aircraft are significant energy consumers). A target reduction in fuel consumption is approximately 550,000 gallons or 42% of the existing annual requirement.

McMurdo Station power generation includes diesel power generators and distributed energy generation from three CHP (2015 project), and from wind turbines. The main focus of distributed energy generation for the McMurdo Area has been on increasing the wind power system. Additional focus is now being placed on adding photovoltaic and solar thermal panels to buildings which can provide alternate energy source. Future deployment of solar systems would aid in relieving the fuel burden during the station's summer high power demand loads when solar radiation is abundant and the station population increases. Proof of concept will be required prior to planning an integration of solar technology.

An existing collaboration with the New Zealand program has proven that wind turbine power is feasible and can realize a significant fuel reduction. With increased wind turbine capability, McMurdo Station can decrease the use of its generator and boiler resources. Additionally, Combined Heat/Power microturbine (CHP) distributed energy generation will significantly improve power generation efficiency and reduce boiler fuel usage. Seven CHP Capstone C65 (65kW capacity) microturbines are planned for installation and proof of concept, four units in BL155 and three units in BL143. Exhaust heat from the CHP heat exchanger will provide usable building heat and the generator provides electrical power. This technology provides a scalable distributed energy generation technology. Waste-to-Heat wood chip boilers are currently being designed for implementation in 2016. Excess energy produced by all sources including CHP and wind turbine power will be used to create a "balance of energy" between heating and power needs.



Combined Heat & Power (CHP)  
Microturbine

Smart Grid technologies will advance the McMurdo Station power distribution grid to a higher level of automation. The smart grid master plan architecture for McMurdo Station incorporates fundamental Smart Grid technologies. Smart Grid technologies are IP-enabled and network-connected and now come with robust security systems. After installation and implementation at the conclusion of the build-out, Smart Grid technologies will provide the foundation for 35-50 years of service at McMurdo Station. These technologies include integrated power grid communications, generation, load sensing and measurement, and improved human interfaces.

McMurdo Station can be a leading example of smart control systems with energy storage, distributed energy generation and Smart Grid technology in a rare independent location. Ultimately, a solid business case exists to reduce the program's operational energy expenditure.



Photovoltaic (PV) Farm



Wind Turbine Farm

# MCMURDO POWER GRID

Electric power generation at McMurdo Station includes five 1400kW Caterpillar AN8 diesel powered electric generation units in a central plant and three Enercon E33, 330kW wind turbines located on Crater Hill, between McMurdo Station and Scott Base. The wind turbines are owned and operated by New Zealand, and they contribute to McMurdo's power grid in addition to serving Scott Base's power grid and its three 200kW AN8 Caterpillar diesel powered electric generation units. Power from these sources is distributed at Medium Voltage (MV) through conductors mounted overhead on power poles. The current distribution topology is a non-redundant, non-looped, radial distribution. This topology evolved over the decades in an organic means as McMurdo Station developed.

Distributing power from the central plant and wind farm via overhead power lines has been a cost effective means, but less than reliable or desirable method. The buildings at McMurdo Station are fed with overhead power lines, which visually impacts the site,

as well as increasing potential risks related to safety, vehicle movement, and reliability/functionality.

Upgrading the MV power distribution from overhead power lines to a ground-based rack distribution system simplifies the maintenance and increases reliability. The rack distribution system can include other utility systems as well. This reduces the overall utility footprint on the McMurdo Station site. Servicing overhead power lines, even during the best of weather conditions, is challenging for maintenance personnel.

The typical commercial alternate method of removing overhead power lines is to install them below grade level. Underground power lines would be more difficult to service and represents a significant capital expenditure due to the nature of the soil conditions. In some locations on site, the soil conditions and permafrost make it cost prohibitive to trench for underground utilities.





This plan moves the overhead power pole and line distribution system to a ground based rack distribution system. This system is mounted on stanchions with conductors routed through a covered rack system. A similar arrangement is currently used at McMurdo Station near the electric utility yard.

The routing of the MV power distribution will be coincidental with other site utilities to the greatest extent. Common routing with telecommunication conductors increases the routing topology and facilitates the integration of smart grid technologies. Coincident routing of MV power distribution with other site utilities also decreases the combined site exposure. At pedestrian and vehicle crossings, the conductors will be routed underground in an utilidor system or the crossing will be built over the utilities (see page 109).

The MV power distribution will be in a station loop configuration, allowing a redundant distribution to the buildings. A redundant loop including the wind farm provides more reliability to the power grid. If the power feeder branch to a facility is severed or rendered useless, the facility can be served through an alternate section of the loop. The combination of a Smart Grid technology and a ground based rack distribution system increases reliability, eases maintenance, provides redundancies, and increases the efficiency of the distribution and consumption of energy at McMurdo Station.

Construction and development of the MV power distribution may require that select loads or buildings be provided with temporary backup power to ensure 100% redundancy in power sources. This will need to be explored during each building design phase. Examples include buildings serving life safety functions and data center functions.

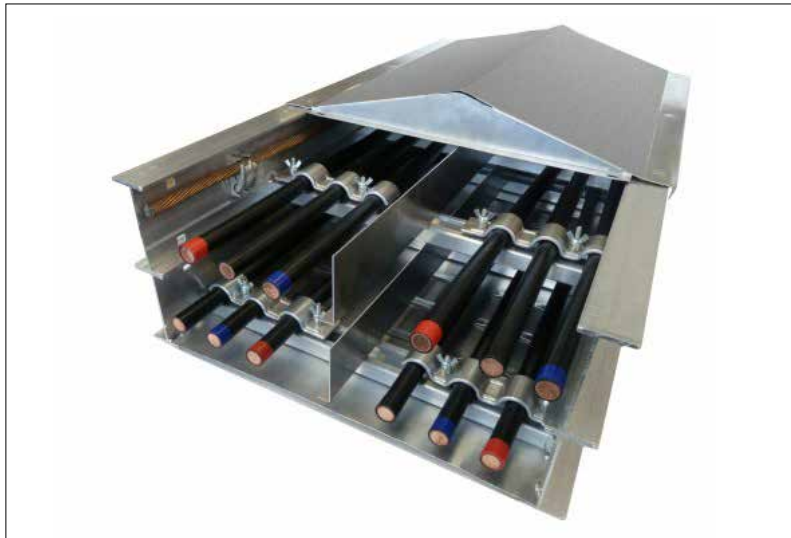

*Images courtesy of MDF Cable Bus Systems*

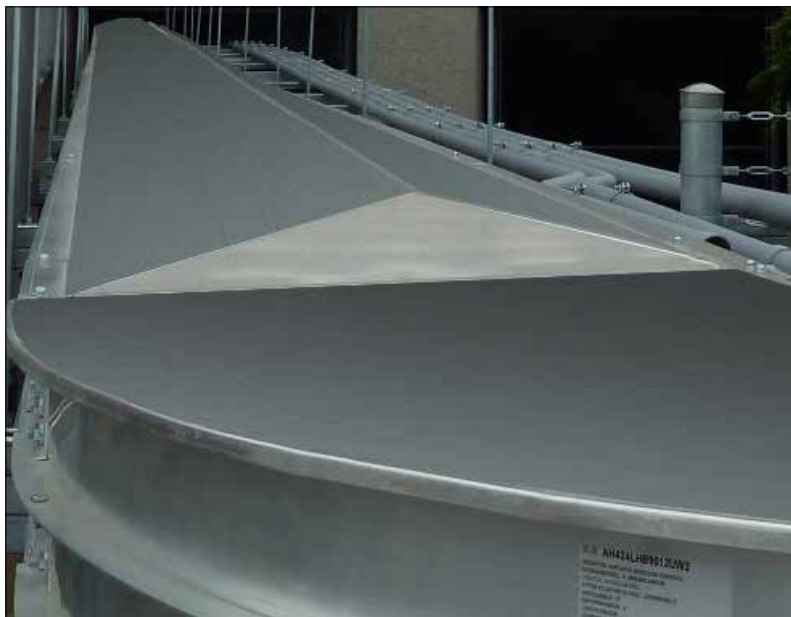

# DISTRIBUTED CHP WITH CENTRAL PLANT BACKUP & ALTERNATIVE ENERGY TECHNOLOGY

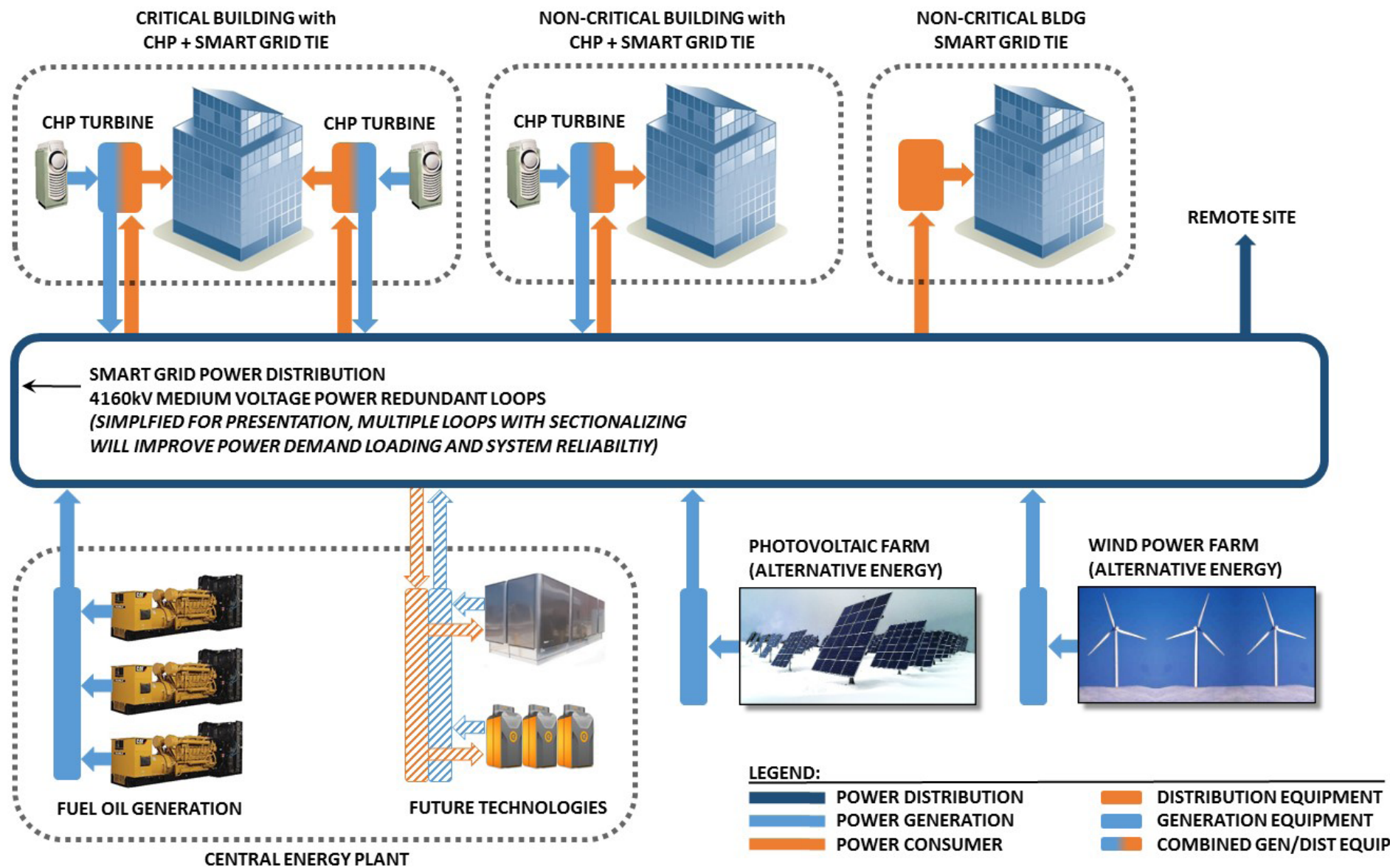

## OVERVIEW

McMurdo Station will employ Smart Grid (SG) power technology to integrate power sources, power distribution, and power loads.

SG power sources consist of the Central Energy Plant (CEP), Combined Power/Heat generation microturbine (CHP), Wind Farm power, potential Photovoltaic power (PV), and future power generation and storage technologies.

SG power distribution consists of a looped system with sectionalizing equipment with the ability to improve system reliability, and improve maintenance and fault isolation.

## DETAILED DESCRIPTION

The following three pages describe the Smart Grid features of energy suppliers and energy consumers in greater detail.





# DISTRIBUTED CHP WITH CENTRAL PLANT BACKUP & ALTERNATIVE ENERGY TECHNOLOGY

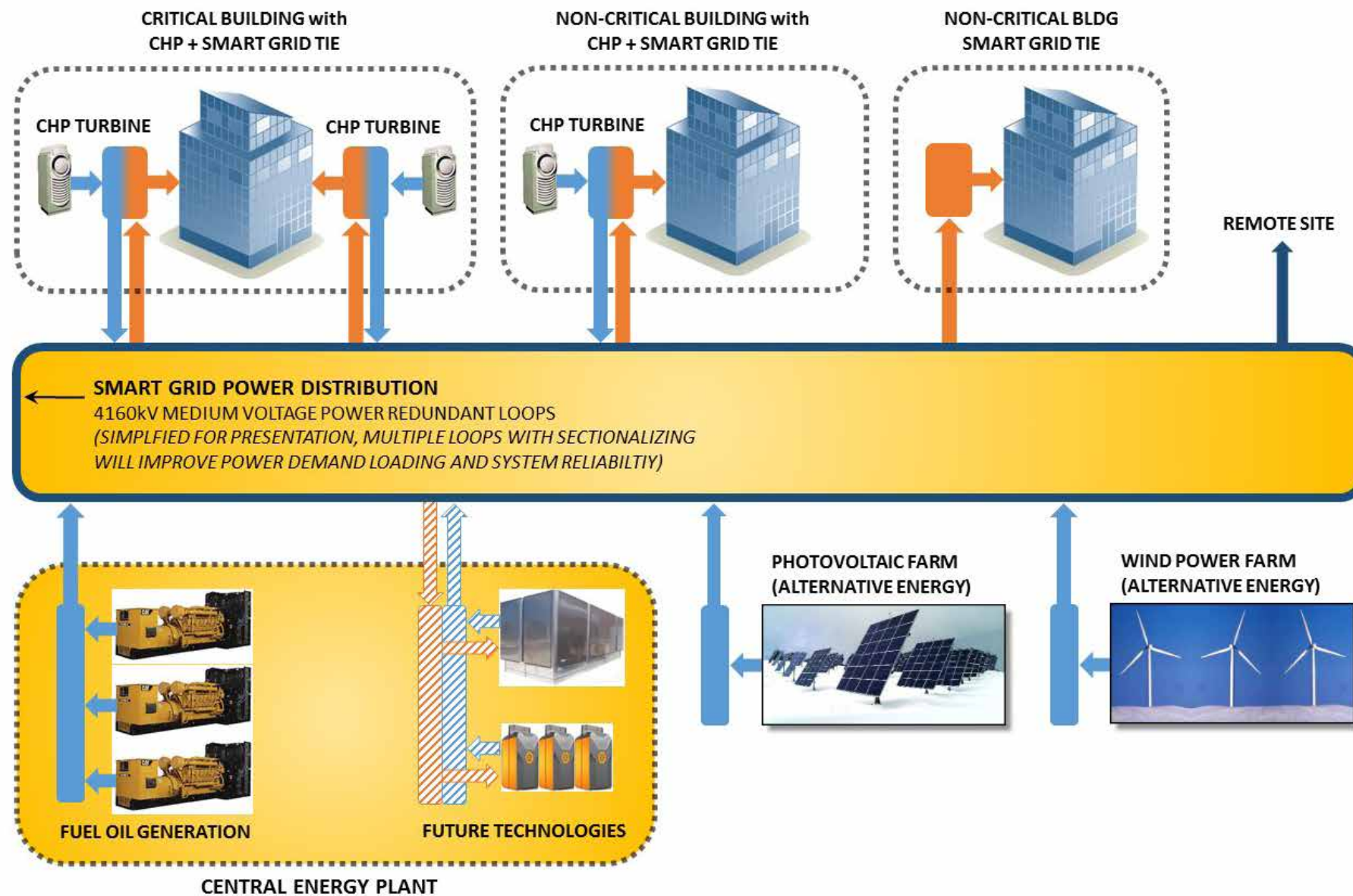

## CENTRAL ENERGY PLANT (CEP)

- CEP provides combined heat and power generation for McMurdo Station
- The CEP will incorporate a SG to integrate power sources, power distribution, and power loads throughout McMurdo Station
- The CEP will provide redundant power for buildings served by integral CHP sources
- The CEP will provide power for buildings lacking integral CHP sources
- The CEP will offer the ability to add future technology energy/power storage and generation at a centralized location

## SMART GRID POWER DISTRIBUTION

- The power distribution system consists of redundant looped medium voltage cable and sectionalizing switch system
- The medium voltage loop will be 4160 volt at 60 hertz, which is compatible with existing distribution equipment and transformers
- The SG allows multiple power sources to serve loads throughout McMurdo Station
- SG power sources include the CEP, building located CHP, wind farm, PV, and future generation technology
- SG reliability is enhanced by using redundant medium voltage loops with the ability to serve critical loads from either loop and bypass cable sections for maintenance and fault isolation
- SG will be monitored and controlled by distributed remote terminal units with monitoring at various locations such as the Contingency Operations Facility, Cray Lab, and the CEP

# DISTRIBUTED CHP WITH CENTRAL PLANT BACKUP & ALTERNATIVE ENERGY TECHNOLOGY

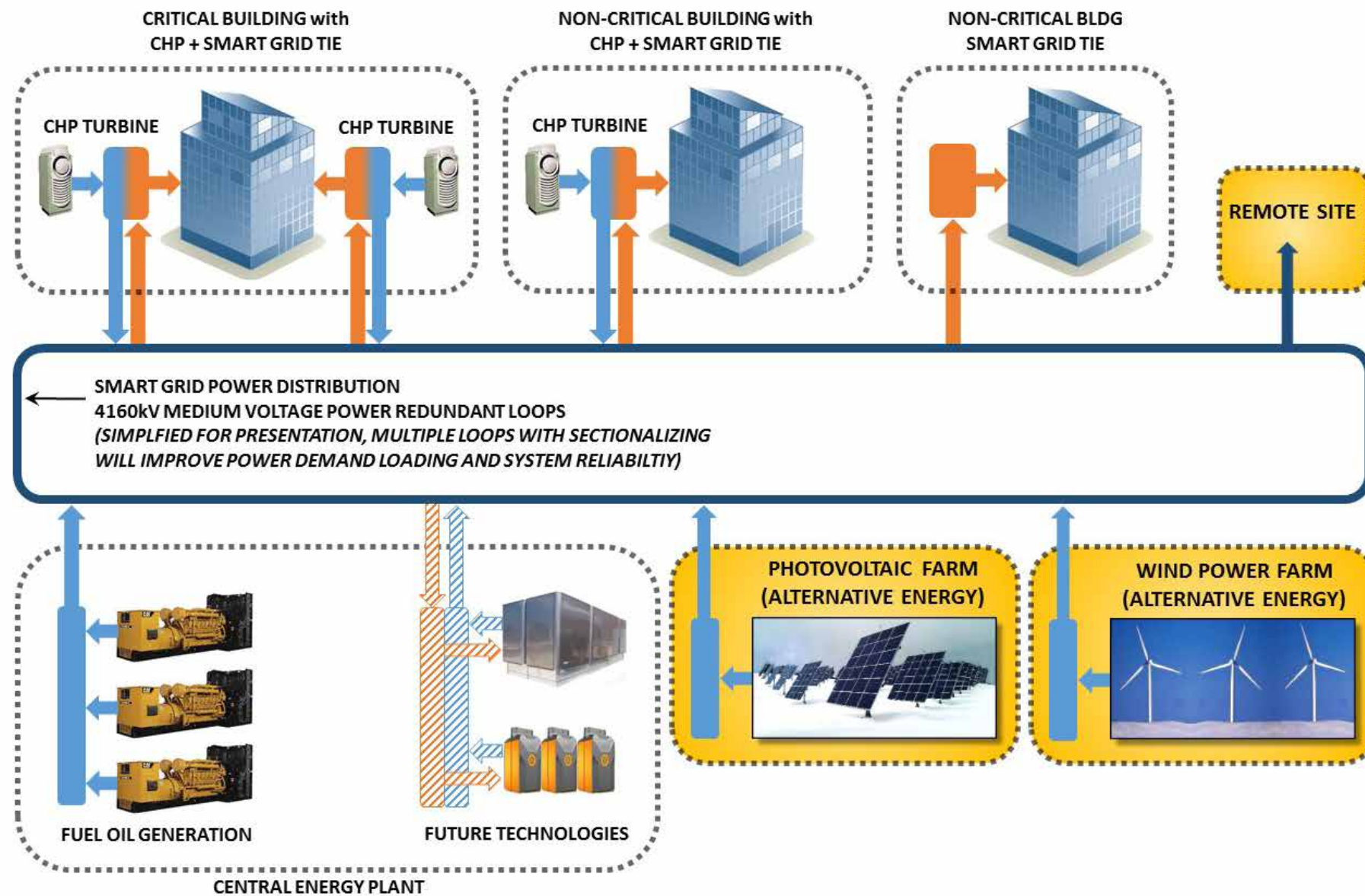

## WIND POWER FARM (ALTERNATIVE ENERGY)

- The Wind Power Farm will supply power to the McMurdo Station SG
- The Wind Power Farm capacity will be optimally sized to serve peak load requirement
- The Wind Power Farm will employ generator field excitation via grid connected transformers or newer generation wind turbines with self-excitation
- All grid connected Wind Power equipment will operate or step-up to 4160 volt and be provided with appropriate interconnection relay protection
- Potential location(s) of a wind power farm will require study during design in order to maximum available wind and tie into the power grid

## PHOTOVOLTAIC POWER FARM (ALTERNATIVE ENERGY)

- A possible PV Power Farm will supply power to the McMurdo Station SG
- The PV Power Farm capacity will be optimally sized as phased site improvements using available real estate and funding
- All grid connected PV equipment will operate or step up to 4160 volt and be provided with appropriate interconnection relay protection
- Locations of PV technology deployment include large flat roof mounted systems and dedicated site area for PV ground mounted farm (optimum location to be determined). Potential locations will require design study for structural concerns, maintenance concerns, and grid tie concerns.

## REMOTE SITE LOADS

- The remote site power will be SG connected with a radial feed
- Critical power remote sites can be grid connected using redundant radial feeds

# DISTRIBUTED CHP WITH CENTRAL PLANT BACKUP & ALTERNATIVE ENERGY TECHNOLOGY

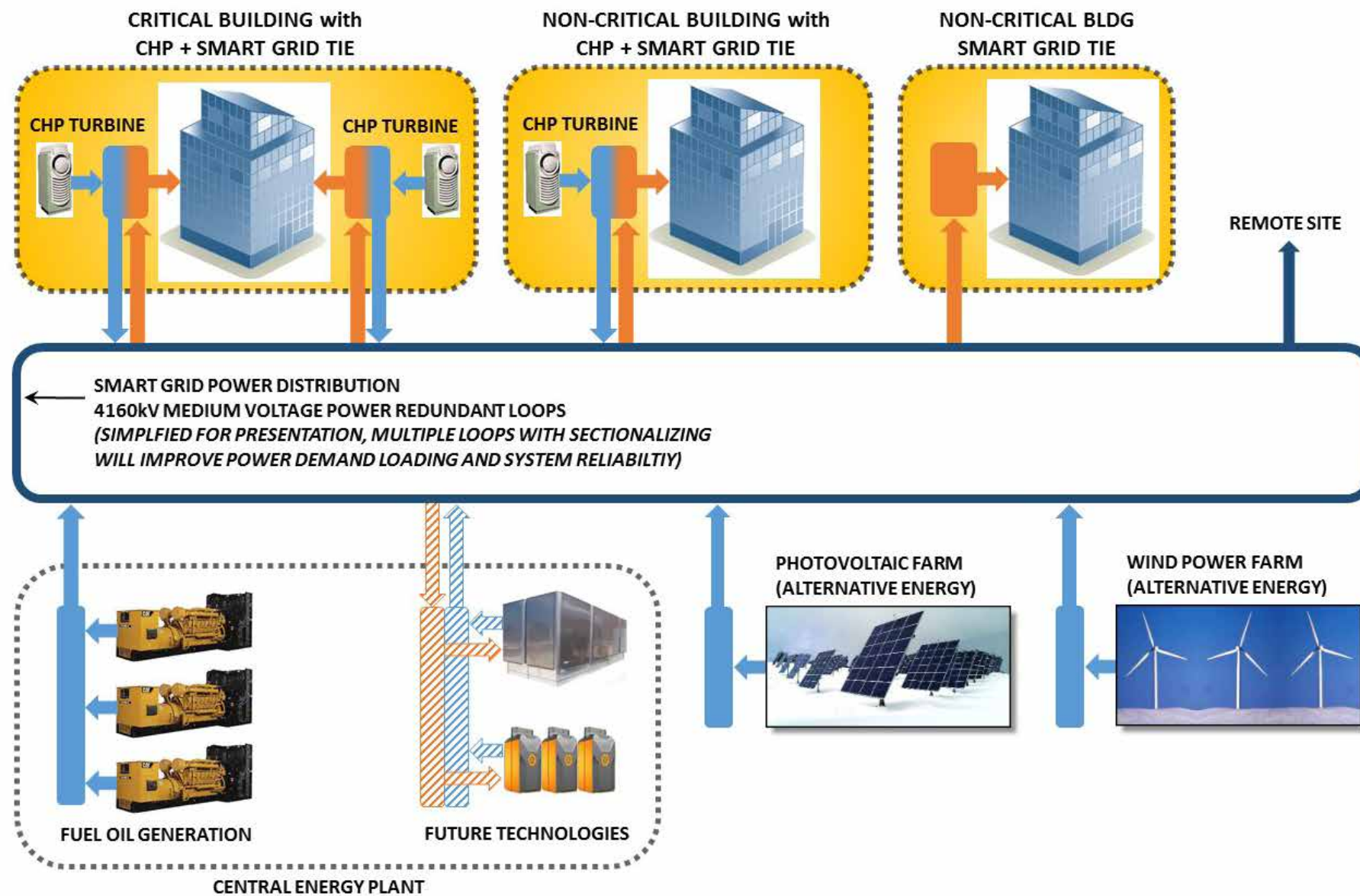

## CRITICAL BUILDINGS WITH CHP & SMART GRID TIE

- Critical buildings are provided with integral redundant CHP technology for facility heat and power
- High efficiency CHP units will be provided in an "N+1" configuration to ensure local redundancy and non-reliance on SG power alone
- Excess CHP power can be fed into the SG to serve other grid connected loads
- The SG serves as an alternate source of power to backup the facility "N+1" CHP systems
- Grid connected equipment will operate or step-up to 4160 volt and be provided with appropriate interconnection relay protection

## NON-CRITICAL BUILDINGS WITH CHP & SMART GRID TIE

- Non-Critical buildings are provided with integral CHP technology for facility heat and power
- High efficiency CHP units will be provided in an "N" configuration with backup power from the SG
- Excess CHP power can be fed into the SG to serve other grid connected loads
- Grid connected equipment will operate or step-up to 4160 volt and be provided with appropriate interconnection relay protection

## NON-CRITICAL BUILDINGS WITH SMART GRID SOURCE

- Non-Critical buildings are provided with primary power from the SG
- Grid switching can be used to provide a measure of redundancy as determined during design

# HEAT RECOVERY LOOP CONFIGURATION & CONTROL

**TYPICAL BUILDING CHP PLANT**

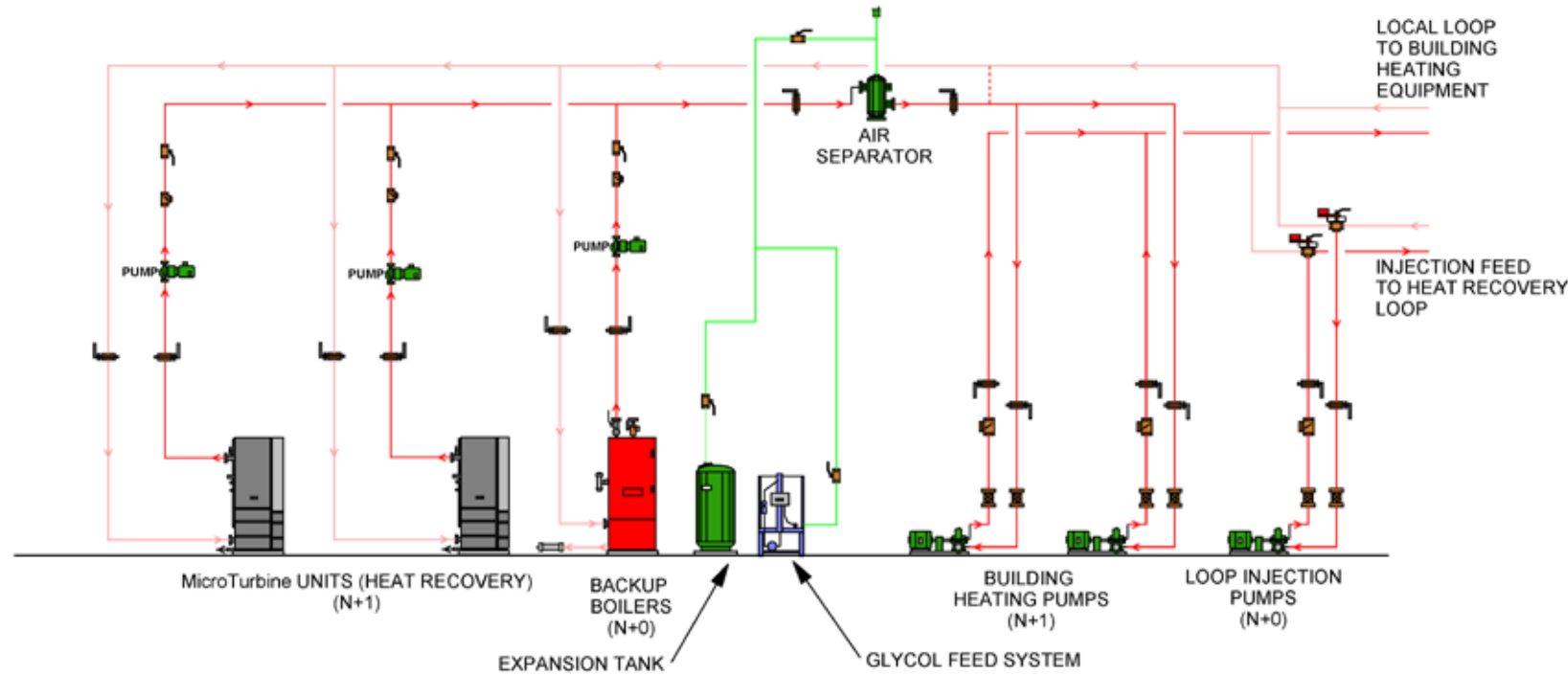

**TYPICAL RADIANT HEATING CONFIGURATION**

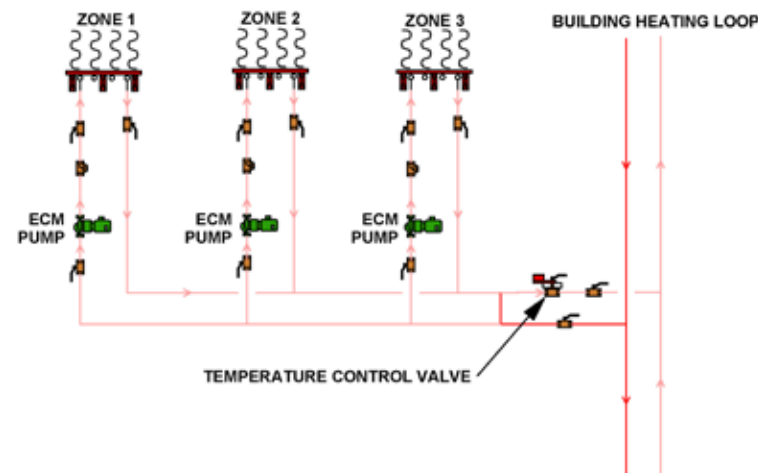

## DISTRIBUTED GENERATION WITH CAPABILITY FOR EXCESS HEAT REJECTION

Combined heat/power microturbine (CHP) units will be placed in all major buildings and buildings with significant heating loads to maximize local heat recovery usage and ensure power and heat reliability. Local CHP plants will include all CHP units, pumps, expansion tanks, makeup water feeds and water treatment services needed for stand-alone operation. CHP units and pumps will be configured as redundant (N+1) to accommodate planned or unplanned maintenance. Additional power and heating backup will be provided via the power grid and heat recovery loop. Excess power and heat will be sent back to the grid and heat recovery loop for use at the smaller outbuildings and as backup for the site.

## LOW TEMPERATURE LOOP

The Heat Recovery Loop will be controlled to a maximum of 180 degrees F to the greatest extent possible. The loop will be maintained at 150 degrees F to maximize heat recovery and minimize heat loss to the environment. During periods of extreme weather, the Heat Recovery Loop maximum temperature of 180 degrees F will be utilized to maximize heating performance and control flexibility.

## HIGH TEMPERATURE DIFFERENTIAL USAGE

The connected terminal equipment will be configured for high temperature differential usage (60 degree F delta T) to minimize pumping energy. Heat Recovery Loop pumping and distribution will be sized for low temperature (30 degree F) differential to ensure efficient and robust operation. Hydronic circulation pumps will be configured with electrically commutated motors (ECM) or variable frequency drives (VFD) to minimize energy usage.



# HEAT RECOVERY LOOP CONFIGURATION & CONTROL

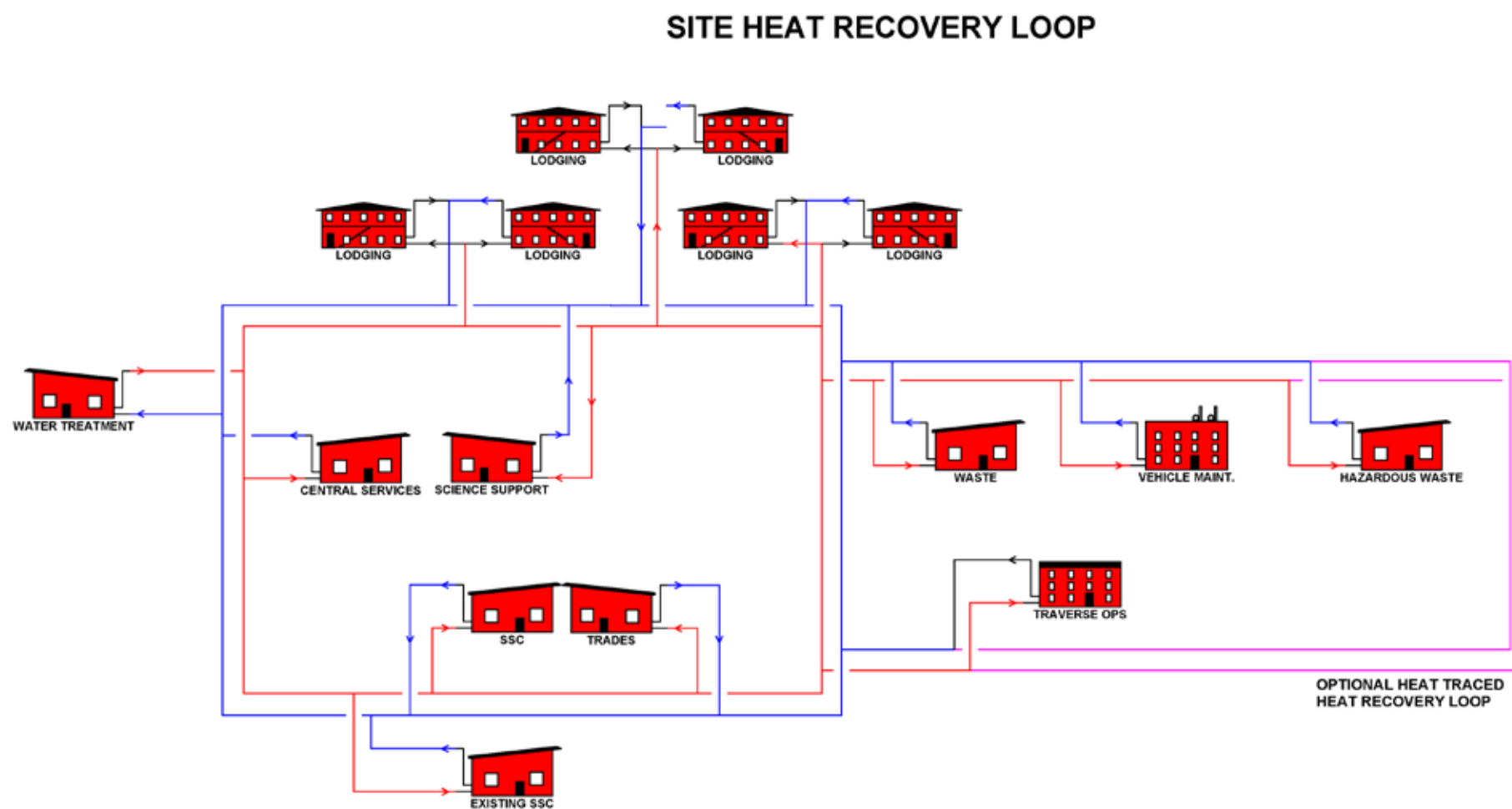

## HEAT RECOVERY LOOP DISTRIBUTION

It is anticipated the Heat Recovery Loop will be co-located with other utilities within the utilidor and follow the same construction phasing. At each phase of construction, a bypass valve will be provided at the end of the line to ensure continuous flow within the loop. When final build-out is complete, the longer legs of the loop will be tied together to create a gridded loop for redundancy. Major legs of the loop will include isolation valves to facilitate loop maintenance and provide alternative pathways should a loop failure occur. Where needed, control valves will be added to ensure there are no dead legs in the distribution loop.

## HEATING PRIORITY

Because the new buildings will utilize modern and more energy efficient construction, we expect the final build-out heating requirements to be substantially lower than current needs. Therefore, there may be opportunities to utilize CHP waste heat to supplement a variety of heating processes throughout the station. As noted above, CHP units will generate local power and heat, with excess power and heat being distributed to other buildings through the power grid and Heat Recovery Loop. To maximize heat recovery loop usage and minimize reliance on fossil fuels, a prioritization scheme is recommended to fully utilize recovered CHP heat before utilizing combustion or electric boilers. The following pages list the recommended priorities.

# WASTE HEAT LOOP CONFIGURATION & CONTROL

## TANK AND DOMESTIC WATER FREEZE PROTECTION

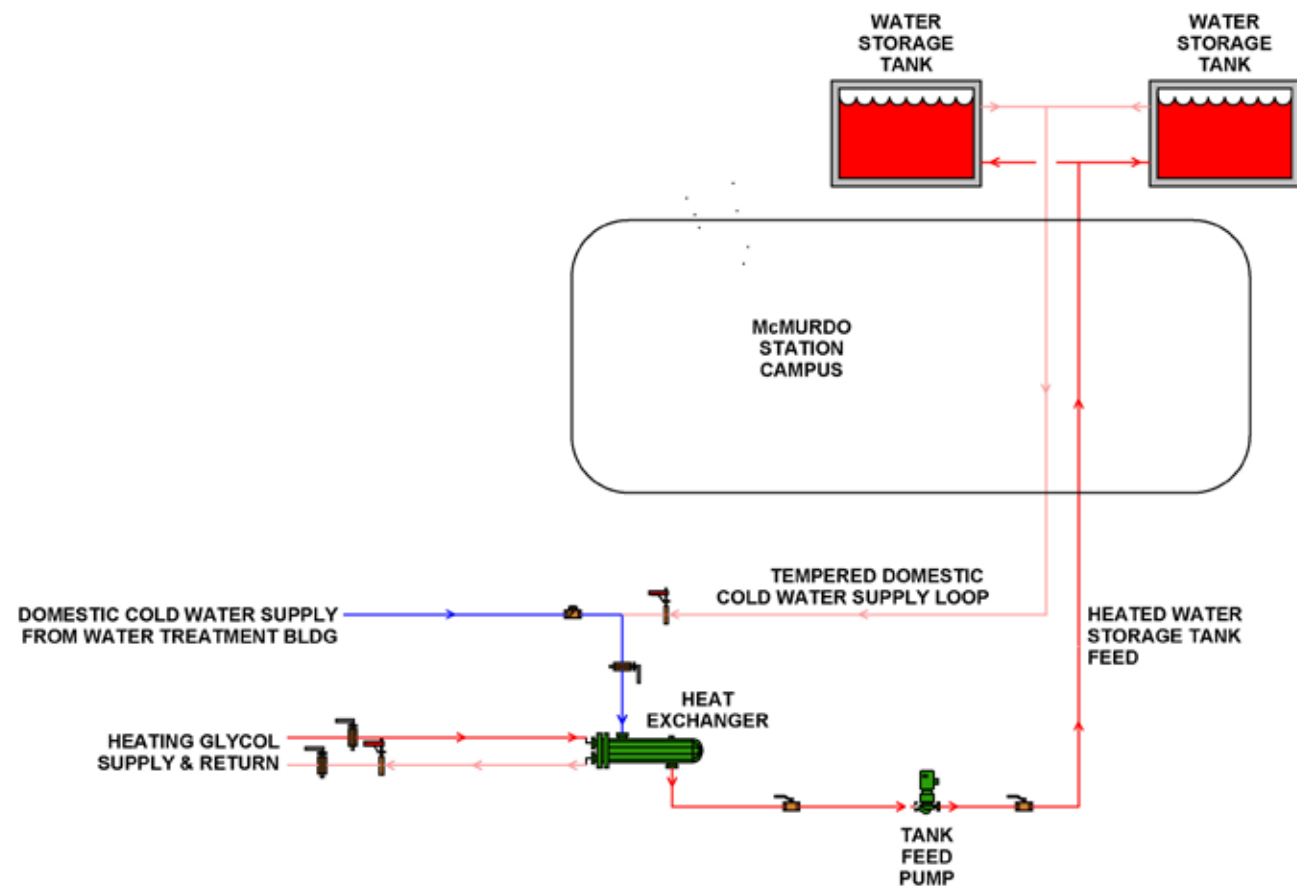

## PRIORITY 1.

### BUILDING SPACE HEATING

Space heating needs will form the largest component of the facility's heat requirements. Using a low temperature heat recovery loop, local space heating will be provided by a pumped secondary loop throughout each building. Surplus heat will then be injected back into the Heat Recovery Loop for use as described herein.

## PRIORITY 2.

### WATER STORAGE TANK HEATING

Water Sources (Domestic and Fire) are an important health and safety concern. Tank heating will be provided via a circulated heating loop. A shell and tube hydronic heat exchanger (STHX) will be utilized to heat the tank feedwater loop, which in turn will maintain tank temperature.

As domestic water is used, heated tank water is fed throughout the site's domestic water distribution loop. During periods of low water usage, a low-flow bypass valve will be opened to maintain heat in the tank and loops. Local recirculation branch lines to each building will maintain minimum water temperature for freeze protection.

Short dead-end runs and selected low flow loops will be heat traced as a backup to heated recirculation to ensure freeze protection is maintained.



# WASTE HEAT LOOP CONFIGURATION & CONTROL

## INSTANTANEOUS DOMESTIC WATER HEATER

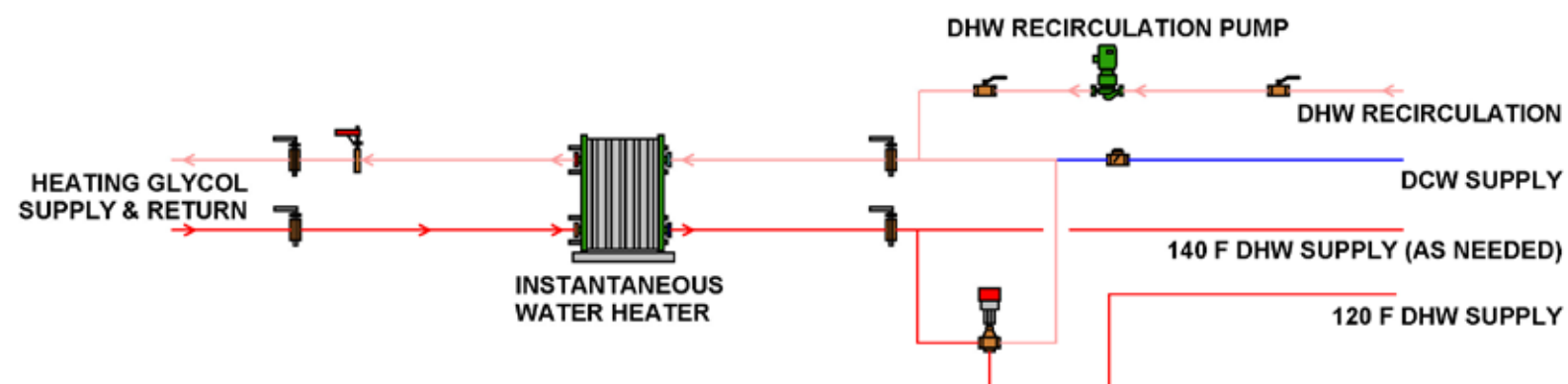

## STORAGE DOMESTIC WATER HEATER

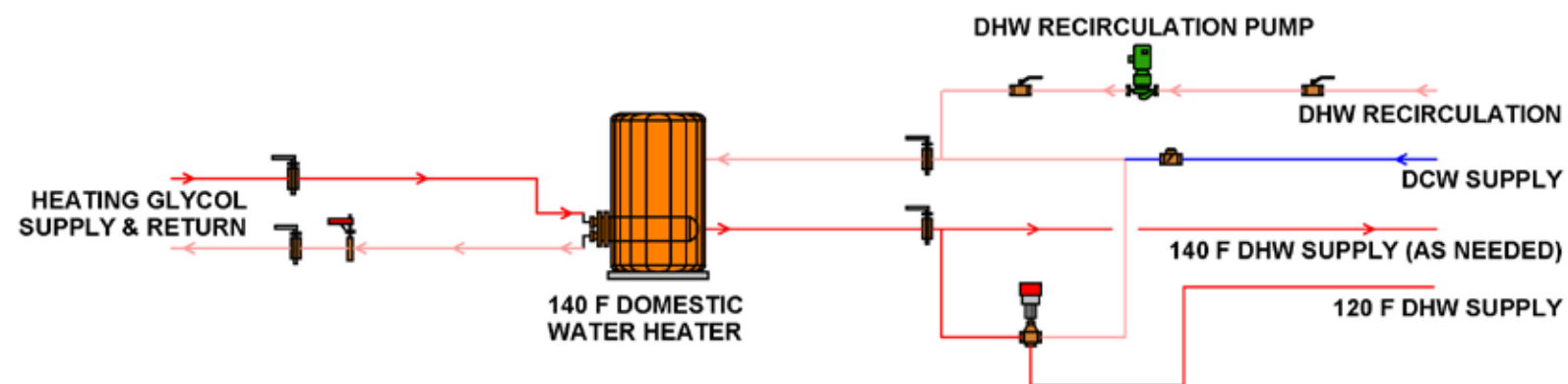

## PRIORITY 3.

## DOMESTIC WATER HEATING

Domestic water heating can be provided as either instantaneous through a plate/frame heat exchanger or in a storage tank with in-tank heater. Each strategy has unique advantages and will be applied as needed based on system configuration and usage during detailed design.

Plate/Frame Heat Exchangers (PFHX) will be used for low and intermittent flow to buildings to minimize standby losses. Domestic Hot Water (DHW) recirculation pumps will be used to maintain building DHW loop temperature and minimize warm-up water waste. DHW recirculation pumps will be operated intermittently as determined by building occupancy to reduce energy usage.

Traditional Domestic Hot Water Storage Tanks with In-Tank Heat Exchangers will be used for high flow, high-occupancy buildings to attenuate peak domestic heating loads. DHW will be generated and stored at 140 degree F to prevent Legionella colonization. 140 degree F DHW will be tempered through a mixing valve down to 120 degree F for distribution through the building, except where 140 degree F water is needed for Kitchen and Laundry needs. Domestic Hot Water (DHW) recirculation pumps will be used to maintain building DHW loop temperature and minimize warm-up water waste. DHW recirculation pumps will be operated intermittently as determined by building occupancy to reduce energy usage.

DHW recirculation pumps will be configured with electrically commutated motors (ECM) to minimize energy usage.

# WASTE HEAT LOOP CONFIGURATION & CONTROL

## PRIORITY 4. DESALINIZATION

Waste heat can support the desalination process as a low temperature source for preheating raw seawater.

Raw seawater will first be processed through a shell and tube heat exchanger (STHX) using treated effluent to recover effluent waste heat. Seawater will then pass through a second STHX using the site's waste heat loop as an energy source.

### DESALINIZATION PREHEAT

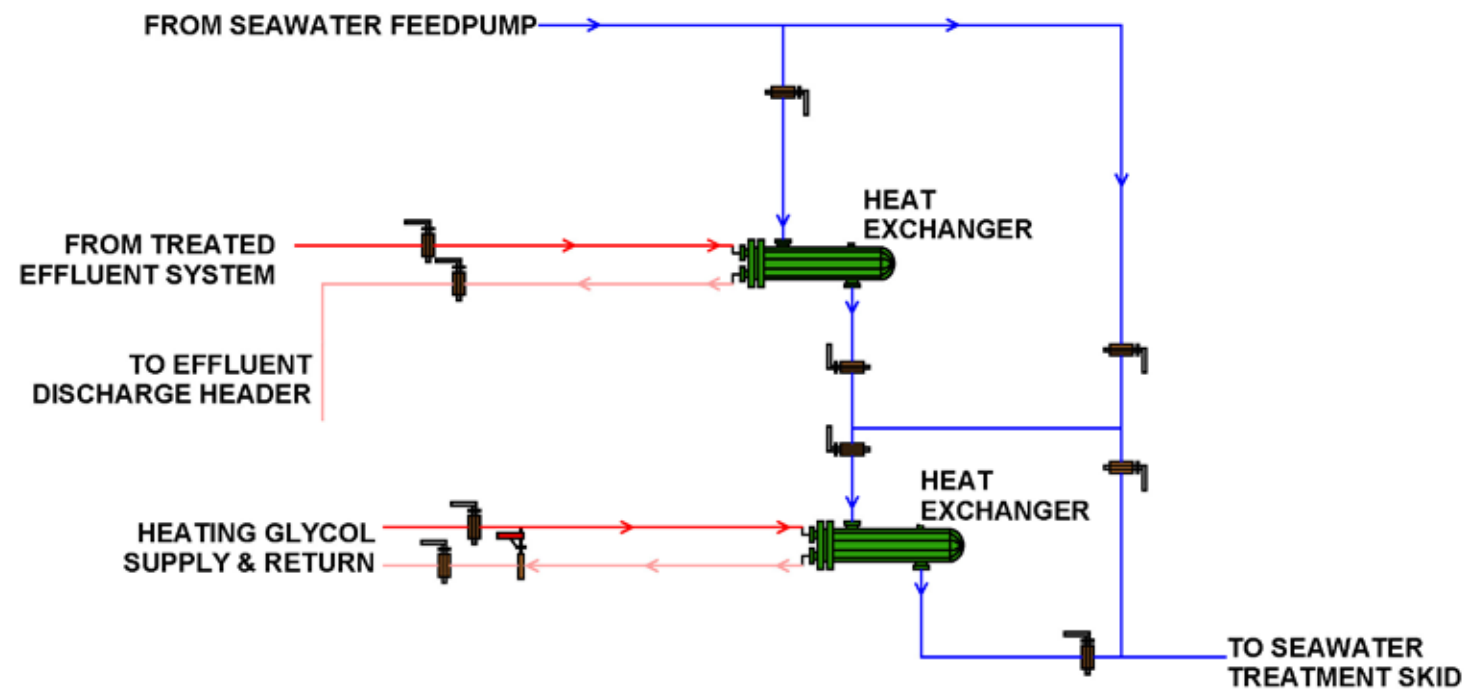



# WASTE HEAT LOOP CONFIGURATION & CONTROL

## SURPLUS POWER HEAT INJECTION

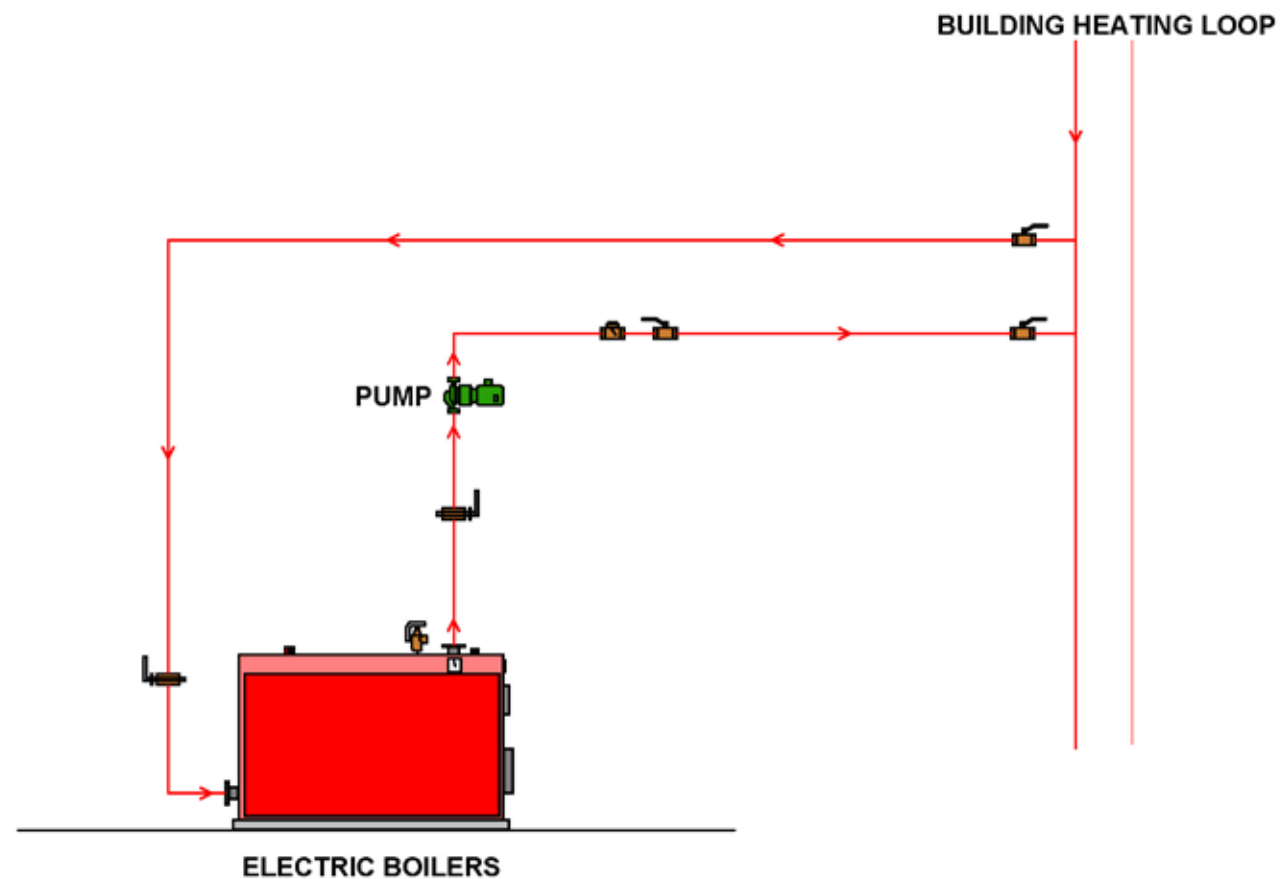

## PRIORITY 5. THERMAL STORAGE

When all other uses for waste heat have been exhausted, surplus heat will be transferred to the site Water Storage Tanks to reduce tank heating needs during peak usage.

## SUSTAINABILITY INITIATIVES

Wind Turbine and Solar Photovoltaic power generation is a targeted goal for long-term sustainability at McMurdo Station. Accordingly, the Heat Recover Loop will be designed to accommodate alternative heat sources as they come online.

Electric boilers will be used to harvest surplus power from connected sustainable sources for injection into local building heating loops. Electric boilers will be configured as variable flow, multistage and silicon controlled rectifier (SCR) controlled to maximize power utilization and reliability. Recirculation pumps will be configured with electrically commutated motors (ECM) to minimize pumping energy.

# INFORMATION TECHNOLOGY & TELECOMMUNICATIONS

---



# INFORMATION TECHNOLOGY & TELECOMMUNICATIONS

The USAP Information Technology Infrastructure is designed around the IT service requirements for the program. These service requirements are tightly integrated into the business processes for the program, work center needs, and future technology trends.

One focus of the McMurdo Station Master Plan is to design facilities that can support whatever IT&C infrastructure may be implemented in the future based on service criteria and program requirements. Since much of the analysis required for this is being completed in parallel to the Master Plan project, many of the IT&C design criteria are based on current service delivery to McMurdo Station. As future service criteria and program requirements are developed, the IT&C design criteria will likely, and should change. As such, the information presented in the following pages are for illustrative purposes. Detailed specifications will be further developed during the design phase.

The IT infrastructure is also heavily influenced by several partner agencies, and critical customers on station. NASA, JPSS and SPAWAR are the most integrated agencies and as such, they have been involved in requirements development to ensure their needs are met for facilities design, and IT&C infrastructure. Parallel analysis of the command and control functions at McMurdo Station has also been performed to develop facility and infrastructure requirements as those functions are tightly integrated in the IT&C infrastructure development.

## Outside and Inside Cable-Plant and Distribution Infrastructure

### *Facility Design Criteria*

- Outside cable plant intended to build out a core backbone that is adequately sized to allow for future growth and to isolate the end-point service locations from the core by using fringe connections at the nodes.
- Inside cable plant intended to use modern structured cabling systems, BICSI standards, horizontal & vertical risers and wiring closets for intermediate service distribution.
- Physical ring architecture segmented into redundant sections.
- Ring structure will include T-site and Arrival Heights area.
- One section of the ring can be disabled and the rest of the ring continues to provide service.
- “Nodes” separate ring sections.
- Buildings are dual-homed to separate nodes for redundancy.

### *Assumptions*

- Transitional Cable Plant is completed prior to demolition of existing buildings/infrastructure.
- Transitional Cable Plant provides same model of service as final product.
- McMurdo Station Telephony system is replaced and relocated prior to demolition of existing buildings/infrastructure.
- NASA/JPSS fiber-optic needs are incorporated into any new Cable Plant (RF over fiber)

## Primary Data Center and Offices (Network Operations, Broadcast Media, Co-location Service and Administration)

### *Facility Design Criteria*

- All spaces to have electronic key card access controls.

- All Data Center spaces to meet current Industry Best Practices for Power, Fire Suppression, Environmental, Security and Design criteria
- Backup generator with automatic switching for entire facility
- UPS system for Data Centers and critical workstations independent of other customers
- Redundant HVAC system that allows maintenance on HVAC without losing environmental conditions
- Redundant Outside physical plant pathways to station cable-plant ring
- Raised flooring with removable 2'X2' floor tiles
- Power provided under-floor
- Overhead cable-tray for signal cables
- Roof access to mount instrumentation and small RF antennas
- Loading dock access to general area with large access doors to Data Centers to allow pallet-jack delivery of large equipment
- 4'X8' loading dock storage for electronics warm-up
- Data center designed to 2008 ASHRAE Environmental Guidelines
- Provides full network, telephony, broadcast media and IT&C network related services for McMurdo Station
- Offices provide space for Network Engineers, Systems Administrators, SATCOM Engineer, Broadcast Engineer and rotating space for project personnel
- Office space includes central network and SATCOM monitoring capabilities

#### *Assumptions*

- Facility is able to support systems and services currently located in BL189 2nd floor, BL182 and BL165. As well as BL155 broadcast studio/CATV head end, record library and radio station.

### **Backup Data Center and Offices**

#### *Facility Design Criteria*

- All spaces to have electronic key card access controls
- All Data Center spaces to meet current Industry Best Practices for Power, Fire Suppression, Environmental, Security and Design criteria
- Backup generator with automatic switching for entire facility
- UPS system for Data Centers and critical workstations independent of other customers
- Redundant HVAC system that allows maintenance on HVAC without losing environmental conditions
- Redundant Outside physical plant pathways to station cable-plant ring
- Raised flooring with removable 2'X2' floor tiles
- Power provided under-floor
- Overhead cable-tray for signal cables
- Roof access to mount instrumentation and small RF antennas



- Loading dock access to general area with large access doors to Data Centers to allow pallet-jack delivery of large equipment
- 4'X8' loading dock storage for electronics warm-up
- Data center designed to 2008 ASHRAE Environmental Guidelines
- Provides full network, telephony, broadcast media and IT&C network related services for McMurdo Station
- Offices provide space for Network Engineers, Systems Administrators, SATCOM Engineer, Broadcast Engineer and rotating space for project personnel
- Office space includes central network and SATCOM monitoring capabilities

#### *Assumptions*

- Facility is able to support systems and services currently located in BL189 2nd floor, BL182 Telco, BL165 Data Center and MacOps.

### **Electronics Trade Shop (Comms, Telco)**

#### *Facility Design Criteria*

- Includes warm storage area for sensitive field electronics and electronic parts
- Includes Electronics bench testing/repair area large enough for 4 technicians to work simultaneously
- Loading dock and wide hallways for movement of field electronics
- Includes battery storage/charging facility with proper ventilation (possible co-location with SPAWAR and Alternative Energy battery facilities)
- Warm/cool storage for solar systems, wind systems, brackets and mounts
- Roof platform with access for testing/mounting RF equipment
- Co-located with SPAWAR Electronics Shop
- Co-located with Antenna Rigging Trade Shop
- Includes office space for IT&C communications staff

#### *Assumptions*

- IT&C Communications services will remain largely as they are today
- Prime Contractor Communications department, SPAWAR, and possibly Alternative Energy department would all benefit being co-located. (Reduced specialized facilities required around station)

## **Computer Trade Shop (Desktop Support)**

### *Facility Design Criteria*

- Includes warm storage for computers, computer and printer parts
- Includes work bench space and/or office space for 5 technicians

### *Assumptions*

- Station workstation footprint will remain the same as today, or increase
- Station workstation technology will remain the same as today (desktop computers) or move to a mobile/thin client technology
- Station print/fax service will be centralized in various buildings rather than distributed as they are today
- Station print/fax systems will be supported with local staff, and annual (at minimum) specialist visits from off-continent

## **Antenna Rigging Trade Shop (Antenna maintenance and rigging)**

### *Facility Design Criteria*

- Includes office space for antenna riggers
- Includes metal fabrication facilities with proper ventilation
- Co-located with Electronics Trade Shop
- Includes warm or cool storage for fabrication materials and parts
- Includes square footage to allow for tower sections to be laid out and/or stood up for fabrication and testing
- Includes overhead crane/lift capabilities
- Loading dock for movement of antenna and wind generator components
- Close proximity to Alternative Energy facility (co-share of tools and systems)

### *Assumptions*

- Antenna rigging shop will continue to work closely with Communications (Electronics) Shop and Alternative energy shop both sharing resources and performing fabrication for both
- Antenna rigging requirements for Station will remain at current levels, or increase as more remote sensing systems and antennas are introduced to the continent

## Service Desk Offices

### *Facility Design Criteria*

- Walk-up window for all Radio, computer and electronics needs
- Office space for Service Desk personnel

### *Assumptions*

- All IT&C related service requests will be routed through this facility, this will include walk-up service for radio, computer and mobile device issue
- This facility will provide phone support for all IT&C related issues
- Phone support for all facility and operational service requests will remain elsewhere. There may be an opportunity for consolidating these functions as well.

## RF Transmission/Receiving site(s)

### *Facility Design Criteria*

- Current Transmission facility (T-site) and environs will remain largely the same
- Current Black Island Receive facility will remain largely the same
- Backup generator able to support T-site and Crater Hill facilities would be included

### *Assumptions*

- Current HF, VHF, UHF, microwave and wireless network requirements would remain largely the same as they are today

## Airfield Communications Facility and distribution infrastructure

### *Facility Design Criteria*

- Single Communications Building, moveable on skis
- 30 foot microwave tower installed directly adjacent to communications building
- Primary power source provided by Runway facility power
- Backup Generator and UPS for facility
- HVAC system for heating/cooling facility, tied to backup generator
- Airfield buildings require new IT&C infrastructure to be installed

### *Assumptions*

- All airfield communications would be serviced via a single Communications facility
- Facility connected to McMurdo Station via redundant microwave link
- Local airfield communications distributed wirelessly
- Airfield local communications can operate independently of McMurdo Station (microwave connection to McMurdo not required for local Comms)
- No Telco cable-plant required between buildings at the airfield. However, the intent is to execute a major technology refresh for the airfield voice and data network services to provide an all wireless inter-facility distribution. This distribution will be based from the dedicated Airfield Communications building and will also provide backhaul communication links into McMurdo Station.

## **NASA/JPSS**

### **Primary Data Center and Offices**

#### *Facility Design Criteria*

- All spaces to have electronic key card access controls
- All Data Center spaces to meet current Industry Best Practices for Power, Fire Suppression, Environmental, Security and Design criteria
- Backup generator with automatic switching for entire facility
- UPS system for Data Centers and critical workstations independent of other customers
- Redundant HVAC system that allows maintenance on HVAC without losing environmental conditions
- Redundant Outside physical plant pathways to station cable-plant ring
- Raised flooring with removable 2'X2' floor tiles
- Power provided under-floor
- Overhead cable-tray for signal cables
- Roof access to mount instrumentation and small RF antennas
- Loading dock access to general area with large access doors to Data Centers to allow pallet-jack delivery of large equipment
- 4'X8' loading dock storage for electronics warm-up
- Data center designed to 2008 ASHRAE Environmental Guidelines

### *Assumptions*

- Facility is able to support systems and services currently located in BL189 1st Floor (NASA MGS)
- NASA/JPSS mission remains at today's level of support





## Backup Data Center and Offices

### *Facility Design Criteria*

- All Data Center spaces to meet current Industry Best Practices for Power, Fire Suppression, Environmental, Security and Design criteria
- Backup generator with automatic switching for entire facility
- UPS system for Data Centers and critical workstations independent of other customers
- Redundant Outside physical plant pathways to station cable-plant ring
- Raised flooring with removable 2'X2' floor tiles
- Power provided under-floor
- Overhead cable-tray for signal cables

### *Assumptions*

- NASA/JPSS would require a backup facility. (Currently there is none)

## SPAWAR

### Primary Data Center and Offices

#### *Facility Design Criteria*

- All spaces to have electronic key card access controls
- All Data Center spaces to meet current Industry Best Practices for Power, Fire Suppression, Environmental, Security and Design criteria
- Backup generator with automatic switching for entire facility
- UPS system for Data Centers and critical workstations
- Redundant HVAC system that allows maintenance on HVAC without losing environmental conditions
- Redundant Outside physical plant pathways to station cable-plant ring
- Raised flooring with removable 2'X2' floor tiles
- Power provided under-floor
- Overhead cable-tray for signal cables
- Roof access to mount instrumentation and small RF antennas
- Loading dock access to general area with large access doors to Data Centers to allow pallet-jack delivery of large equipment

### *Assumptions*

- SPAWAR mission remains at current levels with the possible increase of off-continent support

## **Backup Data Center and Offices**

### *Facility Design Criteria*

- All spaces to have electronic key card access controls
- All Data Center spaces to meet current Industry Best Practices for Power, Fire Suppression, Environmental, Security and Design criteria
- Backup generator with automatic switching for entire facility
- UPS system for Data Centers and critical workstations
- Redundant HVAC system that allows maintenance on HVAC without losing environmental conditions
- Redundant Outside physical plant pathways to station cable-plant ring
- Raised flooring with removable 2'X2' floor tiles
- Power provided under-floor
- Overhead cable-tray for signal cables
- Roof access to mount instrumentation and small RF antennas
- Loading dock access to general area with large access doors to Data Centers to allow pallet-jack delivery of large equipment

### *Assumptions*

- SPAWAR mission remains at current levels with the possible increase of off-continent support
- SPAWAR mission would remain the same or increase during a major station catastrophe as Emergency response and recovery operations would require substantial air and forecasting support

## **Electronics Trade Shop**

### *Facility Design Criteria*

- Includes warm storage area for sensitive field electronics and electronic parts
- Includes Electronics bench testing/repair area large enough for 4 technicians to work simultaneously
- Loading dock and wide hallways for movement of field electronics
- Includes battery storage/charging facility with proper ventilation (possible co-location with IT&C and Alternative Energy battery facilities)
- Warm/cool storage for solar systems, wind systems, brackets and mounts



- Roof platform with access for testing/mounting RF and weather equipment
- Potential co-location with IT&C Electronics Shop
- Potential co-location with Antenna Rigging Trade Shop
- Includes office space for SPAWAR GEM staff

#### *Assumptions*

- SPAWAR services will remain largely as they are today

### **Operations Facility (MacWeather, MacCenter)**

#### *Facility Design Criteria*

- 1000 square feet for MacWeather offices to include walk-up window
- Weather displays at walk-up window
- Windows looking outside for MacWeather
- Roof access for MacWeather
- Briefing area for weather briefings, may be shared with other agencies
- Close proximity to Mission Operations, SFA, and fixed wing planners and contractors
- MacCenter integration into Communications Center with access to full suite of communications systems
- Offices for 2 SPAWAR Managers
- Access to temporary office space for TDY SPAWAR personnel
- Remote camera monitoring of critical weather and flight locations

#### *Assumptions*

- MacWeather and MacCenter functions would largely remain as they are currently
- Off-shoring of MacWeather and MacCenter functions are not in scope due to cost of additional IT&C infrastructure to provide increased up-time of WAN communications

THIS PAGE INTENTIONALLY LEFT BLANK.

## Command and Control, Operations Center

### *Facility Design Criteria*

- 1232 square feet for MacOps, Fire Dispatch and MacCenter communications operators
- Communications Center designed to Industry Standard 911 dispatch and Air Traffic Control center standards
- 2 Offices for Communications staff
- Emergency management office (shared)
- 2 Offices for fixed wing staff
- Printer/copier/storage in close proximity
- 1080 square feet for Emergency Operations Center/Meeting room
- Emergency Operations specific Communications console, private room (sensitive comms) and library/storage
- Outside windows for Mission Communications and Emergency Operations Center
- Internal windows for Mission Communications and Emergency Operations Center
- Wall displays for Mission Communications and Emergency Operations Center
- UPS for Communications consoles and Emergency Operations Center
- Backup Generator for Mission Operations area
- MacOps, MacCenter, Firehouse Dispatch communications functionality
- Close proximity to Mission Operations, SFA, and fixed wing planners and contractors
- Remote camera monitoring of critical mission operations locations

### *Assumptions*

- MacOps, Firehouse Dispatch and MacCenter functions would be combined into one facility
- Off-shoring of MacOps and MacCenter functions are not in scope due to cost of additional IT&C infrastructure to provide increased up-time of WAN communications

# FIRE PROTECTION STRATEGY

---



# FIRE PROTECTION STRATEGY

## INTRODUCTION

In order to provide a holistic fire protection design strategy, this plan identifies three main pillars to achieve fire management, notably: control of the combustion process, fire suppression, and control of fire spread through mitigating construction. These overarching principles will provide a foundation for the evaluation of fire initiation and development; spread, control, and management of smoke; fire detection and notification; automatic and manual fire suppression; egress provisions including occupant behavior; and passive fire protection. In the future, each of these subsystems will be analyzed independently, as well as in combination, to determine their layered affect towards the achievement of defense-in-depth.

## OBJECTIVES

The objective of the Fire Protection Program is to provide a holistic design strategy. In order to achieve this goal, the following fire protection features will be incorporated into the Program:

- A robust and reliable fire water supply
- Automatic sprinkler systems will be installed in all critical structures with the capability of complete fire extinguishment without manual fire-fighting intervention
- Automatic fire detection and notification (alarm) systems will be installed in all structures with the intent to: provide early warning of a fire; notify occupants through voice messaging; alert emergency personnel; and activate fire protection systems, such as smoke management systems, fire/smoke dampers, and door releases
- Non-combustible (Type II) or fire-resistive (Type I) construction for all significant buildings with the intent to prevent structural collapse
- Fire/smoke barriers will be located to: facilitate safe evacuation or defend-in-place areas that are commensurate with the fire hazard; isolate different occupancies; and minimize fire/smoke spread and property loss potential
- Zoned smoke control systems will be provided in all significant buildings with the intent of reducing the hazard resulting from smoke by limiting its production, controlling its movement, and reducing its volume
- An effective fire prevention program, including appropriate controls on accumulations of combustibles, ignition sources, housekeeping, and hazardous materials/processes
- Physical access and appropriate equipment to facilitate effective intervention by the fire department, such as an interior standpipe system(s) in multi-story or large facilities with complex configurations

The incorporation of these active, passive, and manual fire protection systems will provide robust and redundant layers of fire safety for each facility that is associated to the McMurdo Station Master Plan.

## FIRE PROTECTION SYSTEMS

It is recommended that the following fire features be implemented to ensure that a fire is successfully extinguished or contained to the room of origin until the fire response arrives.

### FIRE WATER SUPPLY

#### **Existing Site Fire Water System**

Water is currently supplied to the site through an existing desalinization plant which produces dual purpose potable water. The current water distribution system uses utility pumps located adjacent to the storage tank to lift water up through a 6" main. This Master Plan recommends improvements. The existing system is not capable of delivering the required fire flow necessary to support the automatic and manual fire suppression systems (automatic wet pipe and dry pipe systems), and fire hydrants. Due to this deficiency, this plan upgrades the fire water storage and distribution system to provide a robust and reliable water supply. The "utility" water is then stored in a 100,000 gallon storage tank located near sea level.

#### **Proposed Site Fire Water System**

The domestic/fire "dual use" water supplied by the existing utility system will be re-directed into dedicated storage tanks. The combined domestic/fire water storage tanks will be positioned at an elevation of approximately 100 feet above the main site in order to attain gravity induced pressure. The capacity of the fire water storage tanks may be adjusted during design to ensure minimum fire flow and flow duration criteria as described in the IFC Appendix B.

The required fire flow rate and flow duration is determined based on the area and construction type of the largest facility, as listed in the IFC, Table B105.1. The largest facility area is assumed to be greater than 50,000 square feet and the construction is Type IIB. IFC Table B105.1 indicates the minimum required fire flow rate at 4,750 gpm with a flow duration of four hours. The minimum required fire flow rate is then multiplied by the flow duration; which results in a minimum fire water storage capacity of approximately 1,000,000 gallons. The existing utility water system must be capable of refilling the fire water storage tank in eight continuous hours or less. In order to replenish 1,000,000 gallons of water in eight hours, a minimum flow rate of approximately 2,100 gpm is required. An alternative option for meeting the replenishing rate would be to provide additional storage capacity.

While the now current IFC Table B105.1 will serve as a starting point for determining fire flow rates, it is critical that as design proceeds criteria and requirements be reviewed so that a sufficient system is developed. Initial studies suggest two tanks totaling 1,000,000 gallons (housed separately in two 500,000 gallon tanks for operational and strategic redundancy) meets requirements but this will be addressed and confirmed in subsequent design phases.

#### **Proposed Site Fire Water Distribution**

Fire water will be supplied to the dual use distribution mains through two dedicated fire pumps located within the Fire Water Pumphouse. The two fire pumps will be designed for 100% redundancy and will be separated by 2 hour fire-rated construction.

The combined domestic/fire water distribution mains will be of a looped/gridded type that provides two-way water flow to any point in the system. Sectional control post indicator valves (PIV) will be installed to limit the number of hydrants and individual suppression systems made inoperative during a single line break or impairment. Fire hydrants will be installed in accordance with the IFC and NFPA guidelines to ensure adequate means of manual fire-fighting coverage is furnished. Fire hydrants are required to be within 400 feet of all portions of the exterior of the building. The spacing between fire hydrants will be a maximum of 300 feet adjacent to the fire access road and around each facility. Fire hydrants will be protected by bollards installed within a 3 foot radius.





## FIXED AUTOMATIC SUPPRESSION SYSTEMS

### Automatic Suppression

Automatic sprinkler systems will be installed within all structures located on the McMurdo Station site. Alternative fire suppression systems will be evaluated as necessary where special hazards exist. The intent of these systems are to completely extinguish a fire with minimal manual fire-fighting intervention. The automatic wet pipe, dry pipe, pre-action, and deluge sprinkler system design requirements will include the following:

- Automatic fire sprinkler systems will be designed and installed in accordance with NFPA 13, Standard for the Installation of Sprinkler Systems
- Hydraulically designed fire sprinkler systems will be sized for a supply pressure of 90 percent of the rated system pressure, but no less than 10-psig below the supply curve.

*Administrative/Laboratory Areas:* Automatic wet pipe sprinkler system designed to meet the requirements of NFPA 13 Ordinary Hazard Group 2 with a density of 0.20 gpm/ft<sup>2</sup> over 1500 square feet.

*Residential Areas:* Automatic wet pipe sprinkler system, utilizing residential sprinklers, designed to meet the requirements of NFPA 13 Ordinary Hazard Group 2 with a density of 0.20 gpm/ft<sup>2</sup> over 1500 square feet.

*Storage Areas:* Automatic wet or dry pipe sprinkler systems designed to control high challenge fire hazards. The systems will meet the requirements for storage occupancies in accordance with NFPA 13, Chapters 12 through 20.

*Primary Data Center and High Value Equipment Areas:* Clean agent fire suppression systems will be provided in areas where essential electronics could be damaged by water. The fire suppression system will be designed and installed in accordance with NFPA 2001, Standard on Clean Agent Fire Extinguishing Systems.

*Commercial Kitchen Areas:* Automatic/Manually activated wet chemical suppression systems will be provided in commercial cooking equipment such as deep-fat fryers, griddles, range tops, and broilers where Class K type fire hazards exist. The chemical agent will be UL listed and the systems will meet the requirements of NFPA 17A and UL 300.

## MANUAL SUPPRESSION

### Manual Suppression

Class I standpipes will be provided for manual fire suppression capability in residential and administrative occupancies. Class I systems will utilize 2.5 " hose connections. It may be determined that the 2.5" connections should not be furnished with hoses due to deterioration issues but that will be determined during design. The Class I standpipes will be designed and installed in accordance with NFPA 14.

Means for supporting manual fire suppression efforts within each building will consist of portable, multipurpose, dry-chemical (A, B, & C) extinguishers in accordance with the IFC and NFPA 10.

## DETECTION & ALARM SYSTEMS

Addressable fire detection and alarm systems will be installed throughout each building in accordance with NFPA 72. The fire detection and alarm systems will include the following functions:

- Local alarm to notify occupants for evacuation purposes
- Audible alarm using voice messaging
- Visual alarms for occupants that might be hearing impaired
- Transmission of alarm to the responding fire department command center
- Control Panel located at a main entrance or similar location where emergency responders can access information
- Manual alarm station(s)
- Automatic fire detection
- HVAC shutdown
- Zoned smoke control system activation
- Fire door closure(s)

## LIFE SAFETY

Life safety provisions will be incorporated into the design of each facility in accordance with the IBC. Furthermore, the use and occupancy classification(s) of each area of a building will be defined as described by the IBC.

### Means of Egress Features

Emergency exits will be available, from all areas of a facility, within the allowable maximum travel distance and common path of travel for the specific occupancy. Dead-end corridors shall not exceed 50 feet. Additional fire protection evaluations will be required where egress travel distances cannot be prescriptively met.

The method of performing accountability of facility personnel will be determined during preliminary and detailed design phases. Emergency lighting and marking of the means of egress will be provided in accordance with the IBC.



## FIRE DEPARTMENT RESPONSE & EMERGENCY PLANNING

### **Fire Service Access Features**

Fire service access features will be provided to each facility in accordance with the IFC, Chapter 5, and relevant NFPA codes and standards. Multiple routes for fire service access will be furnished to each facility. Access “roads” will be provided within 150 feet of all portions of each facility and will be a minimum of 26 feet wide. Dead ends exceeding 150 feet will be constructed with turnaround areas to mitigate access hazards associated with maneuvering large emergency vehicles. Street signs and marking will be provided where required by the AHJ. Approved walkways will serve as the primary connection between the fire service access roads and the building openings such as exterior doors.

### **Emergency Planning**

Prior to operations, the Fire Department and NSF/ASC management personnel will prepare emergency preparedness plans that will provide pertinent information about each facility and interior fire areas.

# CONCLUSION

---



# CONCLUSION

This Master Plan has taken a critical look at the current layout and operations of McMurdo Station, and through identification and thorough evaluation of constraints and opportunities, makes detailed recommendations for its future development. It is anticipated that implementation of those recommendations, including the detailed facility and infrastructure plans, will result in improved operational and energy efficiency and will safely allow the conduct and support of a broad range of science in this unique part of the globe.

Additionally, this Master Plan provides a roadmap to guide effective development of McMurdo Station, and it should be adjusted, refined, and revisited as requirements and building technologies evolve, and when deemed appropriate. It also recognizes that as design begins, further engineering evaluation and refinement of the recommendations and facility programs will continue. Finally, this plan is intended to generate discussion on evolution and improvement of McMurdo Station.