



# Geothermal Power and Interconnection: The Economics of Getting to Market

David Hurlbut

**NREL is a national laboratory of the U.S. Department of Energy, Office of Energy Efficiency & Renewable Energy, operated by the Alliance for Sustainable Energy, LLC.**

**Technical Report**  
NREL/TP-6A20-54192  
April 2012

Contract No. DE-AC36-08GO28308

# Geothermal Power and Interconnection: The Economics of Getting to Market

David Hurlbut

Prepared under Task No. WE11.0815

**NREL is a national laboratory of the U.S. Department of Energy, Office of Energy Efficiency & Renewable Energy, operated by the Alliance for Sustainable Energy, LLC.**

## NOTICE

This report was prepared as an account of work sponsored by an agency of the United States government. Neither the United States government nor any agency thereof, nor any of their employees, makes any warranty, express or implied, or assumes any legal liability or responsibility for the accuracy, completeness, or usefulness of any information, apparatus, product, or process disclosed, or represents that its use would not infringe privately owned rights. Reference herein to any specific commercial product, process, or service by trade name, trademark, manufacturer, or otherwise does not necessarily constitute or imply its endorsement, recommendation, or favoring by the United States government or any agency thereof. The views and opinions of authors expressed herein do not necessarily state or reflect those of the United States government or any agency thereof.

Available electronically at <http://www.osti.gov/bridge>

Available for a processing fee to U.S. Department of Energy and its contractors, in paper, from:

U.S. Department of Energy  
Office of Scientific and Technical Information  
P.O. Box 62  
Oak Ridge, TN 37831-0062  
phone: 865.576.8401  
fax: 865.576.5728  
email: <mailto:reports@adonis.osti.gov>

Available for sale to the public, in paper, from:

U.S. Department of Commerce  
National Technical Information Service  
5285 Port Royal Road  
Springfield, VA 22161  
phone: 800.553.6847  
fax: 703.605.6900  
email: [orders@ntis.fedworld.gov](mailto:orders@ntis.fedworld.gov)  
online ordering: <http://www.ntis.gov/help/ordermethods.aspx>

Cover Photos: (left to right) PIX 16416, PIX 17423, PIX 16560, PIX 17613, PIX 17436, PIX 17721



Printed on paper containing at least 50% wastepaper, including 10% post consumer waste.

# Table of Contents

List of Figures .....	iv
List of Tables.....	iv
<b>1 Introduction .....</b>	<b>1</b>
<b>2 Background .....</b>	<b>3</b>
<b>3 Planning and Operating the Transmission System.....</b>	<b>10</b>
Available Capability on Existing Lines .....	11
Network Service.....	11
Point-to-Point Service.....	12
The Uphill Economics of New Transmission.....	16
<b>4 Distributed Generation .....</b>	<b>22</b>
<b>5 Where Geothermal Fits into Transmission Planning .....</b>	<b>24</b>
Conventional Hydrothermal.....	25
Emerging Geothermal Technologies .....	26
Co-Production .....	27
Summary .....	28
<b>6 Opportunities for Development .....</b>	<b>30</b>
Northwest.....	32
California .....	32
Renewable Energy Zones .....	33
<b>7 Conclusions.....</b>	<b>37</b>
<b>References .....</b>	<b>38</b>
Utility Integrated Resource Plans .....	39

## List of Figures

Figure 1. Components of the electricity system.....	3
Figure 2. Balancing authorities in the Western Interconnection.....	4
Figure 3. The Western, Eastern, and Texas Interconnections.....	5
Figure 4. Western Renewable Energy Zones with known geothermal potential.....	7
Figure 5. Geothermal resource favorability in the western United States .....	8
Figure 6. Geographic concentration of North American geothermal resources, 2010 .....	10
Figure 7. Northern Nevada's local transmission network .....	15
Figure 8. Path 24 export rating and Reno peak load (monthly).....	16
Figure 9. Total line and substation costs per megawatt of transfer capability.....	18
Figure 10. Effective revenue requirement for transmission per megawatt-hour delivered.....	19
Figure 11. Geothermal co-production as distributed generation .....	22
Figure 12. Distribution of generation capacity in WECC by size of plant .....	24

## List of Tables

Table 1. Capability on Existing Paths with Known Geothermal Potential (2009) .....	14
Table 2. Approximate Cost of Transmission by Size and Capability.....	17
Table 3. Generation Groupings and Transmission Requirements .....	29
Table 4. Base Load Opportunities in BAs with Access to Significant Geothermal Resources .....	31
Table 5. Renewable Energy Zone Initiatives and Status .....	35

# 1 Introduction

Geothermal technologies have the potential to contribute significantly to the U.S. electricity portfolio. To do that, however, the industry needs to be knowledgeable about transmission planning and grid operations. This need will become more crucial as new geothermal technologies emerge from the development stage and begin to become commercialized. Once new geothermal technologies reach commercialization—that is, when all-in costs become low enough that deployment at scale would not cause customer rates to become unreasonably high—geothermal’s economic fate could depend on how well it adapts to the realities of transmission planning.

This report provides a baseline description of the transmission issues affecting geothermal technologies. It is intended for geothermal experts in either the private or public sector who are less familiar with how the electricity system operates beyond the geothermal plant. The report begins with a comprehensive overview of the grid, how it is planned, how it is used, and how it is paid for. The report then overlays onto this “big picture” three types of geothermal technologies: conventional hydrothermal systems; emerging technologies such as enhanced engineered geothermal systems (EGS) and geopressured geothermal; and geothermal co-production with existing oil and gas wells. Each category of geothermal technology has its own set of interconnection issues, and these are examined separately for each. The report draws conclusions about each technology’s market affinities as defined by factors related to transmission and distribution infrastructure. It finishes with an assessment of selected markets with known geothermal potential, identifying those that offer the best prospects for near-term commercial development and for demonstration projects.

Interconnection affects all types of geothermal technologies, although not every technology has precisely the same challenges. This analysis contemplates the following types of geothermal technologies.<sup>1</sup>

- *Hydrothermal*: Conventional geothermal electric generation from naturally occurring underground steam, or from pressurized underground hot water. These are the most common geothermal generating technologies in use today. In the United States, most conventional hydrothermal generating capacity is in Nevada and California.
- *Enhanced geothermal systems (EGS)*: Electric generation using heat by creating subsurface fractures in high-temperature formations. Water injected into the fractures returns as steam or pressurized hot fluid, which is used to generate electricity. EGS is an emerging geothermal technology, but demonstration projects are proving advances in several crucial component areas.
- *Coproduced fluids*: Electric generation using high-temperature water from oil and gas production. The electric generating capacity for wells with coproduction

---

<sup>1</sup> Categorizations and descriptions drawn from Jefferson W. Tester et al., “The Future of Geothermal Energy: Impact of Enhanced Geothermal Systems (EGS) on the United States in the 21<sup>st</sup> Century,” Massachusetts Institute of Technology, 2006 [hereinafter “MIT Report”]; and Geothermal Energy Association, “The State of Geothermal Technologies,” Part 1 (2007) and Part 2 (2008).

capability tends to be small and depends on the amount of water present with oil and gas production.

- *Geopressured geothermal resources*: Like electric generation from coproduced fluids, except that the fluids are under geological pressure. The Gulf Coast of Texas and Louisiana has the largest potential in the United States, but geopressured conditions exist in other basins as well. While not new—geopressured systems were evaluated as far back as the 1970s—technological improvements could make geopressured systems economically viable.

Because the family of future geothermal resources is diverse, the analysis addresses the entire range of interconnection issues, not just transmission. Some geothermal generation will have no transmission issues at all, for the simple reason that they would not connect to the transmission system but would instead be distributed resources. Whether a particular geothermal option utilizes the transmission or distribution system to deliver its energy depends largely on characteristics inherent to the technology itself. Therefore, this analysis distinguishes between transmission and distribution issues.

This report constitutes a top-down analysis that focuses on how today's system operates as an integrated whole. It assumes hypothetically that geothermal generation will increase by orders of magnitude over the next one to two decades. Without such growth, interconnection issues will tend to be project specific and anecdotal, and the systematic issues addressed in this report will be less pertinent. Several technical challenges stand in the way of such growth and are the subject of ongoing research by DOE and others. The purpose here is not to predict whether growth will occur, but rather:

- To anticipate the interconnection issues that may arise in the event that technological breakthroughs remove the current barriers and enable accelerated geothermal deployment
- To identify the markets where geothermal technologies might enjoy the greatest affinity because interconnection issues would be less problematic.

## 2 Background

*Transmission* is the high-voltage component of the electricity delivery system; *distribution* is the low-voltage component. Transmission is the electric system's superhighway, carrying bulk power long distances along a few high-volume paths. Distribution is a collection of many widely dispersed small-volume paths leading to homes, businesses, and other end-use customers in one area. Substations are the points at which power steps down from the high-voltage transmission system to the lower voltage distribution system, essentially functioning as the off-ramp from the electric superhighway to a local neighborhood. One transmission system feeds many distribution systems. Figure 1 illustrates the main segments of the electricity system.

The distinction between the transmission and distribution systems is important to geothermal technologies because it identifies a project's interconnection issues. Among the issues that differ greatly are: impacts on the rest of the grid, planning requirements, operational obligations, sensitivity to economies of scale, and the time required to obtain approval and full interconnection.

The geographic extent of the local transmission network—which includes all generators connected to the transmission utility's lines, and all distribution systems served by those lines—is the local balancing authority (BA) area. Generators within a BA are managed so that their total real-time output matches real-time network demand as closely as possible, taking into account net power transfers in and out of the control area. Figure 2 shows the location and size of BA areas in the Western Interconnection.

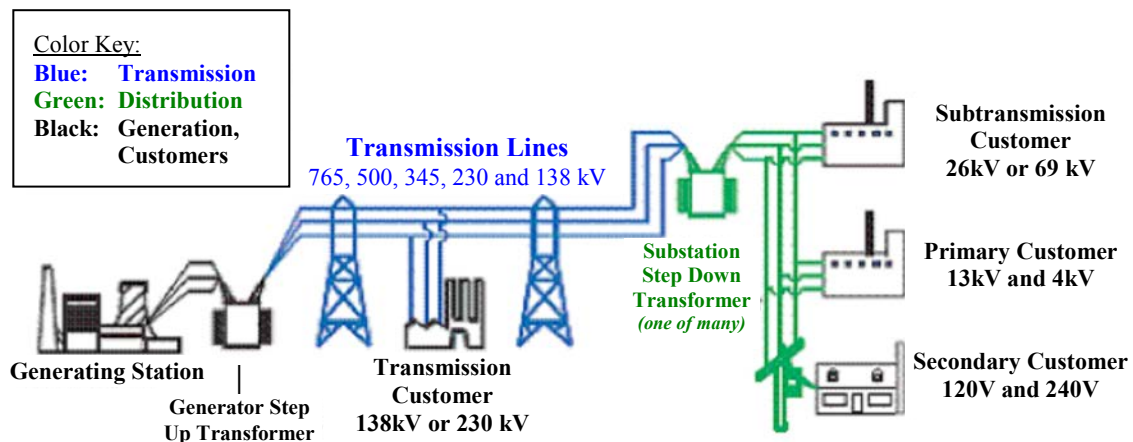

Source: North American Electric Reliability Corporation

**Figure 1. Components of the electricity system**



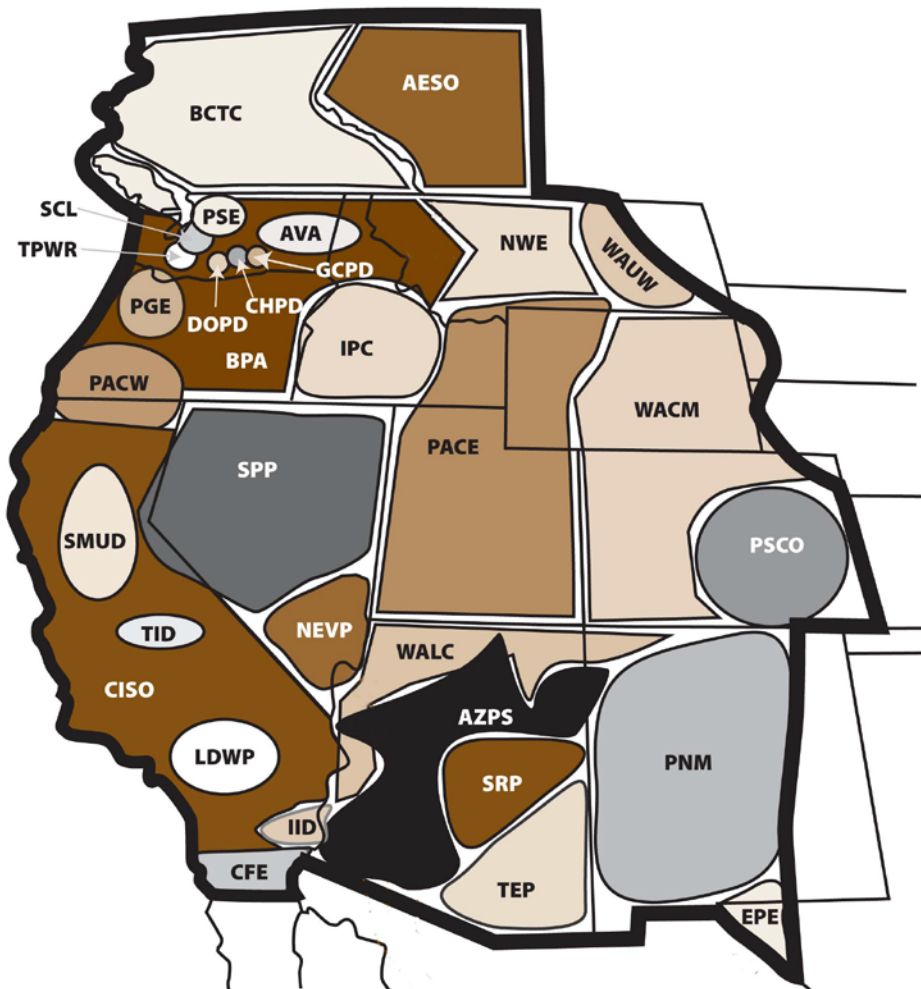

- Alberta Electric System Operator (AESO)
- Arizona Public Service Company (AZPS)
- Avista Corporation (AVA)
- Bonneville Power Administration (BPAT)
- British Columbia Transmission Corporation (BCTC)
- California Independent System Operator (CISO)
- Comisión Federal de Electricidad (CFE)
- El Paso Electric Company (EPE)
- Idaho Power Company (IPC)
- Imperial Irrigation District (IID)
- Los Angeles Department of Water and Power (LDWP)
- Nevada Power Company (NPC)
- NorthWestern Energy (NEW)
- PacifiCorp East (PACE)
- PacifiCorp West (PACW)
- Public Service Company of Colorado (PSCO)
- Public Service Company of New Mexico (PNM)
- PUD No. 1 of Chelan County (CHPD)
- PUD No. 1 of Douglas County (DOPD)
- PUD No. 2 of Grant County (GCPD)
- Puget Sound Energy (PSE)
- Sacramento Municipal Utility District (SMUD)
- Salt River Project (SRP)
- Seattle City Light (SCL)
- Sierra Pacific Power Company (SPP)
- Tacoma Power (TPWR)
- Tucson Electric Power Company (TEP)
- Turlock Irrigation District (TID)
- Western Area Power Administration, Colorado-Missouri Region (WACM)
- Western Area Power Administration, Lower Colorado Region (WALC)
- Western Area Power Administration, Upper Great Plains West (WAUW)

Source: Western Electricity Coordination Council. Map shows load-serving BAs. Energy-only BAs are not shown.

**Figure 2. Balancing authorities in the Western Interconnection**

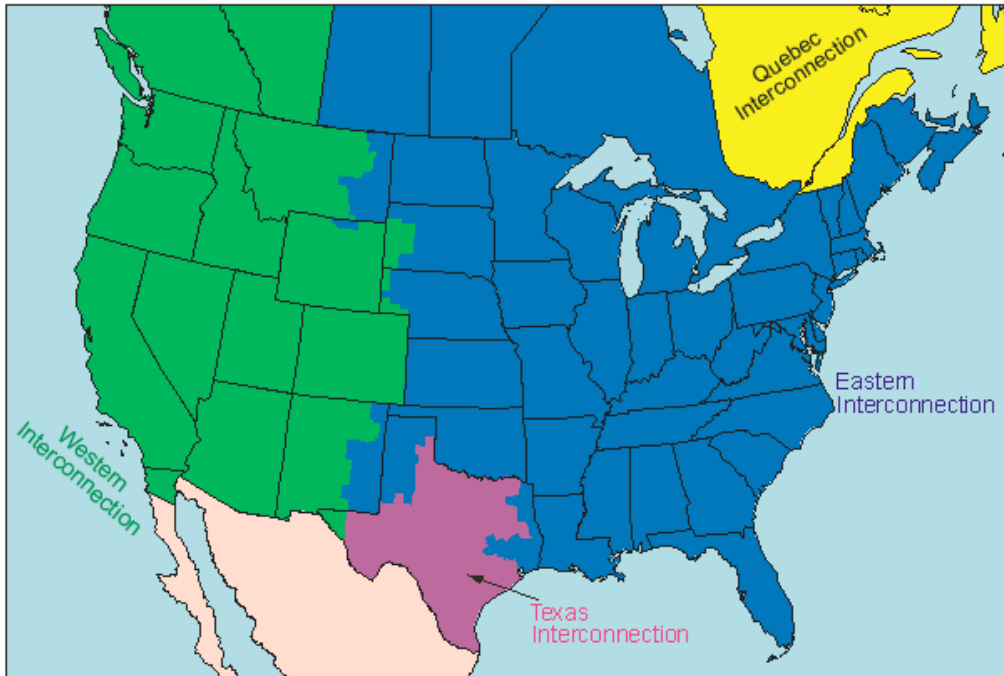

**Figure 3. The Western, Eastern, and Texas Interconnections**

A BA extends as far geographically as all the meters from which it collects data. Neighboring BAs can nevertheless transfer power from one system to another, as long as each BA accurately accounts for its import or export. Transfers among a group of BAs are physically feasible as long as all of the BAs are *synchronously connected*—that is, the transmission networks operate at the same electrical frequency and are capable of being tied together during normal operating conditions.

The continental United States has three large regions capable of synchronous operations: the Western Interconnection, the Eastern Interconnection, and the Texas Interconnection. Figure 3 shows the extent of the three interconnections (two of which extend into Canada) and the Quebec Interconnection. As a general rule, power transfers *within* an interconnection involve financial and contractual challenges but are physically and technically feasible. Transfers *between* interconnections are technically difficult, as it requires special (and costly) equipment to make the transfer physically possible.

Throughout much of this report, the analytical focus will be the Western Interconnection. Good geothermal resources are more widespread throughout the West, and nearly all of the existing geothermal development within the United States to date has happened in California, Nevada, Utah and Idaho. Because of the demonstrated commercial interest, interconnection issues have come to the forefront sooner and may be examined empirically in the context of the entire Western Interconnection. Nevertheless, many of the insights gained from examining geothermal interconnection issues in the West will be applicable to future development in Texas, Louisiana, West Virginia, and other areas of the East where underground heat indicates some latent geothermal potential.

The maps shown in Figure 4 and Figure 5 provide further geographic context for the analysis in the report. Figure 4 shows renewable energy zones (REZs) that are the focus of regional transmission planning by the Western Governors' Association (WGA) and the Western Electricity Coordinating Council (WECC). The zones represent areas in the Western Interconnection where renewable resources are the most concentrated and are likely to have their highest capacity factors, such that a large transmission line from a zone would entail relatively less economic risk. Zone selection was based on stakeholder input and technical analysis conducted by NREL and its subcontractor Black & Veatch. The outcome was endorsed by a steering committee comprising state and provincial policymakers and accepted by the governors in June 2009. Potential resources that were quantified for each REZ were screened not only for their native quality but also for the likelihood that commercially significant development could occur in that area. Seven of these multi-resource areas have significant geothermal potential, based on existing development and exploration as of 2009. Thus, the geothermal resource potential included in a REZ represents current and near-term development prospects for conventional hydrothermal resources, as well as for future enhanced geothermal systems (EGS) development that takes advantage of information on nearby exploration and development to minimize exploration costs and siting risk.<sup>2</sup>

The hub circles in Figure 4 are scaled to show relative annual production potential of all renewable resources in a REZ. (The circles do not indicate the perimeter of a development area; many geothermal resources that were counted toward a REZ are actually outside the circles shown on the map.) Because the zones in southern California and western Utah include large amounts of solar potential in addition to geothermal, these hubs have a larger estimated energy potential than the REZs in northern Nevada, southern Oregon and Idaho, which have significant geothermal potential but little else.

Figure 5 shows the match between the seven REZs with identified geothermal potential and the native favorability contours for EGS, based on geological data compiled by Southern Methodist University.<sup>3</sup> It is important to note that REZs are not geographically precise. For example, stronger commercial interest in geothermal power relative to wind power would shift the geographic focus of the southern Oregon REZ in the direction of the more favorable geothermal resources in the south-central part of the state (which were counted in the estimation of REZ resource potential). Similarly, the centroid of the southwest Idaho REZ is between two favorable areas shown in Figure 5. Geothermal potential from both of these favorable areas was counted in the analysis for the southwest Idaho REZ, reflecting the assumption of one transmission access point serving both areas.

---

<sup>2</sup> For details on the analysis behind zone identification, see Ryan Pletka and Josh Finn, "Western Renewable Energy Zones, Phase I: QRA Identification Technical Report," NREL/SR-6A2-46877, October 2009.

<sup>3</sup> David Blackwell and Maria Richards, *Geothermal Map of North America*, American Association of Petroleum Geologists, 2004. See also Chad Augustine, Katherine R. Young, and Arlene Anderson, "Updated U.S. Geothermal Supply Curve," NREL/CP-6A2-47458, February 1, 2010.

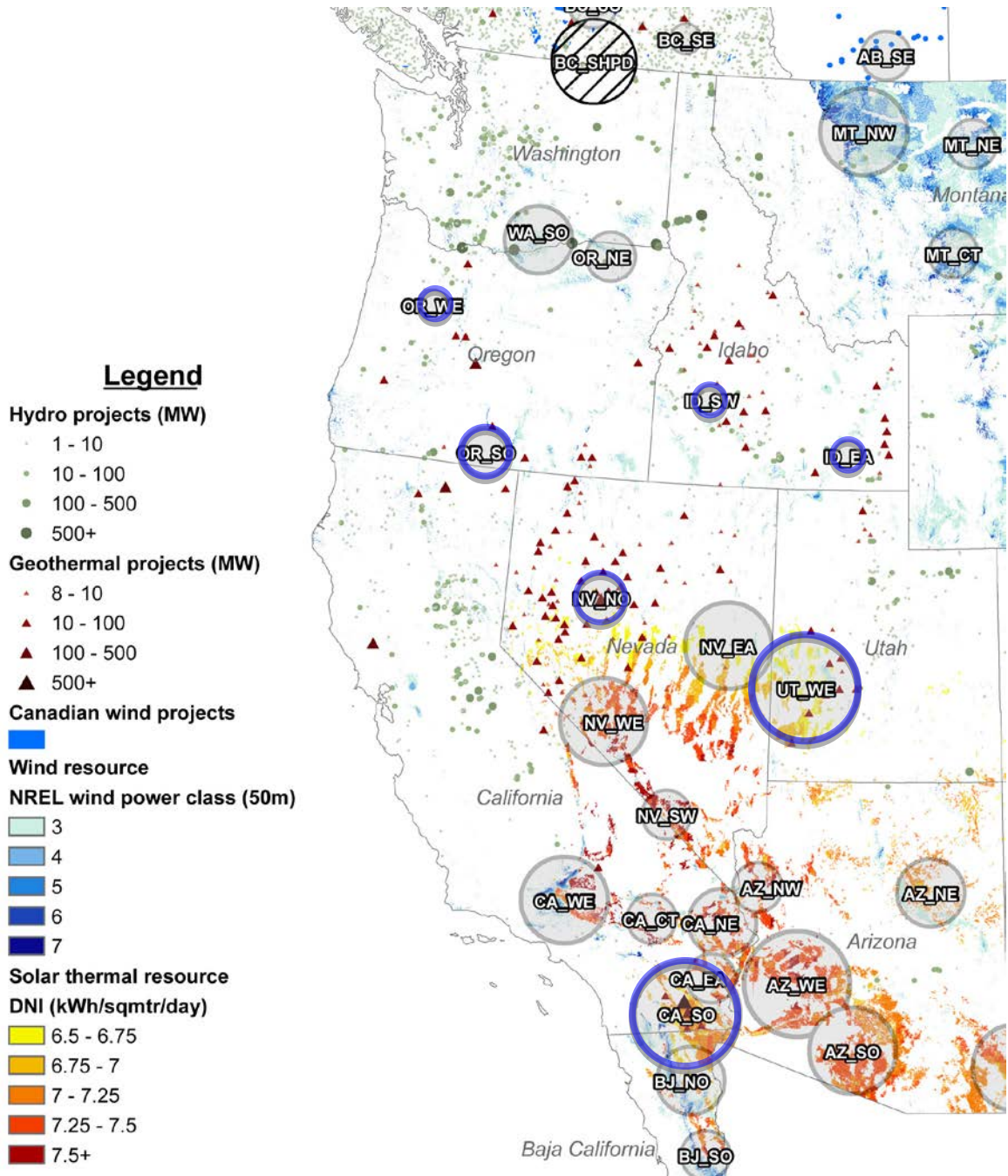

Each gray-shaded circle indicates a renewable energy zone (REZ) hub. Blue circles indicate hubs with significant geothermal potential: Oregon south, Idaho southwest, Idaho east, Idaho southwest, Nevada north, Utah west, and California south. A hub represents a conceptual step-up transformer where the electricity generated by all renewable resources in the REZ would get onto the transmission system. Hub circles are scaled to show relative annual production potential of all renewable resources in the REZ. Circles are not intended to indicate precise location of a new substation; actual collection point may be anywhere in the vicinity of the hub.

**Figure 4. Western Renewable Energy Zones with known geothermal potential**

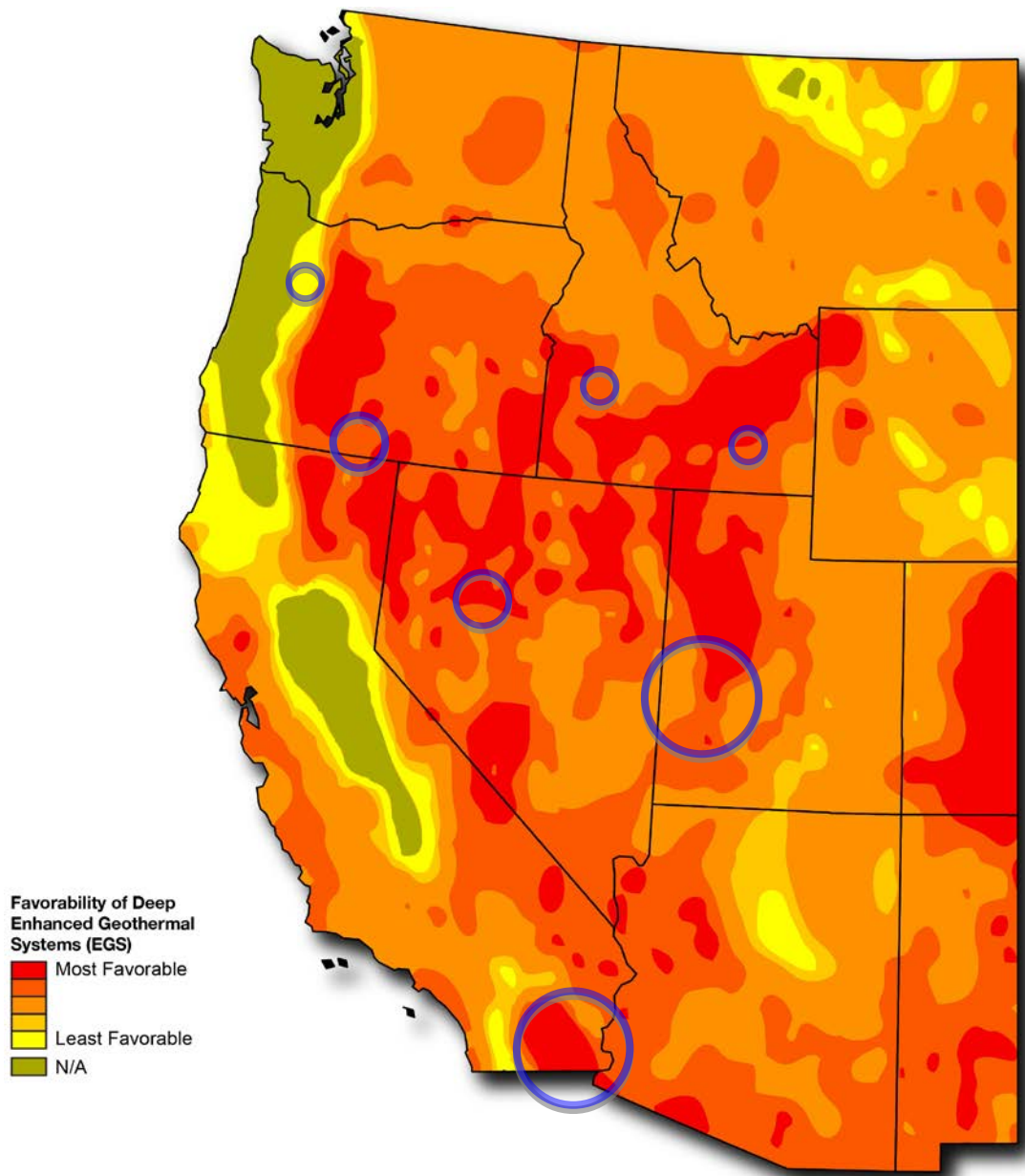

Source data for deep EGS includes temperature at depth from 3 to 10 km provided by Southern Methodist University Geothermal Laboratory (Blackwell & Richards, 2009) and analyses performed by NREL (2009) for regions with temperatures  $\geq 150^{\circ}\text{C}$ . Map does not include shallow EGS resources located near hydrothermal sites or USGS assessment of undiscovered hydrothermal resources. "N/A" regions have temperatures  $< 150^{\circ}\text{C}$  at 10 km depth and were not assessed for deep EGS potential.

**Figure 5. Geothermal resource favorability in the western United States**



Another important difference between Figure 4 and Figure 5 is that REZs take into account areas that are not developable (for example, the geothermal resources in Yellowstone National Park in northwest Wyoming). On the other hand, Figure 5 is based on heat, depth, and flow data without regard to land use constraints on the surface.

Of the seven geothermal REZs, all but one are in areas with very little native load. This means the geothermal industry generally has limited local commercial opportunity in many of its highest-potential areas, and that development at scale depends on access to larger markets. The West's largest demand center is California, which has about 60% of the West's forecasted demand for renewable power.

The balance of this report synthesizes existing and developing knowledge about grid integration issues, emphasizing those issues of particular relevance to geothermal deployment. The following section addresses three general areas related to transmission: connecting to the existing local network, connecting to existing long-distance transmission corridors, and the economics of new transmission.

Section 4 then turns to issues affecting geothermal at the distribution level, with particular emphasis on geothermal co-production in the oil field as a form of distributed generation. Section 5 then places various geothermal electric generation technologies in the context of the interconnection issues they face. Table 3 in this section provides a visual summary of this taxonomy. Section 6 examines the opportunities for near-term geothermal projects as suggested by transmission factors. It identifies likely opportunities on the existing transmission system, and then delves more deeply into REZs as an emerging transmission planning tool. A REZ aggregates units that are too small to justify investment in long-distance transmission individually; consequently, zones may be crucial to the future large-scale deployment of geothermal power.

### 3 Planning and Operating the Transmission System

This section provides an overview of how transmission is planned, built and operated. Infrastructure decisions nearly always give priority to the integrity of the entire network rather than to the economic needs of individual projects. Therefore, understanding the transmission issues affecting any given geothermal project begins with understanding the network as a whole.

Plant size is perhaps the most significant factor affecting where geothermal fits into the larger picture. This report uses 80 MW as a heuristic dividing line between small and large plants, as it is the threshold used in the Federal Power Act to define “small power production facilities.”<sup>4</sup> Eligible renewable energy facilities below 80 MW may become qualifying facilities (QFs), which affords certain benefits with respect to securing power purchase agreements. For example, many geothermal QFs have “must-take” power purchase arrangements with their interconnecting utilities. These arrangements essentially exempt a geothermal plant from having to provide operating reserves and ancillary capacity services to support grid reliability. The utility is obligated to receive everything the geothermal plant can produce, while reliability functions are allocated to other units on the system.

Figure 6 illustrates the relative size of most existing hydrothermal facilities in the Western Interconnection. The categories along the horizontal axis show amount of commercially developed hydrothermal electric generation in the same locality (i.e., plants whose addresses are in the same city); the vertical axis is the number of such localities in that size category. More precisely, the chart shows how many megawatts from existing geothermal resources are close to a single generation step-up transformer (as illustrated previously in Figure 1).

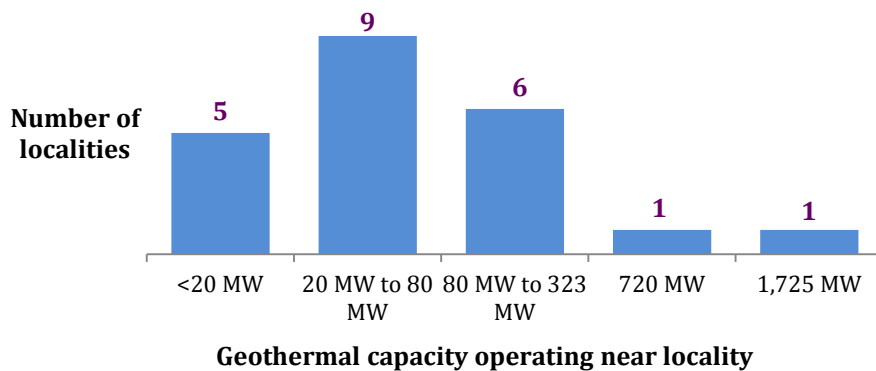

Source: Energy Velocity, Energy Information Administration (EIA) Form 860 database, 2010. “Geothermal capacity operating near locality” is based on plant address.

**Figure 6. Geographic concentration of North American geothermal resources, 2010**

<sup>4</sup> Federal Power Act, 16 U.S.C. Sec. 796(17)(A).

California's Sonoma and Lake counties (north of San Francisco) have the largest amount of geothermal capacity in one locality. This area includes the Geysers, currently the largest geothermal operation in the United States. Cerro Prieto in Baja California is second with 720 MW. All of the remaining capacity exists in concentrations of 323 MW or smaller; nearly two-thirds of the localities that have operating geothermal plants have less than 80 MW nearby.

### **Available Capability on Existing Lines<sup>5</sup>**

Most utilities offer two general types of transmission service: network service and point-to-point service. Network service connects generators and load within the same local network, and it usually does not matter where on the network a generator is located. The geographic extent of the local network is usually the BA. (Recall from Section 2 that network generators within the BA area are managed so that their real-time output matches real-time network demand as closely as possible.) As a general rule, a geothermal development intended to serve local customers would seek network service.

If the aim is to serve load in another market outside the BA, the geothermal plant would need point-to-point service. Physical capacity and existing long-term obligations limit the amount of point-to-point service available on existing regional lines. New lines face considerable economic hurdles that increase the importance of economies of scale and of minimizing uncertainty.

### **Network Service**

"Network service" refers to an operational bundling of local load, generation, and transmission. A network customer (that is, a load-serving entity such as a municipally owned utility or electric cooperative, or an industrial customer with an exceptionally large need for power) must designate the specific metered load it will serve, and the specific resources it will use to serve that load. Once the network customer designates a particular generator as its network resource, the output from that generator cannot exceed what is required to serve the network customer's corresponding load.<sup>6</sup>

A large utility responsible for BA control operations will normally be its own network customer, designating network load and resources as a load-serving entity, and providing network service as a transmission owner. A municipally owned utility within the BA may also be a network customer.

A geothermal plant providing power to its local utility would normally ask the utility for status as a network resource. The designation would, however, make the plant unavailable for firm, long-term sales in any market outside the utility's service area.

---

<sup>5</sup> This report uses the term "capability" to describe the maximum amount of power (in MW) that a transmission line can carry, taking into account the line's voltage as well as other limiting factors. "Capacity" refers to the generation units connecting to the line. If a line's total transfer *capability* is 800 MW, some curtailment may occur if the total generation *capacity* connecting to the line exceeds that capability.

<sup>6</sup> Non-firm (i.e., interruptible) sales outside the network are allowed, as long as the sales do not interfere with service to network load. Pro Forma Open Access Transmission Tariff (OATT) adopted by FERC in its Order 890; see especially Section 30.



A new geothermal plant's small size, *per se*, would not be a barrier to becoming a network resource and obtaining network transmission service, but several other factors outside the control of the geothermal developer may limit the commercial opportunities. If network load is not growing, or if no network resources are likely to be retired, the utility may be reluctant to acquire new network resources. If supplies are adequate to serve expected load, the utility may have no need for further procurements.

Sierra Pacific Power, for example, currently has more than 500 MW of geothermal resources in its generation portfolio—nearly two dozen merchant projects averaging 22 MW, and ranging from 2 MW to 49.5 MW in capacity.<sup>7</sup> The geothermal projects constitute a quarter of Sierra Pacific's total resource needs for 2012, and are equivalent to about half of the utility's base load needs.<sup>8</sup> The utility forecasts that system demand will shrink at an annual rate of 0.6% over the next five years, followed by a post-recession growth rate of about 1.5%. However, Sierra Pacific also anticipates that 330 MW of coal base load capacity will retire by 2022.

A utility may have a disincentive against obtaining additional network resources if doing so would result in stranded capital costs. Stranded costs would occur if (for example) one of the utility's major network units was not fully depreciated, and adding a geothermal plant as a new network resource would require idling that unit. In most cases, a utility's stranded costs end up being borne by its ratepayers. The utility's regulatory body might not approve adding a new geothermal resource in such a case if it finds that doing so would unreasonably increase the rates paid by end users.

So overall, the size of local demand is the main factor that determines the opportunities for new network resources. A network serving a sparse population with a small amount of load will need fewer network generation resources and a relatively smaller amount of network transmission than would be required by a system with a larger load.

### ***Point-to-Point Service***

Point-to-point transmission service is used for power deliveries from a specific generator or injection point to a specific delivery point, sometimes within the same BA area but often to a point outside the BA area. Unlike network service, the amount of point-to-point service available is not restricted to load within the BA.

A *transmission path* is one or more lines that are capable of supporting power transfers between the same two points. A path's rating indicates the maximum amount of transfer capability it can provide, taking into account all safety and reliability limitations. Path ratings act as a hard limit to the amount of point-to-point transmission service that is available to connect a generator to its market.

---

<sup>7</sup> Sierra Pacific Power Company, Integrated Resource Plan (Nevada Public Utilities Commission, Docket No. 10-07003, 2010). This includes a 15% planning reserve margin.

<sup>8</sup> "Base load" refers to the minimum amount of load on the system throughout the year. Base load units operate at constant output levels over extended periods of time; output of other units vary based on real-time demand in excess of base load.

Various factors affect the availability of point-to-point service across a given transmission path. The voltage of path lines might be undersized relative to the commercial demand to move power across the path. Even if the main path is not fully loaded, there may be congestion points on closely related lines that limit the amount of power that can enter or leave the path, due to the instability it might cause elsewhere on the system.

WECC regularly studies power flows across the major transmission paths in the Western Interconnection. In early 2010, WECC released a draft study that compared actual flows with scheduled flows to examine how fully the major transmission paths were utilized.<sup>9</sup> The study observed generally that the amount of unused capacity on most paths was relatively small, thus “the existing WECC transmission system may be considered near full capacity given current uses.”

Five paths are of particular relevance to the known geothermal resource areas shown on the maps in Figure 4 and Figure 5, as they are the corridors over which power would flow to major markets. The three northern paths include:

- Path 14, between Idaho and the Pacific Northwest (west of the geothermal area ID\_SW in Figure 4)
- Path 17, between the geothermal areas ID\_SW and ID\_EA
- Path 66, between Oregon and northern California (south of the geothermal area OR\_SO).

Two southern paths are also relevant:

- Path 35, between Utah and southern Nevada (west of the geothermal area UT\_WE)
- Path 46, west of the Colorado River into southern California.

Path 46 is of particular interest. A new 500 kV line currently under construction in eastern Nevada will, for the first time, enable substantial power flows between the northern and southern parts of the state. Future upgrades to this connection could also give northern Nevada’s geothermal resources (the NV\_NO area in Figure 4) access to Path 46, the corridor by which power from the now-retired Mohave coal plant in southern Nevada used to flow to California.

Accurately measuring transmission utilization in a systematic and consistent manner is problematic. The WECC analysis combined two approaches: tracking the amount of available transmission capability (ATC) posted for a given path on the utility’s open access same-time information system; and comparing the difference between a path’s rating and the amount of power that was scheduled to flow across it. ATC is the amount of point-to-point service available across a given path after taking into account long-term obligations for firm delivery. A certain portion of the line’s transfer capability may be

---

<sup>9</sup> WECC, “2010 Western Interconnection Transmission Path Utilization Study: Path Flows, Schedules and OASIS ATC offerings,” April 20, 2010.

contractually unavailable regardless of whether it is physically used. On the other hand, while tracking scheduled power flows offers a consistent indication of physical utilization, it does not capture all of what is contractually obligated and can therefore overstate what is in fact available. Further complicating WECC’s analysis is the fact that ATC is not reported consistently across the Western Interconnection. For several important paths, ATC data were not available.

Table 1 shows the WECC metrics for the five paths of greatest relevance to geothermal resources. The numbers indicate the amount of transmission capability available 90% of the time. For example, Path 14 had at least 245 MW of ATC 90% of the time in 2009, and at least 517 MW of unused capacity 90% of the time. Paths 66 and 46 tend to have large amounts of unused (i.e., unscheduled) capability, but the lack of ATC information means that some if not most of that capability may be contractually unavailable.

Table 1 also shows the range of monthly transfer ratings for Path 24, which was not included in the WECC study. This path (shown in Figure 7) is important because it is currently the only direct path by which geothermal resources from northern Nevada can get to the California market. It consists of two 120 kV lines and one 60 kV line connecting Reno to the PG&E network—small compared to most of the paths included in the WECC study. Nevertheless, they constitute a clearly defined electricity flowgate from northern Nevada to California.<sup>10</sup>

**Table 1. Capability on Existing Paths with Known Geothermal Potential (2009)**

WECC Path	Location	ATC	Unused capacity
		<i>(MW available 90% of the time in direction of highest use)</i>	
14	Between Idaho and Pacific Northwest	245 MW	517 MW
17	Borah (between eastern and western Idaho)	33 MW	76 MW
66	Between Oregon and northern California	(incomplete data)	824 MW
35	Between Utah and southern Nevada	(incomplete data)	51 MW
46	California west of Colorado River	(incomplete data)	3,307 MW
24	Between Reno NV and California	40-100 MW (path rating)	(unavailable)

Sources: WECC, “2009 Western Interconnection Path Utilization Study,” June 24, 2010; NV Energy, “Path 24, Sierra Summit (PG&E) Intertie,” June 23, 2010. Path 24 data shows range of monthly path ratings, which does not take transmission reservations into account.

<sup>10</sup> Path 76 goes from Reno into northern California but connects with a line owned by the Bonneville Power Administration leading into Oregon.

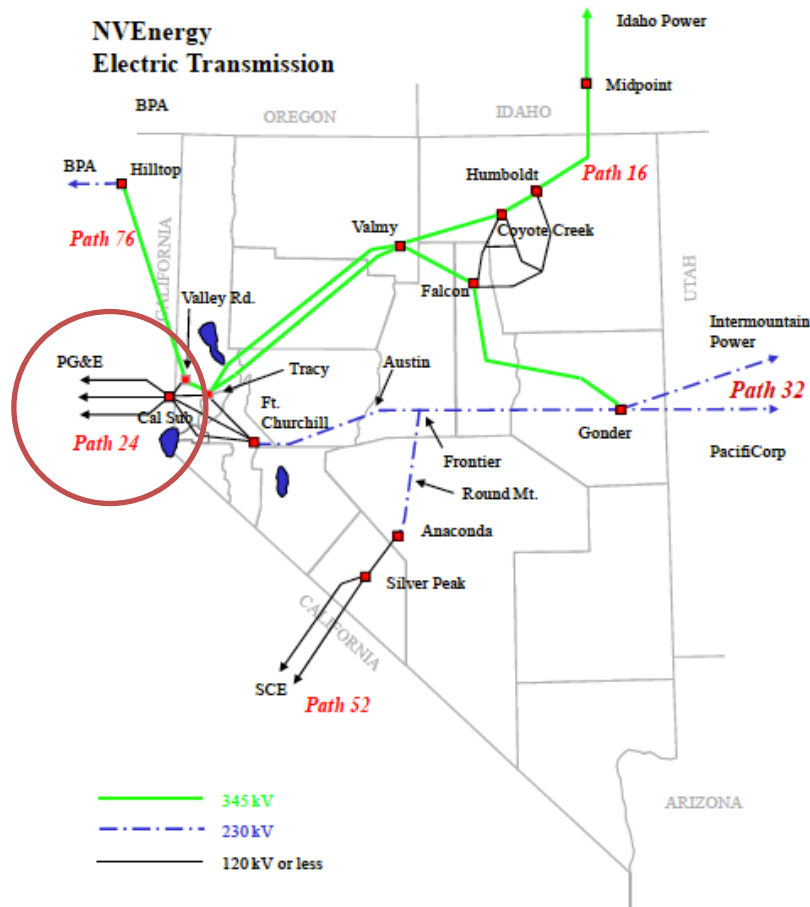

Source: NV Energy

**Figure 7. Northern Nevada's local transmission network**

Because it is a base load resource, a geothermal plant generates a constant level of power over an extended period of time, and it needs a matching amount of similarly constant transmission service. If the amount of ATC on a path varies from one hour to another, then the amount of *commercially useful* ATC will be closer to the minimum hourly level than to the maximum. Geothermal plants generally need transmission service in time strips that do not change and are not punctuated by gaps of scarcity.

Data on ATC and line utilization indicate limited transfer capability from the areas with the best geothermal resources. The best opportunity appears to be from geothermal area ID\_SW to the Pacific Coast. The path has 245 MW of ATC on a consistent basis.

Line capability can vary over time due to changes in network conditions. Nevada's Path 24 provides an example. Figure 7 shows the northern Nevada network and its main transmission lines. The amount of power that can be exported across Path 24 into California changes based on load in the Reno area. Figure 8 shows the path's monthly export rating, as a function of peak demand in Reno for the same month. As Reno's load increases from 499 MW to 803 MW, the east-to-west export rating for Path 24 decreases from 100 MW to 40 MW.

What this means is that if a geothermal developer in northern Nevada intends to sell into the California market, the transmission needed to deliver the output may be physically insufficient in the summer months when Reno’s network load is high. This would limit the amount of power that could be sold as a consistent base load product in the California market. Load growth in Reno could further reduce the amount of ATC available over time.

In short, a geothermal plant’s ability to sell power into markets outside its home BA by way of existing transmission corridors may be as location-constrained as the geothermal resource itself. Among the variables affecting the amount of transmission available are the transmission owner’s network obligations, long-term contractual obligations for point-to-point transmission service, consistency in the amount of ATC available, and seasonal changes in network conditions that could affect a path’s export rating.

**The Uphill Economics of New Transmission**

Geothermal’s greatest challenges with respect to new transmission are rooted in basic transmission economics. A new line’s cost effectiveness depends on how much power it carries, and small quantities pose a greater economic challenge. Small lines (230 kV or less) cost more per megawatt of carrying capability. A larger line costs less per megawatt, but that efficiency is lost if the line’s capability is not fully utilized. Distance magnifies the effects of these factors, posing an extra economic challenge for small generation resources that are far from load.

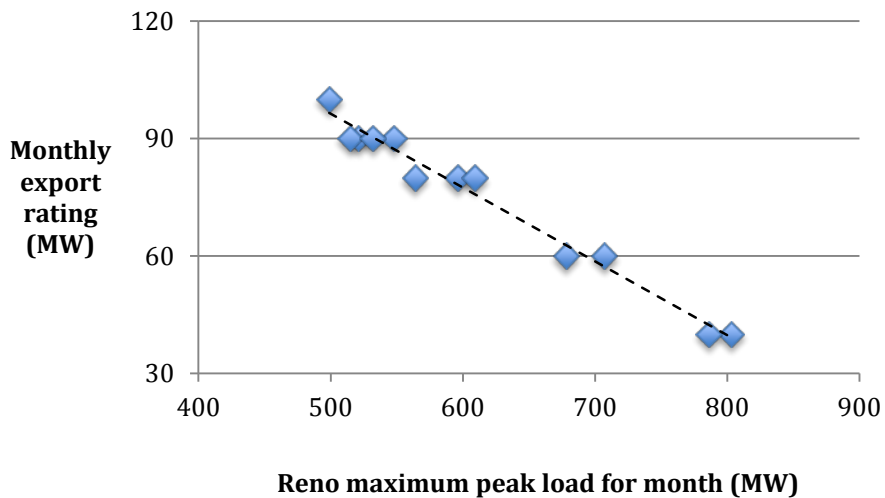

Source: NV Energy, “Path 24, Sierra-Summit (PG&E) Intertie” (Report No. NVN-TOP-019), June 23, 2010.

**Figure 8. Path 24 export rating and Reno peak load (monthly)**

Table 2 breaks out the cost of transmission at different voltage levels. It also shows the total cost per megawatt of carrying capability at distances of 100 miles and 600 miles. A 500 kV DC line is nearly seven times as cost effective as a single-circuit 230 kV AC line,

measured by line cost as a function of transfer capability (\$millions per MW capability) over a distance of 600 miles. The efficiency is due to the fact that as line voltage increases, power transfer capability increases at a much faster rate than do line costs and substation costs. In addition, line losses are much less on higher voltage lines. More energy gets on the line, and less is lost along the way.

Figure 9 visually summarizes how costs change across different sizes of transmission for 100-mile and 600-mile installations, representative of a new in-state line and of a project that would traverse the Western Interconnection crossing several state lines. The figure shows how smaller low voltage lines are extremely cost-inefficient relative to larger high voltage lines, costing five to six times more than larger lines per megawatt of carrying capability.

**Table 2. Approximate Cost of Transmission by Size and Capability**

<b>Line voltage and type</b>	<b>Capability before line loss (MW)</b>	<b>Line cost per mile (\$ millions)</b>	<b>Substation cost (\$ millions) and spacing</b>	<b>Line loss (% per hundred miles)</b>	<b>Transmission cost* (\$ millions per MW capability)</b>	
					<b>600 miles</b>	<b>100 miles</b>
230kV AC single circuit	400	\$0.9	\$35 every 100 miles	6.9%	\$3.37	\$0.43
230kV AC double circuit	800	\$1.4	\$35 every 100 miles	6.9%	\$2.38	\$0.29
345kV AC single circuit	750	\$1.3	\$40 every 150 miles	4.5%	\$1.74	\$0.29
345kV AC double circuit	1,500	\$2.0	\$50 every 150 miles	4.5%	\$1.29	\$0.20
500kV AC single circuit	1,500	\$1.8	\$50 every 200 miles	1.5%	\$0.94	\$0.19
500kV AC double circuit	3,000	\$2.9	\$50 every 200 miles	1.5%	\$0.71	\$0.13
500kV DC bi-pole	3,000	\$1.4	\$250 each terminus	1.2%	\$0.49	\$0.22

\*Line and substation costs only. Component cost estimates provided by WECC transmission owners surveyed by NREL.

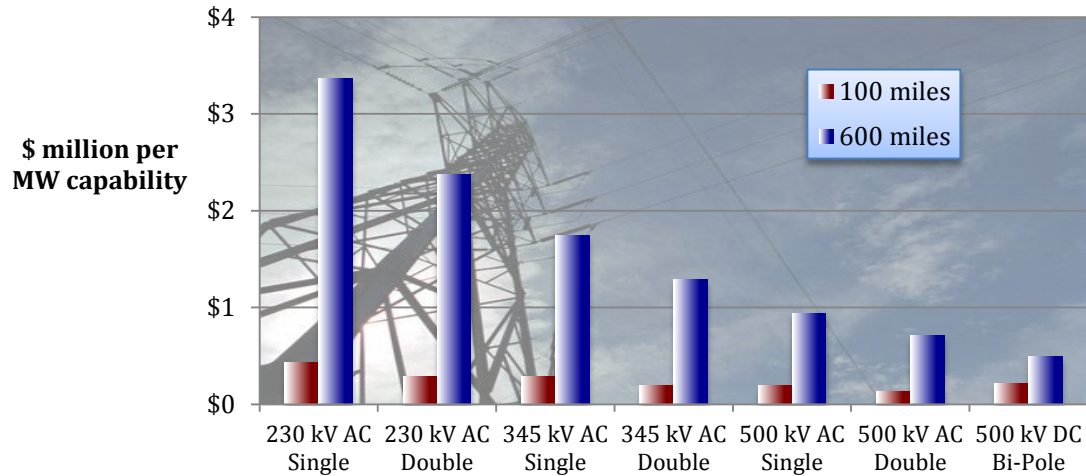

**Figure 9. Total line and substation costs per megawatt of transfer capability**

Whether a large line actually achieves economies of scale depends on how much of the capability is used. For example, if a 500 kV DC line is underutilized by 50%, all of the line’s cost has to be recovered from the 50% that is being used. That effectively doubles the cost per megawatt of capability. Another useful metric, therefore, is a line’s *effective revenue requirement* per megawatt-hour of energy delivered. This represents the theoretical charge that would have to be added to each megawatt-hour delivered to customers in order to recover all of the line’s capital and operating costs, applied evenly over the line’s economic lifetime.

Transmission is an enormously “lumpy” capital investment, in that the entire cost of a project happens all at once, with very little opportunity to phase in costs incrementally as usage increases. Here, the effective revenue requirement metric captures some of this inevitable lumpiness by assuming a lifetime utilization rate of 85%.

Effective revenue requirement captures important factors that enter into regulatory approval of a line. A regulated utility normally recovers the cost of a transmission line from the rates it is allowed to charge its retail customers.<sup>11</sup> Before it can do so, however, the utility must demonstrate to its regulators that the new line is financially prudent, that it will be “used and useful” in serving the needs of the public, and that the costs and resulting rates are “just and reasonable.”<sup>12</sup> If the likelihood of low utilization increases the proposed line’s effective cost per megawatt-hour of delivered power, prudence is difficult to prove—especially if there are alternatives that would impose less of a burden on ratepayers.

<sup>11</sup> It may also offer transmission service to wholesale customers, with these revenues offsetting some of the cost to its jurisdictional retail customers. A utility’s wholesale transmission rates must be approved by the Federal Energy Regulatory Commission (FERC).

<sup>12</sup> The Federal Power Act requires FERC to ensure that transmission rates are “just and reasonable.” The “used and useful” standard is common to most state utility codes that govern line siting.

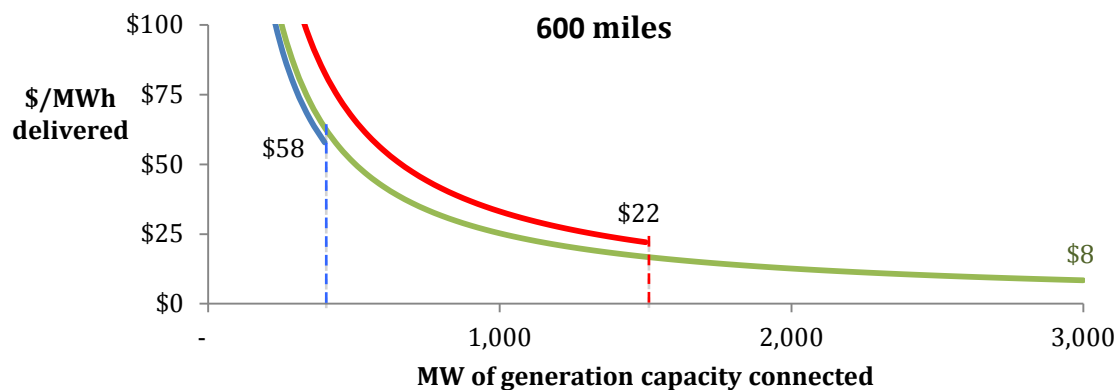
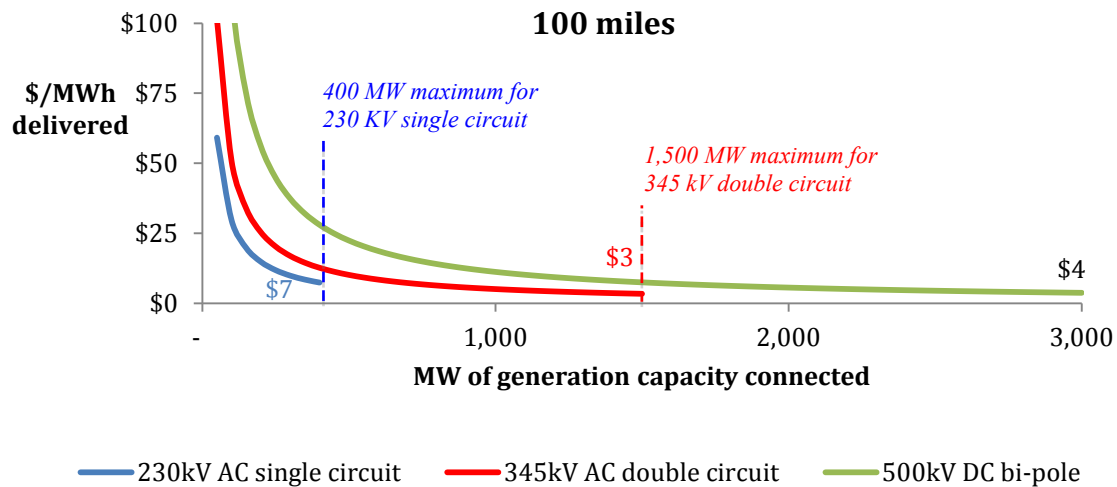

**Figure 10. Effective revenue requirement for transmission per megawatt-hour delivered**

Figure 10 shows the effective revenue requirements of three sizes of transmission lines at different rates of utilization, for line distances of 100 miles and 600 miles. To better illustrate the cost issues as they apply to geothermal, the data shown apply a geothermal-only scenario for new transmission. In other words, the figures show what the transmission owner theoretically would need to collect per megawatt-hour to meet the revenue requirements for that line if nothing but geothermal generation connected to the line.<sup>13</sup>

Based on the above assumptions, if eight 50-MW geothermal plants (400 MW of net capacity in all) were the only generators connecting to a 100-mile line, the effective revenue requirement would be:

- \$7/MWh in the case of a single-circuit 230 kV line

<sup>13</sup> The estimates also assume the line has an economic life of 30 years, and the cost of capital is 12%.



- \$13/MWh in the case of a double-circuit 345-kV line
- \$28/MWh in the case of a 500-kV DC line.

In this example, eight plants would fully utilize the smaller 230-kV line but would leave 87% of the 500-kV line unused.

Revenue requirements could fall as low as \$3/MWh for the 345-kV line if more plants connected. However, achieving that amount of savings would require connecting 1,500 MW of geothermal capacity, equivalent to thirty 50-MW plants in concentrations comparable to the Geysers in Northern California or Cierra Prieto in Baja California. (See Figure 6.) Regulators would consider the line a prudent financial risk only if they had reasonable assurances that 30 plants would actually be built.

Transmission costs over a 600-mile distance tend to be prohibitive for anything but a large line with a high utilization rate. At that distance, a fully utilized 345-kV double-circuit line would have revenue requirements of \$22/MWh, making the power economically uncompetitive on the basis of all-in delivered cost. By comparison, a 500-kV DC line connecting 40 to 60 typically sized geothermal plants would have revenue requirements ranging from \$12/MWh to as low as \$8/MWh.

Access to a DC line is difficult and expensive due to the high cost of substations, however. (See Table 2.) Typically, the only points for electricity to get on or off the line are the two terminal points. Not only would the line need 3,000 MW of generating capacity in order to be fully utilized, all of that capacity would have to be near the same substation.<sup>14</sup>

Wholesale power prices in California illustrate the magnitude of the trends shown in Figure 10. Average wholesale prices (spot market for next-day delivery) for the 12 months ending in April 2011 were \$37/MWh for peak hours and \$25/MWh for off-peak hours.<sup>15</sup>

Some new transmission costs may be allocated to the generation developer directly, which would reduce the costs borne by the utility's ratepayers (thereby improving the odds for regulatory approval) but adding to the developer's project costs. Current general practice is that:

- The utility pays for upgrades that are required anywhere on the network past the transformer at which the generator ties into the network
- The developer posts a surety bond up front to cover the cost of lines and equipment needed to get power from the plant to the transformer, with the bond released once the line is finished and the plant begins producing power

---

<sup>14</sup> DC lines generally do not require intermediate substations. Consequently, all the capacity connecting to the line would do so at the same point.

<sup>15</sup> SNL Energy, energy market price databases, day-ahead on-peak strip and off-peak strip prices.

- The developer pays for anything on the developer's side of the meter, including the cost of collector lines that feed power from several small units to a common meter.

The magnitude of direct charges to the developer vary depending on network conditions and where interconnection occurs, but generally most of the cost of new transmission is picked up by the utility and passed on to ratepayers.

The largest and most potentially lucrative markets are generally far from the best geothermal resource areas. New lines could bring these resources to market, but the economics of building new transmission are extremely problematic for plants that are the size of most geothermal projects operating today. The previous discussion showed that a long-distance line sized to a handful of small projects is costly and loses a great deal of power along the way; a high-capacity line brings greater efficiency, but only if the capacity connecting to it is enough to keep the utilization rate high. These complications offset geothermal's comparative advantage with respect to providing base load power. As discussed later in this report, these challenges suggest a strategy of aggregation: either combining geothermal with other types of technologies connecting to a proposed line or siting the line through an area that could sustain many economically competitive geothermal projects.

## 4 Distributed Generation

*Distributed generation* (DG) is a small generator connected directly to the lower voltage distribution system. Precise definitions vary, but in all cases DG is located close to the particular load that it is intended to serve, follows an operating strategy that supports the served load, and is interconnected to a distribution or sub-transmission system.<sup>16</sup> A DG unit typically has a nameplate capacity of less than 5 MW.

DG often acts as “negative load” with respect to the rest of the transmission network. Load that is on the local distribution system is met in part by local generators that reside on the same distribution system, in contrast with being met by large generating stations that are elsewhere on the network outside the distribution system. Consequently, DG reduces the amount of power flowing from the larger transmission network, through the step-down transformer substation, and to the distribution system. Some DG units are “behind-the-meter” or “customer-sited”—self-produced electricity that exclusively serves the customer’s own demand but is not directly metered or billed by the utility. Commercially, DG does not serve load outside its own distribution system.

Geothermal co-production is evolving as a DG resource. Co-production captures waste hot water from an oil or natural gas well to produce electricity, either at the wellhead or at a collector site fed by several nearby wells. Most of the current demonstration projects are less than one megawatt. In the DG model, a co-production geothermal generator would use the hot water to generate electricity, which would then be used to power pumps and other electrical equipment at the well site. The co-production unit would reduce the amount of electricity taken from the utility grid to operate the well.

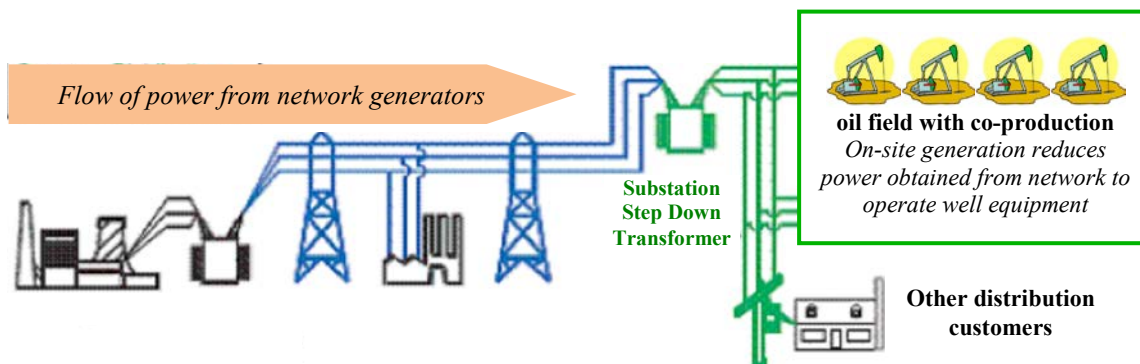

**Figure 11. Geothermal co-production as distributed generation**

Figure 11 depicts an oil field connected to a hypothetical distribution system. If 20 wells in the field each had a 200-kW geothermal co-production unit, the consumption of utility-provided electricity at these 20 wells would decrease by 4 MW if all of the co-production units ran at full capacity.<sup>17</sup> Over the course of a year, the reduction in the amount of

<sup>16</sup> Energy Information Administration, definition at <http://www.eia.doe.gov/tools/glossary/>.

<sup>17</sup> DOE’s Rocky Mountain Oilfield Testing Center has installed a co-production unit at one of its water-oil separation units. The unit’s sustained net output level is 132 kW. Rocky Mountain Oilfield Testing Center

power taken off the grid would be equivalent to the consumption of 2,700 homes.<sup>18</sup> It would also reduce the field operator's purchased power costs by as much as \$2.4 million annually.<sup>19</sup>

Geothermal co-production poses no transmission problem because it does not connect to the transmission system. It is not affected by the lack of ATC, nor does it face the economic hurdles that are inherent in building new transmission. Rather, the issues affecting co-production are the same as those affecting other types of DG.

Behind-the-meter DG is not difficult for grid operators to accommodate as long as the unit produces little excess power. If excess power flows back onto the distribution system from a customer's DG unit, however, the utility would need to monitor the potential effects on other customers. The challenges compound with increased penetration of DG resources on a distribution system. System safety, voltage stability, frequency, and resilience against localized outages are among the issues that become more difficult to manage as DG increases.<sup>20</sup>

Utilities and regulatory bodies have begun to adopt DG interconnection standards. Forty-two states, the District of Columbia and Puerto Rico have DG interconnection policies in place as of June 2011.<sup>21</sup> These standards address compliance with safety codes, requirements for external disconnect devices, operational requirements, assessments of fees for system studies, and other matters. Many set limits on the applicable size of DG units, with larger units subject to normal small-generator interconnection requirements.

As the penetration of co-production and other types of DG increases, utilities and regulators will find it increasingly difficult to balance DG's overall benefits and costs (that is, the benefits accruing to all ratepayers versus the costs assigned to all ratepayers). Widely deployed co-production that reduces the amount of power flowing from the bulk power system to the distribution network can defer the need for the utility to invest in substation and transmission upgrades, which would benefit all ratepayers. On the other hand, co-production resulting in large amounts of excess power could require additional upgrades on the distribution system to accommodate the new flows, and these upgrades would add to customer rates.

---

"Ormat: Low-Temperature Geothermal Power Production," final report, March 2010 ([http://www.rmotc.doe.gov/PDFs/Ormat\\_report.pdf](http://www.rmotc.doe.gov/PDFs/Ormat_report.pdf)).

<sup>18</sup> This assumes that the co-production units have an average capacity factor of 85%. According to the U.S. Energy Information Administration (EIA), the average monthly electricity use by residential customers in 2008 was 920 kWh.

<sup>19</sup> This estimate does not include the additional economic benefit of any renewable energy incentives that might be available. EIA estimates that in the region comprising the oil-producing states of Texas, Louisiana, and Oklahoma, the average retail price of power for industrial customers was \$0.08/kWh in 2008.

<sup>20</sup> Driesen, J.; Belmans, R. "Distributed generation: Challenges and possible solutions," 2006 IEEE Power Engineering Society General Meeting, Montreal, Canada, June 18-22, 2006.

<sup>21</sup> Ten of these state policies are voluntary guidelines, the rest are standards. For a detailed description of each state's DG standards, see U.S. Department of Energy, Database of State Incentives for Renewables and Efficiency (<http://www.dsireusa.org/>).

## 5 Where Geothermal Fits into Transmission Planning

The previous sections of this report have sketched the larger picture into which any new generation resource fits. This section looks at geothermal technologies in particular and places them in that framework.

To begin, this section distinguishes between four categories of generation resources:

- Distributed generation
- Network generation
- Generation intended to serve load outside the BA in which it is located, using point-to-point transmission service on existing lines
- Generation intended to serve load outside the BA in which it is located, but requiring the construction of new bulk transmission.

DG tends to be smaller than 5 MW. Units between 5 MW and 80 MW in size that are not DG are commonly used as network resources. Units larger than 80 MW may be either network resources in their own BA or may serve load in a distant BA. Note that none of the size thresholds used here constitutes a bright line; they serve this analysis as reasonable heuristics for different types of interconnection issues.

Figure 12 shows the distribution of generation capacity in WECC by size. Plants that are between 5 MW and 80 MW in size outnumber larger plants two to one in the West. (Generation smaller than 5 MW is not shown on these charts because many customer-sited distributed generation units are not reported to DOE's Energy Information Administration for its annual inventory of electric generation.) Despite this, large plants greater than 80 MW in size make up the vast majority of total nameplate capacity.

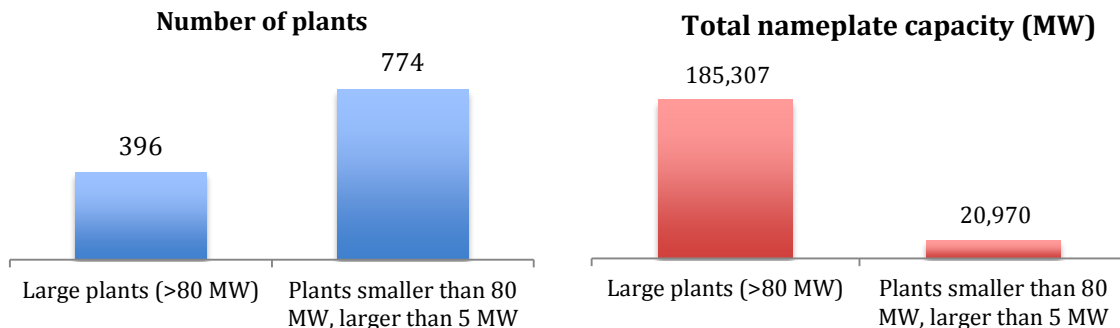

Source: Energy Information Administration, generator-level detailed data files (Form EIA-860).

**Figure 12. Distribution of generation capacity in WECC by size of plant**

The most rigorous planning for future transmission involves the fourth category of resource: larger resources intended to serve load in a distant BA by means of new transmission expansion. Because of the magnitude of the capital investment and the risk involved in major transmission expansion, the present-day commercial maturity of a potential generation technology plays a significant part in regional planning. A technology with a commercial track record brings information to the planning process

that enables plausible modeling of how the grid is likely to operate 10 years into the future under various assumptions and scenarios. These data points include the technology's capital cost, marginal cost, capacity value, the downtime required for normal maintenance, the amount of reactive power it can provide, and other operational information. While improvements and cost efficiencies may occur over the span of a decade, the technology's *current* state provides a commercially validated baseline for the purposes of modeling and analysis.

Technology still in the R&D stage has no such baseline. There may be research goals for costs and operational efficiency, but such goals exist within a probabilistic band of uncertainty and are, therefore, difficult to incorporate into production cost models and other tools used in long-term transmission planning.

Recall the effective cost curves depicted in Figure 10 earlier in this report. If utilization of a new line turns out to be less than anticipated because an "emerging" technology in fact failed to emerge as expected, the effective cost of the line can increase significantly. The risk to utility ratepayers would be high, because the cost would be passed on to them. Billions of dollars are at stake for any major long-distance transmission project, and completion can take seven years or longer. Therefore, regulators who decide whether a major transmission project is prudent enough for rate recovery seldom approve projects that rely on pre-commercial generation technologies.

Consequently, emerging technologies such as EGS are better suited to market opportunities that make use of existing transmission that is available at the time the technology is ready for market. Plant size and long-term system planning are less critical, ratepayer risk is less, and the developer has more operational flexibility. The opportunities may be fewer and smaller, however, depending on the size of the local market in which the geothermal resource is located.

### **Conventional Hydrothermal**

Conventional hydrothermal is a known technology with a track record of commercial deployment. This characteristic is especially crucial to long-term planning for major transmission expansion, and sets conventional geothermal apart from EGS in its current state. Much of the technical information that transmission planners need to model future hydrothermal resources over a 10-year horizon can be obtained from actual plant operations with a reasonably high degree of confidence.

Consequently, conventional hydrothermal can be a player in future long-distance transmission intended to bring distant resources to major markets, because it brings sufficient information to the table for planning. Its main handicap is plant size. Strategies to combine several plants in the same vicinity (or alternatively, to include hydrothermal in a multi-resource portfolio of generation feeding into the same bulk transmission line) could alleviate concerns about a future line's utilization. The Geysers, for example, comprises a dozen individual units, each with an operating capacity between 45 MW and 90 MW. It and other geothermal facilities near Middletown, California, have nearly 2 GW of nameplate capacity capable of providing base load power to the California market.

Most hydrothermal plants currently in operation serve as network resources. This is the “best-fit” market for stand-alone hydrothermal plants that are not part of a multi-plant aggregation. Long-term planning is less crucial; what matters more is the home utility’s short-term need to ensure resources are adequate to meet local demand.

### **Emerging Geothermal Technologies**

Enhanced geothermal systems (EGS) have proven to be technically feasible but still lack a demonstration of commercial capability, at least for the present. While engineered reservoirs have been created successfully, none has enough history to support conclusions about how long an engineered reservoir can provide heat at commercially useful levels.<sup>22</sup> Especially with respect to planning, siting, and approving a major regional transmission line, technical feasibility is not enough to make up for the absence of demonstrated commercial interest. This is the main reason that, at least for the present time, EGS does not enjoy the same visibility in regional transmission planning that wind power and solar power do. Even though wind power’s intermittency and variability pose integration challenges that (in theory) would not be present with the emerging geothermal technologies, grid operators have learned how to model and manage those challenges.<sup>23</sup> The ability to manage known problems means wind power poses less risk, as compared to a technology that is not yet economical.

Geopressured geothermal is not far enough along its development path to determine how large the plants will be. Early demonstrations were DG-sized, but under the right conditions, next-generation geopressured generation could be as large as 10 MW. If the natural gas captured from the well is also used to generate power on site, the transmission requirements could be even larger.

Consequently, the best target markets for the first wave of future EGS development or geopressured geothermal development will be local. The requirements for local interconnection will be less onerous and less time consuming than what is involved for connection to distant regional markets. The ideal BA would have:

- Geothermal resource attributes that would result in lower exploration and production costs per megawatt-hour
- A significant and foreseeable need to add new base load resources near the end of the project’s construction timeline.

EGS or geopressured geothermal development that strategically anticipates a future market means an additional amount of risk for the developer, in that there is no guarantee today that interconnection will be available later. In exchange for taking on that risk, the developer avoids present-day market barriers related to transmission planning and interconnection requirements. Once testing is complete and the project is capable of

---

<sup>22</sup> Massachusetts Institute of Technology, “The Future of Geothermal Energy: Impact of Enhanced Geothermal Systems (EGS) on the United States in the 21<sup>st</sup> Century,” 2006, sec. 5 pp. 18-19 and sec. 9 p. 44.

<sup>23</sup> See, for example, North American Electric Reliability Corporation, “Accommodating High Levels of Variable Generation,” special report, April 2009; NREL, “Western Wind and Solar Integration Study,” Report No. SR-550-47434, May 2010.

delivering power on schedule, the obstacles posed by network interconnection requirements will be minimal, as long as there is no oversupply of base load resource capability on the local network.

Despite the lack of current operational data, EGS can indirectly have a place in regional transmission planning, to the extent it is near conventional hydrothermal that is part of the scenarios being modeled. Planning, permitting and construction of a major line can take seven years or longer. If during that time EGS makes sufficient progress with respect to increasing efficiency and reducing costs, developers now contemplating conventional hydrothermal may find it profitable to switch to or augment power production with EGS by the time the approved line nears completion.

Once EGS becomes commercial, its application will cover a wide range of markets depending largely on the ability to cluster several EGS plants in the vicinity of one transmission access point. If temperature, well depth, and flow rates are such that EGS is economically feasible at one site, and if the engineered reservoir can sustain several more EGS plants with comparable efficiency, then clustering many plants in the same vicinity could make long-distance transmission to a major market reasonable and prudent, based on the commercial operation of the initial EGS plant.

Similarly, the ability of post-takeoff geopressured geothermal to be a credible option for serving load over new long-distance lines will depend on the technology's demonstrated success at plant capacities of 80 MW or greater (either single plants, or clusters of smaller plants). For transmission planning, it would not matter whether the plant was geothermal-only or combined geothermal power with on-site generation from natural gas. Total capacity, the degree of utilization, and the economic viability of the interconnecting generators would determine how transmission planners model the potential line.

In any case, the overall plan for a new line would need to demonstrate a reasonable likelihood that it would be fully utilized. For a 500-kV line, this would require 1–2 GW of EGS or geopressured geothermal clustered near the same place or that the geothermal resource be part of a multi-resource portfolio large enough to ensure high line utilization.

### **Co-Production**

Geothermal power co-produced with oil well operations is a natural DG application. Electricity consumption at the well site—primarily to operate the production pump—is typically larger than the output of any co-production unit currently undergoing field tests. If commercial applications are no different, then the interconnection issues will be minimal. New transmission would not be needed; in fact, commercial deployment of co-production could even defer the need for new transmission.

The main interconnection burden for co-production will be those involved with any DG installation: equipment standards and procedures to enable the unit to run in parallel with the grid. As long as generation from the co-production unit is less than the power used at the well site, no excess power will flow back to the grid and there will be no external barriers to interconnection.



On the other hand, if the DG unit produces more than on-site consumption and results in net flows back onto the grid, some network upgrades may be necessary to ensure that the local distribution system is not overloaded.

### Summary

Table 3 summarizes the four resource types and their transmission dynamics, based on discussions in previous sections. It also shows the relative importance of long-term transmission planning; the larger the plant and the more distant the market, the more critical it is for the technology to be part of the planning process.

The bottom of the table graphically places geothermal technologies based on the discussion in this section. Each geothermal technology has significant market potential, but because different interconnection issues are at play, not all technologies have the same market affinities.

The analysis leads to these conclusions about geothermal generation technologies and their natural market affinities.

- Today's **conventional hydrothermal** is best suited to local network uses, and to exporting power to other BAs along transmission paths that are underutilized. As these opportunities become more limited, access to regional markets via new transmission will depend on the likelihood of aggregating several geothermal projects onto one interconnection point or including geothermal in a multi-resource portfolio of projects that would connect to the new line.
- **Emerging geothermal technologies** will likely find their best initial market opportunities as local network resources. As costs and efficiencies improve, near-hydrothermal field EGS may find opportunities to serve regional markets as a supplemental or substitute technology for conventional hydrothermal. The viability of EGS or other emerging technologies in planning new regional transmission will depend on the ability to cluster several plants into a renewable energy zone (discussed in the next section).

**Co-production** is a distributed generation technology that will likely have particularly high value in relatively remote oil fields. On-site electricity production would eliminate the high line losses that result from moving the same amount of power long distances along low-voltage lines.

**Table 3. Generation Groupings and Transmission Requirements**

	Distributed Generation	Local Network Generation	Power sales to another BA (existing lines)	Power sales to another BA (new lines)
Indicative plant size	<5 MW	5 MW to 80 MW	>80 MW	>80 MW
Attributes	<p>Connected to distribution system, sometimes on customer's side of the meter</p> <p>Effect is to reduce power flowing from the grid to the local network</p>	<p>Plant is part of a generation portfolio sized to meet local demand</p> <p>Does not compete outside local market</p>	<p>Requires enough ATC and point-to-point transmission service to fulfill obligation under power purchase agreement</p>	<p>Amount of new generation from all connecting sources must be sufficient (and sufficiently certain) to justify new line cost</p> <p>Long distance lines need to carry lots of new generation to achieve economies of scale</p>
Challenges getting onto the grid	Minimal	Opportunities limited by size of local load	Getting enough ATC on desired transmission path	<p>Long lead time</p> <p>Regulatory uncertainty</p> <p>Need for economies of scale</p>
Long-term system planning	Not critical			Very critical

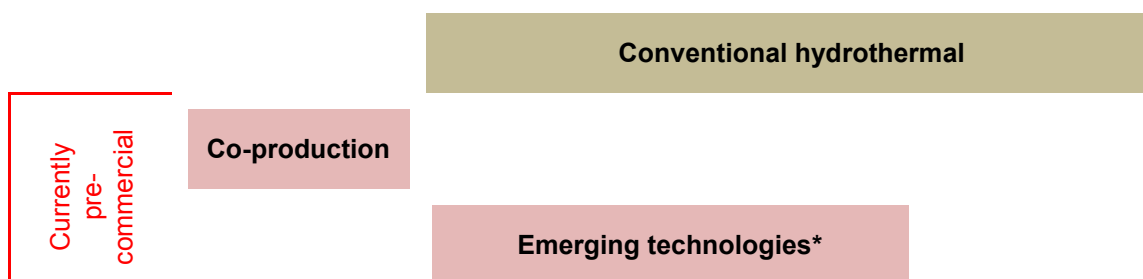

\*Once commercial, these technologies could be a viable resource for long-distance regional transmission planning to the extent many plants can be clustered near one transmission line. If economical at small scale, some may become DG options.

## 6 Opportunities for Development

Taking into account the transmission issues discussed in this analysis, the opportunities most suited to rapid deployment of geothermal are:

- As network resources intended to serve local demand (i.e., load within the BA to which it is connected)
- As new resources connecting to existing lines. Similarly, a new plant situated so that it can access existing regional transmission used by a coal plant slated for retirement could also find some market opportunities.

This section summarizes the current commercial opportunities in detail, based on utility integrated resource plans and other public information. The summaries are organized by region, due to differences in wholesale market structure and transmission planning.

The analysis also distinguishes between areas conducive to normal commercial expansion and areas where full-scale government-supported demonstration projects would pose the least harm to emerging geothermal markets. Distinguishing between these two types of areas—emerging markets and potential for demonstration—is intended to provide DOE and others with an additional point of information for the purposes of long-term strategic programming. Emerging markets can be fragile, but their vulnerability usually has little to do with exploration, reservoir formation, drilling, or any other technological issue. They are fragile because the economic fundamentals are new and vulnerable to disruption. For example, competition among several potential suppliers is one important attribute of a healthy emerging market. If a large-scale government-supported demonstration project has the potential to absorb a large share of local demand, private-sector developers will face a shrinking market with higher risk and will have less incentive to make any commercial foray into that market.

Table 4 details geothermal’s significant base load opportunities in the western United States. It lists BAs whose geographic footprints include large areas favorable to deep EGS exploration (as illustrated by the map in Figure 5) with potential base load needs. (The table excludes special-function BAs with small footprints.) California BAs are examined separately from the remaining BAs that are primarily in the Northwest; this reflects the large demand in California, and the fact that most of the state is served by a regional transmission organization.

**Table 4. Base Load Opportunities in BAs with Access to Significant Geothermal Resources**

Balancing authority area	2009 system demand			Base load resources					Additional base load opportunities <sup>(c)</sup>	
	Annual energy	Peak load	Base load	Coal	Nuclear	Hydro <sup>(a)</sup>	Existing geothermal	Planned geothermal <sup>(b)</sup>		
	(GWh)	(MW)	(MW)	(MW)	(MW)	(MW)	(MW)	(MW)		(MW)
Bonneville Power Administration	56,186	11,561	<b>4,165</b>	1,376	1,146	20,812	-	-	Centralia coal units to close by 2020 and 2025	1,376
PacifiCorp (East & West)	53,388	9,420	<b>4,504</b>	6,833	-	-	45	154	Carbon coal units reach end of depreciable life in 2020	172
Portland General	20,688	4,005	<b>1,418</b>	570	-	676	-	58		
Idaho Power	16,763	3,331	<b>1,120</b>	819	-	1,926	12	40		
Sierra Pacific <sup>(d)</sup>	11,469	1,911	<b>994</b>	722	-	9	346	247	Valmy 1 coal plant retires 2021	254
California ISO	233,892	45,809	<b>18,476</b>	1,708	3,246	6,657	1,433	-	SCE divesting its share of Four Corners (NM) coal plant	730
Los Angeles Dept. of Water & Power	26,825	5,707	<b>1,997</b>	1,230	225	310	-	237	Divesting from Navajo (AZ) coal plant by 2014	630
Sacramento Municipal Util. Dist.	11,448	2,848	<b>823</b>	-	-	2,712	-	120		
Imperial Irrigation District	3,662	988	<b>214</b>	-	-	56	679	77	Salt River Project seeking geothermal for load in AZ	165

<sup>(a)</sup> Availability of hydro to meet base load depends on water availability and other requirements unrelated to power generation.

<sup>(b)</sup> Geothermal acquisitions indicated in utility's most recent integrated resource plan (IRP).

<sup>(c)</sup> Indicated in utility IRP or other industry information sources. In some cases, the utility may anticipate adding a combined-cycle natural gas generator that would run as a base load resource, or it may change the operation of an existing combined cycle plant so that it runs as a base load resource.

<sup>(d)</sup> With the completion of a major 500 kV transmission line in 2013, both of NV Energy's Nevada BAs—Sierra Pacific and Nevada Power—will be substantially interconnected for the first time. This will open up further opportunities for geothermal power in the Sierra Pacific BA to serve load in the Nevada Power BA, which includes Las Vegas and has a base load of 2,000 MW. Three of NV Energy's Reid Gardner coal units near Las Vegas are scheduled for retirement in 2016, which will eliminate 330 MW of coal base load capacity.

Sources: SNL compilations of various EIA databases for 2009; integrated resource plans for PacifiCorp, PGE, Idaho Power, and Sierra Pacific.

## **Northwest**

*Near-term commercial opportunities within a BA:* **Sierra Pacific, Portland General, Idaho Power, PacifiCorp**

*Potential for demonstration projects:* **Bonneville Power Administration, PacifiCorp**

Sierra Pacific is clearly the Northwest's most competitive local market for geothermal development. The amount of geothermal capacity either existing or under contract (as indicated in Sierra Pacific's IRP) is equal to about half of the utility's base load. Future coal plant retirements will create a need for an additional 330 MW of new base load capacity by 2022. Long-term growth is limited, however, by the size of demand in Reno and the rest of northern Nevada, where total base load is less than 1 GW.

Near-term commercial opportunities also exist within the Portland General, Idaho Power, and PacifiCorp networks. All three utilities have signaled their intent to acquire more than 250 MW of new geothermal resources. In addition, Portland General is seeking 300 MW to 500 MW of combined-cycle gas capacity to meet base load.

Bonneville Power Administration (BPA) is primarily a provider of federally managed hydroelectric power, but it may afford opportunities for EGS demonstration projects on its transmission system. Despite having a base load of more than 4 GW, it has only 2.5 GW of coal and nuclear capacity on its system. Commercial development using conventional hydrothermal technologies has been very limited in BPA to date, due largely to environmental challenges related to siting. A demonstration project that in one or two decades proved commercially viable would likely find a large base load market space on the BPA system with little impact on future commercial EGS development.

PacifiCorp may also offer sites suitable for demonstration projects. The utility operates two separate BAs—a western segment comprising parts of Oregon, California, and Washington, and an eastern segment comprising parts of Utah, Wyoming, and Idaho. PacifiCorp has more than 6.8 GW of coal capacity (all in its eastern BA) serving its 4.5 GW of base load in both BAs, and very little of that is scheduled for retirement in the near future. PacifiCorp's surplus of coal capacity relative to its base load means that the market fundamentals driving additional commercial opportunities for geothermal are weaker than they are in the Sierra Pacific BA.

## **California**

*Near-term commercial opportunities:* **Imperial Irrigation District**

*Potential for demonstration projects:* **California ISO**

*Opportunities for delivery to BA:* **Los Angeles Department of Water & Power, Sacramento Municipal Utility District**

On the supply side, the greatest amount of new commercial geothermal activity in California is occurring in the Imperial Irrigation District BA, near California's border with Arizona. Its large agricultural demand results in a much smaller base load level

relative to peak, and the amount of geothermal capacity already existing in the Imperial Valley is three times the BA's base load. Current geothermal technologies are still commercially viable here, however, and some projects serve (or will serve) load elsewhere in California. In addition, utilities in Arizona have signaled interest in purchasing geothermal power from Imperial Valley, potentially taking advantage of lines already planned to connect Arizona's prime solar resources to California.

On the demand side, market fundamentals in California signal a considerable amount of near-term base load opportunities. California utilities will be shedding nearly 1.4 GW of out-of-state coal capacity from their resource portfolios. The state's recent enactment of a 33% renewable portfolio standard provides geothermal with a comparative advantage over combined-cycle natural gas (currently the frequent choice for replacing coal base load capacity). For geothermal to compete, however, new projects will need to either:

- Find sites within California that are both commercially viable and reasonably close to existing transmission
- Take advantage of regional transmission corridors currently used by the out-of-state coal-fired generators that California utilities plan to drop from their resource portfolios
- Collaborate in the creation of a renewable energy zone, as discussed later in this section.

California's demand for future base load would also favor EGS demonstration projects within the California ISO footprint. While commercial opportunities using current hydrothermal technologies are large, total demand in California is so large that a successful EGS demonstration would be unlikely to have any significant impact on competitive suppliers' market space.

### **Renewable Energy Zones**

The earlier discussion of transmission challenges suggests that if a prospective area for geothermal development has little or no available transmission, the likelihood of aggregating several projects in the same area will be a crucial factor in justifying a new line. One 50-MW plant would hardly justify a long corridor of a new high-voltage transmission, but several such plants may.

One tool for transmission planning has been applied successfully to wind development is renewable energy zones (REZs). A REZ is an area of targeted transmission expansion based on demonstrated potential for the development of cost-effective renewable resources. Unlike conventional transmission expansion, which depends on firm commitments from known generators before the line is approved, REZ planning eliminates the need to know in advance precisely where specific projects will be or who will build them. Instead, a REZ is based on the *likelihood* that generators (in this case, geothermal developers) would respond if a strategically sited new transmission line were to define geographically where geothermal development could take place.

The likelihood of future development is established by:

- Technical analysis of the available resources (for example, estimates of subterranean temperature contours calculated from historical well data and heat flow measurements)
- Demand (regulatory requirements such as a renewable portfolio standard, or an economic analysis of cost effectiveness)
- Substantial evidence of real developer interest (such as previous exploration, leasing, or posting letters of credit with the transmission developer).

The REZ model evolved in response to regulators' and utilities' inability to establish the need for a new transmission line based on traditional standards. In the case of wind power, the time required to build new generating capacity is much shorter than the time needed to build a new transmission line. Traditional legal standards for new transmission require evidence that the line will be used and useful, normally in the form of an interconnection agreement with a specific generator. Financing a specific project, however, often requires certainty of interconnection. The first REZs were created to break this circular uncertainty by providing a means to establish a reasonable likelihood that a new line would be used and useful even if the specific generators were not known in advance.

Texas pioneered the zone model for wind development with its Competitive Renewable Energy Zone (CREZ) legislation. State lawmakers passed enabling legislation in 2005, and in 2008 the Texas Public Utilities Commission designated five CREZs and a strategic transmission plan that authorities expect will enable an additional 11.5 GW of wind development.<sup>24</sup> As of May 2011, the commission had certificated nearly all of the new transmission lines included in the CREZ plan, while the Electric Reliability Council of Texas (the independent system operator) was conducting network studies for 30 GW of new interconnection requests for wind projects in and near the five zones.<sup>25</sup>

---

<sup>24</sup> For more detail on the Texas CREZ process and the issues involved, see David J. Hurlbut, "Multistate Decision Making for Renewable Energy and Transmission: An Overview," *University of Colorado Law Review*, vol. 81 (2010), pp. 677-703.

<sup>25</sup> Electric Reliability Council of Texas, "Monthly Status Report to Reliability and Operations Subcommittee," August 2010.

**Table 5. Renewable Energy Zone Initiatives and Status**

<i>State</i>	<i>Initiative</i>	<i>Status</i>
<b><i>Geothermal resources included in zones</i></b>		
WGA	Western Renewable Energy Zones	Zones identified and being used in interconnection-wide planning; WGA examining multistate decision processes
California	Renewable Energy Transmission Initiative*	Potential zones and paths identified, under review by the state and by California ISO
Nevada	Renewable Energy Transmission AAC	Zones adopted by Nevada PUC
Utah	Utah Renewable Energy Zones*	Potential zones identified in 2010
<b><i>Geothermal resources not included in zones</i></b>		
Texas	Competitive Renewable Energy Zones	CREZs designated in 2008; lines certificated and ready for construction; 30 GW of CREZ wind projects under study
Colorado	Senate Bill 06-100	Plan under review by Colorado PUC
Arizona	Fourth Biennial Transmission Assessment	Potential areas identified September 2009; utilities nominated preferred transmission October 2009; currently under review by Arizona Corporation Commission

Table 5 lists the major REZ efforts and their current status. In each case, the objective was to reduce to a select few the number of options for new transmission, based on the likelihood of reaching the most productive renewable energy areas. Beyond this common aim, the REZ initiatives vary with respect to how the results enter into state regulatory decisions regarding new transmission.

Analysis for the Western Governors’ Association (WGA) identified possible geothermal REZs based on existing development and exploration. The maps shown in Figure 4 and Figure 5 earlier in this report show that several areas favorable to deep EGS development are in or near a REZ. The exception is central Colorado, which has had little commercial activity or exploration despite its geological favorability.

Figure 4 highlights the REZs that would be most favorable to regional geothermal development zones, based on the WGA analysis. That is, these are the areas where current data suggests the greatest likelihood of developing enough successful geothermal projects to justify a major transmission expansion that would carry the power to load centers elsewhere in the region. For new geothermal projects *not* in one of these zones, the most likely market would be the local BA where commercial success would not depend on aggregation with many other potential projects.



The WGA analysis suggests the feasibility of a geothermal REZ that generally corresponds to the footprint of the Sierra Pacific BA in Northern Nevada. The analysis also identified a possible geothermal and solar REZ that would include Southern California's Imperial Irrigation District BA. Oregon and Idaho also have potential zones that could include geothermal and wind power.<sup>26</sup>

Nevada's major REZ project was the Renewable Energy Transmission Access Advisory Committee (RETAAC), launched by Gov. Jim Gibbons. The Nevada PUC adopted zones identified by RETAAC and subsequently approved a conceptual transmission plan developed by NV Energy (the state's largest utility), in accordance with legislative requirements. Nevada utilities can build transmission for access to REZ's for purposes of meeting the RPS. Several REZs in northern Nevada were defined by their geothermal potential.

In addition, both the WGA analysis and Utah's renewable energy zone initiative have identified geothermal zones in close proximity to solar and wind zones in the southwestern part of the state.<sup>27</sup>

---

<sup>26</sup> Western Governors' Association, "Western Renewable Energy Zones: Phase 1 Report," June 2009.

<sup>27</sup> Black & Veatch, "Utah Renewable Energy Zone Phase 2 Final Report," September 2010.

## 7 Conclusions

For geothermal power, the market of least resistance with respect to interconnection is in serving local base load—that is, as a generating resource serving load within the same BA using network transmission service. Local transmission access is easier, quicker, and does not entail the uncertainties involved in planning new regional transmission lines. Moreover, several areas with known geothermal potential have foreseeable opportunities for new local base load generation in the near future. Geothermal power’s successful transition to widespread commercialization will depend on taking advantage of these relatively easy opportunities.

A reasonable strategy for testing emerging geothermal technologies is:

- To avoid putting full-scale government-supported demonstration projects in markets where robust competition among commercial developers has already begun
- To site such projects in local markets that are commercially inactive but have a foreseeable need for base load resources in the future.

If successful, the project can interconnect locally with relative ease. Projects testing technologies still in the development phase will not play a part in long-term transmission planning and should not be expected to serve distant markets, as they pose too much financial and regulatory risk.

Accessing regional markets via new transmission will depend on the ability to aggregate several geothermal plants in the same area, or on aggregating geothermal with other complementary generating technologies. Small plants simply cannot provide sufficient justification for a long-distance transmission project on an individual basis. REZs could overcome this formidable economic barrier, however.

Interconnection issues facing geothermal power differ greatly from those affecting wind power or other renewable technologies. The differences are not due to any inherent preference for one technology over another, but to differences in technology characteristics that create affinities for different types of markets. These different markets have different interconnection challenges.

## References

- Black & Veatch. (September 2010). "Utah Renewable Energy Zone Phase 2 Final Report."
- Bonneville Power Administration. (March 2006). "2006 Pacific Northwest Loads & Resources Study."
- Driesen, J.; Belmans, R. (18-22 June 2006). "Distributed Generation: Challenges and Possible Solutions." 2006 IEEE Power Engineering Society General Meeting, Montreal, Canada, Federal Energy Regulatory Commission, 18 CFR Parts 35 and 37 (Order 890).
- Geothermal Energy Association. "The State of Geothermal Technologies," Part 1 (2007) and Part 2 (2008).
- Hurlbut, D.J. (2010). "Multistate Decision Making for Renewable Energy and Transmission: An Overview." *University of Colorado Law Review* (81); pp. 677-703.
- Massachusetts Institute of Technology. (2006). "The Future of Geothermal Energy: Impact of Enhanced Geothermal Systems (EGS) on the United States in the 21<sup>st</sup> Century."
- North American Electric Reliability Corporation. (April 2009). "Accommodating High Levels of Variable Generation," special report.
- National Renewable Energy Laboratory. (May 2010). *Western Wind and Solar Integration Study*. Report No. SR-550-47434. Golden, CO: National Renewable Energy Laboratory.
- Pletka, R.; Finn, J. (October 2009). "Western Renewable Energy Zones, Phase 1: QRA Identification Technical Report." NREL/SR-6A2-46877. Golden, CO: National Renewable Energy Laboratory.
- Rocky Mountain Oilfield Testing Center. (March 2010). "Ormat: Low-Temperature Geothermal Power Production," final report. Accessed April 19, 2012: [http://www.rmotc.doe.gov/PDFs/Ormat\\_report.pdf](http://www.rmotc.doe.gov/PDFs/Ormat_report.pdf).
- U.S. Department of Energy. (September 2010). "Low-Temperature, Coproduced, and Geopressured Geothermal Technology Strategic Action Plan."
- Western Electric Coordinating Council. (20 April 2010). "2010 Western Interconnection Transmission Path Utilization Study: Path Flows, Schedules and OASIS ATC Offerings."
- Western Governors' Association. (June 2009). "Western Renewable Energy Zones: Phase 1 Report."

**Utility Integrated Resource Plans**

Idaho Power Company (Public Utilities Commission of Idaho, Docket No. IPC-E-09-33, 2009).

PacifiCorp (Public Utility Commission of Oregon, Docket No. LC 52, 2011).

Portland General Electric (Public Utility Commission of Oregon, Docket No. LC 48, 2009).

Sierra Pacific Power Company (Public Utilities Commission of Nevada, Docket No. 10-07003, 2010).