



U.S. DEPARTMENT OF
ENERGY

Electricity Delivery
& Energy Reliability

NASPI North American
SynchroPhasor Initiative

American Recovery and
Reinvestment Act of 2009

SynchroPhasor Technology and Renewables Integration

NASPI Technical Workshop

June 7, 2012

NASPI SynchroPhasor Technical Report

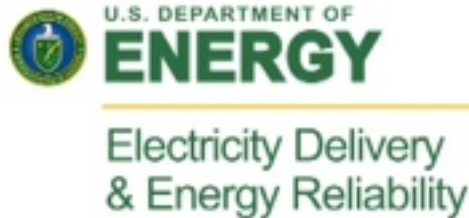

NASPI Synchrophasor Technical Report Renewables Integration with Synchrophasors NASPI Technical Workshop

**June 7, 2102 Workshop
Technical Summary**

Context

This technical material was developed in June 2012 by the North American SynchroPhasor Initiative (NASPI). NASPI is a collaboration between the North American electric industry (utilities, grid operators, vendors and consultants), the North American Electric Reliability Corporation, academics, and the U.S. Department of Energy, to advance and accelerate the development and use of synchrophasor technology for grid reliability and efficiency. The material attached was produced for one of a series of NASPI technical workshops intended to educate and document the stakeholder community on the state of the art for key synchrophasor technology issues.

For this workshop NASPI partnered with the National Renewable Energy Laboratory to explore the use of synchrophasor technology to enhance the integration of renewable generation.

Synchrophasor technology was developed thanks to early research efforts by the U.S. Department of Energy and Bonneville Power Administration in the 1990s. With recognition that synchrophasor technology -- high-speed, wide-area, time-synchronized grid monitoring and sophisticated analysis -- could become a foundational element of grid modernization for transmission system, the Department continued and expanded its investment and industry partnership in the areas of synchrophasor measurement devices, communications, applications, measurements, and technical interoperability standards.

In 2009, the Department committed a total of \$412 million of funds from the American Recovery & Reinvestment Act of 2009 to twelve Smart Grid Investment Grants and one Smart Grid Demonstration Project that implemented and tested synchrophasor

technology using matching private funds. While some of the ARRA funds was spent on other transmission assets, in aggregate over \$328 million of federal and matching private investment was spent on synchrophasor technology and related communications networks.

Additionally, DOE has funded significant technical assistance for NASPI and synchrophasor advancement through the National Laboratories and the National Institute for Standards & Technology.

NASPI serves as a forum for information-sharing and problem-solving among the synchrophasor projects and stakeholders. Much of the work and insights reflected in this technical workshop was enabled by individuals and companies funded by DOE's on-going research and development projects and the ARRA investments. Thus it is appropriate to recognize the insights and work product documented in this workshop and technical report as one of many consequences and work products resulting from the federal Smart Grid investments. Therefore, the Department joins NASPI in re-releasing this material to the smart grid community to document additional impacts and value realized from the federal Smart Grid investments in synchrophasor technology.

The purpose of the Renewables Integration Workshop

In the on-going effort to improve grid reliability for the North American bulk electric system, this workshop looked at how renewable generation can be increased, while protecting grid reliability, using synchrophasor technology. Synchrophasor technology is the most significant control center data improvement tool introduced in the last decade. Additionally, synchrophasor data offers unprecedented insight into the interaction between generators and the bulk power system, enabling sophisticated engineering analysis that can improve grid design and protection.

This workshop was the first opportunity for members of the renewables community to meet with electric system operators and synchrophasor experts to explore how this technology can be used to enhance renewables integration.

This technical report includes the following elements:

1. The workshop summary, prepared by Alison Silverstein (project manager for NASPI), YC Chang (NREL) and David Corbus (NREL).
2. The agenda for the workshop.
3. All of the presentations made by workshop participants.

It is worth noting that since the workshop was held, there has been a significant increase in the number of phasor measurement units deployed on the grid (most installed by participants in the Smart Grid Investment Grants) and in the availability of analytical applications using synchrophasor data for real-time grid operations and engineering analysis. Much of this further progress has been documented in presentations at NASPI meetings (see www.naspi.org/meetings) and in trade and technical press, and much more has been done since then using synchrophasor technology to support the expansion and integration of renewable generation.

**NASPI-NREL
SYNCHROPHASOR TECHNOLOGY AND
RENEWABLES INTEGRATION WORKSHOP
Hyatt Regency Denver Tech Center
Grand Mesa Room
Denver, CO**

**JUNE 7, 2012
8:30am – 12:00pm**

On the day after the North American SynchroPhasor Initiative meeting (on June 5-6 at the Hyatt Regency Denver Tech Center), this workshop will bring together electric industry synchrophasor experts, utility and RTO-ISO leaders at the forefront of renewables use, and NREL experts on renewable energy development and integration. The goal of the workshop is to find opportunities to share and leverage information and insights in each community in ways that advance and accelerate renewables use and grid reliability with phasor technology.

Format – very short presentations in panel format for show-and-tell portions, followed by facilitated discussion on focused topics

Meeting registration -- [NASPI NREL Workshop Registration](#)

AGENDA (speaker confirmations on-going)

- | | |
|---------|--|
| 8:30 am | Introductions |
| 8:45 am | Introduction to synchrophasor technology – Jeff Dagle (PNNL) |
| 8:55 am | Challenges – Dave Corbus (NREL), Kara Clark (NREL), Mike McMullen (MISO), Bob Zavadil (Enernex), John Adams (ERCOT), Karen Forsten (EPRI)
Charlie Smith (UVIG) -- moderator |
- Magnitude of renewables on-line today and coming (5 minutes)
 - Key characteristics of variable generation that create challenges for grid operation (10 minutes)
 - What do we know now about integrating renewables?
 - What do we not know yet that we want to figure out?

- What renewable integration problems are being worked on that phasor data could help solve?
- What insights or projects do renewables research folks have that could be useful for phasor experts trying to support operations people?
- Discussion

9:40 am Break

10:00 am Tools -- Austin White (OG&E), Mike McMullen (MISO), Louis Signoretty (Alstom), Yingchen Zhang (NREL), Jason Banks (NREL), John Adams (ERCOT)
Alison Silverstein (NASPI) -- moderator

- What synchrophasor tools are we using now?
- What synchrophasor tools do we need or want but don't have yet?
- What renewable integration tools and methods are now being used that phasor data could make better?
- Discussion

11:30am Next steps
Alison Silverstein (NASPI) & Dave Corbus (NREL) -- moderators

12:00 pm Adjourn

Topics we expect to come up:

- Phasor-data-based grid monitoring and state estimation
- Fault location
- Real-time monitoring of primary frequency
 - determination of variable generation impacts on primary frequency and inertia
 - oscillation detection and damping
 - assessing real-time inertia
- Active, automated control of wind and solar plants using PMU data collection and feedback
- Real-time monitoring, switching and controls for plant-side and grid-side equipment
 - Storage devices
 - Power electronics, SMES, DSMES, SVCs
 - Switches
- Available Transmission Capacity determination, dynamic line ratings and congestion management using both real-time monitoring and dynamic controls
- Monitoring and screening renewable energy "events" using phasor data

- Equipment and control diagnostics on renewable plants and on plants providing primary frequency response (e.g., stabilizers)
- Voltage monitoring of renewable energy systems using PMUs
- Model validation for renewable energy plants (units v. plants)
- Improving wind and solar forecasting
- Operations prediction – what actions can operators take to resolve problems identified by the tools above?

WORKSHOP COORDINATORS

- Alison Silverstein, NASPI Project Manager -- alisonsilverstein@mac.com
- Dave Corbus, NREL Program Manager, Electric Systems – david_corbus@nrel.gov

If you are interested in the NASPI Work Group meeting that will be held on June 5-6, the meeting agenda is posted at [NASPI Work Group Meeting Registration](#)

NASPI- NREL Synchrophasor Technology and Renewable Integration Workshop

Summary

Denver, CO !

June 7, 2012 !

Opening remarks by Alison Silverstein (project manager for the North American Synchrophasor Initiative) and greetings by Dave Corbus (Lab program manager for electricity systems, National Renewable Energy Laboratory)

The goal of this workshop is to bring two groups together to share and leverage information and insights in each community in ways that advance and accelerate renewables use and grid reliability with phasor technology. System operators will explain their needs and others will explain the tools they have and need that the renewable researchers and synchrophasor community might be able to develop to help address those needs.

In Panel 1, representatives who manage and study grid operations will review the challenges entailed in operating a grid with high levels of renewable generation; in Panel 2, several grid operators offer suggestions for how to use synchrophasor-based tools to improve grid operations and renewable integration. At the end of each panel, and at the close of the workshop, the 80-member group offered comments, observations, responses, and suggestions for further work.

NASPI and NREL thank all of the workshop speakers and audience members for their contributions and participation in this unprecedented discussion.

Panel 1: Challenges

Charlie Smith (UVIG)

- Magnitude of renewables (wind and solar) on-line equals 40-50GW in U.S., 250GW world-wide
- U.S. had 300GW of renewables in interconnection queues as of June 2012
- Variable generation: variability and uncertainty.

Kara Clark (NREL)

- Characterizing the extent of uncertainty and variability
- Spatial and temporal diversity can temper variability
- Means to cope with uncertainty: forecasting, reserves, increased flexibility of wind and other generators (ramp rate, fast scheduling/dispatch), operational procedures, balancing area coordination, storage and demand response, better use of transmission

Mike McMullen (MISO)

- High wind penetration in the Dakotas and Minnesota. 11GW across several generation areas with several transient stability-limited interfaces.
- Transient stability software solve every 45 minutes for stability assessment (critical contingency calculation); high levels of wind generation make transient stability analysis harder.
- PMU and real-time data can be used for the management of wind assets (real time angle calculation) and on-line system stability assessment

Bob Zavadil (Enernex)

- Over the last 10-15 years we have learned how to make wind plants perform like a regular plant in terms of volt/var output.
- Years of work have been done on wind plant dynamic modeling, but vendors treat wind plant model as proprietary. The wind community is working on generic PSS/E, PSLF models which assume 10 sec dynamic performance under constant wind speed.
- Installation of PMUs at each turbine is not practical. Each wind facility needs to have POI monitoring. Wind plant modeling based on point of interconnection metering is essential to improve models of aggregate wind generator behavior.
- Measurements requirement: cycle by cycle, not filtered. Large amount of data will bring a greater analytical burden and requires better data management. There are analytical challenges re asymmetrical events.
- We need to figure out small signal behavior.
- Using markets and newer technology to mimic the behavior of conventional generation to make wind more reliable and predictable as compared to conventional generation
- Are there existing procedures for model validation? How will NERC MOD 26 & 27 be implemented by renewables?

Charlie Smith (UVIG)

- See NERC IVGTF activities with respect to grid codes, especially task 1.3 (interconnection requirement) and task 1.7 (reconciliation of ride-through requirement and drop-out requirement)

John Adams (ERCOT)

- With higher wind penetration, ERCOT is seeing sub-synchronous resonance affecting other frequencies and other generators. Electromagnetic resonance effects are not just on large shaft generators or series-compensated transmission lines.
- There are voltage oscillations in low fault duty ratio driven by wind farm reactive controls. We need better reactive coordination among wind plants.
- Needs for better modeling of wind collector systems and interconnection studies with regards to wind generation, especially in areas with light offsetting load and transmission, to figure out what frequency ranges we should be worrying about.
- Modeling wind generation is a concern because of sub-synchronize resonance phenomenon. We need look into frequencies other than 60Hz in the PSCAD

electromagnetic model to decide which frequency range is a concern. Feedback loops in control systems makes modeling problem harder

- There are primary frequency response issues and frequency deviations caused by new wind plants.
- There is significant ramping related to wind plants, limits need to be put on CPS-1 performance to manage ramping.

Dave Corbus (NREL)

- Lots of high renewable penetration: Puerto Rico high solar with low system inertia and primary frequency response. Also Hawaii has high wind and solar, Ireland has high wind. But wind plants can provide primary frequency response.
- How can we use phasor technology to address the challenges? Real-time monitoring of frequency. Determine the grid impact of renewables on inertia and primary frequency response. Detect oscillation and low damping. Calculate real time inertia.
- Perform active and automated control of wind and solar plants using PMU data, model validation and untapped capabilities of wind generation for grid support.
- Testing these capabilities at NREL's National Wind Technology Center (NWTC).

Alison Silverstein (NASPI) for Dmitry Kosterev (BPA)

- There is 9,900MW of highly concentrated wind penetration, particularly in central Idaho and western Oregon/Washington State.
- Challenges: wind model validation (type 2 wind turbines), voltage control (type 1 and 2 turbines don't have voltage control and can cause problems, type 3 and 4 turbines have the ability for voltage control but it's not always enabled), wind hub voltage control coordination (several plants have the same point of interconnection, effective reactive power sharing, operating in droop mode), dynamic transfer (because of ramping of wind generation, power from conventional plant need to transfer via stability-limited path).

Audience Responses

- Classic controllable generation model versus variable/ungoverned generation sources, how can renewables interact with the classic generation sources?
- Wind plant modeling -- should every turbine be modeled and with all permutations of on/off state etc. for each generator within a plant? Single machine wind plant models compared against more complex multi-machine or statistical models. EPRI is working along these lines.
- PNNL model calibration and validation, looking into wind power solutions, classical governor-based models compared against wind power inputs.
- Advanced wind modeling can require resolution higher than once per cycle output offered by PMUs, approaching waveform capture and similar PQ metering methods. Improving wind plant modeling based on this data.
- System operation continues as this on-going wind research is being done.

Panel 2: Synchrophasor-based tools for managing high levels of renewables

Austin White (OG&E)

- Wind integration (1GW) at Oklahoma Gas and Electric and associated induced oscillations. Using FFT-based tool to automatic detect oscillations. Use it to manage/curtail wind plants that are creating oscillations.
- Some observed event examples (LVRT)

Mike McMullen (MISO)

- Using synchrophasor tools to increase situational awareness with wide-area visualization for operators.
- Using phasor data to improve state estimation, perform angle difference analysis, transient stability analysis.
- Need these tools to solve faster.

Louis Signoretty (Alstom)

- We need measurement-based applications, including wide-area measurement systems using phasor data, to improve visibility into remote wind generation.
- Alstom has different tool sets that concentrate on transmission level and distribution level.
- Transmission: Long transmission lines to transport wind energy is a challenge. PMU based application, model based application plus forecasting capability will provide solution. Example: UK, PMU is used to increase visibility.
- Distribution: Lots of distributed generators are not monitored. We should use PMUs and active management at the distribution feeders, with minimum communications requirements, to enhance and increase local generation with minimal impact.

John Adams (ERCOT)

- There are two barriers to phasor technology adoption. The first is the security issue, which raises the degree of difficulty and cost.
- Bandwidth limitation is also a concern. ERCOT is hitting bandwidth limits on communications, and encryption requirements make this harder.
- The second barrier is, how should system operators respond when they see a problem? We need to understand phasor data and present the information effectively to the system operators in a way that tells them effective options for action.
- ERCOT is currently relying on N-1 analysis but that does not tell you whether the system is stable. The historic voltage stability tools are thermal limit-oriented and don't assume a fault at the time of outage, so we need to figure out new tools for system stability assessment.

Ying-Chen Zhang (NREL)

- New NERC frequency response standard doesn't distinguish between generator types in terms of inertia and frequency response requirements. Renewable generation frequency response is currently investigated by the team of NREL, EPRI and ERCOT.
- Transient stability tools are still model-based. Model validation is essential because even the transient analysis tools are partially model based. NREL is working on renewable generation model validation using PMU data.
- NREL has done extensive work of renewable integration based on production cost simulations.
- Active control and voltage control of wind plant need feedback from fast measurement such as PMUs.
- Current production tools that could use phasor data include:
 - real-time monitoring (but that doesn't look deeply at angle differences between the wind facility and the system).
 - State estimation isn't fast enough yet, not yet synchronized.
 - Transient stability analysis tools (VSAT and DSA), GIS, unit dispatch could use PMU signal to increase visibility, stability assessment and management of renewables.
 - For PSSE and PSLF, can we use actual phasor measurements to inform operations planning and long-term planning?
 - Link phasor data with Geographic Information Systems?

Jason Bank (NREL)

- Dynamic modeling at the distribution level is in its infancy. It has a similar network structure to the PMU and phasor communications network, and we could use high resolution PMUs and power quality monitors at the distribution level in large numbers to collect data on distribution-level loads and generation.
- Use these data to inform advanced inverter and distribution (PV) dynamic modeling.
- Associated visualization applications

John Adams (ERCOT)

- The tools that are already used in production: visualization (map and angle difference display), FFT analysis and modal analysis. CAISO has an example of detecting control system failure at a power plant.

Audience Responses

- PMU can be used for protection but in a supervisory scheme.
- Use PMU at the point of interconnection and PV side to detect islanding and trip-off.
- RIM and Gridlab-D from PNNL for renewable modeling and distribution level modeling
- Going past N-1 security criteria
- Transient limits and the impact of phasors
- Calibration of the developed phasor tools against the existing system to avoid false positives and other nuisance alarming

- Integration of phasor data with DEW (or other distribution modeling packages) particularly with distribution-level phasor measurements. This is something that has already been done to an extent at NREL.

Whole Group Lightning Round

- Continuous feedback and control for phasor/PMU data with renewable generation
- Better models of all generation possible using phasor data, including renewable/variable generation sources
- Feedback from operators on vendor tools such as dynamic analyzer
- Use phasor data to characterize nomograms and identify system operating limits – how much margin is necessary? EPG has used phasor data to set up a dynamic nomogram.
- PJM has lots of phasor and renewables data and invites others to help analyze them
- Mehtatech makes devices that produce point-on-wave and phasor data.
- We need better tools for phasor data mining and analysis
- What are the data handling needs that we (Grid Protection Alliance) can help you solve?
- Redefine the operation of the power system based on results from PMU data collection and model validation
- Phasor data lets us look at the power system very differently – we need to look at primary frequency response impacts from loads as well as generation.
- Better operator tools which recommend immediate solutions, not just display data and show more problems.
- There are institutional problems with putting PMUs on generator terminals.
- Worthwhile to understand what type of data is available and develop applications based on those data.
- Model validation needs to go beyond renewables. Can we develop improved simulators to effectively simulate the whole system using system-level measurements and analysis?
- Most SEL relays and reclosers are PMU function-capable and can be given control capabilities.
- We need to solve critical infrastructure protection issues with respect to phasor systems.
- Need N-1 instability detector and control failure detector.
- Design electric markets to better monetize and use renewable sources
- PMUs enable dynamic line ratings that could let us reduce wind curtailments.
- Data sharing and model sharing are needed not only among utilities but also with the research community. How do we make it safe for utilities and manufacturers to share their data?
- We need to use phasor data to make wind and renewables more controllable, especially for inercial ramping – we should bring the inverter manufacturers into this discussion.
- We need policy support to continue and broaden PMU deployments

- Test case and demos related to renewable integration
- NASPI needs to continue education, training and spreading value messages
- Research toward distribution-level PMUs and distribution-level renewables – once we have more zero net energy homes, we’ll need to be able to manage distributed generation more effectively.
- What can power electronics do in the future to solve some of these issues? Interaction with current modeling regimes?
- If you have a grid event, you should share the data and findings about the problems encountered with the rest of the power and research communities.

Alison Silverstein (NASPI)
YC Zhang (NREL)
Dave Corbus (NREL)



Introduction to Synchrophasor Technology

NASPI-NREL Synchrophasor Technology and Renewables Integration Workshop

June 7, 2012

Jeff Dagle, PE
Chief Electrical Engineer
Advanced Power and Energy Systems
Pacific Northwest National Laboratory
(509) 375-3629
jeff.dagle@pnnl.gov

Wide Area Measurement System (WAMS)

Data acquisition devices (continuously recording and time synchronized)

- ▶ Phasor Measurement Units (PMU)
 - Inputs from potential transformers (PT) and current transformers (CT)
- ▶ Analog signal recorders (with transducer inputs)
- ▶ Point-on-wave (POW) recorders (with PT, CT inputs)
- ▶ Controller monitors (generators, HVDC, FACTS)
 - Inputs from the controller interface or the controlled device
- ▶ Advanced relays and other Intelligent Electronic Devices (IED)
- ▶ Digital fault recorders and other sequence of events recorders

Generally **NOT** supervisory control and data acquisition (SCADA), typically a polling architecture that does not collect time-synchronized measurements (time stamps applied when the signals are logged into the energy management system at the control center)

Lessons Learned from August 10, 1996

Data captured from WAMS was essential to support the blackout investigation

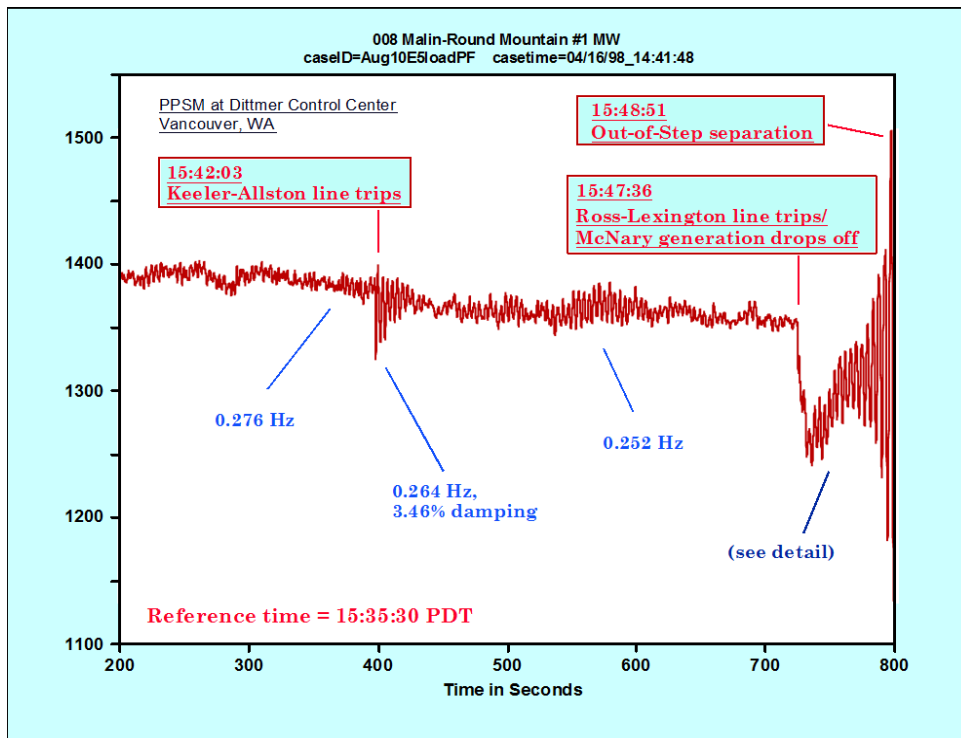

The need for better model validation was demonstrated

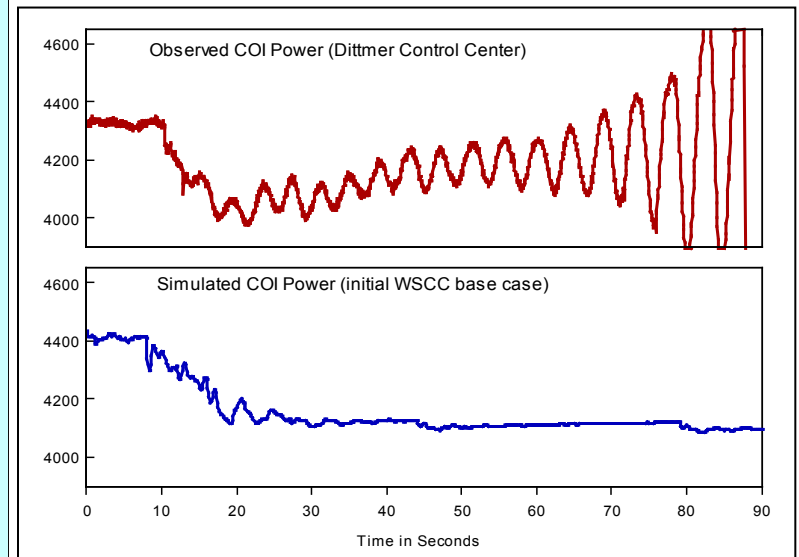

North American SynchroPhasor Initiative

DOE and NERC are working together closely with industry to enable wide area time-synchronized measurements that will enhance the reliability of the electric power grid through improved situational awareness and other applications

April 2007

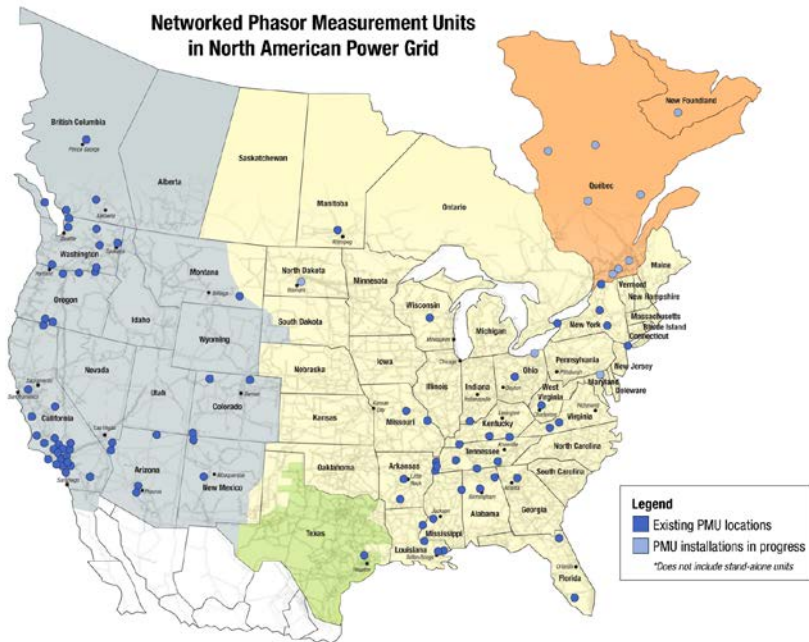

March 2012

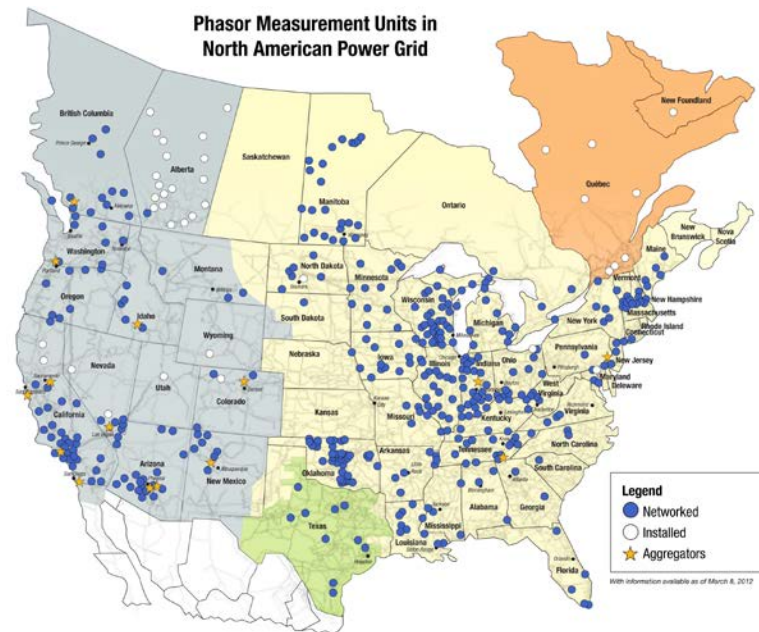

“Better information supports better - and faster - decisions.”

NASPI Organization

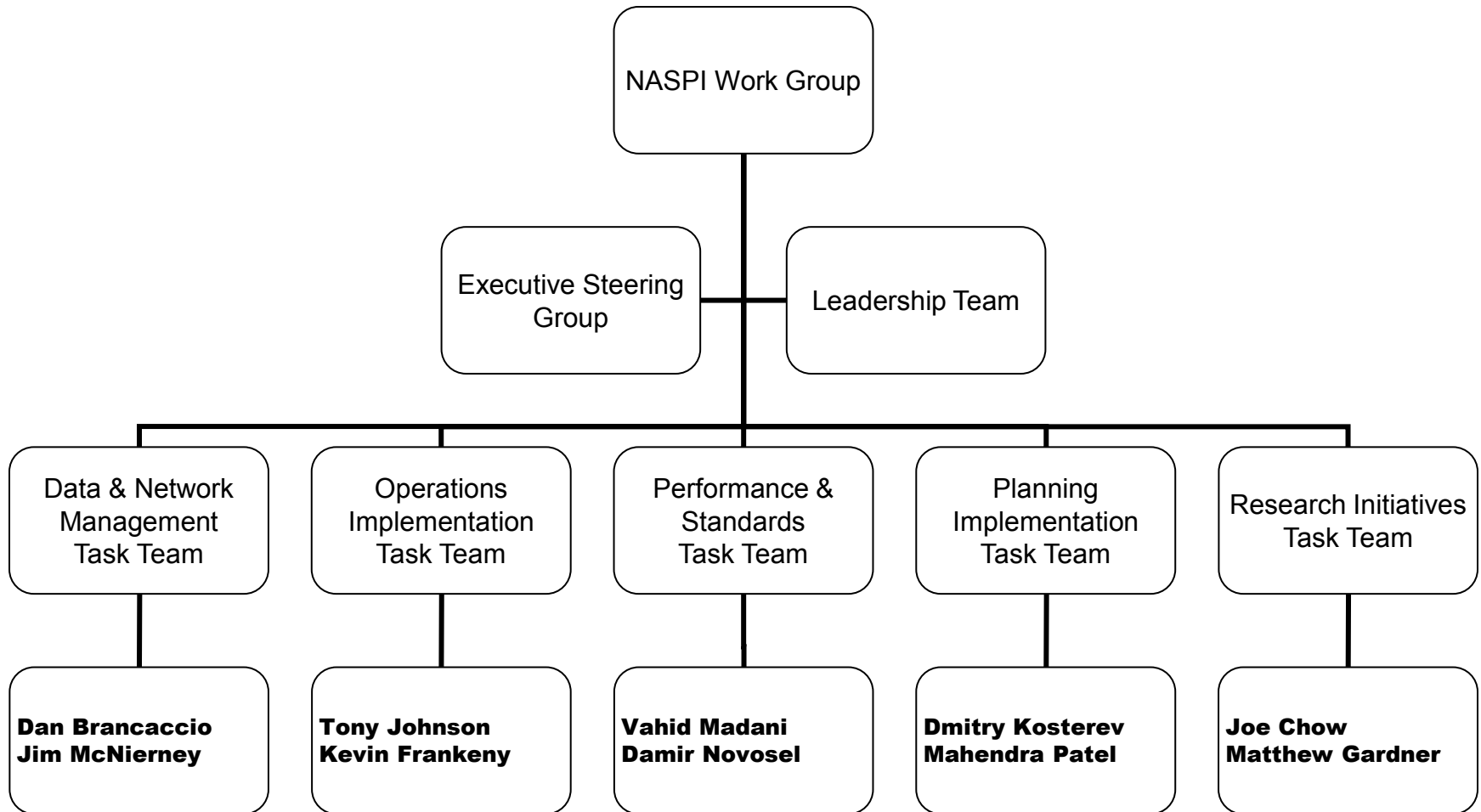

NASPI Work Group Meetings: 2009-2011

Date	Location	Meeting Themes
February 4-5, 2009	Scottsdale, Arizona	Networking and cyber security
June 3-4, 2009	Sacramento, California	Operations and success stories
October 7-8, 2009	Chattanooga, Tennessee	Vendor showcase
February 24-25, 2010	Austin, Texas	Recovery Act projects, technology specifications, intermittent generation
June 8-9, 2010	Vancouver, Canada	International activities and baselining
October 5-6, 2010	Arlington, Virginia	Recovery Act project updates
February 23-24, 2011	Fort Worth, Texas	Technical standards and vendor showcase
June 8-9, 2011	Toronto, Ontario	Success stories
October 12-13, 2011	San Francisco, California	Recovery Act project updates

NASPI Work Group Meetings: 2012

Date	Location	Meeting Themes
Feb. 29-March 1, 2012	Orlando, Florida	Research initiatives and application training sessions
June 6-7, 2012	Denver, Colorado	Success stories and vendor show
October 17-18, 2012	Atlanta, Georgia	Recovery Act project updates

REAL-TIME SYNCHROPHASOR APPLICATIONS AND THEIR PREREQUISITES

Applications

Wide-area Monitoring

- * Visualization
- * Frequency and voltage monitoring
- * Oscillation detection

- * Event detection
- * Alarming

- * Operator decision support

- * Automated wide-area controls
- * Reliability Action Schemes

Functions

- System protection
- Increase in operating transfer capacity
- Renewable integration
- Congestion management
- Outage avoidance
- Situational awareness

← TODAY

→ FUTURE

Prerequisites

ANALYSIS

Good data collection

Interconnection-wide baselining

Pattern detection

Model validation – system & elements

System studies

COMMUNICATIONS

Interoperability standards

High availability, high speed

Appropriate physical & cyber-security

Redundant, fault-tolerant

USERS

Familiarity

Good visual interface

Training



Technology Maturation Progress

- ▶ Sharing users' and vendors' success stories and high-value applications
- ▶ Accelerating development of technical interoperability standards
- ▶ Focusing and facilitating baselining and pattern recognition research (e.g., oscillation detection) and other R&D
- ▶ Early identification of project implementation challenges and community work to develop and share solutions
 - Develop and test PMU device specifications and interoperability
 - Communications network design
 - PMU placement
 - End-to-end data flow and quality
 - Developing requirements for “production-grade” systems
 - Building key software infrastructure (NERC GPA investment)
 - Enhance applications value and operator and user training
 - On the horizon – more technical standards; cyber-security and GPS

The NASPInet Vision – A Distributed Network for Data Exchange and Sharing

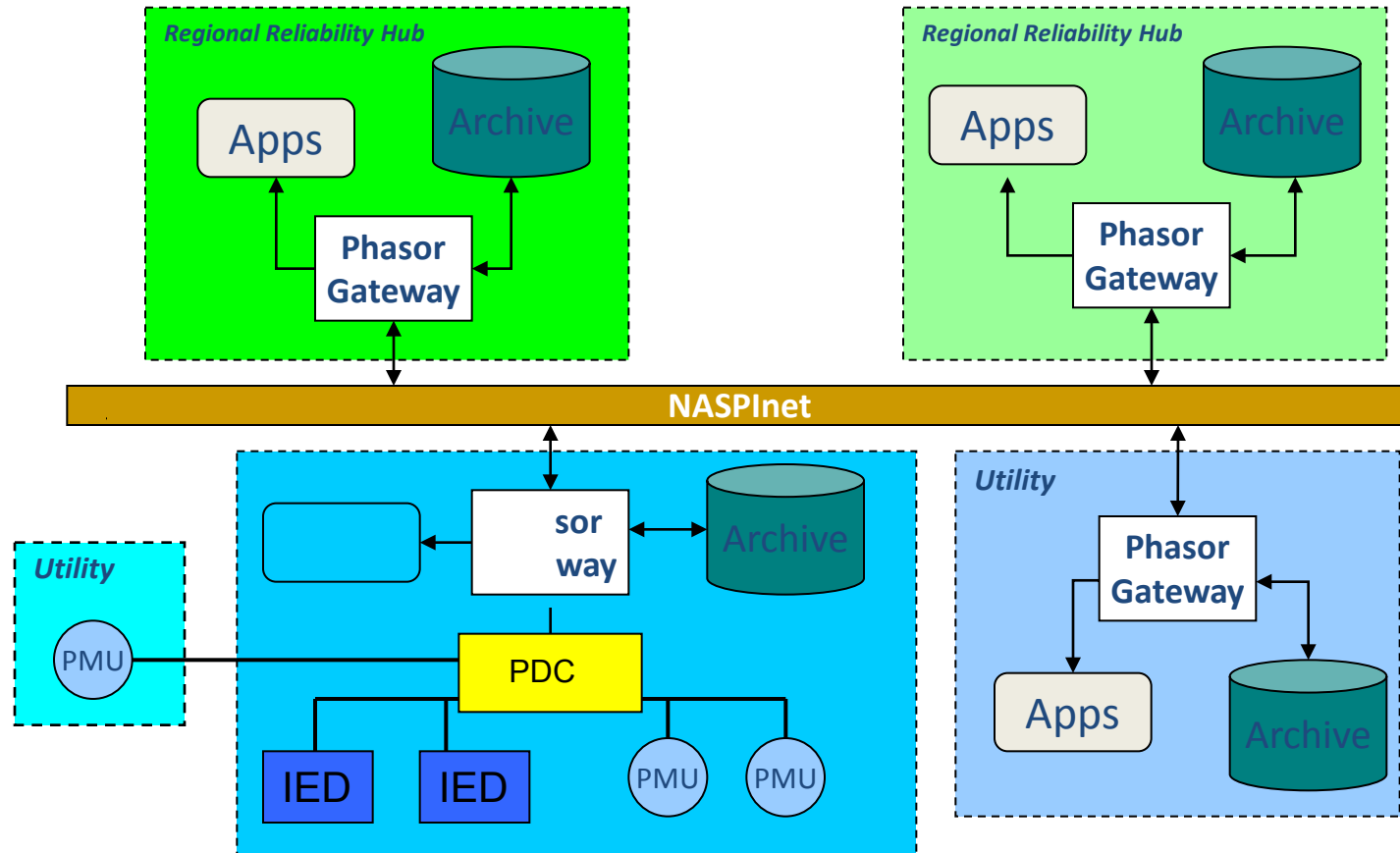

NASPI Application Classification

<i>Class</i>	<i>Basic Description</i>	<i>Sampling/ Data Rate</i>	<i>Required Latency</i>
A	Feedback Control	Fast	Fast
B	Open Loop Control	Medium	Medium
C	Visualization	Medium	Medium
D	Event Analysis	Fast	Slow
E	Research/Experimental	N/A	N/A

Security requirements are a function of the application

Security of Synchrophasors

- ▶ Synchrophasors are becoming part of the bulk electric system and will require physical and cyber security
 - ***But these systems shouldn't be treated any differently than other forms of measurement and control telemetry***
- ▶ Synchrophasor systems will coexist with other bulk electricity system (BES) cyber infrastructure and will have similar dependencies on common communications and network elements
- ▶ System designers and owners are leveraging emerging cyber-security standards and technologies
- ▶ Currently available phasor applications require further data analysis, software refinement and operational validation to be fully effective; many are in advanced development and testing and are not in full operational use
 - Therefore, many of these systems are not currently considered critical cyber assets
- ▶ Due to nature of continuous, high-volume data flows, new technology will likely be required for measurement, communications, and applications
 - Technology anticipated to undergo rapid change and refinement over the next several years

- ▶ DOE has played a key catalyst role in the development and implementation of synchrophasor technology
- ▶ DOE and NERC will continue to support industry efforts to promote and enable widespread adoption of advanced monitoring technologies to ensure grid reliability
- ▶ DOE will actively support needed R&D to ensure that the full value of a North American phasor network will be realized
 - **Hardware** – measurement technologies
 - **Network** – data access and security
 - **Software Applications** – focus on reliability management objectives
 - **Demonstrations** – regional in scope
- ▶ Recovery Act is enabling unprecedented advancement of synchrophasor technology deployment



Pacific Northwest
NATIONAL LABORATORY

Proudly Operated by **Battelle** Since 1965

NASPI *North American
SynchroPhasor Initiative*

<http://www.naspi.org/>

RE Integration and PMUs- How can we use synchrophasors

- **Real-time monitoring of primary frequency**
 - **determination of variable generation impacts on primary frequency and inertia**
 - **oscillation detection and damping**
 - **assessing real-time inertia**
- **Active, automated control of wind and solar plants using PMU data collection and feedback**

56% Power Penetration Example in PSCo

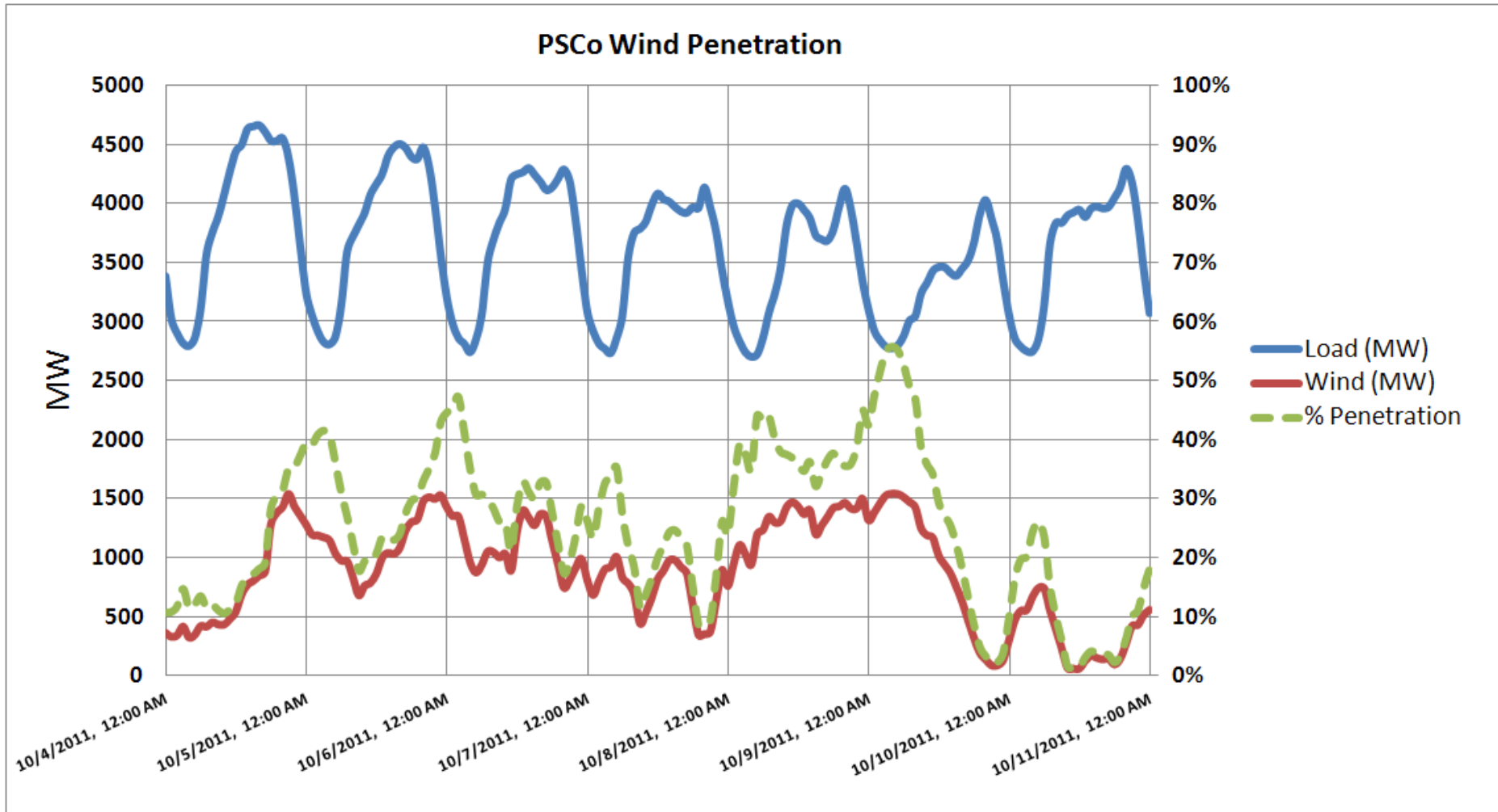

Wind Power to Provide PFR

Example of Island Grid

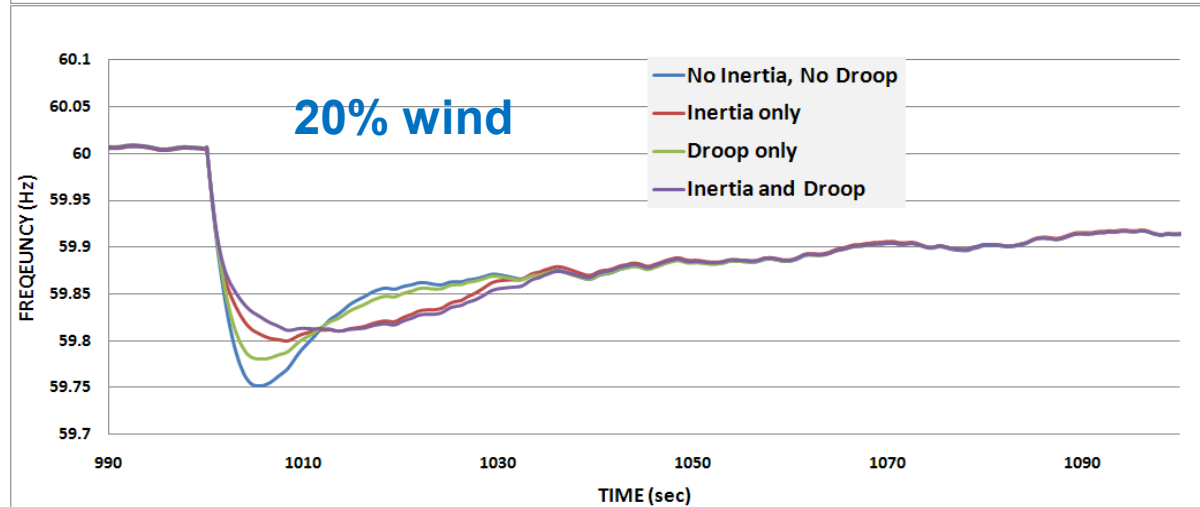
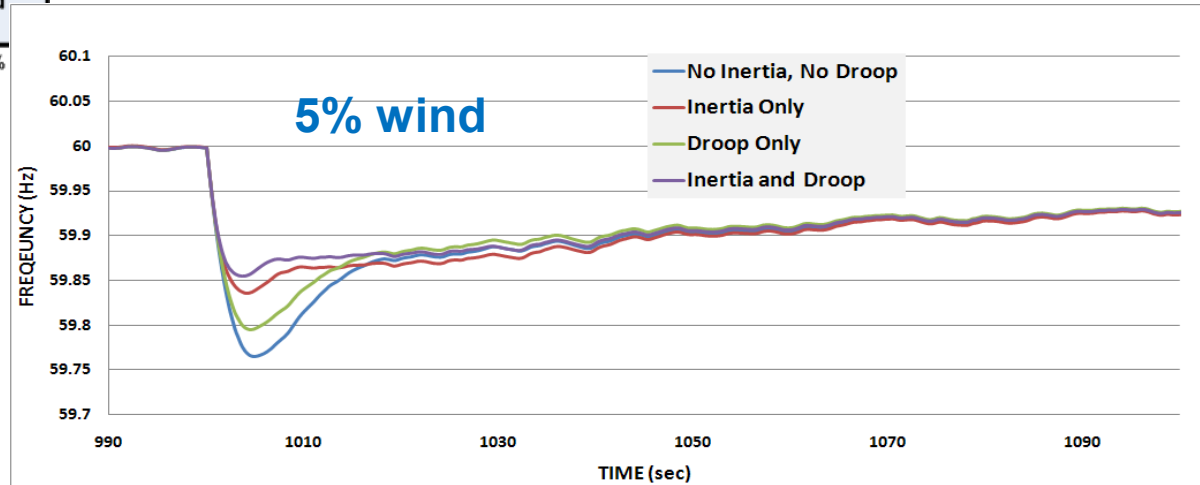
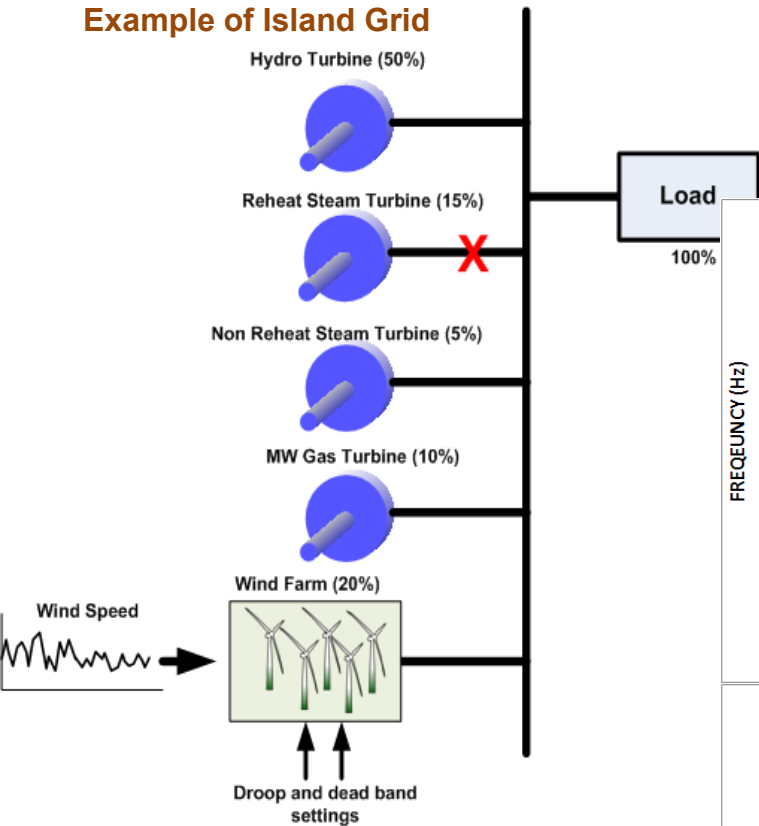

Wind Power to Provide Secondary Reserve

Operation with 10% reserve

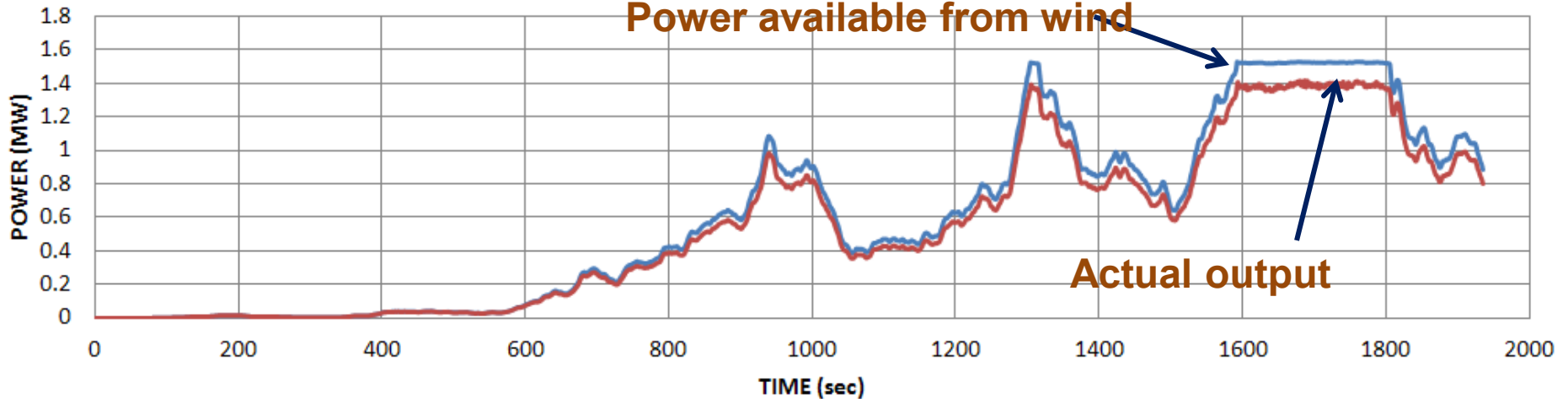
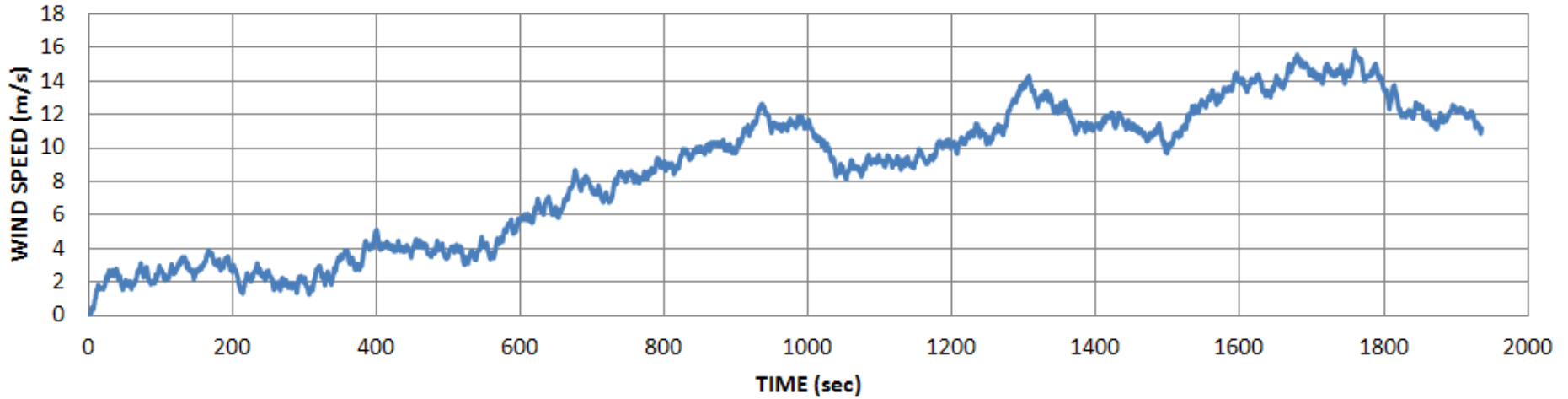

RE Integration and PMUs

- **Voltage monitoring of renewable energy systems using PMUs**
- **Model validation for renewable energy plants (plants not turbine)**
- **Operations prediction – what actions can operators take to resolve problems identified by the tools above?**

Some Issues Not Specific to RE

- Fault location
- Available Transmission Capacity determination, dynamic line ratings and congestion management using both real-time monitoring and dynamic controls
 - Wind conditions cool lines for more ATC
- Equipment and control diagnostics on renewable plants and on plants providing primary frequency response (e.g., stabilizers)

Renewable Plant Model Validation with Synchronphasor Data

NASPI-NREL *

SYNCHROPHASOR TECHNOLOGY AND RENEWABLES INTEGRATION WORKSHOP (

June 7, 2012

Denver, CO *



Robert Zavadil
Executive Vice President
620 Mabry Hood Road, Suite 300
Knoxville, Tennessee 37932
Tel: (865) 218-4600 ex. 6149
bobz@enernex.com
www.enernex.com

Objectives of Presentation

- ❑ Apprise PC of some ongoing activities related to development of planning models for bulk wind plants
- ❑ Convey progress and status regarding model validation
- ❑ Solicit input and advice from PC

Why?

- ❑ >50 GW of bulk wind and PV installed
- ❑ Increasing emphasis on validation of models for BES
- ❑ Novel generation technologies for wind and solar pose new challenges
- ❑ Model needs for bulk renewable plants
 - \$Planning: PSS/E, PSLF; ~ 10 Hz bandwidth; utilized for stability and other dynamic studies (has received most of the attention to date)
 - \$Operating: On-line security assessment; “look-ahead” simulations that may include dynamic or pseudo-dynamic behavior

How? %

- ❑ Validation of as-built plant using recorded disturbance data at POI is likely the best route
 -) Validation may be required for each plant
 -) Other methods more complicated, expensive
- ❑ Requires monitoring at POI for each facility
- ❑ Most existing renewable plants do not have disturbance monitoring at present

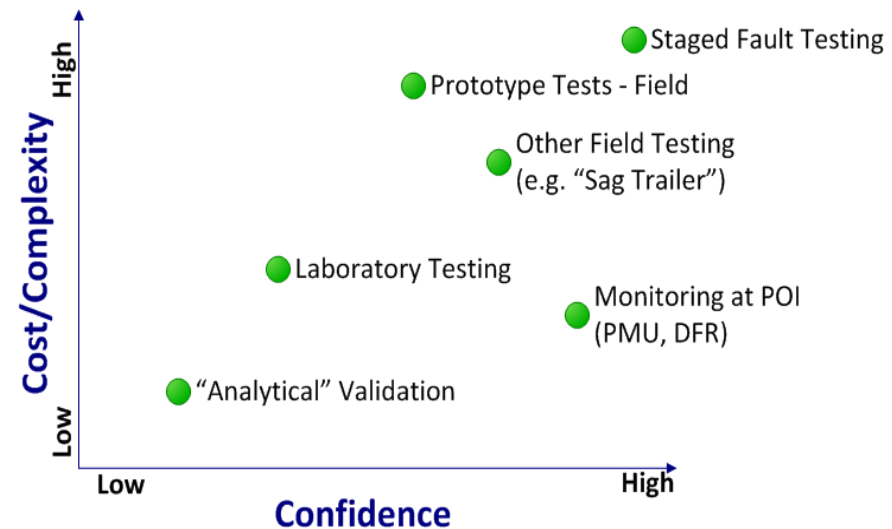

Questions/Issues/Challenges 0

- ❑ Measurement requirements
- ❑ Monitor deployment
- ❑ Clerical and analytical burden
 - *Managing data
 - *Identifying appropriate disturbances for validation
 - *Performing analysis, adjusting models
- ❑ Are there existing processes for validating models on an ongoing basis?
- ❑ How will NERC Mod 26 and 27 be implemented by REs? *



ERCOT Operational concerns with Wind Energy

**John Adams
Principal Engineer
Electric Reliability Council of Texas**

June 7, 2012

Operational Challenges for Wind Integration

- **Uncertainty**
- **Variability**
- **Interconnection**

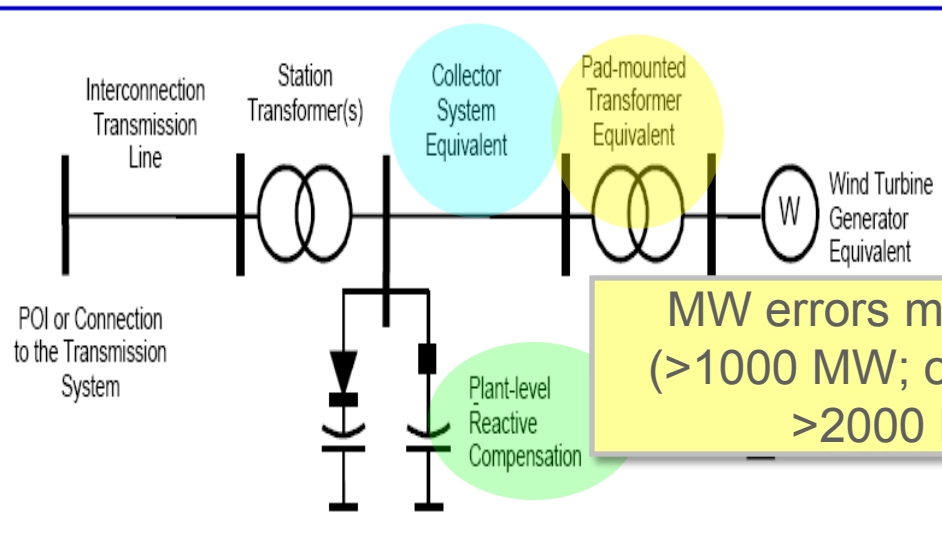
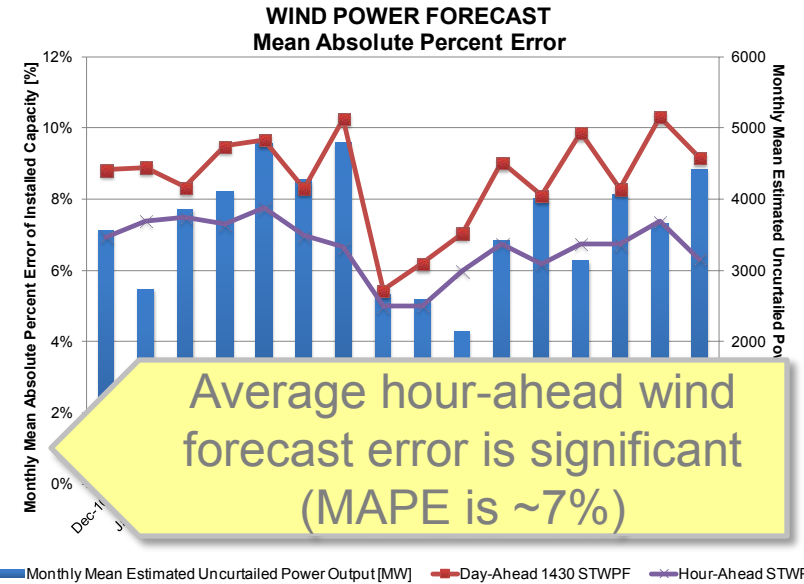

MW errors may be high (>1000 MW; occasionally >2000 MW)

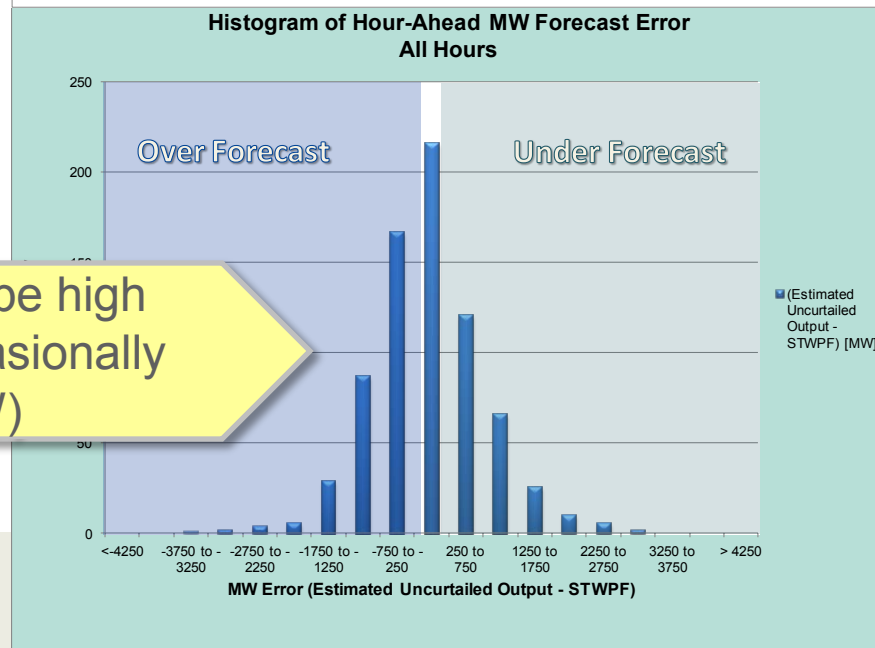

Primary Frequency Response

- All generation in ERCOT is required to provide governor response with a 5% droop setting
- Wind farms were recently required to provide primary frequency response to frequency deviations from 60 Hz.

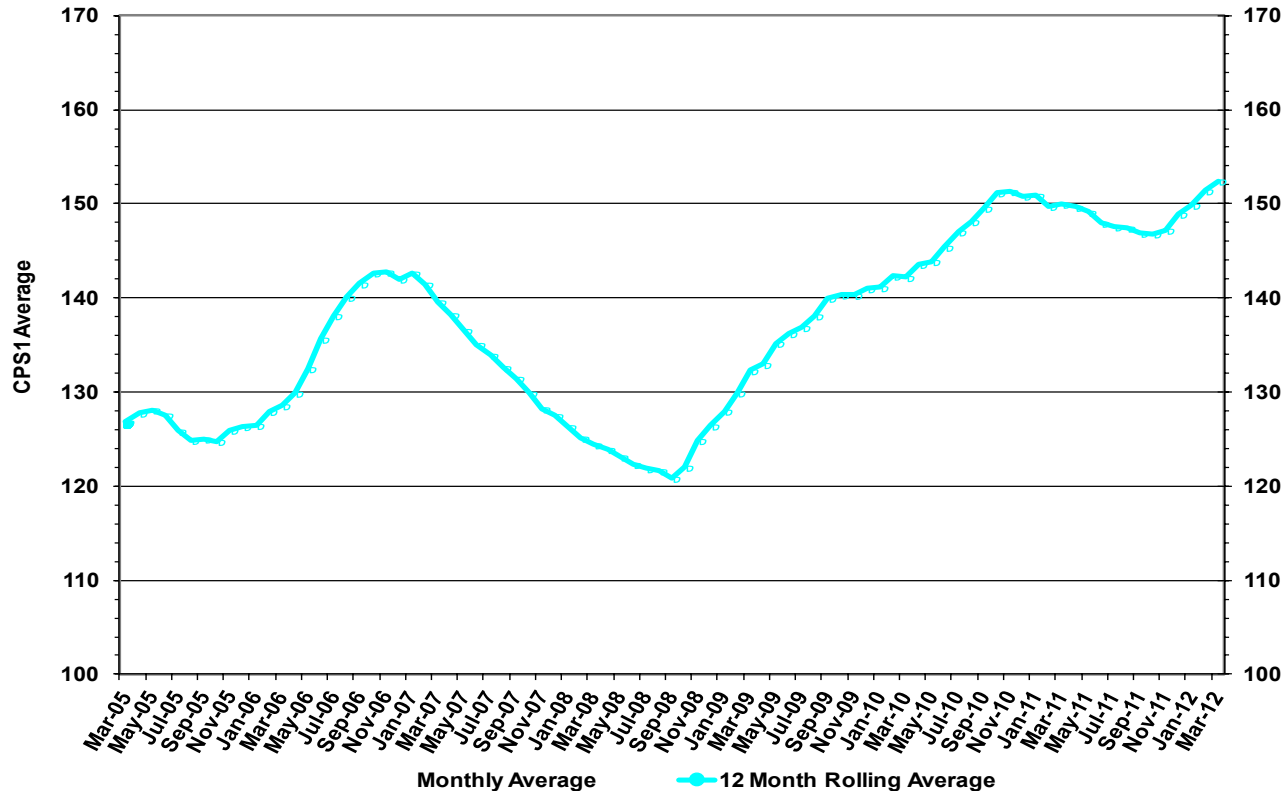

Generation Ramps

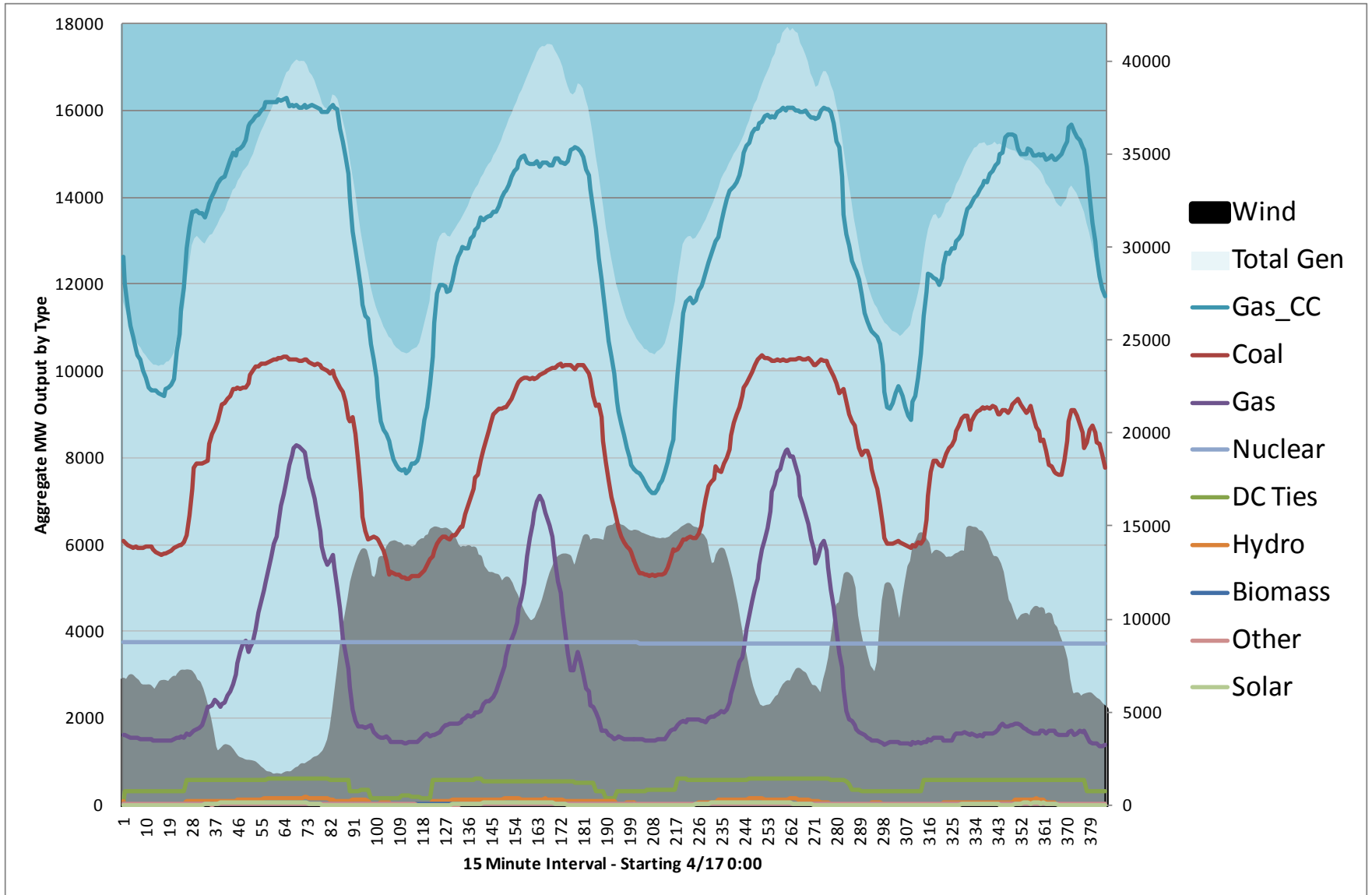

Interconnection-Related Requirements

- Inverter-connected resources may not fit with traditional technical requirements
- **Static and dynamic reactive capability**
- **Voltage-ride through capability**
- **Modeling**
 - Collector system and support device modeling
 - Dynamic model and parameters
- **Reactive coordination** in CREZ area
- **Voltage Oscillations** in low fault duty ratio areas
 - ERCOT has observed voltage oscillations driven by wind farm reactive controls in areas with low fault duty ratio.
- Operational Concerns – **Sub Synchronous Resonance** with Series Compensated Transmission lines

ERCOT Synchrophasor observed voltage event near wind turbine

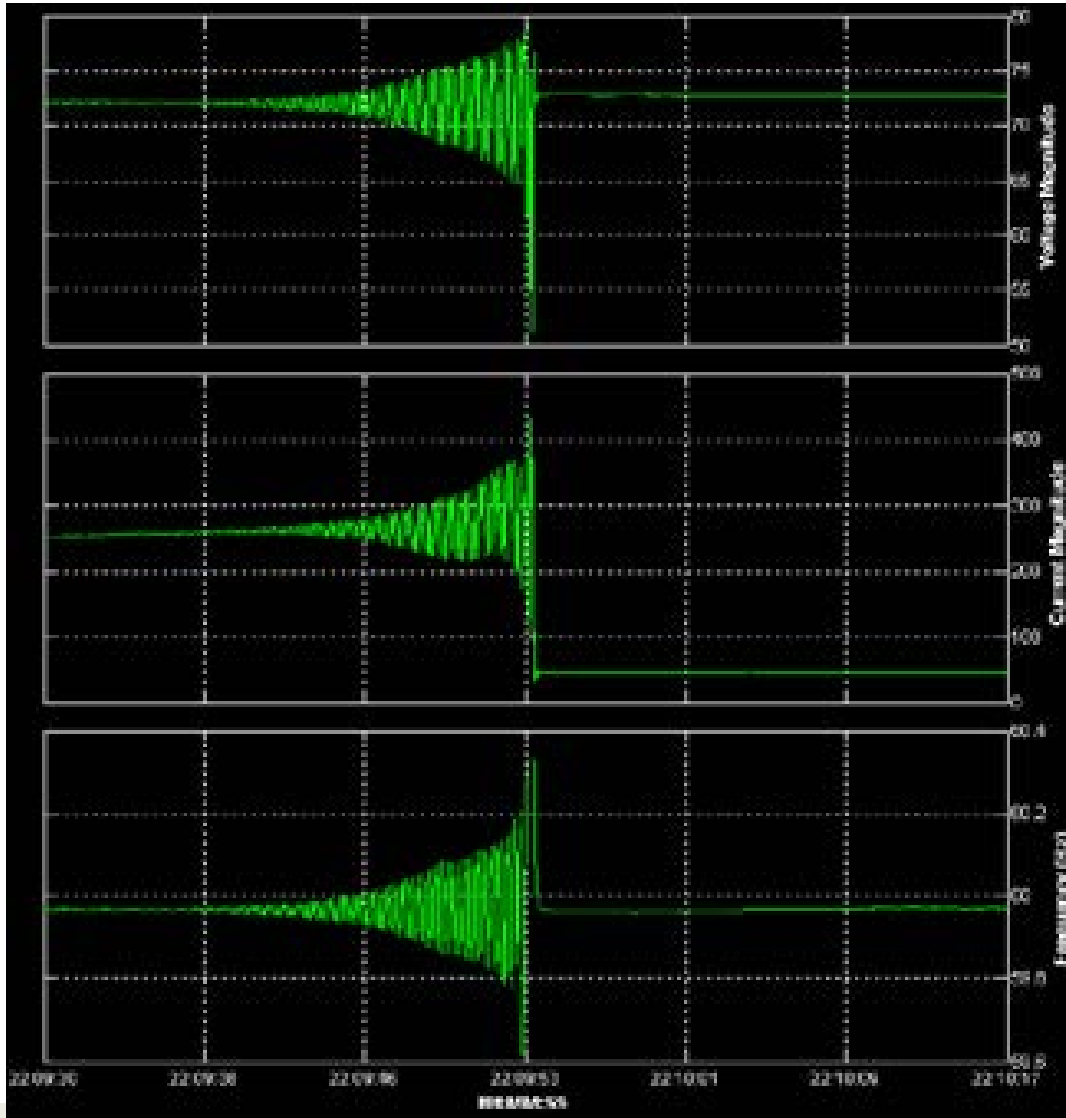

Questions



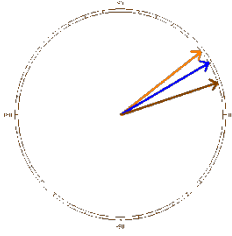

Wind Farm Oscillations

- Only during high winds
- FFT analysis shows 12-14Hz
- Voltage fluctuations as high as 5%
- Determined it is a problem at different wind farms with the same turbine model
- Manufacturer has resolved the problem with new converter parameters
- Some turbines were reverting back to default parameters

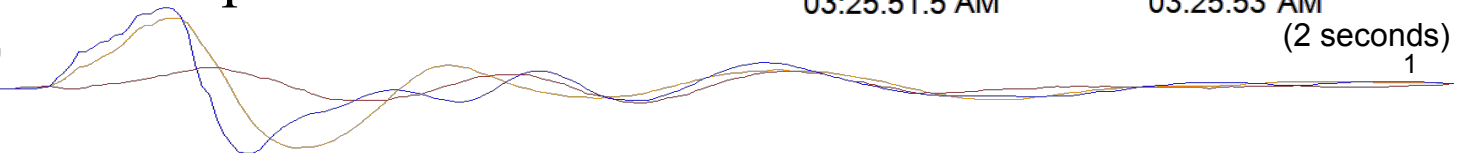
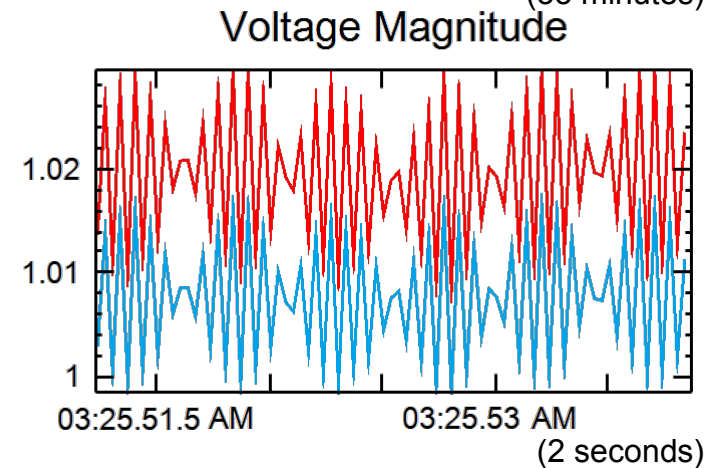
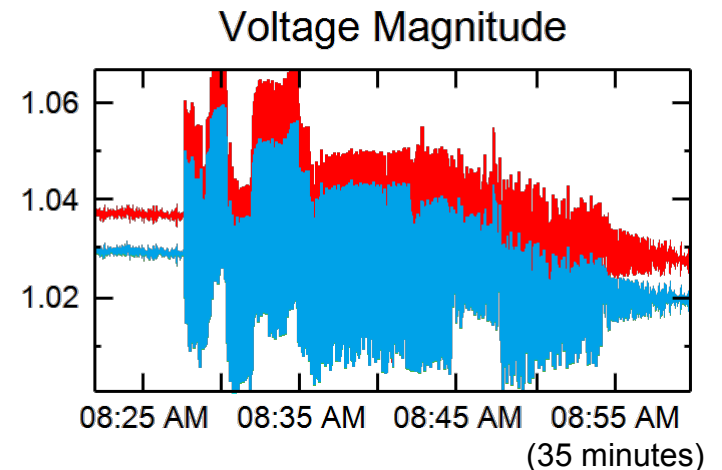

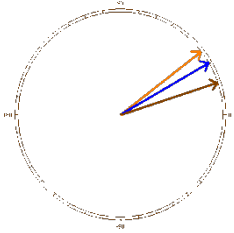

FFT Detection Program

- ❑ Performs an FFT on a sliding window of 256 samples
- ❑ Sends email or text message when the oscillations reach an objectionable level
- ❑ Almost 8 hours of oscillations detected

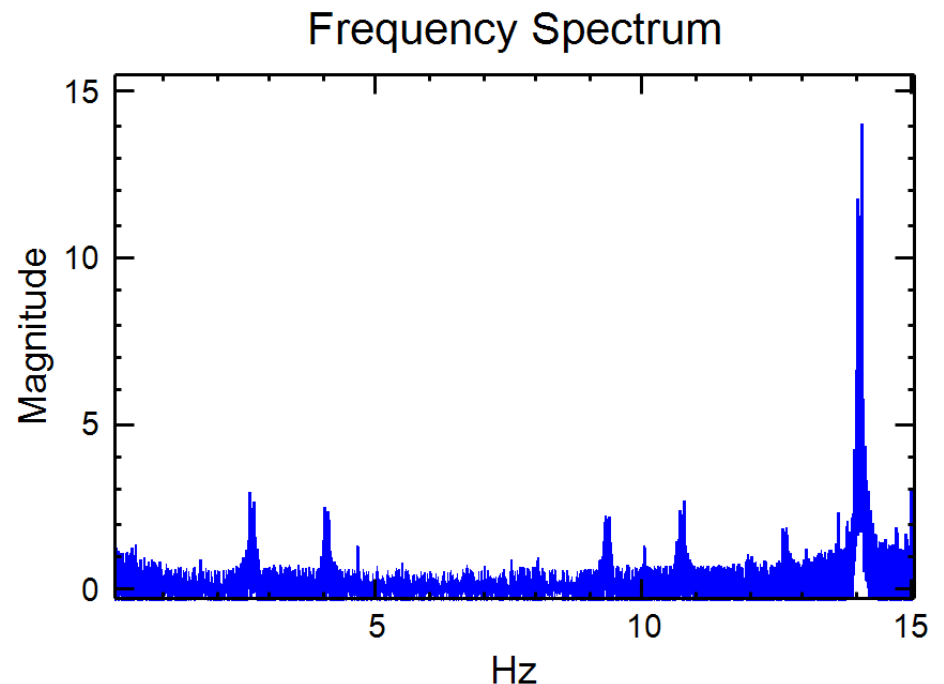

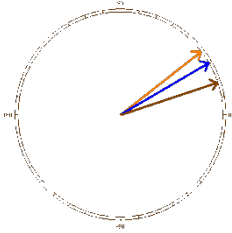

SCADA vs Synchrophasors

- ❑ Black trace shows the voltage magnitude reported by SCADA
- ❑ Red trace shows the synchrophasor data
- ❑ The oscillations are obviously undetectable with SCADA

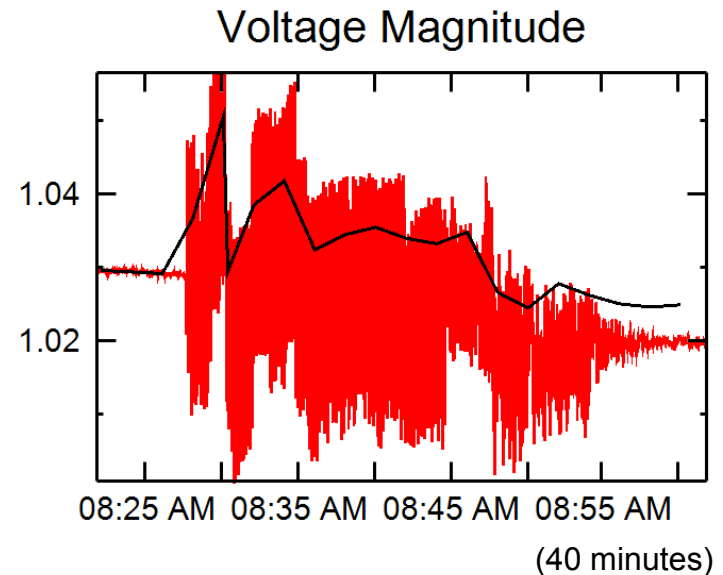

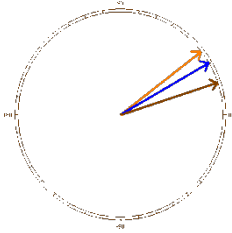

Oscillation/LVRT Event of 12/14

- ❑ One line was out of service for maintenance
- ❑ Fault on another line started the oscillations
- ❑ Voltage pull-down was about 80% for 5 cycles (normal clearing time)
- ❑ Wind farm closest to the disturbance lost 57MW
- ❑ Why didn't the LVRT function properly at this facility?

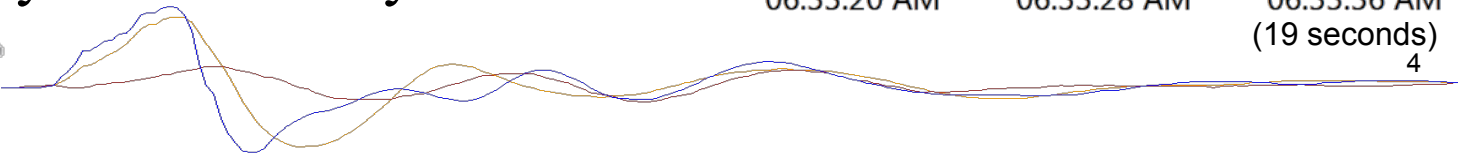
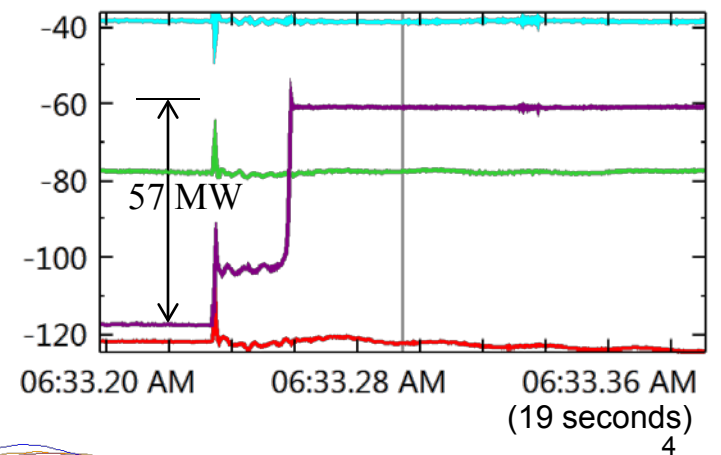
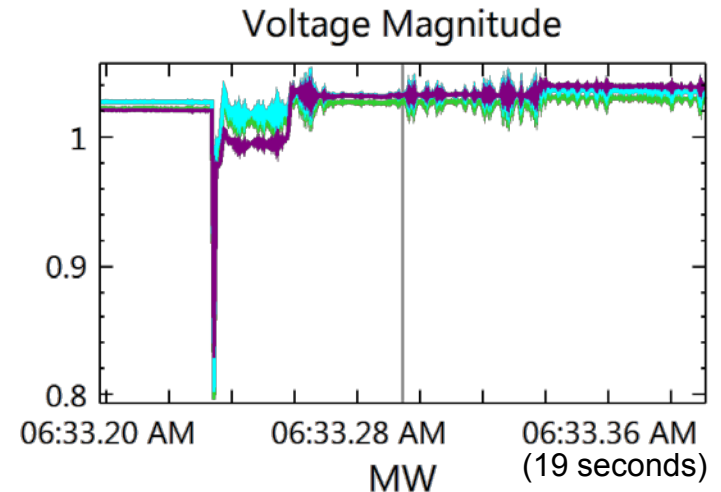

Using PMUs to Facilitate the Reliable Integration of Wind Generation in Pacific Northwest

NASPI Renewable Workshop &

June 2012 &

Presented by Alison Silverstein for BPA &



WIND GENERATION CAPACITY IN THE BPA BALANCING AUTHORITY AREA
 Sequential Increases in Capacity, Based on Date When Actual Generation First Exceeded 50% of Nameplate

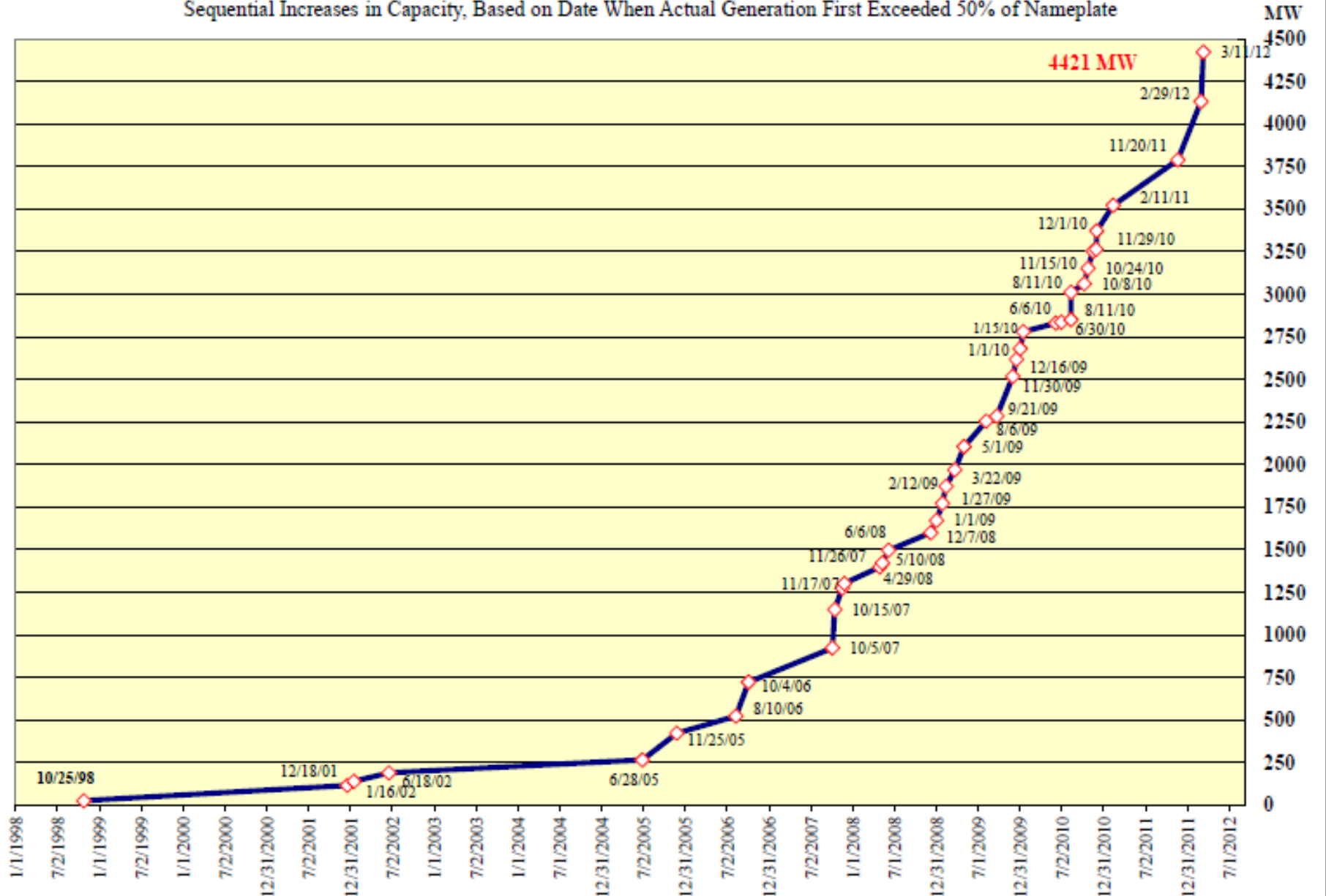

Many of BPA Paths are Stability-Limited

Northern Intertie US – Canada (3,100 MW)

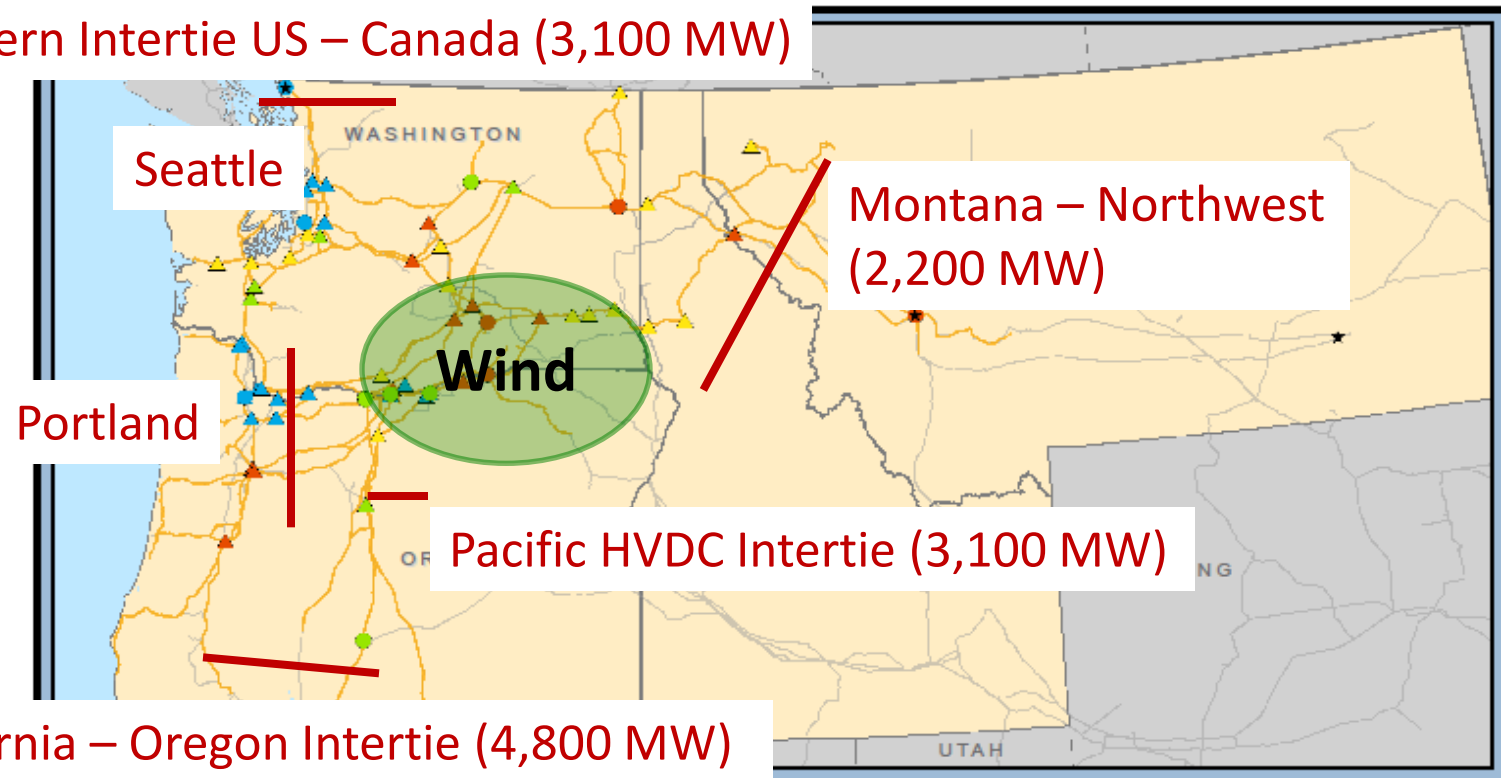

California – Oregon Intertie (4,800 MW)

BPA wind is highly correlated

- Installed capacity is about 4,400 MW
- Actual peak is above 4,000 MW in spring 2012

Challenges

1. Wind power plant models
2. Wind power plant voltage control
3. Wind hub voltage control coordination)
4. Dynamic transfers



1. Wind Power Plant Modeling

- BPA has 4,500 MW of wind generation interconnected with no validated models
- Existing models failed to indicate some of the operational issues
- Type 2 generator models are particularly deficient (next slide)



Type 2 Wind Power Plant Model Validation %

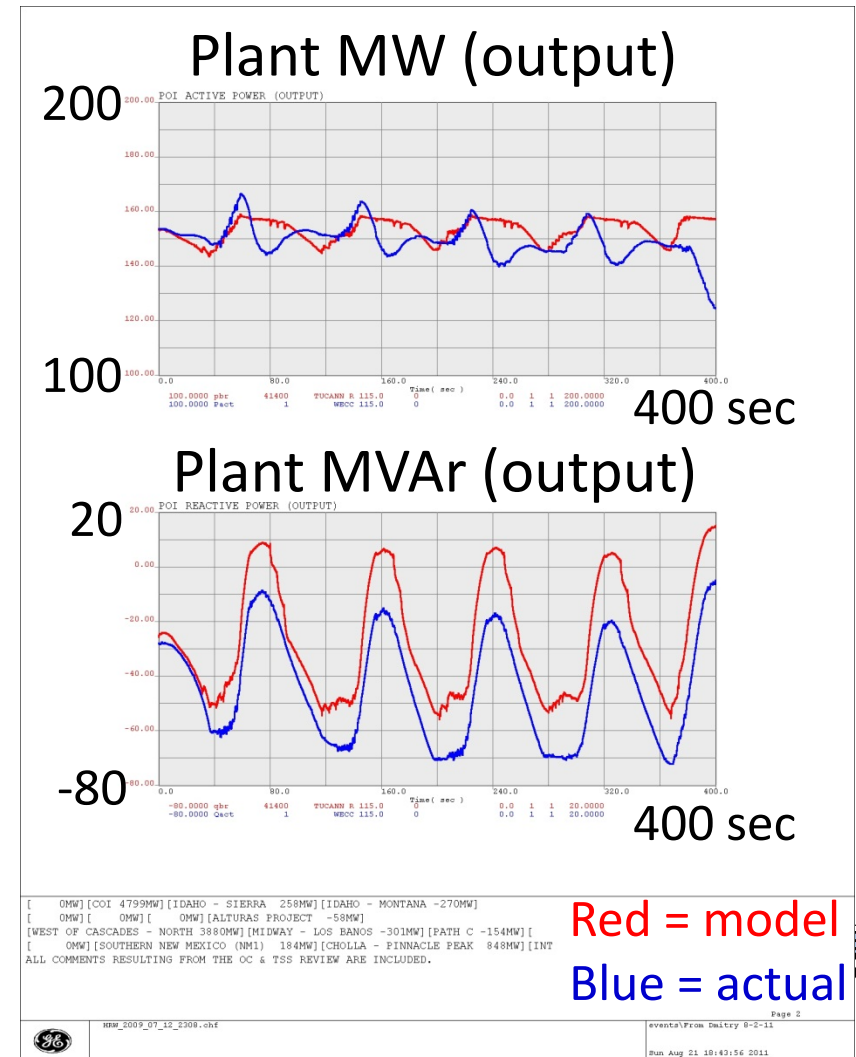
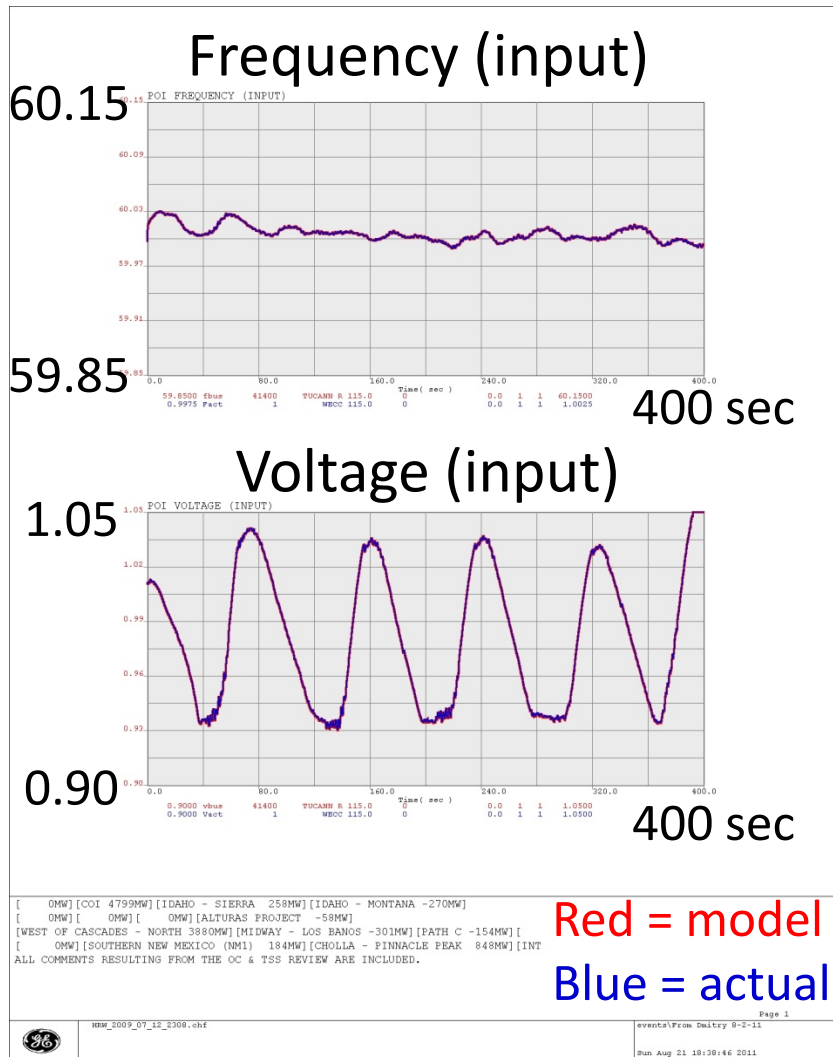

2. Wind Power Plant Voltage Control

- LEGACY PLANTS:

- Legacy plants (with type 1 and 2 technologies) do not have voltage control capabilities
- Account for about 2,000 MW of capacity
- The projects experienced a few operational issues, that were not identified in the planning studies (next two slides)



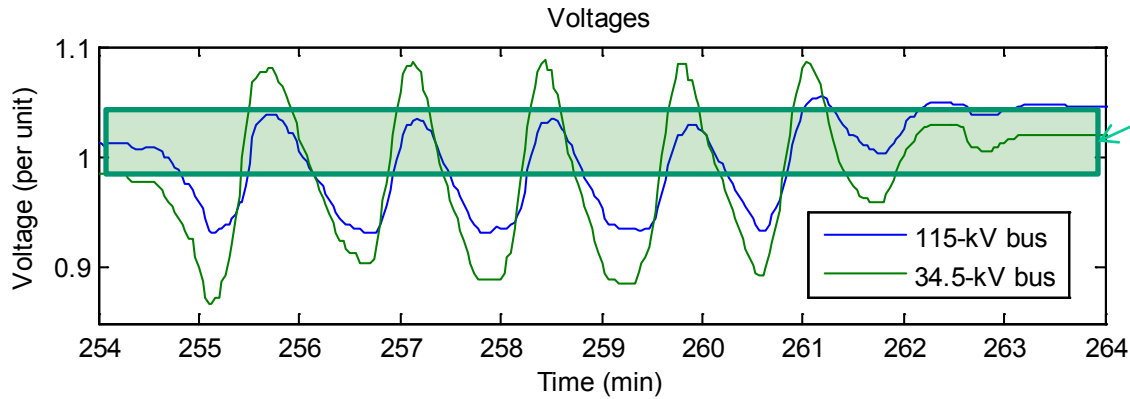

Normal operating range

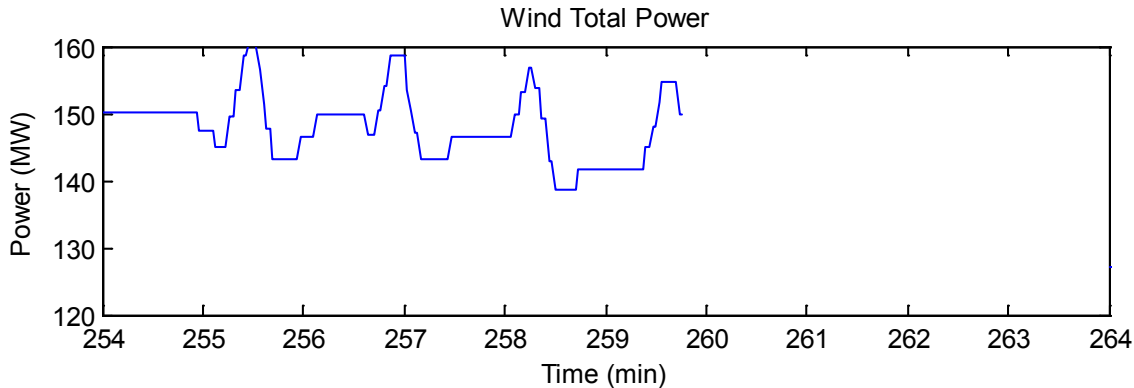

Voltage and power 'oscillations at a type 2' wind power plant, July 2009'

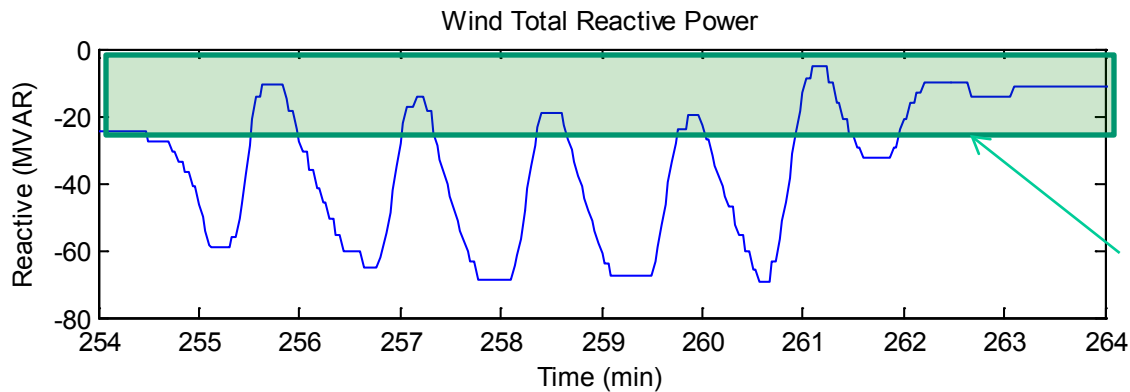

Required MVAR operating range



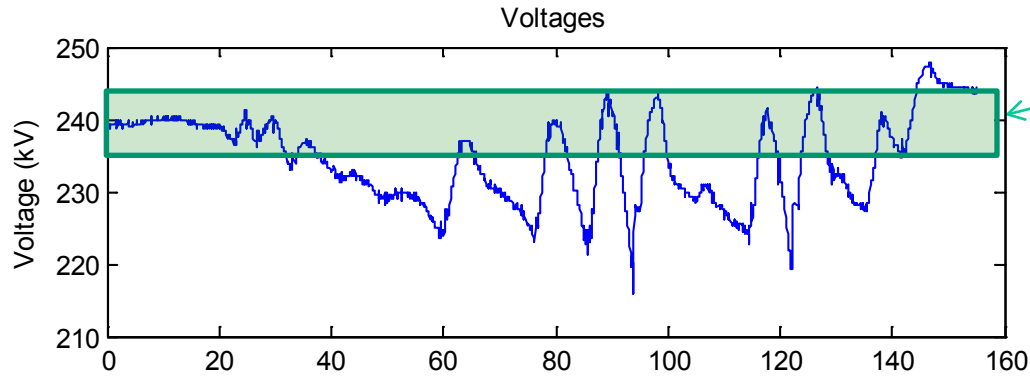

Normal operating range

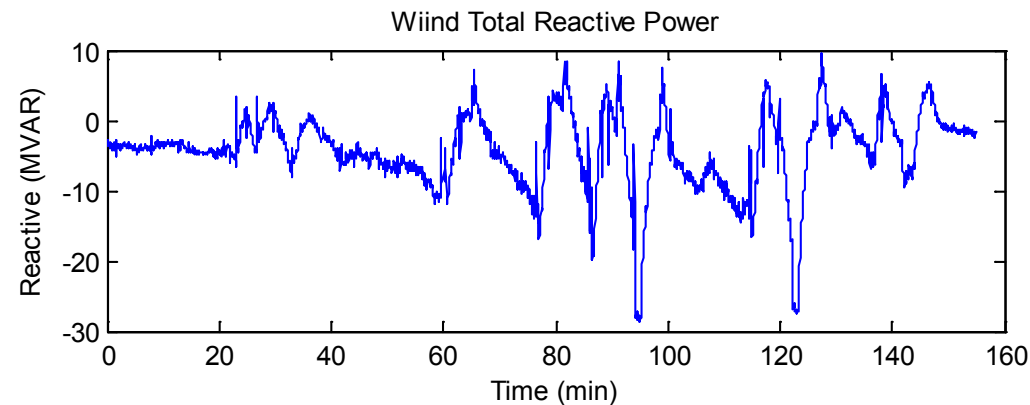
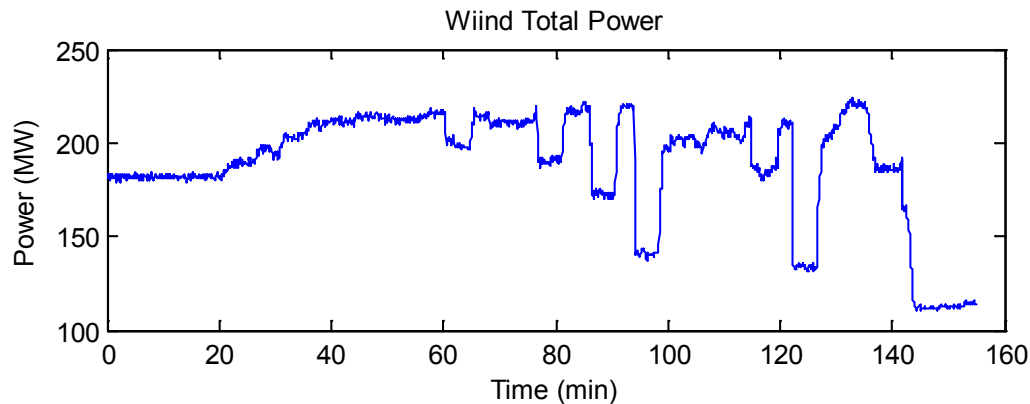

Voltage and power oscillations at a wind hub with type 2 wind power plants and a type 3 plant in power factor mode, December 2010



2. Wind Power Plant Voltage Control

- NEWER PLANTS:
 - Type 3 and 4 generators are capable of voltage controls
 - CAN is not the same as WILL
 - Several plants do not have appropriate controls and operate in power factor mode => BPA is working with plant operators on enabling voltage control functions
 - Many new plants have adequate voltage control and provide adequate voltage support to the grid



Voltage Controls help to increase the amount of wind integration

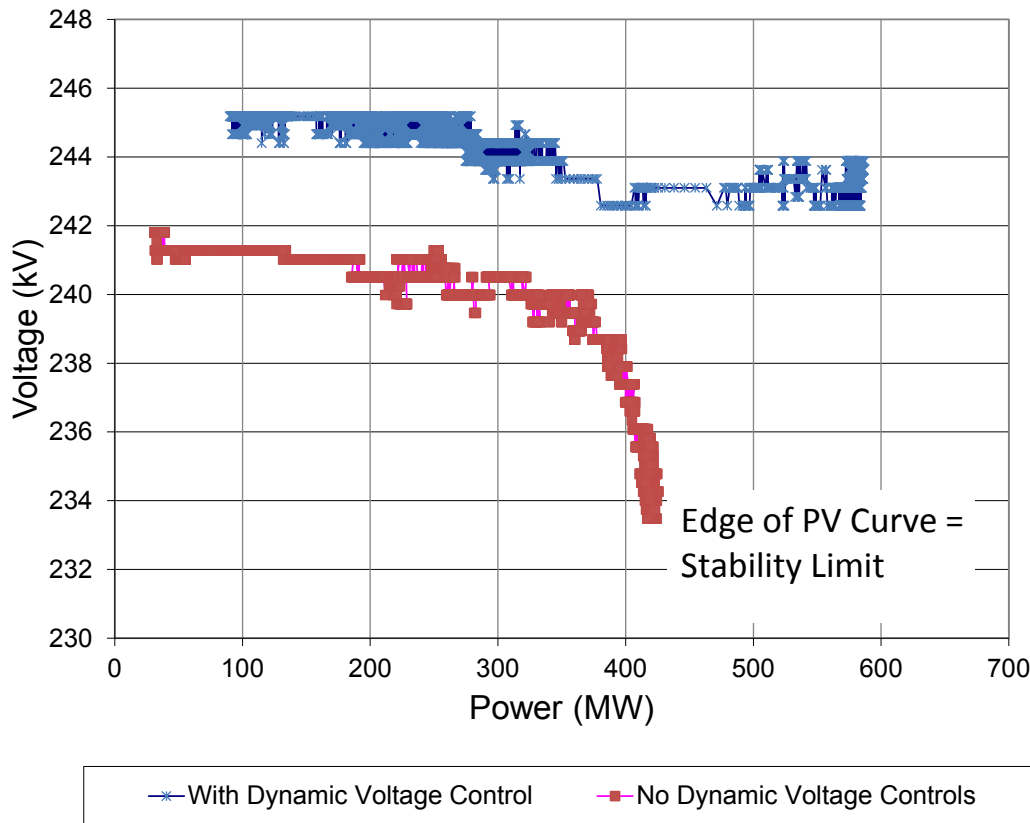

Wind hub reached a 420 MW voltage stability limit with no dynamic voltage control

The hub generation is increased to 600 MW by adding 200 MW of generators with dynamic voltage control capabilities



3. Wind Hub Voltage Control Coordination

- BPA wind is highly concentrated
- Wind plants are clustered into large hubs
- Need to coordinate reactive power sharing among the plants
- New plants operating in voltage control have stable reactive power sharing
- Coordination with legacy technologies remains challenging



- New plants that have dynamic voltage control and operating in droop mode have stable and equitable reactive power sharing

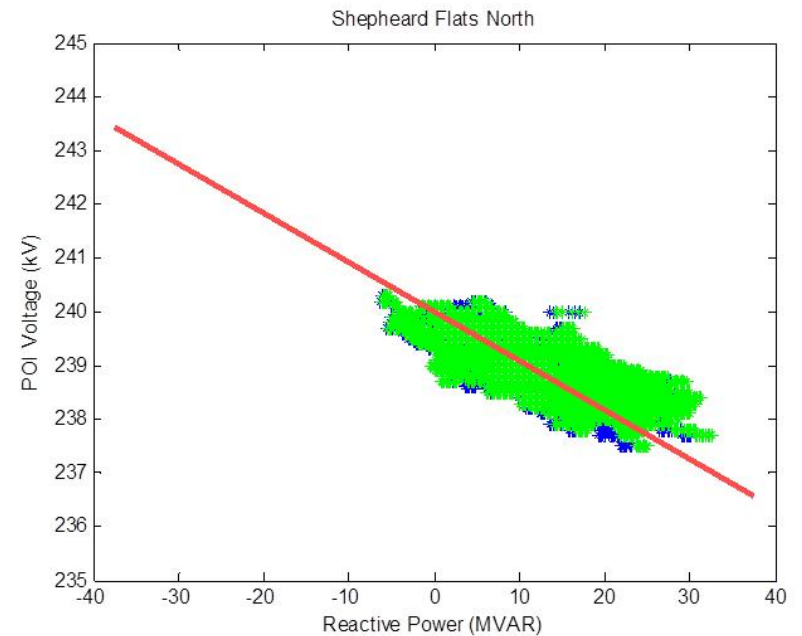
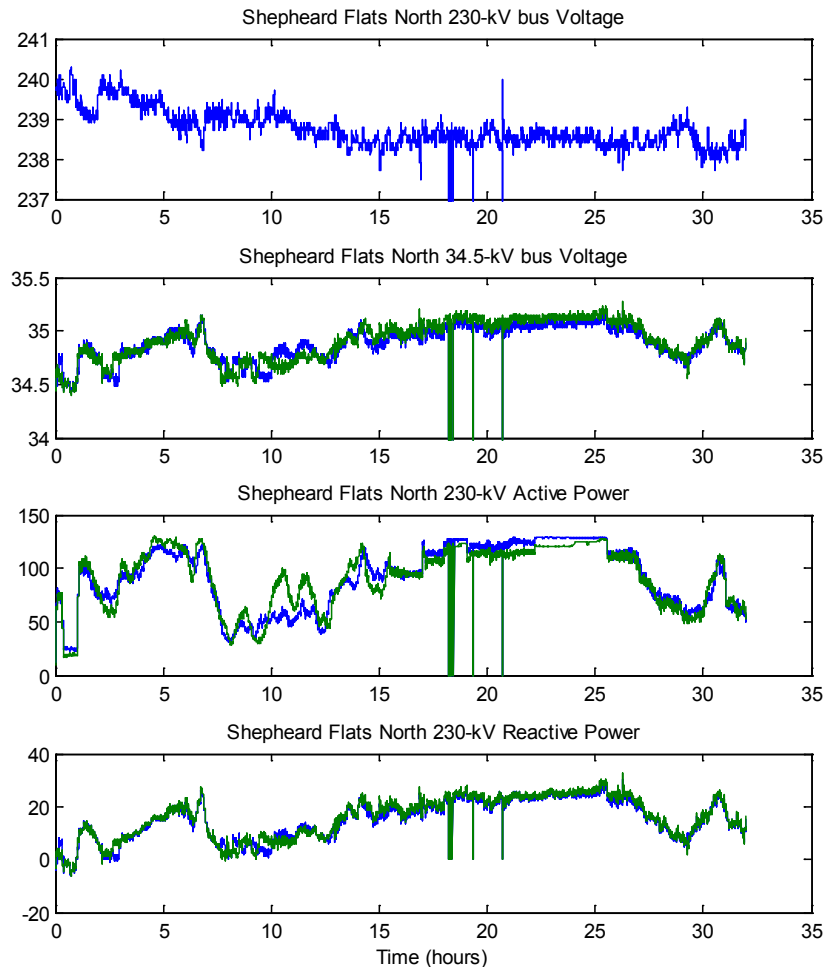

Blue = WPP1
 Green = WPP2
 Red = Desired



- Early wind plants that do not have voltage controls have operational challenges in sharing reactive power

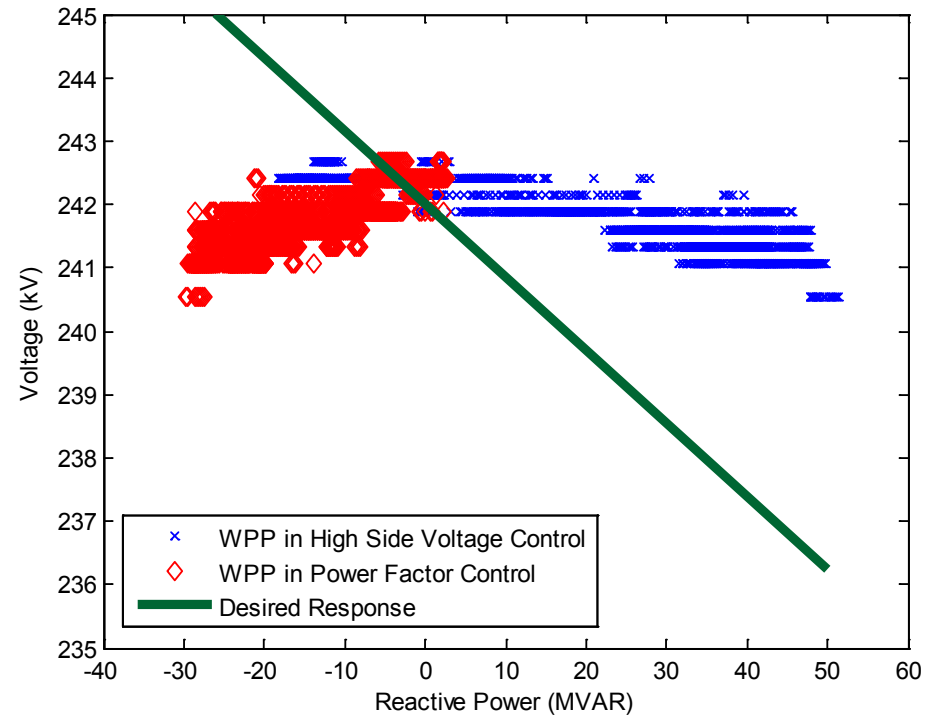
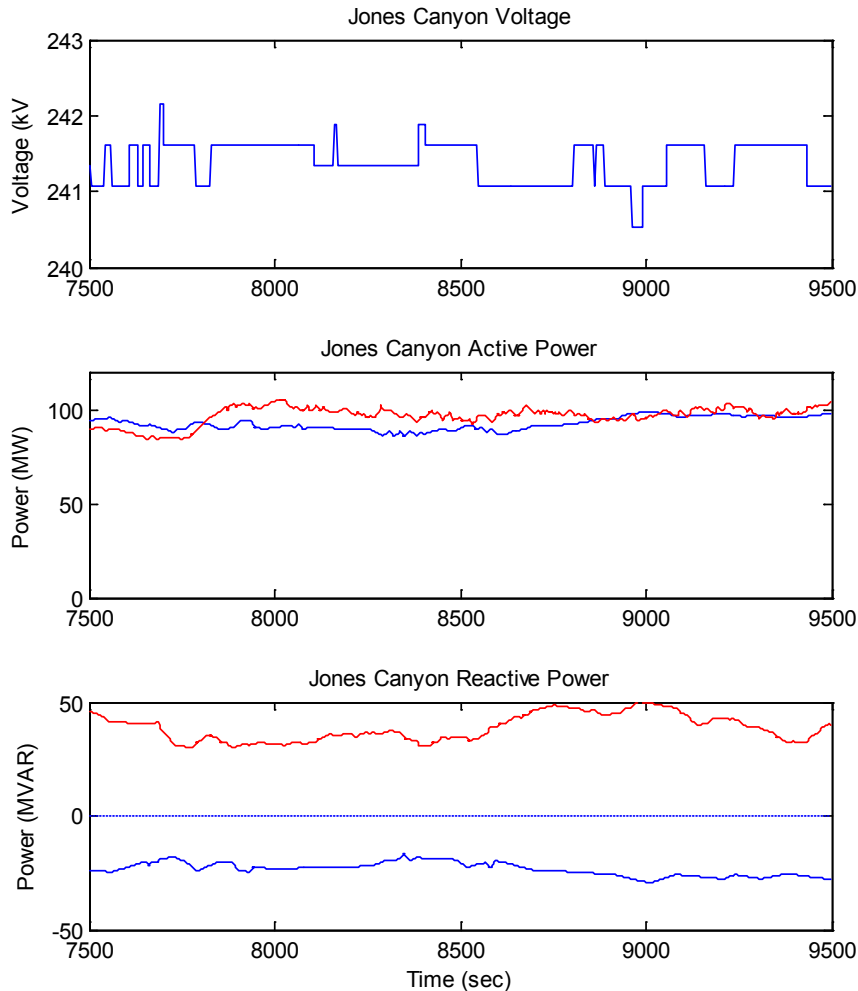

4. Dynamic Transfers

- Wind is ramping up / down
 - BPA wind ramps are large and fast because of high concentration #
- Conventional generation is used to balance wind generation
- Conventional generation is often far from the where the wind is (e.g. British Columbia, Montana, California)
- The power needs to travel across the stability-limited paths
- Need to make sure that the system adjustments are keeping up with the dynamic transfers



Solutions and how Synchro-phasors can help



1. Wind Power Plant Modeling

- BPA is installing PMUs at wind power plants
 - Data from 15 plants is expected in April 2013
- PMU data will be used for wind power plant model validation
- BPA is supporting NREL-UVGIG project on wind power plant model validation



2. Wind Power Plant Voltage Control

- BPA is working with WPP operators on upgrading their voltage controls
- Trust but verify. BPA has developed OSI-Soft PI application for voltage control monitoring

Voltage

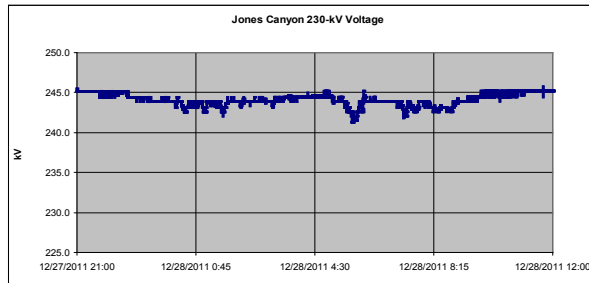

Active Power

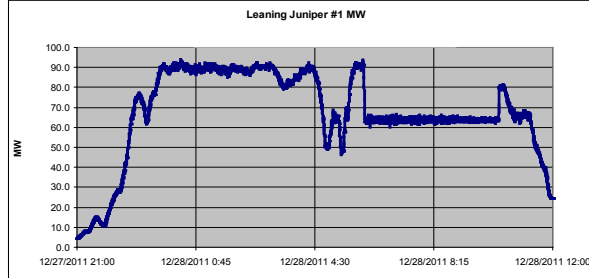

Reactive Power

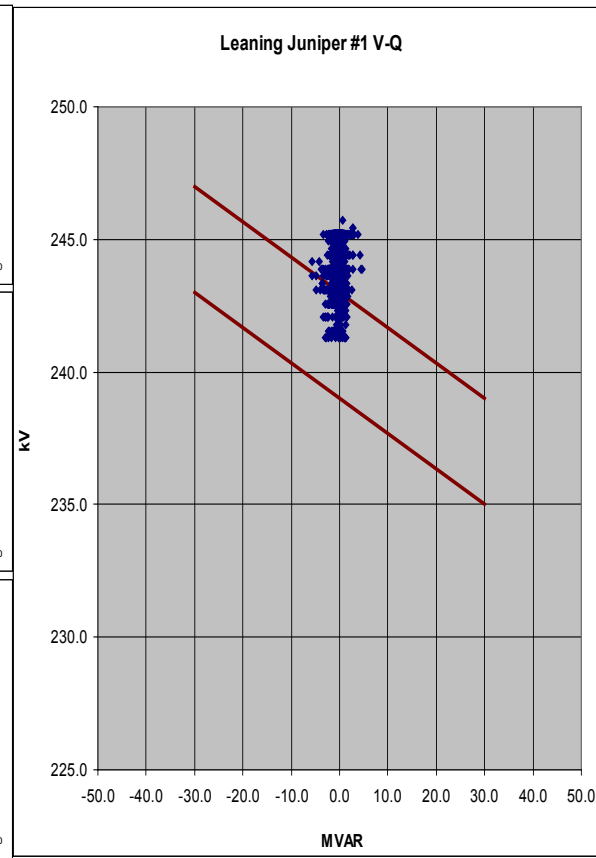
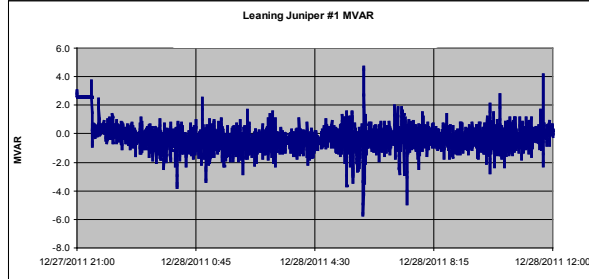

V-Q control:
Red = desired
Blue = actual

Power plant is in powerfactor control



3. Wind Hub Voltage Coordination

- PMU measurements can be used for wind hub voltage control and reactive power coordination
- How ... Studies are in process



4. Dynamic Transfers

- Reliability starts with good planning. BPA is developing time-sequence powerflow capabilities to study voltage stability impacts of fast wind ramps.
- PMU measurements will provide better situational awareness for dispatchers to track voltage stability during fast wind ramps
 - Model-based VSA, similar to V&R ROSE
 - Measurement-based approaches
- Voltage stability controls – reactive switching



BPA Contacts

- Terry Oliver, tvoliver@bpa.gov,
 - BPA Technology Innovation – BPA TI projects to support reliable wind integration

- Dmitry Kosterev, dnkosterev@bpa.gov,
 - BPA Transmission Planning – voltage control, modeling and monitoring



Synchrophasors & Renewables

Renewables Integration

Transmission Connections

Distribution Connections

Network Stability Impact

PhasorPoint:

- **Controller (Angle Constraint Active Management)**
- **Angle & Dynamics baselining and trending**
- **Wide area event analysis**

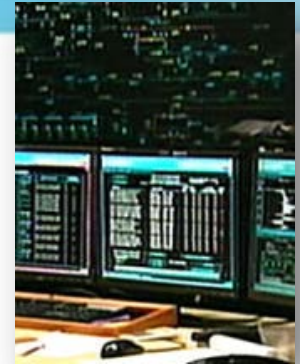

Transmission Connections

- Network constraints across transmission zone boundaries
- Angle difference – a simple measure of stress between zones
 - Related to power flow
 - Related to corridor strength
- Angles useful for
 - Operator awareness / response
 - Constraint definition
 - Control for flexible constraint management

High wind, low load, weak network
Annual mean wind speed at 25m above ground level [m/s]

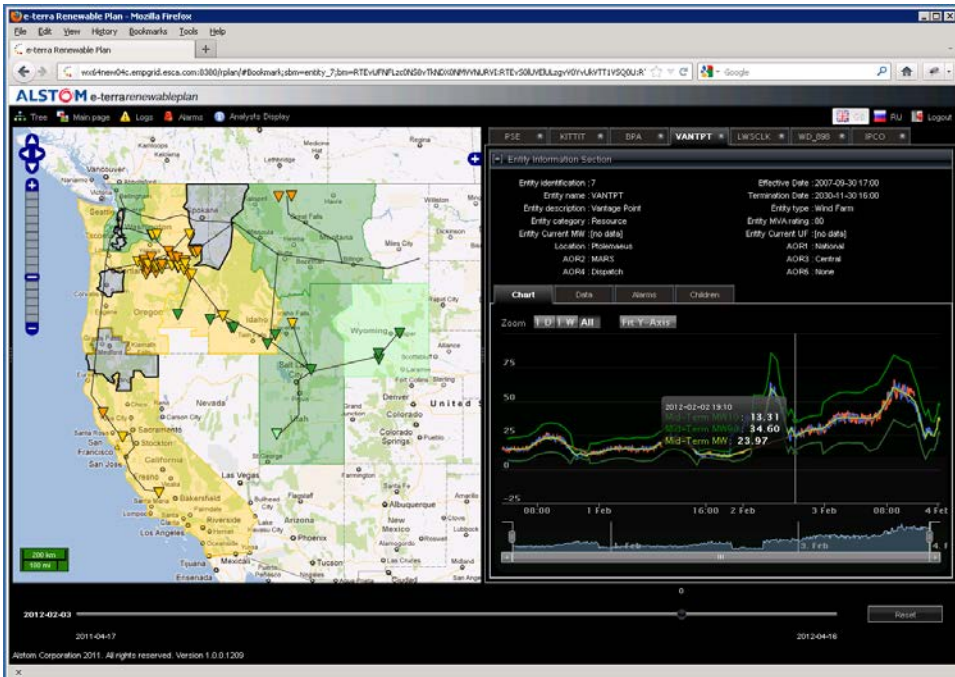
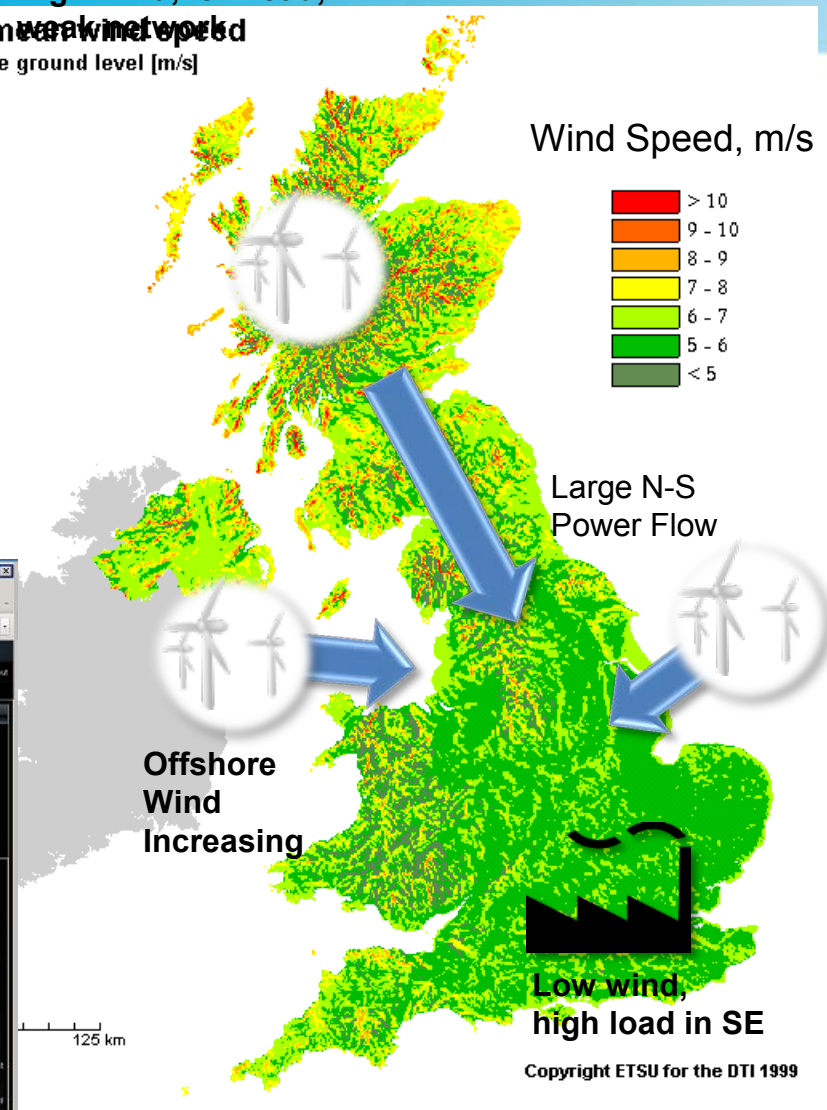

Distribution Connections

Increase capacity by **constraining by angle**:

- Manages multiple constraints
- Simple control logic
- Minimal comms requirements
- Generalized 'connect & manage' solution

Installation also applicable to **Loss-of-Mains** solution

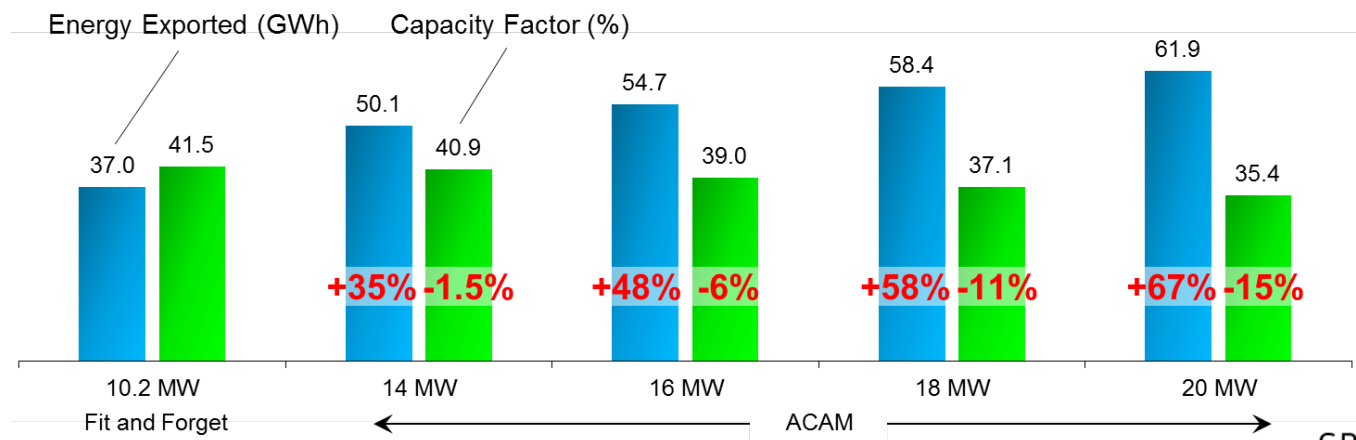
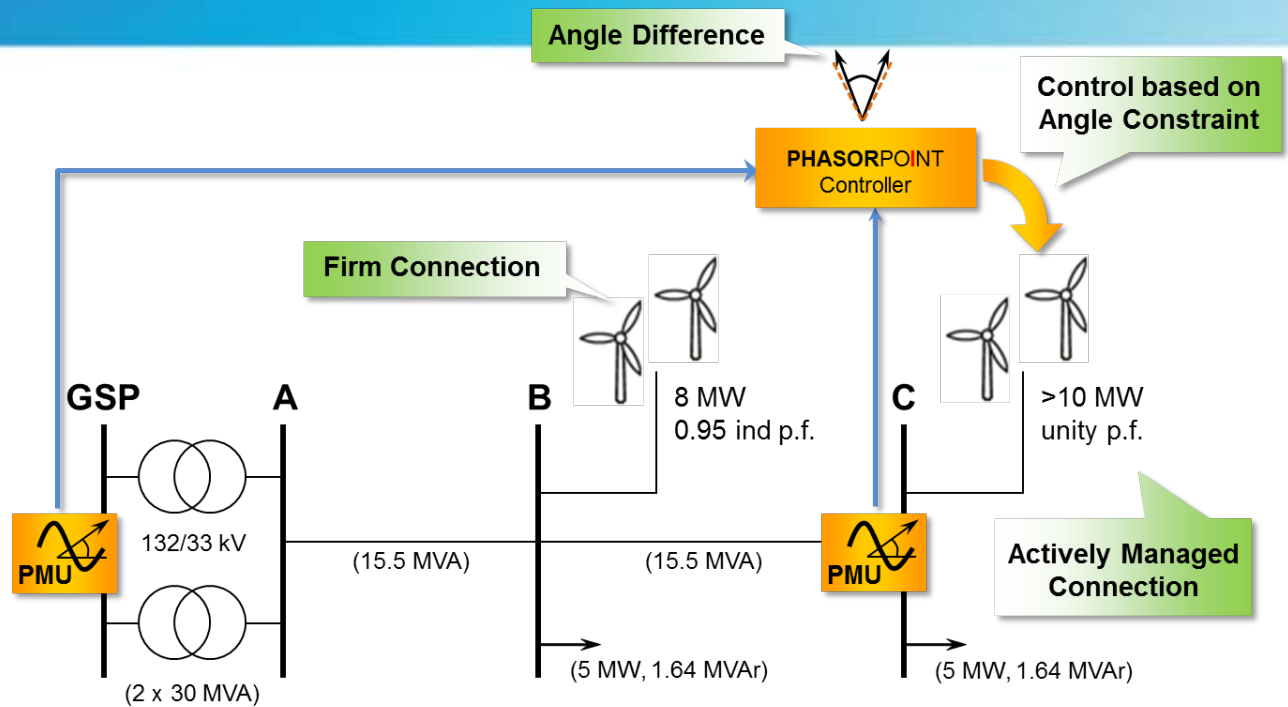

Marginal reduction of capacity factor

- More capacity
- More energy

Renewable integration tools and PMU

Renewable integration

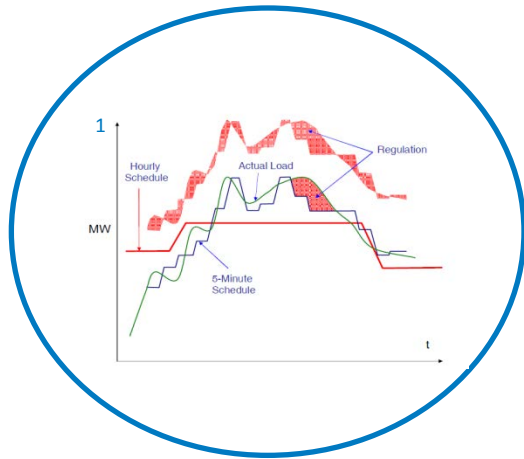

Will renewable generation qualify for regulation? What primary response and secondary response can they provide?



Power System stability studies

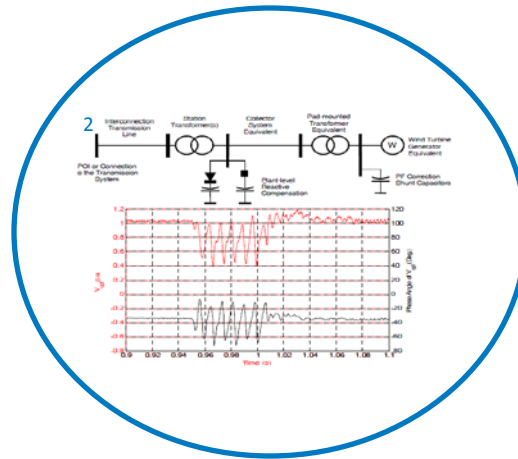

Are the renewable models good enough? What about energy storage, and demand response aggregated with renewables?



Renewable generation field control

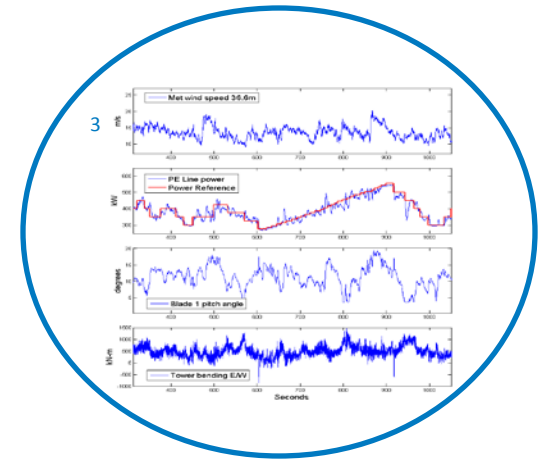

Are the current measurements adequate enough for real, reactive power and other type of control of renewable generations?



PMU provides high resolution measurements of power system states, can provide aid to close-loop control, dynamic modeling, frequency response studies, and?

- 1 Impacts of Integrating Wind Resources into the California ISO Market Construct, Clyde Loutan, Taiyou Yong, Sirajul Chowdhury, A. A. Chowdhury
- 2 Validation of Wind Power Plant Models, E. Muljadi, A. Ellis
- 3 Active Power Control Testing at the U.S. National Wind Technology Center, E. Ela

Tools with/to enable renewable features

Real time monitoring

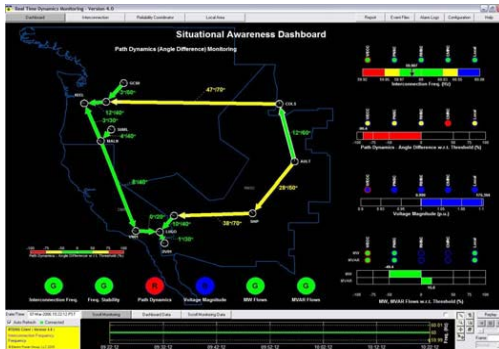

State estimation

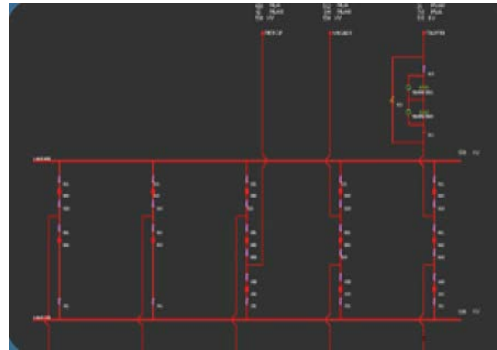

VSA and DSA

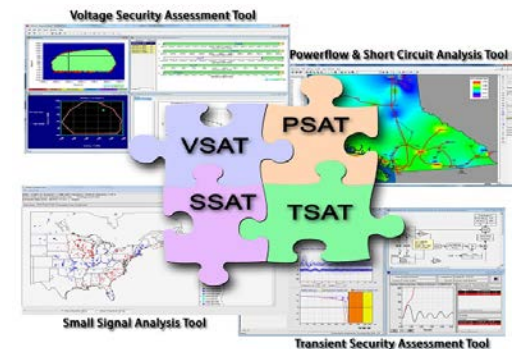

Steady states and dynamic simulation

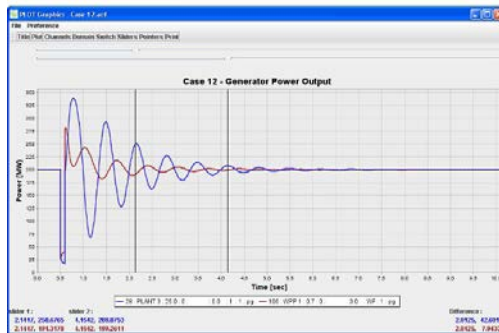

GIS



Unit dispatch

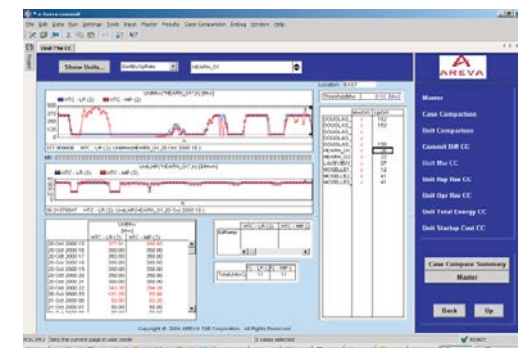

1 www.energy.ca.gov
4 www.ge-energy.com

2 Caiso Five Year Synchrophasor plan
5 routesout.blogspot.com

3 www.dsatools.com
6 www.aimms.com



Distribution Level Metering and Visualization Applications

Jason Bank

May 1, 2012

Data Collection Network Objectives

- In order to support research projects related to the integration of distributed generation NREL has developed a solution for high-speed, real-time, measurement of electrical quantities at low voltage points in a distribution system
- Remote measurement devices stream data back to a set of central data collection servers, in a network architecture similar to those used for PMUs
- The servers collect and store this data which is then made available for end users through a set of query tools and visualization applications
- Most off-the-shelf products did not meet all the requirements for data rates, compact size, all weather capability, and real-time data transmission

Distribution Monitoring Units

- Based in National Instruments sbRIO hardware and C-series modules
- GPS equipped for timestamping and Phasor calculations
- Developed specifically for metering at low voltage points on the distribution level
- Each Unit measures voltage and current phasors, RMS values, real, reactive and apparent power, power factor and temperature (external and internal)
- Output data rate configurable from 1 Hz up to 60 Hz
- Designed for metering at points up to 300 Vrms, higher voltage levels can be achieved with PTs or divider circuits
- Uses clip on voltage probes and Rogowski coils
- 9" x 11" x 3.5"



Distribution Monitoring Units

- High temperature and weather rated for outdoor installations
- Data transmitted in real-time through a Ethernet, WiFi or Cellular internet connection
- 120/240 Split-Phase and 277 Y models have been developed
- Twelve units have been fielded into SMUD's Anatolia Circuit
- Five units have been installed on the Kihei Circuit on Maui

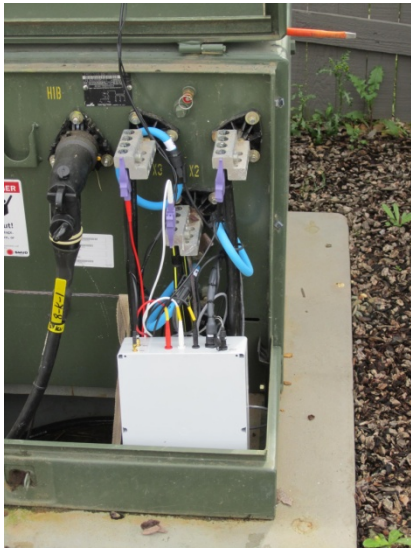

Meter installation on a Pad Mount Residential Transformer in Sacramento %

Data Collection Network

- DMU measurements are immediately sent out through the onboard cellular modem, ethernet or Wi-Fi connection using the PMU communication protocol specified by the IEEE C37.118 Standard
- The data streams pass through the internet, arriving at the Data Concentrator housed at NREL
- The Data Concentrator time-aligns these streams and condenses them into one data set containing all of the measurement data
- The concentrator data stream is sent to the Historian for archival, then onto the Data Visualization applications and any other end users requiring live data feeds.
- The Data Concentrator is capable of receiving data from any internet connected device that can transmit using the C37.118 protocol, which includes almost all off the shelf PMUs and Phasor Data Concentrators
- The OpenPDC software package (<http://openpdc.codeplex.com/>) provides the server-side software for both the concentrator and historian

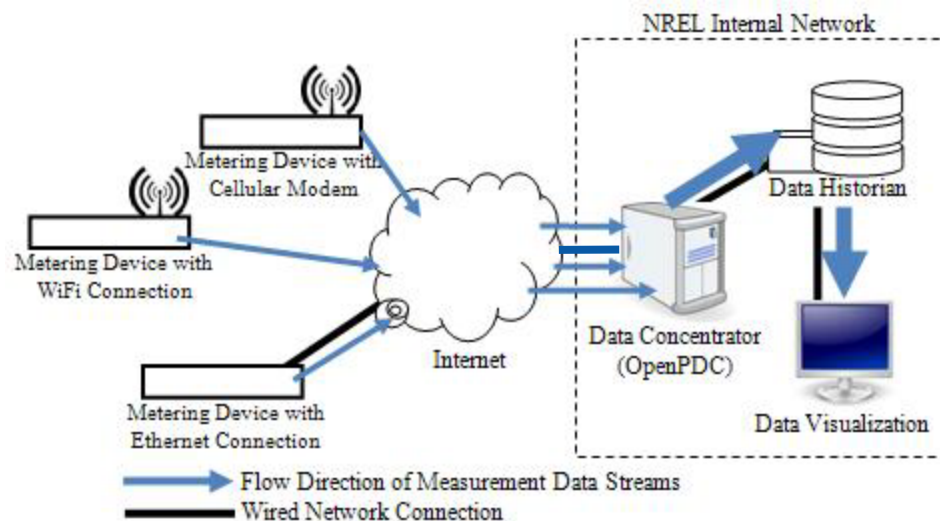

Solar Irradiance Measurements

- This data collection network is focused on irradiance measurement
- Individual stations are solar powered and equipped for cellular communication
- Once fielded the units begin collecting global horizontal measurements at data rates up to once per second
- Data is passed to the central servers at NREL in a batch process



Collected Data – PV Production

- The red traces on these plots are global horizontal Irradiance measurements Taken from a MIDC tower in the Anatolia Neighborhood
- Blue traces are power flow through a transformer serving 10 houses, each with about 2kW of installed rooftop PV
- These plots represent three consecutive days, one cloudy, one sunny and one with intermittent cloud cover

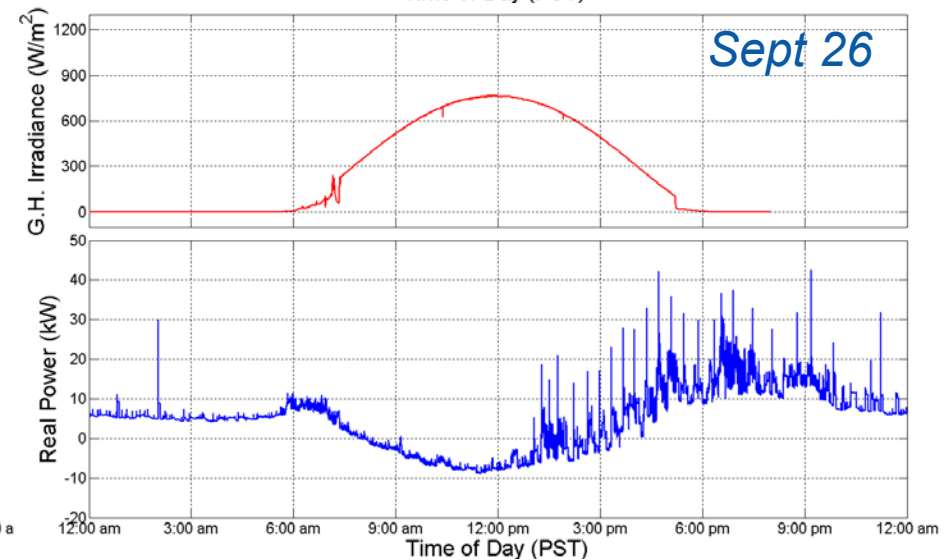
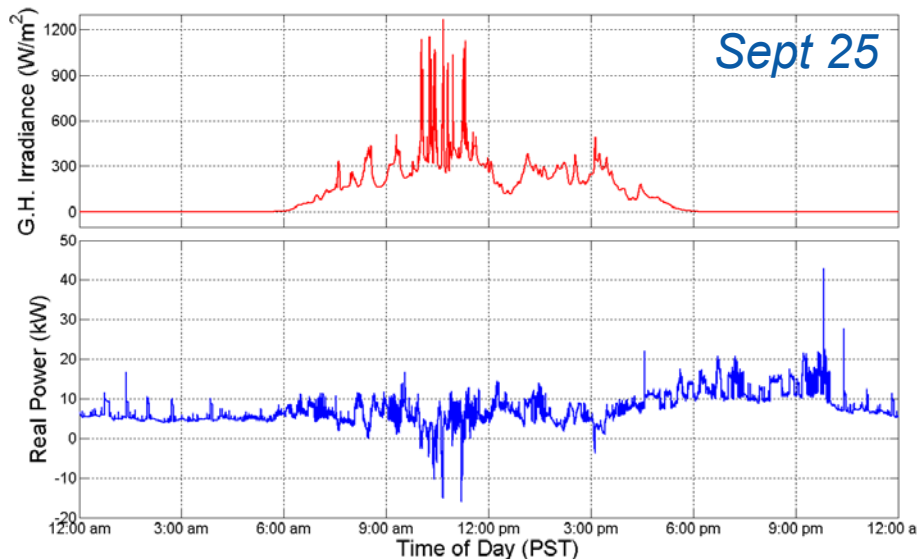
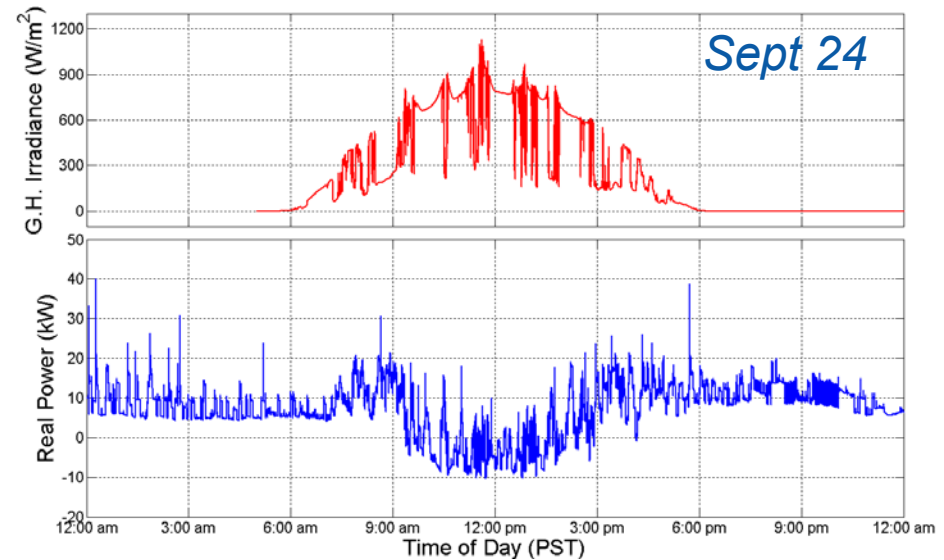

Collected Data – Observed Load Characteristics

- Upper plot is measured P and Q at a transformer serving 10 houses in Anatolia
- A load is observed switching on then off throughout the time span
- This load is about 5 kW and is observed all over the system at all times of day, most likely AC
- This switching effect is also apparent in the voltage measurements on the bottom plot

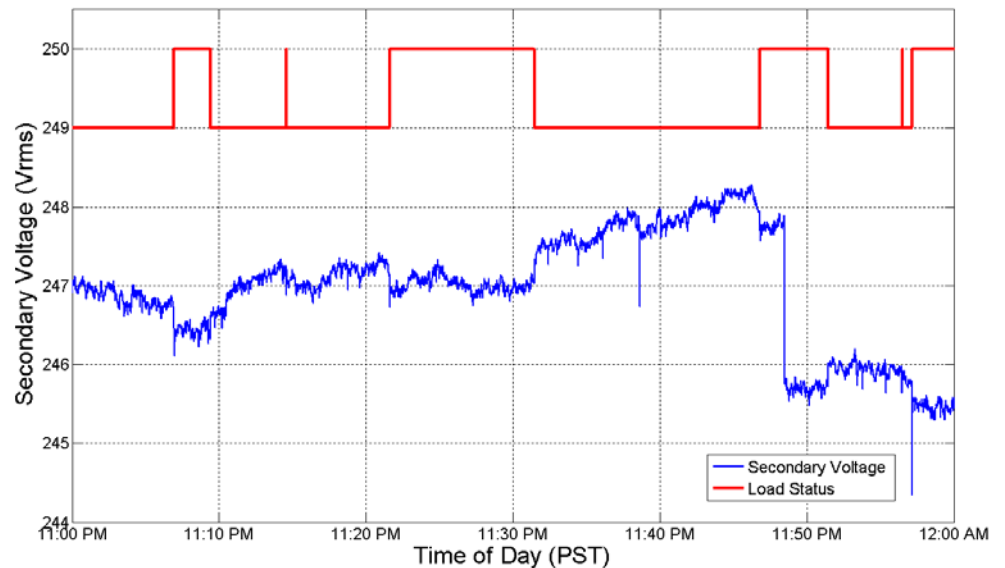
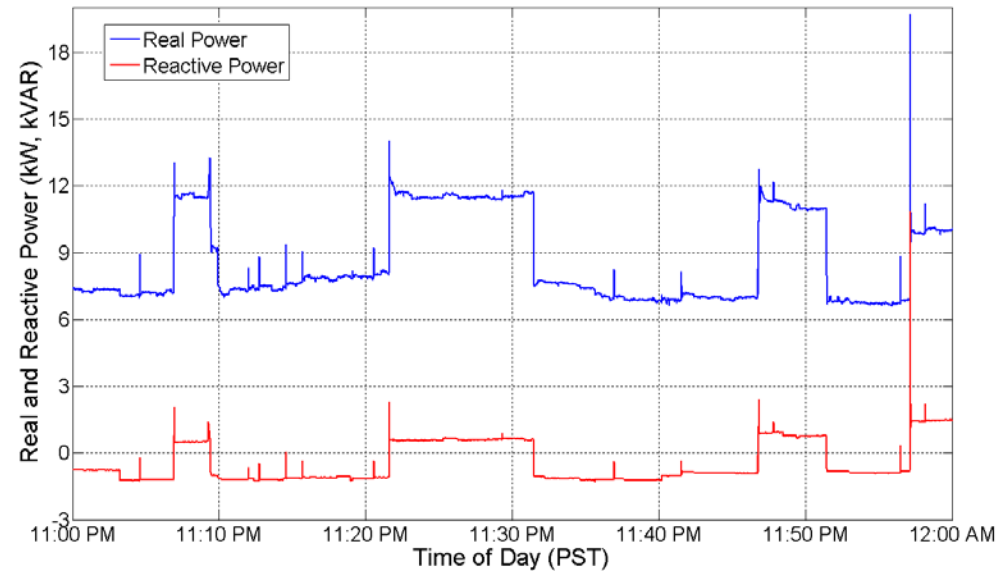

Data Visualization

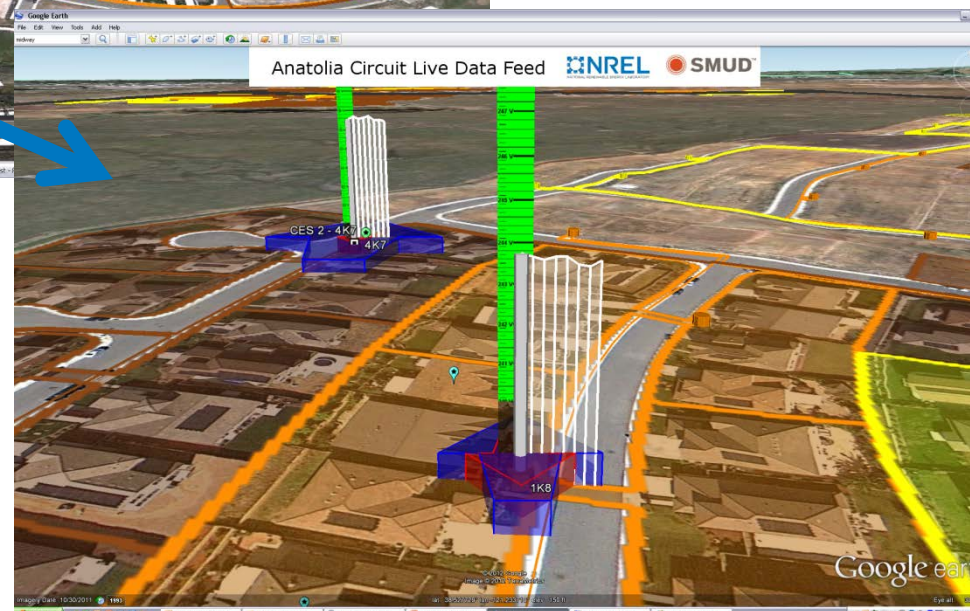
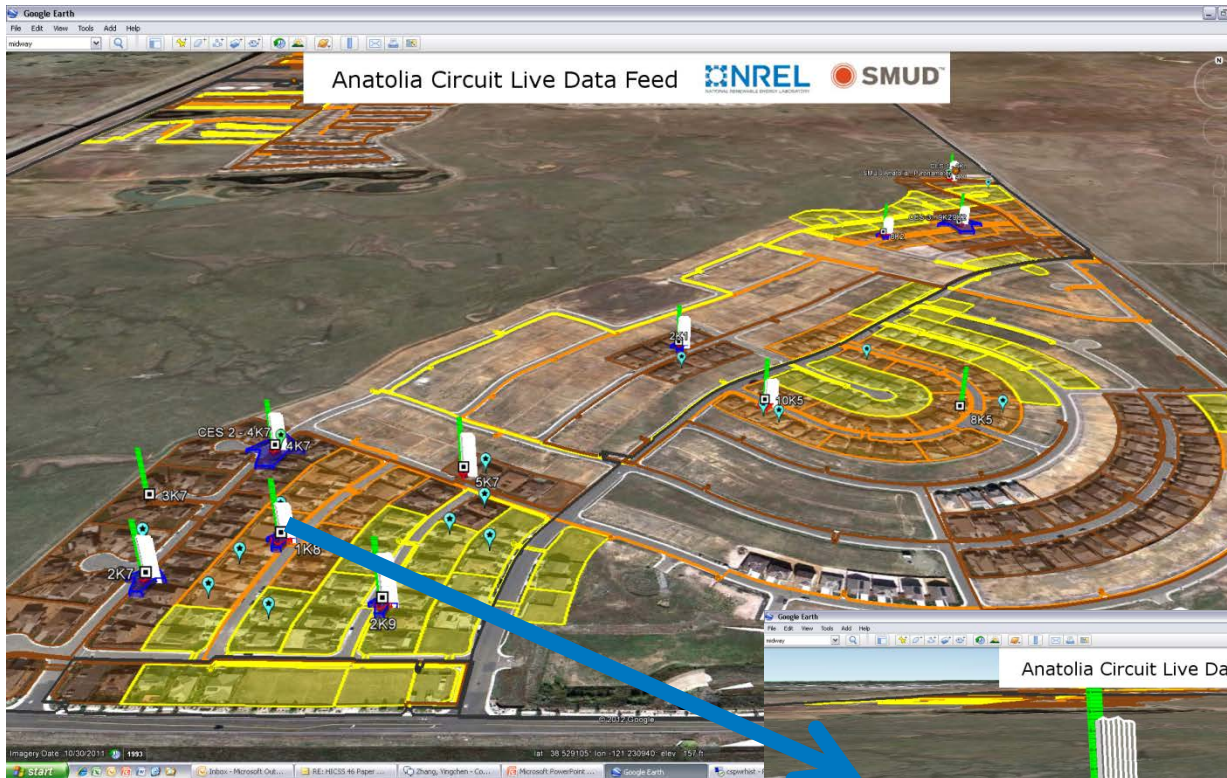

- Live data is displayed in Google Earth
- Accessible to internet connected users with the proper credentials

Strip Chart Displays

- A strip chart based display has also "been developed for this live data"
- This interface uses the IEEE C37.118 protocol to connect directly to data historian
- The data is presented in a series of "strip charts and phasor diagram"
- The user can select individual channels for display on the charts, building up customized live displays
- This package is capable of communicating directly to any IEEE C37.118 compliant device

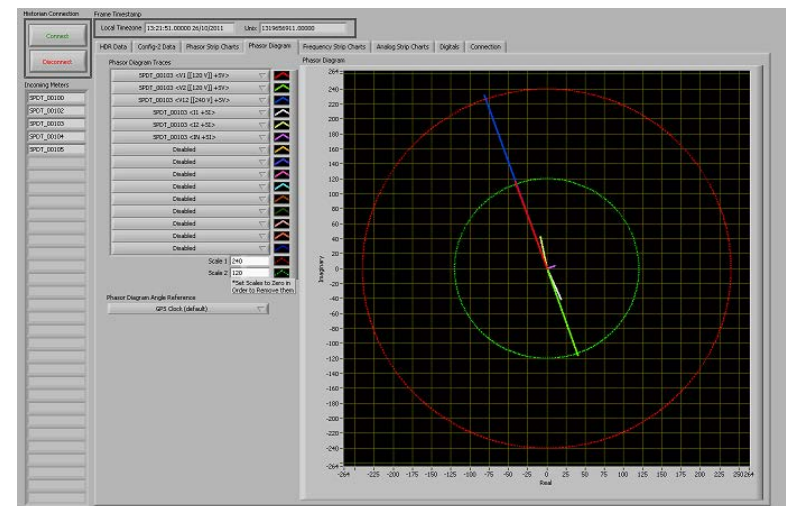

Data Access

- Access to the data sets are granted to project members via a website (username/password authentication)
- With a form based tool a user can request a specific data set
- The website then pulls the required data from the database and returns a delimited text file

Distribution Monitoring Database

ABOUT THE DATABASE
QUERY DATABASE
DOWNLOAD RESULTS
MANAGE PROJECTS
LOG OUT

You are logged in as jason.bank@nrel.gov.

Query the Database

To retrieve a dataset from the database, fill out this form describing the dataset you desire and click the Submit button at the bottom.

Active Project SMUD - RES/CES

Data Set Timing Parameters

Complete the fields below to define a timeframe for your dataset.
 Note: The "with DST" time zone options take Daylight Saving Time into account, and the "without DST" options do not.

	Time & Date	Format	Time Zone
Start Time	<input type="text" value="hh mm ss dd/mm/yyyy"/>	AM <input type="button" value="v"/>	GMT (without DST) <input type="button" value="v"/>
End Time	<input type="text" value="hh mm ss dd/mm/yyyy"/>	AM <input type="button" value="v"/>	
Time Resolution*	<input type="text" value="1"/> second		
Output Time Format	Unix-Style Timestamp (Elapsed Seconds Since 00:00:00 Jan 1 1970 GMT) <input type="button" value="v"/>		

* Minimum of 1 second. Values greater than 1 will degrade from existing 1 second datasets by selecting the nearest point. Only accepts integers.

Distribution Transformer Measurements (from DMUs)

Check the boxes for measurements you want to include in the dataset
 To select or deselect entire rows or columns use the SET and CLR buttons

	Anatolia Transformers															
	2K9	9K2	3K7	8K2	9K1	1K8	2K1	8K5	10K5	4K7	5K7	2K7				
	SET	SET	SET	SET	SET	SET	SET	SET	SET	SET	SET	SET	CLR	CLR	CLR	CLR
V1 Phasor Magnitude	SET	CLR	<input type="checkbox"/>	<input type="checkbox"/>	<input type="checkbox"/>	<input type="checkbox"/>	<input type="checkbox"/>	<input type="checkbox"/>	<input type="checkbox"/>	<input type="checkbox"/>	<input type="checkbox"/>	<input type="checkbox"/>	<input type="checkbox"/>	<input type="checkbox"/>	<input type="checkbox"/>	<input type="checkbox"/>
V1 Phase Angle	SET	CLR	<input type="checkbox"/>	<input type="checkbox"/>	<input type="checkbox"/>	<input type="checkbox"/>	<input type="checkbox"/>	<input type="checkbox"/>	<input type="checkbox"/>	<input type="checkbox"/>	<input type="checkbox"/>	<input type="checkbox"/>	<input type="checkbox"/>	<input type="checkbox"/>	<input type="checkbox"/>	<input type="checkbox"/>
V2 Phasor Magnitude	SET	CLR	<input type="checkbox"/>	<input type="checkbox"/>	<input type="checkbox"/>	<input type="checkbox"/>	<input type="checkbox"/>	<input type="checkbox"/>	<input type="checkbox"/>	<input type="checkbox"/>	<input type="checkbox"/>	<input type="checkbox"/>	<input type="checkbox"/>	<input type="checkbox"/>	<input type="checkbox"/>	<input type="checkbox"/>
V2 Phase Angle	SET	CLR	<input type="checkbox"/>	<input type="checkbox"/>	<input type="checkbox"/>	<input type="checkbox"/>	<input type="checkbox"/>	<input type="checkbox"/>	<input type="checkbox"/>	<input type="checkbox"/>	<input type="checkbox"/>	<input type="checkbox"/>	<input type="checkbox"/>	<input type="checkbox"/>	<input type="checkbox"/>	<input type="checkbox"/>
V12 Phasor Magnitude	SET	CLR	<input type="checkbox"/>	<input type="checkbox"/>	<input type="checkbox"/>	<input type="checkbox"/>	<input type="checkbox"/>	<input type="checkbox"/>	<input type="checkbox"/>	<input type="checkbox"/>	<input type="checkbox"/>	<input type="checkbox"/>	<input type="checkbox"/>	<input type="checkbox"/>	<input type="checkbox"/>	<input type="checkbox"/>
V12 Phase Angle	SET	CLR	<input type="checkbox"/>	<input type="checkbox"/>	<input type="checkbox"/>	<input type="checkbox"/>	<input type="checkbox"/>	<input type="checkbox"/>	<input type="checkbox"/>	<input type="checkbox"/>	<input type="checkbox"/>	<input type="checkbox"/>	<input type="checkbox"/>	<input type="checkbox"/>	<input type="checkbox"/>	<input type="checkbox"/>
I1 Phasor Magnitude	SET	CLR	<input type="checkbox"/>	<input type="checkbox"/>	<input type="checkbox"/>	<input type="checkbox"/>	<input type="checkbox"/>	<input type="checkbox"/>	<input type="checkbox"/>	<input type="checkbox"/>	<input type="checkbox"/>	<input type="checkbox"/>	<input type="checkbox"/>	<input type="checkbox"/>	<input type="checkbox"/>	<input type="checkbox"/>
I1 Phase Angle	SET	CLR	<input type="checkbox"/>	<input type="checkbox"/>	<input type="checkbox"/>	<input type="checkbox"/>	<input type="checkbox"/>	<input type="checkbox"/>	<input type="checkbox"/>	<input type="checkbox"/>	<input type="checkbox"/>	<input type="checkbox"/>	<input type="checkbox"/>	<input type="checkbox"/>	<input type="checkbox"/>	<input type="checkbox"/>
I2 Phasor Magnitude	SET	CLR	<input type="checkbox"/>	<input type="checkbox"/>	<input type="checkbox"/>	<input type="checkbox"/>	<input type="checkbox"/>	<input type="checkbox"/>	<input type="checkbox"/>	<input type="checkbox"/>	<input type="checkbox"/>	<input type="checkbox"/>	<input type="checkbox"/>	<input type="checkbox"/>	<input type="checkbox"/>	<input type="checkbox"/>
I2 Phase Angle	SET	CLR	<input type="checkbox"/>	<input type="checkbox"/>	<input type="checkbox"/>	<input type="checkbox"/>	<input type="checkbox"/>	<input type="checkbox"/>	<input type="checkbox"/>	<input type="checkbox"/>	<input type="checkbox"/>	<input type="checkbox"/>	<input type="checkbox"/>	<input type="checkbox"/>	<input type="checkbox"/>	<input type="checkbox"/>
In Phasor Magnitude	SET	CLR	<input type="checkbox"/>	<input type="checkbox"/>	<input type="checkbox"/>	<input type="checkbox"/>	<input type="checkbox"/>	<input type="checkbox"/>	<input type="checkbox"/>	<input type="checkbox"/>	<input type="checkbox"/>	<input type="checkbox"/>	<input type="checkbox"/>	<input type="checkbox"/>	<input type="checkbox"/>	<input type="checkbox"/>
In Phase Angle	SET	CLR	<input type="checkbox"/>	<input type="checkbox"/>	<input type="checkbox"/>	<input type="checkbox"/>	<input type="checkbox"/>	<input type="checkbox"/>	<input type="checkbox"/>	<input type="checkbox"/>	<input type="checkbox"/>	<input type="checkbox"/>	<input type="checkbox"/>	<input type="checkbox"/>	<input type="checkbox"/>	<input type="checkbox"/>
Frequency	SET	CLR	<input type="checkbox"/>	<input type="checkbox"/>	<input type="checkbox"/>	<input type="checkbox"/>	<input type="checkbox"/>	<input type="checkbox"/>	<input type="checkbox"/>	<input type="checkbox"/>	<input type="checkbox"/>	<input type="checkbox"/>	<input type="checkbox"/>	<input type="checkbox"/>	<input type="checkbox"/>	<input type="checkbox"/>
V1 RMS	SET	CLR	<input type="checkbox"/>	<input type="checkbox"/>	<input type="checkbox"/>	<input type="checkbox"/>	<input type="checkbox"/>	<input type="checkbox"/>	<input type="checkbox"/>	<input type="checkbox"/>	<input type="checkbox"/>	<input type="checkbox"/>	<input type="checkbox"/>	<input type="checkbox"/>	<input type="checkbox"/>	<input type="checkbox"/>
V2 RMS	SET	CLR	<input type="checkbox"/>	<input type="checkbox"/>	<input type="checkbox"/>	<input type="checkbox"/>	<input type="checkbox"/>	<input type="checkbox"/>	<input type="checkbox"/>	<input type="checkbox"/>	<input type="checkbox"/>	<input type="checkbox"/>	<input type="checkbox"/>	<input type="checkbox"/>	<input type="checkbox"/>	<input type="checkbox"/>
V12 RMS	SET	CLR	<input type="checkbox"/>	<input type="checkbox"/>	<input type="checkbox"/>	<input type="checkbox"/>	<input type="checkbox"/>	<input type="checkbox"/>	<input type="checkbox"/>	<input type="checkbox"/>	<input type="checkbox"/>	<input type="checkbox"/>	<input type="checkbox"/>	<input type="checkbox"/>	<input type="checkbox"/>	<input type="checkbox"/>
I1 RMS	SET	CLR	<input type="checkbox"/>	<input type="checkbox"/>	<input type="checkbox"/>	<input type="checkbox"/>	<input type="checkbox"/>	<input type="checkbox"/>	<input type="checkbox"/>	<input type="checkbox"/>	<input type="checkbox"/>	<input type="checkbox"/>	<input type="checkbox"/>	<input type="checkbox"/>	<input type="checkbox"/>	<input type="checkbox"/>
I2 RMS	SET	CLR	<input type="checkbox"/>	<input type="checkbox"/>	<input type="checkbox"/>	<input type="checkbox"/>	<input type="checkbox"/>	<input type="checkbox"/>	<input type="checkbox"/>	<input type="checkbox"/>	<input type="checkbox"/>	<input type="checkbox"/>	<input type="checkbox"/>	<input type="checkbox"/>	<input type="checkbox"/>	<input type="checkbox"/>
In RMS	SET	CLR	<input type="checkbox"/>	<input type="checkbox"/>	<input type="checkbox"/>	<input type="checkbox"/>	<input type="checkbox"/>	<input type="checkbox"/>	<input type="checkbox"/>	<input type="checkbox"/>	<input type="checkbox"/>	<input type="checkbox"/>	<input type="checkbox"/>	<input type="checkbox"/>	<input type="checkbox"/>	<input type="checkbox"/>
Apparent Power Magnitude (S1)	SET	CLR	<input type="checkbox"/>	<input type="checkbox"/>	<input type="checkbox"/>	<input type="checkbox"/>	<input type="checkbox"/>	<input type="checkbox"/>	<input type="checkbox"/>	<input type="checkbox"/>	<input type="checkbox"/>	<input type="checkbox"/>	<input type="checkbox"/>	<input type="checkbox"/>	<input type="checkbox"/>	<input type="checkbox"/>
Real Power (P)	SET	CLR	<input type="checkbox"/>	<input type="checkbox"/>	<input type="checkbox"/>	<input type="checkbox"/>	<input type="checkbox"/>	<input type="checkbox"/>	<input type="checkbox"/>	<input type="checkbox"/>	<input type="checkbox"/>	<input type="checkbox"/>	<input type="checkbox"/>	<input type="checkbox"/>	<input type="checkbox"/>	<input type="checkbox"/>
Reactive Power (Q)	SET	CLR	<input type="checkbox"/>	<input type="checkbox"/>	<input type="checkbox"/>	<input type="checkbox"/>	<input type="checkbox"/>	<input type="checkbox"/>	<input type="checkbox"/>	<input type="checkbox"/>	<input type="checkbox"/>	<input type="checkbox"/>	<input type="checkbox"/>	<input type="checkbox"/>	<input type="checkbox"/>	<input type="checkbox"/>
Power Factor	SET	CLR	<input type="checkbox"/>	<input type="checkbox"/>	<input type="checkbox"/>	<input type="checkbox"/>	<input type="checkbox"/>	<input type="checkbox"/>	<input type="checkbox"/>	<input type="checkbox"/>	<input type="checkbox"/>	<input type="checkbox"/>	<input type="checkbox"/>	<input type="checkbox"/>	<input type="checkbox"/>	<input type="checkbox"/>
Displacement Power Factor	SET	CLR	<input type="checkbox"/>	<input type="checkbox"/>	<input type="checkbox"/>	<input type="checkbox"/>	<input type="checkbox"/>	<input type="checkbox"/>	<input type="checkbox"/>	<input type="checkbox"/>	<input type="checkbox"/>	<input type="checkbox"/>	<input type="checkbox"/>	<input type="checkbox"/>	<input type="checkbox"/>	<input type="checkbox"/>
Meter Internal Temperature	SET	CLR	<input type="checkbox"/>	<input type="checkbox"/>	<input type="checkbox"/>	<input type="checkbox"/>	<input type="checkbox"/>	<input type="checkbox"/>	<input type="checkbox"/>	<input type="checkbox"/>	<input type="checkbox"/>	<input type="checkbox"/>	<input type="checkbox"/>	<input type="checkbox"/>	<input type="checkbox"/>	<input type="checkbox"/>
Transformer Housing Temperature	SET	CLR	<input type="checkbox"/>	<input type="checkbox"/>	<input type="checkbox"/>	<input type="checkbox"/>	<input type="checkbox"/>	<input type="checkbox"/>	<input type="checkbox"/>	<input type="checkbox"/>	<input type="checkbox"/>	<input type="checkbox"/>	<input type="checkbox"/>	<input type="checkbox"/>	<input type="checkbox"/>	<input type="checkbox"/>

Continuing Work

- Further deployment of meters into other distribution circuits
 - SCE High Pen Study
 - CPS Bluewing
- Development of other meter models for additional metering locations and reduced hardware cost
 - DFR-style triggered waveform capture
 - More complete support for Harmonics and THD
 - FTP store and forward version (trades real-time for reliability, higher measurement rates and ease of communications)
- Integration of other, data sets into data retrieval website
 - Utility SCADA data
 - Household level and Smart Meter Data
 - Solar and weather measurements
- Refinement and addition of features to Visualizations
- Integration of other sources into visualizations, including results from simulation and modeling

Integration of Simulation and Modeling

- The communications to the Google Earth and Strip chart displays have an open architecture which allows for easy integration of other data sources
- This would include data sets generated by simulation and modeling packages
- On going work includes the integration of the DEW distribution system modeling package so that simulation results can be incorporated and displayed along with the live data
- DEW can also receive the live data feeds as input to its solver, allowing it to fill in the missing points on the map

NASPI-NREL RENEWABLES WORKSHOP

<u>NAME</u>	<u>ORGANIZATION</u>	<u>PHONE</u>	<u>EMAIL ADDRESS</u>
alison silverstein	NASPI	512 670 3493	alisonsilverstein@mac.com
Jeff Dagle	PNNL	509 375-3629	jeff.dagle@pnnl.gov
David Corbus	NREL	303 384 6966	David.Corbus@NREL.gov
Ken Martin	EPG	503 289 8984	martin@electricpowergroup.com
Eric H. Allen	NERC	609 650 7185	eric.allen@nerc.net
Vikram Budhraj	EPG/CERTS	626 685 2015	budhraj@electricpowergroup.com
Jim Dyer	EPG	714-293-5316	dyerjd@aol.com
Mahendra Patel	PJM	610-633-8277	patelm3@pjm.com
KAREN FORSTEN	EPR1	865-218-9052	kforsten@epri.com
FRED ELMENDORF	GPA	423-702-8136	felmendorf@gpa.net
JIM HACKETT	MEHTA TECH	563-285-9151	hackett@mehtatech.com
TARIA RAHMAN	SDG&E	858-636-5547	trahman@SEMRAUTILITIES.COM
Richard Pinnet	Fluke	425-577-4951	RMPIRRET@gmail.com
Geoff Ives	FLUKE	+44 1603 256 724	geoff.ives@fluke.com
Mike McMullen	MISO	651 632-8404	mcmullen@misoenergy.org
Dino Lelic	quantat.	919-274-1375	dlelic@quanta-technology.com
Marcus Young	ORNL	865-719-1568	young.marc@ornl.gov
BOB ZAVADIL	ENERNEX	865-386-7456	bobz@enernex.com
Phil Overholt	DOE/DE	202-586-8110	philip.overholt@hq.doe.gov
Allen Goldstein	Fluke Calibration	206-274-7347	allen.goldstein@fluke.com
KARL REINHARD	UNIV OF ILLINOIS CHAMPAIGN	217 719 0658	REINHARD@ILLINOIS.EDU
Luigi Vonfretti	KTH Sweden	+46 87906625 +46 73 4612478	LUIGI.V@KTH.SE
Nancy Huang	PJM Interconnection	610 666 4733	huangn@pjm.com
DAVID HISLOP	PJM Interconnection	610.666.4242	hislod@pjm.com
Marissa Hummon	NREL	303-275-3269	marissa.hummon@nrel.gov

<u>NAME</u>	<u>ORGANIZATION</u>	<u>PHONE</u>	<u>EMAIL</u>
Charlie Jones	UVIG	252-715-0796	charlie@uvig.org
Kara Clark	NREL	303-384-7098	kara.clark@nrel.gov
Bill Flerchinger	SEL	509 334-8091	Bill.Flerchinger@selinc.com
John Adams	ERCOT	512 248-3130	jadams@ercot.com
Kevin Frankeny	MISO	317-244-5620	kfranken@misenergy.org
Louis SIGNORETTY	ALSTOM	425-250-2804	Louis.signoretty@alstom.com
Audie White	OGTE	405-553-5996	whitead@oge.com
Yi Hu	Quanta Technology	919-334-3042	yhu@quanta-technology.com
Yingchen (YC) Zhang	NREL	303-384-7090	yingchen.zhang@nrel.gov
Sascha von Meier	CIEE/UCB	707-322-3538	vonmeier@uc-ciee.org
LLOYD CIBULKA	CIEE/U. of CA-Bkly.	510-290-3875	lloyd.cibulka@uc-ciee.org
Ed Muljadi	NREL	(303)384-6904	edward.muljadi@nrel.gov
Yih-huei Wan	NREL	303-384-7025	yih-huei.wan@nrel.gov
Jaswan BANK	NREL	303 275 4338	jaswan.bank@nrel.gov
Barry Mather	NREL	303-275-4378	barry.mather@nrel.gov
Hari Singh	Xcel Energy	303-571-7095	hari.singh@xcelenergy.com
Jeff Otto	SEL	(509) 336-4426	jeff-otto@seliac.com
Justin Fuith	Xcel Energy	612-303-5802	Justin.T.Fuith@xcelenergy.com
Vahan Gevorgian	NREL	303.384.6940	vahan.gevorgian@nrel.gov
HECTOR ANDRES R. VOLKIS	ONS	+55 21 22039990	HECTORVOLKIS@ONS.ORG.BR
Lisa Beard	Quanta Technology	805-323-8799	lbeard@quanta-technology.com
Ittiphong Leevongwat	Univ. of New Orleans	504-280-7381	ILEEVONG@UNO.EDU
ANGELA NELSON	ENERGY	504-365-3614	anel590@entenergy.com
FLOYD GALVAN	ENERGY	504-365-3614	fgalvan@entenergy.com
Joel Phelps	Duke Energy	317-838-6474	Joel.Phelps@Duke-Energy.com
Jim Kleitsch	ATC	608.877.8102	jkleitsch@atell.com

NAME	ORG	PHONE	EMAIL ADDRESS
David Burnham	FERC	202-502-9732	david.burnham@ferc.gov
Hanush Mehta	Mehta Tech, Inc	563-285-9151	hanush@mehtatech.com
DOUG OSBORN	FOA	918-627-4200	DOBORN@OBERLENDER.com
RICH BAUER	IPCO	208-388-5669	rbauer@idahopower.com
Henry Huang	PNNL	509-372-6781	zhenyu.huang@pnnl.gov
Jerry FitzPatrick	NIST	301-975-8922	fitzpa@nist.gov
Tom Nelson	NIST	301-975-2986	thomas.nelson@nist.gov
Mohit Singh	NREL	303-384-6931	mohit.singh@nrel.gov
Alicia Allen	Univ of Texas		aliciajallene@utexas.edu
Joseph Mulvaney	PJM	610-662-6351	mulhej@pjm.com
BHARAT BHARGAVA	EPG	626.685.2015	BHARGAVA@electricpowergroup.com
Laura Hicks	ERLPhase	206-200-1570	lhicks@erlphase.com
TONY RANSON	MEHTATECH, INC	563-285-9151	TRANSON@MEHTATECH.COM
Larry Bugh	Reliability First	330-247-3046	larry.bugh@rfirst.org
RT Ductions	mehtaTech	515-223-0769	
Mike Finto	NREL	720-394-2113	michael.finto@NREL.gov
Aaron Wright	SEL	509-334-8086	Aaron.Wright@selinc.com
Jim Reilly	Reilly Assoc	732-706-9460	jreilly@verizon.net
Clifton Black	Southern Company	205-257-6184	crblack@southernco.com
JACK ARNOLD	NATIONAL INSTRUMENTS	512-683-5720	jack.arnold@ni.com
Jing Liu	PJM	610-666-4326	liuj@pjm.com
Bonnan Shi	Beijing Sifang		shibonnan@sif-auto.com
Yi-hua Tang	NIST	301 975 4691	yi-hua.tang@nist.gov
Shawn Fountain	BRIDGE Energy Group	303.880.9207	sfountain@bridgeenergygroup.com
Said Siddiqui	TVA	423.697.4162	sisidi@tva.gov
Mamadou Diong	Dominion	804.257.4997	MAMADOU.DIONG@DOMINION.COM
Scott Dehman	PowerWorld	217 384 6330	scott@powerworld.com

<u>NAME</u>	<u>ORG</u>	<u>PHONE</u>	<u>EMAIL ADDRESS</u>
David Gao	University of Denver	3038713570	wenzhong.gao@du.edu
Yutaka Kokai	Hitachi America	9149808116	yutaka.kokai@hal.hitachi.com
DAVID BERTANUSI	ISO New England	613-530-5356	dbert@iso-ne.com
Paul Sweat	National Instruments	720-929-8946	paul.sweat@ni.com