



# Flowing Particle Bed Solarthermal Redox Process to Split Water

PI: Alan W. Weimer

Brian D. Ehrhart, Ibraheam Al-Shankiti,  
Samantha L. Miller, Amanda L. Hoskins,  
Arto Groehn, Ryan Trottier, Charles B. Musgrave, Caitlin  
Majlinger, and Hans Funke

University of Colorado at Boulder

6/10/2016

Project ID: PD114

# Overview:

## Year 2 of 3-Year Project



### Timeline

Project Start Date: 9/1/2014

Project End Date: 8/31/2017

% Complete: 50%

### Partners

National Renewable Energy Laboratory (NREL), Golden, CO

- Solar testing facility and capabilities

Allan Lewandowski Solar Consulting, LLC

- Solar field design consultation and modeling

Musgrave Group\*, CU Boulder

- Active materials discovery and DFT modeling (\*NSF/DOE Funding – joint FOA)

**TRL 2 → TRL 3**

### Technical Barriers Addressed

S. High-temperature robust materials

W. Materials and catalysts development

X. Chemical reactor development and capital costs

### Collaborators

Australian National University (ANU), Canberra, AU

- Reactor models and receiver testing at solar simulator facility

Saudi Basic Industries Corporation (SABIC)

- Supplying equipment and materials characterization

Coorstek/Ceramatec

- Preparation of large spherical active materials
- High temperature O<sub>2</sub> transport membrane

### Budget

Total project funding: \$2,000,000

Sub-contract to NREL: \$450,000

Total recipient cost share: \$6,250

Total DOE funds spent\*: \$750,525

\*as of 3/31/2016



***Project Objective: Design and test individual components of a novel flowing particle solarthermal water splitting system capable of producing 50,000 kg H<sub>2</sub>/day at a cost < \$2/kg H<sub>2</sub>***

- Identify and develop high-performance active material formulations
- Synthesize flowable, attrition-resistant, long-use spherical particles from low-cost precursors
- Demonstrate high-temperature tolerant, refractory, non-reactive containment materials
- Construct fluidized bed particle redox test system and test components of system
- Monitor progress toward cost target by incorporating experimental results into frequently updated detailed process model and H<sub>2</sub>A
- On-sun production for a full solar day
- Move from TRL 2 to TRL 3

### ***This Reporting Period:***

- ✓ Improved production method for spherical, multi-sized active materials through spray drying & dynamic mixing (**Barrier W**)
- ✓ Performed fluidization studies with active materials undergoing redox cycling (**Barrier X**)
- ✓ Included inert gas sweep and efficiency calculations in Aspen model for H<sub>2</sub>A (**Barrier X**)
- ✓ Developed preliminary ALD barriers that improved high temperature stability of containment materials (**Barrier S**)
- ✓ Initiated testing of high temperature O<sub>2</sub> transport membrane for inert gas recycle (**Barrier X**)



# Approach: Iterative Materials and Reactor Development

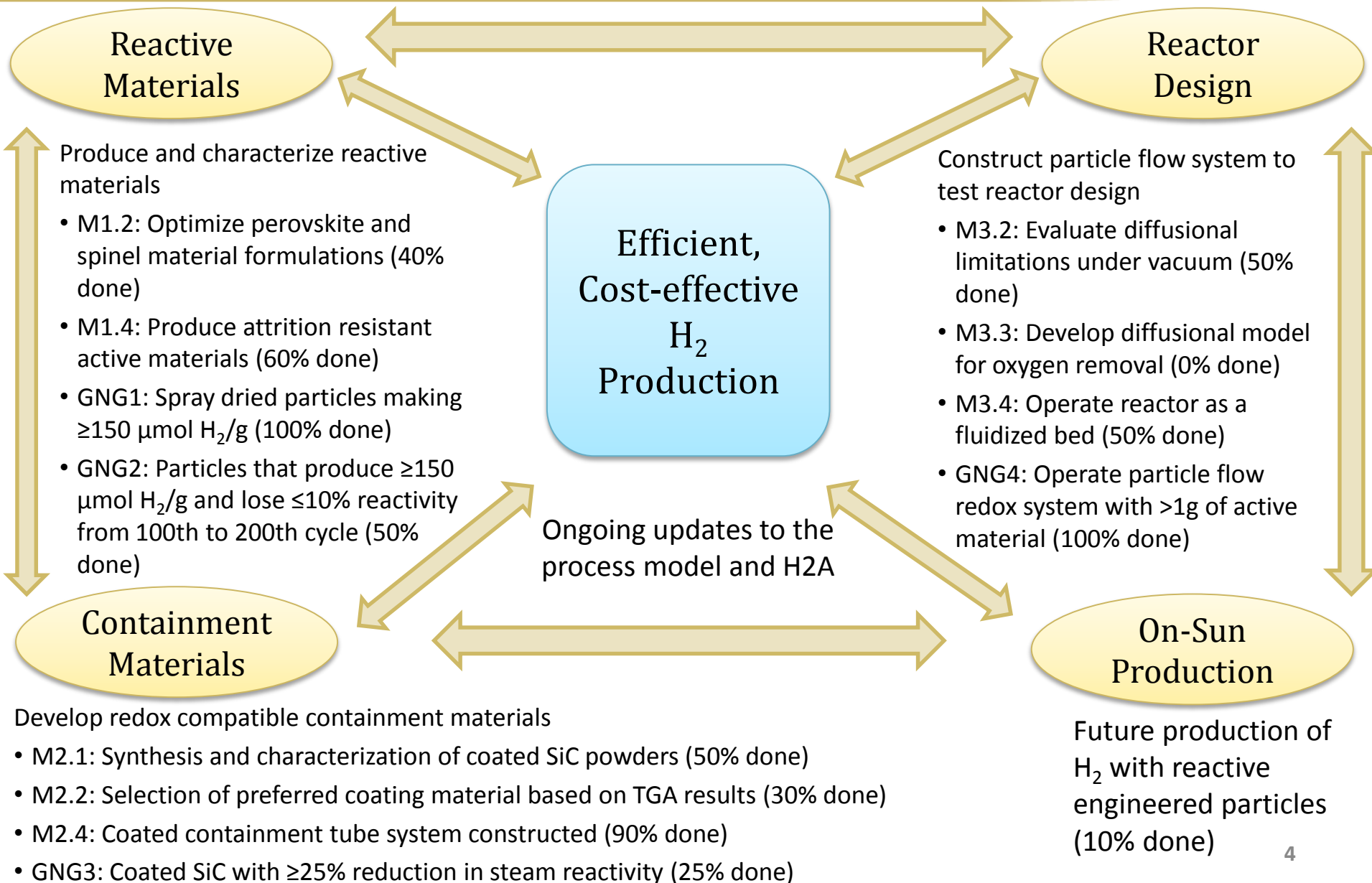

# Accomplishments and Progress: Overall Process R&D

## Reactor Unit Concept (not to scale)

### Containment Materials R&D

- Synthesized  $\text{Al}_2\text{O}_3$  coated SiC
- Improved stability (10%) with  $\text{Al}_2\text{O}_3$  coating shown with TGA
- Test system for coated tubes 90% completed

### Overall System R&D

- Model developed to study radiation, temperature, velocity, solids fraction, and conversion for reactor design; with integrated solar field design

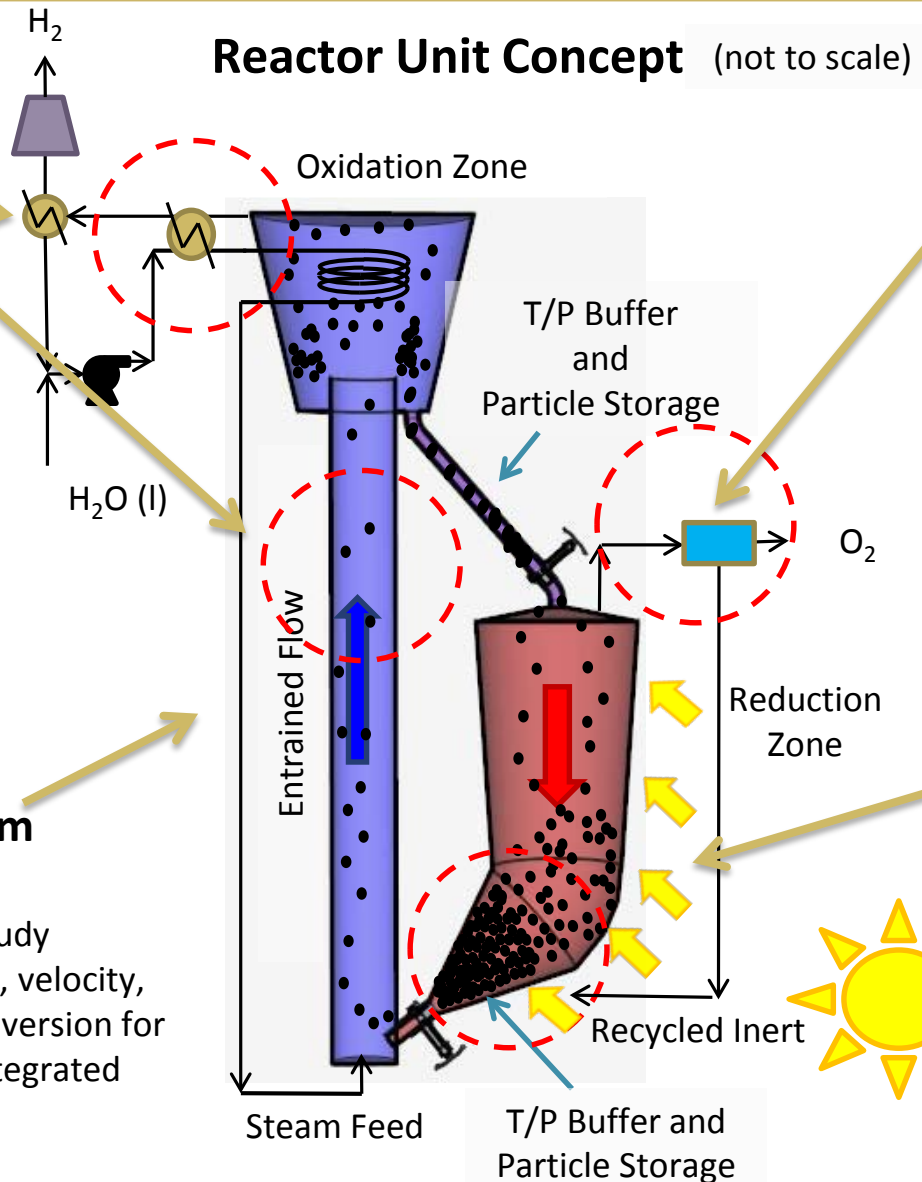

### ITS SEOS for Recycled Inert Gas R&D

- Electrically heated high-temperature  $\text{O}_2$  transport membrane acquired and testing underway
- Investigating effect of  $\text{O}_2$  concentration on reduction kinetics and productivity

### Active Materials R&D

- Upgraded two stagnation flow systems
- Produced robust spray-dried materials generating  $>200 \mu\text{mol/g H}_2$



# Accomplishments and Progress: Pressure Cascade and Recycled Inert Gas Sweep

## Vacuum Cascade

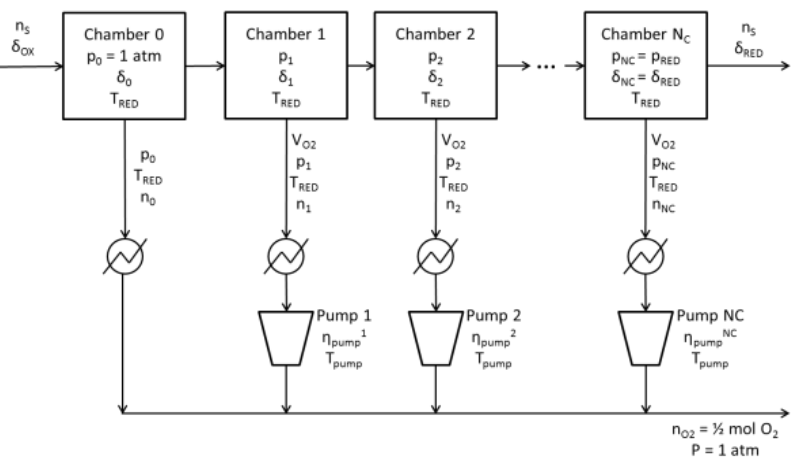

Vacuum cascade uses published pump efficiency data

Inert gas separation uses

## Recycled Inert Gas

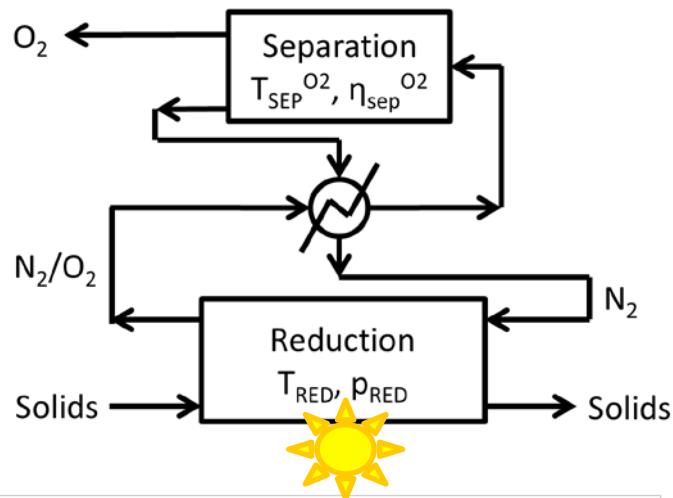

high temperature separation

Ceria,  
 $T_{RED} = 1800 \text{ K}$ ,  
 $\epsilon_{GG} = 0.9$ ,  
 $\epsilon_{SS} = 0.5$

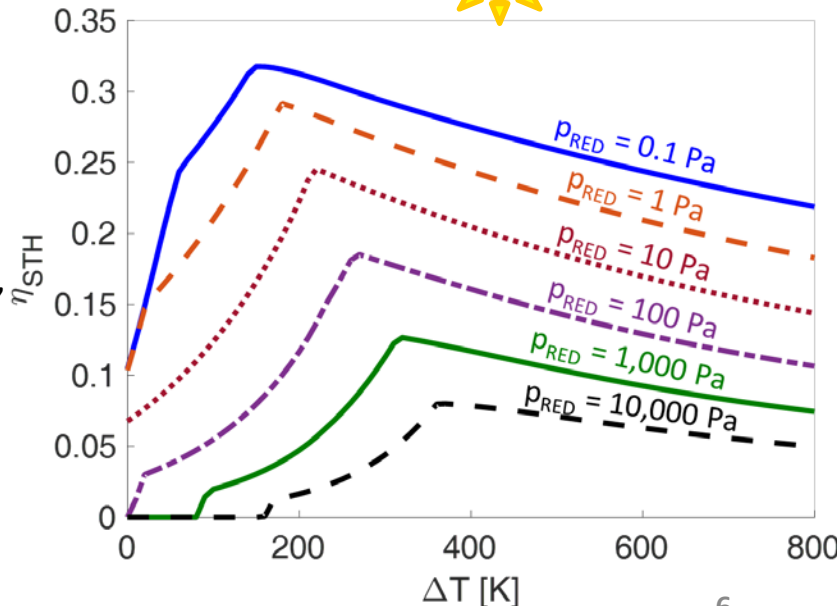
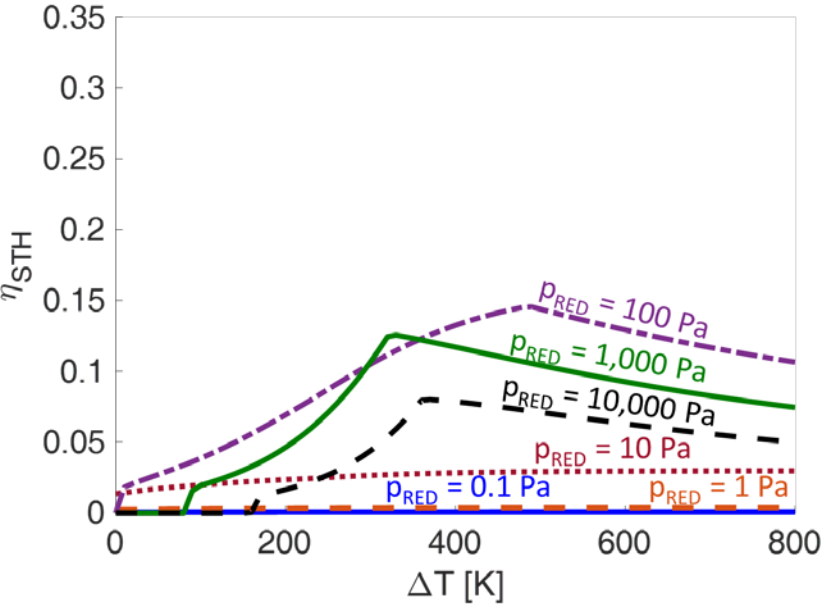

# Accomplishments and Progress:



## H2A- Economics

### Updated H2A

- Replaced vacuum pumps with inert gas sweep and O<sub>2</sub> transport membrane
- H2A default assumptions used
- Capital costs calculated using CapCost
- Material activity represents measured values

### Sensitivity Analysis

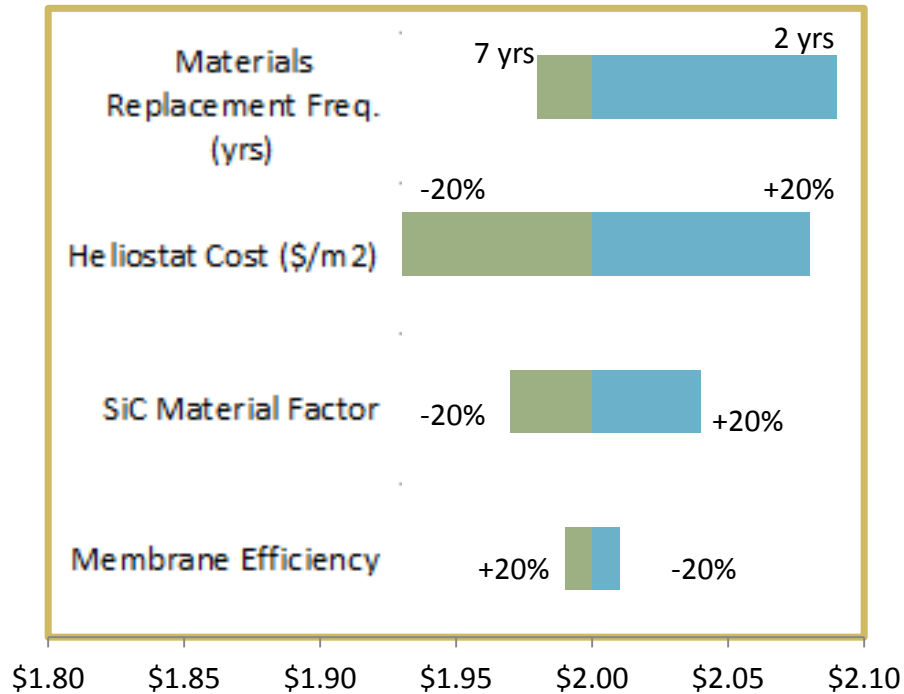

Cost Drivers	2015	2020	Ultimate
Heat exchanger effectiveness	85%	90%	95%
SiC material factor	6	5	3
Replacement frequency (years)	2	5	5
Material activity (μmol H <sub>2</sub> /g)	354	389	425
Enthalpy of reaction (kJ/mol)	384	346	307
Helioostat cost (\$/m <sup>2</sup> )	\$140	\$75	\$75
Cost H <sub>2</sub> (\$/kg)	\$14.34	\$5.36	\$2.00

Economic analysis predicts that scaled-up process can produce H<sub>2</sub> at \$2.00 /kg

# Accomplishments and Progress: Solar-thermal Energy Modeling

**Goal of this work:** Simulate industrial-scale reactor for STWS by active particles

**Ray-tracing<sup>1</sup>**  
**(SolTrace)**

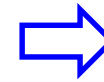

**This Work**  
**(Matlab)**



**Finite-volume<sup>2</sup>**  
**(Fluent)**

Outputs ray coordinates and directions at a given surface

Discretizes ray positions and directions for arbitrary geometries

Discretized fluxes are used as source terms in CFD

## Heliostat-mirrors

**Number: 469 X 3**

**Size: 4 X 4 m**

**DNI: 1000 W/m<sup>2</sup>**

**Solar field efficiency: 76 %**

**Ray-tracing  
radiation model**

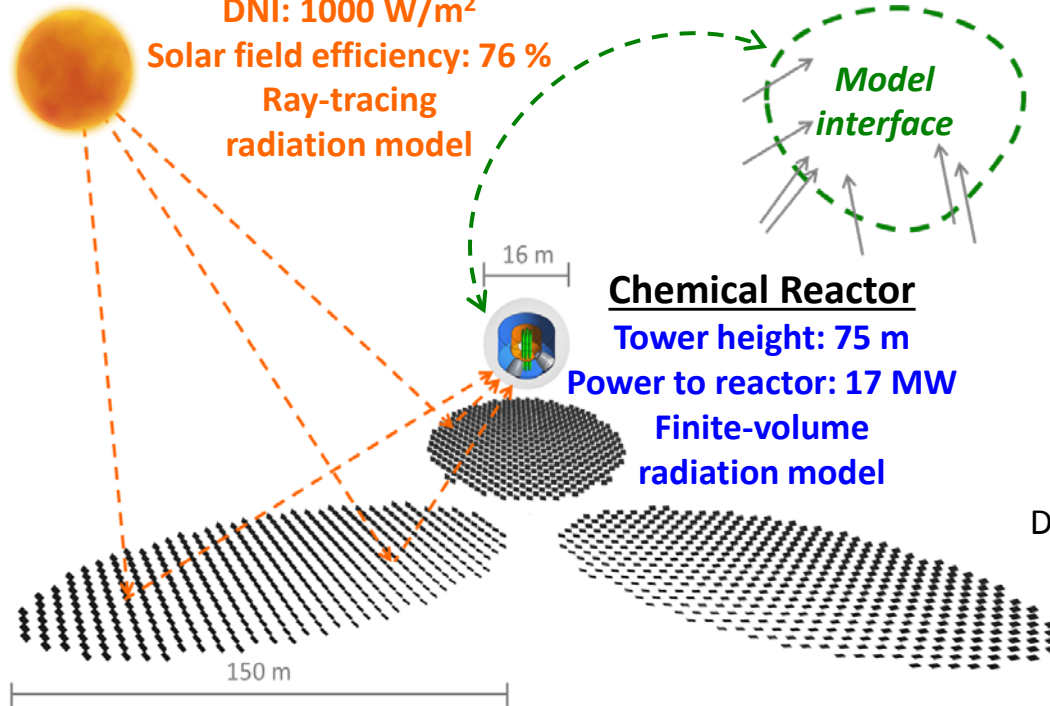

## Chemical Reactor

**Tower height: 75 m**

**Power to reactor: 17 MW**

**Finite-volume  
radiation model**

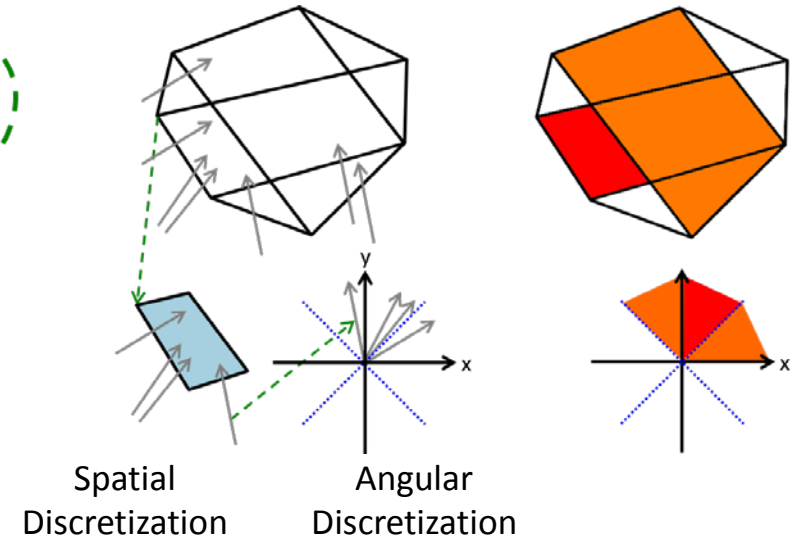

***Using ray-tracing and finite-volume methods in tandem allows modeling of heliostat field and reactor.***

[1] Howell, J. R. (1998). Journal of Heat Transfer, 120, 547-560.

[2] Chui, E. H., & Raithby, G. D. (1993). Numerical Heat Transfer, 23, 269-288.



# Accomplishments and Progress: Results for Multiphase Reactor

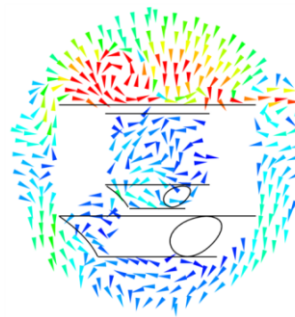
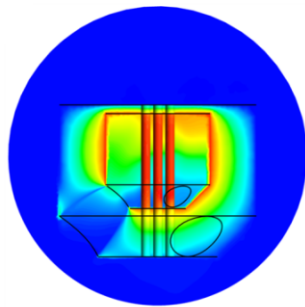
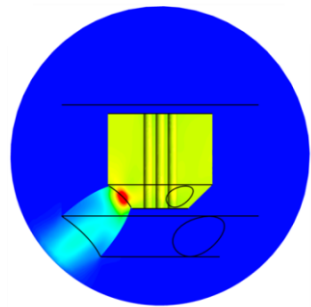
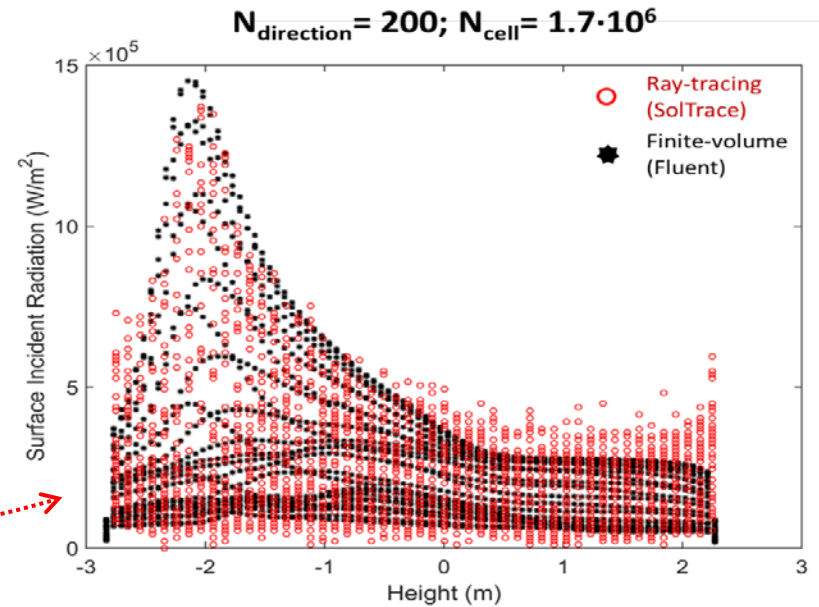
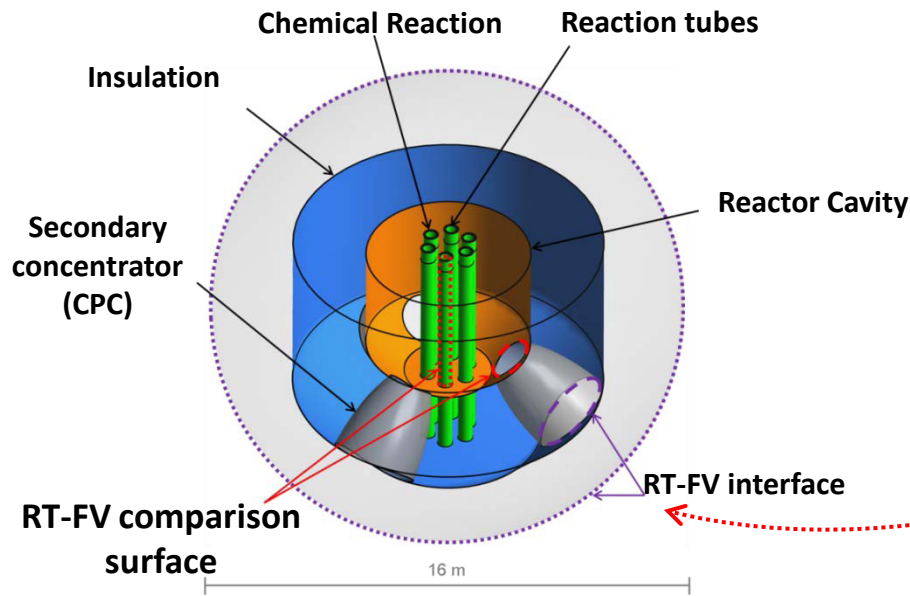

Radiation Intensity

Temperature

Velocity

## Profiles Inside Reactor Tubes

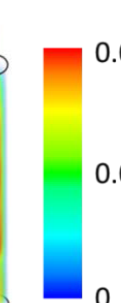
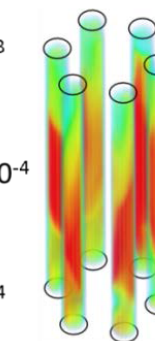
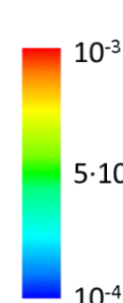
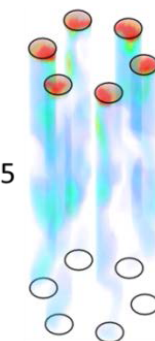
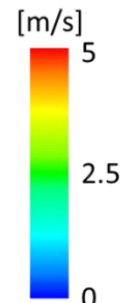
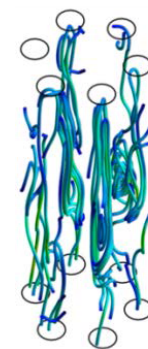

Velocity

Solids fraction

Conversion ( $\delta$ )

*Ray-traced radiation intensity profiles are reproduced within 6% error for peak flux and 2% error for total power with finite-volume model at reactor tube surfaces.*



# Accomplishments and Progress: Modeling for Coating Stability Analysis

- Density Functional Theory (DFT) applied to model chosen barrier materials
- Mullite contains randomly partially occupied lattice sites resulting in a disordered crystal structure
  - Monte-Carlo script generates representative mullite structures
  - Statistical analysis determined significant structural properties
- Calculations compare mullite to bulk alumina and nitride materials stable at high temperatures
  - AlN reacts with water, but matches the lattice constant of SiC → Multi-material barrier
  - BN forms glassy  $\text{BO}_2$  on surface that prevents further oxidation

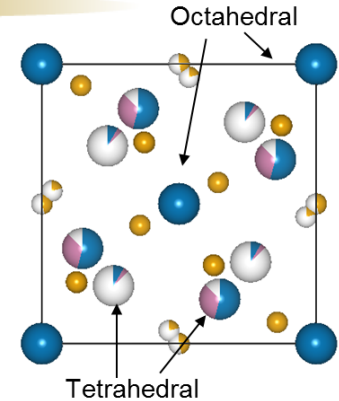

### Vacancy Formation Energies

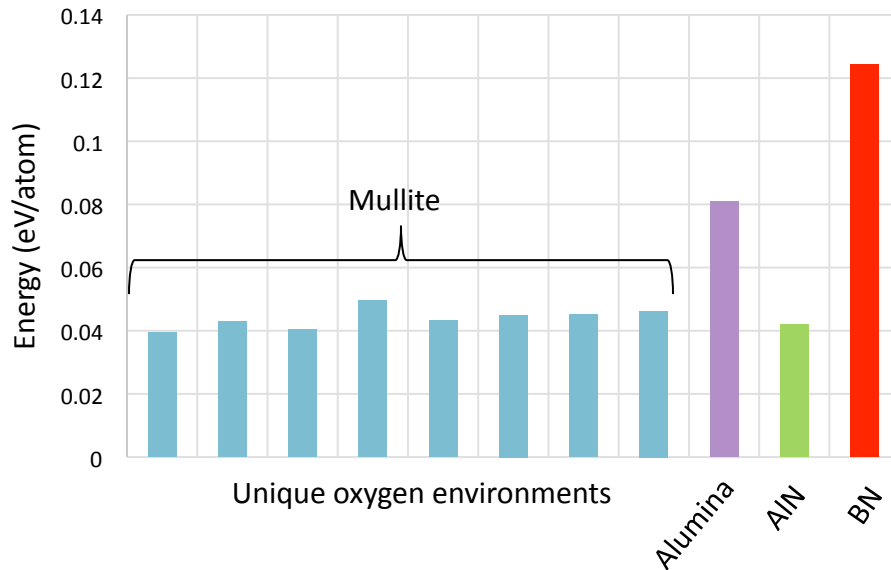

### Migration Barriers

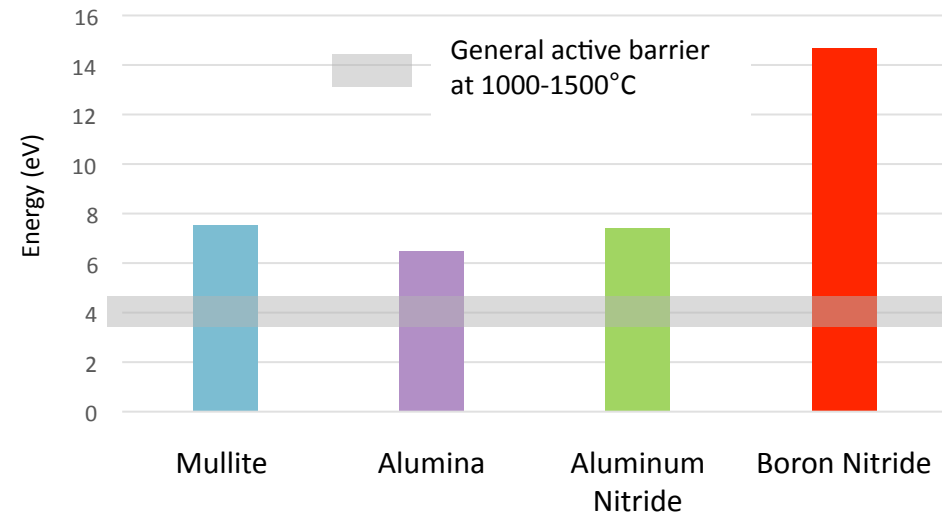

**Mullite and BN are promising barrier materials based on intrinsic properties, calculated oxygen hopping energy, and vacancy formation energy.**



# Accomplishments and Progress: SiC Stabilization in High Temperature Steam (preliminary)

- SiC needs to be stabilized in high temperature oxidative environments
  - Reactor materials
  - High temperature heat exchange → Improve STH efficiency
- Particle ALD to study stabilization effects of diffusion barriers with atomic growth control
  - A barrier to prevent abrasive removal of ALD will be applied in the form of solid alumina
- Mullite ( $3\text{Al}_2\text{O}_3:2\text{SiO}_2$ ) identified as promising barrier material
  - Ratio of  $\text{Al}_2\text{O}_3:\text{SiO}_2$  impacts structure and properties
  - Outside 3:2 ratio phase segregation causes mechanical weaknesses along grain boundaries
- Conformal deposition of alumina on SiC particles completed via ALD

Effect of ALD Film Thickness on the Oxidation Resistance of SiC

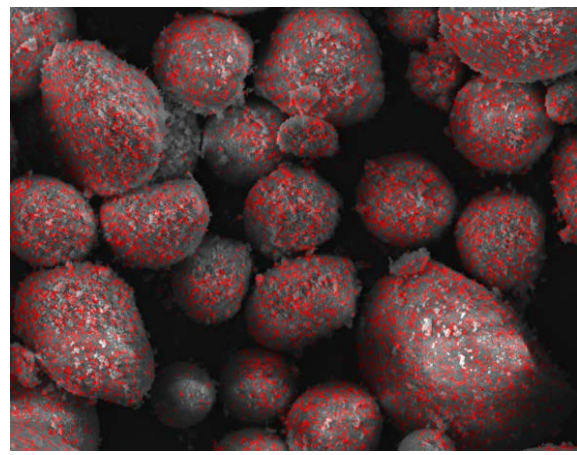
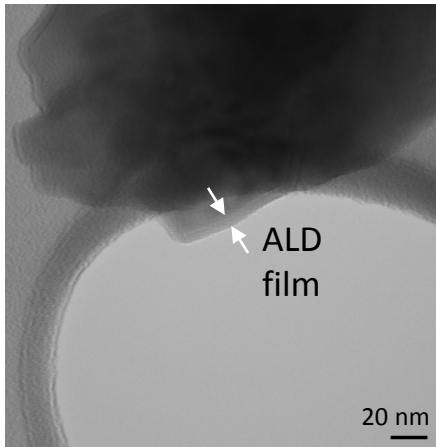
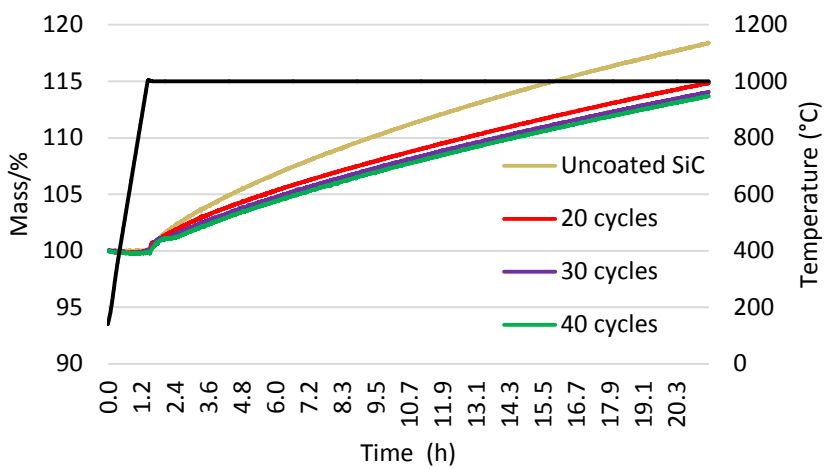

- $\text{H}_2\text{O}$  exposure at  $1000^\circ\text{C}$  for 20 hours
- ALD alumina films show less oxidation than uncoated SiC
- Increased film thickness improves performance
- $1000^\circ\text{C}$  is above the crystallization temperature of alumina causing microcracking in films

**ALD alumina coatings show up to a 10% improvement to the oxidation resistance of SiC.**

# Accomplishments and Progress: Improvements to Particle Size and Morphology



- Spray drying pH tuned, nanopowder suspension
  - Mean spherical diameter 10-20  $\mu\text{m}$
  - Slightly larger would be ideal
  - Somewhat wide particle size range
  - High degree of sphericity
- Up to 1mm diameter particles produced by intensive mixing at Coorstek
  - Less spherical, may be harder to fluidize
  - Larger quantities produced

pH 3.7

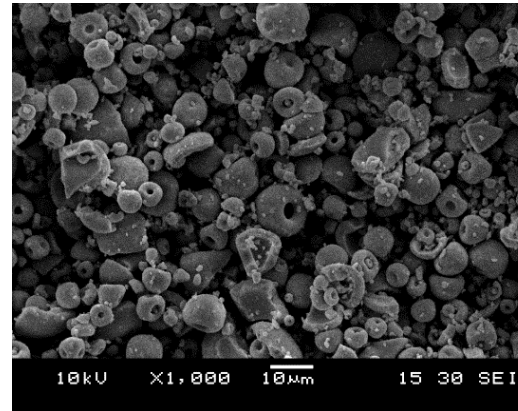

pH 5.4

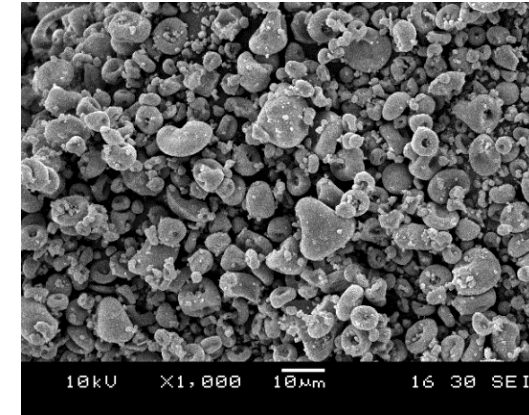

pH 7.4

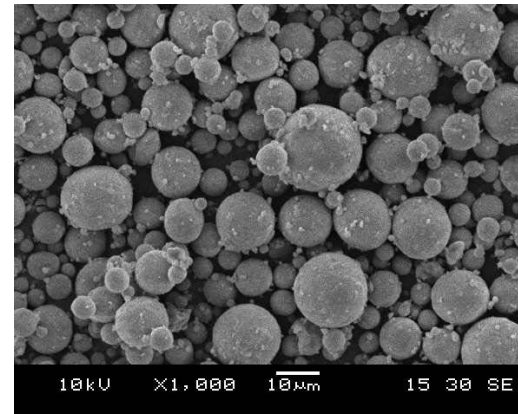

pH 10.1

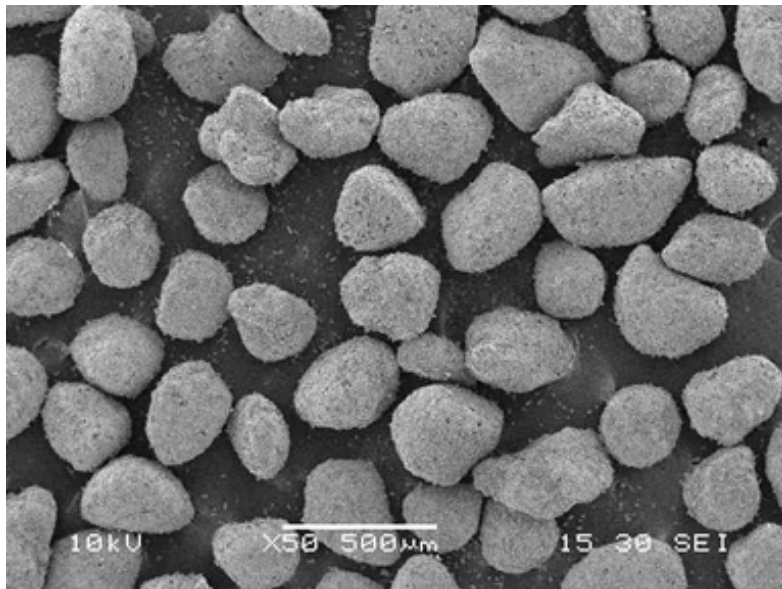
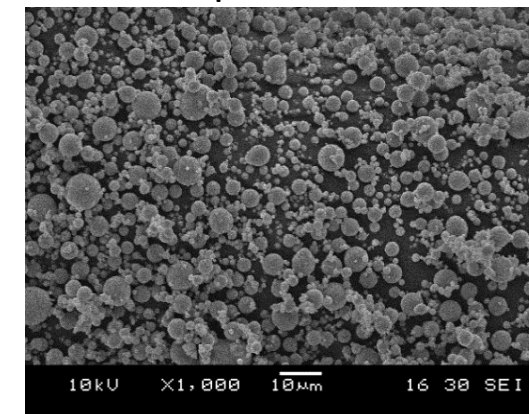

***Large, spherical particles of active material have been synthesized, but further improvements needed***

# Accomplishments and Progress: ITM SEOS Membrane

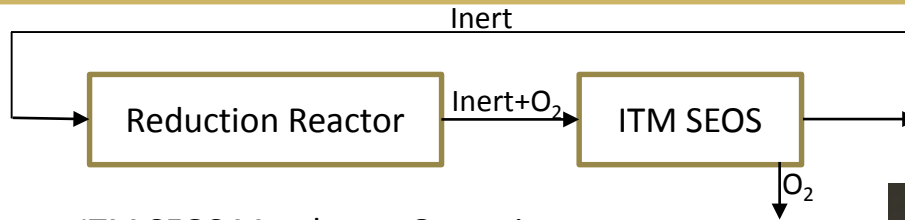

## ITM SEOS Membrane Operations

- Made from oxygen-ion conducting non-porous ceramic materials
- Electrically-driven with fast residence time (seconds)
- Lab size unit is built in collaboration with Ceramtec
- Membrane is currently operated at up to 850°C
- Higher temperature (1200°C) membrane can be built
- R&D is ongoing to estimate energy requirements for inert/O<sub>2</sub> separation

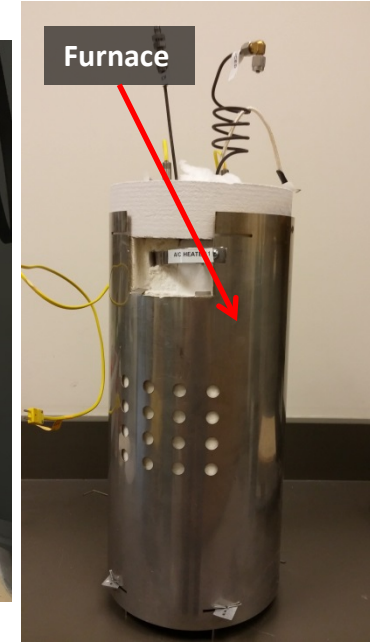
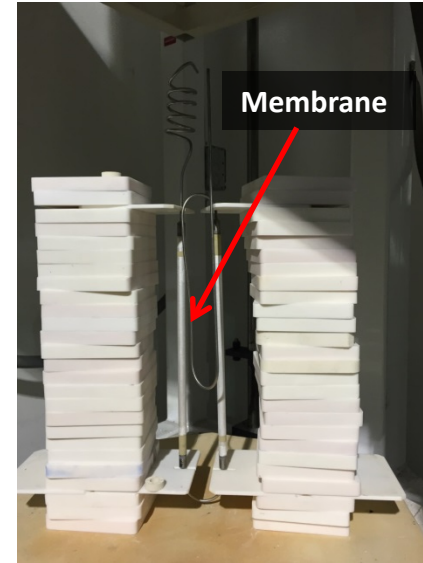
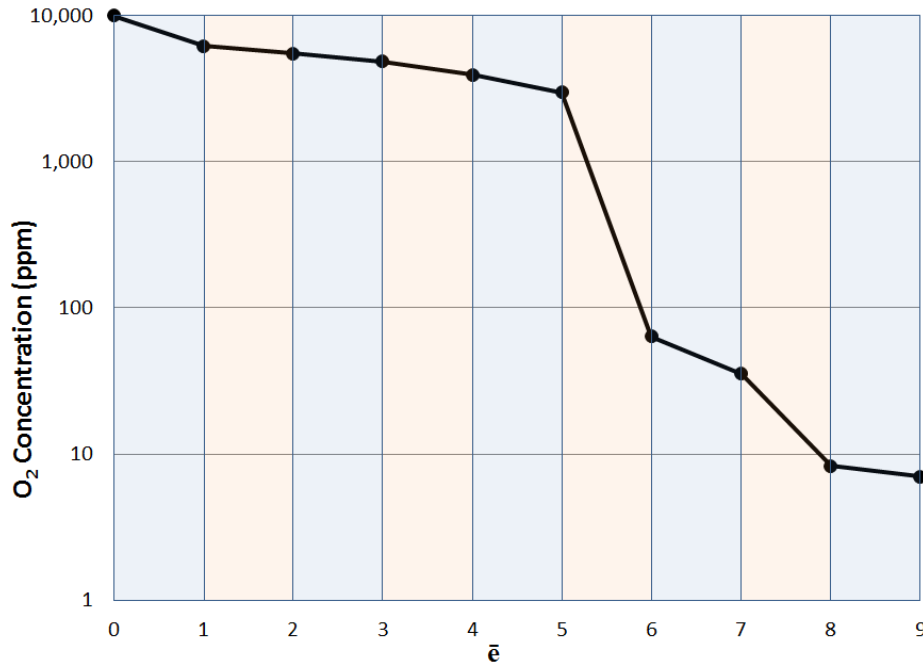

***O<sub>2</sub> concentration reduced to 7ppm from 1% O<sub>2</sub>/N<sub>2</sub> mixture at 1 SLPM using ITM SEOS***

# Accomplishments and Progress: NSF “Sister” Project for STWS Materials Development



## Normal Binary Spinel Screening

### AB<sub>2</sub>O<sub>4</sub> Structure

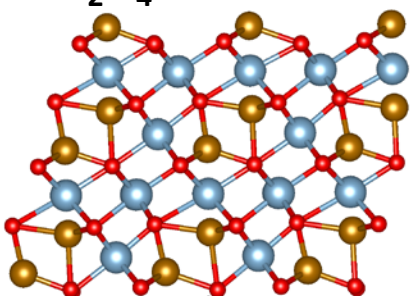

#### Legend:

- A Atom (Fe)
- B Atom (Al)
- Oxygen

### E<sub>v</sub> Distribution

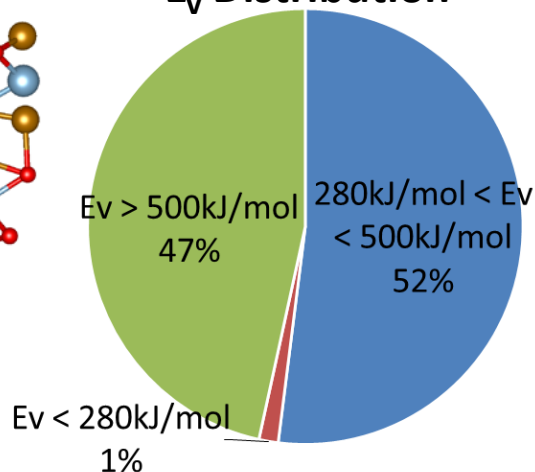

- Computational screening accelerates discovery of promising new STWS materials
- 955 binary normal spinels screened for oxygen vacancy formation energy (E<sub>v</sub>) using DFT
- 489 materials potentially capable of STWS based on E<sub>v</sub>
- Promising materials will be tested in SFR

## ABO<sub>3</sub> Binary Perovskite Screening

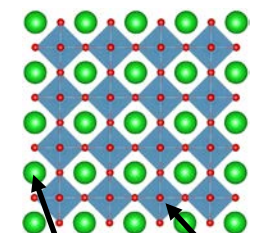

A Atom B Atom

- Improved screening methodology
- Exploring new factors that may impact predicted STWS behavior
- 1343 total structures calculated for impact of these factors
- Eight materials synthesized for experimental validation

## Investigating Inversion in Spinel

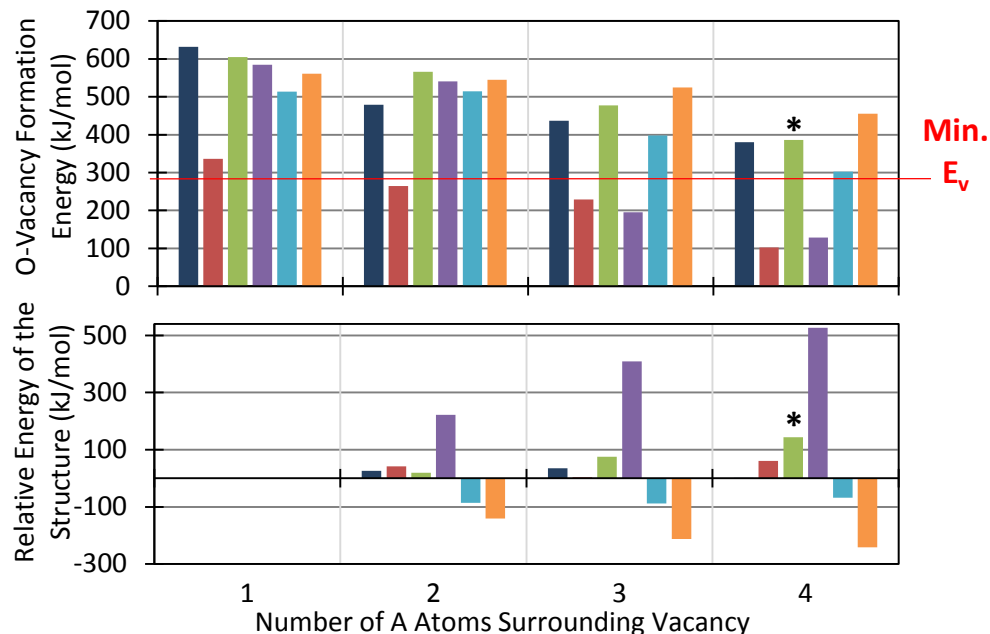

\* H<sub>2</sub> production experimentally verified

**Three promising new spinel materials identified through inversion modeling**

# Accomplishments and Progress: Materials Discovery DFT

- Performed case study of  $H_2$  evolution on hercynite surface
- Multiple reaction pathways with and without dopants
- Studied three dopants at low concentrations:
  - Co: based on experimental results showing favorable kinetics
  - Cu and Mn: important dopants in other redox reaction cycles
- Vacancy migration impacted by doping

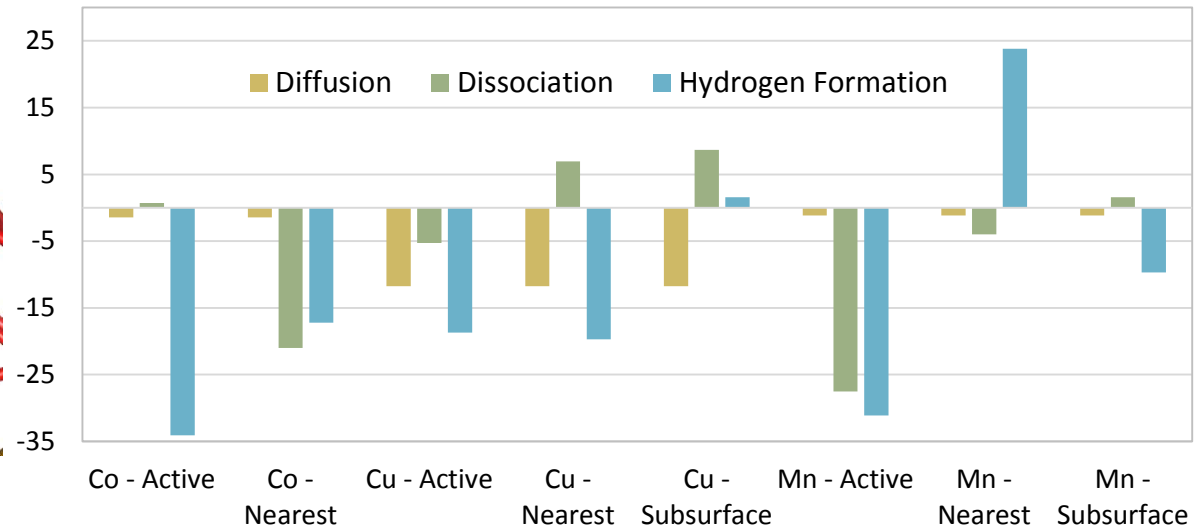
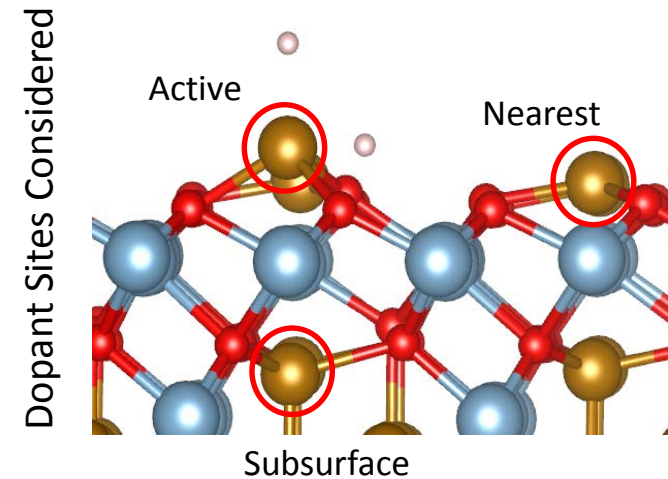
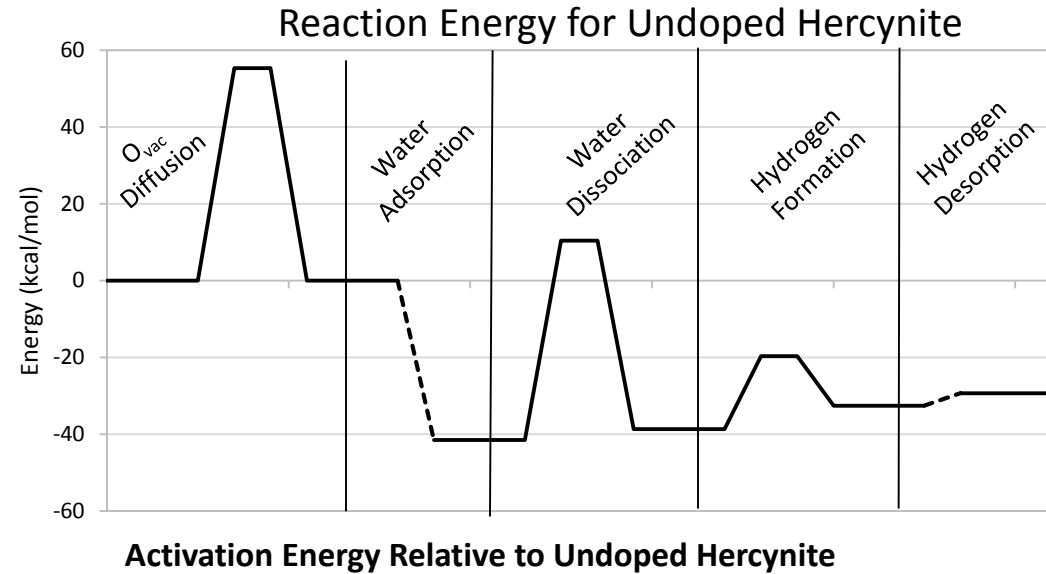

***Mn, Co, and Cu dopants have a significant beneficial impact on kinetics even at low concentrations.***

# Accomplishments and Progress: redox Material Testing



## Comparing Spinel, Perovskite, and Ceria

- Compared hercynite ( $\text{FeAl}_2\text{O}_4$ ) spinel and SLMA ( $\text{Sr}_x\text{La}_{1-x}\text{Mn}_y\text{Al}_{1-y}\text{O}_3$ ) perovskite with ceria in SFR
- 1500°C reduction in He for 60 minutes
- 1350°C oxidation in 50%  $\text{H}_2\text{O}$  for 15 minutes

Cycles 7-12	SLMA Perovskite	Hercynite Spinel	Ceria
Average Production	308 $\mu\text{mol/g} \pm 46.5$	542 $\mu\text{mol/g} \pm 49.2$	82 $\mu\text{mol/g} \pm 10.6$
Peak Rate	3.44 $\mu\text{mol/g/s} \pm 0.27$	2.57 $\mu\text{mol/g/s} \pm 0.26$	2.18 $\mu\text{mol/g/s} \pm 0.25$
Time to Complete Oxidation	7.00 min $\pm 0.19$	> 15 min	2.13 min $\pm 0.13$

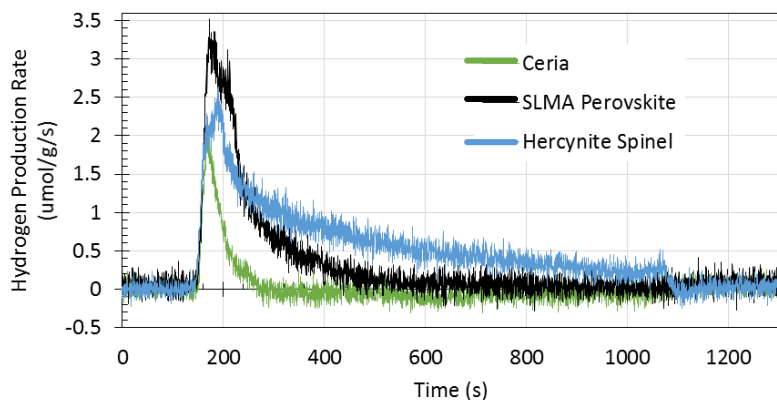

**SLMA has the highest peak rate, ceria has the shortest cycle time, and hercynite produces the most  $\text{H}_2$**

## Long Term Material Testing

- GNG2: Robust spray dried active materials that produce at least 150  $\mu\text{mol H}_2/\text{g}$  total and do not lose more than 10% of its reactivity between the 100<sup>th</sup> and 200<sup>th</sup> redox cycle
- Constructed new stagnation flow reactor system for long-term material testing

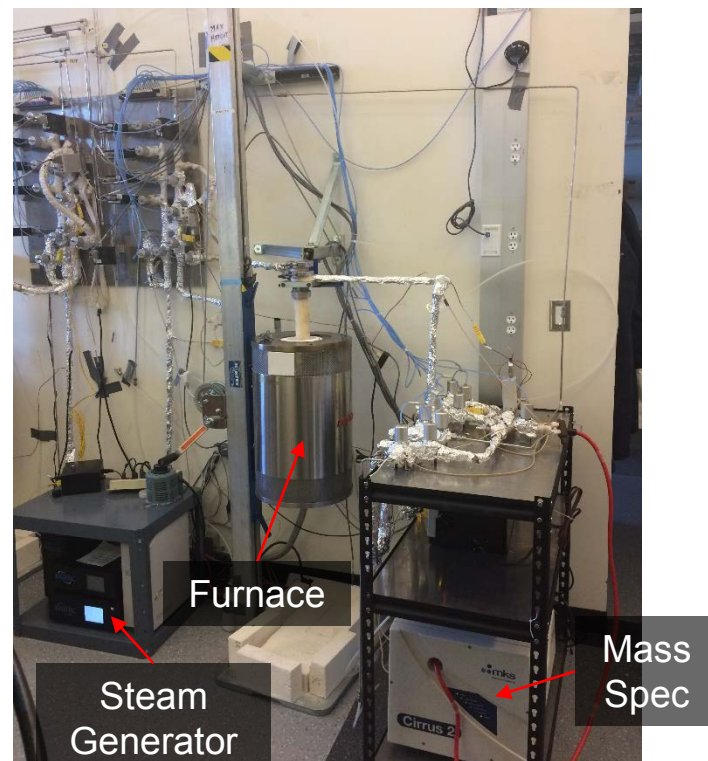



# Accomplishments and Progress: Particle Flow redox Test System (preliminary)

## Particle Flow redox Test System

- Hercynite ( $\text{FeAl}_2\text{O}_4$ ) materials with different particle sizes cycled under fluidizing conditions
- $1500^\circ\text{C}$  reduction in  $\text{N}_2$  (60 min)
- $1350^\circ\text{C}$  oxidation in 50%  $\text{H}_2\text{O}$  (30 min)

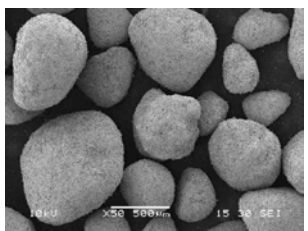

300 – 425  $\mu\text{m}$   $\text{FeAl}_2\text{O}_4$

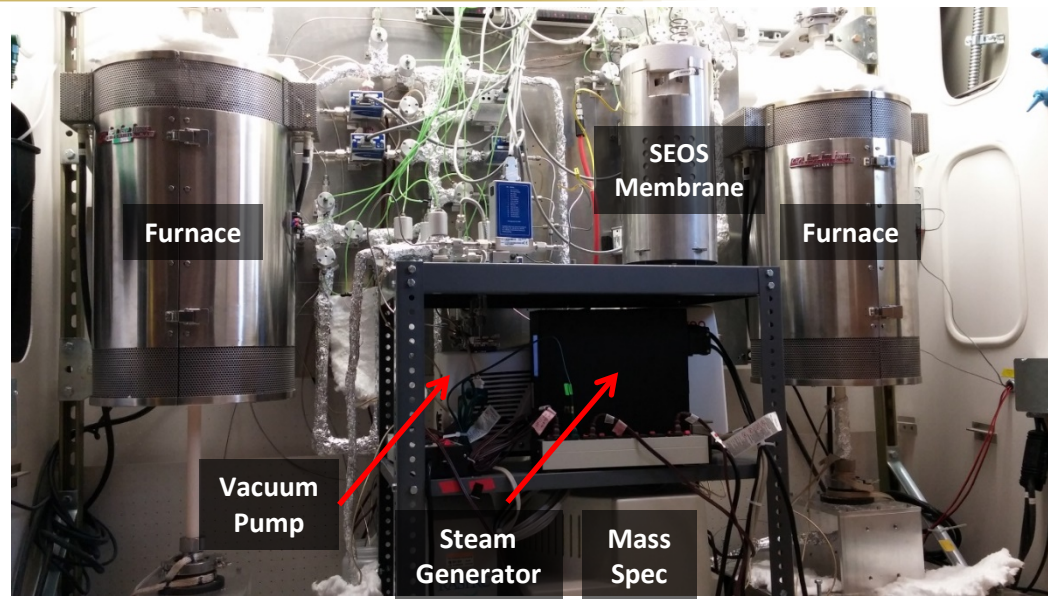
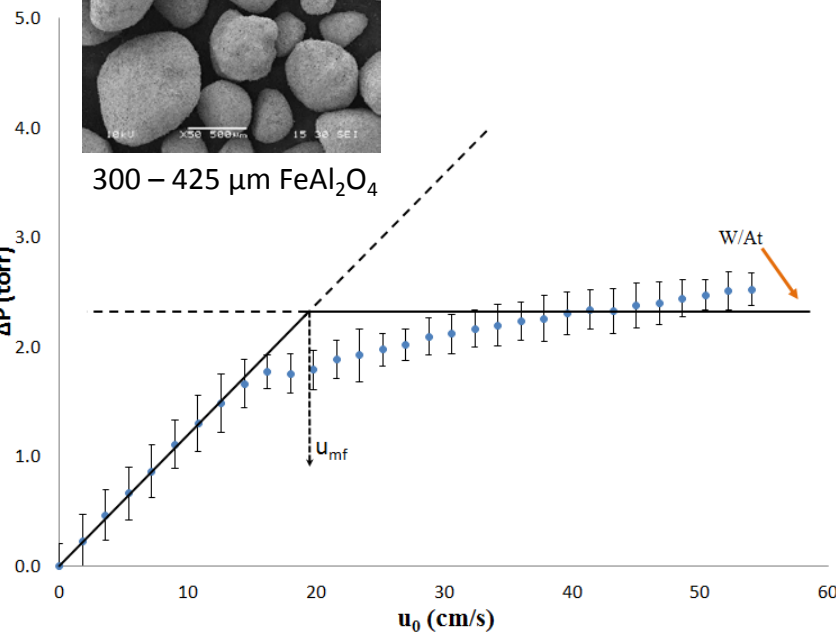

**Reduction and oxidation performed in new fluidized bed system**

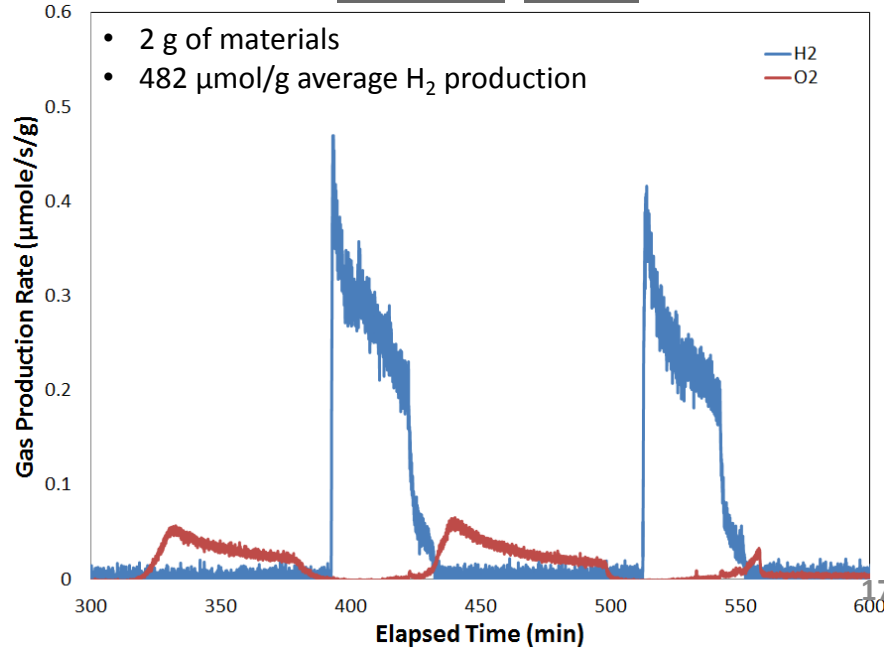

# Accomplishments and Progress: High Flux Solar Furnace

## Objective

- Assist CU in testing a novel solar-thermal chemical process to produce  $H_2$  by splitting water
- Optimize beam location for peak power input to reactor while maximizing flux distribution to accommodate dual tubes inside the reactor

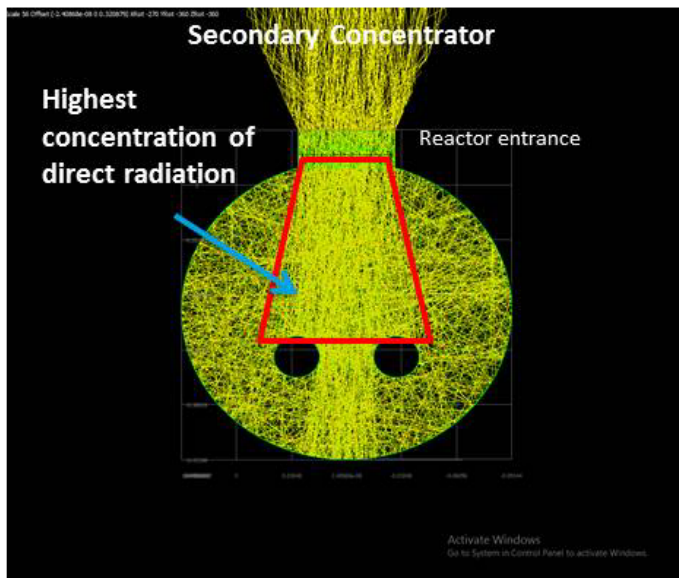
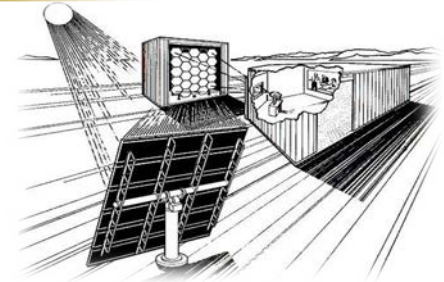

Optimal flux  
distribution and power

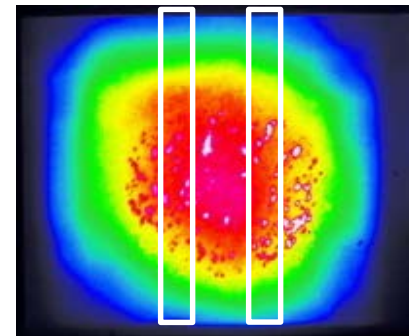

VS

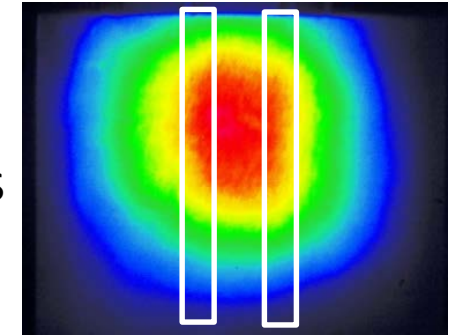

- Multiple focal point assessed to determine ideal illumination of dual tube configuration
- Focal Point at concentrator exit
- High intensity is wide at tubes and will cover two tubes

## Optical ray trace modeling of reactor provides

- Flux distributions within reactor @
  - Secondary entrance and exit apertures
- Power incident on reactor aperture
- Power absorbed by reactor tubes

## Additional work

- Completion of Coupling Window- design, fabrication & characterization
- Preparation of reactor – polished interior to mirror finish
- Purchase & integration of new peripheral equipment-steam generator, computer & flowmeters.

***Optimized balance between power and flux distributions for dual tube operation***



# 2015 Reviewer's Comments

*“Worry somewhat that taking challenge of complex solar reactor design too lightly, given the importance of a high efficiency for converting sunlight to very hot particles in reduction zone.”*

- Our reactor concept is continually examined and updated via experimental and theoretical work. Simulations of heat and fluid transfer characteristics have produced a predictive model of solar field and reactor dynamics. A laboratory-scale fluidized bed reactor with a high-temperature O<sub>2</sub> removal membrane is currently undergoing tests to validate the reactor concept. Efficiency calculations have demonstrated the appeal of inert gas sweep.

*“The H2A indicates that the heat exchanger is key for the success of this system, but there doesn't seem to be a large emphasis on its development.”*

- The same reactor containment materials being developed through ongoing DFT calculations and ALD film synthesis will also be used to stabilize materials for high temperature heat exchange.

*“There is no guarantee that needed production capacity is compatible with material durability.”*



- Highly productive spray-dried and dynamic mixed materials are currently being tested in both the stagnation flow reactor, which will determine long-term production stability, and the fluidized bed reactor, which will determine attrition resistance and diffusional limitations.

*“Heavy academic weighting; lack of collaborators with practical, large-scale engineering experience with complex reactors and processes.”*





- We have established collaborative relationships with CoorsTek, a leader in materials development, and Ceramatec, a firm experienced in ceramics engineering including novel reactors and other chemical process components.



# Collaborations

Fund-Receiving Collaborator		Project Roles
	National Renewable Energy Laboratory (NREL) (sub)	High Flux Solar Furnace (HFSF) user facility for process demonstration
 	Musgrave Group, CU Boulder	Active materials discovery and DFT modeling through “sister” NSF project*

\* Funds from Joint DOE/NSF FOA

Leveraged Collaborators (no funds from DOE)		Project Roles
 Australian National University	Australian National University (ANU)	Reactor models and receiver testing at solar simulator facility
	Saudi Basic Industries Corporation (SABIC)	Materials characterization support; supplying equipment
 		Active Materials Preparation; ITM SEOS Membrane



# Proposed Future Work

- Reactive Materials
  - Perform detailed thermodynamic and kinetic studies of active materials (M1.3 & M1.6)
  - Validate computation work of sister NSF project (M1.1 & M1.2)
    - Poster PD120
  - Demonstrate stable production of spray dried particles of at least  $150 \mu\text{mol H}_2 / \text{g}$  and do not lose more than 10% reactivity between 100<sup>th</sup> and 200<sup>th</sup> cycle (GNG2)
  - Determine long term stability of spray dried particles (M1.7)
- Reactor Design
  - Operate reduction reactor tube under vacuum and evaluate diffusional limitations (M3.2)
  - Refine solar heliostat field model to provide a flux profile over the internal surfaces of the receiver-reactor (M3.5)
- Containment Materials Development
  - Investigate alternative barrier materials deposited with ALD (M2.2)
  - Synthesize ALD films on three SiC tubes having different thicknesses of coating material (M2.3)
  - Test coat tubes for stability in high temperature steam environment, and evaluate tested tubes using SEM, XRD and ICP (M2.5)
- Efficient H<sub>2</sub> production
  - Further refine AspenPlus model and H2A with experimental thermodynamic and kinetic results and optimal operating conditions (M5.1 & M5.2)



# Summary

- Approach
  - Synergistic approach to active material, reactor design, and containment material efforts
- Reactive Materials
  - Computation results indicate importance of dopant materials on reaction kinetics
  - Calculations of reverse spinel structures have identified potentially promising new materials
  - Larger, spherical particles have been developed using two synthesis techniques
- Reactor Design
  - Ray-tracing and finite-volume models have been combined to enhance understanding of heliostat field and reactor interactions
  - Development of particle flow reactor system has enhanced material testing capabilities
- Containment Materials Development
  - Deposition of ALD films on SiC particles is underway
  - TGA studies show ALD films improve stability in high-temperature steam environments
- Efficient H<sub>2</sub> production
  - AspenPlus simulation updated with more detailed operations and realistic assumptions H<sub>2</sub>A capital costs improved
  - Sensitivity studies have identified key cost parameters

# Acknowledgements



# Technical Backup Slide: H2A- Design



## Design assumptions

- Membrane electricity requirements calculated using Nernst equation for  $O_2$ 
  - 1 mole%  $O_2$  in  $N_2$  converted to 7 ppm
- Fluid bed model in Aspen used to determine reactor size and pressure drop
  - Lab particle properties and flow characteristics considered in simulation
- Hercynite extent of reaction = 0.87, same for both oxidation and reduction
- Hercynite reaction enthalpies determined by DFT calculations

## Process Flow Diagram of STWS Process with Inert Sweep

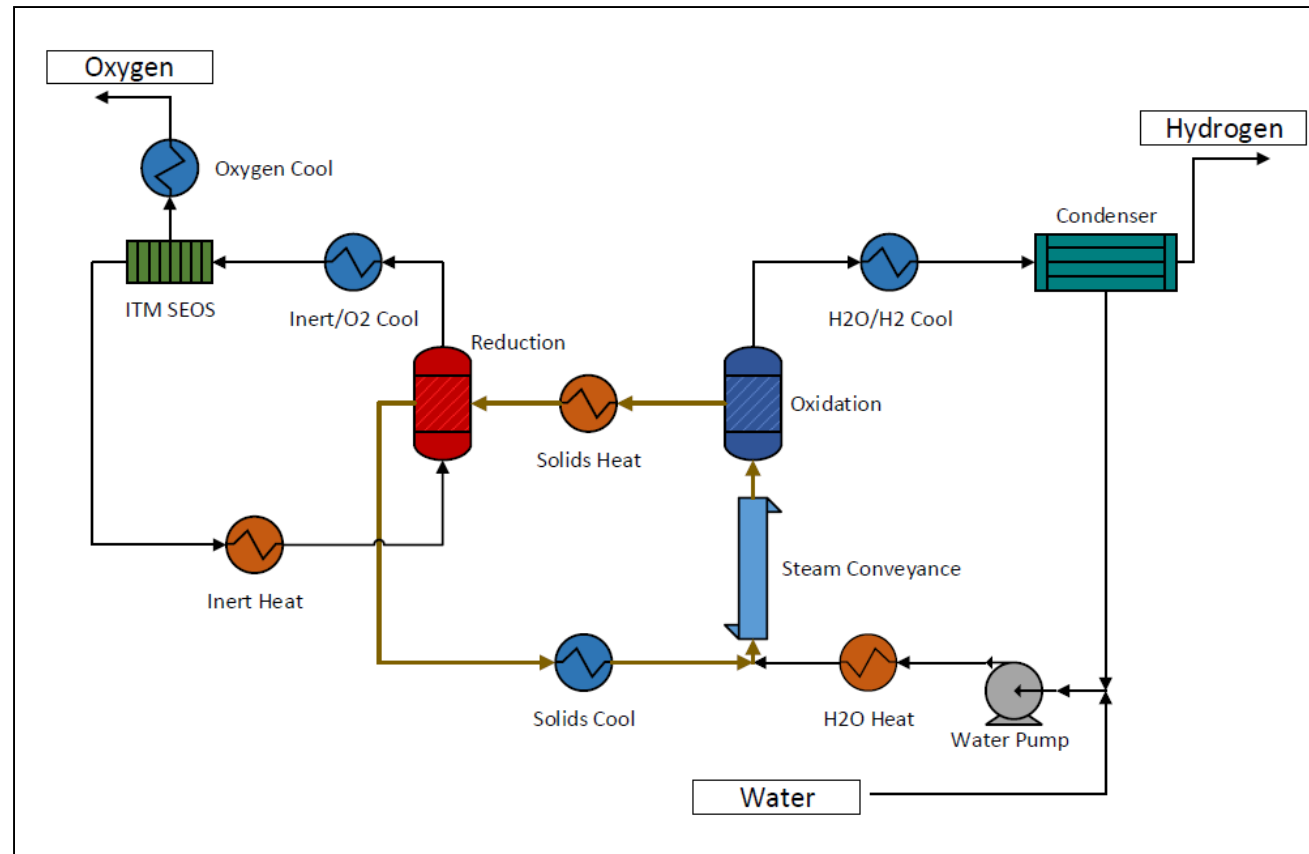



# Technical Back-up Slide: Vacancy Generations vs. Migration

Nitrogen Vacancy Formation:

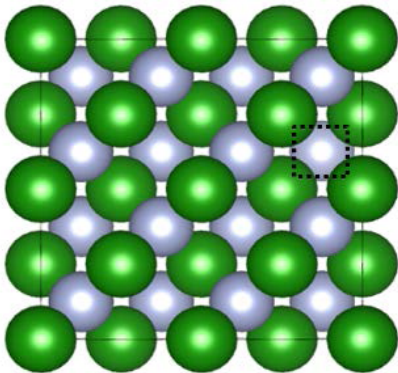
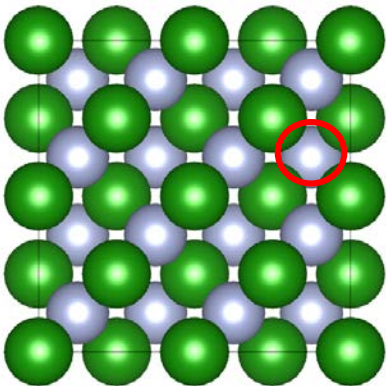

	Vacancy
	Nitrogen
	Oxygen
	Boron

Oxygen Migration:

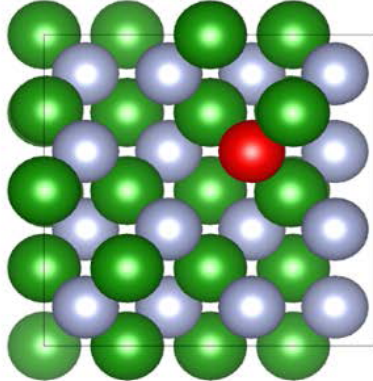
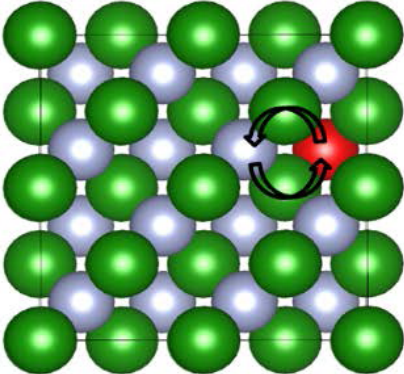
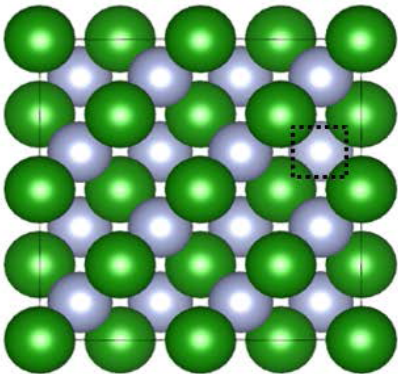



# Technical Backup Slide: Inert Sweep Gas

### Vacuum Pump Efficiency

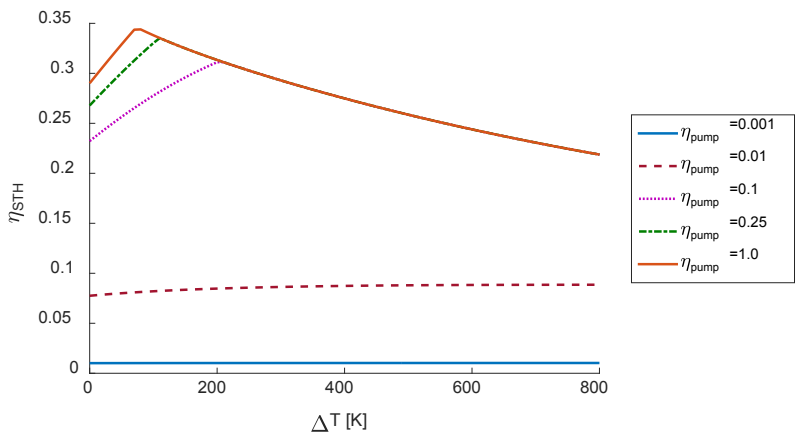

### Inert/O<sub>2</sub> Separation Efficiency

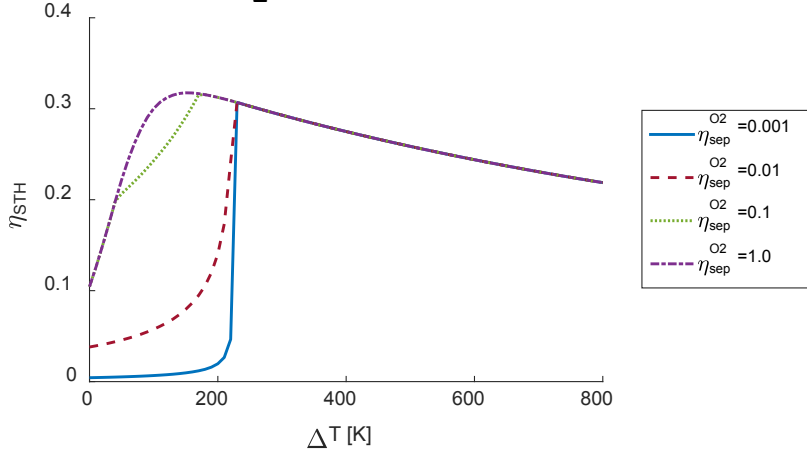

### Multiplier

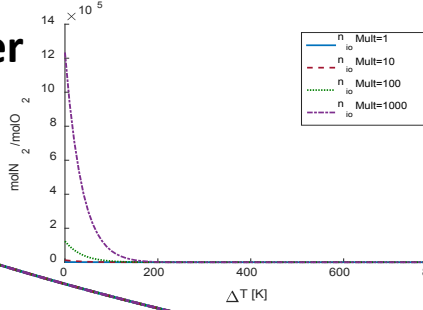

### Varying Inert Gas Flowrate

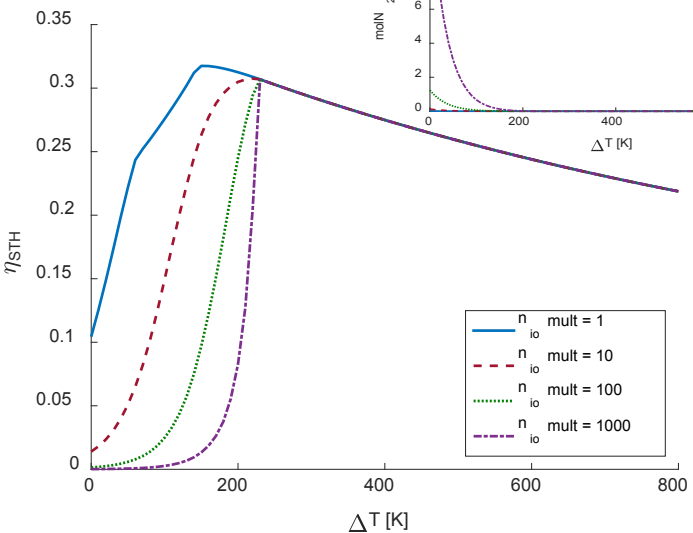

### Minimum Flow

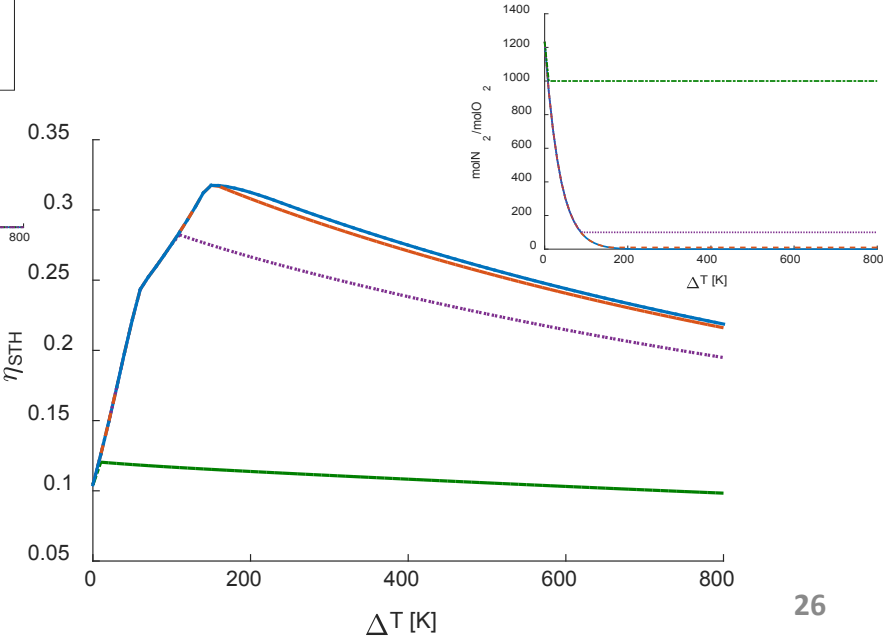



# Technical Backup Slide: Particle Size

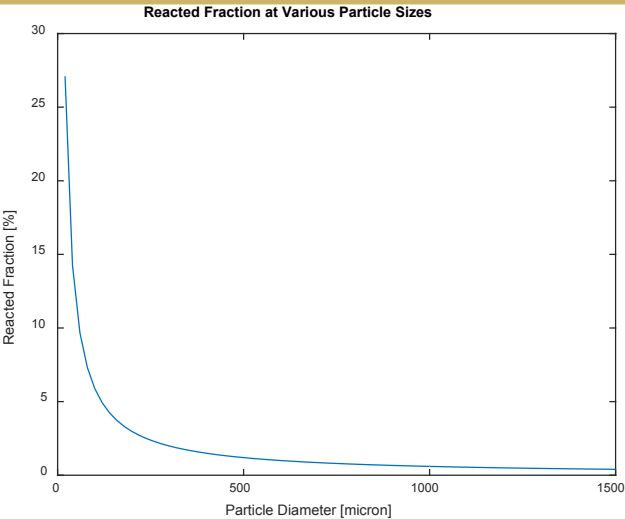

Characteristic time:  $\frac{T_p^* - T_p^{O*}}{T_I^* - T_p^{O*}} = 1 - e^{-1} = 0.632$

- $T_p^*$  = particle temperature
- $T_p^{O*}$  = initial particle temperature
- $T_I^*$  = temperature of interstitial gas
- $t_r$  = c.t. for radiation from interstitial gas
- $t_c$  = c.t. for conduction from interstitial gas
- $t_{c,p}$  = c.t. for conduction within the particle
- If  $t_{c,p} \ll t_r, t_c$ , then can assume isothermal particle

If reaction depth is 1  $\mu\text{m}$

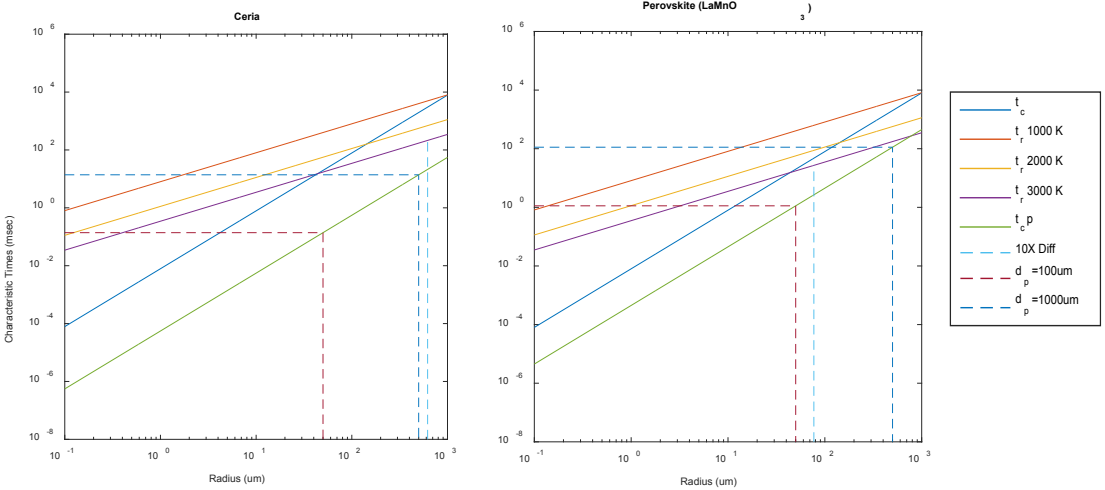
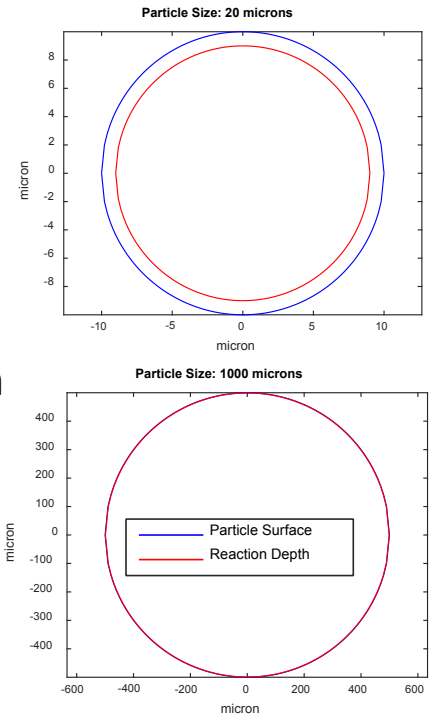

Particles above the 10X line will likely be non-isothermal, which will impact performance  
 A 10X increase in particle size leads to a ~100X increase in characteristic heating time

# Technical Backup Slide: Detailed Results for Multiphase Reactor

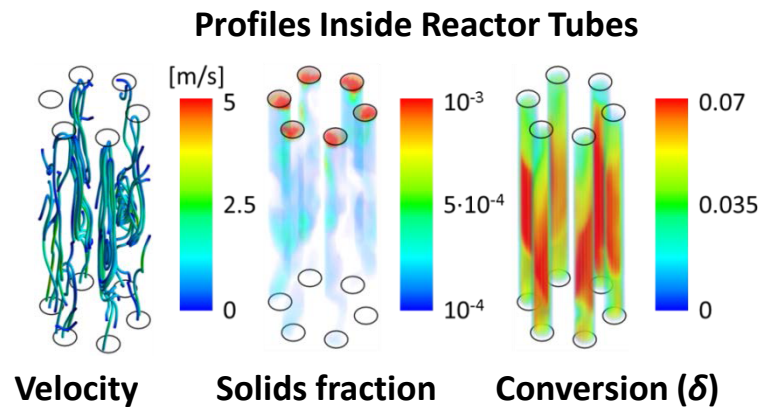
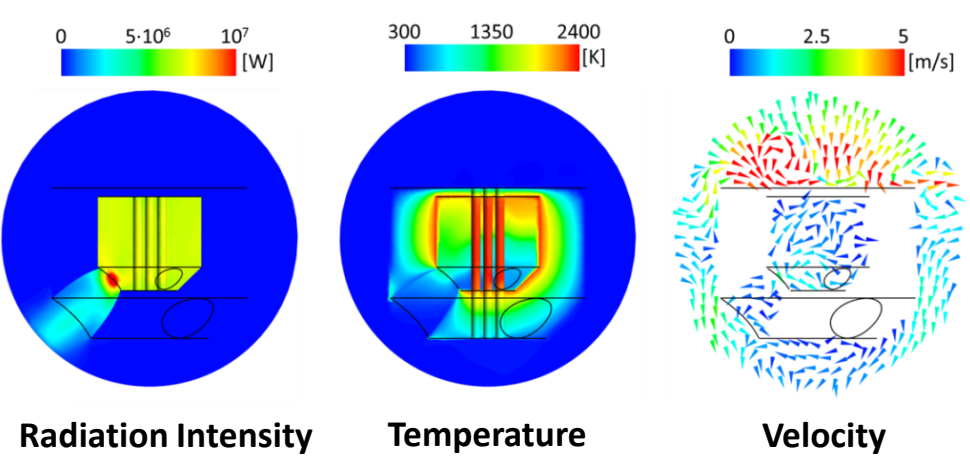
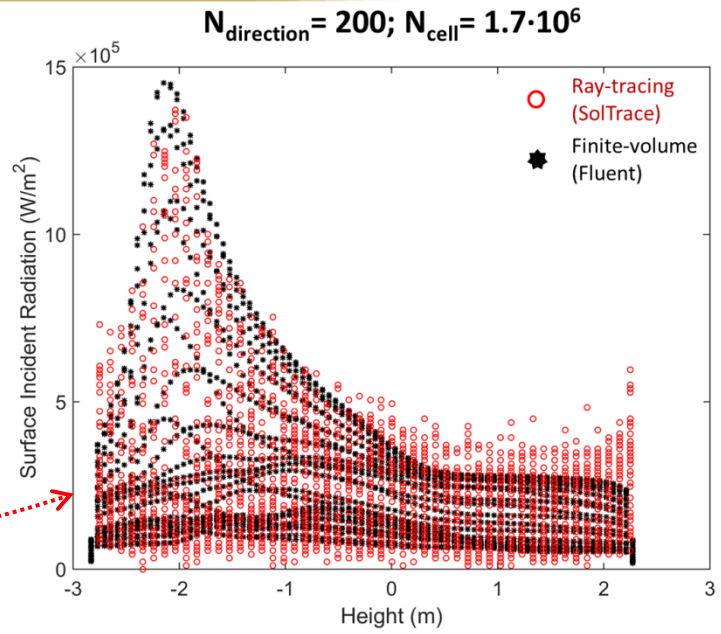
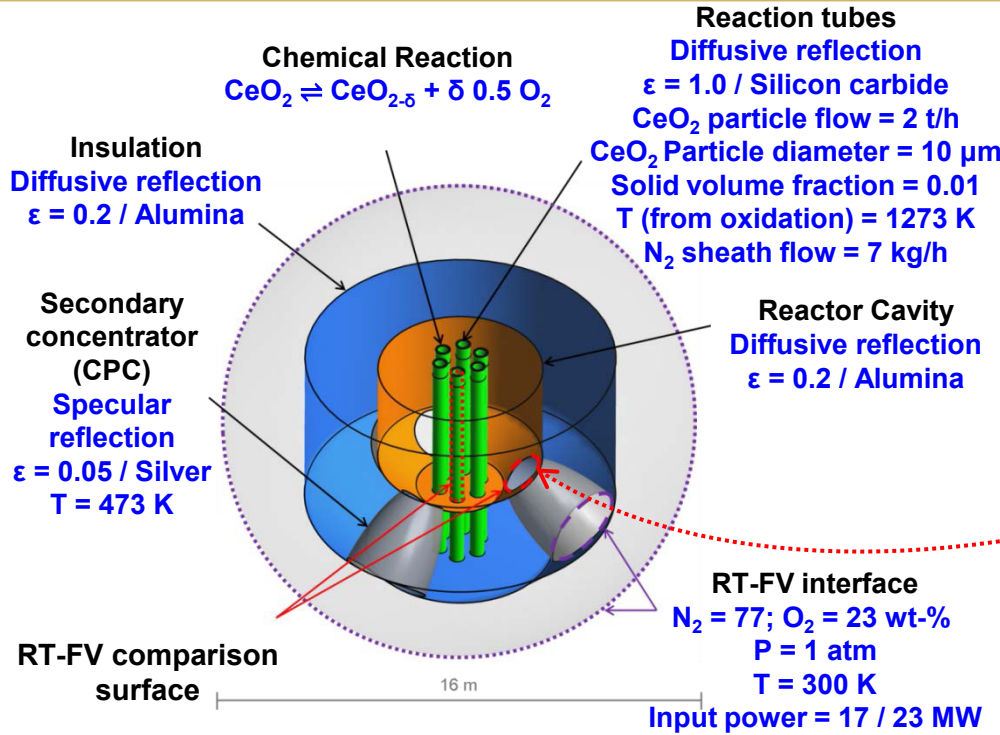

Ray-traced radiation intensity profiles are reproduced well with finite-volume model at reactor tube surfaces