

In-Vehicle Evaluation of Lower-Energy Energy Storage System (LEESS) Devices



PI: Jeff Gonder

Team: Jon Cosgrove, Ahmad Pesaran and Matt Keyser

National Renewable Energy Laboratory

2014 Annual Merit Review and Peer Evaluation Meeting

Washington, D.C.

June 18, 2014

NREL/PR-5400-61855

Project ID: VSS129

This presentation does not contain any proprietary, confidential, or otherwise restricted information.

Overview

Timeline

Project Duration: 2012–2014

Percent Complete: 70%

Budget

Total FY13-FY14 VSST Funding:
\$300K

Equivalent DOE ES program cost share over project duration

Barriers Addressed

- Cost
- Technical target setting
- Risk aversion, and constant advances in technology

Partners

- USABC: Foundational analysis for HEV LEES targets
- Ford: CRADA facilitating vehicle conversion
- JSR Micro: Provided LIC modules for testing
- Maxwell Technologies: Provided ultracapacitor (EDLC) modules
- NREL is project lead

CRADA = Cooperative Research and Development Agreement

EDLC = electrochemical double-layer capacitors

ES = Energy Storage

HEV = hybrid electric vehicle

LIC = lithium-ion capacitor

USABC = United States Advanced Battery Consortium

VSST = Vehicle Systems Simulation and Testing

Relevance for DOE Fuel-Saving Mission

- **HEVs effectively reduce per-vehicle fuel use**
- **Incremental cost remains a barrier to a wider market penetration**
 - HEVs still only 3% of new car sales*
 - ESS arguably the largest cost contributor
- **ESS cost reductions/performance improvements → improved vehicle-level cost vs. benefit**
 - Increase market demand and aggregate fuel savings

* HybridCars.com 2013 calendar year sales dashboard: <http://www.hybridcars.com/december-2013-dashboard/>
ESS = energy storage system

Relevance for Addressing Barriers

- **Cost**
 - Seek to improve cost effectiveness of fuel-saving HEV technology
- **Technical target setting**
 - Establish targets for device developers focused on cost-effective fuel-saving goal
 - Confirm performance of candidate devices in vehicle systems context
- **Risk aversion and constant advances in technology**
 - DOE/NREL helping to evaluate technologies outside the traditional HEV ESS paradigm
 - Reusable test platform can be used to evaluate different systems as they become available—simply swapping out the LEES devices under test

Objectives

- **Explore opportunities to improve HEV ESS cost effectiveness, ultimately leading to increased market penetration and fuel savings**
 - Collaborate with OEMs and suppliers around LEES concept
 - Perform vehicle conversion and evaluate devices in the test bed
- **Specific LEES considerations**
 - **Technical evaluation—can it do the job?**
 - Validation testing related to (recent) USABC technical targets and supporting analysis
 - Potential for lower cost with less energy?
 - Potential benefits from alternative technology?
 - Better ESS life?
 - Better cold temperature performance?

**Project
Focus in
FY14**



OEM = original equipment manufacturer

Milestones & Response to Reviewer Comments

Date	Milestone or Go/No-Go Decision	Description	Status (as of April 2014)
12/31/2013	Milestone	Progress update	Completed
3/31/2014	Milestone	Progress update	Completed – 1 st system testing results summarized here
6/30/2014	Milestone	Testing results with 2 nd LEESS system	Bench testing Maxwell EDLC modules
9/30/2014	Milestone	Testing results with 3 rd LEESS system	Still confirming what the 3 rd system will be

- **This project was not reviewed in FY13 so there are no comments to address**

Approach/Background: Build on Previous Analysis Supporting USABC LEESS Target Setting

- NREL analyzed full-HEV fuel savings sensitivity to ESS energy content
 - Working with an Energy Storage Tech Team Workgroup
 - Re-evaluating past ESS targets established in the late 1990s/early 2000s
- Results suggested power-assist HEVs can still achieve high fuel savings with lower energy and potentially lower cost ESS*

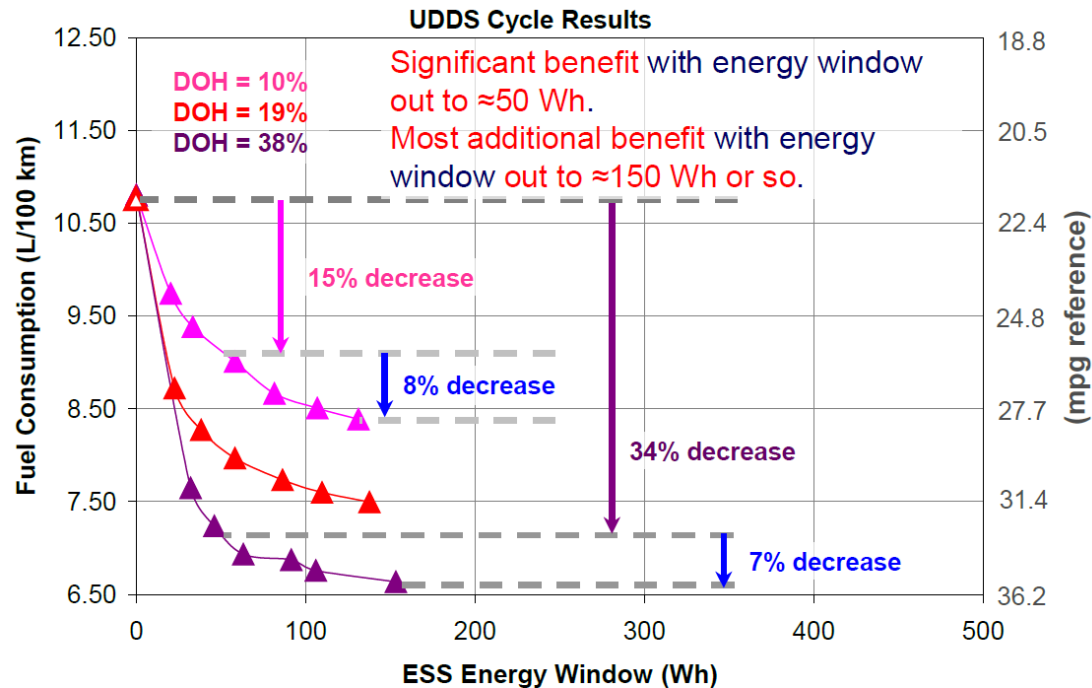

* Gonder, J.; Pesaran, A.; Howell, D.; Tatara, H. "Lower-Energy Requirements for Power-Assist HEV Energy Storage Systems—Analysis and Rationale." Proceedings of the 27th International Battery Seminar and Exhibit; Mar 15-18, 2010, Fort Lauderdale, FL. <http://www.nrel.gov/docs/fy10osti/47682.pdf>

- USABC established targets and began supporting device developers
 - See: http://www.uscar.org/guest/article_view.php?articles_id=87
 - Open to any ESS technology (very high power batteries, EDLCs, or LICs)

DOH = degree of hybridization

UDDS = Urban Dynamometer Driving Schedule (city testing)

Approach/Background: Draw from Past Evaluation for GM of Replacing NiMH ESS with EDLCs in the 42-V Saturn Vue BAS HEV

- Motivation: EDLC potential for superior cycle life, cold temperature performance, and long-term cost reductions
- Bench-tested EDLCs and retrofitted vehicle to operate in three configurations

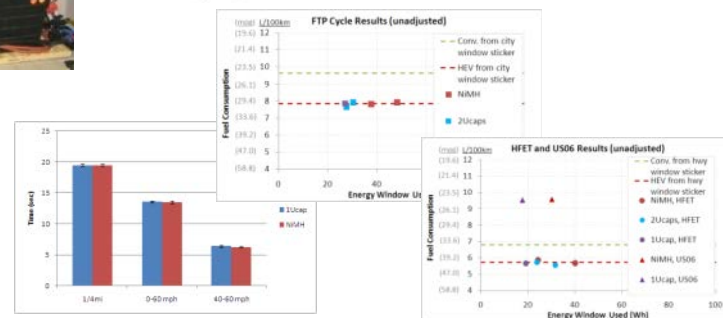
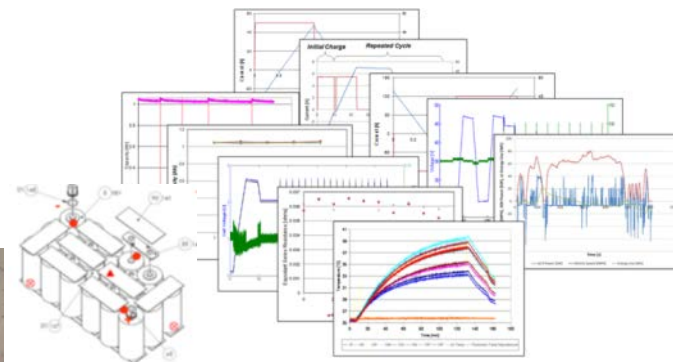
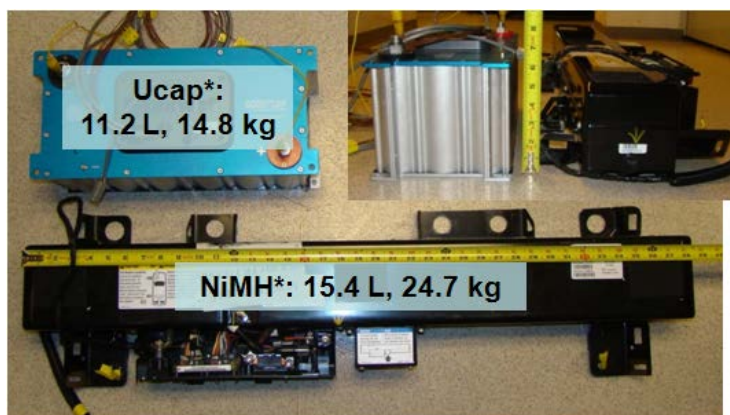

Photos by Jeff Gonder and Jason Lustbader, NREL

Findings: 42-V HEV with ultracapacitors performed at least as well as the stock configuration with a NiMH battery

NiMH = nickel metal hydride; BAS = belt alternator starter ("mild" HEV)

Approach: Create a Full-HEV Test Bed for In-Vehicle LEESS Device Evaluation

- **Modified a 2012 Ford Fusion Hybrid**
 - CRADA with Ford to facilitate
- **Enable operation on alternative LEESS devices**
 - Second set of production control modules to interface with LEESS pack
 - Custom state estimation algorithm
 - dSpace MicroAutoBox (MABx) for control prototyping—signal intercept/replacement, safety controls
- **Maintain stock operating capability (using production NiMH cells)**
 - Able to switch between operation using the stock battery and using the LEESS device under test
 - Provides back-to-back performance comparison

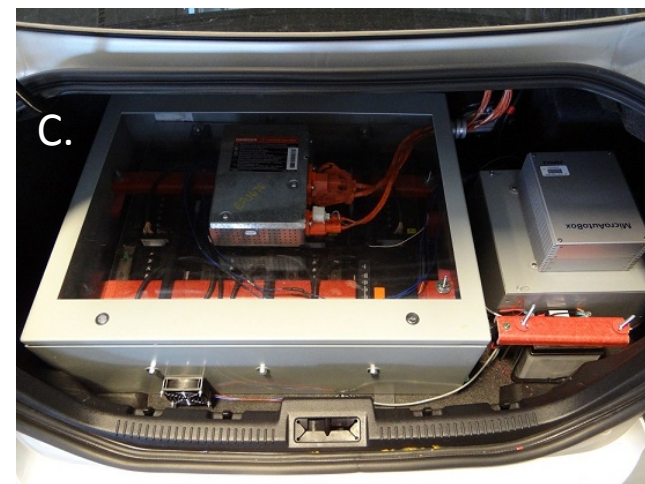

Images: A. Fusion test platform;
B. Production battery showing Bussed Electrical Center (BEC), Battery Pack Sensor Module (BPSM), and Battery Energy Control Module (BECM); C. Alternative LEESS test configuration mounted in the vehicle's trunk;

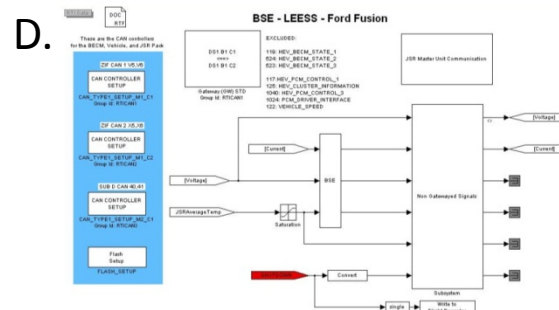

Photos by John Ireland and Jon Cosgrove, NREL

Approach: Perform Comparison Testing between Various LEESS Devices and the Production Battery System

- **Conduct bench testing**
 - Device characterization/benchmarking against production ESS
 - Obtain state estimator calibration data
- **Conduct in-vehicle performance testing**
 - Shakedown testing and control tuning to obtain desired hybrid functions with LEESS devices
 - Acceleration comparison testing
- **Conduct chassis dynamometer testing for fuel economy and hot/cold performance comparison**
 - Test cycles including
 - FTP/UDDS at 75°F, 20°F, and -5°F
 - HFET and US06 at 75°F
 - SC03 at 95°F
 - Data and vehicle CAN traffic recorded using the MABx



Photos by John Ireland, Petr Sindler and Jon Cosgrove, NREL

CAN = controller area network; FTP/UDDS = Federal Test Procedure/Urban Dynamometer Driving Schedule (city testing); HFET = Highway Fuel Economy Test; SC03 = hot test cycle with air conditioning; US06 = aggressive speed/acceleration test cycle

Accomplishments: Bench Testing Completed on First LEESS (LIC) under Evaluation

LIC modules from JSR Micro

- Asymmetric storage device with battery and ultracapacitor-type characteristics

Rated energy comparison

- 96 cell LIC: 260 Wh*
- 204 cell production NiMH: 1,370 Wh**

Bench tested at multiple temperatures

- Static capacity test
- Hybrid pulse power characterization (HPPC)
- Expected US06 power profile

Results indicate LIC impedance 2-3x less than NiMH**

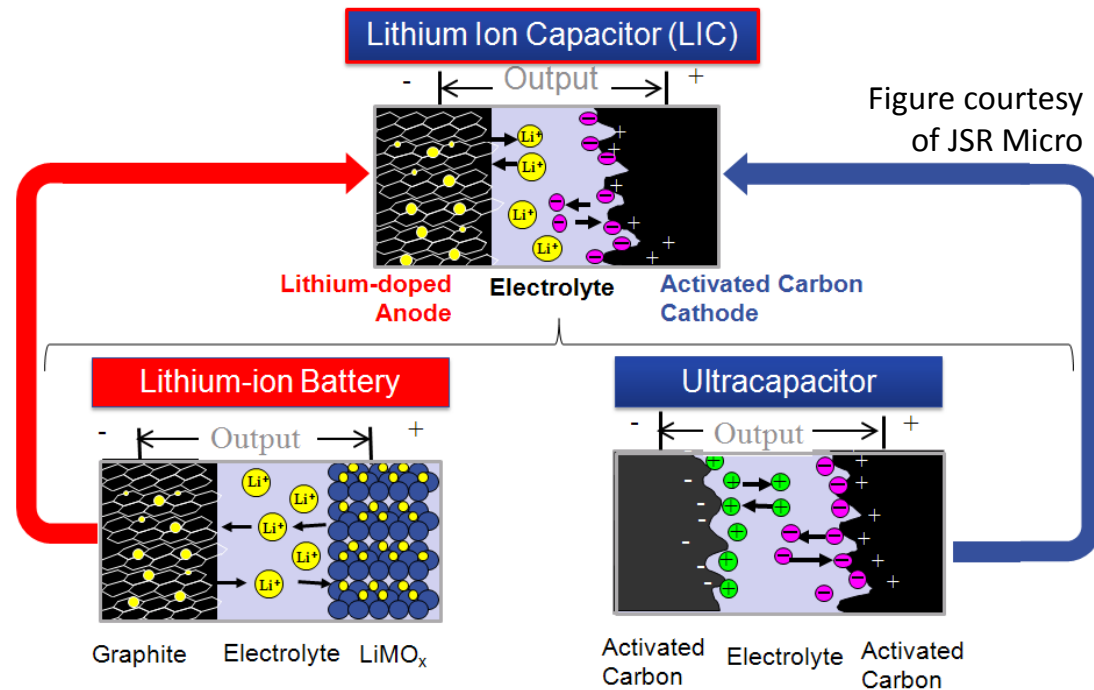
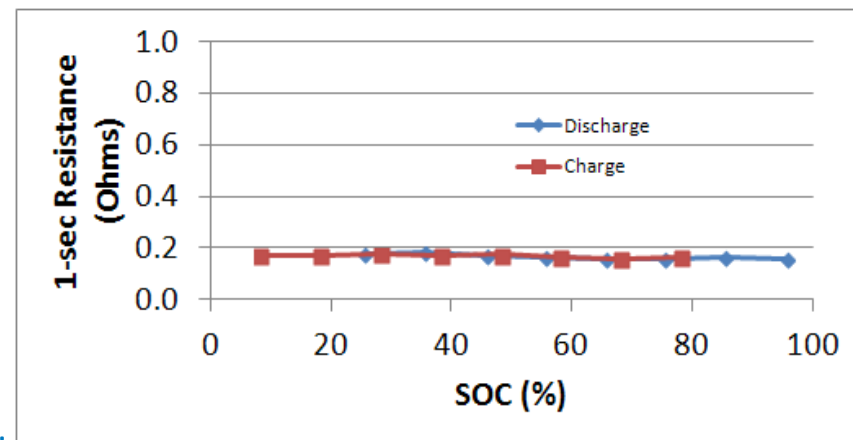

Figure courtesy of JSR Micro



*Assuming 175 V – 350 V maximum in-vehicle operating window

**Based on fact sheet published by Idaho National Laboratory (INL):

www1.eere.energy.gov/vehiclesandfuels/avta/pdfs/hev/batteryfusion4699.pdf

Accomplishments: Successfully Completed Conversion; Conducted 0-60 mph Acceleration Comparison Testing*



Photo by Petr Sindler, NREL

- **Observed comparable performance between production NiMH and LEES LIC configurations**
 - Hybrid operation
 - Equivalent 0-60 mph acceleration times

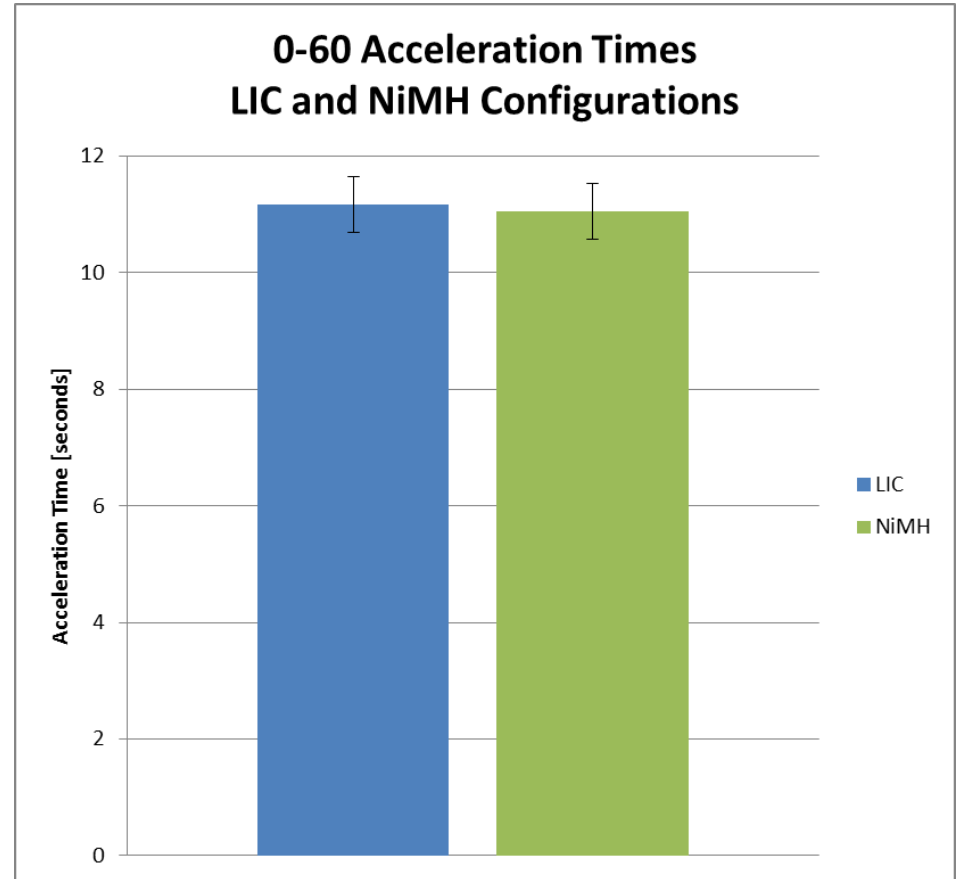

* Simply for comparison and not intended to be official performance specifications.
Runs conducted with extra mass of duplicate ESS/conversion equipment, and at high altitude.

Accomplishments: In-Vehicle Dynamometer Testing—Compared Voltage Range of Production NiMH vs. Three LIC Configurations

- Evaluated several LIC scenarios in addition to the production configuration
 - LIC-High: Energy constrained only by vehicle and device voltage limits
 - LIC-Med: Artificially reduced upper voltage limit to constrain energy
 - LIC-Low: Further reduced upper voltage limit for most constrained evaluation

Voltage Levels During UDDS Testing

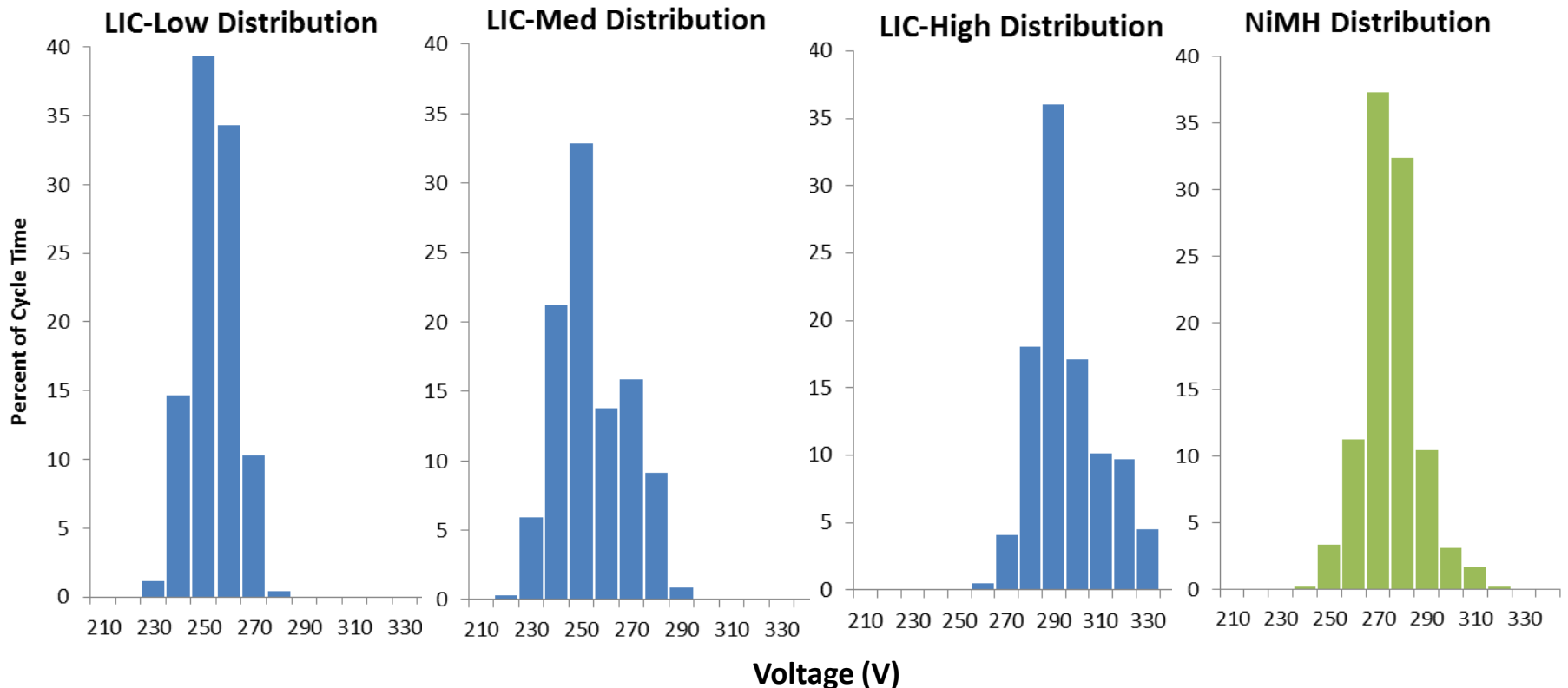

Accomplishments: In-Vehicle Dynamometer Testing—Compared Fuel and Energy Use of NiMH vs. LIC Configurations

- Small fuel use differences between the HEV configurations—all show significant savings compared to the non-hybrid vehicle
- Also measured energy window used by each ESS configuration for each cycle

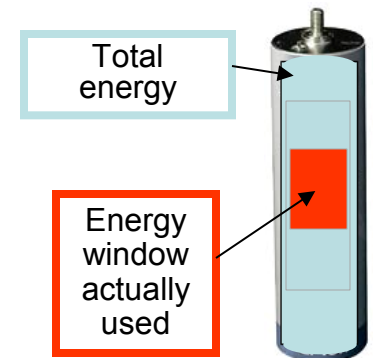
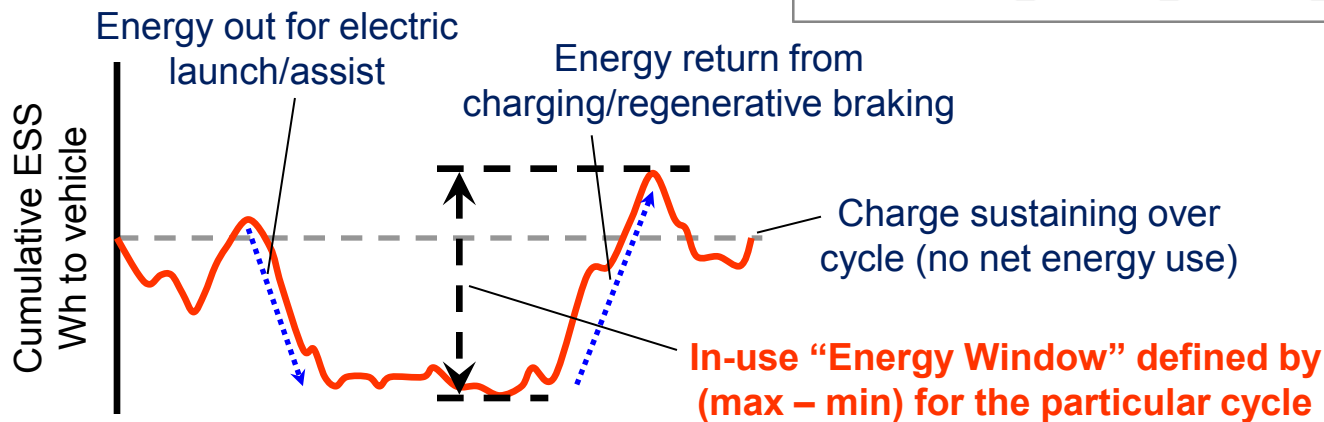
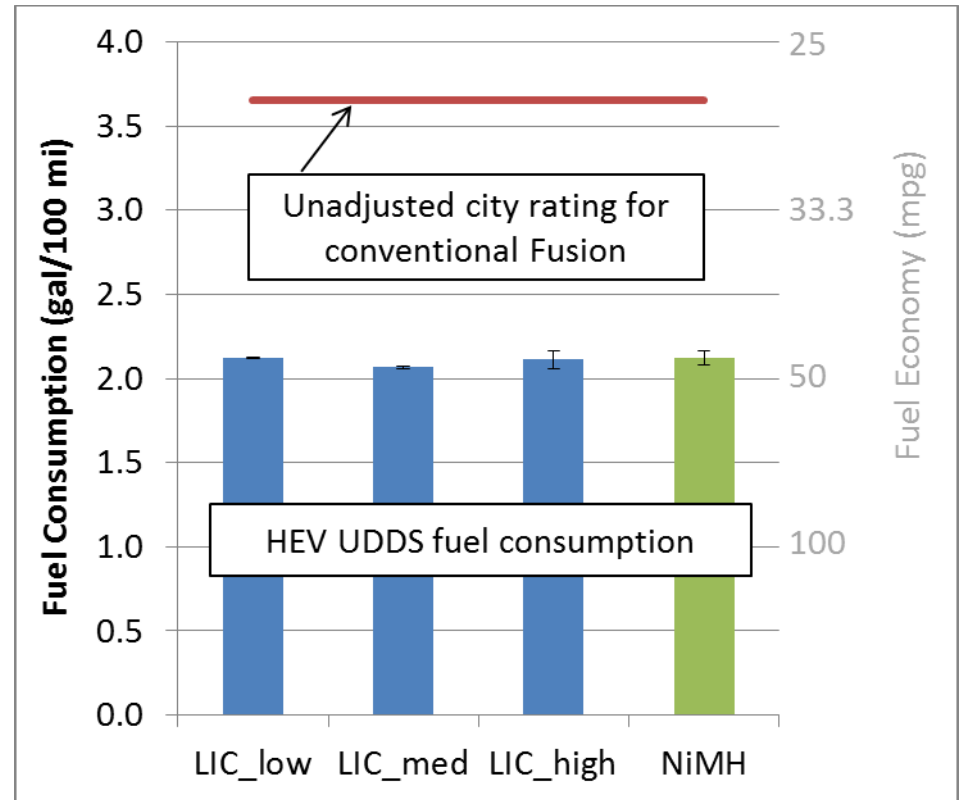

Accomplishments: In-Vehicle Dynamometer Testing—Compared NiMH and LIC-Low Scenarios (among others)

US06 Fuel Use and Energy Window

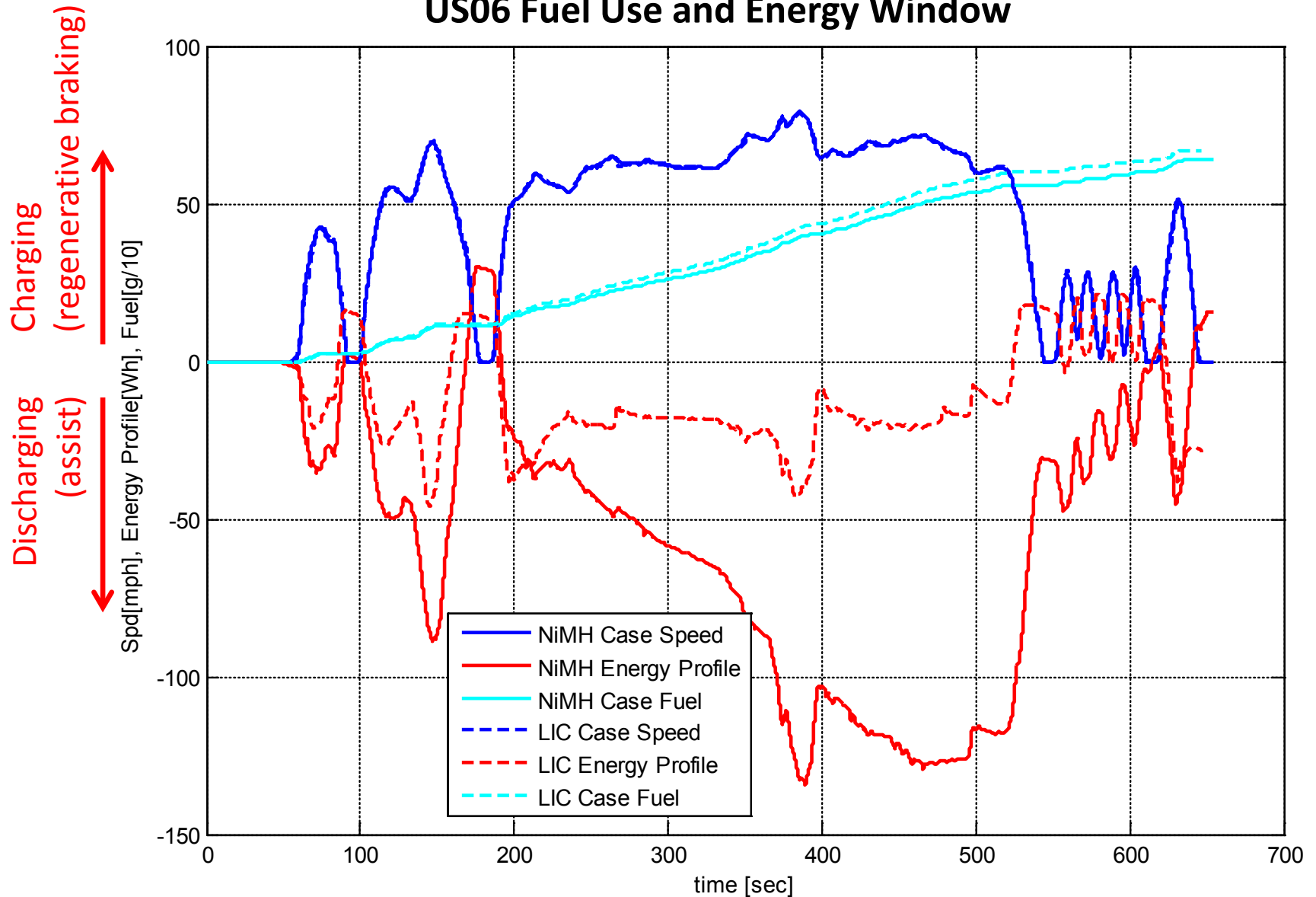

Accomplishments: In-Vehicle Dynamometer Testing—Summarizing Fuel Use and Energy Window Observations to Date

Comparison over All Cycles and Configurations

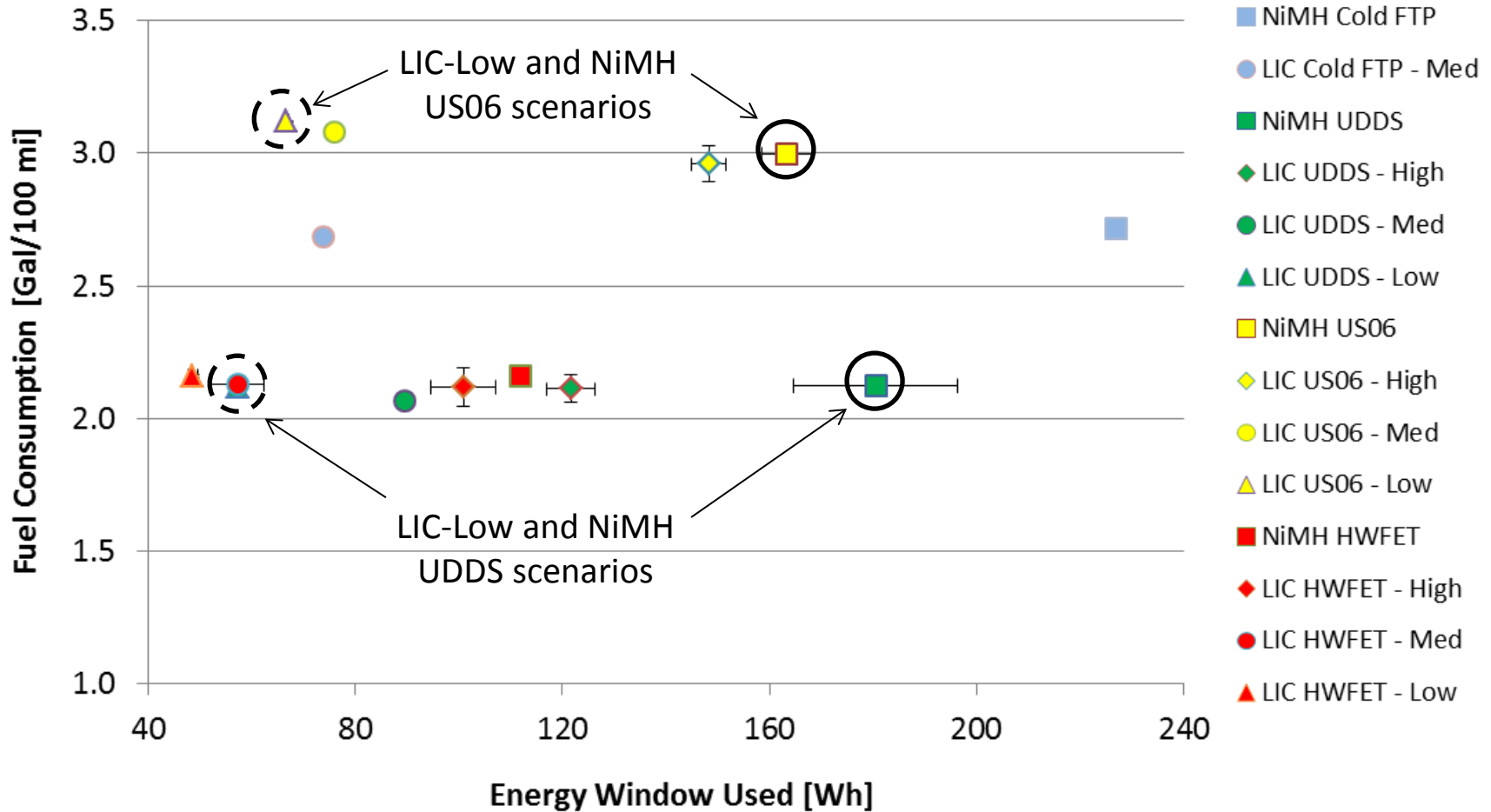

Significantly reduced energy window resulted in negligible fuel consumption difference on most cycles and small increase on US06 test

Collaboration and Coordination with Other Institutions

- **USABC** (Chrysler, Ford, GM, plus DOE with lab input)
 - Collaborated on precursor analysis that established the LEES performance targets for power-assist HEVs
- **Ford Motor Company**
 - CRADA facilitating the vehicle conversion
- **JSR Micro**
 - Provided modules for evaluation and related technical information/support
- **Maxwell Technologies**
 - Provided EDLC modules as next system to test
- **U.S. DOE—Cross-office collaboration**
 - Cost-shared support between two Vehicle Technologies Office activities
 - Vehicle Systems Simulation and Testing (VSST)
 - Energy Storage (ES)

Remaining Challenges and Barriers

- **Need to complete additional JSR LIC testing based on feedback from collaborators**
 - Evaluate any adverse LEESS impact on desired vehicle attributes (e.g., energy reservoir for passing acceleration and engine off at idle under high accessory load)
 - Evaluate additional scenarios where LIC capabilities could be a positive differentiator (e.g., very cold operation down to -5°F)
- **Still need to assess performance capability and any similarities/differences between alternative LEESS devices (as planned)**
- **Should consider possible performance and cost differences from HEV system changes designed to maximize the strengths and minimize the weaknesses of a given LEESS device**
 - The current single-component replacement approach gives a good initial assessment, but an optimized system might include other powertrain changes
- **Whether as a drop-in replacement or an optimized system, LEESS suppliers need to achieve cost targets to beat out incumbent battery technologies**

Potential Future Work

- **Wrap up JSR LIC testing**
 - Passing acceleration tests
 - 95°F SC03 (and extended idle periods) for air conditioning comparison case
 - Very cold (-5°F) operation
- **Complete bench testing followed by in-vehicle evaluation with additional LEES devices**
 - Next system will be Maxwell ultracapacitor modules
- **Evaluate design adjustment opportunities (and resulting cost/fuel economy implications) of optimizing the HEV system around a high-power LEES**
 - For example, could motor power be increased?
 - Or could similar benefits be obtained from a lower voltage system?
- **Conduct rigorous business case assessment combining evaluation results with supplier cost projections**

Summary

- **HEVs can save a lot of fuel, but still have low market penetration**
 - Improving ESS cost vs. benefit could increase penetration and aggregate savings
- **Through collaborations across DOE VTO and with industry partners, NREL created an HEV test bed and is using it to evaluate LEESS devices**
 - Assessing nontraditional HEV ESS devices in a vehicle systems context
- **Results to date suggest technical viability for a LEESS HEV**
 - Small energy LIC conversion configurations achieved equal 0-60 mph acceleration and very similar fuel economy to production system
 - As long as critical attributes (such as engine start under worst-case conditions) can be retained, considerable ESS downsizing may minimally impact fuel savings
- **Published and presented the results and received positive feedback**
- **Proposed next steps include:**
 - Conducting additional LIC system tests in response to comments/suggestions from partners (cold temperature performance, supporting accessory loads, etc.)
 - Completing planned testing on additional LEESS devices
 - Evaluating potential benefits from HEV system optimization around a LEESS device
 - Applying the performance evaluation results and supplier cost estimates to assess potential LEESS HEV business cases

Technical Back-Up Slides

(Note: please include this “separator” slide if you are including back-up technical slides (maximum of five). These back-up technical slides will be available for your presentation and will be included in the DVD and Web PDF files released to the public.)

US06 Profile Comparison: Stock Battery (in vehicle) vs. JSR Micro LIC (in lab)

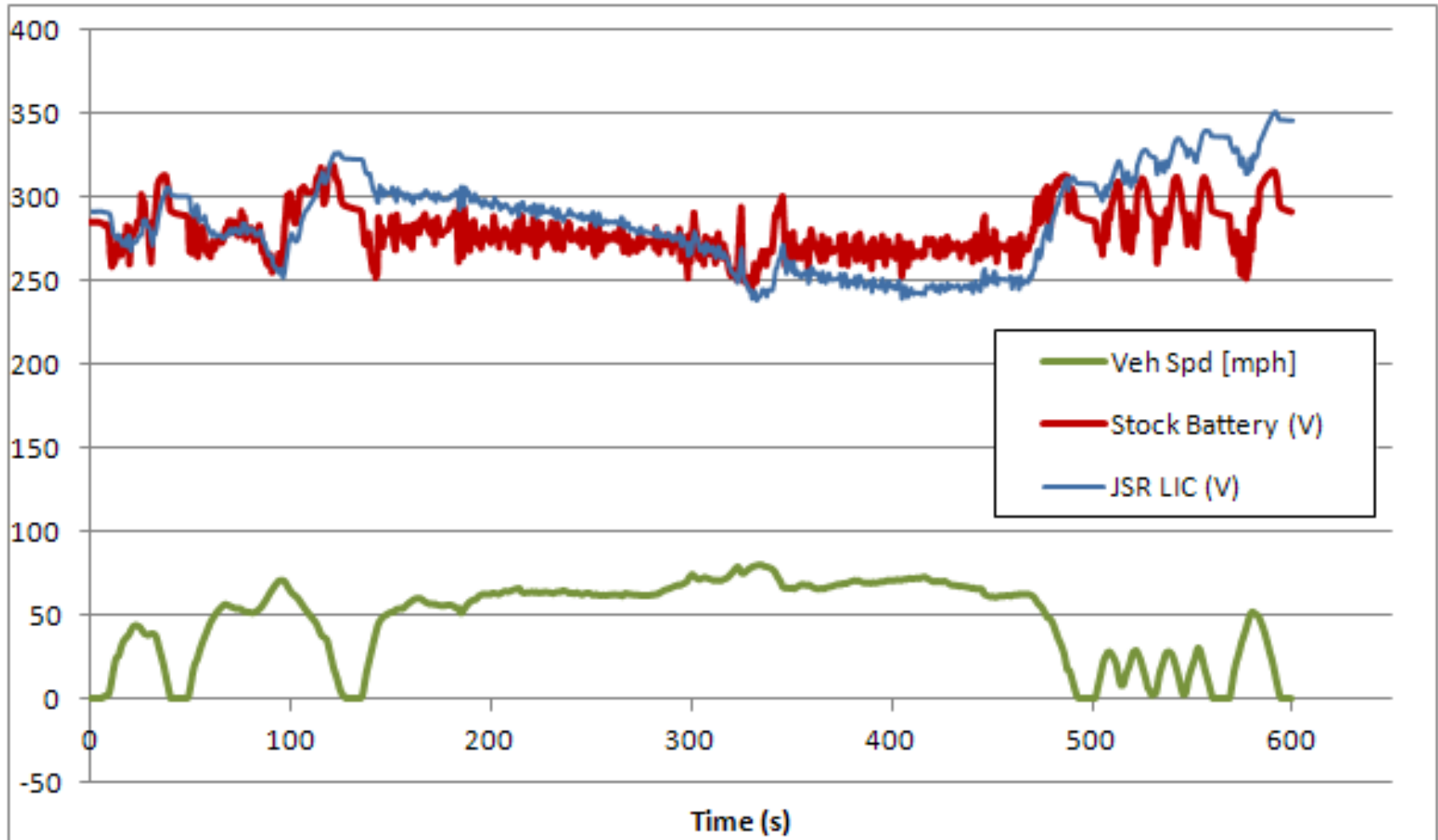

In-Vehicle Dynamometer Testing: Comparing NiMH and LIC-High Scenario

UDDS Fuel Use and Energy Window

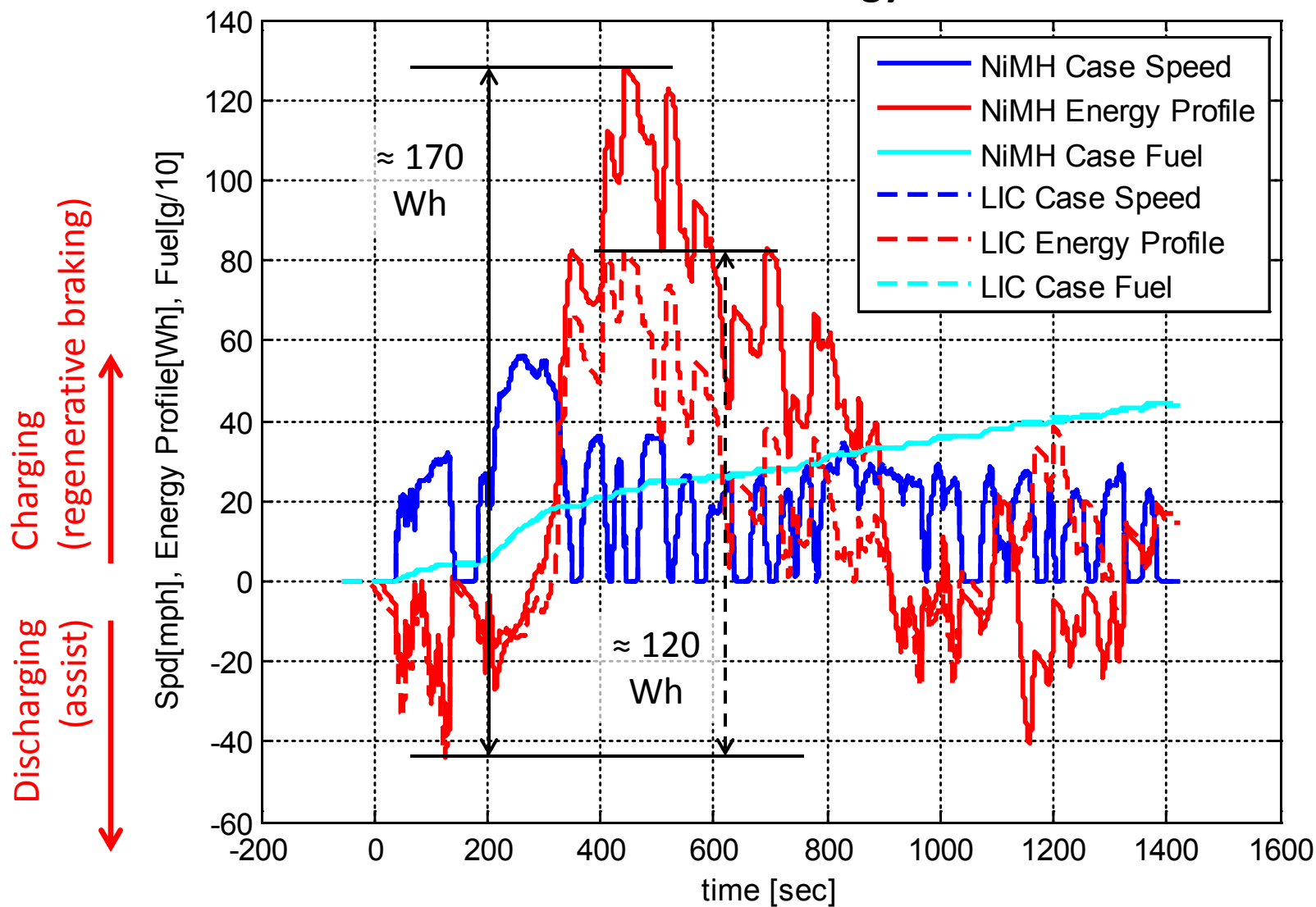

In-Vehicle Dynamometer Testing: Comparing NiMH and LIC-Low Scenario

UDDS Fuel Use and Energy Window

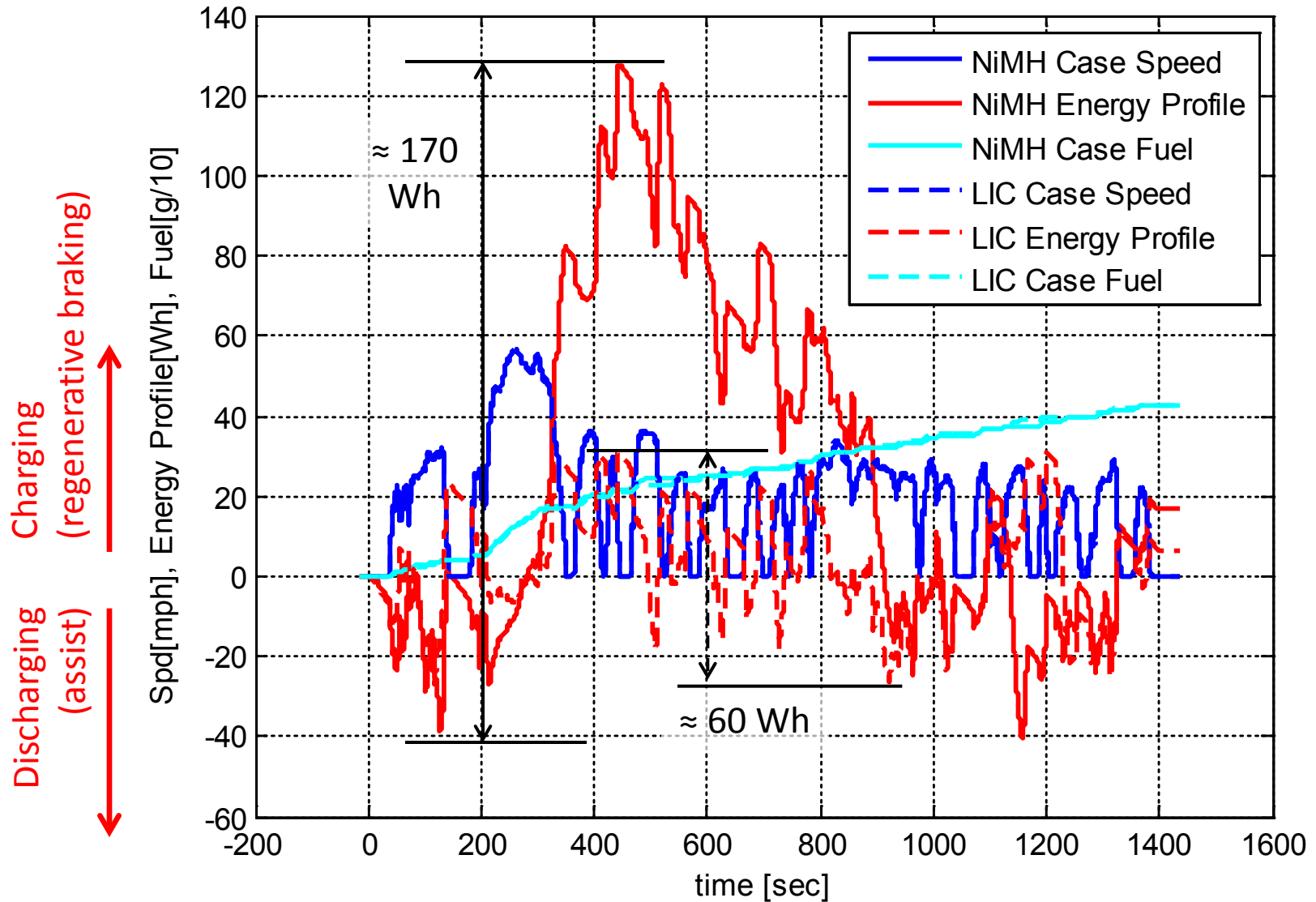

In-Vehicle Dynamometer Testing: Comparing NiMH and LIC-Low Scenario

UDDS Fuel Use and Energy Window

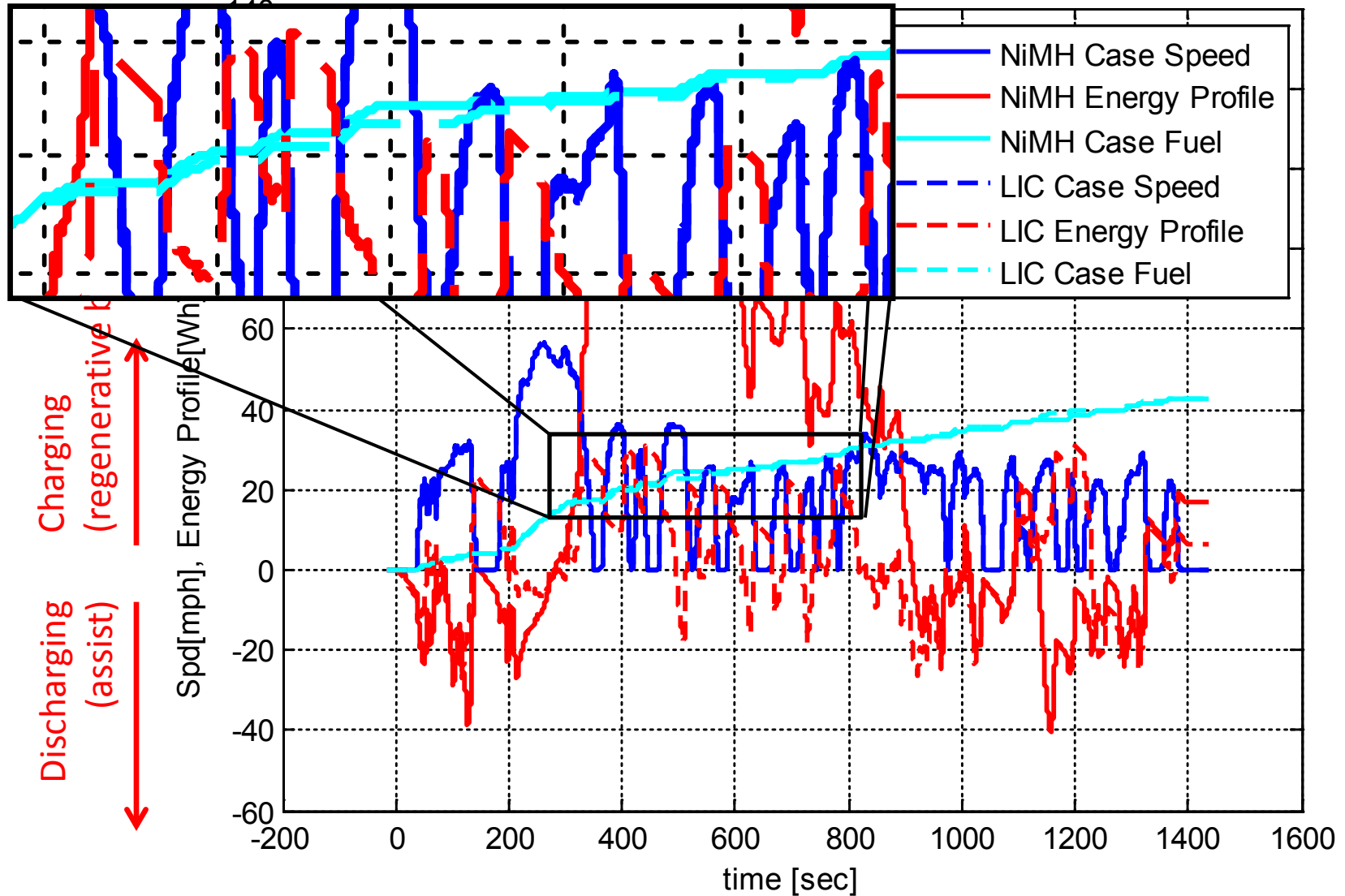

In-Vehicle Dynamometer Testing: Comparing NiMH and LIC-Low Scenario

HWFET Fuel Use and Energy Window

