



Refrigeration Playbook: Natural Refrigerants

Selecting and Designing Energy- Efficient Commercial Refrigeration Systems That Use Low Global Warming Potential Refrigerants

Caleb Nelson, Chuck Reis, Eric Nelson,
James Armer, Rob Arthur, Richard Heath, and
James Rono

*CTA Architects Engineers
Boise, Idaho*

Adam Hirsch and Ian Doebber
*National Renewable Energy Laboratory
Golden, Colorado*

**NREL is a national laboratory of the U.S. Department of Energy
Office of Energy Efficiency & Renewable Energy
Operated by the Alliance for Sustainable Energy, LLC**

This report is available at no cost from the National Renewable Energy
Laboratory (NREL) at www.nrel.gov/publications.

Technical Report
NREL/TP-5500-63821
March 2015

Contract No. DE-AC36-08GO28308

Refrigeration Playbook: Natural Refrigerants

Selecting and Designing Energy- Efficient Commercial Refrigeration Systems That Use Low Global Warming Potential Refrigerants

Caleb Nelson, Chuck Reis, Eric Nelson,
James Armer, Rob Arthur, Richard Heath,
and James Rono

*CTA Architects Engineers
Boise, Idaho*

Adam Hirsch and Ian Doebber
*National Renewable Energy Laboratory
Golden, Colorado*

Prepared under Task No. ARCB1102
Prepared under Subcontract No. AGG-4-42181-01

**NREL is a national laboratory of the U.S. Department of Energy
Office of Energy Efficiency & Renewable Energy
Operated by the Alliance for Sustainable Energy, LLC**

This report is available at no cost from the National Renewable Energy
Laboratory (NREL) at www.nrel.gov/publications.

NOTICE

This report was prepared as an account of work sponsored by an agency of the United States government. Neither the United States government nor any agency thereof, nor any of their employees, makes any warranty, express or implied, or assumes any legal liability or responsibility for the accuracy, completeness, or usefulness of any information, apparatus, product, or process disclosed, or represents that its use would not infringe privately owned rights. Reference herein to any specific commercial product, process, or service by trade name, trademark, manufacturer, or otherwise does not necessarily constitute or imply its endorsement, recommendation, or favoring by the United States government or any agency thereof. The views and opinions of authors expressed herein do not necessarily state or reflect those of the United States government or any agency thereof.

This report is available at no cost from the National Renewable Energy Laboratory (NREL) at www.nrel.gov/publications.

Available electronically at <http://www.osti.gov/scitech>

Available for a processing fee to U.S. Department of Energy and its contractors, in paper, from:

U.S. Department of Energy
Office of Scientific and Technical Information
P.O. Box 62
Oak Ridge, TN 37831-0062
phone: 865.576.8401
fax: 865.576.5728
email: <mailto:reports@adonis.osti.gov>

Available for sale to the public, in paper, from:

U.S. Department of Commerce
National Technical Information Service
5285 Port Royal Road
Springfield, VA 22161
phone: 800.553.6847
fax: 703.605.6900
email: orders@ntis.fedworld.gov
online ordering: <http://www.ntis.gov/help/ordermethods.aspx>

Cover Photos: (left to right) photo by Pat Corkery, NREL 16416, photo from SunEdison, NREL 17423, photo by Pat Corkery, NREL 16560, photo by Dennis Schroeder, NREL 17613, photo by Dean Armstrong, NREL 17436, photo by Pat Corkery, NREL 17721.

Acknowledgments

The *Refrigeration Playbook: Natural Refrigerants* was developed as a joint effort between the National Renewable Energy Laboratory (NREL) and CTA Architects Engineers. This project was made possible with American Recovery and Reinvestment Act of 2009 funds. The authors would like to thank Arah Schuur and Glenn Schatz of the U.S. Department of Energy Building Technology Office for their support and guidance on this work.

The authors would also like to acknowledge the contributions of peer reviewers from industry and at NREL who provided feedback to improve this report, including Neil Monson, Target Corporation; Dustin Searcy, Parker Hannefin Corporation; Shitong Zha, Hill Phoenix; Ren Anderson, Eigen Energy; and Ron Judkoff, NREL.

Abbreviations and Acronyms

ASHRAE	American Society of Heating, Refrigerating and Air-Conditioning Engineers
ASTM	American Society for Testing and Materials
ANSI	American National Standards Institute
Btu	British thermal unit
CBP	Commercial Building Partnerships
CFC	chlorofluorocarbons
CFM	cubic feet per minute
CO ₂	carbon dioxide
DOE	U.S. Department of Energy
DX	direct expansion
EPA	U.S. Environmental Protection Agency
EEV	electronic expansion valve
EUI	energy use intensity
GHG	greenhouse gas
GWP	global warming potential
HCFC	hydrochlorofluorocarbon
HFC	hydrofluorocarbon
HFO	hydrofluoroolefin
HVAC	heating, ventilation, and air-conditioning
LT	low temperature
MT	medium temperature
NH ₃	ammonia
NREL	National Renewable Energy Laboratory
PRV	pressure relief valve
psi	pounds per square inch
TEWI	Total Equivalent Warming Impact
W	Watts

Executive Summary

Background

This refrigeration playbook provides guidance to refrigeration system design teams about selecting energy-efficient refrigeration systems that use low-global warming potential (GWP) refrigerants. It emerged from work done as part of the U.S. Department of Energy's Commercial Building Partnerships (CBP). CBP was a public/private, cost-shared initiative that demonstrated cost-effective, replicable ways to achieve dramatic energy savings in commercial buildings. CBP aimed to reduce energy use by 50% in new construction and 30% in existing buildings compared with minimum code requirements or pre-retrofit energy use. Building owners teamed with the U.S. Department of Energy, national laboratory staff, and private sector experts to explore and implement energy-saving ideas and strategies. Although the analysis presented here was distilled from design work done for a CBP pilot project with the Defense Commissary Agency (which completed construction after CBP had finished), the guidance and tools are intended to benefit the entire supermarket industry.

In recent years, supermarket refrigeration systems have been trending toward using smaller refrigerant charges and applying synthetic refrigerants with lower GWP or natural refrigerants with negligible GWP. In many instances, the driving factors for alternative refrigeration system decisions are marketing exposure and demonstrating good environmental stewardship. Because low-GWP and natural refrigerants have favorable thermodynamic properties compared to standard synthetic refrigerants, energy-efficient systems that also have low-GWP can be designed.

Purpose

The purposes of this playbook and [accompanying spreadsheet](#) are to generalize the detailed CBP analysis and to put tools in the hands of experienced refrigeration designers to evaluate the performance of multiple alternative refrigeration system designs for different climates across the United States. It is also intended to alert designers to the safety and compliance considerations that must be taken into account when working with alternative refrigerants.

Scope

This playbook was written for supermarket design teams at companies considering low-GWP or natural refrigeration systems. Although the concepts discussed apply to a variety of refrigeration technologies, when considering other applications such as convenience stores or industrial refrigeration, care should be taken to determine which parameters should be adjusted to match the application. The calculations presented in the accompanying spreadsheet and described in the appendices will help users estimate energy savings and environmental impacts; they do not necessarily reflect the actual savings realized by a specific system and building. Variables such as low-side system configuration, building usage patterns, and weather patterns can significantly impact the performance of the refrigeration system. Brief chapter summaries follow.

- Chapter 1 presents the goals and scope of the playbook in detail and describes the approach to energy analysis.
- Chapter 2 covers recent history, describes the trends that have focused attention on low-GWP refrigeration systems, and introduces a metric that encompasses the direct environmental impact of refrigerant emissions and indirect effects through the energy

generation required to power the system called the Total Equivalent Warming Impact (TEWI).

- Chapter 3 presents the six alternative refrigeration system configurations considered in the report. System diagrams accompany each application. They are:
 - Low-temperature (LT) or medium-temperature (MT) carbon dioxide (CO₂) overfeed
 - MT hydrofluorocarbon direct expansion (DX) with LT CO₂ DX cascade
 - Hydrofluorocarbon DX primary over combined MT overfeed with LT CO₂ DX
 - Ammonia (NH₃)-flooded primary over combined MT overfeed with LT CO₂ DX
 - CO₂ transcritical booster system
 - Self-contained water-cooled hydrocarbon.
- Chapter 4 describes the physical properties of NH₃, CO₂, and propane and their implications for system design.
- Chapter 5 includes safety and compliance considerations.
- Chapter 6 introduces simple financial evaluation techniques.
- Chapter 7 encompasses high-level considerations for building owners for regulatory compliance, cost control, challenges to adoption of alternative systems, and noneconomic considerations such as corporate image.
- Appendix A provides an introduction to the accompanying spreadsheet that can be used to estimate energy consumption and TEWI of various system designs. Detailed instructions are embedded in the spreadsheet.
- Appendix B provides all the details of the EnergyPlus baseline supermarket used to benchmark whole-building and refrigeration system energy use.
- Appendix C presents EnergyPlus and spreadsheet calculation results for three system types:
 - The multiplex R-404a baseline system described in Appendix B
 - A water-cooled DX NH₃ system cascaded with a combined CO₂ system
 - An air-cooled DX R-134a system cascaded with a combined CO₂ system.

Each chapter provides resources for further study and discussion.

Methods

As a companion to this playbook, a spreadsheet-based tool was created using Microsoft Excel to aid in the comparison of low-GWP refrigeration systems in terms of energy consumption and TEWI contributions, using information that should be readily available for systems being investigated.

The spreadsheet is intended to be relatively self-guided and intuitive. It has an instruction worksheet to explain its intended use. Most of the systems described in the playbook can be

analyzed using the spreadsheet. This includes CO₂, propane, NH₃, R-134a, R-404a, R-407a, R-407c, and R-507 (as primary and secondary refrigerants), and propylene glycol as a secondary heat transfer fluid. Transcritical CO₂ systems cannot be analyzed by the spreadsheet.

A selected group of systems outlined in this playbook were also modeled using EnergyPlus to provide energy consumption comparisons, as described in Appendix C. The baseline building energy model for this playbook was created to be a single-story 47,000-ft² supermarket that was modeled to encompass the assumptions of ASHRAE 90.1-2004 Appendix G, with exceptions or modifications as noted. Baseline refrigerator display case capacities were modeled to adhere to federal standards for maximum allowable daily energy consumption; baseline refrigerator walk-in coolers and freezers were modeled to adhere to mandatory federal requirements for minimum insulation values of walk-in cooler and freezer panels and freezer floors, evaporator fan selection, lighting efficacy, glazing construction, and anti-sweat heater power.

Conclusions

When designing around an alternative refrigeration system technology, developing a strategy to initially predict and then measure the ongoing performance of the installed system is beneficial. This benchmark validation technique provides valuable real-world performance information at a minimal additional cost, if the goal is to develop a reliable and effective technology for deployment.

This playbook includes an overview of key factors that should be considered when implementing a low-GWP or natural refrigeration strategy. It does not address products available for purchase or specifics about how to design the systems. Low-GWP refrigeration systems are relatively new and require more careful attention to details than do conventional systems. To implement an efficient alternative system, the design must be integrated between disciplines. This requires involving the owner, refrigeration designer, mechanical or plumbing designer, and contractor early in the design. To properly evaluate or compare low-GWP or natural refrigeration systems, the *direct* environmental impacts of refrigerant leaks and *indirect* environmental impacts of energy consumption must be considered. This playbook provides guidance for such a balanced evaluation.

The spreadsheet and EnergyPlus models agreed that a cascade approach dramatically reduced TEWI versus a baseline multiplex R-404a system, especially when natural refrigerants are used. They also agreed that a cascade approach reduced primary compressor energy consumption. However, the two calculation methods came to somewhat different conclusions about which system configuration had the lowest *total* energy consumption when secondary compressors, fluid pumps, and fans were included, because of differences in how evaporator loads were modeled. The spreadsheet model typically concluded that the savings in primary compressor energy either outweighed or offset the additional consumption of the ancillary equipment; in EnergyPlus the additional components led to either similar or greater total system energy consumption because the primary compressor energy savings were smaller. Accordingly, we encourage users to carefully tailor the modeling assumptions to the project application at hand and to compare results only for different systems that have been generated with the same tool.

Table of Contents

Chapter 1. Introduction.....	1
Chapter 2. Technologies and Trends.....	2
2.1 History.....	2
2.2 Regulation.....	2
2.3 Initial Response.....	2
2.4 Mixed Results.....	2
2.5 New Metric To Account for Direct and Indirect Global Warming Factors.....	3
2.6 References and Resources.....	3
Chapter 3. Application and Design.....	4
3.1 Introduction.....	4
3.2 Schematics.....	4
3.3 References and Resources.....	9
Chapter 4. Refrigerant Characteristics.....	10
4.1 Design Considerations.....	10
4.2 Carbon Dioxide.....	10
4.3 Ammonia.....	15
4.4 Hydrocarbons.....	18
4.5 Hydrofluoroolefins.....	19
4.6 References and Resources.....	19
Chapter 5. Compliance and Safety.....	20
5.1 Emissions.....	20
5.1.1 Applications of Emission Factors.....	20
5.1.2 Significance of Total Equivalent Warming Impact.....	25
5.1.3 Limitations of Total Equivalent Warming Impact.....	25
5.2 Refrigerant Safety Classification.....	25
5.3 Leak Prevention.....	26
5.4 Pressure Relief.....	26
5.5 Code Compliance.....	26
5.6 U.S. Environmental Protection Agency Compliance.....	27
5.7 References and Resources.....	27
Chapter 6. Financial Evaluation.....	29
6.1 Introduction.....	29
6.2 Gathering Financial Information for Analysis.....	29
6.3 Financial Analysis Methods.....	30
6.3.1 Simple Payback.....	30
6.3.2 Net Present Value.....	31
6.3.3 Internal Rate of Return.....	31
6.3.4 General Cost Information.....	31
6.4 References and Resources.....	32
Chapter 7. End User Considerations.....	33
7.1 Regulatory Requirements.....	33
7.2 Profitability and Cost Control.....	33
7.3 Challenges to Market Entry and Potential Solutions.....	33
7.4 Corporate Image and Environmental Stewardship Goals.....	34
7.5 References and Resources.....	34
Appendix A: Spreadsheet Calculations.....	35
Appendix B: Baseline Assumptions and Results.....	37
Appendix C: Energy Modeling Results.....	44

List of Figures

Figure 3-1. LT or MT CO ₂ overfeed system	5
Figure 3-2. MT HFC/LT CO ₂ DX cascade	5
Figure 3-3. Combined MT pumped/LT DX CO ₂ cascade system	6
Figure 3-4. Combined MT pumped/LT DX CO ₂ cascaded with NH ₃ -flooded system	7
Figure 3-5. CO ₂ two-stage booster transcritical system	8
Figure 3-6. Self-contained hydrocarbon condensing units with a hydronic loop.....	9
Figure 4-1. Refrigerant classification of CO ₂ pressure-enthalpy diagram (ASHRAE 2013)	11
Figure 4-2. Saturated pressure-temperature relationship	12
Figure 4-3. CO ₂ subcritical cycle (ASHRAE 2013)	13
Figure 4-4. CO ₂ Transcritical-booster cycle (ASHRAE 2013)	15
Figure 4-5. Discharge temperature comparison (based on 105°F saturated condensing temperature).....	17
Figure 4-6. Ammonium carbamate	18
Figure 5-1. Source emission factors	22

List of Tables

Table 4-1. Refrigerant Properties	10
Table 4-2. NH ₃ -Saturated Pressures.....	15
Table 5-1. Total and Nonbaseload Emission Factors.....	21
Table 5-2. Total Emissions	24
Table 5-3. Refrigerant Safety Classifications	25
Table 5-4. Select Refrigerant Classifications	26
Table 6-1. Driving Factors for Cost Comparisons	31
Table 7-1. Challenges to Alternatives	34
Table B-1. Representative Cities for Climate Data Evaluation	37
Table B-2. DOE 2012 Governed Baseline Refrigeration Systems	40
Table B-3. LT and MT Compressor Coefficients	41
Table B-4. Baseline Model Whole-Building Energy Consumption.....	42

Chapter 1. Introduction

The *Refrigeration Playbook: Natural Refrigerants* provides guidance for selecting and designing energy-efficient commercial refrigeration systems that use low global warming potential (GWP) refrigerants. Refrigeration systems are generally the largest energy end use in a supermarket type building, often accounting for more than half its energy consumption. Most refrigeration systems today also use hydrofluorocarbon (HFC) refrigerants that can contribute significantly to global warming if leaked. Understanding refrigerant and refrigeration system technology options that influence energy consumption and environmental impacts is a growing trend in the United States as supermarket owners try to boost environmental stewardship practices and stay ahead of growing compliance requirements.

This playbook advances the understanding of low-GWP and natural refrigerant technology applications in supermarkets by providing system designers and owners with transparent methods for calculating actual system performance at design conditions and other times of the year based on analysis of hourly energy performance. Information is included that provides insight into compliance, industry trends, design applications, economic evaluations, potential barriers, and end-use considerations.

This playbook was developed to enable those involved with supermarket refrigeration system designs to make informed decisions about low-GWP and natural refrigerant technologies that maximize value to the building owner.

This playbook was written with a traditional supermarket of 40,000–60,000 ft² in mind, but the concepts also apply to smaller and larger facilities with commercial refrigeration systems. The playbook does not provide a complete design or precise calculations for determining the energy savings associated with applying a low-GWP or natural refrigerant; rather, it equips the user with ideas and tools to assist in the design process.

Chapter 2. Technologies and Trends

2.1 History

The first commercial refrigeration systems used natural refrigerants. Ammonia (NH₃), propane, and carbon dioxide (CO₂) were among the first. Concerns about the safety of these substances, stemming mostly from their toxicity and high working pressures, led to the development of synthetic chemical alternatives. Chemical manufacturers developed competing synthetic refrigerants, known as *safety refrigerants*, most of which consisted of configurations of chlorofluorocarbons, popularly known as *CFCs*. The lower operating pressures, reduced flammability, and lower toxicities of these refrigerants helped mitigate the safety concerns, but presented unexpected environmental consequences. Scientists in the 1970s discovered that release of these chemicals into the atmosphere was depleting the Earth's protective ozone layer.

2.2 Regulation

The first significant step to regulate ozone-depleting substances in the United States came with the adoption in 1989 of the Montreal Protocol developed by the United Nations Environment Programme [1]. The Clean Air Act of 1990 [2] required the U.S. Environmental Protection Agency (EPA) to develop a phase-out plan for ozone-depleting chemicals. Since this regulation took affect, the driving factors for most technology changes in commercial refrigeration have been the concern for the environment and associated regulations. All refrigerants containing chlorine atoms have an associated ozone-depletion potential and were therefore slated for phase-out. For example, R12 is a CFC and R22 is a hydrochlorofluorocarbon (HCFC); both contain chlorine atoms and were the predominant refrigerants used in commercial refrigeration systems.

2.3 Initial Response

Refrigerant manufacturers responded to the Clean Air Act by developing and marketing new synthetic refrigerants that did not contain chlorine. The intent was to replace CFCs and HCFCs with hydrofluorocarbon (HFC) refrigerants. The initial technology solution from refrigeration equipment manufacturers was to develop and market low-charge refrigeration systems, including distributed direct expansion (DX) systems and secondary glycol systems.

2.4 Mixed Results

Implementing HFC refrigerants eliminated the potential for damage to the ozone layer. However, these new HFC refrigerants and the new system designs created two new problems:

- When released into the atmosphere, these new chemical refrigerants directly impact the energy balance of the atmosphere and modify the Earth's climate. This trend is popularly known as *global warming*.
- The new refrigerants and some system designs are less energy efficient than previous systems. This has an indirect negative impact on the environment through emissions caused by power generation.

2.5 New Metric To Account for Direct and Indirect Global Warming Factors

This iteration in technology change was not a perfect solution; however, it did focus attention on a holistic understanding of—and approach to—refrigeration system design with global warming in mind. To quantify the global warming impact of systems, a metric called the Total Equivalent Warming Impact (TEWI) was developed to account for two sources of impact:

- Direct GHG releases of refrigerants caused by inadvertent leaks (for example, at imperfectly sealed fittings) and maintenance service-related releases. All refrigerants are assigned a factor to provide comparison with the 100-year climate impact of CO₂, which has a 100-year GWP of 1. For instance, R-404a has a GWP of 3700 according to *ASHRAE Handbook 2014*, meaning 1 lb of leaked R-404a has the same GWP as 3700 lb of CO₂.
- Indirect GHG emissions from the power generation needed to operate the refrigeration systems. This factor varies based on the system's energy consumption and the methods of power generation; the average value in the United States is 1.23 lb of CO₂ per kilowatt-hour of electricity used [4].

2.6 References and Resources

1. "The Montreal Protocol on Substances that Deplete the Ozone Layer." United Nations Environment Programme, 2011. http://ozone.unep.org/new_site/en/montreal_protocol.php.
2. "Overview – The Clean Air Act Amendments of 2009." U.S. Environmental Protection Agency, 2013. http://epa.gov/oar/caa/caaa_overview.html.
3. Sand, J.R.; Fischer, S.K.; Baxter, V.D. "Energy and Global Warming Impacts of HFC Refrigerants and Emerging Technologies." Oak Ridge, Tennessee: Oak Ridge National Laboratory, 1997. <http://www.afeas.org/tewi/tewi-iii.pdf>.
4. "eGRID." Environmental Protection Agency, 2014. <http://www.epa.gov/cleanenergy/energy-resources/egrid/>.

Chapter 3. Application and Design

3.1 Introduction

This chapter provides an overview of six system types that are applicable to the use of natural refrigerants. To aid in the discussion of these systems, they are numbered as follows:

- Low-temperature (LT) or medium-temperature (MT) CO₂ overfeed
- MT HFC DX with LT CO₂ DX cascade
- HFC DX primary over combined MT overfeed with LT CO₂ DX
- NH₃-flooded primary over combined MT overfeed with LT CO₂ DX
- CO₂ transcritical booster system
- Self-contained water-cooled hydrocarbon.

These six system types do not represent every possible system design or refrigerant pairing; rather, they represent some mainstream options that have been considered, that are being considered, or that will likely be considered, based on the experience of the authors. This chapter introduces these system types and highlights and contrasts some physical characteristics of these systems, including safety, efficiency, cost, and design application.

3.2 Schematics

The term *DX* in this playbook refers to a system that is classified as a “direct” system per the ASHRAE 15 safety classification, where the system’s evaporator “is in direct contact with the air or other substances to be cooled [1].” All other system types are described as *primary*, or *upper cascade*. All systems should also be assumed to be DX unless otherwise described as *flooded*, *pumped*, or *overfeed*.

Figure 3-1 shows an overfeed (pumped) CO₂ system that can be applied to either LT or MT systems (System 1). Liquid CO₂ is pumped through the evaporators, where it is partially evaporated and a mixture of liquid and gas is returned to a large liquid-vapor separator. The vapor is condensed back to a liquid through an intermediate condenser/evaporator by an upper cascade primary refrigerant system. The primary system’s evaporator temperature must be lower than that of the CO₂ system. Because no CO₂ compressors are required, the CO₂ part of this combined system contains no oil.

Figure 3-2 shows a CO₂ DX cascade system used to meet the LT loads (System 2). CO₂ compressors are required to drive the CO₂ part of this system. The CO₂ discharge gas is desuperheated before being condensed in the cascade heat exchanger. (Desuperheating hot discharge gas is common with cascade systems; it reduces the temperature shock in the cascade heat exchanger and increases energy efficiency.) Liquid is collected in a receiver and fed to electronic expansion valves (EEVs) at the LT evaporators. The upper cascade system can be any MT HFC DX refrigeration system or any other system that can reject heat to the ambient air. The same CO₂ DX system cannot be used for the MT temperature loads (without moving to a transcritical CO₂ system); thus, a standard HFC DX system is included for that purpose in this schematic.

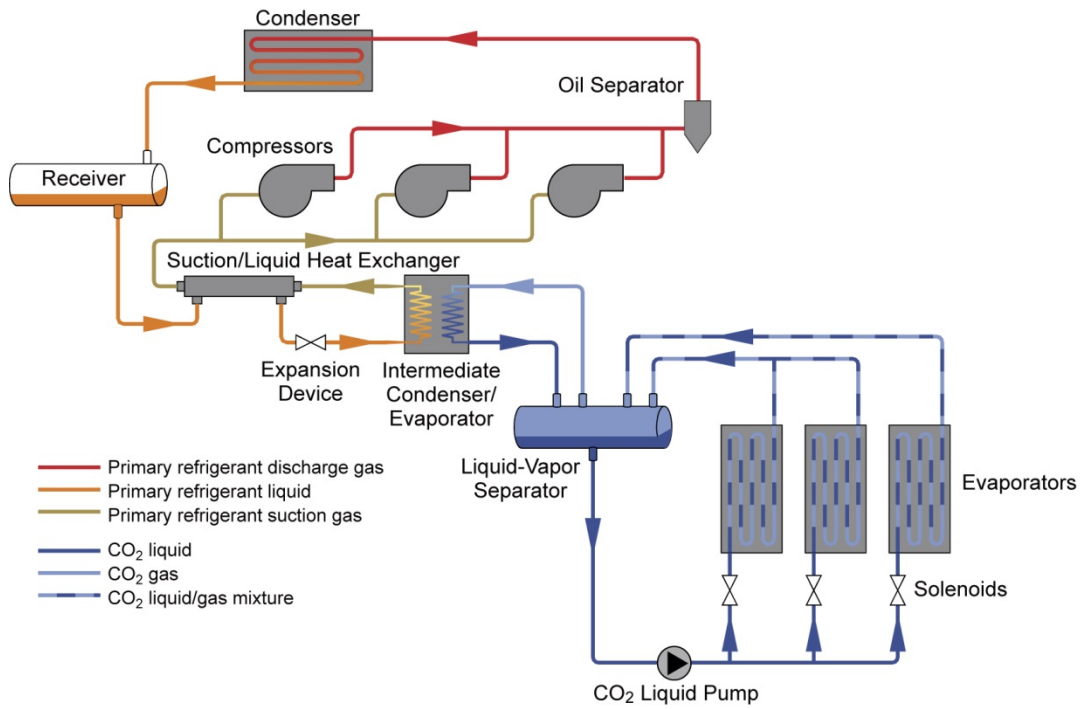

Figure 3-1. LT or MT CO2 overfeed system

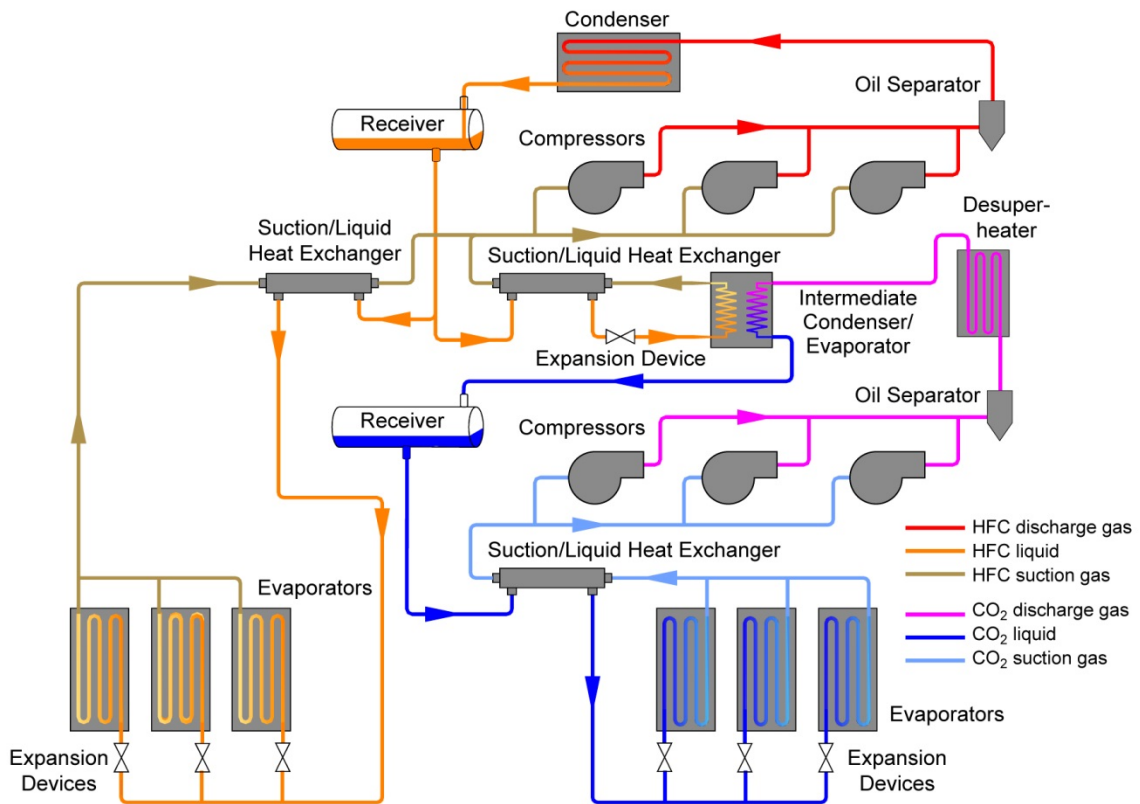

Figure 3-2. MT HFC/LT CO2 DX cascade

Figure 3-3 represents a convergence of Figure 3-1 and Figure 3-2 such that the pumped CO₂ system from Figure 3-1 and the DX CO₂ system from Figure 3-2 are now combined into a single system that provides cooling for all LT and MT loads (System 3). In this system, the CO₂ liquid is still pumped but is fed to the MT evaporators and to the EEVs on the LT evaporators. The two-phase CO₂ return from the MT evaporators is still sent directly to the liquid-vapor separator and the dry gas returning from the LT evaporators is compressed by the CO₂ compressors. Desuperheated CO₂ compressor discharge gas can be combined with the CO₂ gas from the liquid-vapor separator and condensed in the cascade heat exchangers. The CO₂ system is combined, so only one upper cascade system is required.

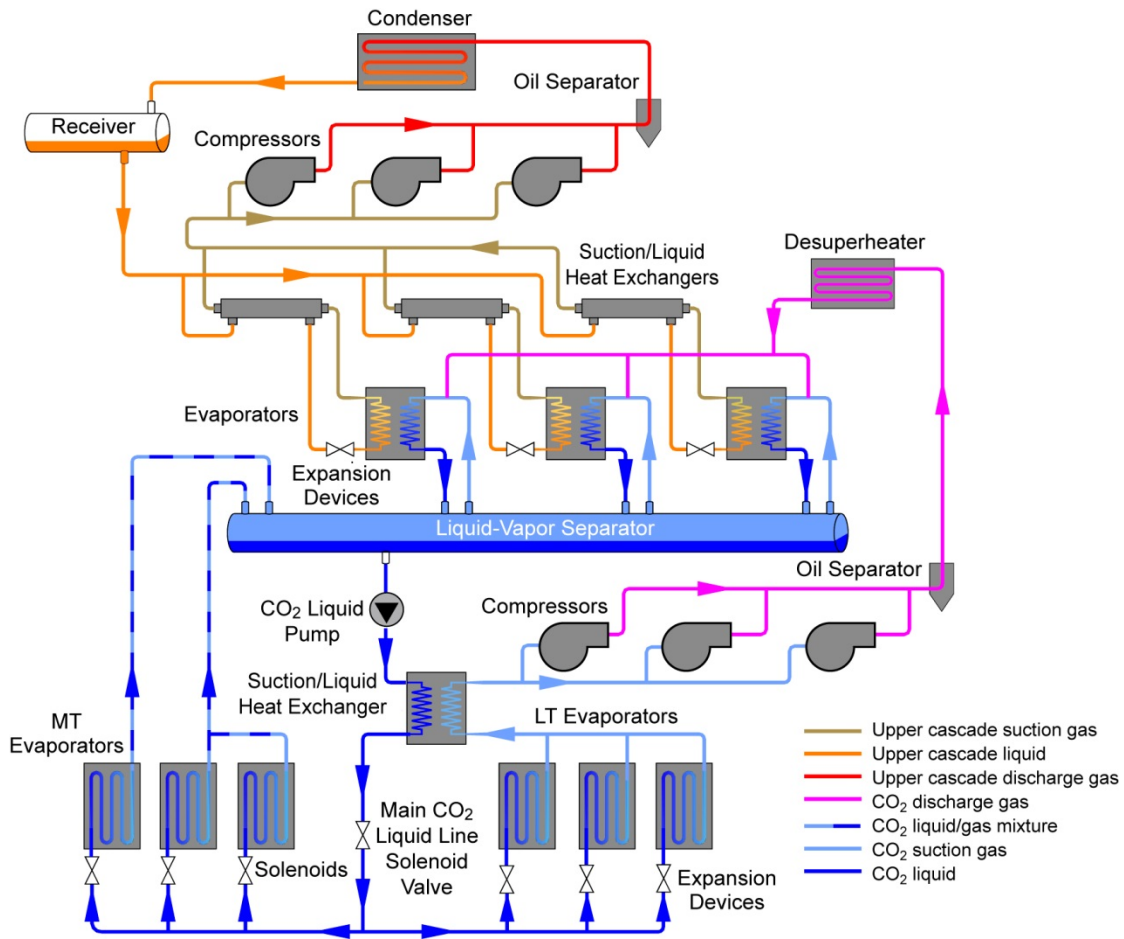

Figure 3-3. Combined MT pumped/LT DX CO₂ cascade system

Figure 3-4 replaces the DX upper cascade system seen in Figure 3-3 with a flooded NH₃ system (System 4). In this system, the NH₃ liquid draining from the condenser is not sent to a high-pressure receiver, which is a common feature of larger NH₃ systems and standard HFC systems. To reduce the NH₃ refrigerant charge, the liquid can be directly expanded to what is known as a *surge vessel*. Within the surge vessel, conditions are saturated and liquid NH₃ is allowed to drop down to the cascade heat exchanger, which provides condensing for the CO₂ system. As energy is transferred from the CO₂ to the NH₃, the NH₃ liquid boils and the gas naturally rises to the top

of the surge vessel. The NH₃ compressors extract this gas from the top of the surge vessel and discharge it directly to the NH₃ condenser.

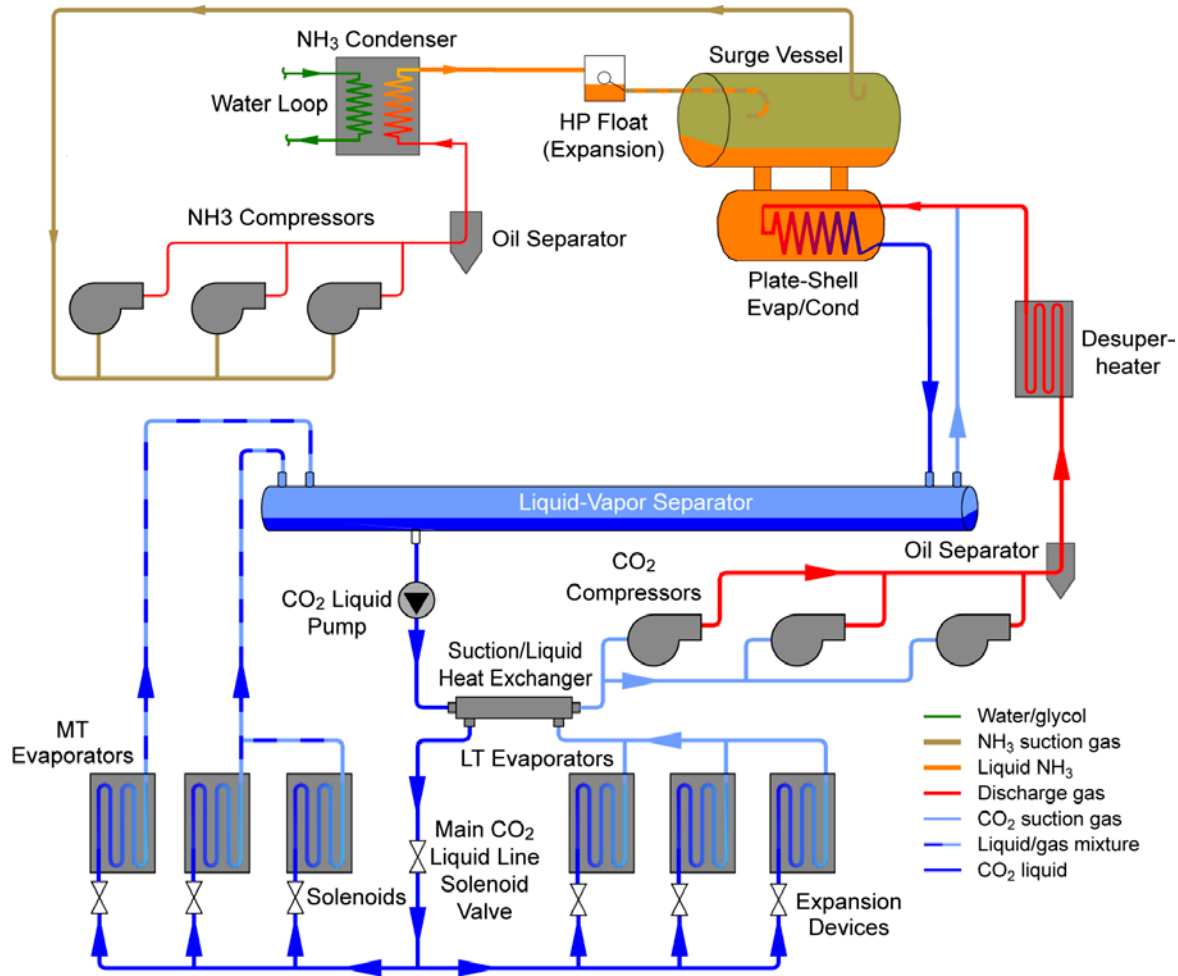

Figure 3-4. Combined MT pumped/LT DX CO₂ cascaded with NH₃-flooded system

Figure 3-5 shows a CO₂ two-stage booster transcritical system (System 5). This DX system can be used for LT and MT loads and does not require a separate primary system. The CO₂ can reject heat directly to the ambient atmosphere because the high-side components can be designed to handle the high pressures that accompany supercritical CO₂. Liquid from the receiver is fed to the LT and MT evaporators. LT suction gas is compressed by the LT compressors and then desuperheated before merging with the MT suction gas. Flash gas from the receiver is also combined with the intermediate pressure gas before it enters the suction side of the MT compressors. A condenser/gas cooler is used for the final heat rejection to the ambient air. (The “intermediate pressure gas” shown in the schematic represents more than one pressure level within the system.) An expansion valve reduces the pressure of the refrigerant leaving the condenser/gas cooler before entering the receiver.

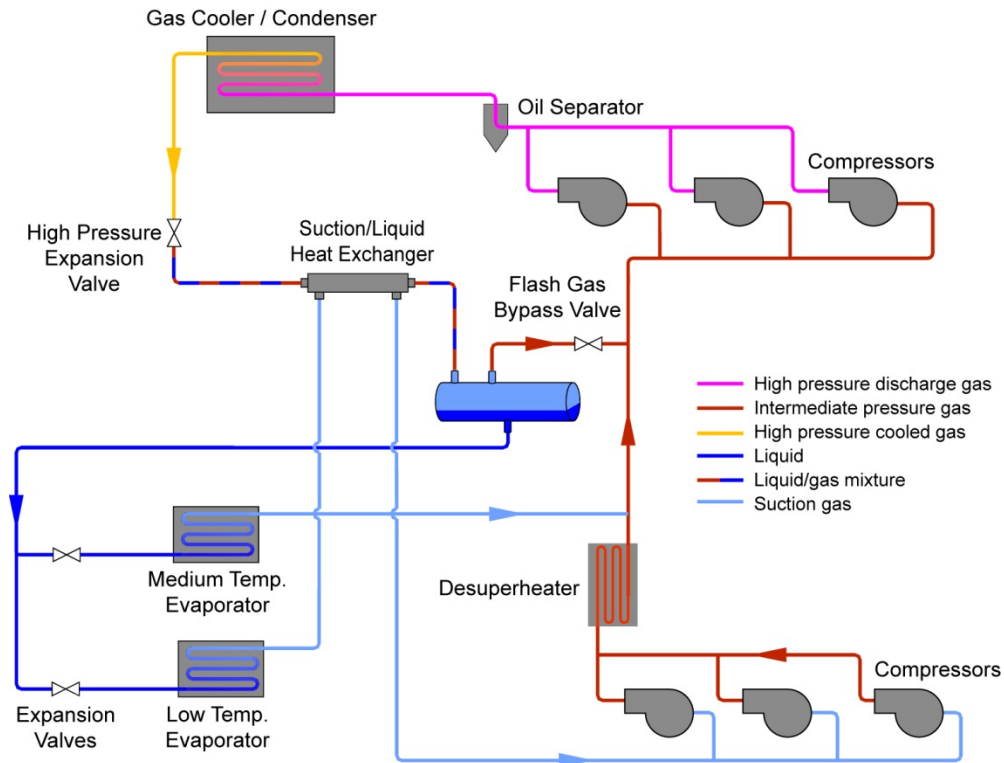

Figure 3-5. CO₂ two-stage booster transcritical system

In subcritical mode the CO₂ is condensed in the condenser and the liquid passes through the high-pressure expansion valve to remove some flash gas and provide a colder liquid to the evaporators. The high-pressure expansion valve is therefore modulated to control the liquid cooling. The flash gas bypass valve controls the pressure within the receiver and allows the flash gas created at the high-pressure expansion valve to flow to the suction of the MT compressors. In supercritical mode, the CO₂ is cooled in the gas cooler. Liquid does not form until the cooled gas flows through the high-pressure expansion valve. In addition to dropping the pressure of the CO₂ below its critical point to form liquid, the high-pressure expansion valve in this mode of operation optimizes the high-side pressure of the system based on the gas cooler's achievable temperature differences.

Figure 3-6 shows one common way to apply a two-stage CO₂ booster system. Other system modifications can also be used. Liquid-suction heat exchange does not always need to occur where shown. Designers may also choose to only subcool the LT liquid line with the LT suction gas. The gas cooler return line can be subcooled upstream of the high-pressure expansion valve. The flash gas from the receiver can also be directly processed by a dedicated compressor operating at a higher saturated suction temperature. As the use of CO₂ transcritical systems has moved to warmer climates, other improvements—such as additional liquid subcooling—have been made to increase efficiency.

Figure 3-6 shows a self-contained hydrocarbon system with a hydronic cooling loop (System 6). This system consists of water-cooled hydrocarbon condensing units located at each evaporator. These condensing units operate on the same type of vapor-compression refrigeration cycle that

any HFC condensing unit uses. A fluid loop is then circulated throughout the facility to cool the condensers. The final stage of heat rejection occurs outside via an evaporative or dry fluid cooler.

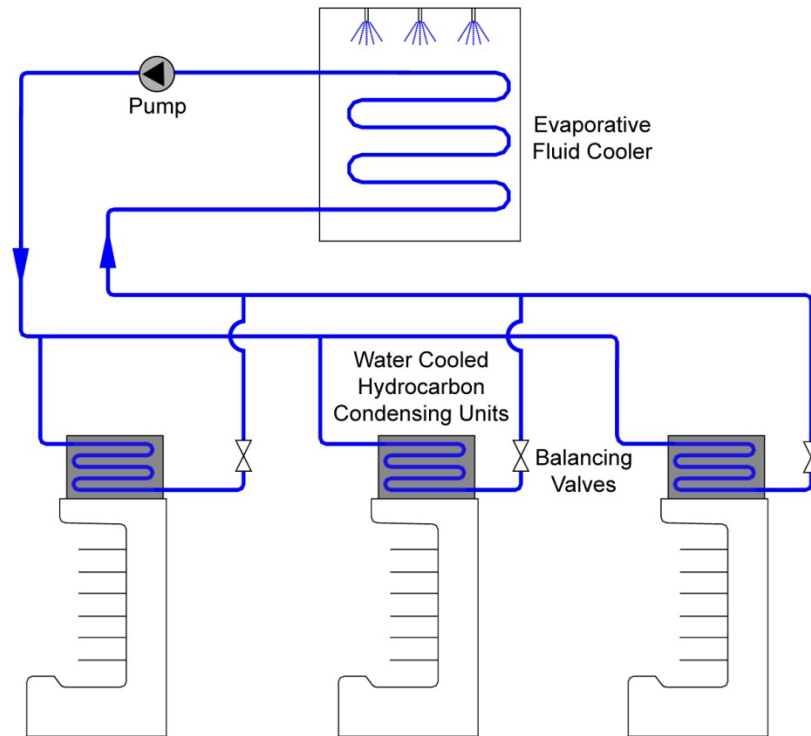

Figure 3-6. Self-contained hydrocarbon condensing units with a hydronic loop

3.3 References and Resources

1. “Standard 15-2013 (packaged w/ Standard 34-2013) -- Safety Standard for Refrigeration Systems and Designation and Classification of Refrigerants (ANSI Approved).” ASHRAE, 2013. <https://www.ashrae.org/resources--publications/bookstore/standards-15--34>.

Chapter 4. Refrigerant Characteristics

4.1 Design Considerations

As users consider alternatives to traditional HFC DX systems, they need to understand the design and performance tradeoffs associated with different system configurations. Different systems have different physical and spatial requirements. The refrigerants circulating through the systems require changes in material selection and maintenance procedures. Regional climate differences can also influence system choices. This section draws attention to some major factors that impact system selection or represent significant design changes.

For the user to understand the system differences, he or she must understand the refrigerant characteristics, how they behave inside the systems, and how that behavior relates to system design. Each refrigerant has a different boiling point, critical temperature, and working pressure; some are flammable, some are mildly flammable, and some are toxic. Some current HFC blends have high glide such that the components boil at different temperatures, causing the saturated liquid and saturated temperatures to vary at constant pressure. All design decisions are based on these refrigerant characteristics. The critical characteristics of several select refrigerants are given in Table 4-1.

Table 4-1. Refrigerant Properties

Refrigerant	Flammability	Toxicity	Safety Class	GWP	Glide	Design Pressure	Discharge Temperatures
CO ₂ (R-744)	None	Low	A1	1	0	High	Normal
NH ₃ (R-717)	Low	High	B2L	0	0	Normal	High
Propane (R-290)	High	Low	A3	3	0	Normal	Normal
R-134a	None	Low	A1	1300	0	Low	Normal
R-404a	None	Low	A1	3780	1.2	Normal	Normal

4.2 Carbon Dioxide

The most noticeable characteristics of CO₂ that differ from other commonly used refrigerants are critical temperature and working pressure. Figure 4-1 shows that CO₂ reaches its critical temperature at 87.7°F with a saturated pressure of 1,055 psig.

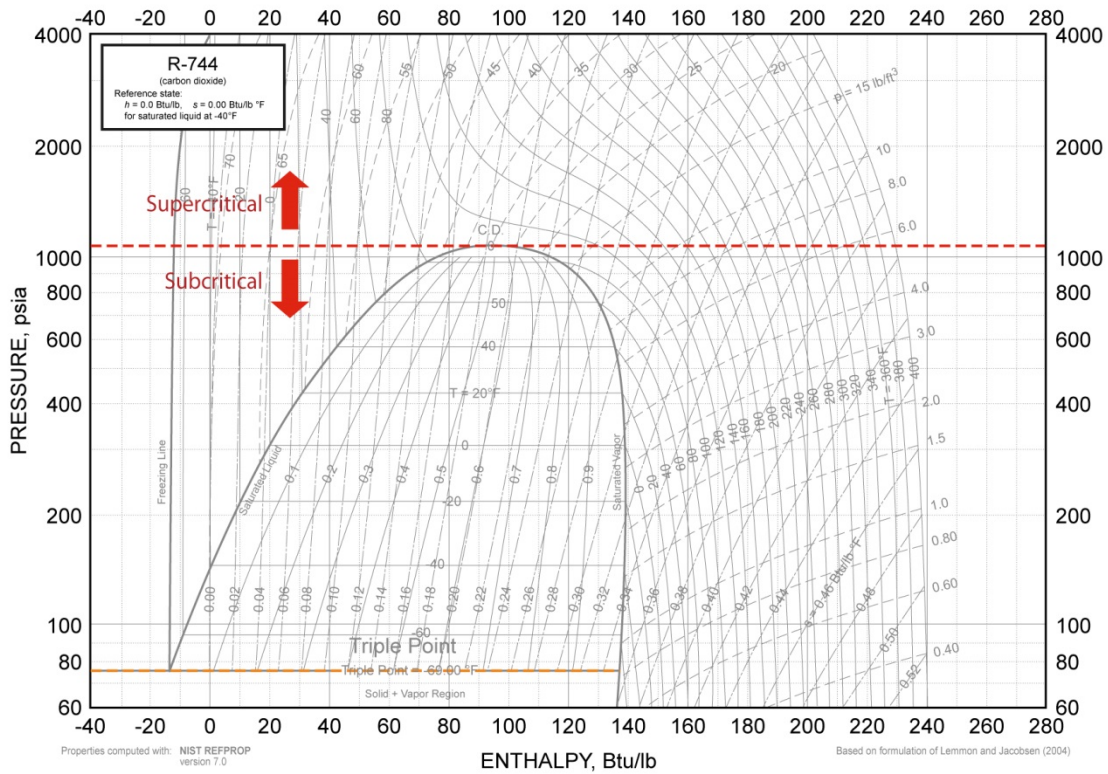

Figure 4-1. Refrigerant classification of CO₂ pressure-enthalpy diagram [1]

Because the critical temperature is lower than the outdoor design condition in many U.S. climates, it cannot use ambient air as the final heat sink for a CO₂ system in these climates without operating in a supercritical mode. And because the pressures are several times higher than other commonly used refrigerants, standard component pressure ratings are not sufficient. Figure 4-2 shows the pressure and temperature relationship for several refrigerants. CO₂ operates at a much higher pressure range.

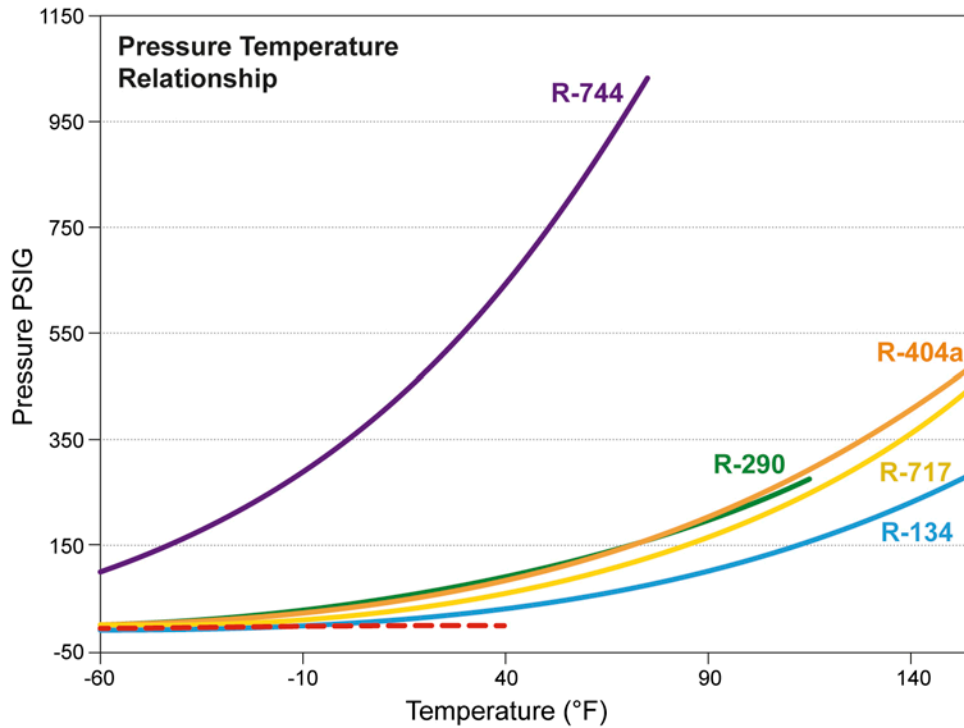

Figure 4-2. Saturated pressure-temperature relationship

Because of these pressure and temperature characteristics, CO₂ has so far been most commonly used in cascade or overfeed system types (Figure 3-1 to Figure 3-3) in the United States to keep pressures lower and maintain operation in the subcritical region. Subcritical CO₂ systems require the least modification from standard HFC systems and the thermodynamic process is similar (see Figure 4-3). Although copper piping can still be used, type K must often be used in lieu of type L. Depending on the system's pressure relief settings, maximum pipe sizes may be limited. The pressure rating of the copper piping can be increased if annealing can be avoided, by using mechanical connections instead of brazed connections. However, brazing is recommended and in subcritical systems does not create a significant hurdle. Designers should coordinate closely with system manufacturers to understand these parameters based on the specific CO₂ application.

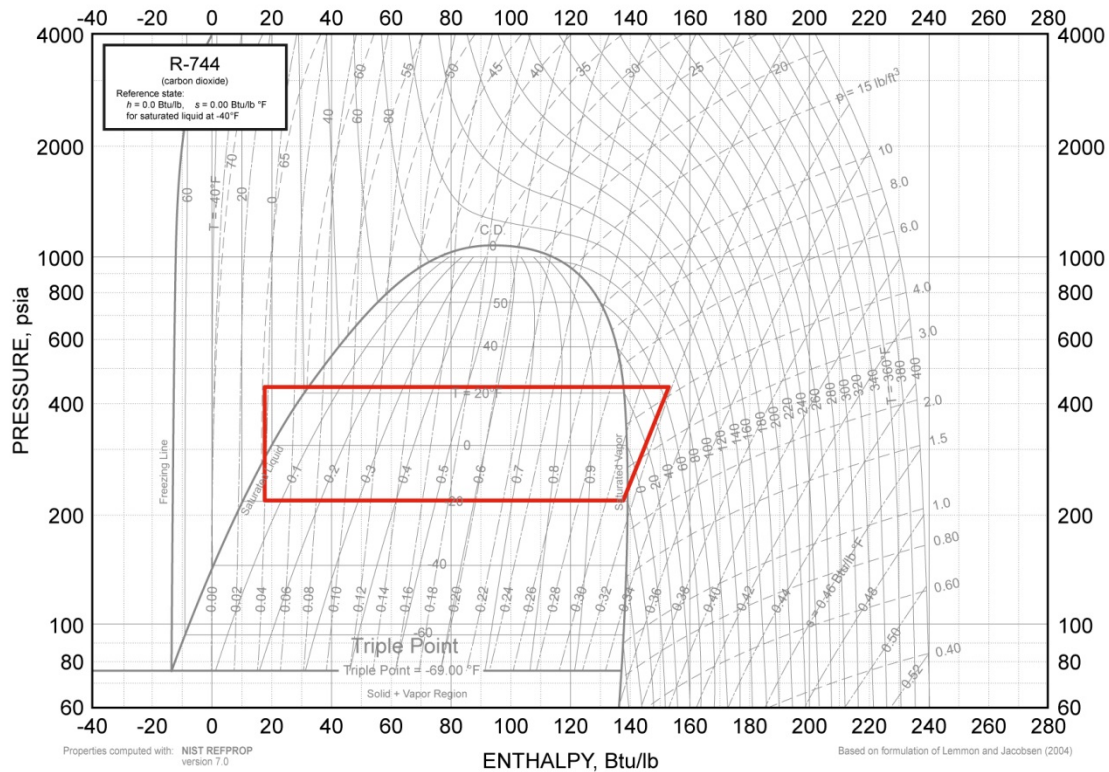

Figure 4-3. CO₂ subcritical cycle [1]

CO₂ shows a small temperature change per psi of pressure change relative to other refrigerants. This is advantageous in pipe sizing, because higher pressure drops (smaller line sizes) can be tolerated without excessive temperature change. For example, in a typical LT suction line, 2°F of evaporating temperature are sacrificed as the system sees approximately 2 psi of pressure loss with R-404a. With CO₂, however, approximately 8 psi of pressure drop is allowed for the same amount of evaporating temperature rise. Because CO₂ systems commonly target a 4 psi or lower pressure drop, half the penalty can be achieved with twice the pressure drop. Combining this allowance with high vapor densities and high latent heat capacities, CO₂ system piping (as well as compressor bodies) can become quite small.

For systems that use CO₂ as a pumped/overfeed refrigerant, the same practices should be used to ensure liquid returns to the liquid-vapor separator that is used to return oil to a compressor in DX systems. Sloped horizontal return piping, trapping, and annular flow in risers (typically <300 fpm) are still applicable.

Another interesting characteristic of CO₂ is that it turns from a liquid into dry ice (solid CO₂) when pressure is reduced from system working pressure to atmospheric pressure. Maintenance staff needs to be aware of this important behavior, which is discussed in more depth in Chapter 5. From a design standpoint, the location of pressure relief valves (PRVs) should be considered. Even if CO₂ vapor is released to the atmosphere, it may pass through a saturated stage (under the p-h dome) on its journey to atmospheric pressure. As vapor passes under the dome, some liquid CO₂ will condense and turn to dry ice at the threshold of the PRV. Thus, the best practice has

been to locate PRVs at the end of any emergency relief piping. In some instances, piping downstream of a PRV has clogged because dry ice has formed; however, some users have tested systems where they tried to intentionally create this scenario and were unsuccessful. The amount of superheat present in the vapor at the point of atmospheric release affects the amount of dry ice produced, so accurately predicting how a specific system will behave is difficult.

Systems must be designed so that liquid and vapor CO₂ cannot be trapped. Liquid refrigerant is not trapped in most systems; however, CO₂ vapor must also not be trapped, because its pressure increases by approximately 2.1 psi for every 1°F. Trapped suction gas at 32°F gains an additional 110 psi if it is warmed to 85°F (by ambient air perhaps). Trapping is of particular concern for liquid CO₂; if enough liquid stays in the isolated part of the system to maintain saturated conditions, the pressure exceeds 1,000 psi in this example. If isolation is necessary—and the system is not designed for these excessive pressures—it must be directly connected to a PRV. However, because isolation is common and necessary, excessive PRVs are not feasible; therefore, bypass and check valves should be used wherever isolation valves are required.

CO₂ evaporators are normally defrosted with an electric defrost heater because the pressure rating that is required to employ hot gas defrost in cascade systems inhibits its use. Evaporator pressure regulators are also not commonly used with CO₂ systems. For DX systems, temperature is controlled with EEVs because precise flow regulation is needed. A dual-temperature evaporator can also be operated on an LT DX system using an EEV. Instead of increasing the evaporating pressure to an MT range (which would most likely violate the system's low-pressure rating), the EEV drives up the superheat within the evaporator. This method must be applied carefully to ensure proper humidity in the case because the lower evaporator temperature tends to pull more moisture out of the air than does a higher one.

When designing CO₂ transcritical systems (Figure 3-5, Figure 4-4) other design considerations result from the even higher pressures seen between the high-stage compressor discharge and the receiver (separator). Copper piping typically must be abandoned and carbon or stainless steel adopted for this part of the system. Copper alloys are used in Europe instead of steel piping, but they are not yet available or approved for use in the United States. If carbon steel is used, ASHRAE recommends seamless (ASTM Standard A333) Grade 6. For stainless, several common alloys such as (ASTM A312) TP 304 are available. Because steel piping must be welded, clean, quality welds must be specified. In situations where it is deemed necessary, a filter with an interchangeable strainer can be installed upstream of the high-pressure expansion valve to catch any welding slag or other impurities in the steel part of the system.

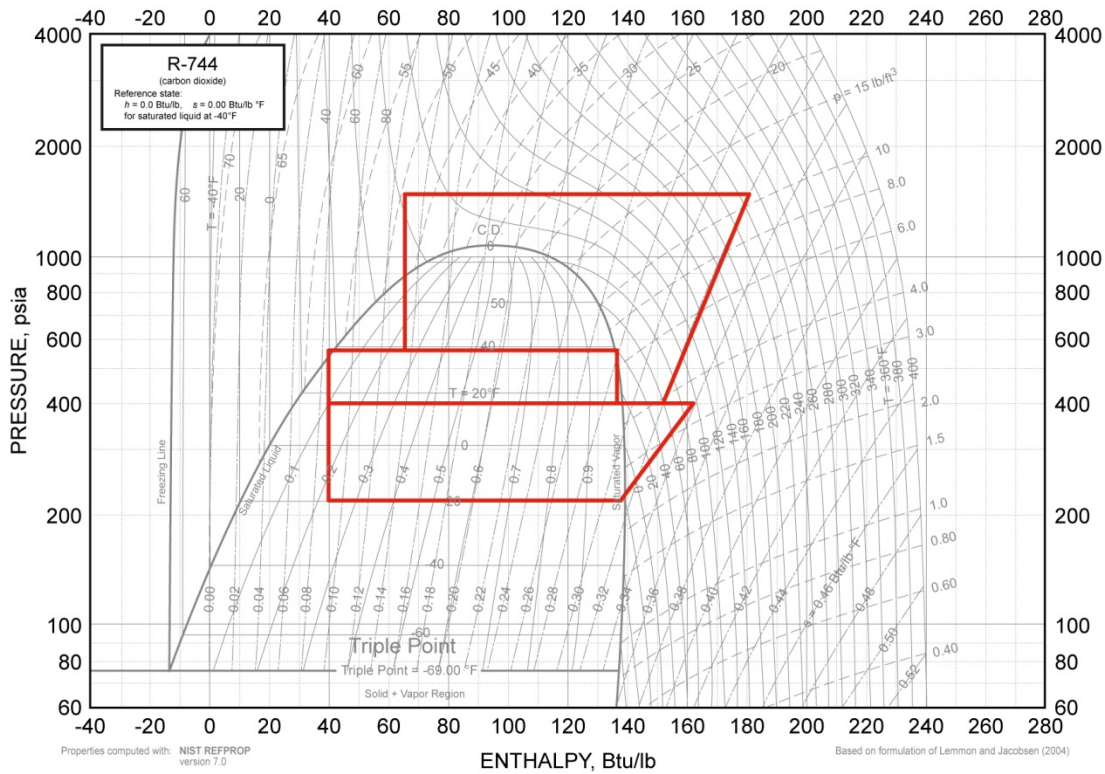

Figure 4-4. CO₂ Transcritical-booster cycle [1]

4.3 Ammonia

Unlike CO₂, NH₃ has a high critical temperature that allows for year-round subcritical operation at more traditional pressures. Even though these pressures are low enough for annealed copper to be used in all pressure zones of the system, copper cannot be used because of its chemical reaction with NH₃. Table 4-2 shows NH₃ pressures at typical low- and high-side saturated temperatures.

Table 4-2. NH₃-Saturated Pressures

Temperature (°F)	Pressure (psig)	
-25	1.3	LT low side
-20	3.6	
15	28.4	MT low side
20	33.5	
100	197.3	High side
115	251.7	

Table 4-2 shows that the operating pressures of NH₃ are very similar to those of other common HFC refrigerants such as R-134a and R-404a. Also, NH₃ operates in a vacuum at saturated temperatures below approximately -27° F. This characteristic should be considered if NH₃ is to

be used in LT systems because running in a vacuum is typically not preferred—the threat of contamination increases from potential leaks in that part of the system. R-134a operates in a vacuum at even warmer temperatures than NH₃, which is one reason it is not used in LT systems.

NH₃'s toxicity and flammability characteristics require it to be used in an indirect system. Figure 3-4 depicts an NH₃/CO₂ cascade system where the NH₃ part can be isolated. Although placing the NH₃ system outdoors is probably the safest and most feasible option, it can be placed in a machinery room designed per the applicable regulatory requirements.

Designers who want to use an NH₃ system should procure an NH₃ “packaged” system from a manufacturer because they are most likely to be leak tight and to have a minimized charge. When possible, the NH₃ evaporator (cascade heat exchanger) and condenser should be located as close as possible to the compressors, such as on a shared skid. Although manufacturers can take total control of the system's design, designers should understand the options available for applying NH₃ and how they affect the project's expectations. NH₃ can be applied in a flooded, overfed, or DX system. Miscible and immiscible oils can be used. Reciprocating, screw, and scroll compressors are all available. Open-drive compressors are required with copper-wound motors; however, semihermetic options that use aluminum windings are also available.

Figure 3-4 shows an NH₃ system that uses standard and proven components and is designed to maximize the energy efficiency of the NH₃ system. Flooded evaporators and standard immiscible oil allow for a negligible superheat at the compressor suction. Open-drive compressors dissipate the motor heat into the air instead of rejecting it through the condenser. Reciprocating compressors maintain good efficiencies as their speeds are reduced; this allows for the common load and ambient swings seen with most systems.

In some instances, reciprocating compressors cannot be used. Because NH₃ systems experience extremely high discharge temperatures (Figure 4-5), single-stage reciprocating compressors run too hot and screw compressors may be required that can use oil cooling to cool the discharge gas within the compression space of the compressor.² Once the system's design conditions are established, designers should be able to determine the best type of compressor technology to use.

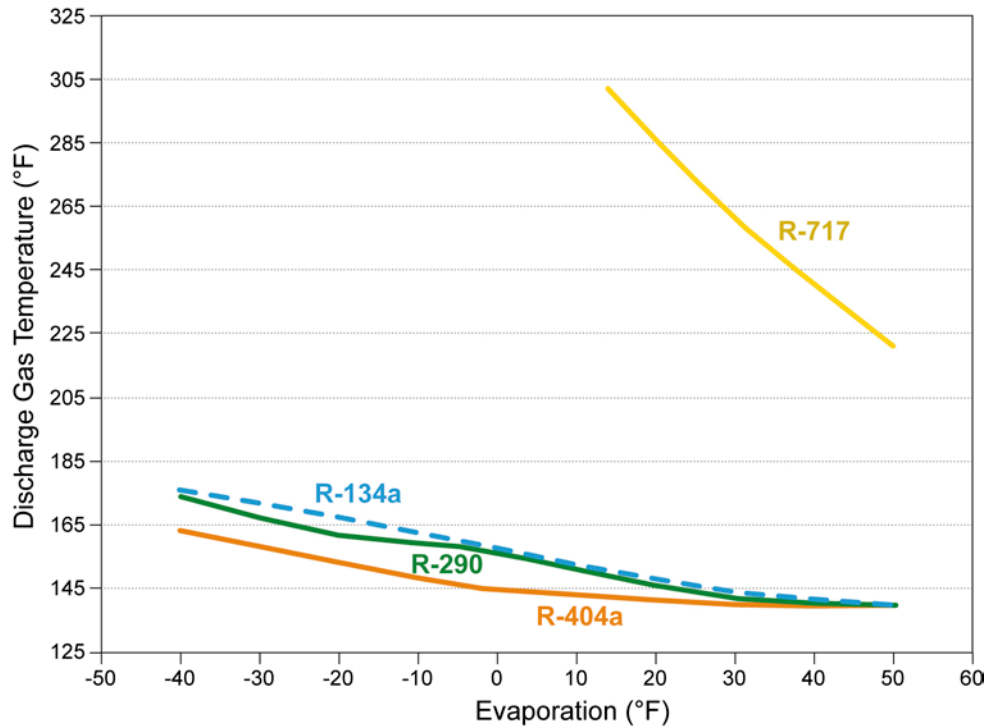

**Figure 4-5. Discharge temperature comparison
(based on 105°F saturated condensing temperature)**

Many factors influence the decision to use flooded evaporators instead of DX. The biggest appeal of a DX system is charge minimization. To realize this benefit, however, designers should consider how the system is affected by this choice in other areas to ensure that efficiency and reliability are not compromised. If a DX system requires miscible oil, care should be taken to ensure that the system can effectively separate the oil. NH_3 has an extremely low vapor density (high specific volume) so any NH_3 that flashes out of the oil in a compressor lubrication space causes significant damage that greatly reduces its lifespan. Oil frothing can also become an issue; thus, immiscible oil is most common. Some systems that use miscible oil rely on inducing a superheat within the evaporator to help drive the NH_3 out of the oil. Unnecessarily high superheats can affect system efficiency and further increase compressor discharge temperatures.

Another caution with the use of miscible oils is that NH_3 has a high attraction to—and miscibility with—water. Up to 2000 parts per million of water in NH_3 is not uncommon in NH_3 systems and has been considered acceptable, because it has not hindered operation in flooded or overflooded systems. The mineral oils typically used with NH_3 are not hygroscopic. The oil thus also performs well with some water in the system. However, if NH_3 miscible oils are used that are also hygroscopic, water in the system can deteriorate the function of the oil and contaminate the rest of the system. Therefore, extra caution should be taken when opening NH_3 systems to the atmosphere when hygroscopic oils are used.

One of the most effective measures for reducing NH_3 charge within the system is to omit a high-pressure receiver. Figure 3-4 shows that liquid draining from the condenser can be directly expanded to the evaporator, where conditions are maintained at the saturated evaporation temperature. A high-pressure receiver connected to the system may still be warranted to achieve

a necessary spare volume for pump-down procedures; however, this vessel should be appropriately isolated and not hold a charge during normal operation.

Another component that requires design consideration is the cascade heat exchanger. When NH_3 and CO_2 are mixed, they create ammonium carbamate—a white crystalline solid—so all vested parties should be comfortable with the robustness of the cascade heat exchanger (Figure 4-6).



Figure 4-6. Ammonium carbamate

Shell-and-tube and plate heat exchangers have been used for this duty successfully; however, hot CO_2 discharge gas should be desuperheated upstream of the cascade heat exchanger to reduce temperature shock and increase its reliability. A system that has been contaminated with ammonium carbamate might be recovered; however, properly cleaning it will severely disrupt its operation.

4.4 Hydrocarbons

Several types of hydrocarbons can be used, but this discussion focuses on propane. The biggest design consideration stems from propane's high flammability, which is always subject to demanding safety regulations. Currently, the EPA has approved propane for commercial use only when the refrigerant charge is limited to 150 grams. Thus, its use is limited to self-contained cooler and freezer cases.

Figure 4-3 shows that propane, like NH_3 , has pressure-temperature relationships that are typical of other common commercial refrigerants. Furthermore, it has no temperature glide, it has low discharge temperatures, it can operate under a wide application range, and it has similar volumetric capacity and efficiency performance as other accepted synthetic refrigerants. Thus, no hurdles arise in designing or manufacturing propane systems outside the low charge limit and the precautionary measures necessary to manage its flammability.

Manufacturers design and build self-contained cases to meet the refrigeration demands of the case and publish the heat rejection requirements. From there, designers need to design the heat rejection system that carries the heat from the propane system to the ambient air. The designer

must collaborate closely with the local authority having jurisdiction and the fire department to gain acceptance. Figure 3-6 shows this being accomplished with a standard hydronic system connected to an evaporative fluid cooler. In order for hydrocarbons to be used in larger systems similar to traditional racks, the laws will need to change. Any additional restrictions and requirements that would follow an allowance for larger systems have not yet been determined.

4.5 Hydrofluoroolefins

Along with natural refrigerants, hydrofluoroolefin (HFO) compounds are emerging as possible replacements for HFC refrigerants. These compounds contain the same basic elements as HFCs, but with significantly lower GWP. For instance, HFO-1234yf is listed with a GWP of 4.4, compared with R-134a with a GWP of 1370.³ This difference is largely due to the relatively low atmospheric lifetime of HFOs, meaning they break down to more basic components relatively quickly. HFOs are favored to replace HFCs because they operate similarly, allowing relatively minor changes to equipment. Key barriers to adoption of HFOs include mild flammability, incompatibility with oils, and relatively high costs.

4.6 References and Resources

1. *ASHRAE Handbook – Fundamentals*. Atlanta, GA: ASHRAE, 2013; pp. 30.
2. Nelson, Caleb. *Feasibility of Ammonia in U.S. Supermarkets*, Alexandria, VA: International Institute of Ammonia Refrigeration, 2010.
3. *ASHRAE Handbook, Fundamentals Volume, 2013*, ASHRAE Fundamentals, ASHRAE, Atlanta, GA, pp.25.5, 2013.

Chapter 5. Compliance and Safety

5.1 Emissions

The EPA compiles air pollutant emission factors (see www.epa.gov under *AP 42 Compilation of air pollutant emission factors*) that can be used to relate the quantity of a pollutant released to the atmosphere with the activity associated with its release. These factors are expressed as the weight of a pollutant released divided by a unit weight, volume, distance, or duration of the activity emitting the pollutant (e.g., kilogram of particulate emitted per megagram of coal burned). They are estimates from various air pollution sources, are usually averages of all available data of acceptable quality, and are widely assumed to be indicative of long-term average emissions.

The general equation for emission estimation [1] is:

$$E = A * EF * (1-ER/100)$$

Where:

E	=	emissions, (unit of pollutant per hour)
A	=	activity rate, (unit of weight, volume, distance, or duration per hour)
EF	=	emission factor, (unit of pollutant per unit of weight, volume, distance, or duration)
ER	=	overall emission reduction efficiency, (%)

5.1.1 Applications of Emission Factors

Emission factors may be used to determine the amount of air pollutants being emitted from a source and make estimates for a point location or geographic area. Information acquired may be used for atmospheric dispersion modeling and analysis if required by state or federal code compliance (Table 5-1 and Figure 5-1). Refrigeration system life cycle analysis usually includes these factors, especially when the TEWI is implemented. As previously discussed, TEWI takes into account the direct effect of inadvertently releasing HFCs to the atmosphere and the indirect effect from emissions produced through the energy consumed in operating the equipment. TEWI is measured in units of CO₂ equivalence.

Table 5-1. Total and Nonbaseload Emission Factors

Electricity Emission Factors

eGRID Subregion	Total output emission factors			Non-baseload emission factors		
	CO ₂ Factor (lb CO ₂ /MWh)	CH ₄ Factor (lb CH ₄ /MWh)	N ₂ O Factor (lb N ₂ O/MWh)	CO ₂ Factor (lb CO ₂ /MWh)	CH ₄ Factor (lb CH ₄ /MWh)	N ₂ O Factor (lb N ₂ O/MWh)
AKGD (ASCC Alaska Grid)	1,256.87	0.02608	0.00718	1,387.37	0.03405	0.00693
AKMS (ASCC Miscellaneous)	448.57	0.01874	0.00368	1,427.76	0.05997	0.01180
SZNM (WECC Southwest)	1,177.61	0.01921	0.01572	1,210.44	0.02188	0.00986
CAMX (WECC California)	610.82	0.02849	0.00603	932.82	0.03591	0.00455
ERCT (ERCOT All)	1,218.17	0.01685	0.01407	1,181.70	0.02012	0.00763
FRCC (FRCC All)	1,196.71	0.03891	0.01375	1,277.42	0.03873	0.01083
HIMS (MICC Miscellaneous)	1,330.16	0.07398	0.01388	1,690.72	0.10405	0.01912
HIOA (HICC Oahu)	1,621.86	0.09930	0.02241	1,588.23	0.11948	0.02010
MROE (MRO East)	1,610.80	0.02429	0.02752	1,755.66	0.03153	0.02799
MROW (MRO West)	1,536.36	0.02853	0.02629	2,054.55	0.05986	0.03553
NEWE (NPCC New England)	722.07	0.07176	0.01298	1,106.82	0.06155	0.01207
NWPP (WECC Northwest)	842.58	0.01605	0.01307	1,340.34	0.04138	0.01784
NYCW (NPCC NYC/Westchester)	622.42	0.02381	0.00280	1,131.63	0.02358	0.00244
NYLI (NPCC Long Island)	1,336.11	0.08149	0.01028	1,445.94	0.03403	0.00391
NYUP (NPCC Upstate NY)	545.79	0.01630	0.00724	1,253.77	0.03683	0.01367
RFCE (RFC East)	1,001.72	0.02707	0.01533	1,562.72	0.03593	0.02002
RFCM (RFC Michigan)	1,629.38	0.03046	0.02684	1,744.52	0.03231	0.02600
RFCW (RFC West)	1,503.47	0.01820	0.02475	1,982.87	0.02450	0.03107
RMPA (WECC Rockies)	1,896.74	0.02266	0.02921	1,808.03	0.02456	0.02289
SPNO (SPP North)	1,799.45	0.02081	0.02862	1,951.83	0.02515	0.02690
SPSO (SPP South)	1,580.60	0.02320	0.02085	1,436.29	0.02794	0.01210
SRMV (SERC Mississippi Valley)	1,029.82	0.02066	0.01076	1,222.40	0.02771	0.00663
SRMW (SERC Midwest)	1,810.83	0.02048	0.02957	1,964.98	0.02393	0.02965
SRSO (SERC South)	1,354.09	0.02282	0.02089	1,574.37	0.02652	0.02149
SRTV (SERC Tennessee Valley)	1,389.20	0.01770	0.02241	1,873.83	0.02499	0.02888
SRVCD (SERC Virginia/Carolina)	1,073.65	0.02169	0.01764	1,624.71	0.03642	0.02306
US Average	1,232.35	0.02414	0.01826	1,520.20	0.03127	0.01834

Source: EPA Year 2010 eGRID 5th edition Version 1.0 February 2014.

Note: Total output emission factors are used for quantifying emissions from purchased electricity. Non-baseload emission factors are used for quantifying the emission reductions from purchased green power.

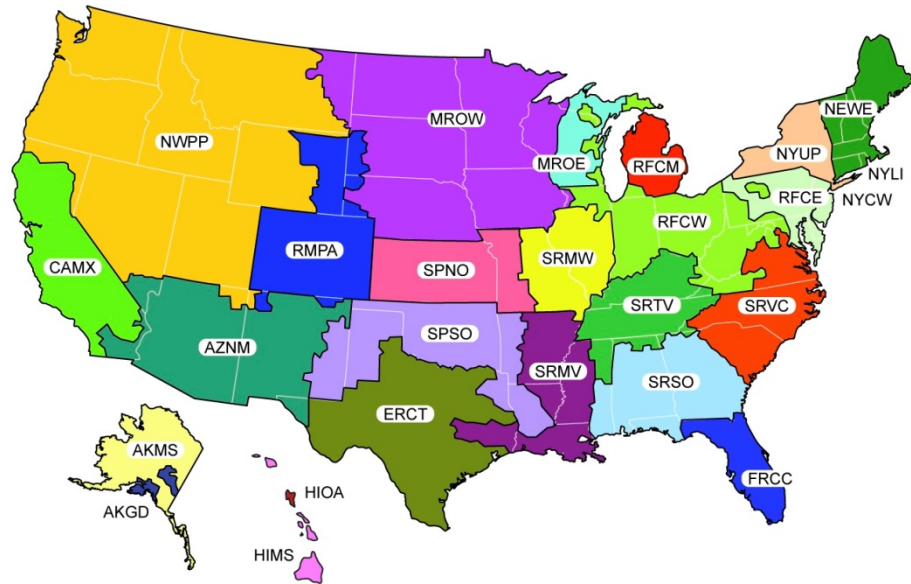

This is a representational map; many of the boundaries shown on this map are approximate because they are based on companies, not on strictly geographical boundaries.

Figure 5-1. Source emission factors [2]

The general equation for TEWI is:

$$\begin{aligned}
 TEWI &= GWP(\text{direct refrigerant leaks}) \\
 &+ (\text{indirect because of electricity consumption}) \\
 &= (GWP * m * L_{annual} * n) + GWP * m * (1 - \alpha) + (E_{annual} * \beta * n)
 \end{aligned}$$

Where:

GWP = global warming potential of refrigerant, relative to CO_2 ($GWP_{CO_2} = 1$)

L_{annual} = leakage rate per annum NOTE: The annual leak rate is the sum of the gradual leakage during normal operation, catastrophic losses amortized over the life of the equipment, and losses during service and maintenance expressed as a percentage of the initial charge per year. Losses at the end of the system life are not included in the annual leak rate.

n = system operating life (units in years)

m = refrigerant charge (units in kg)

α = recovery/recycling factors from 0 to 1

E_{annual} = energy consumption per year (units in kWh per annum)

β = indirect emission factor (units kg CO_2 per kWh)

This method [1] provides estimates for TEWI values of new refrigeration systems that can be used and verified by system designers, subcontractors, owners, and regulating agencies.

The energy that refrigeration systems consume is often produced from fossil fuels, which result in CO₂ emissions. According to ASHRAE, the indirect effect associated with energy consumption is frequently greater than the direct effect of refrigerant emissions.

CO₂ emissions from electricity generation vary from state to state, with time of day, and from season to season (see Table 5-2). TEWI values in any particular region are specific to the electrical power generation characteristics and efficiency. Direct effects can vary from areas with low CO₂ emissions rates (hydro or nuclear generated) to those with high rates (coal generated).

Table 5-2. Total Emissions [2]

Year 2010 eGRID Subregion Emissions - Greenhouse Gases

eGRID subregion acronym	eGRID subregion name	Carbon dioxide (CO ₂)		Methane (CH ₄)		Nitrous oxide (N ₂ O)		Carbon dioxide equivalent (CO ₂ e)	
		Emissions (tons)	Total output emission rate (lb/MWh)	Emissions (lbs)	Total output emission rate (lb/GWh)	Emissions (lbs)	Total output emission rate (lb/GWh)	Emissions (tons)	Total output emission rate (lb/MWh)
AKGD	ASCC Alaska Grid	3,350,817.0	1,258.87	139,035.5	26.08	38,279.9	7.18	3,358,210.3	1,259.64
AKMS	ASCC Miscellaneous	317,398.6	448.57	26,527.0	18.74	5,208.6	3.68	318,484.5	450.10
AZNM	WECC Southwest	104,967,483.8	1,177.61	3,424,005.1	19.21	2,802,975.8	15.72	105,437,897.1	1,182.89
CAMX	WECC California	64,799,260.4	610.82	6,044,809.1	28.49	1,278,773.3	6.03	65,060,940.8	613.28
ERCT	ERCOT All	210,366,837.2	1,218.17	5,820,108.3	16.85	4,859,884.0	14.07	211,181,230.4	1,222.88
FRCC	FRCC All	130,376,587.7	1,198.71	8,478,102.7	38.91	2,995,217.6	13.75	130,929,868.5	1,201.79
HIMS	HICC Miscellaneous	1,963,642.7	1,330.16	218,438.7	73.98	40,985.9	13.88	1,972,289.1	1,336.02
HIOA	HICC Oahu	6,393,027.4	1,621.86	782,825.4	99.30	176,679.8	22.41	6,428,632.4	1,630.90
MROE	MRO East	26,009,237.7	1,610.80	784,331.9	24.29	888,770.5	27.52	26,155,232.6	1,619.84
MROW	MRO West	156,444,752.4	1,536.36	5,809,874.5	28.53	5,354,351.3	26.29	157,335,680.5	1,545.11
NEWE	NPCC New England	46,905,984.7	722.07	9,322,707.0	71.76	1,685,853.4	12.98	47,265,180.4	727.60
NWPP	WECC Northwest	112,891,853.5	842.58	4,300,901.6	16.05	3,502,980.9	13.07	113,479,975.1	846.97
NYCW	NPCC NYC/Westchester	12,733,660.7	622.42	974,161.1	23.81	114,582.6	2.80	12,761,649.6	623.78
NYLI	NPCC Long Island	8,115,858.7	1,336.11	989,929.6	81.49	124,943.6	10.28	8,145,619.2	1,341.01
NYUP	NPCC Upstate NY	24,165,154.6	545.79	1,443,157.6	16.30	641,283.5	7.24	24,279,708.7	548.37
RFCE	RFC East	137,558,868.7	1,001.72	7,434,984.1	27.07	4,210,267.5	15.33	138,289,527.5	1,007.04
RFCM	RFC Michigan	74,602,328.8	1,629.38	2,789,651.5	30.46	2,457,844.2	26.84	75,012,586.0	1,638.34
RFCW	RFC West	449,994,271.4	1,503.47	10,897,168.6	18.20	14,813,680.5	24.75	452,404,812.2	1,511.52
RMPA	WECC Rookies	61,839,528.9	1,896.74	1,477,560.7	22.66	1,904,448.4	29.21	62,150,232.8	1,906.27
SPNO	SPP North	62,457,258.2	1,799.45	1,444,401.4	20.81	1,998,994.1	28.62	62,780,408.5	1,808.76
SPSO	SPP South	117,325,297.0	1,580.60	3,444,187.9	23.20	3,095,469.5	20.85	117,841,258.7	1,587.55
SRMV	SERC Mississippi Valley	90,967,299.2	1,029.82	3,650,522.7	20.66	1,900,187.0	10.76	91,300,158.7	1,033.58
SRMW	SERC Midwest	123,042,911.4	1,810.83	2,783,643.6	20.48	4,019,051.2	29.57	123,895,092.6	1,820.43
SRSO	SERC South	183,236,856.9	1,354.09	6,176,437.4	22.82	5,653,138.2	20.89	184,177,945.9	1,361.05
SRTV	SERC Tennessee Valley	163,960,526.8	1,389.20	4,177,202.5	17.70	5,290,412.2	22.41	164,824,401.3	1,396.52
SRVC	SERC Virginia/Carolina	167,452,188.6	1,073.65	6,766,296.6	21.69	5,502,582.8	17.64	168,376,135.0	1,079.57
U.S.		2,542,238,893.0	1,232.35	99,600,972.2	24.14	75,344,845.9	18.26	2,554,963,154.4	1,238.52

5.1.2 Significance of Total Equivalent Warming Impact

The need to phase out the production and use of chemicals that deplete the ozone layer while searching for ozone-friendly alternatives is the EPA’s approach to the Montreal Protocol and its responsibility in accordance with Title VI of the Clean Air Act. This approach has promoted innovative and effective alternatives that protect the ozone layer. In many cases these also save energy and reduce GHG emissions. Many activities can cause GHG emissions. TEWI is one method of computing the total relevant GHG emissions for a specific application, in this case refrigeration systems. Its application has gained wide acceptance internationally and has gradually been adopted country wide.

5.1.3 Limitations of Total Equivalent Warming Impact

TEWI calculations depend on a number of parameters, including efficiency of electricity generation and transmission, equipment performance, refrigerant characteristics, and patterns of use. The values used, especially those for emission factors and refrigerant GWP, are often subject to significant uncertainty. The designer needs to review the latest literature and technology to be aware of circumstances that might cause data used to exhibit characteristics that differ from those of other typical systems.

The authors recommend that the TEWI be used as tool to evaluate refrigeration systems that have similar purposes and functions.

5.2 Refrigerant Safety Classification

ASHRAE developed a naming classification for refrigerant safety. These consist of a single capital letter representing the toxicity divided into two classes (A or B) and a numerical value representing the flammability divided into four classes (1, 2, 2L, or 3). The toxicity class is determined based on the identification of toxicity at concentrations of ≤ 400 parts per million by volume. If no toxicity is identified, the refrigerant class is “A” but if toxicity is identified, the refrigerant class is “B.” The flammability class is determined based on the test procedures and conducted in accordance with ASTM Standard E681 using a spark ignition source. The flammability level classification spans from a no-flame classification of 1 to a highly flammable rating of 3. The factors that play into the flammability classification are based on a compound’s ability to show flame propagation in a given environment and specified test conditions provided by ASTM E681. Table 5-3 shows the safety group classifications and Table 5-4 shows the ASHRAE Standard 34 safety classification for selected refrigerants.

Table 5-3. Refrigerant Safety Classifications [6]

	Safety Group	
Higher Flammability	A3	B3
Lower Flammability	A2	B2
	A2L	B2L
No Flame Propagation	A1	B1
	Lower toxicity	Higher toxicity

Table 5-4. Select Refrigerant Classifications [6]

Refrigerant	ASHRAE 34 Safety Classification	Toxicity	Flammability
R-134a	A1	Low	No flame propagation
Propane	A3	Low	Highly flammable
NH ₃	B2L	High	Mildly flammable
CO ₂	A1	Low	No flame propagation

5.3 Leak Prevention

Refrigerants pose no safety risk while contained within the refrigerated system. Only when they leave the system are their dangers exposed. ASHRAE Standard 15 [7] provides descriptions for classifying systems as having low or high probability of refrigerant leakage from the systems into an occupied space. This standard also provides an occupancy classification for the location of the refrigeration system as it relates to the ability of individuals to respond to refrigerant exposure. Certain refrigerant uses are restricted based on the occupancy, refrigeration system, and refrigerant safety classifications. These restrictions govern equipment placement, personnel access, construction of enclosures, refrigerant detection, guidelines for open flames/electrical, and containment design. Properly applying these standards minimizes safety concerns when leaks occur.

5.4 Pressure Relief

PRVs should be installed to prevent pressure from exceeding the design pressure of the parts of the system being protected. The design pressure accounts for the pressure experienced under maximum operating, standby, or shipping conditions. The PRVs must be located to maintain safe pressures in the entire refrigeration system and to account for any possible restrictions such as valves closing. Described in ASHRAE Standard 15 [7] are the specific selection, pressures, locations, testing, and operation requirements to be applied to PRVs. To minimize the cost of multiple PRVs, a bypass can be used with a check valve to allow the refrigerant to flow to the nearest PRV.

5.5 Code Compliance

Most jurisdictions have adopted versions of the “international codes” published by the International Code Council. According to the International Mechanical Code, refrigeration systems are required to also comply with ASHRAE 15 [7] and International Institute of Ammonia Refrigeration -2 [8], unless otherwise contradicted by the International Mechanical Code. Most actionable compliance measures stem from refrigerant properties and their associated safety classifications, which determine the amount that is allowed to circulate through a system located in spaces that are considered to be commercial occupancies. Special measures can be taken to allow some spaces to exceed the allowable charge listed in the code; however, the sales floor of a grocery store is not one of these spaces. Therefore, refrigerants such as NH₃ and hydrocarbons cannot be used in direct systems serving evaporators on a sales floor. Minimum requirements must be met for systems in machinery rooms; exceptions apply to systems located outdoors.

Some jurisdictions may have adopted codes other than those from the International Code Council or may use adapted or modified International Code Council codes. Designers should be aware of any additional jurisdictional requirements for cities that have their own special requirements. Additional charge limits are often placed on specific systems or refrigerants such as NH₃.

The Occupational Safety and Health Administration's process safety management and the EPA's risk management plan regulations for NH₃ systems do not apply to commercial systems, because no more than 10,000 lb of NH₃ should ever be used in a commercial system. For systems with less than 10,000 lb, the International Institute of Ammonia Refrigeration developed the Ammonia Refrigeration Management Program, which can be used to comply with the EPA's and Occupational Safety and Health Administration's general duty clauses. This requires employers to provide their employees a workplace that is free from serious hazards.

5.6 U.S. Environmental Protection Agency Compliance

In response to the Montreal Protocol, the EPA created its GreenChill program, which operates as a partnership between the EPA and food retailers to reduce refrigerant emissions and identify acceptable refrigerant alternatives. Furthermore, GreenChill's Significant New Alternatives Policy program was developed and authorized under the Clean Air Act to list substitutes for ozone-depleting substances that reduce overall risk to the environment and to human health. The approved refrigerants, as well as their approved applications, are listed on the EPA's website. The use of any refrigerants not approved by the Significant New Alternatives Policy program is therefore prohibited; however, the EPA welcomes applications for new refrigerants.

NH₃, CO₂, and propane are all approved for commercial use with appropriate restrictions. The most stringent restriction applies to propane, limiting the allowable charge in self-contained equipment to 150 grams or less. This limitation could be loosened and other refrigerants could be approved as they become more widely used and understood.

5.7 References and Resources

1. "eGRID." Environmental Protection Agency, 2014. <http://www.epa.gov/cleanenergy/energy-resources/egrid/>.
2. Sand, J.R.; Fischer, S.K.; Baxter, V.D. "Energy and Global Warming Impacts of HFC Refrigerants and Emerging Technologies: TEWI-III." Presented at the International Conference on Climate Change, June 12-13, 1997. Oak Ridge, TN: Oak Ridge National Laboratory, June 1997. <http://web.ornl.gov/~webworks/cpr/pres/91639.pdf>.
3. http://www.airah.org.au/imis15_prod/Content_Files/BestPracticeGuides/Best_Practice_Tewi_June2012.pdf.
4. "The Montreal Protocol on Substances that Deplete the Ozone Layer." United Nations Environment Programme, 2011. http://ozone.unep.org/new_site/en/montreal_protocol.php.
5. "Overview – The Clean Air Act Amendments of 2009." U.S. Environmental Protection Agency, 2013. http://epa.gov/oar/caa/caaa_overview.html.

6. Maykot, R.; Weber, G.C.; Maciel, R.A. *Using the TEWI Methodology to Evaluate Alternative Refrigeration Technologies*. West Lafayette, IN. Purdue University School of Mechanical Engineering, 2004.
7. <http://docs.lib.purdue.edu/cgi/viewcontent.cgi?article=1708&context=iracc>.
8. “Designation and Safety Classification of Refrigerants.” ANSI/ASHRAE Standard 34-2013, 2013. <http://www.ashrae.org>.
9. “Safety Standard for Refrigeration Systems,” ANSI/ASHRAE Standard 15-2013, 2013. <http://www.ashrae.org>.
10. “American National Standard for Equipment, Design, and Installation of Closed-Circuit Ammonia Mechanical Refrigerating Systems.” ANSI/IIAR Standard 2-2008, 2008. <http://www.iiar.org>.

Chapter 6. Financial Evaluation

6.1 Introduction

Financial analysis of natural refrigerant systems requires an understanding of the factors that vary based on the system and refrigerant being analyzed and how these factors affect installation and annual operating costs. The primary factors affecting installed costs are equipment cost, refrigerant cost, and installation (labor and materials) costs. The primary factors affecting annual operating costs are energy efficiency, maintenance costs, and refrigerant costs associated with specific refrigerant cost per pound and leak rates. Several less predictable factors, including potential future laws or taxes on refrigerants and marketing benefits, should also be considered.

After costs and savings are calculated and assembled, they may be used in many ways to analyze the financial benefit or detriment of a system. Simple payback analysis is the most commonly used method for systems of this type. This method is easy to calculate and can be understood by a broad audience. Other economic metrics should be considered for natural refrigerant systems that account for the time value of money, because these systems have a long useful life and significant upfront cost.

6.2 Gathering Financial Information for Analysis

Regardless of the analysis method used, the input values are largely the same. Care should be taken to minimize the margin of input error to make the most informed decision possible. This margin of error can be minimized by fully designing the proposed system and soliciting bids for the equipment and installation. However, in many cases, the effort of fully designing multiple systems for cost estimating purposes is time and cost prohibitive, so some assumptions may be required, based on previous project costs, manufacturer estimations, or other industry estimates.

For natural refrigerant systems, the initial equipment, installation, and refrigerant costs vary. These costs are not necessarily higher than conventional HFC systems; in fact, the refrigerants often cost significantly less. To determine initial cost, the system's size must be known or estimated. Ideally, the quantity of each type of refrigerated case and walk-in are known. Case manufacturers typically provide cost differences, based on their added or reduced complexity caused by differing types and quantities of valves and other related components. Equipment must be sized at some level of detail to understand the scale of the systems that will be used. Care must be taken to include differential costs of components and the cost of additional components that may not have been required by baseline systems. Some components are identified by system schematics, but other required components, such as safety infrastructure, must also be accounted for. When the design of the system is known, equipment manufacturers should be engaged to provide cost information.

After determining initial equipment costs, the cost of the installation should be evaluated. As with equipment costs, the estimated cost of the installation should be based on the most accurate information available. If schematic design documents are available, a qualified contractor can provide a preliminary budget estimate for the installation. If the system concept has been only partially developed, rough cost estimates can be made based on rules of thumb along with industry cost information, or on previous project information. If previous results are used, care

must be taken to understand how costs are affected by system size, location, construction schedules, and any variations in the design from the referenced system.

Refrigerant cost calculations should account for the differences in charge and unit cost. Natural refrigerant system charges can vary significantly from traditional systems, because their thermodynamic properties and system design (to include liquid/vapor separators, surge vessels, etc.) differ. As with other costs, the most accurate refrigerant cost estimate requires an actual system design, including operating charge of all components. In the absence of a full design, estimates may be made using average pipe sizes and major system component sizing guidelines.

Annual costs of refrigeration systems can be divided into three categories, including energy, maintenance, and refrigerant costs. Energy costs may be estimated using the methods in Appendix A. Maintenance costs can be difficult to estimate because of limited historical data with natural refrigerant systems; however, reasonable estimates can be made based on similarities to systems for which maintenance data are more readily available. Maintenance costs can be broken down by components, making assumptions that components operate similarly regardless of the refrigerant used.

Annual refrigerant leak rates are normally calculated as a percentage of the total system charge. This indirectly accounts for more complex systems with larger volumes having higher numbers of potential leak points. Industry average leak rates range from 10%–20% of system volume per year. In practice, rates can be reduced by reducing the number of leak points, such as with close coupled systems. Systems operating at higher pressures are expected to have higher leak rates; however, in practice this has not been the case. In the absence of historical data or other relevant sources, 15% may be used as a reasonable estimate.

6.3 Financial Analysis Methods

Numerous methods are available for determining economic outcomes of equipment investments based on initial and recurring costs. A method is often selected based on company standards or familiarity. The complexity of costs and benefits and the requirements of the investor or decision maker should dictate which method is selected. Of these methods, simple payback, net present value, and internal rate of return are discussed in this chapter. The reference documents provide in-depth discussions of these and other methods.

6.3.1 Simple Payback

The most basic financial analysis method typically used is known as *simple payback*. As the name indicates, the method calculates the payback of a measure in a simple manner. The differential cost of the system is divided by the yearly savings to produce a payback, normally reported in years. For instance, if a natural refrigerant system costs \$10,000 more than the baseline system and the natural refrigerant system is expected to cost \$2,000 less per year to operate, it will pay back in 5 years. This method is popular because it provides a quick, easy comparison of systems with simple calculations and minimal information is required. It is also effective for communicating financial comparisons in a manner that is easy for varied audiences to understand. Its primary drawback is that it does not account for the time value of money. This is of particular significance with natural refrigerant systems because of their relatively long useful life.

$$\text{Simple Payback}(\text{years}) = \frac{\text{First Cost}}{\text{Yearly Savings}}$$

6.3.2 Net Present Value

As the name indicates, net present value refers to the value of a measure at the time it is purchased. This method takes into account the time value of money, using compound interest rates to determine the present value of each periodic cost or savings. These individual present values are then added together to determine the net present value.

$$\text{Net Present Value} = \frac{\text{Year 1 Saving}}{(1 + \text{Rate})^1} + \frac{\text{Year 2 Saving}}{(1 + \text{Rate})^2} + \dots + \frac{\text{Year X Saving}}{(1 + \text{Rate})^X} - \text{Initial Cost}$$

The selection of rate is typically set at a return rate that is required for the measure to be considered. At this rate, a positive net present value can be considered a good investment; a negative net present value is a poor investment. Savings that are made many years after the initial investment become less and less significant, especially with a high return rate.

6.3.3 Internal Rate of Return

Internal rate of return refers to the return rate for an investment at which the net present value is zero. This value can be used where no required investment return rate is known. Internal rate of return is favored in situations where several projects are competing for the same capital, such as with a low-GWP refrigeration system. Unfortunately, the formula structure does not allow the rate to be directly calculated. The easiest way to calculate the internal rate of return is to estimate what it is and calculate the net present value based on the estimate. If the net present value is positive, the rate estimate is too low, and the net present value is negative, the rate estimate is too high. Based on the outcome of net present value, the rate may be adjusted and recalculated until the error is small enough to be deemed insignificant.

6.3.4 General Cost Information

Each refrigeration system has several variations depending on refrigerant choices. Emerson Climate Technologies published findings and comparisons of 14 systems [1]. Energy use, TEWI, and initial costs were the driving factors for comparison; Table 6-1 summarizes the results.

Table 6-1. Driving Factors for Cost Comparisons

System Type	Energy Use	TEWI	Initial Costs	Maintenance Cost
Central DX	Base	Base	Base	Base
Distributed DX	0% to -3%	-24% to -36%	-13% to -14%	0%
Cascade CO ₂	+4% to +12%	-2% to -28%	+13% to +25%	0% to +100%
Secondary CO ₂	+7% to +12%	-41% to -43%	+17% to +32%	0% to +100%
Transcritical CO ₂	+12%	-14%	+48%	0%

6.4 References and Resources

1. Refrigerant Choices for Commercial Refrigeration: Finding the Right Balance. Emerson Climate Technologies, 2010. http://www.emersonclimate.com/europe/documents/resources/tge124_refrigerant_report_en_1009.pdf.
2. “Capital Budgeting.” Accounting Explained, 2013. <http://accountingexplained.com/managerial/capital-budgeting/>.
3. Fuller, S.K.; Petersen, S.R. *Life-Cycle Costing Manual for the Federal Energy Management Program*. NIST Handbook 135. Gaithersburg, MD: Building and Fire Research Laboratory, 1996.
4. “Building Life Cycle Cost Programs.” U.S. Department of Energy, 2013. http://www1.eere.energy.gov/femp/information/download_blcc.html.
5. “User Friendly Building Life-Cycle Costing: A Spreadsheet Implementation of BLCC.” DOE2, 2012. <http://www.doe2.com/>.

Chapter 7. End User Considerations

7.1 Regulatory Requirements

Refrigeration is required by federal food safety requirements for cold handling of perishable foods. The U.S. Food and Drug Administration requires that all perishable foods be maintained at or below 41°F for cold holding [1]. The agency has no recommendations or requirements for the refrigeration technology used.

Most refrigeration technologies use refrigerants that, when leaked, cause varying degrees of direct harm to the environment. Thus, the EPA has instituted regulatory requirements for handling these refrigerants. All supermarket owners must comply with EPA regulations and the U.S. Food and Drug Administration Food Code.

Implementing refrigeration technologies that use low-GWP refrigerants may reduce EPA compliance reporting requirements.

7.2 Profitability and Cost Control

Supermarkets operate and compete on small net margins. The average net margin for U.S. supermarkets is very close to par with the average cost for utilities and maintenance. The average net margin as a percent of sales is 1.9% and the average costs associated with utilities and maintenance are 2.1% [2].

Any change in costs for utilities or maintenance will result in a nearly equivalent change in net profits. Therefore, any decision to implement new technologies must be scrutinized closely to understand the financial impact to the business. In the absence of regulatory requirements to implement natural or low-GWP refrigerants, voluntary adoption of new technologies is limited if the technology adds cost. At the same time, the opportunity to capture cost savings is very attractive.

7.3 Challenges to Market Entry and Potential Solutions

Several challenges have limited the transition to climate-friendly alternative refrigeration systems. Table 7-1 summarizes the challenges and potential solutions associated with the various alternatives.

Table 7-1. Challenges to Alternatives [3]

Alternative	Challenges to Market Entry	Potential Solutions
Advanced Refrigeration System Designs	Technician experience Energy efficiency concerns	Training and education Standards and service procedures Case studies and operational guidelines
Hydrocarbons	Highly flammable Code restrictions Liability concerns	Safety devices Standards and service procedures Training and education
NH ₃	Toxic Slightly flammable Code restrictions	Engineering design Standards and safety regulations Code revisions
CO ₂	Safety risks High operating pressure	Engineering design Training and education
HFO Blends	Market availability	Research and development

7.4 Corporate Image and Environmental Stewardship Goals

Consumer awareness of environmental concerns has led most corporations to adopt and implement practices to minimize the inherent harms associated with their particular business practices.

Refrigeration system design is an obvious area of concern because of two potential causes of environmental harm: direct harm from leaking refrigerants and indirect harm associated with generating the energy required to power the refrigeration system. Adopting low-GWP or natural refrigerants helps address the environmental concerns for direct refrigerant leakage. However, their associated energy use must also be considered to ensure a net positive environmental impact. If the energy requirements for low-GWP or natural options are higher than other options, the adoption reduces the end user's profitability and does not necessarily reduce potential environmental harm.

7.5 References and Resources

1. 2013 FDA Food Code. US Department of Health and Human Services, Public Health Service, Food and Drug Administration, PB2013-110462, 3-501.16: Time/Temperature Control For Safety Food, Hot and Cold Holding
2. *Financing Health Food Options: Implementation Handbook, Understanding the Grocery Industry*. The Reinvestment Fund, September 30, 2011.
3. *Transitioning to Low-GWP Alternatives in Commercial Refrigeration*. United States Environmental Protection Agency, October 2010. http://www.epa.gov/ozone/downloads/EPA_HFC_ComRef.pdf.

Appendix A: Spreadsheet Calculations

As a companion to this playbook, a spreadsheet-based tool was created using Microsoft Excel to aid in the comparison of low-GWP refrigeration systems in terms of energy consumption and TEWI contributions, using information that is typically readily available for systems being investigated. To minimize the information required from the user, many assumptions or default values are used. The authors recommend that users do not compare the outcomes calculated with energy models for one system with the results from the spreadsheet for another because the differences in definitions or underlying assumptions will likely lead to false comparisons. For example, the spreadsheet estimates evaporator load based on an algorithm developed⁹ for the California Energy Commission. This algorithm adjusts LT and MT display case capacities based upon outdoor air temperatures, using intermediate assumptions about how the indoor conditions relate to the outdoor conditions. This algorithm keeps the spreadsheet simple, but does not account for variations in internal building conditions, occupancy loads, stocking, lighting schedules, etc. This can be a source of considerable differences with a more in-depth energy model, even when comparing the spreadsheet results for a system with energy model results for that same system configuration.

The spreadsheet was created to be highly transparent and accessible. No macros or hidden calculations are used, so users can see and understand how each value is calculated. The user may change the calculations or add additional levels of details in specific parts of the calculation. The open nature of the spreadsheet means that the user must be careful not to unintentionally delete a cell before understanding how the cell is referenced by other cells.

The user needs to fully understand the inputs and outputs of the spreadsheet before using it to make decisions. For example, the evaporator load is a single input value in the spreadsheet, but represents a fairly complex number. The user must understand what is accounted for in this number, including case design safety factors and adherence to DOE requirements.

The spreadsheet is intended to be relatively self-guided and intuitive. It has an instruction worksheet to explain its intended use. As the user selects system options, the spreadsheet adjusts subsequent input fields to tailor the inputs to the system being defined. After system inputs are entered, results can be viewed and the spreadsheet shows intermediate calculations in tabular form for additional processing.

Most of the systems described in the playbook can be analyzed using the spreadsheet. This includes CO₂, propane, NH₃, R-134a, R-404a, R-407a, R-407c, and R-507 as primary and secondary refrigerants. It also includes propylene glycol as a secondary heat transfer fluid. Up to two suction groups of the primary refrigerant and up to two secondary loops/systems may be analyzed at a time. Self-contained systems may be analyzed with the spreadsheet by calculating values for each case individually and adding together. Transcritical CO₂ systems cannot be analyzed with the spreadsheet tool and should be calculated using other methods, such as the Pack Calculation Pro calculator available from Innovation Factory [1].

References and Resources

1. Pack Calculation Pro. Innovation Factory, 2014. <http://en.ipu.dk/Indhold/refrigeration-and-energy-technology/Pack%20Calculation%20Pro/Pack%20Calculation%20Pro.aspx>.

2. Faramarzi, R.T.; Walker, D.H. *Investigation of Secondary Loop Supermarket Refrigeration Systems*. Work prepared by Southern California Edison, Foster-Miller, Inc. Sacramento, California: California Energy Commission, March 2004. http://www.arb.ca.gov/cc/commref/secondary_loop_supermarket_refrigeration_cec_pier_march_2004.pdf.

Appendix B: Baseline Assumptions and Results

EnergyPlus (v8.1) was selected to complete the Natural Refrigerants baseline energy model, because it can model complex supermarket refrigeration systems. The Natural Refrigerants baseline energy model was initially generated using OpenStudio and was then transferred for completion in EnergyPlus, because required features to complete the model were unavailable in OpenStudio at the time.

Climatic design data were selected at the ASHRAE 0.4% dry-bulb cooling and 99.6% dry-bulb heating conditions. Typical Meteorological Year-based EPW weather data for EnergyPlus were used [1]; the model was applied across 17 U.S. locations. Table B-1 lists the cities selected for evaluation to provide geographic depth of results for the baseline energy models.

Table B-1. Representative Cities for Climate Data Evaluation

No.	ASHRAE Climate Zone	Representative City	EPW Weather File Source
1	1A	Miami, Florida	Miami International Airport
2	2A	Houston, Texas	Bush Intercontinental Airport
3	2B	Phoenix, Arizona	Sky Harbor International Airport
4	3A	Atlanta, Georgia	Hartsfield-Jackson International Airport
5	3B	Los Angeles, California	Los Angeles International Airport
6	3B	Las Vegas, Nevada	McCarran International Airport
7	3C	San Francisco, California	San Francisco International Airport
8	4A	Baltimore, Maryland	Baltimore-Washington International Airport
9	4B	Albuquerque, New Mexico	Albuquerque International Airport
10	4C	Seattle, Washington	Seattle-Tacoma International Airport
11	5A	Chicago, Illinois	Chicago-O'Hare International Airport
12	5A	Boston, Massachusetts	Logan International Airport
13	5B	Denver, Colorado	Denver International Airport
14	6A	Minneapolis, Minnesota	Minneapolis-St. Paul International Airport
15	6B	Helena, Montana	Helena Regional Airport
16	7	Duluth, Minnesota	Duluth International Airport
17	8	Fairbanks, Alaska	Fairbanks International Airport

The baseline building energy model for this playbook was created to be a single-story 47,000-ft² supermarket to correspond to a Food Marketing Institute study [2], which indicated that the average supermarket size from 2004 through 2010 was 46,980 ft². The baseline building was divided into five zones: sales floor, refrigeration area, backroom, offices, and service departments. It was modeled to encompass the assumptions of ASHRAE 90.1-2004 [3] Appendix G with exceptions or modifications as noted. This code was selected because it was assumed to be representative of the bulk of existing building stock. This strategy of selecting baseline inputs to applicable building codes applies throughout the baseline model.

Building Constructions

Building envelopes for each climate zone were modeled to meet the baseline requirements established by ASHRAE 90.1-2004 Tables 5.5-1 through 5.5-8 and Appendix G. **Exception:** ASHRAE 90.1-2004 Appendix G indicates that exterior walls shall be steel-frame construction; however, solid-grouted concrete masonry unit walls with continuous insulation were used so as

to better represent common supermarket construction. Building envelope material data were obtained from NREL's Building Component Library [4]. Where materials were unavailable from the Building Component Library, materials were selected from the provided EnergyPlus materials data set or were created from material tables provided in the *ASHRAE Fundamentals 2005 Handbook*.

Zone Loads and Schedules

Zone occupancy, lighting and load profiles, and related mechanical system and building schedules were set to match the profiles established by the ASHRAE 90.1-2004 User Manual Table G-B and Tables G-E through G-N. Because the building is considered mixed use, each modeled zone was independently considered to use the best-matching building type per Table G-B.

Zone Mechanical Systems

HVAC systems were modeled to meet Baseline System 3 (packaged single-zone air conditioning) per ASHRAE 90.1-2004 Tables G3.1.1A and G3.1.1B. **Exception:** Air distribution systems were sized to provide 1 CFM/ft² for supermarkets per the *ASHRAE Applications 2003 Handbook*. Mechanical equipment capacities and efficiencies were sized per ASHRAE 90.1-2004 Appendix G with a heating sizing factor of 1.25, cooling sizing factor of 1.15, and heating and cooling supply temperature differentials of 20°F between the supply air temperature and thermostat set point. Mechanical capacity and energy input ratio curves were modeled using OpenStudio defaults. Economizers were not included because of refrigerated equipment in spaces per ASHRAE 90.1-2004 Section G3.1.2.6(b).

Mechanical heating was modeled as natural gas; cooling was modeled as DX. Fans were set to operate at constant volume during occupied hours and to cycle as required to maintain setback points during unoccupied hours. Zone heating and cooling set points were input per the *ASHRAE Refrigeration 2002 Handbook* for the sales floor zone and *ASHRAE Applications Handbook 2003* for all other zones. Dehumidification controls were established to limit each air-conditioned zone to 50°F dew point temperature to minimize the impact to building refrigeration systems. All conditioned zones were programmed via the EnergyPlus Energy Management System to activate night-cycle operation on either sensible or latent load for space temperature and dehumidification control during unoccupied periods because of building pressurization.

Infiltration air leakage rates were estimated using Chartered Institution of Building Service Engineers TM23 [5] "Building Tightness Specifications for Supermarkets" with infiltration to meet the "Good Practice" qualification. The pressure drop coefficient per Chartered Institution of Building Service Engineers TM23 in CFM/ft² was corrected to match the reference wind speed of the BLAST coefficients (7.5 mph) [6]. Air changes per hour were then calculated volumetrically per zone and scheduled to reduce infiltration to 25% during zone occupied hours because of pressurization from outside air through the system.

Refrigerated display case end-use loads located within the retail sales area were separated into a dedicated zone that shares the HVAC system with the sales floor zone. The purpose was to simulate the microclimate effect in a supermarket when the refrigeration effect of the display cases removed heat from the surrounding environment, causing "cold spots" on the sales floor

where cases are located. The thermostat for the shared HVAC system is located within the sales floor zone, which causes the temperature in the refrigeration area zone to remain relatively lower as the sales floor zone is satisfied. The result is a simulation of the microclimate and a corresponding reduction in required refrigeration load as the temperature difference of the case operating temperatures and their surrounding environment is reduced from their rated conditions.

Service Hot Water

The baseline model water heater component was sized to accommodate an assumed 2,700 gallons per day of hot water consumption at a 140°F set point and 80% fuel efficiency. The load profiles for the service hot water system were applied from the *ASHRAE 90.1-2004 User Manual* Tables G-L. The domestic cold water temperature profile is generated using the EnergyPlus correlation method that estimates entering cold water temperatures based on outside dry bulb temperatures [7].

Refrigeration System Overview

A representative template for baseline supermarket refrigeration systems was adapted from an existing supermarket in western Montana, which was selected because it comprised similar zone and building areas as the intended baseline model. The purpose was to realistically quantify refrigeration system loads and performance for the baseline model. At the time of this publication, no published industry-recognized, national guidelines or standards provided minimum efficiency requirements or recommendations for managing commercial refrigeration systems. Many of the modeled assumptions established for the baseline refrigeration systems were based upon industry standards, common practices, and internal discussions with NREL to confirm and approve these assumptions.

Baseline refrigerated display case capacities were modeled to adhere to the DOE 2012 Standards for Commercial Refrigeration (DOE 2012) [8,9]. The selected standard identifies end-use equipment categorically and identifies the maximum allowable daily energy consumption for each connected refrigeration system. The maximum allowable daily energy consumption for each equipment class in DOE 2012 consolidates all energy required to drive the indicated refrigeration system (compressor power, internal display loads, condenser fan energy, etc.) per each unit of total display area. Technical Support Documents for the DOE 2012 ruling were used to isolate performance characteristics for individual components for each equipment class that comprises the maximum allowable daily energy consumption. This enabled researchers to appropriately input refrigeration systems into EnergyPlus in a manner that complied with the categories defined within DOE 2012.

Baseline refrigerated walk-in coolers and freezers were modeled to adhere to the Energy Independence and Security Act of 2007 [10]. This act established mandatory federal requirements for minimum insulation values of walk-in cooler and freezer panels and freezer floors, evaporator fan selection, lighting efficacy, glazing construction, and anti-sweat heater power (Table B-2).

Table B-2. DOE 2012 Governed Baseline Refrigeration Systems

DOE 2012 Equipment Category	Condensing Unit Configuration	Equipment Family	Equipment Class Designation	Quantity (Linear Feet)
Commercial Refrigerators and Commercial Freezers	Remote (RC)	Vertical open	VOP.RC.M	288
		Semivertical open	SVO.RC.M	56
		Horizontal open	HZO.RC.M	36
		Vertical closed transparent	VCT.RC.L	136
		Service over counter	SOC.RC.M	28
Commercial Ice Cream Freezers	Remote (RC)	Vertical closed transparent	VCT.RC.I	144
		Horizontal open	HZO.RC.I	8
Other Connected Refrigeration Systems				
Equipment Type	Condensing Unit Configuration	Equipment Family	Equipment Class Desig.	Quantity (Square Feet)
MT Walk-Ins	Remote (RC)	N/A	N/A	2,795
LT Walk-In	Remote (RC)	N/A	N/A	120
Ice Cream Walk-In	Remote (RC)	N/A	N/A	520

Refrigeration Compressor Systems

The refrigeration compressor systems were modeled to accommodate a typical installation for a supermarket refrigeration system. The refrigerant for each system was modeled as R-404a, which is a low-glide zeotropic refrigerant that is commonly used in the supermarket industry.

Compressor racks were equipped with semihermetic reciprocating compressors. The baseline refrigeration system comprised four compressor systems: Rack A, Rack B, Rack C, and Rack D. Racks A and B are LT systems that operate at -25°F saturated suction temperature. Racks C and D are MT racks that operate at $+21^{\circ}\text{F}$ saturated suction temperature. End-use loads assigned to the modeled racks were input to correspond to the connected loads of the reference supermarket template.

Each refrigeration compressor system was enabled to simulate floating suction pressure control. To perform this simulation, EnergyPlus calculates the maximum allowable evaporator temperature for each connected system and sets the system temperature to the lowest calculated evaporator temperature per time step.

Each refrigeration compressor system was included with a “Dummy Load,” which was created to set the system operating temperature to account for suction line pressure drop. The compressor system calculations inherent within EnergyPlus set each system operating temperature to 1°C below the lowest connected evaporator temperature. The Dummy Loads further reduced LT systems by 1.2°F and MT systems by 0.2°F to bring the systems in line with conventional temperature reductions of 3°F for LT systems and 2°F for MT systems accounted for during system design. The assigned Dummy Loads did not add or remove evaporator loads from the system and impacted each system’s operating temperature only.

Compressors were selected to maintain a constant return gas superheat setting of 40°F higher than evaporator temperature for LT systems and 30°F for MT systems. EnergyPlus maintains a constant 7°F evaporator superheat throughout the simulation, which is included in the compressor superheat constant. Each rack was equipped with a liquid suction heat exchanger to

transfer heat from the liquid line to the suction line. Each liquid suction heat exchanger was modeled to provide a 50°F subcooled liquid temperature at the minimum condensing condition.

Compressors were input into EnergyPlus using compressor coefficients adhering to the format defined by ANSI/AHRI Standard 540-2004 [11]. EnergyPlus used these compressor coefficients to generate capacity and power performance curves based upon the saturated suction temperature entering and the saturated discharge temperature leaving the compressor. The coefficient formula defined by ANSI/AHRI Standard 540-2004 for calculating compressor performance and compressor coefficients used in the baseline energy model are indicated in the equation and in Table B-3:

$$X = C_1 + C_2(S) + C_3(D) + C_4(S^2) + C_5(S \cdot D) + C_6(D^2) + C_7(S^3) + C_8(D \cdot S^2) + C_9(S \cdot D^2) + C_{10}(D^3)$$

Where:

- D = Condensing dew point temperature in °C
- S = Suction dew point temperature in °C
- X = Compressor capacity or power input in Watts

Table B-3. LT and MT Compressor Coefficients

LT Compressor Coefficients (SI Units*)										
Input Type	C ₁	C ₂	C ₃	C ₄	C ₅	C ₆	C ₇	C ₈	C ₉	C ₁₀
Capacity(W)	170,752	6,103	-2,959	78.26	-90.96	19.79	0.436	-0.609	0.459	-0.041
Power(W)	29,669	1,028	-442.2	18.11	-20.38	11.13	0.140	-0.218	0.204	-0.059
MT Compressor Coefficients (SI Units*)										
Input Type	C ₁	C ₂	C ₃	C ₄	C ₅	C ₆	C ₇	C ₈	C ₉	C ₁₀
Capacity(W)	151,166	5,266	-1,852	60.67	-46.93	5.731	0.136	-0.403	-0.039	-0.036
Power(W)	7,439	-269.6	553.6	-9.856	14.87	-3.386	-0.101	0.097	-0.040	0.010

* Note: EnergyPlus accepts coefficient inputs in SI units only.

Refrigeration Condensers

The refrigeration system condensers were modeled as air cooled for all locations with one condenser assigned per refrigeration compressor system. Condensers operated using constant-volume fans that cycle on load. This was simulated in EnergyPlus by using the fixed condenser fan control method, which calculates part-load fan power as a linear function of the rejected load. Condensers serving LT systems were sized for a saturated condensing temperature at 10°F higher than the ambient dry-bulb temperature. Condensers serving MT systems were sized for condensing temperatures 15°F higher than the outside temperatures. All condensers were controlled to hold a minimum 70°F saturated condensing temperature to maintain required pressures at mechanical thermal expansion valves. Condenser temperature controls were managed using the EnergyPlus energy management system.

Baseline condenser efficiencies were set to provide a minimum 50 Btu/h/W of fan power for LT condensers and a minimum 75 Btu/h/W of fan power for MT condensers as recommended by NREL.

Results

Table B-4 indicates the modeled annual energy whole-building consumption for the baseline energy model in the selected 17 U.S. locations.

Table B-4. Baseline Model Whole-Building Energy Consumption

No.	ASHRAE Climate Zone	Representative City	Baseline Energy Model Annual Results		
			Electricity Use (kWh)	Gas Use (Therms)	Energy Use Intensity (EUI) (kBtuh/ft ²)
1	1A	Miami, Florid	2,068,610	22,665	198.4
2	2A	Houston, Texas	1,872,196	30,325	200.4
3	2B	Phoenix, Arizona	1,735,460	22,785	174.5
4	3A	Atlanta, Georgia	1,663,917	35,496	196.3
5	3B	Las Vegas, Nevada	1,581,930	27,827	174.0
6	3B	Los Angeles, California	1,565,370	31,024	179.6
7	3C	San Francisco, California	1,453,854	35,335	180.7
8	4A	Baltimore, Maryland	1,581,851	43,896	208.2
9	4B	Albuquerque, New Mexico	1,466,758	35,437	181.9
10	4C	Seattle, Washington	1,428,482	43,589	196.4
11	5A	Boston, Massachusetts	1,502,154	49,482	214.3
12	5A	Chicago, Illinois	1,523,575	51,371	219.9
13	5B	Denver, Colorado	1,439,519	41,766	193.4
14	6A	Minneapolis, Minnesota	1,485,231	56,337	227.7
15	6B	Helena, Montana	1,396,064	51,450	210.8
16	7	Duluth, Minnesota	1,413,986	63,273	237.3
17	8	Fairbanks, Alaska	1,352,471	75,355	258.5

U.S. climate zones begin at tropical climates with climate zone 1 and transition to cold climates approaching climate zone 8. Subcategories of climate zones A, B, and C indicate moisture conditions related to the climate zones; A indicates humid, B indicates dry, and C indicates a marine climate. The results demonstrate anticipated energy use per climate zone; warmer climates consume more electricity (refrigeration) and colder climates consume more natural gas (heating).

A comparison of the resulting energy use intensities of the analysis to benchmarks such as EPA's Target Finder [12] may demonstrate that the baseline energy model performs considerably well to available metrics (ENERGY STAR[®] scores: ~80–90). When making comparisons to benchmark such as Target Finder or existing utility billings, several factors in the energy model must be considered. Benchmarks represent actual consumption of existing buildings under real weather conditions, which may contain aging equipment affected by human behavior. An energy model represents a scenario of a building performing ideally with all components (equipment, constructions, people, etc.) behaving predictably and to specification, which is seldom the case in any building that does not receive continuous commissioning.

Other likely discrepancies of note are that many refrigeration systems are not typically controlled to a 70°F minimum condensing temperature and most connected display cases are not DOE 2012 compliant (installed pre-2012). Furthermore, the assumptions used from the *ASHRAE 90.1-2004 User Manual* for miscellaneous equipment loads may not represent all supermarkets. The combination of these items may cause the model to appear too efficient when compared with many supermarkets, but is sufficient when the baseline is being only for “economy of scale” comparisons between refrigeration system components.

References and Resources

1. “EnergyPlus Energy Simulation Software Weather Data.” U.S. Department of Energy, 2014. http://apps1.eere.energy.gov/buildings/energyplus/weatherdata_about.cfm.
2. “Supermarket Facts: Median Total Store Size – Square Feet.” Food Marketing Institute. Arlington, VA: 2010. <http://www.fmi.org/research-resources/supermarket-facts/median-total-store-size-square-feet>.
3. *ANSI/ASHRAE/IESNA Standard 90.1-2004 Energy Standard for Buildings Except Low-Rise Residential Buildings*. Atlanta, GA: American Society of Heating, Refrigerating and Air-Conditioning Engineers, Inc., 2004.
4. “Building Component Library.” National Renewable Energy Laboratory, 2014. <http://bcl.nrel.gov>.
5. *TM23 Testing Buildings for Air Leakage*. London, UK: Chartered Institution of Building Service Engineers, 2014. <http://www.cibse.org/knowledge/cibse-tm/tm23-testing-buildings-for-air-leakage>.
6. Gowri, K.; Winiarski, D.; Jarnagin, R. *Infiltration Modeling Guidelines for Commercial Building Energy Analysis*. Richland, WA: Pacific Northwest National Laboratory, 2009.
7. Burch, J.; Christensen, C. “Towards Development of an Algorithm for Mains Water Temperature.” Proceedings of the Solar 2007 Conference, Jul. 8-12, 2007. Boulder, CO: American Solar Energy Society; 6 pp.
8. *Energy Conservation Program: Energy Conservation Standards for Commercial Refrigeration Equipment*. 10 CFR Part 431-66. Office of Energy Efficiency and Renewable Energy, Department of Energy (2012): RIN 1904-AC19.
9. *Energy Conservation Standards for Ice Cream Freezers; Self-Contained Commercial Refrigerators, Freezers, and Refrigerator-Freezers Without Doors; and Remote-Condensing Commercial Refrigerators, Freezers, and Refrigerator-Freezers*. EERE-2006-STD-0126. Office of Energy Efficiency and Renewable Energy, Department of Energy (2006): RIN 1904-AB59.
10. *Energy Independence and Security Act of 2007*. H.R. 6. 101st Congress, Congressional Record 121 (2007): Public Law 110-140. <http://www.gpo.gov/fdsys/pkg/PLAW-110publ140/pdf/PLAW-110publ140.pdf>.
11. “ANSI/AHRI Standard 540-2004 Standard for Performance Rating of Positive Displacement Refrigerant Compressors and Compressor Units.” Air-Conditioning, Heating, & Refrigeration Institute, 2004. <http://www.ahrinet.org/>.
12. “EPA’s Target Finder Calculator.” ENERGY STAR, 2014. <http://www.energystar.gov/buildings/service-providers/design/step-step-process/evaluate-target/epa%E2%80%99s-target-finder-calculator>.

Appendix C: Energy Modeling Results

Overview

A selected group of systems outlined in this playbook were modeled using EnergyPlus to provide energy consumption comparisons. The energy modeling that was performed was limited to the following comparisons:

- The multiplex R-404a baseline system described in Appendix B
- A water-cooled, DX NH₃ system cascaded with a combined CO₂ system
- An air-cooled, DX R-134a system cascaded with a combined CO₂ system.

These systems were selected for their availability of information for modeling purposes and the industry's interest in using NH₃ as a commercial refrigerant in place of a synthetic refrigerant.

Both proposed designs use subcritical, combined CO₂ systems as the secondary loop of a cascade system. A cascade system has two or more refrigerant loops, each with a condenser, a compressor, and one or more evaporators. An evaporator of the primary loop acts as the condenser for a secondary loop. A subcritical system maintains the system pressure lower than the critical pressure of the fluid (1,055 psig for CO₂). A combined secondary system provides cooling for both medium and LT systems. This is accomplished by transferring heat via chilled fluid through MT heat exchangers and through DX of the same fluid for LT systems. Expanded vapor from the LT system is drawn through compressors and returned to the secondary condenser.

The core building components of the baseline model referenced in Appendix B were used for all three energy models with modifications to the refrigeration systems only. For each model, the same end-use loads for refrigeration systems were used to establish the DOE 2012 compliant display cases as the baseline reference. The results of the energy modeling comparison at the end of this appendix demonstrate the isolation of components related specifically to refrigerant performance: compressor power, condenser power, and pump power. All other outputs are—or are very nearly—identical.

Proposed Design #1—Cascade Ammonia-Carbon Dioxide System

Proposed Design #1 places a primary DX NH₃ system over a combined CO₂ system as the secondary. The refrigeration systems were modeled in EnergyPlus as a cascade system where the primary system evaporator operates at +13°F with a 7°F approach temperature to condense the secondary system at +20°F.

The CO₂ secondary system serves all of the end-use display cases and walk-ins and transfers all acquired loads to the primary system. The CO₂ secondary system was modeled to pump condensed refrigerant liquid to the end-use loads. The secondary pump was modeled as a constant-speed pump sized to meet the total load with a 2.0 recirculation rate. This recirculation rate constitutes the cycling rate of the fluid through the connected MT heat exchangers to achieve a complete latent heat transfer. A recirculation rate of 2.0 indicates that the refrigerant fluid returns to the fluid storage vessel at 50% quality (a half-vapor/half-liquid mixture). The vapor separates and is drawn to the secondary condenser while the remaining liquid portion is

recirculated through the heat exchangers. MT heat exchangers operate at the +20°F temperature of the condensed liquid refrigerant. The MT loads are managed by the Refrigeration:SecondarySystem object within EnergyPlus.

The pump also maintains pressure to LT expansion valves as required. The refrigerant is expanded and used to maintain a -25°F evaporator temperature to the LT systems. The expanded vapor is drawn through semihermetic reciprocating compressors and returned to the secondary condenser. The secondary compressors were input using ANSI/AHRI Standard 1200 compressor coefficients and were selected to maintain a +40°F return gas superheat. EnergyPlus maintains a fixed 7°F evaporator superheat which is a portion of the return gas temperature that performs useful cooling. The LT loads are managed by the Refrigeration:System object within EnergyPlus.

The secondary condenser is served by the primary system evaporator. The primary evaporator expands liquid NH₃ in a DX process to condense the CO₂ secondary system. This process is handled by the Refrigeration:Condenser:Cascade object within EnergyPlus. The expanded vapor from the primary evaporator is drawn through reciprocating compressors and returned to the primary condenser. The primary compressors were input using ANSI/AHRI Standard 1200 compressor coefficients and were selected to maintain a 7°F return gas superheat and a minimum 65°F condensing temperature. The primary load is managed by the Refrigeration:System object within EnergyPlus.

The primary system uses an indirect water-cooled condenser where the refrigerant rejects heat through a water-cooled heat exchanger that conveys the heat via water to a rejection device. The water-cooled heat exchanger is managed by the Refrigeration:Condenser:WaterCooled object in EnergyPlus. The water-cooled condenser was selected to provide a 10°F range and operate at constant flow with a propylene glycol mixture selected according to site for freeze protection. The water-cooled condenser is connected to a fluid loop within the energy model where a constant-speed pump moves the rejection fluid to a variable-speed cooling tower managed by the CoolingTower:VariableSpeed object. Ideally, an evaporative fluid cooler would be used as the rejection device; however, a variable-speed fluid cooler is not available in EnergyPlus at this time. The cooling tower was selected to provide a 10°F approach temperature and operate at a 10°F range. Input fan power and airflow rates were adapted from a selected manufacturer's data sheets with sizing and requirements per ASHRAE climate location to accommodate localized design requirements.

A reset schedule based on outside ambient air temperature was used to control the variable frequency drive to modulate the frequency of the current sent to the motors that power fans and pumps in the tower. This allows for variation in motor power output based on demand. The cooling tower seeks to maintain the temperature of the water exiting the cooling tower at the set point determined by the condenser loop. If the exiting water temperature is higher than set point, the variable-speed tower fan is turned on to reduce the exiting water temperature. If the exiting temperature is lower than set point, the fans are turned off entirely and the water is simply allowed to flow through the tower at a minimum flow rate. Basin heaters are required to prevent freeze up in the tower basin during winter months. A basin set point temperature of 35.6°F was used in the model.

To reasonably model the Evaporator-Condenser in which the CO₂ system rejects heat to the NH₃ system, EnergyPlus Input-Output Reference, Refrigeration:TransferLoadList object was used to distinguish between the two systems and their performance simulated using the Refrigeration:System object reference.

Proposed Design #2—Cascade R-134a-Carbon Dioxide System

Proposed Design #2 places a primary DX R-134a system over a combined CO₂ system as the secondary. The refrigeration systems were modeled in EnergyPlus as a cascade system where the primary system evaporator operates at +13°F with a 7°F approach temperature to condense the secondary system at +20°F.

The primary and secondary system set points and management are identical to the methods described for Proposed Design #1, with the following exceptions: The R-134a refrigerant was substituted for NH₃, the primary compressors were selected for the new refrigerant, and the condensing method was changed from an indirect water-cooled system to a direct air-cooled system.

The primary system uses a direct, air-cooled condenser where the refrigerant rejects heat and condenses through a coil directly exposed to outside air which conveys rejected heat via forced airflow. The air-cooled condenser is managed by the Refrigeration:Condenser:AirCooled object in EnergyPlus. The air-cooled condenser objects provide a 10°F approach temperature for LT systems and a 15°F approach temperature for MT systems. Input fan power was calculated per site location such that the rejection efficiency of any condenser was 5 Btu/Wh·°F at minimum during ASHRAE 99.6% design conditions.

The condenser operated using constant-volume fans that cycled on load. This was simulated in EnergyPlus by using the fixed condenser fan control method. Condenser temperature controls were managed using the EnergyPlus energy management system to maintain constant approach temperatures when the outdoor air temperature exceeds the minimum condensing temperature set point.

Analysis—Understanding the Energy Modeling and Spreadsheet Results

The results for the combined energy analysis represented in this playbook used outputs from the EnergyPlus modeling effort and the spreadsheet tool developed for this playbook. The inputs for the spreadsheet tool matched the inputs for the energy models described in Appendices A and B as much as possible to maintain consistency. All the refrigeration end-use (case and walk-in) and building environmental load outputs are—or are very nearly—identical for the different modeled system types. The key differences lie in the energy consumption of refrigeration system components such as compressors, condensers, and pumps. The results were analyzed and grouped by ASHRAE climate zone, as indicated in Appendix B.

The results of the 17 climate zones show that the whole-building EUI increases in colder climate zones. Although refrigeration systems tend to gain in efficiency in colder climates, these efficiency gains reach a plateau when limited by the minimum condensing temperature of the system. Increased heating requirements for buildings in colder climates tend to outweigh these

efficiency gains and raise the EUI. As an example, the heating required in climate zone 8 (Fairbanks, Alaska) is 55,635 therms/year—a difference of 48,136 therms versus climate zone 1 (Miami, Florida). The refrigeration energy use in Miami is 615,440 kWh. The refrigeration energy use in Fairbanks, Alaska, is 367,520 kWh/year—a difference of an equivalent 8,459 therms. This equates to a net increase of energy consumption in Fairbanks, Alaska, of 39,677 Therms, resulting in an 84.4 kBtu/ft² increase in the reference building's annual EUI.

EnergyPlus and the spreadsheet tool agree that the primary compressors are more efficient in the cascade systems than the parallel R-404a system, with performance of NH₃/CO₂ surpassing the performance of R-134a/CO₂. However, the two approaches disagree when it comes to total refrigeration system energy consumption. EnergyPlus results suggest that, with few exceptions among climate zones, the R-404a parallel system uses less energy than the proposed cascade systems. However, the spreadsheet tool shows that the cascade systems typically outperform the R-404a parallel systems in warm climates. The cause of the total system performance difference between parallel and cascade systems lies in the energy use of the ancillary compressor and pump loads of the cascade systems. In the spreadsheet tool in warm climates, these additional end uses do not add enough energy consumption to outweigh the primary compressor savings. The opposite is true for EnergyPlus. For cooler climates, the spreadsheet tool shows almost the same total system performance for the three systems.

Another important difference between EnergyPlus and the spreadsheet tool is that the energy models apply a floating suction temperature strategy, whereas the spreadsheet model maintains a constant suction temperature. Floating suction strategy allows the refrigeration system suction pressure to rise as display case loads are satisfied which improves overall system performance. This strategy would be more impactful to the R-404a parallel system comparisons, because the modeled cascade systems are held to more constant temperatures to maintain CO₂ condensing temperatures.

The spreadsheet consistently shows higher total refrigeration system energy consumption than EnergyPlus for the same system in the same climate zone. The largest cause of this discrepancy is difference in how end-use refrigeration loads are calculated between the spreadsheet tool and EnergyPlus model. Across all climate zones, the proportion of refrigeration energy consumed by primary compressors for a given system is similar between the spreadsheet and EnergyPlus analyses, even though the total refrigeration system energy consumption is higher for the spreadsheet tool. This indicates that the analysis methods are consistent, but that the loads calculated by EnergyPlus are lower than those calculated in the spreadsheet tool.

The cause of this discrepancy is in the level of detail with which EnergyPlus calculates display case loads and the more simplified California Energy Commission method used by the spreadsheet (see Appendix A). Appendix B describes the method with which refrigeration systems were represented in the baseline EnergyPlus model, where end-use loads were placed within a separate refrigeration zone to simulate the microclimate effect of display cases in their localized environment. The result is that ambient temperatures in this zone are maintained at a condition 10°–15°F lower than the cases' rated condition. EnergyPlus provides corrections for end-use loads based upon the temperature of the zone containing them. The result is that calculated loads to the refrigeration system are much lower than the rated case condition. The intent of placing the end-use equipment in a refrigeration zone was to simulate commonly

observed real-world conditions, but this may not be applicable to all locations. Although zone thermostats are typically located outside refrigeration-affected areas, this may cause temperatures near refrigerator display cases to fall below accepted comfort conditions.

In contrast, the spreadsheet model uses a simple algorithm that corrects the rated case capacity to a load based upon outdoor ambient conditions. MT case loads are calculated at 66% capacity at 40°F outdoor temperature and increase linearly to 100% capacity at 85°F outdoor temperature. LT systems follow the same metric but use an 80% capacity factor at 40°F outdoor temperature. This algorithm assumes that ambient temperatures affect refrigeration system, but that conditions within the refrigeration zone are at manufacturer rated conditions when outdoor temperatures are at 85°F and higher; however, this is not always the case in all locations in reality.

This review of the results then begs the question: “Which results are correct?” The “true” answer likely lies somewhere between the two approaches. The EnergyPlus results demonstrate a scenario where occupant comfort may be sacrificed for the sake of low-cost HVAC installation or improved refrigeration performance, or both. This scenario may be considered indicative of an extreme example in favor of cost and performance. Alternatively, the spreadsheet model demonstrates display cases being maintained at relative rated conditions year round. That is, the occupied environment outside the cases is maintained at comfortable levels for building occupants and at approximately 50%–55% relative humidity throughout the year. This scenario may be considered an extreme example in favor of occupant comfort. Overall, the annual refrigeration system loads calculated by EnergyPlus were approximately 65% of the total calculated load in the spreadsheet tool.

Perhaps the most important area of agreement between EnergyPlus and the spreadsheet tool is on the dramatic total TEWI savings of the cascade systems over the parallel R-404a system and the superior performance of NH₃/CO₂ over R-134a/CO₂. If TEWI takes on more importance in decision making in the future, it will drive designs toward cascade configurations and ultimately to high-side refrigerants such as ammonia with the lowest GWPs.

The designer may choose the method for estimating energy savings and TEWI. However, consistency and good input assumptions are the keys to achieving objective results. When comparing systems, the authors recommend that results from energy models not be directly compared to spreadsheet models or alternative calculation methods. The same methodology should be used for any comparisons and best judgment should be used to predict any variations for specific applications.

Conclusions

For the practical application of an energy model or a spreadsheet calculation, the detail of the information about system operation will be the driving factor to obtaining accurate results from either calculation method. The accuracy of the results throughout this process has leaned heavily upon the tools used and the integrity of the information applied to them. The designer must be diligent in acquiring system operational parameters and control sequences, as well as equipment data and performance specifications, about current and proposed systems to use as inputs for the model.

Although the spreadsheet model received the same principal inputs for compressor performance and equipment capacities as the energy model, the energy model required substantially more input about building construction material characteristics, occupancy behavior, lighting densities and schedules, refrigeration defrost schedules, etc. The correlation of detail between the energy model and the spreadsheet model can be directly related to a function of time required to perform the calculations. Although some may recommend that every project be modeled in great detail for the sake of accuracy, this is not necessarily a practical use of time. The spreadsheet provides an acceptable margin of error for comparative calculations and consumes much less time than an energy model.

As with any predictive calculations, the authors strongly encourage the designer to acquire real data to calibrate and validate the baseline and proposed models. Any measurement and verification process that provides useful data for profiling system performance can be an invaluable tool for forward planning and retrospective analysis.

The results of the EnergyPlus modeling exercise show the R-134a/CO₂ and NH₃/CO₂ cascade system primary compressor performance exceeding that of the R-404a system. The total compressor performance (primary and secondary) is similar between R-404a and NH₃/CO₂ and both surpass the R-134a/CO₂ system. However, the R-404a system generally outperforms the cascade systems in terms of total system energy consumption because of the additional ancillary pump and fan loads and power consumption by secondary compressors.

The results of the spreadsheet model show that the total compressor performance (primary and secondary) of the R-404a and the R-134a/CO₂ systems is often similar and consistently outperformed by the NH₃/CO₂ system. However, when ancillary pump and fan loads are considered, the total performance of the NH₃/CO₂ system begins to converge with the other systems as the analysis moves into colder climates.

The difference between the EnergyPlus and spreadsheet tool results stem from the algorithms used to model the refrigeration loads. In EnergyPlus, the refrigerator cases are placed in a separate refrigeration zone that is allowed to drop below a comfortable set point because of the influence of the refrigeration system on thermal loads; in the spreadsheet model, the evaporator loads never drop below rated conditions. Designers are invited to use both tools and use the assumptions they feel most closely reflect their particular situation but are advised to perform comparative analyses across system designs using one tool.

As with many state-of-the-industry solutions, efficiency remains a balancing act of initial cost to payback alongside the availability of technology. In summary, the owner and designer are responsible to cooperate on design goals and consider prospects to determine the most cost effective and efficient system that meets the owner's goals for financial success and environmental stewardship.

Specific results for each climate zone are shown in the following figures and tables.

Miami, FL - US Climate Zone 1 Results						
Annual Refrigeration System Comparison						
Energy Source	Energy Model Results			Spreadsheet Calculation Results		
	R404A Parallel	R134A/CO2 Cascade	NH3/CO2 Cascade	R404A Parallel	R134A/CO2 Cascade	NH3/CO2 Cascade
Primary Compressors (kWh)	518,156	471,248	396,521	757,142	655,708	537,020
Secondary Compressors (kWh)	-	92,559	92,558	-	86,515	86,515
Secondary Fluid Pump (kWh)	-	6,532	6,532	-	5,918	5,918
Heat Rejection Fan (kWh)	97,284	86,273	97,386	150,866	126,671	123,746
Heat Rejection Pump (kWh)	-	-	53,366	-	-	65,280
Direct TEWI Contribution (kg CO ₂)	14,601,138	902,377	1,973	14,601,138	902,377	1,973
Indirect TEWI Contribution (kg CO ₂)	11,029,523	11,476,509	11,365,240	14,205,753	13,845,370	13,233,792
Total TEWI (kg CO ₂)	25,630,661	12,378,885	11,367,214	28,806,891	14,747,747	13,235,766

Annual Energy Modeled Building Component Comparison						
Energy Source	System-Based Results					
	R404A Parallel Systems		R134A/CO2 Cascade System		NH3/CO2 Cascade System	
	Energy	% of Total	Energy	% of Total	Energy	% of Total
Refrigeration System (kWh)	615,440	22.6%	656,612	23.7%	646,363	23.4%
Case & Walk-In Loads (kWh)	400,507	14.7%	400,510	14.5%	400,510	14.5%
Facility Lighting (kWh)	278,903	10.2%	278,903	10.1%	278,903	10.1%
Miscellaneous Elec. Loads (kWh)	49,399	1.8%	49,399	1.8%	49,399	1.8%
HVAC Fans (kWh)	245,780	9.0%	245,775	8.9%	245,780	8.9%
HVAC Cooling (kWh)	473,808	17.4%	473,873	17.1%	473,757	17.2%
Gas HVAC Heating (Therms)	7,499	8.1%	7,500	7.9%	7,499	8.0%
Gas Water Heaters (Therms)	6,258	6.7%	6,258	6.6%	6,258	6.6%
Gas Cooking Equipment (Therms)	8,908	9.6%	8,908	9.4%	8,908	9.5%
Energy Use Intensity (kBtu/ft ²)	198.0		201.0		200.3	

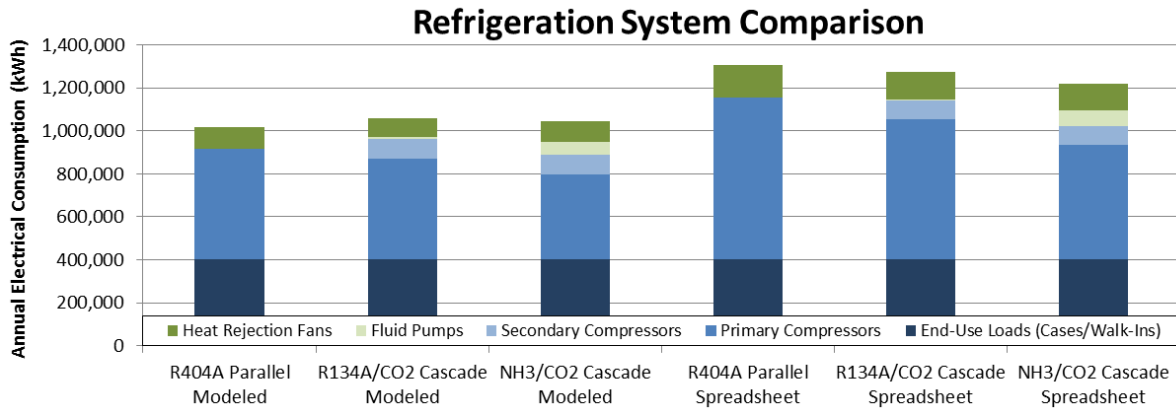

Houston, TX - US Climate Zone 2A Results						
Annual Refrigeration System Comparison						
Energy Source	Energy Model Results			Spreadsheet Calculation Results		
	R404A Parallel	R134A/CO2 Cascade	NH3/CO2 Cascade	R404A Parallel	R134A/CO2 Cascade	NH3/CO2 Cascade
Primary Compressors (kWh)	473,040	434,001	369,342	667,166	578,946	483,602
Secondary Compressors (kWh)	-	91,426	91,426	-	83,486	83,486
Secondary Fluid Pump (kWh)	-	6,532	6,532	-	5,918	5,918
Heat Rejection Fan (kWh)	87,225	77,963	89,266	131,415	112,073	99,518
Heat Rejection Pump (kWh)	-	-	53,953	-	-	65,357
Direct TEWI Contribution (kg CO ₂)	14,601,138	902,377	1,973	14,601,138	902,377	1,973
Indirect TEWI Contribution (kg CO ₂)	10,612,798	11,162,874	11,170,264	13,251,212	13,050,549	12,580,414
Total TEWI (kg CO ₂)	25,213,936	12,065,250	11,172,237	27,852,351	13,952,925	12,582,387

Annual Energy Modeled Building Component Comparison						
Energy Source	System-Based Results					
	R404A Parallel Systems		R134A/CO2 Cascade System		NH3/CO2 Cascade System	
	Energy	% of Total	Energy	% of Total	Energy	% of Total
Refrigeration System (kWh)	560,264	20.3%	609,922	21.7%	610,520	21.8%
Case & Walk-In Loads (kWh)	398,342	14.5%	398,344	14.2%	398,344	14.2%
Facility Lighting (kWh)	278,889	10.1%	278,889	9.9%	278,889	9.9%
Miscellaneous Elec. Loads (kWh)	49,399	1.8%	49,399	1.8%	49,399	1.8%
HVAC Fans (kWh)	248,752	9.0%	248,742	8.9%	248,742	8.9%
HVAC Cooling (kWh)	331,777	12.0%	331,876	11.8%	331,876	11.8%
Gas HVAC Heating (Therms)	14,401	15.3%	14,401	15.0%	14,401	15.0%
Gas Water Heaters (Therms)	7,015	7.5%	7,015	7.3%	7,015	7.3%
Gas Cooking Equipment (Therms)	8,908	9.5%	8,908	9.3%	8,908	9.3%
Energy Use Intensity (kBtu/ft ²)	200.1		203.7		203.7	

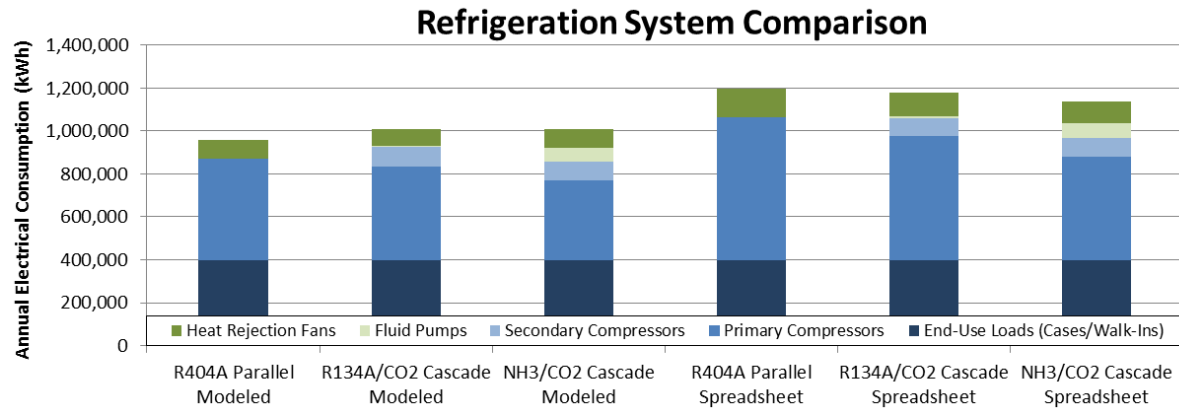

Phoenix, AZ - US Climate Zone 2B Results						
Annual Refrigeration System Comparison						
Energy Source	Energy Model Results			Spreadsheet Calculation Results		
	R404A Parallel	R134A/CO2 Cascade	NH3/CO2 Cascade	R404A Parallel	R134A/CO2 Cascade	NH3/CO2 Cascade
Primary Compressors (kWh)	508,659	454,360	330,330	769,845	653,029	457,950
Secondary Compressors (kWh)	-	89,962	89,962	-	84,808	84,808
Secondary Fluid Pump (kWh)	-	6,532	6,532	-	5,918	5,918
Heat Rejection Fan (kWh)	89,095	78,815	82,164	142,682	120,010	99,083
Heat Rejection Pump (kWh)	-	-	53,112	-	-	64,745
Direct TEWI Contribution (kg CO ₂)	14,601,138	902,377	1,973	14,601,138	902,377	1,973
Indirect TEWI Contribution (kg CO ₂)	10,642,292	10,988,313	10,271,099	14,027,304	13,506,372	11,890,436
Total TEWI (kg CO ₂)	25,243,430	11,890,690	10,273,072	28,628,442	14,408,749	11,892,409

Annual Energy Modeled Building Component Comparison						
Energy Source	System-Based Results					
	R404A Parallel Systems		R134A/CO2 Cascade System		NH3/CO2 Cascade System	
	Energy	% of Total	Energy	% of Total	Energy	% of Total
Refrigeration System (kWh)	597,754	24.9%	629,670	25.9%	562,100	23.8%
Case & Walk-In Loads (kWh)	391,875	16.3%	391,875	16.1%	391,875	16.6%
Facility Lighting (kWh)	278,844	11.6%	278,844	11.5%	278,844	11.8%
Miscellaneous Elec. Loads (kWh)	49,399	2.1%	49,399	2.0%	49,399	2.1%
HVAC Fans (kWh)	230,979	9.6%	230,981	9.5%	230,981	9.8%
HVAC Cooling (kWh)	181,836	7.6%	181,802	7.5%	181,802	7.7%
Gas HVAC Heating (Therms)	7,506	9.2%	7,506	9.1%	7,506	9.3%
Gas Water Heaters (Therms)	6,371	7.8%	6,371	7.7%	6,371	7.9%
Gas Cooking Equipment (Therms)	8,908	10.9%	8,908	10.7%	8,908	11.1%
Energy Use Intensity (kBtu/ft ²)	174.1		176.4		171.5	

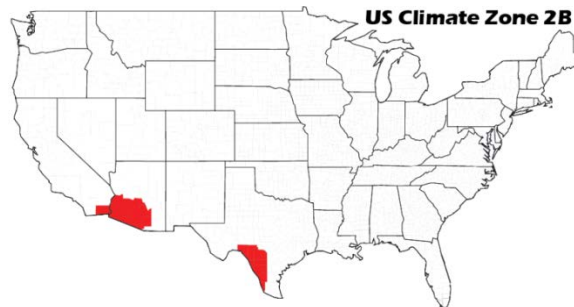
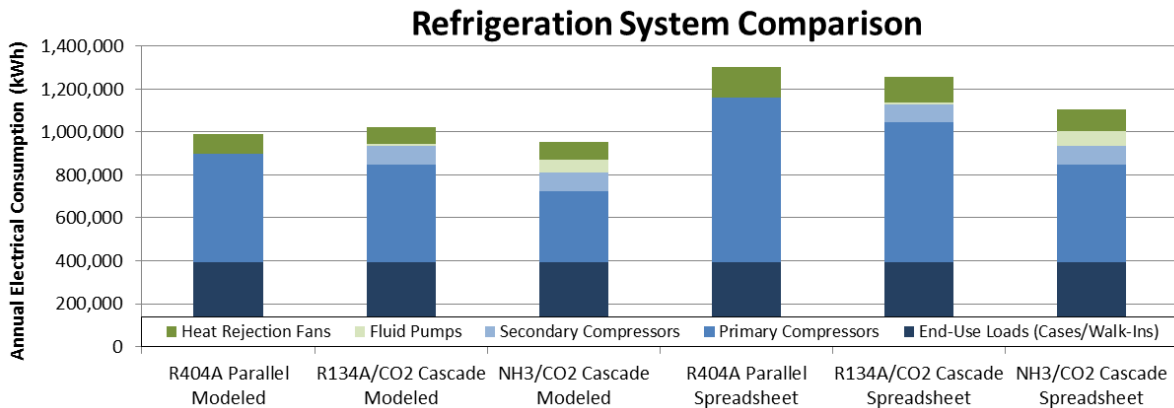

Atlanta, GA - US Climate Zone 3A Results						
Annual Refrigeration System Comparison						
Energy Source	Energy Model Results			Spreadsheet Calculation Results		
	R404A Parallel	R134A/CO2 Cascade	NH3/CO2 Cascade	R404A Parallel	R134A/CO2 Cascade	NH3/CO2 Cascade
Primary Compressors (kWh)	431,335	398,962	336,650	592,266	516,823	436,713
Secondary Compressors (kWh)	-	89,803	89,803	-	81,197	81,197
Secondary Fluid Pump (kWh)	-	6,532	6,532	-	5,918	5,918
Heat Rejection Fan (kWh)	77,730	69,657	75,870	115,142	99,653	80,110
Heat Rejection Pump (kWh)	-	-	53,760	-	-	64,842
Direct TEWI Contribution (kg CO ₂)	14,601,138	902,377	1,973	14,601,138	902,377	1,973
Indirect TEWI Contribution (kg CO ₂)	11,161,577	11,851,626	11,824,618	13,609,781	13,562,889	13,135,262
Total TEWI (kg CO ₂)	25,762,716	12,754,002	11,826,591	28,210,919	14,465,265	13,137,235

Annual Energy Modeled Building Component Comparison						
Energy Source	System-Based Results					
	R404A Parallel Systems		R134A/CO2 Cascade System		NH3/CO2 Cascade System	
	Energy	% of Total	Energy	% of Total	Energy	% of Total
Refrigeration System (kWh)	509,065	18.9%	564,954	20.5%	562,615	20.4%
Case & Walk-In Loads (kWh)	395,201	14.6%	395,202	14.3%	395,202	14.4%
Facility Lighting (kWh)	278,861	10.3%	278,861	10.1%	278,861	10.1%
Miscellaneous Elec. Loads (kWh)	49,399	1.8%	49,399	1.8%	49,399	1.8%
HVAC Fans (kWh)	249,530	9.2%	249,528	9.1%	249,531	9.1%
HVAC Cooling (kWh)	177,088	6.6%	177,069	6.4%	177,070	6.4%
Gas HVAC Heating (Therms)	18,904	20.5%	18,904	20.1%	18,904	20.1%
Gas Water Heaters (Therms)	7,684	8.3%	7,684	8.2%	7,684	8.2%
Gas Cooking Equipment (Therms)	8,908	9.7%	8,908	9.5%	8,908	9.5%
Energy Use Intensity (kBtu/ft ²)	196.0		200.0		199.9	

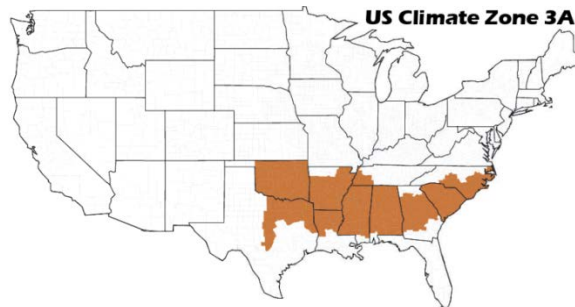
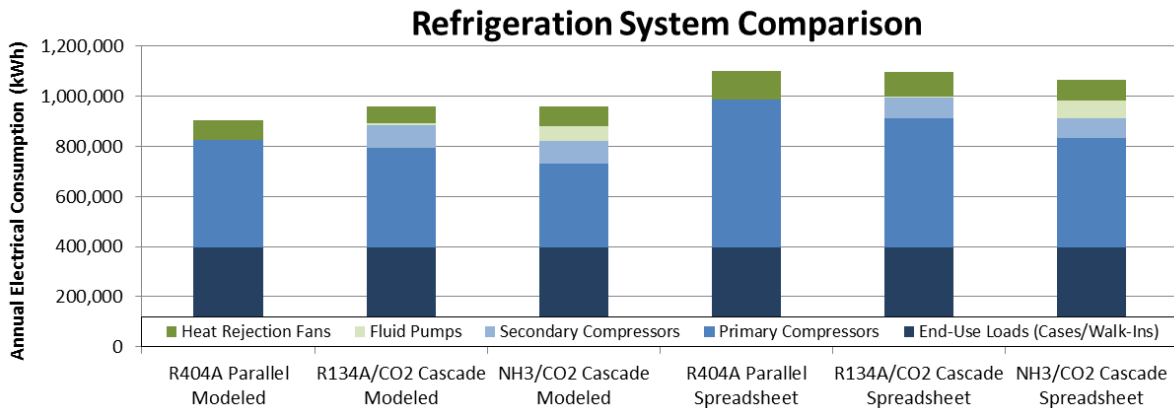

Las Vegas, NV - US Climate Zone 3B Results						
Annual Refrigeration System Comparison						
Energy Source	Energy Model Results			Spreadsheet Calculation Results		
	R404A Parallel	R134A/CO2 Cascade	NH3/CO2 Cascade	R404A Parallel	R134A/CO2 Cascade	NH3/CO2 Cascade
Primary Compressors (kWh)	453,423	408,592	303,161	677,396	579,972	423,152
Secondary Compressors (kWh)	-	87,532	87,532	-	82,528	82,528
Secondary Fluid Pump (kWh)	-	6,532	6,532	-	5,918	5,918
Heat Rejection Fan (kWh)	78,578	69,367	102,151	125,032	106,842	77,868
Heat Rejection Pump (kWh)	-	-	44,939	-	-	64,341
Direct TEWI Contribution (kg CO ₂)	14,601,138	902,377	1,973	14,601,138	902,377	1,973
Indirect TEWI Contribution (kg CO ₂)	9,931,211	10,365,905	10,079,360	12,851,103	12,560,861	11,263,369
Total TEWI (kg CO ₂)	24,532,349	11,268,282	10,081,334	27,452,241	13,463,238	11,265,342

Annual Energy Modeled Building Component Comparison						
Energy Source	System-Based Results					
	R404A Parallel Systems		R134A/CO2 Cascade System		NH3/CO2 Cascade System	
	Energy	% of Total	Energy	% of Total	Energy	% of Total
Refrigeration System (kWh)	532,001	22.2%	572,023	23.5%	544,314	22.6%
Case & Walk-In Loads (kWh)	387,783	16.2%	387,784	15.9%	387,784	16.1%
Facility Lighting (kWh)	278,829	11.7%	278,829	11.5%	278,829	11.6%
Miscellaneous Elec. Loads (kWh)	49,399	2.1%	49,399	2.0%	49,399	2.1%
HVAC Fans (kWh)	243,859	10.2%	243,857	10.0%	243,857	10.1%
HVAC Cooling (kWh)	85,286	3.6%	85,286	3.5%	85,286	3.5%
Gas HVAC Heating (Therms)	11,820	14.5%	11,820	14.2%	11,820	14.4%
Gas Water Heaters (Therms)	7,098	8.7%	7,098	8.6%	7,098	8.7%
Gas Cooking Equipment (Therms)	8,908	10.9%	8,908	10.7%	8,908	10.9%
Energy Use Intensity (kBtu/ft ²)	173.7		176.6		174.6	

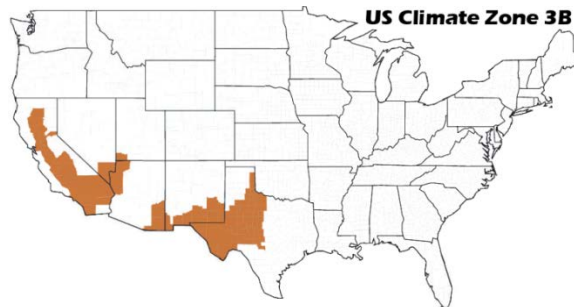
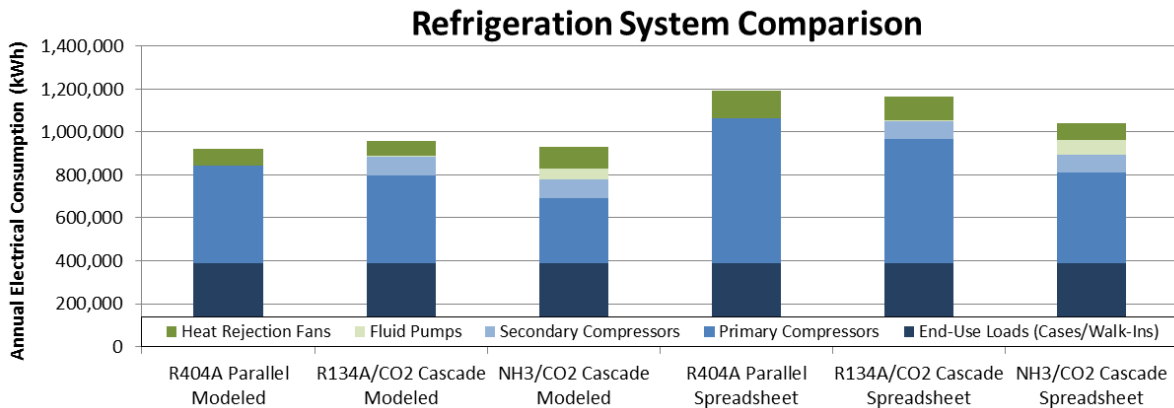

Los Angeles, CA - US Climate Zone 3B Results						
Annual Refrigeration System Comparison						
Energy Source	Energy Model Results			Spreadsheet Calculation Results		
	R404A Parallel	R134A/CO2 Cascade	NH3/CO2 Cascade	R404A Parallel	R134A/CO2 Cascade	NH3/CO2 Cascade
Primary Compressors (kWh)	411,809	388,301	331,549	539,997	479,077	418,468
Secondary Compressors (kWh)	-	91,239	91,239	-	81,092	81,092
Secondary Fluid Pump (kWh)	-	6,532	6,532	-	5,918	5,918
Heat Rejection Fan (kWh)	89,067	79,690	151,277	123,361	107,264	83,522
Heat Rejection Pump (kWh)	-	-	44,483	-	-	64,327
Direct TEWI Contribution (kg CO ₂)	14,601,138	902,377	1,973	14,601,138	902,377	1,973
Indirect TEWI Contribution (kg CO ₂)	4,993,182	5,353,296	5,682,783	5,895,176	5,950,547	5,839,587
Total TEWI (kg CO ₂)	19,594,320	6,255,673	5,684,756	20,496,315	6,852,923	5,841,560

Annual Energy Modeled Building Component Comparison						
Energy Source	System-Based Results					
	R404A Parallel Systems		R134A/CO2 Cascade System		NH3/CO2 Cascade System	
	Energy	% of Total	Energy	% of Total	Energy	% of Total
Refrigeration System (kWh)	500,876	20.3%	565,762	22.3%	625,081	24.1%
Case & Walk-In Loads (kWh)	398,580	16.1%	398,582	15.7%	398,582	15.4%
Facility Lighting (kWh)	278,857	11.3%	278,857	11.0%	278,857	10.7%
Miscellaneous Elec. Loads (kWh)	49,399	2.0%	49,399	1.9%	49,399	1.9%
HVAC Fans (kWh)	246,076	10.0%	246,084	9.7%	246,084	9.5%
HVAC Cooling (kWh)	86,809	3.5%	87,305	3.4%	87,305	3.4%
Gas HVAC Heating (Therms)	14,464	17.2%	14,484	16.7%	14,484	16.4%
Gas Water Heaters (Therms)	7,651	9.1%	7,651	8.8%	7,651	8.6%
Gas Cooking Equipment (Therms)	8,908	10.6%	8,908	10.3%	8,908	10.1%
Energy Use Intensity (kBtu/ft ²)	179.3		184.1		188.4	

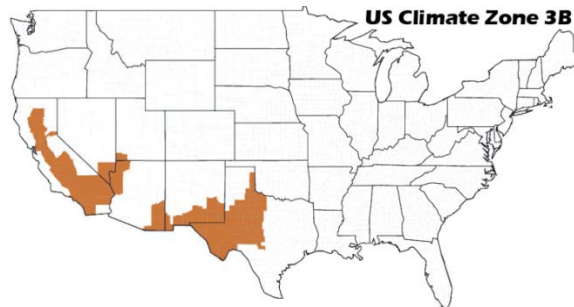
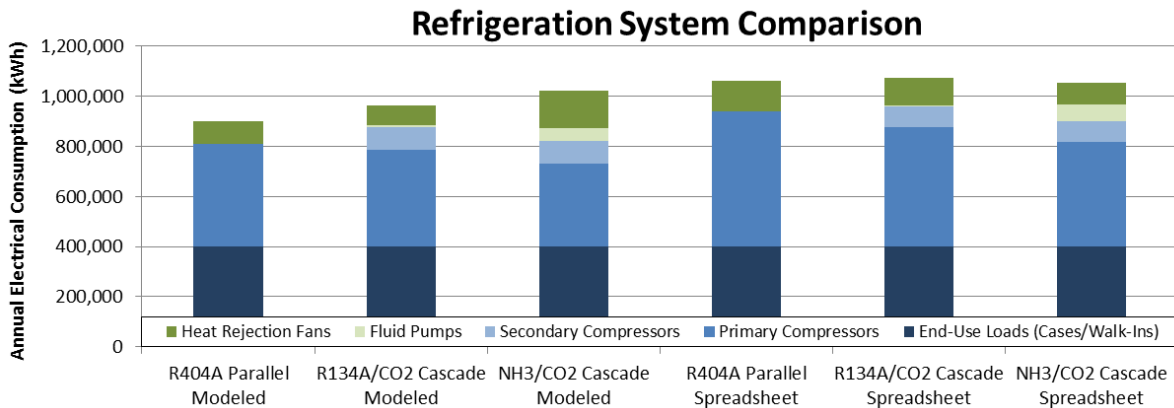

San Francisco, CA - US Climate Zone 3C Results						
Annual Refrigeration System Comparison						
Energy Source	Energy Model Results			Spreadsheet Calculation Results		
	R404A Parallel	R134A/CO2 Cascade	NH3/CO2 Cascade	R404A Parallel	R134A/CO2 Cascade	NH3/CO2 Cascade
Primary Compressors (kWh)	382,193	361,858	311,610	484,104	428,000	385,524
Secondary Compressors (kWh)	-	90,378	90,378	-	78,898	78,898
Secondary Fluid Pump (kWh)	-	6,532	6,532	-	5,918	5,918
Heat Rejection Fan (kWh)	78,526	72,340	125,733	105,385	95,290	67,020
Heat Rejection Pump (kWh)	-	-	44,221	-	-	63,901
Direct TEWI Contribution (kg CO ₂)	14,601,138	902,377	1,973	14,601,138	902,377	1,973
Indirect TEWI Contribution (kg CO ₂)	4,769,572	5,160,746	5,424,332	5,485,848	5,589,006	5,551,083
Total TEWI (kg CO ₂)	19,370,711	6,063,123	5,426,305	20,086,986	6,491,383	5,553,056

Annual Energy Modeled Building Component Comparison						
Energy Source	System-Based Results					
	R404A Parallel Systems		R134A/CO2 Cascade System		NH3/CO2 Cascade System	
	Energy	% of Total	Energy	% of Total	Energy	% of Total
Refrigeration System (kWh)	460,718	18.5%	531,108	20.8%	578,474	22.2%
Case & Walk-In Loads (kWh)	396,747	16.0%	396,748	15.5%	396,748	15.2%
Facility Lighting (kWh)	278,808	11.2%	278,808	10.9%	278,808	10.7%
Miscellaneous Elec. Loads (kWh)	49,399	2.0%	49,399	1.9%	49,399	1.9%
HVAC Fans (kWh)	247,115	9.9%	247,115	9.7%	247,115	9.5%
HVAC Cooling (kWh)	16,293	0.7%	16,291	0.6%	16,291	0.6%
Gas HVAC Heating (Therms)	18,236	21.5%	18,236	20.9%	18,236	20.5%
Gas Water Heaters (Therms)	8,191	9.7%	8,191	9.4%	8,191	9.2%
Gas Cooking Equipment (Therms)	8,908	10.5%	8,908	10.2%	8,908	10.0%
Energy Use Intensity (kBtu/ft ²)	180.4		185.5		188.9	

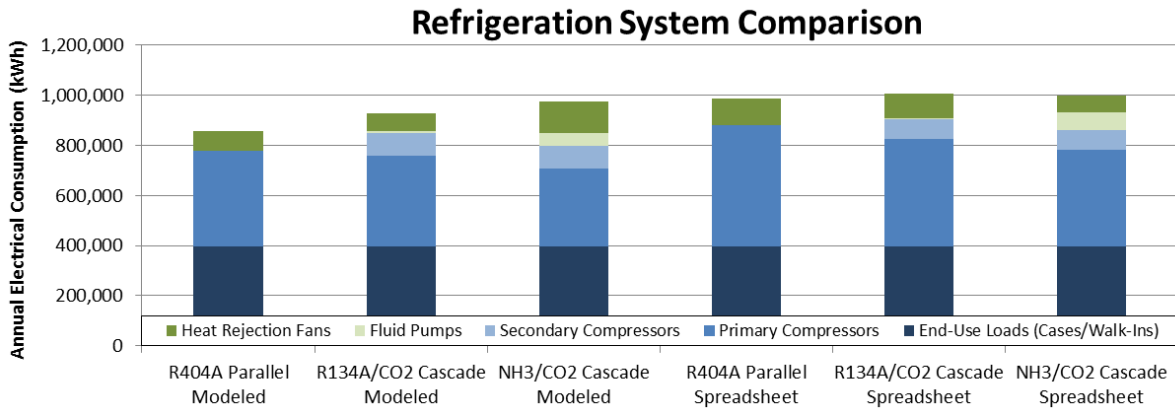

Baltimore, MD - US Climate Zone 4A Results						
Annual Refrigeration System Comparison						
Energy Source	Energy Model Results			Spreadsheet Calculation Results		
	R404A Parallel	R134A/CO2 Cascade	NH3/CO2 Cascade	R404A Parallel	R134A/CO2 Cascade	NH3/CO2 Cascade
Primary Compressors (kWh)	406,405	377,585	322,893	542,033	474,047	411,061
Secondary Compressors (kWh)	-	88,724	88,724	-	79,303	79,303
Secondary Fluid Pump (kWh)	-	6,532	6,532	-	5,918	5,918
Heat Rejection Fan (kWh)	67,783	61,072	65,197	99,040	87,161	64,849
Heat Rejection Pump (kWh)	-	-	54,286	-	-	65,188
Direct TEWI Contribution (kg CO ₂)	14,601,138	902,377	1,973	14,601,138	902,377	1,973
Indirect TEWI Contribution (kg CO ₂)	7,937,606	8,484,043	8,519,305	9,465,333	9,514,009	9,331,255
Total TEWI (kg CO ₂)	22,538,744	9,386,420	8,521,278	24,066,472	10,416,386	9,333,228

Annual Energy Modeled Building Component Comparison						
Energy Source	System-Based Results					
	R404A Parallel Systems		R134A/CO2 Cascade System		NH3/CO2 Cascade System	
	Energy	% of Total	Energy	% of Total	Energy	% of Total
Refrigeration System (kWh)	474,188	16.6%	533,914	18.3%	537,633	18.4%
Case & Walk-In Loads (kWh)	392,894	13.7%	392,895	13.4%	392,895	13.4%
Facility Lighting (kWh)	278,800	9.7%	278,800	9.5%	278,800	9.5%
Miscellaneous Elec. Loads (kWh)	49,399	1.7%	49,399	1.7%	49,399	1.7%
HVAC Fans (kWh)	253,120	8.8%	253,123	8.7%	253,123	8.6%
HVAC Cooling (kWh)	128,676	4.5%	128,737	4.4%	128,737	4.4%
Gas HVAC Heating (Therms)	26,693	27.3%	26,692	26.8%	26,692	26.7%
Gas Water Heaters (Therms)	8,294	8.5%	8,294	8.3%	8,294	8.3%
Gas Cooking Equipment (Therms)	8,908	9.1%	8,908	8.9%	8,908	8.9%
Energy Use Intensity (kBtu/ft ²)	207.9		212.2		212.5	

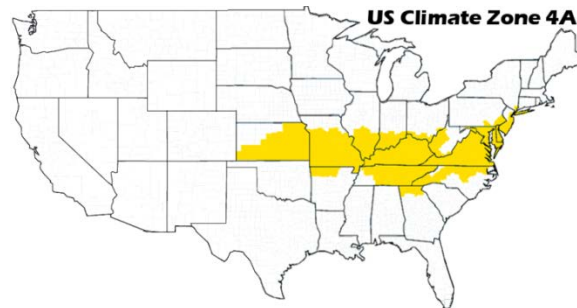
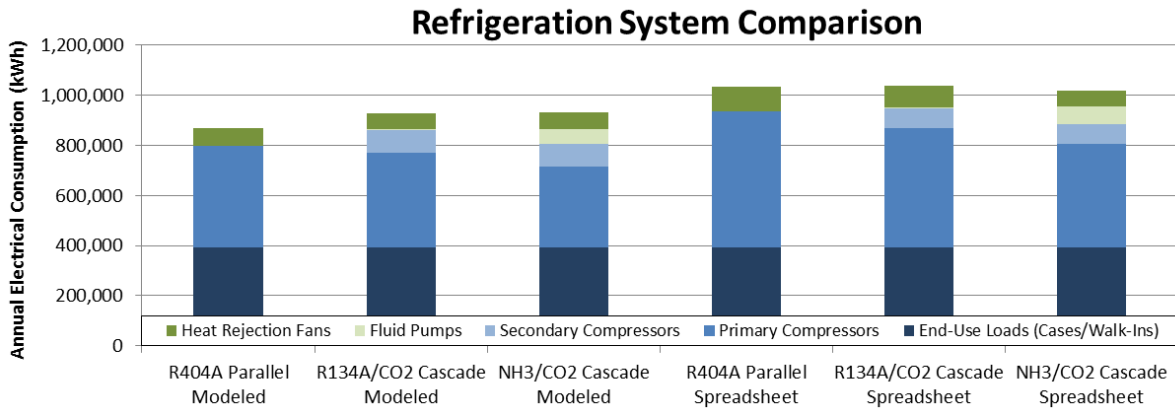

Albuquerque, NM - US Climate Zone 4B Results						
Annual Refrigeration System Comparison						
Energy Source	Energy Model Results			Spreadsheet Calculation Results		
	R404A Parallel	R134A/CO2 Cascade	NH3/CO2 Cascade	R404A Parallel	R134A/CO2 Cascade	NH3/CO2 Cascade
Primary Compressors (kWh)	393,510	363,377	291,672	548,332	478,406	391,218
Secondary Compressors (kWh)	-	86,344	86,344	-	79,345	79,345
Secondary Fluid Pump (kWh)	-	6,532	6,532	-	5,918	5,918
Heat Rejection Fan (kWh)	65,847	58,561	72,795	100,431	87,869	58,727
Heat Rejection Pump (kWh)	-	-	45,202	-	-	63,947
Direct TEWI Contribution (kg CO ₂)	14,601,138	902,377	1,973	14,601,138	902,377	1,973
Indirect TEWI Contribution (kg CO ₂)	9,161,205	9,760,614	9,634,123	11,209,484	11,239,127	10,679,519
Total TEWI (kg CO ₂)	23,762,343	10,662,990	9,636,096	25,810,623	12,141,504	10,681,492

Annual Energy Modeled Building Component Comparison						
Energy Source	System-Based Results					
	R404A Parallel Systems		R134A/CO2 Cascade System		NH3/CO2 Cascade System	
	Energy	% of Total	Energy	% of Total	Energy	% of Total
Refrigeration System (kWh)	459,358	18.4%	514,814	20.1%	502,546	19.8%
Case & Walk-In Loads (kWh)	387,783	15.5%	387,783	15.2%	387,783	15.2%
Facility Lighting (kWh)	278,844	11.2%	278,844	10.9%	278,844	11.0%
Miscellaneous Elec. Loads (kWh)	49,399	2.0%	49,399	1.9%	49,399	1.9%
HVAC Fans (kWh)	252,000	10.1%	252,000	9.9%	252,000	9.9%
HVAC Cooling (kWh)	34,602	1.4%	34,602	1.4%	34,602	1.4%
Gas HVAC Heating (Therms)	18,312	21.5%	18,312	21.0%	18,312	21.1%
Gas Water Heaters (Therms)	8,216	9.6%	8,216	9.4%	8,216	9.5%
Gas Cooking Equipment (Therms)	8,908	10.4%	8,908	10.2%	8,908	10.3%
Energy Use Intensity (kBtu/ft ²)	181.5		185.6		184.7	

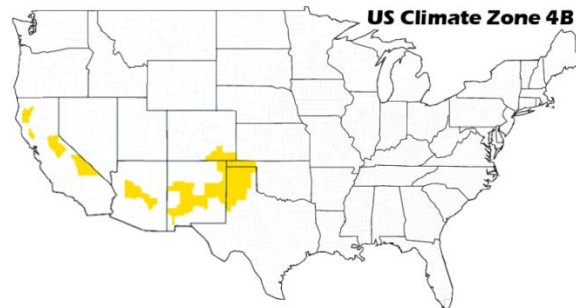
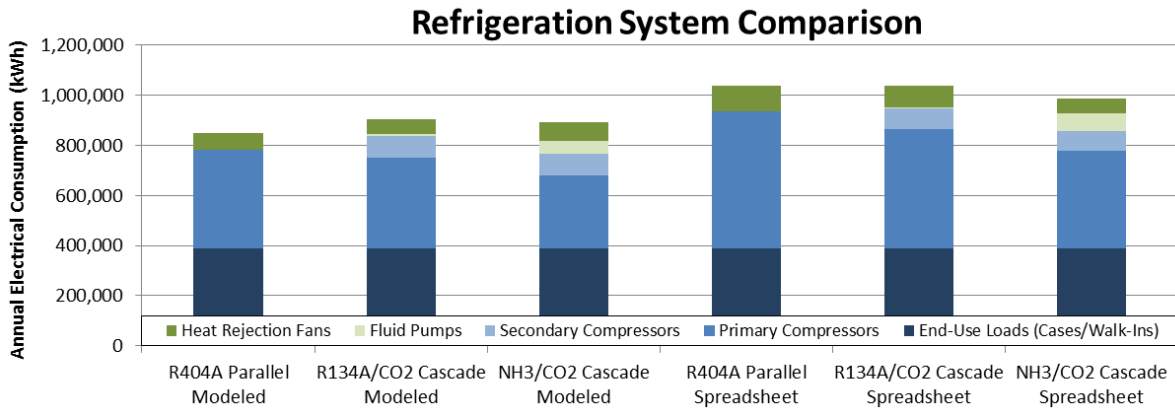

Seattle, WA - US Climate Zone 4C Results						
Annual Refrigeration System Comparison						
Energy Source	Energy Model Results			Spreadsheet Calculation Results		
	R404A Parallel	R134A/CO2 Cascade	NH3/CO2 Cascade	R404A Parallel	R134A/CO2 Cascade	NH3/CO2 Cascade
Primary Compressors (kWh)	372,262	350,720	302,300	467,396	411,268	371,372
Secondary Compressors (kWh)	-	89,183	89,183	-	77,263	77,263
Secondary Fluid Pump (kWh)	-	6,532	6,532	-	5,918	5,918
Heat Rejection Fan (kWh)	64,472	59,335	92,331	87,964	80,093	52,972
Heat Rejection Pump (kWh)	-	-	44,878	-	-	64,004
Direct TEWI Contribution (kg CO ₂)	14,601,138	902,377	1,973	14,601,138	902,377	1,973
Indirect TEWI Contribution (kg CO ₂)	6,393,585	6,923,922	7,150,690	7,306,439	7,453,062	7,430,030
Total TEWI (kg CO ₂)	20,994,724	7,826,299	7,152,664	21,907,578	8,355,438	7,432,003

Annual Energy Modeled Building Component Comparison						
Energy Source	System-Based Results					
	R404A Parallel Systems		R134A/CO2 Cascade System		NH3/CO2 Cascade System	
	Energy	% of Total	Energy	% of Total	Energy	% of Total
Refrigeration System (kWh)	436,734	16.2%	505,771	18.3%	535,224	19.1%
Case & Walk-In Loads (kWh)	394,121	14.6%	394,122	14.2%	394,122	14.1%
Facility Lighting (kWh)	278,687	10.3%	278,687	10.1%	278,687	10.0%
Miscellaneous Elec. Loads (kWh)	49,399	1.8%	49,399	1.8%	49,399	1.8%
HVAC Fans (kWh)	251,762	9.3%	251,762	9.1%	251,762	9.0%
HVAC Cooling (kWh)	13,005	0.5%	13,005	0.5%	13,005	0.5%
Gas HVAC Heating (Therms)	26,025	28.2%	26,025	27.5%	26,025	27.2%
Gas Water Heaters (Therms)	8,655	9.4%	8,655	9.2%	8,655	9.1%
Gas Cooking Equipment (Therms)	8,908	9.7%	8,908	9.4%	8,908	9.3%
Energy Use Intensity (kBtu/ft ²)	196.1		201.1		203.2	

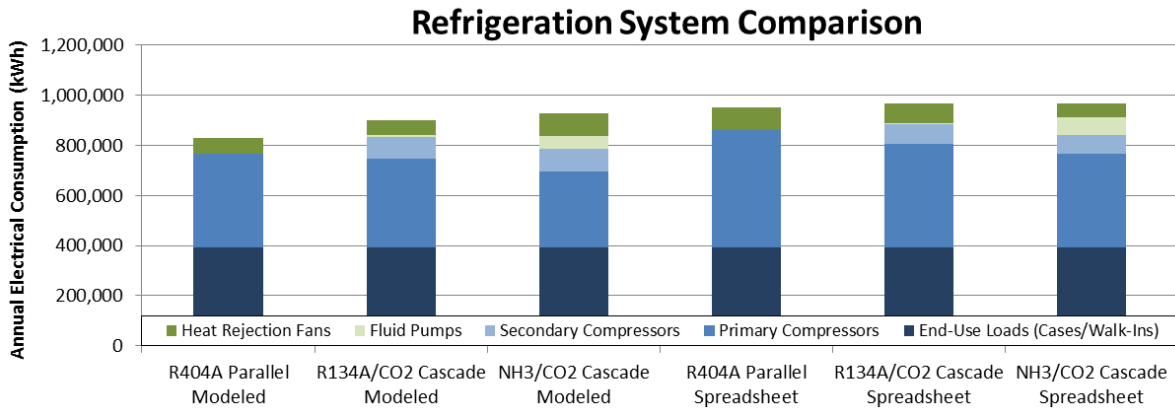

Boston, MA - US Climate Zone 5A Results						
Annual Refrigeration System Comparison						
Energy Source	Energy Model Results			Spreadsheet Calculation Results		
	R404A Parallel	R134A/CO2 Cascade	NH3/CO2 Cascade	R404A Parallel	R134A/CO2 Cascade	NH3/CO2 Cascade
Primary Compressors (kWh)	385,392	360,245	310,454	500,839	438,855	388,147
Secondary Compressors (kWh)	-	88,047	88,047	-	77,789	77,789
Secondary Fluid Pump (kWh)	-	6,532	6,532	-	5,918	5,918
Heat Rejection Fan (kWh)	61,000	55,227	76,299	88,031	78,083	54,818
Heat Rejection Pump (kWh)	-	-	45,403	-	-	64,730
Direct TEWI Contribution (kg CO ₂)	14,601,138	902,377	1,973	14,601,138	902,377	1,973
Indirect TEWI Contribution (kg CO ₂)	5,539,118	5,959,284	6,070,075	6,480,938	6,558,068	6,497,532
Total TEWI (kg CO ₂)	20,140,256	6,861,661	6,072,048	21,082,077	7,460,445	6,499,505

Annual Energy Modeled Building Component Comparison						
Energy Source	System-Based Results					
	R404A Parallel Systems		R134A/CO2 Cascade System		NH3/CO2 Cascade System	
	Energy	% of Total	Energy	% of Total	Energy	% of Total
Refrigeration System (kWh)	446,391	15.1%	510,051	16.9%	526,736	17.4%
Case & Walk-In Loads (kWh)	391,562	13.3%	391,564	13.0%	391,564	12.9%
Facility Lighting (kWh)	278,757	9.5%	278,757	9.3%	278,757	9.2%
Miscellaneous Elec. Loads (kWh)	49,399	1.7%	49,399	1.6%	49,399	1.6%
HVAC Fans (kWh)	254,998	8.7%	254,998	8.5%	254,998	8.4%
HVAC Cooling (kWh)	76,273	2.6%	76,255	2.5%	76,255	2.5%
Gas HVAC Heating (Therms)	31,813	31.6%	31,816	31.0%	31,816	30.8%
Gas Water Heaters (Therms)	8,761	8.7%	8,761	8.5%	8,761	8.5%
Gas Cooking Equipment (Therms)	8,908	8.9%	8,908	8.7%	8,908	8.6%
Energy Use Intensity (kBtu/ft ²)	214.0		218.6		219.8	

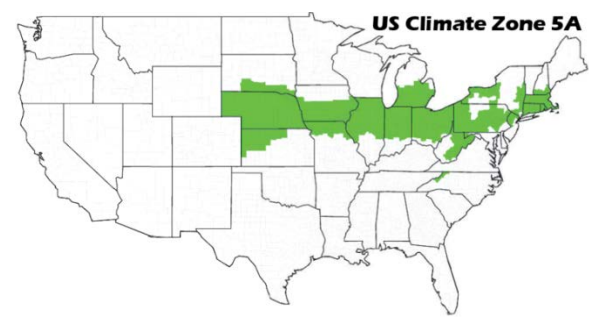
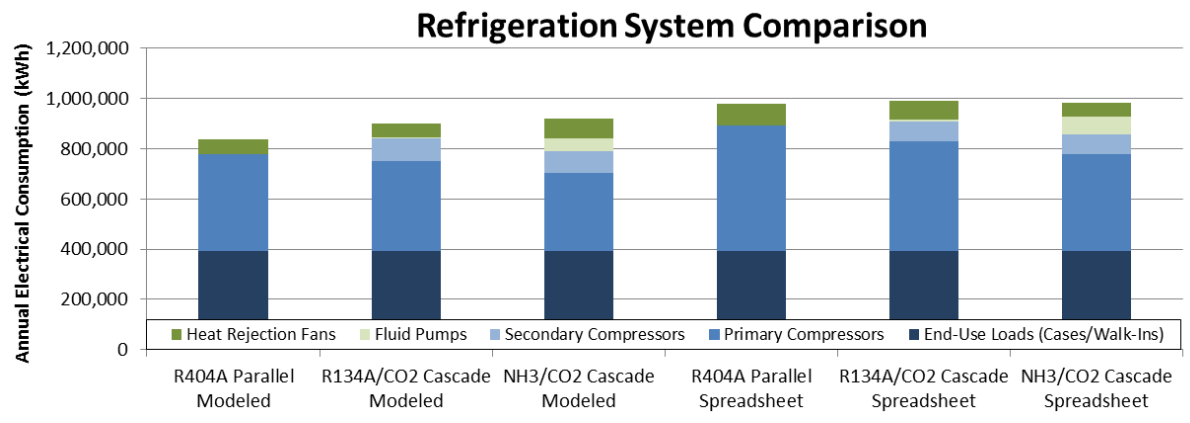

Chicago, IL - US Climate Zone 5A Results						
Annual Refrigeration System Comparison						
Energy Source	Energy Model Results			Spreadsheet Calculation Results		
	R404A Parallel	R134A/CO2 Cascade	NH3/CO2 Cascade	R404A Parallel	R134A/CO2 Cascade	NH3/CO2 Cascade
Primary Compressors (kWh)	389,965	363,839	313,137	512,673	448,450	393,701
Secondary Compressors (kWh)	-	87,951	87,951	-	78,013	78,013
Secondary Fluid Pump (kWh)	-	6,532	6,532	-	5,918	5,918
Heat Rejection Fan (kWh)	59,828	54,003	77,233	87,796	77,379	56,229
Heat Rejection Pump (kWh)	-	-	46,121	-	-	65,120
Direct TEWI Contribution (kg CO ₂)	14,601,138	902,377	1,973	14,601,138	902,377	1,973
Indirect TEWI Contribution (kg CO ₂)	11,579,349	12,438,773	12,696,552	13,652,608	13,779,323	13,632,296
Total TEWI (kg CO ₂)	26,180,487	13,341,150	12,698,525	28,253,746	14,681,700	13,634,269

Annual Energy Modeled Building Component Comparison						
Energy Source	System-Based Results					
	R404A Parallel Systems		R134A/CO2 Cascade System		NH3/CO2 Cascade System	
	Energy	% of Total	Energy	% of Total	Energy	% of Total
Refrigeration System (kWh)	449,793	14.9%	512,326	16.6%	530,975	17.1%
Case & Walk-In Loads (kWh)	391,750	13.0%	391,752	12.7%	391,752	12.6%
Facility Lighting (kWh)	278,770	9.2%	278,770	9.0%	278,770	9.0%
Miscellaneous Elec. Loads (kWh)	49,399	1.6%	49,399	1.6%	49,399	1.6%
HVAC Fans (kWh)	256,038	8.5%	256,037	8.3%	256,037	8.2%
HVAC Cooling (kWh)	93,052	3.1%	92,977	3.0%	92,977	3.0%
Gas HVAC Heating (Therms)	33,577	32.5%	33,576	31.9%	33,576	31.7%
Gas Water Heaters (Therms)	8,885	8.6%	8,885	8.4%	8,885	8.4%
Gas Cooking Equipment (Therms)	8,908	8.6%	8,908	8.5%	8,908	8.4%
Energy Use Intensity (kBtu/ft ²)	219.6		224.1		225.4	

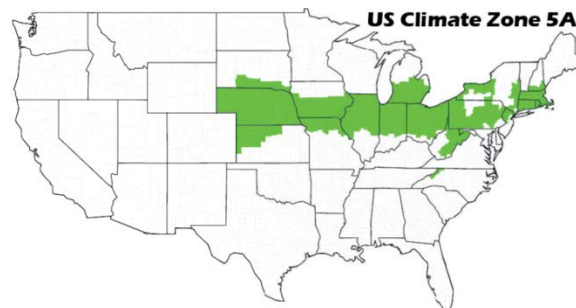
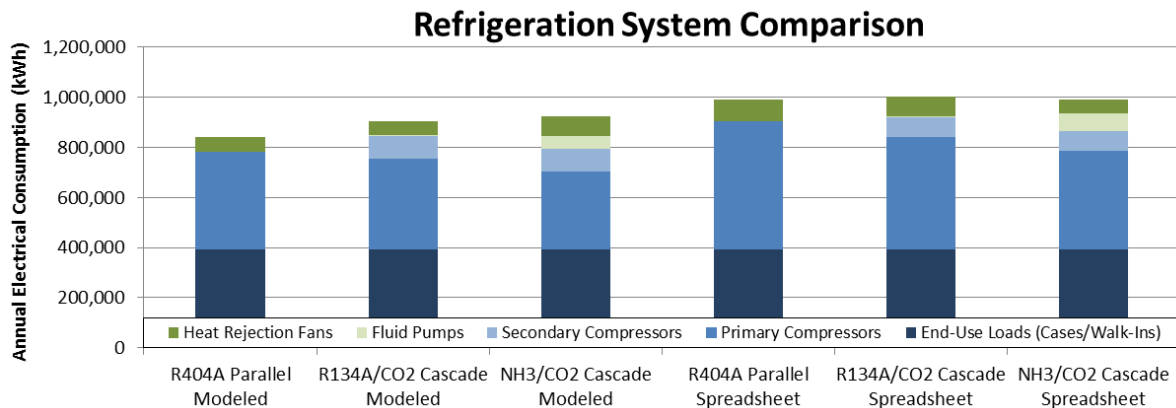

Denver, CO - US Climate Zone 5B Results						
Annual Refrigeration System Comparison						
Energy Source	Energy Model Results			Spreadsheet Calculation Results		
	R404A Parallel	R134A/CO2 Cascade	NH3/CO2 Cascade	R404A Parallel	R134A/CO2 Cascade	NH3/CO2 Cascade
Primary Compressors (kWh)	378,659	351,341	286,952	517,975	452,223	378,515
Secondary Compressors (kWh)	-	85,897	85,893	-	78,089	78,089
Secondary Fluid Pump (kWh)	-	6,532	6,532	-	5,918	5,918
Heat Rejection Fan (kWh)	58,656	52,310	66,514	89,268	78,683	51,877
Heat Rejection Pump (kWh)	-	-	46,051	-	-	63,915
Direct TEWI Contribution (kg CO ₂)	14,601,138	902,377	1,973	14,601,138	902,377	1,973
Indirect TEWI Contribution (kg CO ₂)	14,378,283	15,401,105	15,336,417	17,340,338	17,472,291	16,842,549
Total TEWI (kg CO ₂)	28,979,422	16,303,481	15,338,390	31,941,477	18,374,668	16,844,522

Annual Energy Modeled Building Component Comparison						
Energy Source	System-Based Results					
	R404A Parallel Systems		R134A/CO2 Cascade System		NH3/CO2 Cascade System	
	Energy	% of Total	Energy	% of Total	Energy	% of Total
Refrigeration System (kWh)	437,316	16.4%	496,080	18.3%	491,943	18.1%
Case & Walk-In Loads (kWh)	387,538	14.6%	387,539	14.3%	387,539	14.3%
Facility Lighting (kWh)	278,800	10.5%	278,800	10.3%	278,800	10.3%
Miscellaneous Elec. Loads (kWh)	49,399	1.9%	49,399	1.8%	49,399	1.8%
HVAC Fans (kWh)	255,021	9.6%	255,021	9.4%	255,021	9.4%
HVAC Cooling (kWh)	26,671	1.0%	26,672	1.0%	26,672	1.0%
Gas HVAC Heating (Therms)	24,139	26.6%	24,138	26.0%	24,138	26.1%
Gas Water Heaters (Therms)	8,719	9.6%	8,719	9.4%	8,719	9.4%
Gas Cooking Equipment (Therms)	8,908	9.8%	8,908	9.6%	8,908	9.6%
Energy Use Intensity (kBtu/ft ²)	193.0		197.3		197.0	

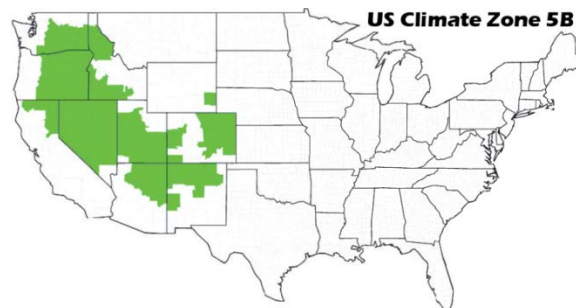
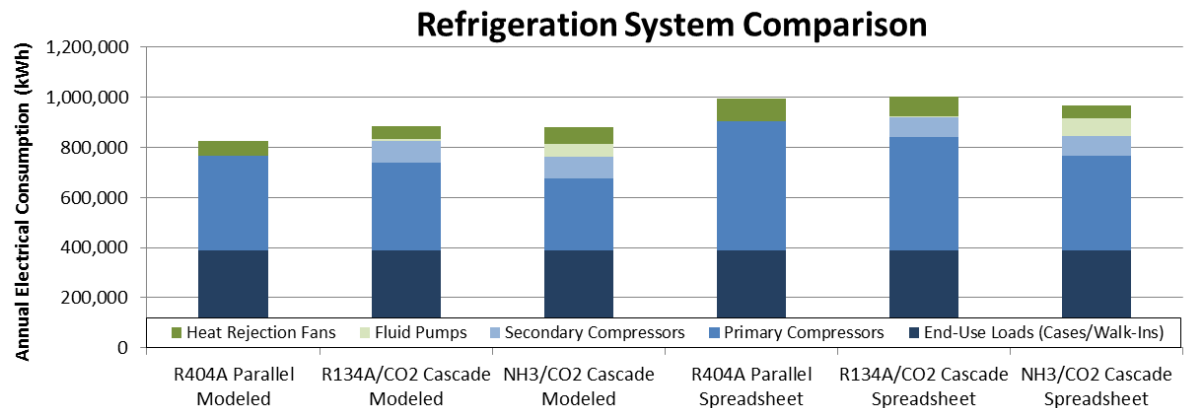

Minneapolis, MN - US Climate Zone 6A Results						
Annual Refrigeration System Comparison						
Energy Source	Energy Model Results			Spreadsheet Calculation Results		
	R404A Parallel	R134A/CO2 Cascade	NH3/CO2 Cascade	R404A Parallel	R134A/CO2 Cascade	NH3/CO2 Cascade
Primary Compressors (kWh)	379,201	354,006	303,496	499,329	436,640	384,125
Secondary Compressors (kWh)	-	86,783	86,783	-	77,345	77,345
Secondary Fluid Pump (kWh)	-	6,532	6,532	-	5,918	5,918
Heat Rejection Fan (kWh)	54,350	48,999	67,333	80,662	71,268	50,031
Heat Rejection Pump (kWh)	-	-	47,944	-	-	65,093
Direct TEWI Contribution (kg CO ₂)	14,601,138	902,377	1,973	14,601,138	902,377	1,973
Indirect TEWI Contribution (kg CO ₂)	11,601,883	12,484,993	12,708,437	13,665,853	13,821,675	13,700,979
Total TEWI (kg CO ₂)	26,203,021	13,387,370	12,710,410	28,266,991	14,724,052	13,702,952

Annual Energy Modeled Building Component Comparison						
Energy Source	System-Based Results					
	R404A Parallel Systems		R134A/CO2 Cascade System		NH3/CO2 Cascade System	
	Energy	% of Total	Energy	% of Total	Energy	% of Total
Refrigeration System (kWh)	433,550	13.8%	496,320	15.5%	512,087	16.0%
Case & Walk-In Loads (kWh)	389,614	12.4%	389,614	12.2%	389,614	12.1%
Facility Lighting (kWh)	278,716	8.9%	278,716	8.7%	278,716	8.7%
Miscellaneous Elec. Loads (kWh)	49,399	1.6%	49,399	1.5%	49,399	1.5%
HVAC Fans (kWh)	258,128	8.2%	258,128	8.1%	258,128	8.0%
HVAC Cooling (kWh)	71,050	2.3%	71,050	2.2%	71,050	2.2%
Gas HVAC Heating (Therms)	38,150	35.7%	38,149	35.0%	38,149	34.8%
Gas Water Heaters (Therms)	9,279	8.7%	9,279	8.5%	9,279	8.5%
Gas Cooking Equipment (Therms)	8,908	8.3%	8,908	8.2%	8,908	8.1%
Energy Use Intensity (kBtu/ft ²)	227.3		231.9		233.0	

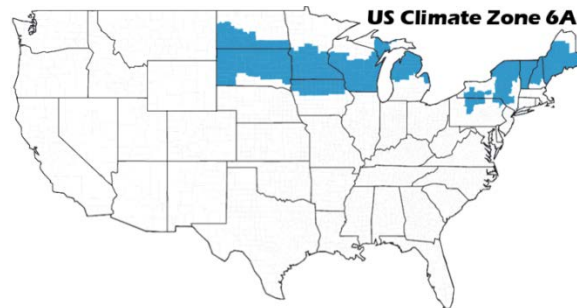
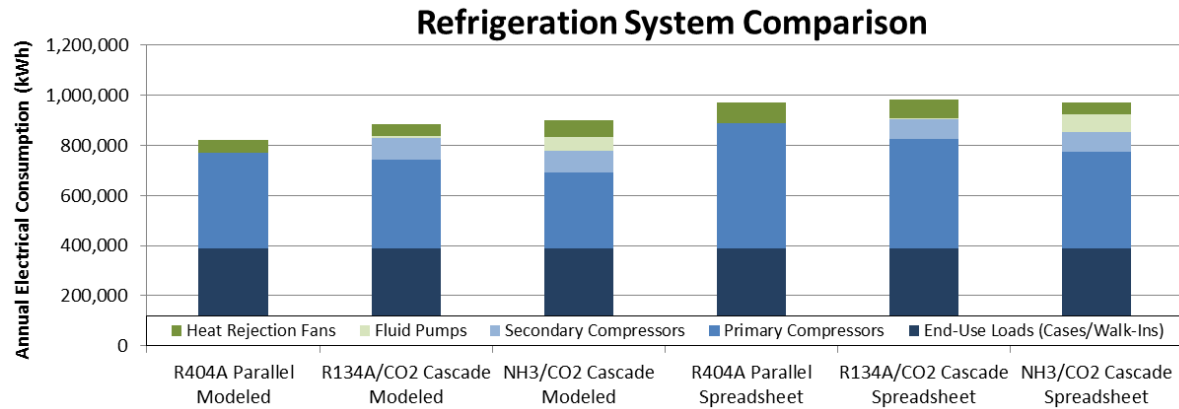

Helena, MT - US Climate Zone 6B Results						
Annual Refrigeration System Comparison						
Energy Source	Energy Model Results			Spreadsheet Calculation Results		
	R404A Parallel	R134A/CO2 Cascade	NH3/CO2 Cascade	R404A Parallel	R134A/CO2 Cascade	NH3/CO2 Cascade
Primary Compressors (kWh)	356,988	333,467	280,685	469,964	411,716	361,656
Secondary Compressors (kWh)	-	85,542	85,542	-	76,395	76,395
Secondary Fluid Pump (kWh)	-	6,532	6,532	-	5,918	5,918
Heat Rejection Fan (kWh)	49,997	45,030	59,969	74,420	67,274	40,514
Heat Rejection Pump (kWh)	-	-	47,488	-	-	63,607
Direct TEWI Contribution (kg CO ₂)	14,601,138	902,377	1,973	14,601,138	902,377	1,973
Indirect TEWI Contribution (kg CO ₂)	6,157,047	6,648,450	6,724,561	7,222,534	7,351,863	7,250,866
Total TEWI (kg CO ₂)	20,758,185	7,550,827	6,726,534	21,823,673	8,254,240	7,252,839

Annual Energy Modeled Building Component Comparison						
Energy Source	System-Based Results					
	R404A Parallel Systems		R134A/CO2 Cascade System		NH3/CO2 Cascade System	
	Energy	% of Total	Energy	% of Total	Energy	% of Total
Refrigeration System (kWh)	406,985	14.0%	470,572	15.9%	480,217	16.2%
Case & Walk-In Loads (kWh)	386,990	13.3%	386,990	13.1%	386,990	13.0%
Facility Lighting (kWh)	278,715	9.6%	278,715	9.4%	278,715	9.4%
Miscellaneous Elec. Loads (kWh)	49,399	1.7%	49,399	1.7%	49,399	1.7%
HVAC Fans (kWh)	257,242	8.9%	257,242	8.7%	257,242	8.7%
HVAC Cooling (kWh)	11,961	0.4%	11,961	0.4%	11,961	0.4%
Gas HVAC Heating (Therms)	33,157	33.5%	33,157	32.8%	33,157	32.7%
Gas Water Heaters (Therms)	9,384	9.5%	9,384	9.3%	9,384	9.3%
Gas Cooking Equipment (Therms)	8,908	9.0%	8,908	8.8%	8,908	8.8%
Energy Use Intensity (kBtu/ft ²)	210.5		215.1		215.8	

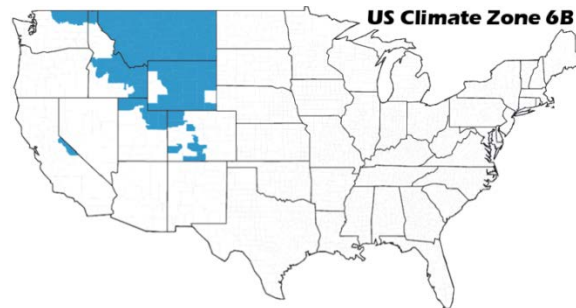
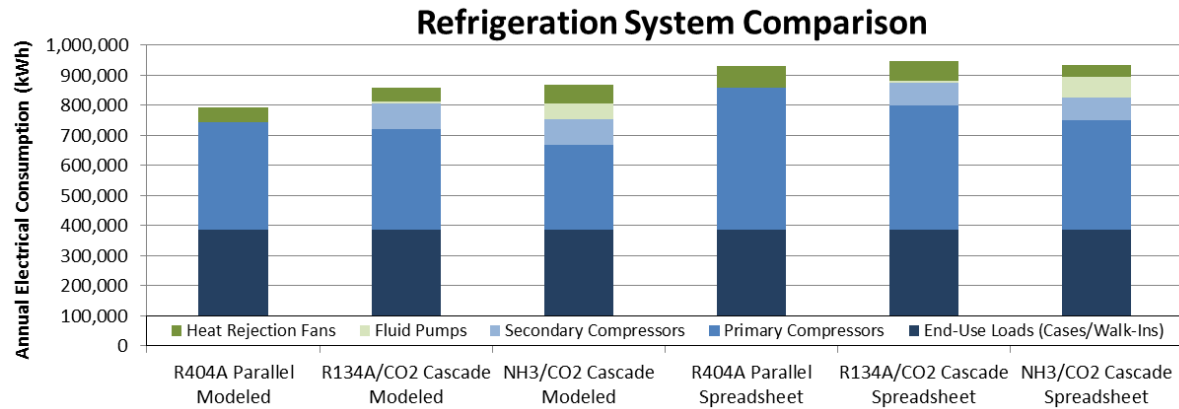

Duluth, MN - US Climate Zone 7 Results						
Annual Refrigeration System Comparison						
Energy Source	Energy Model Results			Spreadsheet Calculation Results		
	R404A Parallel	R134A/CO2 Cascade	NH3/CO2 Cascade	R404A Parallel	R134A/CO2 Cascade	NH3/CO2 Cascade
Primary Compressors (kWh)	353,563	333,034	290,238	453,405	397,679	362,380
Secondary Compressors (kWh)	-	85,711	85,711	-	75,780	75,780
Secondary Fluid Pump (kWh)	-	6,532	6,532	-	5,918	5,918
Heat Rejection Fan (kWh)	47,006	42,809	68,627	68,062	61,464	39,458
Heat Rejection Pump (kWh)	-	-	49,380	-	-	64,522
Direct TEWI Contribution (kg CO ₂)	14,601,138	902,377	1,973	14,601,138	902,377	1,973
Indirect TEWI Contribution (kg CO ₂)	11,142,286	12,092,711	12,549,051	12,850,161	13,120,189	13,220,759
Total TEWI (kg CO ₂)	25,743,424	12,995,088	12,551,024	27,451,299	14,022,566	13,222,732

Annual Energy Modeled Building Component Comparison						
Energy Source	System-Based Results					
	R404A Parallel Systems		R134A/CO2 Cascade System		NH3/CO2 Cascade System	
	Energy	% of Total	Energy	% of Total	Energy	% of Total
Refrigeration System (kWh)	400,569	12.3%	468,087	14.1%	500,489	14.9%
Case & Walk-In Loads (kWh)	388,172	11.9%	388,174	11.7%	388,174	11.5%
Facility Lighting (kWh)	278,699	8.5%	278,699	8.4%	278,699	8.3%
Miscellaneous Elec. Loads (kWh)	49,399	1.5%	49,399	1.5%	49,399	1.5%
HVAC Fans (kWh)	260,188	8.0%	260,187	7.8%	260,187	7.7%
HVAC Cooling (kWh)	32,186	1.0%	32,139	1.0%	32,139	1.0%
Gas HVAC Heating (Therms)	44,422	39.9%	44,416	39.1%	44,416	38.7%
Gas Water Heaters (Therms)	9,942	8.9%	9,942	8.7%	9,942	8.7%
Gas Cooking Equipment (Therms)	8,908	8.0%	8,908	7.8%	8,908	7.8%
Energy Use Intensity (kBtu/ft ²)	236.9		241.8		244.2	

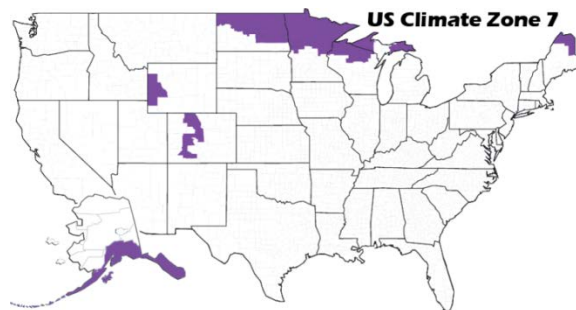
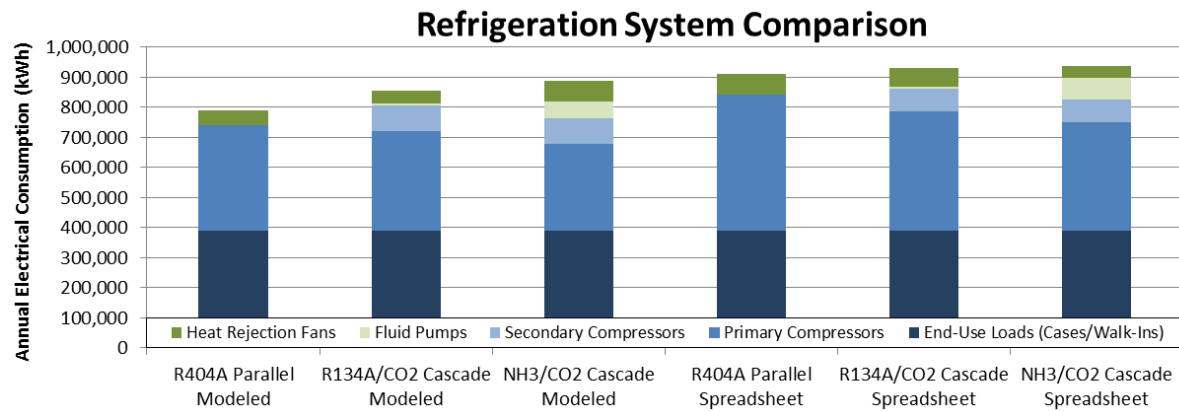

Fairbanks, AK - US Climate Zone 8 Results						
Annual Refrigeration System Comparison						
Energy Source	Energy Model Results			Spreadsheet Calculation Results		
	R404A Parallel	R134A/CO2 Cascade	NH3/CO2 Cascade	R404A Parallel	R134A/CO2 Cascade	NH3/CO2 Cascade
Primary Compressors (kWh)	329,059	310,469	268,696	435,746	381,837	349,277
Secondary Compressors (kWh)	-	82,930	82,930	-	74,907	74,907
Secondary Fluid Pump (kWh)	-	6,532	6,532	-	5,918	5,918
Heat Rejection Fan (kWh)	38,460	35,040	49,156	57,215	52,092	30,640
Heat Rejection Pump (kWh)	-	-	48,793	-	-	63,575
Direct TEWI Contribution (kg CO ₂)	14,601,138	902,377	1,973	14,601,138	902,377	1,973
Indirect TEWI Contribution (kg CO ₂)	8,730,555	9,509,752	9,753,292	10,187,478	10,435,961	10,545,004
Total TEWI (kg CO ₂)	23,331,694	10,412,128	9,755,265	24,788,617	11,338,337	10,546,978

Annual Energy Modeled Building Component Comparison						
Energy Source	System-Based Results					
	R404A Parallel Systems		R134A/CO2 Cascade System		NH3/CO2 Cascade System	
	Energy	% of Total	Energy	% of Total	Energy	% of Total
Refrigeration System (kWh)	367,520	10.3%	434,972	12.0%	456,108	12.5%
Case & Walk-In Loads (kWh)	384,185	10.8%	384,185	10.6%	384,185	10.5%
Facility Lighting (kWh)	278,165	7.8%	278,165	7.7%	278,165	7.6%
Miscellaneous Elec. Loads (kWh)	49,399	1.4%	49,399	1.4%	49,399	1.4%
HVAC Fans (kWh)	263,492	7.4%	263,492	7.3%	263,492	7.2%
HVAC Cooling (kWh)	4,938	0.1%	4,938	0.1%	4,938	0.1%
Gas HVAC Heating (Therms)	55,635	45.9%	55,635	45.0%	55,635	44.7%
Gas Water Heaters (Therms)	10,812	8.9%	10,812	8.7%	10,812	8.7%
Gas Cooking Equipment (Therms)	8,908	7.3%	8,908	7.2%	8,908	7.2%
Energy Use Intensity (kBtu/ft ²)	258.2		263.1		264.6	

