

Lower Yellowstone Intake Diversion Dam Fish Passage Project, Montana

Draft Environmental Impact Statement



Prepared by Joint Lead Agencies:



U.S. Department of the Interior
Bureau of Reclamation
Billings, Montana



U.S. Army Corps of Engineers
Omaha District
Omaha, Nebraska

May 2016

Lower Yellowstone Intake Diversion Dam Fish Passage Project, Montana

Draft Environmental Impact Statement

Joint Lead Agencies

U.S. Army Corps of Engineers
Omaha District
Omaha, Nebraska

U.S. Department of the Interior
Bureau of Reclamation
Billings, Montana

Cooperating Agencies

U.S. Fish and Wildlife Service
Montana Department of Natural Resources
Lower Yellowstone Irrigation Project

Western Area Power Administration
Montana Fish, Wildlife, and Parks

Abstract:

The U.S. Army Corps of Engineers and Department of the Interior, Bureau of Reclamation propose to construct a project to improve passage of pallid sturgeon and other native fish at the Lower Yellowstone Project Intake Diversion Dam while continuing a viable and effective operation of the Project.

This Draft Environmental Impact Statement (EIS) has been prepared pursuant to the National Environmental Policy Act to analyze and disclose the effects of the proposed action on environmental and human resources. The No Action Alternative and five action alternatives are evaluated. The Bypass Channel is the preferred alternative.

The 45-day public review and comment period on the EIS runs from June 3, 2016 to July 18, 2016. Two public meetings are scheduled, at which time verbal comments will be accepted. The first will be held at the Richland County Fair Event Center, Sidney, MT, on Tuesday, June 28, from 5:30 pm to 9:00 pm. The second will be held the following evening, June 29, at the Dawson County High School Auditorium, 900 N. Merrill Avenue, Glendive, MT from 5:30 pm to 9:00 pm. Written comments will be accepted at both meetings.

Written comments may also be submitted via e-mail, sent to cenwo-planning@usace.army.mil, or via regular mail sent to the U.S. Army Corps of Engineers Omaha District, ATTN: CENWO-PM-AA, 1616 Capitol Avenue, Omaha, NE 68102. Please note: If your hardcopy or email comment includes personal identifying information, you may request we withhold that information from public review. However, we cannot guarantee that we will be able to withhold that information from public review.

For further information regarding this Draft Environmental Impact statement, contact:

Tiffany Vanosdall
U.S. Army Corps of Engineers
1616 Capitol Avenue, Omaha, NE 68102
tiffany.k.vanosdall@usace.army.mil

David Trimpe
Bureau of Reclamation, Great Plains Region
P.O. Box 36900, Billings, MT 59107-6900
dtrimpe@usbr.gov

Contents

	Page
Executive Summary	xxv
Description of the Lower Yellowstone Project	xxv
Project Purpose and Need.....	xxvi
Improve Fish Passage	xxvi
Continue Viable and Effective Operation of the Lower Yellowstone Project.....	xxvi
Contribute to Ecosystem Restoration	xxvii
The Pallid Sturgeon	xxvii
Summary of Alternatives.....	xxviii
No Action	xxviii
Rock Ramp	xxix
Bypass Channel	xxix
Modified Side Channel.....	xxx
Multiple Pumps.....	xxx
Multiple Pumps with Conservation Measures	xxxi
Alternative Costs	xxxi
Summary of Environmental Effects	xxxii
Preferred Alternative	xlii
Public Review and Comment	xlii
1 Purpose and Need for the Proposed Action	1-1
1.1 Proposed Action	1-1
1.1.1 Project Location and Study Area.....	1-1
1.1.2 Project Background	1-4
1.1.2.1 Authorization	1-4
1.1.2.2 Regulatory Compliance	1-4
1.1.2.3 Collaboration	1-5
1.1.2.4 Previous Studies and Collaborative Efforts	1-5
1.1.3 Relationship to Other Projects or Activities	1-6
1.2 Project Purpose and Need.....	1-6
1.2.1 Purpose	1-6
1.2.2 Need—Continue Viable and Effective Operation of the Lower Yellowstone Project .	1-6
1.2.3 Need—Improve Fish Passage.....	1-7
1.2.4 Need—Ecosystem Restoration	1-8
1.3 Current Facilities and Operation.....	1-8
1.4 Environmental Review Process	1-10
1.4.1 Previous Environmental Review	1-10
1.4.2 Current Environmental Review	1-10
1.4.2.1 Co-lead and Cooperating Agencies	1-11
1.4.2.2 Key Management Issues	1-11
1.5 Required Permits and Approvals	1-12
1.5.1 Federal Permits and Approvals.....	1-12
1.5.1.1 Endangered Species Act	1-12
1.5.1.2 Native American Consultation.....	1-13
1.5.1.3 Archaeological Resource Protection Act of 1979.....	1-14
1.5.1.4 Clean Water Act of 1977 (as amended).....	1-14
1.5.1.5 Floodplain Management Assessment	1-14

Contents

- 1.5.1.6 Farmland Protection Policy Act of 1995..... 1-15
- 1.5.1.7 Fish and Wildlife Coordination Act of 1958 (as amended) 1-15
- 1.5.1.8 Migratory Bird Treaty Act and Executive Order 13186 (January 2001) 1-15
- 1.5.1.9 Native American Graves Protection and Repatriation Act (Public Law 101-601) 1-16
- 1.5.1.10 National Historic Preservation Act of 1966 (as amended in 2006) 1-16
- 1.5.1.11 Rivers and Harbors Act of 1899 1-16
- 1.5.1.12 Executive Order 13112 for Invasive Species 1-16
- 1.5.1.13 Executive Order 11988 Assessment 1-17
- 1.5.1.14 Other Executive Orders..... 1-17
- 1.5.2 State and Local Permits and Approvals..... 1-17
 - 1.5.2.1 State Water Rights 1-17
 - 1.5.2.2 Montana Environmental Policy Act..... 1-17
 - 1.5.2.3 Stream Protection Act..... 1-18
 - 1.5.2.4 Short-Term Water Quality Standards for Turbidity (318) 1-18
 - 1.5.2.5 Montana Land-use License of Easement on Navigable Waters..... 1-18
 - 1.5.2.6 Stormwater Discharge General Permits 1-18
 - 1.5.2.7 401 Water Quality Certification for Other Federal Permits & Licenses..... 1-19
- 1.6 Decisions to be Made 1-19
- 1.7 Agency and Public Scoping Issues 1-19
- 2 Alternatives 2-22**
 - 2.1 Problems and Opportunities 2-22
 - 2.1.1 Existing Conditions 2-23
 - 2.1.1.1 Pallid Sturgeon..... 2-23
 - 2.1.1.2 Existing Dam and Facilities 2-24
 - 2.1.1.3 Intake Diversion Dam..... 2-25
 - 2.1.1.4 Main Canal Headworks..... 2-25
 - 2.2 Background and History of Alternatives 2-25
 - 2.2.1 Completed Planning Studies..... 2-26
 - 2.2.1.1 Alternatives Report 2-29
 - 2.2.1.2 Value Engineering Study 2-30
 - 2.2.1.3 Value Planning Study 2-30
 - 2.2.1.4 Biological Review Team..... 2-31
 - 2.2.2 2010 NEPA EA 2-31
 - 2.2.2.1 2010 Environmental Assessment NEPA Scoping 2-32
 - 2.2.2.2 Alternatives Eliminated After Initial EA Scoping in 2008 2-32
 - 2.2.3 Alternatives Considered During 2013 Planning Studies 2-33
 - 2.2.4 2015 Final Supplement to the 2010 Environmental Assessment 2-33
 - 2.3 Alternatives Considered in This EIS 2-35
 - 2.3.1 Alternatives proposed in scoping 2-35
 - 2.3.2 Elements Common to All Alternatives..... 2-36
 - 2.3.2.1 Water Conservation Measures 2-36
 - 2.3.2.2 Operation, Maintenance and Replacement (OM&R) of Certain Facilities.. 2-36
 - 2.3.2.3 Pick Sloan Missouri River Basin Program Power 2-37
 - 2.3.2.4 Ongoing Lower Yellowstone Project Activities 2-37
 - 2.3.3 No Action 2-38
 - 2.3.3.1 Existing Dam and Facilities 2-38
 - 2.3.3.2 Operation & Maintenance..... 2-39
 - 2.3.4 Rock Ramp 2-42
 - 2.3.4.1 Construction..... 2-44
 - 2.3.4.2 Operation & Maintenance..... 2-45

2.3.5	Bypass Channel	2-46
2.3.5.1	Bypass Channel Features	2-48
2.3.5.2	Construction.....	2-48
2.3.5.3	Replacement Weir.....	2-50
2.3.5.4	Operation & Maintenance.....	2-52
2.3.6	Modified Side Channel.....	2-54
2.3.6.1	Design Criteria.....	2-57
2.3.6.2	Construction.....	2-60
2.3.6.3	Operation & Maintenance.....	2-62
2.3.7	Multiple Pumping Stations	2-64
2.3.7.1	Fish Screens	2-66
2.3.7.2	Pumping Stations	2-67
2.3.7.3	Power Demand.....	2-70
2.3.7.4	Dam Removal	2-70
2.3.7.5	Canal Operation	2-72
2.3.7.6	Construction.....	2-73
2.3.7.7	Operation and Maintenance	2-75
2.3.8	Multiple Pumping Stations with Conservation Measures.....	2-77
2.3.8.1	Conservation Measures	2-77
2.3.8.2	Pumping Stations Along the River	2-83
2.3.8.3	Dam Removal	2-86
2.3.8.4	Gravity Diversion	2-87
2.3.8.5	Canal Modification	2-90
2.3.8.6	Wind Power	2-92
2.3.8.7	Irrigation Water Requirements and Conservation Measure Effectiveness ..	2-92
2.3.8.8	Construction.....	2-94
2.3.8.9	Operation and Maintenance	2-94
2.4	Alternatives Analysis.....	2-97
2.4.1	Purpose and Need	2-97
2.4.2	Cost Estimates	2-98
2.4.3	Fish Passage Analysis.....	2-99
2.4.4	Cost-Effectiveness	2-100
2.4.5	Comparison Matrix.....	2-102
2.5	Identification of the Preferred Alternative.....	2-105
2.5.1	Reasons for Selected Alternative.....	2-105
2.5.2	Sturgeon Use of Bypass Channels.....	2-105
2.5.2.1	The Potential for Successful Passage in a Bypass Channel by Pallid Sturgeon	2-105
2.5.2.2	Swimming ability and passage of pallid sturgeon	2-105
2.5.2.3	Fish Bypass Channels	2-106
2.5.2.4	Side-channel Ascent by Pallid Sturgeon.....	2-107
2.5.2.5	Bottom Type and Movements by Pallid and Shovelnose Sturgeon.—.....	2-108
2.6	Clean Water Act	2-108
2.7	Monitoring and Adaptive Management.....	2-109
3	Affected Environment.....	3-1
3.1	Climate.....	3-1
3.2	Air Quality.....	3-3
3.2.1	Air Quality Standards	3-3
3.2.2	Meteorological Conditions	3-5
3.2.3	Air Quality in the Study Area.....	3-6
3.3	Surface Water Hydrology	3-7
3.3.1	Setting.....	3-7

Contents

3.3.2	Existing Side Channel	3-13
3.3.3	Hydrology	3-14
3.3.3.1	Daily Flow Percentiles	3-16
3.3.4	Intake Diversion Dam Hydraulics and Water Use.....	3-17
3.3.5	Canal Hydraulics	3-18
3.3.6	Canal Intake Headworks.....	3-19
3.3.7	Ice Jams	3-20
3.3.8	Hydrologic Trends.....	3-21
3.4	Groundwater Hydrology	3-21
3.4.1	Aquifers	3-23
3.4.1.1	Shallow Hydrologic Unit	3-23
3.4.1.2	Deep Hydrologic Unit.....	3-24
3.4.1.3	Fox Hills-Lower Hell Creek	3-25
3.4.2	Water Wells	3-26
3.4.3	Groundwater Use.....	3-26
3.4.3.1	Water Wells	3-26
3.4.3.2	Public Water Supplies.....	3-27
3.4.4	Source Water Protection.....	3-29
3.5	Geomorphology	3-32
3.5.1	Channel Characteristics and Sediment Transport.....	3-32
3.5.1.1	Hydraulic Conditions	3-32
3.5.1.2	Summary of Yellowstone River Cumulative Effects Assessment.....	3-33
3.5.1.3	Channel Migration Zones, Deposition, Erosion, Rate of Change.....	3-35
3.5.1.4	Human Modifications Impacting Yellowstone River Channel Characteristic.....	3-35
3.5.1.5	Split Flow Characteristics at Side Channel.....	3-36
3.5.1.6	Flow Characteristics at Downstream Confluence.....	3-36
3.5.2	Hydraulic Conditions for Fish Migration	3-36
3.5.3	Floodplain.....	3-37
3.5.3.1	Regulatory Setting	3-37
3.6	Water Quality	3-38
3.6.1	Beneficial Uses	3-39
3.6.2	Surface Water Quality	3-41
3.6.2.1	Temperature	3-41
3.6.2.2	pH.....	3-42
3.6.2.3	Dissolved Oxygen.....	3-42
3.6.2.4	Suspended Sediment	3-42
3.6.2.5	Total Dissolved Solids	3-43
3.6.2.6	Fecal Coliform and E. Coli	3-43
3.6.2.7	Nutrients.....	3-43
3.6.2.8	Pesticides	3-44
3.6.2.9	Trace Elements	3-44
3.6.2.10	Mercury.....	3-45
3.6.3	Clean Water Act Section 303(d) Listings and Total Maximum Daily Loads.....	3-45
3.6.4	Groundwater Quality	3-46
3.7	Aquatic Communities	3-47
3.7.1	Yellowstone River	3-47
3.7.2	Missouri River	3-49
3.7.3	Intake Diversion Dam.....	3-49
3.7.4	Fish	3-50
3.7.4.1	Main Channel Species.....	3-52
3.7.4.2	Backwater Species	3-53

3.7.5	Mussels	3-54
3.7.6	Macroinvertebrates	3-55
3.7.7	Aquatic Invasive Species	3-56
3.8	Wildlife	3-57
3.8.1	Wildlife Protection Designations.....	3-57
3.8.1.1	County Protections.....	3-57
3.8.1.2	State Protections	3-58
3.8.1.3	Non-Governmental Protections	3-60
3.8.2	Wildlife by Habitat	3-61
3.8.2.1	Generalist Species.....	3-65
3.8.2.2	Wetland Habitat Species.....	3-65
3.8.2.3	Woody Riparian Habitat Species	3-66
3.8.2.4	Barren Land Habitat Species	3-67
3.8.2.5	Shrubland Habitat Species	3-67
3.8.2.6	Grassland Habitat Species.....	3-68
3.9	Listed Species and State Species of Concern	3-68
3.9.1	Federally Protected Species	3-68
3.9.1.1	Mammals	3-70
3.9.1.2	Birds.....	3-74
3.9.1.3	Fish.....	3-80
3.9.1.4	Insects	3-84
3.9.2	State Species of Concern	3-85
3.9.2.1	Mammals	3-86
3.9.2.2	Birds.....	3-89
3.9.2.3	Amphibians.....	3-95
3.9.2.4	Reptiles	3-96
3.9.2.5	Fish.....	3-97
3.9.2.6	Insects	3-98
3.9.2.7	Plants.....	3-100
3.10	Lands and Vegetation	3-102
3.10.1	Land Use.....	3-102
3.10.2	Zoning	3-104
3.10.3	Land Ownership	3-104
3.10.4	Wetlands	3-104
3.10.5	Riparian Areas	3-107
3.10.6	Woodlands.....	3-110
3.10.7	Shrublands	3-111
3.10.8	Grasslands.....	3-111
3.10.9	Barrens	3-112
3.10.10	Ecological Communities within 100-Year Floodplain	3-112
3.10.11	Noxious weeds.....	3-114
3.11	Recreation.....	3-116
3.11.1	Intake FAS and Joe’s Island	3-116
3.11.2	Fishing	3-121
3.11.3	Paddlefish Caviar.....	3-121
3.11.4	Boating	3-122
3.11.5	Other Activities.....	3-122
3.12	Visual Resources	3-123
3.12.1	Intake Diversion Dam and Surroundings, Including Pump Site #1.....	3-123
3.12.1.1	Intake Diversion Dam	3-123
3.12.1.2	Headworks	3-124

Contents

3.12.1.3	Local Features	3-125
3.12.1.4	Distant Features	3-125
3.12.1.5	Viewer Groups	3-125
3.12.2	Joe’s Island	3-125
3.13	Transportation	3-127
3.13.1	Roadway Network	3-127
3.13.2	Public Transportation	3-131
3.13.3	Railroads	3-131
3.13.4	Airports	3-131
3.14	Noise	3-132
3.15	Social and Economic Conditions	3-134
3.15.1	Population	3-137
3.15.1.1	Population Size	3-137
3.15.1.2	Population Growth	3-138
3.15.1.3	Population Age	3-138
3.15.2	Households and Families	3-140
3.15.3	Home Value	3-141
3.15.4	Industries, Employment, and Income	3-141
3.15.5	Agriculture in the Lower Yellowstone Project Area	3-146
3.15.5.1	Background	3-146
3.15.5.2	Farm Characteristics	3-148
3.16	Environmental Justice	3-151
3.16.1	Methodology	3-151
3.16.2	Data Sources/Data Gaps	3-151
3.16.3	Affected Environment	3-151
3.16.3.1	Race	3-151
3.16.3.2	Labor Force and Unemployment	3-152
3.16.3.3	Educational Attainment	3-154
3.16.3.4	Poverty	3-155
3.16.3.5	Summary	3-157
3.17	Historic Properties	3-157
3.17.1	Definitions	3-157
3.17.1.1	Historic Properties	3-157
3.17.1.2	Pre-Contact-Era Resources	3-157
3.17.1.3	Historic-Era Resources	3-157
3.17.1.4	Ethnographic Resources	3-158
3.17.2	Regulatory Context	3-158
3.17.2.1	Memorandum of Agreement	3-158
3.17.3	Area of Potential Effect	3-159
3.17.4	Paleo-Environmental Setting	3-160
3.17.5	Cultural Setting	3-161
3.17.5.1	Pre-Contact Context	3-161
3.17.5.2	Ethnographic Context	3-167
3.17.5.3	Historic Context	3-168
3.17.5.4	Lower Yellowstone Project	3-168
3.17.6	Cultural Resources Records Search	3-171
3.17.6.1	Previously Conducted Surveys	3-171
3.17.6.2	Previously Recorded Resources	3-179
3.18	Indian Trust Assets	3-186
3.18.1	Historic Treaties with Tribes	3-188
3.18.2	Indian Trust Rights	3-192

3.18.2.1	Hunting, Fishing, and Gathering Rights	3-192
3.18.2.2	Indian Water Rights	3-192
3.18.3	Consultations Conducted with Indian Tribes	3-193
3.18.4	Identified Indian Trust Lands and Rights	3-194
3.19	Ecosystem Services	3-194
4	Environmental Consequences	4-1
4.1	Introduction	4-1
4.1.1	Organization of this Chapter.....	4-1
4.1.2	Definitions of Effects.....	4-1
4.1.3	What is Meant by Determination of Significance?.....	4-2
4.1.4	Past, Present, and Reasonably Foreseeable Future Actions.....	4-3
4.1.4.1	Past and Present Actions.....	4-3
4.1.4.2	Reasonably Foreseeable Future Projects/Actions	4-4
4.2	Climate.....	4-7
4.2.1	Area of Potential Effect	4-7
4.2.2	Summary of Potential Effects.....	4-7
4.2.3	Construction Effects	4-8
4.2.3.1	No Action Alternative.....	4-8
4.2.3.2	Rock Ramp Alternative.....	4-8
4.2.3.3	Bypass Channel Alternative.....	4-8
4.2.3.4	Modified Side Channel Alternative	4-8
4.2.3.5	Multiple Pump Alternative	4-9
4.2.3.6	Multiple Pumps with Conservation Measures Alternative	4-9
4.2.4	Operational Effects.....	4-9
4.2.4.1	No Action Alternative.....	4-10
4.2.4.2	Rock Ramp Alternative.....	4-10
4.2.4.3	Bypass Channel Alternative.....	4-11
4.2.4.4	Modified Side Channel Alternative	4-11
4.2.4.5	Multiple Pump Alternative	4-12
4.2.4.6	Multiple Pumps with Conservation Measures Alternative	4-12
4.2.5	Cumulative Effects	4-12
4.2.6	Actions to Minimize Effects.....	4-12
4.3	Air Quality	4-13
4.3.1	Area of Potential Effect	4-13
4.3.2	Summary of Potential Effects.....	4-13
4.3.3	Construction Effects	4-15
4.3.3.1	No Action Alternative.....	4-16
4.3.3.2	Rock Ramp Alternative.....	4-16
4.3.3.3	Bypass Channel Alternative.....	4-17
4.3.3.4	Modified Side Channel Alternative	4-18
4.3.3.5	Multiple Pump Alternative	4-18
4.3.3.6	Multiple Pumps with Conservation Measures Alternative	4-19
4.3.4	Operational Effects.....	4-19
4.3.4.1	No Action Alternative.....	4-19
4.3.4.2	Rock Ramp Alternative.....	4-20
4.3.4.3	Bypass Channel Alternative.....	4-20
4.3.4.4	Modified Side Channel Alternative	4-21
4.3.4.5	Multiple Pump Alternative	4-21
4.3.4.6	Multiple Pumps with Conservation Measures Alternative	4-22
4.3.5	Cumulative Effects	4-22
4.3.5.1	Cumulative Air Quality Effects	4-22

Contents

	4.3.5.2	Cumulative Climate Change Effects.....	4-23
	4.3.6	Actions to Minimize Effects.....	4-24
4.4		Surface Water Hydrology and Hydraulics.....	4-25
	4.4.1	Area of Potential Effect	4-25
	4.4.2	Summary of Potential Effects.....	4-25
	4.4.3	Construction Effects	4-27
	4.4.3.1	No Action Alternative.....	4-27
	4.4.3.2	Rock Ramp Alternative.....	4-27
	4.4.3.3	Bypass Channel Alternative.....	4-29
	4.4.3.4	Modified Side Channel Alternative	4-30
	4.4.3.5	Multiple Pump Alternative	4-31
	4.4.3.6	Multiple Pumps with Conservation Measures Alternative	4-32
	4.4.4	Operational Effects.....	4-34
	4.4.4.1	No Action Alternative.....	4-34
	4.4.4.2	Rock Ramp Alternative.....	4-37
	4.4.4.3	Bypass Channel Alternative.....	4-42
	4.4.4.4	Modified Side Channel Alternative	4-47
	4.4.4.5	Multiple Pump Alternative	4-50
	4.4.4.6	Multiple Pumps with Conservation Measures Alternative	4-53
	4.4.5	Cumulative Effects	4-55
	4.4.5.1	Geographic and Temporal Extent of Analysis	4-55
	4.4.5.2	Methodology for Determining Effects	4-55
	4.4.5.3	Past, Present, and Reasonably Foreseeable Future Projects Considered	4-55
	4.4.5.4	No Action Alternative.....	4-56
	4.4.5.5	Alternatives That Include Maintaining Intake Diversion Dam.....	4-56
	4.4.5.6	Alternatives That Would Remove Intake Diversion Dam.....	4-57
	4.4.6	Actions to Minimize Effects.....	4-57
4.5		Groundwater Hydrology.....	4-58
	4.5.1	Area of Potential Effect	4-58
	4.5.2	Summary of Potential Effects.....	4-59
	4.5.3	Construction Effects	4-60
	4.5.3.1	No Action Alternative.....	4-60
	4.5.3.2	Rock Ramp Alternative.....	4-60
	4.5.3.3	Bypass Channel Alternative.....	4-67
	4.5.3.4	Modified Side Channel Alternative	4-68
	4.5.3.5	Multiple Pump Alternative	4-69
	4.5.3.6	Multiple Pumps with Conservation Measures Alternative	4-70
	4.5.4	Operational Effects.....	4-71
	4.5.4.1	No Action Alternative.....	4-71
	4.5.4.2	Rock Ramp Alternative.....	4-71
	4.5.4.3	Bypass Channel Alternative.....	4-72
	4.5.4.4	Modified Side Channel Alternative	4-73
	4.5.4.5	Multiple Pump Alternative	4-74
	4.5.4.6	Multiple Pumps with Conservation Measures Alternative	4-75
	4.5.5	Cumulative Effects	4-77
	4.5.5.1	Geographic and Temporal Extent of Analysis	4-77
	4.5.5.2	Methodology for Determining Effects	4-77
	4.5.5.3	Past, Present, and Reasonably Foreseeable Future Projects Considered	4-77
	4.5.5.4	No Action Alternative.....	4-78
	4.5.5.5	Rock Ramp Alternative.....	4-78
	4.5.5.6	Bypass Channel Alternative.....	4-78

4.5.5.7	Modified Side Channel Alternative	4-78
4.5.5.8	Multiple Pump Alternative	4-78
4.5.5.9	Multiple Pumps with Conservation Measures Alternative	4-79
4.5.6	Actions to Minimize Effects	4-79
4.5.6.1	All Alternatives	4-79
4.5.6.2	Rock Ramp Alternative.....	4-80
4.5.6.3	Main CanalBypass Channel Alternative	4-81
4.5.6.4	Modified Side Channel Alternative	4-81
4.5.6.5	Multiple Pump Alternative	4-81
4.5.6.6	Multiple Pumps with Conservation Measures Alternative	4-81
4.6	Geomorphology	4-81
4.6.1	Area of Potential Effect	4-81
4.6.2	Summary of Potential Effects	4-82
4.6.3	Construction Effects	4-83
4.6.3.1	No Action Alternative.....	4-83
4.6.3.2	Rock Ramp Alternative.....	4-83
4.6.3.3	Bypass Channel Alternative.....	4-83
4.6.3.4	Modified Side Channel Alternative	4-84
4.6.3.5	Multiple Pump Alternative	4-84
4.6.3.6	Multiple Pumps with Conservation Measures Alternative	4-85
4.6.4	Operational Effects	4-86
4.6.4.1	No Action Alternative.....	4-86
4.6.4.2	Rock Ramp Alternative.....	4-87
4.6.4.3	Bypass Channel Alternative.....	4-88
4.6.4.4	Modified Side Channel Alternative	4-91
4.6.4.5	Multiple Pump Alternative	4-93
4.6.4.6	Multiple Pumps with Conservation Measures Alternative	4-95
4.6.5	Cumulative Effects	4-97
4.6.5.1	Geographic and Temporal Extent of Analysis	4-97
4.6.5.2	Methodology for Determining Effects	4-97
4.6.5.3	Past, Present, and Reasonably Foreseeable Future Projects Considered	4-97
4.6.5.4	No Action Alternative.....	4-97
4.6.5.5	Rock Ramp Alternative.....	4-98
4.6.5.6	Bypass Channel Alternative.....	4-98
4.6.5.7	Modified Side Channel Alternative	4-98
4.6.5.8	Multiple Pump Alternative and Multiple Pumps with Conservation Measures Alternative	4-99
4.6.6	Actions to Minimize Effects	4-99
4.7	Water Quality	4-100
4.7.1	Area of Potential Effect	4-100
4.7.2	Summary of Potential Effects	4-100
4.7.3	Construction Effects	4-103
4.7.3.1	No Action Alternative.....	4-103
4.7.3.2	Rock Ramp Alternative.....	4-104
4.7.3.3	Bypass Channel Alternative.....	4-105
4.7.3.4	Modifed Side Channel Alternative	4-105
4.7.3.5	Multiple Pump Alternative	4-106
4.7.3.6	Multiple Pumps with Conservation Measures Alternative	4-106
4.7.4	Operational Effects	4-107
4.7.4.1	No Action Alternative.....	4-107
4.7.4.2	Rock Ramp Alternative.....	4-107

Contents

4.7.4.3	Bypass Channel Alternative.....	4-107
4.7.4.4	Modified Side Channel Alternative	4-108
4.7.4.5	Multiple Pump Alternative	4-109
4.7.4.6	Multiple Pumps with Conservation Measures Alternative	4-110
4.7.5	Cumulative Effects	4-110
4.7.5.1	Geographic and Temporal Extent of Analysis	4-110
4.7.5.2	Methodology for Determining Effects	4-110
4.7.5.3	Past, Present, and Reasonably Foreseeable Future Projects Considered ...	4-111
4.7.5.4	No Action Alternative.....	4-111
4.7.5.5	Rock Ramp Alternative.....	4-111
4.7.5.6	Bypass Channel Alternative.....	4-111
4.7.5.7	Modified Side Channel Alternative	4-112
4.7.5.8	Multiple Pump Alternative and Multiple Pumps with Conservation Measures Alternative	4-112
4.7.6	Actions to Minimize Effects.....	4-112
4.8	Aquatic Communities	4-113
4.8.1	Area of Potential Effect	4-113
4.8.2	Summary of Potential Effects	4-113
4.8.3	Construction Effects	4-115
4.8.3.1	No Action Alternative.....	4-115
4.8.3.2	Rock Ramp Alternative.....	4-115
4.8.3.3	Bypass Channel Alternative.....	4-117
4.8.3.4	Modified Side Channel Alternative	4-119
4.8.3.5	Multiple Pump Alternative	4-120
4.8.3.6	Multiple Pumps with Conservation Measures Alternative	4-121
4.8.4	Operational Effects.....	4-123
4.8.4.1	No Action Alternative.....	4-123
4.8.4.2	Rock Ramp Alternative.....	4-124
4.8.4.3	Bypass Channel Alternative.....	4-125
4.8.4.4	Modified Side Channel Alternative	4-127
4.8.4.5	Multiple Pump Alternative	4-129
4.8.4.6	Multiple Pumps with Conservation Measures Alternative	4-131
4.8.5	Cumulative Effects	4-132
4.8.5.1	Geographic and Temporal Extent of Analysis	4-132
4.8.5.2	Methodology for Determining Effects	4-132
4.8.5.3	Past, Present, and Reasonably Foreseeable Future Projects Considered ...	4-132
4.8.5.4	No Action Alternative.....	4-133
4.8.5.5	Rock Ramp Alternative.....	4-133
4.8.5.6	Bypass Channel Alternative.....	4-133
4.8.5.7	Modified Side Channel Alternative	4-133
4.8.5.8	Multiple Pump Alternative	4-134
4.8.5.9	Multiple Pumps with Conservation Measures Alternative	4-134
4.8.6	Actions to Minimize Effects.....	4-134
4.8.6.1	General.....	4-134
4.8.6.2	Fish.....	4-134
4.9	Wildlife.....	4-135
4.9.1	Area of Potential Effect	4-135
4.9.2	Summary of Potential Effects	4-135
4.9.3	Construction Effects	4-137
4.9.3.1	No Action Alternative.....	4-137
4.9.3.2	Rock Ramp Alternative.....	4-137

4.9.3.3	Bypass Channel Alternative.....	4-138
4.9.3.4	Modified Side Channel Alternative	4-140
4.9.3.5	Multiple Pump Alternative	4-141
4.9.3.6	Multiple Pumps with Conservation Measures Alternative	4-142
4.9.4	Operational Effects	4-143
4.9.4.1	No Action Alternative.....	4-143
4.9.4.2	Rock Ramp Alternative.....	4-144
4.9.4.3	Bypass Channel Alternative.....	4-145
4.9.4.4	Modified Side Channel Alternative	4-146
4.9.4.5	Multiple Pump Alternative	4-147
4.9.4.6	Multiple Pumps with Conservation Measures Alternative	4-148
4.9.5	Cumulative Effects	4-149
4.9.6	Actions to Minimize Effects.....	4-150
4.10	Federally Listed Species and State Species of Concern	4-151
4.10.1	Area of Potential Effect	4-151
4.10.2	Relationship Between Recovery Goals, Recruitment and This Project.....	4-152
4.10.3	Biological Criteria for Success	4-152
4.10.4	Summary of Potential Effects.....	4-153
4.10.5	Construction Effects	4-155
4.10.5.1	No Action Alternative.....	4-155
4.10.5.2	Rock Ramp Alternative.....	4-155
4.10.5.3	Bypass Channel Alternative.....	4-157
4.10.5.4	Modified Side Channel Alternative	4-159
4.10.5.5	Multiple Pump Alternative	4-161
4.10.5.6	Multiple Pumps with Conservation Measures Alternative	4-162
4.10.6	Operational Effects	4-163
4.10.6.1	No Action Alternative.....	4-163
4.10.6.2	Rock Ramp Alternative.....	4-164
4.10.6.3	Bypass Channel Alternative.....	4-167
4.10.6.4	Modified Side Channel Alternative	4-170
4.10.6.5	Multiple Pump Alternative	4-172
4.10.6.6	Multiple Pumps with Conservation Measures Alternative	4-174
4.10.7	Cumulative Effects	4-176
4.10.7.1	Geographic and Temporal Extent of Analysis.....	4-176
4.10.7.2	Methodology for Determining Effects.....	4-176
4.10.7.3	Past, Present, and Reasonably Foreseeable Future Projects Considered ...	4-176
4.10.7.4	No Action Alternative.....	4-176
4.10.7.5	Rock Ramp Alternative.....	4-177
4.10.7.6	Bypass Channel Alternative.....	4-177
4.10.7.7	Modified Side Channel Alternative	4-178
4.10.7.8	Multiple Pump Alternative	4-178
4.10.7.9	Multiple Pumps with Conservation Measures Alternative	4-178
4.10.8	Actions to Minimize Effects.....	4-178
4.11	Lands and Vegetation	4-179
4.11.1	Area of Potential Effect	4-180
4.11.2	Summary of Potential Effects.....	4-180
4.11.3	Construction Effects	4-181
4.11.3.1	No Action Alternative.....	4-181
4.11.3.2	Rock Ramp Alternative.....	4-181
4.11.3.3	Bypass Channel Alternative.....	4-182
4.11.3.4	Modified Side Channel Alternative	4-184

Contents

4.11.3.5	Multiple Pump Alternative	4-185
4.11.3.6	Multiple Pumps with Conservation Measures Alternative	4-185
4.11.4	Operational Effects	4-186
4.11.4.1	No Action Alternative.....	4-186
4.11.4.2	Rock Ramp Alternative.....	4-187
4.11.4.3	Bypass Channel Alternative.....	4-188
4.11.4.4	Modified Side Channel Alternative	4-190
4.11.4.5	Multiple Pump Alternative	4-190
4.11.4.6	Multiple Pumps with Conservation Measures Alternative	4-191
4.11.5	Cumulative Effects	4-192
4.11.5.1	Geographic and Temporal Extent of Analysis	4-192
4.11.5.2	Methodology for Determining Effects	4-192
4.11.5.3	Past, Present, and Reasonably Foreseeable Future Projects Considered ...	4-192
4.11.5.4	No Action Alternative.....	4-193
4.11.5.5	Rock Ramp Alternative.....	4-193
4.11.5.6	Bypass Channel Alternative.....	4-193
4.11.5.7	Modified Side Channel Alternative	4-194
4.11.5.8	Multiple Pump Alternative	4-194
4.11.5.9	Multiple Pumps with Conservation Measures Alternative	4-194
4.11.6	Actions to Minimize Effects.....	4-194
4.12	Recreation.....	4-197
4.12.1	Area of Potential Effect	4-197
4.12.2	Summary of Potential Effects	4-197
4.12.3	Construction Effects	4-199
4.12.3.1	No Action Alternative.....	4-199
4.12.3.2	Rock Ramp Alternative.....	4-199
4.12.3.3	Bypass Channel Alternative.....	4-200
4.12.3.4	Modified Side Channel Alternative	4-201
4.12.3.5	Multiple Pump Alternative	4-202
4.12.3.6	Multiple Pumps with Conservation Measures Alternative	4-204
4.12.4	Operational Effects	4-205
4.12.4.1	No Action Alternative.....	4-205
4.12.4.2	Rock Ramp Alternative.....	4-205
4.12.4.3	Bypass Channel Alternative.....	4-206
4.12.4.4	Modified Side Channel Alternative	4-206
4.12.4.5	Multiple Pump Alternative	4-207
4.12.4.6	Multiple Pumps with Conservation Measures Alternative	4-207
4.12.5	Cumulative Effects	4-208
4.12.5.1	Geographic and Temporal Extent of Analysis	4-208
4.12.5.2	Methodology for Determining Effects	4-208
4.12.5.3	Past, Present, and Reasonably Foreseeable Future Projects Considered ...	4-208
4.12.5.4	No Action Alternative.....	4-209
4.12.5.5	Rock Ramp Alternative.....	4-209
4.12.5.6	Bypass Channel Alternative.....	4-209
4.12.5.7	Modified Side Channel Alternative	4-210
4.12.5.8	Multiple Pump Alternative	4-210
4.12.5.9	Multiple Pumps with Conservation Measures Alternative	4-210
4.12.6	Actions to Minimize Effects.....	4-210
4.12.6.1	Rock Ramp Alternative.....	4-211
4.12.6.2	Bypass Channel Alternative.....	4-211
4.12.6.3	Modified Side Channel Alternative	4-211

4.12.6.4	Multiple Pump Alternative	4-211
4.12.6.5	Multiple Pumps with Conservation Measures Alternative	4-211
4.13	Visual Resources	4-212
4.13.1	Area of Potential Effect	4-212
4.13.2	Summary of Potential Effects	4-212
4.13.3	Construction Effects	4-213
4.13.3.1	No Action Alternative.....	4-213
4.13.3.2	Rock Ramp Alternative.....	4-213
4.13.3.3	Bypass Channel Alternative.....	4-214
4.13.3.4	Modified Side Channel Alternative	4-214
4.13.3.5	Multiple Pump Alternative	4-214
4.13.3.6	Multiple Pumps with Conservation Measures Alternative	4-215
4.13.4	Operational Effects	4-215
4.13.4.1	No Action Alternative.....	4-215
4.13.4.2	Rock Ramp Alternative.....	4-216
4.13.4.3	Bypass Channel Alternative.....	4-217
4.13.4.4	Modified Side Channel Alternative	4-217
4.13.4.5	Multiple Pump Alternative	4-218
4.13.4.6	Multiple Pumps with Conservation Measures Alternative	4-219
4.13.5	Cumulative Effects	4-219
4.13.5.1	Geographic and Temporal Extent of Analysis	4-219
4.13.5.2	Methodology for Determining Effects	4-219
4.13.5.3	Past, Present, and Reasonably Foreseeable Future Projects Considered ...	4-219
4.13.5.4	No Action Alternative.....	4-220
4.13.5.5	Rock Ramp Alternative.....	4-220
4.13.5.6	Bypass Channel Alternative.....	4-220
4.13.5.7	Modified Side Channel Alternative	4-220
4.13.5.8	Multiple Pump Alternative	4-220
4.13.5.9	Multiple Pumps with Conservation Measures Alternative	4-220
4.13.6	Actions to Minimize Effects.....	4-221
4.14	Transportation.....	4-221
4.14.1	Area of Potential Effect	4-221
4.14.2	Summary of Potential Effects	4-222
4.14.3	Construction Effects	4-223
4.14.3.1	No Action Alternative.....	4-223
4.14.3.2	Rock Ramp Alternative.....	4-223
4.14.3.3	Bypass Channel Alternative.....	4-225
4.14.3.4	Modified Side Channel Alternative	4-226
4.14.3.5	Multiple Pump Alternative	4-226
4.14.3.6	Multiple Pumps with Conservation Measures Alternative	4-227
4.14.4	Operational Effects	4-228
4.14.4.1	No Action Alternative.....	4-228
4.14.4.2	Rock Ramp Alternative.....	4-229
4.14.4.3	Bypass Channel Alternative.....	4-229
4.14.4.4	Modified Side Channel Alternative	4-229
4.14.4.5	Multiple Pump Alternative	4-229
4.14.4.6	Multiple Pumps with Conservation Measures Alternative	4-230
4.14.5	Cumulative Effects	4-230
4.14.5.1	Geographic and Temporal Extent of Analysis	4-230
4.14.5.2	Methodology for Determining Effects	4-230
4.14.5.3	Past, Present, and Reasonably Foreseeable Future Projects Considered ...	4-230

Contents

4.14.5.4	No Action Alternative.....	4-231
4.14.5.5	Rock Ramp Alternative.....	4-231
4.14.5.6	Bypass Channel Alternative.....	4-231
4.14.5.7	Modified Side Channel Alternative	4-231
4.14.5.8	Multiple Pump Alternative	4-231
4.14.5.9	Multiple Pumps with Conservation Measures Alternative	4-231
4.14.6	Actions to Minimize Effects.....	4-232
4.15	Noise	4-232
4.15.1	Area of Potential Effect	4-232
4.15.2	Summary of Potential Effects.....	4-233
4.15.3	Construction Effects	4-235
4.15.3.1	No Action Alternative.....	4-235
4.15.3.2	Rock Ramp Alternative.....	4-236
4.15.3.3	Bypass Channel Alternative.....	4-237
4.15.3.4	Modified Side Channel Alternative	4-238
4.15.3.5	Multiple Pump Alternative	4-238
4.15.3.6	Multiple Pumps with Conservation Measures Alternative	4-239
4.15.4	Operational Effects.....	4-240
4.15.4.1	No Action Alternative.....	4-240
4.15.4.2	Rock Ramp Alternative.....	4-240
4.15.4.3	Bypass Channel Alternative.....	4-241
4.15.4.4	Modified Side Channel Alternative	4-241
4.15.4.5	Multiple Pump Alternative	4-242
4.15.4.6	Multiple Pumps with Conservation Measures Alternative	4-242
4.15.5	Cumulative Effects	4-243
4.15.5.1	Geographic and Temporal Extent of Analysis.....	4-243
4.15.5.2	Methodology for Determining Effects.....	4-243
4.15.5.3	Past, Present, and Reasonably Foreseeable Future Projects Considered ..	4-244
4.15.6	Actions to Minimize Effects.....	4-244
4.15.6.1	Rock Ramp Alternative.....	4-244
4.15.6.2	Bypass Channel Alternative.....	4-244
4.15.6.3	Modified Side Channel Alternative	4-245
4.15.6.4	Multiple Pump Alternative	4-245
4.15.6.5	Multiple Pumps with Conservation Measures Alternative	4-245
4.16	Social and Economic Conditions.....	4-246
4.16.1	Area of Potential Effect	4-246
4.16.2	Summary of Potential Effects.....	4-246
4.16.3	Methodology.....	4-247
4.16.3.1	General and Direct Physical Effects	4-247
4.16.3.2	Regional Economic Effects.....	4-247
4.16.3.3	Effects of O&M on Farm Income	4-250
4.16.4	Construction Effects	4-252
4.16.4.1	No Action Alternative.....	4-252
4.16.4.2	Rock Ramp Alternative.....	4-252
4.16.4.3	Bypass Channel Alternative.....	4-253
4.16.4.4	Modified Side Channel Alternative	4-254
4.16.4.5	Multiple Pump Alternative	4-255
4.16.4.6	Multiple Pumps with Conservation Measures Alternative	4-256
4.16.4.7	Summary of Regional Economic Construction Effects	4-258
4.16.5	Operational Effects.....	4-258
4.16.5.1	No Action Alternative.....	4-258

- 4.16.5.2 Rock Ramp Alternative..... 4-260
- 4.16.5.3 Bypass Channel Alternative..... 4-260
- 4.16.5.4 Modified Side Channel Alternative 4-261
- 4.16.5.5 Multiple Pump Alternative 4-262
- 4.16.5.6 Multiple Pumps with Conservation Measures Alternative 4-262
- 4.16.5.7 Effects of O&M Expenditures on LYP Net Farm Income..... 4-263
- 4.16.6 Cumulative Effects 4-264
 - 4.16.6.1 Geographic and Temporal Extent of Analysis 4-264
 - 4.16.6.2 Methodology for Determining Effects 4-265
 - 4.16.6.3 Past, Present, and Reasonably Foreseeable Future Projects Considered ... 4-265
 - 4.16.6.4 No Action Alternative..... 4-265
 - 4.16.6.5 Rock Ramp Alternative..... 4-265
 - 4.16.6.6 Bypass Channel Alternative..... 4-265
 - 4.16.6.7 Modified Side Channel Alternative 4-266
 - 4.16.6.8 Multiple Pump Alternative 4-266
 - 4.16.6.9 Multiple Pumps with Conservation Measures Alternative 4-266
- 4.16.7 Actions to Minimize Effects..... 4-266
- 4.17 Environmental Justice..... 4-266
 - 4.17.1 Area of Potential Effect 4-267
 - 4.17.2 Summary of Potential Effects 4-267
 - 4.17.3 Construction Effects 4-268
 - 4.17.3.1 No Action Alternative..... 4-268
 - 4.17.3.2 Rock Ramp Alternative..... 4-268
 - 4.17.3.3 Bypass Channel Alternative..... 4-268
 - 4.17.3.4 Modified Side Channel Alternative 4-268
 - 4.17.3.5 Multiple Pump Alternative 4-269
 - 4.17.3.6 Multiple Pumps with Conservation Measures Alternative 4-269
 - 4.17.4 Operational Effects..... 4-269
 - 4.17.4.1 No Action Alternative..... 4-269
 - 4.17.4.2 Rock Ramp Alternative..... 4-270
 - 4.17.4.3 Bypass Channel Alternative..... 4-270
 - 4.17.4.4 Modified Side Channel Alternative 4-270
 - 4.17.4.5 Multiple Pump Alternative 4-270
 - 4.17.4.6 Multiple Pumps with Conservation Measures Alternative 4-271
 - 4.17.5 Cumulative Effects 4-271
 - 4.17.5.1 Geographic and Temporal Extent of Analysis 4-271
 - 4.17.5.2 Methodology for Determining Effects 4-271
 - 4.17.5.3 Past, Present, and Reasonably Foreseeable Future Projects Considered ... 4-271
 - 4.17.6 Actions to Minimize effects 4-272
- 4.18 Historic Properties 4-272
 - 4.18.1 Area of Potential Effect 4-272
 - 4.18.2 Summary of Potential Effects 4-273
 - 4.18.3 Construction Effects 4-275
 - 4.18.3.1 No Action Alternative..... 4-275
 - 4.18.3.2 Rock Ramp Alternative..... 4-275
 - 4.18.3.3 Bypass Channel Alternative..... 4-276
 - 4.18.3.4 Modified Side Channel Alternative 4-277
 - 4.18.3.5 Multiple Pump Alternative 4-278
 - 4.18.3.6 Multiple Pumps with Conservation Measures Alternative 4-279
 - 4.18.4 Operational Effects..... 4-281
 - 4.18.4.1 No Action Alternative..... 4-281

Contents

- 4.18.4.2 Rock Ramp Alternative.....4-281
- 4.18.4.3 Bypass Channel Alternative.....4-281
- 4.18.4.4 Modified Side Channel Alternative4-282
- 4.18.4.5 Multiple Pump Alternative4-282
- 4.18.4.6 Multiple Pumps with Conservation Measures Alternative4-282
- 4.18.5 Cumulative Effects4-282
 - 4.18.5.1 Geographic and Temporal Extent of Analysis4-282
 - 4.18.5.2 Methodology for Determining Effects4-282
 - 4.18.5.3 Past, Present, and Reasonably Foreseeable Future Projects Considered ...4-282
 - 4.18.5.4 All Alternatives4-283
- 4.18.6 Actions to Minimize Effects.....4-283
 - 4.18.6.1 Rock Ramp Alternative.....4-283
 - 4.18.6.2 Bypass Channel Alternative.....4-283
 - 4.18.6.3 Modified Side Channel Alternative4-284
 - 4.18.6.4 Multiple Pump Alternative4-284
 - 4.18.6.5 Multiple Pumps with Conservation Measures Alternative4-285
- 4.19 Indian Trust Assets4-285
 - 4.19.1 Area of Potential Effect4-286
 - 4.19.2 Summary of Potential Effects4-286
 - 4.19.3 Construction Effects4-286
 - 4.19.3.1 No Action Alternative.....4-286
 - 4.19.3.2 Rock Ramp Alternative.....4-286
 - 4.19.3.3 Bypass Channel Alternative.....4-286
 - 4.19.3.4 Modified Side Channel Alternative4-286
 - 4.19.3.5 Multiple Pump Alternative4-287
 - 4.19.3.6 Multiple Pumps with Conservation Measures Alternative4-287
 - 4.19.4 Operational Effects4-287
 - 4.19.4.1 No Action Alternative.....4-287
 - 4.19.4.2 Rock Ramp Alternative.....4-287
 - 4.19.4.3 Bypass Channel Alternative.....4-287
 - 4.19.4.4 Modified Side Channel Alternative4-287
 - 4.19.4.5 Multiple Pump Alternative4-287
 - 4.19.4.6 Multiple Pumps with Conservation Measures Alternative4-287
 - 4.19.5 Cumulative Effects4-287
 - 4.19.5.1 Geographic and Temporal Extent of Analysis4-287
 - 4.19.5.2 Methodology for Determining Effects4-288
 - 4.19.5.3 Past, Present, and Reasonably Foreseeable Future Projects Considered ...4-288
 - 4.19.5.4 All Alternatives4-288
 - 4.19.6 Actions to Minimize Effects.....4-288
- 4.20 Summary of Effects4-289
- 5 Agency, Public, and Tribal Coordination5-1**
 - 5.1 Public Involvement.....5-1
 - 5.2 Agency and Tribal Involvement5-2
 - 5.2.1 Scoping5-2
 - 5.2.2 Cooperating Agencies.....5-2
 - 5.2.3 Tribal Involvement5-2
 - 5.2.4 ESA Consultation5-4
 - 5.3 Documentation, Coordination and Compliance with Other Applicable Laws, Regulations, and Policies.....5-4
 - 5.3.1 Archaeological Resource Protection Act of 19795-5
 - 5.3.2 Clean Water Act of 1977 (as amended).....5-5

5.3.3	Floodplain Management Assessment	5-5
5.3.4	Farmland Protection Policy Act of 1995	5-6
5.3.5	Fish and Wildlife Coordination Act of 1958 (as amended).....	5-6
5.3.6	Migratory Bird Treaty Act and Executive Order 13186 (January 2001).....	5-6
5.3.7	Native American Graves Protection and Repatriation Act (Public Law 101-601).....	5-7
5.3.8	National Historic Preservation Act of 1966 (as amended in 2006)	5-7
5.3.9	Rivers and Harbors Appropriation Act of 1899	5-7
5.3.10	Executive Order 13112 for Invasive Species.....	5-7
5.3.11	Executive Order 11988 Assessment	5-7
5.3.12	Other Executive Orders	5-8
5.3.13	State Water Rights	5-8
5.3.14	Montana Environmental Policy Act	5-9
5.3.15	Stream Protection Act.....	5-9
5.3.16	Short-Term Water Quality Standards for Turbidity (318).....	5-9
5.3.17	Montana Land-use License of Easement on Navigable Waters	5-9
5.3.18	Stormwater Discharge General Permits.....	5-9
5.3.19	401 Water Quality Certification for Other Federal Permits & Licenses	5-10
List of Preparers		L-1
Distribution List		D-1
Index.....		I-1
References.....		R-1

Appendices

- A Engineering
- B Cost Engineering
- C 404(b)(1)
- D Fish Passage Connectivity Index and CE/ICA
- E Monitoring and Adaptive Management
- F Correspondence

List of Terms

AAHU—Average annual habitat units
 APE—Area of potential effect
 ARM—Administrative Rules of Montana
 BIA—Bureau of Indian Affairs
 BLM—Bureau of Land Management
 BP—Before Present
 CEA—Cumulative Effects Assessment
 CFR—Code of Federal Regulations
 cfs—cubic feet per second
 CH₄—Methane
 CMZ— Channel migration zone
 CO₂—Carbon dioxide
 CO—Carbon monoxide
 CWA—Clean Water Act
 CWS—Canadian Wildlife Service
 dB—decibels
 dBA—A-weighted decibels; an expression of the relative loudness of sounds in air as perceived by the human ear
 EA—Environmental assessment
 EIS—Environmental impact statement
 EO— Executive Order
 EPA— U.S. Environmental Protection Agency
 ESA—Endangered Species Act
 FAS—Fishing access site
 FEMA—Federal Emergency Management Agency
 FHWA—Federal Highway Administration
 FONSI—Finding of No Significant Impact
 FPCI—Fish Passage Connectivity Index
 fps—feet per second
 FWCA—Fish and Wildlife Coordination Act of 1958
 GIS—Geographic information system
 gpm—gallons per minute
 HEC-RAS—Hydrologic Engineering Center River Analysis System
 IMPLAN—A regional economic modeling program (short for impact analysis for planning)
 IPCC—Intergovernmental Panel on Climate Change
 ITA—Indian trust assets
 kW—Kilowatt
 L_{DN}—Day-night average 24-hour sound level with extra weighting for sound between 10 p.m. and 7 a.m.
 L_{eq}—Equivalent sound level
 LIDAR—A surveying technology that measures distance using laser light
 L_{max}—Instantaneous greatest sound level during a designated time interval
 L_{min}—Instantaneous lowest sound level during a designated time interval
 LYP—Lower Yellowstone Project

List of Terms

MBTA—Migratory Bird Treaty Act
MDNRC—Montana Department of Natural Resources and Conservation
MEPA—Montana Environmental Policy Act
MFWP—Montana Fish, Wildlife and Parks
mph—Miles per hour
MSGWG—Montana Sage Grouse Work Group
MTDEQ—Montana Department of Environmental Quality
MTNHP—Montana Natural Heritage Program
NA—Not applicable
N₂O—Nitrous oxide
NAAQS—National Ambient Air Quality Standards
NAWQA—National Water Quality Assessment
NDDOH—North Dakota Department of Health
NDGF—North Dakota Game and Fish Department
NDGS—North Dakota Geological Survey
NDNHP—North Dakota Natural Heritage Program
NDSWC&OSE—North Dakota State Water Commission & Office of the State Engineer
NEPA—National Environmental Policy Act
NFIP—National Flood Insurance Program
NHPA—National Historic Preservation Act
NO₂—Nitrogen dioxide
NO_x—Mono-nitrogen oxides, including nitrogen oxide and nitrogen dioxide
NRCS—Natural Resources Conservation Service
NRHP—National Register of Historic Places
NWR—National Wildlife Refuge
O₃—Ozone
O&M—Operation and maintenance
OM&R—Operation, maintenance and repair
PM₁₀—Particulate matter 10 micrometers in diameter or smaller
PM_{2.5}—Particulate matter 2.5 micrometers in diameter or smaller
ppb—parts per billion
ppm—parts per million
Reclamation—Bureau of Reclamation
RMS—Root mean square
SEL—Sound exposure level
SHPO—State Historic Preservation Office
SO₂—Sulfur dioxide
SO_x—Sulfur oxides
TDS—Total dissolved solids
Thalweg—A line drawn to join the lowest points along the length of a stream bed in its downward slope
The Corps—U.S. Army Corps of Engineers
The Service—U.S. Fish and Wildlife Service
U.S.C.—United States Code
USGCRP—U.S. Global Change Research Program
USGS—U.S. Geological Survey

VOC—Volatile organic compound
Western—Western Area Power Administration
WRCC—Western Regional Climate Center
YRCDC—Yellowstone River Conservation District Council
YRCEA—Yellowstone River Cumulative Effects Assessment

This page intentionally left blank

Executive Summary

The U.S. Army Corps of Engineers (the Corps) and the Bureau of Reclamation (Reclamation) have prepared this environmental impact statement (EIS) to analyze the direct, indirect and cumulative effects associated with actions to improve fish passage at the Lower Yellowstone Intake Diversion Dam in Dawson County, Montana. The proposed action is to improve passage for the endangered pallid sturgeon and other native fish at the Intake Diversion Dam, which is a component of the Lower Yellowstone Project, providing irrigation water for agriculture in eastern Montana.

The Corps and Reclamation issued a Final Environmental Assessment for the Intake Diversion Dam Modification Project in April 2010. In the Environmental Assessment, a new headworks was proposed (and subsequently constructed), and a rock ramp was selected as the preferred alternative for improving fish passage.

A Supplemental Environmental Assessment issued in April 2015 addressed changes in the project. It presented new information related to improving fish passage at Intake Diversion Dam regarding concerns about the cost and effectiveness of the rock ramp and new information about pallid sturgeon use of side channels. The Supplemental Environmental Assessment identified a bypass channel as the preferred alternative.

Description of the Lower Yellowstone Project

Reclamation's Lower Yellowstone Project (LYP) is an irrigation project located in eastern Montana and western North Dakota operated by the Lower Yellowstone Project Board of Control, Reclamation's authorized agent. The LYP includes the Intake Diversion Dam, which is a rock-filled timber crib weir crossing the Yellowstone River about 70 miles upstream of its confluence with Missouri River and 18 miles downstream of Glendive, Montana. The Intake Diversion Dam raises the river water elevation to divert water from the Yellowstone River through the recently constructed headworks to a main irrigation canal on the north side of the river.

River ice and high flows can cause rocks in the Intake Diversion Dam to be displaced. Such displaced rocks have been transported downstream over the years, creating a boulder field on the downstream side of the dam. A side channel on the south side of the Yellowstone River diverges from the main channel upstream of the Intake Diversion Dam and reconnects with the main channel downstream of the dam. The side channel holds water through its entire length only during high river flows. The land between the main channel and the existing side channel is called Joe's Island.

Project Purpose and Need

The purpose of the proposed action is to improve fish passage for pallid sturgeon and other native fish at the Intake Diversion Dam, continue the viable and effective operation of the Lower Yellowstone Project, and contribute to ecosystem restoration.

Improve Fish Passage

Pallid sturgeon occupy the Missouri and Yellowstone Rivers in Montana and North Dakota. The U.S. Fish and Wildlife Service listed the pallid sturgeon as endangered under the federal Endangered Species Act (ESA) in 1990. Adult pallid sturgeon move upstream from the Missouri River into the Yellowstone River for spawning in spring as temperatures and river flows increase. While it remains important to support the irrigation served by the LYP, the requirements of the ESA and benefits to pallid sturgeon and other native species must be supported as well.

Habitats upstream of the Intake Diversion Dam appear to be suitable for spawning and rearing of pallid sturgeon juveniles, but few pallid sturgeon have been observed upstream of the dam. A small number of adult pallid sturgeon were tracked in 2014 and 2015 passing upstream of the Intake Diversion Dam by way of the existing side channel around Joe's Island.

The U.S. Fish and Wildlife Service has suggested that the Intake Diversion Dam is a barrier to upstream passage that may prevent pallid sturgeon from accessing upstream reaches. Therefore, the proposed project is needed to allow fish passage at this structure. Pallid sturgeon recovery is not within the scope of this project, but improving passage for pallid sturgeon at the Intake Diversion Dam would provide access to a large area of the sturgeon's historical range that has been mostly inaccessible since the LYP was built in 1909.

Continue Viable and Effective Operation of the Lower Yellowstone Project

The proposed project needs to allow for continued viable and effective operation of the LYP. The outcomes from this project most likely to influence viable and effective operations are increases in agricultural production costs and decreases in crop production due to insufficient or unreliable water deliveries. Project operation, maintenance and rehabilitation is carried out by the Lower Yellowstone Irrigation Project through funds generated by assessments on farms within the LYP. The ability of farms to pay assessments is dependent on income from crop production, which is a function of reliable and sufficient water deliveries to meet crop requirements.

The LYP irrigates about 58,000 acres on over 400 farms along the canal. Agriculture is an important sector of economic activity in the region, with 2010 agricultural income for the region around the project totaling about \$26.5 million. The LYP provides water to four irrigation districts. Reclamation and the following four districts hold unadjudicated water rights in the state of Montana totaling 1,374 cubic feet per second (cfs):

- Lower Yellowstone Irrigation District #1
- Lower Yellowstone Irrigation District #2
- The Intake Irrigation District
- The Savage Irrigation District

Lower Yellowstone Irrigation District #2, is in North Dakota and represents about one-third of the irrigated lands. Each of the four districts has water service and repayment contracts with Reclamation. All have met their full financial obligation for repayment of the diversion structure and supply works for the project.

Contribute to Ecosystem Restoration

The ESA directs all federal agencies to use their resources for the conservation of federally listed species and the ecosystems upon which they depend. Federal agencies consult with the U.S. Fish and Wildlife Service to ensure that any action authorized, funded or carried out by them is not likely to jeopardize the existence of any federally listed species or result in the destruction or adverse modification of critical habitat. The U.S. Fish and Wildlife Service has identified the lower Yellowstone River as an area of priority for pallid sturgeon recovery because sturgeon are still in the area, there is suitable habitat remaining in the river to assist in recovery, and the Yellowstone River exhibits a natural hydrograph.

Improvements to fish passage at the Intake Diversion Dam will support migration for numerous fish species and contribute to the sustainability of fish populations in the Yellowstone River. This project will support ecosystem functions by restoring access to a large area of suitable fish habitat throughout the lower Yellowstone River ecosystem.

The Pallid Sturgeon

Pallid sturgeon are one of the rarest native fish in the Missouri and Mississippi River basins. A count undertaken in 2004 estimated there were 158 wild adults in the Missouri River between Fort Peck Dam and the headwaters of Lake Sakakawea, including the Yellowstone River. According to studies completed in 2003, the population of mature pallid sturgeon in this area is expected to be locally extinct by 2018 if reproduction and survival of young fish does not improve. According to the U.S. Fish and Wildlife Service (Service, 2003), “the value of restoring the Yellowstone River as a natural migratory route for sturgeon and making the middle Yellowstone function as the spawning and nursery grounds for pallids cannot be overstated.”

The Pallid Sturgeon Conservation Augmentation Program has been supplementing the wild population with hatchery juveniles to help prevent extirpation. Supplemental stocking of pallid sturgeon has been ongoing sporadically since 1998, with the number being stocked based on hatchery success for any given year in the upper Missouri River basin. Pallid sturgeons are stocked to ensure survival of the species in the short term and preserve existing genetics of the wild population. Monitoring data collected through the Pallid Sturgeon Population Assessment Program indicate that stocked pallid sturgeon are surviving, growing, and reaching a size and age that is capable of spawning. As these fish are only beginning to reach maturity, they are not yet contributing to population viability or sustainability.

Research suggests that larval drift distance presently available below the Intake Diversion Dam is too short and has too little settling habitat to result in successful survival, feeding, and growth of pallid sturgeon early life stages. Without sufficient drift distances, larvae could drift into the headwaters of Lake Sakakawea, where it is thought that survival is unlikely.

Summary of Alternatives

Reclamation has been addressing endangered species issues associated with operation and maintenance of the LYP since the 1990s. Concurrently, the Corps has been working to restore habitat and recover endangered pallid sturgeon in the Missouri River Basin. Because of overlapping activities, Reclamation and the Corps have collaborated periodically on technical studies, data collection, and planning for the Lower Yellowstone Project. In 2005, Reclamation and the Corps, along with the U.S. Fish and Wildlife Service, the State of Montana, and The Nature Conservancy, signed a memorandum of understanding to collaboratively address pallid sturgeon issues at the Lower Yellowstone Project.

Over the years, a wide range of alternatives have been considered and analyzed, either in planning studies or in formal environmental review. Packages of alternatives were first developed beginning with 110 ideas that came out of an initial value engineering and value planning effort. Two previous environmental review processes—the 2010 Environmental Assessment and the 2015 Supplemental Environmental Assessment—considered the environmental effects of a number of the alternatives. The current EIS examines five action alternatives—some new, and some refined from alternatives previously considered—as well as a No-Action Alternative.

No Action

The No Action Alternative would continue present operations of the Intake Diversion Dam and headworks to divert water from the Yellowstone River for irrigation as authorized. Under this scenario, it is likely that Reclamation would be obligated to continue ESA consultation with the U.S. Fish and Wildlife Service, with fish passage being an ultimate requirement at the Intake Diversion Dam. However, as a baseline against which to measure benefits and impacts of the action alternatives, the No Action Alternative assumes future conditions continuing the operation of the Intake Diversion Dam without modification for improved fish passage.

The Lower Yellowstone Irrigation Project Board of Control would continue to operate, maintain and repair the existing dam and the new headworks. Operational activities would include lowering fish screens into place for the irrigation season, daily and seasonal adjustments to the headworks gate in response to river flow conditions, crop requirements, and ensure conveyance of diverted water through LYP canals. Diversions—up to 1,374 cfs—generally occur from mid-April to mid-October.

To maintain required water surface elevations, Intake Diversion Dam maintenance would include placement of 1 to 2 feet of rock on the crest of the dam to replace rock moved by ice and high flows. Rock replacement typically occurs in late July or early August, when river flows are low. The rock is stockpiled with a loader, dumped into a skid, and then hauled by an existing overhead trolley cableway over the river to be dumped. The trolley system is old and there is continual risk of failure, which would require repair or replacement in order to continue to place rock.

Rock Ramp

The Rock Ramp Alternative would replace the existing rock-and-timber dam structure with a concrete weir and a shallow-sloped, un-grouted boulder and cobble rock ramp extending downstream well beyond the existing boulder field. The replacement weir would be located downstream of the headworks and approximately 40 feet upstream of the Intake Diversion Dam. It would create sufficient water height to divert the full water right of 1,374 cfs into the Main Canal.

The rock ramp would be designed to mimic natural river function and would have reduced water velocities and turbulence so that migrating fish could pass over the dam, thereby improving fish passage and contributing to ecosystem restoration. Because pallid sturgeon are sensitive to flow velocities and turbulence, the rock ramp would be constructed to be relatively flat over much of its width to keep flow velocities as low as possible. The final configuration would be optimized for pallid sturgeon passage. In limited areas, the ramp would provide resting places along its path. Passage might be problematic due to the amount of time a fish must sustain a burst swimming speed as it passes across the entire rock ramp. Nonetheless, the Rock Ramp Alternative would improve passage for fish by reducing velocities and increasing the range of flows and seasonal timeframes when fish can pass.

Like the No Action Alternative, operational activities would include operation of the headworks, supplemental pumps, and conveyance system. Maintenance of these facilities would be included as well as maintenance of the headworks screens and gates, maintenance and inspection of the canal, and maintenance of associated access roads.

Temporary access would need to be built for major operation and maintenance on the replacement weir and the rock ramp. Work would have to be done when the existing side channel is iced-over, or equipment would need to be brought in by way of boat or barge. It has not been determined how weir structure access would be achieved. If vehicular access across the weir structure cannot be safely achieved, then the existing trolley system might be repaired, a new trolley system constructed, or access provided by a barge.

Bypass Channel

The Bypass Channel Alternative would improve passage for pallid sturgeon around the Intake Diversion Dam by constructing a new bypass channel on Joe's Island. The bypass channel would extend from the upper end of the existing side channel to just downstream of the existing Intake Diversion Dam and boulder field. With the fish entrance to the bypass channel much nearer to the downstream end of the dam, fish that are stopped by the presence of the dam are more likely to find the bypass channel and use it to continue their movement upstream.

A replacement concrete weir would be built just upstream from the existing Intake Diversion Dam in order to provide sufficient water surface elevation to divert appropriate flows through the bypass channel and maintain irrigation diversion through the new headworks and screens.

Operation and maintenance activities for the bypass channel would include periodic inspection and possible replacement of riprap and removal of sediment or debris channel's upstream and downstream confluence areas with the Yellowstone River.

Operational activities would include operation of the headworks, supplemental pumps, and conveyance system. Maintenance activities would include maintenance of the headworks screens and gates, maintenance and inspection of the canal, and maintenance of access roads.

Modified Side Channel

This alternative would improve passage for pallid sturgeon around the Intake Diversion Dam by creating an improved fish bypass using the existing side channel. Pallid sturgeon were documented passing upstream of the Intake Diversion Dam through the existing channel during the 2014 and 2015 spring runoff seasons, when Yellowstone River flows measured at Sidney, Montana were estimated to peak at about 69,800 cfs and 60,500 cfs, respectively. The intent of this alternative is to increase flow in the existing side channel to attract migrating fish and to be passable during most years.

The major features of the Modified Side Channel Alternative are 6,000 feet of new channel at three bend cutoffs, 14,600 feet of channel modification to lower the bed of the existing side channel, three backwater areas, 4,500 feet of bank protection, five grade control structures, one 150-foot single-span bridge, and placement of 50,000 cubic yards of channel cobble substrate to simulate a natural channel bed and bed/bank edges.

Under this alternative the existing Intake Diversion Dam would be maintained. This would require the placement of 1 to 2 feet of rock on the crest of the dam to replace rock moved by ice and high flows. Rock replacement would typically occur in late July or early August, when river flows are low. The rock is stockpiled with a loader, dumped into a skid, and then hauled by an existing overhead trolley cableway over the river to be dumped. The trolley system is old and there is continual risk of failure, which would require repair or replacement in order to continue to place rock.

Operation and maintenance activities for the new channel would include periodic inspection and possible replacement of riprap and removal of sediment or debris from the existing side channel's upstream and downstream confluence areas with the Yellowstone River. Periodic inspections would be performed on the vehicular road and bridge.

Operation and maintenance at the Intake Diversion Dam and canal intake would be similar to the No Action Alternative, including maintenance of the headworks screens and gates, maintenance and inspection of the canal, and maintenance of associated access roads

Multiple Pumps

This alternative would remove the Intake Diversion Dam down to the riverbed and construct five pumping stations on the Yellowstone River to deliver water to the Lower Yellowstone Project. The pumping stations would be designed for a total diversion capacity of 1,374 cfs. They would be constructed at locations along the Lower Yellowstone Project between the headworks and the community of Savage.

Each pumping station would be designed for a capacity of 275 cfs. Water would be drawn from the river through a feeder canal to a fish screen structure. Fish would be screened out and returned to the river through a fish return pipe. Irrigation water would pass through the fish

screen and flow into the pumping station. Discharge pipes would convey the irrigation water to the Main Canal.

The power demand for the pumps would exceed the capacity of the existing power system in this area, requiring upgrading and extension of existing powerlines. Existing sub-stations would also be upgraded to meet the power demand.

The partial removal of the existing Intake Diversion Dam would improve fish passage for the pallid sturgeon and other native fishes by providing a continuous river geometry. It is assumed that only the portion of the dam that is above the adjacent ground elevation would be demolished and removed; the foundation with timber piles and downstream apron would remain in place.

Multiple Pumps with Conservation Measures

This alternative includes water conservation measures, pumping, gravity diversions through the existing headworks, and the use of wind energy to offset pumping costs. The existing dam would be removed to allow fish passage on the Yellowstone River, with new components providing the water source to the LYP.

The conservation measures include check structures, flow measuring devices, laterals to pipe, sprinklers, lining the Main Canal and laterals, control over checking, and groundwater pumping. With these measures, diversion requirements would be reduced by 766 cfs so that required water delivery to the project would be only 608 cfs. Seven installations of six Ranney wells each would be constructed to deliver the required 608 cfs. The canal will likely have to be reconfigured to allow the gravity delivery of water to the laterals with a flow of only 608 cfs.

Removal of the existing intake dam down to the river bed would improve fish passage for the pallid sturgeon and other native fishes by providing continuous river geometry through the current dam location.

A windmill would be used to supply enough energy on average to meet the pumping loads of this alternative. This would require either partnering with a planned wind farm or construction of wind turbines as part of the project. Typically a wind farm requires several years of study for siting and permitting. That analysis has not been completed for this EIS and would be carried out separately and require additional NEPA. Because wind generation would occur over all 12 months of the year while irrigation pump loads would be limited to May through September, arrangements would be made to deliver unneeded wind-generated power to a utility in exchange for receiving power back from that utility when pump loads exceed the wind generation.

Alternative Costs

Table ES-1 provides the annualized costs of each alternative. Annualized costs have been developed and include interest during construction, monitoring and adaptive management and OM&R. OM&R are included in detail under the alternative descriptions in Section 2.5. All of these costs were estimated over a 50-year period of analysis using the current federal discount rate and are presented in April 2016 prices. Monitoring is assumed to occur for the first eight

years and for comparison purposes adaptive management was estimated as 1 percent of the construction cost.

Table ES-1 Annualized Costs for each Alternative

	No Action	Rock Ramp	Bypass Channel	Modified Side Channel	Multiple Pump	Multiple Pumping with Conservation Measures
Total First Cost	0	\$90,454,000	\$57,044,000	\$54,441,000	\$132,028,000	\$477,925,000
Construction (Months)	0	18	28	18	42	90
Interest During Construction	0	\$1,880,000	\$2,002,000	\$1,124,000	\$6,557,000	\$53,790,000
Total Investment Cost	0	\$92,334,000	\$59,046,000	\$55,665,000	\$138,585,000	\$531,715,000
Annualized Investment Costs ¹	\$0	\$3,674,000	\$2,350,000	\$2,215,000	\$5,515,000	\$21,159,000
Annualized Adaptive Management	\$0	\$32,000	\$22,000	\$19,000	\$46,000	\$165,000
Annualized OM&R (includes annual monitoring)	\$2,643,000	\$2,840,000	\$2,799,000	\$2,907,000	\$5,034,000	\$4,386,000
Average Annual Cost	\$2,643,000	\$6,546,000	\$5,171,000	\$5,141,000	\$10,595,000	\$25,710,000

¹ – 3.125% discount rate

Summary of Environmental Effects

The EIS analyzes the environmental consequences of the no-action and five action alternatives. Effects vary by alternative, by environmental resource, and by project phase (construction and operational phases). Table ES-2 provides an overview of the environmental effects, more detailed description and analysis is found within Chapter 4 of the EIS.

Table ES-2 Summary of Environmental Effects

Resource Area	No Action	Rock Ramp	Bypass Channel	Modified Side Channel	Multiple Pump	Multiple Pumps with Conservation Meas.
Surface Water Hydrology and Hydraulics	<u>Construction Effects: No Effect</u>	<u>Construction Effects: Moderate</u> -Temporary cofferdams would increase water surface elevations, change depths and velocities at headworks screens, and increase depths and velocities in the river channel.	<u>Construction Effects: Moderate</u> -Temporary cofferdams would increase water surface elevations, change depths and velocities at headworks screens, and increase depths and velocities in the river channel. -Blockage of flows into existing side channel for likely one runoff season during construction.	<u>Construction Effects: Moderate</u> -Blockage of flows into existing side channel for likely one runoff season during construction.	<u>Construction Effects: Minor to Moderate</u> -Temporary cofferdams would increase water surface elevations, change depths and velocities at headworks screens, and increase depths and velocities in the river channel.	<u>Construction Effects: Moderate</u> -Temporary cofferdams would increase water surface elevations, change depths and velocities at headworks screens, and increase depths and velocities in the river channel.
	<u>Operational Effects: Minor</u> -Ongoing placement of rock to maintain sufficient water surface elevation for irrigation diversions may increase with overall trend of declining river flows.	<u>Operational Effects: Moderate</u> -Reduced velocities over replacement weir and rock ramp compared to existing conditions (beneficial).	<u>Operational Effects: Minor to Major</u> -Slightly reduced flow volumes and velocities over replacement weir compared to existing conditions (beneficial). -Loss of flows into existing side channel and reduced side channel migration. -Replacement of side channel function with new bypass channel with perennial flows.	<u>Operational Effects: Minor to Major</u> -Slightly reduced flow volumes in main channel. -Increased frequency, depths, and velocities of flows in existing side channel.	<u>Operational Effects: Major</u> -Slightly increased flow volumes in river from existing intake to about 20 miles downstream (beneficial). -Return of main channel to natural river hydraulics with removal of dam (beneficial). -Reduced frequency of flows into existing side channel.	<u>Operational Effects: Moderate to Major</u> -Increased flow volumes in river due to reduced diversions (beneficial). -Return of main channel to natural river hydraulics with removal of dam (beneficial). -Reduced frequency of flows into existing side channel -Reduced irrigation diversion flow volumes and reliability, with decreased return flows from irrigation system and decreased velocities in Main Canal.

Executive Summary

Resource Area	No Action	Rock Ramp	Bypass Channel	Modified Side Channel	Multiple Pump	Multiple Pumps with Conservation Meas.
Groundwater Hydrology	<u>Construction Effects: No Effect</u>	<u>Construction Effects: Negligible</u> -Short-term negligible effects on localized shallow groundwater levels from cofferdams.	<u>Construction Effects: Negligible</u> -Short-term negligible effects on localized shallow groundwater levels from cofferdams.	<u>Construction Effects: Negligible</u> -Short-term negligible effects on localized shallow groundwater levels from cofferdams.	<u>Construction Effects: Negligible</u> -Short-term negligible effects on localized shallow groundwater levels from cofferdams.	<u>Construction Effects: Negligible</u> -Short-term negligible effects on localized shallow groundwater levels from cofferdams.
	<u>Operational Effects: Minimal</u> -Ongoing seepage from irrigation system into shallow aquifer	<u>Operational Effects: Minor</u> -Potential removal/relocation of fishing access site well. -Negligible effects on localized shallow groundwater levels in the vicinity of the rock ramp and the replacement weir.	<u>Operational Effects: Minor</u> -Minor effects on localized shallow groundwater levels on Joe’s Island.	<u>Operational Effects: Minor</u> -Minor effects on localized shallow groundwater levels on Joe’s Island.	<u>Operational Effects: Minor</u> -Potential removal/relocation of fishing access site well. -Negligible effects on localized shallow groundwater levels in the vicinity of the pumping stations. -Minor localized effects on shallow groundwater levels in the vicinity of the removed Intake Diversion Dam.	<u>Operational Effects: Minor to Major</u> -Potential removal/relocation of fishing access site well. -Potential major effects on localized shallow groundwater levels in the vicinity of the Ranney well sites. -Minor localized effects on shallow groundwater levels in the vicinity of the removed Intake Diversion Dam.

Resource Area	No Action	Rock Ramp	Bypass Channel	Modified Side Channel	Multiple Pump	Multiple Pumps with Conservation Meas.
Geomorphology	<u>Construction Effects: No Effect</u>	<u>Construction Effects: Minor</u> -Potential for scour and channel migration at existing weir, side channel, and Joe’s Island from temporary cofferdams for up to 28 months.	<u>Construction Effects: Minor to Moderate</u> -Potential for scour and channel migration at existing weir and Joe’s Island from temporary cofferdams for up to 28 months.	<u>Construction Effects: Negligible</u> -Potential for scour and channel migration at existing weir and Joe’s Island from blockage of side channel during construction.	<u>Construction Effects: Negligible</u> -Potential for scour and channel migration at existing weir, side channel, and Joe’s Island from temporary cofferdams for up to 6 months.	<u>Construction Effects: Negligible</u> -Potential for scour and channel migration at existing weir, side channel, and Joe’s Island from temporary cofferdams for up to 6 months.
	<u>Operational Effects: Minor</u> -Ongoing placement of rock increases rock in the river and changes substrate conditions.	<u>Operational Effects: Moderate</u> -Increased volume of rock in river and changed slope of river with ramp. -Placement of additional rock for maintenance of rock ramp.	<u>Operational Effects: Minor to Moderate</u> -Slightly reduced flows/sediment transport in main river channel, -Shorter and slightly steeper bypass channel compared to existing side channel with additional rock to reduce channel migration. -Reduced side channel migration.	<u>Operational Effects: Minor to Moderate</u> -Slightly reduced flows/sediment transport in main channel. -Increased flows/sediment transport and additional rock in modified side channel to reduce channel migration.	<u>Operational Effects: Minor to Major</u> -Return of river hydraulics/sediment transport to natural conditions (beneficial). -Potential for decreased velocity in Main Canal and increased sediment deposition.	<u>Operational Effects: Minor to Major</u> -Return of river hydraulics/sediment transport to natural conditions (beneficial). -Potential for decreased velocity in Main Canal and increased sediment deposition.

Executive Summary

Resource Area	No Action	Rock Ramp	Bypass Channel	Modified Side Channel	Multiple Pump	Multiple Pumps with Conservation Meas.
Aquatic Communities	<u>Construction Effects: No Effect</u>	<u>Construction Effects:</u> Minor -Temporary cofferdams increase depths and velocities at intake screens and in river may hinder fish passage or increase entrainment of fish into canal. -Increased turbidity from construction activities. -Fish avoidance during construction work.	<u>Construction Effects:</u> Minor to Moderate -Temporary cofferdams increase depths and velocities at intake screens and in river may hinder fish passage or increase entrainment of fish into canal. -Increased turbidity from construction activities. -Fish avoidance during construction work. -Existing side channel not accessible.	<u>Construction Effects:</u> Minor to Moderate -Increased turbidity from construction activities. -Fish avoidance during construction work. -Existing side channel not accessible.	<u>Construction Effects:</u> Minor -Temporary cofferdams increase depths and velocities at intake screens and in river may hinder fish passage or increase entrainment of fish into canal. -Increased turbidity from construction activities. -Fish avoidance during construction work.	<u>Construction Effects:</u> Minor -Temporary cofferdams increase depths and velocities at intake screens and in river may hinder fish passage or increase entrainment of fish into canal. -Increased turbidity from construction activities. -Fish avoidance during construction work.
	<u>Operational Effects: Minor to Major</u> -Dam would remain barrier to fish passage. -Rock replenishment would disturb sediment. -Entrainment of fish and eggs into headworks screens	<u>Operational Effects:</u> Moderate to Major -Maintenance of rock ramp could disturb sediment and affect fish and mussels and macroinvertebrates. -Entrainment of fish and eggs into headworks screens -Improved fish passage (beneficial)	<u>Operational Effects:</u> Moderate to Major -Rock placement along bends and banks would disturb sediment. -Side channel plug would limit passage. -Entrainment of fish and eggs into headworks screens -Improved fish passage (beneficial)	<u>Operational Effects:</u> Minor to Major -Riprap replacement and sediment removal disturb sediment. -Entrainment of fish and eggs into headworks screens -Improved fish passage (beneficial)	<u>Operational Effects:</u> Minor to Major -Unhindered fish passage (beneficial) -Surface pumps/screens may injure or entrain fish. -Increased turbidity during pump station maintenance	<u>Operational Effects:</u> Minor to Major -Unhindered fish passage (beneficial).

Resource Area	No Action	Rock Ramp	Bypass Channel	Modified Side Channel	Multiple Pump	Multiple Pumps with Conservation Meas.
Federally Listed Species and State Species of Concern	<u>Construction Effects: No Effect</u>	<u>Construction Effects: Moderate</u> -Noise from pile driving could disturb pallid sturgeon and other species. -Reduced passage from cofferdams for native fish species such as blue sucker, shovelnose sturgeon, paddlefish, sauger during construction period. -Disturbance of riparian habitats during construction.	<u>Construction Effects: Moderate</u> -Noise from pile driving could disturb pallid sturgeon and other species -Side channel not accessible for likely one runoff season during 28-month construction period. -Reduced passage from cofferdams for native fish species such as blue sucker, shovelnose sturgeon, paddlefish, sauger during construction period. -Disturbance of riparian and wetland habitats during construction.	<u>Construction Effects: Minor</u> -Side channel not accessible for likely one runoff season during 18-month construction period. -Disturbance of riparian and wetland habitats during construction.	<u>Construction Effects: Minor</u> -Noise from pile driving could disturb pallid sturgeon and other species. -Reduced passage from cofferdams for native fish species such as blue sucker, shovelnose sturgeon, paddlefish, sauger during construction period. -Disturbance of riparian and wetland habitats during construction.	<u>Construction Effects: Minor</u> -Noise from pile driving could disturb pallid sturgeon and other species. -Reduced passage from cofferdams for native fish species such as blue sucker, shovelnose sturgeon, paddlefish, sauger during construction period. -Disturbance of riparian and wetland habitats during construction.
	<u>Operational Effects: Major</u> -Continued partial or complete blockage of fish passage. -Continued disturbance and turbidity from placement of rock and maintenance of LYP. -Entrainment of larval fish at headworks screens.	<u>Operational Effects: Minor to Major (beneficial)</u> -Improved fish passage for pallid sturgeon and state fish species of concern (beneficial). -Disturbance and turbidity from maintenance activities, more than existing. -Entrainment of larval fish at headworks screens.	<u>Operational Effects: Minor to Major (beneficial)</u> -Improved fish passage for pallid sturgeon and state fish species of concern (beneficial). -Disturbance and turbidity from maintenance activities, although less than existing. -Entrainment of larval fish at headworks screens.	<u>Operational Effects: Minor to Major (beneficial)</u> -Improved fish passage for pallid sturgeon and state fish species of concern (beneficial). -Disturbance and turbidity from maintenance activities, although less than existing. -Entrainment of larval fish at headworks screens.	<u>Operational Effects: Minor to Major (beneficial)</u> -Unhindered fish passage (beneficial) -Entrainment of fish at headworks screens and pumping stations.	<u>Operational Effects: Minor to Major (beneficial)</u> -Unhindered fish passage (beneficial) -Entrainment of fish at headworks screens.

Executive Summary

Resource Area	No Action	Rock Ramp	Bypass Channel	Modified Side Channel	Multiple Pump	Multiple Pumps with Conservation Meas.
Lands and Vegetation	<u>Construction Effects: No Effect</u>	<u>Construction Effects: Minor</u> -Temporary disturbance to grasslands from staging/access.	<u>Construction Effects: Moderate</u> -Fill in existing side channel. -Placement of riprap and temporary cofferdams disturb riverine and riparian habitat. -Temporary disturbance to grasslands from staging/access. -Increased risk of invasive species spread.	<u>Construction Effects: Moderate</u> -Portions of existing side channel filled by bend cutoffs. -Placement of riprap and temporary cofferdams disturb riverine and riparian habitat. -Temporary disturbance to grasslands from staging/access. -Increased risk of invasive species spread.	<u>Construction Effects: Minor</u> -Construction of pumping stations will fill wetlands. -Placement of riprap and temporary cofferdams disturb riverine and riparian habitat. -Temporary disturbance to grasslands from staging/access. -Increased risk of invasive species spread.	<u>Construction Effects: Minor</u> -Temporary cofferdams disturb riverine and riparian habitat. -Temporary disturbance to grasslands from staging/access. -Construction of Ranney wells may fill or dewater wetlands. -Increased risk of invasive species spread.
	<u>Operational Effects: Minor</u> -Rock placement at weir will continue disturbance on Joe’s Island and continue filling in riverine habitat.	<u>Operational Effects: Moderate</u> -Large area of river permanently filled with large rock for ramp, -Rock ramp maintenance will disturb grasslands and riparian areas and continue filling in riverine habitat.	<u>Operational Effects: Moderate</u> -Riverine and emergent wetlands filled. -Grassland converted to side channel (bypass channel). -Maintenance activities disturb riparian areas.	<u>Operational Effects: Minor</u> -Rock placement at weir will continue filling in riverine habitat. -Maintenance activities disturb riparian areas.	<u>Operational Effects: Minor</u> -Removal of sediment from canals disturb riparian areas and grasslands. -Bank riprap maintenance disturb riparian habitat and place additional rock in riverine habitat.	<u>Operational Effects: Minor to Major</u> -Loss of numerous wetlands created or augmented by seepage or return flows from LYP. -Maintenance activities disturb riparian areas and grasslands.

Resource Area	No Action	Rock Ramp	Bypass Channel	Modified Side Channel	Multiple Pump	Multiple Pumps with Conservation Meas.
Recreation	<u>Construction Effects: No Effect</u>	<u>Construction Effects: Moderate</u> -Closure of boat ramp and reduced visitation, fishing, recreation opportunities during 28-month construction period.	<u>Construction Effects: Moderate</u> -Reduced visitation, fishing, recreation opportunities during 28-month construction period. -May reduce Glendive Chamber's caviar program and concessionaire program.	<u>Construction Effects: Minor</u> -Reduced visitation, fishing, recreation opportunities at Joe's Island during 18-month construction period.	<u>Construction Effects: Moderate</u> -Reduced visitation, fishing, recreation opportunities during ~6 month dam demolition period. -May reduce Glendive Chamber's caviar program and concessionaire program.	<u>Construction Effects: Moderate</u> -Reduced visitation, fishing, recreation opportunities during ~6 month dam demolition period. -May reduce Glendive Chamber's caviar program and concessionaire program.
	<u>Operational Effects: No Effect</u>	<u>Operational Effects: Moderate</u> -Relocated fishing access site may reduce fishing quality. -Likely reduce Glendive Chamber's caviar program and concessionaire program.	<u>Operational Effects: Moderate</u> -New navigable channel around the dam. -Upstream migration and new spawning areas may benefit recreational fishery. -Some reduction in fishing success at FAS due to fish able to move upstream. -Likely reduce Glendive Chamber's caviar program and concessionaire program.	<u>Operational Effects: Moderate</u> -New navigable channel around the dam. -Upstream migration and new spawning areas may benefit recreational fishery. -Some reduction in fishing success at FAS due to fish able to move upstream. -May reduce Glendive Chamber's caviar program and concessionaire program.	<u>Operational Effects: Moderate</u> -Unhindered boating through reach. -Upstream migration and new spawning areas may benefit recreational fishery. -Some reduction in fishing success at FAS due to fish able to move upstream. -Likely reduce Glendive Chamber's caviar program and concessionaire program.	<u>Operational Effects: Moderate</u> -Unhindered boating through reach. -Upstream migration and new spawning areas may benefit recreational fishery. -Some reduction in fishing success at FAS due to fish able to move upstream. -Likely reduce Glendive Chamber's caviar program and concessionaire program.

Executive Summary

Resource Area	No Action	Rock Ramp	Bypass Channel	Modified Side Channel	Multiple Pump	Multiple Pumps with Conservation Meas.
Noise	<u>Construction Effects: No effect</u>	Construction Effects: Major -Noise levels from the sheet piling and construction will exceed noise guidelines.			Construction Effects: Major -Noise levels from the construction and removal of the existing dam will exceed noise guidelines.	
	<u>Operational Effects: No Effect</u>	Operational Effects: Minor -Noise levels from operation and maintenance actions would typically be below the EPA guideline thresholds.			Operational Effects: Major -Noise levels from the operations of the pumps and backup generators will exceed the EPA noise guidelines.	
Social and Economic Conditions	<u>Construction Effects: No Effect</u>	Construction Effects: Moderate -Regional benefits from construction spending outweigh minor adverse recreation revenue effects.	Construction Effects: Moderate -Regional benefits from construction spending.	Construction Effects: Moderate -Regional benefits from construction spending.	Construction Effects: Moderate -Regional benefits from construction spending outweigh minor adverse recreation revenue effects.	Construction Effects: Moderate -Highest regional benefits from construction due to high cost.
	<u>Operational Effects: No Effect</u>	Operational Effects: Minor -O&M savings. -Potential for long term recreation-related revenue increase.	Operational Effects: Minor -O&M savings. -Potential for long term recreation-related revenue increase.	Operational Effects: Minor -Minor O&M increase. -Potential for long term recreation-related revenue increase.	Operational Effects: Minor to Major -Regional benefits from O&M spending, but local adverse effect to irrigation districts. -Potential for long term recreation-related revenue increase.	Operational Effects: Minor to Major -Regional benefits from O&M spending, but local adverse effect to irrigation districts. -Potential for long term recreation-related revenue increase. -608 cfs does not meet current crop demands and would reduce agricultural crops/revenue. -Loss of prime farmland, depending on location of Ranney wells.

Resource Area	No Action	Rock Ramp	Bypass Channel	Modified Side Channel	Multiple Pump	Multiple Pumps with Conservation Meas.
Historic Properties	<p><u>Construction Effects: No Effect</u></p>	<p><u>Construction Effects:</u> Major -Impact to structure of Intake Diversion Dam. -Impact to the Brailey Sub Camp from stockpile and construction staging areas. -Unknown impacts from construction activities within unsurveyed portions of the APE.</p>	<p><u>Construction Effects:</u> Major -Impact to Intake Diversion Dam features as a result of moving historic buildings. -Potential impact to dam as a result of cofferdam installation. -Impact to Lower Yellowstone Project quarry and prehistoric lithic scatter as a result of widening haul/access road., -Impacts to prehistoric lithic scatters within stockpile and staging areas. -Potential impacts to subsurface cultural resources at bypass channel location.</p>	<p><u>Construction Effects:</u> Major -Impact to Lower Yellowstone Project quarry and prehistoric lithic scatter from backwater area excavation and widening. -Impacts to prehistoric lithic scatters within stockpile area. -Potential impacts to subsurface cultural resources at side channel.</p>	<p><u>Construction Effects:</u> Major -Impact to Intake Diversion Dam as a result of its removal. -Impacts to the Main Canal, Northern Pacific Railroad, and Savage Headquarters Camp as a result of discharge pipe, feeder canal, and fish return pipe installation at pump station sites. -Unknown impacts from construction activities within unsurveyed portions of the APE.</p>	<p><u>Construction Effects:</u> Major -Impact to Intake Diversion Dam as a result of its removal. -Impacts to the Main Canal as a result of irrigation system modifications. -Impacts to potential historic properties as a result of unknown locations for pipelines and power infrastructure. -Unknown impacts from construction activities within unsurveyed portions of the APE.</p>
	<p><u>Operational Effects: Major</u> -Ground disturbance in unsurveyed portions of rock quarry may impact unrecorded cultural resources or unidentified features associated with known historic properties within the quarry.</p>				<p><u>Operational Effects:</u> No Effect</p>	<p><u>Operational Effects:</u> No Effect</p>

Preferred Alternative

The Council on Environmental Quality's Forty Most Asked Questions Concerning CEQ's National Environmental Policy Act Regulations (1981) states, "The 'agency's preferred alternative' is the alternative which the agency believes would fulfill its statutory mission and responsibilities, giving consideration to economic, environmental, technical and other factors."

Based on this, Reclamation and the Corps have identified the Bypass Channel as the preferred alternative for the following reasons:

- The agencies believe the Bypass Channel Alternative could be constructed, operated, and maintained to meet the physical and biological criteria identified by the Service's BRT, and therefore would provide passage for pallid sturgeon.
- The Bypass Channel Alternative is a cost effective means of providing fish passage.
- Of the action alternatives, the Bypass Channel Alternative is expected to have the lowest annual O&M costs.
- The agencies believe, based on the analysis in this EIS, implementation of the Bypass Channel Alternative, and the associated actions to minimize impacts, would not result in significant long-term adverse environmental impacts.

Public Review and Comment

The 45-day public review and comment period on the EIS runs from June 3, 2016 to July 18, 2016. Two public meetings are scheduled, at which time verbal comments will be accepted. The first will be held at the Richland County Fairgrounds Event Center, Sidney, MT on Tuesday, June 28, from 5:30 pm to 9:00 pm. The second will be held the following evening, June 29, at the Dawson County High School Auditorium, 900 N. Merrill Avenue, Glendive, MT from 5:30 pm to 9:00 pm.

Written comments will be accepted at both meetings or may be submitted as follows:

- E-mail sent to cenwo-planning@usace.army.mil,
- Regular mail sent to U.S. Army Corps of Engineers Omaha District, ATTN: CENWO-PM-AA, 1616 Capitol Avenue, Omaha, NE 68102.

At the end of the comment period, all comment letters will be reviewed by Reclamation and the Corps and will be responded to in the Final EIS, anticipated to be issued in the fall of 2016. The Final EIS will also reflect any changes, modifications or updates as a result of comments received.

If no additional significant adverse effects are identified as a result of the Draft EIS comments, the lead agencies will prepare a Record of Decision (ROD). The ROD will explain the agencies' decision, describe the alternatives considered (including the preferred alternative), and discuss plans for mitigating potential environmental effects and monitoring the effectiveness of mitigation measures. The ROD will be issued no earlier than 30 days after issuance of the Final

EIS. Notice of availability of the Final EIS and the ROD will be sent to all agencies, tribes, and individuals who submitted comments on the Draft EIS.

1 Purpose and Need for the Proposed Action

1.1 Proposed Action

The U.S. Army Corps of Engineers (Corps) and the Bureau of Reclamation (Reclamation) have prepared this Environmental Impact Statement (EIS) to analyze direct, indirect, and cumulative effects associated with the proposed actions to improve pallid sturgeon fish passage at the Lower Yellowstone Project Intake Diversion Dam in Dawson County, Montana.

1.1.1 Project Location and Study Area

Reclamation's Lower Yellowstone Project (LYP) is located in eastern Montana and western North Dakota. The Intake Diversion Dam, one component of the Lower Yellowstone Project, is located approximately 70 miles upstream of the confluence of the Yellowstone and Missouri rivers near Glendive, Montana (Figure 1-1).

The study area for this EIS consists of the following:

- The Yellowstone River from the Cartersville Diversion Dam at River Mile 237 to the confluence with the Missouri River
- The Missouri River downstream to Lake Sakakawea in North Dakota,
- Lands in Dawson, Wibaux, and Richland counties, Montana, and McKenzie and Williams counties, North Dakota serviced by the four irrigation districts that receive water from the LYP (Yellowstone Irrigation Districts #1 and #2, Intake Irrigation District, Savage Irrigation District). Figure 1-2 displays the project area including the four irrigation districts, Main Canal, and laterals.

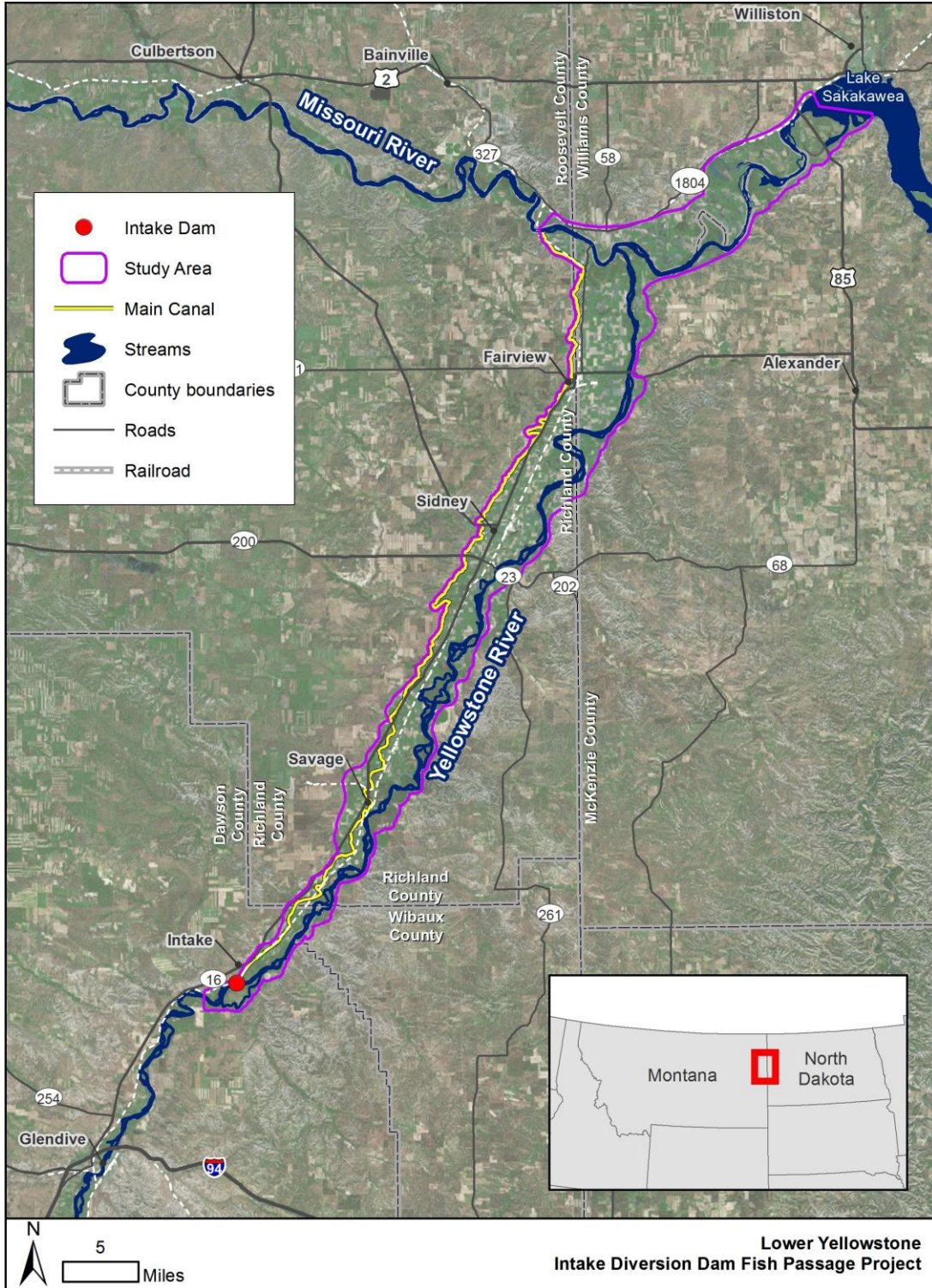

Figure 1-1. Lower Yellowstone Intake Diversion Dam Fish Passage Project

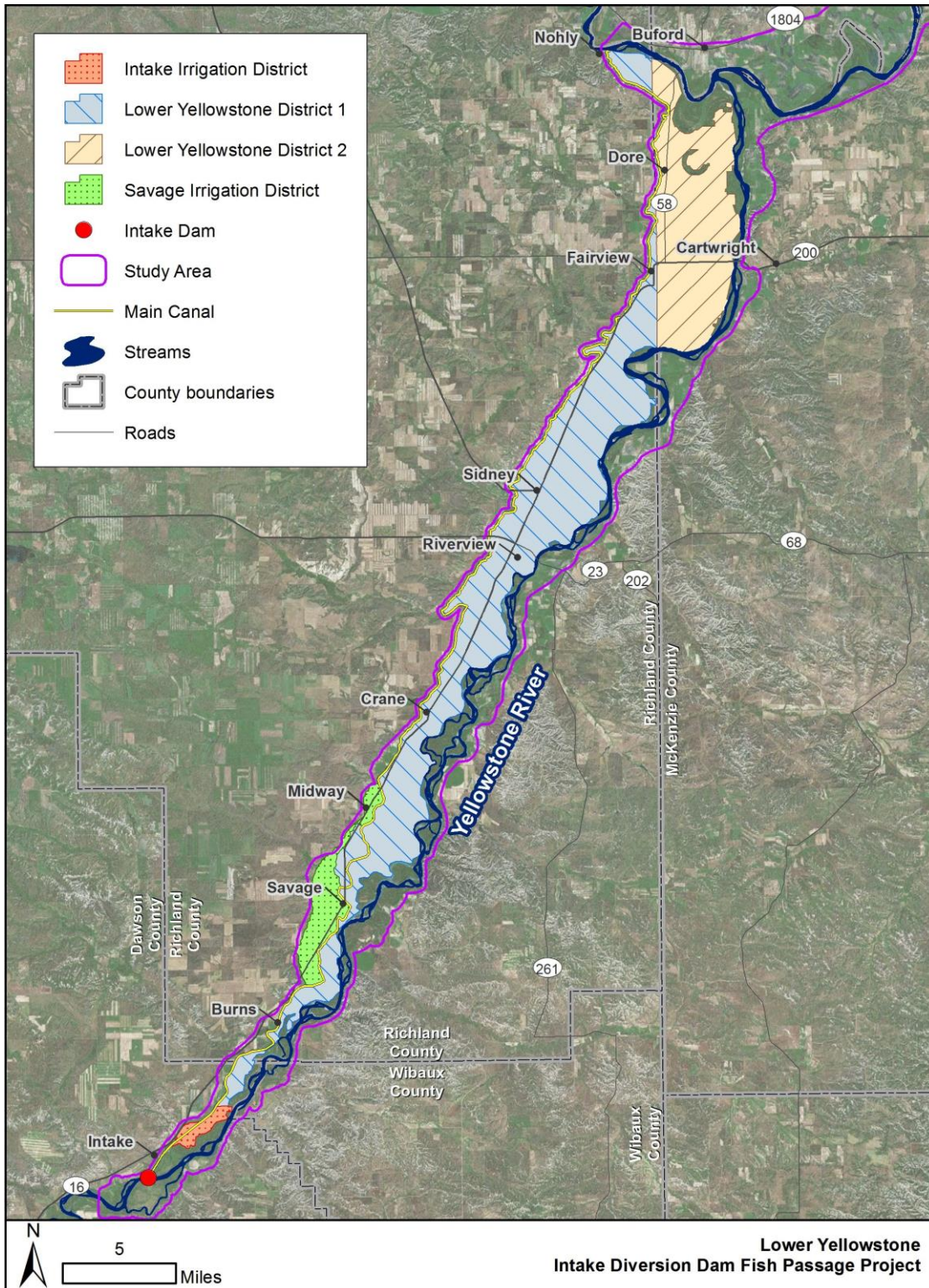

Figure 1-2 Project Area including Lower Yellowstone Project and Irrigation Districts

1.1.2 Project Background

1.1.2.1 Authorization

The Lower Yellowstone Project (LYP) was authorized by the Secretary of the Interior on May 10, 1904 for irrigation purposes. Construction of the LYP began in 1905 and included the Intake Diversion Dam (also known as Yellowstone River Diversion Dam)—a rock-filled timber crib weir that spans the Yellowstone River and a headworks structure to divert water into the Main Canal for irrigation. The LYP was authorized to provide a dependable water supply sufficient to irrigate approximately 54,300 acres of land on the west bank of the Yellowstone River. Water is also supplied to irrigate approximately 830 acres in the Intake Irrigation District and 2,200 acres in the Savage Irrigation District. Both of the smaller irrigation projects pump water from the Main Canal. The average annual volume of water diverted for these projects is 327,046 acre-feet (Corps and Reclamation 2015). A cross section of the existing weir is shown in Figure 1-3

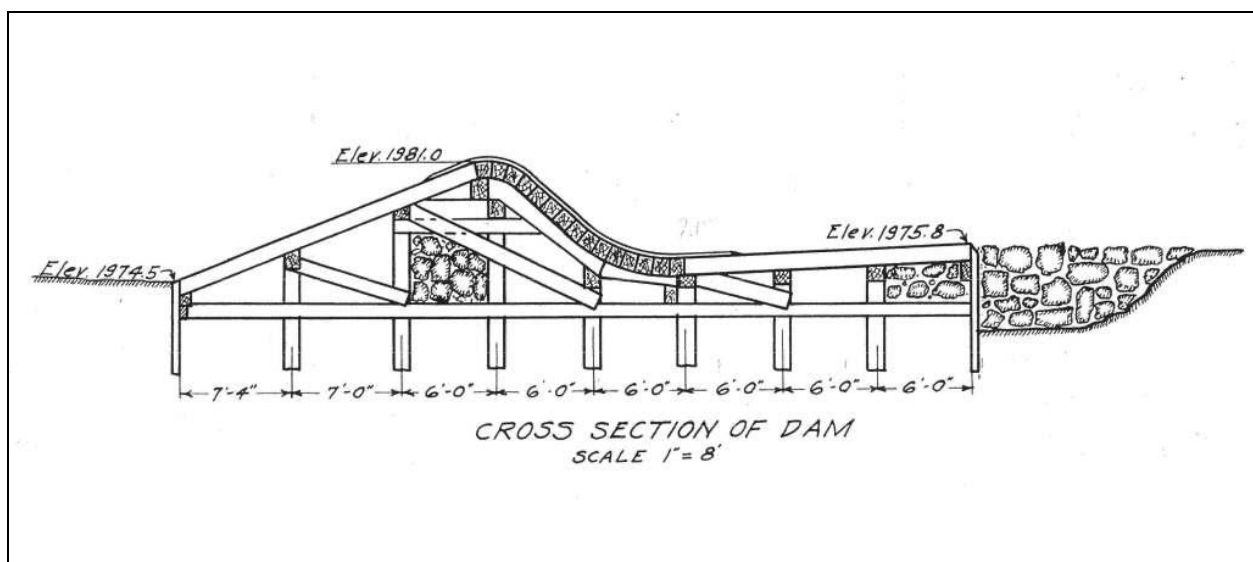

Figure 1-3 Historic Cross Section of Existing Weir, (from Reclamation and Corps 2010)

1.1.2.2 Regulatory Compliance

The U.S. Fish and Wildlife Service (Service) listed the pallid sturgeon as endangered under the Endangered Species Act of 1973 (16 U.S.C. 1531-1544) (ESA) in 1990. Numerous studies suggest that the Intake Diversion Dam impedes upstream migration of pallid sturgeon (*Scaphirhynchus albus*) and their access to spawning and larval drift habitats (Bramblett, 1996; Bramblett & White, 2001; Fuller et al., 2008; Backes et al. 1994). The lower Yellowstone River is considered by the Service to aid the potential for recovery of pallid sturgeon. ESA Section 7(a)(2) requires each federal agency to consult on any action authorized, funded, or carried out by the agency to ensure it does not jeopardize the continued existence of any endangered or threatened species. While the effects of alternatives on recovery of species is analyzed in this EIS, Section 7(a)(2) does not require the actions on which the federal agencies are consulting to contribute to or result in the recovery of the species.

Reclamation has been in formal consultation with the Service to identify potential conservation measures to minimize adverse effects on pallid sturgeon associated with continued operation of

the LYP. The Pallid Sturgeon Recovery Plan (Service 2014) specifically identifies providing passage at the Intake Diversion Dam to protect and restore pallid sturgeon populations. By improving passage at the Intake Diversion Dam, approximately 165 river miles of habitat would become accessible in the Yellowstone River and major tributaries such as the Powder River.

The 2007 Water Resources Development Act (Pub. L. 110–114; 121 Stat. 1041) (Section 3109) authorizes the Corps to use funding from the Missouri River Recovery and Mitigation Program to assist Reclamation in the design and construction of the Lower Yellowstone Project at Intake, Montana for the purpose of ecosystem restoration.

The National Reclamation Act (Pub. L. 57-161, 32 Stat. 388) authorizes Reclamation to construct, operate, and maintain the facilities associated with the LYP consistent with authorized project purposes including actions or modifications necessary to comply with federal law such as the ESA. The LYP is a single purpose project – authorized for irrigation purposes only.

1.1.2.3 Collaboration

1.1.2.4 Previous Studies and Collaborative Efforts

In the 1990's, Reclamation initiated studies to assess the pallid sturgeon and evaluate methods to reduce entrainment and improve fish passage at the Intake Diversion Dam. Several collaborative efforts continued in subsequent years to advance the science related to the pallid sturgeon and evaluate entrainment and passage concepts.

In July 2005, Reclamation entered into a Memorandum of Understanding (MOU) with the Service; Corps; Montana Fish, Wildlife, and Parks; and The Nature Conservancy to share expertise to identify possible options and strategies to address fish passage and entrainment reduction. A value planning study was completed in August 2005 with input from MOU signatories and the LYIP.

In 2010, Reclamation and the Corps moved forward with the recommended alternative (rock ramp and new screened headworks) with the completion of an Environmental Assessment (EA) and Finding of No Significant Impact (FONSI). The construction of the new headworks is complete and began operation during the 2012 irrigation season. During the final design of the rock ramp, following the release of the 2010 EA and FONSI, important new information on the design, constructability, and sustainability of the proposed rock ramp surfaced along with new information regarding pallid sturgeon movement, which led to a reevaluation of fish passage options.

In 2013, the Corps and Reclamation conducted a planning effort to examine new and previously considered alternatives. Following this effort, the Corps and Reclamation identified the bypass channel for detailed analysis. A Supplemental EA and FONSI selecting the bypass channel were completed in 2015.

The Corps and Reclamation signed the FONSI on April 1, 2015, finding that an EIS was not warranted. In February 2015, the Defenders of Wildlife and the Natural Resources Defense Council filed a lawsuit challenging the agencies' process for selecting the preferred alternative. The Corps awarded a contract for the construction of the bypass channel and replacement weir

on August 31, 2015. Since the court issued a preliminary injunction in September 2015, the Corps has not issued a Notice to Proceed on the construction contract.

Previous studies, reports, and environmental compliance documents (listed in Section 2-26) are incorporated by reference and may be accessed online at:
<http://www.usbr.gov/gp/mtao/loweryellowstone/index.html>.

1.1.3 Relationship to Other Projects or Activities

There are six major diversion dams on the main stem Yellowstone River downstream from Billings, Montana. The Intake Diversion Dam, federally owned, is the furthest downstream dam and therefore the first barrier encountered by pallid sturgeon on their migration route. The upstream dam at Huntley is also federally owned. The middle four (Waco, Rancher's Ditch, Yellowstone, and Cartersville) are private dams managed by local irrigation districts. These six diversion dams potentially affect the distribution of some fish species on the Yellowstone River. As stated in the 2015 Yellowstone River Cumulative Effects Assessment (CEA) (Corps and Yellowstone River Conservation District Council 2015):

“although the degree of fragmentation of fish populations caused by these dams is not fully understood for all dams and fish species, these dams potentially affect the distribution of some fish species and reduce the viability of some fish populations.” Specifically, the CEA mentions that the Intake Diversion Dam “is a major passage barrier that is currently the focus of efforts to provide passage for a range of fish species. The structure currently blocks passage by Pallid Sturgeon, Shovelnose Sturgeon, and Paddlefish under most flow conditions. Cartersville Diversion Dam appears to be a complete barrier to passage for Shovelnose Sturgeon.”

1.2 Project Purpose and Need

1.2.1 Purpose

The purpose of the proposed action is to improve fish passage for pallid sturgeon and other native fish at the Intake Diversion Dam, continue the viable and effective operation of the Lower Yellowstone Project, and contribute to ecosystem restoration.

1.2.2 Need—Continue Viable and Effective Operation of the Lower Yellowstone Project

The proposed project needs to allow for continued viable and effective operation of the LYP. The outcomes from this project most likely to influence viable and effective operations are increases in agricultural production costs and decreases in crop production due to insufficient or unreliable water deliveries. Project operation, maintenance and rehabilitation is carried out by the Lower Yellowstone Irrigation Project through funds generated by assessments on farms within the LYP. The ability of farms to pay assessments is dependent on income from crop production, which is a function of reliable and sufficient water deliveries to meet crop requirements.

The LYP diverts water from the Yellowstone River into the main irrigation canal on the north side of the river immediately upstream of the Intake Diversion Dam, at a location 18 miles downstream of Glendive, Montana. The irrigation canal system roughly parallels the

Yellowstone River to its confluence with the Missouri River (see Figure 1.1). Water flows by gravity through 71 miles of the Main Canal, 225 miles of laterals, and 118 miles of drains that flow toward the confluence of the Missouri and Yellowstone rivers. The average annual water supply diverted for these projects is 327,046 acre-feet. Four irrigation districts are included in the LYP. Three of these are in Montana: the Lower Yellowstone Irrigation District #1, Intake Irrigation District, and the Savage Irrigation District. The fourth district, the Lower Yellowstone Irrigation District #2, is in North Dakota and represents about one-third of the irrigated lands.

The Lower Yellowstone Irrigation Project has water rights for claims for the four irrigation districts. Eleven Statements of Claim and one Provisional Permit all identify the Intake Diversion Dam as the point of diversion. Five of these list irrigation as the purpose.

These districts and Reclamation jointly hold the following unadjudicated irrigation water rights in the state of Montana totaling 1,374 cubic feet of water per second (cfs):

- 1,000 cfs (Water Right No. 42M 40806-00)
- 300 cfs (Water Right No. 42M 40807-00)
- 18 cfs (Water Right No. 42M 40808-00)
- 42 cfs (Water Right No. 42M 40809-00)
- 14 cfs Provisional Permit (Savage Irrigation District only; Permit No. 97792-42M)

The period of use on the LYP water right is April 15 - Oct. 15, and Savage Irrigation District from April 1 - Oct. 31 (MDNRC, 2016). The oldest of these claims has a Priority Date of 1905 and a flow rate of 1,000 cfs. In addition to the 1,374 cfs claimed, LYP claims an additional 62.49 cfs for other water rights at Intake that include Stock watering and Domestic and Industrial Use. The system conveys water to irrigate approximately 54,000 acres on about 400 farms along the canal. Each of the four districts has water service and repayment contracts with Reclamation. All have met their full financial obligation for repayment of the diversion structure and supply works (canals, laterals, etc.) for the project.

1.2.3 Need—Improve Fish Passage

Since Intake Diversion Dam impedes upstream movement of pallid sturgeon in the main channel of the Yellowstone River, the proposed project is needed to improve fish passage at this structure. As stated earlier, ESA does not require the actions on which the federal agencies are consulting to contribute to or result in the recovery of the species.

The pallid sturgeon population that occurs in the action area is categorized as the Great Plains Management Unit, extending from Great Falls, Montana to Fort Randall Dam, South Dakota and including the Yellowstone, Marias, and Milk Rivers. An estimated 125 wild pallid sturgeon remain in the segment of this population that occurs in the Missouri River downstream of Fort Peck Dam to the headwaters of Lake Sakakawea and includes the Yellowstone River (Service 2014). The Pallid Sturgeon Conservation Augmentation Program has been supplementing the wild population with hatchery juveniles since 1997 to help prevent extirpation, but these fish are only beginning to reach maturity, so to date, they are not contributing to population viability or sustainability (Service 2008).

Pallid sturgeon are one of the rarest native fish in the Missouri and Mississippi River basins (Service 1993). The declining population of mature wild pallid sturgeon in the Yellowstone

River and Missouri River between Fort Peck Dam and Lake Sakakawea is expected to be locally extinct by 2018 if reproduction and survival of young fish does not improve (Kapusinski 2003a; Kapuscinski 2003b). According to the Service (2003:27), “the value of restoring the Yellowstone River as a natural migratory route for sturgeon and making the middle Yellowstone function as the spawning and nursery grounds for pallids cannot be overstated.”

Adult pallid sturgeon are present seasonally in the Yellowstone River, moving upstream from the Missouri River as temperatures and river flows increase in spring (Bramblett 1996; Fuller and Braaten 2012), for spawning. Very few have been observed above Intake Diversion Dam (Backes, in litt. 2013), although a few pallid sturgeon have been entrained into the irrigation canal at this facility (Jaeger et al. 2004).

Upstream habitats appear to be suitable for spawning and rearing of juveniles (Bramblett and White 2001; Jaeger et al. 2005) and a small number of adult pallid sturgeon were tracked passing upstream of the dam via an existing side channel in 2014 and 2015 (Rugg 2014, 2015). The fragmentation of the Yellowstone River by the Intake Diversion Dam and other diversions has been hypothesized as a factor in the lack of recruitment of pallid sturgeon and has contributed to their decline; anoxic conditions at the headwaters of Lake Sakakawea has also been identified as a factor contributing to this impact (Bramblett, 2016). While pallid sturgeon recovery is not within the scope of this project, improving passage for pallid sturgeon at the Intake Diversion Dam would provide access to a large area of the sturgeon’s historic range that has been mostly inaccessible since 1909. This reach of the Yellowstone River provides a relatively natural flow regime, water temperatures, and habitat conditions.

1.2.4 Need—Ecosystem Restoration

The 2007 Water Resources Development Act (Pub. L. 110–114; 121 Stat. 1041) (Section 3109) authorizes the Corps to use funding from the Missouri River Recovery and Mitigation Program to assist Reclamation in the design and construction of the Lower Yellowstone Project at Intake, Montana for the purpose of ecosystem restoration.

Improvements to fish passage at the Intake Diversion Dam will support migration for numerous fish species and contribute to the sustainability of fish populations in the Yellowstone River. This project will support ecosystem functions by restoring access to a large area of suitable fish habitat throughout the lower Yellowstone River ecosystem.

1.3 Current Facilities and Operation

The Intake Diversion Dam, a submerged, rock filled timber crib weir structure, and headworks includes a low head diversion weir and recently completed (2012) headworks with fish screens designed to reduce fish entrainment into the Main Canal. The weir was designed to divert 1,374 cfs of water to irrigate approximately 54,300 acres of land in Montana and North Dakota. The collective Lower Yellowstone Project facilities include the Intake Diversion Dam, canal headworks structure, pumping stations (including the Intake and Savage pumping stations), supplemental river pumps, 79 miles of Main Canal, approximately 234 miles of laterals, 118 miles of open drains, and over 2,500 water control structures.

The new headworks structure (shown in Figure 1-4 with fish screens down) controls diversions of water into the canal and includes 12 removable rotating drum screens located in the river to minimize entrainment of fish greater than 40 mm long. The screened headworks measures 310 feet wide.

There is no fish ladder at the Intake Diversion Dam. An existing side channel approximately 4.5 miles long provides a route for some fish to pass around the dam during high water periods. Recent monitoring found that five pallid sturgeon used the existing side channel to pass upstream of the dam in 2014 and one did in 2015 (Rugg 2014, 2015).



Figure 1-4. New Headworks and Submerged Fish Screens at Intake Diversion Dam

Because screen design criteria specific to pallid sturgeon are lacking, the fish screens were constructed to meet salmonid criteria established by the Service and National Marine Fisheries Service. Each drum screen measures approximately 6.5 feet in diameter and 25.2 feet in length. Maximum approach velocity in front of the screen is designed at 0.4 feet per second, which provides an even velocity distribution across the rotating screens. Mesh size is a maximum of ¼-inch. Water flows through the cylindrical screens from the lower half of the water column, through the gates and into the canal.

The movable rotating drums allow each screen unit to be adjusted on a track and be raised above the river when not in use to minimize damage from ice and debris flows. The screen cylinders rotate against fixed brushes to clean and remove debris that could impede flow through the screen and to remove fish and other aquatic organisms potentially impinged on the screens.

Under current operations, rock is added to the top of the timber crib diversion weir as needed to create the necessary water surface elevation for diversion of 1,374 cfs. The crest of the timber crib weir is at elevation 1,989 (North American Vertical Datum of 1988). Rock placement on the crest varies from elevation 1985.5 to 1992. The crest of the dam lies about 5 feet above the natural low water mark of the river and 9 feet above the riverbed.

1.4 Environmental Review Process

1.4.1 Previous Environmental Review

As discussed in section 1.1.2, the Corps and Reclamation issued an EA and associated FONSI in 2010 (hereafter referred to as the 2010 EA) and a Supplemental EA and associated FONSI in 2015 (hereafter referred to as the 2015 Supplemental EA). Initial project implementation occurred after the original EA/FONSI with completion of the new headworks. A new alternative to address fish passage issues was covered in the Supplemental EA/FONSI. A contract for implementing the bypass channel alternative was issued in 2015. As a result of a lawsuit filed in Federal District Court over effects on the pallid sturgeon, a preliminary injunction halting the construction was issued by the court in September 2015.

1.4.2 Current Environmental Review

As required by Council on Environmental Quality implementing regulations, this EIS includes consideration of a range of reasonable alternatives that meet the purpose and need of improving pallid sturgeon passage, ecosystem restoration, and continuing a viable and effective operation of the LYP. This document discusses the affected environment (Chapter 3) and analyzes and discloses environmental impacts associated with the proposed federal action and alternatives (Chapter 4) together with engineering, operations and maintenance, social, and economic considerations.

This document will be used to inform decision makers and the public of proposed actions, reasonable alternatives considered, disclose environmental impacts, and consider public comments before final decisions are made.

The EIS process began with a formal scoping process, including a public meeting held in Glendive, Montana in January 2016. See section 1.7 below for details.

The Draft EIS is being issued for agency, tribal, and public review for a period of 45 days. EIS public hearings will be held in Sidney and Glendive, Montana, to receive input. In addition, written comments in the form of letters and emails can be submitted to the Corps during the comment period.

At the end of the comment period, all comment letters will be reviewed by Reclamation and the Corps and will be responded to as appropriate in the Final EIS, anticipated to be issued in the fall of 2016. The Final EIS will also reflect any changes, modifications, or updates as a result of the comments received. Assuming no additional significant adverse effects are identified as a result of the Draft and Final EIS comments, the lead agencies will prepare a Record of Decision (ROD). The ROD explains the agencies' decision, describes the alternatives considered

(including the preferred alternative), and describes the commitments made to protect the environment and monitoring the effectiveness of the commitments. The ROD will be issued no earlier than thirty days after issuance of the Final EIS. Notices of availability for the Final EIS and the ROD will be sent to all agencies, tribes, and individuals who submitted comments on the Draft EIS.

1.4.2.1 Co-lead and Cooperating Agencies

The Corps and Reclamation serve as joint lead federal agencies in the preparation of this EIS. The Corps serves as administrative lead for National Environmental Policy Act (NEPA) compliance activities during preparation of the EIS. The Corps and Reclamation will each consider and approve a ROD regarding the actions and decisions for which the respective agencies are responsible (see Section 1.6).

Reclamation and the Corps established a Cooperating Agency Team to facilitate communication among state and federal agencies. Cooperating agencies provided information based upon their special expertise or jurisdiction related to the Lower Yellowstone Intake Diversion Dam Fish Passage Project and assisted with analyses. The following organizations are participating as cooperating agencies:

- Montana Fish, Wildlife, and Parks (MFWP)
- Montana Department of Natural Resources and Conservation (MDNRC)
- Lower Yellowstone Project Board of Control
- U.S. Fish and Wildlife Service (Service)
- Western Area Power Administration (Western)

1.4.2.2 Key Management Issues

Those management issues determined to be within the scope of this EIS are used to develop one or more of the alternatives or are addressed in other parts of the EIS. For example, as management issues were refined, Reclamation and the Corps worked to develop a reasonable range of alternative designed to address and/or resolve key management issues. The issues and resources potentially affected by and relevant to providing improved fish passage for the pallid sturgeon and other native fish are similar to those identified during the scoping process for the 2010 EA and 2015 Supplemental EA. Scoping for this EIS (see section 1.7 for additional scoping information) identified the following issues and resources as being the most relevant to addressing the project's purpose and need:

- Aquatic communities
- Federally listed/State species of concern
- Historic properties/Trust assets
- Lands and vegetation
- Surface water hydrology
- Geomorphology
- Recreation
- Social and economic conditions
- Water quality
- Wildlife

The following resource areas are also analyzed in this EIS to provide a comprehensive analysis of the affected environment and project effects:

- Air quality
- Noise
- Groundwater hydrology
- Climate
- Transportation
- Environmental justice
- Visual resources

The affected environment (Chapter 3) and environmental consequences (Chapter 4) analysis in this EIS focus primarily on the environmental impacts (direct, indirect, and cumulative) of the various action alternatives and on measures to mitigate significant adverse impacts.

1.5 Required Permits and Approvals

Multiple federal and state laws, regulations, executive orders, and policies are applicable to the proposed project. These regulations are summarized below.

1.5.1 Federal Permits and Approvals

1.5.1.1 Endangered Species Act

The ESA (16 U.S.C. 1531-1544) is administered by the Service and is designed to ensure that the actions taken by federal agencies, including those funded or authorized by such agencies, do not “jeopardize the existence of any listed species.” The pallid sturgeon is formally listed as an endangered species under the ESA.

Under Section 7 of the ESA, federal agencies must consult with the Service when any action the agency carries out, funds, or authorizes (such as through a permit) may affect a listed species. Usually beginning with informal consultation, a federal agency identifies what listed species may occur in the proposed action area, and analyzes the effects the proposed action may have on those species.

When a federal agency determines, through a biological assessment or other review, that its action is likely to adversely affect a listed species, the agency submits to the Service a request for formal consultation. During formal consultation, the Service and the agency share information about the proposed project and the species likely to be affected.

In making a determination on whether an action will result in jeopardy, the Service begins by looking at the current status of the species, or “baseline.” Added to the baseline are the direct, indirect, interrelated, and interdependent effects of the proposed action. The Service also examines the cumulative effects of other non-federal actions that may occur in the action area, including state, tribal, local, or private activities that are reasonably certain to occur in the project area.

Section 7 consultation by Reclamation and the Corps on the action proposed in this EIS has not been concluded at this time. A final biological opinion is anticipated to be complete by fall 2016. Construction will not proceed until the biological opinion is complete and consultation concluded. While the effects of alternatives on recovery of species is analyzed in this EIS, Section 7(a) (2) does not require the actions on which the federal agencies are consulting to contribute to or result in the recovery of the species.

1.5.1.2 Native American Consultation

Tribes were invited to consult throughout preparation of the original 2010 EA, the 2015 Supplemental EA, and the 2016 EIS. In 2008, Reclamation sent letters to 25 tribes in the Upper Missouri River basins. Follow-up telephone calls were made to each tribe. Thirteen of the Missouri River Basin tribes are located directly on the Missouri River, while others are scattered throughout the rest of the basin. All of these tribes could directly or indirectly have historic ties to the Project area. Reclamation requested that the tribes identify any Indian Trust Assets (ITAs) that could be affected by the Project alternatives and invited them to meet and consult on impacts to any such assets. All of these tribes were sent copies of the scoping package and public notice during the public comment period.

Tribes were invited to consult on this EIS by letter dated April 5, 2016. The Tribes that were sent the letter are:

- Assiniboine and Sioux Tribes of Fort Peck
- Blackfeet Tribe
- Cheyenne River Sioux Tribe
- Chippewa Cree Tribe, Rocky Boy's Reservation
- Crow Creek Sioux Tribe
- Crow Tribe
- Eastern Shoshone Tribe
- Flandreau Santee Sioux Tribe
- Fort Belknap Assiniboine and Gros Ventre Tribes
- Iowa Tribe of Kansas
- Kickapoo Tribe
- Lower Brule Sioux Tribe
- Northern Arapaho Tribe
- Northern Cheyenne Tribe
- Oglala Sioux Tribe
- Omaha Tribe
- Ponca Tribe
- Prairie Bend of Potawatami Nation
- Rosebud Sioux Tribe
- Sac and Fox Nation
- Santee Sioux Nation
- Standing Rock Sioux Tribe

- Three Affiliated Tribes (Mandan, Hidatsa, and Arikara)
- Winnebago Tribe
- Yankton Sioux

To date, one Tribe responded to the request to consult. On-going efforts to conduct Tribal consultation and/or outreach will continue throughout the process, including follow-up calls and/or additional correspondence.

1.5.1.3 Archaeological Resource Protection Act of 1979

The Archaeological Resource Protection Act (Pub. L. 96-95; 16 U.S.C. 470aa-mm) protects archaeological resources on federal and tribal lands and requires a permit to remove archaeological resources from these lands. Permits may be issued to educational or scientific institutions only if the removal will increase knowledge about archaeological resources. Compliance with this law will be accomplished through specific actions to minimize effects for all of the alternatives.

1.5.1.4 Clean Water Act of 1977 (as amended)

The Clean Water Act (CWA) (33 U.S.C. §1251 et seq.) is the principal law governing pollution control and water quality of navigable waterways of the United States. Section 402 of the act establishes a National Pollution Discharge Elimination System permitting program to regulate the point source discharge of pollutants into waters of the United States. Both Montana and North Dakota administer state-level programs pursuant to authority delegated by the EPA.

Section 404, administered by the Corps with oversight from EPA, is another permitting program that regulates the placement of dredged or fill materials into waters of the United States. The Corps issues nationwide permits on a state, regional, or nationwide basis for similar activities that cause only minimal adverse environmental effects both individually and cumulatively. Individual permits are required for larger projects that have more than minimal effects on waters of the United States.

Of specific note, the Corps does not issue a CWA permit to authorize its own discharges of dredged or fill material into the waters of the U.S., but does ensure equivalent compliance with the 404(b)(1) guidelines and other substantive requirements of the CWA.

Montana State Water Quality Certification (Section 401) will also be required and is discussed below in Section 1.5.20.

1.5.1.5 Floodplain Management Assessment

The floodplain management assessment is conducted in accordance with the National Flood Insurance Program (NFIP) as outlined in Title 44 of the Code of Federal Regulations (44 CFR). The proposed project modifications are compared to the effective Federal Emergency Management Agency (FEMA) floodplain data for the project area to determine any adverse impacts.

According to FEMA documents, Dawson County, Montana participates in the NFIP and the Intake Diversion Dam is located on FEMA Map Panel 3001400009B, dated April 1978. The

entire Yellowstone River floodplain is delineated as Zone A at this location, which by FEMA definition, indicates a geographical area shown on a Flood Hazard Boundary Map or a Flood Insurance Rate Map that reflects the severity or type of flooding in the area, for a 1-percent-annual-chance flood event (the 100-year flood event).

Additional hydrologic analyses will be conducted in the future as the design of the preferred alternative features are finalized to ensure that the project will comply with County and FEMA requirements for the NFIP.

1.5.1.6 Farmland Protection Policy Act of 1995

The purpose of the Farmland Protection Policy Act (Pub. L. 97-98, subtitle I of Title XV, Section 1539-1549) is to ensure that impacts to prime or unique farmlands are considered in federal projects. It requires federal agencies to consider alternative actions that could lessen impacts and to ensure that their actions are compatible with state, local government, and private programs to protect prime and unique farmland. The Natural Resources Conservation Service is responsible for administering this act. There is prime and unique farmland throughout the study area. Farmlands were considered in this EIS using the key indicators of changes in farm acreage and production. Prime and unique farmlands will be protected to the extent possible during implementation of the Lower Yellowstone Intake Diversion Dam Fish Passage Project.

1.5.1.7 Fish and Wildlife Coordination Act of 1958 (as amended)

The Fish and Wildlife Coordination Act (FWCA, 48 Stat. 401, as amended; 16 U.S.C. 661 et seq.) provides a procedural framework for the orderly consideration of fish and wildlife conservation measures to be incorporated into federal projects and federally permitted or licensed water resource development projects. Agencies that construct, permit, or license projects impacting a water body must consult with the Service and the state agency having jurisdiction over fish and wildlife resources, in this case MFWP. Full consideration must be given to the recommendations made through this consultation process.

Section 2 states that fish and wildlife conservation shall receive equal consideration with other project purposes and will be coordinated with other features of water resource development projects. The FWCA specifically authorizes the Secretary of the Interior to prepare a report referred to as a Coordination Act Report, which recommends measures to minimize impacts to the fish and wildlife. The FWCA report provides input to preparation of NEPA documents, and is a binding document once both the Service and the lead agencies sign it.

1.5.1.8 Migratory Bird Treaty Act and Executive Order 13186 (January 2001)

Under the provisions of the Migratory Bird Treaty Act (16 U.S.C. 703-712) it is unlawful by any means or manner to pursue, hunt, take, capture or kill any migratory birds except as permitted by regulations issued by the Service. Migratory birds include all native birds in the United States with the exception of non-migratory species managed by states. The Service has defined “take” to mean “pursue, hunt, shoot, wound, kill, trap, capture, or collect, or attempt to pursue, hunt, shoot, wound, kill, trap, capture or collect” any migratory bird or any part, nest, or egg of any migratory bird (50 CFR Section 10.12). Executive Order (EO) 13186 requires that each federal agency taking actions that have, or are likely to have, a measurable negative effect on migratory bird populations is directed to develop and implement, with the Service, measures that shall promote the conservation of migratory bird populations.

Compliance with this law will be accomplished through specific actions to minimize effects for all of the alternatives.

1.5.1.9 Native American Graves Protection and Repatriation Act (Public Law 101-601)

The Native American Graves Protection and Repatriation Act establishes federal policy with respect to Native American burials and graves located on federal or tribal lands. Federal agencies are required to consult with and obtain the concurrence of the appropriate tribes with respect to activities that may result in the disturbance and/or removal of burials and graves from federal lands or lands held in trust for a tribe. To ensure compliance with the Act, the Corps and Reclamation will consult with the tribes if any unanticipated discoveries are made during the construction phase of the Intake Project. Compliance with this law will be accomplished through specific actions to minimize effects for all of the alternatives.

1.5.1.10 National Historic Preservation Act of 1966 (as amended in 2006)

The National Historic Preservation Act (NHPA) (Public Law 89-665; 16 U.S.C. 470 et seq) establishes protection of historic properties as federal policy in cooperation with states, tribes, local governments, and the public. Historic properties are those buildings, structures, sites, objects, and districts, or properties of traditional religious and cultural importance to Native Americans, determined to be eligible for inclusion in the National Register of Historic Places.

Section 106 of the act requires federal agencies to consider the effects of proposed actions on historic properties and gives the Advisory Council on Historic Preservation an opportunity to comment. Reclamation is responsible for consultation with the State Historic Preservation Office (SHPO) and/or Tribal Historic Preservation Offices, tribes, applicants, interested parties, and local governments regarding federal undertakings. Compliance with this law will be accomplished through specific actions to minimize effects for all of the alternatives.

1.5.1.11 Rivers and Harbors Act of 1899

Under Section 10 of the Rivers and Harbors Act (33 U.S.C. 403; Chapter 425; 30 Stat. 1151), the construction of any structure in or over any navigable water of the United States, the excavating from or depositing of material in such waters, or the accomplishment of any other work affecting the course, location, condition, or capacity of such waters is unlawful unless the work has been recommended by the Chief of Engineers and authorized by the Secretary of the Army. This project will be designed to ensure compatibility with the act. However, during the Section 404(b)(1) analysis, design features requiring recommendation and approval will be reviewed by the Corps to ensure compliance with the act.

1.5.1.12 Executive Order 13112 for Invasive Species

In 1999, an EO was issued to prevent the introduction of invasive species and to provide for their control. It directs federal agencies to identify applicable actions and to use programs and authorities to minimize the economic, ecological, and human health impacts caused by invasive species. To meet the intent of this order, the proposed project includes actions to prevent and control the spread of invasive species.

1.5.1.13 Executive Order 11988 Assessment

EO 11988 (Floodplain Management) requires federal agencies to avoid developments on floodplains whenever possible or to minimize potential harm to the floodplains.

The intent of the proposed project is to improve fish passage along the Yellowstone River. In order to be compliant with EO 11988, federal investment in the proposed project modifications must not result in any actions or activities that will adversely impact existing structures, and in particular, critical facilities such as hospitals, schools, power generating plants, etc.

1.5.1.14 Other Executive Orders

EO 11990 (Protection of Wetlands) directs federal agencies to avoid destruction, loss, or degradation of wetlands. EO 13007 (Indian Sacred Sites) orders federal agencies to accommodate Indian tribes' requirements for access to and ceremonial use of sacred sites on public lands and to avoid damaging the physical integrity of such sites. EO 12898 (Environmental Justice) directs federal agencies to identify and address disproportionately high and adverse human health or environmental effects on minority populations and low-income populations. Compliance with these orders was considered in the development of action alternatives in this EIS (see Chapter 4, "Lands and Vegetation" and "Historic Properties" sections).

1.5.2 State and Local Permits and Approvals

1.5.2.1 State Water Rights

Montana waters belong to the state, with ownership on behalf of all state citizens. Because water belongs to the state, water rights holders do not own the water; they have a right to use the water within state guidelines. Water rights in Montana are guided by the prior appropriation doctrine, or first in time, first in right. A person's right to use a specific quantity of water depends on when the use first began. The first person to use water from a specific source established the first right, the second established a right to the remaining water and so on. Water rights holders are limited to the amount of water that has been beneficially used. Beneficial uses of water include agricultural purposes, domestic, fish and wildlife, industrial, mining, municipal, power, and recreational uses.

The Montana Water Use Act, effective July 1, 1973, changed water rights administration by requiring a statewide adjudication process on all water right claims existing at that time. Adjudication is a judicial process that determines the elements of all existing water rights in a basin such as flow rate, priority date, acres, and place of use. It also established a system for obtaining water permits for new or additional water uses, created an authorization system for changing water rights and a centralized records system, and provided a system to reserve water for future consumptive uses and maintain minimum instream flows for water quality and fish and wildlife. Senate Bill 76 and House Bill 22 further defined the adjudication process and established a funding mechanism to complete statewide adjudication.

1.5.2.2 Montana Environmental Policy Act

State agencies on the Cooperating Agency Team provided input for compliance with the Montana Environmental Policy Act (MEPA). MEPA was passed in 1971 instituting a policy requiring state agencies to consider the environmental, social, cultural and economic impacts of proposals prior to project approval and mirrors the requirements and benefits of NEPA. The

purpose of MEPA is to foster state government decisions that are informed, accountable, open to public participation, and balanced. MEPA gives a community the ability to provide input into decision-making and helps resolve issues before they become a problem. The agencies may adopt the Intake EIS completed by the co-leads or complete further documentation as they see fit to comply with the MEPA process. The various state permits and approvals mentioned in section 1.5.2 may require completion of MEPA prior to issuance.

1.5.2.3 Stream Protection Act

The purpose of Montana's Stream Protection Act is to protect and preserve fish and wildlife resources and to maintain streams and rivers in their natural or existing state. Any agency or subdivision of federal, state, county, or city government proposing a project that may affect the bed or banks of any stream in Montana for any project including the construction of new facilities or the modification, operation, and maintenance of an existing facility that may affect the natural existing shape and form of any stream or its banks or tributaries must comply with this act. A stream protection permit would be obtained prior to construction.

1.5.2.4 Short-Term Water Quality Standards for Turbidity (318)

Any person, agency, or entity, both public and private, initiating construction activity that will cause short-term or temporary violations of state surface water quality standards for turbidity requires a state permit. The purpose of the permit is to provide a short-term water quality turbidity standard for construction activities, so that construction is carried out in accordance with conditions prescribed by the MTDEQ, to protect water quality and to minimize sedimentation. MTDEQ administers the permit, which will be obtained prior to construction.

1.5.2.5 Montana Land-use License of Easement on Navigable Waters

Any entity proposing a project on lands below the low water mark of navigable waters requires a state license. Projects include the construction, placement, or modification of a structure or improvements in, over, below, or above a navigable stream. The purpose of the law is to protect riparian area and the navigable status of the water body and to provide for the beneficial use of state lands for public and private purposes in a manner that will provide revenues without harming the long-term capability of the land or restricting the original commercial navigability. The MDNRC administers the law. MDNRC notified Reclamation by letter on June 24, 2010 that they would not be required to obtain a Land Use license or Easement for the Intake Diversion Dam Modification project or any other construction activities related to this project that occur within the riverbed of the Yellowstone River.

1.5.2.6 Stormwater Discharge General Permits

Any person, agency, or entity, either public or private, proposing a construction, industrial, mining, or other defined activity that has a discharge of storm water into surface waters must obtain a permit. Under the authority of the Montana Water Quality Act, permit authorization is typically obtained under a Montana Pollutant Discharge Elimination System "General Permit." A permit is generally required for construction activity that will disturb one or more acres, including clearing, grading, and excavating activities.

The purpose of the law is to prevent degradation of surface waters from pollutants such as sediment, waste materials, industrial chemicals or materials, heavy metals, and petroleum products; to protect existing water quality, and to implement and monitor the effectiveness of

Best Management Practices (erosion and sediment controls, etc.) used to reduce pollutant loads. The MTDEQ administers the permit, which will be obtained prior to construction.

1.5.2.7 401 Water Quality Certification for Other Federal Permits & Licenses

Section 401 of the Clean Water Act, administered in this case by the MTDEQ, allows states to review and approve, condition, or deny all federal permits or licenses that might result in a discharge to state waters, including wetlands. States make their decisions to deny, certify, or condition permits or licenses primarily by ensuring the activity will comply with state water quality standards. In addition, states look at whether the activity will violate effluent limitations, new source performance standards, toxic pollutants, and other water resource requirements of state law or regulation. The Section 401 review allows for better consideration of state-specific concerns. A 401 Water Quality Certification would be obtained from MTDEQ, if appropriate.

1.6 Decisions to be Made

Reclamation and the Corps will make the following decisions regarding the proposed federal action in a ROD upon completion of the Final EIS.

Reclamation will decide whether to proceed with the proposed action, or a reasonable alternative to it, to modify the Intake Diversion Dam to improve pallid sturgeon fish passage while continuing a viable and effective operation of the LYP. Related to this decision and upon completion of the project, Reclamation would make decisions related to the modifications of contracts or agreements with the affected irrigation districts.

If Reclamation decides to proceed with the proposed action, the Corps will decide whether to assist Reclamation with the proposed action, or a reasonable alternative to it, and provide funding for design and construction activities needed to modify the Intake Diversion Dam for the purpose of improving fish passage and assisting in restoration of the lower Yellowstone River ecosystem.

1.7 Agency and Public Scoping Issues

The Corps and Reclamation held a public scoping meeting and invited agencies, tribes, non-governmental organizations, and the public to participate in an open exchange of information and to provide comments on the proposed scope of the EIS. The public scoping meeting was held in Glendive, Montana on January 21, 2016 at the Dawson County High School Auditorium. Staff from the Corps and Reclamation were on hand to provide information to the public about the alternatives being considered and issues to be addressed in the EIS, and to answer questions. A meeting with interested agencies was held earlier that day at the Dawson County Chamber of Commerce and Agriculture in Glendive. The public and affected agencies were given the opportunity to provide written comments during the scoping period (January 4 through February 18, 2016) to identify issues and effects that should be addressed in the EIS, as well as reasonable alternatives to improve fish passage at the Intake Diversion Dam.

A total of 93 scoping comment letters, comment forms, and e-mails were received from 77 individuals, eleven agencies/organizations, and five elected officials. Public scoping is not intended to serve as a voting process; rather it is a means to involve the public in identifying issues, data, or substantive comments that should be considered in the NEPA process. An issue or comment that may have been raised in one comment letter is given the same consideration as an issue that may have been raised by several commenters.

Comments were sorted by category as shown in Table 1-1. Comments on alternatives, whether supporting a given alternative, objecting to a given alternative, or offering a new alternative, were the most common, accounting for over half of the total comments. Comments voicing concern about the pallid sturgeon and other threatened or endangered species were next, followed immediately by comments voicing economic concerns, centering on the need to continue providing irrigation for the area's farmers and ranchers. The project's Scoping Summary Report provides additional information on the scoping process and includes a copy of all scoping comments.

TABLE 1-1. SCOPING COMMENTS BY CATEGORY

Category	Number of Comments	Category	Number of Comments
Alternatives	101	Mitigation	9
Aquatic Communities	2	Project Cost	11
Climate	2	Project Process	14
Cumulative Effects	2	Purpose and Need	5
Economics	34	Recreation	3
Energy	2	Transportation	1
Threatened and Endangered Species	35	Utilities	2
General	5	Visual Resources	2
Geomorphology	6	Water Quality	4
Hazardous Materials	1	Water Rights	2
Lands and Vegetation	1	Wildlife	6

Several commenters proposed alternatives that would include removal of the existing dam. One such alternative, proposed by Defenders of Wildlife and the Natural Resources Defense Council, consists of 10 components: 1) water conservation check structures; 2) water conservation flow measuring devices; 3) convert laterals from ditches to pipes; 4) convert fields from flood irrigation to sprinklers; 5) line open canals; 6) control overchecking; 7) water pumping from a source other than the Yellowstone River; 8) pumping stations along the river; 9) use of existing headworks; and 10) renewable energy resources.

Montana Trout Unlimited proposed a similar alternative, also allowing for removal of the existing dam. This would include 1) using gravity flow into the existing headworks when river flow allows; 2) using pumps, either in the river or in the alluvium, during period of low flows; 3) reducing diversion volumes by investing in conservation measures in the canal, at turnouts, and in laterals (lining, piping, possibly sprinkler conversion, improving headgate efficiency, etc.); 4) employing groundwater pumps in appropriate locations within the irrigation project area, as a

backup as necessary; 5) providing power for pumps using a wind generator, or, if feasible, low-head hydro in the Main Canals; and 6) if power cannot be produced on site, establish a trust fund dedicated to purchasing power, and possibly fund operation and maintenance for the pump system.

Other commenters urged consideration of the removal of the existing dam, though with less detail.

Three other alternatives were proposed. The first suggested installing a bypass channel just south of the existing dam that would be approximately 100 feet wide, about 2,000 feet long and with various flow restrictions for sturgeon rest areas as natural flows. The commenter stated that the elevation change in a 2,000-foot run is not any more than some riffles in the Yellowstone River where the sturgeon are able to pass.

The second suggested alternative is to have the MFWP relocate all the sturgeon that they catch below the dam to above the dam each year during their annual survey and undertake a ten-year study to see if the numbers increase or decrease. In the commenter's opinion, if the number of caught sturgeon increases it would mean the sturgeon are spawning and coming downstream. If the number of caught sturgeon decreases, it would mean the sturgeon are going upstream and staying there.

A third suggestion is to move the point of diversion for the canal upstream far enough to allow diversions of water into the canal without a weir. The water delivery canal with inlet and outlet gates, constructed parallel to the BNSF railroad, could provide flood control to the 100-year level for the railroad and the screen structures. The removal of the Intake Diversion Dam would then provide a natural river for fish migration. The rocks removed from the weir could be used as stream bank protection for the new canal.

2 Alternatives

This chapter describes the development and evaluation of alternatives to meet the purpose and need of the proposed action. Six alternatives were selected for analysis in this EIS that represent a reasonable range of reasonable alternatives:

- No Action
- Rock Ramp
- Bypass Channel
- Modified Side Channel
- Multiple Pump Stations
- Multiple Pumps with Conservation Measures

Section 2.3 describes those alternatives in detail. The operation of the new headworks and fish screens are included in the No Action Alternative and referenced as appropriate in each of the other alternatives. Also presented in this chapter is a summary of the history and process for development of alternatives in past studies.

2.1 Problems and Opportunities

The Intake Diversion Dam has impeded upstream migration of pallid sturgeon and other native fish for more than 100 years. The best available science suggests that the dam is essentially a total barrier to pallid sturgeon, due to increased turbulence and velocities associated with the rocks at the dam and immediately downstream (Jaeger et al. 2005; Fuller et al. 2008; Helfrich et al. 1999; White & Mefford 2002; Bramblett & White 2001; Service 2000, 2003, 2007).

During high flows in 2014, five pallid sturgeon were tracked using the existing side channel to successfully bypass the dam (Rugg 2014). A single pallid sturgeon passed upstream in 2015 during similar high flows (Rugg 2015). While this evidence suggests that pallid sturgeon will use a side channel or bypass channel for passage, some biologists stress that this may be a rare event. Monitoring of radio-tagged fish over the past several years indicates that most pallid sturgeon can migrate no further upstream than the Intake Diversion Dam (with the exception of 2014 and 2015) and some spawn downstream of the dam.

Spawning has been documented near River Mile 10 (Allen et al. 2015; Elliot et al. 2015). If spawning occurs below the dam, newly-hatched pallid sturgeon (free embryos and larvae) likely drift into Lake Sakakawea before they are able to settle into suitable riverine habitats for rearing (Braaten et al. 2008; 2011). Recent research indicates oxygen levels in the headwaters of reservoirs such as Fort Peck and Lake Sakakawea are too low for free embryos or larval pallid sturgeon to survive (Guy et al. 2015; Bramblett et al. 2016).

The proposed Intake Project would contribute to recovery of pallid sturgeon by providing up to an additional 165 miles of the Yellowstone River for migration, spawning, and development. The

distance between the next upstream barrier on the Yellowstone River, Cartersville Diversion Dam, and Lake Sakakawea is about 317 miles. This substantial increase in free-flowing river habitat likely would provide adequate drift distance for at least a portion of the larvae (Upper Missouri River Basin Pallid Sturgeon Work Group 2009). Access to tributaries, such as the Tongue and Powder Rivers, would provide additional spawning habitat and could increase larval drift distance. The five pallid sturgeon that passed the Intake Diversion Dam in 2014 were documented in the Powder River and spawning appears to have occurred (Rugg 2014).

2.1.1 Existing Conditions

2.1.1.1 Pallid Sturgeon

Pallid sturgeon occupy the Missouri and Yellowstone Rivers in Montana and North Dakota. These sturgeon use the Missouri River year-round and the Yellowstone River primarily during spring and summer spawning. Klungle and Baxter (2005) estimated 158 wild adult pallid sturgeon inhabit Recovery-Priority Management Area 2. This includes the Missouri River from Fort Peck Dam to the headwaters of Lake Sakakawea and the Yellowstone River below the Intake Diversion Dam (Dryer & Sandvol 1993).

Several population estimates have been developed for the Fort Peck and Yellowstone River reaches (Krentz, 1996; Kapuscinski, 2002; Klungle & Baxter 2005). An estimated 125 wild pallid sturgeon remain in the segment of this population that occurs in the Missouri River downstream of Fort Peck Dam to the headwaters of Lake Sakakawea and includes the Yellowstone River (Service 2014). This estimate and current sampling efforts indicate the reproductive adults in the Yellowstone and Missouri Rivers remain very rare.

Supplemental stocking of pallid sturgeon has been ongoing sporadically since 1998, with various numbers being stocked based on hatchery success for any given year (Service 2006) in the upper Missouri River basin. Hatcheries involved with propagation of Missouri River pallid sturgeon stocked a combined 15,781 fingerling and yearling-sized pallid sturgeon during 2011, with approximately 4,000 of those being stocked in the Recovery-Priority Management Area 2. Pallid sturgeons are stocked to ensure survival of the species in the short term and preserve existing genetics of the wild population. Monitoring data collected through the Pallid Sturgeon Population Assessment Program indicate that stocked pallid sturgeon are surviving, growing, and reaching a size and age that is capable of spawning. Recent survival estimates for hatchery fish stocked into the Missouri River show relatively high rates of survival (Hadley & Rotella 2009; Steffensen et al. 2010) that are similar to other sturgeon species (Ireland et al. 2002).

Bramblett (1996) documented that pallid sturgeon prefer the Yellowstone River over the Missouri River below Fort Peck. Recent data from the Yellowstone River document spawning in the lower Yellowstone River that occurred on coarse substrate (mostly, gravel patches on the larger sand bottom; Allen et al. 2015; Elliot et al. 2015). Pallid sturgeon spawning in the Yellowstone River downstream of the Intake Diversion Dam was also supported by capture of one larvae in 2012 and the absence of eggs in a sexually mature female sturgeon in 2014 (Rugg 2014).

While spawning has now been documented in the Yellowstone River, there is still no evidence of successful recruitment (Delonay et al. 2016). Although most pallid sturgeon migrate up the

Yellowstone River in most years, this was not the case during the 2011 spawning season, likely as a consequence of high runoff in the Missouri River. This atypical run up the Missouri River resulted in the first documented naturally spawned pallid sturgeon above Gavins Point Dam. A naturally spawned pallid sturgeon was confirmed when a day-old larvae was found upstream of Wolf Point Montana in the Missouri River (Fuller 2012).

Pallid sturgeon in the Yellowstone River prefer sandy substrates and deep channels and select reaches with numerous islands (Bramblett & White 2001). They primarily inhabit about a 70-mile stretch of river downstream of the Intake Diversion Dam. More recently radio-tagged hatchery-reared pallid sturgeon have been placed above the dam (Jaeger et al. 2005). Most of these fish stayed upstream of the Intake Diversion Dam, but some were found in the Main Canal of the Lower Yellowstone Project (LYP) (Jaeger et al. 2004).

Despite recent evidence of spawning in the lower Yellowstone River, there are no detectable levels of recruitment occurring (Bergman et al., 2008 (reported as M. Jaeger and D. Fuller personal communication in 2009 Draft Recovery Plan for the Pallid Sturgeon)). The U.S. Fish and Wildlife Service (the Service) (1993) has suggested that the Intake Diversion Dam is a barrier to upstream passage that may prevent pallid sturgeon from accessing upstream reaches. The best available science suggests that the Intake Diversion Dam is a partial barrier to some species (Helfrich et al., 1999; Jaeger et al. 2004; Backes et al. 1994; Stewart 1986, 1988, 1990, 1991). Braaten et al. (2008) suggests larval drift distance presently available below the Intake Diversion Dam is too short. Braaten et al. (2012) showed via a recapture study that pallid sturgeon originally released as free embryos and larvae can survive beyond the first year of life. This highlights the ability of the Yellowstone and Missouri Rivers to provide conditions that support survival, feeding, and growth of pallid sturgeon early life stages. The recently estimated population of 43,000 hatchery-derived pallid sturgeon stocked under the Pallid Sturgeon Conservation and Augmentation Program (PSCAP; Service 2008) indicates that juvenile sturgeon of a variety of ages can survive and grow in the Yellowstone and Missouri Rivers. The critical bottleneck may be survival from egg to exogenously feeding larvae.

2.1.1.2 Existing Dam and Facilities

The first and major portion of the Lower Yellowstone Project was authorized by the Secretary of the Interior on May 10, 1904. The collective features of the Lower Yellowstone Project provide a dependable water supply sufficient to irrigate approximately 54,300 acres of land along the Yellowstone River in east-central Montana and western North Dakota. The Lower Yellowstone Project is primarily a gravity diversion and distribution system, with capacity of up to 1,374 cubic feet per second (cfs) of water diverted from the Yellowstone River into the Main Canal by the Intake Diversion Dam. The collective Lower Yellowstone Project facilities include the Intake Diversion Dam, screened headworks structure, 4 primary pumping stations (including the Intake and Savage pumping stations), 4 supplemental river pumps, 72 miles of Main Canal, approximately 234 miles of laterals, and 118 miles of open drains, and over 2,500 water control structures. The average annual water diversion is 327,046 acre-feet. Electric pumping power service to five of the pumping stations is supplied by the Pick-Sloan Missouri Basin Program.

Since the early 1950s, both the agricultural economy and lands served by the Lower Yellowstone Project have remained relatively stable. In contrast to a dry-land farming trend toward larger, consolidated farms, the number of farm units on the Lower Yellowstone Project has dropped

only slightly. Until recently, the primary irrigated crop was sugar beets with some small grains, alfalfa, and corn. Recently commodity prices have caused a shift to more corn and small grain production, with a corresponding decline in sugar beet acreage.

2.1.1.3 Intake Diversion Dam

This 700-foot long timber and stone-filled structure spans the Yellowstone River and diverts water into the headworks of the Lower Yellowstone Project's Main Canal. The crest of the wooden crib structure is approximate elevation of 1,989 feet, and an additional 1-2 feet of rock are periodically placed on top to an elevation of 1,991. The Dam creates adequate water surface elevation to facilitate irrigation water diversions. A cableway system is used to replace rock at the dam as needed to maintain sufficient elevation for diversion into the Main Canal headworks.

2.1.1.4 Main Canal Headworks

The Intake Diversion Dam diverts water from the Yellowstone River through the screened canal headworks structure into the Main Canal for distribution to the lateral system. Ample flow in the Yellowstone River precludes the need for a water storage reservoir. Irrigation waters are distributed primarily through a gravity flow system, but four pumping stations on the Main Canal supply water for small areas not reached by the gravity system. The headworks and fish screens, constructed in 2012, contain 12 intakes and fish screens controlled at the inlet by metal slide gates. When a gate is open, water flows through the headworks and into the Main Canal. Up to 1,374 cfs can be diverted through the headworks into the Main Canal.

2.2 Background and History of Alternatives

Reclamation has been addressing endangered species issues associated with operation and maintenance of its Lower Yellowstone Project since the 1990's. Concurrently the Corps has been working to restore habitat and recover endangered pallid sturgeon in the Missouri River Basin. Because of overlapping activities, Reclamation and the Corps have collaborated periodically on technical studies, data collection, and planning related to pallid sturgeon. In 2005, Reclamation and the Corps, along with the Service, the state of Montana, and The Nature Conservancy, signed a Memorandum of Understanding (MOU) to collaboratively address Lower Yellowstone Project pallid sturgeon issues. Since 2005 Reclamation and the Corps, in consultation with the Service, have been partners in pallid sturgeon passage at Intake Diversion Dam.

This section describes the previous planning efforts including alternatives considered and evaluated as part of those efforts. As can be seen in the discussion that follows, a wide range of alternatives have been considered and analyzed, either in planning studies or in formal environmental review. Beginning with 110 ideas that came out of an initial value engineering and value planning effort, several alternatives have been developed. Two previous environmental review processes, the 2010 Environmental Assessment (EA) and the 2015 Supplemental EA considered the environmental effects of a number of the alternatives. The current EIS process examines five action alternatives, some new, and some refined from ones previously considered.

2.2.1 Completed Planning Studies

Development of alternatives began in 1997 during early informal ESA consultation, and it has progressed through various stages. The following documents were developed during alternative formulation and evaluation:

- Lower Yellowstone River Fish Passage and Protection Study (Reclamation & Montana Fish Wildlife & Parks 1997)
- Concept I Report (Mefford et al. 2000)
- Fish Entrainment Study (Hiebert et al. 2000)
- Assessment of Sturgeon Behavior and Swimming Ability for Design of Fish Passage Devices (White & Mefford 2002)
- 2002 Alternatives Report (Corps 2002)
- 2002 Value Engineering Study (Reclamation, 2002b)
- Test Results of Intralox Traveling Screen Material (Reclamation 2003)
- Concept II Report (Glickman et al. 2004)
- Value Planning Study (Reclamation 2005)
- Technical Team Recommendations (Technical Team 2005)
- Biological Review Team Comments (Jordan 2006)
- Lower Yellowstone River Intake Dam Fish Passage and Screening Preliminary Design Report (Corps 2006)
- Biological Review Team Comments (Jordan 2008)
- Intake Diversion Dam, Trashrack Appraisal Study for Intake Headworks, Lower Yellowstone Project—Montana-North Dakota (Cha et al. 2008)
- Intake Diversion Dam, Assessment of High Elevation Intake Gates, Lower Yellowstone Project—Montana-North Dakota (Mefford et al. 2008)
- Lower Yellowstone Project Fish Screening and Sediment Sluicing Preliminary Design Report (Corps 2008)
- Final Environmental Assessment (Corps & Reclamation, April 2010)
- Intake Diversion Dam Modification Project Summary of Fish Passage Concepts (Corps, April 2011)
- Final Value Engineering Study Report (VMS / Corps, April 2013)
- Final Supplemental Environmental Assessment (Corps & Reclamation 2015)

Table 2-1 shows the evolution of alternatives from the initial planning studies through this draft EIS. The various alternatives and the evaluation processes are detailed and discussed in the sections that follow.

TABLE 2-1. INTAKE DIVERSION DAM FISH PASSAGE PROJECT: EVOLUTION OF ALTERNATIVES, 2006-2016

Value Planning (VP) Study	Value Planning Recommendations	2010 EA	2013 Planning Studies; 2015 EA	2016 EIS
No Action	Drop—does not meet ESA requirements	Considered as required by NEPA	Kept	Included as No Action Alternative as required by NEPA
L-shaped dam (6,600')	Drop—significance of construction required to implement, high risk of potential failure from floodwaters, ice jamming, erosion, and channel movement	Not considered further	Not considered further	Not considered further
L-shaped dam (20,000')	Drop—same as 6,600' dam	Not considered further	Not considered further	Not considered further
Island	Drop—water risk, construction risk, inability to modify in future, and acceptability	Not considered	Considered but dropped; technically infeasible without constructing a weir across the full width of the river concerns regarding river migrating away from newly constructed headworks when Intake Diversion Dam removed; considerable O&M cost for new dike system. Concerns that hydraulics would not allow irrigation districts to receive full water rights.	Not considered further
Widen Fishway/ V-shaped Screen	Keep	Dropped—duplicative with Removable Rotating Drum Screen Option. More expensive to maintain; would expose juvenile fish to unnatural environment	Not considered further	Not considered further
Multiple Pumping Stations	Duplicative of single pumping station alternative	Reconsidered as a result of scoping comments; but eliminated because of reliability and entrainment concerns, construction costs, O&M costs	Not considered	Included as Multiple Pump Alternative

Lower Yellowstone Intake Diversion Dam Fish Passage Project, Montana
Environmental Impact Statement
May 2016

Value Planning (VP) Study	Value Planning Recommendations	2010 EA	2013 Planning Studies; 2015 EA	2016 EIS
Long, low-gradient channel	Keep	Not considered further	Not considered further	Not considered further
Bypass Channel	Not examined	Not examined	New alternative added in 2015 EA	Included as Bypass Channel Alternative
Remove dam and move diversion upstream	Keep	Dropped—hydraulic analysis determined that a replacement weir with rock ramp would be required to provide sufficient head for reliable diversion of water under low flow conditions.	Not considered further	Not considered further
Rock ramp	Keep	Evaluated as Rock Ramp Alternative	Considered and kept	Included as Rock Ramp Alternative
Collapsible gates	Drop—Concerns regarding operation and maintenance. Would remain a barrier to fish passage since majority of river would be blocked to provide sufficient head for delivery of water into the canal.	Not considered further	Not considered further	Not considered further
Removable rotating drum screen	Not examined	Evaluated as removable rotating drum screen option	No longer required as new headworks construction was completed in 2012	No longer required
Remove dam and build single pumping station	Keep	Dropped due to redundancy with the Rock Ramp Alternative; construction of an expensive new facility; acquisition of real estate; and additional O&M costs that would adversely affect the irrigation districts	Not considered further	Not considered further
Infiltration Gallery Alternative	Not examined	Dropped-would likely require more power and disturb more river channel	Not considered further	Not considered further
Open Channel with Multiple Ranney Wells	Not examined	Not examined	Considered but dropped due to high cost, high energy costs	Included as Multiple Pumps with Conservation Measures Alternative

Value Planning (VP) Study	Value Planning Recommendations	2010 EA	2013 Planning Studies; 2015 EA	2016 EIS
Rock ramp with reduced weir elevation	Not examined	Not examined	This alternative was dropped but important components were combined with the original rock ramp alternative. Analysis conducted at preliminary level, engineers could not confidently say what impacts a lower rock ramp and weir elevation would have on fish passage as it pertained to velocities. Significant cost savings were not achieved in the preliminary estimate.	Not considered further
Combined rock ramp and weir	Not examined	Not examined	Considered but dropped. Comparable in cost to original rock ramp but only provided half the fish passage.	Not considered further
Realigned bypass channel with modified weir	Not examined	Not examined	Considered but dropped. However, many changes considered for bypass channel alternative.	Not considered further
Relocate Main Channel	Not examined	Evaluated and dismissed due to costs and extent of project and impacts	Considered but dropped due to high costs and incompatibility	Not considered further
Hi-Flow Bypass Channel	Not examined	Not examined	Not examined	Included as Modified Side Channel Alternative

These previous planning studies, in combination with informal ESA consultations, resulted in the identification of various fish passage alternatives and screening options; the agencies focused on these. Key milestones in this early plan development process included the 2002 Alternatives Report (Reclamation and the Corps), the 2002 Value Engineering Study (Reclamation), and the 2005 Value Planning Study (Reclamation).

2.2.1.1 Alternatives Report

The 2002 Alternatives Report, which was a joint effort between Reclamation and the Corps, evaluated an array of different fish passage alternatives and also included various swim studies focused on collecting more information on the swimming abilities of pallid sturgeon and their likelihood to successfully navigate through various fish passage structures (fish ladders, rock fish ways, etc.).

2.2.1.2 Value Engineering Study

In July 2002, Reclamation sponsored a Value Engineering Study to identify alternatives that would satisfy essential functions at the highest value (Reclamation, 2002b). The study team included biologists, engineers, and maintenance experts from Reclamation, the irrigation district manager, the Service's Pallid Sturgeon Recovery team leader, and a fisheries professor representing MFWP. The team used the Concept I Report (Mefford et al. 2000) as a baseline proposal for the study.

The team defined critical functions, criteria for those functions, and associated costs of various options. Using brainstorming techniques, they suggested alternative ideas to perform those functions at a lower cost or an increase in long-term value. The team evaluated, analyzed, and prioritized these ideas to develop the best for comparison. The results were summarized in the 2002 Value Engineering Study (Reclamation, 2002b). During the next step, decision-makers from Reclamation's Montana Area Office and the Reclamation's Technical Service Center examined each of the proposals in the 2002 Value Engineering Study and identified alternatives for further evaluation (Reclamation 2004).

2.2.1.3 Value Planning Study

After execution of an MOU in 2005, the MOU partner agencies, along with the irrigation districts, conducted a Value Planning Study to explore various ways to improve fish passage for the Intake Project. The Value Planning Study used the Value Method to compare and contrast these ideas to identify the options with the highest value (Reclamation 2005).

The Value Planning Study process followed a structured approach critically examining Reclamation's originally proposed rock fishway alternative to understand features, costs, and performance characteristics. It also identified desirable functions to compare with other alternatives. The value planning study group brainstormed alternative solutions that would perform these functions at a lower cost or with an increase in long-term value. Brainstorming produced 110 ideas that initially were screened to remove duplicative or technically infeasible alternatives, as well as those beyond the scope of value planning.

The Value Planning Study (Reclamation 2005) recommended that the Long, Low-Gradient Channel Alternative, Rock Ramp Alternative, Remove Dam and Build Single Pumping station Alternative and the Widen Fishway Alternative be carried forward for further consideration. The Remove Dam and Move Diversion Upstream Alternative, Multiple Pumping Stations Alternative, and Collapsible Gates Alternative also were identified for further study. Finally, the study concluded that the Island, L-Shaped Dam 6,600 Feet, and the L-Shaped Dam 20,000 Feet alternatives be eliminated from further consideration, because these alternatives had the lowest scores.

2.2.1.4 Biological Review Team

After the Lower Yellowstone River Intake Dam Fish Passage and Screening Preliminary Design Report (Corps 2006) was completed, the Service formed a team of pallid sturgeon experts, called the Biological Review Team (BRT). The team held an initial meeting on August 17 and 18, 2006, to review the preliminary alternatives. The BRT recommended specific design considerations to improve the probability of successful pallid sturgeon passage and entrainment protection at Intake (Jordan 2006). These recommendations included:

- An improved trashrack
- Increasing the elevation of intakes
- Applying National Marine Fisheries' standards for salmonid screening to screen design
- Further study on larval impingement survival
- Non-step rock fishway design modeled after existing Yellowstone River riffles
- Model of 0.5%, 0.75% and 1.0% non-step ramps
- Development of a physical model to evaluate depths and velocities
- Ramp design to allow fish to avoid headworks
- Remove the Relocate Diversion Upstream Alternative

The team convened again on February 12, 2008, to evaluate the fish screen options being developed for the proposed Intake Project. The team recommended the following (Jordan 2008):

- Screen design should include approach velocities of 0.4 feet per second based on White and Mefford (2002)
- In-canal screen with new trashrack (Cha et al. 2008) has potential
- In-channel screen would be preferable over an in-canal screen
- Sluiceway options require additional detailed study on sediment load and transport analysis to more accurately estimate the amount of water and size of sluiceway required to reduce sediment concerns.

A third meeting on February 17 – 18, 2009, reviewed the action alternatives and developed a method to score alternatives on a relative scale to incorporate biological input. The report (Jordan 2009) offered recommendations for improvement of the alternatives, raised specific concerns, and documented questions about the alternatives.

2.2.2 2010 NEPA EA

Five fish passage alternatives and two fish screen options were initially identified for further analysis in the 2010 EA based on previous studies of the Lower Yellowstone Project. These were presented in the public scoping meetings held in October 2008. Using scoping input from cooperating agencies and the public, these alternatives were screened through criteria and modified into the three alternatives evaluated in the Final EA. These were:

- Rock Ramp Alternative
- Relocate Main Channel Alternative
- Removable Rotating Drum Screen Option.

Proposed modifications for entrainment protection and fish passage were described and analyzed in the April 2010 Final Environmental Assessment¹ (hereafter referred to as the 2010 EA). In the April 26, 2010 Finding of No Significant Impact² (2010 FONSI), Reclamation and the Corps made a joint finding that an Environmental Impact Statement (EIS) was not required for the

proposed project and decided to implement the proposed action to reduce entrainment and improve fish passage. The selected alternative to improve fish passage was the rock ramp alternative. In addition, installation of fish screens and new Main Canal headworks was chosen as the preferred alternative to reduce entrainment.

The modifications to reduce entrainment, construction of the new Main Canal headworks and installation of fish screens, began in October 2010 and have been completed. Irrigation deliveries using the new headworks began in April 2012. The second part of the proposed dam modifications to provide fish passage by installing a rock ramp was then reevaluated by the lead agencies, in coordination with the Service, Montana Fish, Wildlife and Parks (MFWP), Montana Department of Natural Resource Conservation, Montana Department of Environmental Quality, and the District.

2.2.2.1 2010 Environmental Assessment NEPA Scoping

Public scoping meetings were held during October 2008 to invite public comment on the No Action Alternative, four fish passage alternatives, and two fish screen options identified during previous planning studies, identify issues related to them, and collect ideas about other alternatives not previously investigated (Reclamation and the Corps 2009). A number of commenters suggested revisions to the alternatives as well as several new alternatives (Reclamation and the Corps 2009).

After the public scoping meetings, alternative screening criteria based upon Council on Environmental Quality guidelines (40 CFR 1500-1508), legal mandates, and previous Intake Project studies were developed to formulate alternatives for detailed study, and to identify alternatives (or features of alternatives) to be eliminated.

2.2.2.2 Alternatives Eliminated After Initial EA Scoping in 2008

In response to public comment, all of the fish passage alternatives were revised and several were eliminated, as explained in this section. One previously eliminated alternative was identified as worthy of reconsideration: the Multiple Pump Alternative described in the next section. Table 2-2 shows the disposition of the alternatives and screen options disclosed during the initial scoping in October 2008. After preliminary analysis some of these appraisal-level alternatives and features were eliminated from detailed study using screening criteria.

TABLE 2-2. DRAFT EA (2010) ALTERNATIVES AND THEIR DISPOSITION

	Alternative	Disposition
1.	No Action	Evaluated in detail as the No Action Alternative, as required by NEPA.
2.	Rock Ramp	Evaluated in detail as the Rock Ramp Alternative.
3.	Relocate Diversion Upstream	Eliminated from detailed study. Further hydraulic analysis determined that a diversion weir with rock ramp would be required to provide sufficient head for reliable diversion of water under low flow.
4.	Relocate Main Channel	Evaluated in detail as the Relocate Main Channel Alternative.
5.	Single Pumping Station	Eliminated from detailed study. Further hydraulic analysis determined that a diversion weir with rock ramp would be required to provide sufficient head for reliable diversion of water under low flow.

	Alternative	Disposition
6.	Multiple Pumping Stations	Conceptual design developed in response to public scoping, but eliminated from detailed study because of reliability and entrainment concerns and construction and O&M costs.
7.	Removable Rotating Cylindrical Screens	Evaluated in detail as Removable Rotating Drum Screen Option.
8.	V-Shaped Screen	Eliminated from detailed study. Further evaluation required modification to include an in-river trashrack. This alternative is duplicative of the Removable Rotating Drum Screen Option. Both screen options would perform the same function, but the V-Shaped Screen with the trashrack would be more expensive to construct and maintain and would expose juvenile fish to an unnatural environment for a longer duration than the other screen option.

2.2.3 Alternatives Considered During 2013 Planning Studies

A rock ramp was originally proposed in the 2010 EA as a fish passage alternative. This alternative was favored by cooperating entities as the most likely option considered to improve fish passage at Intake. However, due to constructability, maintenance, cost concerns, and new information about pallid sturgeon passage capabilities, the lead agencies believed it was necessary to re-consider other options, and preliminary design work was started on a bypass channel alternative—an alternative considered but not analyzed in detail in the 2010 EA. The bypass channel alternative included a river-wide concrete weir designed to provide adequate water surface elevations for delivery of irrigation water through the newly completed headworks. Construction of a new concrete weir would eliminate the need to repeatedly place rock along the crest of the existing diversion structure to maintain necessary head requirements caused by additional head needed for screening requirements. The preliminary cost estimate of the bypass channel alternative was about \$59 million.

Due to concerns raised by stakeholders and cooperating entities about the bypass channel, a new planning effort was initiated that brought the original cooperating entities (Corps; Service; the state; the irrigation districts) together to revisit the alternatives that had been previously identified along with potential new alternatives for fish passage at the Intake Diversion Dam. The planning effort started with a meeting on June 20, 2013 and continued into September 2013. This planning effort is described in detail in Appendix A1 of (Corps and Reclamation, 2015).

2.2.4 2015 Final Supplement to the 2010 Environmental Assessment

The 2013 Planning Studies were completed in early September 2013. This collaborative planning effort identified the original Bypass Channel Design, with modification, as the acceptable and implementable fish passage alternative to advance. A supplemental EA was initiated to address the new fish passage alternatives. Construction of the headworks with fish screen alternative from the 2010 EA proceeded and was completed in 2012.

During preparation of the Supplemental EA, input was gathered from the cooperating agencies on potential alternatives. All fish passage alternatives that were previously evaluated were reviewed and reconsidered. These alternatives were screened through the criteria and three alternatives were included in the Supplemental EA: No Action, Bypass Channel and Rock Ramp.

The Supplemental EA was prepared to explain and address the changes, and includes new or updated information related to improving fish passage at the Intake Diversion Dam. It described and disclosed the changes in potential effects that could result from other alternatives that were considered to improve fish passage.

The alternatives evaluated in the Supplemental EA were:

- **No Action (Continue Present Operation)**—Under this alternative, Reclamation would continue present operation of the dam and headworks to divert water from the Yellowstone River for irrigation purposes, as authorized. This means operating the irrigation project without any modifications to provide fish passage alternatives until Reclamation completes required ESA consultation activities with the Service and implements any ESA requirements regarding fish passage resulting from that consultation. The Corps has completed construction of a new headworks and fish screens for entrainment protection, which is in operation. Reclamation completed consultation with the Service on operation of the system in March 2012.
- **Bypass Channel**—the primary feature of this alternative would be constructing a bypass channel from the inlet of the existing side channel to just downstream of the Intake Diversion Dam and boulder field. It would also replace Intake Diversion Dam with a concrete weir to raise the surface elevation of the river in front of the new headworks for diversion into the Main Canal. The bypass channel would improve fish passage and contribute to ecosystem restoration.
- **Rock Ramp**—the primary features of this alternative would be replacing the Intake Diversion Dam with a concrete weir, boulder, and cobble rock ramp. This would raise the surface elevation of the river upstream of the replacement weir for diversion into the Main Canal, while improving fish passage and contributing to ecosystem restoration.

For ecosystem restoration projects, benefits are typically non-monetized, but project outcomes can be quantified in terms of habitat units. The objective of the Intake Diversion Dam Fish Passage Project is to provide fish passage and entrainment protection to endangered pallid sturgeon. Providing fish passage would reconnect access to up to 165 river miles of habitat for spawning and recruitment of pallid sturgeon, which may assist in the recovery of a self-sustaining population.

To assist with evaluation of alternatives, the Service again called on the BRT to provide input to the process. According to the BRT, both action alternatives meet the objective of passage based on anticipated hydraulic performance compared against desirable depth and velocity criteria that meet the needs of pallid sturgeon.

The Corps used Cost Effectiveness/Incremental Cost Analysis (CE/ICA) to evaluate the effectiveness and efficiency of the alternatives at producing environmental outputs. In summary, the Bypass Channel Alternative would provide 7,469 habitat units, for an incremental cost of approximately \$319, while the Rock Ramp Alternative would provide 7,649 habitat units for an incremental cost of approximately \$8,597. Considering the steep increase in incremental cost to achieve a slightly higher level of habitat unit outputs, the Bypass Channel was selected as the preferred alternative.

2.3 Alternatives Considered in This EIS

Six alternatives are included in this EIS; No Action, Rock Ramp, Bypass Channel, Modified Side Channel, Multiple Pump, and Multiple Pumps with Conservation Measures. This section describes those alternatives in detail.

2.3.1 Alternatives proposed in scoping

During scoping the following four alternatives were proposed, reasons that they were eliminated from detailed evaluation is described below.

Montana Trout Unlimited Alternative- This alternative proposed several measures that would include removal of the existing dam. This would include 1) using gravity flow into the existing headworks when river flow allows; 2) using pumps, either in the river or in the alluvium, during period of low flows; 3) reducing diversion volumes by investing in conservation measures in the canal, at turnouts, and in laterals (lining, piping, possibly sprinkler conversion, improving headgate efficiency, etc.); 4) employing groundwater pumps in appropriate locations within the irrigation project area, as a backup as necessary; 5) providing power for pumps using a wind generator, or, if feasible, low-head hydro in the Main Canals; and 6) if power cannot be produced on site, establish a trust fund dedicated to purchasing power, and possibly fund operation and maintenance for the pump system.

This alternative is similar to the Multiple Pumping with Conservation Measures Alternative with exception of two components: 1) low-head hydropower in the Main Canals; and 2) establish a trust fund dedicated to purchasing power, etc. Low head hydropower was evaluated by Reclamation in a previous study (Reclamation, 2012). That study identified a potential capacity of 275 Kw could be developed on the LYP canal. This is a fraction of the power that pumps would require to provide water for irrigation. While not a reason for eliminating or not further considering the alternative, Congressional action would be necessary to establish such a trust fund and provide instruction as to how the trust would be funded and managed.

Bypass Channel- This proposed alternative includes a bypass channel just south of the existing dam that would be approximately 100 feet wide, about 2,000 feet long and with various flow restrictions for sturgeon rest areas as natural flows. This is similar to the Bypass Channel alternative that has been considered in detail although a different configuration and size that would likely have a much steeper slope and shallower depths, that may not be able to meet the Service's BRT physical criteria for depths and velocities.

Sturgeon Relocation and Study- This alternative proposed to have the MFWP relocate all the sturgeon that they catch below the dam to above the dam each year during their annual survey and undertake a ten-year study to see if the numbers increase or decrease. This alternative of catching and trucking fish upstream was considered in a previous Value Planning Study (Reclamation, 2005) and the alternative was found to be infeasible as it is very difficult to capture large numbers of sturgeon during high flows and sturgeon could be adversely affected by trapping and transporting them, which could cause them to migrate back downstream and not spawn. This proposal is similar to that alternative which was found to be infeasible. A ten year

relocation study does not meet the purpose and need of providing fish passage, therefore this alternative was dismissed from further consideration.

Relocate Diversion Upstream- One commenter proposed to move the point of diversion for the canal upstream far enough to allow diversions of water into the canal without a weir. The water delivery canal with inlet and outlet gates, constructed parallel to the BNSF railroad, could also provide flood control to the 100-year level for the railroad and the screen structures. The removal of the Intake Diversion Dam would then provide a natural river for fish migration. The rocks removed from the weir could be used as stream bank protection for the new canal.

This alternative is similar to the “Relocated Diversion Upstream Alternative” that was proposed and eliminated in both the 2015 Supplemental EA and the 2010 Environmental Assessment. Hydraulic modeling that was conducted at the time found that it would be technically infeasible without constructing a weir at the upstream diversion location to raise and divert water during low flows. This proposal would also require a new weir constructed upstream, and therefore as constructing a new weir upstream would still not address fish passage; this alternative was eliminated from further consideration.

2.3.2 Elements Common to All Alternatives

2.3.2.1 Water Conservation Measures

Water conservation measures would be implemented under all alternatives. Water conservation measures for irrigation projects include activities such as piping and lining laterals and canals, installing check structures and installing flow measuring devices. The LYIP has routinely implemented water conservation measures over time to improve the efficiency of the Lower Yellowstone Project in an effort to address water deficiencies, improve operations, and conserve water. Under the No Action Alternative, this activity is expected to continue for the same reasons. For all action alternatives, a new or amended operation and maintenance (O&M) transfer agreement would be executed between LYIP and Reclamation that includes mandatory water conservation terms and conditions. For all action alternatives except the Multiple Pumping Station with Conservation Measures Alternative, implementation of water conservation measures would be expected to be implemented at a rate similar to past practice and the No Action Alternative. The specific measures and location would be determined in the future, and if a federal nexus exists, additional NEPA compliance may be necessary. The Multiple Pumping Station with Conservation Measures Alternative proposes to accelerate and implement conservation measures at a much greater rate compared to other alternatives (see section 2.3.8 for details).

2.3.2.2 Operation, Maintenance and Replacement (OM&R) of Certain Facilities

OM&R of certain facilities is expected to be similar under all alternatives, with the exception of the Multiple Pumping Station with Conservation Measures Alternative where OM&R would change as a result of redesign of much of the Lower Yellowstone water conveyance system. Facilities where OM&R is expected to be similar for the remainder of the alternatives include canal headworks structure, four primary pumping stations (including the Intake and Savage pumping stations), five supplemental river pumps, 79 miles of Main Canal, approximately 234 miles of laterals, 118 miles of open drains, and over 2,500 water control structures. Electric

pumping power service to five of the pumping stations is supplied by the Pick-Sloan Missouri Basin Program.

Fish screen operations include lowering them into place for the irrigation season, and daily and seasonal adjustments to headwork gate in response to flow conditions and crop requirements, and conveyance of diverted water through canals, laterals, and drains. Diversions generally occur between mid-April and mid-October, and include diversion of up to 1,374 cfs. Operations also include raising fish screens when water is not being diverted in order to minimize risk of damage.

Maintenance activities would include maintenance of the headworks screens and gates, maintenance and inspection of the canal and laterals, maintenance of associated access roads and weed control. Typical screen and headworks maintenance would include monitoring and repairing of fish screen and diversion gates.

The LYIP is responsible for Intake Diversion Dam, headworks and canal OM&R costs consistent with the authorizing legislation (Reclamation Act of June 17, 1902, as amended; Water Conservation and Utilization Act of August 11, 1939, as amended); the current O&M transfer agreement between Reclamation and the LYIP, and Reclamation policy.

2.3.2.3 Pick Sloan Missouri River Basin Program Power

Reclamation has authority under the Reclamation Act and the Act of December 22, 1944 (Flood Control Act) to create and amend contracts for project use power between the United States of America and an irrigation district. Project use power contracts can be modified to increase the Contract Rate of Delivery (CROD) of power when it is in the interest of the United States and to better serve the needs of the irrigation district due to modifications in project facilities or operations and for irrigation of authorized project lands.

In general, the CROD shall be the amount of power necessary to sufficiently lift project water to provide irrigation service by gravity to authorized and classified project lands. CROD increases will not be authorized for pressurizing pipes or sprinkler systems, for pumping non-project water, or for water conservation (citation). CROD increases will not be authorized to deliver power to privately-owned pumps. The pumps must be owned by Reclamation.

Reclamation and the four Lower Yellowstone Project irrigation districts have power contracts that authorize a specific CROD for power used by existing pumps. Power supplied under these contracts is at a reduced rate compared to purchasing power from a local electrical power supplier. If the LYIP wants additional power at the reduced rate, they would need to make a request to Reclamation, who would need to determine if the increase is appropriate. If approved, LYIP would pay a kilowatt hourly rate of 16.17 mills. Additionally, the LYIP may be responsible to pay up to \$1,047.47 per kilowatt, which is the current rate for the power investment costs.

2.3.2.4 Ongoing Lower Yellowstone Project Activities

Other ongoing activities and agreements will include:

- Continued project use power contracts between Reclamation and four irrigation districts within the Lower Yellowstone Project for reduced cost power for lifting project water to

provide irrigation service by gravity to authorized and classified project lands within the boundary of the Districts.

- Continued water service contracts with four irrigation districts within the Lower Yellowstone Project.
- Continued irrigation of authorized project lands by private landowners.
- Continued management of Reclamation owned lands and associated resources.

2.3.3 No Action

The No Action Alternative is continued operation, maintenance, and rehabilitation of the Lower Yellowstone Project as authorized. This No Action Alternative provides a baseline from which to measure benefits and impacts of implementing fish passage improvement alternatives considered in this document.

Commenters indicated the No Action Alternative should not be defined as continuation of present operations, because they claim present operations violate the ESA. Under no action, if the alternative were ultimately selected, Reclamation believes they would need to consult with the Service on the effects of continued operation and maintenance of the Lower Yellowstone Project pursuant to section 7(a)(2) of the ESA. The outcome of that consultation is unknown and any presumptions about the outcome are speculative. Reclamation's understanding is that once consultation is initiated, continued operation and maintenance of the Lower Yellowstone Project would be consistent with section 7(d) of the ESA. For these reasons, the No Action Alternative has been defined as continued operation and maintenance of the Lower Yellowstone Project. Any specific outcomes of future consultation for the No Action Alternative are not reasonably foreseeable at this time.

Commenters also suggested that no action should not include rock placement on the Intake Diversion Dam, which they claim would result in pallid sturgeon passage. Present operations include the routine placement of rock on top of the Intake Diversion Dam. If future rock placement were halted, the preexisting rock on top of the weir would likely be removed by ice and high flows in the short-term, but the underlying timber crib structure would remain in place and continue to impede pallid sturgeon fish passage at current rates for an extended period, likely several decades. Thus, for purposes of establishing a baseline for upstream passage of pallid sturgeon, an alternative in which no rocking is performed is virtually indistinguishable from an alternative in which present operations continue.

2.3.3.1 Existing Dam and Facilities

The Intake Diversion Dam is a rock filled timber crib structure that was constructed between 1905-1911. About 1/3 of the timber deck was replaced with new timbers and metal straps in the 1970's (Corps and Reclamation, 2010). The trolley system is old and there is continual risk of failure, which would require repair /replacement by the LYIP in order to maintain required water surface elevations. The Intake Diversion Dam and screened headworks (Figure 2-1) are likely to continue to provide reliable water delivery to the Main Canal and irrigation districts into the future with ongoing maintenance.



Figure 2-1. New Headworks and Fish Screens at Intake Diversion Dam

2.3.3.2 Operation & Maintenance

The primary features of this alternative (Figure 2-2) include the continued OM&R of the existing Intake Diversion Dam and the new screened headworks by the LYIP, as Reclamation's authorized agent under the operation and maintenance (O&M) transfer agreements and repayment contracts.



Figure 2-2 No Action Alternative with New Headworks, Intake Diversion Dam and Existing Boulder Field

Dam maintenance requires the periodic placement of 1-2 feet of rock on the crest of the dam, using the existing cableway, to replace rock moved by ice and high-flow events. The volume of rock placed annually has varied between 500 and 7,000 tons depending on river events, high water, and ice movement, and has averaged about 2,500 tons. Typically, rock is placed in late July or early August during seasonal low flow. Rock is quarried from private land about two miles southeast of the Intake Diversion Dam and hauled and stockpiled near the right abutment on Joe's Island. The rock is stockpiled with a loader, dumped into a skid, and hauled to the river and dumped in the river by the overhead trolley cableway.

The operation and maintenance transfer agreement with the four irrigation districts within the Lower Yellowstone Project would remain in effect. It is assumed that Reclamation will enter into Section 7 Consultation with the Service for continued OM&R of the Lower Yellowstone Project. The Corps will continue Section 7 consultation with the Service on the Missouri River. Reclamation completed larval and juvenile fish monitoring at the headworks in 2012-2014. It is assumed that monitoring will continue.

Previous issues with fish mortality resulting from being entrained by the headworks into the Main Canal have been substantially reduced by the replacement of the headworks and the installation of the new fish screens. Fish screens designed to prevent entrainment of most fish larger than 40 mm were installed in 2011. Monitoring data from 2012-2014 has indicated that entrainment is still occurring, but at significantly reduced rates, and based on the first report from

2012 the numbers of fish entrained may be more correlated to the volume of water in the river than the presence of the screens (Horn and Trimpe 2012). There does appear to have been a change in the species composition and size of entrained fish in 2012 with 99 percent of the larval fish captured in the canal belonging to the Cyprinidae and Catostomidae families (predominantly minnows and carp) and typically in the 4-8 mm size range (Horn and Trimpe 2012). Raw data from 2013 and 2014 monitoring indicates similar results as in 2012.

The annual estimated OM&R cost of No Action is \$2,643,043. Table 2-3 summarizes the costs used in developing this estimate. The presented annual cost accounts for the frequency that OM&R activities are expected to occur over a 50 year period. OM&R costs over the period are converted to present values using the FY 16 (3.125-percent) federal discount rate. Annual costs include the ongoing operation and maintenance of LYP canals, laterals, drains, pumps, Intake Diversion Dam (including rocking), and screened headworks. The rehabilitation of the trolley is assumed to occur in the next 10 years, and again in 30 years. Power costs assumed amounts and rates consistent with existing project power use contracts with the four irrigation districts. Monitoring costs are assumed to be incurred for 8 years. Additional detail on OM&R estimates is found in Appendix B Cost Engineering.

TABLE 2-3 SUMMARY OF O&M COSTS FOR NO ACTION

O&M Item Description	Annualized Cost ¹
Main Canal, Laterals, Drains	
Main Canal, Laterals, Drains	\$1,875,000
Headworks	
Sediment Removal	\$10,000
Daily Operations	\$77,000
Fish Screen Manifolds	\$55,041
Fish Screen Cylinder Units	\$32,377
Fish Screen External Brushes	\$45,092
Fish Screen Internal Brushes	\$45,092
Fish Screen Seal System	\$10,408
Diversion Dam	
Diversion Dam Maintenance	\$77,000
Rocking Structure	
Trolley Rehab	\$4,812
Cable Replacement	\$4,074
Pumps	
Existing Pumps	\$235,000
Admin. Costs	
Administrative/Indirect Costs	\$61,000
ESA Monitoring Costs²	
Passage and Entrainment Monitoring	\$111,147
Total Annual O&M	\$2,643,043
<small>1. Annual O&M is based on 50-year period of analysis and 3.125% Federal discount rate 2. Reclamation is committed to monitoring the effectiveness of the project, consistent with the outcome of Endangered Species Act consultation. Funding sources for these monitoring activities will be determined based on Reclamation Law, Policy, and availability of funding.</small>	

2.3.4 Rock Ramp

The Rock Ramp Alternative would replace the existing rock-and-timber crib structure at the Intake Diversion Dam with a concrete weir and a shallow-sloped, well graded angular rip-rap. The rock ramp would be designed to mimic natural river function and would have reduced velocities and turbulence so that migrating fish could pass over the weir, thereby improving fish passage and contributing to ecosystem restoration.

The replacement concrete weir would be located downstream of the new headworks and approximately 40 feet upstream of the Intake Diversion Dam, to create sufficient water height to divert 1,374 cfs into the Main Canal. This concrete weir would replace the existing timber and rock-filled dam providing long-term durability lacking in the current structure. The replacement weir would be constructed as a cast-in-place reinforced concrete wedge spanning the entire width of the Yellowstone River channel. The upstream, sloping face of the concrete weir would be designed to withstand damage from blocks of ice moving over the dam in the spring. The historic headworks have been preserved in place and would serve as a weir abutment on the north (left) bank of the river, while a new concrete weir abutment would be constructed on the south (right) bank at the lateral extent of the replacement weir. It would anchor into the adjacent bank.

The replacement weir crest would vary in elevation, including at least one low-flow channel for fish passage. The variable crest would offer an array of depth-velocity habitat zones for fish migration under a wide range of flows, which are typical on the lower Yellowstone River. The channels in the replacement weir crest would be designed to provide fish passage during late summer and early fall low flows and would be approximately 1 to 2 feet deep. The downstream side of the replacement weir would tie directly into the rock ramp to provide a seamless transition and unimpeded fish passage as fish migrate upstream and downstream.

A rock ramp would be constructed downstream of the replacement weir by placing rock and fill material in the river channel to shape the ramp, followed by placement of rock riprap. The ramp would be constructed to provide flow characteristics consistent with BRT criteria for pallid sturgeon, so the endangered fish would have improved access to habitat upstream of the replacement weir. Figure 2-3 summarizes the features of the Rock Ramp Alternative.

The rock ramp would have a low flow channel and notch through the replacement weir that would facilitate passage of protected fish species upstream and over the newly constructed Intake Diversion Dam. The rock ramp does not always meet the Service's BRT criteria of ≤ 4 feet/second when flows are higher than 30,000 cfs. At low flows of 7,000 cfs and below, the depths are not always sufficient to meet the criteria (≥ 0.5 meters [1.6 feet]). Specifically for pallid sturgeon, the rock ramp also would not have any resting pools or low velocity areas in the primary channel and it may have turbulent flows, thus potentially presenting a passageway that only younger, more vigorous fish would use. However, it is anticipated that many of the pallid sturgeon that approach the dam might use the rock ramp for passage.

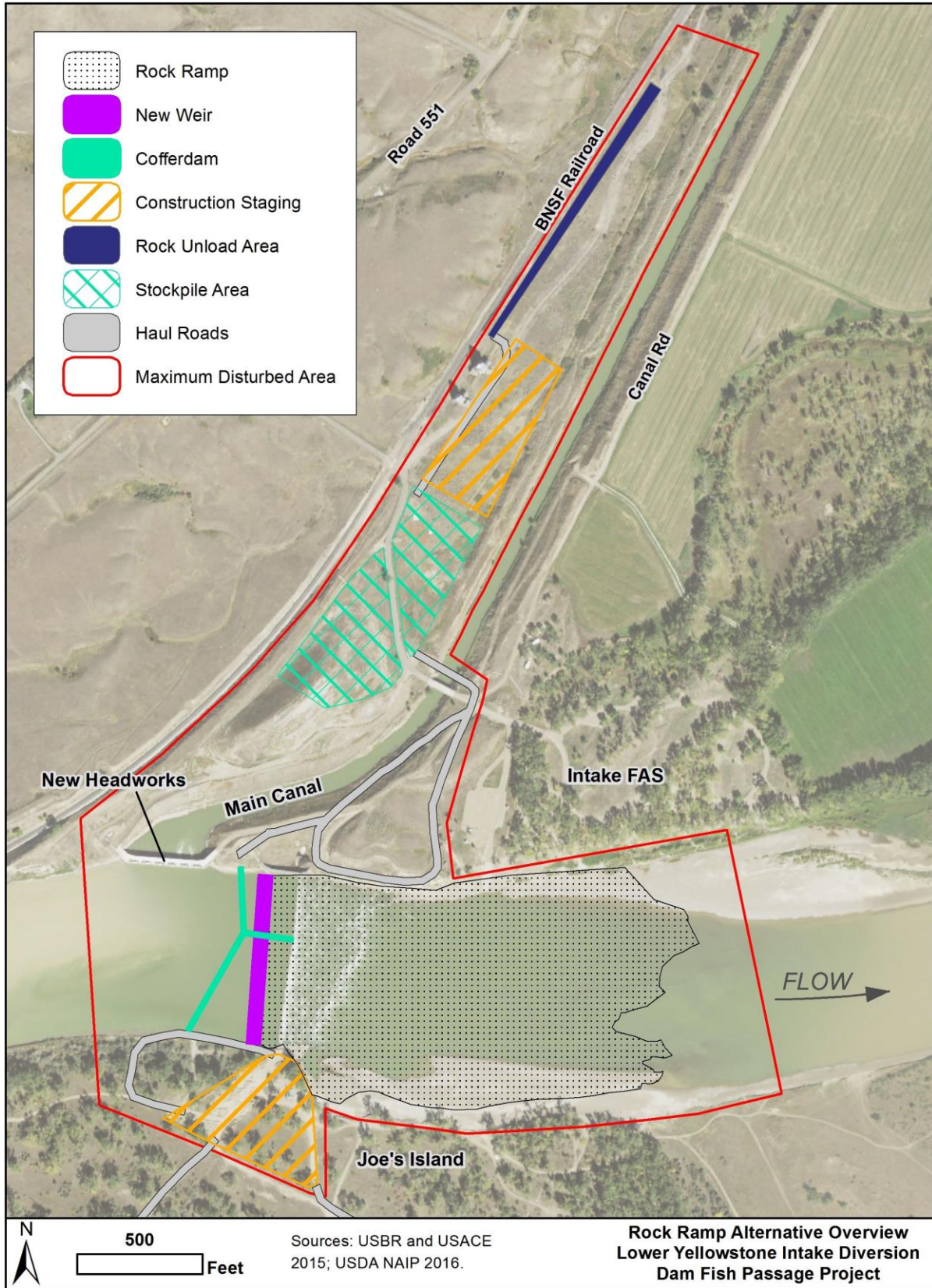

Figure 2-3. Rock Ramp Alternative

The new rock ramp would be constructed over the site of Intake Diversion Dam, preserving most of the historic dam in place. Because the existing dam's boulder field has washed downstream, part of the existing dam crest might be removed and rock moved to accommodate construction of a ramp. The rock ramp would include at least one low flow channel in conjunction with the low flow channel on the crest, which would allow fish migration during low flows.

Because pallid sturgeon are sensitive to flow velocities and turbulence, the rock ramp would be constructed to be relatively flat (approximately 0.4-percent slope) over much of its width to keep flow velocities as low as possible. For comparison purposes, the natural slope of the lower Yellowstone River varies, but typically ranges from 0.04 percent to 0.07 percent. The rock ramp design is very long (1,600 feet) in order to provide for a shallower slope necessary to reduce velocities. The relatively flat slope of the rock ramp would result in lower velocities and greater depth than that over the existing dam, and would likely improve fish passage over current conditions. The rock ramp would function as a long riffle, allowing passage and providing foraging and spawning habitat for a variety of fish species.

The final configuration of the rock ramp would be optimized for pallid sturgeon passage with additional computer modeling. If this alternative were selected, the Service BRT would be consulted during design, including but not limited to reviewing results and making recommendations on hydraulic modeling and final alternative design.

The rocks in the ramp would be sized to resist high flows and ice jams and would range from 1 to 4 feet in diameter. Approximately 450,000 tons of rock riprap and 75,000 tons of fill material would be needed to construct the ramp. Rock would be purchased from existing commercial quarries. Based on rock requirements, rock will need to be purchased from quarries in Wyoming or Minnesota and delivered to Glendive by train before being trucked to Intake. Staging and rock stockpile areas would be located downstream of the headworks on the left bank of the Main Canal which would be accessible by road or rail, and a construction zone would be located on the Joe's Island side of the dam. Haul roads would be provided across Joe's Island to provide access to the road toward Glendive.

A temporary crossing would be constructed across the Main Canal to prevent damage to the existing county bridge from heavy equipment use. The new crossing would use six, 10-foot by 10-foot box culverts with sufficient width and length to bridge the existing canal. More detailed description of the Rock Ramp design is found in the 2015 Supplemental Environmental Assessment and Appendices (Corps 2015d).

2.3.4.1 Construction

Depending on appropriation, it is anticipated that the overall construction would take two years and be conducted in three primary phases. During the first phase, a replacement weir would be constructed on the south half of the river using similar methods to placement of the weir in the Bypass Channel Alternative. In phase two, a cofferdam would be constructed extending from the old headworks, across the end of the replacement weir and return to the north bank below the area of rock ramp placement to allow construction to occur in the dry. After the north half of the replacement weir is in place, rock ramp construction would begin working from the north bank across the river in parallel segments. Construction of the remainder of the rock ramp would be

the final phase of this alternative. It would be completed by working incrementally across the river from the north bank building sections of the ramp.

2.3.4.2 Operation & Maintenance

For major O&M actions on the replacement weir and rock ramp, temporary access would need to be built, work would have to be done when the existing high-flow side channel is iced-over or dry, or equipment would need to be brought in by way of boat or barge. It has not been determined how access to, and on, the replacement weir structure will be achieved for O&M activities. If vehicular access across the replacement weir structure cannot be safely achieved, the existing trolley system may be repaired, a new trolley system constructed, or access provided by a barge.

Reclamation and the Board of Control would most likely need to amend the existing O&M transfer contract to address operation and maintenance of the new headworks and rock ramp consistent with the authorizing legislation (Reclamation Act of June 17, 1902, as amended; Water Conservation and Utilization Act of August 11, 1939, as amended) and Reclamation policy. Funding responsibility for O&M, monitoring, and any necessary adaptive management measures would depend on a number of factors including applicable laws, regulations, and policies. Reclamation intends to work cooperatively with the state of Montana to identify funding resources for monitoring and adaptive management, as appropriate.

Annual OM&R costs for this alternative are estimated as \$2,840,028. The presented annual cost accounts for the frequency that OM&R activities are expected to occur over a 50 year period. OM&R costs over the period are converted to present values using the FY16 (3.125-percent) federal discount rate. Table 2-4 summarizes the costs and assumptions included in the estimate. Additional detail on OM&R estimates is found in Appendix B Cost Engineering.

TABLE 2-4. SUMMARY OF O&M COSTS FOR ROCK RAMP

O&M Item Description	Annualized Cost ¹
Main Canal, Laterals, Drains	
Main Canal, Laterals, Drains	\$1,875,000
Headworks	
Sediment Removal	\$10,000
Daily Operations	\$77,000
Fish Screen Manifolds	\$55,041
Fish Screen Cylinder Units	\$32,377
Fish Screen External Brushes	\$45,092
Fish Screen Internal Brushes	\$45,092
Fish Screen Seal System	\$10,408
Diversion Dam	
Diversion Dam Maintenance	\$10,000
Rock Ramp	
Minor Rock Repairs	\$128,000
Place Rock (Major Repair)	\$21,682

Coffer Dam (Major Repair)	\$86,730
Barge Cost (Major Repair)	\$8,673
Pumps	
Existing Pumps	\$235,000
Admin. Costs	
Administrative/Indirect Costs	\$61,000
ESA Monitoring Costs²	
Passage and Entrainment Monitoring	\$138,934
Total Annual O&M	\$2,840,028
1. Annual O&M is based on 50-year period of analysis and 3.125% Federal discount rate 2. Reclamation is committed to monitoring the effectiveness of the project, consistent with the outcome of Endangered Species Act consultation. Funding sources for these monitoring activities will be determined based on Reclamation Law, Policy, and availability of funding.	

2.3.5 Bypass Channel

This alternative is intended to improve passage (both upstream and downstream) for pallid sturgeon around the Intake Diversion Dam by means of a bypass channel. The alternative includes constructing a bypass channel on Joe’s Island from the inlet of the existing side channel to just downstream of the existing dam and boulder field. It would also replace Intake Diversion Dam with a concrete weir. Construction work and the primary elements of this alternative would be located mainly on Joe’s Island. This land was acquired by Reclamation during construction of the original Intake project. All construction, staging and disposal would occur on Reclamation-owned lands. The bypass channel alignment would require relocation of the historic south rocking tower and boiler building on Joe’s Island. Figure 2-4 summarizes the features of the Bypass Channel Alternative.

A concrete replacement weir would be constructed that would provide water surface elevations similar to no action conditions, which would be adequate for flow into the new bypass channel, ensuring delivery of irrigation water, eliminating concern as to whether continued displacement of rock from the crest of the dam by ice flows could adversely affect the downstream entrance to the bypass channel.. Construction of a replacement weir would eliminate the need to routinely place rock along the crest of the Intake Diversion Dam. While head requirements could theoretically be met through rock placement, a permanent structure provides more reliable flows into the bypass channel, reduces the amount of fill placed into the Yellowstone River, and eliminates concern as to whether continued displacement of rock from the crest of the dam by ice flows could adversely affect the downstream entrance to the bypass channel.

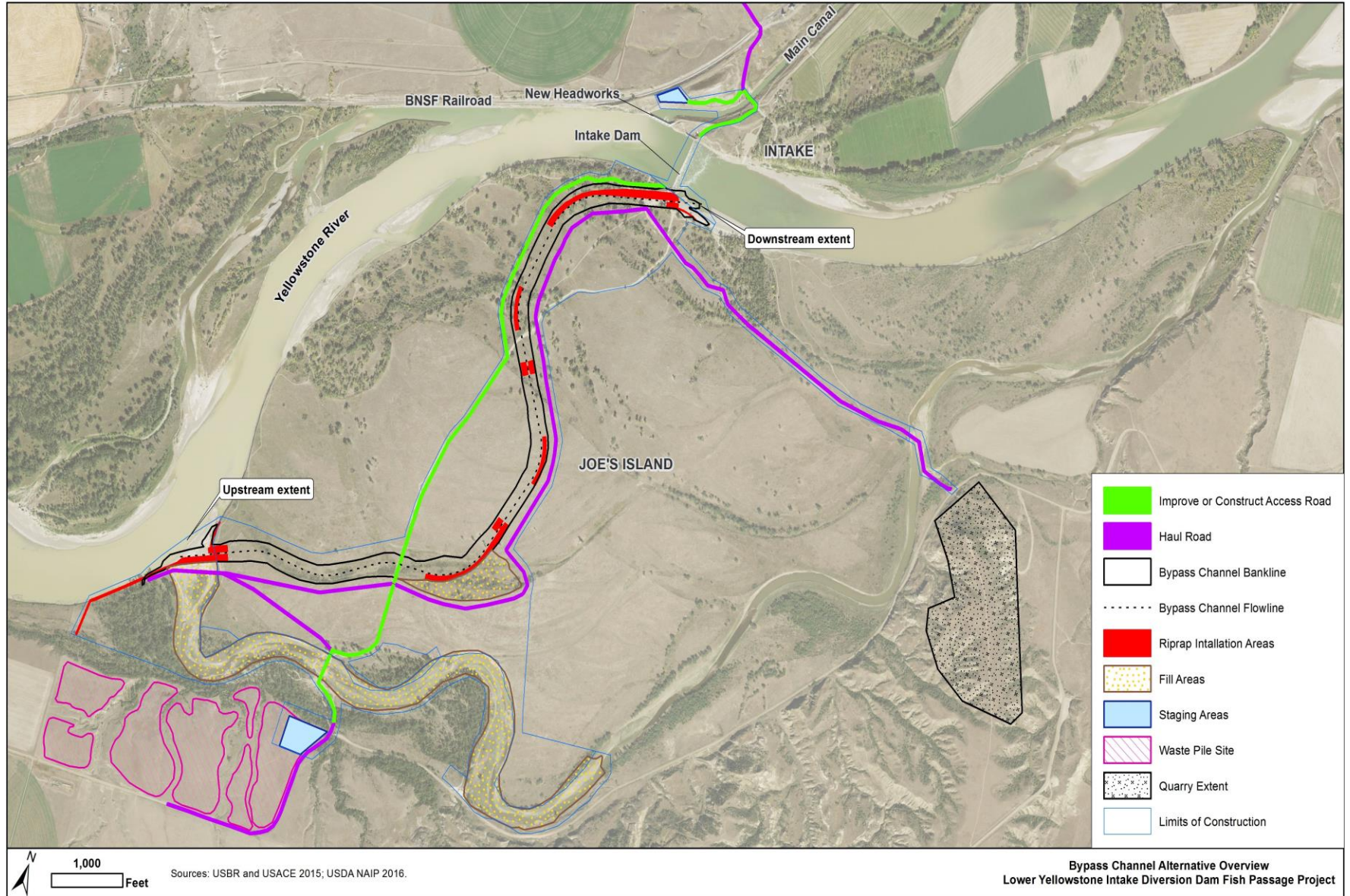

Figure 2-4. Bypass Channel Alternative Overview

2.3.5.1 Bypass Channel Features

The bypass channel would be designed to meet criteria developed by the Service’s Biological Review Team (BRT) to divert approximately 13 to 15 percent of total Yellowstone River flows. Table 2-5 summarizes the design criteria for the bypass channel. As shown in the table, the bypass will be designed for cross-sectional velocities between 2 and 6 fps and minimum depths of 4 to 6 feet, depending on the flow.

TABLE 2-5. BYPASS CHANNEL FLOW SPLITS DESIGN CRITERIA

	Discharge at Sidney, Montana USGS Gage: 7,000 – 14,999 cfs	Discharge at Sidney, Montana USGS Gage: 15,000 – 63,000 cfs
Bypass Channel Flow Split	≥ 12%	13% to ≥ 15%
Bypass Channel cross-sectional velocities (measured as mean column velocity)	2.0 – 6.0 fps	2.4 – 6.0 fps
Bypass Channel Depth (minimum cross-sectional depth for 30 contiguous feet at measured cross-section)	≥ 4.0 feet	≥ 6.0 feet
Bypass Channel Fish Entrance (measured as mean column velocity at HEC-RAS station 136)	2.0 – 6.0 fps	2.4 – 6.0 fps
Bypass Channel Fish Exit (measured as mean column velocity)	≤ 6.0 fps	≤ 6.0 fps

While the channel will typically divert 13 percent of the total flow from the main channel during typical spring and summer discharges, diversion percentages would vary from 10 percent at extreme low flows on the Yellowstone River to 18 percent at extreme high flows as shown in Table 2-6. The geometry of natural side channels on the Yellowstone River near Intake varies greatly. The geometry of the proposed bypass channel falls within the range of all parameters evaluated for observed natural side channels, including length, width, sinuosity, bend radius, and meander wavelength.

2.3.5.2 Construction

The excavation of the bypass channel would remove approximately 869,000 cubic yards of earthen material. The proposed bypass channel alignment extends approximately 11,150 feet in length at a slope of approximately 0.0007 feet/foot (natural Yellowstone River slope is approximately 0.0004 feet/foot to 0.0007 feet/foot). The channel cross section would have a bottom width of 40 feet, a top width of 150-250 feet, and side slopes varying from 1V:12H to 1V:3H.

Following completion of the rock structures, the remainder of the channel would be excavated and disposed of in one of three locations. The majority of the excavated material would likely be disposed of in the upstream portion of the existing side channel. Some material would likely be disposed of in the spoil area on the south side of the new channel. Additionally some material could be side cast on the left bank of the bypass channel to reduce the risk of sediment deposition in the bypass during large flood flows.

TABLE 2-6. ANALYSIS OF BYPASS CHANNEL FLOW SPLITS

Total Yellowstone River Flow (cfs)	Existing Conditions – Existing Side channel Split		30% Design Bypass Channel Flow Split (at upstream end) ^b		May 60% Design Bypass Channel Flow Split (at upstream end) ^{b,c}		August 60% Design Bypass Channel (Alt 1) Flow Split (at upstream end) ^b	
	(cfs)	%	(cfs)	%	(cfs)	%	(cfs)	%
7,000cfs ^{a,d}	0	0	930	13	950	14	940	13
15,000cfs ^a	0	0	2230	15	1930	13	1980	13
30,000cfs ^a	390	1	4630	15	3620	12	4100	14
2-year 54,200cfs	1980	4	8950	17	6750	12	7830	14
63,000cfs ^d	3340	5	10640	17	8070	13	9430	15
10-year 87,600cfs	7170	8	15010	17	11530	13	14300	16
50-year 116,200cfs	11270	10	20430	18	17360	15	19990	17
100-year 128,300cfs	12740	10	22960	18	18070	14	22480	18

- a. 7000cfs is used to represent the 50% exceedance by duration discharge for the summer months; 15,000cfs is used to represent the 50% exceedance by duration discharge for the spring months, and 30,000cfs represents the 20% exceedance by duration discharge for the spring months.
- b. Flow splits taken from upstream end of bypass channel. At extreme flows, some water will exceed the bypass channel bank (absent a levee) and flow overland back to either the river or the existing side channel.
- c. Values differ from May 2014 60% design interim update because modeling includes flow roughness factors and natural channel variation that was not included in the HEC-RAS modeling prior to the May 2014 60% design interim.
- d. Range of flows included in the Bypass Channel Hydraulic and Physical Performance Objectives is 7,000cfs to 63,000cfs.

The construction work zone would be protected by a cofferdam at the upstream entrance and downstream exit of the proposed bypass channel, which would be constructed early in the construction sequence. The cofferdams will consist of sheet piles driven below grade into the coarse alluvium material to control under seepage.

The cofferdam will be large riprap on both the upstream and downstream with a 20' wide crest and 1V on 2H side slopes (help resist ice forces). The cofferdam at the downstream exit will be lower in height because it will be below the existing Intake Diversion Dam, it will be a similar cross section but most of the cross section will be cohesive material. Some of the rock placement on the new channel side slopes will be placed after the cofferdam removal. Grade control structures are included at the downstream and upstream ends of the bypass channel as well as at two intermediate locations to prevent channel bed erosion that could impact passage success. The proposed grade control structures would be composed of buried Riprap covered with gravel/cobble.

Two vertical control structures (riprap sills) are proposed within the bypass channel for maintaining channel slope and allowing for early identification of channel movement. Similar to the upstream control structure, these would be over-excavated and backfilled with natural river rock to give the appearance of a seamless channel invert while providing stability during extreme events.

Additionally, bank riprap is proposed at four outside bends where velocities are higher to minimize the risk of major changes in the bypass channel planform that might reduce the

capability to meet the BRT criteria. Riprap at the upstream end of the bypass channel would extend in a southwesterly direction, as shown in Figure 2-4, to reduce the risk of flanking. Approximately 85,000 tons of riprap would be required for the bypass channel. It is possible that additional protection could be required in the future if assumptions about channel stability are proven incorrect and excessive channel migration or degradation begins to impact passage effectiveness.

Modeling indicates the bypass channel could be subject to bed erosion. Therefore, construction of an armor layer is proposed. The armor layer would consist of large gravel to cobbles, similar in size to the naturally occurring coarse channel material found on Yellowstone River point and mid-channel bars and similar to what would be expected to occur naturally over time. Approximately 28,000 cubic yards of armor layer material (11,150 linear feet by 90-foot wide by 9-inch layer thickness) would be screened from the alluvial material excavated from the bypass channel and placed in the channel bottom to achieve final design grade.

Diversion of flow from the river into the constructed bypass channel will be facilitated by a channel plug constructed at the upstream end of the bypass. Material excavated from the bypass channel would be used to create the channel plug, which will be zoned similar to the upstream cofferdam with large riprap on both the upstream (river side) and downstream (existing side channel) sides, and sheet pile at the crest centerline. Fill would be placed in approximately the first 1.5 miles of the existing side channel. This fill material would be compacted, sloped and reseeded for stability. This plug would not allow any water to be diverted into and flow through the existing side channel under most flow conditions (flows up to at least 97,200 cfs). This would eliminate any flow from entering the existing side channel at the upstream end so that the BRT criteria are met in the bypass channel offering the most opportunity for passage. It's possible that under extreme flood conditions water could exceed the bypass channel and flow overland into the existing side channel, the only water that would regularly enter the side channel would be via a backwater effect at the downstream end. Filling in the upper portion of the existing side channel also reduces the risk of river channel migration into this channel, thus reducing the potential risk of cutting off the bypass channel.

2.3.5.3 Replacement Weir

A new concrete weir is proposed just upstream from the existing rock weir at elevation 1990.5 feet (North American Vertical Datum of 1988) which is equivalent to the existing dam with rock placed on it. The replacement weir would be constructed approximately 40 feet upstream of the existing dam. Rendering of the replacement weir is shown in Figure 2-5.

The replacement weir structure would consist of a cantilevered structural wall created by a deep foundation of either driven piles or drilled shafts with a concrete cap. The replacement weir would require approximately 680 cubic yards of concrete, which would be trucked from Glendive and pumped to the site. Because of the river water level, if drilled shafts were used for the deep foundation, the shafts would be cased (pipe piles cleaned out and filled with reinforced concrete). The piles or shafts would be spaced such that there would be gaps between them below the cap, but the backfill would be completely around them, and for purposes of retaining wall design, a bridge between them.

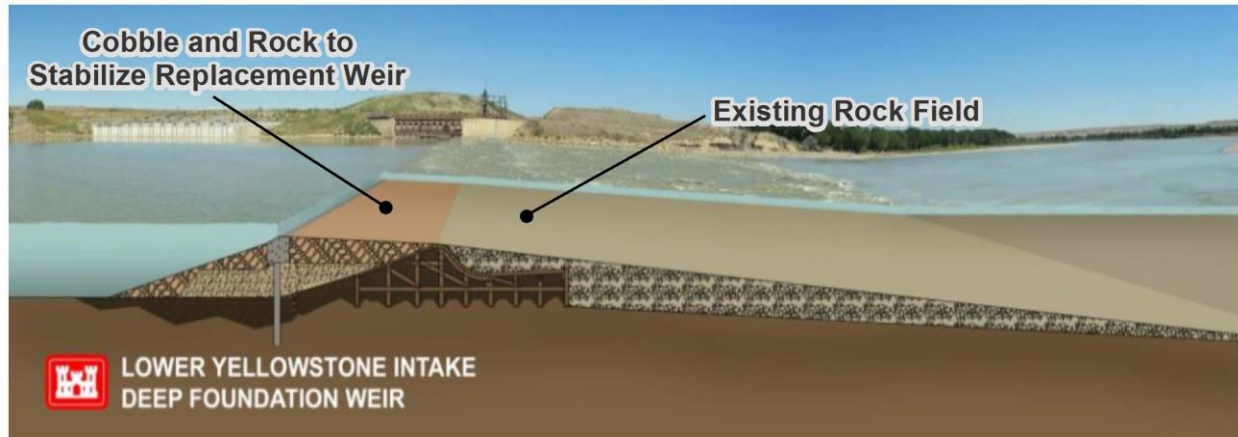

Figure 2-5. Rendering of the Replacement Weir

The replacement weir would have a 125 foot wide and two feet deep notch roughly centered on the river thalweg to facilitate in-river upstream and downstream fish passage. The top of the structure would allow for a smooth crest surface for ice to pass over. Fill would be placed between the replacement weir and the Intake Diversion Dam. Fill would also be placed upstream of the replacement weir structure and sloped to include rock protection. The replacement weir crest will include at least one low-flow channel for fish passage. This would offer an array of depth-velocity habitat zones for fish migration under a wide range of flows, which are typical on the lower Yellowstone River. The channel(s) in the replacement weir crest would provide fish passage during late summer and early fall low flows for various species. It is likely that some maintenance of the riprap channel bottom between the old and replacement weirs would be necessary over the long term. However, the riprap placed between weirs would not be subject to the same level of displacement experienced with the current weir since it will not be subject to direct impact from ice flows.

Construction of the replacement weir would begin on the north side of the river with approximately 1/3 of the replacement weir being constructed at a time. The immediate construction area would be dewatered using a 770-foot sheet pile coffer dam, with piles driven below grade into coarse alluvium material to prevent under seepage. The coffer dam would be installed consistently with the weir replacement, one-third to one-fifth of the channel at a time. Once the replacement weir section is complete, the cofferdam sheet piles would be removed. Cofferdam installation and removal would occur during summer, but not June or July to minimize fish impacts. During construction of the replacement weir and bypass channel, the Board of Control would need to maintain Intake Diversion Dam. During construction, flows in the river could drop to levels that may require additional rock be placed on top of the dam to maintain diversions into the Main Canal. Rock would be placed on top of Intake Diversion Dam has occurred historically up to elevation 1,991.0 feet. Once construction of the replacement weir is completed, there will be no need to place rock on the existing structure to maintain diversions into the Main Canal or bypass channel.

An access road would be constructed along the north side of the river to allow access for heavy equipment during construction. Following completion, the road would likely be left in place for long-term O&M use. In addition, the road between Highway 16 and Intake Fishing Access Site

will be resurfaced. Existing access roads to Joe's Island would be improved as needed to facilitate construction access. Access by motor vehicle across the newly constructed bypass channel is limited and access for maintenance will require temporary cofferdams. More detailed description of the Bypass Channel design is found in, the 2015 Supplemental Environmental Assessment and Appendices (Corps 2015d).

2.3.5.4 Operation & Maintenance

For major O&M actions, temporary access would need to be built, work would have to be done when the bypass channel is iced-over, or equipment would need to be brought in by way of boat, barge, or bridge. It has not been determined how access to, and on, the replacement weir structure will be achieved for O&M activities. If vehicular access across the weir structure cannot be safely achieved, a new trolley system would need to be constructed, or access provided by a barge or bridge.

Maintenance activities specific to the Bypass Channel Alternative include maintenance of rock upstream and downstream of the replacement weir, periodic replacement of riprap along the banks and bottom of the bypass channel, removal of sediment or debris from within the bypass channel, maintenance of fill near the downstream entrance of the bypass channel to enhance attraction flows and reduce eddy formations, maintenance of access roads to the bypass channel, and maintenance of the channel plug in the existing side channel. The bypass channel maintenance would require a temporary cofferdam for substantial maintenance activities, such as sediment management. Maintenance of the boulder field between the existing and replacement weirs would be necessary over the long-term to ensure the stability of the new structure. However, the riprap placed between weirs would not be subjected to the same level of displacement experienced with the Intake Diversion Dam since it would not sustain direct impact from ice and high flows.

Reclamation and the Board of Control would most likely need to amend the existing O&M transfer contract to address operation and maintenance of the new headworks and bypass channel consistent with the authorizing legislation (Reclamation Act of June 17, 1902, as amended; Water Conservation and Utilization Act of August 11, 1939, as amended) and Reclamation policy. Funding responsibility for O&M, monitoring, and any necessary adaptive management measures would depend on a number of factors including applicable laws, regulations, and policies; opportunities for cooperative funding; the nature of the activity; and likely other factors specific to a given O&M, monitoring or adaptive management measure.

Annual OM&R costs for this alternative are estimated as \$\$2,798,759. The presented annual cost accounts for the frequency that OM&R activities are expected to occur over a 50 year period. OM&R costs over the period are converted to present values using the FY16 (3.125-percent) federal discount rate.

Table 2-7 summarizes the costs and assumptions used to develop this estimate. Additional detail on OM&R estimates is found in Appendix B Cost Engineering.

TABLE 2-7. SUMMARY OF O&M COSTS FOR BYPASS CHANNEL

O&M Item Description	Annualized Cost¹
Main Canal, Laterals, Drains	
Main Canal, Laterals, Drains	\$1,875,000
Headworks	
Sediment Removal	\$10,000
Daily Operations	\$77,000
Fish Screen Manifolds	\$55,041
Fish Screen Cylinder Units	\$32,377
Fish Screen External Brushes	\$45,092
Fish Screen Internal Brushes	\$45,092
Fish Screen Seal System	\$10,408
Diversion Dam	
Diversion Dam Maintenance	\$10,000
Rock Replacement (Major Repair)	\$18,788
Barge Cost (Major Repair)	\$18,788
Bypass Channel	
Bypass Channel (Minor Repairs)	\$57,000
Coffer Dam (Major Repairs)	\$43,365
Riprap Repairs (Major Repairs)	\$34,692
Channel Repairs	\$28,183
Bypass Channel Inspection	\$3,000
Pumps	
Existing Pumps	\$235,000
Admin. Costs	
Administrative/Indirect Costs	\$61,000
ESA Monitoring Costs²	
Passage and Entrainment Monitoring	\$138,934
Total Annual O&M	\$2,798,759
1. Annual O&M is based on 50-year period of analysis and 3.125% Federal discount rate 2. Reclamation is committed to monitoring the effectiveness of the project, consistent with the outcome of Endangered Species Act consultation. Funding sources for these monitoring activities will be determined based on Reclamation Law, Policy, and availability of funding.	

2.3.6 Modified Side Channel

The Modified Side Channel Alternative would provide frequent flow and suitable habitat to support pallid sturgeon migration around the Intake Diversion Dam during all years. The existing side channel around Joe’s Island would be modified to flow more frequently and with a larger flow volume. Pallid sturgeon were documented to have passed upstream of the Intake Diversion Dam through the existing side channel during the 2014 and 2015 spring runoff seasons (Rugg 2014;2015) when peak Yellowstone River flows measured at Sidney, Montana (USGS Gage No. 06329500) were estimated to be 69,800 cfs and 60,500 cfs respectively. The existing side channel splits from the right bank of the main channel 1.8 miles upstream of the Intake Diversion

Dam and reconnects with the main channel 1.7 miles downstream; its length is 4.5 miles (Figure 2-6). The major proposed features for the Modified Side Channel Alternative are as follows:

- 6,000 feet of new channel at three bend cutoffs,
- 14,600 feet of channel modification to lower the existing side channel
- Three backwater areas,
- 5,300 feet of bank protection,
- Five grade control structures
- One 150 foot single span bridge, and
- Placement of 50,000 cubic yards of channel cobble substrate to simulate a natural channel bed and bed/bank edges.

Bank riprap is proposed at three locations: at the upstream confluence or split with the Yellowstone River and at the two bend cutoffs. The configuration of the upstream confluence with the Yellowstone River is critical to maintain the required flows splits. Stabilized banks are to minimize the risk of major changes in the existing side channel planform that might reduce the channel's design capacity. Riprap at the upstream end of the bypass channel would extend in a southwesterly direction as shown in Figure 2-6 to reduce the risk of flanking. It is possible that additional protection could be required in the future if assumptions about channel stability are proven incorrect and excessive channel migration or degradation begins to impact passage effectiveness. Riprap banks are also recommended at the two cutoffs to protect from flows flanking the channel fill areas.

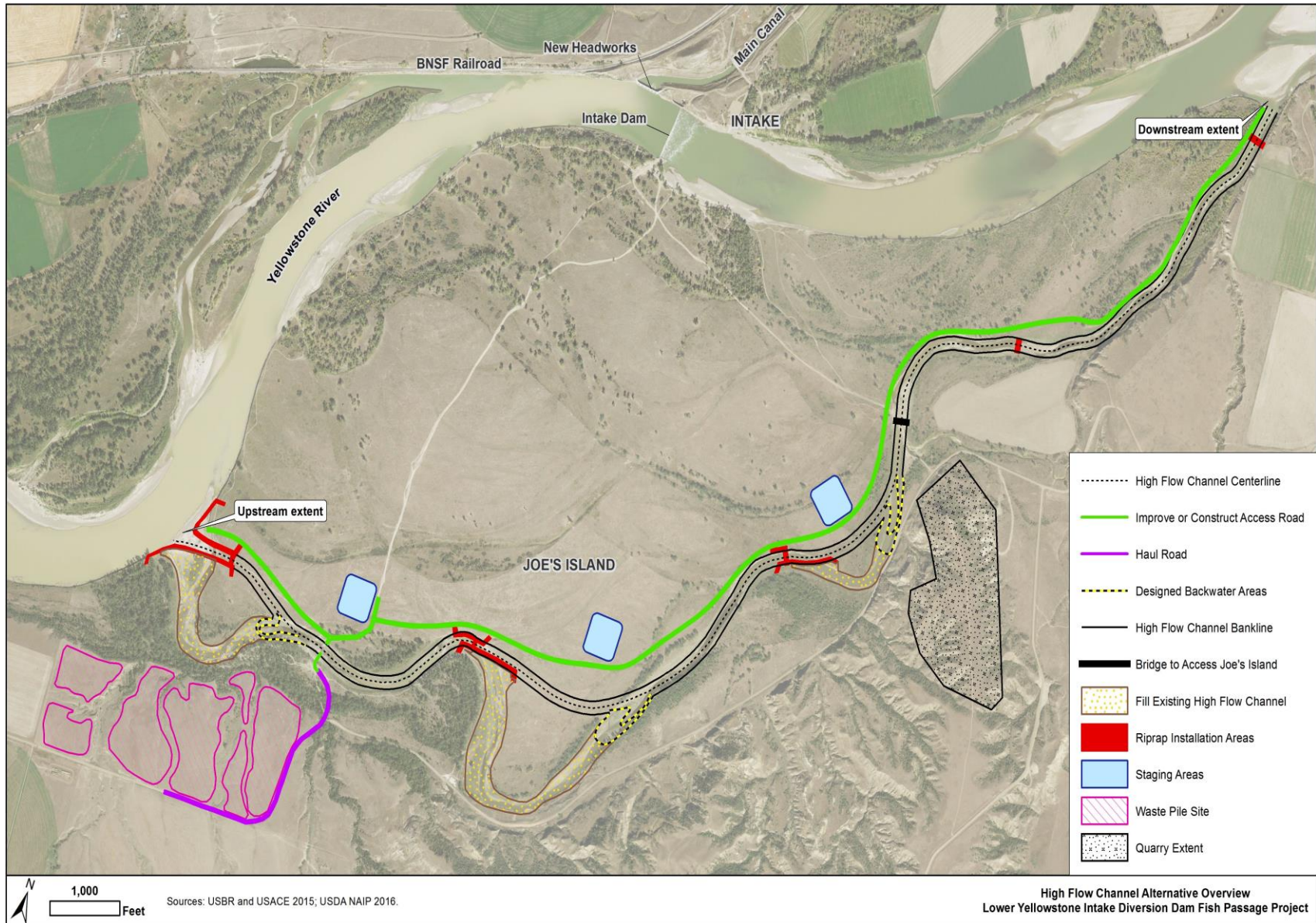

Figure 2-6. Modified Side Channel Alternative

Required water surface elevations for diversions at the Intake Diversion Dam would be met through continued routine rock placement as outlined in the No Action Alternative. Rock is quarried on private land located south and east of Joe’s Island and transported to the dam site by driving through the river and across Joe’s Island. Because the Modified Side Channel Alternative will result in a deeper channel with consistently more water, and because it is desirable to minimize disturbance to the channel bed, a bridge would be constructed to provide for maintenance vehicle access to Joe’s Island. This alternative includes a 150-foot prefabricated clear span truss bridge with abutments set outside of the main channel banks to minimize encroachment into the existing side channel. The new bridge would protect the existing side channel from vehicular disturbance caused by all vehicle crossings, in addition to dam maintenance traffic, and provide year-round recreational access to Joe’s Island. The new bridge would be set with a low chord elevation set two (2) feet above the 100-year water surface in accordance with the State of Montana and the National Flood Insurance Program criteria.

Note that the continued placement of rock to the existing dam will likely require repair or replacement of the trolley by the Board of Control. The Board of Control is responsible for Intake Diversion Dam, headworks and canal O&M costs consistent with the authorizing legislation (Reclamation Act of June 17, 1902, as amended; Water Conservation and Utilization Act of August 11, 1939, as amended), the current O&M contract between Reclamation and the Board of Control, and Reclamation policy.

2.3.6.1 Design Criteria

Design criteria developed by the Service in conjunction with the Biological Review Team (BRT) for use in the Bypass Channel Alternative recommends a range of flow splits, depths and velocities, correlated to Yellowstone River flows, for use in the design of the Bypass Channel Alternative to maximize the probability of successful passage of pallid sturgeon (Walsh 2014). Similarly, the Modified Side Channel Alternative would be designed to meet these same criteria. (Table 2-8).

TABLE 2-8. BYPASS CHANNEL FLOW SPLITS DESIGN CRITERIA

	Discharge at Sidney, Montana USGS Gage: 7,000 – 14,999 cfs	Discharge at Sidney, Montana USGS Gage: 15,000 – 63,000 cfs
Bypass Channel Flow Split	≥12%	13% to ≥ 15%
Bypass Channel cross-sectional velocities (measured as mean column velocity)	2.0 - 6.0 fps	2.4 - 6.0 fps
Bypass Channel Depth (minimum cross-sectional depth for 30 contiguous feet at measured cross-sections)	≥ 4.0 feet	≥ 6.0 feet
Bypass Channel Fish Entrance (measured as mean column velocity)	2.0 - 6.0 fps	≥ 6.0 feet
Bypass Channel Fish Exit (measured as mean column velocity)	≤ 6.0 fps	≤ 6.0 fps

Hydraulic calculations indicate that under existing conditions the existing side channel flow splits are significantly less than the recommended values from the Service and the BRT. Therefore, some modifications are required to increase flow splits. This is achieved primarily by

lowering the existing side channel inlet at the upstream confluence with the Yellowstone River by approximately 5 feet, and to a lesser extent, the widening of the existing side channel.

The existing side channel would be also be lowered at the downstream confluence with the Yellowstone River to ‘daylight’ the lower channel invert and to also improve the attraction to and accessibility of the side channel for fish passage. Between the inlet and outlet the side channel would be realigned in three locations by reducing the radius of curvature creating ‘bend cutoffs.’ Each of the bend cutoffs would include a backwater area for fish refuge and resting areas (Figure 2-6). A connected side channel at each of these bend cutoffs was considered but eliminated due to the side channel reducing the depths and flows in the main side channel to levels that will no longer meet the Service and BRT design criteria. This realignment also provides a slightly shorter channel which will offset the elevation lost by lowering the upstream confluence invert to provide a channel capable of conveying the flows and sediment loads as estimated by the one-dimensional sediment transport model.

The typical channel cross section includes a bottom width of 40 feet and side slopes varying from 1V:8H to 1V:4H. The top width is 150 to 250 feet depending on where the proposed channel intercepts existing ground (Figure 2-7). At the upstream confluence or split from the Yellowstone River, the mouth of the side channel is slightly wider at 50 feet to facilitate the proper flow splits.

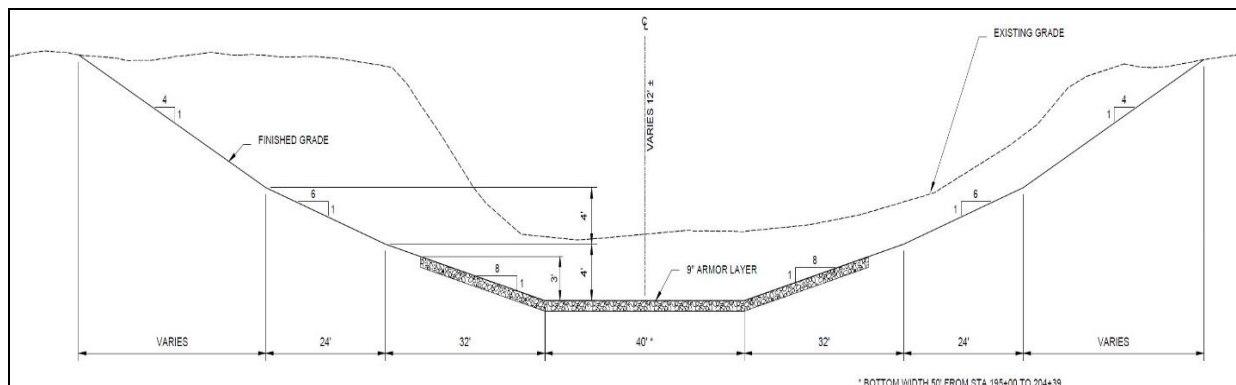

Figure 2-7. Typical Modified Side Channel Cross Section

With the exception of the bend cutoffs, in many portions of the proposed channel, the channel modifications are limited to within the channel banks to lower the channel (Figure 2-8). In addition to the backwater areas at the downstream ends of the bend cutoffs, the existing side channel modifications would also include habitat features to provide cover and resting areas. These would include channel bed undulations, pockets of deeper pools, and bank cover refuge.

The hydraulic analyses of this channel planform indicates that the proposed channel meets the depth and velocity criteria set by the Service and BRT (Table 2-9) The only exception is the average velocity calculated at the upstream fish exit where flows were estimated to be 6.7 feet per second. These velocities are consistent with the average depth velocities in the Yellowstone River and are likely representative of the main channel as opposed to the existing side channel. However, additional design and analyses, particularly a 2-dimensional analysis may be warranted.

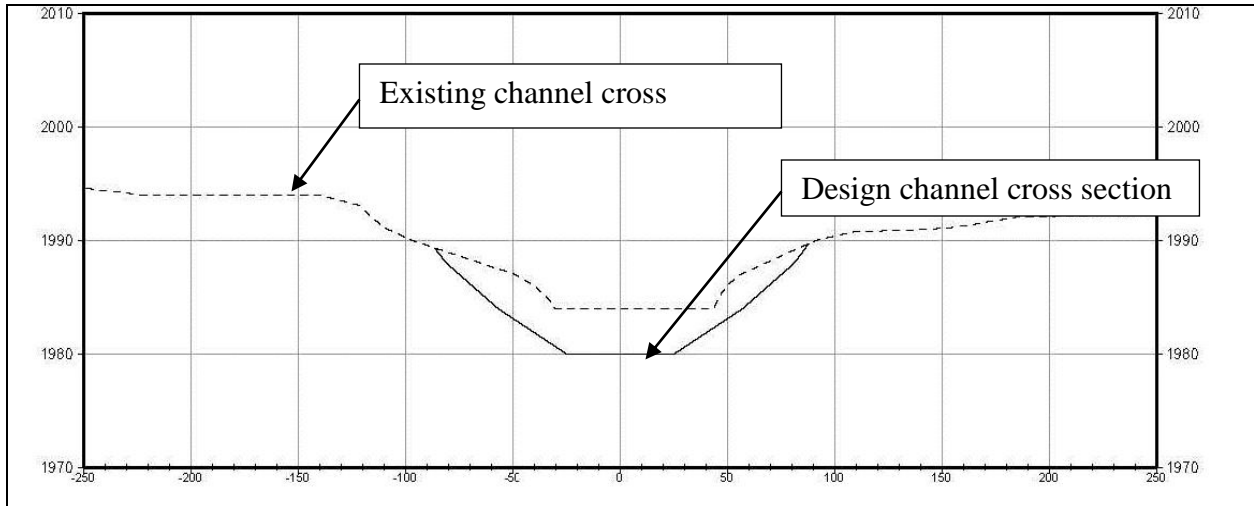

Figure 2-8 Modified Side Channel Cross Section Comparison

TABLE 2-9. SUMMARY OF DESIGN CRITERIA VERSUS PROPOSED CRITERIA FOR FISH PASSAGE

	Discharge at Sidney, Montana USGS Gage: 7,000 – 14,999 cfs	Discharge at Sidney, Montana USGS Gage: 15,000 – 63,000 cfs
Bypass Channel Flow Split		
Design Criterion	≥12% (840 to 1800 cfs)	13% to ≥ 15% (1,950 cfs to 9,450 cfs)
Modified Side channel Alternative	1,100 – 1,910 cfs	2,180 to 8,440 cfs
Bypass Channel cross-sectional velocities (mean column velocity)		
Design Criterion	2.0 - 6.0 fps	2.4 - 6.0 fps
Modified Side channel Alternative	2.6 – 3.1 fps	3.3 – 5.1 fps
Bypass Channel Depth (minimum cross-sectional depth for 30 contiguous feet at measured cross-sections)		
Design Criterion	≥ 4.0 feet	≥ 6.0 feet
Modified Side channel Alternative	≥ 4.0 feet	≥ 6.0 feet
Bypass Channel Fish Entrance (measured as mean column velocity)		
Design Criterion	2.0 - 6.0 fps	2.4-6.0 fps
Modified Side channel Alternative	2.8 – 3.2 fps	3.4 – 5.1 fps
Bypass Channel Fish Exit (measured as mean column velocity)		
Design Criterion	≤ 6.0 fps	≤ 6.0 fps
Modified Side channel Alternative	≤ 5.7 fps	≤ 6.7 fps

Additional flow splits evaluated for broader range of conditions are also evaluated using this conceptual level channel planform and the 1-D model. These results also indicate that for a broad range of flow conditions the Service and BRT recommendations for splits, depths and velocities can be achieved (Table 2-10). Table 2-10 also includes an estimate of exceedance based on daily

flow durations for the months of April through June, which also represent the months of most common for upstream fish passage. Detailed analyses and results can be found in the Modified Side Channel section of the Engineering Appendix.

TABLE 2-10. FLOW FOR A RANGE OF CONDITIONS IN THE MODIFIED SIDE CHANNEL ALTERNATIVE

Discharge at Sidney, Montana USGS Gage	Split Flow into Side channel		Percent Exceedance April-June	Average Velocities in Modified channel	Average Depths in Modified channel
	Flow	Percent of Yellowstone River Flows			
7,000 cfs	1,100 cfs	16%	83%	3.1 fps	4.6 feet
15,000 cfs	2,180 cfs	14%	47%	3.7 fps	6.4 feet
30,000 cfs	4,080 cfs	14%	22%	4.3 fps	8.8 feet
54,200 cfs	7,160 cfs	13%	4%	5.0 fps	11.3 feet
63,000 cfs	8,440 cfs	13%	2%	5.3 fps	12.2 feet
74,400 cfs	10,400 cfs	14%	>1%	5.6 fps	13.2 feet
87,600 cfs	12,500 cfs	14%	>1%	5.9 fps	14.3 feet

2.3.6.2 Construction

The major construction elements for the Modified Side Channel Alternative include:

- Excavation of 1.19 million cubic yards of material for 6,000 feet of new channel at three bend cutoffs and lowering the existing channel,
- Placement of 362,000 cubic yards of material to partially fill three bend cutoffs,
- Haul and place 828,000 cubic yards of material in spoils area on the south bluff,
- Construction of one 150-foot single span bridge,
- 5,300 feet of bank protection (16 to 27 inch average diameter riprap) in three locations including the upstream confluence with the Yellowstone and at two bend cutoffs
- Five grade control structures,
- Placement of 50,000 cubic yards of native substrate in the bed of the existing side channel,
- Approximately 4 miles of construction access road and three staging areas.

The construction work zone within the existing side channel would be protected by a temporary cofferdam at the upstream and downstream confluences of the existing side channel with the Yellowstone River. The cofferdams would be constructed early in the construction sequence and installed when flows in the Yellowstone River are low, typically between October and March. The cofferdams would consist of sheet piles driven below grade into the coarse alluvium material to reduce seepage into the existing side channel and an earthen embankment with bank protection facing the Yellowstone River. The upstream cofferdam would be 600 feet long and the downstream cofferdam 400 feet long. The sheet pile would run the full length of the cofferdams. Based on this conceptual design the cofferdams would be driven 10 feet below grade with 2 feet exposed above grade to tie into the earthen berm. The cofferdam would be removed following construction during a time of low flow in the Yellowstone River (October through March).

A construction access road and three (3) staging areas would be constructed along the north and east side of the existing side channel to provide access for and staging of heavy equipment (Figure 2-6). The staging areas would be removed at the end of construction and restored to natural conditions. The construction access roads on the north and east sides would be left in place for future maintenance needs.

Excavation is required to construct the three bend cutoffs and to lower and widen the existing channel. An estimated 1.19 million cubic yards would be excavated. Approximately one third of this material would be used as fill in the channel bend cutoffs. One small area on the left bank near station 65+00 also requires minor fill to elevate the existing side channel banks to contain the maximum of 8,400 cfs as required by the Service and BRT design criteria (~15 percent of flow at 63,000 cfs). The remaining material would be disposed of in the spoil area on the upper south bluff as shown in Figure 2-9. This will require a ¾-mile haul route on County Road 303, from Joe's Island to the upper bluff. Following construction County Road 303 would likely require reconstruction to return it to current conditions. Erosion control measures in the spoils area would include silt fencing around the spoils piles adjacent to the drainages and bluff to the north.

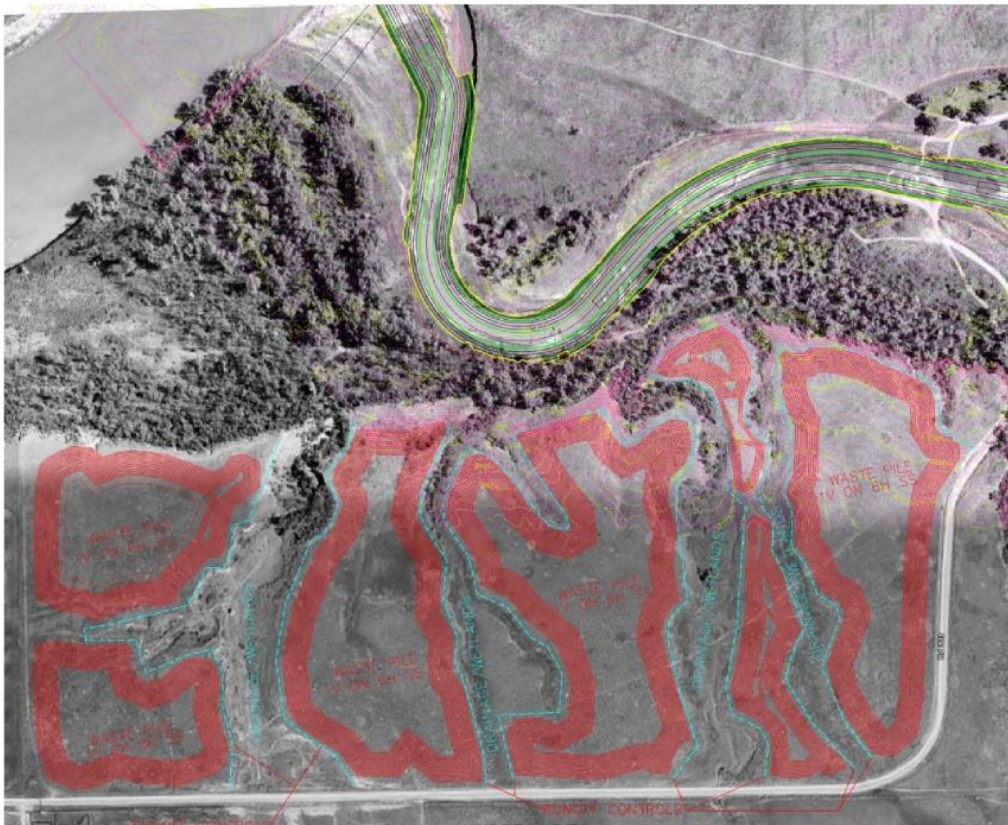

Figure 2-9. Spoil Area

Following construction the spoils area would be graded, seeded, mulched and stabilized with an erosion control blanket.

Bank riprap is proposed for bank stabilization at the upstream confluence with the Yellowstone River, and at the three bend cutoffs; and for the construction of five grade control structures. Approximately 55,000 cubic yards of riprap would be required. The riprap would be purchased from a private source, hauled onsite and stockpiled in one of the staging areas until installed.

The proposed bridge is a 150-foot single span truss bridge designed to span the existing side channel. For purposes of this conceptual design, it is assumed that the foundation of the bridge would be concrete abutments placed on 10 micro piles. Heavy equipment would be required as well as a possible dewatering pond for the construction of the footings in the dry. The dewatering pond would be constructed within the existing side channel, downstream of the bridge. The bridge construction would be phased prior to the channel excavation to facilitate the dewatering needs and to insure that access over the river is in-place as the existing side channel is built.

Although much of the channel excavation work and riprap installation can be performed within the limits of the existing channel banks, some disturbance will occur along the channel margins. These areas along with the bend cutoff fill areas would be all be graded, seeded, mulched and stabilized and an erosion control blanket when complete.

Construction of this alternative would likely take 18 months to 2 years. The first phase would include installation of the cofferdams, construction of the bridge, construction of the staging areas and construction of access roads. That work would be followed by excavation of the channel, installation of the riprap bank stabilization and check structures, and placement of the channel armoring. Finally, there would be final grading, seeding, mulching and placement of the erosion control blanket over all disturbed areas, including the stockpile sites, and restoration of the haul road. Each side of the side channel will have a graded access road left adjacent to the channel banks. During the construction period Joe's Island would be closed to the public.

2.3.6.3 Operation & Maintenance

Operation and maintenance activities specific to the Modified Side Channel Alternative include periodic inspection and possible replacement of riprap along the existing side channel and removal of sediment or debris from the upstream and downstream confluence areas with the Yellowstone River and the existing side channel. Periodic inspections would be performed on the vehicular road and bridge.

Operation and maintenance at the Intake Diversion Dam and canal intake would be similar to the No Action Alternative, including maintenance of the headworks screens and gates, maintenance and inspection of the canal, and maintenance of associated access roads.

Annual OM&R costs for this alternative are estimated as \$2,906,708. The presented annual cost accounts for the frequency that OM&R activities are expected to occur over a 50 year period. OM&R costs over the period are converted to present values using the FY16 (3.125-percent) federal discount rate. Table 2-11 summarizes the costs and assumptions used to develop this estimate. Additional detail on OM&R estimates is found in Appendix B Cost Engineering.

TABLE 2-11. SUMMARY OF O&M COSTS FOR MODIFIED SIDE CHANNEL ALTERNATIVE

O&M Item Description	Annualized Cost¹
Main Canal, Laterals, Drains	
Main Canal, Laterals, Drains	\$1,875,000
Headworks	
Sediment Removal	\$10,000
Daily Operations	\$77,000
Fish Screen Manifolds	\$55,041
Fish Screen Cylinder Units	\$32,377
Fish Screen External Brushes	\$45,092
Fish Screen Internal Brushes	\$45,092
Fish Screen Seal System	\$10,408
Diversion Dam	
Diversion Dam Maintenance	\$77,000
Rocking Structure	
Trolley Rehab	\$4,812
Cable Replacement	\$4,074
Modified Channel	
Minor Channel Repairs	\$100,000
Coffer Dam (Major Repair)	\$43,365
Riprap (Major Repair)	\$39,028
Channel Excavation (Major Repair)	\$23,486
Channel Inspection	\$5,000
Bridge Maintenance	
Bridge Maintenance	\$25,000
Pumps	
Existing Pumps	\$235,000
Admin. Costs	
Administrative/Indirect Costs	\$61,000
ESA Monitoring Costs²	
Passage and Entrainment Monitoring	\$138,934
Total Annual O&M	\$2,906,708
1. Annual O&M is based on 50-year period of analysis and 3.125% Federal discount rate 2. Reclamation is committed to monitoring the effectiveness of the project, consistent with the outcome of Endangered Species Act consultation. Funding sources for these monitoring activities will be determined based on Reclamation Law, Policy, and availability of funding.	

2.3.7 Multiple Pumping Stations

This alternative was developed in response to comments for a “free-flowing river” (e.g., no diversion dam) alternative that would meet the purpose and need for the project. This alternative was designed to achieve commenters’ objectives, but also to represent an alternative with a “distinctly different approach” (Reclamation, 2012a) in comparison to the Multiple Pumping Stations with Conservation Measures Alternative. The two pumping alternatives have been structured in a way that discrete elements from either alternative could be combined or added to one another to achieve a more optimal alternative if new information indicates such combinations would improve alternative performance, reduce impacts, and/or reduce costs.

This alternative proposes removing the Intake Diversion Dam and constructing five pumping stations on the Yellowstone River to deliver water to the Lower Yellowstone Project. The pumping stations would be designed for a total diversion capacity of 1,374 cfs. The pumping stations would be constructed at various locations along the Lower Yellowstone Project between the Intake Diversion Dam and Savage, as shown in Figure 2-10.

The five sites shown were selected on the outside of meander bends to minimize the chances they would be blocked by bar formation and maximize the depth of flow in the Yellowstone, especially during low flows. Both of these factors contribute to the reliability of the diversion and reduce maintenance associated with sediment removal. The placement of these feeder canals on the outside river bends will direct the majority of debris into the feeder canals to be caught on the proposed trash racks, causing frequent debris handling and removal. The downside is that the outside portions of the bends are most likely to erode in the near future. To minimize this potential two additional factors were accounted for in siting the pumping stations; the bends were reviewed and the stations were sited at the more stable bends and the pumping stations were set back approximately 1,000 feet from the channel bank where possible. This placed them at or just inside the outer edge of the channel migration zone (CMZ) (DTM Consulting & AGI 2009). Stability of the bends was assessed by reviewing historical channel locations (DTM Consulting 2009) to determine how much the channel has shifted over the last 60-70 years. The five selected locations have been numbered from upstream to downstream along the river and are generally located as described in Table 2-12.

Each of the five pumping stations would be designed for a capacity of 275 cfs. Water would be drawn from the river through a feeder canal to a fish screen structure. The motors and electrical equipment in both the fish screen structure and the pumping station would be located at least two feet above the 100-year flood elevation. Fish would be screened out and returned to the river through a pumped fish return pipe, and irrigation water would pass through the fish screen and flow into the pumping station¹. Discharge pipes would convey the irrigation water to the Main Canal.

¹ The BRT has not reviewed this design at this time and future BRT review may result in recommendations for changes to the design, which may be substantial if potential adverse impacts to pallid sturgeon are identified.

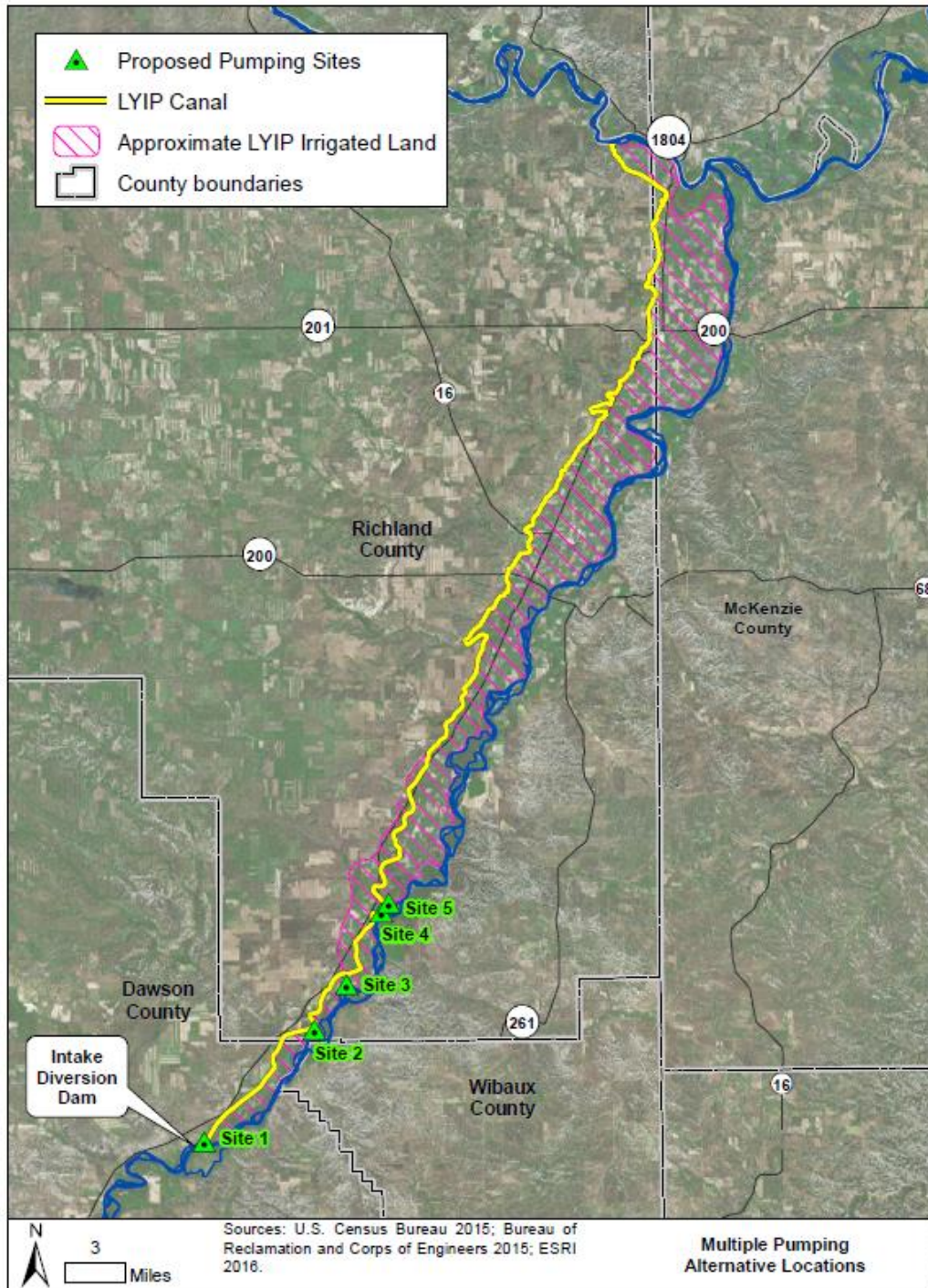

Figure 2-10. Multiple Pumping Station Locations

TABLE 2-12. MULTIPLE PUMPING STATION LOCATIONS

Site	Approximate Location
Site 1	Near Intake Diversion Dam
Site 2	8 miles downstream from Site 1, near Idiom Island
Site 3	3 miles downstream from Site 2, near Mary's Island
Site 4	0.2 miles upstream of Savage
Site 5	0.3 miles downstream of Savage

The major components of the alternative are described and depicted in figures below, and additional detail is in the Multiple Pumping section of the Engineering Appendix.

A feeder canal would be constructed at each site with a trapezoidal section, sloping downward at a 0.1-percent slope to the fish screen structure. The bottom of the feeder canal would be 32' wide with an elevation as close as practical to the thalweg of the river to maximize the flow depth into the feeder canal under low flow conditions. Under low flow conditions, the target depth in the intake feeder canal would be 2.5' deep with an average velocity of 3.1 feet / second. Under higher flow conditions, the depth in the feeder canal could be much greater and average velocities in the feeder canal may be approximately 1 feet per second or less. Typical depths and velocities in the feeder canals ranging from the low flow condition up to the 2-year flood of 54,200 cfs in the Yellowstone River are shown in Table 2-13. Operation of any pump station is expected only for main channel flows less than 30,000 cfs. A bar screen with 1" openings would be constructed in each feeder canal to minimize adult fish entrainment.

TABLE 2-13. FEEDER CANAL DEPTH AND VELOCITY

Main Channel Discharge (cfs)	Feeder Canal Depth (feet)	Feeder Canal Velocity (fps)
3,000	2.5	3.1
5,000	4	1.8
10,000	6.1	1.1
15,000	7.7	0.78
20,000	8.9	0.65
25,000	9.8	0.57
30,000	10.7	0.5
45,000	12.7	0.39
54,200	13.8	0.34

2.3.7.1 Fish Screens

A fish screen structure would be constructed at the downstream end of each feeder canal with a V-shaped vertical fish screen configuration. The fish screens would be designed according to the NMFS fish passage facility design criteria, using screens with an opening width of 1.75 mm, a maximum approach velocity of 0.4 feet / second, and a sweeping velocity, which exceeds the approach velocity. Two wedge-wire fish screen panels would be installed in a V-shaped configuration, each of which is 96' long and 4' high for a gross screen area of 768 square feet or a net screen area of 691 square feet, assuming 10-percent blockage for supports. A travelling screen cleaner would be installed to remove debris and silt from the screens and a 1' deep sill below the fish screens would provide space for silt to collect between cleanings. The slope of the

Yellowstone River is too flat to permit the use of a fish return channel or pipe that operates by gravity; therefore, a fish handling pump is provided downstream of the fish screen to return the juveniles to the river. Plan view of the typical fish screen structure are shown in Figure 2-11.

2.3.7.2 Pumping Stations

After leaving the fish screen, irrigation water would flow into the pumping station. A concrete wet well would be constructed at each site to provide the submergence depth required by the irrigation pumps. Three submersible pumps would be installed in each wet well with a total capacity of 275 cfs, with an additional pump also provided for redundancy. A prefabricated steel building would be constructed over each wet well to house the motors and control. The pumps would be operated by 480V motors and standby generators would be provided at each site as a backup power source during any power outage.

A summary of the irrigation pump requirements is shown in Table 2-14. The head required at the five sites increases as they move downstream because the river slopes more steeply than the irrigation canal. A plan view of a typical pumping station is shown in Figure 2-12.

TABLE 2-14. IRRIGATION PUMP SIZE REQUIREMENTS

	Total Flow Rate (cfs)	Flow Rate per Pump (cfs)	Static Head (feet)	Total Dynamic Head (feet)	Pump Motor Power (HP)
Site 1	275	92	-1	7	107
Site 2	275	92	25	34	408
Site 3	275	92	33	47	564
Site 4	275	92	46	58	703
Site 5	275	92	48	58	703

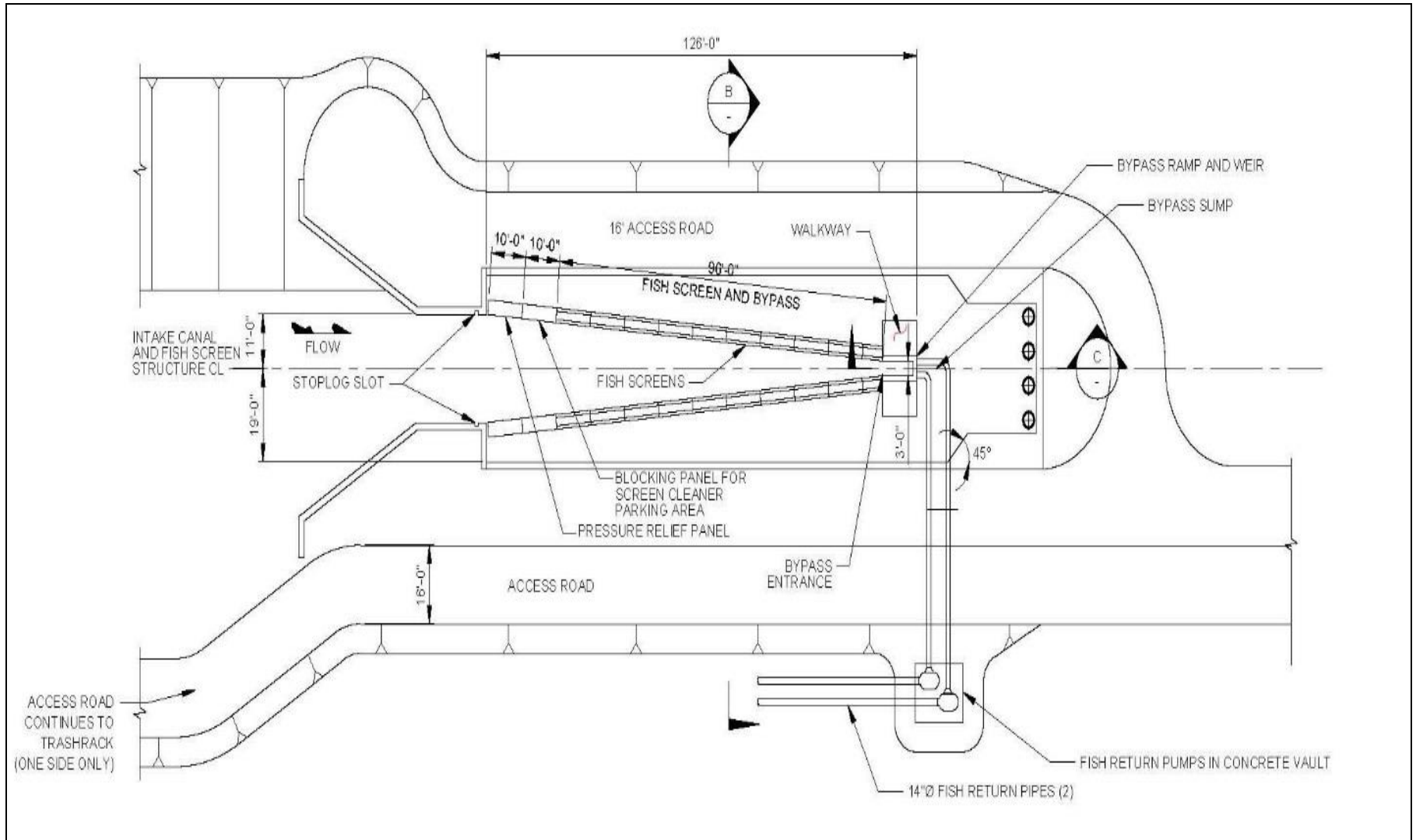

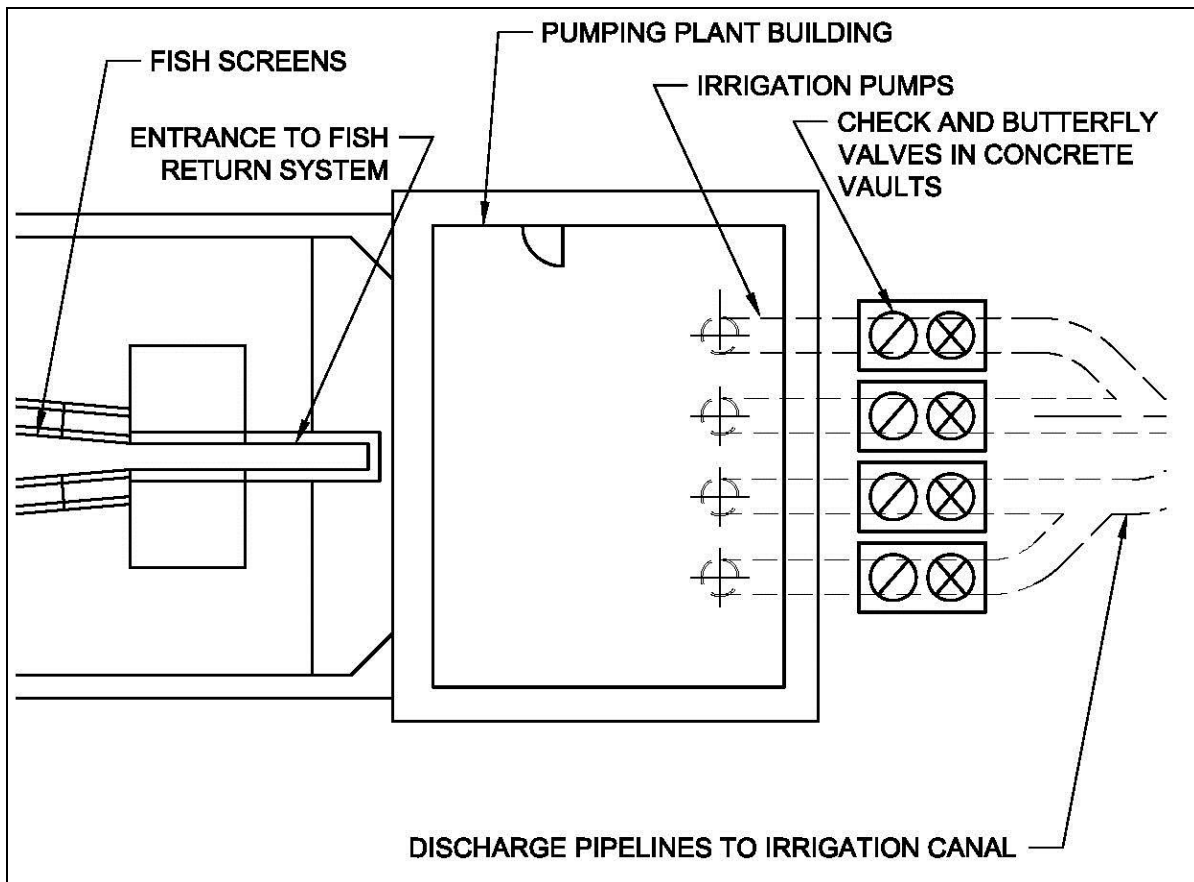

Figure 2-12 Typical Pumping Station (Plan View)

Discharge pipelines would convey irrigation water from each of the pumping stations to the irrigation canal. The discharge pipelines would vary in length from 300' to 5,600'. The discharge pipelines would be steel pipes with a 7' diameter to reduce head losses and energy costs, except at site 1 where a 6' diameter is acceptable due to the short length and low total head. Each discharge pipeline would terminate in the irrigation canal; however, it may be more beneficial to feed some laterals and farms directly from the discharge pipes.

A concrete outlet structure would be designed and constructed at the outlet of each discharge pipeline into the irrigation canal. The outlet structures would be similar to a Bureau of Reclamation Type 1 concrete transition, with an approximate outlet width of 44' and height of 14'. An 18" thick riprap lining would be placed downstream of each concrete outlet structure.

A summary of the discharge pipeline requirements is shown in Table 2-15, below.

TABLE 2-15 DISCHARGE PIPELINE REQUIREMENTS

	Length (feet)	Diameter (feet)	Velocity (fps)
Site 1	300	6	9.7
Site 2	1000	7	7.1
Site 3	5600	7	7.1
Site 4	4100	7	7.1
Site 5	1800	7	7.1

2.3.7.3 Power Demand

The power demand for the pumps would exceed the capacity of the existing power system in this area, requiring uprating of existing powerlines and the extension of existing powerlines to provide 3-phase, 480-volt power to each of the sites. New powerlines would be underground powerlines with 4/0 conductors. Existing sub-stations would also be uprated to meet the power demands required.

A summary of the estimated power demand at each site and power system uprating required is shown in Table 2-16.

TABLE 2-16 ESTIMATED POWER DEMANDS AND POWER SYSTEM UPGRADING

	Total Power Demand (kilowatts)	Length of New Conductors (feet)	Length of New Power Lines (feet)	New Sub-Station Required?
Site 1	500	None- All New	6,600	No
Site 2	1,100	None—All New	6,000	Yes
Site 3	1,300	None—All New	16,000	Yes
Site 4	1,500	5,000	1,500	Yes
Site 5	1,600	(Included in Site 4)		

A diesel standby generator would be provided at each site to provide backup power during an outage. The generators vary in size from 500 kilowatts (kW) to 2000 kW. Each generator would be in a weatherproof housing with minimal sound deadening, and would have a 48-hour fuel supply.

2.3.7.4 Dam Removal

The Intake Diversion Dam was constructed by Reclamation in 1910 to control the water surface elevation of the Yellowstone River at the existing headworks, located just upstream of the dam. The existing dam structure consists of timber frame filled with riprap and riprap apron downstream. Section 106 of the NHPA requires federal agencies to take into account the effects of their undertakings on historic properties and to afford the Advisory Council on Historic Preservation an opportunity to comment. The dam is a historic structure and impacts to it will require consultation under Section 106, Sections 3.17 and 4.17 discuss this in more detail.

For the removal of the weir it was assumed that only the portion of the dam and existing rock field that is above the channel bed elevation would be demolished and removed; the foundation with timber piles and downstream apron would remain in place as shown in Figure 2-13. More detailed design should include an analysis to confirm if the foundation portion of the weir should be removed.

The removal would take place in two phases to allow continuous conveyance of the Yellowstone River to the downstream. In the first phase, only the left half of the existing dam would be removed, while the river would be able to flow downstream over the right half of the existing dam structure. The right half of the existing dam would be removed in the next phase, while the river would flow downstream over the half of the river cross section where the existing dam is now removed. In each phase, the portion of the dam to be removed would be surrounded by temporary earthen cofferdams to prevent the river flow from entering the work area. The cofferdams would be removed at the end of each phase. A typical section of the earthen cofferdam with riprap apron on the riverbed is shown in Figure 2-14. It is assumed that cofferdams would be a combination of sheet pile and compacted fill. The boulder field downstream of the dam is not shown in these figures. That boulder field will be removed from the river.

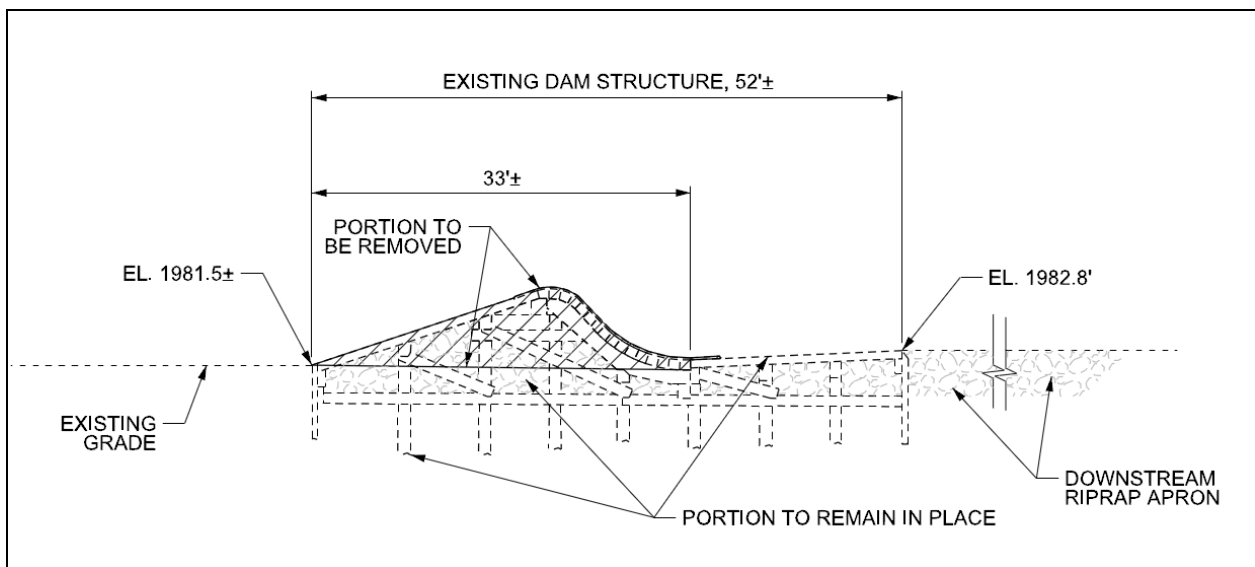

Figure 2-13 Typical Dam Removal Section

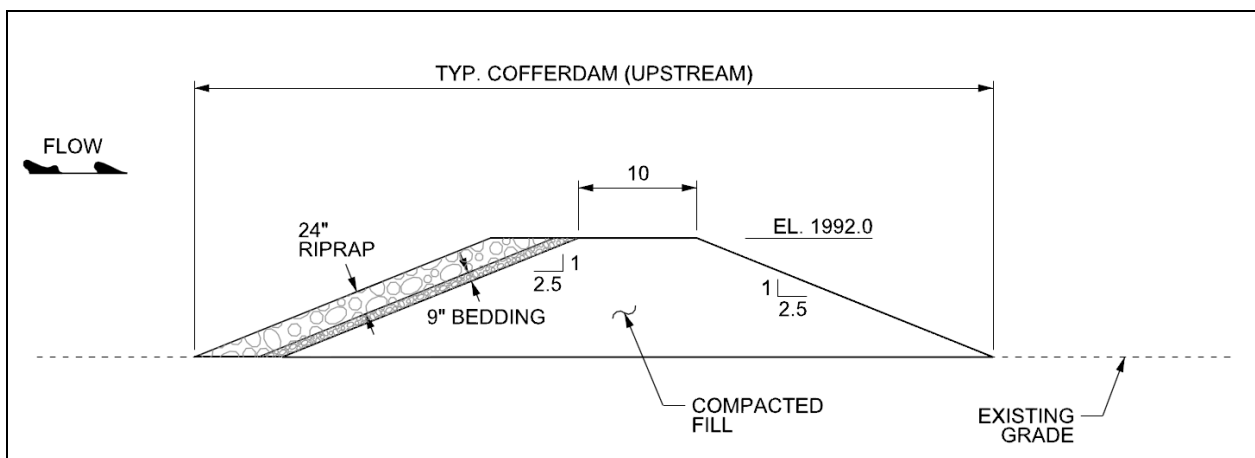

Figure 2-14 Typical Cofferd Dam Section

2.3.7.5 Canal Operation

The irrigation canal system was designed for gravity flow of water primarily from the upstream end at Intake and through the 72-mile-long canal to the laterals. This change was evaluated since the system was designed for gravity flow with all water originating at the diversion structure where the multiple pumping alternative includes stations further downstream. It would be most cost-effective to maximize gravity diversion. When pumped flows create tailwater control at the diversion, gravity diversion would no longer be feasible and all the pumping stations would need to be operated.

A HEC-RAS hydraulic model of the LYP Main Canal was developed to assess both existing conditions within the canal and changes in water surface elevation resulting from the Multiple Pump Alternative. The model geometry was derived from a number of sources. Irrigation canal geometry for the upstream most four miles of the canal were extracted from a previous HEC-RAS model of the Yellowstone River covering the general location of the Intake Diversion Dam (Corps 2015). Seven cross sections representing typical irrigation canal geometry were surveyed between canal miles 6.3 and 22.7. The surveyed cross sections were used to represent irrigation canal geometry from canal mile 6.3 to canal mile 47.0. Structures including the Burns Creek and Peabody Coulee Creek Overchutes, and Prevost Check, NN Check and Gauge, and Crane Check and Gauge were also surveyed and included in the HEC-RAS model. Historical design drawings were then used to represent the irrigation canal geometry for the remainder of the canal, from canal mile 47.0 to the terminal end of the canal at the confluence with the Missouri River. Roughness coefficients were adjusted to best match high water marks collected at the time of the survey, and the rest of the model was not calibrated.

The HEC-RAS model was used to model several flow scenarios within the Main Canal. It was assumed that gravity diversion of flows from the Yellowstone River through the screened headworks would continue concurrently with pumping until river flows are insufficient for gravity diversion through the screened headworks. Water surface elevations profiles were obtained for scenarios where gravity diversion provided all demand within the canal, and then gravity inflow at the headworks was reduced as each pump was turned on commensurate with the flows provided by each pump. Observed flows from July 6, 2012, which had a peak inflow of 1,355 cfs at the headworks, were also modeled to provide a comparison with expected maximum water surface elevations within the canal.

Figure 2-15 shows the results of the upper 20 miles of the HEC-RAS model. This figure includes water surface profiles from complete gravity diversion, and various pumping sites with the remaining flow assumed to be providing the remaining flow needed for a total of 1,374 cfs. For example, the "WS Pump 5" profile assumes 1,110 cfs gravity and 274 cfs at pumping station 5. This figure illustrates the water surface conditions of operating a canal under combined pumping and gravity. When gravity diversion cannot provide 1,110 cfs, then another 275 cfs is pumped and the gravity flow is by 275 cfs to 835 cfs. Pumps are turned on from downstream to upstream to avoid high tailwater at the diversion structure. The water surface in the canal was checked to be sure that tailwater submergence was not excessive at the diversion structure. Below station 280,000, the profiles are unchanged because the same amount of water (1,374 cfs) has been supplied.

It appears from the modelling that a combination of pumping and gravity flow is possible, although areas upstream of the Burns Creek Overchute would either require additional control structures or pumping from the irrigation canal to the laterals, but below this point minimal modification would be required. Pumping from the irrigation canal is probably preferable because pumping a small amount of water from the canal at laterals AA, BB, CC, DD, and FF is less costly than raising the water level and thereby eliminating a much larger gravity-diverted flow. The existing pumps may also need to be replaced if this change were to be made to the operation of the canal.

2.3.7.6 Construction

Construction would be performed over the course of 3 years, beginning the first year after the completion of a final design and acquisition of land rights. During year 1, the access roads and the foundation for the pumping stations would be constructed. During year 2, the discharge pipelines would be extended to the irrigation canal, the fish screen structures would be constructed, and the remainder of the pumping station wet wells would be constructed. During year 3, the fish screen and pumping station equipment would be installed, and the feeder canals would be excavated to a safe distance from the river. Then the feeder canals would be excavated into the river and the fish screen and pumping station equipment would be tested. Modifications to the existing irrigation canal would be performed during the non-irrigation seasons of years 1-3 and power system improvements would be performed at any time during years 1-3. It is assumed that the dam would be removed in year 3 when the pumps are operational.

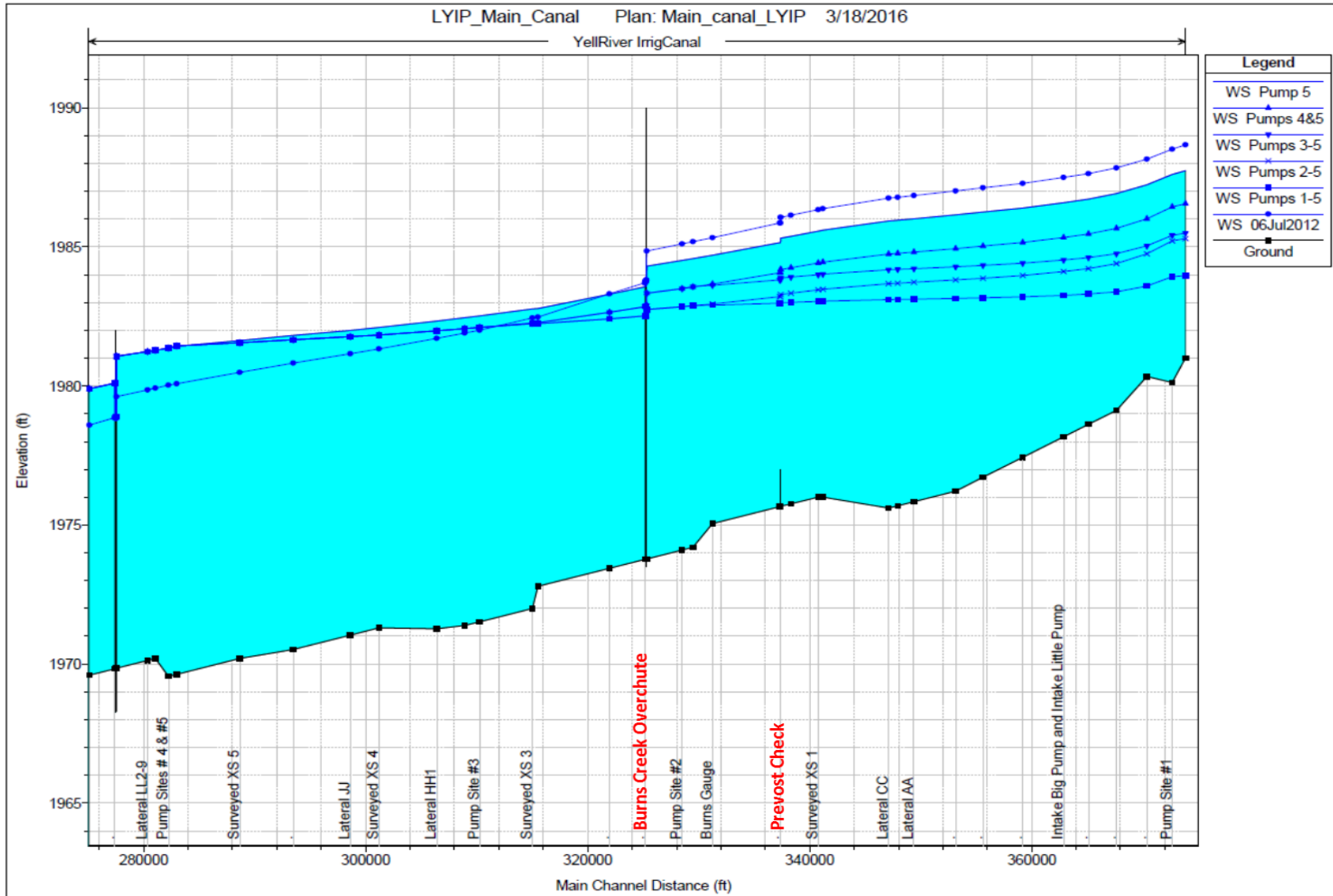

Figure 2-15. LYP Main Canal Water Surface Profiles

2.3.7.7 Operation and Maintenance

It is estimated that this alternative would consume approximately 10 gigawatt-hours of power in a typical year. This estimate assumes an average diversion rate of 1,100 cfs continuously throughout the irrigation season. This diversion rate is based on the average annual diversion rate noted in the EA (Corps 2010) of 327,046 acre-feet over a 5-month irrigation season, which results in an average flow rate of 1,078 cfs. It was assumed that the existing headworks would be used to divert water by gravity when the Yellowstone River water level is high enough to permit gravity diversions to take place, and the pumping stations would be used when they are not. Due to backwater effects between the pumped inflows and gravity diversions, the downstream pumping stations are assumed to be used first. When pumping stations 1 and 2 are required, the headworks would be closed and all irrigation water would be diverted by pumping. Additional details and power calculations are in the Engineering Appendix.

The largest O&M requirement for the project would be sediment removal. The feeder canals would collect the majority of the sediment being deposited in the system and would require annual sediment removal, with more frequent removal during some years possible. Except for emergency situations, the removal could occur during the non-irrigation season or during periods when demand for irrigation water is low enough to permit one pumping station to be shut down. A conservative estimate of the annual deposition in each feeder canal is 2,800 cubic yards, which is estimated as the total amount of sand and larger material entering the feeder canal. Sediment which collects in the fish screen structures would be removed during the non-irrigation season by placing stop logs at the inlet and dewatering them with one of the irrigation pumps, then removing the sediment using a skid-steer or other small excavator. Sediment could also be removed during the irrigation season without dewatering the screen structure using a vacuum truck, if sediment buildup is great enough to require more frequent cleaning.

A significant potential maintenance item that will start to occur several decades after project construction and beyond is stabilization of Yellowstone River banks to protect the pumping stations. The pumping stations were sited to fall near the edge of the CMZ. The CMZ study identified floodplain areas along the river where the channel may migrate over the next 100 years, on the average, based primarily upon historical channel migration. Installing bank protection will likely be necessary at the pumping station locations as the 100-year timeframe identified in the CMZ study approaches. In some locations, this may occur much sooner as the lateral migration rates can vary appreciably. Installation of bank protection should also be considered if the channel migrates to within approximately 200 to 300 feet of a pumping station, depending on site-specific conditions. In most cases, this would require over 1,000 feet of bank protection to stabilize the bend. Another maintenance item is the potential for ice damage to infrastructure at each of the pump station sites such as the buildings, fish screens, storage facilities, and fuel tanks.

As described in section 2.3.2.3 *Pick Sloan Missouri Basin Program Power*, the LYIP may be able to purchase power at a reduced rate compared to local electrical power. Montana-Dakota Utilities, the local electrical power supplier, estimates power costs at current rates for this alternative at \$500,000 per year. If the LYIP is able to secure Pick Sloan Missouri Basin Program power for this alternative, the power costs based on current rates are estimated to be from \$163,317 to \$294,251 per year.

Cost associated with the additional power necessary for this alternate may be less if an increase in the Contract Rate of Delivery (CROD) is requested and approved. If the LYIP requests an increase in the Contract Rate of Delivery (CROD) for the power rate identified above, approval of such a request would result in Reclamation taking an action to amend the LYIP Project Use Power Contracts increasing the CROD.

Annual OM&R costs for this alternative are estimated as \$5,034,094. The presented annual cost accounts for the frequency that OM&R activities are expected to occur over a 50 year period. OM&R costs over the period are converted to present values using the FY16 (3.125-percent) federal discount rate. Table 2-17 summarizes the costs and assumptions used to develop this estimate. Additional detail on OM&R estimates is found in Appendix B Cost Engineering.

TABLE 2-17. SUMMARY OF O&M COSTS FOR MULTIPLE PUMP STATIONS

O&M Item Description	Annualized Cost¹
Main Canal, Laterals, Drains	
Main Canal, Laterals, Drains	\$1,875,000
Headworks	
Sediment Removal	\$10,000
Daily Operations	\$77,000
Fish Screen Manifolds	\$55,041
Fish Screen Cylinder Units	\$32,377
Fish Screen External Brushes	\$45,092
Fish Screen Internal Brushes	\$45,092
Fish Screen Seal System	\$10,408
Pumps	
Lateral Pumps	\$50,000
Large Pumps Rehab	\$468,883
Large Pump Motors Rehab	\$100,000
Large Pumps Replacement	\$59,638
Large Pump Motor Replacement	\$37,589
Pump House Maintenance	\$10,000
Pump and Motor Removal and Install	\$46,888
Control Panel and Electronics	\$5,000
Man Power to Maintain and Operate Pump sites	\$240,000
Vehicle	\$64,152
Power Costs	\$500,000
Service discharge pipes and valves	\$10,792
Existing Pumps	\$235,000
Inlet Channel and Fish Screens	
Fish Screens	\$20,000
Fish Screen and Cleaner Replacement	\$186,275
Dewatering and Sediment Removal from Fish Screens	\$150,000
Sediment Removal from Feeder Canal	\$300,000

Trash Rack Cleaning - Manual	\$48,600
Bank Stabilization	\$12,400
Admin. Costs	
Administrative/Indirect Costs	\$61,000
ESA Monitoring Costs²	
Passage and Entrainment Monitoring	\$277,867
Total Annual O&M	\$5,034,094
<small>1. Annual O&M is based on 50-year period of analysis and 3.125% Federal discount rate 2. Reclamation is committed to monitoring the effectiveness of the project, consistent with the outcome of Endangered Species Act consultation. Funding sources for these monitoring activities will be determined based on Reclamation Law, Policy, and availability of funding.</small>	

2.3.8 Multiple Pumping Stations with Conservation Measures

Scoping comments encouraged analysis of a “free-flowing river” alternative that would use pumps to eliminate the need for a diversion weir. Commenters proposed to include extensive water conservation measures and wind power to reduce pump energy costs. Specifically, commenters proposed water conservation measures to reduce diversions to 608 cfs. Appendix A provides a summary of information pertaining to conservation measures proposed in scoping comments and shows that the quantities shown in Table 2-24 are not possible. Natural Resources Conservation Service Irrigation Water Requirement modeling (Appendix A-3) shows current crops have much higher water demand than could be met by 608 cfs. Based on the modeling, during times of peak evapotranspiration a minimum of 1,150 cfs would be required to grow the Lower Yellowstone Project crop mix under ideal conditions, which assumes a very aggressive 70% on-farm efficiency and 100% efficient delivery system. Consequently, this alternative would not meet the project purpose and need, because the water supply would be insufficient to keep the Lower Yellowstone Project viable. However, a detailed analysis of this alternative is provided for comparative purposes to be responsive to comments and better inform further public comment and agency decision-making.

The proposed components of this alternative are described below.

2.3.8.1 Conservation Measures

Installing water conservation measures throughout the system is proposed to maximize the beneficial use of the water diverted by the Lower Yellowstone Project by reducing losses in the delivery system and on farm inefficiency.

Table 2-18 includes a proposed list of conservation measures and theoretical water that could be conserved as proposed by commenters. Although the values proposed are based upon the draft conservation plan (LYIP, 2009), and a value planning study (Reclamation, 2005, 2013), the estimates included in those documents were not based on field verified data and were only conceptual water savings. In fact, the value planning study noted, “Cost and demand reduction estimates are currently at a low level of confidence and need to be field evaluated and refined.”

The concept proposed has been developed into a conceptual design and cost estimate for alternative comparison purposes and to take a hard look to determine if individual elements may have value if incorporated into one of the other alternatives analyzed.

TABLE 2-18. CONSERVATION MEASURES AND THEORETICAL WATER SAVINGS PROVIDED IN SCOPING COMMENTS (CFS)

Component	Description	Estimated conservation (cfs)
Check Structures	Installation of check structures in the canal for water control	61.5
Flow measuring devices	Measuring devices installed on the canals	18.5
Laterals to pipe	Convert laterals to pipe	255.8
Sprinklers	Install center pivot sprinklers	160
Lining Main Canal/laterals	Line Main Canal and laterals with concrete	200
Control over checking	Operational change to water levels in the canals	20.6
Groundwater pumping	Install groundwater pumps	49.5
Total Savings		765.9 cfs

Check Structures

Check structures provide water control along the canal as a means of maintaining canal water levels high enough to allow match between water needs and water diversions. They consist of a gated structure, and would be automated.

The LYP has a standardized canal check structure that would be used for this project. A typical check structure would be a reinforced concrete check structure with automated gate features as shown in Figure 2-16 and Figure 2-17. The opening of the structure would be either a single bay with a 20-foot opening or double bay with two 16-foot openings.



Figure 2-16. Example Check Structure

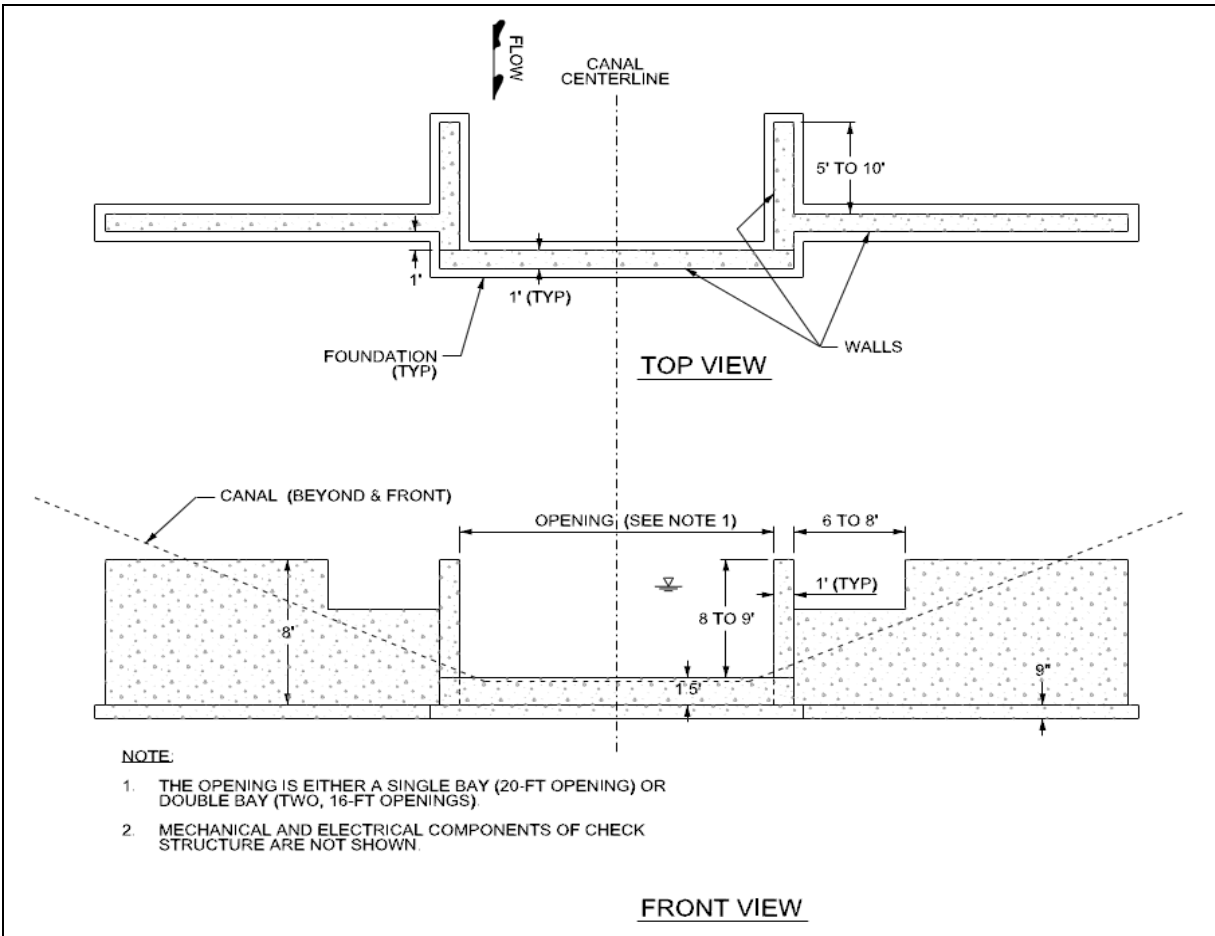

Figure 2-17. Typical Canal Check Structure

Flow Measuring Devices

These would be installed on the Main Canal and laterals to measure water flows. As of 2009, there were 50 turnouts on the project with no measuring devices to track deliveries, and none of the 68 lateral spill locations had measurement devices. Two of five Main Canal spills were also unmeasured. Table 2-19 summarizes new measuring devices that would be installed. It is likely that a Supervisory Control And Data Acquisition (SCADA) system would be needed to monitor and control all pump discharge, turnout points and check locations.

TABLE 2-19. SUMMARY OF NEW MEASURING DEVICES

Locations	Number of Locations	Type of Device
Lateral Turnout Structures	19	50% Cipolletti Weir / 50% Parshall Flumes
Sub-lateral Turnout Structures	31	50% Cipolletti Weir / 50% Parshall Flumes
Lateral End Spill Sites	68	Cipolletti Weir
Four Mile and Ferry Coulee Spillway Sites	2	Overshot Gates

Based on the locations listed in the 2009 Conservation Plan and review of the *Water Measurement Manual* (Reclamation 1997a) we assume the project would require installation of three different types of flow measuring devices (Cipolletti weir, Parshall flume, and Overshot gate) at 120 individual locations. Typical drawings of these measuring devices are available in the engineering appendix.

Convert Laterals from Ditches to Pipe

There are approximately 225 miles of lateral canals throughout the project. Approximately 10 miles of those were enclosed in pipes as of 2009 (Lower Yellowstone Project Board of Control 2009). Piping of water is assumed to reduce losses from evaporation, seepage, bank vegetation consumption, and spillage. However, it should be noted there are areas within the Lower Yellowstone Project where existing unlined and unpiped laterals gain water from sources other than the Main Canal, which would be lost if converted. Table 2-20 summarizes new pipe that would be installed.

TABLE 2-20. SUMMARY OF NEW LATERAL PIPE LENGTHS

Pipe Diameter (feet)	Total Pipe Length (miles)
1.5	0.70
2	8.06
3	33.40
4	19.64
5	9.68
6	1.29
No piping	7.25

Based on the information shown on the operating map, lateral pipes were sized to provide the same flow capacity as the existing lateral channels. A section view of typical replacement pipe section is shown in Figure 2-18.

A pipe diameter was assumed that would convey the same flow rate as the existing channels at the same invert slope. The pipe material was assumed to be concrete (Manning’s n value of 0.015). Most of the laterals have a profile slope that is flatter than 0.0005 foot/foot (0.05 percent). Even with the flow rate that is less than 30 cfs in most pipe reaches, the required pipe sizes are mostly 3 to 4 feet in diameter due to a flat invert slope. Note that installation of pipes larger than 6ft diameter costs approximately the same as lining on a per foot basis. Therefore, it was assumed that the 7 miles of laterals that would require a pipe that size would be lined instead.

To complete detailed design additional information would be necessary to field verify the conditions and operating requirements. Geometries and the ability to gravity feed water would be field verified and flow rates confirmed based on current and future operating requirements. Piping and subsequent reduction in seepage, evaporation and end spillage loss may lead to reduction in required flow diversion to the laterals and reduction in pipe size requirements. There may also be site-specific conditions that constrain the conversion of some laterals to pipe, but were not able to be verified at this level of design.

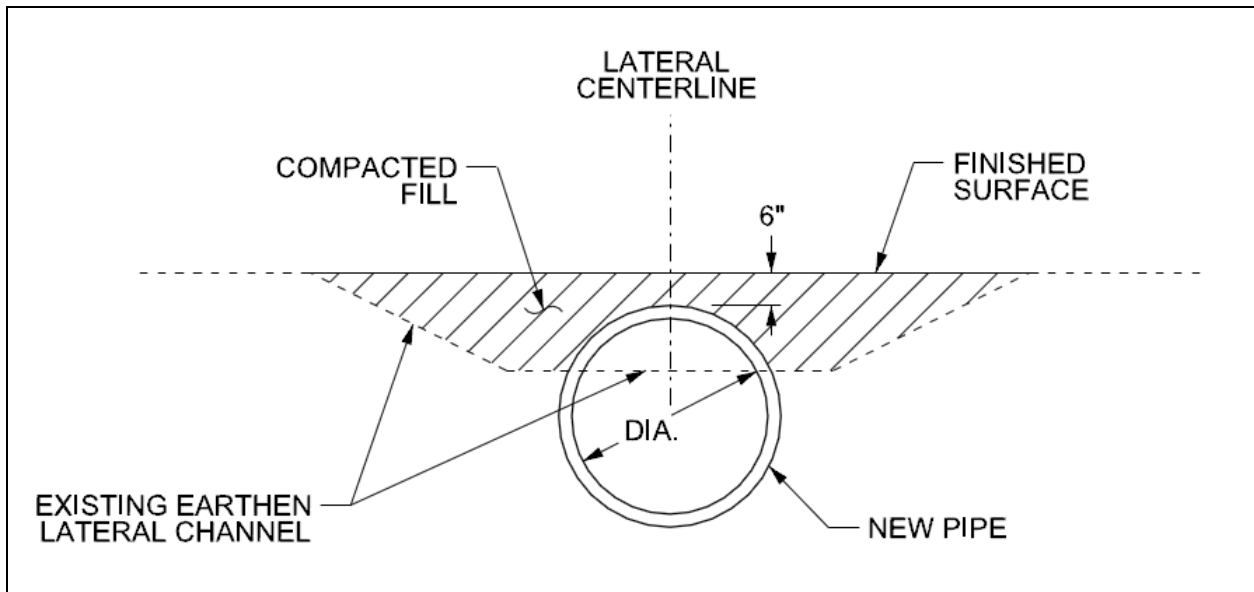

Figure 2-18. Typical Pipe Replacement Section

Convert Fields from Flood Irrigation to Sprinklers

Sprinkler irrigation is generally more efficient than flood irrigation, and is therefore recommended as a measure to reduce on-farm inefficiencies. As of 2009, approximately 9 percent of LYP acres were involved in sprinkler irrigation (LYP Board of Control 2009). As of 2016 approximately 7,988 acres (14 percent) served by the LYP has been converted to sprinkler irrigation (Hier 2016).

Irrigation methods are a farm specific decision and there are many factors that must be considered before converting to sprinkler irrigation. Those include field size and shape, topography, power availability, and water requirements (NDSU 2015). Additional analysis would be required to determine specific sites where the conversion was possible, and the decision to do so would lie with the farm owner themselves. For purposes of estimating the cost of conversion to sprinklers it was assumed that the laterals converted to pipe could supply water to an additional 5,000 acres which would be suitable for sprinkler irrigation. The estimate is presented in the cost appendix.

Line Open Canals

The LYP Main Canal is approximately 72 miles in length and is unlined. There are also 225 miles of lateral canals throughout the project. If 72 miles were to be placed in pipe as proposed above that would leave approximately 153 miles of laterals that could be lined. The lining of canals is proposed to reduce seepage losses, and is estimated to reduce the diversion requirements by 160 cfs or more. However, it should be noted there are areas within the Lower Yellowstone Project where existing unlined and unpiped canals and laterals accrue water from sources other than the Main Canal, which would be lost if converted. In addition, a review of the District's 2000 & 2012 flow records indicate that during peak demand times, losses in the Main Canal are as low as 6% of the flow in the canal.

A typical Main Canal cross section has the bottom width varying from 9 to 29 feet, bank height from 5 to 40 feet, and invert slope of 0.0001 to 0.0003 foot/foot. The side slope of the banks are 1.5:1. The maximum flow velocity is estimated to be 2.4 feet per second at the cross section below Lateral J (Reclamation 1992). For the quantity calculations, each of the 11 cross sections was assumed to be uniform over the reach lengths between the cross section locations.

In order to select a canal lining method, Reclamations canal lining program documents were reviewed. The demonstration project concluded that a type of lining which included geomembrane with concrete cover would result in the best durability (40-60 years), benefit-cost ratio (3.5-3.7), and effectiveness in seepage reduction (95 percent) (Reclamation 2002a).

It was assumed that a typical canal lining section would include placing of geomembrane over re-graded canal geometry and shotcrete cover with the minimum 3-inch thickness as shown in Figure 2-19. It was also assumed that no reinforcing was used to strengthen the shotcrete cover due to a slow flow velocity and that any significant cracks would be repaired during a regular canal-lining maintenance. Geomembrane is likely to prevent any seepage through minor cracks on the shotcrete surface. Re-grading of the existing canal geometry is expected to even out any steep banks or surface irregularities prior to placing the lining material.

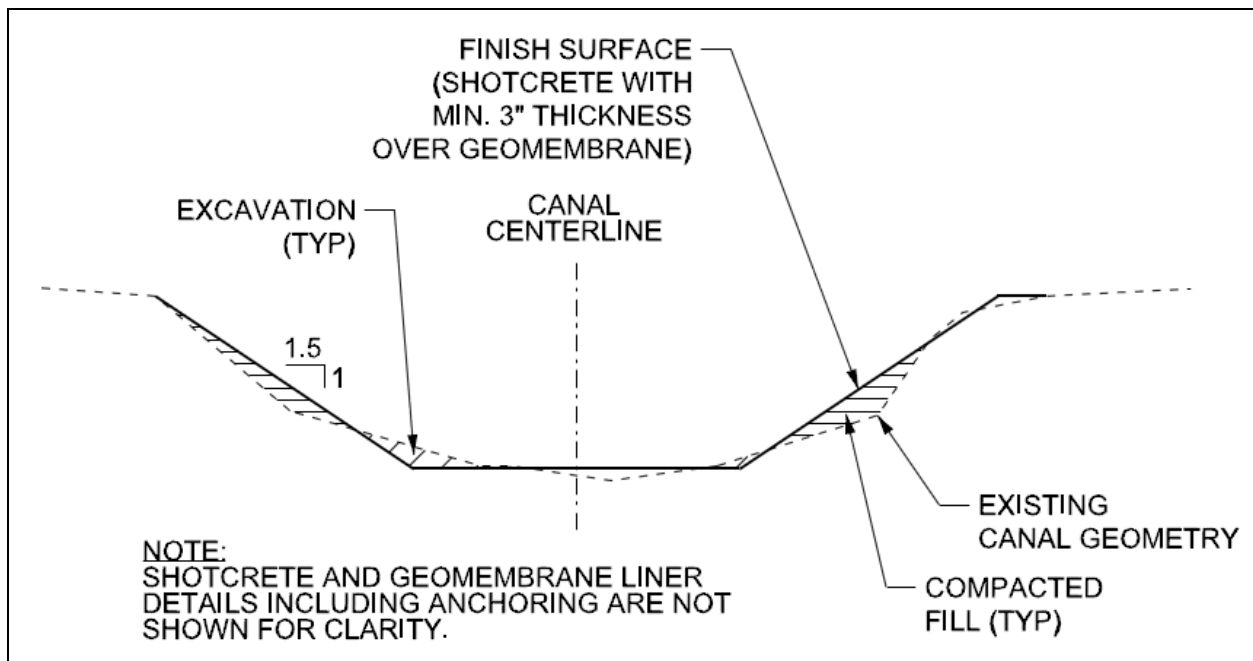

Figure 2-19. Typical Canal-lining Section

Control Over Checking

Over checking is the use of canal check structures to maintain water elevations higher than necessary to meet water needs. Maintaining water levels higher than needed by over checking can exacerbate the seepage losses on unlined canals. This is an operational item and would presumably require operational changes to be carried out by ditch riders.

Pumping Groundwater

This conservation measure proposes the installation of pumps to utilize groundwater to supplement irrigation supplies when needed. This is proposed to reduce diversions by 49.5 cfs, through pumping of groundwater as opposed to surface water.

The largest LYP water right is surface water with a 1905 Priority date (Fraser et al. 2016). Should the Lower Yellowstone Project Board of Control decide to install wells to provide 49.5 cfs instead of using that surface water right it would first require filing of an Application for Beneficial Water Use Permit, and associated documentation, to the MDNRC. This is outlined in Form No. 600 from MDNRC (MDNRC 2016c), where requirements include at the minimum an aquifer testing report. A change application may also be necessary to acquire groundwater rights.

2.3.8.2 Pumping Stations Along the River

One technology assumed to be feasible is the use of infiltration galleries which typically include a reinforced concrete caisson, 10 feet to 20 feet inside diameter, sunk from grade to a confining layer or bedrock. Horizontal well screen laterals are projected into the alluvial aquifer a distance of 100 to 250'. The caisson becomes the foundation of a pumping station. Plan and section views of a typical Ranney well, which is a common example of an infiltration gallery structure are shown in Figure 2-20.

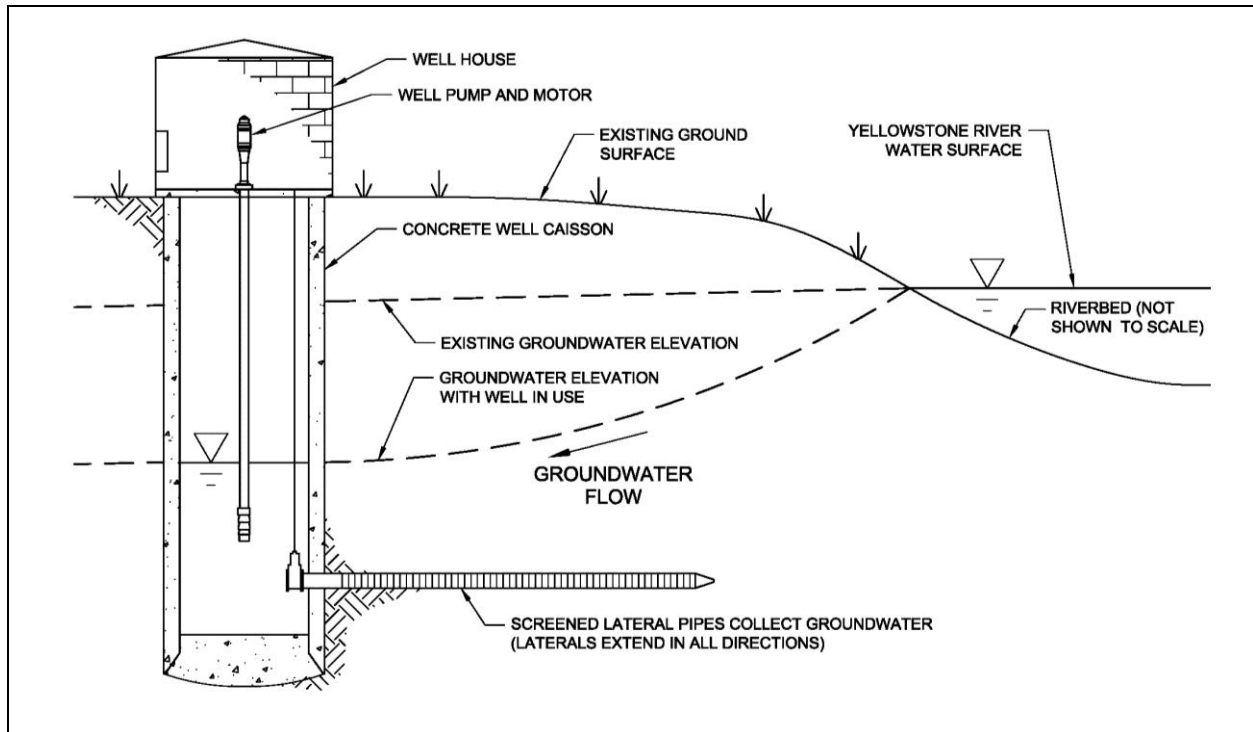

Figure 2-20. Conceptual Ranney Well (Section View)

A Ranney Wells Alternative was discussed in an alternatives analysis from 2013 (Reclamation 2013) and in the 2015 EA (Reclamation and the Corps 2015). That alternative called for the installation of Ranney Wells at seven sites along the Yellowstone River (Reclamation 2013). Sites 1, 2, and 4 from the previously identified sites could be used as the pumps required would be smaller than if they are installed downstream.

Modification of the Ranney Well Proposal

The Ranney Well measure has been considered along with additional information from the study area. While it is true that pumping sites that require less lift and are closer to the canal would require less energy, there is information to indicate that sites closer to Sidney may be more suitable. Both well logs and literature suggest that although there is an alluvial aquifer with up to 80 feet of available drawdown the conditions appear more prevalent near Sidney (Tetra Tech 2016c).

In a memo providing information on Ranney Wells and their feasibility for use on the Lower Yellowstone, Layne Heavy Civil suggested that wells are usually located on the river bank within 100 feet of the water's edge. It was also suggested that individual wells on a site be located a minimum of 1,000 feet from each other to reduce interference while pumping. They suggested that upon completion of a hydrogeological study between 6-10 locations could be chosen (Layne Heavy Civil 2016).

Therefore, the Ranney well measure was modified to account for a broader range of possible sites, and uncertainty of suitable locations. The following assumptions were applied to conceptual design:

- A hydrogeological study including drilling and pumping tests will be required to locate wells within the study area.
- (Layne Heavy Civil 2016) provided a cost estimate with the assumption that 14 collector wells (7,000 gallons per minute (gpm) each) would provide approximately 95,000 gpm. The Multiple Pumps with Conservation Measures Alternative assumes that the proposed 608 cfs is the required flow needed to provide water to the canal. Based on the information provided, the alternative includes 42 Ranney wells to be constructed to provide the 608 cfs.
- While Ranney wells are typically placed on the river bank within 100 feet of the water's edge that placement is not recommended on the Yellowstone River. It is recommended that the wells be placed outside the CMZ, which is up to 1,000 feet wide in some locations (DTM 2009).
- It is assumed that six Ranney wells would be placed at each of the seven sites previously identified between the Intake Diversion Dam and Sydney (Figure 2-21). Possible locations have been identified that are outside or as far away from the CMZ as possible, have road access, and do not require additional grading or clearing of the river floodplain.
- Collector and discharge pipelines, power, and roads will be required. These are quantified in the Cost Appendix.
- An extensive hydrogeological analysis and permit application would be required through the Montana DNRC Water Rights Bureau to change the LYIP Point of Diversion.

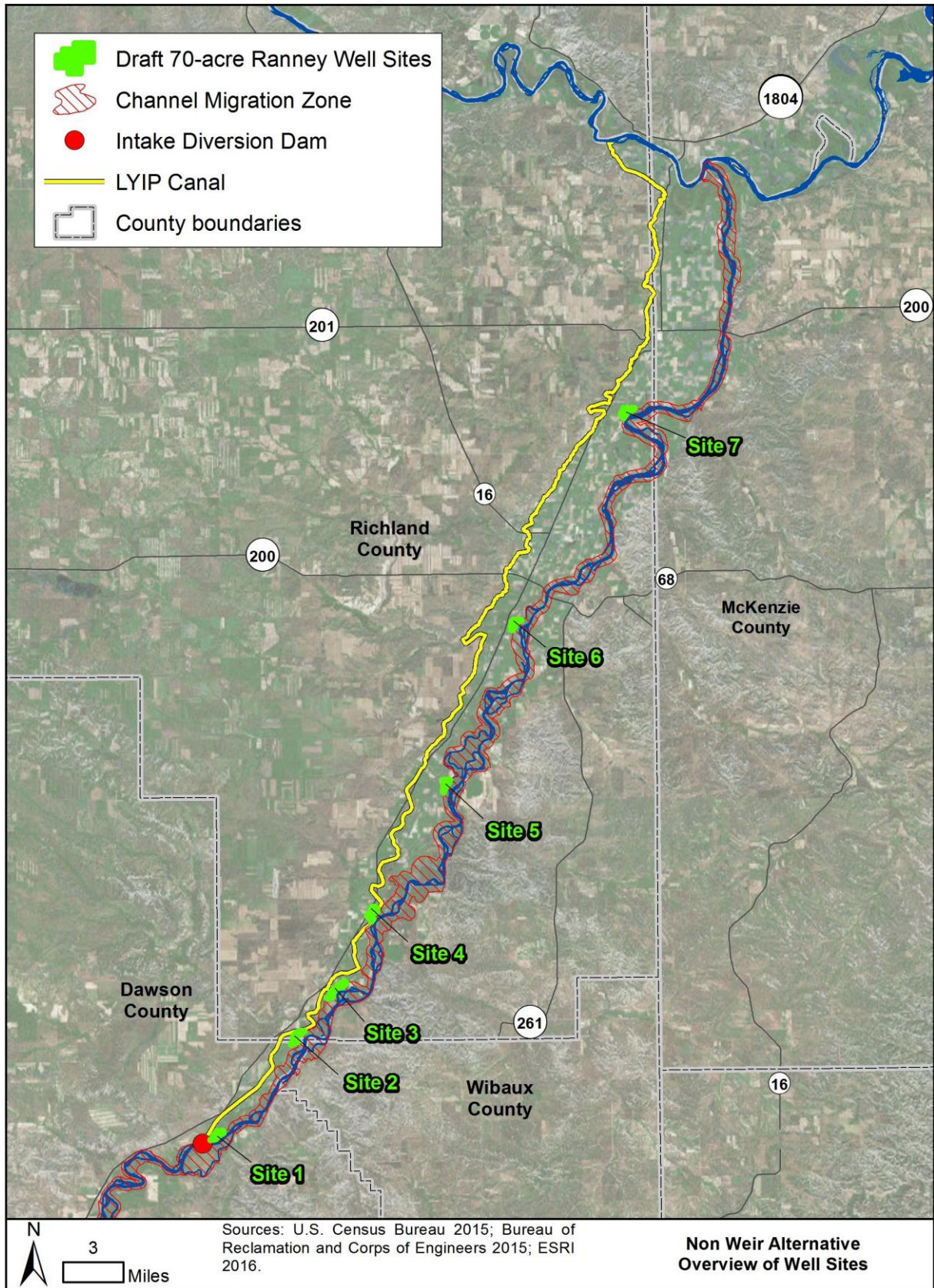

Figure 2-21. Preliminary Locations for Ranney Wells

2.3.8.3 Dam Removal

The existing Intake Diversion Dam was constructed by Reclamation in 1910 to control the water surface elevation of the Yellowstone River at the existing headworks, located just upstream of the dam. The existing dam structure consists of timber crib structure filled with riprap and riprap apron downstream. Currently, as part of its maintenance, new riprap is placed annually over the length of the dam using the overhead trolley system across the river in order to keep the dam crest elevation at 1,991.0 feet.

For the removal, only the portion of the weir that is above the adjacent ground elevation would be demolished and removed, while the foundation with timber piles and downstream apron would remain in place as shown in Figure 2-22. More detailed design should include an analysis to confirm if the foundation portion of the weir should be removed.

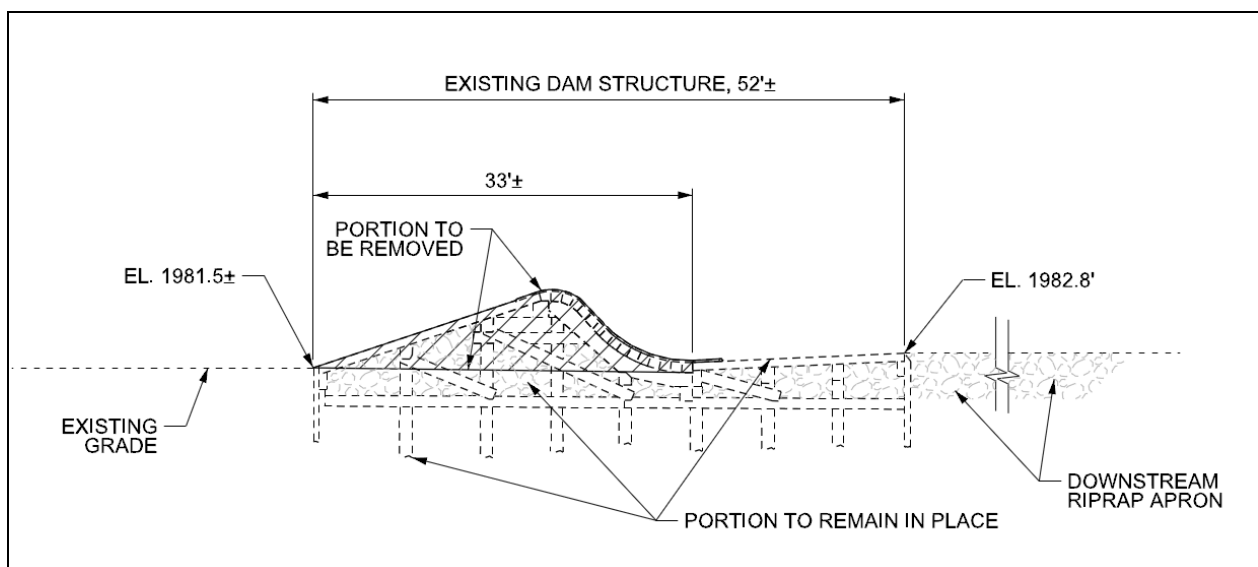

Figure 2-22. Typical Dam Removal Section

The removal would take place in two phases to allow continuous conveyance of the Yellowstone River to the downstream. In the first phase, only the left half of the existing dam would be removed, while the river would be able to flow downstream over the right half of the existing dam structure. The right half of the existing dam would be removed in the next phase, while the river would flow downstream over the half of the river cross section where the existing dam is now removed. In each phase, the portion of the dam to be removed would be surrounded by temporary earthen cofferdams to prevent the river flow from entering the work area. The cofferdams would be removed at the end of each phase. A typical section of the earthen cofferdam with riprap on the riverside is shown in Figure 2-23.

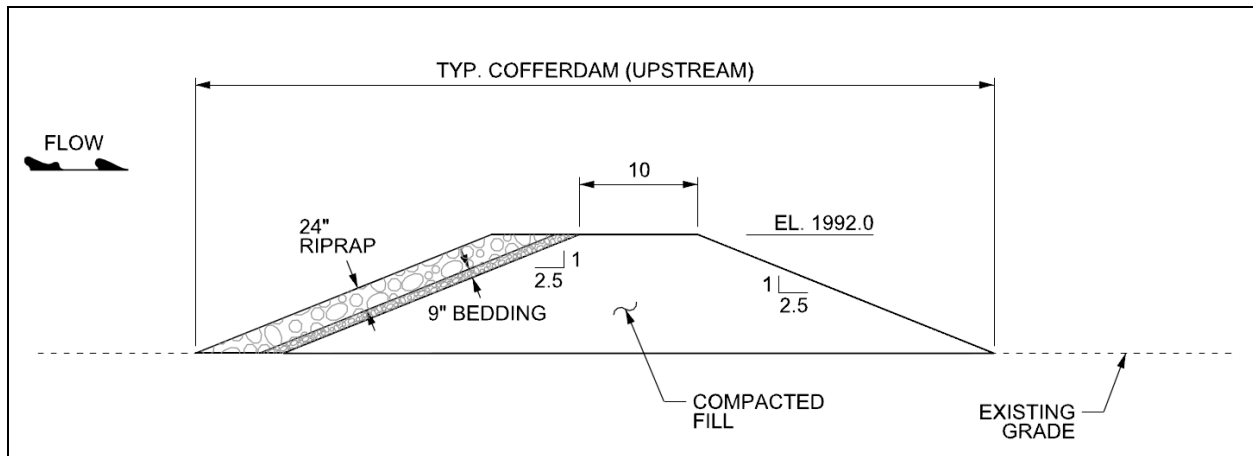

Figure 2-23. Typical Cofferdam Section

2.3.8.4 Gravity Diversion

Based on a cursory analysis of water surface elevations and the historical period of record it was assumed that at a discharge of 9,000 cfs at Intake could achieve a 615 cfs diversion. Therefore, the conceptual alternative proposed that 608 cfs could be diverted by gravity 60 percent of the days of the irrigation season (May-September).

Following review of that original proposal additional evaluation of the removal of the Intake Diversion Dam has been conducted. It focused on the gravity diversion potential assuming the complete removal of the Intake Diversion Dam and downstream rock down to the prevailing natural bed elevations. The existing conditions HEC-RAS model was the starting point for the modeling. The first version of the “no-dam” model simply removed the cross sections representing the dam crest, downstream existing rock, and the scour hole at the downstream end of the rock. The model was run for the 2-year flood discharge to assess whether upstream deposition has occurred over the life of the dam. Figure 2-24 shows the channel bed and 2-year water surface profiles of the with-dam and first version of the no-dam models. Removal of the dam lowers the water surface immediately upstream of the dam by approximately 6 feet for the 2-year flood, but there is also a convexity in the 2-year water surface that likely indicates the presence of a wedge of sediment that has collected during the life of the dam.

The second version of the no-dam model represents an estimate of the future channel condition after the Yellowstone River has adjusted to the removal of the structure and rock. The sediment wedge is considered to be approximately 4 feet thick at the dam and tapers to zero feet at the upstream end of the model. The downstream channel was left unchanged assuming that over several years the sediment released from the wedge would distribute downstream and would have an indiscernible impact. The second version of the model shows no convexity in the water surface profile, so no further adjustments were made. This final model also includes a lateral structure representing the fish screens and gates. The lateral structure incorporates a stage-discharge rating curve for the canal that is offset assuming 1 foot of head loss across the screens and gates to estimate the required stage on the Yellowstone River to determine the potential gravity diversion flow.

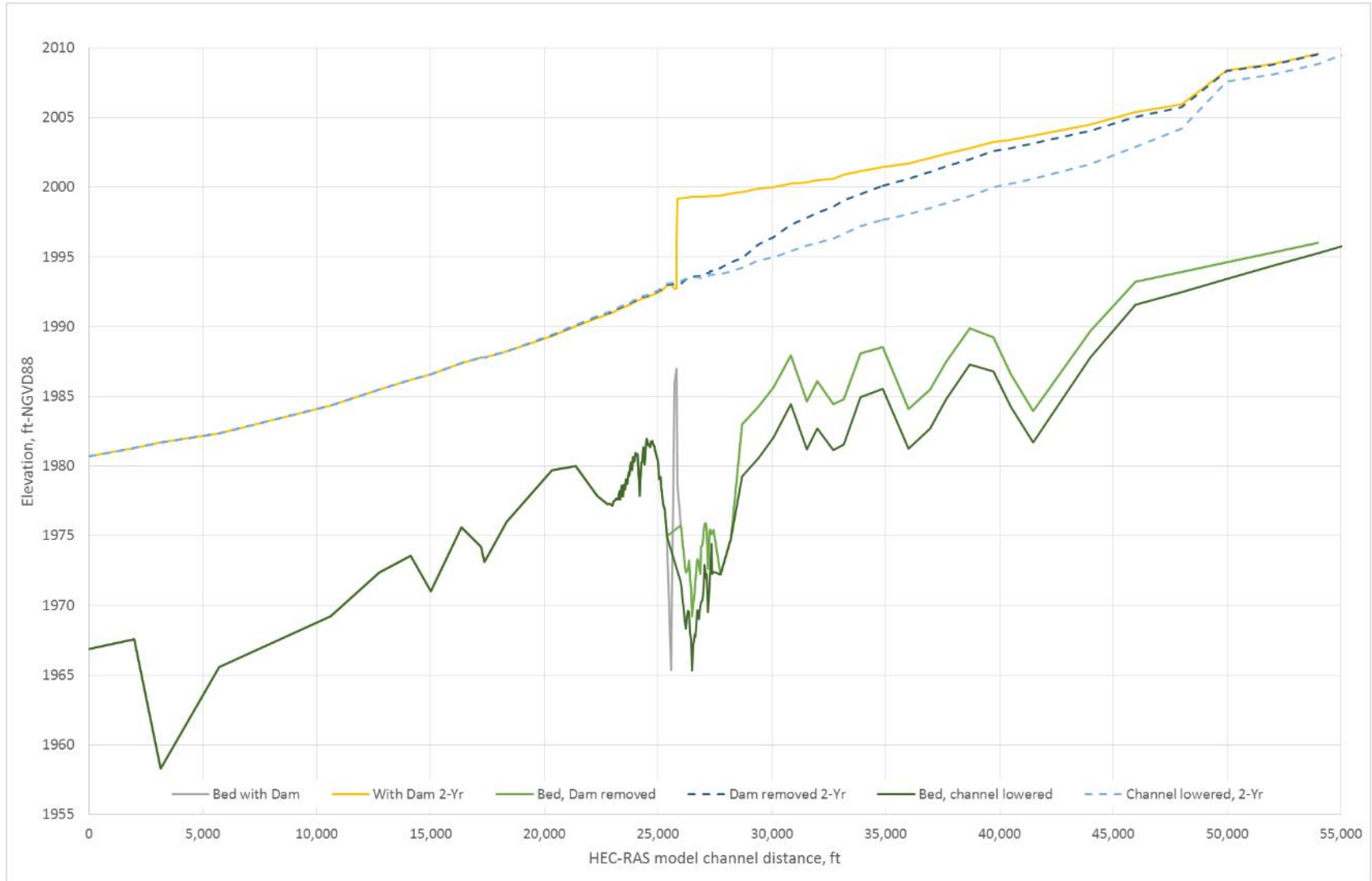

Figure 2-24. Yellowstone River Profiles for Existing and After Dam Removal

When this model is run for a range of flows, the potential gravity diversion for the Multiple Pumping Station with Conservation Measures Alternative is computed. Table 2-21 shows the potential gravity diversion-flow duration curves based on the Yellowstone River flow-duration curves for Sydney Gage (USGS gage # 06329500) (Corps 2006). The gravity diversion of 608 cfs could occur approximately 60 percent of the 5-month irrigation season. The percent time exceeded by month is also shown in the table and you can see that percentage is much higher during runoff but much less during August and September when pumping would likely be necessary 70 to 80 percent of the time.

TABLE 2-21. FLOW DURATION OF POTENTIAL DIVERSIONS BASED ON 1 FOOT HEAD LOSS

Percent Time Exceeded	Diversion potential based on Yellowstone River flow duration, cfs					
	May	June	July	August	Sept	5 months
0.01	1,374	1,374	1,374	1,374	1,374	1,374
0.05	1,374	1,374	1,374	1,374	1,374	1,374
0.1	1,374	1,374	1,374	1,374	1,374	1,374
0.2	1,374	1,374	1,374	1,374	1,331	1,374
0.5	1,374	1,374	1,374	1,302	1,095	1,374
1	1,374	1,374	1,374	1,214	946	1,374
2	1,374	1,374	1,374	1,116	847	1,374
5	1,374	1,374	1,374	904	748	1,374
10	1,374	1,374	1,374	790	692	1,374
15	1,269	1,374	1,374	731	647	1,374
20	1,141	1,374	1,374	692	612	1,282
30	1,002	1,374	1,245	620	569	1,035
40	908	1,374	1,088	544	525	853
50	828	1,374	916	491	472	724
60	765	1,262	801	442	427	620
70	692	1,120	674	379	387	527
80	614	977	523	334	352	443
85	554	908	474	308	331	400
90	513	832	428	267	314	356
95	452	731	385	215	286	307
98	403	625	331	192	247	245
99	364	559	314	187	231	210
99.5	277	521	289	182	203	194
99.8	250	492	254	177	192	186
99.9	231	466	249	174	188	182
99.95	229	464	246	172	186	177
99.99	227	464	240	167	181	169

Shaded boxes indicate full water right (1,374 cfs), bold boxes indicate times when 608 cfs reached

2.3.8.5 Canal Modification

The existing canal was designed for a diversion of 1,374 cfs and gravity flow throughout the 72-mile Main Canal and laterals. To compare how a smaller diversion would affect water levels in the canal several diversion discharges were compared in a HEC-RAS model developed for the Main Canal. Diversion discharges of 1,374 (current diversion flow rate), 1,200 cfs, and 608 cfs (target flow rate for the alternative) entering at the headworks were modeled.

Figure 2-25 shows the results of the upper 20 miles of the Main Canal profiles. This figure illustrates the issues of operating a canal at a much lower discharge than the current diversion discharge. As described above, a 608 cfs flow could be diverted by gravity approximately 60 percent of the irrigation season. The remaining time pumping would be required to bring the Main Canal discharge to the current operational level. Also, the water surface in the Main Canal would probably be too low for gravity diversion into the laterals. This could potentially be compensated through operation of existing and addition of new canal check structures, or by pumping from the Main Canal into the laterals. However, if canal check structure operation produces a higher tailwater at the headworks gravity diversion would be limited or even eliminated.

A substantial amount of additional analysis would be required to develop a revised canal design that accommodates 608 cfs and allows gravity flow to the laterals. The canal would have to be reconfigured to allow the gravity delivery of water to the laterals. For cost comparison we have estimated that ½ of the canal would be filled to provide the cross section necessary to deliver 608 cfs.

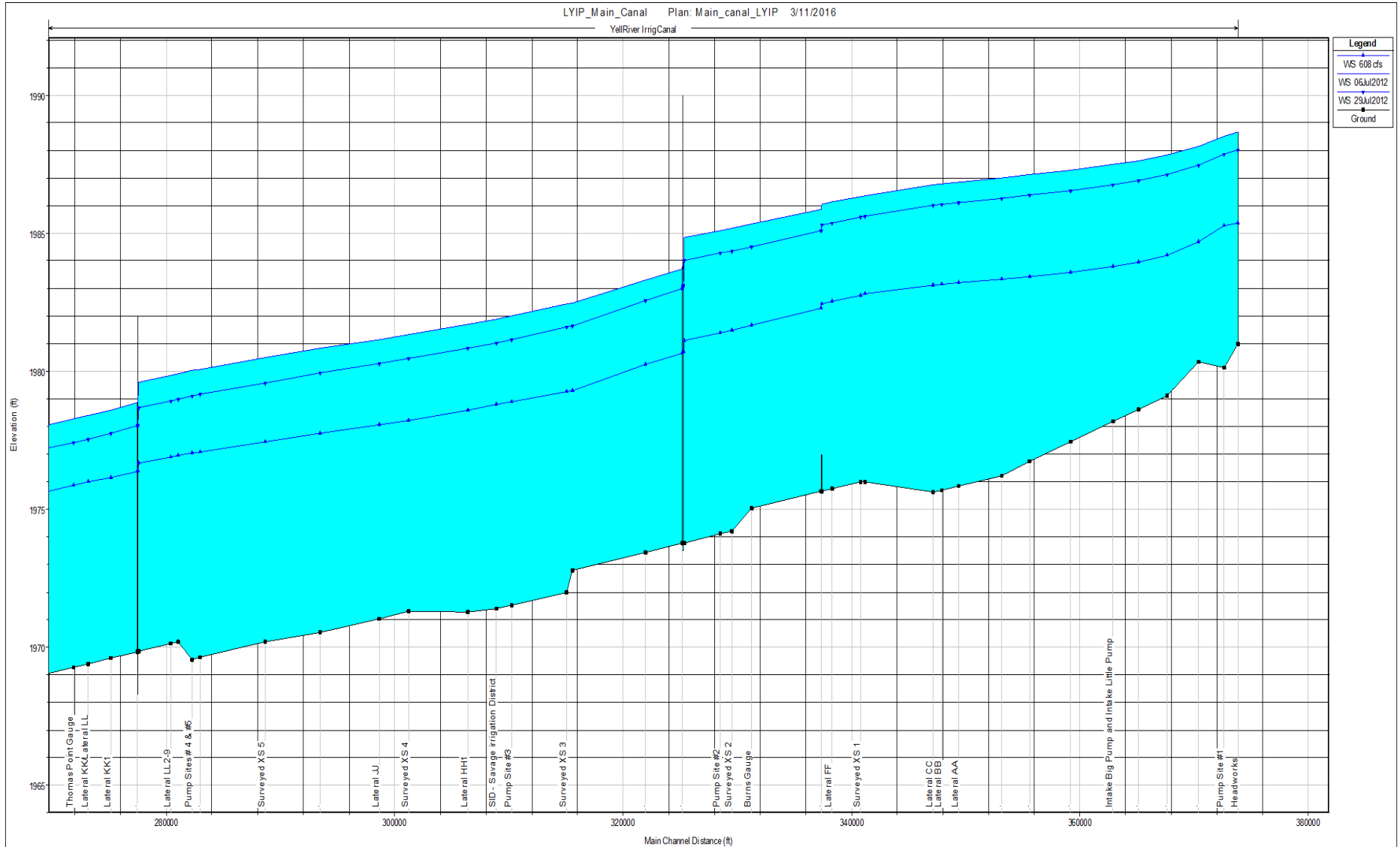

Figure 2-25. Main Canal Water Surface Profiles for Various Discharges

2.3.8.6 Wind Power

Since the upper Great Plains is a region known for its wind energy resources it is proposed under this alternative that Federal funds be used to pay for the capital cost of a windmill that would supply enough energy, on average, to meet the pump loads. Because the hours in which wind generation would occur would be spread across all twelve months of the year, while irrigation pump loads would be limited to May-September, banking arrangements would be needed with a utility to deliver unneeded generation to them in exchange for receiving generation back from them when pump loads exceeded the wind generation. It was proposed that the Western Area Power Administration (Western) could serve as this banking entity. The assumptions on the proposal include that it would require generation of 10 percent in excess of pump loads to account for transmission and distribution losses between the generator and the load, and a further 20 percent in excess of that to account for banking costs.

This component would require either partnering with a planned wind farm or construction of wind turbines as part of the project. If power is marketed (i.e., power is generated in excess of that directly needed to operate the project and sold), it is likely Congressional authorization would be necessary to add power as an authorized purpose on the Lower Yellowstone Project. Discussion with Western staff resulted in the conclusion that Western does not have authority to serve as a power credit banking facility (Shalund, 2016). Western has had past agreements with utilities such as PGE but those were displacement arrangements where Western served PGE loads and vice versa, where each had existing facilities.

An inquiry was made to Montana Dakota Utilities, which serves the project area, about building a wind turbine or buying into one of their facilities. That is not a likely scenario with a regulated utility. Alternatively, there could be a net metering agreement developed if the LYP were to install wind turbines in the project area. This would also require regulatory approval (Helm 2016). Typically, a wind farm requires several years of study for siting and permitting. That analysis is beyond the scope of this EIS, and would be carried out separately.

Reclamation believes it has sufficient authority to carry out actions necessary to accomplish fish passage at the Lower Yellowstone Project, including construction, operation and maintenance of wind power to operate necessary facilities. If power is marketed (i.e., power is generated in excess of that directly needed to operate Lower Yellowstone Project facilities and then sold), it is likely Congressional action would be necessary to authorize power as a project purpose for the Lower Yellowstone Project.

2.3.8.7 Irrigation Water Requirements and Conservation Measure Effectiveness

The proposed measures above are conceptual and quantities of water that could be conserved by implementing them theoretical. In order to quantify the amount of water required to support the current aceage supported by the project the following comparison was completed.

The LYP has water rights for a combined flow of 1,374 cfs, including the four irrigation districts (Savage, Intake and Lower Yellowstone Irrigation Districts #1 & #2) (Fraser et al. 2016). The oldest of these rights has a priority date of 1905 and a flow rate of 1,000 cfs. The LYP currently irrigates approximately 51,158 acres, as shown in Table 2-22.

Table 2-22 Lower Yellowstone Project Crops as of 2013 Crop Census

Crops	Acres
Beets	20,160
Wheat	13,017
Barley	6,994
Corn	4,690
Alfalfa, Hay	7,113
Grass (for hay)	2,493
Soy Bean	691
Total	55,158

Source: Lower Yellowstone Project Board of Control 2013

According to calculations using the NRCS Irrigation Water Requirements (IWR) model, this mix of crops has a consumptive use requirement during the irrigation season that exceeds the 608 cfs proposed for this alternative. Assuming peak evapotranspiration rates and an aggressive 70-percent efficiency, the crops would require 1,150 cfs during July. Even assuming a less conservative average evapotranspiration over the growing season, the crop water requirements from June to August cannot be met by a 608-cfs diversion. Additional details about the Irrigation Water Requirements model are found in of Appendix A-3 (Attachment 3), along with seepage and water conservation information. No field survey of seepage losses has been conducted for the LYP canal and laterals, but some data was identified to estimate the conservation benefits of several proposed measures.

Data from the Sidney Water Users Irrigation District indicates a seepage rate on unlined laterals of 1.33 cfs/mile. Calculation of seepage losses on four laterals in the LYP shows losses of 0.69 cfs/mile. Using those values, placing the proposed 72 miles of laterals into pipe would yield a conservation savings of 50 to 95 cfs—well below the 256 cfs savings indicated in Table 2-18. Lining the remaining 153 miles of LYP laterals could conserve 100 to 200 cfs.

Water loss data from the Main Canal for two years (2000 and 2012) was evaluated by Higley (2016). That analysis of flow records indicates that there are minimal losses during periods of high demand, and not likely 200 cfs that could be conserved by lining the Main Canal. Seepage losses measured in several unlined irrigation canals throughout the state for another study averaged 1.62 cfs/mile (Lafave and Abdo 2015). That rate would indicate a loss of 116 cfs to seepage over the 72-mile LYP canal.

It was also proposed that converting an additional 5,000 acres of land to sprinklers could conserve enough to reduce diversions by 160 cfs. Farm irrigation requirements and conditions are site-specific, but to make an estimate it was assumed, based on the NRCS National Engineering Handbook, that on-farm efficiency is 40 to 50 percent for flood irrigation and 70 to 80 percent for sprinklers. Potential savings from the sprinkler conservation measure were then based on the following assumptions:

- 5,000 acres converted to sprinklers
- Peak daily evapotranspiration for alfalfa of 0.33 inches/day (NRCS IWR Irrigation Water Requirements model data)

- Field flood irrigation efficiency of 45%
- Sprinkler irrigation efficiency of 75% .

With these assumptions, flood irrigation would require 154 cfs and sprinklers 92 cfs, a difference in 62 cfs (see Appendix A-3, Attachment 3).

These analyses indicate that, although reductions in water requirements theoretically could be achieved through conservation measures, they may not be as much as proposed for this alternative and may not be enough to meet the minimum peak demand for crops during the hottest and driest part of the growing season.

2.3.8.8 Construction

The construction schedule for this alternative is dependent on further study and other factors, which must first be determined. Those include additional study to site Ranney wells and siting of a wind turbine. In addition since the conversion to sprinkler irrigation is an individual farm decision its implementation is also uncertain.

It is assumed that at least an 8-year construction schedule would be required to implement this alternative. A general sequence of implementation (5 phases) would ideally replace the water source prior to dam removal and will require staging to avoid closing the entire canal to operation during the growing season.

- Drilling and pump tests for Ranney wells, wind turbine siting study.
- Ranney well installation.
- Canal and lateral modifications.
- Install wind turbine
- Dam removal

2.3.8.9 Operation and Maintenance

The implementation of conservation measures and associated reduction in diversions at the headworks would require large changes to the operation of the irrigation system. It is assumed that the headworks O&M would be the same or higher as under the No Action, including sediment removal activities and monitoring. The five existing pumps would also continue under this alternative. In the estimated O&M for this alternative, the line item including average canal, lateral and drains was reduced according to the miles of laterals piped or lined. Costs for OM&R of those structures were added however, including repair and replacement of piped and lined laterals every 15 and 10 years respectively. There will also be monitoring and periodic sediment removal at each of the new check structures and flow monitoring devices.

Operation of the system at low flows requires additional labor and monitoring. Operation of the system at a diversion of 608 cfs will be similar to the amount of ditch rider effort required during rationing at low flows (Brower 2016). Mr. Brower (LYP) provided an estimate of the number of ditch riders needed to accomplish this. This was added to the operating costs.

Operation and maintenance of center pivot sprinklers averages \$60/acre/year. These costs were added for the 5,000 acres assumed to be converted to sprinklers. In addition, sprinklers have an assumed 35-year lifetime and replacement was assumed over a 10-year period in 35 years.

Sprinklers would likely be an individual farm cost but the costs are part of the alternative and have been included here for comparison.

It is estimated that the Ranney wells associated with this alternative would consume 4.2 gigawatt-hours of power in a typical year. This assumes that 608 cfs could be diverted by gravity for 60 percent of the irrigation season and Ranney wells would pump the remaining time. Additional details and power calculations are in the Engineering Appendix. In addition it was assumed that the wells would require ongoing inspection and maintenance, and rehabilitation every 10 years.

As described in section 2.3.2.3 *Pick Sloan Missouri Basin Program Power*, the LYIP may be able to purchase power at a reduced rate compared to local electrical power. Montana-Dakota Utilities, the local electrical power supplier, estimates power costs at current rates for this alternative at \$240,000 per year for the first five years until wind energy is developed. If the LYIP is able to secure Pick Sloan Missouri Basin Program power for this alternative, the power costs based on current rates are estimated to be from \$67,914 to \$178,083 per year.

Cost associated with the additional power necessary for this alternate may be less if an increase in the Contract Rate of Delivery (CROD) is requested and approved. If the LYIP requests an increase in the Contract Rate of Delivery (CROD) for the power rate identified above, approval of such a request would result in Reclamation taking an action to amend the LYIP Project Use Power Contracts increasing the CROD.

Annual OM&R costs for this alternative are estimated as \$4,385,650. The presented annual cost accounts for the frequency that OM&R activities are expected to occur over a 50 year period. OM&R costs over the period are converted to present values using the FY16 (3.125-percent) federal discount rate. Table 2-23 summarizes the costs and assumptions used to develop this estimate. Additional detail on OM&R estimates is found in Appendix B Cost Engineering.

TABLE 2-23. SUMMARY OF O&M COSTS FOR MULTIPLE PUMPS WITH CONSERVATION MEASURES

O&M Item Description	Annualized Cost ¹
Main Canal, Laterals, Drains	
Main Canal, Laterals, Drains	\$980,000
Conservation Measures	
Additional Ditch Riders	\$583,200
Vehicles	\$129,600
Piped Laterals	\$38,140
Lined Lateral	\$8,673
Lined Open Canals	\$71,552
Remove Sediment and inspect check structures	\$45,000
Flow Measuring devices inspection and sediment removal	\$30,000
Operate and Maintain Center Pivots	\$0
Wind Turbine Maintenance	\$42,626
O&M of SCADA System and Flow Measuring Devices	\$105,000

Technicians for SCADA System	\$120,000
Transportation	\$32,400
Headworks	
Sediment Removal	\$10,000
Daily Operations	\$77,000
Fish Screen Manifolds	\$55,041
Fish Screen Cylinder Units	\$32,377
Fish Screen External Brushes	\$45,092
Fish Screen Internal Brushes	\$45,092
Fish Screen Seal System	\$10,408
Pumps	
Lateral Pumps	\$50,000
Ranney Well Pumps Rehab	\$182,132
Ranney Well Pump Motors Rehab	\$126,000
Ranney Well Pump Replacement	\$85,390
Ranney Well Pump Motor Replacement	\$53,821
Pump and Motor Removal and Install	\$42,000
Inspection and Maintenance of Ranney Well Screens	\$672,000
Control Panel and Electronics	\$7,000
Man Power to Maintain and Operate Pump sites	\$240,000
Vehicle	\$64,152
Power Costs	\$43,582
Service discharge pipes and valves	\$6,799
Existing Pumps	\$235,000
Admin Costs	
Administrative/Indirect Costs	\$61,000
ESA Monitoring Costs²	
Passage and Entrainment Monitoring	\$55,573
Total Annual O&M	
\$4,385,650	
1. Annual O&M is based on 50-year period of analysis and 3.125% Federal discount rate 2. Reclamation is committed to monitoring the effectiveness of the project, consistent with the outcome of Endangered Species Act consultation. Funding sources for these monitoring activities will be determined based on Reclamation Law, Policy, and availability of funding.	

2.4 Alternatives Analysis

Reclamation and the Corps have considered multiple factors in determining the preferred alternative for improving fish passage. This section describes the alternative analysis and comparison of alternatives.

2.4.1 Purpose and Need

As described previously, the purpose of the proposed action is to improve passage of the endangered pallid sturgeon and other native fish at the Intake Diversion Dam in the lower Yellowstone River while continuing a viable and effective operation of the Lower Yellowstone Project. Table 2-24 summarizes each alternative’s ability to achieve these purposes.

The No Action Alternative does not meet the purpose and need, as it does not provide fish passage. The Multiple Pumps with Conservation Measures Alternative does not meet the purpose and need because it does not provide sufficient irrigation water to continue viable and effective operation of the Lower Yellowstone Project.

TABLE 2-24. ALTERNATIVES’ ACHIEVEMENT OF THE PROJECT PURPOSE AND NEED

	Improves Fish Passage	Continue Viable and Effective Operation of the Lower Yellowstone Project
No Action	No	Yes
Rock Ramp	Yes	Yes
Bypass Channel	Yes	Yes
Modified Side Channel	Yes	Yes
Multiple Pump	Yes	Yes*
Multiple Pumps with Conservation Measures	Yes	No

*Questions exist about certain design elements that are not fully developed at the current level of design such as ice damage protection of facilities, OM&R of proposed fish screens, ability to safely return juvenile and adult pallids to the river, and pump design specifications. As designs progress, these elements are expected to be more fully addressed, however the ultimate design of these elements can influence OM&R costs, which has bearing on the ability of the alternative to support continued viable and effective operation of the Lower Yellowstone project.

Although the No Action Alternative and Multiple Pumps with Conservation Measures Alternative do not meet the project purpose and need, they were carried through the alternatives analysis in the EIS.

It should be noted that the action alternatives’ achievement of the project purpose and need identified in Table 2-30 is predicated upon Corps funding of project construction costs. If the Corps is unable to fund construction costs, then likely none of the action alternatives would meet the project purpose and need, and specifically the need to maintain a viable and effective irrigation project. The Lower Yellowstone Project was constructed under the authority of the Reclamation Act of 1902 (Public Law 57-161). Section 6 of the Reclamation Act requires LYIP to reimburse Reclamation expenditures associated with operating and maintaining the Lower

Yellowstone Project. For example, if Reclamation spent \$50 million to implement a fish passage alternative, Lower Yellowstone Project irrigator’s reimbursement share, which is 100 percent, would be approximately \$900 per acre or roughly \$195,000 for the typical farm with 215 irrigated acres. Reimbursement is required the same year the expenditure is made under current authority and policy. This cost is believed to be well beyond irrigator’s ability to pay based on their current net farm income of \$241 per acre. Even if Congress provided appropriations to Reclamation, the District would still be required to reimburse Reclamation under current authority. Thus under Reclamation’s current authority, the action alternatives would not meet the purpose and need if Reclamation, rather than the Corps, funds construction costs.

2.4.2 Cost Estimates

This section describes costs of the proposed alternatives and contains the best available current information on the costs of the action alternatives for the purpose of analysis and comparison. Both construction and OM&R costs have been estimated for comparison of the alternatives. Table 2-25 includes estimates of construction costs, these include construction, design, construction management, and real estate costs. Real estate costs were estimated for the alternatives that require acquisition or easements on private land, there were no costs included for Federal lands. Detailed construction cost estimates for all alternatives are included in Appendix B. These cost estimates should only be used to compare alternatives. All alternative estimates are provided in April 2016 prices, so these are directly comparable from a cost standpoint.

TABLE 2-25. SUMMARY OF ALTERNATIVE CONSTRUCTION COSTS

	No Action	Rock Ramp	Bypass Channel	Modified Side Channel	Multiple Pump	Multiple Pumping with Conservation Measures
Construction Cost		\$79,592,000	\$53,784,000	\$47,557,000	\$115,314,000	\$414,415,000
Design ^a		\$6,480,000	\$0	\$3,944,000	\$9,697,000	\$36,006,000
Construction Management		\$4,382,000	\$3,260,000	\$2,665,000	\$6,463,000	\$24,004,000
Real Estate		\$0	\$0	\$275,000	\$554,000	\$3,500,000
Total First Cost		\$90,454,000	\$57,044,000	\$54,441,000	\$132,028,000	\$477,925,000

a. Design for the Bypass Channel has been completed and is therefore considered a sunk cost.

Table 2-26 provides the annualized costs of each alternative. Annualized costs have been developed and include interest during construction, monitoring and adaptive management and OM&R. OM&R are included in detail under the alternative descriptions in Section 2.5. All of these costs were estimated over a 50-year period of analysis using the current federal discount rate and are presented in April 2016 prices. Monitoring is assumed to occur for the first eight years and for comparison purposes adaptive management was estimated as 1 percent of the construction cost.

TABLE 2-26. ANNUALIZED COSTS FOR EACH ALTERNATIVE (3.125% DISCOUNT RATE)

	No Action	Rock Ramp	Bypass Channel	Modified Side Channel	Multiple Pump	Multiple Pumping with Conservation Measures
Total First Cost	0	\$90,454,000	\$57,044,000	\$54,441,000	\$132,028,000	\$477,925,000
Construction (Months)	0	18	28	18	42	90
Interest During Construction	0	\$1,880,000	\$2,002,000	\$1,124,000	\$6,557,000	\$53,790,000
Total Investment Cost	0	\$92,334,000	\$59,046,000	\$55,665,000	\$138,585,000	\$531,715,000
Annualized Investment Costs	\$0	\$3,674,000	\$2,350,000	\$2,215,000	\$5,515,000	\$21,159,000
Annualized Adaptive Management	\$0	\$32,000	\$22,000	\$19,000	\$46,000	\$165,000
Annualized OM&R (includes annual monitoring)	\$2,643,000	\$2,840,000	\$2,799,000	\$2,907,000	\$5,034,000	\$4,386,000
Average Annual Cost	\$2,643,000	\$6,546,000	\$5,171,000	\$5,141,000	\$10,595,000	\$25,710,000

2.4.3 Fish Passage Analysis

The Fish Passage Connectivity Index was developed to evaluate ecosystem outputs (i.e. benefits) of alternative measures for fish passage improvements on the Upper Mississippi River and Illinois Waterway System for cost-effectiveness and incremental analysis (Corps 2010). The model was developed for use in the plan formulation process for the Navigation and Ecosystem Sustainability Program for the Upper Mississippi River System Lock and Dam 22 fish passage improvement project. The model has subsequently been approved for use in the planning context for fish passage projects on other river systems (Corps 2016). This model was used in an assessment of fish passage alternatives at the Intake Diversion Dam in 2014 (Corps 2014b).

Although the model was developed to measure benefits of fish passage in the Upper Mississippi River, the model is applicable (with slight adjustments) to fish passage projects on other large river systems, especially those with very similar fish communities. This model, with minor adjustment, was used as a planning tool for comparing benefits of alternative plans to improve fish passage at the Intake Diversion Dam. Appendix E describes the input data used and minor adjustments made to the model to demonstrate ecological benefits of the Yellowstone River Intake Diversion Dam fish passage alternatives. Table 2-27 shows the fish passage connectivity index and habitat units for each alternative.

TABLE 2-27. FISH PASSAGE CONNECTIVITY INDEX SCORES AND HABITAT UNITS

Alternative	€ = Fish Passage Connectivity (Avg.)	Avg. Habitat Units	Δ Habitat Units
No Action	0.08	938	0
Rock Ramp	0.43	5158	4220
Bypass Channel	0.67	8054	7178
Modified Side Channel	0.61	7432	6556
Multi Pump	1	11949	11073
Multiple Pumping with Conservation Measures	1	11949	11073

2.4.4 Cost-Effectiveness

When planning for the restoration of environmental resources, cost-effectiveness (CE) and incremental cost analyses (ICA) may be used as tools for the comparison of alternative plans (CE/ICA). CE/ICA are comparisons of the effects of alternative plans; more specifically, they involve comparisons between the outputs and costs of different solutions. Traditional benefit-cost analyses are not applicable to environmental planning when costs and benefits are expressed in different units; however, CE/ICA offers plan evaluation approaches that are consistent with the Principles, Requirements & Guidelines evaluation framework. The Institute for Water Resources Planning Suite software was used to assist in performing the CE/ICA. Alternative plans were evaluated and compared in terms of cost (e.g. construction, operation, and maintenance) and environmental outputs over a 50-year period of analysis. Detailed discussion of the CE/ICA can be found in Appendix E.

2.4.4.1 Cost-Effectiveness Analysis

Cost-effectiveness analysis is a form of economic analysis designed to compare costs and outcomes (or effects) of two or more courses of action. This type of analysis is useful for environmental restoration projects where the benefits are not measured in monetary terms but in environmental output units such as the Habitat Units developed in this study. The purpose of the cost-effectiveness analysis is to ensure that the least cost plan alternative is identified for each possible level of environmental output; and that for any level of investment, the maximum level of output is identified. Table 2-28 provides the results of the cost-effectiveness analysis sorted by increasing output in average annual habitat units (AAHU).

The No Action, Bypass Channel, Modified Side Channel and Multiple Pump alternatives were identified as cost effective. The Rock Ramp alternative is not cost effective because the Bypass Channel alternative provides greater output for less cost. The Multiple Pumps with Conservation Measures alternative is not cost effective because the Multiple Pump Stations alternative provides the same level of output for less cost.

TABLE 2-28. COST-EFFECTIVENESS BY ALTERNATIVE

Alternative	Annual Cost (\$1000)	Net AAHUs	Cost per AAHU (\$)	Cost-Effective?
No Action	\$0	0	\$0	Yes
Rock Ramp	\$6,546	4,220	\$1,551	No
Modified Side Channel	\$5,137	6,494	\$791	Yes
Bypass Channel	\$5,170	7,116	\$727	Yes
Multiple Pump	\$10,594	11,011	\$962	Yes
Multiple Pumping with Conservation Measures	\$25,709	11,011	\$2,335	No

2.4.4.2 Incremental Cost Analysis

Subsequent incremental cost analysis of the cost-effective plans is conducted to reveal changes in costs as output levels are increased. Only plans that were deemed as cost-effective in the cost-effectiveness analysis have been advanced to incremental cost analysis. These cost-effective plans are the No Action, Bypass Channel, and Multiple Pump alternatives. During the ICA, the

cost-effective plans are examined sequentially (by increasing scale in terms of net AAHUs produced) to ascertain which plans are most efficient in the production of additional environmental benefits.

The calculations and values show the incremental cost per unit output between the bypass channel and the no action, and then between the multiple pumping stations alternative and the bypass channel alternative. Table 2-29 shows that the most efficient plan above no action is the Bypass Channel Alternative that provides 7,116 additional habitat units at a cost of \$727 each. If more output is desired, the next most efficient plan available is the multiple pumping stations alternative that provides an additional 3,895 habitat units, at a cost of \$1,393 dollars for each additional unit.

TABLE 2-29. INCREMENTAL COST ANALYSIS SUMMARY

Best Buy Alternative	Annual Cost (\$1000)	Net AAHUs	Incremental Output	Incremental Cost	Incremental Cost per Unit Output
No Action	\$0	0	0	n/a	n/a
Bypass Channel	\$5,170	7,116	7,116	\$5,170	\$727
Multiple Pump	\$10,5594	11,011	3,895	\$5,424	\$1,393

Figure 2-26 provides a visual representation of this increase in incremental cost. The figure graphically illustrates the incremental cost and output differences between the two best buy action alternatives. The width of each box in the chart represents the incremental output of that plan, and the height of each box shows the incremental cost per unit of that output. The relatively wide box for the Bypass Channel alternative shows that it provides about 65 percent of the total output possible at a cost of approximately \$699 per unit. The box for the Multiple Pump alternative shows that to achieve the remaining 35 percent of total possible output would be more expensive per unit than the first 65 percent (\$1,393 each).

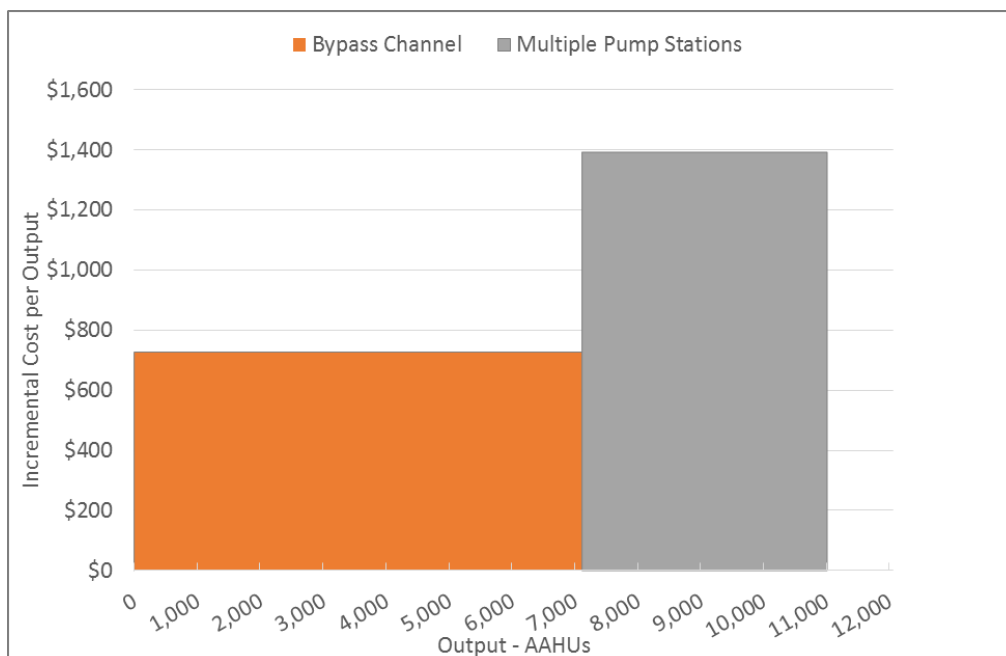

Figure 2-26. Incremental Cost Analysis Chart

2.4.5 Comparison Matrix

A matrix evaluation method was chosen to evaluate several factors and compare the alternatives to determine the best recommendation for the Project. All alternatives were evaluated in terms of how they compare in regards to the following categories as described below.

- **Constructability:** Constructability refers to the ease of constructing the project. It considers the complexity of the construction, duration of construction, and whether it may require new or unique construction methods.
- **Sustainability:** Sustainability refers to the ability of the alternative to perform over the long-term. In the table items that were considered include; ability to withstand ice forces and river flows, ability to be operated and maintained, and long term performance.
- **Adaptive Management:** Ability and potential to adjust project features to meet the fish passage objective. In the table, reference to a high potential for adaptive management means that features can be adjusted if they are not performing as desired, low potential means that there are not features that can be modified.
- **Viability of the Irrigation Project:** comparison of viability includes consideration of the ability of the alternative to provide reliable irrigation water source and impact to farm income.
- **Cost-Effectiveness:** Compares the results of the Cost-Effectiveness/Incremental Cost Analysis that is described in Section 2.6.4.
- **Endangered Species Act Success:** Ability to pass pallid sturgeon and ability to meet FWS criteria.
- **Environmental Impacts:** Summary of environmental consequences such as; duration of construction, effects on recreation, wetlands, cultural resources, side channels, beneficial uses under the Clean Water Act, and state species of concern. Additional detail pertaining to the environmental consequences is found in Chapter 4.

Table 2-30 below is the matrix which includes a qualitative comparison of the alternatives based on these criteria.

TABLE 2-30 ALTERNATIVE COMPARISON MATRIX

	Intake Diversion Dam Fish Passage Alternative Comparison					
	No Action	Rock Ramp	Bypass Channel	Modified Side Channel	Multiple Pump	Multiple Pumping with Conservation Measures
Constructability	There would be no construction	A large quantity of rock will need to be delivered to the site, rock placement during construction will need to be placed to tight tolerances, cofferdams on the river and care of water are required, and construction may be difficult.	Construction of the replacement weir requires cofferdams and care of water while it is being constructed. The channel construction is not complex.	Channel modification is straightforward; a replacement weir does not need to be constructed.	Care of water, dam removal and material in river	Large scale and complex construction required to line canals and implement conservation measures on an operating system. Timing of construction will be complex. Ranney well construction is also uncertain.
Sustainability	No additional maintenance required Long-term rocking—reduces diversion reliability some	Key fish passage element. Ability to withstand ice and O&M provide challenges with rock placement. Long-term performance of the ramp is uncertain.	Any ice damage to the bypass channel is accessible for repairs. Weir damage will likely need a floating plant for performing repairs.	Rock replacement for maintenance of Intake Diversion Dam will be ongoing.	High energy costs and new infrastructure required for pumping. OM&R of the pumps is an ongoing requirements and costly. Although pumps are set back channel movement is a risk.	OM&R of the pumps and Ranney wells will be ongoing. There is uncertainty about the long-term performance and ability to provide water source. Requires power to operate pumps.
Adaptive Management	Minimal Potential to AM	High Potential for AM	Moderate Potential for AM	Moderate Potential for AM	Minimal need for AM	Minimal to need for AM
Viability of the Irrigation Project	Costs for No Action include rehabilitation of the Intake Diversion Dam and trolley, and monitoring not currently included in O&M costs.	Reduced O&M costs due to replacement weir	Reduced O&M costs due to replacement weir	There are increased costs for this due to rehabilitation of the Intake Diversion Dam and trolley.	This alternative has the highest power costs. Would reduce farm income.	This alternative has second highest power costs, but highest operational costs due to reduced diversions and water management requirements. Would reduce farm income.
Cost-Effectiveness	Best buy, but provides no benefits	Not cost-effective	Best buy, lowest incremental cost	Not cost-effective, but costs less	Best buy, higher incremental cost than other best buy	Not cost-effective, most expensive, highest annual cost.
ESA Success	Does not pass fish currently	Doesn't meet hydraulic criteria at all flows, turbulence may impact fish passage.	Meets FWS Criteria and has high potential to pass fish	Meets FWS Criteria but entrance is further downstream, reducing chances of finding the channel	Open river	Open river
Environmental Impacts	No fish passage 303d listing	Fishing access site relocation, partial fish passage, larger temporary construction effects, Changes natural substrate/channel at the dam	Fish passage provided, temporary construction (replacement weir), Blocks side channel-fills waterbody and wetlands, excavates wetlands	May not perform as well due to location, changes existing side channel, ongoing effects of rock placement	Uncertain cultural resources impacts, Potential entrainment of fish at pumps, construction in the CMZ (feeder canals)	Uncertain cultural resources impacts, Effects on irrigation system, Land use changes (Ranney wells), Wetland impacts (reduced return flows) from irrigation canals

Page intentionally left blank

2.5 Identification of the Preferred Alternative

2.5.1 Reasons for Selected Alternative

The Council on Environmental Quality's Forty Most Asked Questions Concerning CEQ's National Environmental Policy Act Regulations (1981) states, "The 'agency's preferred alternative' is the alternative which the agency believes would fulfill its statutory mission and responsibilities, giving consideration to economic, environmental, technical and other factors." Based on this, Reclamation and the Corps have identified the Bypass Channel as the preferred alternative for the following reasons:

The agencies believe the Bypass Channel Alternative could be constructed, operated, and maintained to meet the physical and biological criteria identified by the Service's BRT, and therefore would provide passage for pallid sturgeon.

The Bypass Channel Alternative is a cost effective means of providing fish passage (see section 2.5.4.2).

Of the action alternatives, the Bypass Channel Alternative is expected to have the lowest annual O&M costs (see Table 2-26).

The agencies believe, based on the analysis in this EIS, implementation of the Bypass Channel Alternative, and the associated actions to minimize impacts, would not result in significant long-term adverse environmental impacts.

2.5.2 Sturgeon Use of Bypass Channels

While the Bypass Channel has been evaluated to provide the best likelihood of providing upstream pallid sturgeon passage past the Intake Diversion Dam at a reasonable cost and in consideration of the factors discussed above, there have been concerns raised about whether bypass channels, in general, have been demonstrated to actually be used by sturgeon for passage. The project team researched available literature and data for proposed or constructed fishways in other locations.

2.5.2.1 The Potential for Successful Passage in a Bypass Channel by Pallid Sturgeon

Research on adult pallid sturgeon in controlled flume conditions, which provides critical information on fish behavior and swimming ability under real scale velocity and structural configurations (Kynard 1993) is lacking. Thus, designing a fish passage facility to pass pallid sturgeon upstream of Intake Diversion Dam must rely on all available relevant information on both shovelnose and pallid sturgeon, even though there are obvious differences between the two species for passage ability (for example: shovelnose sturgeon ascend over Intake Diversion Dam in small numbers (Rugg 2016), but there is no evidence that any pallid sturgeon ascend over Intake Diversion Dam). Because, to date, no successful upstream fish passage facility of any type has been built for shovelnose or pallid sturgeon, the use of available information on behavior or swimming ability on these species during migration or in a fishway environment is the best available science that can be used to evaluate the probability of success for a fishway design.

2.5.2.2 Swimming ability and passage of pallid sturgeon

Information on swimming ability relative to fish passage comes from research on behavior and swimming ability of juveniles during fish passage in an artificial flume (Kynard et al. 2002,

2008) and from tracking wild adults in side channels of the Yellowstone River (Braaten et al. 2014). During fish passage observations, 22 4-year old juveniles (mean FL= 1.5 feet; range= 1.1-1.7 feet FL) were observed while swimming in laminar flow over an open bottom channel 11 inches wide x 11.7 feet long. Fish were also observed ascending a side-baffle fish ladder built in a section 9 feet 8 inches long x 1 foot 6 inches wide with three side baffles, each 39 inches apart, positioned perpendicular to flow and extending halfway across the channel and alternating from the left to right side of the channel. Swim speed of the 22 pallid sturgeon with the fastest swim speed against a water velocity of 1.02 feet/second swam at 0.9-2.0 body lengths/second (1.35 – 3 feet/second) for long time periods (20 seconds to 200 minutes). Fish swam for much longer than 200 minutes at 1 body length/second (~1.5 feet/second) using sustained swim mode. Twelve of the 22 fish (55%) ascended 2.0-2.4 feet/second velocity using a prolonged swimming mode of 1.3-1.6 body length/second (1.9 – 2.4 feet/second). Thus, adults that are 3 feet longer should be able to ascend a water current of 4 feet/second using a prolonged swim speed of 1.3 body lengths/second. Behavioral observations on the cultured juvenile pallid sturgeon navigating the fish ladder indicated they quickly learned to adapt to changing velocity and turbulence created by structures and always swam within 2-3 inches of the bottom. The bottom in the artificial flume contained no large rocks or other features, so nothing was learned about pallid sturgeon use of bottom structure. However, in all observations, swimming juveniles were always approximately 2-3 inches above the bottom, so bottom structure is likely important in determining whether a fish passage facility is acceptable for passage or not. Fish swam through a slot created by the baffles in only 2 seconds. The major finding of observations on juveniles was that they could swim in complex flows using a swimming speed of 1-1.6 body lengths/s or greater.

In the Yellowstone River (Braaten, et al. 2014), 58 wild adults were telemetry tracked to reveal the following information during migration: fish used the main channel or side channels up to 2.3 miles long, fish used water depths of 7.7-11.2 feet deep, and used mean water column velocities of 2.9-6.0 feet/second (excluding the lower 0.8 feet of the water column). Mean size of fish was 4.6 feet FL; thus, most fish were swimming in a prolonged swim mode of ≤ 1.3 body lengths/second (if they were in the mean water column depth). However, the observations of juveniles in the flume suggested most wild adults were swimming nearer the bottom in the lower 5% of the water column, where water velocity is slower than the mean column velocity. If correct, the data may overestimate the actual swimming speed of tagged fish. Even if there is an error in water velocity actually used by adults, the data indicates adults should be able to ascend a current of 4 feet/second using prolonged swimming. The study did not record tagged adults using or avoiding bottom structure.

2.5.2.3 Fish Bypass Channels

This semi-natural design for fish passage around dams originated in Germany and Austria in the 1980s and 1990s with hundreds of small bypasses built to provide stream habitat for lotic fishes, and almost secondarily, to provide fish passage (Jungwirth et al. 1998). American Rivers is active with nature-like fishways including bypasses in the eastern USA (see Illustrative Handbook on Nature-like Fishways by Wildman et al. 2011). The Handbook shows the wide range of bypass designs in Europe and in the eastern US, although most of these channels are on small streams. Project team member, B. Kynard, participated in the design of a bypass channel for shortnose sturgeon at Lock & Dam #1 on the Cape Fear River in North Carolina and another similar channel was designed for the Savannah Bluff Lock and Dam in South Carolina. However, neither of these channels have been built. Based on B. Kynard's extensive experience

with flume and field studies of shortnose sturgeon, the Cape Fear Bypass Channel would likely have successfully passed shortnose sturgeon and other migratory fish. A short bypass channel for non-sturgeon fishes was designed for a dam in Minnesota (Aadland 2010). However, design of this bypass does not seem suitable for pallid sturgeon because of the small size of the bypass, abundant large boulders, and shallow slow water flow (B. Kynard pers. observation).

Muggli Bypass Channel on the Tongue River

This bypass channel was constructed in 2007 around the T&Y Diversion Dam on the Tongue River and has been shown to pass many native migratory fish species, but has not yet been shown to pass shovelnose sturgeon, one of the primary target species for passage (McCoy 2013). Shovelnose sturgeon is the only species observed in abundance below the dam that have not been observed successfully ascending the bypass.

No detailed evaluation of this bypass channel has been done but water velocity, boulder placement, and attraction flow are hypothesized to play a role in preventing sturgeon from entering and using the bypass. Water velocities in the lower third of the bypass were rarely less than 7 feet/second during periods of high flow (when shovelnose sturgeon are migrating). The high water velocities in the bypass channel may be attributed to the steep gradient in the lower third of the bypass. Recommended water velocity for shovelnose sturgeon passage is 3-4 feet/second (White and Mefford 2002). Also, spacing of the boulders in the channel may also be a problem. Many of the boulders were placed with a gap of only 8-10 inches, which may be a barrier to the passage of large fish, like shovelnose (or pallid sturgeon) that remain in contact with or just above the bottom most of the time, even when ascending fish passage structure (Kynard, et al. 2002). The recommended boulder spacing for shovelnose sturgeon is 24 inches (White and Mefford 2002). Because boulder spacing is important for shovelnose sturgeon, it is also likely important for pallid sturgeon, but unfortunately, no data on acceptable spacing of boulders for pallid sturgeon are available. One might reasonably expect the acceptable boulder spacing to be much greater for adult pallid sturgeon, which are always longer than adult shovelnose sturgeon. Further, attraction flow of 2 feet/second from the Muggli bypass channel entrance to the thalweg of the river was masked by turbulent flow of water passing over the T&Y Diversion Dam when discharge levels exceeded 800 cfs. Thus, during periods of high discharge (and peak sturgeon migration?) shovelnose may have difficulty finding the bypass fish entrance. To address velocity issues in the lower third of the bypass and masking of attraction water flow, the channel was extended out into the river. Increasing the spacing between boulders should also be done as recommended by White and Mefford 2002. A fish passage efficiency study could provide critical research information to correct the Muggli bypass channel and to inform the design of future bypasses for shovelnose (and pallid) sturgeon.

2.5.2.4 Side-channel Ascent by Pallid Sturgeon

Adults ascend side channels in the Yellowstone River, including the existing side channel that bypasses Intake Diversion Dam (Braaten et al. 2014). These monitoring results suggest a bypass channel with the general geomorphic and flow characteristics of existing side channels in the river could best pass adult pallid sturgeon. Mean velocity from HEC-RAS modeling for this study of the existing side channel at Intake Dam is 2-3 feet/second even at 54,000 cfs river flow, which would have been similar to flows and conditions present when pallid sturgeon were tracked successfully passing through the side channel (Rugg 2014, 2015). The proposed Bypass Channel Alternative design has been modeled to have mean velocities of 3 feet/second at lower

flows (7,000 cfs river flow) and 4-5 feet/second at higher river flows (15,000, 30,000, and 54,000 cfs river flow).

The HEC-RAS modeling of the proposed Bypass Channel Alternative shows that mean column velocity is greatest (4-5 feet/second) in the center section of the bypass channel, velocities on the bypass channel sides are reduced and usually are 2-3 feet/second. The bypass channel provides this slower velocity habitat (< 4 ft/s) on the channel sides during the range of river flows from 7,000 to 54,000 cfs. All observations on swimming of pallid sturgeon in artificial flumes or in the Yellowstone River, show adult pallid sturgeon should be able to ascend a bypass channel with these velocities. The slower velocities along the sides of the channel will likely also be used by other migratory fishes ascending the channel. Also, many observations on adult pallid sturgeon swimming around a 15 ft diameter circular tank or juveniles in the artificial flume show this species, like all other North American sturgeons, have no problem swimming on a slope, even on a vertical slope, as long as there is no structure attached to the bottom or slope (B. Kynard pers. obs.). Finally, adult pallid sturgeon, like other North Temperate Zone sturgeons migrating to spawn, do so after 5-6 months of wintering, so during migration they attempt to conserve energy by using slow velocity on the channel bottom (or slopes) during ascent (Kynard et al. 2012).

2.5.2.5 Bottom Type and Movements by Pallid and Shovelnose Sturgeon.—

Little information is available on bottom type selected by wild adult pallid sturgeon yet this information is important to design any fish passage facility for these bottom cruising swimmers. Adult shovelnose sturgeon will use a bottom with large rocks, but spacing is important for fish to accept the habitat and ascend a flume (White and Medford 2002). Also, during artificial stream tests that gave juveniles (6 months to 10 months old of seven species of N. American sturgeons) a choice of two water velocities (fast vs. slow) and between two bottom types, smooth vs. structured (sand vs. cobble), shovelnose and pallid had the strongest preference of all species for sand substrate (Kynard et al. unpubl. analyzed data). Further, juvenile and adult shortnose sturgeon use of bottom habitat, water depth, and river habitat are similar, indicating no change in preference for bottom type during ontogenetic development (Kynard et al. 2008). Thus, if bottom preference is set early in life like for shortnose sturgeon, pallid and shovelnose juveniles and adults may prefer a similar bottom type (sand) and they may avoid river bottom reaches with a high density of rocks. Shortnose sturgeon avoid rocks during their entire life history except for two periods: 1) spawning, and 2) swimming over short rapids during upstream migrations, even though their two ventral lateral rows of scutes can be severely damaged (Kynard et al. 2012). All evidence suggests the a bypass channel bottom should be rather smooth and devoid of large rocks that extend into the water column.

2.6 Clean Water Act

The potential effects of the proposed project on surface water, groundwater, water quality, and wetlands and other waters of the U.S. have been evaluated and are discussed in Chapter 4. The following sections of the CWA are most relevant to this project:

- Section 401 requires compliance with water quality standards. The Corps will apply to the MTDEQ for Section 401 certification, pursuant to 33 CFR 336.1(a) (1). The Corps will continue to coordinate with the MTDEQ throughout the remaining study, design and

construction phases of this project. This EIS contains sufficient information regarding water quality effects, including consideration of the Section 404(b) (1) guidelines, to meet the EIS content requirements of Section 404(r), should that exemption be invoked.

- Section 404 addresses discharges of dredged or fill material to waters of the U.S. The Corps does not issue itself permits but must demonstrate equivalent compliance with the Section 404(b) (1) guidelines. A Section 404(b) (1) evaluation has been prepared and is found in Appendix C. The following are key elements of compliance with the Section 404(b)(1) guidelines
 - Demonstrating the water dependency of the proposal
 - Evaluating practicable alternatives
 - Evaluating effects on numerous characteristics of waters of the U.S. and special aquatic sites
 - Avoiding, minimizing and mitigating adverse effects on waters of the U.S.
- With implementation of the avoidance and minimization measures listed in this EIS, the proposed discharges of fill will be in compliance with Section 404 of the Clean Water Act.

2.7 Monitoring and Adaptive Management

In order to ensure the effectiveness of the already constructed headworks and screens that were designed to reduce entrainment into the Main Canal and to evaluate the effectiveness of the selected alternative, Reclamation will implement a long-term monitoring and adaptive management plan. A plan was developed in 2015 (Reclamation 2015) and is currently being implemented for the monitoring of the headworks and screens. The plan developed in 2015 was designed to evaluate key project uncertainties related to the design, performance, and biological response of pallid sturgeon and other fish species. The Service has developed further biological criteria to measure success of the selected alternative based upon the overall goal of unimpeded movement by pallid sturgeon through the free-flowing lower Yellowstone River. Thus, a revised monitoring and adaptive management plan is being developed to address both the physical and the biological criteria that would indicate success of the project and are summarized below.

The draft monitoring and adaptive management plan attached as Appendix E outlines the following elements that would apply to any of the alternatives evaluated:

- Physical Criteria Performance
 - Document whether the proposed project consistently meets the physical criteria parameters currently recommended.
- Pallid Sturgeon
 - Document whether motivated adult pallid sturgeon pass upstream of the Intake Diversion Dam during the spawning migration time period (April 1 to June 15). If $\geq 85\%$ of telemetered fish passed upstream without substantial delay the passage way would be considered successful (Service 2016).
 - Conduct field and laboratory swimming capability studies of juvenile pallid sturgeon to determine if upstream juvenile passage is reasonably expected to occur and if upstream passage would benefit condition, growth, and survival of

juveniles. Develop decision criteria to trigger adaptive management options to improve passage for juveniles if the lack of juvenile passage is demonstrate to result in negative population level effects.

- Monitor adult sturgeon passing downstream of the Intake Diversion Dam for injury or evidence of adverse stress to ensure that mortality of adults passing downstream does not exceed 1% during the first 10 years of project implementation.
- Monitor the irrigation canal downstream of the screens and the river immediately downstream of the boulder field below the Intake Diversion Dam to assess potential injury and mortality to free-embryo, larvae and young-of-year sturgeon. Experiments could be undertaken including the release of free-embryo pallid or shovelnose sturgeon upstream of the dam to assess entrainment or impingement at the screens and injury from drift over the dam crest and through the boulder field.
- Native Fish
 - Document if native fish are able to migrate upstream and downstream of the Intake Diversion Dam.

3 Affected Environment

The following sections describe the existing conditions within the study area for the environmental resources of concern. This provides a baseline by which to evaluate and determine potential impacts that may result from implementation of the alternatives. The potential resource impacts are described in Chapter 4.

3.1 Climate

Climate data and general narrative descriptions of Montana climatic regions were obtained from the Western Regional Climate Center (WRCC), overseen by the National Oceanic and Atmospheric Administration. Climate change information developed for the Great Plains Region and State of Montana was obtained from Reclamation, the National Climate Assessment and the State of Montana.

The Yellowstone Valley region of eastern Montana is within the Temperate Steppe Ecoregion, specifically the Great Plains-Palouse Dry Steppe Province (USFS 2016), which is characterized by a continental climate with cold winters, hot summers, and relatively little rainfall.

In Glendive, the coldest months tend to be December, January and February, with an average minimum temperature of 9.6°F in December, 4°F in January, and 7.7°F in February. The hottest months are typically June, July and August, with an average maximum temperature of 80°F in June, 89°F in July, and 88°F in August. The hottest temperature recorded in Montana is a tie with 117°F recorded in Glendive on July 20, 1893 and Medicine Lake on July 5, 1937 (WRCC 2016a, 2016b). Average total precipitation in Glendive is 13.93 inches, with an average snowfall of 28.6 inches. Average snow depth is typically only 1 inch. The typical frost-free period is 130 days or longer in the Yellowstone Valley through Dawson and Richland Counties (NRCS 1914). Temperature and precipitation conditions in Sidney are very similar to those in Glendive, although slightly colder. Severe storms, including tornadoes, windstorms and thunderstorms, can occur but are not frequent.

The potential evapotranspiration rate near Glendive (WRCC 2016b) is over 72 inches, which is the rate that could occur if that quantity of water were available. The mean annual evapotranspiration rate near Glendive is approximately 10 inches (Montana Climate Office 2016).

Climate change predictions for the Great Plains include continued warming temperatures that could increase the number of hot days in summer and result in warmer winters with less snowpack and more rainfall (Shafer 2014). This could result in more favorable crop-growing conditions (longer growing season) but could also cause more stress on crops and increased requirements for irrigation due to warmer temperatures and increased rates of evapotranspiration.

Reclamation has undertaken several recent studies on climate change risks and water supply security (Reclamation 2016a, 2016b, 2012a) that have updated climate and hydrologic models.

The following summary statements from the Hydroclimate Projects Report (Reclamation 2016a) display that future climate and hydrologic projections are consistent with earlier projections and observed trends, characterized generally across the western United States:

- Temperature increases have already resulted in decreased snowpack, differences in the timing and volume of spring runoff, and an increase in peak flows for some western U.S. basins. The impacts to snowpack and runoff affect the timing and availability of water supplies.
- Warming is expected to continue, causing further impacts to supplies, increasing agricultural water demands, and affecting the seasonal demand for hydropower electricity.
- Precipitation patterns are also expected to change, interacting with warming to cause longer-term and more frequent droughts and larger and more numerous floods, varying by basin.
- Cool-season runoff is projected to increase over the West Coast basins, from California to Washington, and over the North-Central U.S., but little change to slight decreases are projected over the southwestern U.S. and the Southern Rockies.
- Warm-season runoff is projected to decrease substantially over a region spanning southern Oregon, the southwestern U.S., and the Southern Rockies. However, north of this region, warm-season runoff is projected to change little or to slightly increase.
- Projected increasing precipitation in the northern tier of the western U.S. could counteract warming-related decreases in warm-season runoff, whereas projected decreases in precipitation in the southern tier of the western U.S. could amplify warming-related decreases in warm season runoff.

The Montana Department of Natural Resources and Conservation presented similar results in the State Water Plan, which identifies an overall decline in snowpack in western North America and an increased percentage of precipitation falling as rain (MDNRC 2014). This could lead to earlier and lower levels of runoff for the Yellowstone basin because most runoff in the basin is a result of snowmelt. However, increased spring precipitation has also tended to maintain and may increase overall annual discharges.

A study of low flows on streams in the Rocky Mountains (Lippi 2012) also indicates that late summer low flows are showing a declining trend, and declines in stream flow show a negative correlation with air temperature (as air temperature increases, stream flow decreases).

The overall effects of climate change may change demands for the irrigation delivery system (i.e. more water could be needed earlier due to warming temperatures) and the timing and availability of runoff may cause difficulties in delivering water when it is most needed. Increased temperatures may also influence fish and wildlife habitats including potentially drying up wetlands and changing the growth and development of various plant communities, including possibly increasing the spread of invasive species (Reclamation 2016b).

3.2 Air Quality

This section describes air quality within the study area, including a definition of climate and typical weather conditions that could affect the dispersion of air emissions in the area of the Project and the Clean Air Act’s regulatory framework for National Ambient Air Quality Standards (NAAQS), which the U.S. Environmental Protection Agency (EPA) enforces. Additionally, it describes the existing ambient air quality that is considered representative of the study area. For discussion of the affected environment, the study area for air quality included areas and counties within the Yellowstone River valley that could be affected by construction and operation of the Project alternatives. In general, the study area includes Dawson, Richland, and Wibaux Counties, Montana.

3.2.1 Air Quality Standards

The Montana Department of Environmental Quality (MTDEQ) ambient air quality standards are the same as the NAAQS. Project construction and operational activities will need to comply with MTDEQ and/or localities’ applicable air regulations and/or may require permits.

Air quality is determined primarily by how much pollution is emitted and how much dispersion (air movement and mixing) occurs in the area. Pollution sources include: stationary sources (e.g., factories, power plants), mobile sources (e.g., cars, planes), and naturally occurring sources (e.g., windblown dust, volcanic eruptions). Weather patterns, topography, and climate affect how air moves in the region and thus how these pollutants are transported. These factors and how they relate to the study area are described in the following sections.

Air pollutants can be divided into three classes: criteria pollutants, toxic pollutants, and greenhouse gases. The following air pollutants are criteria pollutants for which EPA has developed NAAQS: sulfur dioxide (SO₂), carbon monoxide (CO), nitrogen dioxide (NO₂), ozone (O₃), particulate matter 10 micrometers in diameter or smaller (PM₁₀), particulate matter 2.5 micrometers in diameter or smaller (PM_{2.5}), and lead and its compounds (measured as lead) (Table 3-1).

TABLE 3-1. CRITERIA POLLUTANTS, NATIONAL AMBIENT AIR QUALITY STANDARDS

Air Pollutant	Averaging Period	Primary NAAQS	Secondary NAAQS
SO ₂ (ppb)	1-Hour <i>a</i>	75	NA
	3-Hour	NA	500
CO (ppm)	1-Hour <i>b</i>	35	NA
	8-Hour <i>b</i>	9	NA
NO ₂ (ppb)	1-Hour <i>c</i>	100	NA
	Annual	53	53
Ozone (ppm)	8-Hour <i>d</i>	0.075	0.075
PM ₁₀ (µg/m ³)	24-Hour <i>e</i>	150	150
PM _{2.5} (µg/m ³)	24-Hour <i>f</i>	35	35
	Annual <i>g</i>	12.0	15.0
Lead (µg/m ³)	3-Month <i>h</i>	0.15	0.15

µg/m³ = micrograms per cubic meter
 ppb = parts per billion

ppm = parts per million

- a. NAAQS applies to the 3-year average of the annual (99th percentile) of the daily maximum 1-hour average concentration.
- b. NAAQS is not to be exceeded more than once per calendar year.
- c. NAAQS applies to the 3-year average of the annual (98th percentile) of the daily maximum 1-hour average concentration.
- d. NAAQS applies to the 3-year average of the annual 4th highest daily maximum 8-hour average concentration.
- e. Not to be exceeded more than once per year on average over 3 years.
- f. NAAQS applies to the 3-year average of the annual 98th percentile 24-hour concentration.
- g. NAAQS applies to the 3-year average of annual concentrations.
- h. NAAQS applies to the maximum arithmetic 3-month mean.

Precursors to criteria pollutants include those that cause the formation of the pollutant after they are emitted; for example, O₃ in the ambient air is predominantly formed by photochemical reactions between mono-nitrogen oxides (NO_x; these include both nitrogen oxide (NO) and NO₂) and volatile organic compounds (VOCs). NO_x and VOCs can be generated by numerous types of air emission sources. The most common sources are those that combust fossil fuels such as non-road construction equipment, on-road vehicles, and stationary sources such as emergency generators, which are associated with the activities of this project.

Concentrations of pollutants in the ambient air vary over time, and therefore many of the NAAQS (Table 3-1) are focused on statistical functions (98th percentile concentrations, 99th percentile concentrations, etc.). They also vary spatially, so a network of air quality monitoring stations is used to assess regional air quality to determine whether counties should be designated as “attainment” or “nonattainment” with respect to the NAAQS. For any particular NAAQS, if an area previously designated as “nonattainment” is redesignated as “attainment,” it is classified as a “maintenance” area (i.e., the subset of attainment areas that were previously designated as nonattainment for that standard). As identified in Title 40 of the Code of Federal Regulation, Part 81 (40 CFR 81), the study area has been designated as attainment for all of the NAAQS.

Each criteria pollutant listed in Table 3-1, except ozone, is emitted directly. Ozone can be emitted directly by a few sources, such as wastewater treatment operations that generate ozone for use as an oxidizer and sanitizer, but is predominantly a result of reactions between NO_x and VOCs in the air, particularly in warmer months. For this reason, criteria pollutant emissions inventories include NO_x and VOCs, even though they are not criteria pollutants themselves.

While the scientific understanding of climate change continues to evolve, the Intergovernmental Panel on Climate Change (IPCC) Fifth Assessment Report has stated that warming of the Earth’s climate is unequivocal, that continued emissions of greenhouse gases will cause further warming and changes in all components of the climate system, and that limiting climate change will require substantial and sustained reductions of greenhouse gas emissions (IPCC 2013). The report also states the following (IPCC 2013):

- It is “virtually certain” that there will be more frequent hot and fewer cold temperature extremes over most land areas on daily and seasonal timescales as global mean temperatures increase.
- It is “very likely” that heat waves will occur with a higher frequency and duration.
- It is “very likely” that the global oceans will continue to warm during the 21st century.
- Global mean sea level will continue to rise during the 21st century.
- Most aspects of climate change will persist for many centuries even if emissions of carbon dioxide (CO₂) are stopped.

Greenhouse gases include CO₂, methane (CH₄), and nitrous oxide (N₂O). No specific “ambient standards” exist for these pollutants. For context, total U.S. anthropogenic (human-caused) greenhouse gas emissions were 6,576 million metric tons carbon dioxide equivalent (CO₂e) in 2009, and 40 percent of these were from the electric power sector (EIA 2011). Unlike criteria pollutants and air toxics, greenhouse gas concentrations have been increasing over time, and are continuing to increase.

Although there are not localized monitoring networks in the study area (or globally), 2011 average global concentrations of CO₂, CH₄, and N₂O were 391 parts per million (ppm), 1,803 parts per billion (ppb), and 324 ppb, respectively. These levels exceeded pre-industrial levels (year 1750) by about 40 percent, 150 percent, and 20 percent, respectively (IPCC 2013). The IPCC (2013) has concluded that it is “likely” (66 percent to 100 percent probability) that greenhouse gas contributed a global mean surface warming in the range of 0.5°C to 1.3°C over the period 1951 to 2010 and “extremely likely” (95 percent to 100 percent probability) that more than half of the observed increase in global average surface temperature from 1951 to 2010 was caused by the anthropogenic increase in greenhouse gas concentrations and other anthropogenic factors.

3.2.2 Meteorological Conditions

The study area is located east of the Continental Divide, where winters are more severe, precipitation is less evenly distributed throughout the year, summers are warmer, and winds are higher than on the western side (WRCC 2016c). Cold waves are known to cover parts of Montana on the average of 6 to 12 times a winter. In small areas ideally situated for radiation cooling, low temperatures can fall to -50°F or lower. In some areas east of the Continental Divide, January or February can average zero or below, but such occurrences range from infrequent to about once in 10 to 15 years in the coldest spots. Most snow falls during the November-March period; and in the northeastern portion of Montana, early or late season snows are not very common. All rivers carry floating ice during the late winter or early spring, although few streams freeze solid and water generally continues to flow beneath the ice.

During the summer, hot weather occurs fairly often in the eastern parts of the state. The highest recorded temperature was 117°F at Glendive on July 20, 1893, and at Medicine Lake on July 5, 1937. However, summer nights are significantly cooler. Nearly half the annual long-term average precipitation total falls from May through July. Tornadoes develop infrequently (about two per year) and occur almost entirely east of the Continental Divide in Montana. Severe windstorms are rare but can occur locally several times a year (WRCC 2016c).

Table 3-2 and Table 3-3 provide meteorological data for two weather stations in and near the study area (WRCC 2016c). The climate includes average minimum temperatures of 2°F to 7°F during January and average maximum temperatures of 85°F to 89°F in July. Average annual precipitation is 14 inches and primarily occurs during late spring and summer. Average annual snowfall is 29 to 33 inches and primarily occurs from November through March.

TABLE 3-2. CLIMATE SUMMARY DATA FOR STATIONS NEAR THE STUDY AREA

	Jan	Feb	Mar	Apr	May	Jun	Jul	Aug	Sep	Oct	Nov	Dec	Annual
GLENDIVE, MONTANA (243581)													
<i>Period of Record : 01/01/1893 to 01/21/2015</i>													
Average Max. Temperature (°F)	26.4	31.3	43.3	60.1	71.2	80	89	87.7	75.6	62.2	43.4	30.9	58.4
Average Min. Temperature (°F)	4	7.7	19.1	33	43.7	53	58.8	56	44.9	33.8	20.9	9.6	32
Average Total Precipitation (in.)	0.44	0.37	0.65	1.17	2.08	3.07	1.82	1.38	1.19	0.85	0.45	0.45	13.93
Average Total Snow Fall (in.)	5.8	4.6	5.6	1.9	0.4	0	0	0	0.1	1.1	3.6	5.4	28.6
Average Snow Depth (in.)	4	4	1	0	0	0	0	0	0	0	1	2	1
SIDNEY, MONTANA (247560)													
<i>Period of Record : 10/16/1910 to 01/21/2015</i>													
Average Max. Temperature (°F)	23.4	30	42	58.7	69.9	78.1	85.2	84.2	72.7	59.5	41.2	28.5	56.1
Average Min. Temperature (°F)	1.5	7.6	17.7	30.5	41.5	50.5	55.2	52.9	42.7	32.3	19.1	7.5	29.9
Average Total Precipitation (in.)	0.4	0.35	0.54	1.14	2.06	2.76	2.14	1.42	1.32	0.97	0.48	0.43	14.02
Average Total Snow Fall (in.)	6.1	5.2	5	2.6	0.6	0	0	0	0.3	1.5	4.8	6.7	32.8
Average Snow Depth (in.)	5	4	2	0	0	0	0	0	0	0	1	3	1

Source: WRCC 2016c.

TABLE 3-3. AVERAGE WIND SPEED (MPH) BY MONTH

(1996 – 2006)	Jan	Feb	Mar	Apr	May	Jun	Jul	Aug	Sep	Oct	Nov	Dec	Annual
Average Wind Speed at Glendive Airport Automated Weather Observing System (mph)	9.5	9.7	10.5	11.3	11.6	10.4	9.4	9.6	9.6	10.1	9.7	10.2	10.1
Average Wind Speed at Sidney Airport Automated Weather Observing System (mph)	8.9	9.0	9.5	10.2	10.4	9.0	7.7	7.9	8.2	8.8	8.7	9.4	9.0

Source: WRCC 2016d

3.2.3 Air Quality in the Study Area

The air quality in the study area meets the national and state standards for the criteria pollutants of carbon monoxide, lead, particulate matter, and sulfur dioxide. There is one air quality monitoring station in northeastern Montana, located over 15 miles northwest of Sidney, Montana and approximately 35 miles from the project area. This monitoring station monitors SO₂, NO₂, PM₁₀, PM_{2.5}, O₃, and meteorological data. Air quality at the station is generally regarded as good (MTDEQ 2016b) and there is continuous monitoring for SO₂, NO₂, PM₁₀, PM_{2.5}, and O₃. Table 3-4 provides existing air quality monitoring data for criteria air pollutants for the Sidney station (MTDEQ 2015a and EPA 2016).

TABLE 3-4. CRITERIA POLLUTANTS, NAAQS AND EXISTING AIR QUALITY

Air Pollutant	Averaging Period	Primary NAAQS	Secondary NAAQS	Most Recent Quality-Assured Data ^j	Nearest Ambient Monitoring Site	Distance to Nearest Monitoring Station ⁱ
SO ₂ (ppb)	1-Hour ^a	75	NA	4	Sidney, MT	35 miles
	3-Hour	NA	500	4	Sidney, MT	35 miles
CO (ppm)	1-Hour ^b	35	NA	NA	NA ^k	NA
	8-Hour ^b	9	NA	NA	NA ^k	NA
NO ₂ (ppb)	1-Hour ^c	100	NA	12	Sidney, MT	35 miles
	Annual	53	53	1.2	Sidney, MT	35 miles
Ozone (ppm)	8-Hour ^d	0.075	0.075	0.056	Sidney, MT	35 miles
PM ₁₀ (µg/m ³)	24-Hour ^e	150	150	131 ^m	Sidney, MT	35 miles
PM _{2.5} (µg/m ³)	24-Hour ^f	35	35	15	Sidney, MT	35 miles
	Annual ^g	12.0	15.0	7	Sidney, MT	35 miles
Lead (µg/m ³)	3-Month ^h	0.15	0.15	NA	NA ^l	NA

Source: MTDEQ 2015a and EPA 2016

µg/m³ = micrograms per cubic meter; ppb = parts per billion; ppm = parts per million

- a. NAAQS applies to the 3-year average of the annual (99th percentile) of the daily maximum 1-hour average concentration.
- b. NAAQS is not to be exceeded more than once per calendar year.
- c. NAAQS applies to the 3-year average of the annual (98th percentile) of the daily maximum 1-hour average concentration.
- d. NAAQS applies to the 3-year average of the annual 4th highest daily maximum 8-hour average concentration.
- e. Not to be exceeded more than once per year on average over 3 years.
- f. NAAQS applies to the 3-year average of the annual 98th percentile 24-hour concentration.
- g. NAAQS applies to the 3-year average of annual concentrations.
- h. NAAQS applies to the maximum arithmetic 3-month mean.
- i. Distance to the nearest monitoring station was estimated.
- j. These averages not tabulated, since highest one-hour concentrations are well below the average standard.
- k. No CO monitors in vicinity of study area and not required since rural areas with no population area greater than 1,000,000.
- l. No available lead monitors in vicinity of study area and none in Montana as well as neighboring states.
- m. Three year average, data obtained from EPA AirData website.

The Sidney station is located in an area of heavy oil and gas development and therefore does not specifically reflect air quality at the location of the Project in the Yellowstone River valley. Air quality in rural areas not subject to oil and gas development or other industrial or construction development activities would generally be expected have somewhat lower pollutant levels than the Sidney station pollutant levels.

3.3 Surface Water Hydrology

Data used to prepare this section was derived from the Environmental Assessment (EA) for this Project (Reclamation and the Corps 2010) and the Supplemental EA (Reclamation and the Corps 2015), along with appendices, attachments, aerial imagery, topography, and gaging station records. Other data sources included U.S. Geological Survey (USGS) stream gage analyses (Chase 2014), a fish passage planning study prepared by Reclamation (Reclamation 2004), and hydrologic and hydraulic analyses prepared by the U.S. Army Corps of Engineers (Corps 2006, 2009, 2010, 2015a, 2015b, 2015c, 2015d).

3.3.1 Setting

The Yellowstone River is one of the longest free-flowing rivers in the lower 48 states, draining about 70,000 square miles as it flows more than 600 miles from its origin east of Yellowstone

National Park, Wyoming, through Montana to the confluence with the Missouri River in North Dakota (Figure 3-1) (Chase 2014). At the Missouri River confluence, the Yellowstone River contributes more than 50 percent of the average annual flow (Corps 2010).

The Intake Diversion Dam is located near the town of Intake in Dawson County, Montana. Built over 100 years ago, it is the most downstream and largest in a series of six diversion structures on the Yellowstone River downstream of Billings, Montana (Figure 3-2). The Intake Diversion Dam is maintained and operated by the Board of Control of the Lower Yellowstone Project.

The affected environment for surface water hydrology is discussed at different scales that encompass two different areas:

- The Intake Diversion Dam area comprises the Yellowstone River and its overbanks from the existing side channel confluence upstream of the Intake Diversion Dam to the existing side channel confluence downstream of the Intake Diversion Dam, a distance of about 4 miles. This includes the right overbank floodplain immediately east of the Intake Diversion Dam referred to as Joe's Island. Joe's Island is bounded by the existing side channel and the Yellowstone River (Figure 3-3).
- The LYP area comprises the Lower Yellowstone Project, which includes the Yellowstone River, the Main Canal, and the floodplain area between the river and canal, from the Intake Diversion Dam to the confluence with the Missouri River, a channel distance of about 70 miles (Figure 3-4).



Base modified from U.S. Geological Survey Digital Line Graph (DLG), 1:2,000,000, 1973, Lambert Conformal Conic Projection Standard parallels 45°00' and 49°00' central meridian -109°30' North American Datum of 1983 (NAD 83).

Figure 3-1. Yellowstone River Basin (Chase 2014)

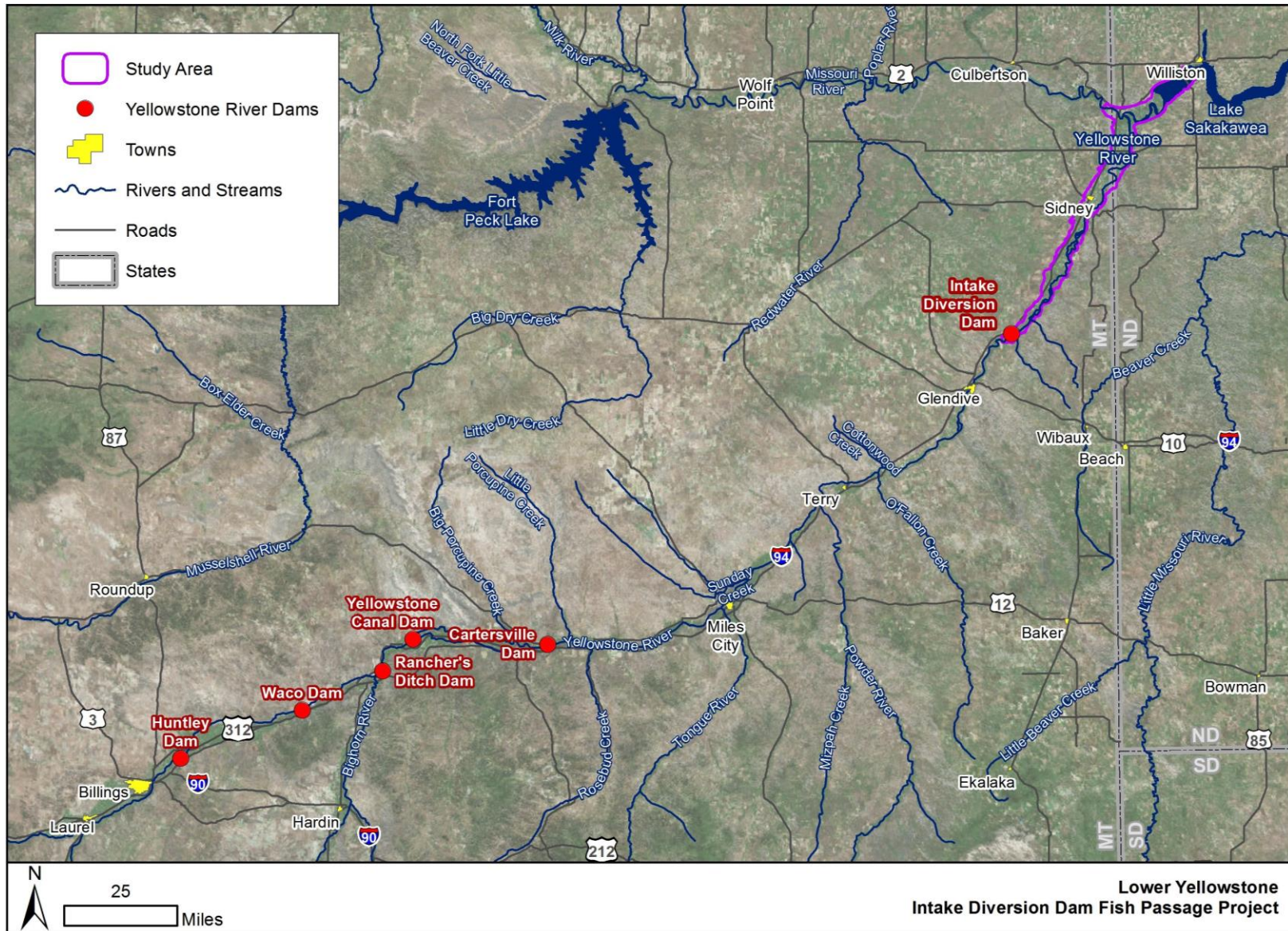

Figure 3-2. Diversion Dams Downstream of Billings MT, along the Yellowstone River (Corps 2010)

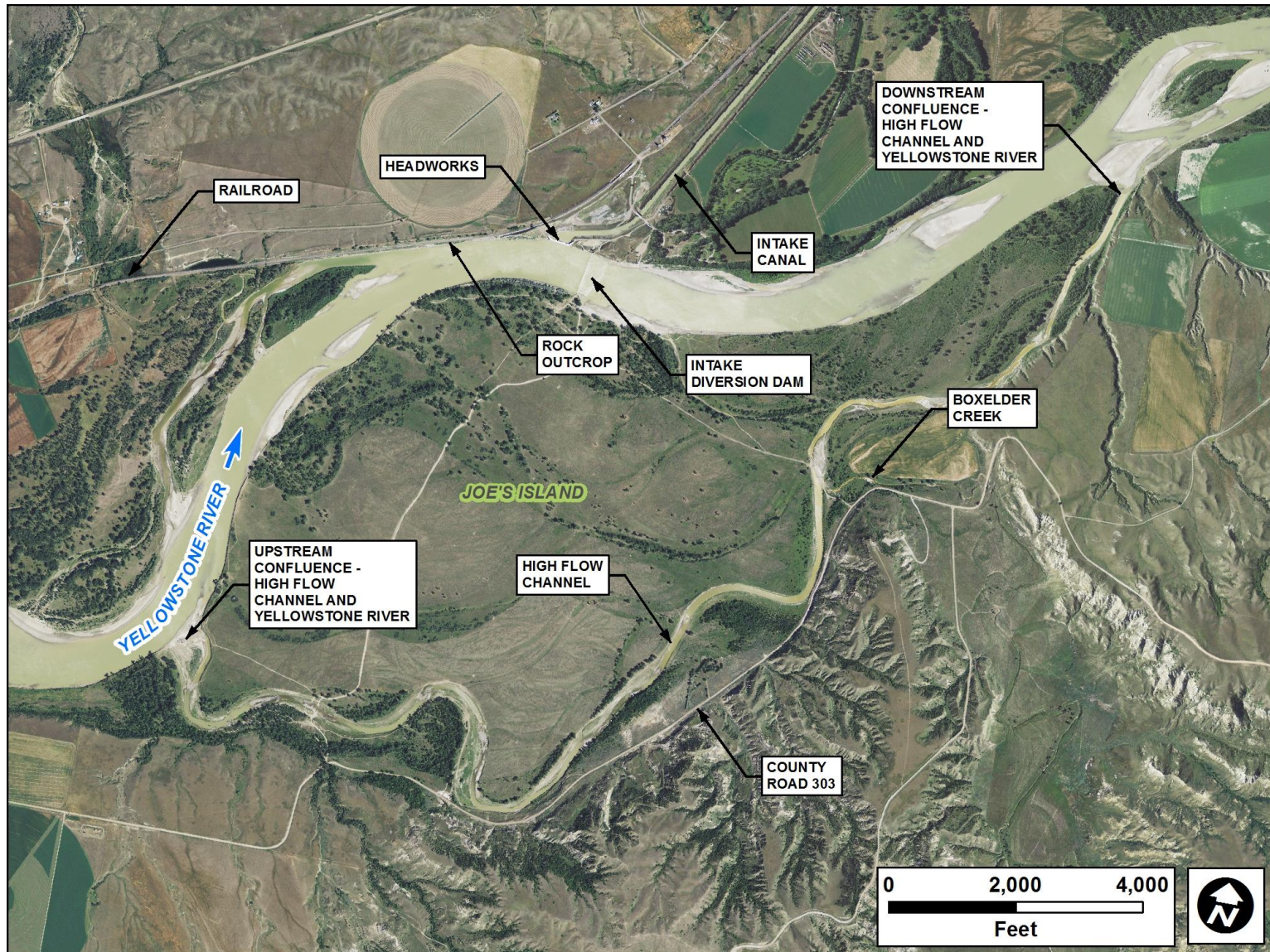

Figure 3-3. Intake Diversion Dam Area

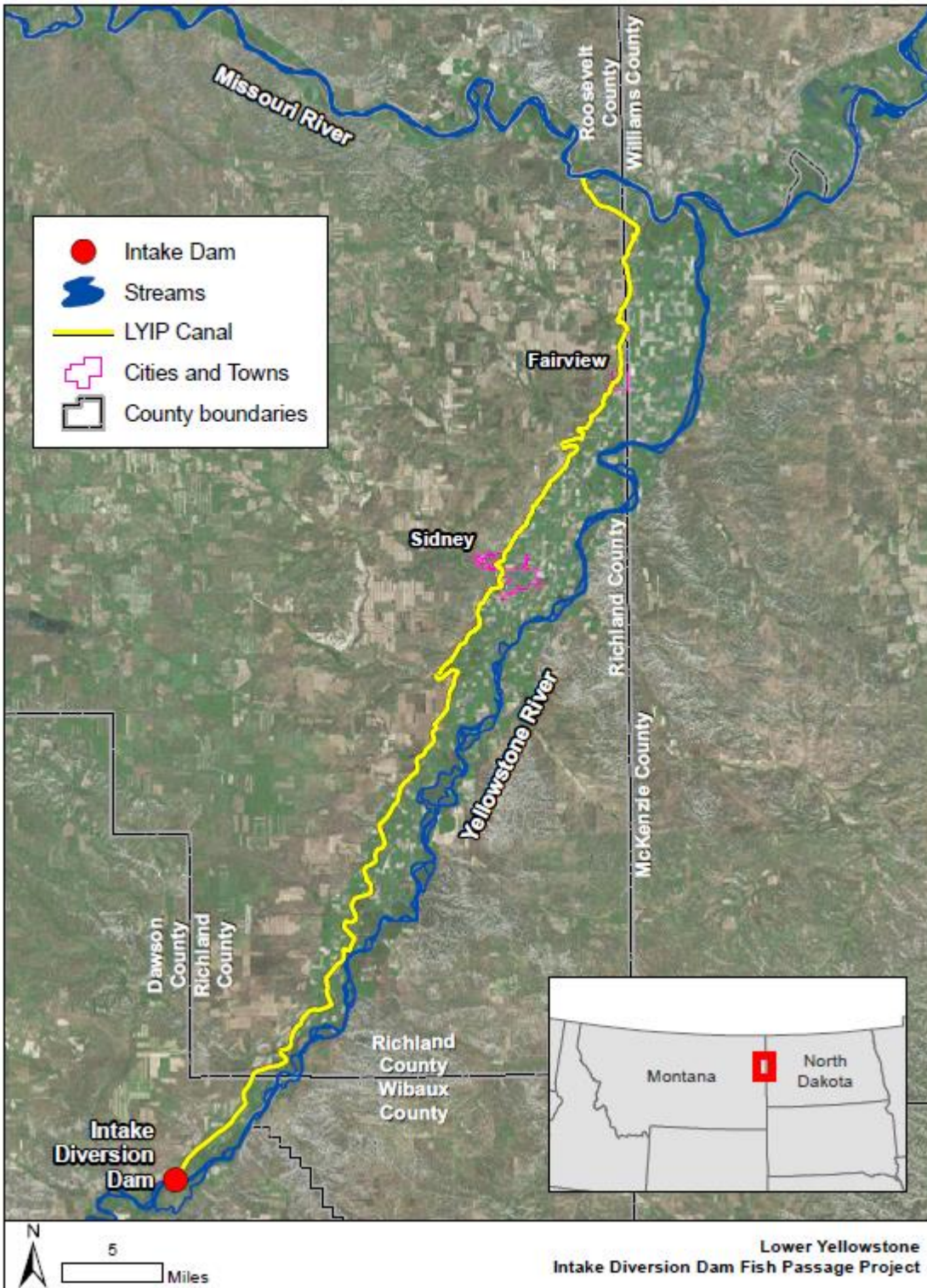

Figure 3-4. LYP Area (Reclamation and the Corps 2010)

3.3.2 Existing Side Channel

The existing side channel splits from the right bank of the main channel 1.8 miles upstream of the dam and reconnects with the main channel 1.7 miles downstream of the dam; its path is 4.5 miles long (Figure 3-3). The east bank of the existing side channel is well defined and confined by a shale/siltstone bluff (Figure 3-5). Flow in the existing side channel only occurs when flows in the Yellowstone River are greater than approximately 20,000 to 25,000 cubic feet per second (cfs), which is slightly higher than the annual peak flow (Table 3-5)..



Figure 3-5. Panorama of Joe's Island looking West, with Side Channel in Foreground; Shale Siltstone Bluff behind Photographer

Joe's Island is gently sloped, with little topographic variability. It is covered by grasses and has sparse tree cover (Figure 3-5). Box Elder Creek is the only notable tributary to the existing side channel, joining from the south at about 3 miles downstream of the upstream confluence of the existing side channel and the Yellowstone River (Figure 3-3) There are two locations where vehicles appear to be crossing the existing side channel to access Joe's Island; both crossings are accessible from County Road 303. Other than the road crossings and the south bank of the Intake Diversion Dam, there is little anthropogenic activity on Joe's Island.

The Intake Diversion Dam and Main Canal are primary features of the Lower Yellowstone Project. The Main Canal extends for approximately 70 miles from the Intake Diversion Dam on the Lower Yellowstone River to the Missouri River. Land use is agricultural with little riparian vegetation remaining. The Main Canal is generally described as follows (Reclamation and the Corps 2010):

The Lower Yellowstone Project is primarily a gravity diversion and distribution system, with approximately 1,400 cfs of water diverted from the Yellowstone River into the Main Canal by the Intake Diversion Dam during the irrigation season. The collective Lower Yellowstone Project facilities include the Intake Diversion Dam, canal headworks structure, 4 primary pumping stations (including the Intake and Savage pumping

stations), 4 supplemental river pumps, 79 miles of Main Canal, approximately 234 miles of laterals, and 118 miles of open drains, and over 2,500 water control structures. The total irrigated acreage is 54,300 acres, with an average annual water diversion of 327,000 acre-feet. Electric pumping power service to five of the pumping stations is supplied by the Pick-Sloan Missouri Basin Program.

The Main Canal of the Lower Yellowstone Project is an open earthen ditch varying from more than 30 feet wide and 11 feet deep at the intake in Dawson County, Montana, to less than 10 feet wide and 3 feet deep at its terminus at the Missouri River near Nohly, Montana. The Main Canal runs along the west side of the Yellowstone River. As the irrigation water is diverted into laterals, the capacity and size of the Main Canal decreases. For its first 26 miles the canal passes through relatively rugged terrain with little irrigable land along a narrow river valley. In the vicinity of Crane, Montana, the valley bottom expands out 5 miles. Approximately 70% of the Intake Project's irrigable lands are between this point and the end of the canal at the Missouri River. Four pumps lift water to serve lands above the canal, and a pumping station is located on a project drain that reuses project water.

Calls for irrigation water typically occur by May 10, requiring the gates at the Intake Diversion Dam be open by May 1. Occasionally operations will begin as early as April 15. The canal typically operates through September of each year. Water rights are summarized in Section 1.2.2, the period of use on the LYP water right is April 15 - Oct. 15, and Savage Irrigation District from April 1 - Oct. 31.

3.3.3 Hydrology

The purpose of this hydrology section is to report on hydrology analyses previously conducted at the Intake Diversion Dam to provide context for the assessment of alternatives. Flow frequency and flow duration curves were developed for the Project site by USGS (Chase 2014) and the Corps (Corps 2006).

The Corps analyzed the flow records at the Sidney Montana gage (USGS Gage No. 06329500) located 36 miles downstream of the Intake Diversion Dam, and at the Glendive Montana gage (USGS Gage No. 06327500) located 18 miles upstream of the Intake Diversion Dam. Flows at the Sidney gage are affected by operations at Yellowtail Dam, which is located on the Bighorn River in south central Montana, approximately 90 miles upstream of the confluence with the Yellowstone River. Yellowtail Dam regulates 28 percent of the base flows upstream of Sidney, and reservoir operations can alter the flow regime (Corps 2006).

The Corps recommended using the flow frequency and flow duration values developed by USGS for the design and evaluation of the proposed bypass channel (Corps 2015a). The flow frequency values are provided in Table 3-5 and the flow duration values are provided in Table 3-6.

TABLE 3-5. FLOOD FLOW FREQUENCY (CHASE 2014)

Percent Chance Exceedance	Return Period (yrs)	Flow (cfs)
0.2	500	156,200
0.5	200	140,200
1	100	128,300
2	50	116,200
10	10	87,600
20	5	74,400
50	2	54,200

TABLE 3-6. FLOW DURATION

Regulated Data from "Streamflow Statistics for Unregulated and Regulated Streamflow Conditions for Selected Locations on the Yellowstone, Tongue, and Powder Rivers, Montana and Wyoming 1928-2002" (USGS 2013)					
Percent Time Flow Equaled or Exceeded	Discharge (cfs)				
	Annual	Fall (OCT-DEC)	Winter (JAN-MAR)	Spring (APR-JUN)	Summer (JUL-SEP)
1	56,800	13,700	35,300	66,600	55,500
2	49,500	12,500	25,000	60,500	46,200
5	36,900	11,300	17,000	52,000	35,300
10	25,800	10,400	12,400	43,500	26,900
15	18,700	9,740	10,500	36,800	21,100
20	14,500	9,230	9,500	31,600	16,600
25	12,200	8,840	8,800	27,500	13,700
30	10,700	8,510	8,250	23,800	12,000
40	9,030	7,890	7,500	18,000	9,700
50	7,990	7,300	6,810	14,300	8,230
60	7,070	6,730	6,130	11,500	6,860
70	6,210	6,050	5,560	9,110	5,680
75	5,780	5,660	5,250	8,230	5,150
80	5,350	5,300	4,970	7,500	4,600
85	4,880	4,850	4,560	6,640	4,010
90	4,270	4,320	4,120	5,860	3,460
95	3,440	3,490	3,510	5,220	2,550
98	2,520	2,610	2,830	4,530	1,940
99	2,060	2,200	2,560	3,620	1,550

Source: Corps 2015

A data review performed for the Yellowstone River Cumulative Effects Assessment (CEA) found downward trends in spring and summer hydrology due to anthropogenic activity, particularly on the Bighorn River due to water management at the Yellowtail Dam. Hydrologic trends of note presented in the CEA include the following (Corps and YRCDC 2015):

- Peak flows have decreased for the 2-, 10-, and 100-year floods, particularly downstream of the Bighorn River where the 2-year flood has been reduced by about 23%.
- Spring and summer base flows have been reduced by over 20% under regulated conditions.
- Base flows in the fall and winter have increased.
- Increased air temperatures are linked to reduced flows in August at a pristine gage, unaffected by water management, at the Yellowstone Lake outlet.
- Overall reduced spring and summer flows have resulted in reduced side channel flooding.

In spite of the declining trends in peak and low flows, the Yellowstone River generally maintains natural hydrologic characteristics, including natural cues for fish spawning and migration.

3.3.3.1 Daily Flow Percentiles

Daily flows were also calculated by the Corps for the period of record at Sidney, Montana for the 5th, 10th, 25th, 75th, 90th, and 95th percentiles. The resulting hydrographs show a spring time 'pulse' in mid-March through mid-April, which occurs in about 50 percent of the years, and a larger rise starting in early May, peaking in late June and receding by early August (Figure 3-6).

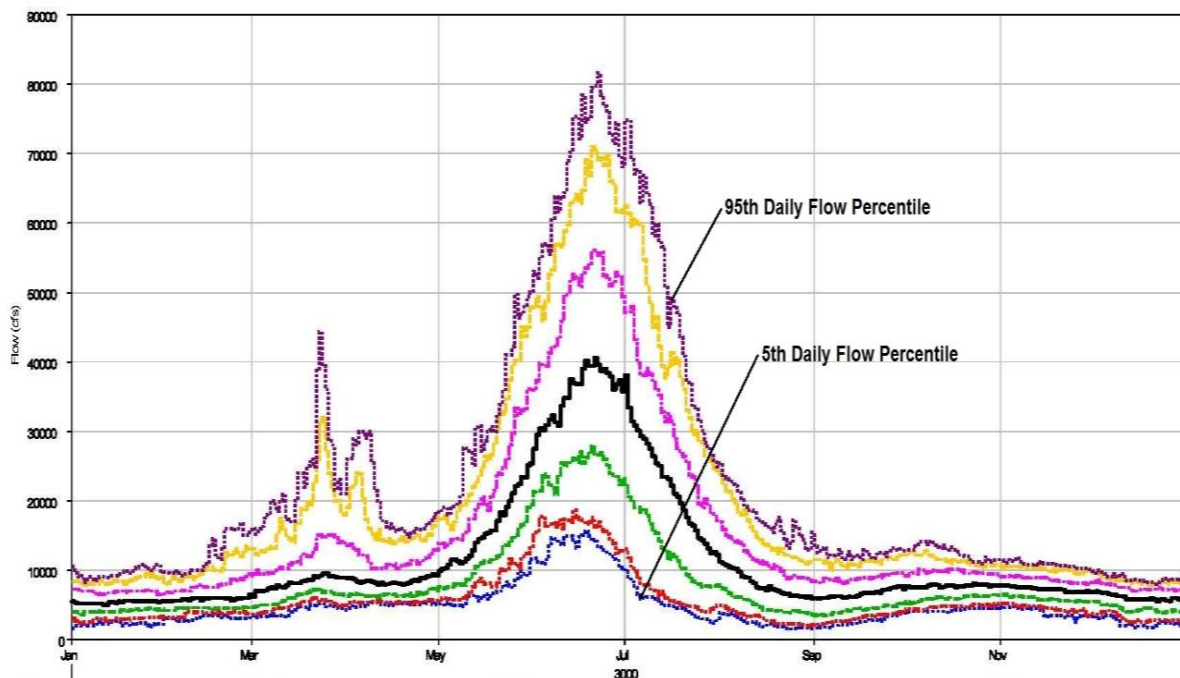

Figure 3-6. 5th, 10th, 25th, 50th, 75th, 90th, and 95th, Daily flow Percentiles for Period of Record Water Years 1911-1934, and Water Years 1934-2005, Sidney, MT (USGS Gage No. 06329500) (Corps 2006)

The first rise is generally driven by snowmelt and rain in the plains region of the basin. The second rise is primarily driven by mountain snowmelt (Corps 2006). An evaluation of records at the Sidney gage indicates that this early spring pulse may be dampening, likely a result of upstream alterations on the Powder River (Corps and YRCDC 2015).

3.3.4 Intake Diversion Dam Hydraulics and Water Use

The Intake Diversion Dam is located on the Yellowstone River just downstream of the canal headworks. It is a rock-filled timber crib weir spanning the width of the river (Figure 3-7). The crest elevation of the timber structure is 1,989 feet. Rock is placed on the crest of the weir almost annually to maintain the required water surface elevations for diverting into the canal (generally at 1,991 feet). The rock is trucked from a quarry and delivered to the south bank of the Yellowstone River, where it is placed on the dam using a cable and pulley system. Rocks displaced by ice are transported downstream, forming a scattered rock rubble field downstream of the dam (Reclamation 2013).



Figure 3-7. Intake Diversion Dam

3.3.5 Canal Hydraulics

The Main Canal was constructed in 1909. The canal is 71.6 miles long and conveys water along the north side of the Yellowstone River until it discharges to the Missouri River near the confluence of the Yellowstone and Missouri Rivers (Reclamation 2013). The canal has a design capacity of 1,400 cfs. The canal slope is 0.0002 feet/foot. The channel has a bottom width of 30 feet and side slopes of 1.5:1 horizontal to vertical. The canal is approximately 10 feet deep at the design capacity. Diversions are made into the canal typically from May through the end of September. Water diverted at the Intake Diversion Dam is measured daily at a bridge on the Main Canal, 2.8 miles downstream of the headworks. The annual diversions range from approximately 234,000 acre-feet to 378,000 acre-feet, with an average of 327,000 acre-feet (Reclamation and Corps 2010).

An example of irrigation season diversions for 2015 shows a slight ramping up to the maximum diversion right of 1,374 cfs at the beginning of the irrigation season, continued diversions near 1,374 cfs through the summer and a ramp down beginning in late August in preparation for the end of the irrigation season (Figure 3-8).

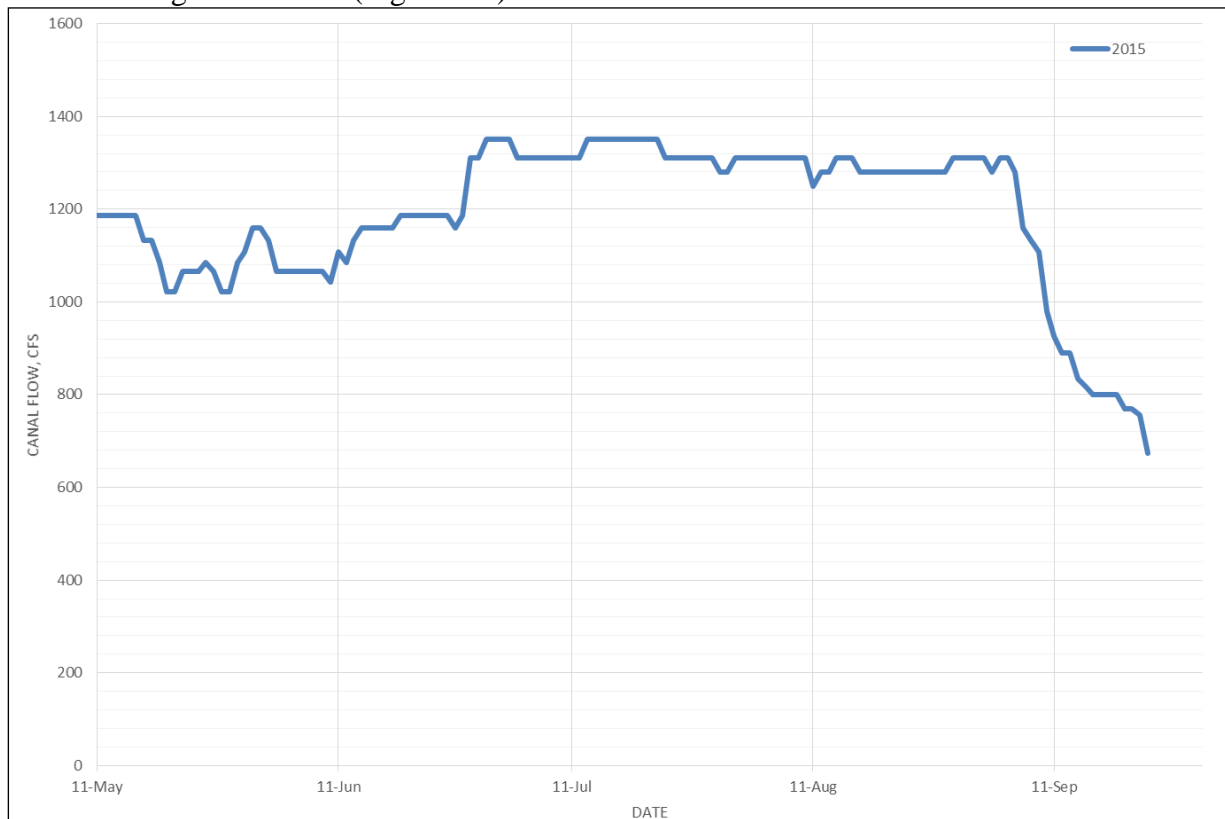

Figure 3-8. Main Canal Diversions for 2015

A hydraulic model of the canal was prepared by the Corps to develop a rating curve at the intake headworks (Corps 2009). The HEC-RAS hydraulic model was developed using existing design information and topographic survey data. The cross sections in the model assume side slopes of 1:1 horizontal to vertical, and the bottom widths were varied to match available survey data. The model was calibrated to measured discharge and water-surface elevations collected by USGS in

2008 at the bridge 670 feet downstream from the existing headworks. The model-predicted water-surface elevations were found to be slightly higher than the measured values (Corps 2010).

The irrigation system has a number of return flows going back to Yellowstone River, including through small tributaries and into side channels, thus sustaining wetlands and channel features along the lower Yellowstone River.

3.3.6 Canal Intake Headworks

In 2012 the canal intake headworks was modified to include screens to prevent fish entering the canal. The headworks was relocated slightly upstream of the existing intake and fit with 12 gate openings, each with screen units. The screens are on the river side of the gated headworks, mounted on a rail that allows them to be raised during the non-irrigation season to prevent damage, primarily from ice flows and jams during the winter and early spring.

Slide gate discharge computations at the headworks were based on the head loss through the screens and gates structure and the tailwater elevations calculated by the canal hydraulics model at the cross section just downstream from the headworks, as shown in Figure 3-9 (Corps 2010).

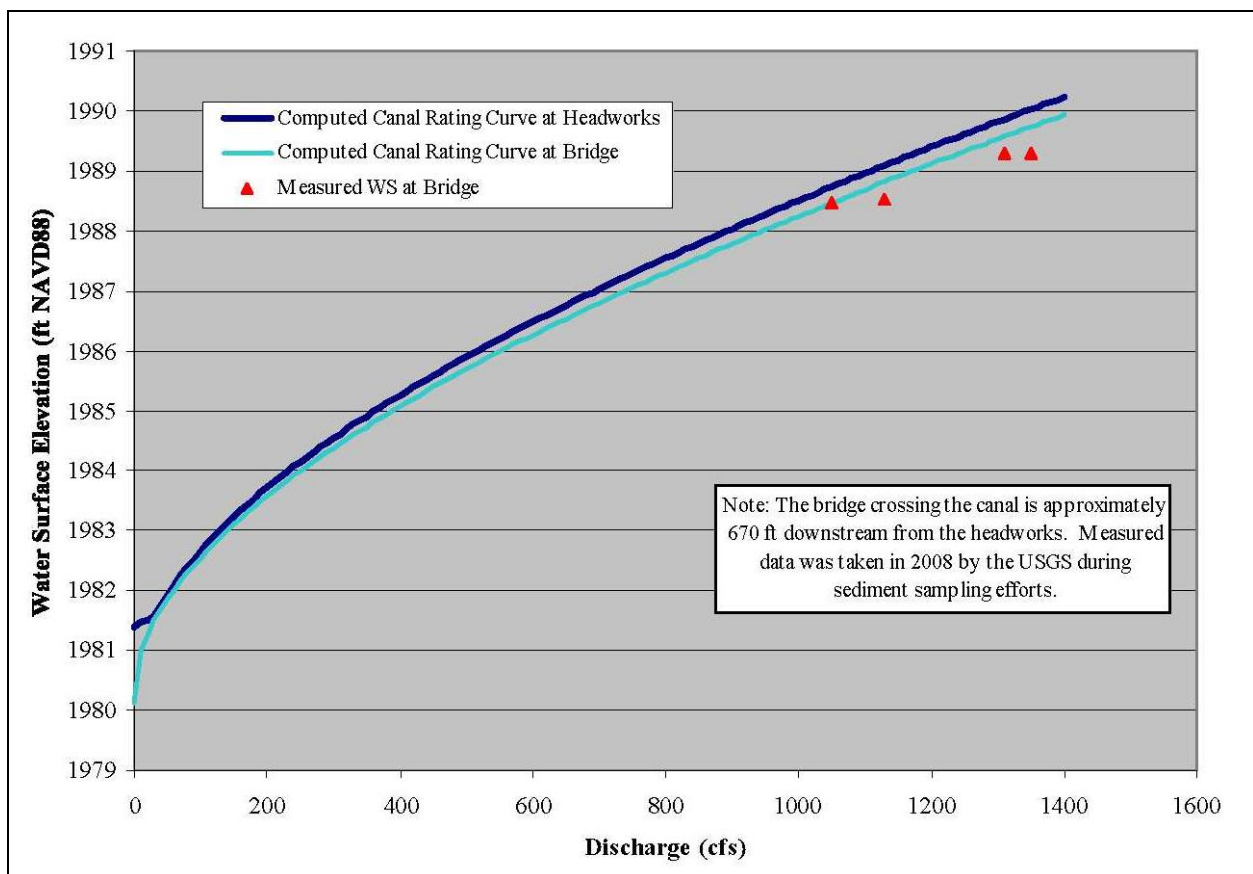

Figure 3-9. Rating Curve for Main Canal at the Headworks

The screen design was based on National Marine Fisheries Service *Screen Criteria for Juvenile Salmonids*, which includes a maximum screen approach velocity of 0.4 feet per second (fps).

Recommended sweeping velocities, addressed on some of the initial concept reports, vary from 2.0 to 2.5 fps (Reclamation 2004). Based on this criterion, each screen unit consists of two screen cylinders 78 inches in diameter and 100 inches long, for a total area of 340 square feet per unit or opening, resulting in a maximum discharge of 136 cfs per unit. With all 12 screen units in operation and flow evenly distributed, each unit will deliver 115 cfs with an approach velocity of 0.34 fps. With 11 screen units, each unit will deliver 125 cfs with an approach velocity of 0.37 fps. Based on manufacturer data (Intake Screens, Inc.) the head losses through the fish screens for these variations is approximately 0.5 feet. The Corps estimated that the gate structures further increase the head loss by 40 percent. Thus the total loss through the units (screens and gates) is estimated to be 0.7 feet or, more generally, between 0.5 and 1.0 feet (Corps 2010).

The screen head loss analysis was conducted for a total discharge of 1,400 cfs into the canal based on water surface elevations in the Yellowstone River at or above the extreme low flow elevation of 1,991.3 feet, corresponding to 3,000 cfs in the Yellowstone River.

3.3.7 Ice Jams

In 2011 and 2012 the Corps' Engineering Research and Development Center/Cold Regions Research and Engineering Laboratory provided an assessment of ice impacts and design guidance on the Intake Diversion Dam and headworks structure and the proposed bypass channel (Tuthill and Carr 2012; Reclamation and the Corps 2015). The assessment included review of past ice-related design efforts and the development of design and recommendations for the protection of proposed structures. The report notes that ice breakup on the lower Yellowstone River typically progresses downstream from warmer to colder climates (southwest to northeast) in a series of ice jams and releases. These jams tend to increase in severity as the breaking front encounters stronger, thicker ice. Jams in the main channel push flow and ice into side channels and onto the overbanks, leaving behind ice pieces. Historically when these jams form, the wide floodplains in the lower Yellowstone River system serve as a relief mechanism for collecting and storing ice. The overbank velocities of the ice pieces are low, (typically less than 2 fps at 40,000 cfs as calculated using HEC-RAS).

From review of past ice jam events, the Corps estimates that a late-season ice cover will release in the Intake Diversion Dam reach at a discharge of about 20,000 cfs, with breakup ice at a discharge of about 40,000 cfs.

In March 2014, a large ice event occurred in the Project reach. A multi-agency site visit provided observations (Corps 2014a) as follows:

Based on estimated stages at the headworks structure, the high flows in addition to a large volume of ice resulted in approximately a 50-100 year ice jam event at Intake. The headworks structure on the north side appeared to be in good shape. Debris was noticed above the steel cover plates on the front of the headworks.

Site observations on the south side of the river along the high-flow channel indicated extremely high stages and large volumes of ice deposited in the overbanks. Ice thickness ranged from approximately 18 inches to 40 inches. Many trees were missing bark and a number of trees were completely bent over or sheared off. In general, the high-flow

channel banks were relatively undamaged. Several areas with localized scour were observed, but large scale damage to the channel banks or invert was not apparent.

3.3.8 Hydrologic Trends

The hydrologic assessment prepared by the Corps (Corps 2006) included the development of a 5-year moving average of flow. The analysis indicates an overall increase in flows during the winter but an overall annual decrease in flow. The report notes that while this may intuitively seem to be due to irrigation diversions and reservoir operation—with higher summer flows diverted or held in storage and winter flows augmented with reservoir releases—the trends are not pronounced enough to determine if flows have been impacted through irrigation and reservoir operation or if the trends are due to climatic factors or coincidence. Analyses and data review in the CEA indicate a similar pattern of hydrologic trends, with decreasing August flows over the period of record including at sites considered to be unaffected by influences of water use and management (Corps and YRCDC 2015). The CEA also notes that there is strong evidence of decreasing annual flow, decreasing annual minimum discharge, decreasing peak discharge and earlier return of base flow conditions.

3.4 Groundwater Hydrology

Data sources used to evaluate the affected environment for groundwater include the following:

- Montana Groundwater Information Center (MBMG 2016)
- Groundwater Resources of the Lower Yellowstone River Area (MBMG 2000)
- Draft Yellowstone River Diversion Desktop Hydrogeologic Review (Tetra Tech 2015)
- Ranney Well Preliminary Design Review (Tetra Tech 2016a)
- Review of Collection Well Assumptions, Yellowstone River Diversion (Tetra Tech 2016b)
- Montana Cadastral Mapping Program (Montana State Library 2015a)
- Thickness of Unconsolidated Deposits, Lower Yellowstone River Area. (Smith 1998)
- Groundwater Resources of the Lower Yellowstone Dawson, Fallon, Prairie, Richland and Wibaux Counties, Montana. (Smith et al. 2000)
- Groundwater and Wells Second Edition (Driscoll 1986)
- Applied Hydrogeology Third Edition (Fetter 1994)
- Montana Department of Natural Resources and Conservation Water Right Query System (Montana State Library 2016)
- Groundwater Hydrology Second Edition (Todd 1980)
- Geology and Groundwater Resources of the Lower Yellowstone River Valley between Glendive and Sidney, Montana (USGS 1956)
- Geology of McKenzie County, North Dakota (NDGS 1985)
- North Dakota water well database (NDSWC&OSE 2016)
- North Dakota Department of Health Source Water Protection Program (NDDOH 2016).

Data from these sources may have been developed to assess compliance with one or more regulations designed to protect groundwater sources, including the following:

- **Safe Drinking Water Act**—The Safe Drinking Water Act (42 USC § 300f et seq.; Amendments of 1996: Sections 1423 and 1453) establishes measures to protect the

quality of public water supplies and sources of drinking water. It also requires states to develop wellhead protection programs and source water assessments to protect public water supply wells. The assessments evaluate a public water supply's susceptibility to contamination. The Montana Department of Environmental Quality's Source Water Assessment and Protection Program is completing assessments of contamination threats to all public water sources.

- **The Montana Groundwater Assessment Act**—in response to concerns about management of groundwater in Montana, the 1989 Legislature instructed the Environmental Quality Council to evaluate the state's groundwater programs. An Environmental Quality Council task force identified major problems in managing groundwater that were attributable to insufficient data and lack of systematic data collection (MBMG 2000). The task force recommended implementing long-term monitoring, conducting a systematic characterization of groundwater resources, and creating a computerized data base. Following these recommendations, the 1991 Legislature passed the Montana Groundwater Assessment Act (85-2-901 et seq., Montana Code Annotated) to improve the quality of decisions related to groundwater management, protection, and development within the public and private sectors. The Act established three programs at the Montana Bureau of Mines and Geology to address groundwater information needs in Montana:
 - The groundwater monitoring program—To provide long-term records of water quality and water levels for the state's major aquifers
 - The groundwater information center—To provide readily accessible information about groundwater to land users, well drillers, and local, state, and federal agencies
 - The groundwater characterization program—To map the distribution of and document the water quality and water-yielding properties of individual aquifers in specific areas.

Program implementation is overseen by the Groundwater Assessment Steering Committee. The Steering Committee consists of representatives from water agencies in state and federal government and representatives from local governments and water user groups. The committee provides a forum through which units of state, federal, and local government can coordinate functions of groundwater research.

- **Montana Controlled Groundwater Areas**—Montana has authority to designate a controlled groundwater area to prevent new appropriations or limit certain types of water appropriations due to water availability or water quality problems for the protection of existing water rights (85-2-501 et seq., Montana Code Annotated) (MDNRC 2016a). A petition may be filed by a state or local public health agency or by water users of groundwater or surface water. The petition must be filed with the Department of Natural Resources and Conservation and provide facts showing that one or more of the criteria listed is met. There are no controlled groundwater areas in the study area for this Project (MDNRC 2016b).

This section is a summary of existing groundwater resources in the study area, including the major aquifers and their hydrological characteristics, water well information, groundwater use, public supplies, and source water protection. The study area is the immediate area of the Yellowstone River valley and basin and generally includes available aquifer information for

Dawson, Richland and Wibaux Counties in Montana and McKenzie County, North Dakota. Groundwater quality is discussed in Section 3.6.4.

3.4.1 Aquifers

The Montana Bureau of Mines and Geology has divided groundwater zones in the lower Yellowstone River valley above the Pierre Shale Formation into hydrologic units as shown in Table 3-7. An earlier study of groundwater in the study area was performed by the U.S. Geological Survey (USGS 1956). These groundwater zones are also generally applicable in the portion of the lower Yellowstone River valley located in McKenzie County, North Dakota.

TABLE 3-7. AQUIFERS IN THE STUDY AREA

System	Stratigraphic Unit	Thickness	Yield (gallons/minute)	Description
Shallow Hydrologic Unit			Average of 35 gpm	
Quaternary	Unconsolidated deposits	0 – 100 feet	Average of 35 gpm	Sand, silt, gravel, and clay within major river valleys; alluvium, colluvium and glacial lake silts and clays
Quaternary or Tertiary	Unconsolidated deposits	0 – 200 feet	Average of 35 gpm	Sand, silt, gravel, and clay underlying terraces above river valleys; includes alluvium, till, and minor amounts of wind-affected and lake sediment.
Tertiary	Fort Union Formation (upper portion only)	Up to 1,600 feet	Average of 10 gpm and < 15 gpm	Yellow, orange, buff, and light-gray, fine-grained sandstone, siltstone, mudstone, and shale.
Deep Hydrologic Unit		> 200 feet	Average of 10 gpm and < 15 gpm	Lies above extensive claystone and shale in the upper Hell Creek Formation
Tertiary	Fort Union Formation (lower portion)	Up to 1,600 feet	Average of 10 gpm and < 15 gpm	Yellow, orange, buff, and light-gray, fine-grained sandstone, siltstone, mudstone, and shale.
Fox Hills-Lower Hell Creek		600-1,600 feet	Generally < 15 gpm (some reports of up to 100 gpm)	Near continuous sandstone found in the lower part of the Hell Creek Formation and most of the Fox Hills Formation
Upper Cretaceous	Hell Creek Formation	200 – 900 feet	Generally < 15 gpm (some reports of up to 100 gpm)	Gray and brown, silty shale, mudstone, fine- and medium grained sandstone
Upper Cretaceous	Fox Hills Formation	60 – 400 feet	Generally < 15 gpm (some reports of up to 100 gpm)	Light gray and white fine, and medium-grained sandstone; brownish gray, sandy shale, siltstone, and fine-grained sandstone
Lower Confining Layer				
Upper Cretaceous	Pierre Shale	1,300 – 3,000 feet	Not an aquifer	Dark gray shale

Source: MBMG 2000

3.4.1.1 Shallow Hydrologic Unit

The Shallow Hydrologic Unit includes aquifers within 200 feet of the land surface. In most places, this includes aquifers within the alluvium and terrace deposits and sandstones in the upper part of the Fort Union Formation. These generally include sand and gravel aquifers and

sandstone and siltstone aquifers (Fort Union Formation) where groundwater moves from drainage divides toward nearby valley bottoms and generally follows land-surface topography. Aquifers in this region have been grouped together based on their depth from the land surface. The groups are referred to as hydrologic units. Thicknesses of unconsolidated sand and gravel deposits range from zero to more than 100 feet along the Yellowstone River valley. These unconsolidated deposits are generally coarsest near the contact with underlying consolidated bedrock. Reported well yields for the Shallow Hydrologic Unit average 35 gallons per minute (gpm), although well yields can reach up to 200 gpm locally.

Water recharges the Shallow Hydrologic Unit primarily through infiltration of precipitation. Groundwater levels are typically highest in the spring when recharge from snowmelt and precipitation peaks. Water levels decline during the summer when recharge rates decline, and they are lowest in the winter when snow stores potential recharge at the land surface. Lesser quantities of recharge result from stream losses into the aquifer, leakage from irrigation ditches, and irrigation water lost by percolation through fields. Groundwater discharges from the Shallow Hydrologic Unit include springs and seeps along valley bottoms and sides, reaches of perennial streams that gain water, vegetative cover in valley bottoms (by transpiration), flow into deeper aquifers, and pumping of water wells. Alluvial groundwater is closely tied to surface water, as the water may readily flow from the streambed into the alluvium and vice versa. It is likely that leakage/seepage from the LYP irrigation system contributes to the shallow aquifer, but this has not been quantified.

Based on an evaluation of well logs in the Montana study area, the thickness of the Yellowstone River alluvial aquifer through the study area is most likely 30 to 80 feet, with a saturated aquifer thickness of 20 to 50 feet (Tetra Tech 2016a). These alluvial materials are most likely composed of sands and gravels with some clay. Four high-production Yellowstone River alluvial wells were located within 2 to 4 miles of the study area. Based on data from the production wells, the hydraulic conductivity was estimated to be in the range of 80 to 125 feet per day. Long-term water level trends in most Shallow Hydrologic Unit groundwater wells follow climatic trends more than short-term precipitation events, indicating that the shallow unconsolidated materials are of relatively low permeability, which slows percolation from the surface. This supports the observation of low productivity from Shallow Hydrologic Unit wells.

3.4.1.2 Deep Hydrologic Unit

The Deep Hydrologic Unit is composed of aquifers at depths greater than 200 feet below the land surface in the lower part of the Fort Union Formation and upper part of the Hell Creek Formation (MBMG 2000). This unit is composed of sandstone, siltstone, mudstone and shale and is characterized by intermediate to regional flow patterns. Groundwater levels in the aquifer system generally follow the regional topography. Groundwater flow in the aquifer system is predominantly away from major drainage divides and toward the Yellowstone and Missouri Rivers. Average well yields in the unit are 10 gpm.

Groundwater flow within the deep hydrologic unit is from upland areas toward major streams and is generally thought to bypass or flow beneath local tributary valleys. Groundwater levels in wells that tap the aquifer system do not generally reflect seasonal changes; the system is primarily recharged by slow leakage from overlying aquifers. Upward flow from the Fox Hills–Lower Hell Creek aquifer also recharges the Deep Hydrologic Unit in topographically low areas.

Discharge areas coincide with the major stream valleys, such as along the Yellowstone and Missouri Rivers.

3.4.1.3 Fox Hills-Lower Hell Creek

The Fox Hills-Lower Hell Creek aquifer is regional and occurs at depths from 600 to 1,600 feet below land surface (MBMG 2000). Mudstones in the Hell Creek Formation confine the upper part of the aquifer, and the Pierre Shale confines its base.

Groundwater inflows regionally from upland recharge areas south of the study area toward the Yellowstone River. The aquifer is under confined conditions, and flowing wells are common in the Yellowstone River valley. In topographically high areas, recharge also occurs by slow downward leakage from overlying aquifers through the confining mudstones of the Hell Creek Formation. Groundwater discharges from the aquifer to wells and, in topographically lower areas, by upward leakage to shallower aquifers and streams.

Water-level records for wells in the Fox Hills–Lower Hell Creek aquifer show no obvious responses to climatic conditions but show that industrial water use and the practice of allowing wells to flow unrestricted may have impacted artesian pressures. Long-term declines in water levels suggest that more water is being removed from the aquifer than is being recharged. The undesirable effects of declining water levels include cessation of flowing conditions, the need to install pumps in wells, and the need to lower existing pump intakes in wells. Unrestricted discharge from flowing wells—a process that bleeds pressure from the aquifer—may aggravate the declining water levels.

The effects of overdraft from the Fox Hills–Lower Hell Creek aquifer resulted in the first controlled groundwater area in Montana, near the South Pine oil field. In the early 1960s, near the South Pine oil field between Glendive and Baker, groundwater was pumped from the Fox Hills–Lower Hell Creek aquifer at a cumulative rate of about 450 gpm and injected into much deeper oil-producing formations to enhance secondary oil recovery. The withdrawals resulted in water-level declines that affected many surrounding stock and domestic wells and caused many landowner complaints.

Montana created the South Pine Controlled Ground Water Area in 1967 to limit the pumping from the aquifer. This slowed the rate of water-level decline (MBMG 2000). Between 1975 and 1977, the industrial wells used for the oil recovery operation were phased out of production and water levels in the area began to recover; however, water levels are still about 40 feet below the 1962 levels.

Aquifers in the area of the confluence with the Missouri River in McKenzie County, North Dakota also include the Charbonneau alluvial aquifer and the Yellowstone Buried Channel aquifer (NDSWC&OSE 2016). In general, glacial and alluvial aquifers in the confluence area are much thicker and subsequently, the underlying bedrock aquifers are at a greater depth. The Bullion Creek aquifer is within the middle Fort Union sequence, and the Sentinel Butte-Tongue River aquifer is within the upper Fort Union sequence in the confluence area (NDGS 1985).

3.4.2 Water Wells

Based on water well information available for Richland, Dawson, and Wibaux Counties, groundwater use is a significant source of water, and aquifers include both alluvial and bedrock aquifers. Table 3-8 provides a summary of aquifer data for these counties. Approximately 54 percent of the wells in the Montana study area have depths of less than 100 feet; and approximately 80 percent of the wells in the study area have depths less than 200 feet.

TABLE 3-8. WATER WELL INFORMATION REPORTED GEOLOGIC SOURCE

Well Location (Depth or Aquifer)	Number of Wells		
	Richland County	Dawson County	Wibaux County
Total Wells	4,585	3,480	1,318
Wells 0 – 99 Feet Deep	2,719	1,873	512
Wells 100 – 199 Feet Deep	990	995	396
Alluvium (Holocene)	85	72	<40
Alluvium (Quaternary)	410	258	<40
Sand and Gravel (Quaternary)	45	<40	<40
Terrace Deposits (Quaternary)	173	44	<40
Fort Union Formation (Tertiary)	432	395	522
Tongue River Member (of Fort Union Formation)	1,252	930	228
Colorado Shale or Formation (Upper Cretaceous-Colorado Group)	<40	<40	51
Hell Creek Formation (Upper Cretaceous)	<40	510	54
Fox Hills-Hell Creek Aquifer (upper Cretaceous)	78	114	59
Fox Hills Formation or Sandstone (Upper Cretaceous)	40	44	<40

Source: MBMG 2016a

Water well information for McKenzie County, North Dakota is available from the North Dakota State Water Commission & Office of the State Engineer (NDSWC&OSE 2016). A total of 1,213 water well records are in the database for the county. Most of the records indicate that the specific aquifer was not recorded. Aquifers recorded for water wells in the Yellowstone basin include (in order of prominence) the Sentinel Butte-Tongue Creek, Fox Hills, Fort Union, Charbonneau, Yellowstone Buried Valley, Tongue River, and Bullion Creek. Most of the bedrock wells have depths of 1,000 feet or more.

3.4.3 Groundwater Use

3.4.3.1 Water Wells

Surface water constitutes the overwhelming majority of water resources in the study area, likely because groundwater resources are limited. Groundwater from the three hydrologic units is used throughout the study area for domestic and stock-watering purposes. Aquifers in the Shallow Hydrologic Unit are the most utilized and are generally the most productive. Groundwater from the Shallow Hydrologic Unit is used for domestic, stock, and irrigation purposes. Well locations in the Shallow Hydrologic Unit are concentrated along the Yellowstone River valley (MBMG 2000). Table 3-9 lists water well use in Richland, Dawson, and Wibaux Counties. Primary uses are stock water (56 percent) and domestic (40 percent).

TABLE 3-9. WATER WELL REPORTED USES

Well Use	Number of Wells		
	Richland County	Dawson County	Wibaux County
Total Wells (a well may have more than one reported use)	5,642	4,187	287
Unknown	139	96	70
Recreation	0	3	0
Industrial	7	21	12
Other	33	17	4
Public Water Supply	98	90	18
Test Well	141	1	8
Unused	193	210	45
Fire Protection	1	3	1
Monitoring	341	324	113
Commercial	51	15	2
Irrigation	126	80	25
Research	24	1	0
Geothermal-Extraction	0	8	0
Geotechnical	71	72	21
Geothermal-Injection	5	0	0
Institutional	0	1	1
Stock Water	2,429	1,849	1,001
Domestic	1,916	1,395	447
Coal Bed Methane	0	0	1

Source: MBMG 2016a

Most of the well records for McKenzie County, North Dakota are monitoring or test wells or wells with an unknown purpose (NDSWC&OSE 2016). There are 240 domestic wells, 229 stock wells, 38 industrial wells, and 25 irrigation wells reported in the county.

3.4.3.2 Public Water Supplies

There are numerous public water supplies that use groundwater in the study area as shown on Table 3-10. Although the City of Glendive obtains its water from the Yellowstone River, most of the other public water supplies in the study area use groundwater. Most of the public supplies are located in Glendive and Sidney and include commercial establishments, school districts, and small residential communities. The City of Sidney has a groundwater supply that serves a population of 5,000. One public supply is located at the Intake Fishing Access Site (FAS). Available well on-line records (MTDEQ 2016c) indicate that wells are generally completed to depths of 240 feet or less.

There are three public water supply wells in the Yellowstone River valley in McKenzie County, North Dakota. Most of the public water supplies listed in EPA's database (EPA 2016b) are located in the vicinity of Watford City.

TABLE 3-10. PUBLIC WATER SUPPLIES GROUNDWATER SOURCE

Water System Name	City Served	Population Served	Water System ID	Well Information (total depth / water level) in feet
Dawson County, Montana				
Casitas Del Mesa Mobile Home Park	Glendive	30	MT0002738	Not available
Forest Park Water Rural Special Improvement District 24	Glendive	1,200	MT0000233	180-205 / 54-57
Highland Park Utilities Assn	Glendive	500	MT0000570	240 / not available
I-94 Mobile Home Park	Glendive	90	MT0000410	100 / 65
Whispering Trees Mobile Park	Glendive	100	MT0000408	104 / 60
Jefferson School District No 1	Glendive	270	MT0001209	208 / 126
Berg Automotive	Glendive	100	MT0004141	65 / 50
Cottonwood Country Club Glendive	Glendive	40	MT0001214	231 / 100
Crossroads Conoco	Glendive	25	MT0004069	220 / 51
Frosty's In And Out	Glendive	54	MT0001211	Not available
Glen Bowl Lanes	Glendive	120	MT0001210	Not available
Glendive Alliance Church	Glendive	150	MT0003977	Not available
Glendive Bad Route West Rest	Glendive	1,200	MT0001696	Not available
Green Valley Campground	Glendive	27	MT0000407	Not available
Intake FAS	Glendive	25	MT0042451	Not available
Riverside Inn Glendive	Glendive	27	MT0003475	Not available
Trail Star Cafe And Truck Stop	Glendive	400	MT0001215	Not available
Wagon Wheel Bar	Glendive	100	MT0001206	Not available
West Park Cenex Glendive	Glendive	50	MT0004665	125 / 28
Westgate Cenex	Glendive	600	MT0003811	Not available
Richland County, Montana				
Fairview Town Of	Fairview	1,000	MT0000213	145-150 / not available
Mount Pleasant Estates	Sidney	45	MT0000644	118 / 20
Richland County Valley View Water Users Association	Sidney	85	MT0000514	Not available
Sidney City Of	Sidney	5,000	MT0000330	107 / 17
Sidney Circle Homeowners Assn	Sidney	75	MT0002583	Not available
Central Water Conditioning	Sidney	50	MT0004502	Not available
Rau School District No 21	Sidney	80	MT0003089	Not available
Savage Public School	Savage	114	MT0001542	Not available
350 Truck Park	Fairview	40	MT0004776	Not available
Bagnell's RV Park Inc.	Not Reported	30	MT0004761	Not available
Eagle RV Park	Sidney	80	MT0004791	Not available
Eagles Landing Work Camp	Sidney	730	MT0004815	Not available
Four Mile RV Park Unapproved	Fairview	46	MT0004795	Not available
Four Seasons Trailer Court	Sidney	25	MT0000387	Not available
Mindt RV Park	Fairview	80	MT0004793	Not available
North Drive Mobile Home Court	Sidney	34	MT0004794	49 / 18
Reynolds Market Sidney	Sidney	25	MT0003411	17 / not available

Water System Name	City Served	Population Served	Water System ID	Well Information (total depth / water level) in feet
Sadie's Cafe & Sidney Livestock Market Center	Sidney	100	MT0002656	Not available
Sidney Gymnastics Club	Sidney	25	MT0004308	Not available
Sunrise Motel The	Sidney	200	MT0001906	41 / 8
Valley Fuel And Supply	Savage	75	MT0003706	Not available
McKenzie County, North Dakota				
Ridgeview Park	Fairview	161	ND2701623	Not available
Wildcat Estates	Fairview	25	ND2711700	Not available
Dore Terminal Musket Corp Transload	Fairview	40	ND2711659	Not available

Sources: MTDEQ 2016c; EPA 2016b.

3.4.4 Source Water Protection

This section provides information on groundwater protection issues and well locations in the study area that might be impacted by Project alternatives. Under a 1986 amendment to the Safe Drinking Water Act, each state is required to develop and implement a wellhead protection program in order to identify the land and recharge areas contributing to public supply wells and prevent the contamination of drinking water supplies. The Safe Drinking Water Act was updated in 1996 to require the development of a broader-based source water assessment program, which includes the assessment of potential contamination to both groundwater and surface water through a watershed approach. The Source Water Assessment and Protection Program for the Montana Department of Environmental Quality is completing assessments of contamination threats to all public water sources.

Source Water Delineation and Assessment Reports that have been completed in the study area was performed were reviewed for potential contaminant sources and contaminant issues of concern. Public water supplies in the study area are primarily in or near the cities of Glendive and Sidney, Montana. According to the City of Glendive's report (Montana MTDEQ 2016d), the susceptibility of the public water supply to potential contamination from the following contaminant sources is moderate to high:

- **State Superfund Sites**—The Burlington Northern Fueling Facility is a potential source of contaminants that could infiltrate into the shallow groundwater and migrate to the Yellowstone River. The site is ranked as a “medium priority” by the state Superfund Program, indicating it represents a potential long-term threat to surface or groundwater that requires action. It is not clear from available information if remediation has been initiated at the site. With no barriers identified, the susceptibility of the public water supply to this contaminant source is rated as high.
- **Petroleum Pipeline**—There is potential hazard of releases, spills, or leaks from a major natural gas pipeline that crosses several tributaries and runs close to the Yellowstone River in several places. Susceptibility of the public water supply to the pipeline is rated as high, even with two barriers recognized. This is justified based on the 2015 break in Bridger Pipeline's Poplar Pipeline, which resulted in contaminated water entering the Glendive intake.

- **Railroads**—The potential hazard represented by pesticides, fertilizers, volatile organic compounds and synthetic organic chemicals from spills along the Burlington Northern Railway pose a moderate to high hazard, depending on the proximity of the spill to the Yellowstone River and shallow aquifer recharge areas. With mitigation measures such as emergency response, the susceptibility to this potential contaminant source is rated as moderate to high.
- **Highway**—There is a potential hazard of hazardous materials that could be accidentally spilled on or along a highway or secondary highways, depending on whether a spill occurs close to the Yellowstone River or shallow groundwater recharge areas. Susceptibility is rated as moderate to high.
- **Cultivated Crop lands**—There is a potential hazard from pathogens and nitrate originating from agricultural lands that might be released to surface water or groundwater recharge areas. Cropped agricultural lands occupy a significant part of the Yellowstone River alluvial valley. The susceptibility of the Yellowstone River and shallow groundwater recharge areas to these agricultural sources of nitrate and pathogens is rated as moderate.
- **Underground Storage Tanks/Leaking Underground Storage Tanks**—There is a potential hazard of volatile organic compounds and petroleum hydrocarbons at three inactive tank sites with leak histories in the Glendive area and for three active tank sites without leak histories. Overall, the susceptibility ranges from moderate to low, depending on specific mitigation activities and location considerations.

According to the City of Sidney's report (Montana MTDEQ 2016e), the susceptibility of the public water supply to potential contamination from the following contaminant sources is moderate to high:

- **Crop Duster Mixing Site**—A crop duster chemical mixing and airport de-icer site is located near the Sidney airport beacon. Spills and leaks of pesticide and herbicides at this site are considered to be significant potential contaminant sources. However, it is not known if commercial volumes of chemicals are stored and used at the site. Susceptibility is rated as moderate.
- **County Shops**—County shops with above-ground fuel tanks are located near State Highway 16/200 in Sidney. Solvents used to clean equipment may also be stored at this site. It is not known whether commercial volumes of fuels and solvents are stored at this site. Susceptibility is rated as moderate.
- **Irrigation Canal**—The Yellowstone Project Main Canal passes up-gradient from the city's wells. Water loss from canals is common, and in some cases results in a substantial volume of water moving from the canal into the aquifer system below. Lone Tree Creek loses water to the aquifer in the area, so it is likely that the canal does also. The canal may receive water that is lower quality than the aquifer prior to flowing past Sidney, and in that case, the canal would contribute the lower quality water to the aquifer. Susceptibility is rated as moderate.
- **Cultivated Crop lands**—There is a potential hazard from pathogens and nitrate originating from agricultural lands due to the large amount of agricultural lands around Sidney. Within the groundwater recharge region, susceptibility is rated as moderate.
- **Oil Wells and Test Hole**—Petroleum exploration activities in the Sidney area have been significant in the past 50 to 60 years. Numerous test holes and exploratory wells have

been completed in the area. When the old exploratory wells are not properly plugged and abandoned, they can act as conduits for highly saline formation water to gain access to aquifers that are used for water supply. Due to the fact that water in the deeper formations is under higher hydrostatic pressure, the saline water can rise up the well borehole and be pushed into other shallower deposits. If those shallower deposits are aquifers, the saline waters will contaminate the aquifer and degrade the original water quality. In some parts of the state this is a serious problem that threatens the source water for several communities. Due to the significant number of exploratory wells in the recharge region, susceptibility is rated as high.

Smaller public water supplies in Glendive and Sidney are primarily sourced from shallow groundwater (less than 200 feet in depth). According to a review of these Source Water Delineation and Assessment Reports (MTDEQ 2016c), the susceptibility of the public water supply to potential contamination from the following contaminant sources is moderate to high (in addition to the sources listed above):

- **Municipal Sewer Mains**—Sewer mains in specific areas of Glendive are considered a potential source of contamination because the lines can leak. Susceptibility is rated as moderate to low.
- **Irrigation Canal**—Irrigation canals in Glendive can introduce contaminants to shallow groundwater. Susceptibility to public groundwater supplies is rated as moderate.
- **Septic Systems**—Areas of high and moderate septic density are potential sources of contamination, depending on their location in the vicinity of public water wells. Susceptibility is rated as low to high depending on the distance from the well.
- **Abandoned Wells**—Wells that are not properly abandoned can be a contaminant source because they represent a potential conduit for contaminants to access aquifers. Susceptibility is rated as low to high depending on the distance from a public supply well.

The only public water supply in the study area that is significantly distant from the cities of Sidney and Glendive is the Intake FAS. Susceptibility to potential contaminant sources was generally assessed both for the aquifer and the public water supply well (MTDEQ 2016f). According to the Montana Source Water Protection Program criteria, an aquifer consisting of unconsolidated alluvium that is semi-confined is rated as moderately sensitive to potential sources of contamination. The relatively low percentage of agricultural land in the area of the assessment represents a low hazard for this public water supply. The aquifer was determined to have a moderate sensitivity to potential nitrate contamination from agricultural lands within the assessment area. Overall, the susceptibility of Intake FAS is rated as low for pathogens and moderate for nitrate.

The North Dakota Source Water Assessment Strategic Plan was approved by EPA in 1999 and source water assessments have been completed by the North Dakota Department of Health, based on the plan for public water supplies in the state (NDDOH 2016). The Ridgeview Park public water supply well has a designated wellhead protection area that has a radius of 0.25 miles surrounding the well (NDDOH 2016). The other two smaller public water supplies in the City of Fairview area have smaller wellhead protection areas. All of these wells are classified with an overall moderate susceptibility to contamination (NDDOH 2016).

3.5 Geomorphology

The primary data sources for the affected environment assessment of stream geomorphology include the EA (Reclamation and the Corps 2010) and Supplemental EA (Reclamation and the Corps 2015), including associated engineering appendices with supporting hydraulic and sediment transport models, spreadsheets, aerial imagery, geographic information system (GIS) files, topography, and gaging station records. The Yellowstone River Cumulative Effects Assessment (YRCEA) (Corps and YRCDC 2015) provides information on geomorphic trends along the Yellowstone River primarily for the period from 1950 to 2001. The YRCEA study extent included 564 river miles and includes information summarized for the entire river, five regions covering between 80 and 150 miles, and reaches as short as 1.6 miles. Data provided by the Corps included the following:

- 2007 LIDAR triangulated irregular network
- 2011 LIDAR with main channel bathymetry as a combined triangulated irregular network
- Aerial Imagery (1950s, 1977, 2007, 2011, 2013)
- HEC-RAS hydraulic model of existing conditions including Yellowstone River main channel, existing side channel, and Main Canal
- HEC-RAS sediment transport model of the proposed bypass channel
- Spreadsheets containing sediment bed material gradations (surface and subsurface), sediment loads and gradations, long-term hydrology (daily flow records), flow splits, and results of sediment transport sensitivity runs.

The study area used to describe the geomorphic affected environment comprises the Yellowstone River and its overbanks from the existing side channel confluence upstream of the Intake Diversion Dam to the existing side channel confluence downstream of the Intake Diversion Dam, a distance of about 4 miles. This includes Joe's Island, the right overbank floodplain area immediately east of the Intake Diversion Dam that is bounded by the existing side channel and the Yellowstone River (Figure 3-3).

The study area is included in the CEA (Corps and YRCDC 2015) within their geographic classification as Region D. Region D extends 149 miles from the Powder River confluence with the Yellowstone River to the Yellowstone River confluence with the Missouri River. Region D includes sixteen sub reaches and Intake Diversion Dam is within their geomorphic Reach D8 that includes 10.2 miles of the Yellowstone River from RM 81.4 to 71.1 and is considered a partly confined anabranching reach. The study area also extends downstream to the confluence with the Missouri River.

3.5.1 Channel Characteristics and Sediment Transport

3.5.1.1 Hydraulic Conditions

The HEC-RAS hydraulic model includes approximately 10 miles of the Yellowstone River with the Intake Diversion Dam near the midpoint of the reach. The model includes the existing side channel that splits from the right bank of the main channel 1.8 miles upstream of the dam and reconnects with the main channel 1.7 miles downstream of the dam. The dam raises water

surface levels between 6 and 7 feet for flows ranging from 3,000 cfs to the 2-year flood of 54,200 cfs, providing sufficient head to divert the water right of 1,374 cfs into the canal.

There is also a 1.25-mile-long secondary channel connected to the left side of the Yellowstone River just downstream and opposite of the upstream end of the existing side channel. This side channel is classified as a secondary channel by the CEA because it is wetted at flows much less than bank-full. This side channel reconnects to the primary channel in the backwater pool of the Intake Diversion Dam, along the railroad embankment on the left bank. The channel would likely persist as a secondary channel even without the Intake Diversion Dam, but the downstream end would be shallower than present conditions.

The Yellowstone River along this reach is generally 600 to 900 feet wide, and at the 2-year flood, flow velocities range from 5 to 6 fps downstream of the dam and 4 to 6 fps upstream of the dam. Average flow depths for this discharge are generally between 7 and 14 feet downstream and between 8 and 14 feet upstream, except for the first 2,000 feet upstream of the dam, where average flow depths range from 14 to 18 feet. The average channel slope is 0.0006 feet per foot.

The existing side channel starts conveying water when the main channel discharge is in the range of 20,000 to 25,000 cfs. At the 2-year flood (54,200 cfs), the existing side channel conveys approximately 2,000 cfs, or 4 percent of the total flow. The existing side channel has a lower gradient (0.0005 feet per foot), is typically between 150 and 250 feet wide, and at the 2-year flood has flow velocity generally less than 4 fps and average depths between 3 and 6 feet.

3.5.1.2 Summary of Yellowstone River Cumulative Effects Assessment

The YRCEA (Corps and YRCDC 2015) describes geomorphic trends primarily occurring after 1950, with a focus on analysis of GIS data to describe the spatial distribution and temporal shifts of overall channel planform and associated complexity. The analysis included degree of braiding, extent and blockage of side channels, bank-full channel area, floodplain turnover and channel migration, and bank armoring.

Reach D8, which is upstream of the existing side channel's downstream confluence with the Yellowstone River, is described as a partially confined anabranching channel (a channel with branches that separate from the main stream and flow parallel to it for long distances before rejoining it) with moderate natural bedrock confinement, moderate gravel bar frequency, and high side channel frequency. Reach D9, which is downstream of the existing side channel's downstream confluence with the Yellowstone River, is described as a partially confined meandering channel with islands and moderate natural bedrock confinement, low to moderate gravel bar frequency, and moderate side channel frequency.

Region D has an average sinuosity of 1.16 with Reach D8 having a sinuosity of 1.45 and Reach D9 having a sinuosity of 1.15. The bank-full braiding parameter is defined as the primary plus anabranching channel lengths divided by the primary channel length, under bank-full flow conditions. Reach D8 and D9 have braiding parameters of 2.2 and 2.0, respectively for 2001 conditions, which represent increases from 1.9 and 1.8 in 1950. This is opposite the trend of a declining braiding parameter for the Yellowstone River on average.

Side channels are classified by the YRCEA as part of the bank-full flow conveyance but not wetted at low flows. Blockage of side channels, typically by small dikes, is noted as a common practice along the Yellowstone River, with 48 miles of side channels blocked after 1950 and 42 miles having already been blocked prior to 1950. Reach D8, which includes the 4-mile-long existing side channel forming Joe's Island, has no side channel blockage pre- or post-1950. Reach D9, which is only 3.5 miles long, includes approximately 4 miles of side channels that have been blocked, of which nearly 3 miles was blocked prior to 1950.

The amount of secondary channels (channels that are separated from the main channel by gravel bars or minimally vegetated islands that are wetted at low flows) has also reduced over time. Region D has experienced the most significant loss of secondary channel, starting at Reach D4 and continuing down to the confluence with the Missouri River. From 1950 to 2001, Reach D8 and D9 each lost approximately 3,000 feet of secondary channel. Over this period, Region C lost approximately 10 miles of secondary channel and Region D lost approximately 30 miles. Each of these regions is approximately 150 miles long.

The total bar area (point bars, bank-attached bars, and mid-channel bars) decreased by approximately 7 acres per valley mile in Reach D8 and increased by approximately 13 acres per valley mile in Reach D9 between 1950 and 2001. The greatest loss occurred in the reaches downstream of Reach D9, averaging approximately 14 acres per valley mile in this time period. Bank-full channel area, which is the entire channel footprint within the bank-full channel lines, shows a general gain in Regions A and B and general loss in Regions C and D. The loss in the total 300 miles of Regions C and D from 1950 to 2001 was approximately 4,500 acres, or approximately 120 feet of bank-full width. Most of this loss of bank-full channel area was in Region D, with reaches losing up to 80 acres per valley mile, or 660 feet of width. Reaches D8 and D9 had approximately 27 and 5 acres of loss in bank-full channel area per valley mile over the time period, respectively, which is 220 feet and 40 feet of width.

Channel migration rates, which directly relate to floodplain turnover and large woody debris recruitment, have generally decreased in the last 25 years. This is true for the river on average, for Region D and for Reaches D8 and D9. For Reach D8, the floodplain turnover was approximately 170 acres from 1950 to 1976 and approximately 100 acres from 1976 to 2001. In Reach D9, the floodplain turnover was approximately 100 acres and 60 acres for these time periods. This represents an approximate reduction in floodplain turnover of 0.4 acres per year per valley mile for both of these reaches. In terms of channel migration, the reduction is 3.3 feet per year, from 7.5 feet per year to 5.2 feet per year. Where channel migration coincides with wooded land, large woody debris recruitment would be affected. Region C, which would be the primary supply of large woody debris to Region D, shows a reduction of 0.35 acres per year per valley mile of channel migration into wooded land in the 1976 to 2001 period compared to 1950 to 1976. Region D shows a slight increase of 0.7 acres per year per valley mile between those time periods.

By 2011, there was 136 miles of bank armoring along the 560 miles of the Yellowstone River below Gardiner, which is predominantly made up of riprap. This includes approximately 13 miles added after 2001. Relatively little of the bank armor is in Dawson County, with 3.1 miles of bank armor in the 50.3 river miles in this county, or 6 percent, which is representative of

Region D as a whole. This compares to 23-percent to 36-percent armor coverage for the counties along the upstream reaches. Most of the bank armor in Region D is near Glendive and Sidney, and no bank armor was noted in Reach D9. Reach D8 has bank armor along the railroad alignment. This coincides with the location just upstream of the Intake Diversion Dam, where the channel impinges on a bedrock outcrop.

3.5.1.3 Channel Migration Zones, Deposition, Erosion, Rate of Change

The Yellowstone River channel boundaries are generally within alluvium consisting primarily of sand and gravel. The channel migrates within the alluvial materials and occasionally comes in contact with bedrock. Comparisons of 1950s aerial photography to recent aerial photography show that the channel bank lines are consistent, with generally less than 150 feet of migration. Two locations in the area of potential effect have experienced more than 300 feet of migration over this time period. At the upstream end of the existing side channel, the Yellowstone River has shifted up to 400 feet and at the bank opposite the downstream end of the existing side channel there is up to 450 feet of bank movement where a large channel bar has developed into a vegetated island.

One area that exhibits little or no channel migration is the left bank line upstream of the Intake Diversion Dam. In this area, the river flows along the railroad alignment, which is at least partially protected by riprap. This area also coincides with a high shale and silt stone bluff.

Channel bed materials consist of gravel, cobble, and sand. Islands are relatively common, as are channel bars and point bars on the insides of bends. Based on measurements at the Sidney gage (USGS Gage No. 06329500) and at the Project site, silt and clay are the predominant suspended load. Bed material loads (sediment sizes found in appreciable quantities in the channel bed) are predominantly sand with small amounts of gravel.

The existing side channel has maintained its sinuous form over the period since the 1950s, but channel migration of up to 150 feet has occurred on the outside of bends along the upper 2 miles of the channel. Therefore, relative to its size, the existing side channel has exhibited greater migration. At the very upstream end, the existing side channel has shifted up to 400 feet, which is consistent with the Yellowstone River at this location. The right bank of the existing side channel comes in contact with shale/silt stone bluff line on the south side of the floodplain, which appears to have halted channel migration. At 1.3 miles upstream of the existing side channel confluence with the Yellowstone River, Box Elder Creek enters the existing side channel. There is a large fan and point bar extending into the existing side channel at this location. There is also a large bar at the downstream confluence of the existing side channel in all the aerial photography.

3.5.1.4 Human Modifications Impacting Yellowstone River Channel Characteristic

The primary modification to Yellowstone River in this vicinity is the Intake Diversion Dam, raising water surface levels to an approximate water surface elevation of 1,991 feet for most flow conditions. This produces the head for diverting flow into the canal. Although there is almost certainly deposition of material in the channel bed upstream of the structure, the amount appears to be limited and is not readily discernable in the thalweg profile. Although localized downstream degradation could be present, it is likely that the channel no longer reflects a sediment imbalance, given that the dam has been in place for over 100 years and there is no

evidence of vertical instability. There is a localized scour hole at the downstream end of the rock rubble field.

The only other modification in the area is the railroad alignment along the left bank of the channel. Riprap placed along this channel bank may be responsible for the deep thalweg where the channel impinges on this lateral constraint. However, the shale/silt stone bluff may also be responsible, or at least contribute to the deepened thalweg along this bank.

3.5.1.5 Split Flow Characteristics at Side Channel

Flows begin to split into the existing side channel when the Yellowstone River flow is between 20,000 and 25,000 cfs. Based on discharge measurements by the Corps and Reclamation in June 2014, when the total flow was 49,200 cfs, the existing side channel conveyed approximately 1,350 cfs (Corps 2014b). As reported in the 2010 EA hydraulics appendix, the estimated flow split was between 300 and 400 cfs when flow at the Glendive gage (USGS gage #06327500, 16 miles upstream) was between 26,600 and 29,600 cfs. Small changes in the upstream cross section have a significant impact on the flow splits. Since this is a geomorphically active area in terms of lateral erosion and deposition, the flow splits to the existing existing side channel are probably highly variable.

The existing side channel splits off the main channel at an angle greater 90 degrees, which would reduce the efficiency of the flow split. There is also a tight bend on the existing side channel that is constrained by the bluff line, which produces backwater and reduce the amount of water that split off at this location. The higher backwater on the existing side channel would tend to reduce discharges diverting into the existing side channel. The severe angle of the existing side channel entrance and the backwater from the tight bend would contribute to the development of the approximate 5-foot-high bar at the upstream end of the side channel (based on site observations and LIDAR data).

3.5.1.6 Flow Characteristics at Downstream Confluence

The downstream confluence of the existing side channel and the main river is also active geomorphically. There is a bar at the downstream confluence of the existing side channel in all aerial images dating back to the 1950s. In the 1950s, there was a small amount of vegetation on the bar; currently the bar is an established vegetated island. The presence and growth of the island has caused the left bank of the Yellowstone River to migrate up to 450 feet since the 1950s. As the island expands, flows are deflected into the left bank. When flows are not entering the upstream end of the existing side channel, the downstream end (up to 2,000 feet) is in backwater from the main channel. For flows in the main channel up to the 2-year flood event (54,200 cfs) the downstream 2,000 feet would have flow velocities generally less than 2 fps.

3.5.2 Hydraulic Conditions for Fish Migration

Design criteria for support of pallid sturgeon fish passage were developed in concert with the proposed bypass channel design, with guidance from the Biological Review Team and the U.S. Fish and Wildlife Service (the Service). Separate sets of design criteria were developed for Yellowstone River discharges less than 15,000 cfs and discharges equal to or greater than

15,000 cfs, as summarized in Table 3-11 (Walsh 2014; Reclamation and the Corps 2015). The criteria are presented here as they may be applicable to other alternatives.

TABLE 3-11. FISH PASSAGE DESIGN CRITERIA FOR PROPOSED BYPASS CHANNEL

	Discharge at Sidney, Montana USGS Gage: 7,000 - 14,999 cfs	Discharge at Sidney, Montana USGS Gage: 15,000 - 63,000 cfs
Bypass Channel Flow Split	≥12%	13% to ≥ 15%
Bypass Channel Cross-Sectional Velocities (measured as mean column velocity)	2.0 - 6.0 fps	2.4 - 6.0 fps
Bypass Channel Depth (minimum cross-sectional depth for 30 contiguous feet at measured cross-sections)	≥ 4.0 feet	≥ 6.0 feet
Bypass Channel Fish Entrance (measured as mean column velocity)	2.0 - 6.0 fps	2.4-6.0 fps
Bypass Channel Fish Exit (measured as mean column velocity)	≤ 6.0 fps	≤ 6.0 fps

The following are additional considerations for fish passage improvements:

- Channel characteristics that maintain variability of flow within or on the margins of the proposed bypass channel without introducing significant turbulence are highly valued.
- Minimum depths should be assessed across 30 contiguous feet of measured channel profile. Pallid sturgeon typically prefer depths greater than 3.3 feet (1 meter).

3.5.3 Floodplain

3.5.3.1 Regulatory Setting

Dawson County, Montana participates in the National Flood Insurance Program, and floodplain management is conducted in accordance with the requirements of the program. The Intake Diversion Dam is on FEMA Map Panel 3001400009B, dated April 1978 (Figure 3-10). The entire Yellowstone River within the study area, including Joe’s Island, is delineated as Zone A, which is defined as areas subject to inundation by the 100-year flood event, generally determined using approximate methodologies. Because detailed hydraulic analyses have not been performed, no base flood elevations or flood depths are shown.

The State of Montana has adopted model state floodplain regulations for development in the flood fringe or regulated flood hazard area. The following are pertinent regulations for the Intake Diversion Dam:

- Base flood elevations must be determined by an engineer and used in the design and layout of the Project.
- The maximum allowable encroachment shall be an increase of 0.5 feet or less to the base flood elevation, unless an approved FEMA conditional letter of map revision is obtained.
- The minimum freeboard is 2 feet above base flood elevations. The low chord of bridges must be at least 2 feet above the 100-year base flood elevation.

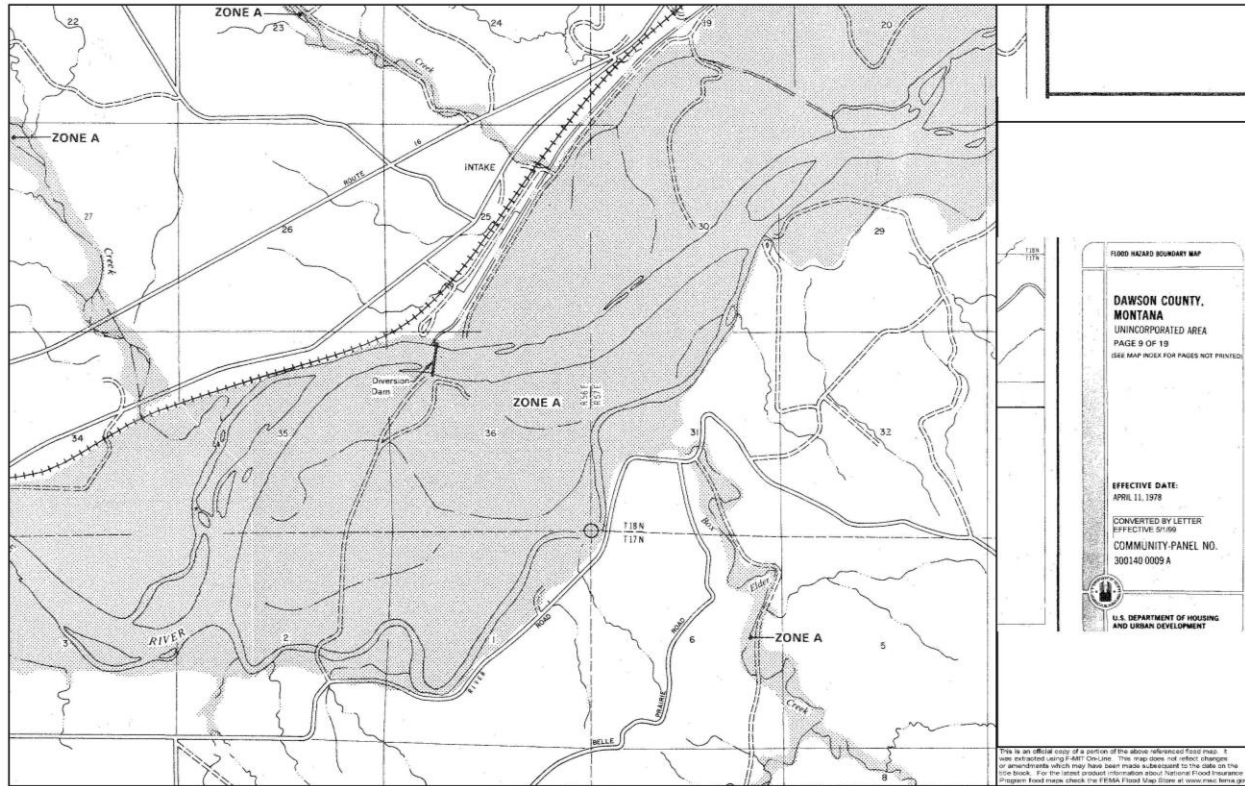

Figure 3-10. Flood Insurance Rate Map for Area of Potential Effect

3.6 Water Quality

The area of potential effect for water quality includes water bodies in the vicinity of proposed construction for each alternative, as well as the areas downstream where the effects of construction or operation could extend. This could include all areas along the Yellowstone River from Cartersville Dam downstream to the confluence with the Missouri River, including irrigation canals, lakes, side channels, or backwater habitat connected to this reach.

The Montana Department of Environmental Quality and the North Dakota Department of Health monitor and assess the condition of surface waters within their respective states. Some oversight is also provided by the U.S. Environmental Protection Agency. The U.S. Geological Survey is also an active participant in assessing water quality in the Yellowstone River Basin.

Water quality is determined through monitoring of physical, chemical and biological parameters. Those data allow agencies to set standards to ensure continued protection of water quality. The raw data for physical, chemical and biological parameters are presented here, as well as the standards for protection of water quality. The following concepts are used in the discussion:

- **Beneficial uses** for the Yellowstone River are uses approved by state entities, with specific water quality standards assigned for each.
- **Surface water quality** describes the existing quality of water in the Yellowstone River and whether standards have been met for beneficial uses.

- **Clean Water Act 303(d) listings** are designations of water segments that do not meet water quality standards.
- **Total maximum daily loads** are reports prepared for 303(d)-listed segments, detailing measures for restoring water quality for the listed parameter.

3.6.1 Beneficial Uses

Under the federal Clean Water Act (CWA) surface waters are designated for specific beneficial uses. The Administrative Rules of Montana designate the main stem Yellowstone River as Class B-3 waters (ARM 17.30.611). Water quality standards for Class B-3 waters (ARM 17.30.625) include Montana numeric water quality standards from Circular DEQ-7 (MTDEQ 2012). Class B-3 waters are suitable for the following beneficial uses:

- Drinking water, including culinary use and food processing purposes after conventional treatment
- Primary contact recreation, including bathing, swimming, and recreation
- Aquatic life, including the growth and propagation of non-salmonid fishes and associated aquatic life, waterfowl, and furbearers
- Agricultural use, including industrial water supply.

Table 3-12 summarizes how each of these uses is currently supported for the study area.

TABLE 3-12. BENEFICIAL USES OF THE YELLOWSTONE RIVER FROM THE INTAKE DIVERSION DAM TO NORTH DAKOTA

Beneficial Use	Fully Supporting	Not Supporting	Threatened	Insufficient Information^a
Drinking Water	X		No	
Primary Contact Recreation	X		No	
Agricultural Use	X		No	
Aquatic Life		X	No	

a. There are no beneficial uses with insufficient information to be assessed for the study area.

The Yellowstone River, including the segment from the Intake Diversion Dam to the North Dakota border, has been evaluated for beneficial use support since 1996 (MTDEQ 2014). In 1996, this reach was listed as only partially supporting its aquatic life, warmwater fisheries, drinking water supply, recreation and swimmable beneficial uses as a result of elevated metals, nutrients, pathogens, salinity/total dissolved solids (TDS)/chlorides, suspended solids and pH, as well as habitat alterations. Impairments that are 303(d)-listed are described in Table 3-13. These were the likely result of agriculture, irrigated crop production, municipal point sources, natural sources, rangeland management, and streambank erosion and modification/destabilization.

TABLE 3-13. SOURCES OF 303(D) IMPAIRMENTS RESULTING IN NONSUPPORT OF AQUATIC LIFE BENEFICIAL USES

Impairment	Probable Source	Total Maximum Daily Load Study Completed
Chromium (total)	Sources are unknown	No
Copper	Natural or unknown sources	No
Fish Passage Barrier	Impacts from hydro-structure flow regulation and modification	No
Lead	Sources are unknown	No
Sedimentation/Siltation	Rangeland grazing, irrigated crop production, streambank modifications and destabilization, hydro-structure flow regulation and modification, and unknown sources	No
Total Dissolved Solids	Natural or unknown sources	No
pH	Natural or unknown sources	No
Nitrogen (Total)	Irrigated crop production, streambank modification and destabilization, and unknown sources	No
Phosphorous (Total)	Irrigated crop production, rangeland grazing, streambank modifications and destabilization, and unknown sources	No
Alteration in Stream-Side or Littoral Vegetative Covers	Irrigated crop production, rangeland grazing, streambank modifications and destabilization	No

In the 2006 assessment, the reach was found to only partially support aquatic life, warmwater fisheries, drinking water supply, and recreation (MTDEQ 2014). Aquatic life support limitations were the result of alterations in stream-side covers the presence of a fish passage barrier, as well as elevated levels of chromium (total), copper, lead, sedimentation/siltation, TDS, pH, nitrogen (total), and phosphorus (total). These were noted as likely resulting from flow regulation and modification, streambank modification, irrigated crop production, rangeland management, natural causes, and unknown sources.

The most recent findings, from 2014, show an improvement in beneficial use conditions compared to 2006 results (MTDEQ 2014). The river now fully supports the beneficial uses for agriculture, drinking water, and recreation, while remaining limited in supporting beneficial uses for aquatic life (Table 3-12). Causes for non-support of aquatic life result from the alternation in stream-side vegetation covers, presence of chromium, copper, lead, and high levels of nitrogen, phosphorous, sediment, TDS, and pH. Other causes for nonsupport include the presence of the Intake Diversion Dam, which is a fish passage barrier. Many of these are currently considered 303(d) impairments, shown in Table 3-13.

On January 17, 2015, the breach of Bridger Pipeline's Poplar Pipeline released approximately 32,000 gallons of crude oil into the Yellowstone River upstream of Glendive. This spill temporarily contaminated the city water supply with dissolved benzene. According to the after-spill action report, drinking water standards were restored within seven days (MTDEQ 2015b). The drinking water plant continues to be monitored for signs of benzene and other volatile organic compounds by new water-testing machines, in addition to the regularly required off-site laboratory analysis of water samples.

3.6.2 Surface Water Quality

Water quality data presented in the following sections are taken from a selection of previously prepared reports, as well as raw data available online. Unless otherwise noted, data presented below come from four primary sources:

- National Water Quality Assessment (NAWQA) 1999-2001 report (USGS 2004), which provides numeric water quality data,
- 2014 Final Water Quality Integrated Report for Montana (MTDEQ 2014), which provides generalized water quality data and assessment for the state,
- Yellowstone River Cumulative Effects Analysis, Technical Appendix 5 Water Quality (Corps and YRCDC 2015)
- Raw water quality measurements available at U.S. Geological Survey Water Quality Page (USGS 2016a). Raw USGS water quality data comes from a monitoring gage near the City of Sidney (Gage 06329500). Recent data may be provisional, providing water quality measurements that have not been finalized.

State surface water quality standards are established in Montana's administrative rules, and in two circulars prepared by MTDEQ that further clarify and set water quality standards. Not all water parameters have been assigned standards and many are given narrative standards that change under each stream classification. The water quality standards described below are taken from these resources:

- ARM 17.30.620 to ARM 17.30.670, including ARM 17.30.625 (B-3 Classification Standards)
- Department Circular DEQ-7 Montana Numeric Water Quality Standards (MTDEQ 2012)
- Department Circular DEQ-12A, Montana Base Numeric Nutrient Standards (MTDEQ 2013a). This circular provides nitrogen and phosphorous concentrations standards to reflect the intent of the narrative at ARM 17.30.637(1)(e) and precludes the need for case-by-case interpretations of that standard in most cases. These standards were approved by the EPA in 2015 (EPA 2015a).

3.6.2.1 Temperature

State water quality standards are designed to prevent sudden changes in temperature as a result of anthropogenic activities:

- A 3°F maximum increase above naturally occurring water temperature is allowed within the range of 32°F to 82°F
- Within the range of 82°F to 84.5°F, no discharge is allowed that will cause the water temperature to exceed 85°F;
- Where the naturally occurring water temperature is 84.5°F or greater, the maximum allowable increase in water temperature is 0.5°F.

Temperature measurements at the Sidney gage between 2004 and 2014 show that summer water temperature fluctuated between 50°F and 82.4°F. Raw data from year-round temperatures for 2012 through 2015 range from 32°F to 81.5°F, with an average of 59°F. All measurements have been within published standards for temperature.

3.6.2.2 pH

The ARM pH standard for Class B-3 waters is 6.5 to 9.0, with an allowable human induced variation of less than 0.5 units. Natural pH outside this range must be maintained without change. Natural pH above 7.0 must be maintained above 7.0.

Acidity and alkalinity are measured in water using free hydrogen-ion content, referred to as pH. A 7.0 pH represents a neutral solution, greater than 7.0 is alkaline and below 7.0 is acidic. In general, water in the Yellowstone River is considered alkaline, with pH ranging from 7.4 to 8.6. Values of pH tend to increase moving from upstream to downstream. All values measured for pH have met water quality standards.

3.6.2.3 Dissolved Oxygen

Dissolved oxygen enters the water column from the atmosphere and from photosynthesis by aquatic plants, and is depleted through chemical oxidation and respiration by aquatic life.

Dissolved oxygen standards for Class B-3 waters are based on aquatic life stages:

- To protect early life stages (e.g., eggs and fry), the minimum 7-day mean is 6.0 mg/L and the 1-day minimum is 5.0 mg/L
- To protect remaining life stages, the 7-day minimum is 4.0 mg/L and the 1-day minimum is 3.0 mg/L.

Concentrations of dissolved oxygen in the Yellowstone River are generally 8 to 10 mg/L, or near saturation. Yellowstone River water between Glendive and Sidney gages typically had high concentrations of dissolved oxygen, resulting from continuous flow and mixing of the water column with few sources for depletion, such as slower moving or still water. At the Sidney gage, of all available dissolved oxygen measurements taken between 2005 and 2015, the range of dissolved oxygen was 7.5 to 15 mg/L, with an average concentration of 10.5 mg/L. All dissolved oxygen water quality measurements met water quality standards at these locations.

3.6.2.4 Suspended Sediment

Water quality standards prevent increases above naturally occurring concentrations of sediment or suspended sediment, settleable solids, oils, or floating solids, which will or are likely to create a nuisance or render the waters harmful, detrimental, or injurious to public health or beneficial uses like recreation, safety, welfare, livestock, wild animals, birds, fish, or other wildlife. Water quality standards are established to prevent increases in turbidity more than 10 units above naturally occurring conditions.

Suspended sediment concentrations are generally higher at upstream locations and lower at downstream locations on the Yellowstone River. Near Sidney, the median suspended sediment concentration is 82 mg/L, but the concentration varies greatly from 1 mg/L to over 4,700 mg/L. Suspended sediment concentration is generally highest in the spring and early summer, corresponding with runoff. Streambank erosion and runoff from adjacent agricultural lands also affect suspended sediment concentrations. Nearly a third of the annual sediment load in the Yellowstone River near Sidney comes from the Powder River Basin (though it contributes less than 5 percent of the annual Yellowstone stream flow).

The presence of the Intake Diversion Dam modifies the natural movement of sediment through the Yellowstone River. The lower Yellowstone River is a naturally turbid, or highly sediment-

laden, system, and the warmwater fishery has adapted to these conditions. Sedimentation or siltation has occurred behind the Intake Diversion Dam, however, which may be reducing the natural turbidity in downstream reaches.

Turbidity data collected at the Sidney gage between 1998 and 2001 ranged from 2.8 to 1,600 nephelometric turbidity units. The median value was 65. No data for comparison has been collected for the Glendive gage upstream of the Intake Diversion Dam.

3.6.2.5 Total Dissolved Solids

TDS is a measure of the amount of major ions like sodium, calcium, magnesium, bicarbonate, chloride and other dissolved solids in water.

The general water chemistry of the lower Yellowstone River is dominated by sodium and calcium (cations), and sulfate and bicarbonate (anions). Raw TDS values measured in 2012 through 2015 at the Sidney gage ranged from 156 mg/L to 699 mg/L, with an average of 415 mg/L. Samples collected in the NAWQA program from 1999-2001 showed slightly higher TDS, with a median concentration of about 450 mg/L. TDS varies seasonally, and is generally lowest in the spring and early summer when flows are highest (snowmelt runoff). Highest concentrations occur in the fall and winter when the stream flows are lowest and groundwater dominates water chemistry. TDS concentrations on the lower Yellowstone River are primarily attributed to natural factors, but irrigation return flow may also contribute to elevated TDS concentrations at some sites in the Yellowstone River Basin. Raw USGS data show that several measurements of TDS for the Yellowstone River near Sidney exceed the national secondary drinking water standard of 500 mg/L. The lower Yellowstone River below the Intake Diversion Dam is classified as “partially supporting” for aquatic life and warmwater fisheries, with the occasionally elevated TDS concentrations listed as a probable cause of impairment.

3.6.2.6 Fecal Coliform and *E. Coli*

Between 2000 and 2001, several fecal coliform and *E. coli* samples were collected throughout the Yellowstone River from Billings to Sidney. None of the samples in this reach exceeded standards for fecal coliform or *E. coli*.

3.6.2.7 Nutrients

Nutrients, including phosphorous and nitrogen, are important for the growth of organisms but can be considered pollutants at high concentrations. For the study area, recently adopted standards from August 1 through October 31 are 815 micrograms (μg)/L of nitrogen and 95 μg /L of phosphorous (MTDEQ 2013a).

Nitrogen enters streams through natural biological processes and chemical reactions, decay of plant material, and non-natural processes such as application of fertilizer, stormwater runoff or sewage disposal. Total nitrogen concentrations in the lower Yellowstone River near Sidney ranged from 0.16 mg/L to 9.30 mg/L, with a median of 0.87 mg/L. Total nitrogen varies seasonally, with highest concentrations typically in the spring and early summer. High concentrations during this period are likely related to suspended organic matter during snowmelt runoff. Total nitrogen is listed as a probable cause of impairment for aquatic life and warmwater fisheries in the lower Yellowstone River below the Intake Diversion Dam.

Natural sources of phosphorus in the study area include soils and sediments derived from marine sedimentary rocks, animal and human waste, and fertilizer. Total phosphorus concentrations on the lower Yellowstone River near Sidney ranged from < 0.01 mg/L to 2.7 mg/L, with a median of 0.09 mg/L. Like total nitrogen, highest total phosphorus concentrations typically occur in the spring and early summer during the snowmelt runoff when suspended sediment concentrations are high. Total phosphorus is listed as a probable cause of impairment for aquatic life and warmwater fisheries in the lower Yellowstone River below the Intake Diversion Dam.

3.6.2.8 Pesticides

Pesticides are frequently detected in the lower Yellowstone River, but are found at very low concentrations. Near Sidney, pesticides were detected in 42 of 44 water samples collected in the NAWQA study in 1999-2001. Sixteen pesticides (11 herbicides and 5 insecticides) were detected in one or more samples. Concentrations of all compounds were generally reported below 0.01 µg/L, and were substantially lower than standards and guidelines for human health and aquatic life. Concentrations of pesticides in bed sediments and fish tissue in the lower Yellowstone River were also very low.

All samples collected in the NAWQA study in the Yellowstone River near Sidney were below State of Montana limits. However, no criteria have been set for 20 of the pesticides, so no determination can be made about the potential effects on human or aquatic health. Furthermore, water quality standards do not consider the effects of a combination of two or more pesticides, and the aquatic life criteria do not account for the potential combined effects of pesticides and other stressors, such as temperature fluctuations. However, at this time, no pesticides exceed water quality standards.

3.6.2.9 Trace Elements

Water Column

Testing of arsenic, copper, and lead in the water column have found exceedances of water quality standards (USGS 2004). Arsenic concentrations throughout the river ranged from <1 µg/L to 42 µg/L. The EPA has set the arsenic maximum contaminant level in drinking water at 10 µg/L (EPA 2001). Geothermal waters from Yellowstone National Park are a significant source of arsenic in the Yellowstone River (USGS 2004). Copper concentrations exceeded state water-quality standards in a few instances in 2003 at Sidney, exceeding both the acute (3.79 µg/L at 25 mg/L hardness) and chronic life (2.85 µg/L at 25 mg/L hardness) standards. Elevated copper levels are commonly associated with acid mine drainage (USGS 2004). Lead concentrations in 2003 at Sidney exceeded the chronic life standard (0.545 µg/L at 25 mg/L hardness) by 233 percent. Lead naturally occurs in Tertiary and Cretaceous period volcanic rocks, which are associated with the Yellowstone River area, or may result from stormwater runoff from urban and industrial areas (Corps and YRCDC 2015).

Sediments

There are no state or U.S. standards for concentrations of trace elements in sediments. The Canadian Council of Ministers of the Environment have developed guidelines for sediment concentrations of trace elements that may be toxic to aquatic life. The guidelines establish two levels of effect:

- The interim sediment quality guideline concentration, below which adverse biological effects are not expected
- Probable effect level concentration, above which frequent adverse effects are anticipated.

The Yellowstone River Basin was evaluated for 44 trace elements in streambed sediments (USGS 1998). Trace element concentrations in waters of the lower Yellowstone River near Sidney are generally below established standards. However, four of these elements were found in potentially toxic concentrations at one or more sites in the basin, including arsenic, chromium, copper, and lead.

In the lower Yellowstone River near Sidney, concentrations of arsenic and chromium exceeded the interim sediment quality guideline, indicating the potential for adverse effects on aquatic life. Copper and lead concentrations were below the guideline. Concentrations of all four elements were below the probable effect level.

3.6.2.10 Mercury

Mercury concentrations in fish-muscle and bed-sediment samples were collected in cooperation with the National Mercury Project (USGS 1998). Total mercury in the fish tissue of two sampled saugers was 1.29 µg/g dry weight and 0.250 µg/g wet weight. The total mercury in sediment was 18.7 µg/g. The mercury concentrations in the sauger from this site were similar to the median and mean concentrations of mercury from a national study of chemical residues in fish. No standards are set for fish tissues. The State of Montana maintains guidance regarding sportfish consumption, which includes a chart showing where potentially contaminated fish should be avoided; the chart does not indicate that any fish are unsafe for consumption within the Yellowstone River (MFWP and Montana 2014).

3.6.3 Clean Water Act Section 303(d) Listings and Total Maximum Daily Loads

When a water body does not meet the numeric or qualitative standards for protecting beneficial uses, it may be placed on the CWA Section 303(d) list, depending on the water quality impaired listing policy. Listings for water quality impairment may require multiple observations within a reasonable time period (e.g., 30 days).

The Yellowstone River is designated water quality Category 5, defined as waters where one or more applicable beneficial uses have been assessed as being impaired or threatened. The Yellowstone River between the Intake Diversion Dam and the North Dakota border has eight water quality parameters that are consistently not meeting regulatory state water quality standards: chromium, copper, lead, nitrogen, phosphorous, sedimentation or siltation, TDS, and pH. Each of these has been reported as a separate 303(d) listing under the CWA. Causes and sources of impairments are summarized in Table 3-13 (MTDEQ 2014). Additional impairments caused by physical factors include the presence of the Intake Diversion Dam, which acts as a fish barrier, and alterations to stream-side or littoral vegetative covers.

The CWA requires that each state prioritize its 303(d) listed water body segments in order of most need. The Yellowstone River 303(d) listed segments are currently considered a low priority for the state of Montana, in comparison to other listed reaches. As a result, no total maximum daily loads have been prepared for the 303(d) listed parameters to date.

3.6.4 Groundwater Quality

Throughout the lower Yellowstone River area, farms, ranches, and municipalities rely on wells as sources of drinking water. Specific uses, in decreasing volume, include irrigation, public water supply, livestock, industrial, commercial, private-system domestic, mining, and cooling for electrical power production. In most communities, domestic supplies and most water for livestock come from groundwater. At Glendive, surface water from the Yellowstone River provides for these uses.

Groundwater quality standards are set by ARM 17.30.1001 to 17.30.1045. Groundwater resources of the lower Yellowstone River area, including the counties of Dawson, Richland, and Wibaux, were evaluated by the Montana Bureau of Mines and Geology (Smith et al. 2000). The following summarizes key findings from this report.

All groundwater used in the lower Yellowstone River Area occurs in the sedimentary rock units above the Pierre Shale, in three distinct units:

- The Shallow Hydrologic Unit is composed of groundwater within 200 feet of the land surface and supplies most wells. Groundwater flow in the Shallow Hydrologic Unit is characterized by local flow systems where groundwater moves from drainage divides toward nearby valley bottoms.
- The Deep Hydrologic Unit is composed of aquifers at depths greater than 200 feet below the land surface in the lower part of the Fort Union Formation and the upper part of the Hell Creek Formation.
- The Fox Hills–Lower Hell Creek aquifer lies at depths between 600 and 1,600 feet below land surface throughout most of the study area. The top of the aquifer is limited by mudstones in the Hell Creek Formation; the Pierre Shale confines the base of the aquifer.

Groundwater from all three hydrologic units is used for domestic and stock-watering purposes and a few towns use the Fox Hills–Lower Hell Creek aquifer for drinking water. Aquifers in the Shallow Hydrologic Unit are the most utilized and generally provide the most water, averaging about 35 gpm. Wells completed in the Deep Hydrologic Unit and Fox Hills–Lower Hell Creek aquifer are reported to provide less than 15 gpm, though well drillers report that some wells yield as much as 100 gpm in these aquifers.

Much like the Yellowstone River, most groundwater in the area is mineralized, having a high level of dissolved constituents. The average concentration of dissolved constituents in each unit is greater than 1,400 mg/L. The Shallow Hydrologic Unit varies from less than 500 mg/L to more than 5,000 mg/L. This results from the variety of near-surface geologic materials, the differing lengths of groundwater flow paths, and the dissimilar recharge sources. Within the Deep Hydrologic Unit, median dissolved-constituent concentration is higher than in other units (2,150 mg/L), but varies less than in the Shallow Hydrologic Unit. The most uniform water in the study area is in the Fox Hills–lower Hell Creek aquifer where reported concentrations of dissolved constituents were generally between 1,000 and 2,500 mg/L. Decreasing variability in the lower units suggests more chemically stable systems.

Nitrate concentrations are generally low in groundwater, although the Shallow Hydrologic Unit had concentrations above the maximum contaminant level of 10 mg/L in 7 percent of samples

taken, a trend seen in drinking water conditions. Few other groundwater data are available, though levels of tritium plus nitrate in groundwater indicate that newly recharged groundwater may be more susceptible to contamination. Tritium occurs in groundwater that has been recharged in the last 50 years and, in the Montana Department of Mines and Geology study, it was detected in 15 of 22 samples. Thirteen of those samples also had detectable nitrate. The report notes that the coincidence of tritium and nitrate in the Shallow Hydrologic Unit shows that areas where water has been recharged within the last 50 years are more susceptible to contamination.

Aquifers act as natural water-storage reservoirs and fluctuate in response to the addition or withdrawal of water. Shallow groundwater recharge occurs during rain events and as a result of snowmelt. Recharge of deeper aquifers usually occurs much more slowly. Aquifers can become depleted from drought and excessive water withdrawals. Records from the Deep Hydrologic Unit show that water levels have fluctuated less than 5 feet since the early 1980s. Records for the Fox Hills–Lower Hell Creek aquifer show that water levels have declined steadily since the 1970s at a rate of about 1 foot per year. Some fluctuation is natural, related to annual weather variations, but long-term declines in water levels suggest that more water is being removed from the aquifer than is being recharged. Declining water levels can result in the need to install pumps in wells or drill ever deeper to find water.

3.7 Aquatic Communities

The aquatic community includes fish, mussels, and macroinvertebrates and the overall food web in aquatic areas that could be affected by the intake Project. Aquatic species protected under the Endangered Species Act or considered species of concern by the states of Montana and North Dakota are described in Section 3.9. The potential extent of affected environment for aquatic communities includes the Yellowstone River from the Cartersville Diversion Dam at River Mile 237 to its confluence with the Missouri River, and the Missouri River from Fort Peck to Lake Sakakawea in North Dakota, including irrigation canals, lakes, side channels, or backwater habitat connected to these reaches (Figure 3-11).

At the Intake Diversion Dam site, aquatic habitats include the main river channel, the floodplain and wetlands on Joe’s Island, and the 4-mile existing side channel on the south side of Joe’s Island. The Intake Diversion Dam consists of a large boulder field on the downstream side and a deep hole at the diversion canal intake, upstream of the dam. Riprap extends along the banks at least 300 feet downstream of the Intake Diversion Dam.

3.7.1 Yellowstone River

The Yellowstone River changes from a coldwater mountain stream at its headwaters to a warmwater prairie river at its confluence with the Missouri River in McKenzie County, North Dakota. The potential extent of affected environment for the Yellowstone River lies entirely within the lower warmwater zone, which extends from the confluence of the Bighorn River to the confluence with the Missouri River.

The Yellowstone River channel morphology in the study area ranges from partially confined braided channels to partially confined meandering channels with vegetated islands. Confined

meandering and confined straight sections are dominant from River Mile 195 to River Mile 301 (Jaeger et al., 2005a). The dominant substrate for most of the river consists of gravel and cobble, until the last reach from River Mile 56 to the confluence with the Missouri River, where the dominant substrate consists of fines and sand (Jaeger et al., 2005a). Instream habitats of the lower Yellowstone River include main channel pools, runs, riffles, side channels, and backwaters. Most pools are 5 to 10 feet deep, although some are at least 18 feet deep during summer flows.

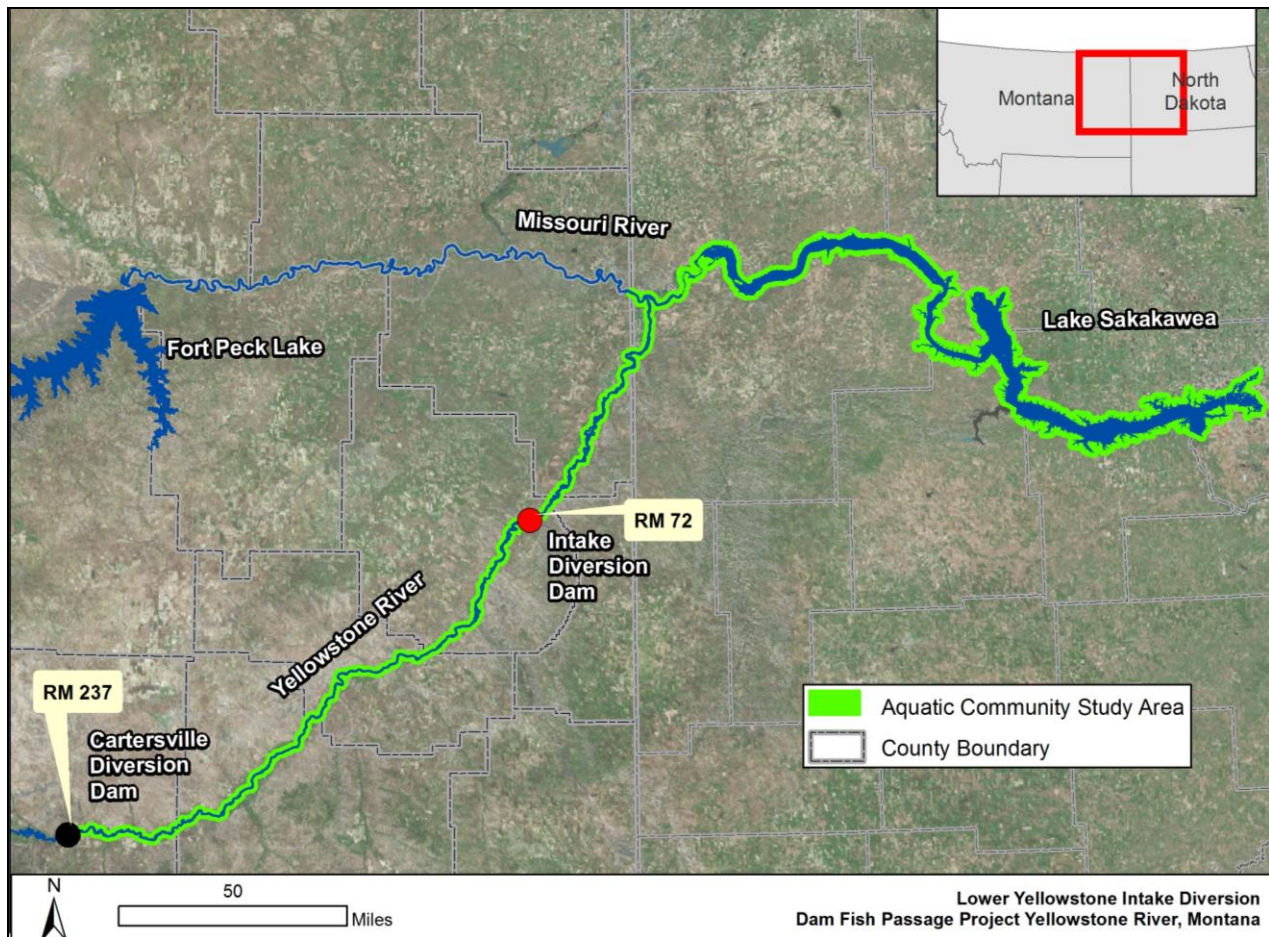

Figure 3-11. Study Area for the Aquatic Community Includes Yellowstone River from Cartersville Dam to the Confluence with the Missouri River, and the Missouri River to Lake Sakakawea

The channel is often braided or split and long side channels are common. Islands and bars range from large vegetated islands to unvegetated point and mid-channel bars (White and Bramblett 1993). The availability of side channels influences the composition and abundance of the Yellowstone River fish community (Reinhold et al. 2014). A disproportionately high number of telemetered pallid sturgeon used geologically constrained bluff pools in the lower reaches of the Yellowstone River (Jaeger et al. 2006). Bluff pools on the Yellowstone are generally longer and have lower average and bottom velocities (Jaeger et al. 2008).

The Yellowstone River still has relatively pristine character (Jaeger et al. 2006). However, several anthropogenic factors influence the fishery (Corps, 2015b):

- Altered hydrograph
- Altered geomorphology
- Altered riparian vegetation and wetlands
- Altered land use
- Altered longitudinal and main stem-tributary connectivity
- Altered water quality
- Introduced species
- Pressure from recreational fishing.

3.7.2 Missouri River

The segment of the Missouri River between Fort Peck Dam, Montana and Lake Sakakawea, North Dakota is highly altered by main stem dams, reservoirs and bank stabilization projects (Welker and Scarnecchia 2006). The Missouri River above the Yellowstone River confluence has been strongly influenced by Fort Peck Dam. Controlled water releases have resulted in a more stable discharge, a reduction in sediment load, and colder summer water temperatures than before impoundment (Welker and Scarnecchia 2004).

The Missouri River between Fort Peck Dam and the North Dakota border, as described in Simon et al. (1999), has a channel pattern that is considered meandering, although several straight reaches do occur. Islands and bars are common in the channel, which is 800 to 1,150 feet wide. The floodplain has many meander scars. Older meander scars have filled with sediment and organic material and are now swales. Younger meander scars contain standing water year-round. The river channel is entrenched and is flanked by distinct terraces, with the highest terrace about 10 feet above the present high water level. Side channels, considered to be important habitat, have seen a significant decrease in abundance since the 1950s, which in turn may be detrimental to fish populations over time (Reinhold 2014). Bed material is medium to fine sand with occasional deposits of coarse gravel, cobbles, and dense clay.

3.7.3 Intake Diversion Dam

Little is known regarding the passage of the majority of fish species found in the Yellowstone River, including ecologically important forage fishes and species of concern (Corps 2015b). Main Canal Because the canal headworks at the Intake Diversion Dam was recently rebuilt and incorporated removable rotating drum screens that meet screening criteria for minimizing entrainment, it is anticipated that entrainment is not a substantive issue.

Concern exists that the metal construction material found within dams or fish passage structures could prevent passage. Paddlefish, for example, have highly developed electro reception and exhibit an unambiguous avoidance behavior elicited by aluminum obstacles; metallic structure could therefore interfere with paddlefish migrations (Gurgens et al. 2000). Similar considerations apply to Shovelnose and Pallid Sturgeon, which also possess a passive electro-sense (Teeter et al. 1980) and migrate long distances. The Intake Diversion Dam is known to have extensive amounts of metal in its structure (Corps 2015d).

The Yellowstone River experienced extremely high flows in 2011. Monitoring by Montana Fish, Wildlife and Parks (MFWP) showed a significant increase in passage past the Intake Diversion Dam by many of the native species, which may have been due to increased depths over the weir

or reduced turbulence from rock displacement (Corps 2015d). The large amount of rock displaced during 2011 resulted in the LYP Board of Control placing 1,493 cubic yards of new rock on the Intake Diversion Dam to raise the water surface high enough to divert its full water right. A below-average water year occurred in 2012, so the large quantity of rock is believed to have created additional passage problems (Corps 2015d).

3.7.4 Fish

The Yellowstone and Missouri Rivers have a combined total of 62 fish species. In the Yellowstone River, 25 of the species present are nonnative (White and Bramblett 1993; MFWP 2016d). Table 3-14 indicates the fish species in each river, and which of the following zones they inhabit in the Yellowstone River (White and Bramblett 1993):

- Zone 1 is the salmonid zone, which is the coldwater zone in the upper elevations
- Zone 2 is the transition zone between upper and lower elevations
- Zone 3 is the lower-elevation warmwater zone. The study area is completely contained within this zone.

TABLE 3-14. FISH SPECIES OF THE YELLOWSTONE AND MISSOURI RIVERS

Family	Common Name	Yellowstone	Zone ^d	Missouri	Scientific Name
Acipenseridae	Pallid Sturgeon	X	3	X	<i>Scaphirhynchus albus</i>
	Shovelnose Sturgeon	X	3	X	<i>Scaphirhynchus platyrhynchus</i>
Polyodontidae	Paddlefish	X	3	X	<i>Polyodon spathula</i>
Lepisosteidae	Shortnose Gar	X	3	X	<i>Lepisosteus platostomus</i>
Hiodontidae	Goldeye	X	1,2,3	X	<i>Hiodon alosoides</i>
Cyprinidae	Northern Redbelly Dace	X	3	X	<i>Chrosomus eos</i>
	Lake Chub	X	1,2,3	X	<i>Couesius plumbeus</i>
	Common Carp ^a	X	1,2,3	X	<i>Cyprinus carpio</i>
	Western Silvery Minnow	X	2,3	X	<i>Hybognathus argyritis</i>
	Brassy Minnow	X	3	X	<i>Hybognathus hankinsoni</i>
	Plains Minnow	X	3	X	<i>Hybognathus placitus</i>
	Sturgeon Chub	X	3	X	<i>Macrhybopsis gelida</i>
	Sicklefin Chub	X	3	X	<i>Macrhybopsis meeki</i>
	Emerald Shiner	X	2,3	X	<i>Notropis atherinoides</i>
	Sand Shiner	X	3	X	<i>Notropis stramineus</i>
	Fathead Minnow	X	2,3	X	<i>Pimephales promelas</i>
	Flathead Chub	X	2,3	X	<i>Platygobio gracilis</i>
	Longnose Dace	X	1,2,3	X	<i>Rhinichthys cataractae</i>
	Golden Shiner ^a	X	3		<i>Notemigonus crysoleucas</i>
Catostomidae	River Carpsucker	X	2,3	X	<i>Carpionodes carpio</i>
	Blue Sucker	X	3	X	<i>Cycleptus elongatus</i>
	Longnose Sucker	X	1,2,3	X	<i>Catostomus</i>
	White Sucker	X	1,2,3	X	<i>Catostomus commersonii</i>
	Mountain Sucker	X	1,2,3	X	<i>Catostomus platyrhynchus</i>
	Smallmouth Buffalo	X	2,3	X	<i>Ictiobus bubalus</i>
	Bigmouth Buffalo	X	3	X	<i>Ictiobus cyprinellus</i>
	Shorthead Redhorse	X	1,2,3	X	<i>Moxostoma macrolepidotum</i>

Family	Common Name	Yellowstone	Zone ^d	Missouri	Scientific Name
Ictaluridae	Black Bullhead ^a	X	2,3	X	<i>Ameiurus melas</i>
	Yellow Bullhead ^a	X	3	X	<i>Ameiurus natalis</i>
	Channel Catfish	X	2,3	X	<i>Ictalurus punctatus</i>
	Stonecat	X	2,3	X	<i>Noturus flavus</i>
Esocidae	Northern Pike	X	3	X	<i>Esox lucius</i>
Osmeridae	Rainbow Smelt ^a	X	3	X	<i>Osmerus mordax</i>
Salmonidae	Rainbow Trout ^a	X	1,2,3	X	<i>Oncorhynchus mykiss</i>
	Brown Trout ^a	X	1,2,3	X	<i>Salmo trutta</i>
	Arctic Grayling		N/A	X	<i>Thymallus arcticus</i>
	Cisco ^{a,b}		N/A	X	<i>Coregonus artedi</i>
	Lake Trout		N/A	X	<i>Salvelinus namaycush</i>
	Chinook Salmon		N/A	X	<i>Oncorhynchus tshawytscha</i>
	Kokanee		N/A	X	<i>Oncorhynchus nerka</i>
	Lake Whitefish		N/A	X	<i>Coregonus clupeaformis</i>
Westslope Cutthroat Trout		N/A	X	<i>Oncorhynchus clarki lewisi</i>	
Lotidae	Burbot	X	1,2,3	X	<i>Lota lota</i>
Fundulidae	Northern Plains Killifish ^a	X	3		<i>Fundulus kansae</i>
Gasterosteidae	Brook Stickleback ^c	X	1,2,3	X	<i>Culaea inconstans</i>
Moronidae	White Bass ^a	X	3	X	<i>Morone chrysops</i>
Centrarchidae	Rock Bass ^a	X	3		<i>Ambloplites rupestris</i>
	Green Sunfish ^a	X	3	X	<i>Lepomis cyanellus</i>
	Pumpkinseed ^a	X	3	X	<i>Lepomis gibbosus</i>
	Bluegill ^a	X	2		<i>Lepomis macrochirus</i>
	Smallmouth Bass ^a	X	2,3	X	<i>Micropterus dolomieu</i>
	Largemouth Bass ^a	X	2,3	X	<i>Micropterus salmoides</i>
	White Crappie ^a	X	3	X	<i>Pomoxis annularis</i>
	Black Crappie ^a	X	3	X	<i>Pomoxis nigromaculatus</i>
Percidae	Yellow Perch ^a	X	2,3	X	<i>Perca flavescens</i>
	Sauger	X	2,3	X	<i>Sander canadensis</i>
	Walleye ^a	X	2,3	X	<i>Sander vitreus</i>
	Iowa Darter		N/A	X	<i>Etheostoma exile</i>
Sciaenidae	Freshwater Drum	X	2,3	X	<i>Aplodinotus grunniens</i>
Poeciliidae	Sailfin Molly ^{a,b}	X	3		<i>Poecilia latipinna</i>
Cyprinidae	Spottail shiner ^{a,b}	X	3	X	<i>Notropis hudsonius</i>
Esocidae	Tiger Muskellunge ^{a,b}	X	2,3		<i>Esox masquinongy</i> X <i>Esox lucius</i>

- a. Not native to the Yellowstone River.
b. Found only on Montana Fish, Wildlife and Parks (MFWP) list (all others found on both MFWP and White and Bramblett 1993; except Note c below)
c. Found only on White and Bramblett, 1993 list.
d. Yellowstone River Zones: 1 = salmonid (coldwater) 2 = transition 3 = warmwater (White and Bramblett 1993)

The most widespread species in the Yellowstone River is White Sucker (*Catostomus commersonii*), which is abundant in all three river zones. Other Yellowstone River species found in all three zones are Goldeye (*Hiodon alosoides*), Common Carp (*Cyprinus carpio*), Longnose

Dace (*Rhinichthys cataractae*), Shorthead Redhorse (*Moxostoma macrolepidotum*), Burbot (*Lota lota*), Pallid Sturgeon fingerlings (*Scaphirhynchus albus*), Mountain Sucker (*Catostomus platyrhynchus*), Rainbow Trout (*Oncorhynchus mykiss*), and Brown Trout (*Salmo trutta*) (White and Bramblett 1993). The species abundant in the warmwater zone include Shovelnose Sturgeon (*Scaphirhynchus platyrhynchus*), Goldeye, Common Carp, Flathead Chub (*Platygobio gracilis*), Emerald Shiner (*Notropis atherinoides*), River Carpsucker (*Carpiodes carpio*), Shorthead Redhorse, White Sucker, Channel Catfish (*Ictalurus punctatus*), Stonecat (*Noturus flavus*), Burbot, and Sauger (*Sander Canadensis*) (White and Bramblett 1993). Rainbow Trout and Brown Trout do not reproduce in the warmwater zone (White and Bramblett 1993).

The fish community of the Yellowstone River can be categorized between species preferring either of two main habitats: main-channel, high-turbidity, rapid-flow, deep waters; or sluggish backwaters. The Yellowstone's natural dynamics provide this habitat heterogeneity.

3.7.4.1 Main Channel Species

The following are main channel species that prefer rapid, deep flows and are tolerant of high turbidity.

- White Sucker is the most common and abundant fish in the Yellowstone River. It feeds on benthic macroinvertebrates of extremely varied habitats. It spawns in the spring and can navigate the Intake Diversion Dam at high flows (Helfrich et al. 1999).
- Longnose Sucker is a sympatric associate to White Sucker and also spawns in the spring, usually in tributaries of larger water bodies, most often lakes (Edwards 1983, cited in Reclamation 1997b). Longnose Sucker is found in rapid flows with runs and pools with high turbidity (Propst and Carlson 1986, cited in Reclamation 1997b).
- Mountain Sucker is a close associate with Longnose and White Sucker and prefers rocky substrates with cool, rapid water (Campbell 1992, cited in Reclamation 1997b). Mountain Sucker spawns in the spring as it is water-temperature dependent (Belica and Nebbelink 2006).
- Goldeye are commonly found in highly turbid, deep waters along with Blue Suckers, who generally prefer deep riffles. Goldeye and Blue Sucker are commonly seen passing upstream of the Intake Diversion Dam (Corps 2015b). Spawning for Goldeye and Blue Sucker occurs in the spring (Berg 1981, cited in Reclamation 1997b).
- Bigmouth Buffalo prefer deeper pools of large streams, lakes and impoundments and migrate large distances in the spring (Pflieger 1975, cited in Reclamation 1997b).
- Smallmouth Buffalo have been documented passing upstream of the Intake Diversion Dam (Helfrich et al. 1999).
- Freshwater Drum and River Carpsucker are main channel and deep water species that migrate in the spring to tributaries of the Yellowstone River to spawn (Corps 2015b).
- Sicklefin Chub is a benthic feeder that prefers open channels, swift currents, and firm substrates—a habitat that has increased with river channelization (Pflieger and Grace 1985, cited in Reclamation 1997b).
- The Sturgeon Chub is a benthic feeder that prefers open channels of large, silty rivers and occurs in swift current over a bottom of sand or fine gravel (Pflieger 1975, cited in Reclamation 1997b). The reproductive biology of Sicklefin and Sturgeon Chub is largely unknown, however it is believed that they spawn in the spring (Service 2001).

- The Longnose Dace is found in the benthic/riffle habitat of swift-flowing water (Edwards et al. 1983, cited in Reclamation 1997b). Peak Longnose Dace spawning occurs in June and early July (Edwards et al. 1983, cited in Reclamation 1997b).
- The Stonecat finds its prey along the bottoms of high-gradient reaches, with rocky riffles common (Walsh and Burr 1985, cited in Reclamation 1997b). Stonecat spawning occurs between June and August, peaking in late June (Brown 1971, cited in Reclamation 1997b).
- Burbot is a benthic feeding fish, feeding on aquatic insects when young and then other fish in later years. Burbot has a wide distribution in Montana and is one of the few species that occurs in cold, cool and warmwater rivers (Wuellner and Guy 2008). Burbot fishing is popular in late winter and early spring (White and Bramblett 1993). Burbot can pass upstream of the Intake Diversion Dam via the main channel, although the dam is still considered to impede migration during spawning (Corps 2015b).
- Sauger is a popular game fish that is native and common to abundant in the Yellowstone River, with abundance increasing from upstream to downstream (White and Bramblett 1993). In the lower Yellowstone River, Sauger spawn at numerous locations from the confluence of the Tongue River to below the Intake Diversion Dam. However, the Powder River is rarely used for spawning by Sauger, and no Sauger spawning was documented in the Tongue River (Jaeger et al. 2005b). Diversion dams on the lower Yellowstone River do not hinder the upstream movement of adult Sauger, but passage by juveniles is restricted (Jaeger et al. 2005b). Entrainment at the intake is estimated to account for between 50% and 78% of non-fishing Sauger mortality, as it is estimated that 86% of the entrained Sauger die (Jaeger et al. 2005b).
- Walleye are introduced but provide substantial angling opportunities, and are most abundant below the Intake Diversion Dam when fish migrate upstream to spawn (White and Bramblett 1993). Graham et al. (1979) found Walleye could negotiate the Intake Diversion Dam, but nearly all movement was downstream after spawning.

3.7.4.2 Backwater Species

The following are species that prefer slower currents and backwaters:

- Western Silvery Minnows and Plains Minnows typically occur in silty backwaters (Pflieger and Grace 1985, cited in Reclamation 1997b). The Silvery Minnow prefers a sluggish reach (Zelt et al. 1999) and utilizes tributaries to spawn (Corps 2015b).
- The Shorthead Redhorse can be found in transition zones that generally have slow current, less turbidity, some vegetation, and gravel substrates (Zelt et al. 1999). The Shorthead Redhorse has been known to make it past the Intake Diversion Dam at high flows (Helfrich et al. 1999). Shorthead Redhorse spawn in the spring.
- Western Paddlefish are dependent on backwater habitat and spawn when the water warms. The Paddlefish population in Lake Sakakawea increased with the early reservoir creation after dam closure; however, it has levelled out as the reservoir has aged (Scarnecchia et al. 2007). Paddlefish exhibit highly variable annual migrations in both the Yellowstone and Missouri Rivers, and in years of high runoff move either over or around the Intake Diversion Dam (via flooded side-channel) upstream as far as the Cartersville Diversion Dam at Forsyth (Scarnecchia et al. 2007). Paddlefish snagging at the Intake Diversion Dam is a popular sport fishery, with a large spawning population moving upriver in the spring (White and Bramblett 1993).

- Channel Catfish are a native and abundant sportfish. Channel Catfish prefer deep pools and backwater areas of larger rivers with turbid waters (Jackson 1995, cited in Reclamation 1997b). Backwaters are important for Catfish spawning areas due to suitable temperatures (White and Bramblett 1993). Catfish typically migrate upstream to spawn (Dames et al. 1989, cited in Reclamation 1997b) in the spring which occurs from May into July after water temperatures exceed 75°F (Brown 1971, cited in Reclamation 1997b). Channel Catfish have been documented passing the Intake Diversion Dam via the main channel (Corps 2015b).
- Shovelnose Sturgeon feed mostly on aquatic invertebrates in gravel and cobble substrates (Bramblett 1996). Closely related to the Pallid Sturgeon, the Shovelnose has been known to hybridize with Pallid Sturgeon, although the Pallid Sturgeon were found at greater depths, with a sandier substrate (Bramblett 1996). Shovelnose Sturgeon migrate long distances and spawn in the early summer. Shovelnose Sturgeon movement is thought to be mostly blocked by the Intake Diversion Dam, but some have been documented passing upstream (Rugg 2016). Pallid sturgeon are discussed in detail in Section 3.9.1.3.
- Flathead Chub is a benthic feeding fish that is considered an important food for Pallid Sturgeon (Corps 2015b) and prefers a more unstable sand/silt substrate (Pflieger and Grace 1985, cited in Reclamation 1997b). Its population has markedly declined, much like the Pallid Sturgeon (Pflieger and Grace 1985, cited in Reclamation 1997b). Flathead Chub spawning season is from July to August (Gould 1985).

3.7.5 Mussels

The following discussion on the mussels potentially encountered on the lower Yellowstone River or Missouri River comes from the Montana Natural Heritage Program (Stagliano 2010). Low native mussel diversity in Montana has translated into sparse information on the Lower Yellowstone. Three native species and three introduced species of freshwater mussels (order Unionoida; families Unionidae and Margaritiferidae) are documented to occur in Montana. Two of the native species are potentially found in the Yellowstone and Missouri Rivers:

- The Fatmucket (*Lampsilis siliquoidea*) is a native mussel that has been located in the study area above and below the Intake Diversion Dam. They prefer low-velocity areas, runs and pools of medium to large warm prairie rivers (Missouri, Milk, Yellowstone and Little Missouri River drainages) with pebble, gravel, sand or silt substrates.
- The Giant Floater (*Pyganodon grandis*) is a native mussel that inhabits pool and side channel areas of small to large warm prairie rivers (Missouri, Milk and Little Missouri River drainages) with a mud, sand or gravel substrate.

Introduced mussels include the following:

- Black Sandshells (*Ligumia recta*) prefer medium to large warm prairie rivers (Missouri Musselshell and Milk Rivers) in riffles or runs with pebble, gravel or firm sand substrates. This mussel is fairly intolerant of silt and warm water temperatures.
- White (Creek) Heelsplitters (*Lasmigona complanata*) prefer medium to large sluggish prairie rivers with a mud, sand, or fine gravel bottom.
- Mapleleafs (*Quadrula quadrula*) are known only from the lower Yellowstone River and the Tongue River. They prefer pools or runs in large prairie rivers or reservoirs with a mud, sand, or gravel bottom. They are usually not found in stream reaches with swift current.

Freshwater mussel life history involves four basic stages: reproductive, larval or parasitic, juvenile, and adult. Mussel larvae must briefly parasitize a vertebrate host, which in most cases is a fish, in order to complete its development. The larva attaches to the gills of a fish, the species of which can vary and be either native or nonnative. For the Fatmucket, host species include Freshwater Drum, Channel Catfish, Stonecat, Sturgeons, Common Carp, Bullheads, Centrarchids and Yellow Perch. The Giant Floater uses Iowa Darter, Brook Stickleback, Channel Catfish, Carp, Bullheads, Centrarchids and Yellow Perch.

North American freshwater mussels have declined severely, and they currently are one of the most imperiled groups of animals on the planet. In Montana, mussel populations are not abundant. Declines can be associated to stream habitat degradation and fragmentation, host fish declines, and pollution. Anthropogenic sediment can degrade mussel habitats by embedding the substrate, which decreases substrate permeability. Impounded stream channels also create an environment that is intolerable for most mussels. Once free-flowing, well-oxygenated streams become stagnant and prone to silt deposition. Sediment can also restrict the spawning success of host species. In Montana, the nonnative species unexpectedly do not limit the success of the native species, rather they seemingly augment the state's low diversity.

Mussels were surveyed by the Montana Natural Heritage Program (MTNHP) on the Yellowstone River in July and September in 2009. The survey included intensive searches upstream and downstream of the Intake Diversion Dam. The estimated numbers based on the sample taken between the boat ramp and the Intake Diversion Dam were 24 individuals (Fatmuckets), and not worth relocation efforts.

3.7.6 Macroinvertebrates

Benthic macroinvertebrates serve as a primary food source for fish (Barbour et al. 1999). The macroinvertebrates abundant in the lower Yellowstone River are predominately tolerant of silt and turbidity (Newell 1977; Zelt et al. 1999). Lowland reaches of the Yellowstone are typically characterized by warmer water temperatures (especially during summer), gentle gradients, turbidity, sediment deposition, fine substrates, and smaller concentrations of dissolved oxygen (Zelt et al. 1999).

Within the lower Yellowstone River Basin, invertebrate fauna includes 17 species of mayflies (*Ephemeroptera*) of which, for example, *Baetis* prefer rapid currents and *Tricorythodes* prefer slower velocities. Also found are four species of caddisflies (*Trichoptera*), and three species of stoneflies (*Plecoptera*) (Newell 1977). True flies (*Diptera*) are also common, as well as midges (*Chironomidae*) and earthworms (*Oligochaeta*) where slow current velocities increase the deposition of organic sediment. Other true flies, mostly non-biting midges and seven species of stoneflies, generally prefer rapid currents and are diverse but not abundant (Newell 1977). Four species of true bugs and two species of water beetles have also been documented (Newell 1977). Deposition of organic sediment at slow current velocities in channel riparian and sandbar complexes may increase production of midges (Zelt et al. 1999).

In the lower Yellowstone River, a higher percentage of *Ephemeroptera*, *Plecoptera* and *Trichoptera* than that of the midge and worm taxa indicates a relatively healthy ecosystem (Peterson et al. 2004). Macroinvertebrate productivity often varies through the year in response

to changes in seasonal flow. Factors influencing both distribution and abundance of aquatic invertebrates include current velocity, water temperature, substrate, stability of aquatic and riparian vegetation, dissolved substances, competition, zoogeography, food, disturbance history, and human practices. Large, stable substrates such as boulders and cobbles support larger, more productive invertebrate populations than do unstable gravel and sand substrates (Zelt et al. 1999).

3.7.7 Aquatic Invasive Species

Aquatic invasive species are non-native plants, animals, or pathogens that can rapidly spread and threaten native communities and may have adverse effects on recreation, water supply infrastructure and agriculture. Invasive plant species include the terrestrial Russian olive (*Elaeagnus angustifolia*) and saltcedar (*Tamarix* spp.) and the aquatic hydrilla (*Hydrilla verticillata*), Eurasian water milfoil (*Myriophyllum spicatum*) and Brazilian Elodea (*Egeria densa*). Invasive mussel species include the zebra mussel (*Dreissena polymorpha*), and quagga mussel (*Dreissena bugensis*). Diseases caused by invasive pathogens consist of whirling disease, iridovirus, and viral hemorrhagic septicemia. New Zealand mudsnails (*Potamopyrgus antipodarum*) and Asian carp are also priority concerns in Montana rivers.

Terrestrial invasive species have potential to impact water quality, in that the plants contain compounds that are soluble in water. Russian olive and saltcedar have been shown to affect water quality. Saltcedar plants have been shown to accumulate salts and metals in their leaves and exude these elements on the leaf surface (Corps 2015b). In arid climates, saltcedar can transpire huge amounts of water per day, and thus concentrate sodium and sulfate near the soil surface (Meredith and Wheaton 2011). Dense Russian olive stands adjacent to streams affect the delivery of organic nitrogen to surface and groundwater, thus altering biochemical cycling. The increased organic load added by Russian olive leaves and olive fruits in surface water can increase the biological oxygen demand and reduce dissolved oxygen levels (Pick 2013).

Aquatic invasive species have the potential to affect water quality by altering the amount of organic material in the carbon cycle that is decomposed in the river. Species such as hydrilla (undetected in Montana), Eurasian water milfoil (present in Montana), and Brazilian elodea (undetected in Montana) are priority invasive species in Montana because their growth of dense masses of submerged and emergent vegetation are benefited by elevated nutrients in water (Ryce, 2011; MFWP 2014). The added load of decomposing organic materials created by these invasive species can tie up dissolved oxygen, harming aquatic life. Floating, single-celled algae and phytoplankton can increase the turbidity of water. Some invasive species such as zebra mussels and quagga mussels (both still undetected in Montana) can alter water clarity and the nutrient balance (turbidity) through the process of filtration.

Whirling disease (present in Montana) and iridovirus (detected in Montana) are two diseases of great concern in the lower Yellowstone River. Whirling disease was detected at the Miles City fish hatchery in 2002, but has not been subsequently documented at the hatchery or in the lower Yellowstone River. It is not known whether the whirling disease spores were present in the Yellowstone River water used by the hatchery or were transferred through alternate pathways (e.g., fish-eating birds). In 2005, Miles City State Fish Hatchery workers detected an extremely low level of whirling disease in samples taken from trout being kept at the hatchery; however, this proved to be a false positive, according to MFWP. Iridovirus is of great concern for sturgeon species. Iridovirus can cause mortality in hatchery-reared sturgeon (Kurobe 2011) and its effects

on free-ranging sturgeon species in the Missouri and Yellowstone Rivers are still unknown. Iridovirus was recently documented in hatchery-reared Pallid Sturgeon at the Garrison Dam National Fish Hatchery Complex. Viral hemorrhagic septicemia virus is also a concern in Montana, and efforts are ongoing to prevent its entering into state waters (Ryce 2011).

Mudsnails are found near the confluence of the Bighorn River, with eventual spread to the lower Yellowstone River likely. Common carp are present in the Yellowstone River both upstream and downstream of the Intake Diversion Dam. Carp are strong swimmers and can probably pass upstream at the Intake Diversion Dam under most flows. Bighead Carp, Silver Carp, Black Carp, and Grass Carp, collectively referred to as Asian Carp, are invasive species that were either accidentally or intentionally introduced into the Mississippi River Basin. They have subsequently become established within the lower Missouri River (Wanner and Klumb 2009), but are still undetected in Montana (MFWP 2014). Dams, while detrimental to many native migratory species, have provided some protection from Asian Carp establishment in the upper Missouri River system. The Montana Aquatic Nuisance Species Management Plan (2002) acknowledges the fact that while they are not currently present, it is possible that Asian carp will eventually make their way up the river and could impact native fish, due to competition for habitat and food. Because Asian Carp are strong swimmers, the Intake Diversion Dam would likely not afford protection to the upper Yellowstone River should they become established below the dam.

3.8 Wildlife

The study area provides a diversity of wildlife habitats—from perennial riverine to arid upland. These habitats are diverse across place and season, with each hosting different wildlife assemblages throughout the year. Many habitats are in relatively natural condition, although all have been somewhat altered by ongoing human land uses, including stock grazing, agriculture, stream flow alterations, development, and recreation.

3.8.1 Wildlife Protection Designations

In an effort to manage natural resources more sustainably, some non-federal protections have been established for the wildlife and supporting habitat features found in the study area.

3.8.1.1 County Protections

Limited protections are provided by various counties within the study area. Dawson and Richland County planning documents present requirements to identify major wildlife use and known important wildlife areas such as big game winter range and waterfowl nesting areas (Dawson County Unknown year; 2010), or to identify significant, important and critical habitat for wildlife (Richland County 2015). It is unclear at this time whether these regulations apply to the proposed project because the type or location of the action may not be covered. Wibaux County, Montana, has no published regulations for wildlife conservation. In North Dakota, the *Williams County Comprehensive Plan 2035* (Williams County 2012) identifies the need to protect Wildlife Management Areas. The *McKenzie County Comprehensive Plan*, however, describes no explicit protections (McKenzie County 2013).

3.8.1.2 State Protections

Montana Fish, Wildlife and Parks (MFWP) has identified five Wildlife Management Areas within the study area (see Figure 51), with the following wildlife management goals and objectives:

- **Elk Island:** To provide maximum hunting opportunities, primarily for white-tailed deer and pheasants, while also maintaining wildlife populations and the unique riparian ecosystem in a viable and healthy condition. Hunting opportunities include ducks, geese, mourning dove (*Zenaida macroura*), ring-necked pheasant (*Phasianus colchicus*), and white-tailed deer (*Odocoileus virginianus*).
- **Seven Sisters:** To provide maximum hunting opportunities, primarily for white-tailed deer and ring-necked pheasants, while also maintaining wildlife populations and the unique riparian ecosystem in a viable and healthy condition. Hunting opportunities include ducks, geese, ring-necked pheasant, sharp-tailed grouse (*Tympanuchus phasianellus*), and white-tailed deer.
- **Three Mile:** Goals are not specified, but hunting opportunities include ducks, geese, and white-tailed deer.
- **War Dance Island:** Goals are not specified, but hunting opportunities include ducks, geese, ring-necked pheasant, and white-tailed deer.
- **F Island Wildlife Habitat Protection Area:** Conserve existing habitat for the benefit of wildlife. Hunting opportunities include ducks, geese, ring-necked pheasant, and white-tailed deer.

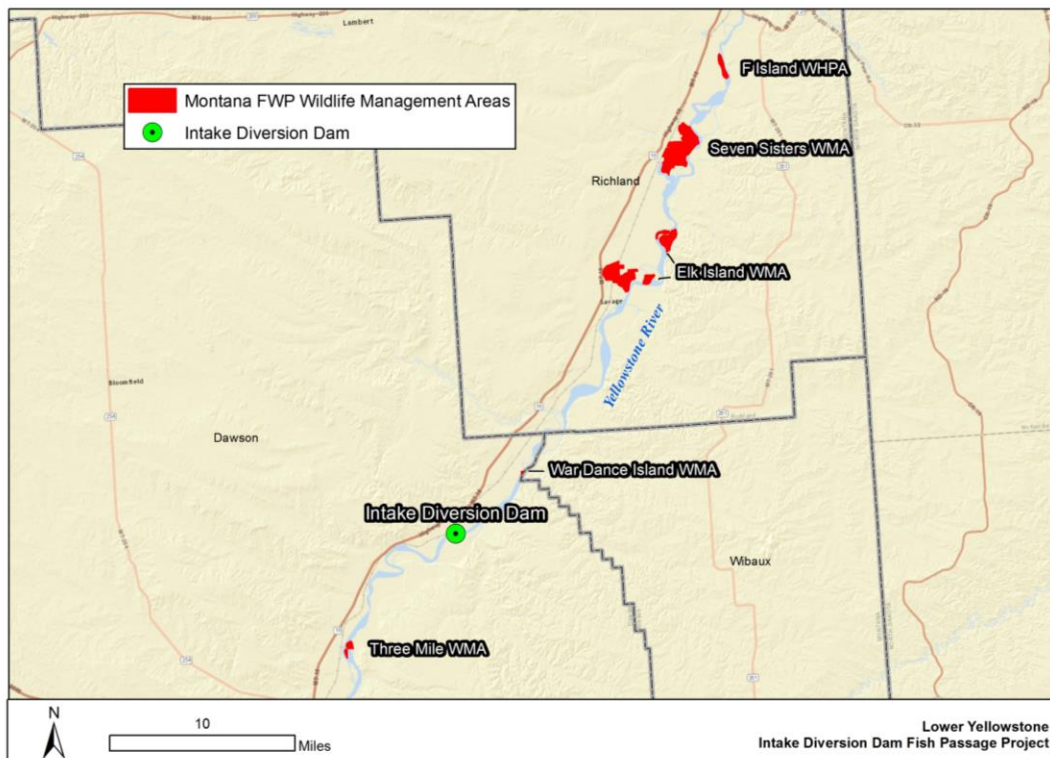

Figure 3-12. Location map of Wildlife Management Areas within the study area.

MFWP has reported the location of big game winter range in its *Fish and Wildlife Recommendations for Subdivision Development in Montana* (MFWP 2012). That document identifies mule deer (*Odocoileus hemionus*), white-tailed deer, and pronghorn (*Antilocapra americana*) as having “winter/general range” throughout the majority or all of the study area, depending on species (Figures 52 through 54).

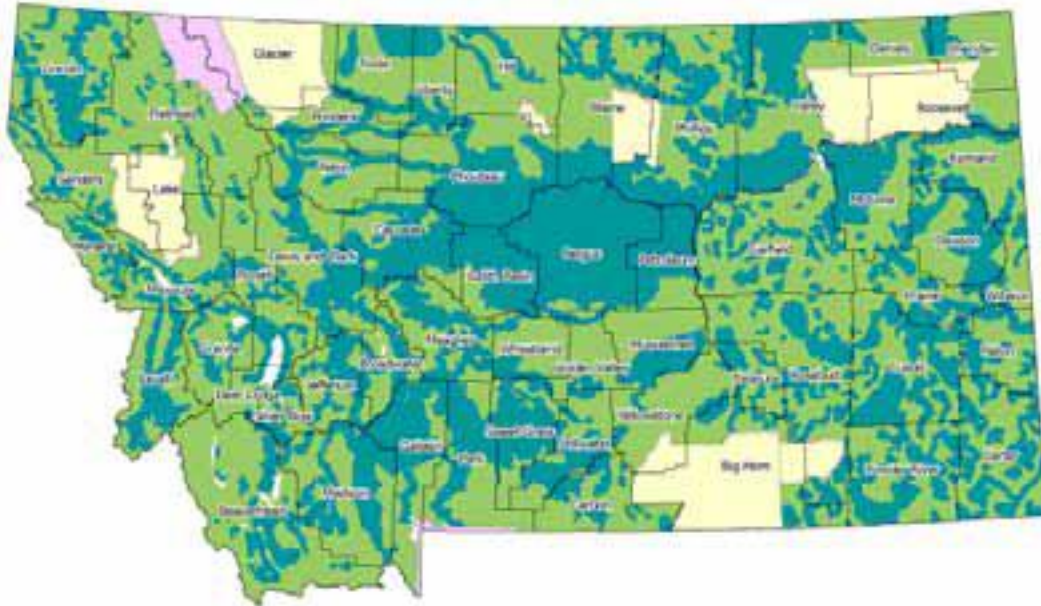

Figure 3-13. Map showing general range and winter/general range of mule deer in Montana.



Figure 3-14. Map showing general range and winter/general of white-tailed deer in Montana.

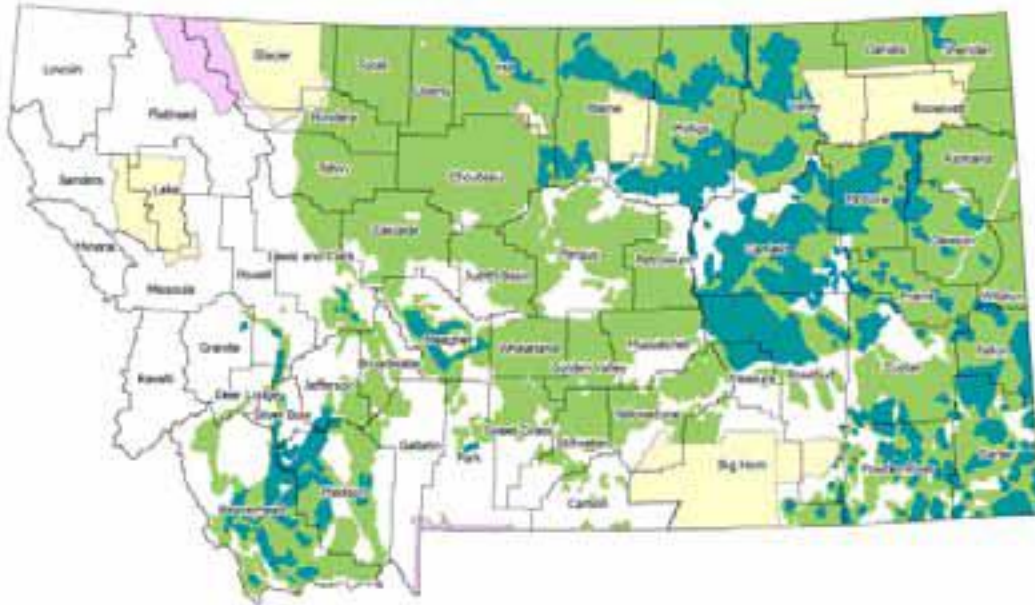

Figure 3-15. Map showing general range and winter/general range of pronghorn in Montana.

North Dakota Game and Fish Department has identified three Wildlife Management Areas within the study area: Lewis and Clark, Trenton, and Big Oxbow. These areas are managed for hunting, fishing, and trapping of wildlife species, including deer, turkey (*Meleagris gallopavo*), elk (*Cervus canadensis*), moose (*Alces alces*), bighorn sheep (*Ovis canadensis*), pronghorn, waterfowl, and small game and furbearers.

3.8.1.3 Non-Governmental Protections

Designations from non-governmental sources may also apply to the study area. In 2012, the Montana Audubon Society initiated the delineation of the Yellowstone River Lower important bird area in the study area (MFWP 2016c), but there is no evidence that it has been created, as indicated by the National Audubon Society's important bird area database (Audubon 2016). The proposed important bird area, if enacted, would be considered a "Riverine important bird area," which is an important bird area located along a key waterway in Montana (MFWP 2016c). A Montana Audubon-published brochure—*Our Birds Call This Home; A Guide to Living with Birds along Montana's Rivers and Streams* (Montana Audubon Society 2011)—presents best management practices for riverine systems. No other non-governmental-designated conservation resources are found in the study area.

One geographic feature that would play a prominent role in proposed project is Joe's Island. This feature is a microcosm of the study area, hosting all wildlife habitats (when including the adjacent mainland) and potentially all non-listed wildlife species. Although the Yellowstone River borders the Island to the north, limiting access by terrestrial and fossorial wildlife, the restricted seasonal flows of the existing side channel bordering it to the south does not provide such a barrier. This geographic setting results in the relative isolation and preservation of the Island's habitats, buoying their quality for wildlife. Areas currently impacted by humans are restricted to a few access roads and the site around the existing Intake Diversion Dam, which are relatively small and degraded. Recreation, generally restricted to boat-based fishing, does bring people to the shoreline of the Island, but disturbance does not likely penetrate beyond that area.

The relatively low level of human disturbance and land use on the Island allows wildlife to freely access the habitats that are present, which is apparent in the ubiquitous network of game trails linking the various habitats together.

3.8.2 Wildlife by Habitat

Five general habitat types in the study area provide productive ecological support for native wildlife: wetland, woody riparian, barren land, shrubland, and grassland. These habitats include the ecological systems (MTNHP 2013) described in Section 3.10, but are more general and applicable to the species (both wildlife and non-wildlife) found in the study area. Table 3-15 lists typical wildlife species in the study area, organized by class and listed in alphabetical order by common name. This list captures most common wildlife species but is not intended to serve as an inventory. Information is primarily from MFWP (MFWP 2016c).

TABLE 3-15. TYPICAL WILDLIFE SPECIES FOUND IN THE STUDY AREA

Common Name	Scientific Name	Habitat
Amphibians		
Boreal chorus frog	<i>Pseudacris maculata</i>	Wetlands in riparian areas
Tiger salamander	<i>Amystoma tigrinum</i>	May occupy wetlands in riparian areas
Woodhouse's toad	<i>Bufo woodhousii</i>	May occupy wetlands in riparian areas
Reptiles		
Common garter snake	<i>Thamnophis sirtalis</i>	Generalist; particularly moist habitats near water
Eastern racer	<i>Coluber constrictor</i>	Associated with relatively open habitats either in shortgrass prairie or forested areas
Gopher snake	<i>Pituophis catenifer</i>	Generalist; primarily associated with dry habitats, including open pine forests
Milk snake	<i>Lampropeltis triangulum</i>	Generalist; usually coniferous/deciduous forest edges, also open woodland, dry or wet prairies, savannahs, rocky hillsides, small streams or marshes, and agricultural or suburban areas
Painted turtle	<i>Chrysemys picta</i>	Wetlands that contain some shallow water areas and a soft bottom, also river backwaters and oxbows
Plains garter snake	<i>Thamnophis radix</i>	Grasslands near wetlands
Sagebrush lizard	<i>Sceloporus graciosus</i>	Predominately in sagebrush cover, but also in greasewood and other desert shrubs and small rocky outcrops
Snapping turtle	<i>Chelydra serpentine</i>	Backwaters along rivers, with permanent flowing water and sandy or muddy bottoms
Spiny softshell turtle	<i>Apalone spinifera</i>	Occupies larger rivers and tributaries, in areas of soft sandy and muddy banks
Western hog-nose snake	<i>Heterodon nasicus</i>	Prefers sandy or gravelly habitats, often by rivers or sagebrush-grassland habitat and near pine savannah in grasslands
Birds		
American bittern	<i>Botaurus lentiginosus</i>	Wetland and riverine habitats that receive little disturbance
American coot	<i>Fulica americana</i>	May be found in almost any of a broad variety of wetlands, including freshwater lakes, ponds, marshes, roadside ditches, and industrial-waste impoundments, as well as in coastal marine habitats

Lower Yellowstone Intake Diversion Dam Fish Passage Project, Montana
 Environmental Impact Statement
 May 2016

Common Name	Scientific Name	Habitat
American crow	<i>Corvus brachyrhynchos</i>	Generalist; floodplain forests breeding habitat
American kestrel	<i>Falco sparverius</i>	Found in nearly all habitats in Montana; nests often in cavities in trees, banks, cliffs, and buildings; usually hunt in open habitat
American redstart	<i>Setophaga ruticilla</i>	Floodplain forests breeding habitat
American robin	<i>Turdus migratorius</i>	Floodplain forests breeding habitat
Bald eagle	<i>Haliaeetus leucocephalus</i>	Riverine, primarily associated to areas with large trees
Bank swallow	<i>Riparia</i>	Wetland and riverine; nesting colonies found in artificial sites such as sand and gravel quarries and road cuts, as well as rivers and streams with eroding stream-side banks
Belted kingfisher	<i>Megaceryle alcyon</i>	Riverine zones supporting fish
Black-billed magpie	<i>Pica hudsonia</i>	Floodplain forests breeding habitat
Black-capped chickadee	<i>Poecile atricapillus</i>	Floodplain forests breeding habitat
Black-crowned night heron	<i>Nycticorax</i>	Wetland and riverine habitats
Black-headed grosbeak	<i>Pheucticus melanocephalus</i>	Floodplain forests breeding habitat
Blue jay	<i>Cyanocitta cristata</i>	Primarily inhabits deciduous, coniferous, and mixed forests and woodlands. Common in towns and residential areas, especially those having large oaks or other mast-producing trees
Brewer's blackbird	<i>Euphagus cyanocephalus</i>	Generalist; open, human-modified habitats including parks and disturbed areas
Brown thrasher	<i>Toxostoma rufum</i>	Frequents thickets, hedgerows, forest edges, and overgrown clearings in deciduous forest
Brown-headed cowbird	<i>Molothrus ater</i>	Generalist; mixed grass prairie breeding bird
Canada goose	<i>Branta canadensis</i>	On the lower Yellowstone River, broods are reared on island grasslands and meadows along the river; dense brush is used when not feeding
Cliff swallow	<i>Petrochelidon pyrrhonota</i>	Wetland and riverine; open canyons, foothills, escarpments, and river valleys that offer vertical cliff faces with horizontal overhangs for nest attachment, also found in a wide variety human-made habitat with artificial nesting structures such as bridges and buildings
Common grackle	<i>Quiscalus quiscula</i>	Open woodland and forest edges; also swamps, marshes, and around human habitation
Common merganser	<i>Mergus merganser</i>	Riverine zones supporting fish
Common yellowthroat	<i>Geothlypis trichas</i>	Occupies thick vegetation in wide range of habitats from wetlands to prairie to pine forest
Cooper's hawk	<i>Accipiter cooperii</i>	Nest in dense deciduous and coniferous forest cover, often in draws or riparian areas; hunt in these areas or in adjacent open country
Downy woodpecker	<i>Picoides pubescens</i>	Floodplain forests breeding habitat

Common Name	Scientific Name	Habitat
Golden eagle	<i>Aquila chrysaetos</i>	Nest on cliffs and in large trees (occasionally on power poles), and hunt over prairie and open woodlands
Gray catbird	<i>Dumetella carolinensis</i>	Live amid dense shrubs, vine tangles, and thickets of young trees in both summer and winter
Great blue heron	<i>Ardea herodias</i>	Wetland and riverine habitats as well as ag fields
Great horned owl	<i>Bubo virginianus</i>	Floodplain forests breeding habitat
Hairy woodpecker	<i>Picoides villosus</i>	Floodplain forests breeding habitat
Horned lark	<i>Eremophila alpestris</i>	Mixed grass prairie breeding bird
House wren	<i>Troglodytes aedon</i>	Open, shrubby woodlands
Lazuli bunting	<i>Passerina amoena</i>	Floodplain forests breeding habitat
Least flycatcher	<i>Empidonax minimus</i>	Floodplain forests breeding habitat
Loggerhead shrike	<i>Lanius ludovicianus</i>	Open shrubby grasslands
Mallard	<i>Anas platyrhynchos</i>	Uses wide variety of situations with dense cover, including grasslands, marshes, bogs, riverine floodplains, dikes, roadside ditches, pastures, cropland, shrubland, fence lines, rock piles, forests, and fragments of cover around farmsteads
Marsh wren	<i>Cistothorus palustris</i>	Riparian and wetland habitats
Mourning dove	<i>Zenaida macroura</i>	Generally shuns deep woods or extensive forest and selects more open woodlands and edges between forest and prairie biomes for nesting—human alteration of original vegetation is generally beneficial for this species
Northern flicker	<i>Colaptes auratus</i>	Floodplain forests breeding habitat
Prairie falcon	<i>Falco mexicanus</i>	Use cliffs for nesting, and grassland and prairie habitats for hunting
Red-eyed vireo	<i>Vireo olivaceus</i>	Floodplain forests breeding habitat
Red-headed woodpecker	<i>Melanerpes erythrocephalus</i>	Riverine forests
Red-necked phalarope	<i>Phalaropus lobatus</i>	Occurs in large flocks on lakes and less frequently on ponds and in flooded fields
Red-tailed hawk	<i>Buteo jamaicensis</i>	Generalist, floodplain forests breeding bird
Red-winged blackbird	<i>Agelaius phoeniceus</i>	Riparian and wetland habitats
Sage grouse	<i>Centrocercus urophasianus</i>	Sagebrush and grassland habitats
Say's phoebe	<i>Sayornis saya</i>	Open dry country; prairies, sagebrush plains, and associated draws
Sharp-shinned hawk	<i>Accipiter striatus</i>	Use heavy timber, especially even-aged stands of conifers, but sometimes hunt in open areas
Spotted sandpiper	<i>Actitis macularius</i>	Occurs on edges of lakes, ponds, flooded fields, and streams
Spotted towhee	<i>Pipilo maculatus</i>	Floodplain forests breeding habitat
Swainson's thrush	<i>Catharus ustulatus</i>	Floodplain forests breeding habitat
Tree swallow	<i>Tachycineta bicolor</i>	Wetland and riverine
Virginia Rail	<i>Rallus limicola</i>	Wetland and riverine habitats that receive little disturbance
Warbling vireo	<i>Vireo gilvus</i>	Floodplain forests breeding habitat
Western meadowlark	<i>Sturnella neglecta</i>	Mixed grass prairie breeding bird
Yellow warbler	<i>Dendroica petechia</i>	Floodplain forests breeding habitat

Lower Yellowstone Intake Diversion Dam Fish Passage Project, Montana
 Environmental Impact Statement
 May 2016

Common Name	Scientific Name	Habitat
Yellow-breasted chat	<i>Icteria virens</i>	Found in low, dense vegetation without a closed tree canopy, including shrubby habitat along stream, swamp, and pond margins, as well as forest edges and disturbed forest patches
Mammals		
American badger	<i>Taxidea taxus</i>	Grasslands and arid shrublands
Beaver	<i>Castor canadensis</i>	Water and associated woody vegetation
Big brown bat	<i>Eptesicus fuscus</i>	Grasslands and riparian areas; summer day roosts include attics, barns, bridges, rock outcrops and bat houses, hibernacula include caves and mines
Coyote	<i>Canis latrans</i>	Generalist found virtually in all habitats
Desert cottontail	<i>Sylvilagus audubonii</i>	Grasslands and sagebrush areas
Eastern fox squirrel	<i>Sciurus niger</i>	Riparian cottonwood forests
Hayden's shrew	<i>Sorex haydeni</i>	Moist grassy environments
Least chipmunk	<i>Tamias minimus</i>	Found regularly in sagebrush area of eastern Montana; also found in brushy grasslands, coniferous forests, alpine tundra, and timberline krummholz; habitat preference influenced by sympatric chipmunk species
Least weasel	<i>Mustela nivalis</i>	Meadows, fields, brushy areas, and open woods
Long-eared bat	<i>Myotis evotis</i>	Woody and rocky areas, year-round resident
Long-legged bat	<i>Myotis volans</i>	Wooded areas, likely migratory
Long-tailed weasel	<i>Mustela frenata</i>	Generalist; found in almost all land habitats near water
Meadow jumping mouse	<i>Zapus hudsonius</i>	Grassy fields, thick riparian vegetation, and wooded areas
Meadow vole	<i>Microtus pennsylvanicus</i>	Wet grassland habitat
Mink	<i>Mustela vison</i>	Along streams and lakes
Mountain cottontail	<i>Sylvilagus nuttallii</i>	Generalist; primarily dense shrubby undergrowth, riparian areas
Mule deer	<i>Odocoileus hemionus</i>	Generalist; grasslands interspersed with brushy coulees, riparian, and agricultural grassland mix
Muskrat	<i>Ondatra zibethicus</i>	Marshes, edges of ponds, lakes, streams, cattails, and rushes are typical habitats
Northern pocket gopher	<i>Thomomys talpoides</i>	Generalist; cultivated fields, prairie, and wooded areas
Olive-backed pocket mouse	<i>Perognathus fasciatus</i>	Grasslands and meadows in sandy habitats
Ord's kangaroo rat	<i>Dipodomys ordii</i>	Sandy areas along dry streams and flats
Porcupine	<i>Erethizon dorsatum</i>	Generalist; wooded and brushy areas along streams
Prairie vole	<i>Microtus ochrogaster</i>	Grassland and sometimes riparian areas
Pronghorn	<i>Antilocapra americana</i>	Grassland/agricultural mixed habitat
Raccoon	<i>Procyon lotor</i>	Generalist; riparian and wetland habitats
Snowshoe hare	<i>Lepus americanus</i>	Dense riparian thickets
Southern red-backed vole	<i>Southern red-backed vole</i>	Occurs in open forest types
Striped skunk	<i>Mephitis</i>	Generalist; mixed woods, prairie, and brush

Common Name	Scientific Name	Habitat
Thirteen-lined ground squirrel	<i>Spermophilus tridecemlineatus</i>	Tallgrass grasslands and brushy edges with predominantly herbaceous vegetation that provides dense cover
Western jumping mouse	<i>Zapus princeps</i>	Usually tall grass along streams, with or without a brush or tree canopy
White-tailed deer	<i>Odocoileus virginianus</i>	River and creek bottoms and agricultural grassland mix
White-tailed jackrabbit	<i>Lepus townsendii</i>	Generalist; grasslands and wooded or riparian areas in winter

3.8.2.1 Generalist Species

While each habitat hosts a diversity of wildlife, some species are restricted to one or a few habitats, while others are generalists and spend a significant amount of time in several. True habitat generalists are typically the most common species in the study area.

Reptiles likely to be found throughout all habitats include snake species such as the common garter snake (*Thamnophis sirtalis*), milk snake (*Lampropeltis triangulum*), and gopher snake (*Pituophis catenifer*). Garter snakes gravitate more to riparian areas, and milk snakes and gopher snakes spend more time in dryer sites. Common birds include Brewer’s blackbird (*Euphagus cyanocephalus*), American crow (*Corvus brachyrhynchos*), and red-tailed hawk (*Buteo jamaicensis*), which all make use of each habitat. Common mammal species found across all habitats include mountain cottontail (*Sylvilagus nuttallii*), mule deer, northern pocket gopher (*Thomomys talpoides*), porcupine (*Erethizon dorsatum*), raccoon (*Procyon lotor*), coyote (*Canis latrans*), and striped skunk (*Mephitis mephitis*). Most of these species spend time in or near the riparian zone because of their requirements for food and cover.

Wildlife species in the study area that use a more narrow range of habitats are described in the following sections, according to the habitat where they would spend most of their time. Those with narrower habitat affinities are normally less common.

3.8.2.2 Wetland Habitat Species

Wetland can be found in various ecological systems, including Great Plains Riparian, Great Plains Floodplain, Introduced Riparian and Wetland Vegetation, and Great Plains Closed Depressional Wetland (MTNHP, 2013; see Section 3.10). Wetlands can have dominant vegetation composed of emergent plants, woody shrubs, or trees species. In the study area, wetland is most commonly located in off-channel areas, as well as adjacent to the main channel along the riparian fringe. Wetlands are also present throughout the large, complex matrix of irrigation canals and channels of the LYP system where they line open water and have become established in adjacent wet sites. Wetlands in this area are expansive, but lower in quality for wildlife than naturally occurring wetlands due to high frequency of exotic plants and human disturbance, and presences of agricultural water pollution. All wetlands provide a diversity of important habitat for both aquatic and terrestrial wildlife. The close association between wetlands and flowing water results in frequent disturbances, which continually shapes this dynamic habitat. Wetland composes up to 31 percent of the total study area (MTNHP 2013).

Many wildlife species found in off-channel wetlands (those with water that is relatively still when present) are generally the same as those found in riparian fringe wetlands, with exceptions based on subtleties in wildlife habitat preferences for vegetation composition. All amphibians and turtles found in the study area would frequent off-channel wetlands. Common species would

include the boreal chorus frog (*Pseudacris maculate*), Woodhouse's toad (*Bufo woodhousii*), tiger salamander (*Amystoma tigrinum*), and painted turtle (*Chrysemys picta*). Occasionally snapping turtle (*Chelydra serpentine*) and spiny softshell turtle (*Apalone spinifera*) would also be present, but they are more typical of riverine areas. Common garter snakes are the only reptile species that would frequent this habitat.

The high diversity of vegetation structure, high densities of invertebrate and small vertebrate prey species, and extensive cover for loafing and nesting all contribute to off-channel wetlands being important habitat for many bird species. Common wetland-associated species include; great blue heron (*Ardea herodias*), American bittern (*Botaurus lentiginosus*), Virginia rail (*Rallus limicola*), black-crowned night heron (*Nycticorax nycticorax*), marsh wren (*Cistothorus palustris*), common yellowthroat (*Geothlypis trichas*), red-winged blackbird (*Agelaius phoeniceus*), and tree swallow (*Tachycineta bicolor*). Where wetlands border open, generally slack and shallow water, species such as American coot (*Fulica americana*) and most ducks, geese, and waders would be common.

A few mammal species spend the majority of their time in off-channel wetland habitat. Mammals typical to this area include beaver (*Castor canadensis*), muskrat (*Ondatra zibethicus*), and white-tailed deer, although many other species such as bats, rodents, and various predators frequently visit wetlands to forage and drink.

Along the Yellowstone River, the transition areas that lie between the aquatic and terrestrial ecosystems are generally the riparian zone, and are where riparian fringe wetlands occur. Riparian wetland areas consist of rooted vegetation growing along or throughout channel islands and bars, channel banks, floodplains, and lower terraces. Riparian wetland habitat is highly productive and supports an abundance of wildlife. In the study area, riparian wetland vegetation is variable in composition and structure and consists of a mix of herbs and woody shrubs and trees, which attracts wildlife with an affinity to higher proportions of woody plants and more diverse structure.

The same amphibians, reptiles, birds, and mammals associated with off-channel wetlands are also associated with riparian wetlands. Some species are found in riparian wetlands at higher frequencies, however, and include birds such as belted kingfisher (*Megaceryle alcyon*), common merganser (*Mergus merganser*), spotted sandpiper (*Actitis macularius*), American dipper (*Cinclus mexicanus*), least flycatcher (*Empidonax minimus*), bank swallow (*Riparia riparia*), cliff swallow (*Petrochelidon pyrrhonota*), and Swainson's thrush (*Catharus ustulatus*). One mammal primarily associated with riparian wetlands is the mink (*Mustela vison*).

3.8.2.3 Woody Riparian Habitat Species

Woody riparian habitat can be found in various ecological systems, including Great Plains Riparian, Great Plains Floodplain, Great Plains Wooded Draw and Ravine, and Introduced Riparian and Wetland Vegetation (MTNHP, 2013; see Section 3.10). This habitat can take the form of open woodland savanna, non-wetland riverine woodland, including gallery forest, and closed wooded draws. It can provide expansive habitat patches such as open woodland, as well as small, discrete microhabitats commonly found in draws. The single condition typifying woody riparian is having trees generally greater than 20 feet tall with a tree canopy greater than 25 percent. This condition is associated with a diversity of woody species, size classes, and life

stages, all of which provide physical niches that wildlife rely upon. Woody riparian habitat also acts as an important corridor for wildlife movement along the river and its tributaries, as well as away from the riverine system to upland areas. Woody riparian habitat composes up to 31 percent of the total study area (MTNHP 2013).

Wildlife species found in woody riparian habitat are diverse and generally share a need to access woody plants for breeding, foraging, or shelter. Typical reptiles include eastern racer and plains garter snake. Common birds include northern flicker (*Colaptes auratus*), downy woodpecker (*Picoides pubescens*), red-headed woodpecker (*Melanerpes erythrocephalus*), hairy woodpecker (*Picoides villosus*), red-eyed vireo (*Vireo olivaceus*), and forest raptors such as sharp-shinned hawk (*Accipiter striatus*) and Cooper's hawk (*Accipiter cooperii*). Mammals that use woody riparian habitat almost exclusively are restricted to tree squirrels, although several other mammals are drawn into this habitat to seek food or shelter in snags, rotting logs, or piles of woody debris. Examples include raccoons, bats, and snowshoe hare (*Lepus americanus*).

3.8.2.4 Barren Land Habitat Species

Barren land can be found in only one ecological system: Great Plains Badlands (MTNHP, 2013; see Section 3.10). It can take the form of bluffs, badlands, cliffs, dry ephemeral stream channels, and outcrops. These are mostly erosional features, and have a sporadic distribution along river. A prominent site in the study area is the existing rock quarry used for extracting material for the maintenance of the Intake Diversion Dam. Despite its past and ongoing use, the quarry appears to be relatively little altered/disturbed and likely provides moderate-quality habitat consisting of a large rock outcrop, cliffs, upland woodland, shrubland and grassland, all of which are interspersed by a dense network of game trails, suggesting frequent wildlife use. Barren land provides unique habitat that affords protection and isolation to wildlife by way of its desolation, despite the tradeoffs from its relative aridity and remoteness. Barren land composes up to 1 percent of the total study area (MTNHP 2013).

Barren land often has exposed erodible soil layers and rock that provide habitat for reptiles and burrow- or outcrop-nesting birds such as swallows, nightjars, and wrens. Some of the larger features such as cliffs and rock outcrops would provide additional nesting and foraging habitat for various open country raptors, including hawks, falcons, owls, and potentially golden eagle (*Aquila chrysaetos*). Bird species that commonly use outcrops for nesting, particularly raptors, may be limited by the availability of suitable patches of barren land, indicating the importance of this habitat feature.

3.8.2.5 Shrubland Habitat Species

Shrubland can be found in two ecological systems: Great Plains Mixedgrass Prairie and Great Plains Badlands (MTNHP, 2013; see Section 3.10). It can take the form of shrub-steppe and savanna systems where woody shrubs co-occur with varying densities of grasses and forbs. Shrubland is characterized as an area dominated by woody shrubs with a shrub canopy greater than 25 percent. This is an open, relatively flat upland habitat that is common in the Great Plains. Despite it being relative arid, shrubland provides upland habitat important for wildlife, particularly for wintering mammals and during the spring breeding bird season. Shrubland composes up to 12 percent of the total study area (MTNHP 2013).

Most upland reptiles found in other communities are also found in shrubland; many of them being generalist species. However species such as the sagebrush lizard (*Sceloporus graciosus*) are primarily found only in shrubland habitat. Common bird species include mourning dove, Say's phoebe (*Sayornis saya*), black-billed magpie (*Pica hudsonia*), brown thrasher (*Toxostoma rufum*), and loggerhead shrike (*Lanius ludovicianus*). Mammals that would be found in this habitat include American badger (*Taxidea taxus*), desert cottontail (*Sylvilagus audubonii*), white-tailed jackrabbit (*Lepus townsendii*), and pronghorn. As with reptiles, many generalist mammals spend significant time in shrubland as well as other upland habitats.

Sage grouse (*Centrocercus urophasianus*) are supported by shrubland habitat. Preferred habitat patches are generally larger and receive less disturbance than what is available in the study area (MSGWG 2005). However, the presence of this habitat, as well as the projection that the current sage grouse distribution borders and may extend into the study area (MSGWG 2005), suggests potential may exist for their presence.

3.8.2.6 Grassland Habitat Species

Grassland can be found in three ecological systems: Great Plains Mixedgrass Prairie, Great Plains Sand Prairie, and Great Plains Badlands (MTNHP, 2013; see Section 3.10). This habitat forms extensive transition zones with most other habitats in the study area. Grassland is found mainly in valleys and plains and along flat-bottomed channels, but is restricted to arid areas. Like shrubland, grassland is an open, relatively flat or sloping upland habitat that is common in the Great Plains. It provides upland habitat important for wildlife, particularly for wintering mammals and during the spring breeding bird season. Grassland composes up to 18 percent of the total study area (MTNHP 2013).

Most grassland species are found in other upland communities but overlap the most with shrubland wildlife. Typical reptiles are the same as those listed for shrublands, with the exception of the eastern racer, which gravitates more to grasslands. Bird species that spend most of their time in grassland habitat include horned lark (*Eremophila alpestris*), western meadowlark (*Sturnella neglecta*), and brown-headed cowbird (*Molothrus ater*). Typical mammals include least weasel (*Mustela nivalis*), thirteen-lined ground squirrel (*Spermophilus tridecemlineatus*), and various mice and voles.

3.9 Listed Species and State Species of Concern

The potential areas of effect for plants and animals of concern are the areas where flora and fauna may be affected by the proposed alternatives. For aquatic species, this includes the Yellowstone River from the Cartersville Diversion Dam at River Mile 237 downstream to its confluence with the Missouri River, and the Missouri River from the Yellowstone River confluence downstream to Lake Sakakawea in North Dakota. For terrestrial species, the affected environment includes only areas where construction or staging is proposed, including areas around the Intake Diversion Dam, Joe's Island, the Main Canal and the sites of proposed pumps.

3.9.1 Federally Protected Species

Based on letters from the U.S. Fish and Wildlife Service, nine species that may occur within the proposed study area are listed under the Endangered Species Act (ESA) (Service 2016a, Service

2016b). These species include four found in both Montana and North Dakota and five found only in North Dakota. This section evaluates the potential for each of the listed or candidate species to be present in the study area, based on the following:

- Recorded occurrences of the species in the state’s natural heritage database
- Presence of critical habitat for the species
- Presence of the species’ preferred habitats.

Occurrence data for protected species in Montana was provided by the Montana Natural Heritage Program (MTNHP) (MTNHP 2015a), along with species occurrence mapping via GIS layers and spreadsheets. Occurrence data for protected species in North Dakota was provided by the North Dakota Natural Heritage Program (NDNHP) (NDNHP 2016), along with species occurrence mapping via GIS layers and spreadsheets. MFWP oversees the MTNHP and together they maintain a repository of species data online at the Montana Field Guide (MFWP 2016e). Additional references were utilized when information from these sources did not provide enough data to assess life history, diet, threats, or occurrence. According to the Service’s Environmental Conservation Online System, there are no critical habitats for any of the ESA species or candidate species within the established study area (Service 2016c). Based on the analysis of species occurrence and habitat preferences, the likelihood of each species’ presence in the study area is summarized in Table 3-16.

TABLE 3-16. FEDERALLY LISTED SPECIES OR CANDIDATE SPECIES IN MONTANA AND NORTH DAKOTA AND LIKELIHOOD OF PRESENCE IN STUDY AREA

Common Name	Scientific Name	MT ^b	ND ^b	ESA Status	Likely Presence in Study Area
Mammals					
Black-footed ferret	<i>Mustela nigripes</i>		X	Endangered	Not present
Gray wolf ^a	<i>Canis lupus</i>		X	Endangered	Not likely to be present
Northern long-eared bat	<i>Myotis septentrionalis</i>		X	Threatened	Not likely to be present
Birds					
Least tern	<i>Sternula antillarum</i>	X	X	Endangered	Likely to be present
Piping plover	<i>Charadrius melodus</i>	X	X	Threatened	Likely to be present
Red knot	<i>Calidris canutus rufa</i>		X	Threatened	Not present
Whooping crane	<i>Grus americana</i>	X	X	Endangered	Likely to be present
Fish					
Pallid sturgeon	<i>Scaphirhynchus albus</i>	X	X	Endangered	Present
Insects					
Dakota skipper	<i>Hesperia dacotae</i>		X	Threatened	Not present

a. Gray wolf has been delisted in Montana and is considered in recovery; it remains endangered in North Dakota.

b. Checked boxes indicate the species is federally listed for protection within that state, according to Service 2016a and Service 2016b.

Only one protected species is confirmed to be present within the study area: the Pallid Sturgeon. Three protected bird species are known to occur in the study area vicinity and are likely to be present within the study area: the least tern, the piping plover, and the whooping crane. Two protected species that are not likely to be present are the gray wolf and northern long-eared bat. The red knot, black-footed ferret, and Dakota skipper are not present in the study area.

3.9.1.1 Mammals

Black-Footed Ferret (*Mustela nigripes*), Endangered

Status

The black-footed ferret was listed as endangered throughout its range in 1967 under the precursor to the ESA, the Endangered Species Preservation Act of 1966 (Service 1967). By 1987, only 18 individuals were known to exist in the world, all at the Meeteetse site in Wyoming (Service 2015a). These last 18 ferrets were placed into captivity programs and offspring have since been reintroduced through 20 separate reintroduction projects since 1991 (Service 2013a). The International Union for Conservation of Nature and Natural Resources estimates that only 295 adults were present in the wild at the end of 2015, with breeding adults having declined 40 percent since 2008 (Belant et al. 2015). The majority of those individuals occur at the four most successful colonies, which are located in Arizona, South Dakota and Wyoming. No wild populations of black-footed ferrets have been found following capture of each of the rediscovered wild Meeteetse ferrets in 1987 (Service 2013a). It is considered very unlikely that any undiscovered wild populations occur (Service 2013a). There is no critical habitat designated within the study area or vicinity.

Occurrence

There are no known occurrences of black-footed ferret in the study area, including Dawson, Richland, or Wibaux Counties in Montana (MTNHP 2015a). In North Dakota, the last records for black-footed ferret are from 1971 in McKenzie County, almost 8 miles from proposed Ranney Well Site #7 (NDNHP 2016).

Habitat

The black-footed ferret life history is entirely dependent on prairie dogs. The ferret relies on prairie dogs for creating shelter in underground colonies and as its main food source (MFWP 2016e). Black-tailed prairie dog (*Cynomys ludovicianus*), white-tailed prairie dog (*C. leucurus*) and Gunnison's prairie dog (*C. gunnisoni*) are all species that the black-footed ferret is dependent upon.

The close association of ferrets and prairie dogs means that it would be necessary to identify existing prairie dog colonies to determine where ferrets may occur. Prairie dog colonies are generally found on grasslands and shrub grasslands that are flat and open, with low and relatively sparse vegetation (MFWP 2016e). The white-tailed prairie dog occurs only in a small area in the south central portion of Montana. No known occurrences are recorded elsewhere in Montana (MTNHP 2015a). The black-tailed prairie dog has two recorded occurrences in Richland County. One of these sites is over 6 miles from Pump #4. The second occurrence is along the Yellowstone River near the City of Sidney, between Pumps #6 and #7. Neither site is within the proposed footprint for any alternative.

Life History

The black-footed ferret is the only ferret species native to the Americas and is a medium-sized mustelid typically weighing 1.4 to 2.5 pounds (Service 2013a). In captivity, ferrets begin breeding after reaching one year of age, starting in March through early April. Gestation is 42 to 45 days, and litters average about 3.5 kits. Young typically appear above ground in July and

disperse in the fall (MFWP 2016e). These ferrets are secretive and solitary and are nocturnal predators, making them rarely observed except at night (NatureServe 2015).

Diet

Field observations indicate that black-footed ferrets feed almost entirely on prairie dogs. Diet samples support this, although other species of vertebrate prey have occasionally been reported (MFWP 2016d).

Threats

Threats to the ferret include the decline of prairie dogs, which have declined due to extermination by landowners, diseases such as plague and distemper, and conversion of grasslands to agricultural uses (Belant et al. 2015). The greatest impacts on ferret populations have resulted from the conversion of native prairie to cropland and the spread of native canine distemper and nonnative sylvatic plague. The greatest threat to the recovery of the black-footed ferret may lie in failure to manage prairie dog colonies properly, including continued poisoning by landowners who consider the species a pest (Service 2013a).

Presence

The black-footed ferret may occur in McKenzie County of North Dakota (Service 2016b). However, the species is not considered to be present in the Montana portions of the study area, according to the Service's Montana list (Service 2016a). It is highly unlikely that black-footed ferret would become established within the study area. Populations are extremely rare and well documented, and are not known to occur along the Yellowstone River. In addition, any potential habitat for the black-footed ferret, which includes existing prairie dog colonies, is several miles from the study area.

Gray Wolf (*Canis lupus*), Delisted in Montana, Endangered in North Dakota

Status

Gray wolves were part of the original Endangered Species Preservation Act of 1966, but were subsequently reclassified and listed as endangered in 1978 throughout the contiguous United States and Mexico, except for the Minnesota gray wolf population, which was classified as threatened (Service 1978). Gray wolf populations in Idaho and Montana were delisted as of 2011, due to adequate recovery (Service 2015b). Wolves in Montana became a species managed solely by the state of Montana. However, gray wolves in North Dakota remain listed as endangered and protected under the ESA (Service 2016d, Service 2015b). There is no critical habitat designated within the study area or vicinity (Service 2016c).

Occurrence

The original range of the gray wolf included much of the northern hemisphere in every habitat where large ungulates were found (Mech 1995). The gray wolf is rarely seen in North Dakota, with only occasional confirmed sightings. There is no known breeding population (NDGF 2012a). Wolf observations in the Dakotas were reported to begin increasing in the early 1990s, likely related to range expansion and population increases in adjacent areas, especially Minnesota (Licht and Fritts 1994). Most occurrences were of young individuals, which suggests that individuals are dispersing to the area instead of breeding there (Licht and Fritts 1994). There are no occurrences of gray wolves reported by the NDNHP (2016).

Habitat

Wolves occupy a wide range of habitat types and elevations, limited only to areas where prey sources exist, such as elk, white-tailed deer, mule deer or moose (MFWP 2016e). In Midwestern states, habitats currently used by wolves range from mixed hardwood-coniferous forests in wilderness and sparsely settled areas to forest and prairie landscapes dominated by agricultural and pasture lands (NDGF 2012a).

Life History

Wolves live in groups called packs that typically include a breeding pair and their offspring, as well as other non-breeding adults. Breeding begins by age two or three, and on average produces five pups in early spring. Pups are reared in dens for the first six weeks and cared for by the entire pack (MFWP 2016e). Young wolves disperse from the pack to find a mate and form a pack after a year or two, and can travel as far as 600 miles in search of a mate or territory (Service 2011). Territories can range in size from 50 to over 1,000 square miles. The size of the territory depends on the availability and seasonal movements of prey (Service 2011).

Diet

Most ungulates such as deer, elk, and moose, as well as smaller mammals such as beavers and arctic hares, can serve as prey for wolves. Wolves may select both wild and domestic species as prey (Mech 1995, NDGF 2012). Wolves will readily scavenge and occasionally augment their diet with birds, fish, and rodents (Service 2016e, NatureServe 2015).

Threats

Wolves could recolonize portions of their former range on the Dakota prairies, though the widespread conversion of prairies to agriculture and relatively high densities of roads would be the greatest challenges to successful reestablishment (Licht and Fritts 1994). As wolves move into these agricultural areas, conflicts with humans greatly increase, resulting in a higher number of wolves killed for animal control or by accident when confused with coyotes (Mech 1995, NDGF 2012).

Presence

In a survey of wildlife biologists and animal control personnel in North Dakota, one study found confirmation that gray wolves have been seen in North Dakota, though sightings are very rare and sporadic (Licht and Huffman 1996). A wolf killed in January 1992 in Dunn County, east of McKenzie County, is the nearest record of wolf activity to the study area (Licht and Huffman 1996). Due to the rarity of occurrences of this species and the altered habitat and development in the study area, it is unlikely that gray wolves would be within the study area.

Northern Long-Eared Bat (*Myotis septentrionalis*), Threatened

Status

The northern long-eared bat was listed as endangered throughout its range in 2013 (Service 2013b). In 2015, the species was reclassified to threatened (Service 2015c) and in early 2016, the final 4(d) rule set provisional conservation protections (Service 2016f). The 4(d) rule prohibits purposeful take of northern long-eared bats throughout the species' range, as usual for most protected species, but provides for exceptions in instances of removal of the bats from human structures, when necessary for defense of human life, and when removal of hazardous

trees is needed for protection of human life and property. There is no critical habitat designated within the study area or vicinity.

Occurrence

The northern long-eared bat is a permanent resident throughout much of the north and northeastern portions of North America. Historically, eastern Montana and Wyoming marked the western limits of the range, including areas around the Yellowstone River area (MFWP 2016e). A single observation of the northern long-eared bat is recorded in Montana, in the north central part of Richland County in 1978 (MTNHP 2015a). There are no records of occurrence in North Dakota Counties within the study area (NDNHP 2016).

Habitat

Northern long-eared bats move between varying habitats depending on season. Winter hibernation habitat, or hibernacula, typically includes underground caves or structures with similar microclimates, such as mines and railroad tunnels. Bats prefer hibernacula with large passages, cracks and crevices large enough for roosting, a relatively constant, cool temperature of about 32°F to 48°F, high humidity, and minimal air currents.

During summer, suitable habitat can include forested habitats, but may also include adjacent habitats such as wetlands, agricultural fields, and pastures. Roosts may be found in rock cavities and the crevices or hollows of both live and dead trees. Suitable wooded areas have a wide range of tree densities and canopy closures. Individual trees may be considered suitable habitat when they have good roost opportunities and are within 1,000 feet of other suitable wooded habitat. This bat has occasionally been found roosting in structures such as barns, bridges, and bat houses, particularly when other suitable roosts are unavailable.

Suitable spring staging and fall swarming habitat is similar to that of summer habitat, but is typically within 5 miles of hibernacula. Spring staging and fall swarming habitats are generally used from early April to mid-May and mid-August to mid-November, respectively. Roost sites are changed every few nights during spring, summer, and fall. Bats may also change hibernacula multiple times in one winter (Service 2014a, MFWP 2016, NatureServe 2015).

Life History

Northern long-eared bats typically hibernate between mid-fall and mid-spring each year. Breeding begins prior to hibernation, in late summer or early fall, as males begin swarming near hibernacula. Females store sperm during hibernation and in spring emerge from their hibernacula and the delayed fertilization takes place. Estimates for seasonal habitat use time periods in Montana for this bat are from October 1 to May 15 for hibernation season and from April 1 to September 30 for the summer maternity season. Maternity colonies consisting of females and their pups can range from 7 to 100 individuals, but are most commonly 30 to 60 individuals. Volancy, when pups are able to fly, occurs at about three weeks (MFWP 2016, NatureServe 2015).

Diet

As is typical for bats, the northern long-eared bat emerges at dusk to forage on insects such as moths, flies, crickets, grasshoppers, and beetles, which they catch while in flight using echolocation or seize from vegetation and water surfaces. In addition to insects, these bats are

known to consume spiders. Foraging periods are nocturnal and binodal, with two feeding excursions each night, the first a few hours after sunset and the second seven to eight hours after sunset (MFWP 2016, NatureServe 2015).

Threats

The greatest threat to the northern long-eared bat is white-nose syndrome, a fungal disease that invades deep skin tissues and causes extensive damage during hibernation. Long-eared bats with white-nose syndrome were first observed in New York in 2006 and it has spread rapidly through much of the bats' range. White-nose syndrome has not made its way to Montana or North Dakota. Other threats to this bat include, to a much lesser degree in comparison to white-nose syndrome, human alterations to hibernacula openings, human disturbance during hibernation, removal of forest habitats, prescribed fires near hibernacula, use of pesticides or herbicides, and the introduction of wind turbines that cause mortality during migration (MFWP 2016, NatureServe 2015).

Presence

The most recent occurrence of northern long-eared bat in Montana was in 1978 (MTNHP 2015a). However, these bats are difficult to detect, hiding in deep crevices during hibernation and mixing with larger colonies of other bats; they may be present in more areas than are known. In the study area, hibernacula of appropriate condition are rare. It is unlikely that this species would be within the area of effect.

3.9.1.2 Birds

Least Tern (*Sternula antillarum*, previously known as *Sterna antillarum*), Endangered

Status

The least tern was listed as endangered in 1985 (Service 1985a). The recovery plan for the interior population of least terns within the Missouri River system specifies that essential habitat be protected, enhanced or restored and that a population level of 2,100 adult birds be maintained for 10 years. In Montana, the northwestern limit of the tern's breeding range, the specific recovery goal is maintaining 50 breeding adults (Service 1990). While critical habitat has not been designated for this population, the recovery plan does recognize riverine sandbars, river channels with appropriate channel widths and flows, and lake shorelines as essential breeding habitat (Service 1990). There is no critical habitat designated within the study area or vicinity.

Occurrence

Interior least terns are migratory, breeding along rivers systems in the United States and wintering along the coast in Central and South America (Service 1990). Within the Missouri River system, breeding sites occur along the Missouri River and many of its major tributaries in eastern Montana and North Dakota (Service 1990). Within Montana, least terns breed along the Yellowstone River, downstream of Miles City. Historical records are rare prior to their listing, with only two non-breeding records before 1985 (Atkinson and Dood 2006a). In 1987, one tern attempted to nest along Fort Peck Reservoir, but the attempt failed. Targeted tern surveys were conducted along the Yellowstone River during the 1994-1996 breeding seasons, finding an average of 27 adult birds across years within the reach between Miles City and the Seven Sisters Recreation Area (Bacon 1996). MTNHP reports occurrences of interior least tern throughout the entirety of the study area from as early as 1988 and as recently as 2013 (MTNHP 2015a).

NDNHP data includes records of occurrence on the Yellowstone River from the 1990s at the confluence with the Missouri River (NDNHP 2016).

Habitat

Breeding terns prefer to nest on sandbars and sandy islands but may also nest within gravel pits, along river channel environments, and on lake and reservoir shorelines. Important physical attributes of a nest site generally include the presence of suitable nesting substrate, a lack of vegetative cover, favorable water levels and proximity to stable food resources. Preferred nesting substrates are dry, flat, barren to sparsely vegetated sections of sand or pebble beach within a wide, unobstructed, river channel. Suitable water levels occur after summer flows recede and dry sandbars or islands are exposed. Suitable foraging sites during breeding season are most often along shorelines where shallow-water habitats are adjacent to the main channel. Foraging habitats near nest sites are preferred, usually within 300 feet of the colony. Nest sites observed along the Yellowstone River were on bare cobble on the upstream portion of channel bars sparsely vegetated with cottonwood and willow saplings. More generally, breeding sites on the Yellowstone River occur where increased channel sinuosity results in more channel bars and overlapping islands surrounded by irregular channel activity (MFWP 2016, Atkinson and Dood 2006a).

Life History

Least terns lay eggs primarily May through June, though renesting can occur in July and August if initial nests fail. Two to three eggs are produced per clutch and are incubated about 20 to 25 days before hatching. Both parents tend to the young, usually until a few weeks after fledging occurs, which is at about three to four weeks. Terns typically begin breeding at about one year old. Spring arrival times progress northward, with the first birds arriving at breeding grounds in the lower Mississippi from mid-April to early May. In Montana, spring arrival of the species occurs in mid to late May, with departure generally occurring by mid-August. In general, regardless of geographic location, most breeding sites are left by early September (MFWP 2016, Atkinson and Dood 2006a, NatureServe 2015).

Diet

Least terns feed almost exclusively on fish, but will also take crustaceans, mollusks, and annelids. Fish species captured by least terns tend to be surface schoolers found in shallow water. Therefore, waters less than 3 feet deep are preferred forage sites. For most successful reproduction, suitable foraging habitat must be located near enough to the colony, usually within 300 feet (MFWP 2016, Atkinson and Dood 2006a).

Threats

The greatest factor resulting in population reductions of the least tern is the alteration of river hydrographs in their range (Service 1990). Channelized and impounded rivers and rivers that are dammed are no longer flowing naturally. This results in two significant changes to least tern habitat: a dramatic reduction in the availability of widely braided river channels; and inappropriately timed water releases from reservoirs that inundate sandbars and drown nests prior to fledging.

The presence of people, pets or vehicles in the vicinity of nest sites may also result in nest failure. Breeding birds may be reluctant to return to the nest after human or pet disturbance,

leaving eggs and/or chicks vulnerable to temperature fluctuations. In areas where river levels are low, off-road vehicles driving through exposed sandbars have been reported to result in chick and adult mortalities. Poorly timed management activities, such as vegetation removal, can result in disturbance if conducted during nesting periods.

Presence

Although Montana supports one of the smallest populations of interior least terns, this species is likely to be present and to be breeding along the Yellowstone River within the study area (MTNHP 2016). Though the study area is at the limit of the terns' preferred range, it is noted as being a potentially important alternative site in years that rivers within the preferred range are at higher water levels; substantial water diversion for agricultural purposes makes the Yellowstone River unlikely to pose an inundation threat to tern nests. For these reasons, it is expected that the breeding least tern could be present in the study area.

Piping Plover (*Charadrius melodus*), Threatened

Status

The piping plover was listed as threatened in Montana and North Dakota in the Northeast Region (Region 5) in 1985 (Service 1985b). Though critical habitat is present in Montana, there is no critical habitat designated within the study area or vicinity.

Occurrence

The breeding range of the Northern Great Plains piping plover population includes Alberta, southern Saskatchewan, southern Manitoba, eastern Montana, North Dakota, South Dakota, Minnesota, Nebraska and Iowa. The majority of breeding pairs in this range are in North Dakota, Montana, South Dakota and Nebraska, specifically including the northeastern portion of Montana at Nelson Reservoir and Bowdoin National Wildlife Refuge (NWR), and along the Missouri River including Fort Peck Reservoir (MFWP 2016, Atkinson and Dood 2006b). Plovers were first recorded in Montana in 1967 and were known to breed at Bowdoin NWR and Fort Peck Reservoir prior to 1985. MTNHP data shows confirmed occurrences of breeding for piping plovers along the Yellowstone River near its confluence with Clear and Cedar Creeks as recently as 2013 (MTNHP 2015a).

Habitat

In Montana, nesting may occur on a variety of habitat types, including alkali wetlands, lakes, reservoirs, and rivers. Piping plovers prefer unvegetated sand or pebble beaches on shorelines or islands. Other nest sites may be opportunistically selected, including sandpits, industrial ponds and gravel mines. Preferred nest sites most often have a gravel substrate and are in an area where there is little vegetation cover for predators and suitable surrounding water levels. Nests are initiated after spring and early summer flows recede and dry areas on sandbars are exposed. Studies on specific habitat parameters preferred by nesting plovers reported preferential nest site selection on relatively large sandbars averaging 938 feet long by 180 feet wide, with vegetative cover of 0 percent to 10 percent, and located about 7 inches above the river surface elevation. These variables indicate that plovers prefer nest sites that provide visibility against terrestrial predators and sufficient protection from rising waters (MFWP 2016, Atkinson and Dood 2006b).

Life History

In Montana, spring arrival of the species most often occurs from late April through early May, with departure from the breeding colony for southern wintering grounds occurring by late August. Following arrival on breeding grounds, males begin establishing territories including shoreline and adjacent open ground, and courtship activities begin. A shallow depression in the sand, often lined with gravel or shells, is created by the plovers and acts as the nest for a typical clutch size of three to four eggs. Incubation requires 27 to 30 days, and eggs begin hatching in mid-June in Montana. Chicks leave the nest quickly, within hours of hatching, and begin foraging. Chicks fledge anywhere from 20 to 35 days after hatching. Piping plovers may re-nest if initial nest fails and may switch mating partners after clutches or between years. Site fidelity is highly variable. Breeding begins at one year of age and plovers may live up to 14 years (MFWP 2016, Atkinson and Dood 2006b).

Diet

Food preferences are understood from studies conducted throughout the range of the piping plover. The information is limited to observations of feeding and fecal analysis; few stomach content analyses have been done, so a complete review of prey items is unknown. Diet is generally reported to consist of worms, fly larvae, beetles, crustaceans, mollusks, and other invertebrates. Plovers forage by pecking in sandy or muddy substrates. Adults typically forage within about 16 feet of the water's edge, while chicks remain on higher ground at greater distances from the shoreline (MFWP 2016, Atkinson and Dood 2006b).

Threat

Threats to the piping plover include their natural predators and the loss of habitat due to anthropogenic alterations to river channels and river hydrographs. Predators include mink, fox, skunk, raccoon, larger birds, and domestic cats and dogs. As rivers have become channelized and normal flood cycles are altered, vegetation has increased in cover and density. Predators can more easily stalk these ground-nesting birds when they have been forced to select nest sites in areas with more vegetation than preferred. Channelization, bank stabilization, and construction of reservoirs have contributed to the degradation or loss of sandbar nesting habitat. Piping plovers are dependent on a period of low water flows after the initial spring floods. This allows the natural flows of the river to create sandbars and sandy islands with little vegetation that can be safely nested on during naturally low water levels of later spring and summer. Other threats include loss of wetlands, reduced food availability, disease, livestock disturbance, human disturbance, and environmental pollution (MFWP 2016, Atkinson and Dood 2006b).

Presence

The piping plover is likely to occur in the study area and there is potential for the species to be nesting in the study area (MTNHP 2015a). Breeding species occurrences are confirmed for sandbar and sandy shoreline habitats within the Yellowstone River just upstream of Glendive, and suitable nesting habitat is present between the Intake Diversion Dam and the Missouri River.

Rufa Red Knot (*Calidris canutus rufa*), Threatened

Status

The Rufa red knot, also known as the red knot, is a shoreline bird related to dowitchers and sandpipers. It was listed as threatened in 2014 (Service 2014b) throughout its entire range. Within Montana, the species rank is not applicable because it is not confidently present in the

state or it is only present with accidental or irregular stopovers (MFWP 2016e). Population estimates show that this species' populations have declined by nearly 80 percent since the early 1990s (Service 2014c).

Occurrence

Red knots are one of the longest-distance migrants, breeding in the polar regions of North America and overwintering in the southern latitudes of South America (Service 2014c). The red knot is rarely observed in Montana wetlands, with about 50 observations since the 1970s, and only as a transient during migration in May or July through October (MFWP 2016e). However, no red knots have been observed, either breeding or transient, within any of the study area counties (MTNHP 2015a, NDNHP 2016).

Habitat

The red knot's unique life history depends on suitable habitat, food, and weather conditions within narrow seasonal limits, as it travels great distances between wintering and breeding areas (Service 2014c). Habitat preferences during migration are largely based upon their unique migration style and need for food items. Red knots can fly more than 9,300 miles from south to north every spring and back in the fall. They overwinter and migrate in large flocks containing hundreds of birds. Due to physical changes the bird undergoes while flying (sometimes 1,500 miles non-stop), knots arriving from long trips are not able to feed maximally until their digestive systems regenerate, a process that may take several days. This makes it necessary to locate stopover spots that are rich in easily digested food. Precise timing of stopovers with the spawning seasons of intertidal invertebrates is essential to successful migration. Some nearly double their body weights during stopovers. Red knots commonly utilize muddy or sandy coastal areas, specifically, the mouths of bays and estuaries, tidal flats, and unimproved tidal inlets during migration and overwintering. Inland saline lakes may be used as stopovers in the Northern Great Plains. Best available data suggest that red knots may also use freshwater habitats along migration routes (Service 2014c, MFWP 2016e).

Life History

The red knot breeds in the central Canadian Arctic, nesting in dry elevated tundra. Female red knots lay only one clutch, typically including four eggs, in late May or early June. Incubation takes 22 days. Young leave the nest within 24 hours of hatching and are able to forage for themselves (Service 2014c).

Diet

For much of the year, red knots eat small clams, mussels, snails and other invertebrates, swallowing their prey whole.

Threats

With timing critical for red knots, climate change can have a momentous effect by making events such as spawning seasons fluctuate. Even the slightest change can have disastrous effects on the red knot population.

Presence

Red knots have not been observed within the study area in Montana, and stopovers by red knots anywhere in Montana are rare, with fewer than four sightings in Montana wetlands any given year (MTNHP 2015a). Preferred primary habitats of coastal bays and inlets are not available, and

freshwater habitats used are typically impoundments and not streams. The red knot is not present in the study area.

Whooping Crane (*Grus americana*), Endangered

Status

The whooping crane was listed as threatened with extinction in 1967 (Service 1967) and then designated endangered in 1970 (Service 1970). It was listed as an endangered species in Canada under the Species at Risk Act in 2003. In 1938, the wild whooping crane population had declined to 29 adults. In 2006, it had only improved to 343 individuals (CWS and Service 2007). These cranes are endemic to North America and currently breed in the wild at only three locations, none within Montana or North Dakota (MFWP 2016e). Whooping cranes are migrants through these states during spring and fall migration. Critical habitat for this species lies outside the study area.

Occurrence

There are documented sightings of whooping crane along the Yellowstone River drainage, but not immediately adjacent to the river (MTNHP 2015a). In Montana, these cranes have been recorded in marsh habitats at Medicine Lake and Red Rock Lake NWRs and on riparian habitats on the Missouri River (CWS and Service 2007). In North Dakota, sightings along the Missouri River have been confirmed in McKenzie County (NDNHP 2016). The whooping crane is not known to breed in either state. There are no observations of nesting in Montana near the study area.

Habitat

Montana and North Dakota are part of the migration path for whooping cranes. These cranes use a variety of habitats during migration, stopping to feed in croplands and roosting in wetlands. The whooping crane prefers freshwater marshes, wet prairies, shallow portions of rivers and reservoirs, grain and stubble fields, shallow lakes, and wastewater lagoons for feeding and loafing during migration. Areas with habitat mosaics, or a variety of these habitats interspersed together, are preferable. Overnight roosting sites usually have shallow water in which whooping cranes stand. Whooping cranes roost on unvegetated sandbars, in wetlands, and in some isolated stock ponds. Whooping cranes are usually found in small groups of seven or fewer individuals. They are easily disturbed when roosting or feeding (MFWP 2016e, CWS and Service 2007).

Life History

Whooping cranes migrate from wintering grounds at Aransas NWR on the Texas Gulf Coast to breeding grounds at Wood Buffalo National Park in Canada. Montana occurrences indicate that spring migration dates bring individuals through the area as early as April, with departure as late as the end of October. Whooping cranes are a long-lived species with estimates for longevity in the wild of at least 30 years. Captive individuals are known to live 35 to 40 years. Cranes begin breeding at age five on average, and as early as three. A typical clutch of two eggs is laid in April through May. Hatching takes place about a month later. Chicks fledge after 33 to 34 days but remain with parents until the following year (MFWP 2016e, CWS and Service 2007).

Diet

Whooping cranes are omnivorous and eat a variety of prey items. Studies have found that food items can include insects, frogs, rodents, small birds, crayfish, minnows, and berries. Migrating

cranes were found to spend most of their foraging time within harvested grain fields and that agricultural grains made up a portion of the diet. However, croplands are not used when more desirable foraging grounds are available. Cranes probe mud or sand in or near shallow water for prey and may also take prey from the water column (MFWP 2016e, CWS and Service 2007).

Threats

The historical decline of the species was primarily the result of hunting and the conversion of native habitats to farmland and other development. Continuing stressors that compromise the rebuilding of the population may include predation, delayed sexual maturity, small clutch size, and low recruitment rates. During migration, collision with utility lines is the principal cause of loss (MFWP 2016e, CWS and Service 2007).

Presence

Whooping cranes are known to occur in the eastern portion of Montana and North Dakota during migration periods (MTNHP 2015a, NDNHP 2016). Stopover habitat within wetlands environs throughout the Yellowstone River corridor is available to whooping cranes. Though the species is rare, there is potential for their presence in the study area during migration months.

3.9.1.3 Fish

Pallid Sturgeon (*Scaphirhynchus albus*), Endangered

Status

The pallid sturgeon was listed as endangered throughout its range in 1990 (Service 1990). A Recovery Plan was developed in 1993 (Service 1993) and updated in 2014 (Service 2014). Range-wide, the status of sturgeon populations has improved and is currently stable. However, the upper Missouri River populations are continuing to decline (Service 2014). To prevent extirpation in the near-term, the Pallid Sturgeon Conservation Augmentation Program has been undertaken to supplement wild populations with hatchery-spawned and -reared juveniles (Service 2008). This program appears to be successful in increasing the total number of fish, although the juveniles are only now beginning to reach maturity and have not yet demonstrated successful reproduction. If supplementation efforts were to cease, the species could once again face local extirpation within several reaches. Even with conservation stocking, the catch rate of pallid sturgeon (and shovelnose sturgeon) is much lower upstream of the Intake Diversion Dam than downstream (Rugg 2014, 2015). Thus, the Intake Diversion Dam is likely affecting upstream movement of fish and ultimately the natural reproductive success of pallid sturgeons.

Current abundance has been estimated through sampling and tagging of adult wild pallid sturgeon by many researchers. An estimate in 1995 indicated that about 45 wild pallid sturgeon existed in the Missouri River upstream of Fort Peck Reservoir (Gardner 1996), but more recent information indicates far fewer wild fish are present (Service 2015). In 2004, an estimated 158 wild adult pallid sturgeon were reported to remain in the population from Fort Peck Dam to the headwaters of Lake Sakakawea, including the Yellowstone River (95-percent confidence interval = 129 to 193 adults; Klungle et al. 2005). More recently, Jaeger et al. (2009) estimated even fewer remain—approximately 125 adult pallid sturgeon. Age of the remaining adults was estimated at 43 to 57 years; the older of these would have spawned before Lake Sakakawea was filled in the 1950s (Braaten et al. 2015). If the adult mortality rate is approximately 5 percent per

year, there could already be fewer than 100 wild adult fish, but the first of the hatchery stocked fish should be reaching maturity currently.

Occurrence

The historical distribution of the pallid sturgeon includes the Missouri and Yellowstone Rivers in Montana downstream to the Missouri-Mississippi confluence, and the Mississippi River possibly from near Keokuk, Iowa downstream to New Orleans, Louisiana (MFWP 2016e). Pallid sturgeon also were documented in the lower reaches of some of the larger tributaries to the Missouri, Mississippi, and Yellowstone Rivers, including the Tongue and Milk Rivers (MFWP 2016e). Pallid use the Missouri River year-round and the Yellowstone River primarily during spring and summer spawning. Radio-tagged hatchery-reared pallid sturgeon have been observed upstream of the Intake Diversion Dam (Jaeger et al. 2005a). Most of these fish stayed above the Intake Diversion Dam, but some were found in the Main Canal of the Lower Yellowstone Project.

Habitat

The pallid sturgeon is native to the Missouri and Mississippi Rivers and is adapted to the habitat conditions that historically existed. These conditions generally can be described as large, free-flowing, warmwater, turbid rivers with a high sediment load that contributed to a shifting, dynamic, complex river morphology. Pallid sturgeon are a bottom-oriented, large river obligate fish that primarily use the main channel, side-channels, and channel border habitats and have rarely been observed in habitats without flowing water, such as backwaters (Service 2014). Pallid sturgeon have been documented over a variety of substrates, but are often associated with sandy and fine bottom materials, preferring that to mud, silt, or vegetated river bottoms. Pallid sturgeon are benthic fishes, spending the majority of their time at or near the river bottom. Across their range, pallid have been documented in waters of varying depths and velocities. Pallid sturgeon were collected at depths ranging from 1.9 to >65 feet, although there appears to be a preference for areas approximately 2.6 feet deep. Despite the wide range of depths associated with capture locations, one commonality is that pallid sturgeon are typically found in the bottom fourth of the water column (relative depth of 75 percent). Bottom water velocities associated with collection locations are generally 4.9 feet per second, with reported averages ranging from 1.9 to 2.9 fps. (Bramblett and White 2001; Gerrity 2005; Jordan et al. 2006).

Recent data from the Yellowstone River found spawning occurred on coarse substrate (mostly gravel patches on the larger sand bottom) (Allen et al. 2015; Elliot et al. 2015). Spawning in the lower Missouri River was documented in fast water on a rocky revetment along the channel margins (velocity 1.5 to 7.4 fps) (DeLonay et al. 2014). A probable spawning location was identified in the Yellowstone River (~River Mile 6.9) in 2012 in the center of a single-threaded channel reach that, while not measured, likely had high velocities and coarse substrate (DeLonay et al. 2014).

Upon hatching, free embryos are photopositive, and using swim-up and drift behavior, the yolk-sac bearing fish depart the spawning habitat (Kynard et al. 2002). It is not known whether they hide in the sediment interstices for any time before beginning drift (DeLonay et al. 2014). Artificial stream experiments first indicated wild free embryos have a long dispersal (estimated to last approximately 9 to 17 days, depending upon water temperature) that can carry the fish anywhere from 80 to 300 miles (Kynard et al. 2007; Braaten et al. 2008). Artificial stream

experiments also found habitat of dispersing free embryos was near the bottom (Kynard et al. 2007). Field tests found free embryos in a side channel were near the bottom in channel habitat (Braaten et al. 2008, 2010, 2011, 2012), drifting slightly slower than the mean column velocity. Older free embryos drifted at a slower rate than younger fish (Braaten et al. 2008; DeLonay et al. 2014). The general habitat used by dispersing free embryos is likely similar across the species range. Verification of this is difficult due to low abundance of free embryos and the difficulty of sampling.

Life History

Based on wild fish, estimated age at first reproduction is 15 to 20 years for females and approximately 5 years for males. Females spawning periodicity is between 2 and 3 years. Fecundity is related to body size, with larger females producing more eggs. Spawning appears to occur between April and July (in June in the Yellowstone River) (Rugg 2014, 2015; Allen et al. 2015; Elliott et al. 2015). Incubation rates depend on water temperature in hatchery settings, where fertilized eggs hatched in approximately 5 to 7 days. Incubation rates may deviate from this in the wild.

Diet

Juvenile and adult wild pallid sturgeon feed opportunistically on benthic macroinvertebrates, with a trend with age toward greater piscivory (Gerrity et al. 2006). Larvae and year-0 juveniles consume brine shrimp in hatchery settings. This indicates that they may feed on zooplankton and other small invertebrates in the wild, but, like other sturgeon larvae, they are believed to forage on the bottom for any invertebrate or zooplankton that fits into their mouth (Buckley and Kynard 1981). Juveniles forage on a wide variety of macroinvertebrates, including Diptera, Chinomidae, Ephemeroptera, and Trichoptera. They also forage on fish such as sturgeon chub and sicklefin chub (Braaten et al. 2012; Gerrity 2005; Gerrity et al. 2006).

Threats

The following factors have caused the decline of pallid sturgeon and pose current threats (Service 2014):

- Destruction, modification, or curtailment of its habitat or range
- Overutilization for commercial, recreational, scientific, or educational purposes
- Disease or predation
- Inadequacy of regulatory mechanisms
- Other natural or manmade factors.

Construction and operation of large dams and river channelization have eliminated and degraded historically occupied sturgeon habitat. On the main stem of the Missouri River, approximately 36 percent of riverine habitat within the pallid sturgeon's range was eliminated by construction of six dams between 1926 and 1952 (Service 1993). Dams are believed to block migrations, and the reservoirs likely inundated historical spawning and nursery areas. River channelization has resulted in another 40 percent of habitats altered. The remaining 24 percent has been altered due to changes in water flows caused by dam operation, irrigation withdrawals and other water uses.

The age structure of pallid sturgeon populations in Montana are highly skewed, with mature pallid sturgeon making up the bulk of the population (Braaten et al. 2015, 2009). It is estimated that the remaining wild adult pallid sturgeon are 30-50 years old, which means they would have

recruited from spawning occurring in the mid 1950s to early 1970s. Successful spawning and recruitment thus appears to have occurred for many years after the construction of Intake Diversion Dam and Fort Peck Dam, but since the 1970s, there does not appear to have been successful recruitment. Garrison Dam and the impoundment of Lake Sakakawea was completed in 1955, which lends credence to the hypothesis that recruitment is being inhibited by a lack of drift distance for pallid sturgeon larvae to settle out before reaching Lake Sakakawea. Despite recent evidence of spawning in the lower Yellowstone and Powder Rivers, there are no detectable levels of recruitment occurring in these rivers. Extremely low recruitment is possibly occurring in the Missouri River.

The following natural life history characteristics of pallid sturgeon cause difficulties in recruitment.

- Pallid sturgeon have delayed sexual maturity, taking many years to begin spawning (15 to 20 years);
- Females do not spawn every year, with a typical periodicity of spawning every 2 to 3 years;
- Larvae drift far downstream of spawning sites, often entering river reaches that have been modified into reservoirs by damming.

The presence of the Intake Diversion Dam restricts upstream passage of pallid adults, causing the following issues

- Avoidance due to high turbulence and water velocities
- Failure of pallid sturgeon to find suitable spawning habitat in areas upstream of the dam
- A limitation of the extent of available spawning habitat downstream
- Insufficient distance for free embryo drift before they enter the headwaters of a reservoir and develop into foraging larvae.

Recent studies suggest free embryo drift distance available below the Intake Diversion Dam is insufficient for pallid free embryos to reach suitable nursery habitat (Braaten et al. 2008; 2011). If these young fish do not have adequate distance to drift and then to stop as they develop into larvae in suitable stream habitat, they will reach Lake Sakakawea, where rearing conditions are not likely to be suitable (DeLonay et al. 2014). Biologists also suspect that pallid sturgeon larvae are intolerant of sediments in the river-reservoir transition zone (Wildhaber et al. 2005). The cause of larval deaths in the reservoir is unknown but could be the lack of food, predation, or sedimentation in reservoirs (Bergman et al. 2008). Recent research indicates that oxygen levels in the headwaters of reservoirs such as Fort Peck and Lake Sakakawea may be too low for larval pallid sturgeon to survive (Guy et al. 2015; Bramblett & Scholl 2016). Hybridization with shovelnose sturgeon has been documented, but it is unclear whether hybridization is a threat (Service 2007).

Presence

Pallid sturgeon are present in the project area and are confirmed to be spawning in the Yellowstone and Powder Rivers. Hatchery-raised pallid sturgeon have been stocked both upstream and downstream of the Intake Diversion Dam. Observations of both wild adult pallid sturgeon and hatchery juveniles above and below the Intake Diversion Dam have been confirmed by telemetry showing adults migrate up to the weir and a few individuals passed upstream

through the existing side channel in 2014 and 2015. Adults are likely to be present in the Yellowstone River from April through August (Rugg 2014, 2015). Juveniles may be present year-round. Larvae are unlikely to be present as there has only been one indication of spawning upstream of the weir in 2014 and no larvae were subsequently found.

3.9.1.4 Insects

Dakota Skipper (*Hesperia dacotae*), Threatened

Status

The Dakota skipper, a small butterfly with 1-inch wingspan, was listed as threatened in 2014 (Service 2014e) throughout its known range, including North Dakota.

Occurrence

The Dakota skipper has been extirpated from Illinois and Iowa and now occurs in remnants of native mixed and tallgrass prairie in Minnesota, the Dakotas and southern Canada (Service 2015e). There is one confirmed observation from 1997 in McKenzie County, North Dakota, over 60 miles east of the study area (NDNHP 2016). Dakota skippers do not have occurrence records in Montana (MTNHP 2015a).

Habitat

The Dakota skipper is a small butterfly that lives in high-quality mixed and tallgrass prairie. Specifically, the Dakota skipper is found in moist bluestem prairie in close association with three wildflower species, usually when blooming: wood lily (*Lilium philadelphicum*), harebell (*Campanula rotundifolia*) and smooth camas (*Zygadenus elegans*). It can also be found in relatively dry upland prairie on ridges and hillsides where bluestem grasses and needle grasses dominate with purple coneflower (*Echinacea angustifolia*) also present (Service 2015e).

Life History

In June and July, females lay eggs on the underside of leaves. Eggs take about 10 days to hatch into larvae (caterpillar). After hatching, larvae build shelters at or below the ground surface and emerge at night to feed on grass leaves. This continues until fall when larvae become dormant. They overwinter in shelters at or just below ground level, usually in the base of native bunchgrasses. The following spring, larvae emerge to continue developing. Pupation takes about 10 days and usually happens in June. Adults emerge from pupae and live for only three weeks, at most. Females may lay up to 250 eggs if longevity is maximized and flower nectar is available (Service 2015e).

Diet

Nectar provides both water and food and is crucial for survival of both sexes during the adult flight period, which often occurs during the hottest part of summer (Service 2015e).

Threats

Dakota skipper populations declined due to overall conversion of native prairie to farmland, ranches, and other uses. They are generally absent in overgrazed or otherwise degraded prairies (Service 2015e).

Presence

Dakota skippers are not found in Montana, and only rarely occur in North Dakota (MTNHP 2015a, NDNHP 2016). They are not expected to be located along the Yellowstone River in McKenzie County, due to the presence of degraded prairie and the lack of recorded occurrences in the area.

3.9.2 State Species of Concern

State species of concern that may occur within the footprint of construction for each of the proposed alternatives are listed in Table 3-17 and described below. Species life history accounts come from the Montana Field Guide (MFWP 2016e). Occurrence records are taken from geospatial data provided by the MTNHP (2015b) and NDNHP (2016).

TABLE 3-17. STATE SPECIES OF CONCERN THAT MAY OCCUR IN STUDY AREA

Common Name	Scientific Name	Common Name	Scientific Name
Mammals			
Black-tailed prairie dog	<i>Cynomys ludovicianus</i>	Merriam’s shrew	<i>Sorex merriami</i>
Dwarf shrew	<i>Sorex nanus</i>	Preble’s shrew	<i>Sorex preblei</i>
Fringed myotis	<i>Myotis thysanodes</i>	Spotted bat	<i>Euderma maculatum</i>
Hoary bat	<i>Lasiurus cinereus</i>	Townsend’s big-eared bat	<i>Corynorhinus townsendii</i>
Little brown myotis	<i>Myotis lucifugus</i>		
Birds			
Baird’s sparrow	<i>Ammodramus bairdii</i>	Great blue heron	<i>Ardea herodias</i>
Bald eagle ^a	<i>Haliaeetus leucocephalus</i>	Greater sage grouse	<i>Centrocercus urophasianus</i>
Black-billed cuckoo	<i>Coccyzus erythrophthalmus</i>	Loggerhead shrike	<i>Lanius ludovicianus</i>
Bobolink	<i>Dolichonyx oryzivorus</i>	Long-billed curlew	<i>Numenius americanus</i>
Brewer’s sparrow	<i>Spizella breweri</i>	Peregrine falcon	<i>Falco peregrinus</i>
Burrowing owl	<i>Athene cunicularia</i>	Red-headed woodpecker	<i>Melanerpes erythrocephalus</i>
Chestnut collared longspur	<i>Calcarius ornatus</i>	Sage thrasher	<i>Oreoscoptes mantanus</i>
Ferruginous hawk	<i>Buteo regalis</i>	Veery	<i>Catharus fuscescens</i>
Golden eagle	<i>Aquila chrysaetos</i>	Yellow-billed cuckoo	<i>Coccyzus americanus</i>
Amphibians			
Great plains toad	<i>Anaxyrus cognatus</i>	Snapping turtle	<i>Chelydra serpentina</i>
Plains spadefoot	<i>Spea bombifrons</i>	Spiny softshell	<i>Apalone spinifera</i>
Reptiles			
Greater short-horned lizard	<i>Phrynosoma hernandesi</i>	Western milk snake	<i>Lampropeltis triangulum</i>
Plains hog-nosed snake	<i>Heterodon nasicus</i>		
Fish			
Blue sucker	<i>Cycleptus elongatus</i>	Sauger	<i>Sander canadensis</i>
Iowa darter	<i>Etheostoma exile</i>	Shortnose gar	<i>Lepisosteus platostomus</i>
Northern redbelly dace	<i>Chrosomus eos</i>	Sicklefin chub	<i>Macrhybopsis meeki</i>
Paddlefish	<i>Polyodon spathula</i>	Sturgeon chub	<i>Macrhybopsis gelida</i>
Pearl dace	<i>Margariscus margarita</i>		

Common Name	Scientific Name	Common Name	Scientific Name
Insects			
Brimstone clubtail	<i>Stylurus intricatus</i>	Sand-dwelling mayfly sp.	<i>Homoeoneuria alleni</i>
Gray comma	<i>Polygonia progne</i>	Sand-dwelling mayfly sp.	<i>Lachlania saskatchewanensis</i>
Sand-dwelling mayfly sp.	<i>Anapeorus rusticus</i>	Sand-dwelling mayfly sp.	<i>Macdunmoa nipawinia</i>
Plants			
Blue toadflax	<i>Nuttallanthus texanus</i>	Persistent-sepal yellowcress	<i>Rorippa calycina</i>
Bractless blazing star	<i>Mentzelia nuda</i>	Prairie goldenrod	<i>Oligoneuron album</i>
Heavy sedge	<i>Carex gravida</i>	Red-root flatsedge	<i>Cyperus erythrorhizos</i>
Large flowered beardtongue	<i>Penstemon grandifloras</i>	Slender-branched popcorn flower	<i>Plagiobothrys leptoladus</i>
Nannyberry	<i>Viburnum lentago</i>	Silky Prairie-clover	<i>Dalea villosa</i>
Narrowleaf penstemon	<i>Penstemon angustifolius</i>	Schweinitz's flatsedge	<i>Cyperus scheinitzii</i>
Nine-anther prairie clover	<i>Dalea enneandra</i>	Tall dropseed	<i>Sporobolus compositus</i>
Pale-spike lobelia	<i>Lobelia spicata</i>		

a. Bald eagle is a species of special concern in Montana and covered under the Bald and Golden Eagle Protection Act of 1940 and the Migratory Bird Treaty Act of 1918.

The species of concern list includes both plants and animals and comes from coordination letters from the MTNHP and the NDNHP. Included species are ranked S1, S2, or S3 by the state of Montana according to its sensitivity to extinction, defined as follows:

- “S” refers to the state rank (“G” refers to global rank set at a federal level)
- “1” includes critically imperiled species
- “2” includes imperiled species
- “3” includes species vulnerable to extirpation
- “B” denotes when a breeding population is being ranked
- Multiple rank numbers (e.g., S2S3) indicate that different populations of the same species are subject to different threat levels
- A question mark after the rank value indicates that more information is needed to confirm the current ranking.

Aquatic species are included if they occur within the Yellowstone River from its confluence with the Missouri River upstream to Cartersville, or within the Missouri River from Fort Peck to Lake Sakakawea. Terrestrial species are included only if they have the potential to utilize habitats that are within the area of influence of the alternatives. This includes the areas of wildlife habitat subject to physical alteration resulting from construction or installation of alternative components.

3.9.2.1 Mammals

Black-Tailed Prairie Dog (*Cynomys ludovicianus*) (G4, S3)

Black-tailed prairie dogs form colonies on flat, open grasslands or shrub grasslands with low sparse vegetation. In Montana, preferred habitat is dominated by western wheatgrass, blue grama and big sagebrush. Colony sizes range from 10 to several hundred hectares, though average colony size is typically 20 to 60 hectares. Black-tailed prairie dogs consume mostly grasses and

apparently do not require free water. Instead, adequate water is obtained through vegetation. Black-tailed prairie dogs have declined due to loss of habitat from agricultural development and active eradication (MFWP 2016e). The MTNHP (2015) has identified black-tailed prairie dog presence at two locations in Richland County, one of which is at the confluence of Bennie Peer Creek and the Yellowstone River. The second site is approximately 7 miles west of the Yellowstone River, west of the town of Savage. It is unlikely that black-tailed prairie dogs are within the study area.

Dwarf Shrew (*Sorex nanus*) (G4, S2S3)

The dwarf shrew is generally found in many types of habitats, including coniferous forests, pinyon-juniper woodlands, meadows within lower-elevation forests, shrublands, marshes, prairies, and dry stubble fields. Habitats where dwarf shrews have been documented in Montana include rocky locations in alpine terrain and subalpine talus. Lesser numbers have been captured in montane grassland, sagebrush-grassland, and prairie riparian habitat dominated by green ash, rose, and timothy. Their diet is not well understood. Individuals in captivity have been observed feeding on vertebrate carcasses, spiders and insects. They may also consume plant matter. Factors causing their decline include alteration or removal of grassland and sagebrush through fire, herbicides, or mechanical methods (MFWP 2016e). There has been only one confirmed breeding occurrence in the study vicinity, reported in 2004 at the Makoshika State Park, 17 miles southwest of the Intake Diversion Dam (MTNHP 2015a). Dwarf shrew are unlikely to be in the study area.

Fringed Myotis (*Myotis thysanodes*) (G4, S3)

The fringed myotis is found primarily in desert shrublands, sagebrush-grassland, and woodlands consisting of ponderosa pine forest, oak and pine habitats, and Douglas fir. It roosts in caves, mines, rock crevices, buildings, and other protected sites. Fringed myotis in riparian areas tend to be more active over intermittent streams with wider channels (5.5 to 10.5 meters). Range-wide information states that fringed myotis are insectivorous, including beetles, moths, insects, and spiders. Bats forage aerially or by gleaning from the ground. Little is known about fringed myotis in Montana, though it is likely that habitat losses and alterations are challenges to population recovery. This bat is not yet known to be afflicted by white-nose syndrome (MFWP 2016e). The fringed myotis is reported to occur throughout the badlands in the northern Great Plains. Confirmed areas of occupancy in eastern Montana for this species are only reported for Prairie (2003 and 2012) and Custer (2003) Counties. Fringed myotis are not known to occur within the study area (MTNHP 2015a).

Hoary Bat (*Lasiurus cinereus*) (G5, S3)

During the summer, hoary bats occupy forested areas, often seen foraging over water sources within forested terrain, both conifer and hardwood, as well as along riparian corridors. This bat appears to be solitary, roosting primarily in trees but reported infrequently from caves (dead individuals), squirrel nests, and clinging to the sides of buildings. These bats generally emerge at dusk (although in winter they may rouse from hibernation and forage on warm afternoons). Most captures occur 3 to 4 hours after sunset. This bat is reported to favor moths, but stomach contents of seven individuals captured in Carter County revealed beetles, moths, true bugs, leafhoppers, lacewings, and true flies. They are also predatory on other vertebrates and have been reported to attack, kill, and eat pipistrelle bats. No important predators of hoary bats are known, but undoubtedly hawks and owls capture some. There is at least one report of predation by a snake.

Fatal collisions with barbed wire and wind turbines are reported (MFWP 2016e). This bat is a breeding summer resident throughout Montana and is found in Dawson, Richland, and Wibaux Counties. Hoary bat is migratory, and records in Montana are from early June through September. Ten occurrences were reported between 2008 and 2009 between Glendive and Sidney, confirming this bat as present in the area and possibly occurring in the study area (MTNHP 2015a).

Little Brown Myotis (*Myotis lucifugus*) (G3, S3)

Little brown myotis is a small bat found in a variety of habitats across a large elevation gradient. They most commonly forage over water habitats. Summer day roosts are diverse and include attics, barns, bridges, snags, loose bark, and bat houses. In Montana, maternity roosts are primarily buildings, and hibernacula include caves and mines. Diet consists mostly of insects, including gnats, mosquitoes, crane flies, beetles, wasps, and moths. Prey is often caught with the tip of the bat wing then transferred immediately to the mouth. Threats are unknown, but are likely to be similar to those of other bats, including loss of hibernacula due to human influence. This bat is a year-round resident throughout Montana, and is found in Dawson, Richland, and Wibaux Counties (MFWP 2016e). This bat has rarely been seen within the Yellowstone River corridor since 1977. The most recent occurrence was in 2003 near the town of Crane. Another occurrence was confirmed in the Lone Tree Creek drainage in 2008, over 8 miles from Pump #6 (MTNHP 2015a). This bat may be present in the study area.

Merriam's Shrew (*Sorex merriami*) (G5, S3)

Merriam's shrews in Montana have been captured mostly in arid sagebrush-grassland habitat, but also in non-native grasses and forbs. They also have been identified in poorly developed riparian habitat at creek-side in a shrub-steppe and grassland region. In eastern Washington, analysis of Merriam's shrew diet showed it hunts primarily on the ground for caterpillars, beetles, crickets, ichneumonid wasps, and spiders. Alteration or removal of grassland and sagebrush through fire, herbicides, or mechanical methods may impact local populations (MFWP 2016e). Merriam's shrew is not known in the study area. (MTNHP 2015a). However, as very little is known about this species in Montana in general, potential remains that they may be present, as supporting habitat features are present. No information is available on movements of this species in Montana, but the species is thought to be non-migratory, with only local movements (MFWP 2016e).

Preble's Shrew (*Sorex preblei*) (G4, S3)

Most Preble's shrews in Montana have been captured in sagebrush-grassland habitats, sometimes in openings surrounded by subalpine coniferous forest. Throughout its range, the Preble's shrew occupies a variety of habitats, including arid and semiarid shrub-grass associations, openings in montane coniferous forests dominated by sagebrush, willow-fringed creeks and marshes, bunchgrass associations, sagebrush-aspen associations, sagebrush-grassland, oak chaparral, open ponderosa pine-Gambel oak stands, and alkaline shrubland. Shrews feed on insects and other small invertebrates, including worms, mollusks, and centipedes. Its relatively low bite force suggests that it feeds on soft-bodied prey. Alteration or removal of sagebrush through fire, herbicides, or mechanical methods may impact local populations (MFWP 2016e). This shrew is a year-round resident of most of the eastern two-thirds of Montana, although it has not been recorded in Dawson County since 1963 (MTNHP 2015a); thus, it is unlikely that this species is present in the study area.

Spotted Bat (*Euderma maculatum*) (G4, S3)

Spotted bats have been encountered most often in open arid habitats dominated by juniper and sagebrush, sometimes intermixed with limber pine or Douglas-fir, or in grassy meadows in ponderosa pine savannah. Cliffs, rocky outcrops, and water habitats are also utilized. Roost habitats and sites have not been documented in Montana. Spotted bats roost in caves and in cracks and crevices in cliffs and canyons. This species is insectivorous, primarily selecting noctuid moths, and sometimes beetles. Threats include habitat loss due to construction of dams that inundate high cliffs and canyon walls, overgrazing of meadows, expansion of invasive plant species, and non-target pesticide spraying. Collisions with wind turbines may pose a threat to small local populations. As of 2012, white-nose syndrome had not been detected in this species (MFWP 2016e). Species occurrences are verified in Dawson and Richland Counties. In Richland County the spotted bat was documented in 2000 west of the study area about 12 miles west of Pump #6. In Dawson County the species was confirmed in 2004 in Makoshika State Park, about 11 miles southwest of the Intake Diversion Dam (MTNHP 2015a). It is possible this species occurs within the study area.

Townsend's Big-Eared Bat (*Corynorhinus townsendii*) (G3G4, S3)

Like most bats, this bat utilizes caves and abandoned mines for maternity roosts and hibernation shelter. Habitats in the vicinity of roosts include Douglas-fir and lodgepole pine forests, ponderosa pine woodlands, juniper-sagebrush scrub, and cottonwood bottomland. Townsend's big-eared bat feeds nocturnally, primarily on small moths, but also on lacewings, beetles, true flies, and wasps. Threats include disturbance and destruction of roost sites resulting from a variety of causes, including recreational caving or mine exploration, mining, destruction of buildings used as roosts, or reuse of buildings by people, leading to deliberate exclusion of bats. In large portions of its western range, dependence upon abandoned mines puts this species at risk if mine reclamation and renewed mining projects do not mitigate for roost loss, or do not conduct adequate biological surveys prior to mine closure. Predators can significantly depress reproductive success in some maternity colonies (MFWP 2016e). This bat has not been affected by white-nose syndrome (USGS 2016b). Rare occurrences have been verified for the Townsend's big-eared bat in eastern Montana near the Missouri and Yellowstone Rivers. In 1977 an area of occupancy was confirmed just east of Pump #6. Three other areas of occupancy were confirmed downstream of the study area in Prairie and Custer Counties in 2005 and 2015 (MTNHP 2016). It is unlikely that this bat would be in the study area.

3.9.2.2 Birds

Baird's Sparrow (*Ammodramus bairdii*) (G4, S3B)

Preferred nesting habitat includes native mixed-grass prairie with less than 10 percent woody cover and a mosaic of forbs, bare soil, and grasses (Wiggins 2006). Nesting generally begins in late May and continues through August (MFWP 2016e). Studies indicate that Baird's sparrows forage on the ground for seeds, insects, and spiders. Nestlings are fed an exclusive diet of insects. The adult diet changes over the year, with summer breeding season diet including a variety of insects and seeds, and the rest of the year's diet focused on seeds alone. Threats are loss of habitat resulting from conversion of native grassland to agriculture, mowing, grazing, and fire (MFWP 2016e). This sparrow is a rare breeding resident throughout much of Montana. Species occurrences are verified in Dawson, Richland, and Wibaux Counties, with the closest occurrences to the study area reported from 1975 and 1992, over 3 miles west of Pump #4, west

of the town of Savage. Another breeding occurrence was reported over 6 miles east of the Yellowstone River in 1993. The most recent occurrence was in Richland County near the North Dakota border in 2009 (MTNHP 2015a).

Bald Eagle (*Haliaeetus leucocephalus*) (G5, S4)

The bald eagle was delisted from federal protection as of July 9, 2007 and is now classified as a special status species in Montana. It is protected under the Bald and Golden Eagle Protection Act and the Migratory Bird Treaty Act. In Montana, bald eagles prefer riparian forested areas along rivers and lakes. Wintering habitat may include upland sites. Nesting sites are generally in larger forested areas near lakes and rivers, where the tallest, oldest, largest-diameter trees are selected for nest sites. Nest sites also depend on local forage availability and distance from human disturbance. Bald eagles prey on fish most often, but also consume waterfowl, carrion and small mammals and birds. Though bald eagle populations are becoming more stable, there are still many threats to their success. Primary threats include human development and encroachment on nest sites, contaminants, collision with vehicles at road kill sites, and electrocutions from power lines (MFWP 2016e). The bald eagle is a known breeding resident of the Yellowstone River throughout the proposed study area. In 2015, there were two bald eagle nests reported along the river, one in the vicinity of the Intake Diversion Dam and one near proposed Pump #5. Between Glendive and Sidney alone from 2003 to 2015 there were 15 nesting bald eagles observed on the Yellowstone River (MTNHP 2015a).

Black-Billed Cuckoo (*Coccyzus erythrophthalmus*) (G5, S3B)

Black-billed cuckoos in Montana are found most often in riparian cottonwoods, green ashes, and American elms with a shrubby understory of willows, box elders, and alders. They also occur in foothill deciduous woodland. Diet includes caterpillars, crickets, grasshoppers, and butterflies, as well as mollusks, fish, small vertebrates, fruits and berries. Cuckoos are sensitive to forest fragmentation and habitat modification, such as removal of forest understory. They are also frequently killed during migration as a result of midair collisions with utility lines and towers (MFWP 2016e). Sightings of this bird have been confirmed along the Yellowstone River from upstream of the town of Terry to the area near Pump #6. In 2005, an observation with evidence of breeding activity was confirmed at the Intake Diversion Dam near the fishing access site. Three black-billed cuckoo occurrences were reported as recently as 2012 along the river—two of those sightings between Pumps #5 and #6. This bird is a summer resident to the area, typically arriving in Montana early to mid-June and departing before October (MTNHP 2015a).

Bobolink (*Dolichonyx oryzivorus*) (G5, S3B)

Bobolinks find habitat in tall grasslands, uncut pastures, overgrown fields and meadows, and prairies. During migration and wintering, bobolinks will rest along marshes and in agricultural fields, particularly preferring rice paddies. Nests are built in tall grasses and hay fields with high grass-to-legume ratios. Breeding season diet consists of seeds and a variety of larvae, spiders and insects. During winter, wild and domesticated rice, oats, other small grains, corn, tassels, seeds, and occasional insects are consumed. Threats to this bird include habitat loss, drought in relation to climate change, and mowing of tall grasses (NatureServe 2015). The presence of breeding bobolink has been confirmed at three locations within a mile of the Yellowstone River between 2012 and 2014. These are northeast of Seven Sisters Island and near the intersection of Highway 23 and County Road 122 east of the Yellowstone River (MTNHP 2015a).

Brewer's Sparrow (*Spizella breweri*) (G5, S3B)

This sparrow typically breeds in shrub steppe habitats and prefers to nest in sagebrush averaging 16 inches in height. Food items are primarily insects during the breeding season, and young are fed almost exclusively arthropods. The primary threats to Brewer's sparrow breeding populations are fragmentation and loss of sagebrush shrublands and shrub-steppe habitats. An increase in fire frequency may also pose risks (MFWP 2016e). This sparrow has six confirmed breeding occurrences in Dawson, Richland, and Wibaux Counties between 1999 and 2009. The nearest breeding occurrence to the study area was in 2007 at the Savage Mine, west of the town of Savage. Montana nesting grounds are reached in mid to late April, and nests with eggs are observed in late May or June (MTNHP 2015a).

Burrowing Owl (*Athene cunicularia*) (G4, S3B)

Burrowing owls are found in open grasslands, where they utilize abandoned burrows dug by mammals. Colonies created by ground squirrels, prairie dogs, and badgers provide the majority of habitat sites. Abandoned burrows may be enlarged or modified to suit. Burrowing owls can be found on the ground or on low perches such as fence posts or dirt mounds within their habitats. Burrowing owls are opportunistic feeders. They may hunt aerially or scavenge, and their variable diet may depend upon the time of year. Favorite foods include insects, small mammals, amphibians, reptiles, and birds. They are most active at dawn and dusk. Habitat losses resulting from prairie dog control by state agricultural agencies is the primary threat to burrowing owls (MFWP 2016e). Habitat losses resulting from land development also contributes (McDonald et al. 2004). This owl occurs near the Yellowstone River downstream of the study area and near the Missouri River. The closest breeding areas were confirmed over 23 miles southwest of the Intake Diversion Dam at three sites in Dawson County in 1981, including west of Glendive in Pleasant View. Six breeding areas were confirmed near the Missouri River from 1979 to 2010 (MTNHP 2015a).

Chestnut-Collared Longspur (*Calcarius ornatus*) (G5, S2B)

This species prefers to nest in grasses less than 8 to 12 inches tall that have been recently grazed or mowed, especially native prairie, but will also use hay fields. Diet consists of grass seeds, insects and spiders. These birds are threatened by the loss of native prairie grassland habitats and introduction of grazing and prescribed fires. Predation of nests can further reduce the longspur's ability to recover populations (MFWP 2016e). Breeding areas were confirmed over 4 miles northwest of the town of Savage and Pump #4 from 1974 and 1975, and at three sites over 7 miles southeast of Pump #3 from 1999 to 2007. Two other breeding areas were confirmed in Richland: one in 2012 over 6 miles northwest of Pump #7; and one in 2013 over 30 miles northwest of Pump #7 near County Road 146. Two breeding areas were confirmed in 2003 and 2006, in Wibaux County over 15 miles southeast of the Intake Diversion Dam. Two others were confirmed in 2012 east of the town of Wibaux over 28 miles southeast of the dam (MTNHP 2015a).

Ferruginous Hawk (*Buteo regalis*) (G4, S3B)

In southeastern Montana, ferruginous hawks use primarily mixed-grass prairie with black greasewood and big sagebrush in uplands and drainages. Nest site habitats have been found to include sagebrush and grasslands, where hawks build large ground nests. Ferruginous hawks do not appear to nest in croplands, likely due to lack of prey availability. Prey items for the ferruginous hawk include mammals, birds, reptiles, insects, and amphibians. Ferruginous hawks

avoid dense vegetation that reduces their ability to see prey and intensive agricultural practices, such as annual plowing and leaving fields fallow, which exclude many prey species (MFWP 2016e). Primary threats to this hawk result from habitat losses and habitat alterations that lead to reductions in small mammal food sources. Other threats to recovery of the species include a lack of secure nest substrates, lack of suitable prey species, human disturbance during the reproductive period, lack of suitable habitat surrounding nest sites, and threats to survival of adult hawks (Collins et al. 2005). Two species occurrences are verified in Dawson County. One nesting area was over 34 miles west of the Intake Diversion Dam, confirmed in 2000. The other nesting area was west of Glendive near Sand Creek, over 22 miles southwest of the dam, confirmed in 1981 (MTNHP 2015a).

Golden Eagle (*Aquila chrysaetos*) (G5, S3)

Golden eagles nest from March to early August, building nests on cliffs and in large trees, and hunting over prairie and open woodlands. Nest sites have included high rock outcroppings, power line poles, cliffs, and snags. Most nests have been found between 4,000 and 6,000 feet in elevation, near sagebrush or grassland habitat. In Montana, golden eagles eat primarily jackrabbits, ground squirrels, and carrion. Golden eagles hunt aerially and can carry no more than about seven pounds while flying. Shooting, trapping, and ingestion of poisoned bait have been significant threats in the past. Today, shooting remains a threat, along with poisoning from the ingestion of lead fragments. Collisions with wind turbines and electrocutions from high voltage powerlines also continue to present significant threats (MFWP 2016e). In Dawson County there were two confirmed nesting areas in 2015, 14 miles south and 36 miles southwest of the Intake Diversion Dam. In Richland County a nesting area was confirmed along the Missouri River over 20 miles northwest of Pump #7. In McKenzie County, a golden eagle was recorded in 1981, 6.4 miles from Pump #7 (MTNHP 2015a).

Great Blue Heron (*Ardea herodias*) (G5, S3)

Great blue herons utilize both urban wetlands and wilderness settings. Most Montana nesting colonies are in cottonwoods along major rivers and lakes, with a smaller number occurring in riparian ponderosa pines and on islands in prairie wetlands. Nesting trees are generally the largest trees available. Great blue herons build bulky stick nests high in the trees when nesting near the shores of rivers and lakes and on the ground or in low shrubs when nesting on treeless islands. Diet items include mostly fish but also amphibians, invertebrates, reptiles, mammals, and birds. Threats include disturbance by humans and loss of protected colony sites. Chemical contaminants continue to be a problem related to egg-shell thinning and direct mortality of young and adults (MFWP 2016e). Species occurrences are verified along the Yellowstone River in Dawson, Richland, and Wibaux Counties. The earliest reported nesting areas were in 1975 downstream of the study area in Rosebud County. In Richland County nesting areas were confirmed on the Yellowstone River just upstream of Pump #6 in 2009 and at Pump #5 in 1988. In Richland and Wibaux Counties three sites at the Intake Diversion Dam were confirmed from 1976 to 1977, and four nesting areas within 20 miles downstream of the dam were documented between 1977 and 2009. Two breeding areas were confirmed in Richland County on the Missouri River in 1997 and 2007 (MTNHP 2015a).

Greater Sage Grouse (*Centrocercus urophasianus*) (G3G4, S2)

In Montana, breeding habitat for this upland bird includes strutting grounds, where breeding actually occurs, most often consisting of clearings surrounded by sagebrush cover (Montana

Sage Grouse Work Group 2005). The importance of shrub height increases with snow depth, which can limit the availability of wintering sites to sage grouse. As palatability of summer forbs declines, sage grouse move to moist areas that still support succulent vegetation, including alfalfa fields, roadside ditches, and other moist sites. Grazing and agricultural development are the primary causes of population decline. Other important factors in the species' decline include fire and invasive plant species (MFWP 2016e). The natural year-round range for this grouse is most of Montana from Great Falls and Helena, east to the state line. It is found in Dawson and Wibaux Counties and has been observed as recently as 2011 in the Yellowstone River corridor (MTNHP 2015a).

Loggerhead Shrike (*Lanius ludovicianus*) (G4, S3B)

Loggerhead shrikes prefer open habitat characterized by low grasses and forbs interspersed with bare ground and shrubs or low trees. In the study area, they can be found in prairies, pastures, sagebrush fencerows or shelterbelts of agricultural fields, as well as riparian areas, open woodlands, and farmsteads. Loggerhead shrikes eat insects and other arthropods, amphibians, reptiles, small mammals, and birds. Populations have fallen sharply over the past half-century, coinciding with chemical pesticide use. Other threats to the shrike include collision with vehicles, urban development, conversion of hayfields and pastureland, decimation of hedgerows, habitat destruction by surface-coal strip-mining, and altering of prey populations by livestock grazing (MFWP 2016e). The loggerhead shrike is a breeding summer resident throughout the eastern portion of Montana and is found in Dawson, Richland, and Wibaux Counties. Occurrences have been steadily reported since the early 1990s east of the Yellowstone River along county roads 6 to 10 miles from the study area (MTNHP 2015a).

Long-Billed Curlew (*Numenius americanus*) (G5, S3B)

The long-billed curlew breeds in mixed grass prairie habitats and moist meadows throughout Montana. It prefers to nest in open, short-statured grasslands and avoids areas with trees, dense shrubs, or tall, dense grasses. During the breeding season, the long-billed curlew feeds in open prairie grasslands and meadows, at the edges of prairie ponds and sloughs, and occasionally in agricultural fields. This species is an opportunistic forager, feeding primarily on invertebrates and also on bird eggs and nestlings. In winter, the long-billed curlew probes at tidal areas and mudflats. Threats include degradation or loss of grassland breeding habitat to agricultural and residential development, off-road vehicle use and other human disturbances (MFWP 2016e). The long-billed curlew is a breeding summer migrant throughout all of Montana, and is found in Dawson, Richland, and Wibaux Counties. Three confirmed records from 2012 place the long-billed curlew in the general vicinity of the study area, with the nearest sighting just over 4 miles east of the Intake Diversion Dam (MTNHP 2015a).

Peregrine Falcon (*Falco peregrinus*) (G4, S3)

Peregrine falcon nests are typically found on ledges of vertical cliffs, often with a sheltering overhang. Ideal locations include undisturbed areas with a wide view and proximity to water and prey. Human-made sites can include tall buildings, bridges, rock quarries, and raised platforms. Peregrine falcons prey almost exclusively on birds, but will also eat small reptiles and mammals. Post-war use of pesticides has been the main cause of the decline of these birds. Great-horned owl may be a significant nest predator (MFWP 2016e). This raptor is a year-round resident of the entire state, but is known only in Richland County in the recent past. The nearest nesting

peregrine falcon to the study area was observed in 1980 near Terry (MTNHP 2015a). It is unlikely this bird is present within the study area.

Red-Headed Woodpecker (*Melanerpes erythrocephalus*) (G5, S3B)

Little is known about red-headed woodpecker habitat in Montana. When they have been observed, they are usually found along major rivers having riparian forest associated with them. They may also be found in open savannah country, as long as adequate ground cover, snags, and canopy cover can be found. They nest in holes excavated in live trees, dead stubs, utility poles, or fence posts. Red-headed woodpeckers eat insects and other invertebrates, berries and nuts, sap, and the young and eggs of other bird species. Threats in Montana are unknown. European starlings usurped 52 percent of red-headed woodpecker nest cavities in Michigan and 15 percent in Ohio (MFWP 2016e). This woodpecker is a summer migrant in the eastern half of Montana. Red-headed woodpeckers are thought to arrive in mid-May and leave August or September. During migration, red-headed woodpeckers likely follow watercourses in and out of the state. Confirmed breeding areas occur along the Yellowstone River, with recent sightings in 2003 less than 2 miles from Pump #6, and three occurrences within a mile of Pump #2 (MTNHP 2015a).

Sage Thrasher (*Oreoscoptes montanus*) (G5, S3B)

In Montana, the sage thrasher breeds in habitats dominated by big sagebrush. Abundance is positively correlated with sagebrush cover and negatively correlated with grass cover. During the breeding season, this species eats primarily insects, with a small percentage consisting of other arthropods and plant material. It will also eat berries and small fruits if available. Threats include loss or fragmentation of intact sagebrush landscapes due to fire, residential development, or conversion to agriculture (MFWP 2016e). This thrasher occurs throughout all but the northwestern quarter of Montana and is known to occur in Richland County. In Montana, adults arrive on the breeding grounds from April 25 to May 15, with fall migration from July 30 to August 15. One occurrence of sage thrasher was noted in Richland County in 2012 south of Terry (MTNHP 2015a).

Veery (*Catharus fuscescens*) (G5, S3B)

The veery is a small bird that generally inhabits damp, deciduous forests with denser understory, and has a strong preference for riparian habitats. In Montana, they are associated with willow thickets and cottonwood along streams and lakes. They are often present in a variety of plant community types, including box elder, alder, aspen, cottonwood, and lodgepole pine, as long as willow is a significant component. The veery is primarily a ground forager, preferring insects during breeding and fruit in late summer and fall. Preference for large riparian stands and susceptibility to cowbird parasitism make the veery vulnerable to landscape changes and disturbances (MFWP 2016e). This species was observed with evidence of breeding activity in 1995 in Richland County on the Yellowstone River by Pump #5. The most recent observations were in 2004 and 2005 on the Missouri River north of the study area (MTNHP 2015a).

Yellow-Billed Cuckoo (*Coccyzus americanus*) (G5, S3B)

Throughout its range, the yellow-billed cuckoo prefers to breed in woodland habitat, especially where undergrowth is thick. They are also known to use parks. Nests are found in trees, shrubs or vines, an average of 1 to 3 meters above ground. This cuckoo prefers caterpillars, and also consumes other insects, some fruits, and sometimes small lizards, frogs and bird eggs. The primary threats to this bird include the loss and degradation of habitat from altered watercourse

hydrology and natural stream processes, livestock overgrazing, encroachment from agriculture, and conversion of native habitat (MFWP 2016e). This species has been verified in Richland and Wibaux Counties. One observation with evidence of breeding was confirmed in 2012 on the Yellowstone River upstream of Pump #2. Two observations were confirmed in 1921 and 1982 near Miles City on the Tongue River, over 87 miles southwest of the study area (MTNHP 2015a).

3.9.2.3 Amphibians

Great Plains Toad (*Anaxyrus cognatus*) (G5, S2)

Great Plains toad has been reported from sagebrush-grassland habitats, rainwater pools in road ruts, stream valleys, small reservoirs and stock ponds, and rural farms. Breeding has been documented in small reservoirs and backwater sites along streams. This species enters water only to breed. Eggs and larvae develop in shallow water, usually clear or slightly turbid, but not muddy. Great Plains toads are generally known to eat a variety of small spiders and insects. Larvae eat suspended matter, organic debris, algae, and plant tissue. Threats include intensive cultivation and pesticide use (MFWP 2016e). The Great Plains toad has rarely been observed in eastern Montana, with the closest occurrence to the study area in 2005 over 87 miles southwest of the Intake Diversion Dam (MTNHP 2015a).

Plains Spadefoot (*Spea bombifrons*) (G5, S3)

Plains spadefoot toads are usually found in areas with soft sandy or gravelly soils near permanent or temporary bodies of water. They live in burrows during inactive periods and enter water only to breed. Following heavy rains, adults have been reported to use almost any temporarily flooded pool, as long as it was less than 12 inches in depth. Plains spadefoot are reported to eat spiders, terrestrial amphipods, snails, earthworms, centipedes, and insects. Threats are not well known in Montana, but likely include habitat loss and alteration, predation, and disturbance by livestock (MFWP 2016e). This amphibian is a year-round resident of the eastern two-thirds of Montana. The nearest occurrence to the study area was observed in 2009 near Makoshika State Park (MTNHP 2015a).

Snapping Turtle (*Chelydra serpentina*) (G5, S3)

Snapping turtles occur in shallow freshwater habitats, such as streams, rivers, reservoirs, and ponds, particularly those with a soft mud bottom and abundant aquatic vegetation or submerged brush and logs. Hatchlings and juveniles tend to occupy shallower sites than mature individuals in the same water bodies. They are mostly bottom dwellers, where they spend much of their time. Although highly aquatic, they may make long movements overland if their pond or marsh dries. Snapping turtles are known to eat about anything that can be captured while foraging in the water, including fish, amphibians, reptiles, aquatic birds, small mammals, insects, spiders, crustaceans, mollusks, leeches, sponges, algae, and carrion. Threats to the snapping turtle include nest predation, habitat loss due to dams and large reservoirs (MFWP 2016e). Snapping turtles are present in Dawson, Richland, and Wibaux Counties. This species was confirmed in 2010 in Burns Creek, a tributary to the Yellowstone River that enters the Yellowstone River upstream of Pump #2. In 2003, a snapping turtle was observed on Thirteenmile Creek, which enters the Yellowstone River below the Intake Diversion Dam (MTNHP 2015a).

Spiny Softshell (*Apalone spinifera*) (G5, S3)

Spiny softshell turtles prefer riverine habitats where there are open sandy or muddy banks, a soft bottom, and submerged brush and other debris. These turtles bask on shores or emergent debris and burrow into the river bottom during winter. Eggs are laid in nests dug in open areas in sand, gravel, or soft soil near water. They forage in shallow water and consume crayfish, aquatic insects, fish, mollusks, worms, isopods, amphibians, carrion, and vegetation. Threats to this turtle include egg predation, incidental capture by anglers, and loss of habitat due to construction of dams and large reservoirs (MFWP 2016e). The spiny softshell turtle is present in Dawson, Richland, and Wibaux Counties and has been regularly documented between 1806 and 2013 along the Yellowstone River through the study area (MTNHP 2015a).

3.9.2.4 Reptiles

Greater Short-Horned Lizard (*Phrynosoma hernandesi*) (G5, S3)

This lizard utilizes ridge crests between coulees, and sparse, short grass and sagebrush habitats with sunbaked soil. Adult greater short-horned lizards are diurnal and active during the warmer daylight hours. This species consumes mostly ants and beetles, and will also eat other insects, spiders, snails, sowbugs, and other invertebrates. Threats to this lizard include habitat loss due to the conversion of prairie to cropland, presence of off-road recreational vehicle traffic, increased traffic associated with road building, and indiscriminant use of insecticides to control some insect species, which could affect the food supply of this lizard (MFWP 2016e). This species of lizard is found in Dawson, Richland, and Wibaux Counties and is a year-round resident in Montana. Several of these lizards were recorded during a 2004 survey, as near as 7 miles east of the Yellowstone River (MTNHP 2015a).

Plains Hog-Nosed Snake (*Heterodon nasicus*) (G5, S2)

This snake has been reported in areas of sagebrush-grassland habitat and near pine savannah in grasslands with sandy soil. It typically prefers sandy or gravelly habitats, often by rivers. Plains hog-nosed snake is considered a specialist predator on toads, but other main items in its diet include lizards and reptile eggs, and to a lesser extent frogs, salamanders, snakes, birds, and mammals. Declines have resulted from habitat loss associated with conversion of prairie to agricultural landscapes; this continues to be a threat. Other threats include road mortality and draining of prairie wetlands, which results in loss of prey (MFWP 2016e). This snake is a year-round resident of the eastern two-thirds of Montana and is found in Dawson and Richland Counties. One confirmed breeding occurrence is reported from 1998 at a location over 5 miles from Savage. All other occurrences are well outside the study area (MTNHP 2015a).

Western Milk Snake (*Lampropeltis gentilis*) (G4G5, S2)

Milk snakes have been reported in areas of open sagebrush-grassland habitat and ponderosa pine savannah with sandy soils. They are most often in or near areas of rocky outcrops and hillsides or badland scarps. This carnivorous species eats mostly small vertebrates, including snakes, lizards, reptile eggs, birds, bird eggs, small mammals, and occasionally insects and worms. Populations are relatively stable. Localized threats are likely habitat loss, degradation, and disturbance (MFWP 2016e). One confirmed breeding area for this snake was observed in Dawson County in 2012 about 3 miles west of the Intake Diversion Dam. Other breeding areas were confirmed from 2002 to 2009 in Makoshika State Park south of Glendive and approximately 15 miles southeast of the dam (MTNHP 2015a).

3.9.2.5 Fish

Blue Sucker (*Cycleptus elongates*) (G3G4, S2S3)

The blue sucker is a long slender fish that can reach 3 feet in length. They prefer swift currents in large, turbid rivers with rocky or gravelly bottoms. It was once commercially fished in the Mississippi River, but is now too rare. Montana is considered to have some of the best habitat for blue suckers found in their range. Losses of Montana populations would be significant to the overall gene pool. Blue suckers feed mainly on aquatic insects. Populations appear to be stable, but this species may be susceptible to population declines as a long-lived, low recruitment species, and also due to its reliance on high flows in tributary streams for spawning. The blue sucker is a resident of the Missouri and Yellowstone Rivers and is known to be present or expected to be present throughout the Yellowstone River from the Missouri River to just upstream of the town of Treasure, Montana. It inhabits many of the larger tributaries to these rivers as well; the Tongue, Marias, Milk and Teton Rivers are most heavily used (MFWP 2016e, MTNHP 2015a).

Iowa Darter (*Etheostoma exile*) (G5, S3)

Iowa darters are found near shores of lakes and streams during breeding and then move to deeper water in lakes, reservoirs, or stream pools. Iowa darters prefer clear slow-flowing streams with solid bottoms. Food consists mostly of small crustaceans and aquatic insect larvae. Threats to the Iowa darter include predation and changes to habitat through stream modifications (MFWP 2016e). This fish is a year-round resident in the northeastern portion of Montana and is found in Dawson, Richland, and Wibaux Counties. The Iowa darter is known to occur in Lone Tree Creek, a small tributary to the Yellowstone River just south of Sidney (MTNHP 2015a).

Northern Redbelly Dace (*Chrosomus eos*) (G5, S3)

Northern redbelly dace are found in clear, cool, slow-flowing creeks, ponds and lakes with vegetation. Food items have been reported to include algae, diatoms, dinoflagellates, zooplankton, and macroinvertebrates. As with many small native stream fishes, northern redbelly dace may be threatened by modifications to stream habitat and predation (MFWP 2016e). This fish is a year-round resident in the northeastern portion of Montana and is believed to inhabit the Yellowstone River near Glendive and near Crane, as well as several tributaries to the Yellowstone River (MTNHP 2015a).

Paddlefish (*Polyodon spathula*) (G4, S2)

The paddlefish prefers low-velocity waters and spawns from May to June. Paddlefish can occasionally live past 50. The largest paddlefish caught in Montana state was 142.5 pounds, caught above Fort Peck in 1973. Paddlefish feed by swimming with their mouths open to filter zooplankton from the water. In some places, adult paddlefish also filter aquatic insects and occasionally tiny fish. Paddlefish stocks in Montana are adequate to support a recreational fishery (MFWP 2016e). The paddlefish is a year-round resident of the Missouri and Yellowstone Rivers and is found in Dawson, Richland, and Wibaux Counties. Migration only includes spawning migrations, which are tied closely with the timing of spring high-water. This fish is known to spawn within the Yellowstone River near Sidney and Fairview (MTNHP 2015a).

Pearl Dace (*Margariscus margarita*) (G5, S2)

Pearl dace prefer small cool streams of varying turbidity, though they tend to spawn in clear water at depths of 1 to 2 feet over a gravel or sand bottom. They eat a variety of aquatic

organisms including insects, crustaceans, worms, and small fish. Threats to this dace include introduced species, especially northern pike, and loss of habitat from stock ponds, dams and diversions disrupting hydrologic regimes in the permanent pools of the prairie streams they inhabit (MFWP 2016e). This fish is a year-round resident of the Missouri River and is found in Richland County water bodies only (MTNHP 2015a). Although they are not reported in the proposed study area, suitable habitat is present and is linked to known habitats.

Sauger (*Sander canadensis*) (G5, S2)

Sauger spawn in the Yellowstone River and tributaries on gravelly or rocky areas in shallow, turbid waters. Spawning occurs from mid-April to May. Young fish begin eating zooplankton, graduating to aquatic insects and crustaceans. Adults feed mainly on fish. No specific threats are known (MFWP 2016e). Sauger are present in Dawson, Richland, and Wibaux Counties in the Yellowstone River and its tributaries and in the Missouri River. The species has been confirmed throughout the study area in the Yellowstone River (MTNHP 2015a).

Shortnose Gar (*Lepisosteus platostomus*) (G5, S1)

Shortnose gar are found in large rivers and backwaters. This fish has a higher tolerance to turbid water than other gar species and can often be found in dredge cuts below Fort Peck Dam. Gar are primarily fish-eaters. They will also eat crayfish and insects. Young gar feed on small insects and zooplankton. Range-wide population is stable and no threats are known. Localized threats probably include changes to habitat and prey condition and availability (MFWP 2016e). The shortnose gar is noted to be present in the Yellowstone and Missouri Rivers, including through the study area (MTNHP 2015a).

Sicklefin Chub (*Macrhybopsis meeki*) (G3, S1)

Sicklefin chub prefer large turbid rivers, usually with a sandy or gravelly bottom. This fish swims in the main river channel at any depth. Major threats are to habitat, resulting from flow alterations from dams, diversions, irrigation operations and riparian development (MFWP 2016e). Sicklefin chub are noted to be present within the Yellowstone River, near Glendive (MTNHP 2015a).

Sturgeon Chub (*Macrhybopsis gelida*) (G3, S2S3)

Sturgeon chub are found in turbid water with moderate to strong current over rocks and gravel or coarse sand. Sturgeon chub feed mostly on small invertebrates living on substrate. Threats include habitat loss and alteration due to changes in river hydrology (MFWP 2016e). This species is present in Dawson, Richland, and Wibaux Counties in the Yellowstone River throughout the study area (MTNHP 2015a).

3.9.2.6 Insects

Brimstone Clubtail (*Stylurus intricatus*) (G4, S1)

The larval and adult habitat of the Brimstone clubtail includes slow-moving, sand-bottomed, warm muddy rivers in open country. Larvae feed on aquatic insects, including larvae, freshwater shrimp, very small fish and tadpoles. Adult dragonflies hunt while flying and select soft-bodied flying insects such as mosquitoes, flies, small moths, mayflies, and flying ants or termites. Habitat loss due to damming is the primary threat to this dragonfly (MFWP 2016e). Breeding areas were reported on the Yellowstone River near Sidney at two locations between Pumps #6

and #7 from 1999 to 2000, and between Pumps #3 and #4 from 2000 to 2002. The most recent reported breeding areas were on the Missouri River at Brockton in 2012 (MTNHP 2015a).

Gray Comma (*Polytonia progne*) (G4G5, S2)

This species occurs along dirt roads and stream sides and within clearings in woods, aspen parks, yards, and gardens. The gray comma in caterpillar phase inhabits and feeds on gooseberries and azalea plants. Adult food is primarily sap, but may rarely include flower nectar. There are no threats known or reported for the gray comma. However, it is likely that loss of habitat and human disturbance are contributors (MFWP 2016e). In Dawson County, breeding was confirmed in 1998 about 3 miles south of Glendive, which is over 16 miles south of the Intake Diversion Dam. In Richland County one breeding area was confirmed near the Yellowstone River between Pumps #5 and #6 in 2003 (MTNHP 2015a).

Sand-Dwelling Mayfly (*Anapeorus rusticus*) (G2, S1)

This species is associated with larger, perennially flowing prairie rivers with sand-dominated bottoms and cobble riffles. It is a predaceous mayfly, which is unusual, and moves along underwater sandbars searching for prey. Threats to this species include the loss of large river shifting sandbar habitat due to flow reductions and modification caused by dams, drought and water diversions (MFWP 2016e). This sand-dwelling mayfly is a year-round resident in most of the eastern half of Montana, but was most recently reported in 1975 in the Powder River. There are no recorded occurrences in the study area (MTNHP 2015a).

Sand-Dwelling Mayfly (*Homoeoneuria alleni*) (G4, S2)

This species is associated with burrows in sandy or silty depositional areas of larger prairie rivers with sand-gravel dominated bottoms. It is a filtering collector, sifting and eating organic particles from water flowing over its burrow. Threats to this species include dams and diversions altering flow patterns and increased siltation that covers burrows (MFWP 2016e). This mayfly is a year-round resident in eastern Montana, but is known only to Richland County. It was reported within the study area as recently as 2002, in the lower Yellowstone River just upstream of Pump #7 (MTNHP 2015a).

Sand-Dwelling Mayfly (*Lachlania saskatchewanensis*) (G4, S1)

This species is associated with large, perennially flowing prairie rivers with sand-gravel dominated bottoms and cobble riffles. Information on diet has not been reported. This species is in decline in Montana, most likely due to siltation and habitat changes brought on by the long-standing drought and the cumulative effects of dams on its large prairie river habitats. Continuing threats to this species include dams and diversions and increased siltation that covers burrows (MFWP 2016e). This sand-dwelling mayfly is a year-round resident in most of the eastern half of Montana, and has been observed in 2002 both within the Yellowstone River near the confluence with Bennie Peer Creek and 3.8 miles upstream of Pump #7 (MTNHP 2015a).

Sand-Dwelling Mayfly (*Macdunnoa nipawinia*) (G2G3, S2)

Information for this mayfly is similar to *L. saskatchewanensis* above (MFWP 2016e). As with previous sand-dwelling mayflies, this species is known to occur in the Yellowstone River. The most recent occurrence was in 2002 near the confluence with Bennie Peer Creek (MTNHP 2015a).

3.9.2.7 Plants

Blue Toadflax (*Nuttallanthus texanus*) (G4G5, S1S2)

Blue toadflax is a winter annual from the plantain family. It is known from one extant occurrence in southeastern Montana near Alzada and another from Makoshika State Park in Dawson County (record of occurrence from 1982) (MTNHP 2015a). This plant prefers open, sandy or acid shale soils within plains grasslands or woodlands. Habitat for occurrence near Alzada is described as pine-oak-juniper woodland on Mowry shale-clay (MFWP 2016e).

Bractless Blazing Star (*Mentzelia nuda*) (G5, S1S2)

The bractless blazing star is an herbaceous biennial or short-lived perennial that is extirpated or possibly extirpated in Montana. The most recent known observance was along the Yellowstone River upstream of Miles City in 1954 (MTNHP 2015a). It prefers sandy or gravelly soil of open hills and roadsides (MFWP 2016e).

Heavy Sedge (*Carex gravida*) (G5, S3)

A single occurrence of this sedge is recorded in MTNHP data within Richland County from 1988. Heavy sedge has been found at a few widely scattered locations in eastern Montana. Though it is not generally abundant, it likely is more abundant than current data shows (MTNHP 2015a). Habitats include moist, green ash woodlands, which are also often used by livestock, putting the plant at risk of trampling (MFWP 2016e).

Large Flowered Beardtongue (*Penstemon grandiflorus*) (G5?, S1)

This purple flower of the plantain family is a stout perennial herb that grows on prairie bluffs and loess hills in open grass places in Montana (Steyermark 1963). It is rare, with only three occurrences recorded, each of them upstream of Miles City on the Yellowstone River between 1977 and 1996 (MTNHP 2015a).

Nannyberry (*Viburnum lentago*) (G5, S2S3)

Nannyberry is part of the honeysuckle family and grows as a small tree 20 to 25 feet tall. It has been observed at three locations in eastern Montana. The nearest to the study area was recorded in 1979 along the Missouri River upstream of the confluence with the Yellowstone River. Nannyberry prefers woods and thickets with rich, moist soil (Connecticut Botanical Society 2015).

Narrowleaf Penstemon (*Penstemon angustifolius*) (G5, S2S3)

This short lived perennial, a member of the plantain family, lives in sandy-soiled, prairie grasslands on hills and slopes. Plants are often most abundant on sparsely vegetated sandy areas (MFWP 2016e). One of its few occurrences was reported along the Glendive River, a tributary to the Yellowstone River just downstream of Glendive. It has not been observed in the area since 1941 (MTNHP 2015a).

Nine-Anther Prairie Clover (*Dalea enneandra*) (G5, S2S3)

This clover, a member of the pea family, is known from a few poorly documented individual occurrences. One was in 1979 along Fox Creek, about 5 miles upstream from the confluence with the Yellowstone River. A 1993 survey found several occurrences on a small tributary about 2 miles upstream of the Yellowstone confluence between Miles City and Hathaway (MTNHP

2015a). This perennial herb prefers plains grasslands with gravelly soils and also occurs on slopes (MFWP 2016e).

Pale-Spiked Lobelia (*Lobelia spicata*) (G5, S2?)

Occurrence of this Bellflower family species along the Yellowstone River was most recently observed in 1937. The question mark indicates that the species is rare and peripheral in Montana and known only from a few locations, but that additional data on population levels and trends are needed (MTNHP 2015a). This lobelia is an herbaceous perennial classified as a facultative wetland plant, meaning it is capable of growing in moist soils. It is generally noted as being a moist meadow species (MFWP 2016e).

Persistent-Sepal Yellowcress (*Rorippa calycina*) (G3, SH)

The state rank (SH) indicates that this mustard family species is known only from historical records but that it may be rediscovered. This yellowcress was most recently observed along the Yellowstone River in 1854 (MTNHP 2015a). It is a regionally endemic plant adapted to wetland and riparian habitats (MFWP 2016e).

Prairie Goldenrod (*Solidago ptarmicoides*) (G5, S2S3)

The prairie goldenrod is rare in Montana and has been documented in only a few locations on the eastern plains, including a 1979 observation near Crane Creek at a point over 2 miles upstream from its confluence with the Yellowstone River (MTNHP 2015a). This is an herbaceous fall-flowering perennial that prefers native tallgrass and mixed grass prairie. It also grows along roadsides, in old fields, disturbed prairies, overgrazed range, open woods, and rocky outcrops (MFWP 2016e).

Red-Root Flatsedge (*Cyperus erythrorhizos*) (G5, S2?)

There is only one recorded occurrence of this sedge in Montana, along the Yellowstone River upstream of the town of Terry in 2008 (MTNHP 2015a). It is commonly associated with wetland and riparian woodland and shrubland systems and is native throughout North America (MFWP 2016e). MTNHP notes that survey work in appropriate habitat would likely discover additional locations in Montana (2015).

Silky Prairie-Clover (*Dalea villosa*) (G5, S2)

The silky prairie clover was last seen in Montana in 1979 along Crane Creek, over 2 miles upstream of its confluence with the Yellowstone River. More than one individual was likely seen (MTNHP 2015a). This is a perennial herb that prefers sparsely vegetated prairies and open woodlands with sandy soils. It can often be found near sandstone outcrops or on dunes and roadsides (MFWP 2016e).

Schweinitz's Flatsedge (*Cyperus schweinitzii*) (G5, S2)

Another species commonly associated with Great Plains Sand Prairie is the Schweinitz's flatsedge. This sedge prefers sparsely vegetated, sandy soils or sandy dunes within prairie grasslands (MFWP 2016e). The last time this plant was observed along the Yellowstone River was in 1977, upstream of the Tongue River confluence (MTNHP 2015a).

Slender-Branched Popcorn Flower (*Plagiobothrys leptocladus*) (G4, S2S3)

One occurrence is recorded in the MTNHP from 1937 near Moon Creek, a tributary to the Yellowstone River upstream of Miles City. Additional data on population levels is needed to

more precisely evaluate its status, but because it occurs in the drying mud of ponds, wetlands, and stock ponds, it is likely that additional populations do occur in Montana (MFWP 2016). This member of the Borage family is commonly associated with Great Plains Closed Depressional Wetland, Freshwater Depression Wetland, and Prairie Pothole.

Tall Dropseed (*Sporobolus compositus*) (G5, SH)

This perennial grass species occurs in open forests and grasslands on the plains (MFWP 2016e). Its nearest occurrence to the study area is along the Tongue River, a tributary to the Yellowstone River upstream of Miles City, last seen in 1957 (MTNHP 2015a).

3.10 Lands and Vegetation

The Yellowstone River Basin is located in the Greater Yellowstone Ecosystem, which is one of the largest relatively intact temperate zone ecosystems on the planet. The Yellowstone River Basin covers approximately 71,000 square miles, from the river's headwaters in Wyoming and Montana to its confluence with the Missouri River in far western North Dakota. The Yellowstone River flows through several physiographic provinces including the Northern Rocky Mountains, Middle Rocky Mountains, and the Great Plains (Zelt et al. 1999). The Great Plains are generally composed of gently rolling hills with some sharply dissected badlands, a product of easily eroded shale. The Yellowstone River, from the Intake Diversion Dam to the confluence with the Missouri River, lies entirely in the Missouri Plateau subsection of the Great Plains Province. Landscape characteristics of the Missouri Plateau include plains and terraces, which are eroded sedimentary shale, siltstone, and sandstone; and fans and floodplains, which are alluvial in origin (water-deposited sediment). Elevations within the Missouri Plateau range from 1,000 to 3,500 feet (Nesser et al. 1997).

3.10.1 Land Use

Land use within the study area was mapped as part of the Yellowstone Cumulative Effects Analysis conducted by the Corps and the Yellowstone River Conservation District Council (Thatcher and Swindell 2013) (Figure 3-16 and Figure 3-17). Land use was classified into the following categories:

- Non-agricultural land, which includes transportation, urban, exurban, and other
- Agricultural land:
 - Irrigated land, categorized by method of irrigation (pivot, flood, or sprinkler)
 - Non-irrigated land, categorized as either as hay/pasture or multiple use
- Channel, consisting of all areas within a channel migration zone, including islands.

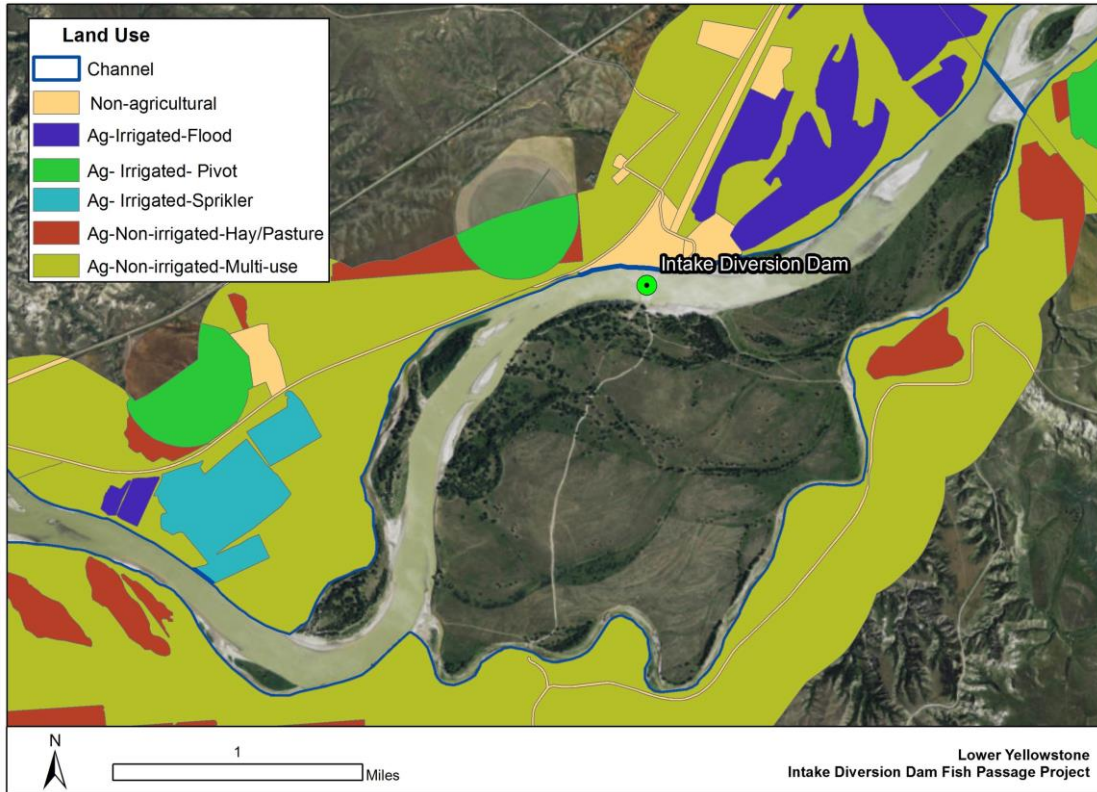

Figure 3-16. Land Use along the Yellowstone River in the Study Area (MTNHP 2013).

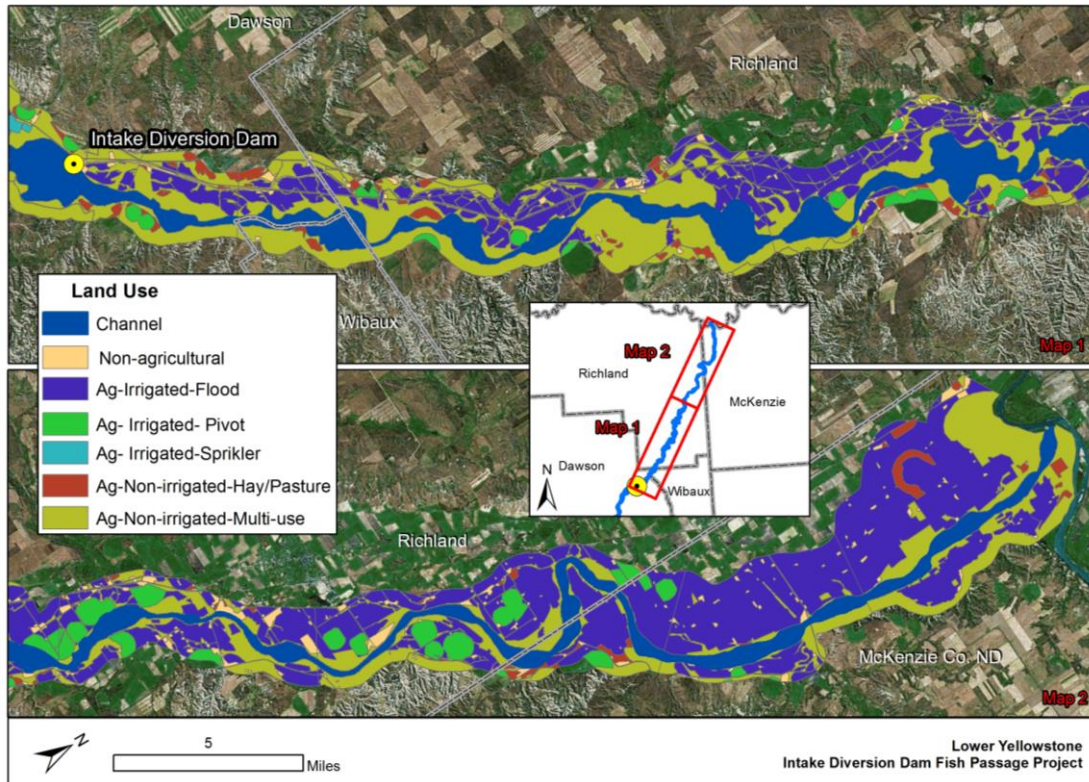

Figure 3-17. Land Use along the Yellowstone River from the Intake Diversion Dam to the Missouri River (MTNHP 2013).

3.10.2 Zoning

In Richland County, Montana, zoning is defined only inside Sidney and Fairview city limits (Richland County 2007). In Dawson County, Montana, zoning is defined only in the City of Glendive (Dawson County 2013). McKenzie County, North Dakota is zoned along the Yellowstone River according to the Yellowstone Township Zoning Ordinance (Yellowstone Township 2012).

3.10.3 Land Ownership

The majority of land along the Yellowstone River is privately owned. Federal land ownership includes both Bureau of Reclamation and Bureau of Land Management (BLM). State landowners included MFWP, Montana State Land Trust, and Montana Department of Transportation. Land ownership surrounding Intake Diversion Dam and Joe’s Island includes both BLM and Bureau of Reclamation . Most of Joe’s Island is owned by Reclamation, but easement or acquisition would be required to access a nearby quarry, should rock be acquired from it.

3.10.4 Wetlands

Within the Yellowstone River Basin, a number of types of wetlands occur, providing a multitude of benefits. They provide habitat for fish, wildlife, and a variety of plants. Wetlands are nurseries for many freshwater fish and shellfish of commercial and recreational importance. Wetlands are

important landscape features because they hold and slowly release floodwater and snow melt, recharge groundwater, recycle nutrients, and provide recreation and wildlife viewing opportunities for millions of people (MTDEQ 2013; NAS 2001). While wetlands within the Yellowstone River corridor make up a relatively small portion of the landscape in area (roughly 4,300 acres), they provide multiple environmental services in addition to key aquatic and terrestrial wildlife habitat (Kudray and Schemm 2006). The riparian corridor and associated wetlands are dynamic, are affected by channel migration and fluvial processes, and persist only a few years or decades (Kudray and Schemm 2006).

A diversity of wetland types are found within the study area (Figure 3-18). Freshwater emergent wetlands are the most common type of wetland in the study area. They typically contain rooted herbaceous vegetation. Dominant graminoids found in these types of wetlands include foxtail barley (*Hordeum jubatum*) and western wheatgrass (*Pascopyrum smithii*) on drier sites, and bulrush (*Schoenoplectus* spp.), sedges (*Carex* spp.), cattails (*Typha* spp.), and bluejoint reedgrass (*Calamagrostis canadensis*) on wetter sites (Corps and YRCDC 2015). Halophytic species such as saltgrass (*Distichlis spicata*) and Nuttall's alkaligrass (*Puccinellia nuttalliana*) occur on sites with saline soils.

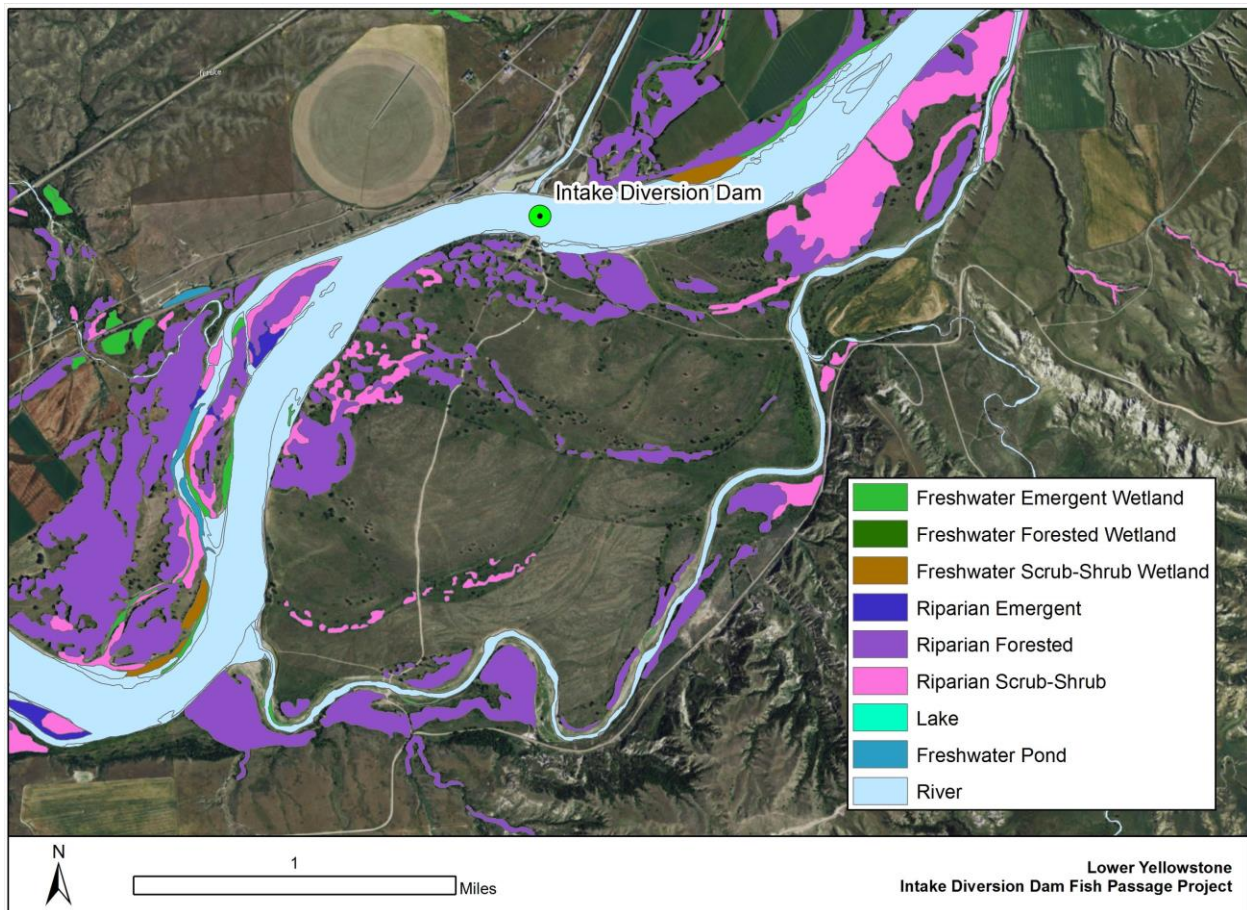

Figure 3-18. Riparian Land and Wetlands in the Study Area

Freshwater scrub-shrub wetlands are associated with streams and rivers in the study area. These types of wetlands are dominated by woody vegetation less than 20 feet tall. Native species in scrub/shrub wetlands are red-osier dogwood (*Cornus sericea*), chokecherry (*Prunus virginiana*), western snowberry (*Symphoricarpos occidentalis*), silver buffaloberry (*Shepherdia argentea*), silverberry (*Elaeagnus commutata*), sandbar willow (*Salix exigua*), peach-leaf willow (*Salix amygdaloides*), several cottonwood species (*Populus* spp.), and Rocky Mountain juniper (*Juniperus scopulorum*) (Corps and YRCDC 2015). In many cases, this wetland type represents transitional plant communities of younger age classes of forest communities.

Freshwater forested wetlands are dominated by trees taller than 20 feet and are typically classified as seasonally flooded. Cottonwood species are the tallest and most visible native woody species, Great Plains cottonwood (*Populus deltoides*) being the dominant species. Other native woody species such as peach-leaf willow, sandbar willow, yellow willow (*Salix lutea*) and green ash (*Fraxinus pennsylvanica*) are present throughout (Corps and YRCDC 2015).

Riverine wetlands include lower perennial unconsolidated bottom wetlands which are low gradient and have a slow water velocity. Substrates in this system are predominantly sand and mud, and floodplains are usually well developed. Also present are lower perennial unconsolidated shore wetlands, which are the shorelines to low gradient rivers that have less than 75-percent areal cover of stones, cobbles, boulders or bedrock and less than 30-percent vegetative cover. These shorelines are irregularly exposed due to flooding and drying. Mountain alder (*Alnus incana*), water birch (*Betula occidentalis*), western snowberry (*Symphoricarpos occidentalis*), silver sagebrush (*Artemisia cana*), chokecherry, and red-osier dogwood are common along riverine floodplains (Corps and YRCDC 2015).

A 2012 Corps wetland delineation in the study area confirmed the presence of a seep spring, wetlands, and intermittent waterway near the western boundary of a waste pile site in a drainage way that connects to the existing side side channel (Figure 3-19) (Corps 2015c). The side channel that flows around Joe's Island had a gravel/cobble bed that was intermittently exposed and contained patchy emergent wetlands. Flow was not apparent during the investigation.

It is also likely that a number of riverine and/or emergent wetlands present along the LYP are sustained by groundwater or surface water flows from the irrigation system, either from leakage within the system or from surface water returns towards the river. At this time, it is not known how many acres of wetlands may have been created or have been augmented by the irrigation system.

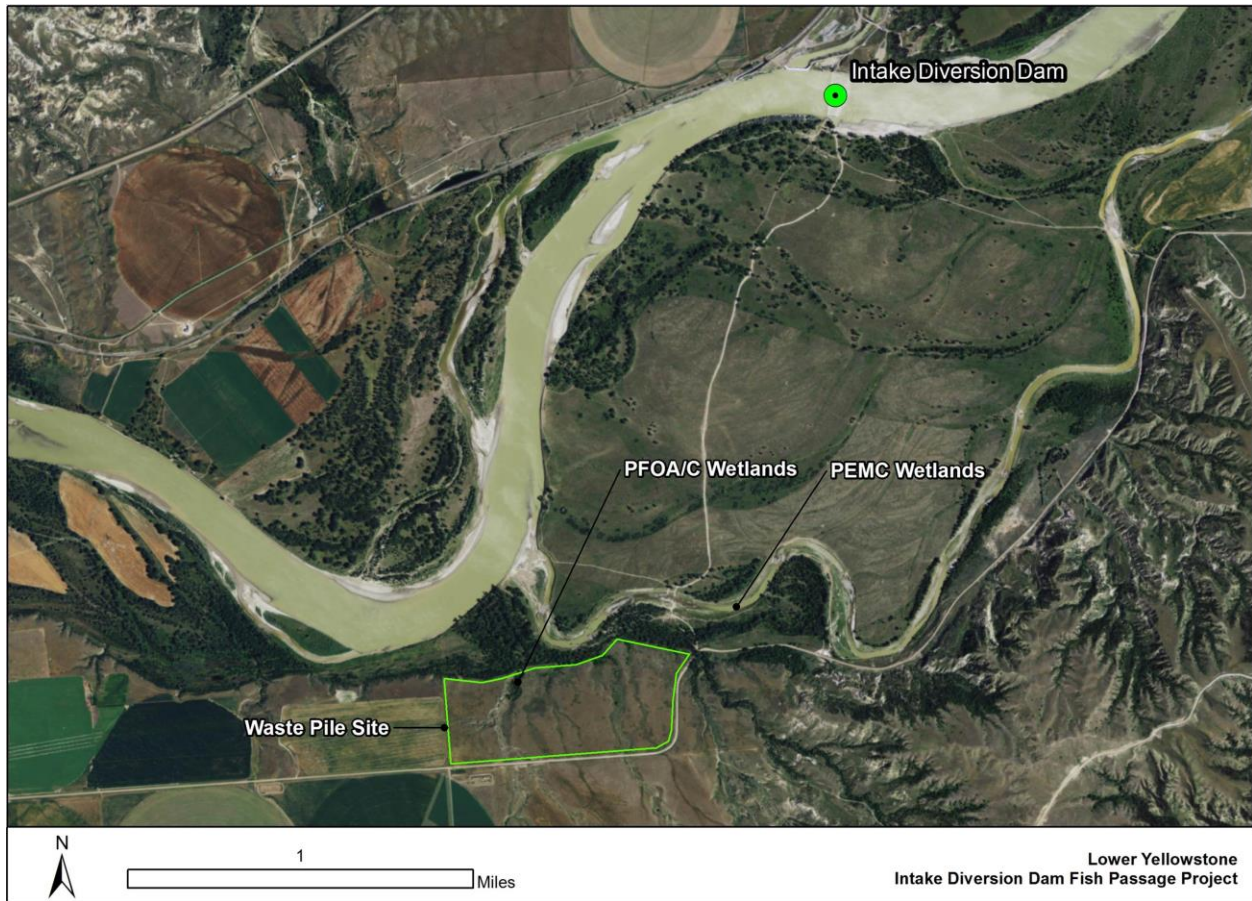

Figure 3-19. Waste Pile Site and Wetlands Found in Corps 2012 Delineation

Note: PFOA/C = Palustrine (Freshwater) Forested Wetlands; PEMC = Palustrine (Freshwater) Emergent Wetlands.

3.10.5 Riparian Areas

The riparian zone is the transition area between the aquatic and terrestrial ecosystems. The Montana Natural Heritage Program mapped riparian areas along the Yellowstone River (Figure 3-18 and Figure 3-20). Riparian zones consist of rooted vegetation in areas such as channel islands and bars, channel banks, floodplains, and lower terraces. Mapped riparian types are not necessarily wetlands but have vegetation affected by the hydrology and other fluvial processes of a nearby water body (river, stream, or lake). Some riparian types are not wet enough for a long enough period of time to be classified as wetlands. Riparian vegetation communities are highly productive and support an abundance of wildlife. The vegetation in riparian areas can control or influence several important aquatic ecological functions, such as habitat complexity, canopy closure, water temperature, primary productivity, benthic invertebrate community composition, stream bank stability, and recruitment of coarse woody debris into the aquatic system (Zelt et al. 1999).

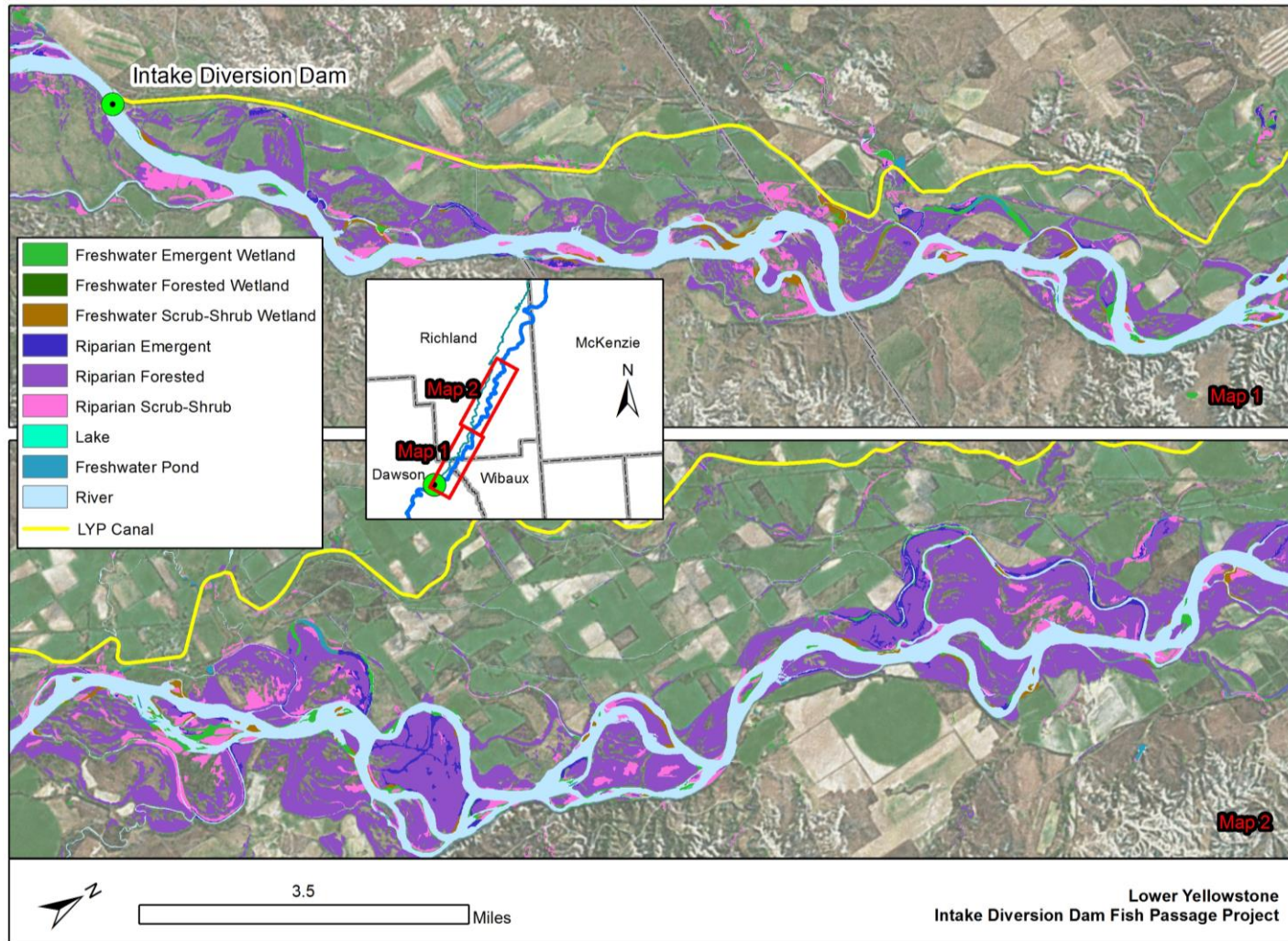

Figure 3-20. Wetlands and Riparian Areas Along the Yellowstone River from the Intake Diversion Dam to the Missouri River (MTNHP 2015b).

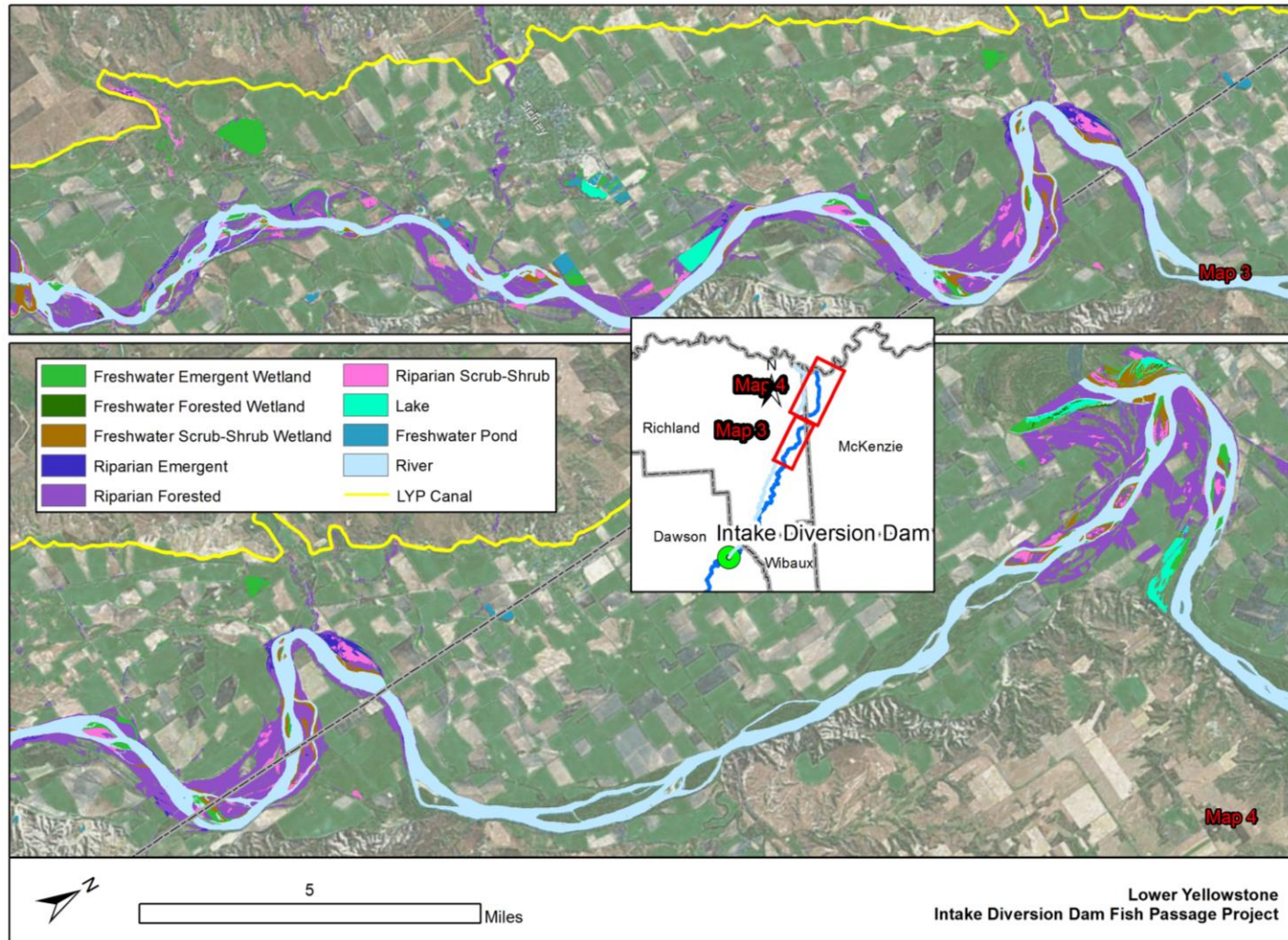

Figure 3-20 (continued). Wetlands and Riparian Areas Along the Yellowstone River from the Intake Diversion Dam to the Missouri River (MTNHP 2015b).

Riparian areas have seen significant declines over the last century as they have been cleared for timber use and converted to other land uses. Historical records indicate that much of the Yellowstone River floodplain in the early 1800s consisted of abundant stands of cottonwood timber and shrubs, with extensive herds of wild ungulates. The Yellowstone Cumulative Effects Analysis (Corps and YRCDC 2015) documented that over 6,800 acres of woody riparian vegetation present in 1950 was converted to another land use by 2001, in addition to the substantial changes that had occurred prior to 1950 as the valley was first settled and converted to agricultural uses. Over 5,500 acres of the change from 1950 to 2001 was conversion of riparian forest to irrigated agriculture. The main factors of riparian habitat loss are floodplain isolation and channel migration, as well as direct conversion (Corps and YRCDC 2015).

The loss of riparian vegetation increases the risk of erosion of organic matter, nutrients, and sediment stored in floodplains if areas are burned then flooded in rapid succession (McIntyre and Minshall, 1996, cited in Zelt 1999). Changes in riparian community composition and age structure due to grazing or hydrologic alterations can favor exotic species such as Russian olive (*Eleagnace umbellata*) and saltcedar (*Tamarix* spp.). This can alter the retention or sequestration of potential pollutants in riparian areas (Corps and YRCDC 2015).

Riparian vegetation is variable along the Yellowstone River and can include any combination of marsh, meadow, shrubland, or forest communities. Flooding, with associated sediment erosion and deposition, is the most important ecosystem process, creating suitable substrates for seed dispersal and seedling establishment, and controlling vegetation succession (Vance et al. 2010b). Along many streams of the eastern Montana plains, grasses, rushes, and sedges are dominant plants in herbaceous riparian communities. Dominant shrub species in riparian communities include greasewood (*Sarcobatus vermiculatus*), common chokecherry, coyote willow (*Salix exigua*), silver buffaloberry, silver sagebrush, and western snowberry. Woodland riparian communities are dominated by plains cottonwood (*Populus deltoides*), along with green ash, box elder (*Acer negundo*), willows, and the exotic Russian olive (Jones and Walford 1995). Cottonwood regeneration and the recruitment of old-growth cottonwoods are declining due to the lack of flooding and the resulting limitation of suitable substrate (bare sand and gravel) for cottonwoods to germinate (Johnson et al. 2012). This will lead to a natural decline of riparian forest over time as existing cottonwoods age and die out.

3.10.6 Woodlands

Woodlands include areas with trees usually greater than 20 feet tall with a tree canopy covering greater than 25 percent. Within the study area, this includes Great Plains Floodplain, Great Plains Riparian, and Great Plains Wooded Draw and Ravine. Deciduous woodlands are generally made up of cottonwood, green ash, Russian olive, and box elder trees. Although some of the deciduous woodland species are hydrophytic and could be found in wetlands, the herbaceous understory consists of upland vegetation. Great Plains Floodplains ecosystem type consist of the dominant narrowleaf cottonwood (*Populus angustifolia*) and plains cottonwood. In relatively undisturbed stands, willow (*Salix* sp.), red-osier dogwood and common chokecherry (*Prunus virginiana*) form a thick, multi-layered shrub understory, with a mixture of cool and warm season grasses below. Box elder (*Acer negundo*) and green ash (*Fraxinus pennsylvanica*) are also found in the understory (Vance et al. 2010c).

A concentration of moisture led to the development of the Great Plains Wooded Draw and Ravine community (Vance and Luna, 2010b). These long and narrow systems in drainages on hillslopes have deep soils and very short-duration flooding. Green ash or chokecherry are the typical dominants, with an understory of western snowberry and a ground layer of sedges and grasses such as northern reedgrass (*Calamagrostis stricta*), western wheatgrass, bluebunch wheatgrass (*Pseudoroegneria spicata*), and thickspike wheatgrass (*Elymus lanceolatus*).

3.10.7 Shrublands

Shrublands are areas dominated by a shrub canopy covering greater than 25 percent of the area. In the eastern part of Montana, the Big Sagebrush Steppe community is widespread (Vance et al., 2010a). This system is mostly dominated by Wyoming big sagebrush (*Artemisia tridentata ssp. Wyomingensis*) with western wheatgrass also very common. Japanese brome (*Bromus japonicus*) and cheatgrass (*Bromus tectorum*) are common indicators of disturbance. Soils are typically deep and non-saline, often with a microphytic crust, which is a biological soil crust, formed by living organisms and their by-products.

Another less common shrubland in eastern Montana is the Mat Saltbush Shrubland, where soils are saline or alkaline clays and silts with low infiltration rates (Luna 2010). Pure stands of Gardner's saltbush (*Atriplex gardneri*) or birdfoot sagebrush (*Artemisia pedatifida*) are the most common vegetation, with other shrubs including longleaf wormwood (*Artemisia longifolia*), bud sagebrush (*Picrothamnus desertorum*), winterfat (*Krascheninnikovia lanata*), shortspine horsebrush (*Tetradymia spinosa*), shadscale saltbush (*Atriplex confertifolia*) or fourwing saltbush (*Atriplex canescens*).

In the study area, sagebrush communities on Joe's Island include silver sagebrush (*Artemisia cana*), common snowberry, chokecherry, buffaloberry, and some willows (Corps 2015c).

3.10.8 Grasslands

The majority of the grassland in the study area is generally Great Plains Mixed Grass Prairie (Luna and Vance 2010a). This is a system that covers much of the eastern two-thirds of Montana. Soils are primarily fine and medium-textured. Grasses typically make up the greatest canopy cover, and western wheatgrass is usually dominant. Other species include thickspike wheatgrass (*Elymus lanceolatus*), green needlegrass (*Nassella viridula*), blue grama (*Bouteloua gracilis*), and needle and thread (*Hesperostipa comata*).

Other grasses found in the valleys and plains include Idaho fescue (*Festuca idahoensis*), bluebunch wheatgrass (*Pseudoroegneria spicata*), nonnative crested wheatgrass (*Agropyron cristatum*), and Japanese brome (*Bromus japonicus*). Both little bluestem (*Schizachyrium scoparium*) and buffalo grass (*Bouteloua dactyloides*) are found along flat-bottomed channels. Common forbs within this system include yarrow (*Achillea millefolium*), scarlet globemallow (*Sphaeralcea coccinea*), western sagewort, (*Artemisia ludoviciana*), boreal sagewort (*Artemisia frigida*), silver lupine (*Lupinus argenteus*), fuzzy beardtongue (*Penstemon eriantherus*), shining penstemon (*Penstemon nitidus*), prairie cinquefoil (*Potentilla gracilis*), Missouri goldenrod (*Solidago missouriensis*) and dalea (*Dalea sp.*).

Another common system, interspersed within the mixed grass matrix, is the Great Plains Sand Prairie (Luna and Vance 2010b). The coarse textured soil of sand prairie has commonly been

weathered in place from sandstone outcrops. Dominant graminoid vegetation includes the dominant needle and thread grass along with the frequent little bluestem and threadleaf sedge (*Carex filifolia*).

Other prominent vegetation in the study area includes agricultural crops such as native hay, alfalfa, and seasonal crops such as small grains, beans, sugar beets, and corn.

3.10.9 Barrens

Within the matrix of mixed grass and sand prairies of eastern Montana, erosion by wind or water can create Great Plains Badlands communities, where the highly erodible parent material makes vegetation sparse (Vance and Luna, 2010c). This community still has some patchy but unique vegetation, with clumps of curlycup gumweed (*Grindelia squarrosa*), threadleaf snakeweed (*Gutierrezia sarothrae*), greasewood, Gardner’s saltbush (*Atriplex gardneri*), buckwheat (*Eriogonum* sp.), plains muhly (*Muhlenbergia cuspidata*), bluebunch wheatgrass (*Pseudoroegneria spicata*), and Hooker’s sandwort (*Arenaria hookeri*). Sagebrush also exists in these barrens.

3.10.10 Ecological Communities within 100-Year Floodplain

Using the Montana Land Cover Framework 2013 geodatabase (MTNHP 2013), the acres of each Ecological System Type within the 100-year floodplain plus a 500 meter buffer were mapped and calculated (Figure 3-21). This is the same area used in the land use evaluation. The results are listed in Table 3-18.

TABLE 3-18. LAND COVER INCLUDING ECOLOGICAL SYSTEMS WITHIN 100 YEAR FLOODPLAIN

Ecological System Type	Acres	Percentage (%)
Agriculture	24,590	36.1
Developed/Ruderal	2737	4.0
Open Water	7473	11
Great Plains Floodplain	20,656	30.4
Great Plains Mixedgrass Prairie	7,580	11.1
Great Plains Sand Prairie	3,571	5.2
Great Plains Badlands	810	1.2
Great Plains Wooded Draw and Ravine	376	0.6
Introduced Riparian and Wetland Vegetation	139	0.2
Great Plains Riparian	92	0.1
Great Plains Closed Depressional Wetland	1	0.0

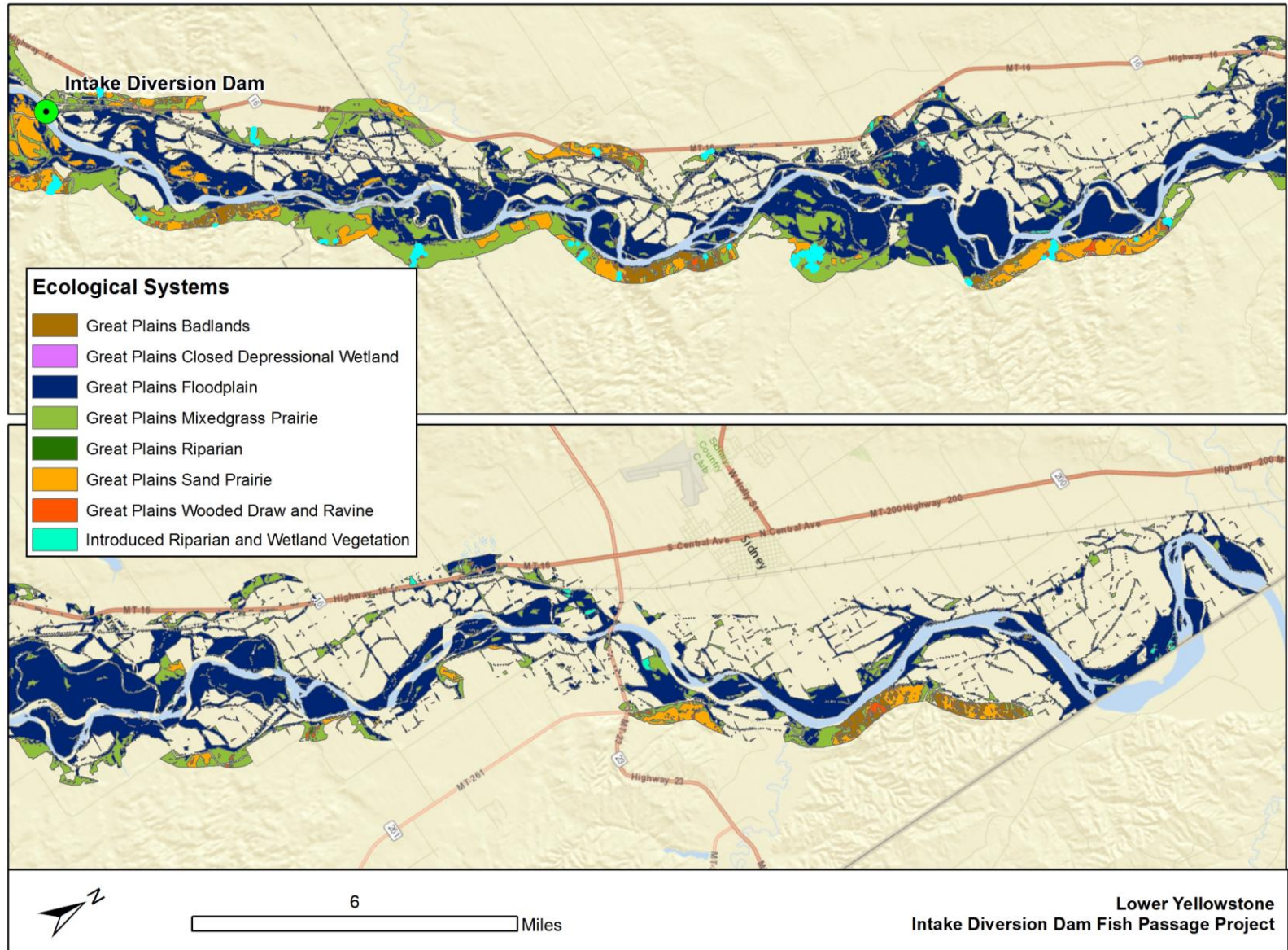

Figure 3-21. Ecological Systems within 100-Year Floodplain

3.10.11 Noxious weeds

Table 3-19 is a list of noxious and invasive plants found in Dawson, Richland and Wibaux Counties in Montana, and McKenzie County in North Dakota (Montana Department of Agriculture, 2015; Montana Weed Control Association, 2015; North Dakota Department of Agriculture 2015).

TABLE 3-19. NOXIOUS AND INVASIVE PLANTS

Weeds	Priority ^a	Dawson ^b	Richland ^b	Wibaux ^b	McKenzie, ND ^c
Yellow starthistle (<i>Centaurea solstitialis</i>)	1A	-	-	-	-
Dyer's woad (<i>Isatis tinctoria</i>)	1A	-	-	-	-
Common reed (<i>Phragmites australis</i> ssp. <i>australis</i>)	1A	-	-	-	-
Knotweed complex (<i>Polygonum cuspidatum</i> , <i>P. sachalinense</i> , <i>P. bohemicum</i> , <i>Fallopia japonica</i> , <i>F. sachalinensis</i> , <i>F. bohémica</i> , <i>Reynoutria japonica</i> , <i>R. sachalinensis</i> , and <i>R. bohémica</i>)	1B	-	-	-	-
Purple loosestrife (<i>Lythrum salicaria</i>)	1B	-	-	-	+
Rush skeletonweed (<i>Chondrilla juncea</i>)	1B	-	-	-	-
Scotch broom (<i>Cytisus scoparius</i>)	1B	-	-	-	-
Tansy ragwort (<i>Senecio jacobaea</i> , <i>Jacobaea vulgaris</i>)	2A	-	-	-	-
Meadow hawkweed complex (<i>Hieracium caespitosum</i> , <i>H. praealtum</i> , <i>H. floridundum</i> , and <i>Pilosella caespitosa</i>)	2A	-	-	-	-
Orange hawkweed (<i>Hieracium aurantiacum</i> , <i>Pilosella aurantiaca</i>)	2A	-	-	-	-
Tall buttercup (<i>Ranunculus acris</i>)	2A	-	-	-	-
Perennial pepperweed (<i>Lepidium latifolium</i>)	2A	-	-	-	-
Yellowflag iris (<i>Iris pseudacorus</i>)	2A	-	-	-	-
Blueweed (<i>Echium vulgare</i>)	2A	-	-	-	-
Eurasian watermilfoil (<i>Myriophyllum spicatum</i>)	2A	-	-	-	-
Flowering rush (<i>Butomus umbellatus</i>)	2A	-	-	-	-
Canada thistle (<i>Cirsium arvense</i>)	2B	+	+	+	+
Field bindweed (<i>Convolvulus arvensis</i>)	2B	+	+	-	-
Leafy spurge (<i>Euphorbia esula</i>)	2B	+	+	+	+
Whitetop (<i>Cardaria draba</i> , <i>Lepidium draba</i>)	2B	+	+	+	-
Russian knapweed (<i>Acroptilon repens</i> , <i>Rhaponticum repens</i>)	2B	+	+	-	+
Spotted knapweed (<i>Centaurea stoebe</i> , <i>C. maculosa</i>)	2B	+	+	-	+
Diffuse knapweed (<i>Centaurea diffusa</i>)	2B	+	+	-	+
Dalmatian toadflax (<i>Linaria dalmatica</i>)	2B	+	+	-	+
St. Johnswort (<i>Hypericum perforatum</i>)	2B	+	-	-	-
Sulfur cinquefoil (<i>Potentilla recta</i>)	2B	-	-	-	-
Common tansy (<i>Tanacetum vulgare</i>)	2B	+	-	-	-

Weeds	Priority ^a	Dawson ^b	Richland ^b	Wibaux ^b	McKenzie, ND ^c
Oxeye daisy (<i>Leucanthemum vulgare</i>)	2B	-	-	-	-
Houndstongue (<i>Cynoglossum officinale</i>)	2B	+	+	-	+
Yellow toadflax (<i>Linaria vulgaris</i>)	2B	-	-	-	+
Saltcedar (<i>Tamarix spp.</i>)	2B	+	+	-	+
Curlyleaf pondweed (<i>Potamogeton crispus</i>)	2B	-	-	-	-
Hoary alyssum (<i>Berteroa incana</i>)	2B	-	-	-	-
Cheatgrass (<i>Bromus tectorum</i>)	3	+	+	+	-
Hydrilla (<i>Hydrilla verticillata</i>)	3	-	-	-	-
Russian olive (<i>Elaeagnus angustifolia</i>)	3	+	+	+	-
Brazilian waterweed (<i>Egeria densa</i>)	3	-	-	-	-
Parrot feather watermilfoil (<i>Myriophyllum aquaticum</i> or <i>M. brasiliense</i>)	3	-	-	-	-
Absinth Wormwood (<i>Artemisia absinthium</i>)	N/A	-	-	-	+
Musk Thistle (<i>Carduus nutans</i>)	N/A	-	-	-	+
Black henbane (<i>Hyoscyamus niger</i>)	N/A	-	-	-	+
Common burdock (<i>Arctium minus</i>)	N/A	-	-	-	+
Halogeton (<i>Halogeton glomeratus</i>)	N/A	-	-	-	+
Baby's breath (<i>Gypsophila sp.</i>)	N/A	-	-	-	+

- a. Montana Category 1B noxious weed species have limited presence in Montana. Montana Category 2A noxious weed species are common in isolated areas of Montana. Montana Category 2B noxious weed species are abundant in Montana and widespread in many counties. Category 3 are regulated plants but not Montana listed noxious weeds.
- b. Montana Department of Agriculture, 2015 and Montana Weed Control Association, 2015
- c. North Dakota Department of Agriculture, 2015

Foremost exotic species in the study area are two invasive shrubs: Russian olive and Saltcedar. Russian olive (*Elaeagnus angustifolia*) was introduced around the turn of the 1900s to Montana for use in conservation and ornamental plantings and as windbreaks. It is very drought tolerant, grows quickly, and has become naturalized or invasive on sites in eastern Montana with moist, slightly to moderately saline soil. Russian olive has many competitive advantages over native vegetation. Its large seed is viable for a long period. Russian olive is tolerant to moist, moderately saline or sodic sites. It matures early and has strong drought tolerance. Russian olive disperses its seeds by both water and animals. It has low browse palatability, few disease and insect problems, strong sprouting habit, and extreme cold tolerance (Corps and YRCDC 2015). Saltcedar (*Tamarix spp.*) or tamarisk is a long-living, deciduous, noxious weed. The shrub was imported from Eurasia to control streambank erosion in the 1900s. Saltcedar is adapted to colonizing freshly disturbed substrates. Saltcedar reproduces vigorously by seed, root sprouts, and cuttings. Adaptations give it a decided advantage over native species. Extremely dense stands of saltcedar exclude other vegetation and the shed leaves contain concentrations of salt, which makes seed germination difficult for competing species (Corps and YRCDC 2015).

3.11 Recreation

The analysis area for recreation resources is defined as the recreation areas and facilities adjacent to the Yellowstone River and the Main Canal between the Intake Diversion Dam and the confluence with Missouri River. This analysis area encompasses primary recreation-related resources and activities within or adjacent to the river channel and canal; recreation-related resources beyond the recreation analysis area (the river corridor) are removed from any proposed construction or operation activities. Figure 3-22 provides an overview of recreation resources in the vicinity.

Data used in this section was obtained primarily from the Montana Department of Fish, Wildlife & Parks (MFWP) and the North Dakota Game and Fish Department. Additional information was obtained from the Glendive Chamber of Commerce website and various documents, news articles, and brochures.

Regularly collected visitation data is not available for the recreation areas and facilities discussed in this section. Cited visitation estimates are point estimates that were found in individual publications or provided via personal communication as part of the 2015 Supplement to the 2010 Environmental Assessment (Reclamation and the Corps 2015).

Recreation activities in the vicinity of the Intake Diversion Dam and downstream to the Missouri River includes hunting, fishing, boating, camping, picnicking, walking, hiking, birdwatching and scenic and wildlife viewing within recreation areas along the river. Recreation facilities range from open space with no amenities to established camping areas with water and vault toilets. Recreation visitation in the analysis area is concentrated primarily at the facilities/sites described in Table 3-20. Within the analysis area, the recreation visitation most proximate to the project area includes Intake Dam Fishing Access Site (FAS) and Joe's Island. These two area are described in more detail below. Because many of the sites are predominately open space and minimally developed, little data is available to quantify visitation.

3.11.1 Intake FAS and Joe's Island

The Intake FAS and Joe's Island are situated on opposite sides of the Yellowstone River at the Intake Diversion Dam, about 16 miles north of Glendive on State Highway 16 (see Figure 3-23).

The Intake FAS site is a 93-acre area on left bank of the Yellowstone River, just downstream of the Intake Diversion Dam. The site is easily accessed from State Highway 16 via Road 551 and Canal Road. A parking area is provided for users of the day use area and boat ramp. There is a 17-site campground loop with picnic tables and fire rings. Potable water is available between May 15 and October 1, and vault toilets are provided year-round. The portion of the site adjacent to the river, which includes the boat ramp, campground, and day use facilities, is on lands owned by Reclamation and, under agreement, managed by the State of Montana. The remainder of the site is on private land managed by the MFWP (Montana State Library 2014). Dawson County developed and maintains access to the Intake FAS. Limited visitation information is collected for the Intake FAS. During the 2008 paddlefish season (beginning May 15), MFWP recorded 3,110 visitors and 214 campers. During the non-paddlefish season in 2008, 4,325 visitors and 300 campers were recorded (Reclamation and the Corps 2015).

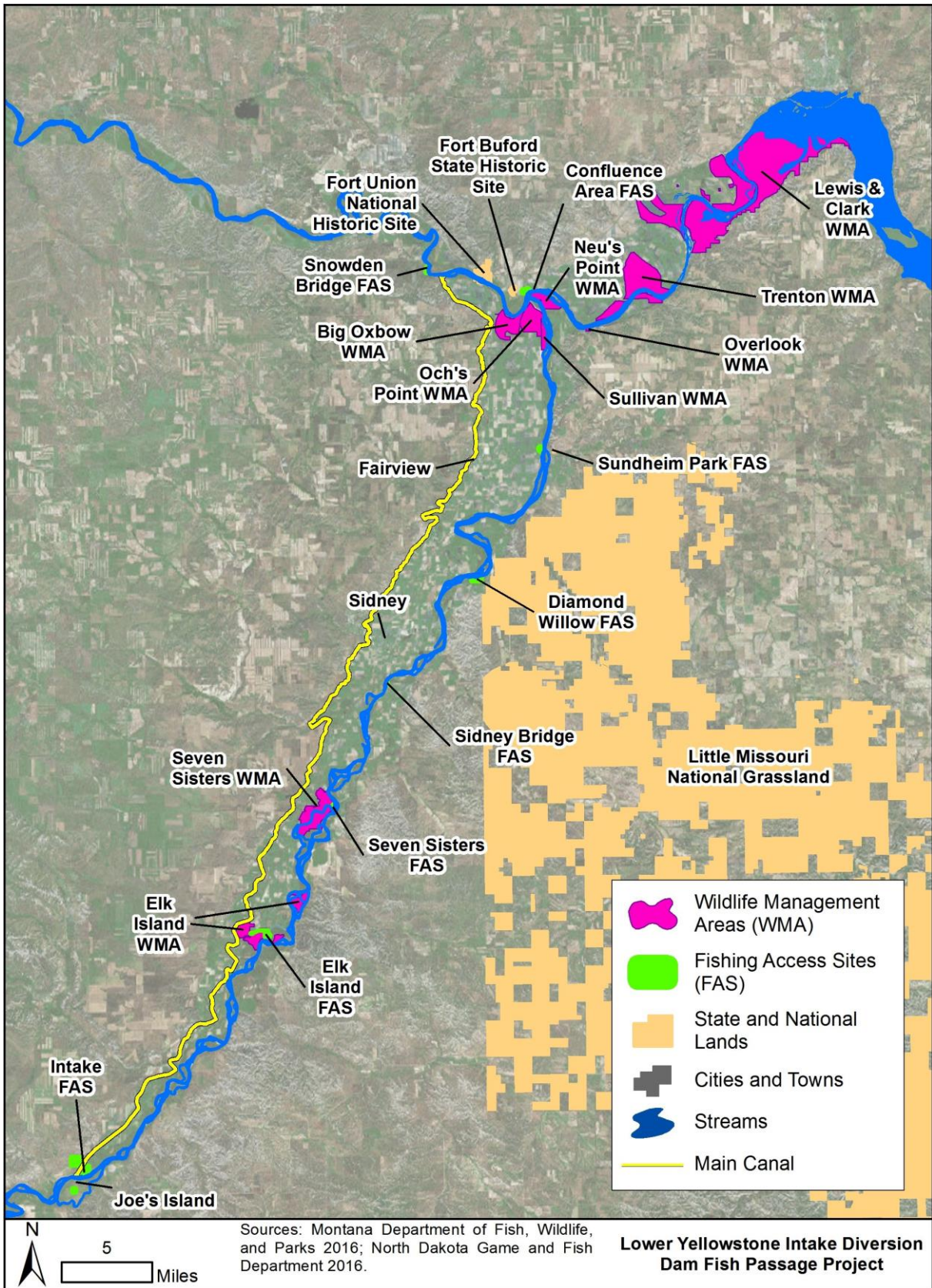

Figure 3-22. Recreation Resources

TABLE 3-20. RECREATION RESOURCES

Name	Managing Agency	Location	Facilities/Activities Description	Size (acres)
Intake FAS	MFWP	Yellowstone River at Intake Diversion Dam, left bank	Fishing, hunting, boat ramp, 17 campsites, potable water, vault toilets, day use parking.	93
Joe's Island	MFWP	Yellowstone River at Intake Diversion Dam, right bank	No facilities, accessed via gravel road from Glendive.	1,335
Elk Island Wildlife Management Area	MFWP	Yellowstone River, downstream of town of Savage, both banks	Fishing, hunting. No camping, no facilities other than at fishing access site.	1,070
Elk Island Fishing Access Site	MFWP	Yellowstone River, downstream of town of Savage, left bank	Concrete boat launch at upstream end usable during high flows only. New gravel boat ramp and parking area at downstream end with vault toilet. Day use only.	948
Seven Sisters Wildlife Management Area	MFWP	Yellowstone River, just upstream of town of Crane, left bank	Fishing, hunting. No camping, no facilities other than at fishing access site.	560
Seven Sisters Fishing Access Site	MFWP	Yellowstone River, just upstream of town of Crane, left bank	Fishing, hunting, primitive camping (no facilities), hand launch boats only. Road may be impassible during flood conditions.	2
Sidney Bridge Fishing Access Site	MFWP	Yellowstone River, upstream of Sidney, left bank	River access for boating and fishing. No camping or hunting. Concrete boat ramp and toilet.	2
Diamond Willow Fishing Access Site	MFWP	Yellowstone River, downstream of Sidney, right bank	Primitive site, may be impassible when wet. Fishing and hunting allowed. No camping. Hand boat launch only.	82
Sundheim Park Fishing Access Site	McKenzie County Park Board	Yellowstone River, Hwy 200 bridge in North Dakota, left bank	Walking trails, disc golf, picnic tables, concrete boat launch, vault toilet.	6
Sullivan Wildlife Management Area	NDGF	Yellowstone River upstream of confluence with Missouri River, on left bank	Unless otherwise specified, open to hunting, fishing, and trapping. No overnight camping.	265
Och's Point Wildlife Management Area	NDGF	At confluence of Missouri River and Yellowstone River, Yellowstone River left bank and Missouri River right bank	Unless otherwise specified, open to hunting, fishing, and trapping. No overnight camping.	1,000
Snowden Bridge Fishing Access Site	MFWP	Missouri River right bank upstream of Yellowstone River confluence	Three campsites, gravel boat ramp, vault toilet, hunting and fishing allowed.	12

Lower Yellowstone Intake Diversion Dam Fish Passage Project, Montana
Environmental Impact Statement
May 2016

Name	Managing Agency	Location	Facilities/Activities Description	Size (acres)
Fort Union National Historic Site	NPS	Missouri River left bank upstream of Yellowstone River confluence	Visitor center, parking lot, park grounds with historical structures, accessible, restrooms. On Lewis and Clark National Historic Trail.	412
Fort Buford State Historic Site and Missouri-Yellowstone Confluence Interpretive Center	North Dakota State Historical Society	Missouri River left bank upstream/at Yellowstone River confluence	Visitor center, parking lot, park grounds with historical structures, accessible, restrooms, campground, picnic area. Interpretive center includes permanent historical and cultural exhibits, located on the Lewis and Clark National Historic Trail.	58
Big Oxbow Wildlife Management Area	NDGF	Missouri River right bank upstream of Yellowstone River confluence	Unless otherwise specified, open to hunting, fishing, and trapping. No overnight camping. Boat access may be required.	987
Confluence Area Fishing Access Site	Williams County Water Resources District	Missouri River left bank at Yellowstone River confluence	Day use, parking lot, picnic shelter, concrete boat ramp, vault toilets. Listed as birding hotspot by Yellowstone Valley Audubon Society (YVAS 2015).	18
Neu's Point Wildlife Management Area	NDGF	At confluence of Missouri River and Yellowstone River, Yellowstone River right bank and Missouri River right bank	Unless otherwise specified, open to hunting, fishing, and trapping. No overnight camping.	500
Overlook Wildlife Management Area	NDGF	Missouri River right bank downstream of Yellowstone River confluence	Unless otherwise specified, open to hunting, fishing, and trapping. No overnight camping.	32
Trenton Wildlife Management Area	NDGF	Missouri River left bank downstream of Yellowstone River confluence	Unless otherwise specified, open to hunting, fishing, and trapping. No overnight camping.	2,647
Lewis and Clark Wildlife Management Area	NDGF	Missouri River left and right bank downstream of Yellowstone River confluence	Unless otherwise specified, open to hunting, fishing, and trapping. No overnight camping.	12,151
Little Missouri National Grassland	USFS	Right bank of Yellowstone River, approaches closest to river between Sidney and Fairview	Administered by the U.S. Forest Service as part of the Dakota Prairie Grasslands. Portions approaching the river are open space with no facilities or designated access, and are separated from the river by private land.	>1 million

Source: (Montana Fish, Wildlife & Parks 2016a); (Montana Fish, Wildlife & Parks 2016b) (North Dakota Game and Fish Department 2012b); (North Dakota State Historical Society 2013); (National Park Service 2016)



Figure 3-23. Intake FAS and Joe's Island

Joe's Island is an approximately 1,335-acre island on the right bank of the Yellowstone River directly across the river from the Intake FAS. Because it is on the right bank of the river, Joe's Island is accessible by car only via a gravel road out of Glendive, 20 miles to the south. Access to Joe's Island is limited by the existing high-flow side channel that flows around the southern edge of the island, which may become impassible during high flows. The island is also frequently accessed by boaters launching across the river at the Intake FAS. There are no facilities or amenities on Joe's Island. Visitation data is not recorded.

Both sites are local and regional resources for fishing, camping, boating, picnicking, and swimming. Hunting is not allowed on the developed portion of the Intake FAS, but the remainder of the site is open to archery and shotgun hunting during appropriate seasons and in accordance with State and local hunting regulations. Hunting is allowed on Joe's Island without firearm restrictions (see applicable State and local hunting regulations for current information). Species present in the area include deer, pheasant, waterfowl, turkey, rabbit, squirrels, etc. The activity that draws the most visitors to the area is fishing, especially the annual paddlefish season, as discussed in more detail in the next section (Reclamation and the Corps 2015).

3.11.2 Fishing

Game fish in the lower Yellowstone River include paddlefish, shovelnose sturgeon, walleye, sauger, catfish, bass, and trout. The protected pallid sturgeon must be released if caught. Fishing is a popular activity on the river along the whole length between Intake and the state line. The City of Sidney has two annual catfish tournaments. Two additional tournaments were proposed in 2015, one at Miles City, and one at Savage (Corps and YRCDC 2015).

The most popular game fish is the paddlefish, with nearly half of the annual visitation to the site occurring during the paddlefish season in May and June. Visitors come from across Montana and from other states. Paddlefish congregate on the downstream side of the Intake Diversion Dam, presenting an accessible location for paddlefish snagging. Fishing by boat is prohibited within a quarter-mile downstream of the Intake Diversion Dam during paddlefish season.

The MFWP monitors the number of paddlefish caught and closes the season when the quota is met, meaning the length of the season is variable and dependent upon angler success. In 2015, the quota was 1,000 paddlefish caught in the Missouri River downstream of Fort Peck Dam and the Yellowstone River. The Intake FAS has its own annual limit of 800 fish. In 2015, the harvest season lasted from May 15 through June 3, with catch-and-release closing on June 13 (Stuart 2015). The 2015 season was atypically long at Intake. In some years, the quota is met in a week (Reclamation and the Corps 2015).

3.11.3 Paddlefish Caviar

Montana law prohibits commercialization of fish and wildlife; however, special state legislation authorizes an MFWP-designated Montana non-profit corporation to accept paddlefish roe donations and process and market the roe as caviar. The MFWP issues a yearly memorandum of understanding to one non-profit corporation for this opportunity, which has been the Glendive Chamber of Commerce and Agriculture since the inception of the program in 1990.

The Chamber maintains a temporary cleaning station at the Intake FAS during the paddlefish season and offers free cleaning for all paddlefish caught on the Yellowstone River between the

Burlington Northern Railroad Bridge at Glendive, Montana, and the North Dakota state line. Roe from female paddlefish may be donated to the Chamber. Thirty percent of the proceeds from the sale of paddlefish caviar products, in excess of the costs of collection, processing, and marketing, must be deposited in a state fund established for MFWP. The funds and interest are used to support paddlefish fisheries, fishing access, habitat improvements, etc. The remaining 70 percent of the proceeds go to the non-profit association that processes and markets the caviar. The proceeds may be used to cover administrative costs and to fund historical, cultural, recreational, and fish and wildlife projects, or as seed money for grants (Reclamation and the Corps 2015).

In addition to the cleaning station, the Chamber is authorized to issue a 3-year concession permit for limited commercial services as the Intake FAS. The concessionaire typically pays a \$750 permit fee, sells food and drinks, and offers fishing tackle for rent or purchase. Additionally, the Chamber issues single-season subcontracts to support the cleaning station and roe donation service. Services provided by these subcontractors include administrative/liaison support, fish cleaning, roe processing, shuttle services for anglers, and transportation services for fish and roe products to the packaging center (Reclamation and the Corps 2015).

3.11.4 Boating

Boating is allowed (subject to state and local regulations or other restrictions) on the lower Yellowstone River, and access is provided via boat ramps at fishing access sites (refer to Table 3-20). The Intake FAS provides a concrete boat ramp below the Intake Diversion Dam. The nearest upstream access is at the Black Bridge FAS in Glendive, which has a concrete boat ramp. Downstream of Intake, the Elk Island FAS provides a gravel boat ramp at the downstream end of the site and an older concrete ramp at the upstream end of the site that may not be usable except during high flows.

Boaters are unlikely to travel upstream or downstream over the Intake Diversion Dam. Most boaters launching from the Intake FAS downstream for fishing, hunting, boat touring, or pulling persons on inner tubes or other flotation devices. Waterskiing is not a popular recreational activity at the Intake FAS. The Intake FAS may also be used by boaters to access Joe's Island.

3.11.5 Other Activities

Activities other than fishing, hunting, and boating that visitors may engage in at the Intake FAS include wildlife viewing, birdwatching, ice fishing, picnicking, and other general day use. Access to and enjoyment of the river is an important recreation activity; however the river itself poses hazards and threats due to swift currents and submerged hazards. Picnicking and day use facilities are open to the public at no cost, and may be used throughout the year. While most fishing visitation occurs during the spring, summer, and fall, anglers do engage in ice fishing during the winter. Because of the Intake Diversion Dam, the river typically freezes over at the Intake FAS, and anglers typically fish upstream or downstream of the Intake Diversion Dam.

Additionally, the Yellowstone River is designated as part of the Lewis and Clark National Historic Trail. National Historic Trails are managed in accordance with the National Trails System Act of 1968, as amended (16 USC 1241-1251) to recognize the resources, qualities, values and associated settings of the areas through which such trails may pass. While access to the river and some visitor amenities exist at the Intake FAS, there are limited opportunities to provide interpretive information about the Lewis and Clark National Historic Trail at this site.

However interpretive opportunities are available within local communities in the region. Within the study region, major interpretive and educational opportunities are available at Fort Union National Historic Site, managed by NPS (at the confluence of the Yellowstone and Missouri Rivers). Outside the study region, the next major opportunity along the Yellowstone River is upstream at Pompeys Pillar National Monument (managed by BLM near Pompeys Pillar, MT).

3.12 Visual Resources

Visual quality is narratively described in this section, including localized natural and man-made landscape features, as well as views of surrounding topography. The potential area of affected environment for visual resources consists of areas where construction and maintenance activities are proposed to take place. This includes the areas around the Intake Diversion Dam, Joe's Island where the bypass or existing side channel would be located, each of the proposed pumping station sites, and associated staging and access points.

The FAS adjacent to the river includes existing facilities and infrastructure, including gravel access roads, parking areas and day-use and campground facilities and are also present within the viewshed. Existing structures in this area have been present in the area for years and have historically dominated the immediate viewshed. However the predominant natural features and character offer the casual observer visual quality aspects in context of the broader landscape and viewshed. Design features can be incorporated to minimize disturbance to the viewshed and retain the visual character of the larger distant viewshed within the area.

In general, visual resources within the study area are dominated by the Yellowstone River, native and non-native vegetation communities, instream and floodplain habitats, transportation and utility infrastructure, agricultural lands, homes, and distant views of bluffs. Viewer groups that could be sensitive to changes in visual quality of the study area include local residents, recreationists, motorists, boaters, agriculture workers, and road or other infrastructure workers.

The following is a description of existing structures and facilities in and proximate to the analysis area.

3.12.1 Intake Diversion Dam and Surroundings, Including Pump Site #1

The Intake Diversion Dam at River Mile 73 on the Yellowstone River is the primary project location and the site of proposed Pump #1. Features at this site include the Intake Diversion Dam, the boulder field downstream of the dam, the intake structure, the Main Canal, recreational facilities, roads, and a railroad.

3.12.1.1 Intake Diversion Dam

The Intake Diversion Dam is a timber crib and rock weir reaching approximately 700 feet from bank to bank across the Yellowstone River, creating a large riffle (Figure 3-24). The riffle may extend to 300 feet downstream, as river dynamics and ice floes move rocks downstream. Additional rocks are placed in most years over the timber crib to replenish those that have moved downstream. This 700-foot long, submerged dam is a timber and stone-filled structure that spans the Yellowstone River and diverts water into the headworks of the Lower Yellowstone Project's Main Canal. An overhead cableway remains in place permanently to allow replacement of

rocks. The cableway has two wooden towers on either bank to suspend the metal cable directly over the Intake Diversion Dam.

The Intake Diversion Dam changes in appearance seasonally. In spring and fall, water may cover most rocks and appear as a large riffle. In winter, the entire feature may be obscured by ice. During late summer, rocks can become exposed. The timber crib is rarely, if ever, visible.



Figure 3-24. (Left) Low Water Exposes the Intake Diversion Dam Rock Weir; (Right) Higher Waters Create Riffle, Overhead Cableway Delivers Rocks to Weir

3.12.1.2 Headworks

Adjacent to the Intake Diversion Dam on the left (north) bank lies the headworks to the Main Canal. A new headworks structure (Figure 3-25) controls diversions of water into the canal and includes 12 removable rotating drum screens in the river to minimize entrainment of fish. The headworks structure supporting the screens measures 310 feet. Because screen design criteria specific to pallid sturgeon are lacking, the fish screens were constructed to meet salmonid criteria established by the U.S. Fish and Wildlife Service and National Marine Fisheries Service. Each drum screen is 6.5 feet in diameter and 25.2 feet in length. This structure controls the diversion of water into the Main Canal. The canal was originally designed with a 30-foot bottom width and 1.5:1 side slope. At full capacity the canal is designed to carry about 1,400 cfs at a flow depth of about 10 feet. The canal operates from May 1 through the end of September in a typical year, but may operate from April through October.



Figure 3-25. New Headworks at the Entrance of the Main Canal with Fish Screens Completed in 2011

3.12.1.3 Local Features

From points on and near the Intake Diversion Dam, views include the wide, turbid stretch of the Yellowstone River, screened headworks at the entrance of the Main Canal, the canal itself, a network of unpaved roadways, lands with exposed dirt, rock and sand shoreline along the river, agricultural lands, and sparse cottonwood and other vegetation communities. In winter, snow and ice may cover the area, creating a white expanse dotted by defoliated trees. In summer, the study area has a dichotomy of aesthetics, with areas around the canal and headworks having a barren and industrial appearance in contrast to the river and green cottonwood galleries providing a more natural look. On the south shore of the river, sandy shorelines, grasslands, shrublands, and cottonwood gallery make up the visual environment.

3.12.1.4 Distant Features

Distant views from higher points at the site are of the low elevation bluffs that are part of the Great Plains Badlands. William Clark of the Lewis and Clark Expedition wrote that the lands along the Yellowstone River near the town of Terry were “various colored earth...washed into curious formed mounds and hills and...cut much with ravines” (University of Nebraska 2016). The badlands are generally described as rugged, eroded, and often colorful land formations, where there is a relative absence of vegetative cover (MFWP 2016e).

3.12.1.5 Viewer Groups

Visitors to this area are primarily and most often recreationists. The site offers a boat ramp and shoreline fishing access, as well as camp sites, picnic tables, and natural areas where wildlife observation, birding, or other nature appreciation could be undertaken.

3.12.2 Joe’s Island

Joe’s Island, directly south of the Intake Diversion Dam, is an approximately 1,000-acre island formed by a side channel to the Yellowstone River (Figure 3-26). The island topography is shaped by overbank flooding and formation of side channels. Cottonwoods and other riparian trees and vegetation occupy the depressions where old side channels once flowed. A combination of native and non-native prairie and shrub steppe vegetation occupies the remaining areas (Figure 3-27). There are no homes, but a modest network of dirt roads provides access to most of

the island, including the right bank cableway tower. Distant views of low badlands bluffs can be seen to the south.



Figure 3-26. Aerial view of Joe's Island, Between the Yellowstone River and Side Channel to the South



Figure 3-27. View West Across Joe's Island During Winter, Bluffs in Distance

3.13 Transportation

The area of potential effect for transportation resources is defined as the transportation facilities adjacent to the Yellowstone River and the Main Canal between the Intake Diversion Dam and the confluence with Missouri River. Transportation-related resources and facilities further from the river are not likely to be impacted by construction or operation of a project that is within or adjacent to the river channel and canal.

Data used in this section was obtained primarily from the State of Montana Department of Transportation and the State of North Dakota Department of Transportation. Additional information was obtained from county and municipal agency websites, as cited.

3.13.1 Roadway Network

Figure 3-28 is an excerpt from the Montana Department of Transportation's Official Montana Highway Map showing the main roadways in the study area (Montana Department of Transportation 2013). State highway segments provide access between cities and towns in the vicinity, and a number of local paved and gravel roadways provide all other access.

Source: (Montana Department of Transportation 2013)

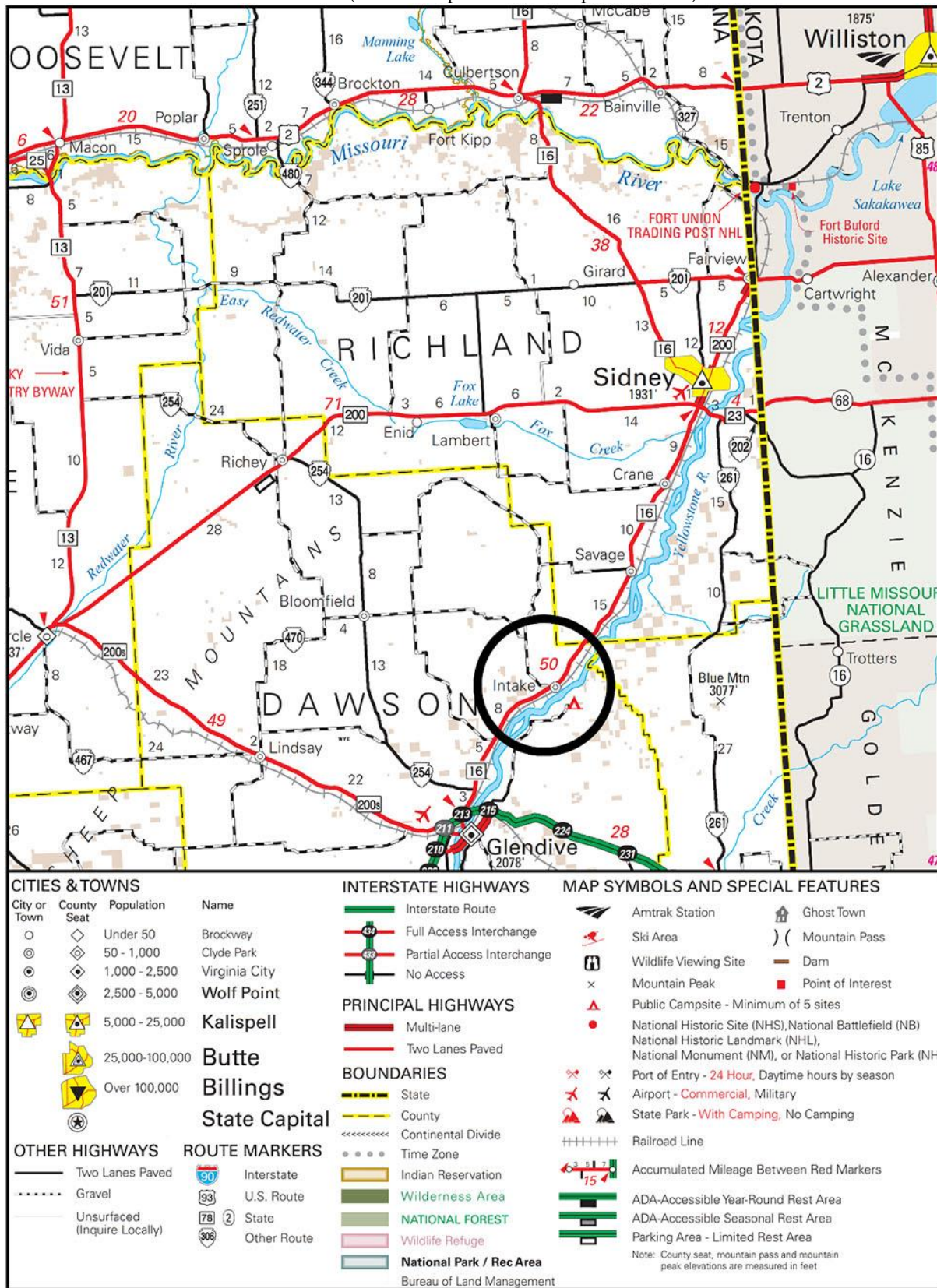

Figure 3-28. Transportation Resources

Adjacent to the Intake Diversion Dam, State Highway 16 is the only highway of note. It is the main thoroughfare along the left bank of the Yellowstone River between the City of Glendive and the City of Sidney, passing through the communities of Intake, Savage, and Crane. At Sidney, the highway turns northwest, away from the river, eventually crossing the Missouri River at Culbertson, Montana before intersecting U.S. Highway 2. Highway 200 continues along the river between Sidney and Fairview. It terminates at Route 201, which runs east-to-west and provides access to Cartwright, North Dakota on the right bank. These are all two-lane paved highways (State Highway 16 is a two-lane with a center turn lane in Sidney). U.S. Highway 2 runs east-to-west along the left bank of the Missouri River and provides the main thoroughfare between population centers along the Missouri River in Wolf Point, Montana and Williston, North Dakota.

Traffic data for highway segments was obtained from the Montana Department of Transportation and the North Dakota Department of Transportation (Montana Department of Transportation 2015, North Dakota Department of Transportation 2015b). Table 3-21 provides average annual daily traffic counts for key roadway segments in the study area; Figure 3-29 shows the locations of the counts in the table. The distance between towns in the study area can be seen on Figure 3-28. As shown in the table, the majority of the traffic moving through the area is along State Highway 16 between Glendive and Sidney, then along Highway 200 between Sidney and Fairview, then heading east into North Dakota, toward either Williston or Watford City.

TABLE 3-21. AVERAGE ANNUAL DAILY TRAFFIC

Route	Location Description	2014 Average Annual Daily Traffic	Site Code (see Figure 3-29)
MONTANA			
State Highway 16	North of I-94 in Glendive and north of Highland Park	4,480	11-5A-24
State Highway 16	North of Intake and southwest of Richland County line	3,210	42-4-1
State Highway 16	South of 4th Avenue in Savage	4,190	42-4-2
State Highway 16	0.5 miles northeast of Crane	4,880	42-4-3
State Highway 200	West of intersection with Hwy 16, south of Sidney	3,080	42-4A-45
State Highway 16	Between 5th Street and 4th Avenue, downtown Sidney	13,050	42-4A-15
State Highway 16	East of 35th Avenue, northeast of downtown Sidney	3,650	42-4A-53
State Highway 200	7.5 mi southwest of S-201, north of Sidney	7,610	42-2-1
State Highway 200	North of 2nd Street in Fairview, north of downtown Fairview, last counter in Montana before state line	7,110	42-2-14
State Highway 201	West of Dawson Avenue in Fairview, west of downtown Fairview	2,040	42-2-15
State Route 327	Left bank of Missouri River upstream of state line at Snowden	200	43-5-9
NORTH DAKOTA			
State Highway 200	West of ND 58 in Fairview, north of downtown Fairview, last counter in ND before state line	6,730	177
State Highway 58	South of Missouri River	5,710	28
State Highway 68	East of state line	1,170	144

Source: (Montana Department of Transportation 2015), (North Dakota Department of Transportation 2015b)

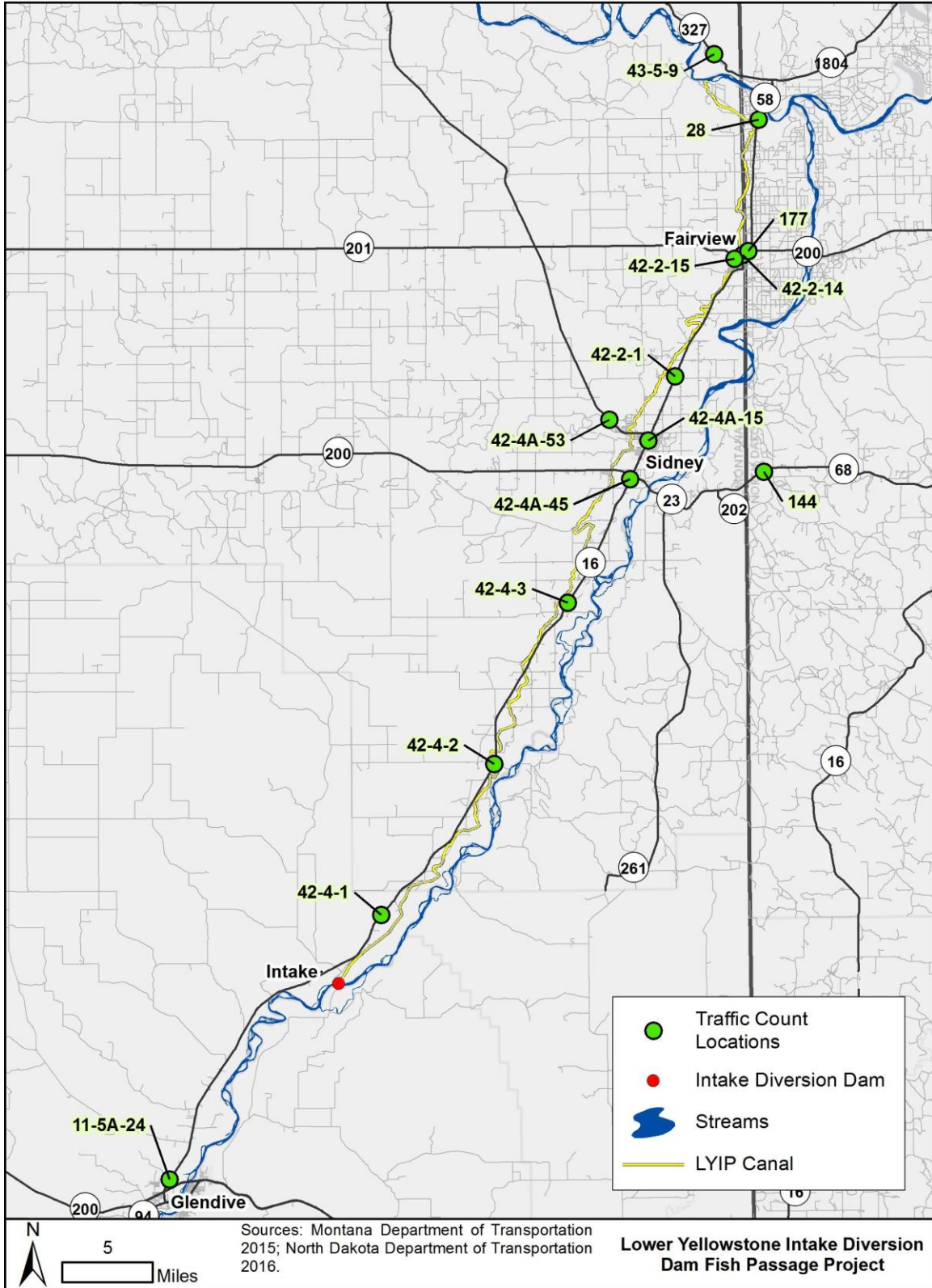

Figure 3-29. Traffic Count Locations

3.13.2 Public Transportation

The region around the Lower Yellowstone Project is largely rural, and public transportation infrastructure is limited to bus and van services. The larger cities in the region are served by for-profit bus companies as well, including Greyhound and Jefferson Lines. Jefferson Lines operates daily service linking Billings, Glendive, Sidney, Williston, Minot, and Bismarck (also ticketed by Greyhound). The larger cities in the region are served by for-profit bus charters as well, including Greyhound, Jefferson Lines, and Amtrak. County or regional transit agencies offer a range of services, from fixed route intra-city buses, to weekly inter-city routes, and on-demand door-to-door service.

3.13.3 Railroads

As shown in Figure 3-28, there is a rail line along the lower Yellowstone River from Glendive to the Missouri River confluence. This single-track line is a Class I freight railroad owned and operated by BNSF Railway, called the Sidney Line. In years prior to the recent oil production boom, BNSF Railway leased most operation of this length of track to the Yellowstone Valley Railroad. Following a steep increase in demand for rail services in the region, BNSF Railway has resumed the majority of operations in the region (Progressive Railroading 2011). Traffic on the line is predominantly coal and oil headed south from the Bakken and Three Forks region. In February 2015, BNSF Railway announced plans to make track upgrades along the Sidney Line to replace some old rails and to improve several bridges along the route (Lutey 2015).

BNSF Railway also operates a main east-west line through Montana that parallels U.S. Highway 2 and the Missouri River. This is a portion of the rail line between Seattle and Chicago. Amtrak has track rights along this main line, with stations in Williston, North Dakota, and Wolf Point, Montana, as shown on Figure 3-28. Amtrak's Thruway Connecting Services offer buses to Sidney and Glendive via the Jefferson Line for connection to Amtrak trains (Amtrak 2016).

3.13.4 Airports

Two small regional airports in the vicinity of the Lower Yellowstone Project (see Figure 3-28) offer general aviation services including fueling, maintenance, flight instruction, and charter services (Travel Montana 2015; Hyannis Air Service, Inc. (Cape Air) 2016):

- The Dawson Community Airport at Glendive has regional service provided by Cape Air, which flies two round-trips daily between Glendive and Billings (Dawson County 2011).
- The Sidney-Richland Airport outside Sidney has regional service provided by Cape Air, which flies five round-trips between Sidney and Billings daily.

The City of Williston, North Dakota operates the busiest airport in the region, at Sloulin Field International Airport. Sloulin Field is a small airfield, but has seen enormous increases in traffic since the spike in oil production in the region. It is served by national airlines. In September 2015 the Federal Aviation Administration signed the Finding of No Significant Impact for the proposed relocation and expansion of the airport (Sloulin Field International Airport 2016).

Fairview also has a small, unpaved airstrip outside of town, but minimal services are provided.

3.14 Noise

Noise is generally defined as unwanted or objectionable sound. The effects of noise on people can include general annoyance, interference with speech communication, sleep disturbance, and, in the extreme, hearing impairment.

Sound is a physical disturbance in a medium, such as air, that is capable of being detected by the human ear. Sound is measured in units of decibels (dB) on a logarithmic scale. The pitch of the sound is a description of frequency (high or low), which is measured in hertz. Most common environmental sounds are composed of a composite of frequencies.

A normal human ear can usually detect sounds with frequencies from 20 hertz to about 20,000 hertz. Humans are most sensitive to frequencies from 500 hertz to 4,000 hertz. Because human hearing is not equally sensitive to all frequencies of sound, certain frequencies are given more weight during assessment by applying A-weighted correction factors. These are widely applied in the industry to de-emphasize the very low and very high sound frequencies in a manner similar to the response of the human ear. A-weighted decibel levels (dBA) correlate well to a human's subjective reaction to noise.

Noise levels capable of being heard by humans are measured in dBA. A noise level change of 3 dBA is barely noticeable to people in a community. A 5-dBA change in noise level, however, is clearly noticeable. A 10-dBA change in noise level is perceived as a doubling or halving of noise loudness. A 20-dBA change is considered a dramatic change in loudness. Table 3-22 provides typical instantaneous noise levels of common activities in dBA.

TABLE 3-22. TYPICAL NOISE LEVELS

Common Outdoor Activities	Noise Level (dBA)	Common Indoor Activities
	110	Rock band
Jet fly-over at 1,000 feet	100	
Gas lawn mower at 3 feet	90	
Diesel truck at 50 miles per hour at 50 feet	80	Food blender at 3 feet
Noisy urban area daytime, gas lawn mower at 100 feet	70	Vacuum cleaner at 10 feet
Commercial area heavy traffic at 300 feet	60	Normal speech at 3 feet
Quiet urban daytime	50	Large business office, dishwasher in next room
Quiet urban nighttime	40	Theater, large conference room (background)
Quiet suburban nighttime	30	Library
Quiet rural nighttime	20	Bedroom at night
	10	Broadcast/recording studio
Lowest threshold of human hearing	0	Lowest threshold of human hearing

Source: Caltrans Technical Noise Supplement, October 1998

The outdoor ambient acoustic environment in the vicinity of a community varies throughout a typical day due to sound contributions from many sources such as natural sounds (e.g., wind), vehicles, stationary equipment, as well as short-duration single-event sources like aircraft and sirens. Evaluation of the community noise environment is based on measurements of noise exposure over a period of time to characterize cumulative noise impacts. The metrics are time-varying and are defined as statistical noise descriptors. The most common metrics for evaluating community noise are as follows:

- L_{eq} : The equivalent sound level, or the time-integrated continuous sound level, that represents the same sound energy as the varying sound levels, logarithmically averaged over a specified monitoring period
- L_{DN} : The day-night average sound level, representing a 24-hour A-weighted sound level average from midnight to midnight, with sound levels from 10 p.m. to 7 a.m. having an added 10 dB weighting.

The Project is located in a rural, sparsely populated area in northwestern Montana. The existing ambient noise environment in the immediate vicinity is mainly made up of natural sounds and vehicle noise associated with State Highway 16 and small community roadway segments near the Yellowstone River. There is also a BNSF Railway line adjacent to the river. There are no documented noise studies of measured ambient noise levels at or near the study area. Research shows that typical ambient noise levels for rural areas range from 35 to 40 dBA L_{eq} during the day and 30 to 35 dBA L_{eq} at night (Harris 1998).

The intake and the site of Pump #1 are in Dawson County north of Glendive, within the Yellowstone River. The nearest noise-sensitive receptors are the First Congregational Church of Intake and scattered residential homes to the north within a distance of 1 mile. The sites of Pumps #2 through #7 are in Richland County. Residential homes are scattered throughout the pump site areas, with the town of Knife River 0.3 miles from Pump #4, the town of Crane 2.7 miles from Pump #5, the City of Sydney 3 miles from Pump #6, and the town of Fairview 3 miles from Pump #7.

There are no federal, state, or local noise regulations directly affecting the Project site or offsite noise-sensitive receptors. The Environmental Protection Agency developed environmental noise criteria to be used as a guideline when no other local, county, or state standard has been established (EPA 1974). Table 3-23 summarizes the maximum recommended noise level for specified land use areas.

TABLE 3-23. MAXIMUM NOISE LEVELS TO PROTECT PUBLIC HEALTH AND WELFARE WITH AN ADEQUATE MARGIN OF SAFETY

Effect	Maximum Noise Level	Land Use Area
Hearing Loss	$L_{eq}(24) \leq 70$ dB	All Areas
Outdoor activity interference and annoyance	$L_{DN} \leq 55$ dB	Outdoors in residential areas and farms and other outdoor areas where people spend widely varying amounts of time and other places in which quiet is a basis for use.

Effect	Maximum Noise Level	Land Use Area
Hearing Loss	$L_{eq}(24) \leq 70$ dB	All Areas
	$L_{eq}(24) \leq 55$ dB	Outdoor areas where people spend limited amounts of time, such as school yards, playgrounds, etc.
Indoor activity interference and annoyance	$L_{DN} \leq 45$ dB	Indoor residential areas.
	$L_{eq}(24) \leq 45$ dB	Other indoor areas with human activities such as schools, etc.

Source: EPA 1974

An L_{DN} of 45 dBA indoors and 55 dBA outdoors for residential areas in a rural setting is identified as the maximum allowable noise level with no effect on public health and welfare (defined as interference with speech or other activities). These levels would protect the vast majority of the population under most conditions against annoyance.

3.15 Social and Economic Conditions

The social and economic study area includes counties that have social and economic links to the region that would be directly impacted by the Project. The study area includes Dawson, McCone, Prairie, Richland, Roosevelt, and Wibaux Counties in Montana and McKenzie and Williams Counties in North Dakota. Figure 3-30 shows the location of these counties in relation to the Lower Yellowstone Project. This section includes the socioeconomic characteristics of the counties within the study area and provides context for the information by comparing to statewide totals.

Indicators used to assess the study area are population size and age, employment and income, and housing characteristics. Additional socioeconomic indicators (race, educational attainment, poverty status, unemployment, and health insurance coverage status) are included in Section 3.16. The discussion of the agricultural industry focuses on the lands in agricultural use within the LYP, as these would experience direct effects of operational changes to the LYP.

Data used in this section was obtained from the U.S. Census Bureau, U.S. Department of Agriculture, State of Montana Department of Commerce, and the State of North Dakota Census Office. The information published by these agencies represents the most recently published data. However, with the recent growth and decline of the energy sector in eastern Montana and western North Dakota, conditions may change more quickly than annually published datasets can reflect. The discussion reflects best-available data and includes consideration of regional trends and projections as available in published datasets and reports.

A key data source for socioeconomic indicators was the U.S. Census Bureau's American Community Survey (ACS) program. The program continually collects survey data and publishes an updated dataset annually. The 2010-2014 ACS 5-Year dataset represents data collected over 60 months ending December 31, 2014. It is considered the most reliable source of information for analysis of small populations. It is also able to provide a consistent level of detail for all counties in the study area (U.S. Census Bureau 2015a).

Economic information specific to agriculture was obtained primarily from the U.S. Department of Agriculture and its various divisions, including the Census of Agriculture and the National Agricultural Statistics Service. County-level data from the 2012 Census of Agriculture was used to characterize the types of agricultural products produced on lands irrigated by the LYP (U.S. Department of Agriculture 2012). This dataset represents the most recently collected information for the region. Although the data are not specific to the LYP, it was possible to highlight the most relevant information by focusing on data related to irrigated cropland and grazing land, the two predominant agricultural land uses within the LYP. The National Agricultural Statistics Service's 2014 Cropland Data Layer provided a graphic representation of lands in the LYP by crop or use type (National Agricultural Statistics Service 2014).

In many cases social effects are less quantifiable, but can be described in terms of quality of life, which could include the quantity and quality of available resources or the health of regional industries, including energy, agriculture, and recreation opportunities. Outdoor recreation is a component of most lifestyles in the study area. Prominent recreation opportunities and key issues in the study area include fishing, camping, boating, hiking/walking, hunting, birdwatching, and wildlife viewing. Recreationists represent diverse groups of people and changes to recreation opportunities can affect individuals differently based on need and preference.

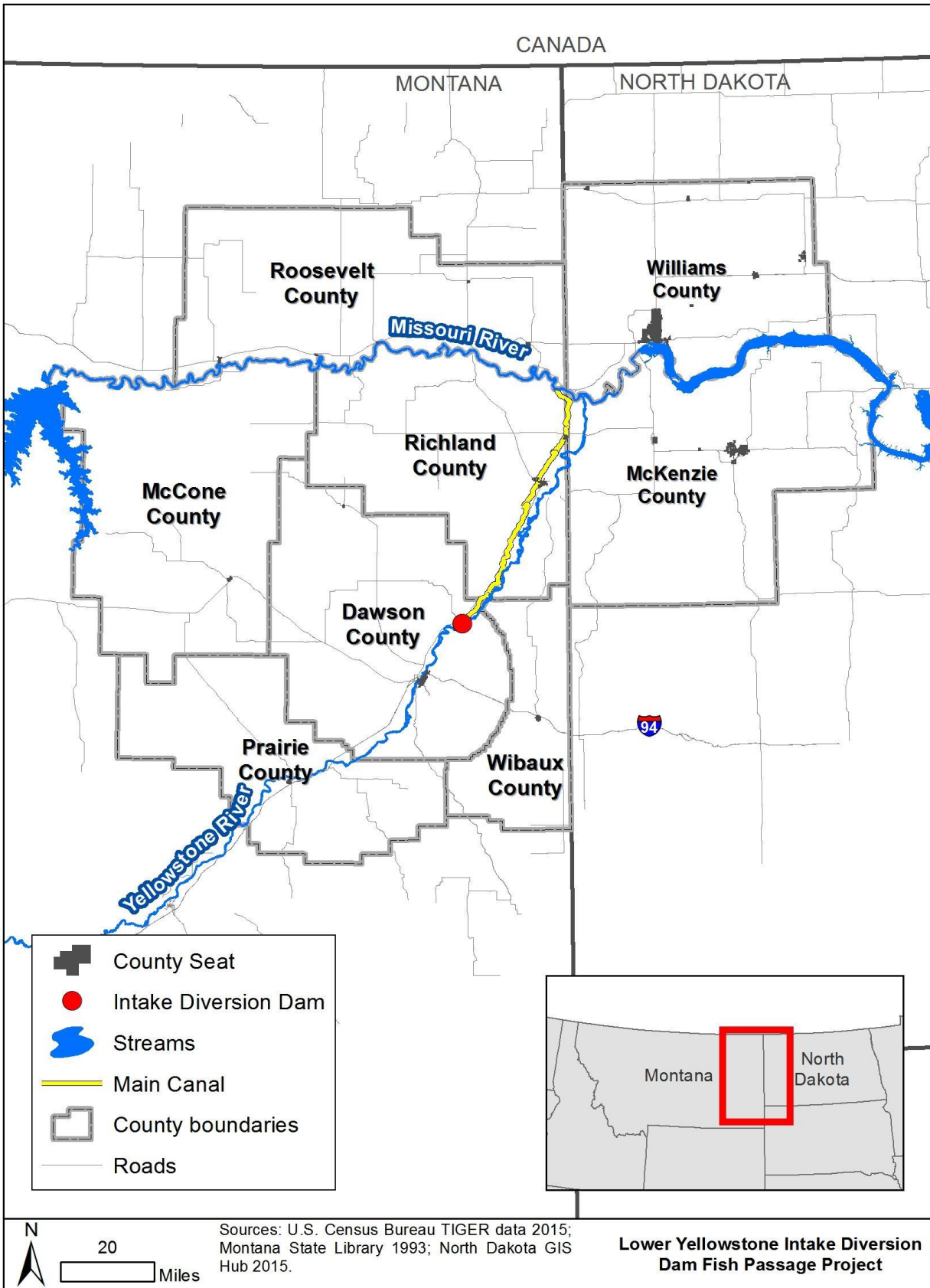

Figure 3-30. Socioeconomic Area of Potential Effect

3.15.1 Population

3.15.1.1 Population Size

Table 3-24 displays the estimated population of each county in the study area between 2010 and 2014. The counties are predominantly rural. The six Montana counties have a combined area of 12,157 square miles—8.2 percent of the state’s total area (Montana State Library 2015b). The two North Dakota counties have a combined area of 5,010 square miles—7.1 percent of North Dakota’s area (North Dakota State Water Commission 2013). With a total study area population of 70,192 in 2014, the population density of the study area is estimated at 4.1 people per square mile, which falls below both North Dakota’s and Montana’s overall population density of 10.5 and 7 people per square mile, respectively. While there are six counties included in Montana and just two in North Dakota, the two North Dakota counties account for just over 50 percent of the study area population. Prairie, McCone and Wibaux Counties together account for less than 6 percent of the total study area population.

TABLE 3-24. POPULATION BY COUNTY

Location	Population					Percent of Affected Area 2014 Total
	2010	2011	2012	2013	2014	
<i>Montana (statewide)</i>	<i>973,739</i>	<i>982,854</i>	<i>990,785</i>	<i>998,554</i>	<i>1,006,370</i>	
<i>North Dakota (statewide)</i>	<i>659,858</i>	<i>666,783</i>	<i>676,253</i>	<i>689,781</i>	<i>704,925</i>	
States Total	1,633,597	1,649,637	1,667,038	1,688,335	1,711,295	
Dawson, MT	8,933	8,961	9,022	9,132	9,219	13.1%
McCone, MT	1,714	1,815	1,808	1,794	1,758	2.5%
Prairie, MT	1,089	1,093	1,193	1,186	1,282	1.8%
Richland, MT	9,498	9,669	9,961	10,318	10,686	15.2%
Roosevelt, MT	10,273	10,323	10,477	10,665	10,861	15.5%
Wibaux, MT	1,067	964	899	928	987	1.4%
McKenzie, ND	6,004	6,262	6,692	7,377	8,333	11.9%
Williams, ND	21,194	22,046	23,287	25,024	27,066	38.6%
Total Study Area	59,772	61,133	63,339	66,424	70,192	100%

Source: U.S. Census Bureau 2015a

Table 3-25 presents the estimated population of the city or town that is the county seat for each county in the study area. Williston, North Dakota, in Williams County, is the largest city in the study area, followed by Sidney and Glendive in Montana. The population of the county seats represents over half of the total population of the study area. The City of Williston, as the center of oil production in the area, accounts for nearly three quarters of the population of Williams County and between one-quarter and one-third of the total population in the study area.

TABLE 3-25. POPULATION BY COUNTY SEAT

County Seat	County	2014 County Seat Population	Percent of County's Population	Percent of Study Area Population
Glendive	Dawson, MT	5,167	56.0%	7.4%
Circle	McCone, MT	614	34.9%	0.9%
Terry	Prairie, MT	686	53.5%	1.0%
Sidney	Richland, MT	5,888	55.1%	8.4%
Wolf Point	Roosevelt, MT	2,730	25.1%	3.9%
Wibaux	Wibaux, MT	513	52.0%	0.7%
McKenzie	McKenzie, ND	2,738	32.9%	3.9%
Williston	Williams, ND	19,849	73.3%	28.3%

Source: U.S. Census Bureau 2015a

The study area's total population is trending upward in nearly all counties. Between 2010 and 2014, the total population of the study area grew by 17.4 percent, which greatly outpaced Montana's (3.35 percent) and North Dakota's (6.8 percent) overall growth for the same period. The growth in the study area's population is largely attributable to the increase in production of shale oil in the Williston Basin's Bakken and Three Forks formations in North Dakota and Eastern Montana, as shown in Figure 3-31 (Kulbeth and Coleman 2014).

3.15.1.2 Population Growth

Low oil prices in 2015 have led to a leveling off of oil production in the region, introducing substantial uncertainty regarding growth trends in the coming years (North Dakota Department of Mineral Resources 2015). Because continued growth is highly dependent upon oil production, Montana's Department of Commerce and North Dakota's Department of Commerce accounted for this in their most recent county-by-county population projections (Montana Department of Commerce 2013 and North Dakota Department of Commerce 2016). Table 3-26 summarizes projected growth in the eight study area counties. As shown in the table, growth in the Montana portion of the study area is expected to match or outpace the state as a whole for another 10 years, after which growth begins to slow, level off, and possibly decline as oil resources are depleted. In North Dakota, a much larger initial period of growth is expected, such that even as growth slows toward the end of the projection period, it still outpaces statewide growth substantially.

3.15.1.3 Population Age

Population growth stemming from one industry can affect the age of the population. Table 3-27 summarizes population age by county based on the 2014 ACS (U.S. Census Bureau 2015a). Age distributions vary substantially by county. In Montana, Roosevelt and Richland Counties have a greater percentage of working age people, and lower percentage of people over 65, than the state as a whole. However, Wibaux, Prairie, McCone, and Dawson Counties all have a greater number of people over 65 than the state as a whole and fewer children. In North Dakota, both McKenzie and Williams Counties show more working age people and fewer people over 65 than the state as a whole. Comparing these data to Figure 3-31 shows that counties within the major energy production areas have younger populations than the states as a whole.

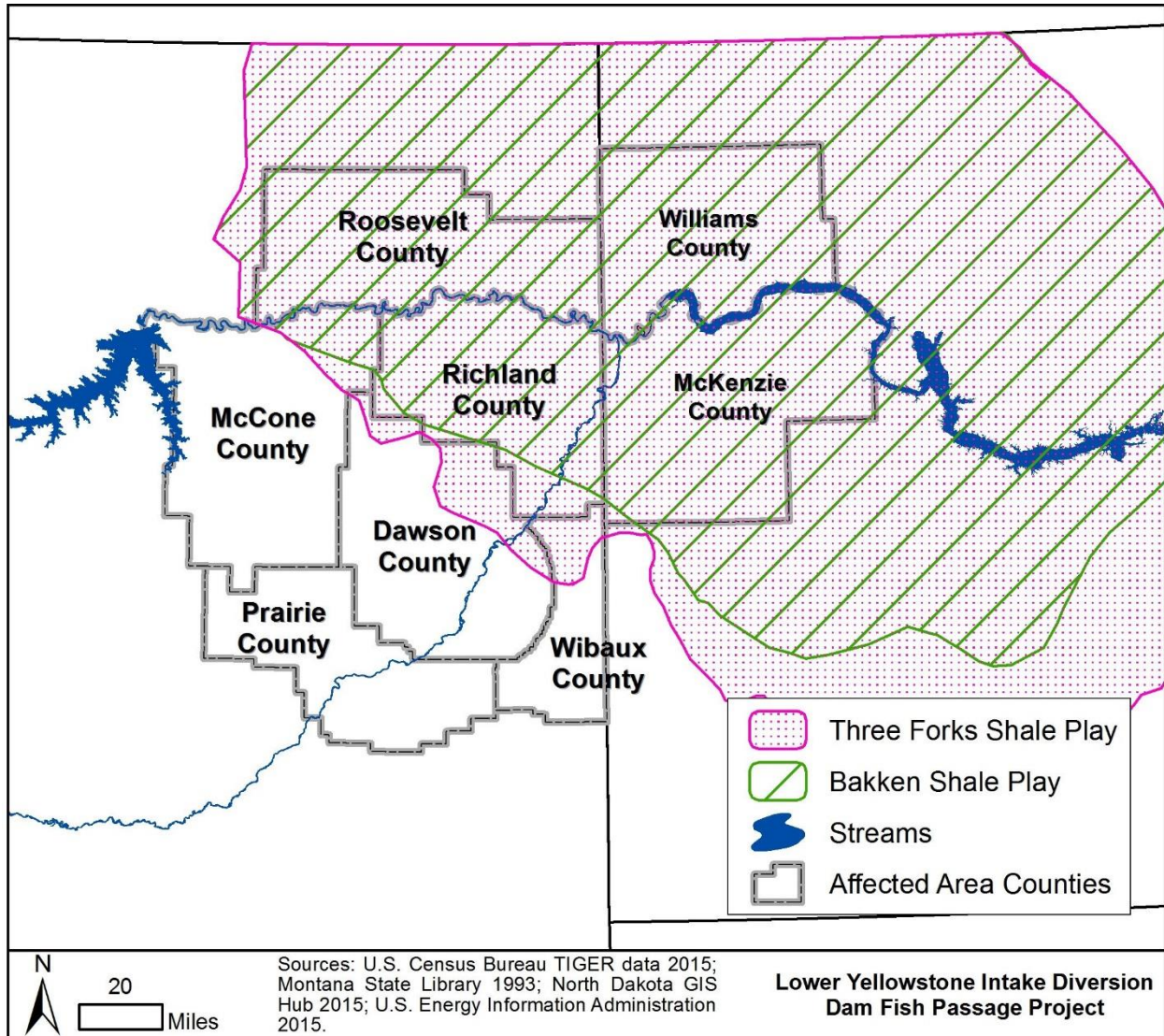

Figure 3-31. Shale Oil Plays near the Area of Potential Effect

TABLE 3-26. POPULATION PROJECTION FOR MONTANA COUNTIES

Location	Percent Change Over the Period			
	2015-2020	2020-2025	2025-2030	2030-2035
<i>Montana (statewide)</i>	4.9%	3.6%	2.0%	0.5%
Dawson, MT	3.6%	2.4%	0.7%	-1.0%
McCone, MT	4.5%	2.5%	0.1%	-1.8%
Prairie, MT	8.0%	5.1%	1.4%	-2.0%
Richland, MT	9.3%	5.8%	2.7%	0.2%
Roosevelt, MT	2.3%	1.2%	-0.3%	-2.7%
Wibaux, MT	4.6%	3.7%	3.6%	2.6%
<i>North Dakota (statewide)</i>	8.9%	7.3%	5.3%	3.7%
McKenzie, ND	35.9%	23.6%	14.7%	9.4%
Williams, ND	27.3%	19.5%	12.6%	8.5%

Source: Montana Department of Commerce 2013, North Dakota Department of Commerce 2016

TABLE 3-27. POPULATION AGE

Location	Under 18 years old (%)	18- 65 years old (%)	Over 65 years old (%)
<i>Montana (statewide)</i>	22.2%	62.1%	15.7%
<i>North Dakota (statewide)</i>	22.5%	63.2%	14.3%
Dawson, MT	15.1%	67.8%	17.1%
McCone, MT	13.1%	64.2%	22.7%
Prairie, MT	15.0%	57.5%	27.5%
Richland, MT	16.6%	69.5%	13.9%
Roosevelt, MT	22.1%	67.2%	10.7%
Wibaux, MT	18.6%	56.9%	24.5%
McKenzie, ND	20.2%	68.8%	11.0%
Williams, ND	16.6%	71.9%	11.5%

Source: U.S. Census Bureau 2015a

3.15.2 Households and Families

Table 3-28 summarizes the number of households and families in the study area counties, as well as the proportion of housing that is owner and renter occupied. A household consists of all residents living in a single housing unit, whether a single resident, a family or unrelated residents. Families represent only households with at least two residents who are related.

TABLE 3-28. HOUSEHOLDS AND FAMILIES

Location	Total Households	Percent Owner Occupied	Percent Renter Occupied	Total Families	Average Family Size
<i>Montana (statewide)</i>	486,782	67.7%	32.3%	256,008	2.98
<i>North Dakota (statewide)</i>	332,010	65.1%	34.9%	178,003	2.93
States Total	818,792	66.6%	33.4%	434,011	2.96
Dawson, MT	3,884	69.4%	30.6%	2,678	2.68
McCone, MT	762	80.8%	19.2%	509	2.83
Prairie, MT	525	86.9%	13.1%	344	2.91
Richland, MT	4,294	67.5%	32.5%	2,743	3.09
Roosevelt, MT	3,142	59.7%	40.3%	2,034	4.46
Wibaux, MT	437	72.5%	27.5%	280	2.75
McKenzie, ND	2,755	68.6%	31.4%	1,894	3.57
Williams, ND	11,113	67.9%	32.1%	6,865	2.97
Total	26,912	68.0%	32.0%	17,347	3.18

Source: U.S. Census Bureau 2015a

Overall, the study area reflects housing patterns similar to those of the states as a whole. Outliers include the relatively low number of renters in McCone and Prairie Counties, and the higher than average family size in Roosevelt and McKenzie Counties.

3.15.3 Home Value

Table 3-29 summarizes the median home value for owner-occupied units with and without a mortgage. In Montana, home values in the study area are below the statewide median because the Montana counties do not contain large urbanized areas where real estate values tend to be higher. The median home values in the two North Dakota counties exceed the statewide median, due to the presence of the City of Williston in Williams County and Watford City in McKenzie County. Those cities are regional population centers that have experienced substantial growth in response to the region’s oil and gas boom over the last five years.

TABLE 3-29. MEDIAN HOME VALUE

Location	Median Value for Owner Occupied Units without a Mortgage	Median Value for Owner Occupied Units with a Mortgage
<i>Montana (statewide)</i>	<i>\$203,200</i>	<i>\$161,900</i>
<i>North Dakota (statewide)</i>	<i>\$158,800</i>	<i>\$111,100</i>
Dawson, MT	\$160,500	\$119,600
McCone, MT	\$161,500	\$101,100
Prairie, MT	\$126,800	\$78,900
Richland, MT	\$174,300	\$141,800
Roosevelt, MT	\$99,200	\$76,300
Wibaux, MT	\$116,700	\$102,200
McKenzie, ND	\$201,600	\$158,700
Williams, ND	\$185,500	\$160,300

Source: U.S. Census Bureau 2015a

3.15.4 Industries, Employment, and Income

The regional economy of the study area is driven by the following industries:

- Educational services, and health care and social assistance
- Mining, quarrying, and oil and gas extraction
- Transportation and warehousing, and utilities
- Construction
- Agriculture, forestry, fishing and hunting
- Retail trade.

Detailed summaries of economic activity by industry are presented in Table 3-30 to Table 3-34. Table 3-30 presents combined full-time civilian employment by industry for the study area counties. Table 3-32 presents the same data separately for each county, and provides statewide values for comparison (U.S. Census Bureau 2015a). Table 3-31 presents median household and family income by county for the study area. Table 3-33 presents median earnings by industry and county. Table 3-34 presents estimates of hired farm labor and contract labor costs for the agricultural industry by county (U.S. Department of Agriculture 2012).

As shown in the tables, the proportion of jobs in agriculture is greater in Montana counties than in North Dakota counties. In North Dakota, there are a greater proportion of jobs in the energy industry. Median earnings are higher in the energy industry than in the agricultural industry. The large impact of the energy sector on the regional economy is especially evident in Williams,

McKenzie, Richland, and Wibaux counties. Future boom and bust cycles the energy sector would affect 8-county regional economy, including direct impacts on employment and income, as well as indirect effects on tax revenues and other industries dependent on consumer spending. The presence of a healthy regional agricultural industry, not directly tied to the energy sector, may provide a moderating and stabilizing influence during periods of volatility in other primary industries. While a smaller proportion of regional economic, the recreation and tourism industries provide a similar stabilizing effect, as well as being a vital component of the social character of the study region. Other than the industry-level data reported below, there is little baseline data on recreation/tourism revenue in the study region. Recreation visitation is not recorded, and tourism revenues are not readily available.

TABLE 3-30. EMPLOYMENT BY INDUSTRY FOR THE STUDY AREA

Industry	Employment Proportion (%)^a	Reported Full Time Jobs ^b
Educational services, and health care and social assistance	16.9%	4,330
Mining, quarrying, and oil and gas extraction	13.6%	3,492
Transportation and warehousing, and utilities	9.5%	2,440
Construction	9.2%	2,362
Agriculture, forestry, fishing and hunting	9.2%	2,360
Retail trade	8.9%	2,285
Public administration	6.0%	1,536
Professional, scientific, and management, and administrative and waste management services	4.8%	1,239
Manufacturing	4.4%	1,131
Arts, entertainment, and recreation, and accommodation and food services:	4.4%	1,119
Finance and insurance, and real estate and rental and leasing:	4.2%	1,086
Other services, except public administration	4.0%	1,028
Wholesale trade	3.3%	856
Information	1.4%	349

Source: U.S. Census Bureau 2015a

- a. Based on the proportion of full-time civilian employees 16 years and older.
- b. Total number of full-time, year-round, civilian employees 16 years and older as reported in the ACS. This does not include part time jobs and is not the same as full-time-equivalent jobs, which does account for part-time (fractional) employment.

TABLE 3-31. MEDIAN INCOME BY COUNTY

Location	Median Household Income (\$)	Median Family Income (\$)
<i>Montana (statewide)</i>	<i>\$46,766</i>	<i>\$60,581</i>
<i>North Dakota (statewide)</i>	<i>\$46,766</i>	<i>\$72,770</i>
Dawson, MT	\$49,955	\$64,940
McCone, MT	\$48,194	\$65,625
Prairie, MT	\$40,580	\$46,000
Richland, MT	\$61,438	\$70,417
Roosevelt, MT	\$36,825	\$48,585
Wibaux, MT	\$39,097	\$57,143
McKenzie, ND	\$67,578	\$86,731
Williams, ND	\$82,823	\$93,778

Source: (U.S. Census Bureau, 2010-2014 American Community Survey 5-Year Estimates 2015)

TABLE 3-32. PROPORTION OF EMPLOYMENT BY INDUSTRY AND COUNTY

Industry	Montana Statewide (%)	North Dakota Statewide (%)	Dawson, MT (%)	McCone, MT (%)	Prairie, MT (%)	Richland, MT (%)	Roosevelt, MT (%)	Wibaux, MT (%)	McKenzie, ND (%)	Williams, ND (%)
Agriculture, forestry, fishing and hunting	6.1%	6.7%	10.0%	34.0%	35.1%	10.0%	12.5%	21.7%	10.4%	4.4%
Mining, quarrying, and oil and gas extraction	2.3%	3.6%	6.4%	0.8%	3.1%	14.3%	3.7%	11.8%	15.4%	19.1%
Construction	8.0%	8.1%	5.7%	8.5%	7.3%	9.7%	8.1%	3.5%	7.0%	11.3%
Manufacturing	5.4%	8.4%	2.8%	1.3%	1.2%	5.2%	3.1%	2.5%	5.0%	5.2%
Wholesale trade	3.0%	4.1%	1.7%	1.3%	0.9%	3.6%	1.6%	0.6%	2.9%	4.6%
Retail trade	11.3%	10.2%	8.1%	11.4%	13.2%	11.4%	8.5%	9.6%	8.0%	8.2%
Transportation and warehousing, and utilities	5.7%	6.2%	15.7%	5.2%	3.1%	10.8%	5.4%	13.1%	11.2%	8.4%
Information	2.1%	1.7%	4.1%	3.1%	0.9%	0.0%	0.9%	1.9%	1.2%	1.1%
Finance and insurance, and real estate and rental and leasing	6.8%	6.7%	3.1%	5.6%	1.9%	5.7%	2.1%	4.8%	5.7%	4.2%
Professional, scientific, and management, and administrative and waste management services	7.9%	6.7%	6.5%	3.7%	4.0%	3.5%	2.6%	4.8%	3.1%	6.1%
Educational services, and health care and social assistance	21.7%	22.0%	16.1%	14.0%	17.2%	13.3%	29.3%	15.6%	10.8%	17.0%
Arts, entertainment, and recreation, and accommodation and food services	6.8%	5.1%	5.6%	3.0%	0.9%	5.8%	4.5%	1.3%	7.7%	2.9%
Other services, except public administration	4.3%	4.2%	5.7%	1.7%	5.9%	3.8%	1.6%	0.0%	5.5%	4.1%
Public administration	8.5%	6.3%	8.4%	6.6%	5.4%	3.0%	16.1%	8.9%	6.0%	3.5%

Source: U.S. Census Bureau 2015a

TABLE 3-33. MEDIAN EARNINGS BY INDUSTRY AND COUNTY

Industry	Montana statewide (\$)	North Dakota statewide (\$)	Dawson, MT (\$)	McCone, MT (\$)	Prairie, MT (\$)	Richland, MT (\$)	Roosevelt, MT (\$)	Wibaux, MT (\$)	McKenzie, ND (\$)	Williams, ND (\$)
Agriculture, forestry, fishing and hunting	\$27,601	\$39,314	\$17,813	\$31,202	\$20,625	\$30,833	\$42,561	\$34,167	\$30,625	\$63,750
Mining, quarrying, and oil and gas extraction	\$62,897	\$70,903	\$83,333	D	D	\$60,000	\$37,917	\$57,083	\$63,529	\$70,859
Construction	\$34,502	\$40,445	\$32,333	\$37,670	\$26,563	\$35,536	\$33,750	\$41,250	\$41,107	\$60,673
Manufacturing	\$34,494	\$39,907	\$45,921	\$28,500	D	\$36,964	\$37,000	D	\$49,250	\$44,375
Wholesale trade	\$36,859	\$42,555	\$46,932	\$50,469	D	\$35,865	\$38,750	D	\$50,598	\$42,045
Retail trade	\$21,338	\$23,082	\$19,621	\$29,091	\$32,500	\$26,604	\$27,778	\$39,583	\$22,708	\$25,450
Transportation and warehousing, and utilities	\$43,607	\$51,126	\$62,426	\$29,821	\$29,792	\$39,130	\$33,333	\$35,268	\$64,886	\$62,398
Information	\$32,138	\$37,043	\$33,988	\$34,545	D	D	\$34,375	D	\$62,000	\$81,328
Finance and insurance, and real estate and rental and leasing	\$33,914	\$35,939	\$20,682	\$30,500	\$37,969	\$33,240	\$33,661	\$41,000	\$33,911	\$33,871
Professional, scientific, and management, and administrative and waste management services	\$32,440	\$36,076	\$27,917	\$24,773	\$18,875	\$35,900	\$32,024	\$28,750	\$21,875	\$41,324
Educational services, and health care and social assistance	\$29,164	\$31,090	\$30,163	\$35,859	\$30,089	\$35,357	\$30,911	\$18,750	\$32,695	\$31,671
Arts, entertainment, and recreation, and accommodation and food services	\$13,504	\$13,423	\$16,364	\$7,500	D	\$14,872	\$19,559	\$33,125	\$13,851	\$12,315
Other services, except public administration	\$21,155	\$27,054	\$14,808	\$27,500	\$33,750	\$25,789	\$10,625	D	\$31,136	\$37,917
Public administration	\$42,232	\$44,026	\$41,813	\$31,875	\$35,893	\$33,359	\$34,545	\$20,962	\$40,000	\$48,571

Source: U.S. Census Bureau 2015b

a. "D" indicates data was suppressed in the source.

TABLE 3-34. SUMMARY OF FARM LABOR COSTS

Location	Farm Labor (\$ 2012) ^a	Percent of Effected Area Total
<i>Montana (statewide)</i>	<i>\$279,032,000</i>	
<i>North Dakota (statewide)</i>	<i>\$314,312,000</i>	
States Total	\$593,344,000	
Dawson, MT	\$3,223,000	10.0%
McCone, MT	\$3,094,000	9.6%
Prairie, MT	\$1,334,000	4.1%
Richland, MT	\$9,123,000	28.2%
Roosevelt, MT	\$4,540,000	14.0%
Wibaux, MT	\$1,973,000	6.1%
McKenzie, ND	\$5,052,000	15.6%
Williams, ND	\$4,029,000	12.4%
Total Study Area	\$32,368,000	100%

Source: U.S. Department of Agriculture 2012

a. Includes both Hired Farm Labor and Contract Farm Labor. Hired farm labor includes the total amount paid for farm or ranch labor including regular workers, part-time workers, and members of the operator's family if they received payments for labor. Expenses include social security taxes, State taxes, unemployment tax, payment for sick leave or vacation pay, workman's compensation, insurance premiums, and pension plans. Contract labor include payments made to contractors, crew leaders, cooperatives, or any other organization hired to furnish a crew of laborers to do a job that may involve one or more agricultural operations.

Industry data was obtained from multiple sources. For most industries, U.S. Census Bureau datasets provide the best data (U.S. Census Bureau 2015a). The 2012 Census of Agriculture from the U.S. Department of Agriculture was also referenced regarding economic activity from agriculture in the study area (U.S. Department of Agriculture 2012). Further discussion of the agricultural industry in the study area is provided in the next section. Other socioeconomic indicators related to employment and income are discussed in Section 3.16.

3.15.5 Agriculture in the Lower Yellowstone Project Area

3.15.5.1 Background

The LYP provides irrigation to about 55,000 acres of farmland along the lower Yellowstone River. Acreage irrigated by the LYP is generally located between the Main Canal and the river in the Montana counties of Dawson and Richland, as well as in McKenzie County, North Dakota (see Figure 3-32).

The LYP facilities are owned by the Bureau of Reclamation but are operated and maintained by the water users via irrigation districts and the Board of Control of the Lower Yellowstone Project. Members of the Board of Control include the Intake Irrigation District, the Savage Irrigation District, and the Lower Yellowstone Irrigation Districts #1 and #2. The entire irrigation area and facilities are collectively referred to as the Lower Yellowstone Project. All of the irrigation districts obtain water from the LYP's Main Canal (Reclamation and the Corps 2015).

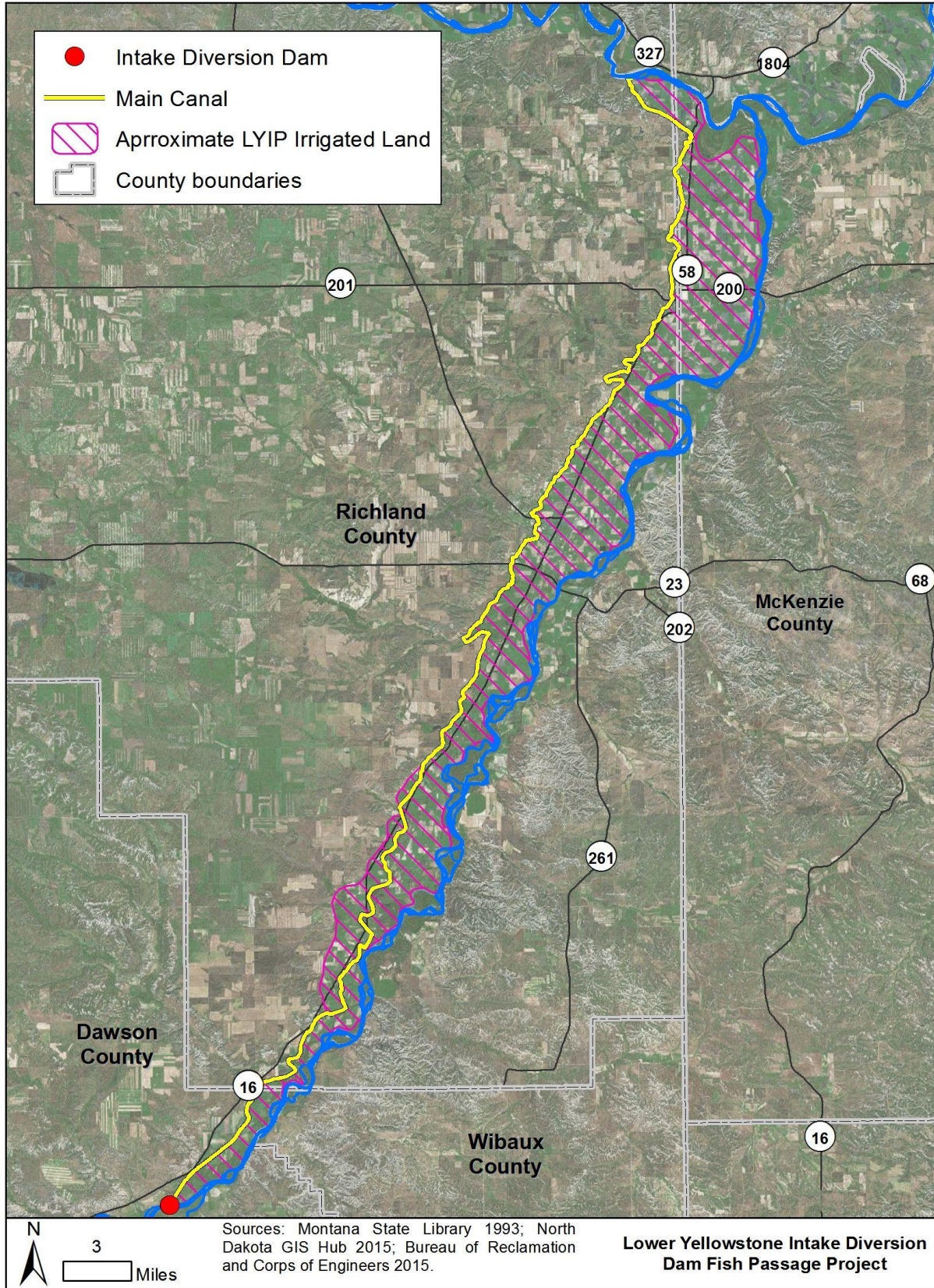

Figure 3-32. Approximate Lands Irrigated by the LYP

The agricultural economy and the lands served by the LYP have remained relatively stable since the early 1950s. In contrast to a dry-land farming trend toward larger, consolidated farms, the number of farm units on the LYP has dropped only slightly. Until recently, the primary irrigated crop was sugar beets, with some small grains, alfalfa, and corn. Recently, commodity prices have caused a shift to more corn and small grain production, with a corresponding decline in sugar beet acreage. Sugar beets remain the highest crop in terms of valuation, accounting for over half the total crop revenue in 2014 (see Table 3-37).

3.15.5.2 Farm Characteristics

Table 3-35 provides County-level summary information from the 2012 Census of Agriculture (U.S. Department of Agriculture 2012). Irrigated farms are a minority within the counties as a whole. Richland County has the greatest share of irrigated acres among the three counties by a large margin; this is consistent within the LYP as well, since most of the irrigated lands are within this county (see Figure 3-32).

Figure 3-33 shows the distribution of croplands in the LYP using the Cropland Data Layer for the 2014 growing season (National Agricultural Statistics Service 2014). This dataset is developed annually for the whole nation based on specialized processing of satellite imagery and extensive ground-truthing at a resolution of 30 meters. The figure includes a symbol for seven crops, grass/pastureland, and idle/fallow cropland. Together, these represent over 98 percent of the acreage in agricultural use within the LYP according to the 2014 Cropland Data Layer. The dataset was developed at a gross scale and should be considered in terms of the relative distribution of croplands, not assumed to provide precise measurement.

Actual crop acreages for the LYP were obtained directly from the LYP Board of Control, whose most recent acreage survey was conducted in 2013 (Lower Yellowstone Project Board of Control 2013). Table 3-36 presents these reported crop acreages for lands irrigated by the LYP. Total irrigated acreage is estimated at 55,158 acres.

As shown in the figure and table, sugar beets, wheat, alfalfa, and barley together account for 80 percent of the cropland irrigated by the LYP. Using recent crop yields and prices from the National Agricultural Statistics Service, a production value (gross revenue) of about \$51.2 million dollars may be estimated for lands irrigated by the LYP. This estimate illustrates that while the LYP makes up under 2 percent of land in farms in the three counties, it accounts for about 15 percent of the market value of agricultural products sold. This indicates that the value of the LYP to the agricultural industry of the counties, and of the region, is substantial.

A review of USDA's farmland classification map database shows that much of the farmland near the Lower Yellowstone River is considered prime farmland if irrigated or farmland of statewide significance (USDA 2016a). Prime farmland, as defined by the U.S. Department of Agriculture, is "land that has the best combination of physical and chemical characteristics for producing food, feed, forage, fiber, and oilseed crops and is available for these uses. It could be cultivated land, pastureland, forestland, or other land, but it is not urban or built-up land or water areas." Farmland of statewide significance is farmland that does not meet the criteria for prime or unique farmland but meets the State of Montana's criteria of importance in the production of food, feed,

fiber, forage, and oilseed crops (USDA 2016b). It should also be noted that there are considerable areas near or adjacent to the river that are classified as “Not Prime Farmland.”

TABLE 3-35. COUNTY-LEVEL FARM CHARACTERISTICS

	Dawson, MT	Richland, MT	McKenzie, ND
Farms			
Total Farms	485	544	574
Average Size (acres)	2,594	2,377	1,854
Median Size (acres)	1,000	1,021	771
Irrigated Land			
Total Farms	74	154	49
Total Acres	17,151	62,730	19,913
Cropland Acres	16,463	62,220	19,830
Pasture and Other Acres	688	510	83
Average Market Value of Land and Buildings			
per Farm	\$1,163,130	\$1,418,388	\$1,366,372
per Acre	\$448	\$597	\$737
Market Value of Agricultural Products Sold			
Total	\$80,365,000	\$139,166,000	\$114,448,000
Average per Farm	\$165,701	\$255,821	\$199,386

Source: U.S. Department of Agriculture 2012

TABLE 3-36. CROPS MIX IN THE LYP

Category	Acres ^a	Percent	Yield ^b	Price ^c	Estimated Value
Beets	20,160	37%	27.9 (tons/acre)	\$59.69	\$33,621,000
Wheat	13,017	24%	65.1 (bushels/acre)	\$6.96	\$5,896,000
Barley	6,994	13%	92.8 (bushels/acre)	\$5.31	\$3,445,000
Corn	4,690	9%	142.1 (bushels/acre)	\$5.54	\$3,692,000
Alfalfa, Hay	7,113	13%	4.56 (tons/acre)	\$103.30	\$3,350,000
Grass (for hay)	2,493	5%	4.56 (tons/acre)	\$83.90	\$953,900
Soy Bean	691	1%	28.9 (bushels/acre)	\$11.69	\$233,400
Total	55,158	100%	–	–	\$51,191,000

Note: Values may not add due to rounding.

- a. Lower Yellowstone Project Board of Control 2013
- b. National Agricultural Statistics Service 2016
- c. National Agricultural Statistics Service 2015, National Agricultural Statistics Service 2015b

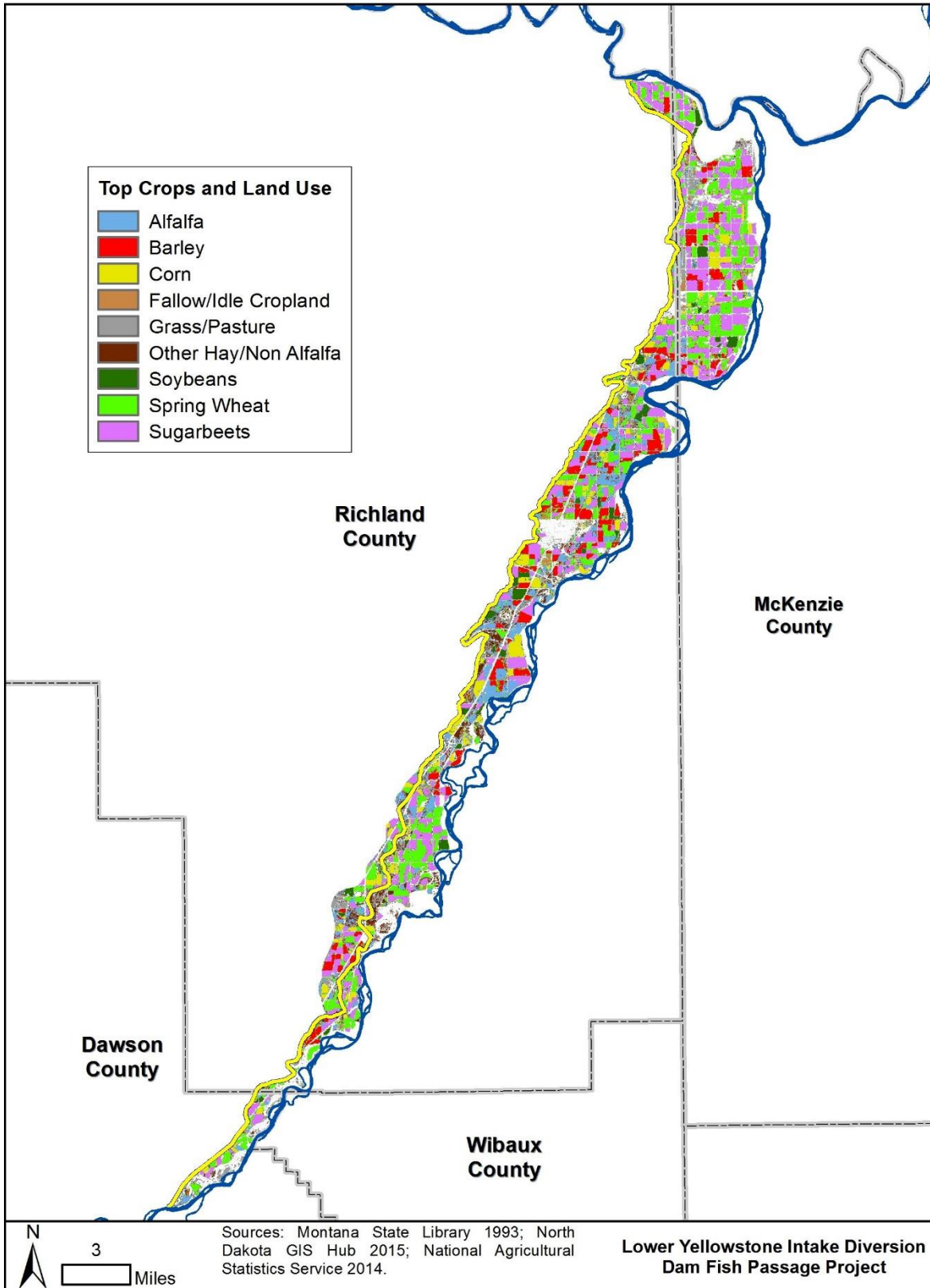

Figure 3-33. Cropland Data Layer 2014

3.16 Environmental Justice

Executive Order 12898 (Federal Actions to Address Environmental Justice in Minority Populations and Low-Income Populations, 1994) was issued with the goal of achieving environmental protection for all communities by focusing on identifying and addressing disproportionately high and adverse human health effects on minority and low-income populations. Consideration of environmental justice acknowledges that the quality of the environment affects living quality and that minority and low-income populations should not suffer disproportionately. The Executive Order directs federal agencies to identify and address any disproportionately high and adverse effects from federal actions on environmental justice communities, and to provide minority and low-income populations access to public information and public participation in the planning process for federal actions (Environmental Protection Agency 2015b).

The study area for the environmental justice evaluation is the same as that of the social and economic conditions discussion. It includes six counties in Montana and two in North Dakota, as shown in Figure 3-30. The purpose of the environmental justice evaluation is to identify and characterize any populations in the study area with a potential for disproportionately high and adverse human health or environmental effects. The evaluation focuses on multiple and cumulative exposures of low-income populations, minority populations, and Indian tribes to environmental hazards. Federal actions must mitigate any disproportionate negative impacts on environmental justice populations.

3.16.1 Methodology

The environmental justice discussion presents a range of socioeconomic indicators that describe populations in the study area: race, unemployment rates, poverty rates, educational attainment, and health insurance coverage status. Data was obtained from the U.S. Census Bureau's ACS program (U.S. Census Bureau 2015a). The discussions of socioeconomic indicators in Section 3.15 are referenced as well.

3.16.2 Data Sources/Data Gaps

The U.S. Census Bureau's ACS program continually collects survey data and publishes an updated dataset annually. The 2010-2014 ACS 5-Year dataset represents data collected over 60 months ending December 31, 2014. It is considered the most reliable source of information for analysis of small populations and is able to provide a consistent level of detail for all counties in the study area (U.S. Census Bureau 2015a).

3.16.3 Affected Environment

3.16.3.1 Race

Table 3-37 presents a summary of race in the study area counties compared to the states as a whole. Race within the study area is fairly homogenous throughout the counties, with the exception of Roosevelt County in Montana and McKenzie County in North Dakota, which both contain portions of federal Indian reservations and have a substantially larger proportion of American Indian population. Aside from these counties, the population in the study area is predominantly white.

TABLE 3-37. SUMMARY OF RACE

Location	White Alone (%)	Black or African Am. Alone (%)	Am. Indian or Alaskan Native Alone (%)	Asian Alone (%)	Native Hawaii-an or Other Pacific Islander Alone (%)	Some Other Race Alone (%)	Two or More Races (%)
<i>Montana (statewide)</i>	89.4%	0.5%	6.5%	0.7%	0.1%	0.5%	2.5%
<i>North Dakota (statewide)</i>	89.20%	1.5%	5.2%	1.2%	0%	0.7%	2.1%
Dawson, MT	95.5%	0.6%	1.6%	0.4%	0.1%	0.5%	1.3%
McCone, MT	95.8%	0.0%	2.2%	0.2%	0%	0%	1.9%
Prairie, MT	96.0%	0.0%	2.0%	0%	0.1%	0%	1.9%
Richland, MT	94.4%	0.4%	2.3%	0.3%	0%	1.4%	1.2%
Roosevelt, MT	36.6%	0.1%	55.1%	0.2%	0%	0.5%	7.5%
Wibaux, MT	100%	0%	0%	0%	0%	0%	0%
McKenzie, ND	79.0%	0.2%	17.2%	0.6%	0%	1.0%	2.0%
Williams, ND	90.8%	1.1%	4.2%	0.6%	0%	1.3%	2.1%

Source: U.S. Census Bureau 2015a

As shown in Figure 3-34, the Fort Peck Indian Reservation occupies more than half of Roosevelt County’s area, and the Fort Berthold Indian Reservation intersects the eastern edge of McKenzie County. In Roosevelt County, Fort Peck is home to the Sioux Nation and the Assiniboine Nation. Over half of the population of Roosevelt County is American Indian. In McKenzie County, Fort Berthold is home to the Mandan, Hidatsa, and Arikara Nation. While only a small portion of the reservation intersects the county, 17 percent of the county’s population is American Indian.

3.16.3.2 Labor Force and Unemployment

Regional labor force and unemployment data provide information about the capability of the region to provide labor for future growth as well as the current availability of jobs for people seeking work. The ACS provides information on the size of the labor force by county. The civilian labor force is defined as the population of civilians 16 and older who are employed or unemployed, where the unemployed are defined as people who were without work during the data collection period but had actively looked for work during the previous month. The civilian labor force excludes members of the U.S. Armed Forces on active duty. The unemployment rate represents the unemployed as a percentage of the civilian labor force. Table 3-38 presents a summary of labor force and unemployment for the study area.

The ratio of population to civilian labor force in the study area is generally consistent with statewide averages. Overall, the study area represents just 3.9 percent of the total civilian labor force of Montana and North Dakota, despite occupying about 8 percent of total land area of the two states.

The study area as a whole has an unemployment rate (2.2 percent) that falls below both the Montana (6.8 percent) and North Dakota (3.1 percent) rates. Prairie County has the highest rate of unemployment (7.8 percent) and is the only county with an unemployment rate above its state’s unemployment rate. Overall, unemployment is low for the study area.

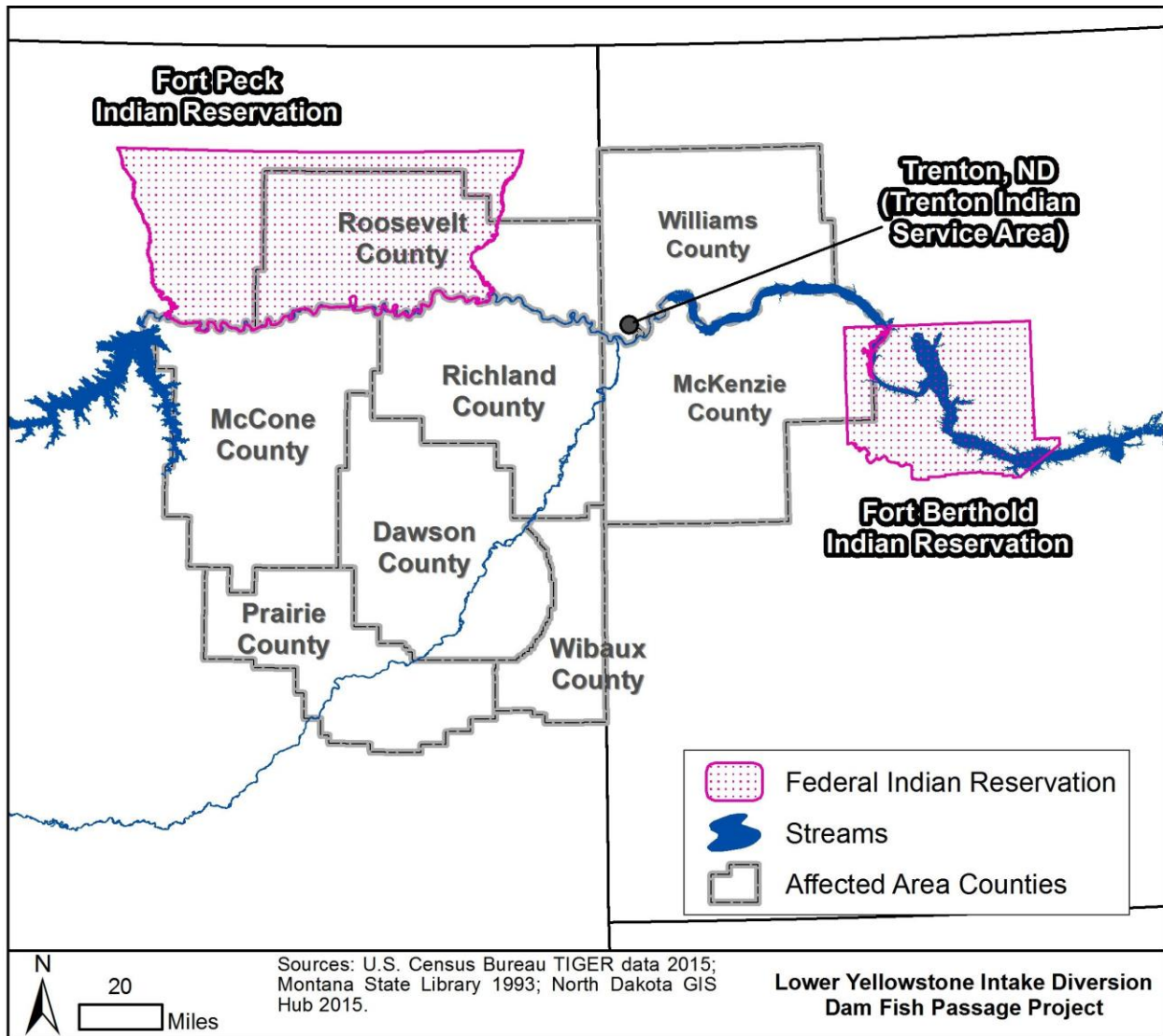

Figure 3-34. Federal Indian Reservations in the Study Area

TABLE 3-38. LABOR FORCE AND UNEMPLOYMENT

Location	Population 16 Years and Older	Percent Not in Labor Force ^a	Civilian Labor Force ^b	Employed		Unemployed	
				Count	Percent	Count	Percent ^c
<i>Montana (statewide)</i>	807,917	35.7%	516,403	481,119	93.2%	35,284	6.8%
<i>North Dakota (statewide)</i>	563,755	29.5%	392,185	379,972	96.9%	12,213	3.1%
Dawson, MT	7,502	37.3%	4,706	4,604	97.8%	102	2.2%
McCone, MT	1,445	30.5%	1,004	993	98.9%	11	1.1%
Prairie, MT	1,083	47.7%	566	522	92.2%	44	7.8%
Richland, MT	8,502	31.5%	5,821	5,651	97.1%	170	2.9%
Roosevelt, MT	7,741	51.0%	3,790	3,647	96.2%	143	3.8%
Wibaux, MT	818	44.5%	454	444	97.8%	10	2.2%
McKenzie, ND	6,299	32.8%	4,231	4,115	97.3%	116	2.7%
Williams, ND	21,229	28.2%	15,188	15,000	98.8%	188	1.2%
Total Study Area	54,619	34.4%	35,760	34,976	97.8%	784	2.2%

Source: U.S. Census Bureau 2015a

- People 16 years and over not in labor force include mostly students, homemakers, retirees, institutionalized people, and other specific cases of unemployed people not looking for work.
- Table uses civilian labor force rather than total labor force because the Armed Forces population in the affected area adds less than 0.1% to the labor force size.
- Calculated based upon unemployment count and total civilian labor force.

3.16.3.3 Educational Attainment

Educational attainment for the population over 25 in the study area is summarized in Table 3-39. Estimates are given for the current regional labor force as well as expected changes in the labor force in the future. This metric addresses the region's ability to attract businesses and supply skilled labor.

TABLE 3-39. EDUCATIONAL ATTAINMENT

Location	Percent High School Graduate or Higher	Percent Bachelor's Degree or Higher
<i>Montana (statewide)</i>	92.4%	29.1%
<i>North Dakota (statewide)</i>	91.3%	27.3%
Dawson, MT	90.7%	18.3%
McCone, MT	93.3%	17.5%
Prairie, MT	87.5%	14.0%
Richland, MT	91.6%	17.3%
Roosevelt, MT	83.7%	12.6%
Wibaux, MT	83.5%	18.4%
McKenzie, ND	90.2%	21.1%
Williams, ND	90.4%	19.1%
Total Study Area	89.6%	17.9%

Source: U.S. Census Bureau 2015a

Educational attainment in the study area varies by county, but most counties have slightly lower high school and college degree attainment rates than the statewide averages. Overall the study area has a 9- to 11-percent lower rate of bachelor's degree attainment than the states as a whole,

but only a 1- to 3-percent lower rate of high school education attainment. While the lower attainment of bachelor’s degrees may limit some employment opportunities for the current population, educational attainment statistics do not consider whether the types of employment available in the region necessitate advanced or higher level degrees. Some industries may favor skilled and specialist laborers, which is not measured here.

3.16.3.4 Poverty

Poverty is determined based on thresholds specified by the Office of Management and Budget that vary by family size and composition. Thresholds for people living alone or with nonrelatives vary by age. Thresholds for two-person families vary by the age of the householder. The ACS accounts for these thresholds and applies the appropriate threshold to families, nonrelative households, and individuals living alone. For families, all people in the family are considered to be in poverty if income is below the threshold. For nonrelative households and individuals living alone, poverty is determined based on individual income. Table 3-40 presents a summary of poverty rate for families and for all people.

TABLE 3-40. POVERTY

Location	Poverty Rate, All Families (%)	Poverty Rate, All People (%)
<i>Montana (statewide)</i>	<i>10%</i>	<i>15.3%</i>
<i>North Dakota (statewide)</i>	<i>7.3%</i>	<i>11.9%</i>
Dawson, MT	9.9%	14.6%
McCone, MT	6.9%	9.1%
Prairie, MT	13.1%	19.2%
Richland, MT	8.5%	13.4%
Roosevelt, MT	19.3%	25.7%
Wibaux, MT	11.8%	14.2%
McKenzie, ND	8.9%	14.6%
Williams, ND	6.3%	8.2%

Source: U.S. Census Bureau 2015a

Poverty rates in Prairie, Roosevelt, and Wibaux Counties exceed the Montana statewide rate:

- In Prairie County, the poverty rate is above the state rate for families and for all people in poverty, indicating an economic climate that is moderately depressed relative to the state.
- In Roosevelt County, the family and all-people poverty rates are approximately 10% higher than the statewide rates, indicating a substantially more depressed economic climate.
- Wibaux County’s poverty rate for families is marginally above the statewide rate, but its rate for all people is marginally below the statewide rate, suggesting poverty in the county is not substantially different than the statewide rates.

In North Dakota, McKenzie County’s family poverty rate exceeds the statewide rate, while Williams County is below the state rate. McKenzie County contains a portion of the Fort Berthold Indian Reservation and has a high American Indian population.

Table 3-41 compares the poverty rate for All People for the two most populous races in the study area—white alone and American Indian and Alaskan native alone. Roosevelt and McKenzie

Counties have substantial populations of American Indians and exhibit higher rates of poverty among these populations. However, the statewide rate of poverty within the American Indian population is also high, and the rates in these counties are within 10 percent of the statewide rate.

TABLE 3-41. COMPARISON OF POVERTY BY RACE

Location	Population of White Alone		Population of American Indian and Alaskan Native Alone	
	All People (count)	Percent in Poverty	All People (count)	Percent in Poverty
<i>Montana (statewide)</i>	<i>879,101</i>	<i>13.5%</i>	<i>62,478</i>	<i>37%</i>
<i>North Dakota (statewide)</i>	<i>607,214</i>	<i>9.4%</i>	<i>35,650</i>	<i>41%</i>
Dawson, MT	8,457	14.7%	91	8%
McCone, MT	1,666	9.4%	21	0%
Prairie, MT	1,213	18.5%	20	75%
Richland, MT	10,055	13.5%	245	9%
Roosevelt, MT	3,848	7.3%	5,895	39%
Wibaux, MT	956	14.2%	0	—
McKenzie, ND	6,494	6.5%	1,406	48%
Williams, ND	24,079	7.3%	1,124	10%
All Study Area	56,768	10%	8,802	36%

Source: U.S. Census Bureau 2015a

Over 50% of Roosevelt County’s area is occupied by the Fort Peck Indian Reservation, and the county has a high American Indian population. The reservation is home to two American Indian nations, each composed of numerous bands and divisions. The Sioux divisions of Sisseton, Wahpetons, the Yanktonais, and the Teton Hunkpapa are all represented, and the Assiniboine bands of Canoe Paddler and Red Bottom are represented (Fork Peck Tribes 2014).

Williams County has a large population of American Indians, but the poverty rate in this population is well below the statewide rate. The recognized American Indian community in Williams County is the Trenton Indian Service Area, centered on the unincorporated town of Trenton, southwest of Williston. American Indians in this community are mostly descendants of transplanted Turtle Mountain Chippewas (Mala, Johnson and Kramer 1999). The Trenton Indian Service area lies in northwest North Dakota, and northeast Montana. Much of the area consists of Williams and Divide Counties and the northern portion of McKenzie County. The area covers approximately 6,200 square miles, bounded by the Canadian border on the north and the Fort Peck Indian Reservation in Montana on the west. These lands are not on a reservation but are designed to allow resident Indians to receive federal Indian program services (U.S. Department of the Interior 2012). Figure 3-34 indicates the location of the community of Trenton.

In summary, American Indian populations in the study area often have higher poverty rates than the rest of the population, but not exclusively so. The total population of American Indians in all of the study area does not have a higher poverty rate than the statewide totals. However, the American Indian populations in Roosevelt and McKenzie Counties appear to be minority and low-income populations, which should be considered in the environmental justice analysis of Project effects.

3.16.3.5 Summary

The characterization of environmental justice in the study area noted three populations for Environmental Justice evaluation:

- Prairie County, Montana had the highest unemployment rate (7.8%) of all the counties in the study area.
- Roosevelt County, Montana and McKenzie County, North Dakota both had poverty rates above the statewide rates.

3.17 Historic Properties

This section summarizes the efforts thus far to inventory cultural resources within the area of potential effect, identify historic properties, consult with Indian tribes about properties of religious or cultural importance, and consult with the Montana State Historic Preservation Office (SHPO) and other interested parties about potential project effects. It also provides an analysis of regulatory compliance related to cultural resources.

3.17.1 Definitions

Cultural resources include the following:

- Expressions of human culture and history in the physical environment, such as pre-contact or historic archaeological sites, buildings, structures, objects, districts, or other places.
- Natural features, plants, and animals that are considered to be important to a culture, subculture, or community or that allow the group to continue traditional lifeways and spiritual practices.

3.17.1.1 Historic Properties

Generally, cultural resources are considered to be historic properties under the National Historic Preservation Act (NHPA) if they are over 50 years old and meet the significance criteria for listing on the National Register of Historic Places (NRHP) (36 CFR 60.4). Considerations may be made for culturally significant resources less than 50 years old. Adverse effects on historic properties under the NHPA are typically considered significant impacts under the National Environmental Policy Act. They may be mitigated to lessen the degree of significance.

3.17.1.2 Pre-Contact-Era Resources

Pre-contact resources are physical properties resulting from human activities that predate written records. These are generally identified as isolated finds or sites. Areas of intense pre-contact use, such as near freshwater, productive habitats for subsistence resources, or lithic sources/quarries, are particularly sensitive for such resources. Pre-contact resources can include archaeological village sites, temporary camps, fishing weirs, lithic scatters, roasting pits/hearths, milling features, petroglyphs, rock features, and burial plots.

3.17.1.3 Historic-Era Resources

Historic resources consist of physical properties, structures, or other built items resulting from human activities that post-date European exploration and settlement in the Project region. Historic resources can include archaeological remains and standing architectural resources. Historic archaeological sites may include abandoned town sites and homesteads, maritime

features, refuse concentrations, and features or artifacts associated with early exploration (e.g. trails, wagon roads, early railroads). Historic architectural resources may include houses, cabins, barns, bridges, local structures (such as docks, ports, churches, post offices, and meeting halls), and water conveyance features (such as dams and canals).

3.17.1.4 Ethnographic Resources

Ethnographic resources are sites, areas, and materials important to Native Americans for religious, spiritual, or traditional reasons. These resources may include archaeological sites, village locations, burial plots, petroglyphs, rock features, springs, and traditional cultural properties (NRHP-eligible or -listed ethnographic resources). Fundamental to traditional religions is the belief in the sacred character of physical places, such as mountain peaks, springs, or burial plots. Traditional rituals often prescribe the use of particular native plants, animals, or minerals; therefore, activities that can affect sacred areas, their accessibility, or the availability of materials used in traditional practices are of primary concern. Although some types of ethnographic resources overlap with pre-contact and historic resources, they are assessed here as a separate category of cultural resources.

3.17.2 Regulatory Context

Section 106 of the NHPA requires federal agencies to take into account the effects of their undertakings on historic properties and to afford the Advisory Council on Historic Preservation an opportunity to comment. The procedures for complying with Section 106 are outlined at 36 CFR 800. The effects the Project may have on properties of traditional religious and cultural importance to Indian tribes must be considered in accordance with Section 101(d)(6) of the NHPA and the American Indian Religious Freedom Act.

The Project meets the definition of an undertaking under Section 106, so all cooperating federal agencies, including Reclamation and the Corps, have responsibilities under Section 106 to consider the Project's effects on historic properties. As the lead National Environmental Policy Act agency for the Project, the Corps addresses compliance with Section 106 jointly with the co-lead and cooperating agencies. However, agencies that administer federal lands have other responsibilities associated with the management of cultural resources under Section 110 of the NHPA, the Archaeological Resource Protection Act, the Native American Graves Protection and Repatriation Act, and Executive Order 13007 addressing Native American sacred sites. Additional federal laws and regulations and agency-specific requirements may also apply.

3.17.2.1 Memorandum of Agreement

A memorandum of agreement was completed in June 2010 to address adverse effects of the Project—as proposed in the original EA and Supplemental EA—under Section 106 of the NHPA. The memorandum of agreement between the Reclamation Montana Area Office, the Corps' Omaha District Office, SHPO, and Board of Control of the Lower Yellowstone Project outlined stipulations that Reclamation would ensure be completed to mitigate for adverse effects:

- Conduct a cultural resource inventory of the entire APE (as proposed in 2010), including equipment and material staging areas, borrow sources, and all ancillary impact areas that had not been subjected to a Class III Cultural Resource inventory (i.e. 100% pedestrian survey).
- Reproduce select historic photographs taken by Reclamation during the construction of the Lower Yellowstone/Intake Diversion Dam with appropriate background information

on the history of the Lower Yellowstone Project. Make the resulting documentation available to the Montana Historical Society and local libraries and schools.

- Reproduce select historic drawings and maps of the headworks structure, Intake Diversion Dam, and associated features, and provide them to the Montana State Historic Society.
- Develop and install interpretive signs at a point of public access. Signs would provide information on the Lower Yellowstone Project and its importance to development of the area.
- Keep the headworks and Main Canal inlet channel (Site 24DW287) in place, with the slide gates left in the closed position, inlet pipes filled with concrete, and a portion of the Main Canal inlet channel filled in, but not destroyed. Leave the majority of the Main Canal undisturbed, but extend it with a new headworks to the west of the present one.
- Preserve the Intake Diversion Dam (Site 24DW443) in place, with the exception of a small section that may be removed to facilitate flows into the Main Canal. Build replacement weir upstream from the existing dam. Preserve the north cableway tower in place. Move the south tower of the cableway, power plant, and engineer's house offsite and preserve them. If practicable, return these structures to the general proximity of their original location. If not, offer the properties for adoption with appropriate preservation.
- Photograph and record the headworks camp/gate tender residence (Site 24DW447) and associated outbuildings. Relocate the house, garage, and outhouse to a nearby property during construction. If practicable, return these structures to the general proximity of their original location. If not, offer the properties for adoption with appropriate preservation covenants. Develop and implement a data recovery plan in consultation with SHPO and other interested parties as appropriate.
- Fence and avoid the Old Cameron and Brailey Sub-Camp site (Site 24DW298) during construction to prevent damage.
- Avoid pre-contact sites 24DW430 and 24DW434 to prevent damage. (Note: These resources do not appear to be included near the Project as proposed in this environmental impact statement.)

The historic photographs and drawings have been reproduced and publicly distributed. Additional distribution is anticipated (George W. Shannon 2016). In addition, the headworks camp (24DW447) archaeological site has been documented and a report developed (Toom et al. 2011). Documentation of the architectural features at the site has not been completed. The memorandum of agreement terminated on December 31, 2014, however it is anticipated to be re-established in the spring of 2016 with the same signatories and stipulations (as necessary) to address adverse effects by the current Project under Section 106. The remaining, uncompleted stipulations, as well as any new stipulations would be initiated following signing of the re-established memorandum of agreement (George W. Shannon 2016)

3.17.3 Area of Potential Effect

In general, APEs are considered to be the horizontal and vertical extent of ground disturbing activities associated with an undertaking under Section 106 of the NHPA, including areas of construction, excavation, grading, staging, and access roads. In some cases, it includes adjacent areas that may be indirectly impacted. For the purposes of this EIS, the APE is dependent upon the alternative analyzed. Under each alternative, the APE encompasses the surfaces and depths

of disturbance and new construction. The APE of the Bypass (417.7 acres), Modified Side Channel (643.7 acres), and Rock Ramp (127 acres) alternatives are restricted to the area around the Intake Diversion Dam and Joe's Island. The Multiple Pump Alternative (8.7 acres) and Multiple Pumps with Conservation Measures Alternative (492.7 acres) are restricted to localized areas at the Intake Diversion Dam and downstream sites. A study area surrounding the APE of each alternative was established to provide a better understanding of the archaeological sensitivity of the APEs and a context for cultural resources identified within each. The study area extends one mile around each APE.

3.17.4 Paleo-Environmental Setting

Paleo-environmental studies of areas surrounding eastern Montana, such as southern Canada and western North Dakota, provide information that can be used to characterize the pre-contact environment of the study area. A study prepared by Aaberg Cultural Resource Consulting Service (Aaberg et al. 2006) provides a summary of regional paleo-environmental studies, synthesized with implications for pre-contact archaeological patterns. The following discussions are based on that study.

By 18,000 years before present (BP), the Laurentide-Keewatin Ice Sheet had reached its maximum extent, covering the study area. The Yellowstone River valley, particularly from Intake downstream, was affected by the glacier's advancement into the valley as the river became dammed by the ice. However, the study area was at the southern extent of the ice sheet, resulting in its exposure by 14,000 BP. Paleo-botanical studies indicate that pre-contact vegetation in the study area thereafter developed from a Grassland Steppe Biome to a Grassland Biome at 13,000 BP, to a Grassland and/or Steppe Biome at 12,000 BP, to a Steppe Biome with sagebrush-chenopod-grassland associations at 11,000 and 10,000 BP, and finally to a Grassland or Steppe Biome with sagebrush-chenopod-grassland associations at 9,000 BP (Aaberg et al. 2006). The biome determined for a time period can be used to infer the climate for that period.

Recession of the Laurentide-Keewatin Ice Sheet may have been caused by the Bølling-Allerød, a global warming trend that began around 12,700 BP in North America. The warmer temperatures not only resulted in the melting glaciers, but also allowed grasslands to establish in previously glaciated areas. Although this was a warming period, temperatures were still likely cooler than they are today. The Younger Dryas brought a cooling period between 11,000 and 10,000 BP, allowing sagebrush to begin to grow in the early grasslands of the study area. Temperatures during this time were likely temperate, with less severe winters than today. A warming and drying trend began around 10,000 BP, becoming fully developed by 9,000 BP and allowing for establishment of vegetation biomes that were most like those seen in undeveloped areas today. This pattern became even more pronounced during the Altithermal period of the mid-Holocene and strongest between 8,300 and 5,900 BP. However, there is evidence that suggests the climatic period was not as prolonged or severe in eastern Montana as in adjoining regions. Wetter conditions prevailed between 5,800 and 1,750 BP, followed by a more arid period between 2,000 and 1,300 BP. The period between 1,100 and 700 BP witnessed even more aridity and is referred to as the Medieval Climatic Anomaly. This was followed by the Little Ice Age between AD 1550 and 1850. Although it was the coldest period recorded during the Holocene, it experienced cycles of wet and dry weather patterns (Aaberg et al. 2006).

The varied pre-contact and historic climates of the region affected the vegetation and water availability in the region, thus affecting the distribution and adaptations of human and game. Studies suggest that the prairie biomes are quickly affected by periods of drought, resulting in the die off of grasses and forbs. However, the vegetation has been found to rebound quickly once wet cycles consistently reoccur. Adaptations to arid periods, such as during the Altithermal, should have allowed game and humans to continue to live in the region, yet evidence for human occupation in eastern Montana during the Altithermal is minimal. Populations, human and animal alike, likely focused on areas near permanent and reliable water sources, such as the Yellowstone and Missouri Rivers. Human populations likely also adapted to limited big game availability by expanding their hunting to include smaller prey and prey that lived in riverine and stream habitats. This may have resulted in sites being occupied for shorter periods of time than in previous, more productive climates. In turn, this would have resulted in a smaller archaeological signature more susceptible to destruction by natural forces such as erosion, and being overlooked. In the Yellowstone River valley, there is increased possibility for archaeological resources to be buried beneath alluvial fan and valley slope deposits (Aaberg et al. 2006).

3.17.5 Cultural Setting

The pre-contact, ethnographic, and historic contexts below focus on eastern Montana, rather than the study area. This approach provides a better understanding of resources that have been recorded within the study area.

3.17.5.1 Pre-Contact Context

Typical archaeological sites associated with the Pre-Contact Period of eastern Montana include the following (Aaberg et al. 2006):

- Lithic scatters
- Fire hearths, roasting pits, and fire-affected rock
- Tipi ring, stone circles, and ring sites
- Cairns and rock piles
- Rock alignments and mass kill sites
- Vision quest structures and medicine wheels
- Eagle catching pits/traps, battle pits, other pits, fortifications, and ambush game drives
- Lithic procurement sites
- Rock shelters and caves
- Rock art sites; workshops
- Other rock structures, circular walls, and rock piles
- Trails.

Aaberg et al. (2006) outlines a pre-contact cultural chronology for eastern Montana consisting of four main periods, with one period divided into three sub-periods, as summarized in Table 3-42. Each period is closely tied to the projectile point typologies used during that time. The sections below describe these periods and sub-periods.

TABLE 3-42. EASTERN MONTANA PRE-CONTACT CULTURAL CHRONOLOGY

Period Name	Timeframe
Early Pre-Contact/Paleoindian Period	ca. 12,500 BP – 7,800 BP
Middle Pre-Contact Period	
Early Plains Archaic Period	ca. 7,800 – 5,000 BP
Middle Plains Archaic	ca. 5,000 – 3,000 BP
Late Plains Archaic Period	ca. 3,000 – 1,500 BP
Late Pre-Contact Period	ca. 1,500 – 200 BP
Protohistoric Period	ca. 250 – 100 BP

Source: Aaberg et al. 2006

Early Pre-Contact/Paleoindian Period (ca. 12,500 BP – 7,800 BP)

Human populations entered the Project region shortly after the Laurentide-Keewatin Ice Sheet receded, hunting now-extinct megafauna species, such as mammoth and the ancestors of modern bison. These species had largely disappeared by 9,500 BP, although there is evidence for some larger and intermediate bison species persisting until about 6,400 BP. Spears with large lanceolate points and *atlatls* with dart points are believed to have been used at first, followed by stemmed points near the middle of the time period. By the end of the period the variation of points had further increased, leading to the identification by archaeologists of several overlapping cultural complexes. There is minimal archaeological evidence that dates to this time period in eastern Montana; however, that evidence and evidence from surrounding areas suggests that populations focused on bison hunting (Aaberg et al. 2006). The lengthy time period also encompasses varied stone tool technological complexes.

Pre-Clovis

Pre-Clovis period (pre-12,500 BP) archaeological evidence in Montana is minimal (Aaberg et al. 2006). However, a pre-Clovis occupation of North America is widely accepted today based on evidence from sites including Wilson Butte Cave in Idaho, Paisley and Connley caves in Oregon, Meadowcroft Rock Shelter in Pennsylvania, and Monte Verde in Chile (Aaberg et al. 2006; Aikens et al. 2011).

Clovis Complex

In the northern Plains, evidence for the Clovis Complex is minimal. However, the evidence does suggest a presence between 12,000 and 10,500 BP. Sites from this part of the Paleoindian Period typically include Clovis projectile points and indicate a subsistence focus on mammoth, supplemented by pronghorn antelope and bison. In Montana, the Anzick Site (a burial) provides the most definitive evidence for the Clovis Complex. Located in the west-central portion of the state, the site demonstrates Clovis peoples had well-developed burial practices. In eastern Montana, Clovis Complex sites include the Lindsay Mammoth Site (24DW501) in west-central Dawson County (11,925 to 9,490 BP), buried Site 24DW278 in southeastern Dawson County (pre-7,230 BP), and two surface localities in Sheridan and Carter Counties (Aaberg et al. 2006).

Goshen Complex

The Goshen Complex in Montana appears to have overlapped with the preceding Clovis Complex and the Folsom Complex. Dates obtained from the Goshen Complex Mill Iron Site (24CT30) in eastern Carter County and the OTL Ridge Site (24DW272) in southeastern Dawson County suggest the cultural expression was practiced and Goshen points used between 11,000

and about 9,000 BP. However, the data obtained from the OTL Ridge site may have been obtained from redeposited materials, so the end date for the Goshen Complex is uncertain. An isolated Goshen point has also been recovered at a surface locality in southeastern Dawson County (Aaberg et al. 2006).

Folsom Complex

Midland projectile points have been recovered from Folsom Complex occupations in Colorado and Wyoming, leading researchers to attribute both Midland and Folsom projectile points to the Folsom Complex. The complex has been dated to between 10,900 and 10,200 BP in the Plains through study of sites in western Montana and surrounding regions. These studies have concluded that Folsom peoples continued to hunt bison and produced finely-made tools, including the Folsom projectile points, bone needles, and artifacts made of perishable materials. Few Folsom sites have been studied in eastern Montana and evidence for such an occupation in the region comes from isolated projectile points, surface localities, and sites with poor preservation. Folsom points have been collected or reported in Dawson, Sheridan, and McCone Counties. Surface or shallow Folsom sites have been recorded in Roosevelt and Custer Counties, including 24RV0002 and 24CR410, both of which have had little close examination (Aaberg et al. 2006).

Agate Basin Complex

The Agate Basin Complex persisted between 10,500 and 10,000 BP, and possibly has late as 9,350 BP. Similar to the Folsom Complex, artifacts found at Agate Basin sites are finely made. Subsistence practices focused on big game hunting and bison trapping. Agate Basin sites in eastern Montana have not been closely studied, however some Agate Basin projectile points have been reported from surface finds. The points have been found in Dawson, Wibaux, Powder River, Custer, Big Horn, Sheridan, and Rosebud Counties (Aaberg et al. 2006).

Hell Gap Complex

The Hell Gap Complex has been dated to between 10,000 and 9,600 BP in the Plains. People during this time using Hell Gap projectile points appear to have focused on big game hunting, emphasizing bison. The projectile point is believed to have developed from production of Agate Basin points. Similar to the Agate Basin Complex, Hell Gap sites in eastern Montana have not been closely studied. Sites are attributed to the complex based on the presence of the Hell Gap projectile point type within assemblages, rather than radiocarbon dating of archaeological materials. Hell Gap sites have been identified in Dawson, Powder River, Carter, Custer, Sheridan, and Big Horn Counties.

Alberta Complex

The Alberta Complex is attributed to the time period between 9,500 and 9,000 BP. However, some researchers have noted that evidence from Wyoming suggests it may have begun even earlier, around 10,000 BP. Alberta projectile points represent a change in projectile point typology as the first truly stemmed points in the Plains. All previous projectile point typology was lanceolate in general shape. Despite the change in technology, archaeological evidence suggests bison continued to be the focus of subsistence. Alberta Complex sites have been identified in Dawson, Sheridan, Treasure, and Powder River Counties (Aaberg et al. 2006).

Cody Complex

The Cody Complex is represented by both the Eden and Scottsbluff projectile points, dated to between 9,200 and 8,800 BP. Cody Complex sites or site components in eastern Montana provide poor context for the archaeological assemblages. However, Cody points or sites have been recorded in Dawson, Sheridan, Wibaux, Custer, Carter, Rosebud, and Big Horn Counties (Aaberg et al. 2006).

Frederick Complex

The Frederick Complex dates to between 8,400 and 8,000 BP and represents a transition back to lanceolate points. Projectile points of the same form have been identified in neighboring states, as well as at sites within Montana, but assigned different names, making tracking this complex difficult. In eastern Montana, Frederick sites have been identified in Custer, Big Horn, Powder River, and Rosebud Counties (Aaberg et al. 2006).

Lusk Complex

Lusk projectile points are similar to Frederick points, but less well-made. Being similar in appearance to Agate Basin points, some researchers believe that Agate Basin points are sometimes misidentified as Lusk points. Further, the context in which Lusk points have been identified have been questionable. This has resulted in a poor understanding of the Lusk Complex, assumed to have existed around 7,900 BP (Aaberg et al. 2006).

Middle Pre-Contact Period

Early Plains Archaic Period (ca. 7,800 – 5,000 BP)

The Altithermal resulted in reduced populations by the Middle Pre-Contact/Early Plains Archaic Period, further resulting in a reduced archaeological inventory for the time period. Aaberg et al. (2006) state that at the time of their publication no Early Plains Archaic sites had been confirmed in eastern Montana. However, sites confirmed to be from this time period have been identified in surrounding regions, suggesting that unidentified contemporaneous sites are present in eastern Montana, possibly buried and/or eroded.

The large lanceolate and stemmed points of the preceding Paleoindian Period are replaced by corner- and side-notched projectile points during the Early Plains Archaic Period. However, evidence suggests that big game hunting continued to be as important as in earlier years and was supplemented by smaller game. Plants also began to play a more prominent role in the diet, evidenced by the production of groundstone artifacts used to process seeds and plants. Pit houses have also been identified in Early Plains Archaic Period sites (Aaberg et al. 2006).

Projectile point types associated with the Early Plains Archaic Period include Hawken, Pahaska Side-Notched, Blackwater Draw Side-Notched, Mummy Cave Complex Side- and Corner-Notched, and Oxbow. Hawken points have been identified at archaeological sites in the Glendive area as well as in Carter, Fallon, and Powder River Counties. Mummy Cave Corner-Notched points have also been identified in Carter, Fallon, and Powder River Counties, while Oxbow points have been identified in Powder River, Rosebud, and Big Horn Counties. None of these point types appear to have been used region-wide as well-developed cultural complexes, like during the Paleoindian Period. This may be due to the restricted population movements caused by the restricted resource base of the Altithermal. This relative isolation likely resulted in the

development of varied localized adaptations and stone tool construction techniques (Aaberg et al. 2006).

Middle Plains Archaic (ca. 5,000 – 3,000 BP)

With the conclusion of the Altithermal, human and game populations began to increase during the Middle Plains Archaic. The focus on bison as a primary subsistence resource continued, as did a supplemental diet of other game, including pronghorn, deer, elk, moose, and a variety of smaller species during the early portion of this time period. Tipi rings are well-represented in the archaeological record of Montana by 4,000 BP, although pit houses continued to be used in adjoining regions. The variety of projectile point types seen during the Early Plains Archaic Period developed further into two recognizable complexes: Oxbow and McKean (Aaberg et al. 2006).

Use of the Oxbow projectile point, a side-notched type, began during the Early Plain Archaic and became more widespread during the Middle Plains Archaic. Other stone tools commonly associated with Oxbow site assemblages include oval bifacial knives, lanceolate bifaces (likely preforms for Oxbow points), small end scrapers, thin uni-facial knives or side-scrapers, pebble hammer stones, crude choppers, irregular polyhedral cores, perforators, and flake tools. Faunal remains that have been identified in Oxbow assemblages include bison, elk, wolf, coyote, dog, fox, rabbit, marten, goose, frog, mussel, pronghorn antelope, mountain sheep, birds, and small mammals. Fire-affected rock as well as small basin hearths are also associated with Oxbow sites. Oxbow Complex sites have been identified in Big Horn, Custer, Dawson, McCone, Powder River, Rosebud, Richland, Treasure, and Sheridan Counties. All of the sites were identified as part of the Oxbow Complex based on the presence of possible Oxbow projectile points (Aaberg et al. 2006).

The McKean Complex is the most common during the Middle Plains Archaic. In addition to McKean style projectile points, the complex is characterized by an increase in groundstone implements, varied faunal assemblages, and communal bison kill sites. Communal and individual hunting of deer, pronghorn, and mountain sheep are also indicated. Cooking features, such as hearths, are varied and frequent, while tipi rings become more common in eastern Montana than during previous time periods. Other materials recovered from McKean sites include basketry, cordage, clothing, bone tools and ornaments, plant fibers, leather, and shell. McKean Complex sites have been identified in Rosebud, Big Horn, Custer, Carter, Fallon, Garfield, McCone, Powder River, Richland, Roosevelt, Sheridan, and Wibaux Counties (Aaberg et al. 2006).

Late Plains Archaic Period (ca. 3,000 – 1,500 BP)

The number of bison kill sites and tipi ring sites increases in the Northern Plains during the Late Plains Archaic Period. This suggests that communal game procurement developed and expanded during this time period, as tipis became the primary residential structure. Domestication of dogs also appears to have occurred in Montana during this time period. Use of ceramics began toward the end of the period. Projectile points during the Late Plains Archaic are dominated by corner-notched forms, with a lesser amount of side-notched forms. Several phases of cultural development have been identified in the region based on common projectile point types (Aaberg et al. 2006):

- The Yonkee Phase is associated with bison kill sites between 3,100 and 2,300 BP. Yonkee groups are characterized as high-level bison hunters that conducted communal kills through the use of bison jumps, traps, and impounding or corralling. The animals would be processed at each kill site. Although bison were the focus of Yonkee hunting, pronghorn, deer, sheep, and canids were also taken. A variety of hearths, including shallow basin-shaped hearths, surface hearths, slab-lined hearths, and rock-filled ovens, along with tipi rings have been identified at Yonkee sites. Typical Yonkee artifact assemblages include groundstone tools, flake tools, drills, scrapers, bifacial cores, and beveled edge bifacial knives. Yonkee assemblages have been identified in Big Horn, Rosebud, and Powder River Counties.
- The Pelican Lake Phase is dated to between 3,000 and ca. 2,000 BP, but appeared even earlier in western Montana. Numerous Pelican Lake Phase sites have been identified in Montana, suggesting the population had increased during this time. Projectile points attributed to the phase vary, but the Pelican Lake projectile point is a large corner-notched point with barbed shoulders. The phase is poorly understood by researchers. Bison hunting via trapping, jumps, and hunts appears to have continued in importance, as well as generalized big game hunting. Pelican Lake sites have been identified in Big Horn, Dawson, Rosebud, Custer, Carter, Daniels, Fallon, Garfield, McCone, Prairie, Powder River, Richland, Roosevelt, Sheridan, Valley, and Wibaux Counties. The most notable Pelican Lake Phase bison kill sites are in Prairie, Garfield, and Dawson Counties.
- The Besant Phase extends from 2,190 BP to 1,030 BP, covering both the Late Plains Archaic Period and the subsequent Late Pre-Contact Period. The hunting of bison continued to be emphasized, evidenced by bison corrals and bison kill sites. Although these types of features have not been identified in eastern Montana sites, a bison bone midden has been identified in the region and bison bone dominates faunal assemblages. Other foods identified in faunal assemblages of Besant Phase sites include pronghorn, rabbit, canid, deer, shellfish, large birds, and small mammals. Other artifacts and features associated with Besant sites include a variety of hearths and ovens, tipi rings, groundstone, chipped stone tools, and ceramics. Besant projectile points are likely attributable to *atlatl* use and have been found in association with Pelican Lake points. Besant sites have been identified in Big Horn, Dawson, Powder River, Rosebud, Custer, Carter, Daniels, Garfield, McCone, Prairie, Richland, Roosevelt, Sheridan Treasure, and Wibaux Counties.

Late Pre-Contact Period (ca. 1,500– 200 BP)

The focus on big game hunting emphasizing bison communal kills and hunting continued into the Late Pre-Contact Period. In general, Late Pre-Contact bison kill sites are common in eastern Montana (with the exception of Avonlea Phase sites). This was not to the exclusion of smaller species however, such as pronghorn. There is also evidence of an expanded subsistence resource base during the late fall, winter, and early spring when mobility was decreased. Use of rock shelters as base camps and later as task camp sites becomes more common during this period. Ceramics are also associated with Late Pre-Contact assemblages (again, with the exception of at Avonlea Phase sites) (Aaberg et al. 2006).

The bow and arrow was introduced during this time period. The first true bow and arrow culture in the region is represented by the Avonlea Phase between 1,800 and 1,050 BP. Tipi rings, bison

kill sites, and ceramics are uncommon in eastern Montana during the Avonlea Phase, although bison kills and ceramics have been found in other regions. In general, there are few Avonlea-associated sites in eastern Montana. The few sites that have been identified are in Big Horn, Rosebud, Wibaux, Custer, Carter, Dawson, Fallon, Garfield, McCone, Prairie, Powder River, and Sheridan Counties (Aaberg et al. 2006).

As suggested by the Avonlea Phase, localized expressions of cultural phases and sub-phases have been noted in the northern Plains Late Pre-Contact Period, indicated in varied artifacts and adaptations. The varied forms of artifacts, specifically projectile points, have been suggested to be evidence of influence from areas of the Plains to the east and west. Non-Avonlea Late Pre-Contact Period sites in eastern Montana include bison kills, open campsites/occupations, rock shelters, and ceramic-bearing sites in Big Horn, Custer, Carter, Dawson, Fallon, Garfield, McCone, Prairie, Powder River, Rosebud, Richland, Roosevelt, Sheridan, Treasure, Valley, and Wibaux Counties (Aaberg et al. 2006).

Protohistoric Period (ca. 250–100 BP)

The onset of the Protohistoric Period varies between locations depending on the timing of European contact with native cultures, including the introduction of the horse. In the Northern Plains, this occurred between AD 1700 and 1750, with the Shoshone being the first tribe to obtain horses, followed quickly by the Crow. The horse, as well as guns, continued to be obtained by other tribes with time. The horse allowed Native Americans to increase their mobility and made their hunting and subsistence strategies more efficient. In addition, the political structure of tribes was likely altered through increased contact between individual tribes and the accumulation of horses (Aaberg et al. 2006).

The French explorer Sieur de la Verendrye was likely the first European to enter eastern Montana in 1742. He was followed by Francois Larocque, of the Canadian-owned NorthWest Company, in 1805. Despite these early contacts with explorers and trappers, European settlement did not occur until after Lewis and Clark travelled through the area between 1805 and 1806 and the establishment of Manuel Lisa's outpost on the Big Horn River in 1807. These events opened the region up to expanded fur trapping, trade between Native Americans and Europeans and Euro-Americans, and settlement. Popular trade goods included beads, guns, ammunition, blankets, metal weapons, and domestic items. In addition to the use of European firearms, stone and metal arrow points were used by Native Americans during the Protohistoric Period, and possibly persisted into the historic period (Aaberg et al. 2006).

In general, Protohistoric Period sites in eastern Montana are infrequent, however little study has been conducted in areas where such sites would be expected to occur (Aaberg et al. 2006).

3.17.5.2 Ethnographic Context

The Project is located within the northern part of the Plains cultural area of North America. Different Native American groups likely traversed and occupied the study area. The Crow were present and documented ethnographically here, followed by the Sioux and Shoshone. Other tribes existed in the region prior to AD 1500, as evidenced by the documented migration of the Crow into the region between the AD 1550s and AD 1720, but it is difficult to determine which tribes. Even after AD 1500, migration and external forces, such as Euro-American contact, the

introduction of horses, and establishment of reservations, resulted in other tribes occupying the region for periods of time (Aaberg et al. 2006; Kordecki et al. 2000; DeMallie 2001).

The Crow migrated to the study area in a series of separations from the Hidatsa in North Dakota. The Crow initially expanded along the Yellowstone River drainage by the 1600s and were concentrated there and in the Bighorn drainage by 1720. Also during the 1700s, the Shoshone quickly expanded into eastern Montana and north, benefited by their early adoption of the horse. However, once other tribes acquired horses and firearms in the mid-18th century, the Shoshone were forced to retreat southward. Bands of Sioux ranged into the buffalo country of eastern Montana for hunting during the 1800s (Aaberg et al. 2006).

3.17.5.3 Historic Context

The Historic Period began ca. 1800, when Europeans and Euro-Americans began to more extensively enter the Project region, overlapping slightly with the Protohistoric Period. Euro-Americans dominated eastern Montana by the late 19th century, establishing westward trails, outposts, and forts. In the late 1860s and early 1870s, railroads were constructed and military outposts were established, attracting homesteaders who established towns and permanent settlements and practiced agriculture and ranching.

The Lower Yellowstone Valley was relatively slow to develop settlements due to its distance from railroad corridors and the markets that were closely connected to the railroads. In addition, the region was considered unsuitable for agriculture. The grasslands of the area were considered suitable for ranching, which began in the area in the 1870s leading to initial permanent Euro-American settlement of the valley. The establishment of a Northern Pacific Railroad line between Bismarck, North Dakota and Glendive allowed the ranching industry to expand (Kordecki et al. 2000).

It was not until the late 19th and early 20th centuries that the river valley bottomlands were recognized as fertile agricultural locations and dry land farmers began to settle in the valley. Small towns upriver of Glendive began to be established and homesteading accelerated. Some of the early homesteaders established small-scale irrigation on their lands to support agricultural practices. This included simple and general flooding of hay meadows using stormwater and digging of small private ditches to water gardens and tree wind breaks. These efforts were greatly expanded by A.F. Nohle's early irrigation system of dams and reservoirs along a tributary of the Yellowstone, although the system did not receive much use. Construction of irrigation systems to irrigate larger areas proved too expensive for individual farmers or even the small irrigation companies that they formed. The Reclamation Service began work on a number of irrigation projects in Montana in the early 1900s, including the Lower Yellowstone Project along the Montana-North Dakota border (Kordecki et al. 2000; Dick 1993).

3.17.5.4 Lower Yellowstone Project

The Lower Yellowstone Project is a significant early-20th-century public works project by the Reclamation Service (referred to today as Reclamation) that contributed to the establishment of agriculture in the region. The project extends between east-central Montana and western North Dakota and includes the Lower Yellowstone/Intake Diversion Dam, two pumping stations, the Main Canal, 225 miles of laterals, and 118 miles of drains. The system was designed to provide a dependable supply of irrigation water to approximately 54,000 acres of land along the west bank

of the Yellowstone River by diverting water from the river into the Main Canal at the Intake Diversion Dam. The water is distributed mostly through a gravity flow system to agricultural lands served by the project. The Thomas Point and Crane pumping stations along the Main Canal deliver water to an area that cannot be served by the gravity system (Dick 1993; Toom et al. 2011).

Preliminary surveys of the Lower Yellowstone Project were initiated by Reclamation in 1903. Engineers estimated that the cost at the time to construct the system and irrigate an estimated 64,144 acres of land (more than the acreage served by the system today) would be \$1,800,000. Construction of the project was authorized by Secretary of the Interior Ethan A. Hitchcock in May 1904 and initial plans for a diversion dam, pumping station, and canal and lateral system were drafted in 1904 and 1905 (Dick 1993; Toom et al. 2011).

Reclamation established field camps along the project in spring and summer of 1905 to house and provide office space for engineers and staff. One of the first camps, at the headworks, housed a small number of engineers to oversee construction of the dam, the headworks, and the first 34 miles of the Main Canal. The camp was constructed with a simple wood-frame office, dormitory, and stable. The office was the only permanent building, intended to be converted to a house and residence for the future headworks gate tender (Toom et al. 2011).

The design of the dam included driving several piling rows across the river, placing large stone fill between the piling rows, and facing the dam with timbers. The Pacific Coast Construction Company set up a camp on Joe's Island, across the river from headworks camp, with four bunkhouses, a mess hall, a commissary, a superintendent's house, a boiler house, a blacksmith shop, and three log buildings including a 30-horse stable. The crew began to build the south dam abutment and dike on Joe's Island and quarried the stone for the dam between in 1906 and 1907. The pilings began to be driven in spring 1908. High water in the river caused multiple delays in the construction, and the design required alterations after it was realized that the geology of the riverbed would not allow the planned wooden sheet piles to be driven. Reclamation abandoned the use of wooden sheet piles in August 1909, opting instead to use solid Douglas Fir tongue and groove timbers and some steel sheet pilings. At that time, Pacific Coast Construction Company refused to work on the project and Reclamation took over the construction, housing all workers at its headworks camp (Dick 1993; Toom et al. 2011).

Housing the anticipated 30 to 200 workers required Reclamation to expand the camp using materials from the former Pacific Coast Construction Company camp. Reclamation constructed additional residences and a new industrial plant at the headworks camp. In addition to the original 1905 headworks camp buildings, the expanded 1909 camp included a hospital, a store, two cottages, several bunkhouses and dormitories, washhouses, two mess halls, two meat houses, and some storage sheds. A small living quarters camp for foreign laborers was constructed east of the main camp, including two bunkhouses and a mess hall and washhouse. Other features were constructed after the larger camp in 1910, including a minimum of two root cellars, a barn, and a warehouse near where the Northern Pacific Railway Missouri River Railway branch was to be built. The camp served the project until the completion of construction (Toom et al. 2011).

The Intake Diversion Dam was completed in March 1910 as a 12-foot-high, 700-foot-wide rock-filled timber-crib weir. It is capable of diverting 1,100 cfs of water to the Main Canal. Construction of the Main Canal and lateral system began in 1905 but was delayed by weather and limited labor supplies. Steam shovels and dredges were used to excavate a 62-mile-long canal, which was then lined with stone and gravel in sections considered susceptible to seepage. The canal was extended in 1912 to 66.7 miles using dredge excavation machines.

All headworks, spillways, sluiceways, and conduits along the canal are constructed of concrete. Flumes and siphons at creek crossings were originally constructed of either wood or concrete, depending on the necessity of design; today they are all constructed of concrete. The 45-foot-tall headworks at the Intake Diversion Dam is constructed on a shale foundation and includes 11 circular sluiceways that are 5 feet in diameter. Irrigation water from the project became available in 1909 with a capacity to serve 424 farms on 40,535 acres. The 1912 canal extension allowed for an additional 2,100 acres of land to be irrigated.

After construction of the project, Reclamation's focus was on expanding the distribution system, constructing a pumping station and drainage system, and maintaining the system:

- Major repairs that replaced wooden pilings with steel ones and added rock downstream of the apron were completed at the Intake Diversion Dam in 1911 and 1918.
- An underground drainage system was installed in 1912, using open trenches and tile drain, to drain 700 acres of land that were affected by seepage from the Main Canal and laterals.
- The canal was extended 52 miles in 1923 to allow irrigation of another 17,000 acres.
- Drainage canals were installed between 1927 and 1931 to prevent water logging of irrigated lands. Drains continued to be constructed through the 1950s.
- Plans for a pumping station along the Main Canal were prepared in 1908. However, it was not until 1922 that the Thomas Point Pumping station was constructed at the head of Lateral KK, 19 miles downstream of the headgates, allowing an additional 2,300 acres of high land north of Savage to be irrigated.
- The Crane Pumping station was constructed at Crane Creek and Lateral BP-1 in 1960 and 1961 in response to checking at the creek.

Following completion of initial construction, the headworks camp was partially dismantled, including all temporary buildings, a hospital building, a small bunk house, and all Pacific Coast Construction Company buildings. This left only the office/gate tender house, stable, and 1905 dormitory standing on site. The 1911 repairs required Reclamation to re-open and re-construct the headworks camp, with fewer buildings than the 1909 camp. The reconstructed camp included a large mess hall, five bunkhouses, a stable, a warehouse, and a few additional outbuildings. It is unclear what happened to the new camp after the repairs were completed, but it is assumed that most features were sold or destroyed the following summer. Features that were left in place included the office, a storehouse/warehouse, a mess hall, and possibly a blacksmith shop. The headworks camp continued to provide a location for small, short-lived camps for Reclamation employees until 1914. After that, it is likely tent camps were utilized at the site when repairs were needed. The 1905 office and remaining outbuildings were converted and used a residence for the headworks gate tender during the irrigation season until the late 1980s (Dick 1993; Toom et al. 2011).

According to Dick (1993), settlers were wary of the irrigation project initially, dissuaded by periodically adequate rainfall for their farming and costs for access to the system. He states that although the system could provide water for 424 farms at the time of its completion in 1909, only 67 farms used the system. However, Toom et al. (2011) state that the project was well received by area farmers and that Reclamation had secured commitments from 95 percent of area settlers in 1904. Dry years between 1917 and 1919 and the establishment of irrigation districts in the 1920s, however, surely encouraged any hesitant farmers to use the system, which in turn increased the population and increased land values (Dick 1993).

Two irrigation districts were formed in 1920 to help fund maintenance and rehabilitation efforts for the project: Lower Yellowstone Irrigation District #1 for irrigated lands in Montana and Lower Yellowstone Irrigation District #2 for irrigated lands in North Dakota. Lower Yellowstone Irrigation District #1 constructed an additional 5 miles of the Main Canal and 50 miles of laterals between 1921 and 1922. Lower Yellowstone Irrigation District #1 contracted with Reclamation to construct the Thomas Point Pumping station (Dick 1993).

Water from the Lower Yellowstone Project is used primarily for irrigation. The primary crops grown in lands irrigated by the project are sugar beets, alfalfa, small grains, pasture, silage, and beans. Sugar beets and alfalfa were historically the staple crops of the region, promoted by Reclamation as crops that allowed for more permanent farming techniques that replenished soils and increased profits (Dick 1993).

3.17.6 Cultural Resources Records Search

A records search was conducted in January and March 2016 through the SHPO for the proposed Project alternatives, focusing on the study area extending 1 mile surrounding the APE. GIS data were requested for previously recorded sites and previously conducted surveys within the township, range, and sections of the study area. Site forms for all resources in the study area were requested, as were relevant survey reports (primarily those related to the Lower Yellowstone Project).

3.17.6.1 Previously Conducted Surveys

Most surveys conducted in the study area were linear surveys focused on pipelines, utilities, roadways, and irrigation projects. This has resulted in minimal survey coverage. Nevertheless, surveys were conducted in the study area between 1977 and 2014, as listed in Table 3-43. Seven of these surveys covered 66 percent of the Bypass Channel Alternative; four surveys covered 44 percent of the Modified Side Channel Alternative; four surveys covered 5 percent of the Multiple Pumps with Conservation Measures Alternative; three surveys covered 27 percent of the Pumping Stations Alternative; and nine surveys covered 80 percent of the Rock Ramp Alternative.

The systematic pedestrian survey of Survey Report DW 6 23072 (Kordecki et al. 2000) covered all linear features (canals and laterals) of the irrigation system as well as all Reclamation-owned and -administered lands along the system that had not been previously surveyed. Survey of the system's linear features totaled 288 miles: 71.6 miles of Main Canal and 202 miles of laterals. The Reclamation-owned and administered lands were surveyed in 12 blocks totaling 3,082 acres. The survey identified 12 historic engineering and architectural sites directly related to the Lower Yellowstone Project:

- The Lower Yellowstone/Intake Diversion Dam (24DW443)
- The Lower Yellowstone Main Canal and Lateral System (24DW287/ 24RL204/ 32MZ1174)
- The Savage Sluiceway (24RL142)
- The Intake Pumping station (24DW446)
- The Thomas Point Pumping station (24RL231)
- The Savage Irrigation Unit (24RL275)
- The Headworks Camp/Gate Tender Residence (24DW447)
- The Crane Canal Rider Residence (24RL277)
- The Savage Headquarters Camp (24RL209)
- The Ridgelawn Camp (24RL80)
- The Fairview Canal Rider Residence (24RL208)
- The Lateral LL Reclamation Building (24RL283).

These sites represent an NRHP-eligible historic district, although the pumping station component of the Savage Irrigation Unit and the Crane Canal Rider Residence are not considered contributing elements to the district. The survey also identified several bridges associated with the initial construction of the system, and 25 prehistoric archaeological sites (20 newly recorded and five previously recorded sites that were updated by the survey).

TABLE 3-43. PREVIOUSLY CONDUCTED CULTURAL RESOURCES SURVEYS

Survey Report No.	Author	Date	Title	Alternative APEs					Alternative Study Areas					
				Rock Ramp	Bypass	High Flow	Ranney Wells	Pumping Stations	Rock Ramp	Bypass	High Flow	Ranney Wells	Pumping Stations	
RL 2 8868	Clark, Gerald R.	1977	<i>Elk Island: HMP Proposed Boundary Fence</i>											X
DW 2 10606	Clark, Gerald R.	1980	<i>Sobotka-Tomolino Proposed Land Purchase</i>											
DW 6 2401	Herbort, Dale P.	1980	<i>Cultural Resource Evaluation Belle Prairie and Box Elder Reservoir</i>	X	X	X			X	X	X	X	X	X
RL 4 8924	Smith, Charline G.	1980	<i>Highway Construction Project F20-2(2)52 Sidney-Fairview</i>									X		
DW 4 2348	Huppe, Katherine M.	1981	<i>Cultural Resource Reconnaissance of a Portion of Montana Department of Highways Project Fr20-1(1)19, Glendive-Sidney, And Associated Materials Sources</i>											
DW 6 2406	Pearson, Jay et al.	1981	<i>A Class III Intensive Inventory for All Cultural Resources Along the Proposed Route of the Montana-Dakota Utilities Cabin Creek to Williston Pipeline from the Saco-Morgan Creek Line to the Richland-Dawson County Line</i>						X	X		X	X	X
RL 6 38053	Simon, Arleyn W.	1983	<i>Proposed MDU Cabin Creek to Williston Pipeline</i>									X		
DW 2 2384	Gauer, Mary R.	1984	<i>Exchange Ringling Sobotka Lr Ranch</i>											
DW 6 2411	Aaberg, Stephen A.	1984	<i>Intake State Recreation Area</i>	X				X	X	X	X	X	X	X
RL 6 20052	Davis, Leslie B.	1984	<i>1983 Effort, Nollmeyer (Letter Report to Dr. Ann Johnson, NPS)</i>									X		
RL 4 8931	Wood, Garvey C.	1985	<i>Hilde Construction—Molly Eidness Pit (Pit 136-3)</i>									X		
RL 4 8932	Wood, Garvey C.	1985	<i>Hilde Construction—Glen Danielson Pit (Pit 136-4)</i>									X		

Lower Yellowstone Intake Diversion Dam Fish Passage Project, Montana
Environmental Impact Statement
May 2016

Survey Report No.	Author	Date	Title	Alternative APEs					Alternative Study Areas				
				Rock Ramp	Bypass	High Flow	Ranney Wells	Pumping Stations	Rock Ramp	Bypass	High Flow	Ranney Wells	Pumping Stations
RL 4 8934	Wood, Garvey C.	1985	<i>Hilde Construction—James Bieber Pit (Pit 136-6)</i>									X	
DW 4 2352	Rossillon, Mitzi	1987	<i>A Cultural Resources Inventory at the Bridge over the Diversion Canal at Intake</i>	X					X	X	X	X	X
RL 4 30084	Vinson, Edrie L.	1988	<i>Lower Yellowstone Project Main Canal Bridge U.S. Reclamation Service 1907-1908</i>									X	X
RL 6 8959	Andrews, Michael J.	1988	<i>A Cultural Resources Inventory for Selected Canal Repairs, Lower Yellowstone Project</i>									X	
DW 6 2414	Andrews, Michael J.	1989	<i>A Cultural Resources Inventory for a Rock Quarry, Dawson County, Montana Projects Office, Montana</i>							X	X		
DW 6 12536	Coutant, Brad A.	1991	<i>The Once and Future Quarry: A Class III Cultural Resource Inventory of a Proposed Rock Quarry Near the Lower Yellowstone/Intake Diversion Dam</i>		X				X	X	X	X	X
RL 6 13050	Coutant, Brad A.	1991	<i>Fifteen Assorted Structures on the Lower Yellowstone Irrigation District, Richland County, Montana</i>									X	X
DW 6 15872	Tingwall, Douglas et al.	1994	<i>Intake Fishing Access Site</i>	X			X	X	X	X	X	X	X
RL 4 15917	Platt, Steve	1994	<i>District 4 MCS Sites</i>									X	
RL 6 16617	Olson, Byron L.	1994	<i>Savage Water Supply</i>									X	X

Lower Yellowstone Intake Diversion Dam Fish Passage Project, Montana
Environmental Impact Statement
May 2016

Survey Report No.	Author	Date	Title	Alternative APEs					Alternative Study Areas				
				Rock Ramp	Bypass	High Flow	Ranney Wells	Pumping Stations	Rock Ramp	Bypass	High Flow	Ranney Wells	Pumping Stations
DW 6 23072	Kordecki, Cynthia et al.	2000	<i>Lower Yellowstone Irrigation Project, 1996 and 1997 Cultural Resources Inventory, Dawson and Richland Counties, Montana and McKenzie County, North Dakota</i>	X	X				X	X	X	X	X
RL 6 23550	Brumley, John H.	2000	<i>A Cultural Inventory of 14 Bridge Projects Areas within Richland County, Montana</i>									X	X
ZZ 6 23753 ^a	Kordecki, Cynthia et al.	2001	<i>Lower Yellowstone Irrigation Project, 1996 and 1997 Cultural Resources Inventory, Dawson and Richland Counties, Montana and McKenzie County in North Dakota</i>	X	X	X	X	X	X	X	X	X	X
DW 4 24430	Aaberg, Stephen A. and Chris Crofutt	2002	<i>30 KM Northeast of Glendive Northeast Class III Cultural Resource Survey Results in Dawson County and Richland County, Montana</i>									X	X
RL 6 24567	Vincent, William B.	2002	<i>Notification of Undertaking—Proposed Replacement of a Deteriorated Chute at the Savage Spillway Structure and Associated Bridge in Richland County Montana</i>									X	X
RL 6 27974	Bleier, Amy	2004	<i>A Cultural Resources Inventory of the Sidney Lateral and Outlying Segments in Richland County, Montana</i>									X	
RL 6 27967	Wagers, Scott J.	2005	<i>Addendum To: 30 KM Northeast Class III Cultural Resource Survey Results in Dawson County and Richland County, Montana</i>									X	X

Lower Yellowstone Intake Diversion Dam Fish Passage Project, Montana
Environmental Impact Statement
May 2016

Survey Report No.	Author	Date	Title	Alternative APEs					Alternative Study Areas				
				Rock Ramp	Bypass	High Flow	Ranney Wells	Pumping Stations	Rock Ramp	Bypass	High Flow	Ranney Wells	Pumping Stations
RL 6 33651	Greer, John and Mavis	2005	<i>Cultural Resource Evaluation of USBR Canal Bridge 24RL165 in Richland County, Montana</i>									X	X
RL 4 29739	Aaberg, Stephen A. and Chris Crofutt	2007	<i>30 KM Northeast of Glendive Northeast, Evaluative Testing of 24RL295, Richland County, Montana</i>										X
RL 6 30349	Boughton, John et al.	2008	<i>Williston Basin Interstate Pipeline Company: A Cultural Resource Inventory Along the Cabin Creek-Williston Pipeline, in Richland County, Montana</i>									X	X
DW 6 34023	Vincent, William B.	2009	<i>Test Drilling Near the Lower Yellowstone/Intake Diversion Dam and Canal, Dawson County, Montana</i>	X	X				X	X	X	X	X
DW 6 34030	Vincent, William B.	2009	<i>Intake Diversion Dam Modification, Lower Yellowstone Project</i>	X	X				X	X	X	X	X
RL 4 30746	Aaberg, Steven A. et al.	2009	<i>30 KM Northeast of Glendive Northeast Evaluation of 24RL0296, 24RL0297, and the Burns Creek Bridge (24RL0363), Richland County, Montana</i>									X	X
DW 6 33239	Moore, Roger A.	2011	<i>Dawson County Road 303</i>			X			X	X	X		
DW 6 34186	Toom, Dennis et al.	2011	<i>Headworks Camp (24DW0447) Historic Site Archaeological Excavations, Dawson County, Montana</i>	X					X	X	X	X	X
DW 6 33992	Macy, Jennifer and Mary Mitchell	2012	<i>West Glendive Exchange: A Class III Cultural Resource Inventory in Dawson and Wibaux Counties, Montana</i>		X	X			X	X	X		

Lower Yellowstone Intake Diversion Dam Fish Passage Project, Montana
Environmental Impact Statement
May 2016

Survey Report No.	Author	Date	Title	Alternative APEs					Alternative Study Areas				
				Rock Ramp	Bypass	High Flow	Ranney Wells	Pumping Stations	Rock Ramp	Bypass	High Flow	Ranney Wells	Pumping Stations
RL 6 33495	Passmann, Dori and Heather Luinstra	2012	<i>Cultural Resource Inventory Report: Nelson Pivot Project</i>									X	
RL 6 33660	Schleicher, Jolene et al.	2012	<i>A Class I and Class III Cultural Resource Inventory of the Oneok Rockies Midstream Stateline NGL Pipeline, Richland and Roosevelt Counties, Montana</i>									X	
RL 2 35413	Brooks, Brittany A.	2013	<i>Weber 24-30-1H, 2H, 3H, and 4H Well Pad and Access Road: A Class III Cultural Resource Inventory in Richland County, Montana</i>				X					X	
RL 4 36685	Wagers, Scott J. et al.	2013	<i>Sidney To Fairview: A Class III Cultural Resource Inventory Along State Highway 200 Between Sidney and Fairview, Richland County, Montana</i>									X	
RL 6 34235	O'Dell, Kevin C.	2013	<i>A Class III Cultural Resource Survey for Mercury Towers' Mt46467 Savage Communications Tower in Richland County, Montana</i>									X	X
RL 6 36650	Person, Amanda C. and Wade K. Burns	2013	<i>Lower Yellowstone Irrigation Canal/Drain Crossings: A Class III Intensive Cultural Resource Inventory in Richland County, Montana</i>									X	
RL 6 36909	Littlestrand, Eric and Wade K. Burns	2013	<i>Balducki, Yellowstone Farms, and Oberfall Borehole Locations: A Class III Intensive Cultural Resource Inventory in Richland County, Montana</i>									X	

Lower Yellowstone Intake Diversion Dam Fish Passage Project, Montana
 Environmental Impact Statement
 May 2016

Survey Report No.	Author	Date	Title	Alternative APEs					Alternative Study Areas				
				Rock Ramp	Bypass	High Flow	Ranney Wells	Pumping Stations	Rock Ramp	Bypass	High Flow	Ranney Wells	Pumping Stations
RL 6 37204	Livers, Michael C.	2013	<i>Lower Yellowstone Irrigation Project PW # 1442 DR 1996: A Cultural Resource Survey for the Lateral HH Replacement Project, Richland County, Montana</i>									X	X
RL 2 37039	Brooks, Brittany A.	2014	<i>Asbeck 12-31-1H, Asbeck Federal 13-31-2H, 13-31-3H, and 13-31-4H Well Pad and Access Road: A Class III Intensive Cultural Resource Inventory in Richland County, Montana</i>				X					X	

Survey ZZ 6 23753 is listed in SHPO's database with a date of 2001. However, the report title page indicates a date of 2000. Therefore, the report is referenced in this document as Kordecki et al. (2000).

Survey Report DW 6 34186 (Toom et al. 2011) documents a large-scale archaeological excavation at the headworks camp (24DW447). The excavation was conducted as mitigation for Project impacts as proposed in the 2010 EA and 2015 Supplemental EA and as required by the 2010 memorandum of agreement. The excavation sought to examine the relationships between structural features, status-diagnostic artifacts, and social stratification within the camp, as reflected in the archaeological record. Although many period artifacts of interest were recovered, few structural features of original camp buildings, such as foundations, were found, so the researchers were unable to achieve their primary goal of assessing social stratification.

3.17.6.2 Previously Recorded Resources

The GIS data obtained through the records search indicates that most known cultural resources in the Yellowstone River valley are linear and related to the Lower Yellowstone Project. A smaller number of prehistoric archaeological sites have also been documented. A total of 70 sites have been previously recorded within the study areas of the various alternatives (Table 3-44). Fifteen of the sites are within the APE of one or more alternative:

- Bypass Channel Alternative—24DW0443, 24DW0295, 24DW0296, 24DW0430, 24DW0431, and 24DW0442
- Modified Side Channel Alternative—24DW0295, 24DW0296, 24DW0430, 24DW0431, 24DW0442, and 24DW0299
- Multiple Pumps with Conservation Measures Alternative—24RL0204, 24RL0230, and 24RL0321
- Multiple Pump Alternative—24RL0204, 24RL0230, 24DW0287, and 24RL0209
- Rock Ramp Alternative—24DW0295, 24DW0296, 24DW0287, 24DW0298, 24DW0419, 24DW0443, and 24DW0447

Although not within the construction footprint of the Bypass, Modified Side, and Rock Ramp Alternatives, the Lower Yellowstone quarry currently used for maintenance of the dam is considered part of the APE for these alternatives since rock from the quarry would continue to be used in maintenance.

Eleven of the sites are NRHP-eligible and considered historic properties for the purposes of this analysis (24DW0287, 24DW0296, 24DW0298, 24DW0419, 24DW0430, 24DW0443, 24DW0447, 24RL0204, 24RL0230, 24RL0209, and 24RL0321). (Sites 24DW0287 and 24RL0204 are both portions of the Lower Yellowstone Project Main Canal, in Dawson and Richland Counties; sections in different counties are given different identifying site trinomials.)

TABLE 3-44. PREVIOUSLY RECORDED CULTURAL RESOURCES

Site No.	Time Period	Site Type	NRHP Status	Alternative APEs					Alternative Study Areas				
				Rock Ramp	Bypass	Modified Side	Pump Stations	Multiple Pumps	Rock Ramp	Bypass	Modified Side	Pump Stations	Multiple Pumps
24DW0137	Historic	Deerfly Bite Homestead	Undetermined							X			
24DW0144	Multicomponent	Prehistoric Lithic Scatter & Historic Petroglyph Panel	Undetermined						X	X	X		
24DW0287	Historic	Main Canal Lower Yellowstone Reclamation Project (Dawson County)	Eligible	X			X		X	X	X	X	X
24DW0295	Prehistoric	Lithic Scatter & Campsite	Unresolved	X	X	X							
24DW0296	Multicomponent	Prehistoric Lithic Scatter & Historic South Quarry	Eligible	X	X	X			X	X	X	X	X
24DW0298	Historic	Dug-Out & Refuse Scatter	Eligible	X					X	X	X	X	X
24DW0299	Historic	Dug-Out	Ineligible			X			X	X	X		
24DW0300	Historic	Dug-Out	Ineligible						X	X	X	X	X
24DW0419	Historic	Northern Pacific Railroad (Dawson County)	Eligible	X					X	X	X	X	X
24DW0430	Prehistoric	Lithic Scatter	Eligible		X	X			X	X	X		
24DW0431	Historic	Dug-Out & Refuse Scatter	Ineligible		X	X			X	X	X		
24DW0432	Prehistoric	Lithic Scatter	Ineligible						X	X	X		
24DW0433	Prehistoric	Lithic Scatter	Unresolved						X	X	X		
24DW0434	Prehistoric	Lithic Scatter	Eligible						X	X	X		
24DW0435	Prehistoric	Lithic Scatter	Unresolved						X	X	X		
24DW0436	Historic	Historic Dug-Outs with Isolated Prehistoric Debitage	Ineligible						X	X	X		
24DW0437	Historic	Log Structure	Ineligible						X	X	X		
24DW0438	Prehistoric	Lithic Scatter	Ineligible						X	X	X		
24DW0439	Prehistoric	Lithic Scatter	Ineligible							X	X		
24DW0440	Prehistoric	Lithic Scatter	Ineligible							X	X		
24DW0441	Prehistoric	Lithic Scatter	Ineligible						X	X	X		
24DW0442	Prehistoric	Lithic Scatter	Undetermined		X	X			X	X	X		

Lower Yellowstone Intake Diversion Dam Fish Passage Project, Montana
Environmental Impact Statement
May 2016

Site No.	Time Period	Site Type	NRHP Status	Alternative APEs					Alternative Study Areas				
				Rock Ramp	Bypass	Modified Side	Pump Stations	Multiple Pumps	Rock Ramp	Bypass	Modified Side	Pump Stations	Multiple Pumps
24DW0443	Historic	LYP Intake Diversion Dam & Associated Features	Eligible	X	X				X	X	X	X	X
24DW0444	Historic	Joe's Island Cabin Remains	Ineligible						X	X	X	X	X
24DW0447	Historic	LYP Headworks Camp/Gate Tender Residence	Eligible	X					X	X	X	X	X
24DW0521	Historic	Cabin Creek-Williston Pipeline (Dawson County)	Eligible						X	X		X	X
24RL0012	Historic	Newlon Townsite	Unresolved										X
24RL0046	Historic	O'Brien's Stage Station	Unresolved										X
24RL0141	Historic	Vehicular/Foot Bridge (Treated Timber & Concrete)	Undetermined										X
24RL0142	Historic	LYP Main Canal Bridge (Treated Timber & Concrete)	Eligible									X	X
24RL0151	Historic	LYP Main Canal Bridge at Savage (Pratt Pony Truss)	Eligible									X	X
24RL0152	Historic	Pat's Bar/Pat's Club (Former Post Office, Residence, & Printing Shop)	Undetermined									X	X
24RL0153	Historic	Burn's Creek Inn (Former Hardware Store)	Undetermined									X	X
24RL0163	Historic	LYP Main Canal Bridge (Pratt Through Truss)	Eligible									X	X
24RL0164	Historic	LYP Main Canal Bridge at Burns (Pratt Pony Truss)	Eligible									X	X
24RL0165	Historic	LYP Main Canal Bridge (Pratt Through Truss)	Eligible									X	X
24RL0166	Historic	Displaced LYP Main Canal Bridge (Pratt Pony Truss)	Undetermined									X	X
24RL0188	Historic	LYP Main Canal Bridge (Pratt Pony Truss)	Eligible									X	X

Lower Yellowstone Intake Diversion Dam Fish Passage Project, Montana
Environmental Impact Statement
May 2016

Site No.	Time Period	Site Type	NRHP Status	Alternative APEs					Alternative Study Areas				
				Rock Ramp	Bypass	Modified Side	Pump Stations	Multiple Pumps	Rock Ramp	Bypass	Modified Side	Pump Stations	Multiple Pumps
24RL0204	Historic	Main Canal Lower Yellowstone Reclamation Project (Richland County)	Eligible				X	X				X	X
24RL0209	Historic	LYP Savage Reclamation/Headquarters Camp	Eligible				X					X	X
24RL0230	Historic	Northern Pacific Railroad (Richland County)	Eligible				X	X				X	X
24RL0231	Historic	LYP Thomas Point Pumping station	Eligible									X	
24RL0255	Historic	Dug-Out	Ineligible									X	X
24RL0256	Prehistoric	Lithic Scatter	Eligible									X	X
24RL0257	Historic	Historic Petroglyph Panel	Eligible										X
24RL0258	Prehistoric	Lithic Scatter with Possible Rock Cairn	Undetermined									X	X
24RL0259	Prehistoric	Lithic Scatter	Ineligible									X	X
24RL0260	Prehistoric	Lithic Scatter	Ineligible									X	X
24RL0264	Historic	Dug-Out, Refuse Scatter	Ineligible										X
24RL0265	Historic	Dug-Out	Ineligible										X
24RL0266	Historic	Refuse Scatter	Ineligible									X	X
24RL0267	Prehistoric	Lithic Scatter	Unresolved									X	
24RL0271	Prehistoric	Lithic Scatter	Ineligible										X
24RL0275	Historic	LYP Savage Irrigation Unit	Eligible									X	X
24RL0276	Historic	Refuse Scatter (associated with Lower Yellowstone Project Main Canal)	Eligible									X	X
24RL0278	Historic	Miller Homestead Shack	Eligible									X	X
24RL0280	Historic	Bailey Place (Log Cabin & Outbuildings)	Unresolved									X	X
24RL0292	Historic	Homestead/Farmstead	Ineligible										X
24RL0293	Prehistoric	Lithic Scatter	Ineligible										X
24RL0294	Prehistoric	Lithic Scatter with Fire-Cracked Rock	Ineligible									X	X

Lower Yellowstone Intake Diversion Dam Fish Passage Project, Montana
Environmental Impact Statement
May 2016

Site No.	Time Period	Site Type	NRHP Status	Alternative APEs					Alternative Study Areas				
				Rock Ramp	Bypass	Modified Side	Pump Stations	Multiple Pumps	Rock Ramp	Bypass	Modified Side	Pump Stations	Multiple Pumps
24RL0295	Prehistoric	Lithic Scatter with Fire-Cracked Rock	Eligible									X	
24RL0297	Prehistoric	Lithic Scatter with Fire-Cracked Rock	Ineligible									X	X
24RL0298	Historic	Beef Slough Rural School Site	Ineligible									X	X
24RL0308	Historic	Great Northern Railroad (Richland County)	Eligible										X
24RL0321	Historic	Cabin Creek-Williston Pipeline (Richland County)	Eligible					X					X
24RL0363	Historic	Highway 16 Burns Creek Bridge (Stringer/Multi-Beam or Girder)	Ineligible									X	X
24RL0364	Historic	Works Progress Administration Sidney Pumping Project	Unresolved										X
24RL0421	Historic	Residence, Outbuildings	Ineligible										X
24RL0436	Historic	Residence	Ineligible										X
24RL1004	Prehistoric	Sedentary Horticultural Earthlodge Village	Undetermined										X

Two of the sites are not considered eligible for listing on the NRHP (24DW0299 and 24DW0431) and the remaining two sites are either unevaluated or have an unresolved NRHP status (24DW0295 and 24DW0442).

- 24DW0287 and 24RL0204 are the Main Canal of the Lower Yellowstone Project in Dawson and Richland counties, respectively. The site is a contributing element to the Lower Yellowstone Irrigation Project Historic District and is considered an NRHP-eligible historic property.
- 24DW0295 is a prehistoric lithic scatter and campsite that includes lithic debitage, groundstone, a battered cobble, fire-cracked rock, a small cairn, and a possible second cairn within a historic rock quarry. Testing of the site indicate a very good chance for intact subsurface cultural materials within the site. Two historic features are included within the site: a piece of steel driven into the sandstone bedrock and a likely recent depression associated with the rock quarrying. The NRHP-eligibility status of the site is unresolved.
- 24DW0296 consists of a prehistoric lithic scatter and a historic period rock quarry. The prehistoric component consists of two small lithic scatters with debitage, a quartzite cobble, and fire-cracked rock. The soils within the scatters suggest there is potential for subsurface cultural materials. The historic component includes haul roads, remnants of a derrick, a small dry-laid stone and lumber structure, minor amounts of refuse, and other remnants of a rock quarry that was used for construction of the Intake Diversion Dam between ca. 1907 and 1912. The quarry has been expanded and is currently used for maintenance of the Intake Diversion Dam, however 24DW0296 and another NRHP-eligible site within the larger, modern quarry are avoided by these Reclamation activities (David Trimpe, personal communication 2016). The quarry provided rock for the construction and maintenance of the Lower Yellowstone Diversion Dam. An unrecorded workers camp is likely north of the quarry across an access road. The prehistoric component is unevaluated, while the historic component contributes to the significance of the Lower Yellowstone Project and is considered NRHP-eligible.
- 24DW0298 consists of 14 historic depressions (i.e. dug outs) and structural refuse. The depressions indicate the locations of former structures associated with the Old Cameron and Brailey Sub Camp. The camp was a construction camp for workers building the Lower Yellowstone Main Canal in 1906. Some of the depressions retain structural remains. The site is NRHP-eligible for its association with the Lower Yellowstone Project.
- 24DW0299 includes two historic depressions. One of the dugouts is fairly large with a sod rim. Remnants of fence posts are adjacent to the depressions. Minor amounts of historic refuse are also present. The site likely represents early settlement attempts. The site is not eligible for listing on the NRHP.
- 24DW0419 and 24RL0230 is the historic Northern Pacific Railroad in Dawson and Richland counties, respectively, including the Main Line, Redwater Branchline, and the Glendive to Bainville Branchline. The railroad is considered a significant historic transportation corridor and is the first of the so-called northern route transcontinental railroad lines. The line was originally constructed as a single-track line on a grade with passing tracks or siding generally situated at 4 to 5-mile intervals. Physical features considered part of the site include tracks, ties, buildings, grades, culverts, bridges, road crossings, firebreaks, wooden power poles, mile post markers, signage, water stations,

tunnels, switching equipment, and right-of-way fences. The Northern Pacific merged in 1970 with Great Northern and Chicago, Burlington and Quincy railways to become the Burlington Northern Railway Company, which continued to operate the Northern Pacific mainline, but abandoned most branches. The site is NRHP-eligible for the role it played in the settlement and development of the west and its association with Jay Cooke, a prominent east coast banker who acted as financial agent for the railroad during its construction. Further, the line in Dawson County has been minimally altered and continues to be active.

- 24DW0430 an extensive scatter of prehistoric artifacts eroding from a road cut that exposes subsurface cultural materials. Lithic debitage, fire-cracked rock, a projectile point base, a chopper, a biface, and bone, some burned, are present. Although the road has destroyed much of the site, portions outside of the road cut may be intact and include subsurface materials. The site is NRHP-eligible for its potential to yield additional information significant to the nation's prehistory.
- 24DW0431 consists of three historic depressions and historic refuse scatter. Two of the depressions include lumber and wooden posts. The site is not considered eligible for listing on the NRHP.
- 24DW0442 is a sparse prehistoric lithic scatter with two concentrations. Although the recorders noted little potential for intact subsurface cultural materials, the site's NRHP-eligibility status is undetermined.
- 24DW0443 is the Lower Yellowstone Project/Intake Diversion Dam. The site is a contributing element to the Lower Yellowstone Irrigation Project Historic District and is considered an NRHP-eligible historic property.
- 24DW0447 is the site of the Lower Yellowstone Project headworks camp/gate tender residence. The site is a contributing element to the Lower Yellowstone Irrigation Project Historic District and is considered an NRHP-eligible historic property.
- 24RL0209 is Reclamation's historic Savage Headquarters Camp associated with the construction of the Lower Yellowstone Project. The site includes three houses and two garages built between ca. 1907 and 1910. One of the houses includes a concrete vault built to house records and documents. The camp housed maintenance crews and ditch riders. Miscellaneous refuse, including materials associated with the Lower Yellowstone Project, is scattered across the site; however, most is noted to be modern. The site is a contributing element to the Lower Yellowstone Irrigation Project Historic District and is considered an NRHP-eligible historic property.
- 24RL0321 is the Cabin Creek-Williston Pipeline in Richland County. The 93.3-mile-long 12-inch diameter pipeline originates in Fallon County and trends northward through Wibaux, Dawson, and Richland counties to terminate in Williston, North Dakota. It was constructed in 1930 and is generally buried three to four feet below ground surface. The pipe was constructed to provide natural gas to residential customers throughout eastern Montana and has provided gas to several electrical generating facilities for eastern Montana. The pipeline was the first segment constructed of a large distribution system based out of the Cedar Creek anticline gas fields, the first commercially-developed gas fields in Montana. The system eventually incorporated much of eastern Montana, most of North Dakota, portions of northern South Dakota, and portions of north-central Wyoming. The line is considered NRHP-eligible for its contribution to the development

of the infrastructure for modern energy distribution in eastern Montana and, in turn, the economic development of the region.

An additional 16 NRHP-eligible sites are within the study areas of the alternatives. Three of these are prehistoric lithic scatter sites and 12 are historic above-ground resources. The remaining site is a historic refuse scatter associated with the Lower Yellowstone Project. It is unclear at this time if the new construction within the APEs of the alternatives will be within the viewshed of the 12 historic above-ground resources. Twenty-four NRHP-ineligible resources are within the study areas, including 11 prehistoric lithic scatters, 12 historic above-ground resources, and one historic refuse scatter. The remaining 15 sites within the study areas are either unevaluated for the NRHP or have unresolved NRHP statuses. These resources include five prehistoric lithic scatters, one prehistoric village, seven historic above-ground resources, one historic stage route, and one historic settlement site.

Combined with the paleo-environmental and cultural settings of the Project, the records search results suggest that the following site types are most likely to occur in unsurveyed portions of the APEs:

- Native American lithic scatters (prehistoric and historic),
- Native American campsites (prehistoric and historic),
- Native American village sites (prehistoric and historic),
- Historic refuse scatters (some potentially associated with the Lower Yellowstone Project),
- Historic agricultural features,
- Historic railroad or other transportation features,
- Historic buildings or structures, and
- Historic irrigation systems or features.

Of the resources identified by the records search, 23 of the 47 historic-era resources (49 percent) are NRHP-eligible and four of the 24 prehistoric sites (17 percent) are NRHP-eligible. This suggests unevaluated and unrecorded cultural resources in the region or identified resources with unresolved NRHP-statuses have a low to moderate likelihood of being considered significant historic properties.

3.18 Indian Trust Assets

The trust responsibility is the U.S. Government's permanent legal obligation to exercise statutory and other legal authorities to protect tribal lands, assets, resources, and treaty rights, as well as a duty to carry out the mandates of federal law with respect to American Indian Tribes. Federal Indian policy and trust responsibilities have developed from court decisions, congressional laws, and policies articulated by U.S. Presidents. Various departments, branches of government, and agencies have defined responsibilities. The Secretary of the Interior has specific trust responsibilities not delegated to any other department or agency, including holding land in trust and maintaining monetary accounts for tribes and individual tribal members.

As federal land managing agencies, Reclamation and the Corps have the responsibility to identify and consider potential impacts of plans, projects, programs, or activities on Indian lands, trust resources, and treaty rights. For any proposed action, the agencies must ensure that all anticipated effects on Indian lands, trust resources, and treaty rights are addressed in the planning, decision, and operational documents. Federal agencies must ensure that meaningful consultation and coordination are conducted on a government-to-government basis with federally recognized tribes.

Much of the public domain land in the continental U.S. was originally obtained by treaties made with Indian tribes. Treaties are negotiated contracts made pursuant to the U.S. Constitution and take precedence over any conflicting state laws because of the Constitution's supremacy clause (Article 6, Clause 2). Treaty rights are not gifts or grants from the U.S., but are bargained-for concessions between sovereign governments. Other sources of defined reciprocal rights and obligations assumed by the federal government and Indian tribes include congressional and executive branch actions to acquire Indian lands, establish reservations, provide federal recognition of tribes, and remove Indian peoples to reservations. Rights on federal lands are interpreted and applied by the federal courts. Some federal statutes, congressional acts, and executive orders do not distinguish between federally and non-federally recognized tribes and bands. Indian tribes often view these rights and resource uses as holistically interconnected with culture, tradition, and spiritual practice. Among many groups, land, water, geologic features, landscapes, and other seemingly inanimate objects are considered sacred. Federal land policy and legal precedents, however, make distinctions between economic rights and resource uses and those that are cultural or spiritual.

Indian trust assets (ITAs) are legal interests in assets held in trust by the federal government for federally recognized Indian tribes or nations or for individual Indians. Assets are anything owned that has monetary value. A legal interest refers to a property interest for which a legal remedy, such as compensation or injunction, may be obtained if there is improper interference. A trust has three components: the trustee, the beneficiary, and the trust asset. The beneficiary is sometimes referred to as the beneficial owner of the trust asset. In the Indian trust relationship, the U.S. is the trustee and holds title to these assets for the benefit of an Indian tribe or nation or for individuals.

These assets can be real property, physical assets, or intangible property rights. Examples include lands, minerals, water rights, gathering rights, hunting and fishing rights, rights to other natural resources and forest products, money, or claims. They need not be owned outright, but can include other types of property interest, such as a lease or a right to use something. Some treaties express a priority right for a resource; others express a proportional, or in common, right. ITAs cannot be sold, leased, or otherwise alienated without federal or tribal approval.

ITAs do not include things in which a tribe has no legal interest. Without a treaty or act of Congress specifying otherwise, land ownership can affect the determination of whether or not a resource is an ITA. For example, an off-reservation resource-gathering area in which a tribe has no legal property interest would generally not be considered an ITA. In this case, if religious or cultural resources could be affected by the Project, these interests would be addressed as part of the cultural resources or social impact assessment because of the lack of legal property interest.

The same resource on a reservation, trust, or ceded land may be an ITA, as determined on a case-by-case basis.

The U.S. Department of the Interior's Departmental Manual Part 303, *Indian Trust Assets*, defines general Department policy and principles for managing ITAs, under which the following requirements apply to Department of the Interior agencies (including Reclamation):

- Protect and preserve ITAs
- Ensure their use promotes the interests of the beneficial owner
- Enforce leases
- Promote tribal control
- Manage and distribute income
- Maintain good records
- Protect treaty-based fishing, hunting, gathering, and similar rights of access and resource use on traditional tribal lands.

Some tribes are also interested in recovering ownership of lands that were part of their original land base and, therefore, would be concerned about committing lands to other uses. The federal government has the right to convey land to federally recognized tribes under different authorities. Federal agencies may exchange or transfer land and Congress may legislatively restore or create tribal land out of federal land.

Some tribes that were parties to unratified treaties did not surrender any land or resources to the U.S. Although these cases were settled, some individuals and tribes did not accept the land settlement money. The Department of the Interior, through the Bureau of Indian Affairs, holds accounts for those who have not extinguished their aboriginal claims to land and who continue to reserve the right to pursue further legal action. Other tribal interests include general concerns about ecosystem management, maintaining healthy lands and water, and restoring the natural resource base. Tribal communities and regional entities often request that their local knowledge be included in resource management decisions.

The following discussions are based on consultations and research documented in the 2010 EA and 2015 Supplemental EA. They reflect the status of ITAs relative to the Project as proposed in those documents. Additional Corps consultation with Indian Tribes is ongoing regarding ITAs and the current proposed Project and alternatives.

3.18.1 Historic Treaties with Tribes

Reclamation purchased the lands of the Lower Yellowstone Intake from the State of Montana on April 17, 1908. The land had been provided to the State of Montana as a school section under its charter of statehood in November 8, 1889.

Historically, many Indian tribes occupied this area for hunting, fishing, gathering and other purposes (see Section 3.17.5). These included but are not limited to the Assiniboine, Arapaho, Arikara, Blackfeet, Cheyenne, Crow, Gros Ventre, Mandan, and Sioux or Lakota Nation. Some of these tribes used the area for subsistence; others also resided in the area.

Reclamation reviewed historic treaties with Missouri River Basin tribes to determine if any ITAs were specified in them. The United States entered into at least 54 treaties with the above tribes, many of which applied to multiple tribes (Table 3-45). Frequently, treaties involved land cessions in which the tribes retained certain rights of access, most often for hunting, fishing, and gathering on the ceded lands. U.S. Supreme Court decisions have defined other retained rights not specified in the treaties.

TABLE 3-45. HISTORIC TREATIES OF THE MISSOURI RIVER BASIN TRIBES AND RETAINED RIGHTS

Tribe	Treaty	Retained Rights
Assiniboine and Sioux Tribes of Fort Peck	1851 Fort Laramie Treaty 1868 Treaty with Sioux Brule/Fort Laramie Treaty 1873 Executive Order established the Fort Peck Reservation 1889 Congress established boundaries	1851-hunting and fishing 1868-hunting
Blackfeet Tribe	1855 Treaty with Blackfeet Sioux	1855-hunting, fishing, gathering, and grazing
Cheyenne River Sioux Tribe	1851 Fort Laramie Treaty 1868 Treaty with Sioux Brule/Fort Laramie Treaty 1889 Congressional Act; Great Sioux Settlement	1851-hunting and fishing 1868-hunting 1889-irrigation
Chippewa Cree Tribe, Rocky Boy's Reservation	1825 Treaty with the Sioux 1916 Executive Order establishing the Reservation boundary	1825-reciprocal hunting
Crow Creek Sioux Tribe	1825 Treaty with the Sioux 1851 Fort Laramie Treaty 1863 Executive Order establishing the Reservation boundary 1868 Treaty with Sioux Brule/Fort Laramie Treaty 1889 Congressional Act; Great Sioux Settlement	1825-reciprocal hunting 1851-hunting and fishing 1868-hunting 1889-irrigation
Crow Tribe	1826 Treaty 1851 Fort Laramie Treaty	1851-hunting and fishing
Eastern Shoshone Tribe	1863 and 1868 Fort Bridger Treaty 1872 Brunot Agreement 1898 and 1904 McLaughlin Agreement	
Flandreau Santee Sioux Tribe	1851 Fort Laramie Treaty 1858 Treaty with the Sioux 1863 Executive Order 1868 Treaty with Sioux Brule/Fort Laramie Treaty	1851-hunting and fishing 1868-hunting
Fort Belknap Assiniboine and Gros Ventre Tribes	1851 Fort Laramie Treaty 1855 Blackfeet Treaty 1889 Congressional Act; Great Sioux Settlement	1851-hunting and fishing 1855-hunting, fishing, gathering, and grazing 1889-irrigation
Iowa Tribe of Kansas	1825 Treaty with the Sioux 1830 Treaty with Sauk, Foxes	1825-reciprocal hunting
Kickapoo Tribe	1819 Treaty with the Kickapoo 1832 Treaty with the Kickapoo 1854 Treaty with the Kickapoo 1864 Amendment to Treaty with the Kickapoo	

Lower Yellowstone Intake Diversion Dam Fish Passage Project, Montana
Environmental Impact Statement
May 2016

Tribe	Treaty	Retained Rights
Lower Brule Sioux Tribe	1851 Fort Laramie Treaty 1865 Treaty with Sioux Lower Brule Band 1868 Treaty with Sioux Brule/Fort Laramie Treaty 1889 Congressional Act; Great Sioux Settlement	1851-hunting and fishing 1868-hunting 1889-irrigation
Northern Arapaho Business Council	1863 and 1868 Fort Bridger Treaty 1872 Brunot Agreement 1898 and 1904 McLaughlin Agreement	
Northern Cheyenne Tribe	1851 Fort Laramie Treaty 1868 Treaty with Sioux Brule etc./Fort Laramie Treaty 1884 Executive Order 1889 Congressional Act; Great Sioux Settlement	1851-hunting and fishing 1868-hunting 1889-irrigation
Oglala Sioux Tribe	1851 Fort Laramie Treaty 1868 Treaty with Sioux Brule etc./Fort Laramie Treaty 1889 Congressional Act; Great Sioux Settlement	1851-hunting and fishing 1868-hunting 1889-irrigation
Omaha Tribe	1830 Treaty with Sauk, Foxes 1836 Treaty with the Oto etc. 1854 Treaty with the Omaha	
Ponca Tribe	1817 Treaty with the Ponca 1825 Treaty with the Sioux 1858 Treaty with the Ponca 1865 Treaty with the Ponca 1868 Treaty with Sioux Brule/Fort Laramie Treaty 1881 Act of Congress	1825-reciprocal hunting 1868-hunting
Prairie Bend of Potawatami Nation	1846 Treaty with the Potawatami Nation	
Rosebud Sioux Tribe	1851 Fort Laramie Treaty 1868 Treaty with Sioux Brule/Fort Laramie Treaty 1889 Congressional Act; Great Sioux Settlement	1851-hunting and fishing 1868-hunting 1889-irrigation
Sac and Fox Nation	1825 Treaty with the Sioux 1830 Treaty with Sauk, Foxes 1832 Treaty of Fort Armstrong	1825-reciprocal hunting
Santee Sioux Nation	1825 Treaty with the Sioux 1830 Treaty with Sauk, Foxes 1836 Treaty with the Oto 1851 Fort Laramie Treaty 1867 Treaty with the Sioux Sisseton and Wahpeton Bands 1868 Treaty with Sioux Brule/Fort Laramie Treaty	1825-reciprocal hunting 1851-hunting and fishing 1868-hunting
Standing Rock Sioux Tribe	1851 Fort Laramie Treaty 1868 Treaty with Sioux Brule etc./Fort Laramie Treaty 1882 Agreement with Sioux of various tribes (not ratified) 1889 Congressional Act; Great Sioux Settlement	1851-hunting and fishing 1868-hunting 1889-irrigation
Three Affiliated Tribes (Mandan, Hidatsa, and Arikara)	1851 Fort Laramie Treaty 1866 Fort Berthold Agreement (not ratified) 1868 Treaty with Sioux Brule/Fort Laramie Treaty 1870 Executive Order 1880 Executive Order	1851-hunting and fishing 1868-hunting

Tribe	Treaty	Retained Rights
Winnebago Tribe	1825 Treaty with the Sioux 1830 Treaty with Sauk, Foxes 1832 Treaty with Winnebago 1837 Treaty with Winnebago 1846 Treaty with Winnebago 1855 Treaty with Winnebago 1859 Treaty with Winnebago 1865 Treaty with Winnebago	1825-reciprocal hunting
Yankton Sioux	1815 Treaty with Yankton Sioux 1825 Treaty with the Teton etc. 1830 Treaty with Sauk, Foxes 1836 Treaty with the Oto 1837 Treaty with Yankton Sioux 1858 Treaty with Yankton Sioux 1865 Treaty with the Sioux Yanktonai 1868 Treaty with Sioux Brule/Fort 1894 Act of Congress reduced reservation	

The following actions related to ITAs are most relevant to the study area for this Project:

- The Fort Laramie Treaty of 1851 included the area of the Lower Yellowstone in the territorial boundaries for several tribes: the Gros Ventre, Mandan, and Arikara nations and the Assiniboine.
- The Assiniboine ceded their territory described in the Fort Laramie Treaty of 1851 via another treaty in 1866. Although that treaty was never ratified, their acceptance of a home on the reserve for the Blackfeet, Blood, Gros Ventre, Piegan, and River Crow, established April 15, 1874, relinquished it in all practicality.
- The Fort Laramie Treaty of 1868 redefined the boundaries of the Sioux Nation and Arapahoe Tribe to ensure the undisturbed use and occupation of certain lands. No changes were made in the boundaries of lands for the Gros Ventre, Mandan, Arikara, or Assiniboine as noted in the 1851 Fort Laramie Treaty.
- The Executive Order of April 12, 1870, set aside a reservation at Fort Berthold, Dakota Territory, and redefined the Fort Berthold Reservation as described in the 1851 Fort Laramie Treaty by ceding lands south and east of a line extending from the point where the Little Powder River unites with Powder River to a point on the Missouri River 4 miles below the Indian Village of Berthold.
- Executive Orders on July 13, 1880, ceded lands around the current location of the Intake Diversion Dam and headworks that were formerly reserved to the Arikara, Mandan and Gros Ventre.
- An act of Congress on May 1, 1888, established the Fort Peck and Fort Belknap Reservations for the Gros Ventre and Assiniboine as currently defined and ceded all other lands to the United States.
- The Indian Claims Commission addressed tribal land claims during its tenure from 1946 to 1978. Unresolved claims were transferred to the U. S. Court of Claims. There are no known pending cases before the U. S. Court of Claims.

A review of the master title plat files at Reclamation’s Montana Area Office indicates that lands within 2 miles of the Intake Diversion Dam are currently either privately owned or within the

jurisdiction of Reclamation. There are no vacant or unreserved public domain lands or individual Turtle Mountain Chippewa allotments within 2 miles of the Intake. An updated review of the files for this Project by Reclamation and/or the Corps has not been completed.

Prior to the 2010 E, Reclamation consulted with the Rocky Mountain Region of the Bureau of Indian Affairs (BIA) and the Corps' Omaha District, as well as Reclamation cultural resource specialists. These sources were not aware of any quantified treaty rights in the area of the Intake Diversion Dam.

3.18.2 Indian Trust Rights

3.18.2.1 Hunting, Fishing, and Gathering Rights

According to Reclamation's ITA policy, hunting and fishing rights and, by extension, gathering rights may qualify as ITAs. This is because in many treaties tribes retained the right to continue hunting, fishing, and gathering on ceded lands. No court has ruled on whether these activities collectively constitute ITAs, although the U.S. Supreme Court ruled in *Minnesota v. Mille Lacs* (1999) that hunting, fishing, and gathering are usufructuary rights (rights to obtain food, water, and other necessities on ceded lands, which include the right to use the ceded property to hunt, fish and gather on the land).

3.18.2.2 Indian Water Rights

The United States government has recognized that tribes in the western United States (west of the Mississippi) may hold rights to water in streams running through or alongside the boundaries of their reservations. The basis for Indian water rights stems from the U. S. Supreme Court decision *Winters v. United States* (1908), which enunciated the Winters Doctrine. According to the Winters Doctrine, implicit in the establishment of an Indian reservation was a reservation of sufficient water to fulfill the purposes for which the reservation was created, with the priority date being the date the reservation was established. As such, Indian water rights for both surface water and groundwater, when quantified, constitute an ITA.

When a reservation is established with expressed or implicit purposes beyond agriculture, such as to preserve fishing, then water may also be reserved in quantities to sustain use. The U.S. Supreme Court upheld this concept in *Arizona v. California* (1963). The Court held that tribes need not confine the actual use of water to agricultural pursuits, regardless of the wording in the document establishing the reservation. However, the amount of water quantified was still determined by the amount of water necessary to irrigate the "practicably irrigable acreage" on a reservation. The Court also held that the water allocated should be sufficient to meet both present and future needs of the reservation to ensure the viability of the reservation as a homeland. Case law also supports the premise that Indian reserved water rights are not lost through non-use.

The Winters Doctrine applies to any Indian water rights in Montana or along the Missouri River.

Surface Water

The Corps, the federal agency responsible for operations of the Missouri River, has recognized that certain Missouri River Basin tribes are entitled to water rights in streams running through and along their reservations under the Winters Doctrine. Several Missouri River Basin tribes have quantified or were in the process of quantifying their water rights at the time of the 2015

Supplemental EA. At that time, only the following only tribal-reserved water rights that had been legally quantified:

- State of Wyoming settlement with tribes of the Wind River Reservation (adjudicated under the McCarran Amendment)
- Compact between the State of Montana and the tribes of the Fort Peck Reservation (awaiting congressional approval at time of 2015 Supplemental EA; current status unknown)
- Compact between the State of Montana and the tribes of the Fort Belknap Reservation (ratified by the state legislature)
- Compact between the State of Montana and the Crow Tribe (Crow Tribe Water Rights Settlement Act of 2010a (Public Law 111-291))
- Compact between the State of Montana and the tribes of the Rocky Boy's Reservation (Chippewa Cree Tribe of the Rocky Boy's Reservation Indian Reserved Water Rights Settlement and Water Supply Enhancement Act of 1999 (Public Law 106-163))
- Compact between the State of Montana and the Northern Cheyenne Tribe (The Northern Cheyenne Indian Reserved Water Rights Settlement Act of 1992 (Public Law 102-374)).

Groundwater

Groundwater can constitute an ITA as a water right. Montana regulates and permits groundwater withdrawals.

3.18.3 Consultations Conducted with Indian Tribes

Tribes were invited to consult throughout preparation of the original 2010 EA, the 2015 Supplemental EA, and the 2016 EIS. In 2008, Reclamation sent letters to 25 tribes in the Upper Missouri River basins. Follow-up telephone calls were made to each tribe. Thirteen of the Missouri River Basin tribes are located directly on the Missouri River, while others are scattered throughout the rest of the basin. All of these tribes could directly or indirectly have historic ties to the Project area. Reclamation requested that the tribes identify any Indian Trust Assets (ITAs) that could be affected by the Project alternatives and invited them to meet and consult on impacts to any such assets. All of these tribes were sent copies of the scoping package and public notice during the public comment period.

Tribes were invited to consult on this EIS by letter dated April 5, 2016. The Tribes that were sent the letter are:

- Assiniboine and Sioux Tribes of Fort Peck
- Blackfeet Tribe
- Cheyenne River Sioux Tribe
- Chippewa Cree Tribe, Rocky Boy's Reservation
- Crow Creek Sioux Tribe
- Crow Tribe
- Eastern Shoshone Tribe
- Flandreau Santee Sioux Tribe
- Fort Belknap Assiniboine and Gros Ventre Tribes
- Iowa Tribe of Kansas

- Kickapoo Tribe
- Lower Brule Sioux Tribe
- Northern Arapaho Tribe
- Northern Cheyenne Tribe
- Oglala Sioux Tribe
- Omaha Tribe
- Ponca Tribe
- Prairie Bend of Potawatami Nation
- Rosebud Sioux Tribe
- Sac and Fox Nation
- Santee Sioux Nation
- Standing Rock Sioux Tribe
- Three Affiliated Tribes (Mandan, Hidatsa, and Arikara)
- Winnebago Tribe
- Yankton Sioux

To date, one Tribe responded to the request to consult. On-going efforts to conduct Tribal consultation and/or outreach will continue throughout the process, including follow-up calls and/or additional correspondence.

3.18.4 Identified Indian Trust Lands and Rights

No trust lands were identified in the study area analyzed in the 2010 EA and 2015 Supplemental EA as a result of Reclamation's consultations with tribes and review of treaties, master land plats, and BIA land databases.

3.19 Ecosystem Services

Ecosystem services can generally be defined as those things provided by nature that are of use to humans. Evaluating the ecosystem services effects of proposed federal actions examines the elements that form the connection between the biophysical elements of an ecosystem and the health and well-being of the human populations that depend on that ecosystem. (US Department of the Interior, 7070 DM 1 Handbook; 707 DM 1 HB, 11/10/2015 *Agency Specific Procedures for Implementing the Council on Environmental Quality's Principals, Requirements, and guidelines for Water and Land Related Resources Implementation Studies*).

Ecosystem services provide vital contributions to economic and social well-being. Examples of ecosystem services applicable to Federal Water Resources projects include services such as: Ecosystem Sustainability, Water Supply, Hazard Management, Navigation, Recreation, and Cultural Support. Figure 3-35 presents a conceptual framework for discussing ecosystem services (Corps 2013, *Incorporating Ecosystem Goods and Services in Environmental Planning*).

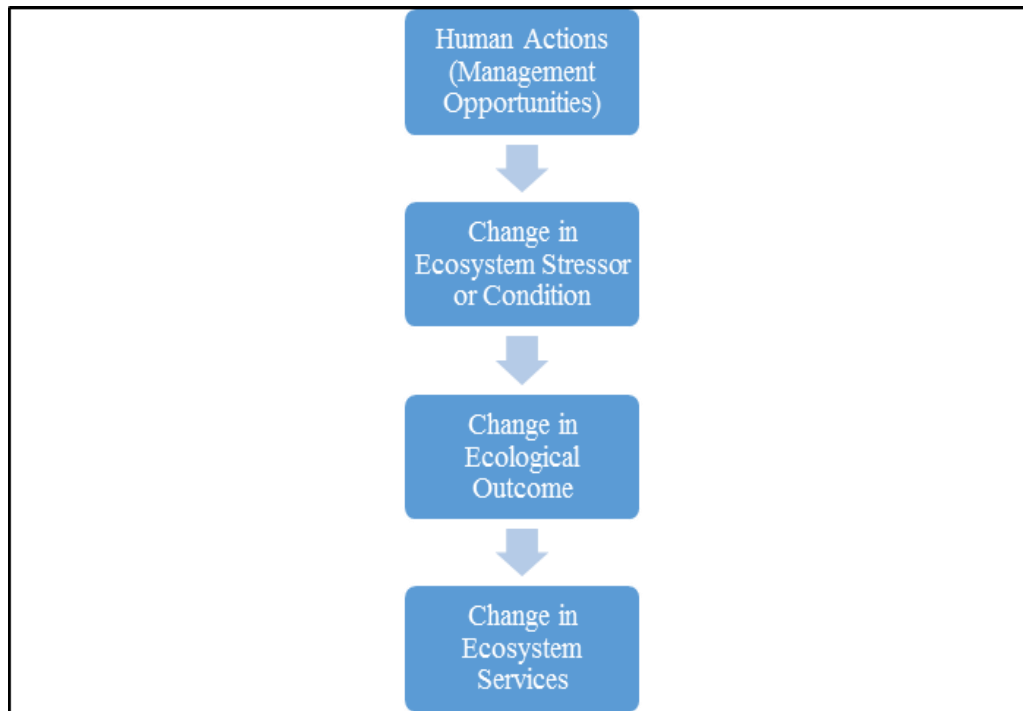

Figure 3-35. Ecosystem Services Conceptual Framework (Corps 2013)

The framework in Figure 3-35 was applied to discuss the ecosystem services effects of the project in the following paragraphs.

- *Human Actions*: Five human actions (alternatives) in addition to the No Action Alternative are identified and evaluated in this EIS.
- *Change in Ecosystem Stressor or Condition*: Each action alternative is intended to alleviate the environmental stressor identified as inadequate fish passage at the Intake Diversion Dam.
- *Change in Ecological Outcome*: The Fish Passage Connectivity Index Model (Section 2.6.3 and Appendix Y) was developed to quantify the change in ecological outcome associated with each alternative relative to the project's goals and objectives.
- *Change in Ecosystem Services*: The actions required to achieve these desired changes in ecological outcomes and the ecological outcomes themselves have intended and unintended effects of changing ecosystem services relative to the levels provided under without project conditions (conditions under the No Action Plan).

For the project, ecosystem services have been identified to include Ecosystem Sustainability (Aquatic Communities, Wildlife, Listed Species, State Species of Concern, and Lands and Vegetation); Irrigation Water Supply; Water Quality; Recreation; Aesthetics; and Cultural Resources.

The potential consequences of each alternative on each of these categories of ecosystem services is documented in Chapter Four of the EIS and is summarized in this Chapter. Table 3-46 provides a cross walk of the identified ecosystem service and the location of analysis in Chapter Four of this report.

TABLE 3-46 ECOSYSTEM SERVICES/ EIS IMPACT ANALYSIS CROSSWALK

Ecosystem Service Category	EIS Resource Category and Section with Impact Analysis
Ecosystem Sustainability	4.7 Aquatic Communities
	4.8 Wildlife
	4.9 Federally Listed and State Species of Concern
	4.10 Lands and Vegetation
Water Supply and Regulation	4.15 Social and Economic Conditions
	4.4 Surface and Groundwater Hydrology
Water Quality	4.6 Water Quality
Recreation	4.11 Recreation
Aesthetics	4.12 Visual Resources
Cultural Resources	4.17 Historic Properties
	4.18 Indian Trust Assets

4 Environmental Consequences

4.1 Introduction

4.1.1 Organization of this Chapter

This chapter describes the direct, indirect, and cumulative effects of the alternatives on the environmental resources and issues described in Chapter 3. The evaluation of each resource addresses the following:

- Definitions of effects
- Area of potential effect
- Summary of potential effects (table)
- Construction effects
- Operational effects
- Cumulative effects
- Actions to minimize effects

4.1.2 Definitions of Effects

This chapter describes the effects of alternatives on the resources evaluated. NEPA defines types of effects as follows (Sec. 1508.8 and 1508.7):

Direct effects—Effects that are caused by the action and occur at the same time and place.

Indirect effects—Effects that are caused by the action and are later in time or farther removed in distance, but are still reasonably foreseeable. Indirect effects may include
Growth-inducing effects and other effects related to induced changes in the pattern of land use, population density or growth rate

Effects on air and water and other natural systems, including ecosystems.

Cumulative Impact—The impact on the environment that results from the incremental impact of the action when added to other past, present, and reasonably foreseeable future actions, regardless of what agency (federal or non-federal) or person undertakes such other actions. Cumulative impacts can result from individually minor but collectively significant actions taking place over a period of time.

Each environmental resource is evaluated to determine effects associated with construction of the project as well as ongoing operations:

Construction effects are those effects resulting from construction activities while construction is underway.

Operational effects are the resulting permanent effects that occur from the final constructed project and effects from operation and maintenance over the 50-year period of analysis after construction is complete.

4.1.3 What is Meant by Determination of Significance?

A primary consideration for environmental reviews under NEPA is whether an action would cause a significant adverse effect on the natural or built environment. According to Council on Environmental Quality regulations (40 CFR 1500-1508), “the determination of a significant impact is a function of context and intensity.” Consideration of significance should include the severity (quality and sensitivity) of the impact on the specific resource, the location and context of the project, and the effect’s duration (short- or long-term). Significance will vary with the project’s setting and surrounding uses, such as residential, commercial, farmland, natural sites.

For each environmental resource in this chapter, the impacts of each alternative are examined to determine the beneficial and adverse significance. For some alternatives, the setting is specific (the location of a new channel, for instance), while for others the effects are more scattered (such as the pumping alternatives). For some resources, the setting is larger, such as on aquatic resources, where the setting is the larger river segments. The following factors can be considered in determining the severity of impact (40 CFR 1508.27):

- Impacts that may be both beneficial and adverse. A significant effect may exist even if the federal agency believes that on balance the effect will be beneficial.
- The degree to which the proposed action affects public health or safety.
- Unique characteristics of the geographic area, such as proximity to historic or cultural resources, park lands, prime farmlands, wetlands, wild and scenic rivers, or ecologically critical areas.
- The degree to which possible effects on the quality of the human environment are likely to be controversial.
- The degree to which possible effects on the human environment are uncertain or involve unique or unknown risks.
- The degree to which the action may establish a precedent for future actions with significant effects or represents a decision in principle about a future consideration.
- Whether the action is related to other actions with individually insignificant but cumulatively significant impacts. Significance exists if it is reasonable to anticipate a cumulatively significant impact on the environment. Significance cannot be avoided by terming an action temporary or by breaking it down into small component parts.
- The degree to which the action may adversely affect districts, sites, highways, structures, or objects listed in or eligible for listing in the National Register of Historic Places or may cause loss or destruction of significant scientific, cultural or historic resources.
- The degree to which the action may adversely affect an endangered or threatened species or its habitat that has been determined to be critical under the Endangered Species Act.
- Whether the action threatens a violation of federal, state, or local law or requirements imposed for the protection of the environment.

For each resource the section describes the intensity of impacts on the project alternatives characterized using the following terms:

- **No effect**—No discernable or measurable effect.
- **Negligible**—Effects would be at the lowest levels of detection, barely measurable, with no perceptible consequences.
- **Minor**—Effects result in a detectable change, but the change would be slight.

- **Moderate**—Effects would result in a clearly detectable change, with measurable effects.
- **Major**—Effects would be readily apparent with substantial consequences.

4.1.4 Past, Present, and Reasonably Foreseeable Future Actions

An assessment of environmental consequences considers the effects of past, present and anticipated future actions in the project area as follows:

- According to the Council on Environmental Quality, a cumulative effects analysis may assess past actions in the project area by focusing on “the current aggregate effects of past actions without delving into the historical details of individual past actions.” The effects of all past actions have created the current affected environment (the existing condition), so specific past actions do not need to be identified for the cumulative impacts analysis. In general, relevant past actions include construction of dams, other water diversions or water impoundments, grazing, farming, transportation development, recreational camping, and fishing.
- Present actions are typically ongoing activities and are treated similarly to past actions. Anticipated future changes in these activities are included under reasonably foreseeable actions.
- Reasonably foreseeable actions are those included under formal proposals or decisions not yet implemented at the time of the analysis. Reasonably foreseeable actions proposed in the analysis area have been considered in the cumulative effects analysis for each resource. These activities will continue to influence the landscape.

4.1.4.1 Past and Present Actions

Agriculture

The Yellowstone Valley prior to 1950 had already been developed for agricultural land uses (greater than 95 percent of the valley). Irrigated agriculture has become much more dominant in the study area since 1950 as a result of the Lower Yellowstone Project and other irrigation projects, adding nearly 10,000 acres of irrigated agriculture area between 1950 and 2011, generally from conversion of previously non-irrigated agricultural lands (Corps 2015). New agricultural conversion in the study area continues a trend toward more conversion to irrigation. Recent land use conversions have often replaced areas of formerly natural riparian land cover.

Dam Construction

The Intake Diversion Dam is the largest diversion dam on the Yellowstone River and is the subject of this EIS. Construction of the dam began in 1905, in response to authorization under the Reclamation Act of 1902. The Intake Diversion Dam was completed in 1911 and is used to irrigate land in eastern Montana and western North Dakota. It feeds the LYP Main Canal and a ~225-mile network of lateral canals that distribute water to approximately 400 farms. It is one of six major diversion dams on the main stem Yellowstone River downstream from Billings, Montana and is the furthest downstream dam and thus the first barrier encountered by pallid sturgeon on their migration route. These six diversion dams potentially affect the distribution of some fish species and have impacted fish passage and fish habitat connectivity on the Yellowstone River.

Previous studies indicate, prior to the completion of the screened headworks in 2012, that approximately 500,000 fish were being entrained into the LYP Main Canal annually. The fish screens are intended to reduce the entrainment of fish larger than 40 mm.

4.1.4.2 Reasonably Foreseeable Future Projects/Actions

Specific Projects and Programs

Missouri River Management Plan

The Missouri River Management Plan currently being developed by the Corps evaluates the effectiveness of current habitat development and will recommend modifications “to more effectively create habitat and avoid jeopardy to the species.” An adaptive management plan will be developed, and actions taken pursuant to the 2003 Amended Biological Opinion (Service 2003) are being assessed for their effectiveness. The geographic scope is the main stem of the Missouri River from the Fort Peck Reservoir to its confluence with the Mississippi River in Missouri, and the Yellowstone River from Intake to the confluence with the Missouri River.

Fort Peck Dry Prairie Regional Water System Improvements

The Fort Peck Dry Prairie Regional Water System is “designed to bring high quality drinking water to residents of the region.” The project includes a water treatment plant and water supply pipelines. The service area is the area in Montana north of the Missouri River, south of the Canadian Border, west of the North Dakota border and east of the western line of Range 39 East in Valley County. Portions of the project are on the Fort Peck Tribes Reservation. The tribes own water rights to 1 million acre-feet of the Missouri River annually, dating back to 1888. Approximately 7 million acre-feet flow through northeast Montana every year, and this system will use about 6,000 acre-feet annually when fully completed. (Montana DRC 2016b; Dry Prairie Rural Water 2016)

Crow Irrigation Project (Section 405 of Crow Settlement Act 2010)

The irrigation system on the Crow Reservation was constructed in the 1940s, and maintenance of the system has not kept pace with the aging infrastructure. Lack of maintenance, combined with other factors, has resulted in reduced efficiency of the entire system, unreliable irrigation water deliveries, impacts on natural resources, and an imbalance in the benefits provided to tribal and non-tribal uses. The purpose of the Crow Irrigation Project is to address the deficiencies in the irrigation system through rehabilitation and improvement activities, to implement modern, more efficient technologies and practices, to improve the cost-effectiveness of the system, and to increase its capacity.

Crow Municipal, Rural and Industrial Water Project (Section 406 of Crow Settlement Act 2010)

The Crow Tribe is proposing to construct a municipal, rural and industrial water system. Existing community systems and individual groundwater wells have a multitude of issues with water quality (not meeting standards of the federal Safe Drinking Water Act) and water quantity (insufficient quantity to serve current population and projected growth). The Tribe has proposed to construct a reservation-wide system with the following major components:

- Intake (source from the Bighorn River)
- Water treatment plant
- Distribution system/pipeline

- Pumping stations
- Service connections
- Storage facilities
- Accessory structures (electrical systems, valves, etc.).

The draft EA will likely be available for public review in May or June 2016.

Storage Allocation (Section 408 of Crow Settlement Act of 2010)

The Crow Settlement Act of 2010 allocated the Crow Tribe 300,000 acre-feet per year of water stored in Bighorn Lake, with stipulations regarding natural flow rights and natural flow storage.

Streamflow and Lake Level Management Plan (Section 412 of Crow Settlement Act of 2010)

Reclamation is required to update its Streamflow and Lake Level Management Plan to reflect the allocations identified in Section 408 of the Crow Settlement Act of 2010.

Yellowtail Afterbay Power Generation (Section 412 of Crow Settlement Act of 2010)

Reclamation and the Crow Tribe have entered into an agreement for hydropower development on the Yellowtail Afterbay (Reclamation 2015). Reclamation will provide technical assistance in reviewing designs and making sure the new hydroelectric facility coexists with the existing Yellowtail Afterbay Dam in a safe and reliable manner. The next steps include completion of design data collection, followed by design and implementation of Reclamation's dam safety processes for proposed modifications to the existing structure. The project, when completed, will generate 8 to 12 megawatts of electricity.

The Crow Tribe has exclusive right to generate and market power from the Yellowtail Afterbay, a re-regulating reservoir downstream from Yellowtail Dam. (Billings Gazette 2014). The completed project will be run of the river and will not affect releases on the Bighorn River, a tributary to Yellowstone River. It is not likely to substantially affect overall Yellowstone River flows in the study area. At this time, the Tribe is undertaking geologic data collection activities in order to inform/support future design efforts for a hydropower plant.

Montana SR-16 Improvements

In 2012, the Montana Department of Transportation published the *MT 16 / MT 200 Glendive to Fairview Corridor Planning Study*, which assessed existing and projected traffic along the corridor. The study found that average annual daily traffic increased rapidly in response to the oil and gas boom, but that it was showing signs of leveling off in 2012. The report included some roadway resurfacing and improvement options (passing opportunities, transitions, intersections) that would help maintain a consistent level of service through 2035. No funding for major projects was secured (Montana Department of Transportation 2012).

General Trends

The Bakken Oil Fields and Fracking

The recent oil boom in the Bakken Oil Fields has led to major development activities in both Sidney and Glendive. Oil prices are currently much lower than 2011, resulting in the slowing of growth in communities that serve the oil industry. These communities, however, continue to plan for future growth if and when oil prices stabilize and increase. Glendive is completing a new

wastewater treatment plant in 2016 designed, in part, to handle future growth in Glendive and West Glendive (Glendive Ranger-Review, 9/3/14). Additional infrastructure to support oil transport could include additional pipelines or railroad infrastructure over the long-term.

Climate Change

Climate change model simulations developed in support of the recently completed Montana state water plan all generally predict earlier runoff and reduced summer flows (MDNRC 2014). Median daily flow data compiled for pre- and post-1990 conditions on the upper Yellowstone River at Livingston in the YRCEA (Corps and YRCDC 2015) demonstrate this general pattern; in the past 15 years, runoff has typically started about a week earlier and peaked 10 days earlier than it typically did between 1896 and 1990.

A study of low flows on streams in the Rocky Mountains (Lippi 2012) also indicates that late summer low flows are showing a declining trend, and declines in stream flow show a negative correlation with air temperature (as air temperature increases, stream flow decreases).

Dam Safety

Reclamation released a Final EA and FONSI in January 2014 involving a dam safety issue on the Milk River in Montana. The project involves safety modifications to two Nelson Reservoir dikes to correct structural deficiencies caused by seepage through the dikes (Reclamation 2014). Over the 50-year time horizon of the Intake project, other dams, dikes and related facilities along the Yellowstone and Missouri Rivers in Montana may be found to have structural deficiencies that require modifications or reconstruction. Any modifications would need to comply with current environmental regulations and would likely only result in temporary effects on the rivers during construction.

Montana Paddlefish Regulations

State regulations on fishing for paddlefish on the lower Yellowstone River saw no changes from 2011 and 2016. Future regulations are subject to change based on estimated populations of paddlefish, as agreed to by the states of Montana and North Dakota.

Pivot Irrigation and Bank Armoring

Since 2001, a number of landowners along the lower Yellowstone River have invested in converting flood irrigation systems to pivot irrigation sprinkler systems (Corps and YRCDC 2015). It is anticipated that this trend will continue, as sprinkler systems are more efficient. When this expensive infrastructure is installed in areas of potential channel migration, bank stabilization to protect the infrastructure is expected to continue. (Corps and YRCDC 2015)

Spills at Oil/Gas/Brine Water Pipeline Crossings

Two recent oil spills from pipe ruptures (in 2011 near Laurel, MT and in 2015 near Glendive, MT) have shown the vulnerability of oil pipelines along the Yellowstone River. The YRCEA includes a number of recommendations to minimize the risk of such pipeline spills, though there could be additional spills during the 50-year time horizon for this analysis.

Urbanization

The lower reaches of the Yellowstone River have generally not had substantial urban growth since 1950 (Corps and YRCDC 2015). Glendive is an anomaly to this general trend, which likely

due to the routing of Interstate 94, completed in the 1960s, close to the city. After completion of the Interstate, almost 300 acres of urban expansion occurred, mainly in industrial and commercial development. More recently, Glendive and Sidney have seen development associated with supporting oil production and workers.

4.2 Climate

Climate in eastern Montana is driven by regional and global factors, including topography, size of land masses, oceanic water temperatures, polar and mountain glaciation, and ice cover. Thus, the project alternatives would not affect the local or regional climate to any measureable extent. Any potential releases of greenhouse gas emissions that could lead to impacts on climate are discussed in the Air Quality section.

This section discusses the potential effects of climatic conditions on each project alternative and the potential long-term effects on the region and on project alternatives that could occur due to climate change.

4.2.1 Area of Potential Effect

The area of consideration for potential effects from climate change is central eastern Montana, including Dawson, Richland, Prairie and Wibaux counties and McKenzie County in central western North Dakota.

4.2.2 Summary of Potential Effects

Table 4-1 summarizes the potential effects of climate on each alternative. Details are provided in the following sections.

TABLE 4-1. SUMMARY OF POTENTIAL CLIMATE EFFECTS ON EACH ALTERNATIVE

Impact Type	Level of Impact	Impact Description
No Action Alternative		
Construction Effects	No Effect	<ul style="list-style-type: none"> No construction activities
Operational Effects	Moderate	<ul style="list-style-type: none"> Risk of not reliably providing irrigation water right in some years due to climatic conditions.
Rock Ramp Alternative		
Construction Effects	Minor	<ul style="list-style-type: none"> Possible delays in construction due to extreme flows or weather conditions
Operational Effects	Moderate	<ul style="list-style-type: none"> Risk of not reliably providing irrigation water right in some years due to climatic conditions.
Bypass Channel Alternative		
Construction Effects	Minor	<ul style="list-style-type: none"> Possible delays in construction due to extreme flows or weather conditions
Operational Effects	Moderate	<ul style="list-style-type: none"> Risk of not reliably providing irrigation water right in some years due to climatic conditions.
Modified Side Channel Alternative		
Construction Effects	Minor	<ul style="list-style-type: none"> Possible delays in construction due to extreme flows or weather conditions

Impact Type	Level of Impact	Impact Description
Operational Effects	Moderate	<ul style="list-style-type: none"> Risk of not reliably providing irrigation water right in some years due to climatic conditions.
Multiple Pump Alternative		
Construction Effects	Minor	<ul style="list-style-type: none"> Possible delays in construction due to extreme flows or weather conditions
Operational Effects	Moderate	<ul style="list-style-type: none"> Risk of not reliably providing irrigation water right in some years due to climatic conditions.
Multiple Pumps with Conservation Measures Alternative		
Construction Effects	Minor	<ul style="list-style-type: none"> Possible delays in construction due to extreme flows or weather conditions
Operational Effects	Moderate	<ul style="list-style-type: none"> Risk of not reliably providing irrigation water right in some years due to climatic conditions.

4.2.3 Construction Effects

4.2.3.1 No Action Alternative

The No Action Alternative does not have any new construction elements, so there would be no effects associated with construction.

4.2.3.2 Rock Ramp Alternative

During construction of the Rock Ramp Alternative, coffer dams would be used to isolate in-river work zones. It can be expected that a steel sheet pile cofferdam would be constructed upstream of the Intake Diversion Dam to allow construction of the replacement weir and that a coffer dam or rock deflectors may be used to construct the rock ramp in linear segments. As this work would likely take about 18 months, climatic conditions could cause work delays if extreme cold or rainy weather caused unusual ice conditions or caused flood events. This could require a longer construction period or cause the cost of the project to increase if ice carried away rock that was partially placed for the ramp or if ice or flood flows shortened the work season or otherwise damaged construction features. Overall, there could be minor effects or delays to the work due to climatic conditions.

4.2.3.3 Bypass Channel Alternative

During construction of the Bypass Channel Alternative, cofferdams would be used to isolate the in-river work zone for construction of the replacement weir. Cofferdams would also be used at the upstream and downstream ends of the proposed bypass channel. As this work would likely take 2 to 3 years, climatic conditions could cause work delays if extreme cold or rainy weather caused unusual ice conditions or caused flood events. This could require a longer construction period or cause the cost of the project to increase if ice or flood flows shortened the work season or otherwise damaged construction features. Overall, there could be minor effects or delays to the work due to climatic conditions.

4.2.3.4 Modified Side Channel Alternative

During construction of the Modified Side Channel Alternative, cofferdams or other isolation measures would be necessary at the upstream and downstream ends of the existing side channel to facilitate excavation. It is estimated that this alternative would take approximately 18 months to complete, climatic conditions could cause work delays if extreme cold or rainy weather caused

unusual is conditions or caused flood events. This could require a longer duration for construction or cause the cost of the project to increase. Because most of the work for this alternative would occur away from the main river flow in the side channel area, the risk of any effects of ice or flooding on this work is much reduced. Overall, there could be minor effects or delays to the work due to climatic conditions.

4.2.3.5 Multiple Pump Alternative

During construction of the Multiple Pump Alternative, cofferdams would be used to isolate the in-river work zone for demolition and removal of the Intake Diversion Dam. Cofferdams or soil/rock plugs may be used to isolate the work zone for excavation of the feeder canals to the pumping stations. Demolition of the Intake Diversion Dam is only anticipated to take one season, so the risk of extreme climatic conditions delaying this portion of the work is low. As most of the work for the pumping stations would occur away from the river, the risk of extreme climatic conditions delaying the work is low. It is assumed that the Intake Diversion Dam could not be removed until all other features associated with this alternative are installed. Therefore, there could be at least a 3-year period when the Intake Diversion Dam would remain in place while other features are in construction. However, overall, there could be minor effects or delays to the work due to climatic conditions.

4.2.3.6 Multiple Pumps with Conservation Measures Alternative

During construction of the Multiple Pumps with Conservation Measures Alternative, cofferdams would be used to isolate the in-river work zone for demolition and removal of the Intake Diversion Dam. Demolition of the dam is only anticipated to take one season, so the risk of extreme climatic conditions delaying this portion of the work is low. It is assumed that the dam could not be removed until all other features associated with this alternative are installed. Therefore, there could be at least a 6-year period when the Intake Diversion Dam would remain in place while other features are in construction. However, overall, there could be minor effects or delays to the work due to climatic conditions.

4.2.4 Operational Effects

Over the 50-year period of analysis, it is likely that the climate will continue to warm, with a greater percentage of precipitation occurring as rainfall and reduced snowfall and snowpack.

Information from the Hydroclimate Projections Report (Reclamation 2016a) states, “there is an increasing trend of total annual precipitation and mean annual temperature across the basin. April first snow water equivalent shows a decreasing trend, while the annual runoff shows an increasing trend.” To determine what the percent increase in annual runoff may occur at the Yellowstone River at Glendive, Reclamation ran global climate models from the Scripps Institute of Oceanography and evaluated the potential for increased annual runoff volume centered on the 2065 time frame. The results of analysis displays there is an increase of about fifteen percent centered on the 2065 time frame, which is the 50 year life of the project. This trend would occur for the no action or any of the action alternatives.

The most recent assessment of climate change by the U.S. Climate Change Science Program in 2014 included a summary for the Great Plains region (Shafer et al. 2014). This summary indicates that temperatures are likely to continue to increase, with eastern Montana experiencing 10 to 20 more of the hottest days in summer (days hotter than 90°F) and 20 to 25 more of the

warmest nights per year (nights warmer than 60°F). Predictions are that precipitation may increase in springtime, which could reduce demand for irrigation in the early growing season. However, warmer temperatures and longer growing seasons may increase demand for irrigation later in the season when river flows are typically low, by increasing evapotranspiration and growth rates.

A study of low flows on streams in the Rocky Mountains (Lippi 2012) indicates that late summer low flows are declining and that declines in stream flow show a negative correlation with air temperature (as air temperature increases, stream flow decreases).

In the Yellowstone Cumulative Effects Assessment (Corps & YRCDC 2015), an analysis of median daily hydrographs from the Livingston gage on the Yellowstone River indicates that since 1990 runoff has generally started about one week earlier and peak runoff has occurred about 10 days earlier than the median from 1896 through 1990.

Gray & McCabe (2008) studied tree-rings to estimate the range in variability of historical precipitation and runoff in the Yellowstone watershed. Tree-rings indicate that there have been periods of extreme drought that extended for many years and were more severe than those recorded since Euro-American settlement of the region. Regardless of the potential for increased warming, there is a likelihood of future droughts that would cause reduced flows below those in the gage record. Increased warming could magnify the amplitude and duration of future droughts even beyond the historical tree-ring record. Associated with warming temperatures and droughts could be an increased risk of fires, earlier budding/leaf out of plants, and the potential for species ranges to trend northward towards cooler climates.

These climatic changes are likely to affect the performance of all of the potential alternatives, including the reliability of providing fish passage and the reliability of providing irrigation water.

4.2.4.1 No Action Alternative

For the No Action Alternative, operations would require annual placement of rock on top of the Intake Diversion Dam to ensure sufficient head to divert the 1,374 cfs of flow into the canal, down to 3,000 cfs in the river. If runoff continues to occur earlier, it may change the timing of rock placement. However, replacement of the rock could become less frequent if cold temperatures and ice conditions are less frequent in the future, thus reducing the potential for periodic damage. Changed timing or reductions in runoff could also reduce depths over the weir, causing further fish passage problems. There may be increased occurrences of flows less than 3,000 cfs in the river, which would lead to more difficulty in diverting 1,374 cfs from gravity flows, particularly in late summer and fall when flows are typically lowest. This could lead to the need for further supplemental pumping to provide the full irrigation water right, or a reduction in the amount of water available during peak demand. If this is the case, the number of acres irrigated could be impacted. Overall, there is moderate risk for the No Action Alternative of not being able to divert the full irrigation water right due to climatic conditions.

4.2.4.2 Rock Ramp Alternative

For the Rock Ramp Alternative, it is likely that periodic replacement or reconfiguration of the rock ramp may be required due to the potential for ice damage and movement of rocks downstream. If runoff occurs earlier, it may be very difficult to place rock and maintain the

designed ramp configuration prior to the migration season for species such as pallid sturgeon. However, repairs of the rock ramp could become less frequent if cold temperatures and ice conditions are less frequent in the future, thus reducing the potential for periodic damage. Changed timing or reductions in runoff could also reduce depths over the weir and ramp, causing fish passage problems. If river flows below 3,000 cfs become more frequent, there could also be reduced depths and velocities on the rock ramp, which may be unsuitable for fish passage.

Any increased frequency of flows less than 3,000 cfs in the river would lead to more difficulty in diverting 1,374 cfs from gravity flows, even with the higher elevation replacement weir, particularly in late summer and fall when flows are typically lowest. This could lead to the need for further supplemental pumping to provide the full irrigation water right, or it could cause an increased impetus for water conservation measures. Overall, for the Rock Ramp Alternative there is moderate risk of not being able to divert the full irrigation water right or difficulty maintaining the rock ramp due to climatic conditions over the long-term.

4.2.4.3 Bypass Channel Alternative

The Bypass Channel Alternative is intended to provide 12 to 15 percent of the Yellowstone River flow volume through the bypass channel at all flows. During drought years, the channel could have very little flow and thus shallow depths, which could be unsuitable for some fish species using the bypass channel for passage. An increased frequency of flooding could damage the bypass channel, requiring more maintenance than anticipated.

Any increased frequency of flows less than 3,000 cfs in the river would lead to more difficulty in diverting 1,374 cfs from gravity flows, particularly in late summer and fall when flows are typically lowest. This could lead to the need for further supplemental pumping to provide the full irrigation water right, or it could cause an increased impetus for water conservation measures. Overall, for the Bypass Channel Alternative there is moderate risk of not being able to divert the full irrigation water right and a minor risk to fish passage performance due to climatic conditions over the long-term.

4.2.4.4 Modified Side Channel Alternative

The Modified Side Channel Alternative is intended to provide 12 to 15 percent of the Yellowstone River flow volume through the existing side channel at all flows. During drought years, the channel could have very little flow and thus shallow depths, which could be unsuitable for some fish species using it for passage. An increased incidence of flooding could damage the existing side channel, although this channel is less likely than the bypass channel to be damaged, due to its flatter slope and longer length, which would tend to reduce velocities scouring.

Earlier runoff could make it more difficult to place rock on the Intake Diversion Dam to ensure delivery of the irrigation water right of 1,374 cfs. However, replacement of the rock could become less frequent if cold temperatures and ice conditions are less frequent in the future, thus reducing the potential for periodic damage. There also may be increased occurrences of flows less than 3,000 cfs in the river, leading to more difficulty in diverting 1,374 cfs from gravity flows, particularly in late summer and fall when flows are typically lowest. This could lead to the need for further supplemental pumping to provide the full irrigation water right, or it could cause an increased impetus for water conservation measures. Overall, for the Modified Side Channel

Alternative there is moderate risk of not being able to divert the full irrigation water right and a minor risk to fish passage performance due to climatic conditions over the long-term.

4.2.4.5 Multiple Pump Alternative

Because the Intake Diversion Dam would be removed for the Multiple Pump Alternative, changes in the timing and volume of runoff or reduced low flows would have less of a potential to reduce fish passage beyond that which would occur along the entire river. Reduced river flows could make it difficult to obtain the desired gravity flow volumes or shorten the season when gravity flow is possible. Reduced low flows could also make it difficult to pump the entire 1,374 cfs water right into the Main Canal. This could lead to the need for an additional pumping station to provide the full irrigation water right, or it could cause an increased impetus for water conservation measures. Overall, for the Multiple Pump Alternative there is moderate risk of not being able to pump the full irrigation water right due to climatic conditions over the long-term.

4.2.4.6 Multiple Pumps with Conservation Measures Alternative

Because Intake Diversion Dam would be removed for the Multiple Pumps with Conservation Measures Alternative, changes in the timing and volume of runoff or reduced low flows would have less potential to reduce fish passage beyond that which would occur along the entire river. Reduced river flows could make it difficult to obtain the desired gravity flow volumes or shorten the season when gravity flow is possible. It could also make it more difficult to pump the proposed 608 cfs from groundwater into the canal, which could lead to the need for additional wells or surface water pumps to provide the irrigation water right. As all possible water conservation measures would have already been installed for this alternative, there would not be much recourse during very dry years other than to fallow the farmland. Overall, for the Multiple Pumps with Conservation Measures Alternative there is moderate risk of not being able to provide even the proposed reduced irrigation flows due to climatic conditions over the long-term.

4.2.5 Cumulative Effects

Climate change is likely to contribute to cumulative effects in the area of potential effect and is one of several ongoing trends in the area of potential effect identified in Section 4.1.4. The only project that could contribute to climate effects would be the continued oil shale development, which may incrementally contribute to climate change. None of the alternatives would contribute to any cumulative effects on climatic conditions.

For the Multiple Pump Alternative and Multiple Pumps with Conservation Measures Alternative, which require pumping of surface or groundwater, the required use of energy could contribute incrementally to an increase in carbon dioxide, which could have a very minor additional contribution to climate change. The cumulative effects of potential emissions from energy sources required for these alternatives is discussed in Section 4.3.5.

4.2.6 Actions to Minimize Effects

No actions to avoid or minimize impacts associated with climate have been identified.

4.3 Air Quality

This section qualitatively evaluates environmental consequences on air quality from each project alternative, based on available information at this planning phase of the project.

4.3.1 Area of Potential Effect

The area of potential effect for evaluation of air quality impacts is both local and regional. The local study area is alternative-specific and depends on the location of construction areas and of components of the alternative. Construction effects within the local study area are associated with fugitive dust emissions and emissions from construction equipment. Operation and maintenance effects would be primarily evaluated for the local study area, associated with maintenance activities. The local study area for the alternatives are as follows:

- **No Action Alternative.** The local study area is limited to the area of the existing Intake Diversion Dam.
- **Rock Ramp Alternative.** The local study area for the Rock Ramp Alternative is limited to the area immediately surrounding the existing Intake Diversion Dam.
- **Bypass Channel Alternative.** The local study area for the Bypass Channel Alternative includes the area immediately surrounding the existing Intake Diversion Dam and Joe's Island.
- **Modified Side Channel Alternative.** The local study area for the Modified Side Channel Alternative includes the area immediately surrounding the existing Intake Diversion Dam and Joe's Island.
- **Multiple Pump Alternative.** The local study area for the Multiple Pump Alternative includes the area immediately surrounding the existing Intake Diversion Dam and the areas surrounding the five pumping stations and their components (see Figure 2-10).
- **Multiple Pumps with Conservation Measures Alternative.** The local study area for the Multiple Pumps with Conservation Measures Alternative includes the area immediately surrounding the existing Intake Diversion Dam and the areas surrounding the seven pumping stations, conservation measures, and their components (see Figure 2-21).

The regional study area encompasses the Yellowstone River valley and the counties of Dawson, Richland, and Wibaux in northeastern Montana. Construction effects within the regional study area are associated with construction hauling and construction worker trips. Surrounding areas might be minimally impacted by increased construction traffic. The regional study area is important for the Multiple Pump Alternative and the Multiple Pumps with Conservation Measures Alternative, due to the dispersed facilities and the unknown locations of required new transmission lines, substation upgrades, and new substations.

4.3.2 Summary of Potential Effects

Table 4-2 summarizes the potential effects on air quality for each alternative. Details are provided in the following sections.

TABLE 4-2. SUMMARY OF POTENTIAL EFFECTS ON AIR QUALITY FROM EACH ALTERNATIVE

Impact Type	Level of Impact	Impact Description
No Action Alternative		
Construction Effects	No effect	<ul style="list-style-type: none"> No effects
Operational Effects	Negligible	<ul style="list-style-type: none"> Negligible effects from regular maintenance activities.
Rock Ramp Alternative		
Construction Effects	Negligible	<ul style="list-style-type: none"> Construction activities might have short-term negligible effects on local air quality from excavation, hauling, and construction in the area of the Intake Diversion Dam and Joe's Island.
Operational Effects	Negligible	<ul style="list-style-type: none"> Negligible effects on local air quality from maintenance of the rock ramp in the area of the Intake Diversion Dam and Joe's Island.
Bypass Channel Alternative		
Construction Effects	Negligible	<ul style="list-style-type: none"> Construction activities might have short-term negligible effects on local air quality from excavation, hauling, and construction in the area of the Intake Diversion Dam and Joe's Island.
Operational Effects	Negligible	<ul style="list-style-type: none"> Negligible effects on local air quality from maintenance of the bypass channel in the area of the Intake Diversion Dam and Joe's Island.
Modified Side Channel Alternative		
Construction Effects	Negligible	<ul style="list-style-type: none"> Construction activities might have short-term negligible effects on local air quality from excavation, hauling, and construction in the area of the Intake Diversion Dam and Joe's Island.
Operational Effects	Negligible	<ul style="list-style-type: none"> Negligible effects on local air quality from maintenance of the side channel in the area of the Intake Diversion Dam and Joe's Island.
Multiple Pump Alternative		
Construction Effects	Negligible	<ul style="list-style-type: none"> Construction activities might have short-term negligible effects on local air quality from excavation, hauling, and removal of the Intake Diversion Dam; in the areas of the five pumping sites; and in areas of new power infrastructure.
Operational Effects	Negligible	<ul style="list-style-type: none"> Negligible effects on local air quality from maintenance and operation of the five pumping sites (including canals) and new power infrastructure.
Multiple Pumps with Conservation Measures Alternative		
Construction Effects	Negligible	<ul style="list-style-type: none"> Construction activities might have short-term negligible effects on local air quality from excavation, hauling, and removal of the Intake Diversion Dam; in the areas of the seven well sites; and in areas of new power infrastructure.
Operational Effects	Negligible	<ul style="list-style-type: none"> Negligible effects on local air quality from maintenance and operation of the seven well sites (including canals), conservation measures, and in areas of new power infrastructure.

The No Action Alternative would have negligible effect on air quality; the only impact would be associated with operation and maintenance activities. Air quality effects associated with the action alternatives would all be associated with earth disturbing activities. However, the overall

effects on air quality with any action alternatives would be minor and temporary, having a negligible contribution to air quality in the local and regional area.

The Rock Ramp, Bypass Channel and Modified Side Channel alternatives all require excavation and placement of fill and import of various quantities of rock and concrete. Effects on air quality would be localized to the construction area and would be minor and temporary, having a negligible contribution to air quality in the local and regional areas.

The Multiple Pump Alternative and Multiple Pumps with Conservation Measures Alternative would involve removal of the existing dam and construction of new power infrastructure. Potential construction of new wind turbines for the Multiple Pumps with Conservation Measures Alternative would also contribute to air quality effects. Even though these alternatives would require construction and maintenance over a wider regional area, effects on air quality would be localized to the construction area and would be minor and temporary, having a negligible contribution to air quality in the local and regional area. Operations for the Multiple Pump Alternative and Multiple Pumps with Conservation Measures Alternative would include the use of emergency diesel generators. Emissions from these sources would be minimal and would not require permitting; therefore, effects on air quality from these sources would have a negligible contribution to air quality.

With implementation of actions to minimize effects for each action alternative, emissions would be minimized, further reducing the minor temporary effects on air quality.

4.3.3 Construction Effects

Construction emissions would be temporary, occurring on an intermittent basis during the construction season over the course of two to ten years, depending on the alternative (see Table 4-3). These emissions could impact sensitive areas nearby. Construction activities that would generate emissions include earthwork (i.e., land clearing, ground excavation, and cut-and-fill operations), aggregate/material handling, and construction of project structures. All of the alternatives (except the No Action Alternative) would cause short-term increased exhaust emissions associated with construction vehicles (employee, delivery, and heavy-duty equipment). Construction would also create fugitive dust.

The intermittent and short-term emissions generated by these activities would include fugitive dust from soil disruption and combustion emissions from the construction equipment and on-road vehicles. Emissions associated with construction equipment and on-road vehicles include criteria pollutants (PM₁₀, PM_{2.5}, NO_x, CO, VOCs, and SO_x), greenhouse gases, and small amounts of air toxics. These emissions are expected to be within acceptable air quality standards.

TABLE 4-3. CONSTRUCTION EFFECTS BY ALTERNATIVE

Alternative	Estimated Area Disturbed	Estimated Material Handled	Duration
No Action	none	none	Already constructed
Rock Ramp	Staging and stockpile areas, construction zone on Joe's Island, haul roads (acreage not available)	450,000 tons of rock riprap; 75,000 tons of fill material	8 months
Bypass Channel	Up to 64 acres (for the channel only); access roads and other construction zones (acreage not available)	65,000 tons of riprap; excavation and disposal of approximately 869,000 cubic yards of earthen material; 28,000 cubic yards of channel bed armor material	28 months
Modified SideChannel	Up to 34 acres (new channel only); approximately 10 acres (to modify existing channel); acreage is not available for the following: 3 new access roads; 3 staging areas; spoils area; new bridge	Excavation of 1.19 million cubic yards of material (new channel and to lower existing channel); placement of 362 cubic yards of material (fill for bend cutoffs); disposal of 828,000 cubic yards of material; 5,300 feet of riprap bank protection; placement of 50,000 cubic yards of fill	18 months
Multiple Pump	17 acres (for 5 pumping sites including all components and access roads); over 30,100 feet of new power lines; 3 new substations and substation modification (acreage not available)	Not available (excavation and disposal of earth material for pump structures—5 sites); excavation and disposal of material for dam removal	3.5 years
Multiple Pumps with Conservation Measures	490 acres (7 pumping stations); New power lines or substations (unknown acreage)	Cofferdam fill material: 38,352 cubic yards; Bedding stone: 2,140 cubic yards; riprap: 8,553 cubic yards; Dam removal: 45,168 cubic yards; Not available (excavation and disposal of earth material for pump structures at 7 sites)	5-10 years (see Chapter 2)

4.3.3.1 No Action Alternative

Under the No Action Alternative, operation of the existing Intake Diversion Dam would continue and ground disturbance and construction activities would not be necessary. No temporary or long-term impacts on air quality from fugitive dust or other air pollutants would result, since there would not be any construction activity. Air quality effects for this alternative would be consistent with current conditions with no anticipated long-term impacts. This alternative would require operation and maintenance activities to continue as described and evaluated for air quality effects in the Operational Effects section.

4.3.3.2 Rock Ramp Alternative

The primary features of the Rock Ramp Alternative include replacement of the existing rock-and-timber crib structure at the Intake Diversion Dam with a concrete weir and shallow-sloped, un-grouted boulder and cobble rock ramp. Construction work and the primary elements of this alternative would be located in the immediate vicinity of the dam, including Joe's Island. Construction of the alternative would take three years and be conducted in three primary phases, depending on funding.

Construction activities associated with the Rock Ramp Alternative include the following: a replacement concrete weir, placement of rock and fill material (approximately 75,000 tons) in the river to shape the ramp, placement of rock riprap (approximately 450,000 tons), staging and rock stockpile areas on the left bank of the Main Canal, a construction zone on Joe's Island, access roads, and a temporary crossing over the Main Canal.

Emissions from these construction activities would primarily be fugitive dust from the earth disturbing and material handling activities, and combustion emissions from the non-road heavy construction equipment. Fugitive dust and combustion emissions would also be generated from vehicles traveling on unpaved roads and commuting to and from the construction areas. These emissions would occur on an intermittent and short-term basis during the construction season for a two-year period. Based on an evaluation of the estimated equipment types to be used, areas to be disturbed on a given basis, length of the construction schedule, amount of material to be handled, and other construction activities, the resulting impacts on air quality would be minor and temporary and localized to the vicinity of the construction activities. These minor temporary increases in air emission are anticipated to have a negligible contribution to air quality in the local and regional area and are not anticipated to exceed any federal, state, or local air regulations.

With implementation of proposed actions to minimize effects, air emission associated with this alternative would be minimized. Furthermore, the air emissions associated with these construction activities would be solely from mobile sources and mobile construction activities, and would not be subject to federal or Montana air quality requirements requiring consultation or permitting.

4.3.3.3 Bypass Channel Alternative

The primary features of the Bypass Channel Alternative include use of the screened headworks structure, construction of a new concrete weir, and construction of a new bypass channel on Joe's Island. Construction work and the primary elements of this alternative would be located primarily on Joe's Island. This land was acquired by Reclamation during construction of the original Intake project. All construction, staging, and disposal would occur on Reclamation-owned lands. Construction of the alternative would take two to three years.

Construction activities associated with the Bypass Channel Alternative include the following: replacement weir, excavation and disposal of approximately 1,100,000 cubic yards of earthen material from Joe's Island, disturbance of up to 64 acres of ground surface for construction of the channel, two cofferdams, four riprap grade control structures, two vertical control structures (riprap sills), bank riprap at four outside bends of the channel (approximately 65,000 tons), channel bed armor material (approximately 28,000 cubic yards), an access road along the north side of the river, and a channel plug in the upstream portion of the existing side channel. Additional details regarding earth-moving equipment and vehicle necessary for the Bypass Channel Alternative are included in Appendix B.

With implementation of proposed actions to minimize effects, air emission associated with this alternative would be minimized. Overall, construction emissions would be minor and temporary, having a negligible contribution to air quality in the local and regional area. Furthermore, the air emissions associated with these construction activities would be solely from mobile sources and

mobile construction activities, and would not be subject to federal or Montana air quality requirements requiring consultation or permitting.

4.3.3.4 Modified Side Channel Alternative

This alternative would make improvements to the existing side channel. Construction of the Modified Side Channel Alternative would take 18 months. The modified side channel would be located on Joe's Island.

Construction activities associated with the Modified Side Channel Alternative include the following: excavation of 1.19 million cubic yards of material for 6,000 feet of new channel at three bend cutoffs and lowering the existing channel, placement of 362,000 cubic yards of material to partially fill three bend cutoffs, hauling and placement of 828,000 cubic yards of material in spoils area on the south bluff, construction of one 150-foot single span bridge, 5,300 feet of bank protection (16 to 27 inch average diameter riprap) in three locations including the upstream confluence with the Yellowstone and at two bend cutoffs, five grade control structures, placement of 50,000 cubic yards of native substrate in the bed of the existing side channel, 3 miles of construction access roads, and three staging areas. Additional details regarding earth-moving equipment and vehicles necessary for the Modified Side Channel Alternative are included in Appendix B.

With implementation of proposed actions to minimize effects, air emission associated with this alternative would be minimized. Overall, the construction emissions would be minor and temporary, having a negligible contribution to air quality in the local and regional area. Furthermore, air emissions associated with these construction activities would be solely from mobile sources and mobile construction activities, and would not be subject to federal or Montana air quality requirements requiring consultation or permitting.

4.3.3.5 Multiple Pump Alternative

This alternative would remove the Intake Diversion Dam and construct five pumping stations on the Yellowstone River to deliver water to the Lower Yellowstone Project.

Discharge pipelines varying in length from 300 feet to 5,600 feet would convey irrigation water from each of the pumping stations to the irrigation canal. The power demand for the pumps would exceed the capacity of the existing power system in this area, requiring uprating of existing powerlines and the extension of powerlines to each site. Existing substations would also be uprated to meet the power demands required and at least three new substations would be required. The estimated total power demand for the five sites is 6,000 kW. This alternative would consume approximately 10 gigawatt-hours of power in a typical year. Construction of the alternative would take at least 4 years and would be completed in phases.

Construction activities associated with the Multiple Pump Alternative include the following: removal of the existing dam, construction of five pumping stations (total of approximately 17 acres including all components and access roads), construction of over 30,100 feet of new power lines, construction of three new substations, and upgrades to other substations. Additional details regarding earth-moving equipment and vehicles necessary for the Multiple Pump Alternative are included in Appendix B.

The construction of new power lines and substations would take place over a broader regional area; however, the minor air quality impacts would still be localized to the immediate vicinity of the construction area. In any case, such effects would be minimized with the implementation of proposed actions to minimize effects. Construction emissions would be minor and temporary, having a negligible contribution to air quality in the local and regional area, similar to that described for the other action alternatives. Air emissions associated with these construction activities would be solely from mobile sources and mobile construction activities, and would not be subject to federal or Montana air quality requirements requiring consultation or permitting.

4.3.3.6 Multiple Pumps with Conservation Measures Alternative

This alternative proposes to remove the existing dam, install water conservation measures on the LYP system, construction of 42 Ranney wells (six wells at each of seven sites), and power that pumping through alternative energy. The seven sites would be constructed outside the channel migration zone, at 70 acres each for a total of 490 acres. The Ranney wells would be designed to provide a total of 608 cfs. Conservation measures to reduce the loss of water in the canal would include check structures, flow measuring devices, conversion of laterals to pipe, sprinklers, lining Main Canal and laterals, control over checking, and groundwater pumping. The alternative also includes the use of wind energy to offset pumping costs. The construction period of the alternative would depend on funding and other considerations as discussed in Chapter 2. It is likely that additional power lines would be necessary to supply power to the pumps at each site. Additional details regarding earth-moving equipment and vehicles necessary for the Multiple Pumps with Conservation Measures Alternative are included in Appendix B.

Effects on air quality would result from earth moving activities associated with the removal of the dam and construction of the seven well sites. However, these effects would be minimized with proposed actions to minimize effects. Construction emissions would be minor and temporary, having a negligible contribution to air quality in the local and regional area, similar to that described for the other action alternatives. Air emissions associated with construction activities would be solely from mobile sources and mobile construction activities, and would not be subject to federal or Montana air quality requirements requiring consultation or permitting.

4.3.4 Operational Effects

Emissions expected from operation and maintenance for any of the action alternatives is generally expected to be considerably less than emissions expected during construction and thus anticipated to have a negligible effect on local or regional air quality. Effects on air quality would generally result from combustion emissions from non-road maintenance equipment and on-road vehicles, and fugitive dust associated with vehicular and equipment travel on unpaved roads, earth disturbance activities and material handling and storage. Operation of pumps associated with some of the alternatives would not be expected to result in emissions because the pumps would be powered by electricity; however, emergency generators fueled by diesel would generate combustion emissions to power the pumps in the event of power outage or other disruption in service.

4.3.4.1 No Action Alternative

Maintenance activities associated with the No Action Alternative include maintenance of the headworks screens and gates, maintenance of rock on the dam, and maintenance and inspection of the canal, as well as maintenance of associated access roads. Dam maintenance requires the

annual placement of 1 to 2 feet of rock on the crest of the dam, using the existing cableway, to replace rock moved by ice and high-flow events. The volume of rock placed annually has varied between 500 and 7,000 tons depending on river events, high water, and ice movement, and has averaged about 2,500 tons. Rock is sourced from a quarry on private land about 2 miles southeast of the Intake Diversion Dam and hauled and stockpiled near the right abutment on Joe's Island. The rock is stockpiled with a loader, dumped into a skid, and hauled across the river and dumped in the river by the overhead trolley cableway. The trolley system is old and there is continual risk of failure, which would require repair or replacement in order to maintain required water surface elevations.

Vehicles and equipment would include trucks and other maintenance vehicles required for regular maintenance of the dam and canal structures, as well as normal maintenance of access roads. Rock placement would require trucks to haul rock approximately 2 miles. Other equipment includes the operation of a skid and trolley cableway.

Although regular operation and maintenance activities associated with the No Action Alternative would generate fugitive dust and combustion emissions, these emissions would be considered negligible. Therefore, it is anticipated that no long-term impacts to the local air quality would result from operation and maintenance activities of the No Action Alternative.

4.3.4.2 Rock Ramp Alternative

Operation and maintenance activities associated with the Rock Ramp Alternative are similar to those for the No Action Alternative with the exception of additional earthwork activities, since it is likely that some amount of rock (on the ramp) would move over time, requiring maintenance.

Although regular operation and maintenance activities associated with the Rock Ramp Alternative would generate fugitive dust and combustion emissions, these emissions would be considered negligible. Therefore, it is anticipated that no long-term impacts to local air quality would result from operation and maintenance of the Rock Ramp Alternative.

4.3.4.3 Bypass Channel Alternative

Operation and maintenance activities associated with the Bypass Channel Alternative include activities that would be performed for the No Action Alternative except reduced maintenance at the replacement weir (i.e. rock placement would not be required annually). Additional operation and maintenance requirements include maintenance of additional access roads, periodic maintenance of rock upstream and downstream of the replacement weir, periodic replacement of riprap along the banks and bottom of the bypass channel, removal of sediment or debris from within the bypass channel, maintenance of fill near the downstream entrance of the bypass channel, and maintenance of the channel plug.

Although regular operation and maintenance activities associated with the Bypass Channel Alternative would generate fugitive dust and combustion emissions, these emissions would be negligible. Even though fugitive dust and combustion emissions from non-road equipment and on-road vehicles associated with the Bypass Channel Alternative would be higher than those associated with No Action due to additional maintenance requirements, no long-term effects on local air quality are anticipated. Federal, state, or local air regulations are not anticipated to be exceeded.

4.3.4.4 Modified Side Channel Alternative

Operation and maintenance activities associated with the Modified Side Channel Alternative includes activities that would be performed for the No Action Alternative. Additional operation and maintenance requirements include periodic inspection, possible replacement of riprap along the existing side channel, removal of sediment or debris from the upstream and downstream confluence areas of the Yellowstone River and the existing side channel, and regular maintenance of access roads and bridge.

Although regular operation and maintenance activities associated with the Modified Side Channel Alternative would generate fugitive dust and combustion emissions, these emissions would be negligible. Even though fugitive dust and combustion emissions from non-road equipment and on-road vehicles associated with the Bypass Channel Alternative would be higher than those associated with No Action due to additional maintenance requirements, no long-term effects on local air quality are anticipated. Federal, state, or local air regulations are not anticipated to be exceeded.

4.3.4.5 Multiple Pump Alternative

Operation and maintenance activities associated with the Multiple Pump Alternative include operation and maintenance of the five pumping stations, annual sediment removal in the feeder canals, bank stabilization in the area of the pumping stations, and cleaning of trashracks on a monthly basis. A conservative estimate of the annual deposition in each feeder canal is 2,800 cubic yards. It is estimated that 1,000 feet of bank stabilization would be necessary for each pumping station. The pumping stations would be used around 126 days annually, drawing 6,000 kW of power and resulting in an average annual energy consumption of 10 gigawatt-hours. Pump adjustment would be required when switching from gravity to diversion pumping. Pumps at the pumping stations would be electrically driven, and each station would require an emergency generator in the event of a power outage or disruption in service. These generators would range from 500 kW to 2,000 kW and would be fueled by diesel.

Regular operation and maintenance activities associated with the Multiple Pump Alternative would generate fugitive dust emissions from removal and handling of feeder canal sediment during removal operations as well as combustion emissions from the non-road equipment and on-road vehicles.

Combustion emissions would be generated from the emergency generators at the five pumping stations, but these engines would be emergency generators, limited to 500 operating hours per year, including emergency scenarios and required maintenance and testing. In accordance with Montana Department of Environmental Quality's air regulations (Administrative Rules of Montana Title 17, Chapter 8, Subchapter 7, Rule 17.8.744(1)(g)), emergency equipment would be exempt from obtaining an air quality permit. Emissions from each of these units would not exceed the minimum permitting threshold of five tons of any pollutant. Even though these units would be exempt from permitting, they would need to comply with all applicable requirements in the New Source Performance Standards for Stationary Compression Ignition Internal Combustion Engines (40 CFR Part 60 Subpart IIII) and the National Emissions Standards for Hazardous Air Pollutants for Stationary Reciprocating Internal Combustion Engines (40 CFR Part 63 Subpart ZZZZ).

The emissions associated with this alternative would consist of fugitive dust, combustion from non-road mobile equipment, on-road equipment, and stationary engines. They would be considered negligible, and no long-term impacts on local air quality are anticipated from the operation and maintenance activities.

4.3.4.6 Multiple Pumps with Conservation Measures Alternative

Operation and maintenance activities associated with the Multiple Pumps with Conservation Measures Alternative include operation and maintenance of the seven pumping stations as described in Chapter 2. The pumping stations would normally use renewable power from wind energy. In the event of a power outage or disruption in service, each station would require an emergency generator that would range from 500 kW to 2,000 kW and would be fueled by diesel.

Regular operation and maintenance activities associated with the Multiple Pumps with Conservation Measures Alternative would generate minimal fugitive dust emissions from maintenance and operation of the seven pumping sites. Fugitive dust emissions would be comparable to the No Action Alternative. Combustion emissions would be generated from the emergency generators at the seven pumping stations, but they would be limited to 500 operating hours per year, including emergency scenarios and required maintenance and testing. In accordance with Montana Department of Environmental Quality's air regulations (Administrative Rules of Montana Title 17, Chapter 8, Subchapter 7, Rule 17.8.744(1)(g)), emergency equipment would be exempt from obtaining an air quality permit. Emissions from each of these units would not exceed the minimum permitting threshold of five tons of any pollutant. Even though these units would be exempt from permitting, they would need to comply with applicable requirements of 40 CFR Part 60 Subpart IIII and 40 CFR Part 63 Subpart ZZZZ.

The emissions associated with this alternative would consist of fugitive dust, combustion from non-road mobile equipment, on-road equipment, and stationary engines. They would be considered negligible, and no long-term impacts on local air quality are anticipated from the operation and maintenance activities.

4.3.5 Cumulative Effects

Cumulative impacts can result from individually minor but collectively significant actions taking place over time. The air quality cumulative impact analysis evaluates the impact on the environment resulting from the incremental impact of the Project air emissions when added to other air emissions from past, present, and reasonably foreseeable future actions. Air quality impacts of concern for the project are primarily associated with construction and include the following:

- Fugitive dust emissions
- Exhaust from construction equipment exhausts
- Vehicle exhaust for work travel and movement of supplies.

4.3.5.1 Cumulative Air Quality Effects

Air quality impacts during operation and maintenance of the Project would be similar to construction but limited due to the extent of work to be performed. The Multiple Pump Alternative and Multiple Pumps with Conservation Measures Alternative would generate additional emissions associated with the combustion of fossil fuels for the emergency generators. Since federal and Montana air quality regulations apply only to stationary sources, the air

emissions associated with construction, operation and maintenance that are solely from mobile activities, would not require consultation or permitting. Emissions associated with emergency generators that are part of the Multiple Pump Alternative and Multiple Pumps with Conservation Measures Alternative would be considered minor sources, but these emission sources would be considered exempt from an air quality permit in accordance with Montana air quality regulations. However, they would still need to comply with applicable requirements of 40 CFR Part 60 Subpart IIII and 40 CFR Part 63 Subpart ZZZZ.

Based on analysis of the alternatives, the potential associated emissions would only result in minor, short-term impacts on local ambient air quality. Emissions would be temporary in nature, localized to the construction area, and would not occur on a steady basis. Additionally, construction-related emissions would occur at ground level, limiting the dispersion of pollutants to the Project workspace.

Based on available information, the present and reasonably foreseeable future actions described in Section 4.1 are similar to the proposed project in that air emissions associated with these actions would also be primarily from construction or minor stationary sources and would have effects similar to those listed above. None of the identified actions involve long-term operations with notable major air emission sources. Construction air emissions from the present and reasonably foreseeable future actions would be cumulative with those of the Intake Diversion Dam project if they were to occur at the same time and in the same general area. However, most of the actions would involve air emissions characterized as intermittent and short term, with only minor temporary impacts on air quality in the vicinity of the construction. Therefore, while the combination of the proposed project and other actions would generate cumulative impacts on air quality near the project, the project itself would have a negligible contribution that would be temporary and therefore not contribute to air quality impacts on a continued basis.

4.3.5.2 Cumulative Climate Change Effects

Climate change is the modification of climate over time, whether due to natural causes or as a result of human activities. Climate change cannot be represented by single annual events or individual anomalies. For example, a single large flood event or particularly hot summer is not an indication of climate change. However, unusually frequent or severe flooding, or several consecutive years of abnormally hot summers over a large region, may be indicative of climate change.

The Intergovernmental Panel on Climate Change (IPCC) is the leading international, multi-governmental scientific body for the assessment of climate change. The United States is a member of the IPCC and participates in IPCC working groups. IPCC's Fifth Assessment Report indicated that more than half of the observed increase in global average surface temperature from 1951 to 2010 is very likely (90 to 100 percent probability) due to human-caused increase in greenhouse gas concentrations (IPCC 2013). The leading United States scientific body on climate change is the U.S. Global Change Research Program (USGCRP), which began as a presidential initiative in 1989 and was mandated by Congress in the Global Change Research Act of 1990 (Pub. L. 101-606). Thirteen federal departments and agencies participate in the USGCRP.

The USGCRP Third National Climate Assessment, Global Climate Change Impacts in the United States (USGCRP 2014) summarizes the impacts climate change has already had on the United States and may have in the future. Conclusions include the following:

- Global climate is changing, the change is apparent across a wide range of observations, and global warming of the past 50 years is primarily due to human activities (USGCRP 2014, p 20).
- Carbon dioxide made up 84 percent of U.S. greenhouse gas emissions in 2011. Forty-one percent of these emissions were attributable to liquid fuels (petroleum), followed by solid fuels (principally coal in electric generation) and natural gas. The two dominant sectors responsible for these emissions are electric power generation (coal and gas) and transportation (petroleum). (USGCRP 2014, p 652).

On December 24, 2014, the Council on Environmental Quality revised its 2010 draft guidance to provide federal agencies with direction on how to consider the effects of greenhouse gas emissions on climate change as part of their evaluations under NEPA. The 2010 guidance, which was never finalized, addressed the impact of greenhouse gas emissions on climate change but did not apply to land and resource management activities.

The 2014 draft guidance establishes an emissions threshold of 25,000 metric tons per year of CO_{2e} emissions, above which a quantitative analysis of greenhouse gas emissions is recommended. The guidance does not distinguish between short-term emissions such as construction emissions or long-term emissions such as operation and maintenance emissions. The EPA defines climate change as significant change in the measures of climate lasting for an extended period (several decades or longer). Because construction emissions do not occur over an extended period, they were excluded from this evaluation of climate change.

Based on an analysis of the potential emissions from each Project alternative, the expected potential CO_{2e} emissions from the Project would be less than the threshold of 25,000 metric tons per year. Consequently, the Project contribution to greenhouse gas emissions would be negligible.

4.3.6 Actions to Minimize Effects

The following general actions would help to avoid or minimize impacts on air quality for each alternative during construction, operation and maintenance:

- Minimize clearing vegetation within the all construction work areas, access areas, and project facilities.
- Conduct construction, operation, and maintenance activities to minimize the creation of dust. This may include measures such as limitations on equipment, speed, and/or travel routes. Water, dust palliative, gravel, combinations of these, or similar control measures may be used.
- Implement measures to minimize the transfer of mud onto public roads.
- Maintain construction, operation and maintenance equipment in good working order. Equipment and vehicles with excessive emissions due to poor engine adjustments or other inefficient operating conditions would be repaired or adjusted.
- In active construction areas, including access roads, limit speeds of non-earth-moving equipment to 15 miles per hour. Limit speed of earth-moving equipment to 10 mph.

- Limit idling of heavy equipment to less than 5 minutes unless needed for the safe operation of the equipment; verify through unscheduled inspections. Turn off idling equipment when not in use.
- Implement a fugitive particulate emission control plan that specifies steps to minimize fugitive dust generation.
- Stabilize spoil piles and sources of fugitive dust by implementing control measures, such as covering and/or applying water or chemical/organic dust palliative where appropriate at active and inactive sites during workdays, weekends, holidays, and windy conditions.
- Install wind fencing and phase grading operations where appropriate, and operate water trucks for stabilization of surfaces under windy conditions.
- Prevent spillage when hauling spoil material.
- Plan construction scheduling to minimize vehicle trips.
- Maintain and tune engines per manufacturer's specifications to perform at EPA certification levels. Prevent tampering of source engines (i.e., knowingly disabling an emission control system component or element of design of a certified engine so that it no longer meets the manufacturer's specifications). Conduct unscheduled inspections to ensure these measures are followed.

4.4 Surface Water Hydrology and Hydraulics

This section describes the potential effects that the Project alternatives could have on surface water flows, including the timing and duration of flows in the Yellowstone River and its side channels, impacts on Main Canal operations and return flows from the Lower Yellowstone Project into the Yellowstone River.

4.4.1 Area of Potential Effect

The area of potential effect for surface water consists of the Yellowstone River floodplain beginning upstream of the Intake Diversion Dam at the location of the existing side channel confluence and extending downstream to the confluence with the Missouri River. This includes Joe's Island, which is bounded by the existing side channel and the Yellowstone River (Figure 2-6). The area of potential effect also includes the Lower Yellowstone Project, which includes the LYP Main Canal and lateral canals as well as various return flows and supported agricultural lands from the Intake Diversion Dam to the confluence with the Missouri River, approximately 70 river miles.

4.4.2 Summary of Potential Effects

Table 4-4 summarizes the potential effects on surface water hydrology for each alternative. Details are provided in the following sections.

TABLE 4-4. SUMMARY OF POTENTIAL EFFECTS ON SURFACE WATER HYDROLOGY FROM EACH ALTERNATIVE

Impact Type	Level of Impact	Impact Description
No Action Alternative		
Construction Effects	No Effect	<ul style="list-style-type: none"> N/A
Operational Effects	Minor	<ul style="list-style-type: none"> Ongoing placement of rock to slightly higher elevations to ensure irrigation diversions with overall slight trend of declining river flows Ongoing return flows from the Main Canal
Rock Ramp Alternative		
Construction Effects	Moderate	<ul style="list-style-type: none"> Increased water surface elevations when coffer dams are in place, including for flood flows Changed depths and velocities at headworks screens when coffer dams are in place Changed depths and velocities in the main channel of the Yellowstone River when coffer dams are in place
Operational Effects	Moderate	<ul style="list-style-type: none"> Reduced velocities over replacement weir and rock ramp compared to existing conditions Ongoing return flows from the Main Canal
Bypass Channel Alternative		
Construction Effects	Moderate	<ul style="list-style-type: none"> Increased water surface elevations when coffer dams are in place, including for flood flows Changed depths and velocities at headworks screens when coffer dams are in place Changed depths and velocities in the main channel of the Yellowstone River when coffer dams are in place Blockage of flows during one runoff season existing side channel
Operational Effects	Minor	<ul style="list-style-type: none"> Slightly reduced flow volumes and velocities over replacement weir compared to existing conditions Loss of existing side channel and side channel migration and change to backwater channel at lower end Ongoing return flows from the Main Canal
	Major	<ul style="list-style-type: none"> Replacement of existing side channel function with new bypass channel
Modified Side Channel Alternative		
Construction Effects	Moderate	<ul style="list-style-type: none"> Blockage of flows during one runoff season to existing side channel Limited change to ice flows while channel is blocked
Operational Effects	Minor	<ul style="list-style-type: none"> Slightly reduced flow volumes in main channel Ongoing return flows from the Main Canal
	Major	<ul style="list-style-type: none"> Increased frequency, depths, velocities of flows in existing side channel

Impact Type	Level of Impact	Impact Description
Multiple Pump Alternative		
Construction Effects	Moderate	<ul style="list-style-type: none"> • Increased water surface elevations when coffer dams are in place, including for flood flows • Changed depths and velocities at headworks screens when coffer dams are in place • Changed depths and velocities in the main channel of the Yellowstone River when coffer dams are in place
	Minor	<ul style="list-style-type: none"> • Excavation of feeder canals/connection to river
Operational Effects	Moderate	<ul style="list-style-type: none"> • Slightly increased flow volumes from existing intake to about 20 miles downstream (beneficial) • Return of main channel to natural river hydraulics with removal of dam (beneficial) • Ongoing return flows from the Main Canal
	Major	<ul style="list-style-type: none"> • Reduced frequency of flows into existing side channel
Multiple Pumps with Conservation Measures Alternative		
Construction Effects	Moderate	<ul style="list-style-type: none"> • Increased water surface elevations when coffer dams are in place, including for flood flows • Changed depths and velocities at headworks screens when coffer dams are in place • Changed depths and velocities in the main channel of the Yellowstone River when coffer dams are in place
Operational Effects	Moderate	<ul style="list-style-type: none"> • Increased flow volumes in river due to reduced diversions (beneficial) • Return of main channel to natural river hydraulics with removal of dam (beneficial) • Decreased volumes, velocities in the Main Canal
	Major	<ul style="list-style-type: none"> • Reduced frequency of flows into existing side channel • Reduced irrigation diversion flow volumes and reliability • Main Canal Decreased return flows

4.4.3 Construction Effects

4.4.3.1 No Action Alternative

The No Action Alternative would not have any new construction elements, therefore, no effects from construction would occur.

4.4.3.2 Rock Ramp Alternative

During construction of the Rock Ramp Alternative, coffer dams would be used to isolate in-river work zones by diverting river flows from one side of the main channel to the other. A steel sheet pile cofferdam would be constructed upstream of the Intake Diversion Dam to allow construction of the replacement weir. This coffer dam would be installed first on the south side of the river and enclose approximately 350 feet by 60 feet (21,000 square feet or 0.5 acres) and send river flows to the north half of the channel. This cofferdam would be in place approximately one year. After it is removed, a second coffer dam would be installed on the north half of the river and enclose a smaller area for construction of the north half of the replacement weir (12,000 square feet or 0.3 acres), also remaining in place for approximately one year.

During the 18 months of constructing the replacement weir and rock ramp, the river flow would have roughly half the width, and nearly double the depth, with increased velocities through the reach. For example, during a flow of 15,000 cfs, the existing depth and velocity over the weir are 2.5 feet and 7.6 feet per second (fps); with the width reduced by 300 to 350 feet, the depth could be 3.9 feet and the velocity could be 9.9 fps (similar to depths and velocities for a flow of 30,000 cfs under existing conditions).

There would likely be some erosion and scour of the channel substrate and/or banks, primarily along the right bank on Joe's Island, as a result of confining the flows. There could be a temporary rise in water surface elevations, including for the 100-year and other flood flows. The coffer dam could also cause additional head for the Main Canal. It is likely that sweeping velocities at the headworks and screens could decrease when the cofferdam is on the north half of the river and increase when the cofferdam is on the south half of the river.

The cofferdams would be constructed to a height equal to the elevation of the 2-year flood. Work would likely be halted in late fall once freezing temperatures regularly occur. At that time, the site would be stabilized to withstand winter ice conditions, and a segment of the cofferdam (downstream side) could be removed to allow the work zone to drain downstream. During the spring runoff, flows higher than the 2-year flood (54,200 cfs) could overtop the cofferdam, but if a segment were kept open to drain, then the work zone would readily drain out. Once the cofferdams were removed, river flows would be similar to the existing condition.

Flows also would need to be deflected away from the work area with cofferdams to place rock. Rock would be placed individually to lock into place and create suitable low flow channels within the overall ramp.

During ice break-up, the presence of coffer dams would likely affect where ice would flow and deposit in the floodplain. This could cause an ice damming effect at the replacement weir, as there would be a reduced width for flow, temporarily raising water surface elevations upstream of the weir during ice break up and spring runoff. This effect could extend for 1.8 miles upstream to the first side channel, which is the existing side channel, where ice is often pushed out of the main channel as the ice dam moves upstream.

Access would be required across the Main Canal. Because the existing bridge is likely not adequate for heavy construction equipment, a temporary crossing over the Main Canal would be installed for use during construction. This would be done outside of the irrigation season, between late October and late March when the canal is dry, so it would not affect flows in the canal.

Rock and bedding material would be stockpiled in the staging area used for the headworks construction on the left side of the Main Canal, out of the 100-year floodplain. Rock would also be stockpiled on Joe's Island, which could be subject to shallow flood flows, typically when the Yellowstone River reaches or exceeds the 10-year flood. Thus the staging and stockpile areas on Joe's Island could be flooded during construction; however, depths and velocities are expected to be low and unlikely to move rock materials downstream.

Overall construction activities for the Rock Ramp Alternative would likely have a moderate temporary effect on the river surface water flows, including a 100-year flood event if it were to occur, during the estimated 2 years when cofferdams are present for replacement weir construction. Depths and velocities would increase as a result of the coffer dams and flow diversion during construction of the replacement weir. This could also have moderate effects on the operation of the headworks and screens for 2 years, as depths and sweeping velocities would likely change in this area as a result of flows being deflected from one side of the river to the other.

4.4.3.3 Bypass Channel Alternative

During construction of the Bypass Channel Alternative, cofferdams would be used to isolate in-river work zones by diverting river flows from one side of the main channel to the other. A steel sheet pile cofferdam would be constructed upstream of the Intake Diversion Dam to allow construction of the replacement weir. This coffer dam would be installed first on the south side of the river and enclose approximately 350 feet by 60 feet (21,000 square feet or 0.5 acres) and send river flows to the north half of the channel. This cofferdam would be in place approximately one year. After it is removed, a second cofferdam would be installed on the north half of the river and enclose a smaller area for construction of the north half of the replacement weir (12,000 square feet or 0.3 acres), also remaining in place for approximately one year.

During the approximate one year of constructing the replacement weir, the river flow would have roughly half the width, and nearly double the depth, with increased velocities through the reach. For example, during a flow of 15,000 cfs, the existing depth and velocity over the weir are 2.5 feet and 7.6 fps; with the width reduced by 300 to 350 feet, the depth could be 3.9 feet and the velocity could be 9.9 fps (similar to depths and velocities for a flow of 30,000 cfs under existing conditions).

There would likely be some erosion and scour of the channel substrate and/or banks, primarily along the right bank on Joe's Island, as a result of confining the flows. There could be a temporary rise in water surface elevations, including for the 100-year and other flood flows. The cofferdam could also cause additional head for the Main Canal. It is likely that sweeping velocities at the headworks and screens could decrease when the cofferdam is on the north half of the river and increase when the cofferdam is on the south half of the river.

The cofferdams would be constructed to a height equal to the elevation of the 2-year flood. Work would likely be halted in late fall once freezing temperatures regularly occur. At that time, the site would be stabilized to withstand winter ice conditions, and a segment of the cofferdam (downstream side) could be removed to allow the work zone to drain downstream. During the spring runoff, flows higher than the 2-year flood (54,200 cfs) could overtop the cofferdam, but if a segment were kept open to drain, then the work zone would readily drain out. Once the cofferdams were removed, river flows would be similar to the existing condition.

Cofferdams or other isolation measures would be necessary at the upstream and downstream ends of the proposed bypass channel to allow excavation and grading of the new channel prior to connecting to the river. Cofferdams or other isolation measures would be necessary at the upstream and downstream extents of where fill would be placed in the existing side channel as

well. It is assumed these cofferdams would be installed in the bank line and not in-water and would likely remain in place for 2 years. All excavation and filling work would be performed within the isolated work zone and when complete, the cofferdams would be removed. The cofferdams at the proposed bypass channel location would not affect any river flows unless there was a flow higher than a 2-year flood event during construction, which could overtop the cofferdams and could cause minor erosion/scouring at the cofferdam locations. Excavation activities will likely encounter high groundwater, so pumping of water from the excavation areas and discharging this water to infiltration ponds on Joe's Island is likely to occur. The dewatering would have only negligible effects on surface water.

Filling of the existing side channel would prevent river flows into the upstream half of the channel as soon as the coffer dams are installed, thus eliminating the flow-through nature of the channel. The downstream end below the cofferdams would still be connected as a backwater channel. If a flood flow high enough to inundate Joe's Island (a 1-percent to 2-percent chance occurrence event) were to occur during construction, floodplain flow would enter the existing channel and flow downstream.

Rock might be stockpiled on Joe's Island, which could be subject to flood flows, although the primary staging area would likely be located out of the 100-year floodplain. Overtopping depths and velocities are expected to be low and unlikely to move rock materials downstream.

During ice break-up, the presence of coffer dams would likely affect where ice would flow and deposit in the floodplain. This could cause an ice damming effect at the replacement weir, as there would be a reduced width for flow, temporarily raising water surface elevations upstream of the weir during ice break up and spring runoff. This effect could extend for 1.8 miles upstream to the first side channel, which is the existing side channel, where ice is often pushed out of the main channel as the ice dam moves upstream.

Overall construction activities for the Bypass Channel Alternative would likely have a moderate temporary effect on surface water flows during the estimated 2 years when the multiple cofferdams are present. Depths and velocities would increase as a result of the cofferdams and flow diversion during construction of the replacement weir. This could also have moderate effects on the operation of the headworks and screens, as depths and velocities would likely change in this area as a result of flows being deflected from one side of the river to the other.

The cofferdams and filling in of the upper half of the existing side channel would have a major effect on the side channel by eliminating approximately 1.5 miles of channel and changing this side channel from a flow-through to a backwater channel.

4.4.3.4 Modified Side Channel Alternative

During construction of the Modified Side Channel Alternative, cofferdams or other isolation measures would be necessary at the upstream and downstream ends of the existing side channel to facilitate excavation. It is assumed these cofferdams would be installed in the bank line and not in-water. The total duration of excavation and filling work for the existing side channel would take approximately 18 months. All excavation work would be completed within the isolated work zone. When work is complete, the cofferdams would be removed. The cofferdams

would immediately eliminate connectivity of the side channel to the river for the duration of construction.

It is not likely that the cofferdams would be installed to a height to prevent flood overtopping. They would likely be installed to prevent overtopping during construction for flows up to a 2-year flood event. If a flow higher than a 2-year event were to occur during construction, the overtopping could cause erosion or scouring at and around the cofferdam locations.

Excavation activities will likely encounter high groundwater and runoff from Box Elder Creek and other minor tributaries, so pumping of water from the excavation areas and discharging this water to infiltration ponds on Joe's Island is likely to be necessary and would occur. Box Elder Creek and other minor tributaries The dewatering would have only negligible effects on surface water.

Rock or excavated material might be stockpiled on Joe's Island, which could be subject to flood flows, although the primary staging area would likely be located out of the 100-year floodplain. Overtopping depths and velocities are expected to be low and unlikely to moving rock material downstream.

The cofferdams will likely have a minor effect on the movement of ice flows. Typically as the ice breaks up in the Yellowstone River, ice blocks move up onto the floodplain and into the existing side channel. The cofferdams would deflect ice from entering the existing side channel but not from moving up onto the floodplain.

Overall construction activities for the Modified Side Channel Alternative would likely have a minor temporary effect on surface water flows during the estimated 18 months when cofferdams are present by disconnecting the side channel from the river during construction. Once construction is complete and the cofferdams are removed, the channel will be reconnected to the river for perennial flows.

4.4.3.5 Multiple Pump Alternative

During construction of the Multiple Pump Alternative, cofferdams would be used to isolate the in-river work zone for demolition and removal of the Intake Diversion Dam by diverting river flows from one side of the main channel to the other. This coffer dam would be installed first on the south side of the river and enclose approximately 350 feet by 60 feet (21,000 square feet or 0.5 acres) and send river flows to the north half of the channel. This cofferdam would be in place approximately three months. After it is removed, a second cofferdam would be installed on the north half of the river and enclose a smaller area for removal of the north half of the replacement weir (12,000 square feet or 0.3 acres), also remaining in place for approximately 3 months.

During the removal of the Intake Diversion Dam, the river flow would have roughly half the width, and nearly double the depth, with increased velocities through the reach. For example, during a flow of 15,000 cfs, the existing depth and velocity over the weir are 2.5 feet and 7.6 fps; with the width reduced by 300 to 350 feet, the depth could be 3.9 feet and the velocity could be 9.9 fps (similar to depths and velocities for a flow of 30,000 cfs under existing conditions).

There would likely be some erosion and scour of the channel substrate and/or banks, primarily along the right bank on Joe's Island, as a result of confining the flows. There could be a temporary rise in water surface elevations, including for the 100-year and other flood flows. The cofferdam could also cause additional head for the Main Canal. It is likely that sweeping velocities at the headworks and screens could decrease when the cofferdam is on the north half of the river and increase when the cofferdam is on the south half of the river.

The cofferdams would be constructed to a height equal to the elevation of the 2-year flood. If the cofferdam was in place during the spring runoff, flows higher than the 2-year flood (54,200 cfs) could overtop the cofferdam. If a segment were kept open to drain, then the work zone would readily drain out. Once the cofferdams were removed, the river flows would have similar depths and velocities to natural reaches of channel upstream or downstream of the site.

It is assumed that the Intake Diversion Dam would not be removed until all other features associated with this alternative are installed, which could take about 3 years. At the locations of each proposed pumping station/canal, excavation and grading of the new canal would be done by leaving a "plug" of land adjacent to the river, until ready to connect to the river, or a cofferdam could be used. All excavation and filling work would be completed within the isolated work zone. When it is complete, final connection to the river would be made. This off-channel work would not affect any river flows unless there was a flow higher than a 2-year flood event during construction, which could overtop into the work zone and cause minor erosion/scouring. Excavation activities would likely encounter high groundwater, so pumping of water from the excavation areas and discharging it to infiltrate into the adjacent riparian zone or farmland is likely. This would have only negligible effects on surface water.

Overall, construction activities for the Multiple Pump Alternative would likely have a moderate temporary effect on surface water flows during the time when cofferdams are present. Depths and velocities would increase as a result of the cofferdams and flow diversion during removal of the Intake Diversion Dam. This could also have moderate effects on the operation of the headworks and screens, as depths and velocities would likely change in this area as a result of flows being deflected from one side of the river to the other.

The cofferdams and excavation of canals for each pumping station and placement of minor quantities of rock along the bank would have only minor temporary effects on surface water during construction, as work in water would be minimal.

4.4.3.6 Multiple Pumps with Conservation Measures Alternative

During construction of the Multiple Pumps with Conservation Measures Alternative, cofferdams would be used to isolate the in-river work zone for demolition and removal of the Intake Diversion Dam by diverting river flows from one side of the main channel to the other. This coffer dam would be installed first on the south side of the river and enclose approximately 350 feet by 60 feet (21,000 square feet or 0.5 acres) and send river flows to the north half of the channel. This cofferdam would be in place approximately three months. After it is removed, a second cofferdam would be installed on the north half of the river and enclose a smaller area for removal of the north half of the Intake Diversion Dam (12,000 square feet or 0.3 acres), also remaining in place for approximately 3 months.

During the removal of the existing Intake Diversion Dam, the river flow would have roughly half the width, and nearly double the depth, with increased velocities through the reach. For example, during a flow of 15,000 cfs, the existing depth and velocity over the weir are 2.5 feet and 7.6 fps; with the width reduced by 300 to 350 feet, the depth could be 3.9 feet and the velocity could be 9.9 fps (similar to depths and velocities for a flow of 30,000 cfs under existing conditions).

There would likely be some erosion and scour of the channel substrate and/or banks, primarily along the right bank on Joe's Island, as a result of confining the flows. There could be a temporary rise in water surface elevations, including for flood flows. The cofferdam could also create additional head for the Main Canal. It is likely that velocities at the intake and screens could decrease when the cofferdam is on the north half of the river and increase when the cofferdam is on the south half of the river.

The cofferdams would be constructed to a height equal to the elevation of the 2-year flood. If the cofferdam was in place during the spring runoff, flows higher than the 2-year flood (54,200 cfs) could overtop the cofferdam. If a segment were kept open to drain, then the work zone would readily drain out. Once the cofferdams were removed, the river flows would have similar depths and velocities to natural reaches of channel upstream or downstream of the site.

Water levels and deliveries in the Main Canal would not be affected as the existing dam would not be removed until all other features associated with this alternative are installed, which could take 5-10 years:

- This alternative would require installing a concrete liner along the entire length of the LYP Main Canal and 153 miles of lateral canals. It is estimated that construction of this element alone could take 2 to 3 years. Construction would occur outside of the irrigation season to avoid disrupting irrigation flows.
- This alternative would require filling in approximately half of the Main Canal to function with appropriate depths and velocities for the 608 cfs (approximately 40% of the existing maximum flow). Construction of these elements would need to occur outside of the irrigation season after other water conservation features are installed.
- This alternative may require installing check structures within the Main Canal. Construction of these features would likely occur outside of the irrigation season to avoid affecting irrigation flows.
- Conversion of lateral ditches to pipes (approximately 72 miles) would also occur outside of the irrigation season. Construction could take 4 to 5 years, but would not have effects on surface water.
- Construction of Ranney wells would occur outside of the channel migration zone and would not affect surface water.

Overall, construction activities for the Multiple Pumps with Conservation Measures Alternative would likely have a moderate temporary effect on surface water flows during the time when cofferdams are present. Depths and velocities would increase as a result of the cofferdams and flow diversion during removal of the Intake Diversion Dam. This could also have moderate effects on operation of the headworks and screens, as depths and velocities would likely change in this area as a result of flows being deflected from one side of the river to the other.

4.4.4 Operational Effects

4.4.4.1 No Action Alternative

The operational effects of the No Action Alternative are those resulting from ongoing operation and maintenance activities that keep the project functioning for irrigation withdrawals.

Hydrology

The hydrology in the Yellowstone River is reduced at the Intake Diversion Dam by the amount of flow diverted into the canal, typically up to 1,374 cfs. This represents a 1 percent to 46 percent flow reduction from the Intake Diversion Dam to the Missouri River, depending on the flows in the Yellowstone. (Table 4-5). The diversion impacts the Yellowstone over a distance of 71 miles. For comparative purposes the 50-percent exceedance spring time flow during which time pallid sturgeon are expected to migrate is 14,300 cfs (Table 4-6).

TABLE 4-5. EXISTING FLOW SPLIT AT THE INTAKE DIVERSION DAM

Discharge at Sidney, Montana USGS Gage (return period) (cfs)	Flow Diverted to Canal at Intake Diversion Dam	
	Diverted Flow (cfs)	Portion of Yellowstone River Flow (percent)
3,000	1,374	46
7,000	1,374	20
15,000	1,374	9
30,000	1,374	5
54,200 (2-year)	1,374	3
63,000	1,374	2
74,400 (5-year)	1,374	2
87,600 (10-year)	1,374	2
128,300 (100-year)	1,374	1

TABLE 4-6. SEASONAL YELLOWSTONE RIVER FLOW DURAION VALUES

Percent Time Flow Equaled or Exceeded	Discharge (cfs)				
	Annual	Fall (OCT-DEC)	Winter (JAN-MAR)	Spring (APR-JUN)	Summer (JUL-SEP)
1	56,800	13,700	35,300	66,600	55,500
2	49,500	12,500	25,000	60,500	46,200
5	36,900	11,300	17,000	52,000	35,300
10	25,800	10,400	12,400	43,500	26,900
15	18,700	9,740	10,500	36,800	21,100
20	14,500	9,230	9,500	31,600	16,600
25	12,200	8,840	8,800	27,500	13,700
30	10,700	8,510	8,250	23,800	12,000
40	9,030	7,890	7,500	18,000	9,700
50	7,990	7,300	6,810	14,300	8,230
60	7,070	6,730	6,130	11,500	6,860
70	6,210	6,050	5,560	9,110	5,680
75	5,780	5,660	5,250	8,230	5,150
80	5,350	5,300	4,970	7,500	4,600
85	4,880	4,850	4,560	6,640	4,010
90	4,270	4,320	4,120	5,860	3,460
95	3,440	3,490	3,510	5,220	2,550
98	2,520	2,610	2,830	4,530	1,940
99	2,060	2,200	2,560	3,620	1,550

Source: Corps 2015

Under the No Action Alternative, flows into the existing side channel begin when the Yellowstone River flows reach 20,000 to 25,000 cfs (Table 4-7). The relative split of flows between the river and the side channel would not change with the No Action Alternative unless the side channel inlet conditions or capacity changed naturally due to channel migration or sedimentation processes, which could change the characteristics of the side channel.

TABLE 4-7. FLOWS IN THE EXISTING HIGH-FLOW SIDE CHANNEL

Discharge at Sidney, Montana USGS Gage (return period) (cfs)	Existing Conditions Flow into the side channel (cfs)
7,000	0
15,000	0
30,000	570
54,200 (2-year)	2,200
63,000	4,000
74,400 (5-year)	5,800
87,600 (10-year)	7,500
128,300 (100-year)	12,400

With the No Action Alternative, the full water right of 1,374 cfs would continue to be delivered and the Main Canal would continue to send return flows back to the river in multiple locations including through some tributaries. Return flows are much greater outside peak irrigation demand time periods (i.e. April through June).

Over time, with potential climate change influences, the hydrology of the Yellowstone River could change. A study on climate change for the Missouri River Basin (Reclamation, 2012b) compared historical hydrology to down-scaled global climate models for a variety of future scenarios. The results indicate that a small increase in mean annual flow may occur. The 50th percentile estimate is a mean annual flow increase of 3 to 5 percent at Garrison Dam, which includes the input from the Yellowstone River (however, from the 5th to the 95th percentile estimate, the like flow change ranges from a decrease of 10 percent to an increase of 30 percent change in flow).

Predicted mean monthly flows generally indicate the potential for increased flows from January through June and decreased flows for July through December. The Montana Department of Natural Resources and Conservation's State Water Plan (MDNRC 2014) predicts an overall decline in snowpack in western North American, with an increased percentage of precipitation falling as rain. This could lead to earlier and lower levels of runoff for the Yellowstone basin, where the majority of runoff is a result of snowmelt. However, increased spring precipitation has also tended to maintain overall annual discharges.

A study of low flows on streams in the Rocky Mountains (Lippi 2012) indicates that late summer low flows are showing a declining trend, and that stream flows show a negative correlation with air temperature (as air temperature increases, stream flow decreases).

Overall, there is likely to be a trend of declining low flows, increases in winter flows, and earlier spring runoff for the No Action Alternative.

Intake Diversion Dam Hydraulics

In 2010 a screened headworks structure was constructed, with fish screens to minimize entrainment of fish more than 40 mm (1.6 inches) in length. Water flows by gravity through the cylindrical screens from the lower half of the water column, through the gates and into the Main Canal. The removable rotating drums allow each screen unit to be adjusted on a track and be raised above the river when not in use to minimize damage from ice and debris. The screen cylinders rotate against fixed brushes to clean and remove debris that could impede flow through the screen and to remove fish and other aquatic organisms potentially impinged on the screens.

In order to maintain a diversion of 1,374 cfs when Yellowstone River flows are at a low flow of 3,000 cfs (measured at Sidney gage), the headworks structure requires 0.7 feet more head in the river (rounded to 1 foot of head) than was required prior to construction of the screens and gates. To achieve the additional head, rock is added to the existing timber crib diversion structure as needed to create the necessary water elevation. This additional rock placement is slightly higher than the historical placements to achieve the head required for diversion. The additional rock placement is not likely to affect water depths or velocities over the Intake Diversion Dam, as the rocks never have a uniform elevation and flows between and over the rocks varies in both the existing and No Action condition.

Placement of rock on the Intake Diversion Dam is required almost every year, as ice typically moves some of the rock downstream of the dam into the boulder field. Annual rock placement would continue for the No Action Alternative and would likely result in a larger and denser boulder field over the 50-year time period of analysis. The boulder field typically has lower velocities than the velocities across the weir, although there is turbulent flow over and around the boulders. There is a deep scour hole approximately 250 feet downstream of the dam and approximately 250 feet out from the right bank. It is unlikely that this scour hole would fill in over time. Representative velocities at the scour hole are 2 to 6 fps; however, there is an eddy and turbulence that could preclude pallid sturgeon passage past the right bank at the toe of the rock rubble field.

Hydraulic conditions for the No Action Alternative were calculated for approximately 2 miles upstream and downstream of the Intake Diversion Dam. The calculations indicated that for a range of flows from 7,000 cfs to 54,200 cfs—representing flow durations of 1.5 to 95 percent of the spring time flows—depths and velocities in the Yellowstone River are typically within the guidelines provided by the Service and BRT for pallid sturgeon migration, including depths greater than 4 feet and velocities less than 6 fps (Walsh 2014). The exception is at the Intake Diversion Dam for all flow conditions (Table 4-8). Hydraulic conditions at the Intake Diversion Dam do not allow passage of pallid sturgeon, as there has never been a pallid sturgeon documented to have ascended over the dam.

TABLE 4-8. EXISTING HYDRAULIC CONDITIONS FOR NO ACTION ALTERNATIVE^a

Discharge at USGS Sidney, Montana Gage (cfs)	Percent Time Flow Equaled or Exceeded ^d (percent)	Above and Below Intake Diversion Dam ^b		At Intake Diversion Dam ^c	
		Average Channel Cross-Sectional Velocities (fps)	Average Channel Depth (feet)	Average Channel Cross-Sectional Velocities (fps)	Average Channel Depth (feet)
7,000	82	2.0	10.6	5.3	1.5
15,000	52	3.1	12.3	5.6	2.5
30,000	22	4.4	14.6	9.9	3.9
54,200	4	5.7	17.2	11.2	6.2

- a. Values that meet Service and BRT criteria are shown in green and values outside of criteria in red.
- b. Average of HEC-RAS results between 2,000 feet upstream and 3,000 feet downstream of the Intake Diversion Dam
- c. Average of HEC-RAS results at the dam
- d. Flow exceedances are estimated for springtime flow, April through June

Overall, the No Action Alternative would have minor to moderate long-term effects on surface water hydraulics, primarily by having a slightly different height of rock placed on the Intake Diversion Dam and a larger boulder field over time with continued movement downstream of rock from the weir. Canal diversions (600 cfs - 1,473 cfs) and return flows from operational spills would continue under No Action. There would be negligible effects on the floodplain or water surface elevations during floods.

4.4.4.2 Rock Ramp Alternative

The Rock Ramp in this alternative would have an approximate slope of 0.2 to 0.5 percent and extend for approximately 1,200 feet downstream of the replacement weir. One low flow channel

would be formed in the placed rock to facilitate fish passage by pallid sturgeon and other species, generally meeting the BRT criteria for pallid sturgeon migration.

Hydrology

The Rock Ramp Alternative would have no effects on the hydrology in the Yellowstone River or existing side channel within the potentially affected area.

The Rock Ramp Alternative is designed to provide more reliable flows into the Main Canal at river flows down to 3,000 cfs by construction of a replacement weir to an elevation of 1,991 feet, thus allowing a more reliable diversion with the new headworks and screens. This will be a minor beneficial effect for the reliability of diverting the irrigation water right.

The existing side channel would still continue to function as described under the No Action Alternative. It would begin to pass flows when the total Yellowstone River flow was 20,000 cfs or greater. This would remain the same, unless channel migration or sediment deposition occurred near the upstream entrance, blocking the flow of water.

With the Rock Ramp Alternative, the full water right of 1,374 cfs would continue to be delivered and the Main Canal would continue to send return flows back to the river in multiple locations including through some tributaries. Return flows are much greater outside peak irrigation demand time periods (i.e. April through June).

Over time, climate change influences are likely to show a trend of declining low flows, increases in winter flows, and earlier spring runoff for the Rock Ramp Alternative, which could cause minor changes in the reliability of diverting the full 1,374 cfs into the Main Canal or require additional rock to achieve the diversion during the lowest flows in summer and fall. This could result in even lower flows in the Yellowstone River downstream of the dam.

Intake Diversion Dam Hydraulics

The Rock Ramp Alternative would be constructed with a replacement weir at the crest designed to create the water surface elevations required for diversion through the headworks structure. The replacement weir would eliminate or minimize the need for rock placement currently required to maintain the higher water surface elevations for diversions through the headworks, although maintenance of the rock ramp is expected due to high flows and ice damage. The replacement weir would also include a notch to facilitate fish passage during the lowest summer/fall flows (i.e. at 3,000 cfs).

The rock ramp would begin at the replacement weir, configured to match the shape of the notch at the crest and extended downstream at 0.2 to 0.5 percent slope for 1,200 feet to tie into the existing channel bottom. Several notch configurations and alignments were assessed. The selected configuration is a trapezoidal shape, 3 feet deep, 80 feet wide on the bottom and approximately 350 feet wide at the top, with variable side slopes. From the top of the trapezoidal notch to the channel banks, the ramp would extend to the banks with a slight slope. At the crest of the dam, the bottom elevation of the notch is 1,988 feet, the top elevation is 1,991 feet and the replacement weir elevation at the banks is 1,992 feet. The centerline of the notch would be located about 200 feet from the left bank. At the toe of the ramp, the centerline of the notch would be located at the center of the channel. With this configuration, the trapezoidal notch is

slightly wider at the bottom of the ramp than at the crest. Consequently the velocities would be higher at the toe of the ramp than at the crest, and depths would be shallower.

Velocities over the Intake Diversion Dam are 8 feet per second, with depths of about 2.1 to 2.9 feet during flows of 15,000 cfs (median flows for the spring pallid sturgeon migration period (April through June). As flows pass through the boulder field s, velocities range from 2 to 4 feet per second, likely due to backwater at the toe of the dam. Upstream of the dam, average velocities are typically less than 2 feet per second. Downstream of the boulder field, average velocities are typically 3 to 4 feet per second.

During flows of 15,000 cfs, velocities in the notch with the proposed rock ramp would be 5.0 to 7.1 fps, with depths of 7.1 to 5.4 feet. In the right overbank, velocity would be 2.7 fps, with depths of 2.7 feet (Table 4-9). Figure 4-1 and Figure 4-2 show modeled depths and velocities for the Rock Ramp Alternative at the representative flow of 15,000 cfs.

TABLE 4-9. HYDRAULIC CONDITIONS WITH ROCK RAMP ALTERNATIVE^a

Discharge at Sidney, Montana USGS Gage	Percent time flow equaled or exceed	Above and Below Intake Diversion Dam ^b		At Rock Ramp ^c		At Rock Ramp on Right Bank	
		Average channel cross-sectional velocities (fps)	Average Channel Depth (feet)	Average channel cross-sectional velocities (fps)	Average Channel Depth (feet)	Average Velocity (fps)	Average Depth (feet)
7,000 cfs	82%	1.0	12.5	3.6 (U/S) 5.4 (D/S)	5.3 (U/S) 4.0 (D/S)	1.0	1.0
15,000 cfs	52%	2.0	14.3	5.0 (U/S) 7.1 (D/S)	7.1 (U/S) 5.4 (D/S)	2.7	2.7
30,000 cfs	22%	3.3	16.8	6.9 (U/S) 8.9 (D/S)	9.2 (U/S) 7.2 (D/S)	4.7	4.6
54,200 cfs	4%	5.0	19.7	9.2 (U/S) 9.8 (D/S)	11.7 (U/S) 9.9 (D/S)	6.9	6.9

- a. Values that meet Service’s BRT criteria are shown in green and values outside of criteria in red.
- b. Average of HEC-RAS results between 2,000 feet upstream and 3,000 feet downstream of the Intake Diversion Dam
- c. Values are provided for conditions in the trapezoidal notch at the top of the rock ramp (U/S) and at the toe of the ramp (D/S)

The ramp is intended to facilitate fish passage by pallid sturgeon and other species, with previously provided BRT criteria from 2009 that generally required depths of 4 feet and velocities less than or equal to 4 feet/section. Migration would be achieved through the trapezoidal notch when flows in the Yellowstone River are low, and along the banks—particularly the right bank—when flows in the Yellowstone River are high. When flows in the Yellowstone River are higher than 15,000 cfs, (such as at 30,000 cfs when velocities in the notch exceed the 4-fps BRT criterion for pallid sturgeon migration), the right overbank would be an alternative path for pallid sturgeon migration. Table 4-9 shows predicted velocities and depth for the right bank.



Figure 4-1. Proposed Rock Ramp Alternative Modeled Velocities at 15,000 cfs (velocity contours superimposed on aerial photo of existing conditions)

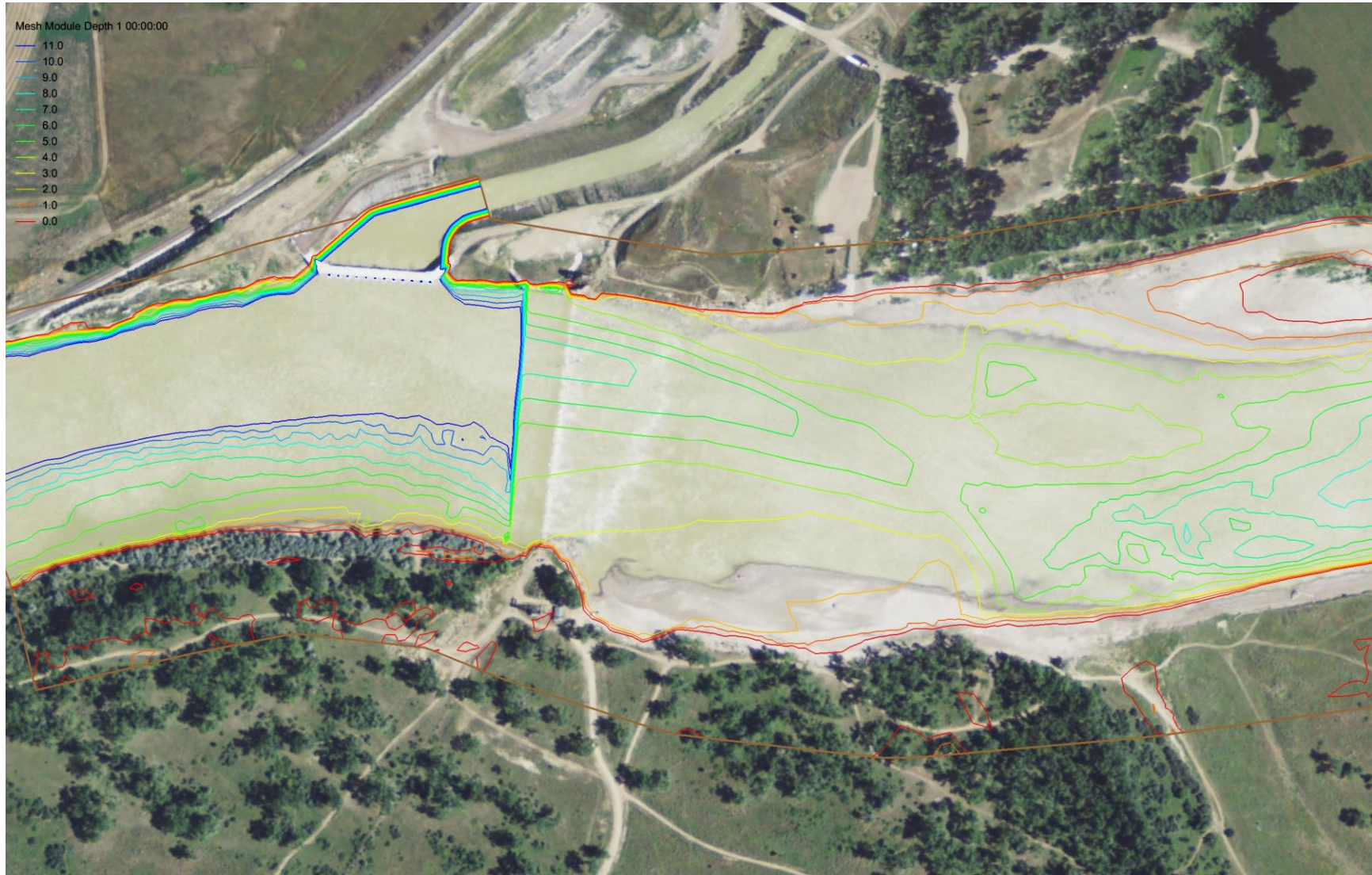

Figure 4-2. Proposed Rock Ramp Alternative Modeled Depths at 15,000 cfs (depth contours superimposed on aerial photo of existing conditions)

The rock would be sized between 1 and 4 feet in diameter. Rocks would be placed individually to be as locked into place as possible to minimize the potential for ice moving the rock out of place. However, some rock movement is anticipated, so there is a potential for continued need to place rock. The rock is also likely to cause turbulent flow that may reduce the potential for passage by benthic oriented fish such as pallid sturgeon.

Overall, the Rock Ramp Alternative would likely have moderate long-term effects on surface water hydraulics, primarily by having a slightly different configuration and crest height at the replacement weir. There would likely be moderate effects on the floodplain or water surface elevations during floods.

Major O&M actions are likely over the life of the Rock Ramp. It would be expected that rock repairs would need to be conducted frequently to ensure fish passage. A cofferdam or barge would be utilized to fill scour areas located in the rock ramp. If a cofferdam is used it would be temporary and likely be utilized in late summer when summer base flows make work in the river practicable.

Overall, the Rock Ramp Alternative would have moderate effects on channel hydraulics by changing velocities and depths for approximately 1,200 feet downstream of the replacement weir, compared to existing conditions. It would provide somewhat reduced velocities and increased depths that would partially meet the BRT criteria for pallid sturgeon passage. The Rock Ramp Alternative would essentially create a lengthy riffle that has some similarities to natural bedrock riffles in the Yellowstone River, although it is likely much longer than a natural riffle and would not have resting pools for fish to pause on their way up the ramp.

4.4.4.3 Bypass Channel Alternative

The new bypass channel under this alternative would be approximately 11,150 feet in length, with a slope that varies from 0.02 to 0.07 percent, a bottom width of 40 feet, and side slopes varying from 1V:8H to 1V:3H.

Hydrology

The Bypass Channel Alternative is designed to provide reliable flows into the Main Canal at river flows down to 3,000 cfs by construction of a replacement weir to an elevation of 1,991 feet. This will be unchanged from the existing elevation when rock is placed on the existing weir.

The Bypass Channel Alternative is designed to meet the Service's BRT criteria for pallid sturgeon passage, which include a 12- to 15-percent split of flow from the Yellowstone River into the bypass channel. This alternative would directly affect the river's hydrology by reducing its flows by 14 to 16 percent between the upstream and downstream confluences of the bypass channel, a distance of approximately 2 miles. This is intended to be beneficial for fish passage, by providing an alternate route with more favorable depths and velocities than over the replacement weir.

The bypass channel has length and slope characteristics within the range of natural side channels on the Yellowstone River. Splitting flow between the main channel and side channels is a natural

condition throughout the Yellowstone River. Flow splits between the main Yellowstone River channel and the bypass channel are shown for a range of conditions in Table 4-10.

TABLE 4-10. FLOW SPLITS FOR THE PROPOSED BYPASS CHANNEL^a

Discharge at Sidney, Montana USGS Gage (return period) (cfs)	Flow Split (cfs)		Bypass Channel Flow as a Portion of Yellowstone River Flow (percent)	
	Bypass Channel	Remaining in Yellowstone River	Bypass Channel Alternative	Service and BRT Criteria
7,000	1,100	5,900	16	≥12
15,000	2,200	12,800	15	13 to 15
30,000	4,100	25,900	14	13 to 15
54,200 (2-year)	7,500	46,700	14	13 to 15
63,000	8,700	54,300	14	13 to 15
74,400 (5-year)	10,700	53,700	14	–
87,600 (10-year)	12,900	74,700	15	–
128,300 (100-year)	20,000	108,300	16	–

a. Values that meet Service and BRT criteria are shown in green and values outside of criteria in red.

In the existing condition, flows from the Yellowstone River split into the existing side channel when the Yellowstone River reaches approximately 20,000 cfs to 25,000 cfs (almost an annual event). With the Bypass Channel Alternative, flows will no longer split into the existing side channel due to the proposed channel fill designed to ensure sufficient flows to meet BRT criteria in the bypass channel. The fill is also proposed to stabilize the upstream entrance of the bypass channel, which reduces the risk of the Yellowstone River avulsing into the new channel and migrating away from the screened headworks structure.

When Yellowstone River flows reach and exceed the 10-year event (87,600 cfs), flows will begin to overtop the bypass channel and the banks of the Yellowstone River. These overtopping flows would flow onto and across Joe’s Island and could reach the downstream half of the existing side channel, creating the potential for “attraction flows” for fish in that part of the existing side channel, but not providing an upstream exit for fish. This effect would be negligible at the 10-year flood, and minor at the 50- and 100-year floods.

The bypass channel would return the split flows to the base of the Intake Diversion Dam. Thus the hydrology in the Yellowstone River below the Intake Diversion Dam would be reduced only by diversions into the Main Canal, as described in the No Action Alternative.

Overall, the Bypass Channel Alternative would have minor effects on the hydrology of the Yellowstone River by directing perennial flows into the bypass channel, which would be within the range of other split or secondary channels along the Yellowstone River. The Bypass Channel Alternative would have major effects on the existing side channel by eliminating flows in the upstream 1.5 miles. This would change this side channel to a primarily backwater channel, and cause the potential for false “attraction” flows at the downstream end at flows at or above the 10-year flood flow. The Bypass Channel Alternative would have minor effects by providing “attraction” flows for fish at the outlet of the new bypass channel downstream of the replacement weir, thus changing hydraulics for a short distance downstream of the weir.

With the Bypass Channel Alternative, the full water right of 1,374 cfs would continue to be delivered and the Main Canal would continue to send return flows back to the river in multiple locations including through some tributaries. Return flows are much greater outside peak irrigation demand time periods (i.e. April through June).

Over time, climate change influences are likely to show a trend of declining low flows, increases in winter flows, and earlier spring runoff for the Bypass Channel Alternative, which could cause a minor to moderate effect on the reliability of diverting the full 1,374 cfs into the canal or require additional rock to provide the diversion during the lowest flows in summer and fall.

Intake Diversion Dam Hydraulics

The change in flow due to split flows at the bypass channel would reduce flows in the Yellowstone River at the Intake Diversion Dam by 14 to 16 percent. The reduction is minor and would not reduce the capability to divert the 1,374 cfs into the Main Canal with the replacement weir that was designed recognizing that the slightly reduced flows in the river from the split flows will result in depths over the weir about 0.5 feet lower at flows of 7,000 cfs and about 1 foot less at flows of 30,000 cfs.

The Bypass Channel Alternative would be constructed with a replacement weir designed to provide the water surface elevations required for diversion through the screened headworks structure, which includes a low flow notch to facilitate fish passage. This would eliminate the need for rock placement currently required to maintain water surface elevations for diversions through the headworks. However, the rock immediately downstream of the new weir would need to be maintained periodically for structural stability. This rock would not be subject to direct flow and ice impacts so it is not expected to occur on a yearly basis. Maintenance on this rock would need to be conducted from a barge or behind a cofferdam during low summer flows when working in the river is practicable. If a cofferdam is used flows could be temporarily diverted to one side of the river.

The replacement weir would have at least one low flow notch to facilitate fish passage during the lowest summer/fall flows (i.e. at 3,000 cfs). This notch would have an 85-foot bottom width at elevation 1,988 feet and variable side slopes up to the replacement weir crest at elevation 1,991 feet. The notch would be located about 100 feet from the left bank.

Velocities over the existing Intake Diversion Dam are more than 8 fps with depths of about 2.1 to 2.9 feet during flows of 15,000 cfs (median flows for spring pallid sturgeon migration period (April through June)). As flows pass the weir through the boulder field, velocities are 2 to 4 fps. Upstream of the weir, average velocities are typically less than 2 fps. Downstream of the rock rubble field, velocities are typically 3 to 4 fps.

The replacement weir in the low-flow notch location would generally have velocities slightly above 5 fps at 15,000 cfs, except closer to the banks, where velocities would be slightly lower at 5 fps (above 6 fps at flows at or above 30,000 cfs). Depths through the notch would be about 3.5 feet at low flows (7,000 cfs or less). At flows above 30,000 cfs, depths would be greater than 7 feet through the notch.

Bypass channel velocities would be 2 to 6 fps over the range of flows assessed for meeting Service and BRT criteria (see Table 4-11), with depths greater than 4 feet for all flows (Figure 4-3). Appropriate attraction flows must be maintained at the downstream entrance to the bypass channel. Placing fill at the left bank corner (facing downstream) and excavating at the right bank corner at the downstream entrance will maintain velocities through and out of the bypass channel and into the river. This also would minimize sediment deposition at the entrance.

A number of O&M actions are expected periodically during the life of the bypass channel to ensure fish passage. Such O&M actions would include replacement of riprap on outside bends, sediment removal, channel realignment and debris removal. These actions will likely require a cofferdam be placed at the upstream entrance of the bypass channel completely shutting off flows to the channel. The cofferdam would be temporary and utilized during the summer base flows. When the cofferdam is in place there would be a minor increase in flows in the Yellowstone River through the weir and headworks area. This would be similar to existing flows, thus resulting in only negligible effects.

Implementation of this alternative would modify flood conditions on Joe's Island by increasing flows to the bypass channel. The increase in 100-year flood depths is expected to be minor (less than half a foot); however, a map revision may be required. The lack of flow through the existing side channel would result in essentially no velocity in the side channel except during floods greater than the 10-year flood event, which could promote sediment deposition in the side channel, primarily near the downstream outlet of the channel to the Yellowstone River.

Overall, the Bypass Channel Alternative would have minor effects on the main channel of the Yellowstone River, with slightly reduced velocities over the replacement weir, but increased depths via the low-flow notch. Slightly lower flows in the main channel would have negligible effect on the ability to divert flows to the Main Canal as the replacement weir is designed to divert the full water right. The Bypass Channel Alternative would have major beneficial effects on secondary channel hydraulics by intentionally providing a bypass channel with perennial flows that meet the Service's BRT criteria for pallid sturgeon passage depths and velocities and replacing an existing side channel with the engineered channel.

TABLE 4-11. SUMMARY OF DESIGN CRITERIA VERSUS PROPOSED CRITERIA FOR FISH PASSAGE IN THE PROPOSED BYPASS CHANNEL^a

Parameter and criteria	Discharge at Sidney, Montana USGS Gage: 7,000 – 14,999 cfs	Discharge at Sidney, Montana USGS Gage: 15,000 – 63,000 cfs
Bypass Channel Flow Split		
Design Criteria	≥12% (840 to 1800 cfs)	13% to ≥ 15% (1,950 cfs to 9,450 cfs)
Bypass Channel Alternative	940 – 1,950 cfs	1,950 to 8,610 cfs
Bypass Channel cross-sectional velocities (mean column velocity^b)		
Design Criteria	2.0 - 6.0 fps	2.4 - 6.0 fps
Bypass Channel Alternative	2.8 – 3.5 fps	3.5 – 5.2 fps
Bypass Channel Depth (minimum cross-sectional depth for 30 contiguous feet at measured cross-sections)		
Design Criteria	≥ 4.0 feet	≥ 6.0 feet
Bypass Channel Alternative	4.5 – 6.3 feet	6.3-12.6 feet
Bypass Channel Fish Entrance (measured as mean column velocity^b)		
Design Criteria	2.0 - 6.0 fps	2.4-6.0 fps
Bypass Channel Alternative	3.1 – 3.8 fps	3.8 – 5.8 fps
Bypass Channel Fish Exit (measured as mean column velocity^b)		
Design Criteria	≤ 6.0 fps	≤ 6.0 fps
Bypass Channel Alternative	3.3 – 3.5 fps	3.5 – 5.0 fps

- a. Values that meet Service and BRT criteria are shown in green and values outside of criteria in red.
- b. The term “measured mean column velocity” is provided by the Service and BRT as guidance for design and subsequently for monitoring following construction if the alternative were to be carried forward. The velocities presented in this report are not based on measurements, but on results of hydraulic models.

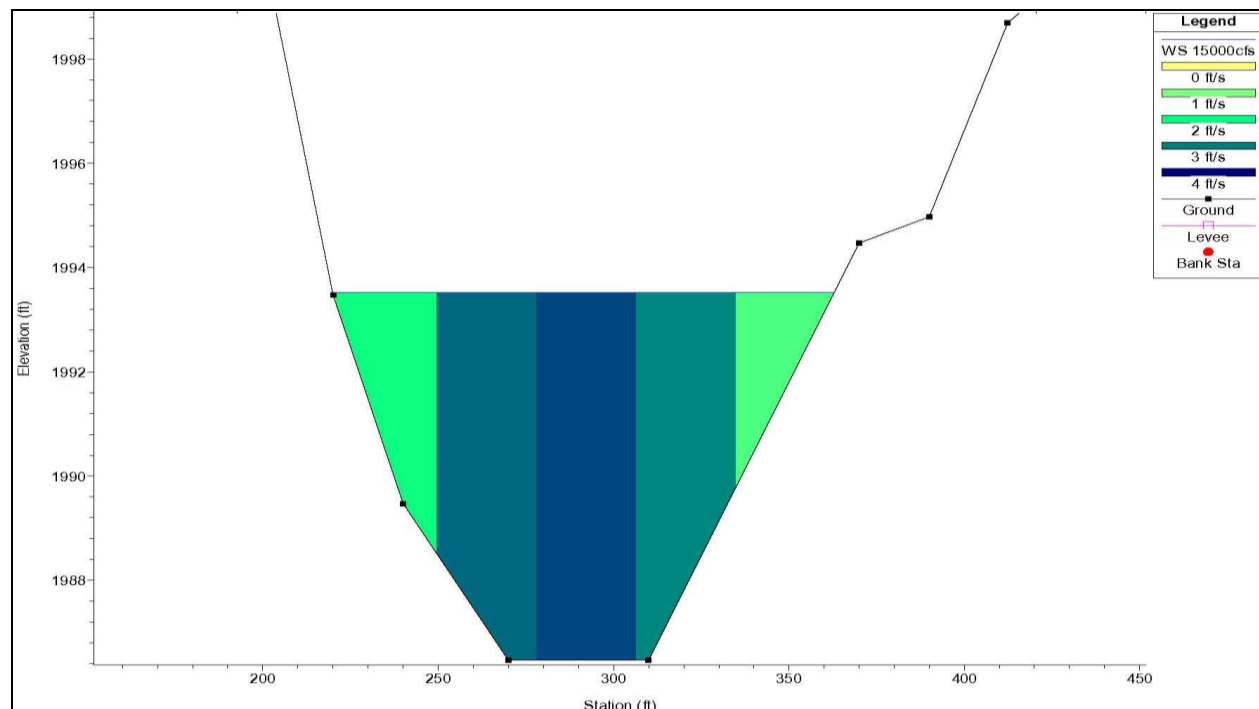

Figure 4-3. Typical Modeled Mean Column Velocity for the Bypass Channel Alternative

4.4.4.4 Modified Side Channel Alternative

Hydrology

The Modified Side Channel Alternative would leave the Intake Diversion Dam in place, which would require annual placement of rock at the slightly higher average elevation to ensure diversion of the full 1,374 cfs when river flows are at 3,000 cfs, due to the increased head requirement of the new headworks and screens. This would be the same as the No Action Alternative.

With the Modified Side Channel Alternative, the full water right of 1,374 cfs would continue to be delivered and the Main Canal would continue to send return flows back to the river in multiple locations including through some tributaries. Return flows are much greater outside peak irrigation demand time periods (i.e. April through June).

The Modified Side Channel Alternative is designed to meet the same BRT criteria as the Bypass Channel Alternative, including an increase in the split of flows from the Yellowstone River into the existing side channel. This alternative would affect the hydrology by reducing Yellowstone River flows by 13 to 16 percent between the upstream and downstream confluences of the existing side channel. The flow reduction in the Yellowstone River would be minor to moderate, extending along 4 miles of the river. The existing side channel would have increased flows when the Yellowstone River reaches and exceeds 7,000 cfs (Table 4-12). This alternative would substantially increase flow peaks and frequency in the existing side channel compared to existing conditions as describe under the No Action Alternative (Table 4-13).

TABLE 4-12. FLOW SPLITS FOR THE MODIFIED SIDE CHANNEL^a

Discharge at Sidney, Montana USGS Gage (return period) (cfs)	Flow Split (cfs)		Bypass Channel Flow as a Portion of Yellowstone River Flow (percent)	
	Side Channel	Remaining in Yellowstone River	Modified Side Channel Alternative	Service and BRT Criteria
7,000	1,100	5,900	16	≥12
15,000	2,180	12,800	14	13 to ≥ 15
30,000	4,080	25,900	14	13 to ≥ 15
54,200 (2-year)	7,160	46,700	13	13 to ≥ 15
63,000	8,440	54,300	13	13 to ≥ 15
74,400 (5-year)	10,400	53,700	14	–
87,600 (10-year)	12,500	74,700	14	–
128,300 (100-year)	17,600	108,300	14	–

a. Values that meet Service and BRT criteria are shown in green and values outside of criteria in red.

TABLE 4-13. EXISTING VS. PROPOSED FLOWS IN THE SIDE CHANNEL

Discharge at Sidney, Montana USGS Gage (return period) (cfs)	Flows in the Side Channel (cfs)	
	Existing Condition	Proposed Condition
3,000	0	480
7,000	0	1,100
15,000	0	2,180
30,000	570	4,080

Discharge at Sidney, Montana USGS Gage (return period) (cfs)	Flows in the Side Channel (cfs)	
	Existing Condition	Proposed Condition
54,200 (2-year)	2,200	7,160
63,000	4,000	8,440
74,400 (5 year)	5,800	10,400
87,600 (10 year)	7,500	12,500
128,300 (100 year)	12,400	17,600

Overall, the Modified Side Channel Alternative would have minor effects on the hydrology of the Yellowstone River by directing perennial flows into the existing side channel, which would be within the range of other split or secondary channels along the Yellowstone River.

Modified Side Channel Hydraulics

The deepened existing side channel would be 20,350 feet in length, which is slightly shorter than the existing channel due to cutting off two bends. The channel slope would be 0.06 percent and the channel bottom width would be approximately 40 feet. Side slopes would vary from 8:1 to 4:1 horizontal to vertical.

With the exception of the bend cutoffs, channel modifications for most of the proposed channel would be limited to lowering the channel within its banks. Backwater areas would be left at the downstream ends of the bend cutoffs. The channel modifications would also include habitat features such as channel bed undulations and deeper pools that would have lower velocities.

The hydraulic analyses of this channel configuration indicates that it would meet the BRT depth and velocity criteria (Table 4-14) except for average velocity at the upstream fish exit, where flows were estimated to be 6.7 fps. These velocities are consistent with the average velocities in the Yellowstone River and may represent the main channel, as opposed to the existing side channel, due to the limitations of the one-dimensional model used for the analysis. Additional design and analyses, particularly a two-dimensional analysis, would be warranted for more detailed design of this alternative.

TABLE 4-14. SUMMARY OF DESIGN CRITERIA VERSUS PROPOSED CRITERIA FOR FISH PASSAGE^b

Parameter and criteria	Discharge at Sidney, Montana USGS Gage 7,000-14,999 cfs	Discharge at Sidney, Montana USGS Gage 15,000-63,000 cfs
Side channel Flow Split		
Design Criteria	≥12% (840 to 1800 cfs)	13% to ≥ 15% (1,950 cfs to 9,450 cfs)
Modified side channel Alternative	1,100 – 1,910 cfs	2,180 to 8,440 cfs
Side channel cross-sectional velocities (mean column velocity^b)		
Design Criteria	2.0 - 6.0 fps	2.4 - 6.0 fps
Modified side channel Alternative	2.6 – 3.1 fps	3.3 – 5.1 fps
Side channel Depth (minimum cross-sectional depth for 30 contiguous feet at measured cross-sections)		
Design Criteria	≥ 4.0 feet	≥ 6.0 feet
Modified side channel Alternative	≥ 4.0 feet	≥ 6.0 feet
Side channel Downstream Fish Entrance (measured as mean column velocity^b)		
Design Criteria	2.0 - 6.0 fps	2.4-6.0 fps

Parameter and criteria	Discharge at Sidney, Montana USGS Gage 7,000-14,999 cfs	Discharge at Sidney, Montana USGS Gage 15,000-63,000 cfs
Modified side channel Alternative	2.8 – 3.2 fps	3.4 – 5.1 fps
Modified Side Channel Upstream Fish Exit (measured as mean column velocity^b)		
Design Criteria	≤ 6.0 fps	≤ 6.0 fps
Modified side channel Alternative	≤ 5.7 fps	≤ 6.7 fps

- a. Values that meet Service and BRT criteria are shown in green and values outside of criteria in red.
- b. The term “measured mean column velocity” is provided by the Service and BRT as guidance for design and subsequently for monitoring following construction if the alternative were to be carried forward. The velocities presented in this report and used for design are not based on measurements, but on results of hydraulic models.

Table 4-15 summarizes the percent of time flows are exceeded for the months of April through June, which are the months of interest for upstream sturgeon passage. Detailed analyses and results can be found in the Engineering Appendix.

TABLE 4-15. FLOW CONDITIONS FOR A RANGE OF CONDITIONS IN THE SIDE CHANNEL^a

Discharge at Sidney, Montana USGS Gage (cfs)	Split Flow into Side channel		Percent of Time Discharge is Exceeded Apr- June (percent)	Average Velocities in Side channel (fps)	Average Depths in Side channel (feet)
	Flow (cfs)	Percent of Yellowstone River Flows (percent)			
7,000	1,100	16	83	3.1	4.6
15,000	2,180	14	47	3.7	6.4
30,000	4,080	14	22	4.3	8.8
54,200	7,160	13	4	5.0	11.3
63,000	8,440	13	2	5.3	12.2
74,400	10,400	14	>1	5.6	13.2
87,600	12,500	14	>1	5.9	14.3

- a. Values that meet Service and BRT criteria are shown in green and values outside of criteria in red.

Implementation of this alternative would modify flood conditions on Joe’s Island by increasing flows to the existing side channel. The increase in 100-year flood depths is expected to be minor; however, a map revision may be required. Further analysis would be required.

Box Elder Creek currently enters the side channel approximately 3 miles downstream or 1 mile upstream from the confluence with the Yellowstone River. Flows out of Box Elder Creek would not be changed and would be allowed to enter the newly constructed channel unimpeded. This extra water may increase flow volumes and depths within the last mile of channel. Several other smaller tributaries enter the side channel off the county road (County Road 303). This may impact sediment deposition or side channel alignment during severe runoff events.

Major and minor O&M actions are expected during the life of the modified side channel. Such O&M actions would include: replacement of riprap on outside bends, sediment removal, channel realignment and debris removal. These actions will likely require a cofferdam be placed at the upstream entrance of the channel completely shutting off flows. The coffer dam would be temporary and utilized during the fall when summer base flows are likely. When the cofferdam is in place there would be a minor increase in flows in the Yellowstone River through the weir

and headworks area. This would be similar to what currently occurs today with no additional impacts expected.

The Modified Side Channel Alternative would have minor effects on flows in the river and over the existing weir (i.e. reducing flow volumes by 12-15%). The flow split will slightly reduce depths flowing over the weir by about 0.5 feet at flows of 7,000 cfs and by about 1 foot at flows of 30,000 cfs. This would likely further preclude fish passage over the existing weir, but the side channel would be available for fish passage.

Overall, the Modified Side Channel Alternative would have minor effects on the main channel Yellowstone River, with slightly reduced flows and depths. The Modified Side Channel Alternative would have major beneficial effects on secondary channel hydraulics by intentionally providing perennial flows that meet the BRT criteria for pallid sturgeon passage depths and velocities. There would be a major change to the natural existing side channel. Flows from Box Elder Creek and other smaller tributaries are not expected to be affected under this alternative.

4.4.4.5 Multiple Pump Alternative

Hydrology

The Multiple Pump Alternative would include removal of the Intake Diversion Dam, reducing the potential for gravity flow diversions into the Main Canal at all Yellowstone flows below 30,000 cfs at the Sidney Gage (31,000 cfs at the Intake Diversion Dam). Estimated flows that could be gravity diverted without the dam in place are summarized in Table 4-16. This alternative assumes the potential for three operating conditions:

- **Operation Condition 1**—Flows in the Yellowstone River are high enough to fully divert 1,374 cfs by gravity through the Intake Diversion headworks (greater than approximately 30,000 as measured at Sidney).
- **Operation Condition 2**—Flow is insufficient to gravity-divert the full allocation. In this case, 1,100 cfs would be gravity-diverted and 274 cfs would be pumped from the furthest downstream pumping site. This would not interfere with gravity diversion. When gravity cannot divert 1,100 cfs, the second most downstream pump would be brought online and 825 cfs would be gravity diverted. Again, gravity diversion would not be impeded by this condition. One more pumping site could be brought online in this manner, when gravity would not allow for 825 cfs.

TABLE 4-16. POTENTIAL GRAVITY FLOWS TO THE LYP MAIN CANAL WITH THE INTAKE DIVERSION DAM REMOVED

Discharge at Sidney, Montana USGS Gage (cfs)	Estimated Flow at Intake Diversion Dam (cfs)	Gravity Flow into Main Canal (cfs)
2,000	3,100	150
3,000	4,100	225
5,000	6,100	330
7,000	8,100	440
9,000	10,100	530
11,000	12,100	620
13,000	14,100	710

15,000	16,100	790
20,000	21,100	980
25,000	26,100	1,200
30,000	31,100	1,330
31,400	32,500	1,374

- Operation Condition 3**—No flow is diverted by gravity through the Intake Diversion headworks and all flow is pumped further downstream. Below 550 cfs, gravity diversion is not feasible and the head gates would be closed and the remaining two pumping sites would be brought online.

With any combination of gravity and pumping or pumping only, it is assumed that diversions to the upper laterals (AA through FF) would need to be pumped from the Main Canal, which is estimated to total less than 50 cfs. If this alternative would be advanced, further assessment would be required to optimize canal operations.

The Multiple Pump Alternative would provide pumped flows into the Main Canal at five locations, 1, 8, 11, 11.2 and 11.5 miles downstream from the Intake Diversion Dam. Each site would pump 274 cfs, yielding a total diversion of 1,374 cfs. The effect of this alternative on river hydrology, when the pumps are operating, would be to increase flows in the Yellowstone River over the 11.5 miles downstream of the Intake Diversion Dam, with the greatest increase in the first 8 miles. At 11.5 miles downstream, the river flow volume would be equivalent to the existing condition. When gravity diversions are supplying all the canal flow, there would be no change in Yellowstone River hydrology.

With the Multiple Pump Alternative, the full water right of 1,374 cfs would continue to be delivered and the Main Canal would continue to send return flows back to the river in multiple locations including through some tributaries. Return flows are much greater outside peak irrigation demand time periods (i.e. April through June).

Overall, the Multiple Pump Alternative would provide a moderate beneficial effect of increased flow volumes in the Yellowstone River and side channels for up to 11.5 miles below the Intake Diversion Dam, except when gravity flows can divert the full 1,374 cfs. Under the latter condition, the alternative would have no effect on the hydrology in the Yellowstone.

Intake Diversion Dam Hydraulics

The Multiple Pump Alternative proposes to remove the Intake Diversion Dam and would change the hydraulics at the dam location and immediately downstream by changing the river gradient back to 0.04 to 0.07 percent. Velocities over the Intake Diversion Dam are more than 8 fps, with depths of 2.1 to 2.9 feet during flows of 15,000 cfs (median flows for spring pallid sturgeon migration period (April through June)). As flows pass through the boulder field, velocities are in the 2- to 4-fps range, likely due to backwater at the toe of the dam. Upstream of the Intake Diversion Dam, average velocities are lower, typically less than 2 fps. Downstream of the boulder field, average velocities are typically 3 to 4 fps.

With the Intake Diversion Dam removed, the main river channel would generally have average velocities of 3.1 fps at 15,000 cfs and 4.4 fps at 30,000 cfs. Average channel depths would be about 7 feet at low flows (7,000 cfs or less). At flows above 30,000 cfs, average channel depths would be about 11 feet, which is similar to depths and velocities in the upstream/downstream river channel.

It is assumed that removal of the Intake Diversion Dam would result in the natural erosion of a wedge of sediment upstream for several thousand feet, and this sediment would naturally redistribute downstream. Removal of the Intake Diversion Dam would change the flows at which the existing side channel connects to the river, from about 20,000 cfs under existing conditions to 35,000 cfs.

The five pump sites would be on the outside of meander bends to minimize the chances they would be blocked by bar formation and maximize their connectivity to the deepest part of the channel (i.e. thalweg) in the Yellowstone. Both of these factors would contribute to the reliability of the diversion and reduce maintenance associated with sediment removal. Canals would be excavated to connect the pumps to the river. Each would be 300 to 1,000 feet in length with a 32-foot bottom width, excavated to match the elevation of the thalweg in the adjacent river. The pumps would be pumping greater volumes of water when flows in the river are lower. Velocities in the channels would be highest when the pumps are pumping the full 275 cfs at each station. Typical depths and velocities are shown in Table 4-17.

TABLE 4-17. FEEDER CANAL DEPTH AND VELOCITY

Main Channel Discharge (cfs)	Feeder Canal Depth (feet)	Feeder Canal Velocity (fps)
3,000	2.5	3.1
5,000	4.0	1.8
10,000	6.1	1.1
15,000	7.7	0.78
20,000	8.9	0.65
25,000	9.8	0.57
30,000	10.7	0.50
45,000	12.7	0.39
54,200	13.8	0.34

Sediment removal and bank stabilization are likely to be required to maintain conditions suitable for pumping and diversions through the screened headworks. Sediment deposition, channel migration or bank erosion would likely result in a moderate risk to the reliability of diverting the full quantity of water (1,374 cfs) into the canals.

Removal of the Intake Diversion Dam and rock immediately surrounding it would reduce the likelihood of ice jamming up, as there would not be an obstruction spanning the channel. Ice jams could still occur in the vicinity of the headworks, but overall, there would be a reduced risk of ice jams. Although ice jam potential would be reduced, there is an increased risk that the main channel of the Yellowstone River could migrate away from the screened headworks structure. It

is likely that the south side of the Yellowstone River would need to be stabilized to continue diversions through the screened headworks.

Overall, the Multiple Pump Alternative would likely have moderate long-term effects on surface water hydraulics associated with a lower water surface elevation during floods at the crest of the Intake Diversion Dam. The minor increase in flows in the Yellowstone River would likely have a negligible effect on the water surface elevations during floods.

The Multiple Pump Alternative would have a major effect on hydraulics by removing the Intake Diversion Dam and some of the rock around the weir. It also would have a major effect on the existing side channel by reducing the frequency of flows into that channel (flows would not occur in the existing side channel until river flows reach 35,000 cfs), although flow into the side channel would continue to be an annual occurrence.

Removal of the Intake Diversion Dam would likely substantially improve fish passage ability through the main river channel, as depths and velocities would be similar to those found in upstream/downstream reaches of the river. The pumping stations would have a minor effect on surface water hydraulics by creating off-line diversions and placing some rock to protect the pumping stations. The Multiple Pump Alternative would have minor to moderate effects on the development of ice jams in the reach by removal of the Intake Diversion Dam.

4.4.4.6 Multiple Pumps with Conservation Measures Alternative

Hydrology

The Multiple Pumps with Conservation Measures Alternative would include removal of the Intake Diversion Dam, which would reduce the potential for gravity flow diversions Main Canal. The reduced requirement of 608 cfs achieved by conservation measures included in this alternative could be diverted to the Main Canal with the dam removed when flows in the Yellowstone are at or above 15,200 cfs. However, flows are frequently below 15,200 cfs during the irrigation months, so pumping would often be required. Full diversion of required flows into the canal would rely on Ranney wells designed to pump a total of 608 cfs. Groundwater recharge and composition of the alluvial aquifer would affect the ability to pump, creating a risk for reliability to provide the 608 cfs into the canal.

The Multiple Pumps with Conservation Measures Alternative would have a direct impact on flows in the Yellowstone River by decreasing direct diversions at the Intake Diversion Dam headworks and leaving 700 cfs more flow in the Yellowstone River that would normally be diverted. However, Ranney wells or other groundwater pumping would withdraw water from the shallow alluvial aquifer, which is directly connected to and fed by the Yellowstone River. While some dampening of the withdrawals would likely occur by the storage effect in the aquifer, it is likely the surface water hydrology would be reduced in the Yellowstone River due to pumping from the Ranney wells. Groundwater pumping may also increase seepage losses in the canal and laterals (if unlined) by increasing the hydraulic gradient of the groundwater in the vicinity of the canal. This would require further analysis if this alternative is carried forward. Check structures may be required in the Main Canal to maintain head for lateral pipes or pumps, although this alternative includes filling in half the dimension of the Main Canal in order to maintain appropriate depths and velocities with the reduced volume of flow. Nonetheless, there could be

somewhat reduced velocities in the Main Canal and subsequent increased sediment deposition which could have moderate operational effects on the delivery system.

The water conservation measures would reduce the volume of flow going down the Main Canal, thereby reducing both seepage and return flows substantially throughout the system. This could have effects on groundwater levels (see Groundwater section) and various wetlands (see wetlands section) and aquatic habitats (see aquatic resources section) that may have been created or enlarged as a result of irrigation returns or seepage, but the net result would be increased surface water flows in the Yellowstone River.

Overall, the Multiple Pumps with Conservation Measures Alternative would have a major effect on irrigation diversions in the Main Canal and the reliability of providing irrigation water. This alternative would also have a moderate beneficial effect of increased flow volumes in the Yellowstone River and side channels for the entire 73 miles of the lower river.

Intake Diversion Dam Hydraulics

With the removal of the Intake Diversion Dam, the Multiple Pumps with Conservation Measures Alternative would change the hydraulics at the dam location and immediately downstream by changing the river gradient to 0.04 to 0.07 percent. Velocities over the Intake Diversion Dam are more than 8 fps, with depths of about 2.1 to 2.9 feet during flows of 15,000 cfs (median flows for spring pallid sturgeon migration period (April through June)). As flows pass the dam through the boulder field for existing conditions, velocities are in the 2- to 4-fps range, likely due to backwater at the toe of the dam. Upstream of the dam, average velocities are lower, typically less than 2 fps. Downstream of the boulder field, average velocities are typically 3 to 4 fps.

With the dam removed, the main river channel would generally have average velocities of 3.1 fps at 15,000 cfs and 4.4 fps at 30,000 cfs. Average channel depths would be about 9 feet at low flows (7,000 cfs or less). At flows above 30,000 cfs, average channel depths would be greater than 13.5 feet, which is similar to depths and velocities in the upstream/downstream river channel.

It is assumed that removal of the dam would result in the natural erosion of a wedge of sediment upstream for several thousand feet, and this sediment would naturally redistribute downstream. Removal of the dam would change the flows at which the existing high-flow side channel connects to the river, from about 20,000 cfs under existing conditions to 35,000 cfs.

Removal of the dam and rock immediately surrounding the dam would reduce the likelihood of ice jamming up, as there would not be an obstruction in the channel. Ice jams could still occur in the vicinity of the headworks, but overall, there should be a reduced risk of ice jams. Although ice jam potential would be reduced, there is an increased risk that the main channel of the Yellowstone River could migrate away from the screened headworks structure. It is likely that the south side of the Yellowstone River would need to be stabilized to continue diversions through the screened headworks.

Overall, the Multiple Pumps with Conservation Measures Alternative would likely have moderate long-term effects on surface water hydraulics associated with a lower water surface

elevation during floods. The increase in flows in the Yellowstone River would likely have a negligible effect on the water surface elevations during floods.

The Multiple Pumps with Conservation Measures Alternative would have a major effect on hydraulics by removing the Intake Diversion Dam and the rock around the weir. It would also have a major effect on the existing side channel by reducing the frequency of flows into the side channel, as discussed for the Multiple Pump Alternative. Removal of the Intake Diversion Dam would likely substantially improve fish passage through the main river channel, as depths and velocities would be similar to those found in upstream and downstream reaches of the river.

The Ranney Wells would slightly increase depths and velocities in the Yellowstone River due to reduced diversions, having a minor effect on the surface water hydraulics. Reduced diversions could have a moderate effect on the operations of the Main Canal by reducing water elevations and velocity, and increasing sediment deposition. This alternative would have minor to moderate effects on the development of ice jams in the reach by removal of the Intake Diversion Dam.

4.4.5 Cumulative Effects

4.4.5.1 Geographic and Temporal Extent of Analysis

The geographic extent for evaluating cumulative effects on surface water includes the lower Yellowstone River and its floodplain (including the LYP) from approximately 2 miles upstream of the Intake Diversion Dam to the confluence with the Missouri River, and the Missouri River from Fort Peck Dam to Lake Sakakawea.

4.4.5.2 Methodology for Determining Effects

The methodology for determining effects was an evaluation of the cumulative effects on hydrology presented in the Yellowstone River Cumulative Effects Assessment (Corps & YRCDC 2015), hydraulic modeling conducted for this study, and an evaluation of the potential for reasonably foreseeable future projects and climate change to affect river flows.

4.4.5.3 Past, Present, and Reasonably Foreseeable Future Projects Considered

A list of the past, present, and reasonably foreseeable future projects in the area of potential effect is provided in Section 4.1.4. The net result of the small and large dams in the basin and ongoing irrigation diversions has had a moderate effect on Yellowstone River hydrology, but the large dams and flood control and navigation operations have had a major effect on Missouri River hydrology. The combination has resulted in a condition that does not allow for pallid sturgeon passage upstream in the Yellowstone River or successful recruitment in the Yellowstone or upper Missouri River under most conditions.

The following are key potential future projects and trends that could affect surface water:

- Missouri River Recovery Management Plan
- Fort Peck Dry Prairie Regional Water System Improvements
- Crow Irrigation Project (Section 405 of the Crow Settlement Act of 2010)
- Crow Municipal, Rural and Industrial Water Project (Section 406 of the Crow Settlement Act of 2010)
- Yellowtail Storage Allocation (Section 408 of the Crow Settlement Act of 2010)

- Bighorn Streamflow and Lake Level Management Plan (Section 412 of the Crow Settlement Act of 2010)
- Yellowtail Afterbay Power Generation (Section 412 of the Crow Settlement Act of 2010)
- Ongoing trends of oil and gas development
- Ongoing trends of pivot irrigation and other water conservation measures
- Ongoing trends of climate change.
- Ongoing trends in urbanization

4.4.5.4 No Action Alternative

The No Action Alternative would take no action to provide fish passage at the Intake Diversion Dam and would continue the status quo operation and diversion of 1,374 cfs into the Main Canal. The presence of the Intake Diversion Dam and the diversion of water have contributed to cumulative effects on surface water and the aquatic ecosystem by reducing passage of pallid sturgeon and other species. The Yellowstone River Cumulative Effects Assessment (Corps & YRCDC 2015) documented that peak flows in the lower Yellowstone River have been reduced by 15 percent for the 10-year and 100-year flood flows and 23 percent for the 2-year flood at Glendive. Summer low flows have been reduced by approximately 50 percent compared to the unregulated condition, whereas winter low flows have increased by approximately 50 percent. Reduced peak and low flow volumes result in lower depths and velocities and reduced scour.

The projects associated with the Crow Settlement Agreement could affect flows in the Bighorn River by withdrawing more water for irrigation and municipal and industrial uses. In comparison to the estimated 3,200 million gallons per day along the Yellowstone River, these additional uses are likely to be minor (less than 1 percent). With ongoing trends in the use of groundwater for oil and gas development and the use of groundwater and surface water for municipal uses, there could be minor additional cumulative effects particularly on low flows. Climate change predictions indicate the likelihood of reduced summer low flows, and there has been documentation of reduced flows in the Rocky Mountains in August associated with increased air temperatures (Lippi et al. 2012).

The Missouri River Management Plan is currently developing an adaptive management process that will look at concepts and potential measures such as changes in flows and water temperatures from the Fort Peck Dam or changes in the operation of Garrison Dam and the resultant levels of Lake Sakakawea, which, if found feasible, could be considered in the future as ways to restore somewhat more natural conditions to improve pallid sturgeon survival and reproduction.

Overall, the No Action Alternative is likely to continue contributing to cumulative effects on surface water in the area of analysis, with additional minor cumulative effects anticipated from reasonably foreseeable future projects and trends.

4.4.5.5 Alternatives That Include Maintaining Intake Diversion Dam

All of the alternatives that would maintain the Intake Diversion Dam whether in its existing condition or with installation of a new concrete weir (Rock Ramp, Bypass Channel, Modified Side Channel) would provide a suitable surface water route for fish passage during most flows. There would be some flows with depths or velocities not be suitable for passage for the rock

ramp, but the overall cumulative effect would be an improvement for the aquatic ecosystem and fish passage.

There is likely to be a minor reduction in flows, particularly low flows, in the Yellowstone River, due to several expected trends:

- Likely climate induced changes
- Additional water withdrawals and hydropower development at Yellowtail Dam
- Increased use of groundwater for oil and gas development and municipal uses.

However, the net effect with these action alternatives would be a slight reversal of cumulative effects on surface water, with benefits to the aquatic ecosystem and fish passage in the Yellowstone River. Implementation of the Missouri River Management Plan will likely help to slightly further reduce cumulative effects on surface water in the Missouri River.

Overall, for the alternatives that keep the Intake Diversion Dam in place, there is likely to be a minor net improvement to cumulative effects that have occurred to surface water.

4.4.5.6 Alternatives That Would Remove Intake Diversion Dam

The alternatives that include removing the Intake Diversion Dam, (Multiple Pump Alternative and Multiple Pumps with Conservation Measures Alternative) would remove a feature that has contributed to cumulative adverse effects on surface water, the aquatic ecosystem and pallid sturgeon.

There is likely to be a minor reduction in flows, particularly low flows, in the Yellowstone River, due to several expected trends:

- Likely climate induced changes
- Additional water withdrawals and hydropower development at Yellowtail Dam
- Increased use of groundwater for oil and gas development and municipal uses.

However, the net effect with these action alternatives would be a moderate reversal of cumulative effects on surface water, with benefits to the aquatic ecosystem and fish passage in the Yellowstone River. Implementation of the Missouri River Management Plan will likely help to slightly further reduce cumulative effects on surface water in the upper Missouri River basin.

Overall, for the alternatives that remove Intake Diversion Dam, there is likely to be a moderate net improvement to cumulative effects that have occurred to surface water.

4.4.6 Actions to Minimize Effects

For any of the action alternatives, the following actions are recommended to minimize effects on surface water during construction and during long-term operation and maintenance:

- Ensure compliance with the provisions of Section 404 of the Clean Water Act for temporary or permanent discharges of dredge or fill material into waters of the U.S., including minimizing quantities of dredge or fill.
- Design coffer dams to obstruct the least amount of the channel or floodway to minimize the potential for affecting flood flows or ice jams.

- Consider further water conservation elements in the long-term operation of the LYP to reduce the demand for water withdrawals and the need for placing rock with alternatives that leave the Intake Diversion Dam in place.

4.5 Groundwater Hydrology

This section qualitatively evaluates environmental consequences to groundwater resources from the Project alternatives, based on available information at this planning phase of the project.

4.5.1 Area of Potential Effect

The study area for evaluation of groundwater impacts is both local and regional, due to the presence of both a local, surficial aquifer and a deeper regional aquifer. The local study area is alternative-specific and is dependent on the location of construction areas and the components of the alternative. The regional study area encompasses the Yellowstone River valley, the counties of Dawson, Richland and Wibaux in Montana, and the county of McKenzie in North Dakota. The study area for the alternatives generally includes the areas of the Main Canal and laterals of the LYIP (see Figure 3-4) and additionally are as follows:

- **No Action Alternative.** The local study area is the area of the existing Intake Diversion Dam and the Main Canal.
- **Rock Ramp Alternative.** The local study area is the area immediately surrounding the existing Intake Diversion Dam and the Main Canal.
- **Bypass Channel Alternative.** The local study area is the area immediately surrounding the existing Intake Diversion Dam, the Main Canal, and Joe's Island.
- **Modified Side Channel Alternative.** The local study area is the area immediately surrounding the existing Intake Diversion Dam, the Main Canal, and Joe's Island.
- **Multiple Pump Alternative.** The local study area is the area immediately surrounding the existing Intake Diversion Dam, the Main Canal, and the areas surrounding the five pumping stations and their components (see Figure 2-10). The regional study area for this alternative is important due to the dispersed facilities and the unknown locations of required new transmission lines, substation upgrades, and new substations.
- **Multiple Pumps with Conservation Measures Alternative.** The local study area is the area immediately surrounding the existing Intake Diversion Dam, the Main Canal, and the areas the seven pumping stations and their components (see Figure 2-21). The regional study area for this alternative is important due to the dispersed facilities and the unknown locations of potential required new transmission lines; and any necessary substation upgrades and/or new substations.

Construction effects within the local study area are associated with potential releases of contaminants from construction vehicles and equipment; construction dewatering activities; use of groundwater during construction; and possible effects on public or private groundwater supplies during construction. Surrounding areas might be minimally impacted by increased construction traffic. Operation and maintenance effects were evaluated for both the local and regional study area in terms of the regular maintenance activities associated with the location of each alternative.

4.5.2 Summary of Potential Effects

Table 4-18 summarizes the potential effects on groundwater hydrology for each alternative. Details are provided in the following sections.

TABLE 4-18. SUMMARY OF POTENTIAL EFFECTS ON GROUNDWATER HYDROLOGY FROM EACH ALTERNATIVE

Impact Type	Level of Impact	Impact Description
No Action Alternative		
Construction Effects	No Effect	<ul style="list-style-type: none"> • No effects
Operational Effects	Minor	<ul style="list-style-type: none"> • Ongoing seepage from irrigation system into shallow aquifer
Rock Ramp Alternative		
Construction Effects	Negligible	<ul style="list-style-type: none"> • Construction might have short-term negligible effects on levels of very localized shallow groundwater that is in connection with the river alluvium.
Operational Effects	Minor	<ul style="list-style-type: none"> • If the fishing access site is removed, the public water supply well would require removal. This would constitute a minor effect. • Negligible effects on levels of localized shallow groundwater that is in connection with river alluvium in the vicinity of the rock ramp and replacement weir. • Ongoing seepage from irrigation system into shallow aquifer
Bypass Channel Alternative		
Construction Effects	Negligible	<ul style="list-style-type: none"> • Construction might have short-term negligible effects on levels of very localized shallow groundwater that is in connection with the river alluvium.
Operational Effects	Minor	<ul style="list-style-type: none"> • Minor effects on levels of localized shallow groundwater that is in connection with river alluvium in the vicinity of Joe’s Island. • Ongoing seepage from irrigation system into shallow aquifer
Modified Side Channel Alternative		
Construction Effects	Negligible	<ul style="list-style-type: none"> • Construction might have short-term negligible effects on levels of very localized shallow groundwater that is in connection with the river alluvium.
Operational Effects	Minor	<ul style="list-style-type: none"> • Minor effects on levels of localized shallow groundwater that is in connection with river alluvium in the vicinity of Joe’s Island. • Ongoing seepage from irrigation system into shallow aquifer.
Multiple Pump Alternative		
Construction Effects	Negligible	<ul style="list-style-type: none"> • Construction might have short-term negligible effects on levels of very localized shallow groundwater that is in connection with the river alluvium.
Operational Effects	Minor	<ul style="list-style-type: none"> • If the fishing access site is removed, the public water supply well would require removal. This would constitute a minor effect. • Negligible effects on levels of localized shallow groundwater that is in connection with river alluvium in the vicinity of the pumping stations. Further hydrogeological characterization would be necessary to substantiate that effects would be negligible. • Minor localized effects on levels of shallow groundwater that is in connection with the river alluvium in the vicinity of the removed Intake Diversion Dam and modified feeder canal. • Ongoing seepage from irrigation system into shallow aquifer.

Impact Type	Level of Impact	Impact Description
Multiple Pumps with Conservation Measures Alternative		
Construction Effects	Minor	<ul style="list-style-type: none"> Construction might have short-term minor effects on levels of localized shallow groundwater that is in connection with the river alluvium at the Ranney well sites.
Operational Effects	Major	<ul style="list-style-type: none"> If the fishing access site is removed, the public water supply well would require removal. This would constitute a minor effect. If the fishing access site well remains in place, pumping at Site #1 could have major effects. Further hydrogeological characterization would be necessary to define drawdown levels and groundwater surface mapping. Potentially major effects on levels of localized shallow groundwater that is in connection with the river alluvium in the vicinity of the well site stations. Further hydrogeological characterization would be necessary to define drawdown levels and groundwater surface mapping for each well site. Potentially major effects to nearby wells and shallow groundwater levels that are influenced by seepage recharge from the irrigation canal that would be reduced with conservation measures. Main Canal. Minor, localized effects on levels of shallow groundwater that is in connection with the river alluvium in the vicinity of the removed Intake Diversion Dam and modified feeder canal.

The No Action Alternative would have no effects on groundwater. The greatest potential effects on groundwater resources are predicted for the Multiple Pumps with Conservation Measures Alternative because the alternative would pump substantial amounts of groundwater from the Yellowstone River alluvial aquifer. These effects are unknown without additional studies. They could range from negligible to major and have the potential to adversely affect area groundwater supplies. Further hydrogeological characterization would define drawdown levels and groundwater surface mapping for each well site.

4.5.3 Construction Effects

All of the action alternatives would involve construction activities that would create a potential for inadvertent releases of contaminants (fuel, oil, and other construction materials) to the soil and to shallow groundwater. Local and temporary effects on groundwater levels might also occur during construction due to necessary flow control measures on the Yellowstone River. The tapping of a new groundwater supply is not anticipated to be necessary during construction of any of the alternatives, however if the FAS is relocated a new well may be required. Dewatering activities would be associated with any flow control measures necessary along the Yellowstone River and any excavation necessary for construction of new infrastructure.

4.5.3.1 No Action Alternative

With the No Action Alternative, there would be continued operation of the Intake Diversion Dam and Main Canal. Ground disturbance and construction activities would not be necessary, so no temporary or long-term effects on groundwater resources would result from construction.

4.5.3.2 Rock Ramp Alternative

Construction activities associated with placement of the weir and fill and riprap, construction work and staging areas, canal crossing, and access roads would create the potential for inadvertent releases of contaminants (fuel, oil, and other construction materials) to the soil and to

shallow groundwater. Local and temporary effects on groundwater levels might also occur during construction of the rock ramp due to necessary flow control measures on the Yellowstone River. This alternative would be constructed in three phases, and potential effects on groundwater would be dependent on activities and duration of each phase. The tapping of a new groundwater supply is not anticipated to be necessary during construction, however if the FAS is relocated a new well may be required. Dewatering would be associated with Yellowstone River flow control measures for construction of the rock ramp.

Ground disturbance might cause changes in groundwater infiltration rates, either by loosening soil and increasing ground infiltration or by compacting soil and decreasing ground infiltration. With implementation of proposed actions to minimize effects, no effects on groundwater are anticipated from changes in infiltration.

The Intake Fishing Access Site (Inatek FAS) is served by a public water supply well, located near the southwest corner of the parking area. No other public water supply wells are located in the vicinity of the Rock Ramp Alternative. The entire Intake FAS would be relocated during construction further downstream. During the relocation, the water well would be properly plugged and abandoned. This would constitute a minor effect. It is assumed that the water supply would be replaced at a proposed new recreational facility.

As documented in Table 4-19 (see Site #1 in the table), a private well and spring were identified in the general area of the Intake Diversion Dam. Measures to protect private groundwater supplies include identification of water wells and springs within 150 feet of construction areas and subsequent measures to avoid direct or indirect effects on these supplies.

Groundwater source water protection areas are a potential concern in populated and developed areas along the Yellowstone River Valley. The Rock Ramp Alternative is not located in a potential area of source water protection concern because the existing well at the fishing access site is rated low for susceptibility to contamination (MTDEQ 2016) and no other public groundwater supplies are located in the vicinity of the alternative.

Short-term and temporary potential contaminant releases from construction vehicles and equipment and short-term and temporary effects on groundwater levels would be localized in construction areas near the Intake Diversion Dam. However, with the implementation of actions to minimize effects, potential contaminant releases would be contained and groundwater contamination would be prevented. Potential effects on groundwater levels would be too small to contribute to any noticeable changes in local or regional groundwater. Any slight changes to groundwater levels would return to current conditions once construction activities are completed, with no long-term effects on groundwater resources.

TABLE 4-19. WATER WELLS NEAR WELL AND PUMPING STATION SITES

Well and Pumping Sites / owner names	Total Depth (feet)	Water Level (feet)	Yield (gpm)	Use
Site #1—Areas Searched: T18N R57E Sec: 24, 26, 25, 36; T18N R58E Sec: 30				
K & W Ranch	675	106	15	stock
T.J. Bar Inc. Williams Residence (Spring)	NA	NA	Not provided	residential
Site #2—Areas Searched: 18N Range: 57E Sec: 3; Township: 19N Range: 57E Sec: 34, 35				
McPherson Farms Inc.	28	10	25	domestic
S Bran	145	Not provided	1	domestic
Rice G	36	Not provided	10	domestic
Bean	300	flowing	Not provided	domestic
Prevost, Fred	196	29	6	domestic
Hanzek, Larry	75	44	8	domestic
Smith, Joanne	280	15	10	domestic
D Davies	582	Not provided	10	domestic
Bolinder, Shane	825	Not provided	85	domestic
Jimison, C.H.	727	113	90	domestic
Prevost, Elwin	20	7	8	domestic
Site #3—Areas Searched: T19N R57E Sec: 24; T19N R58E Sec 19, 20				
Wilson, Wade H And Michelle A	Not provided	Not provided	Not provided	Not provided
Larsen Kenneth	16	6	5	stock
Willis H Wilson	11	Not provided	Not provided	stock
Wilson Vernon	180	Not provided	Not provided	domestic
Agricultural Enterprises	340	172	7	stock
Barone Rene	350	Not provided	2	domestic
Barone Rene	350	Not provided	2	domestic
Wilson Vernon	22	Not provided	12	stock
Pasture Creek Co	118	12	24	domestic
Wilson, Wade	820	Not provided	80	domestic
Site #4 (and Site #5 for pumping alternative)—Areas Searched: T20N R58E Sec: 32, 33				
Basta, Todd	1,000	Not provided	Not provided	domestic
BNSF * Savage* Section House	107	Not provided	Not provided	Public water supply
Etzel Carl	31	15	10	domestic
Gear John	31	24	6	domestic
Hagler, Leonard	31	33	15	domestic
Hedegard, James	35	16	20	domestic
Hoeger F G	Not provided	Not provided	30	domestic
Kizziar Anna	89	18	15	domestic
Ler Melvin	34	21	10	domestic
Lowry Jenny	34	12	8	domestic
Nitschke E A	89	18	20	domestic
Schmierer, Dennis	42	12	12	domestic
Seeve, Ida	Not provided	Not provided	20	domestic
Tieszen, Sam	39	16	30	domestic
Binder, Walter	60	25	12	domestic

Lower Yellowstone Intake Diversion Dam Fish Passage Project, Montana
Environmental Impact Statement
May 2016

Well and Pumping Sites / owner names	Total Depth (feet)	Water Level (feet)	Yield (gpm)	Use
Wiebe, Bill	35	22	20	domestic
Madsen, Jeff	100	18	25	domestic
Stanford, Bryon	100	15	50	domestic
Verhasselt, Jill	98	18	25	domestic
Verhasselt, Jill	98	18	35	domestic
Badt, Clydette	43	16	15	domestic
Carolyn's Kitchen	100	12	25	Public water supply
Starkey Robert & Venita	33	17	25	domestic
Madsen Jeff and Christi	40	16	13	domestic
C H Gebhardt	19	Not provided	Not provided	domestic
Johnson Ruth	32	16	Not provided	stock
Gedrose, David	39	21	15	domestic
Mrs. C Jackson	28	Not provided	Not provided	domestic
Reynolds, Duane	32	25	7	domestic
Reynolds, Duane Jr	33	24	10	domestic
Stanvick, Lester	30	22	7	domestic
Land Melvin/Miller Joyce	40	21	14	domestic
Scheetz, Herman	40	23	14	domestic
Braun, Terry & Rosa Lyan	36	18	1	domestic
Deshaw Betty	1,008	185	Not provided	domestic
First Lutheran Church	32	20	6	domestic
Valley Fuel and Supply	38	23	16	Public water supply
Sunwall, Byron	30	12	10	domestic
Spithoven, Jack/Mildred	28	14	8	domestic
Sheets Dennis	32	25	12	domestic
Sunrise Manor	50	19	30	domestic
Hilliard, Russell #3	30	Not provided	8	domestic
Larson Oscar S	14	Not provided	2	domestic
Larson Oscar S	14	Not provided	2	domestic
Hilliard, Russell #2	30	Not provided	8	domestic
Seeve, Robert W./Ida	38	21	12	domestic
Savage Cem Asso	45	20	15	domestic
Schmierer, Irene and Dennis	50	30	12	domestic
Schmierer, Irene and Dennis	50	30	12	domestic
Fred Meyer	18	Not provided	Not provided	domestic
Miller, James	85	30	25	domestic
Hafele, Tom	30	9	15	stock
Anderson, Michael	72	30	10	domestic
Prigan Philip	98	26	10	domestic
Trzinski, Joseph	30	20	10	unknown
Build Inc.	58	16	20	Public water supply
Burns Creek Inn	30	18	15	domestic
Savage Cong. Church	Not provided	30	20	domestic

Lower Yellowstone Intake Diversion Dam Fish Passage Project, Montana
Environmental Impact Statement
May 2016

Well and Pumping Sites / owner names	Total Depth (feet)	Water Level (feet)	Yield (gpm)	Use
Savage School	60	Not provided	30	irrigation
Staci Ricelang	1,000	173	Not provided	domestic
Dave McConaha	13	Not provided	Not provided	domestic
Dave McConaha	20	Not provided	Not provided	domestic
Reclamation Cmp	13	Not provided	Not provided	domestic
Savage School	80	23	11	domestic
Savage School	80	23	30	domestic
Edward Bureau	30	Not provided	Not provided	domestic
Fitzgerald, Robert/S.	31	18	15	domestic
White, Allen	85	20	35	domestic
U.S. Bur. Of Rec.	24	4	35	domestic
Considine, Rose	85	25	30	domestic
Emil Caneva	33	Not provided	Not provided	domestic
Jones, Jim	110	24	18	domestic
Jones, Jim	110	24	60	domestic
Nelson, Jason	30	20	5	domestic
Northern Pacific Rr	256	Not provided	10	domestic
Savage High School	35	20	60	Public water supply
Karsten, Patricia	30	21	15	domestic
Deshaw, Brian	110	20	10	domestic
Harmon, Howard/Tom	60	16	11	domestic
Savage Public School	29	15	15	domestic
Roy Beagle	28	Not provided	Not provided	domestic
Nelson, Jason	80	24	25	domestic
Site #5 (Non-Weir)—Areas Searched: T20N R58E Sec: 2, 1; T21N R58E Sec: 28, 27; T21N R58E Sec: 33, 34, 35				
Nelson, Charles	Not provided	20	5	stock
Nelson, Charles	Not provided	25	5	domestic
Schmierer, Karl	Not provided	Not provided	5	stock
H Kincade	14	Not provided	Not provided	stock
Sig Jonasen	25	Not provided	Not provided	stock
Peterson, Vernon	77	9	30	stock
Albert., Hoffman	12	Not provided	Not provided	domestic
Erickson, Jerren	60	12	11	domestic
Erickson, Jerren	60	12	30	domestic
Price Kevin	38	7	20	domestic
Leo Kappel	16	Not provided	Not provided	stock
Arneson, Francis	Not provided	Not provided	Not provided	domestic
Arneson, Francis	Not provided	Not provided	Not provided	irrigation
Huber Ted	28	12	35	domestic
Jonald, Jorgensen	38	18	10	domestic
Unknown	20	Not provided	Not provided	stock
Whitlock., Hi	53	14	15	domestic

Lower Yellowstone Intake Diversion Dam Fish Passage Project, Montana
Environmental Impact Statement
May 2016

Well and Pumping Sites / owner names	Total Depth (feet)	Water Level (feet)	Yield (gpm)	Use
Whitlock, Hi	53	28	Not provided	domestic
Whitlock, Hi	20	16	Not provided	stock
Ted Huber	16	Not provided	Not provided	domestic
G A Nollmeyer	21	Not provided	Not provided	domestic
Fred Peterson	25	Not provided	Not provided	stock
Dardis Gary	31	14	20	stock
Miller, Jeff and Jackie	57	21	Not provided	domestic
Dardis Gary	30	14	15	stock
Rankin, Jc	55	12	33	domestic
Nollmeyer, Henry	990	220	35	domestic
Gn Ollmeyer	16	Not provided	Not provided	domestic
Site #6 (Non-Weir)—Areas Searched: T22N R59E Sec: 19, 30				
Garner, Robert and Patie	45	13	20	Public water supply
Simonson Merrien	9	3	Not provided	stock
Groskinsky A H & A	100	20	9	domestic
M Simonson	7	Not provided	Not provided	domestic
O'Brien Henry	24	11	3	stock
O'Brien Bertha H.	40	Not provided	6	domestic
O'Brien Bertha H.	215	200	35	stock
Navratil Jerry	63	12	10	domestic
Navratil Jerry #2	Not provided	Not provided	Not provided	Not provided
O'Brien	12	Not provided	Not provided	domestic
O'Brien Henry	185	Not provided	4	stock
Simard Sam	220	Not provided	Not provided	domestic
Simard Farms Inc.	1,180	148	Not provided	domestic
Steinbeisser Don	155	Not provided	Not provided	domestic
Unknown	12	Not provided	Not provided	domestic
Site #7 (Non-Weir)—Areas Searched: T24N R60E Sec: 29, 30; T24N R59E Sec: 25, 36; T23N R59E Sec: 1,2; T23N R60E Sec: 5, 6				
Asbeck Hugo	Not provided	Not provided	Not provided	Not provided
Garz Yscension & S	30	18	8	domestic
Garza Ascension	122	19	18	domestic
Garza Ascension	22	Not provided	Not provided	domestic
Dave Hoch	40	10	60	domestic
Weber Mike	37	20	20	domestic
Bieber James	35	7	11	domestic
Putnam Elsie W	Not provided	Not provided	4	domestic
Garza Properties	123	20	35	domestic
Danielson Glen	50	22	4	domestic
Danielson Glen	12	10	Not provided	stock
Candee Angus Ranch	70	44	18	domestic
Lapka Gary	32	20	4	domestic
Salsbury Jeff	42	35	3	domestic

Lower Yellowstone Intake Diversion Dam Fish Passage Project, Montana
Environmental Impact Statement
May 2016

Well and Pumping Sites / owner names	Total Depth (feet)	Water Level (feet)	Yield (gpm)	Use
Thrums Blake	36	23	20	domestic
Nankivel, Bill	60	20	11	domestic
Danielson Glen	100	35	30	domestic
Mindt RV Park	42	5	35	Public water supply
Mindt RV Park	42	5	22	Public water supply
Kindt Gary	38	11	38	domestic
Rodgers Robert	50	6	10	domestic
Asbeck Glen	177	26	26	domestic
Dahl, Harold	30	25	30	domestic
Dahl, Harold	60	20	30	domestic
Dahl, Harold	30	20	20	domestic
Dilday, Carl	75	14	3	domestic
Lake, Kevin	Not provided	Not provided	Not provided	domestic
Mex Labor House	Not provided	Not provided	Not provided	domestic
H.B.R.	118	20	48	domestic
Richland Partners LLC	175	29	15	domestic
Taylor, Rodney L.	140	27	13	domestic
Tony Pominville	8	Not provided	Not provided	stock
Wheeler, Iola M.	52	42	10	stock
Mindt, Beth And Larry	78	14	10	domestic
Schilling, Ed	85	17	15	domestic
Schilling, Ed	120	25	9	domestic
First Energy	122	30	25	domestic
Einer, Conradson	95	34	5	domestic
Bob Wheeler	96	Not provided	Not provided	domestic
H B R	110	25	14	stock
Marie Sorenson	15	Not provided	Not provided	domestic
Bucklin, Oliver	Not provided	Not provided	4	domestic
Severson, Chris	80	24	35	domestic
Severson, Chris E.	247	Not provided	10	domestic
Tjelde, Paul	55	10	34	domestic
Ruben Nelson	14	Not provided	Not provided	stock
Tjelde, Paul	55	12	15	domestic
Dahl, Harold	Not provided	Not provided	30	domestic
Tjelde, Paul	280	16	1	domestic
Sidney Land & Livestock	Not provided	Not provided	140	stock
U S Bureau Of Reclamation	190	Not provided	Not provided	domestic
Steinbeisser, John	85	70	7	domestic
Ruonavaara, Erichard	135	20	13	domestic
Usa	95	10	5	domestic
Iverson	14	Not provided	Not provided	stock
Jay Gibbs	12	Not provided	Not provided	domestic
The Boyz, LLC	115	11	12	domestic

Well and Pumping Sites / owner names	Total Depth (feet)	Water Level (feet)	Yield (gpm)	Use
Iversen, Enoch	12	7	500	domestic
A Breiting	10	Not provided	Not provided	stock
Braun, Colby	90	10	35	domestic
Erickson, Quin	80	13	20	domestic
Mex Labor House	17	Not provided	Not provided	domestic
Ridgelawn Sch	10	Not provided	Not provided	stock
Pipestone Mechanical Inc.	125	20	7	domestic
Turbiville, Larry	86	11	35	domestic
Elmer Ward	30	Not provided	Not provided	domestic
Bill Petersen	21	Not provided	Not provided	domestic
R N Erps	28	Not provided	Not provided	stock

Sources: Montana Groundwater Information Center. Accessed December 14 and 16, 2015, and March 15, 2016. Search engine available at: <http://mbmggwic.mtech.edu/>. Tetra Tech Memorandum to Tiffany Vanosdall, Corps Omaha District—Ranney Well Preliminary Design Review, January 15, 2016.

4.5.3.3 Bypass Channel Alternative

Construction activities associated with the excavation of the bypass channel, disposal of excavated materials, placement of riprap and armor materials, and other construction activities (weir, channel plug, grade control structures, vertical control structures, and access road construction) would create the potential for inadvertent releases of contaminants (fuel, oil, and other construction materials) to the soil and to shallow groundwater. Local and temporary effects on groundwater levels might also occur during construction of the bypass channel if groundwater is encountered during construction or if dewatering is necessary. The tapping of a new groundwater supply is not anticipated to be necessary during construction of the alternative. Dewatering would be associated with any flow control measures necessary during construction of the bypass channel, or along the Yellowstone River for construction of other components.

Ground disturbance might cause changes in groundwater infiltration rates, either by loosening soil and increasing ground infiltration or by compacting soil and decreasing ground infiltration. With implementation of proposed actions to minimize effects, no effects on groundwater are anticipated from changes in infiltration.

The Intake FAS water well is located near the southwest corner of the parking area. No other public water supply wells are located in the vicinity of the Bypass Channel Alternative. No groundwater source water protection areas are relevant to potential alternative effects during construction. This alternative would not have effects on the Intake FAS water well.

As documented in Table 4-19 (see Site #1 in the table), a private well and spring were identified in the general area of the Intake Diversion Dam. Measures to protect private groundwater supplies include identification of water wells and springs within 150 feet of construction areas and subsequent measures to avoid direct or indirect effects on these supplies. No effects on private or public water supplies are associated with construction of this alternative.

Short-term and temporary potential contaminant releases from construction vehicles and equipment and short-term and temporary effects on groundwater levels would be localized to construction areas near the Intake Diversion Dam, nearby along the Yellowstone River, and on Joe's Island. However, with the implementation of actions to minimize effects, potential contaminant releases would be contained and groundwater contamination would be prevented. Potential effects on groundwater levels would be too small to contribute to any noticeable changes in local or regional groundwater. Any slight changes to groundwater levels would return to current conditions once construction activities are completed, with no long-term effects on groundwater resources.

4.5.3.4 Modified Side Channel Alternative

Construction activities associated with the excavation of the existing side channel, disposal of excavated materials, and placement of fill and riprap materials would create the potential for inadvertent releases of contaminants (fuel, oil, and other construction materials) to the soil and to shallow groundwater. Local and temporary effects on groundwater levels might occur during construction of the existing side channel if groundwater is encountered during construction or if dewatering is necessary. The tapping of a new groundwater supply is not anticipated to be necessary. Dewatering would be associated with any flow control measures necessary during construction of the existing side channel or construction of other components along the Yellowstone River.

Ground disturbance might cause changes in groundwater infiltration rates, either by loosening soil and increasing ground infiltration or by compacting soil and decreasing ground infiltration. With implementation of proposed actions to minimize effects, no effects on groundwater are anticipated from changes in infiltration.

The Intake FAS water well is located near the southwest corner of the parking area. No other public water supply wells are located in the vicinity of the Modified Side Channel Alternative; and no groundwater source water protection areas are relevant to potential alternative effects during construction. The alternative would not have effects on the water well.

As documented in Table 4-19 (see Site #1 in the table), a private well and spring were identified in the general area of the Intake Diversion Dam, but the locations appear to be at least 500 feet from the dam. Measures to protect private groundwater supplies include identification of water wells and springs within 150 feet of construction areas and subsequent measures to avoid direct or indirect effects on these supplies. No effects on private or public water supplies are associated with construction of the Modified Side Channel Alternative.

Short-term and temporary potential contaminant releases from construction vehicles and equipment and short-term and temporary effects on groundwater levels would be localized to construction areas near the Intake Diversion Dam, nearby along the Yellowstone River, and on Joe's Island. However, with the implementation of actions to minimize effects, potential contaminant releases would be contained and groundwater contamination would be prevented. Potential effects on groundwater levels would be too small to contribute to any noticeable changes in local or regional groundwater. Any slight and negligible changes to groundwater levels would return to current conditions once construction activities are completed, with no long-term effects on groundwater resources.

4.5.3.5 Multiple Pump Alternative

Construction activities associated with the removal of the Intake Diversion Dam, disposal of excavated materials, construction of five pumping stations (including discharge pipelines to connect with the irrigation canal), and construction of new power infrastructure (transmission lines, substation modifications, and three new substations) would create the potential for inadvertent releases of contaminants (fuel, oil, and other construction materials) to the soil and to shallow groundwater. Local and temporary effects on groundwater levels might occur during removal of the Intake Diversion Dam if groundwater is encountered during construction or if dewatering is necessary. The tapping of a new groundwater supply is not anticipated to be necessary. Dewatering activities would be associated with any flow control measures necessary during removal of the Intake Diversion Dam or construction of other components along the Yellowstone River.

Ground disturbance might cause changes in groundwater infiltration rates, either by loosening soil and increasing ground infiltration or by compacting soil and decreasing ground infiltration. With implementation of proposed actions to minimize effects, no effects on groundwater are anticipated from changes in infiltration.

The Intake FAS is served by a public water supply well located near the southwest corner of the parking area. The entire Intake FAS would be relocated during construction of this alternative. During the relocation, the water well would be properly plugged and abandoned. This would constitute a minor effect. However, it is assumed that the water supply would be replaced at a proposed new recreational facility.

Groundwater source water protection areas are a potential concern in populated and developed areas along the Yellowstone River Valley. The Multiple Pump Alternative is not located in a potential area of source water protection concern because the existing well at the fishing access site is rated low for susceptibility to contamination (MTDEQ 2016) and no other public groundwater supplies are located in the immediate vicinity of the alternative.

As documented in Table 4-19 (see Site #1 in the table), a private well and spring were identified in the general area of the Intake Diversion Dam and Pumping Station Site #1. Eleven private wells were identified in the vicinity of Pumping Station Site #2, 10 in the vicinity of Pumping Station Site #3, and 77 in the vicinity of Pumping Station Sites #4 and #5. Based on a review of aerial imagery, no residences or farmsteads are located within 500 feet of the pumping station sites.

The water wells in the vicinity of Pumping Station Sites #4 and #5 are likely primarily associated with the small community of Savage. Therefore, direct impacts on these wells during construction of the alternative are not indicated at this time. Measures to protect private groundwater supplies include identification of water wells and springs within 150 feet of construction areas and subsequent measures to avoid direct or indirect effects on these supplies.

Short-term and temporary potential contaminant releases from construction vehicles and equipment and short-term and temporary effects on groundwater levels would be localized to construction areas near the Intake Diversion Dam, nearby along the Yellowstone River, in the

vicinity of the five pumping stations in Dawson and Richland counties along the Yellowstone River, and in the vicinity of new power infrastructure. With the implementation of actions to minimize effects, potential contaminant releases would be contained and groundwater contamination would be prevented. Potential effects on groundwater levels would be too small to contribute to any noticeable changes in local or regional groundwater. Any slight and negligible changes to groundwater levels would return to current conditions once construction activities are completed, with no long-term effects on groundwater resources.

4.5.3.6 Multiple Pumps with Conservation Measures Alternative

Construction activities associated with the removal of the dam, disposal of excavated materials, installation of water conservation measures on the LYP, and construction of the seven (70-acre) pumping stations/Ranney well sites would create the potential for inadvertent releases of contaminants (fuel, oil, and other construction materials) to the soil and to shallow groundwater. Local and temporary effects on groundwater levels might occur during removal of the Intake Diversion Dam if groundwater is encountered during construction or if dewatering is necessary. The tapping of a new groundwater supply is not anticipated to be necessary. Dewatering activities would be associated with any flow control measures necessary during removal of the Intake Diversion Dam or construction of other components along the Yellowstone River.

Ground disturbance might cause changes in groundwater infiltration rates, either by loosening soil and increasing ground infiltration or by compacting soil and decreasing ground infiltration. With implementation of proposed actions to minimize effects, no effects on groundwater are anticipated from changes in infiltration.

The Intake FAS is served by a public water supply well near the southwest corner of the parking area. The entire Intake FAS would be relocated during construction of the alternative. During the relocation, the water well would be properly plugged and abandoned. This would constitute a minor effect. However, it is assumed that the water supply would be replaced at a proposed new recreational facility.

As documented in Table 4-19 (see Site #1 in the table), a private well and spring were identified in the general area of the Intake Diversion Dam and Well Site #1. Eleven private wells were identified in the vicinity of Well Site #2, 10 in the vicinity of Well Site #3, 77 in the vicinity of Well Site #4, 28 in the vicinity of Well Site #5, 14 in the vicinity of Well Site #6, and 64 in the vicinity of Well Site #7. The water wells in the vicinity of Well Site #4 are likely primarily associated with the small community of Savage. The water wells in the vicinity of Well Site #7 are likely associated with more dense development between the communities of Fairview and Sidney. Based on a review of aerial imagery, no residences or farmsteads are within 500 feet of the well sites. Therefore, direct impacts on these wells during construction of the alternative are not indicated at this time. Measures to protect private groundwater supplies include identification of water wells and springs within 150 feet of construction areas and subsequent measures to avoid direct or indirect effects on these supplies.

Groundwater source water protection areas are a potential concern in populated and developed areas along the Yellowstone River Valley. The Multiple Pumps with Conservation Measures Alternative is not located in a potential area of source water protection concern because the existing well at the fishing access site is rated low for susceptibility to contamination (MTDEQ

2016) and no other public groundwater supplies are in the immediate vicinity of the alternative. However, Well Site #7 is located in a region of oil and gas development.

Short-term and temporary potential contaminant releases from construction vehicles and equipment and short-term and temporary effects on groundwater levels would be localized to construction areas near the Intake Diversion Dam, nearby along the Yellowstone River, in the vicinity of the seven well sites in Dawson and Richland counties, and in the vicinity of any required new power infrastructure. With the implementation of actions to minimize effects, potential contaminant releases would be contained and groundwater contamination would be prevented. Potential effects on groundwater levels would be too small to contribute to any noticeable changes in local or regional groundwater. Any slight and negligible changes to groundwater levels would return to current conditions once construction activities are completed, with no long-term effects on groundwater resources.

4.5.4 Operational Effects

4.5.4.1 No Action Alternative

Operations and maintenance activities associated with the No Action Alternative include maintenance of the headworks screens and gates, maintenance of rock on the dam, and maintenance and inspection of the canal, as well as maintenance of associated access roads. Vehicles and equipment would include trucks and other maintenance vehicles required for regular maintenance of the dam and canal structures, including hauling, as well as normal maintenance of access roads. Other equipment includes the operation of the skid and trolley cableway.

Although regular operation and maintenance for the No Action Alternative would present the potential for inadvertent releases of contaminants (fuel, oil, and other construction materials) to the soil and to shallow groundwater, these incidents are expected to be very infrequent and minimal. The alternative would not have an effect on public or private groundwater supplies. Groundwater would continue to be influenced by leakage from the irrigation system and return flows and generally maintain existing normal levels and seasonal fluctuations. No long-term impacts to local or regional groundwater resources are indicated during operation and maintenance of the No Action Alternative.

4.5.4.2 Rock Ramp Alternative

Operation and maintenance for the Rock Ramp Alternative includes activities that would be performed for the No Action Alternative. In addition, some amount of rock on the ramp would likely move over time and require maintenance. Although regular operation and maintenance for the Rock Ramp Alternative would present the potential for inadvertent releases of contaminants (fuel, oil, and other construction materials) to the soil and to shallow groundwater, these incidents are expected to be very infrequent and minimal. Actions to minimize effects would be implemented to prevent and address potential releases that might impact groundwater quality.

The entire Intake FAS would be relocated for operation of this alternative. The existing water well would be removed and this would constitute a permanent minor effect. It is assumed that the water supply would be replaced at a proposed new recreational facility.

As documented in Table 4-19 (see Site #1 in the table), a private well and spring were identified in the general area of the Intake Diversion Dam. Measures to protect private groundwater supplies include identification of water wells and springs within 150 feet of construction areas and subsequent measures to avoid direct or indirect effects on these supplies.

Groundwater source water protection areas are a potential concern in populated and developed areas along the Yellowstone River Valley. The Rock Ramp Alternative is not located in a potential area of source water protection concern because the existing well at the fishing access site is rated low for susceptibility to contamination (MTDEQ 2016) and no other public groundwater supplies are located in the vicinity of the alternative.

The alternative would not have an effect on public or private groundwater supplies. Although there might be slight and negligible effects on local groundwater levels that are in connection with the river alluvial aquifer due to the permanent change in configuration of surficial flow hydraulics in the vicinity of the rock ramp and replacement weir, such changes are expected to be minimal. Groundwater would continue to be influenced by leakage from the irrigation system and return flows and generally existing normal levels and seasonal fluctuations are expected to be maintained. No long-term effects on local or regional groundwater resources are indicated during operation and maintenance of the Rock Ramp Alternative.

4.5.4.3 Bypass Channel Alternative

Operation and maintenance for the Bypass Channel Alternative includes activities that would be performed for the No Action Alternative. Additional operation and maintenance requirements include maintenance of new access roads, maintenance of rock upstream and downstream of the replacement weir, periodic replacement of riprap along the banks and bottom of the bypass channel, removal of sediment or debris from the bypass channel, maintenance of fill near the downstream end of the bypass channel, and maintenance of the channel plug.

Regular operation and maintenance for the Bypass Channel Alternative would present the potential for inadvertent releases of contaminants (fuel, oil, and other construction materials) to the soil and to shallow groundwater. These incidents would have a greater likelihood than with the No Action and Rock Ramp alternatives, but they are still expected to be very infrequent and minimal. Actions to minimize effects would be implemented to prevent and address potential releases that might impact groundwater quality.

Perennial flow through the bypass channel is likely to result in some exchange with the groundwater table on Joe's Island, potentially resulting in a slightly higher groundwater table than currently exists.

The Intake FAS is served by a public water supply well near the southwest corner of the site's parking area. No other public water supply wells are located in the vicinity of the Bypass Channel Alternative; and no water wells are located on Joe's Island. As documented in Table 4-19 (see Site #1 in the table), a private well and spring were identified in the general area of the Intake Diversion Dam. Measures to protect private groundwater supplies include identification of water wells and springs within 150 feet of construction areas and subsequent measures to avoid direct or indirect effects on these supplies. No effects on private or public water supplies are associated with construction of the Bypass Channel Alternative. Any slight

effects on groundwater levels and hydrology from the Main Canal, new weir are expected to be negligible and would not affect the fishing access site water well or other nearby private wells and springs.

The Bypass Channel Alternative is not located in a potential area of source water protection concern because the existing well at the fishing access site is rated low for susceptibility to contamination (MTDEQ 2016) and no other public groundwater supplies are located in the vicinity of the alternative.

Although there might be negligible to minor effects on local groundwater levels in the vicinity of Joe's Island that are in connection with the river alluvial aquifer due to the change in configuration of surficial flow hydraulics and increased flows associated with the bypass channel, such changes are expected to be minimal. Groundwater would continue to be influenced by leakage from the irrigation system and return flows and generally existing normal levels and seasonal fluctuations are expected to be maintained. No long-term effects on local or regional groundwater resources are indicated during operation and maintenance of the Bypass Channel Alternative.

4.5.4.4 Modified Side Channel Alternative

Operation and maintenance for the Modified Side Channel Alternative includes activities that would be performed for the No Action Alternative. Additional requirements include periodic inspection, possible replacement of riprap along the existing side channel, removal of sediment or debris from the channel's confluence areas with the Yellowstone River, and regular maintenance of access roads and the bridge.

Regular operation and maintenance for the Modified Side Channel Alternative would present the potential for inadvertent releases of contaminants (fuel, oil, and other construction materials) to the soil and to shallow groundwater. These incidents would have a greater likelihood than with the No Action and Rock Ramp alternatives, but they are still expected to be very infrequent and minimal. Actions to minimize effects would be implemented to prevent and address potential releases that might impact groundwater quality.

Perennial flow through the modified side channel is likely to result in an increased level of exchange with the groundwater table on Joe's Island, potentially resulting in a slightly higher groundwater table than currently exists.

The Intake FAS is served by a public water supply well near the southwest corner of the site's parking area. No other public water supply wells are located in the vicinity of the Modified Side Channel Alternative; and no water wells are located on Joe's Island. As documented in Table 4-19 (see Site #1 in the table), a private well and spring were identified in the general area of the Intake Diversion Dam. Measures to protect private groundwater supplies include identification of water wells and springs within 150 feet of construction areas and subsequent measures to avoid direct or indirect effects on these supplies. No effects on private or public water supplies are associated with construction of the Modified Side Channel Alternative. Any slight effects on groundwater levels and hydrology from the existing side channel are expected to be negligible and would not affect the fishing access site water well or other nearby private wells and springs.

The Modified Side Channel Alternative is not located in a potential area of source water protection concern because the existing well at the fishing access site is rated low for susceptibility to contamination (MTDEQ 2016) and no other public groundwater supplies are located in the immediate vicinity of the alternative.

Although there might be negligible to minor effects on local groundwater levels in the vicinity of Joe's Island that are in connection with the river alluvial aquifer due to the change in configuration of surficial flow hydraulics and increased flow associated with the existing side channel, such changes are expected to be minimal. Groundwater would continue to be influenced by leakage from the irrigation system and return flows and generally existing normal levels and seasonal fluctuations are expected to be maintained. No long-term effects on local or regional groundwater resources are indicated during operation and maintenance of the Modified Side Channel Alternative.

4.5.4.5 Multiple Pump Alternative

Operation and maintenance activities for the Multiple Pump Alternative include operation and maintenance of the five pumping stations, annual sediment removal in the feeder canals, bank stabilization in the area of the pumping stations, and cleaning of trashracks on a daily basis. A conservative estimate of the annual deposition in each feeder canal is 2,800 cubic yards. It is estimated that 1,000 feet of bank stabilization would be necessary for each pumping station. The pumping stations would be used 126 days annually, drawing 6,000 kW of power and resulting in an average annual energy consumption of 10 gigawatt-hours. Pump adjustment would be required when switching from gravity to diversion pumping.

Regular operation and maintenance for the Multiple Pump Alternative would present the potential for inadvertent releases of contaminants (fuel, oil, and other construction materials) to the soil and to shallow groundwater. These incidents would have a greater likelihood than with the No Action and Rock Ramp alternatives, but they are still expected to be very infrequent and minimal. Actions to minimize effects would be implemented to prevent and address potential releases that might impact groundwater quality.

The Intake FAS is served by a public water supply well near the southwest corner of the site's parking area. It is possible that the entire Intake FAS would be relocated for operation of the alternative. If relocation is necessary, the water well would be properly plugged and abandoned. If the water well were removed, this would constitute a long-term minor effect. However, it is assumed that the water supply would be replaced at a new recreational facility.

As documented in Table 4-19 (see Site #1 in the table), a private well and spring were identified in the general area of the Intake Diversion Dam and pumping station Site #1. Eleven private wells were identified in the vicinity of Site #2, 10 in the vicinity of Site #3, and 77 in the vicinity of Sites #4 and #5. Based on a review of aerial imagery, no residences or farmsteads are located within 500 feet of the pumping stations. The water wells in the vicinity of Sites #4 and #5 are likely primarily associated with the small community of Savage. Measures to protect private groundwater supplies include identification of water wells and springs within 150 feet of construction areas and subsequent measures to avoid direct or indirect effects on these supplies.

The Multiple Pump Alternative (Site #1) is not located in a potential area of source water protection concern because the existing well at the fishing access site is rated low for susceptibility to contamination (MTDEQ 2016) and no other public groundwater supplies are located in the immediate vicinity of the alternative. Water supplies for the community of Savage (near Pumping Station Sites #4 and #5) are sourced by numerous private wells.

The shallow hydrologic unit groundwater wells in this area follow climatic trends more than short-term precipitation events, indicating that the shallow unconsolidated materials are of relatively low permeability, which slows percolation from the surface. Therefore, localized and limited withdrawals from the Yellowstone River are not expected to have any significant effect on groundwater levels.

Although there might be slight and negligible effects on local groundwater levels that are in connection with the river alluvial aquifer due to the removal of the Intake Diversion Dam, the pumping at the five stations, and the interconnection of surface water to groundwater surrounding the new feeder canals, such changes are expected to be minimal. Groundwater would continue to be influenced by leakage from the irrigation system and return flows and generally existing normal levels and seasonal fluctuations are expected to be maintained.

Some minor localized groundwater level decrease might be expected due to the removal of the Intake Diversion Dam and modifications to the feeder canal infrastructure. Although no long-term impacts on local or regional groundwater resources are currently indicated during operation and maintenance of the Multiple Pump Alternative, additional hydrogeological characterization would be performed for each pumping station to ensure that the alternative would not deplete the alluvial aquifer or adversely affect nearby public or private wells.

4.5.4.6 Multiple Pumps with Conservation Measures Alternative

Operation and maintenance for the Multiple Pumps with Conservation Measures Alternative include operation and maintenance of the seven well pumping stations (6 Ranney wells each) that include infrastructure for connection to the irrigation canal and for power supplies, and implementation of water conservation measures to reduce efficiencies. The well pumping stations would use renewable wind energy. The screened headworks at the Intake Diversion Dam would continue to allow gravity diversion from the Yellowstone River when flows are high enough to supply the head necessary for the system. At times of lower river flows, the system would use the well pump systems to supplement the flow. Preliminary estimates (Tetra Tech 2016b) indicate that the wells would require the capacity to supply 10,000 gpm of water to the irrigation canal.

Regular operation and maintenance for the Multiple Pumps with Conservation Measures Alternative would present the potential for inadvertent releases of contaminants (fuel, oil, and other construction materials) to the soil and to shallow groundwater. These incidents would have a greater likelihood than with the No Action and Rock Ramp alternatives, but they are still expected to be very infrequent and minimal. Actions to minimize effects would be implemented to prevent and address potential releases that might impact groundwater quality.

The Intake FAS is served by a public water supply well near the southwest corner of the site's parking area. The entire Intake FAS would be relocated for operation of this alternative. The

water well would be properly plugged and abandoned, which would constitute a long-term minor effect. However, it is assumed that the water supply would be replaced at a new recreational facility.

For the evaluation of potential effects to water wells, 500 feet from the well station sites was generally used. However, additional engineering studies would be performed prior to final design of the alternative as discussed in the Actions to Minimize Effects section to ensure that groundwater withdrawals would not significantly draw down nearby public or private supply wells. Such studies would determine the distances of groundwater drawdown effects and if they would extend to or beyond 500 feet. If effects were determined to extend beyond 500 feet, additional well identification would be performed to ensure study and protection of these resources.

As documented in Table 4-19 (see Site #1 in the table), a private well and spring were identified in the general area of the Intake Diversion Dam and well station Site #1. Eleven private wells were identified in the vicinity of Site #2, 10 in the vicinity of Site #3, 77 in the vicinity of Site #4, 28 in the vicinity of Site #5, 14 in the vicinity of Site #6, and 64 in the vicinity of Site #7. The water wells in the vicinity of Site #4 are likely primarily associated with the small community of Savage. The water wells in the vicinity of Site #7 are likely associated with more dense development between the communities of Fairview and Sidney.

Based on a review of aerial imagery, no residences or farmsteads are located within 500 feet of the well station sites. Measures to protect private groundwater supplies include identification of water wells and springs within 150 feet of construction areas and subsequent measures to avoid direct or indirect effects on these supplies. In addition, further evaluation of this alternative would be performed in relation to effects on the alluvial aquifer and nearby private and public wells if the alternative were selected. The additional hydrogeological characterization would be required to determine the extent of any such effects, which could be major.

The Multiple Pumps with Conservation Measures Alternative (Site #1) is not located in a potential area of source water protection concern because the existing well at the fishing access site is rated low for susceptibility to contamination (MTDEQ 2016). No other public groundwater supplies are located in the immediate vicinity of the alternative. Water supplies for the community of Savage (near well Site #4) are sourced by numerous private wells. Well Site #7 is located approximately 7 miles north-northeast of Sidney and approximately 3 miles south-southwest of Fairview. The area within 3 miles of the well site appears to include a relatively more developed area to the south-southwest that has a railroad spur, farmsteads, and potential residential development. The railroad spur area, oil and gas production, and other unknown features shown on aerial photos, as well as the nearby communities of Sidney and Fairview, present a greater potential for groundwater contaminant releases into the shallow aquifer. Such potential releases could cause effects on the wells at Site #7 and to the irrigation canal supply.

Additional engineering studies would be performed prior to final design of the alternative to ensure that groundwater withdrawals would not significantly draw down nearby public or private supply wells. The additional hydrogeological characterization would be required to determine the extent of any such effects, which could be major. Potential effects from the 7 pumping stations

would include a long-term decrease in local groundwater levels and long-term aquifer depletion that might extend to the regional aquifer system. Such effects could potentially be major.

Because this alternative taps the alluvial aquifer, it has the greatest potential to have an effect on groundwater levels. Some minor localized groundwater level decrease might be expected due to the removal of the Intake Diversion Dam and modifications to the feeder canal infrastructure.

Seepage (or leakage) from the existing canal is likely to provide some portion of localized (and potentially regional) recharge to the shallow aquifer. This seepage is also likely to have created or augmented wetlands all along the length of the irrigation system. Therefore, removal or reduction of this seepage recharge through the installation of a canal liner or from reduced canal flows could have potential major effects to nearby wells and shallow groundwater levels and may dry up wetlands. Further hydrogeological characterization would be necessary to define the influence of canal seepage on existing groundwater levels and to determine how the removal of seepage recharge would impact wetlands, groundwater levels and nearby wells.

4.5.5 Cumulative Effects

4.5.5.1 Geographic and Temporal Extent of Analysis

The geographic extent of cumulative effects on groundwater resources includes the area of the Yellowstone River Valley from Glendive, Montana to Buford, North Dakota. The Intake Diversion Dam was built in 1905 and reasonably foreseeable future projects including climate change concerns extend to an unknown time in the future.

4.5.5.2 Methodology for Determining Effects

Past and potential future actions that might affect groundwater resources are evaluated for the Project alternatives, based on the alternatives' potential to contribute to cumulative effects on groundwater in the geographic extent of the analysis.

4.5.5.3 Past, Present, and Reasonably Foreseeable Future Projects Considered

The following past, present and reasonably foreseeable future actions described in Section 4.1.4 have the potential to affect groundwater resources in the geographic area:

- *Pivot Irrigation and Bank Armoring*—The continued trend for expanded use of pivot irrigation for agricultural lands could affect the availability of area groundwater resources and supplies.
- *The Bakken Oil Fields and Fracking*—The recent oil boom in the Bakken Oil Fields has led to major development in Sidney and Glendive. The presence of oil and gas production has the potential to affect groundwater quality. Any use of groundwater for these operations might affect area groundwater supplies.
- *Climate Change*—Model simulations predict earlier runoff and reduced summer river flows. Reduced summer river flows would affect groundwater levels in the alluvial aquifer zone and could contribute to overall lower water levels in the aquifer.
- *Spills at Oil/Gas/Brine Water Pipeline Crossings*—Recent oil spills from pipe ruptures indicate the potential for such releases continuing into the future. Such spills have the potential to affect area groundwater quality.

- *Urbanization*—The City of Glendive has grown from 39 acres of urban development in the 100-year floodplain to 414 acres through 2011. Continued growth would create increasing water supply demands and has the potential to affect groundwater supplies in the Yellowstone River Valley.

4.5.5.4 No Action Alternative

The No Action Alternative would have no effects on groundwater resources, so no cumulative effects are anticipated.

4.5.5.5 Rock Ramp Alternative

The potential removal of the fishing access site water well and replacement of the water supply in some other location would have a negligible cumulative effect on overall water supplies in the area because the well only supplies water to 25 persons. The localized negligible effects on groundwater levels during construction and operation of the Rock Ramp Alternative would not contribute to cumulative effects from the noted increased use of groundwater for irrigation, urbanization and associated increased water supply needs, or reduced river flows during the summer associated with climate change.

4.5.5.6 Bypass Channel Alternative

The localized negligible effects on groundwater levels in the vicinity of Joe's Island and the Intake Diversion Dam during construction and operation of the Bypass Channel Alternative would not contribute to cumulative effects from the noted increased use of groundwater for irrigation, urbanization and associated increased water supply needs, or reduced river flows during the summer associated with climate change.

4.5.5.7 Modified Side Channel Alternative

The localized negligible effects on groundwater levels in the vicinity of Joe's Island and the Intake Diversion Dam during construction and operation of the Modified Side Channel Alternative would not contribute to cumulative effects from the noted increased use of groundwater for irrigation, urbanization and associated increased water supply needs, or reduced river flows during the summer associated with climate change.

4.5.5.8 Multiple Pump Alternative

The potential removal of the fishing access site water well and replacement of the water supply in some other location would have a negligible cumulative effect on overall water supplies in the area because the well only supplies water to 25 persons. The localized negligible effects on groundwater levels in the vicinity of the pumping stations and the localized minor effects on groundwater levels in the vicinity of the removed Intake Diversion Dam and modified feeder canal during construction and operation of the Multiple Pump Alternative would not contribute to cumulative effects on groundwater resources. The relevant potential cumulative past and foreseeable actions include the increased trend in the use of groundwater for irrigation, urbanization and associated increased water supply needs, and the documented reduced river flows during the summer associated with climate change. The alternative would not have any effects on groundwater quality, and therefore, cumulative actions that might contribute to groundwater quality are not relevant.

4.5.5.9 Multiple Pumps with Conservation Measures Alternative

The potential removal of the fishing access site water well and replacement of the water supply in some other location would have a negligible cumulative effect on overall water supplies in the area because the well only supplies water to 25 persons. The localized groundwater levels in the vicinity of the seven well sites could be major; and additional hydrogeological characterization is necessary to determine the extent of such effects. If there are moderate or major effects on the alluvial and/or regional aquifer, such effects might contribute to cumulative effects on groundwater resources.

The localized minor or negligible effects on groundwater levels in the vicinity of the removed Intake Diversion Dam and modified feeder canal during construction and operation of the Multiple Pumps with Conservation Measures Alternative would not contribute to cumulative effects on groundwater resources. The relevant potential cumulative past and foreseeable actions include the increased trend in the use of groundwater for irrigation, urbanization and associated increased water supply needs, and the documented reduced river flows during the summer associated with climate change.

The alternative would not have any effects on groundwater quality, so cumulative actions that might contribute to groundwater quality are not relevant. Well Site #7 is in the vicinity of increased oil and gas production, and groundwater quality in this area might lead to subsequent cumulative effects associated with the alternative. Use of groundwater for fracking might also affect area groundwater hydrology and groundwater levels.

4.5.6 Actions to Minimize Effects

4.5.6.1 All Alternatives

Minimize the Potential for Release or Mismanagement of Hazardous Materials

The following practices would be implemented to minimize the potential for release or mismanagement of hazardous materials that could result in groundwater contamination:

- Contamination of water at construction sites from spills of fuel, lubricants, and chemicals will be minimized by following safe storage and handling procedures in accordance with state laws and regulations.
- Personnel training on health, safety, and environmental matters will include practices, techniques, and protocols required by federal and state regulations and applicable permits.
- Any herbicides used during construction and operation and maintenance will be applied according to label instructions and any federal, state, and local regulations.
- Emergency and spill response equipment will be kept on hand during construction and operation.
- Refueling and maintenance of vehicles and the storage of fuels and hazardous chemicals will be restricted within at least 100 feet of wetlands, surface water bodies, and groundwater wells, or as otherwise required by federal, state, or local regulations.
- Sanitary toilets convenient to construction will be provided. These will be located more than 100 feet from any stream, tributary or wetland. They will be regularly serviced and maintained. Waste disposal will be properly manifested. Employees will be notified of sanitation regulations and will be required to use sanitary facilities.

Minimize Changes to Stormwater Runoff and Infiltration Rates

The following practices would be implemented to minimize changes to stormwater runoff and infiltration rates that could change quantities and locations of groundwater recharge:

- Measures will be employed to reduce wind and water erosion. Erosion and sediment controls will be monitored daily during construction for effectiveness, particularly after storm events. The most effective techniques will be identified and employed.
- Contractor will be required to have an approved construction stormwater management plan to control runoff.
- All areas along the bank disturbed by construction will be seeded with native vegetation to minimize erosion.
- Silt barriers, fabric mats, or other effective means will be placed on slopes or other eroding areas where necessary to reduce sediment runoff into stream channels and wetlands until vegetation is re-established. This will be accomplished before or as soon as practical after disturbance activities.
- Clearing of vegetation within construction areas will be minimized.
- Vehicular travel will be restricted to construction areas and other established areas within the construction, access, or maintenance easements.
- Roads not otherwise needed for maintenance and operations will be restored to preconstruction conditions. Restoration practices may include decompacting, recontouring, and re-seeding.
- Avoid or minimize damage to drainage features and other improvements such as ditches, culverts, levees, tiles, and terrace. If these features or improvements are inadvertently damaged, they will be repaired or replaced.
- Minimize compaction of soils and rutting through appropriate use of construction equipment (e.g., low ground pressure equipment and temporary equipment mats).
- Minimize the amount of time that any excavations remain open.

Minimize Changes to Existing Groundwater Availability

The following practices would be implemented to minimize changes to existing groundwater availability, including avoiding damage to water wells and utilities:

- River morphology will be monitored to assess potential changes to the stream channel resulting from construction of the selected alternative.
- Access roads will be constructed to minimize disruption of natural drainage patterns, including perennial, intermittent, and ephemeral streams.
- Groundwater wells and springs within 150 feet of construction areas will be located and impacts on them will be minimized.
- If any groundwater wells are needed to support operational facilities, withdrawal volumes will be limited so as not to adversely affect supplies for other uses.
- Water will be procured from municipal water systems where such water supplies are within a reasonable haul distance; any other water required will be obtained through permitted sources or through supply agreements with landowners.

4.5.6.2 Rock Ramp Alternative

Specific commitments to protect groundwater resources for the Rock Ramp Alternative include the following:

- Water quality monitoring of the Intake FAS well will be performed during construction if it is not removed.

4.5.6.3 Main Canal Bypass Channel Alternative

Specific commitments to protect groundwater resources have not been identified for the Bypass Channel Alternative.

4.5.6.4 Modified Side Channel Alternative

Specific commitments to protect groundwater resources have not been identified for the Modified Side Channel Alternative.

4.5.6.5 Multiple Pump Alternative

Specific commitments to protect groundwater resources for the Multiple Pump Alternative include the following:

- Water quality monitoring of the Intake FAS well will be performed during construction if it is not removed.
- Further engineering design evaluation of the Multiple Pump Alternative will be conducted in relation to potential surface water pumping and effects on the alluvial aquifer.
- An engineering design study will be performed prior to final design to evaluate the effects of the alternative in terms of drawdown zones and distances, alluvial aquifer interconnection with the river, and potential effects on nearby public or private water supply wells.

4.5.6.6 Multiple Pumps with Conservation Measures Alternative

Specific commitments to protect groundwater resources for the Multiple Pump Alternative include the following:

- Water quality monitoring of the Intake FAS well will be performed during construction if it is not removed.
- An engineering design study will be performed prior to final design to evaluate the effects of the alternative in terms of drawdown zones and distances and potential effects on nearby public or private water supply wells.

4.6 Geomorphology

This section describes the potential effects that the Intake Diversion Dam fish passage alternatives could have on the Yellowstone River geomorphology, including channel migration, and the potential effects that natural geomorphic processes could have on the fish passage alternatives.

4.6.1 Area of Potential Effect

The area of potential effect for geomorphic characteristics of the Yellowstone River comprises the Yellowstone River and its floodplain beginning approximately 2 miles upstream of the Intake Diversion Dam and extending to the confluence with the Missouri River, approximately 73 river miles.

4.6.2 Summary of Potential Effects

Table 4-20 summarizes the potential effects on river geomorphology for each alternative. Details are provided in the following sections.

TABLE 4-20. SUMMARY OF POTENTIAL EFFECTS ON RIVER GEOMORPHOLOGY FROM EACH ALTERNATIVE

Impact Type	Level of Impact	Impact Description
No Action Alternative		
Construction Effects	No Effect	<ul style="list-style-type: none"> N/A
Operational Effects	Minor	<ul style="list-style-type: none"> Ongoing placement of rock increases rock in the river and changes substrate conditions
Rock Ramp Alternative		
Construction Effects	Minor	<ul style="list-style-type: none"> Scour from coffer dams/flow diversion of main channel Risk of flooding/scour to existing side channel Risk of scour of staging/stockpiling areas
Operational Effects	Moderate	<ul style="list-style-type: none"> Large permanent volume of rock in river and changed river slope for ramp Periodic placement of rock or reworking of ramp
Bypass Channel Alternative		
Construction Effects	Minor	<ul style="list-style-type: none"> Scour from coffer dams/flow diversion of main channel Work zone within channel migration zone
	Moderate	<ul style="list-style-type: none"> Blockage of side channel with reduced channel migration
Operational Effects	Minor	<ul style="list-style-type: none"> Reduced flows/sediment transport in main channel Shorter bypass channel compared to existing side channel Removal of sediment from bypass channel Maintenance of riprap to prevent channel migration
	Moderate	<ul style="list-style-type: none"> Loss of side channel migration
Modified Side Channel Alternative		
Construction Effects	Moderate	<ul style="list-style-type: none"> Blockage of side channel
Operational Effects	Minor	<ul style="list-style-type: none"> Reduced flows/sediment transport in main channel Increased flows/sediment transport in side channel Removal of sediment from modified side channel
	Moderate	<ul style="list-style-type: none"> Reduced side channel migration
Multiple Pump Alternative		
Construction Effects	Negligible	<ul style="list-style-type: none"> Scour from coffer dams/flow diversion of main channel Placement of riprap at canal ends/pipes
Operational Effects	Major (beneficial)	<ul style="list-style-type: none"> Return of river hydraulics/sediment transport to natural conditions (beneficial)
	Minor	<ul style="list-style-type: none"> Potential for decreased velocity in the Main Canal with increased sediment deposition Limited change to channel migration
Multiple Pumps with Conservation Measures Alternative		
Construction Effects	Negligible	<ul style="list-style-type: none"> Scour from coffer dams/flow diversion of main channel
Operational Effects	Major (beneficial)	<ul style="list-style-type: none"> Return of river hydraulics/sediment transport to natural conditions (beneficial)Main Canal

Impact Type	Level of Impact	Impact Description
	Moderate	<ul style="list-style-type: none"> • Reduced capacity and potential for decreased velocity in the Main Canal with increased sediment deposition
	Minor	<ul style="list-style-type: none"> • Limited change to channel migration

4.6.3 Construction Effects

4.6.3.1 No Action Alternative

The No Action Alternative would not have any new construction elements, so no effects from construction would occur.

4.6.3.2 Rock Ramp Alternative

During construction of the Rock Ramp Alternative, the coffer dams used for construction of the replacement weir could cause increased depths and velocities in the river channel as the river is diverted from one side to the other, as described in Section 4.4.3. This could cause localized erosion and scour, particularly on the right bank at Joe’s Island. However, due to the presence of riprap along the right bank in the vicinity of the Intake Diversion Dam, this is expected to be negligible.

If a flood event larger than a 10-year flood were to occur during construction, the presence of cofferdams or the partially completed rock ramp could cause increased depths of flow or velocities across Joe’s Island. Increased scour from such an event at the existing side channel could allow more frequent flows down the side channel or cause migration of the side channel. This is likely to be a minor temporary effect, as sediment deposition would likely continue at the upstream end of the side channel as has been the trend in this area and the side channel is continuing to migrate naturally.

The temporary storage of materials and staging areas and haul routes would occur in approximately 25 acres of the channel migration zone. This would be a minor temporary effect as much of this area is already currently stabilized with rock and is not very susceptible to channel migration. Once construction is complete, this disturbed area would be restored to pre-existing conditions.

Overall, construction activities for the Rock Ramp Alternative are likely to have minor temporary effects on Yellowstone River geomorphology and channel migration.

4.6.3.3 Bypass Channel Alternative

The presence of cofferdams during construction could cause increased depths and velocities in the river channel as the river is diverted from one side to the other. This could cause localized erosion and scour, particularly on the right bank at Joe’s Island. However, due to the presence of riprap along the right bank in the vicinity of the Intake Diversion Dam, this is expected to be negligible.

If a flood event larger than a 10-year flood were to occur during construction, the presence of cofferdams could cause increased depths of flow or velocities across Joe’s Island that could cause localized scour. This is likely to be a minor temporary effect because once the cofferdams are removed; there would be no effect on flood elevations.

Placement of cofferdams and filling in the upper 1.5 miles of the existing side channel would immediately block this side channel early in construction, causing a loss of over 4 miles of flow-through side channel length in this reach and reducing the potential for channel migration in this reach. During construction, the approximately 2-mile-long bypass channel would not be completed, so it could not be considered available to the river or the aquatic communities. However, as the existing side channel does not have flows every year, it is likely that the blockage during construction would only result in a moderate temporary effect of preventing flows in one of the two years of construction.

During construction, much of the upper half of Joe's Island would be part of the work zone with stockpiling, staging, haul routes and other activities. This would affect up to 150 acres of the channel migration zone along the south valley wall, essentially reducing the potential for channel migration. This is a moderate effect on the channel migration zone in this reach of the river.

Overall, construction activities for the Bypass Channel Alternative are likely to have moderate effects on Yellowstone River geomorphology and channel migration.

4.6.3.4 Modified Side Channel Alternative

During construction of the Modified Side Channel Alternative, there would be cofferdams placed at the upstream and downstream ends of the existing side channel in order to allow excavation of the channel to proceed isolated from the river. This would eliminate the side channel connectivity to the river during the 1 to 2 years of construction. This could cause increased velocities in the main channel during high flows, as more water would tend to flow down the main channel. There could also be some increased scour of the bar at the upstream end of the existing side channel. This is expected to be a negligible effect on Yellowstone River geomorphology or channel migration during construction, as the presence of riprap along the left bank of the river associated with the railroad line and the Intake Diversion Dam already prevents channel migration in this area and any temporary scour of the bar would likely be eliminated once the coffer dams are removed.

The downstream cofferdam would impede groundwater, local runoff, and tributary inflows (e.g. from Boxelder Creek) from directly draining into the Yellowstone River at the downstream end of the existing side channel. Other than the need to provide for this contingency during construction, this is expected to have a negligible effect on the Yellowstone River geomorphology. During construction, the over 4-mile-long existing side channel would not be available to the river or the aquatic communities. However, as the existing side channel does not have flows every year, it is likely that the blockage during construction would only result in a moderate temporary effect of preventing flows in one runoff period during the 18 months of construction.

Overall, construction activities for the Modified Side Channel Alternative are likely to have moderate temporary effects on Yellowstone River geomorphology and channel migration.

4.6.3.5 Multiple Pump Alternative

During construction of the Multiple Pump Alternative, cofferdams would be present for removal of the Intake Diversion Dam, which could cause increased depths and velocities in the river

channel as the river is diverted from one side to the other. This could cause localized erosion and scour, particularly on the right bank at Joe's Island. However, due to the presence of riprap along the right bank in the vicinity of the Intake Diversion Dam, this is expected to be negligible.

If a flood event larger than a 10-year flood were to occur during construction, the presence of cofferdams could cause increased depths of flow or velocities across Joe's Island that could cause localized scour. This is likely to be a negligible temporary effect because the coffer dams would only be in place for a short duration. Once the cofferdams are removed, there would be no effect on flood elevations.

Excavation of the canals to the pumping stations would be isolated from the river through the use of coffer dams or by leaving a "plug" of soil during excavation and then making the final connection when the canal is complete. Rock would be placed on the river bank at the location of the fish return pipe to protect the pipe outlet and along the bank upstream and downstream of the canal to protect the canal from bank erosion or migration. This would be a minor area of rock—approximately 500 linear feet total during the three-year construction period—and would have only negligible effects on channel migration during construction.

Overall, construction activities for the Multiple Pump Alternative would have negligible effects on Yellowstone River geomorphology and channel migration.

4.6.3.6 Multiple Pumps with Conservation Measures Alternative

During construction of the Multiple Pumps with Conservation Measures Alternative, coffer dams would be present for removal of the Intake Diversion Dam, which could cause increased depths and velocities in the river channel as the river is diverted from one side to the other. This could cause localized erosion and scour, particularly on the right bank at Joe's Island. However, due to the presence of riprap along the right bank in the vicinity of the Intake Diversion Dam, this is expected to be negligible.

If a flood event larger than a 10-year flood were to occur during construction, the presence of cofferdams could cause increased depths of flow or velocities across Joe's Island that could cause localized scour. This is likely to be a negligible temporary effect because the cofferdams would only be in place for a short duration. Once the cofferdams are removed, there would be no effect on flood elevations.

The location of the Ranney wells would need to be evaluated on a site-specific basis, but the intent is to install them outside of the channel migration zone to reduce long-term risk of damage to the expensive infrastructure. Thus, the construction of water conservation measures and the Ranney wells would occur outside of the channel migration zone and would have no effects on Yellowstone River geomorphology, including channel migration.

Overall, construction activities for the Multiple Pumps with Conservation Measures Alternative would have negligible effects on Yellowstone River geomorphology and channel migration.

4.6.4 Operational Effects

4.6.4.1 No Action Alternative

Hydraulic Conditions of the Yellowstone River and High-Flow Side Channel

Overall, the No Action Alternative would not change the hydraulic conditions of the Yellowstone River and the side channels. Flow splits into the existing side channel would remain as described in Section 4.4.4.

The headworks structure and screens constructed in 2010 require an additional 1 foot of head to maintain a diversion of 1,374 cfs when the Yellowstone River flows are at the extreme low flow of 3,000 cfs. To achieve the additional head, rock is added to the existing timber crib diversion structure as needed to create the necessary water elevation. This additional rock placement is higher than the historical placements to achieve the head required for diversion, resulting in a slightly elevated backwater elevation. This slightly increases channel depths and widths, slightly decreases velocities, and slightly decreases sediment transport past the Intake Diversion Dam.

The potential climate change effect of future lower low flows could exacerbate this issue and require even higher placements of rock. However, this small and localized increase in surface water would have only a minor effect on the Yellowstone River hydraulic and geomorphic characteristics and no effect on flows into the existing side channel.

Channel Migration Zones

Comparisons of the 1950s to recent aerial photography indicate that the channel bank lines that encompass Joe's Island (between approximately River Mile 71 and River Mile 76) are relatively stable, with little migration except at the existing side channel confluences, which have average annual historical rates of channel migration up to 10 feet per year. The left bank line upstream of the Intake Diversion Dam area has exhibited very little channel migration, which is partially due to the presence of riprap. This area also coincides with a high shale and silt stone bluff. The No Action Alternative would not likely have any effect on channel migration zones.

The Intake Diversion Dam has been in place for over 100 years, with little to no evidence of vertical or horizontal instability except a localized scour hole at the downstream end of the boulder field. The riprap placed to protect the railroad bed along the left bank of the channel upstream of the diversion may be responsible for the deep thalweg where the channel impinges on this lateral constraint. However, the shale/silt stone bluff may also be responsible, or at least contribute to the deepened thalweg along this portion of the bank. These conditions are not expected to change with the No Action Alternative.

The existing side channel confluence area is geomorphically active in terms of lateral erosion and deposition, so diversions to the existing side channel are probably highly variable over time and likely to remain highly variable under the No Action Alternative.

The downstream confluence of the existing side channel and the main river is also geomorphically active. The presence and growth of bars and islands has caused the left bank of the Yellowstone River to migrate laterally, which is not expected to change with the No Action Alternative. When flows are not entering the upstream end of the existing side channel, the

downstream end (up to 2,000 feet) is in backwater from the main channel. This would not be affected by the No Action Alternative.

Overall, there is likely to be no effect on channel migration zones from the No Action Alternative.

Channel Slope and Substrate Characteristics

The No Action Alternative would require the continued placement of rock on the crest of the weir, which would continue to be transported downstream into the boulder field from ice and high flows, enlarging the boulder field somewhat. This would not change the slope of the channel through this area, which is currently approximately 2 percent, but would increase the volume of rock in the channel over time. Overall, there would only be minor effects on channel slope and substrate characteristics from the No Action Alternative, continuing current trends.

4.6.4.2 Rock Ramp Alternative

Hydraulic Conditions of the Yellowstone River and High-Flow Side Channel

The Rock Ramp Alternative proposes a 1,200-foot ramp to be constructed downstream from the top of the intake diversion to tie into existing grade. The ramp would have a varying slope of 0.20 to 0.70 percent. With a short steeper grade of 2 percent at the toe of the ramp, it would tie into an existing depression in the channel bottom, likely extending into the channel bed as a toe-down for stability. Velocities would be somewhat reduced compared to current conditions. There would be somewhat less turbulence because the rock would be tightly packed together, although turbulence would still be likely.

Major O&M actions are likely over the life of the Rock Ramp Alternative as rocks may become displaced from ice or high flows. It would be expected that rock repairs would need to be conducted frequently to ensure fish passage. A cofferdam or barge would be utilized to place or realign rock. If a cofferdam is used it would be temporary and likely be utilized in late summer when base flows are low, thus reducing the potential for geomorphic effects. Thus, O&M actions are likely to only have a minor effect on the river hydraulics or geomorphology, primarily resulting from continued placement of rock in the river that may extend a new rock rubble field downstream of the rock ramp.

Flows into the existing side channel currently begin when discharge in the Yellowstone River is between 20,000 and 25,000 cfs. Although the Rock Ramp Alternative would slightly increase backwater depths upstream of the Intake Diversion Dam, the increase would be negligible at the upstream end of the existing side channel. This is a geomorphically active area in terms of lateral erosion and deposition, so splits to the existing side channel are highly variable; they likely would remain so under the Rock Ramp Alternative.

The downstream confluence of the existing side channel and the main river is geomorphically active. The presence and growth of islands has caused the left bank of the Yellowstone River to migrate laterally, which is not expected to change with the Rock Ramp Alternative. When flows are not entering the upstream end of the existing side channel, the downstream end (up to 2000 feet) is in backwater from the main channel. This would not be affected by the Rock Ramp Alternative. The new rock ramp would tie into the river channel approximately 1.5 miles

upstream of the downstream end of the existing side channel. Thus the alternative would likely have no effect at the downstream end of the existing side channel.

Channel Migration Zones

The rock ramp would result in channel modifications immediately downstream of the Intake Diversion Dam within approximately 32 acres of the channel migration zone and 5-year floodplain. Because the ramp would elevate the channel bed and the floodplain immediately downstream of the dam, overbank flooding would increase, likely resulting in a moderate impact that could result in localized scour and possible channel migration upstream of the ramp, particularly along the right bank. The left bank is mostly stabilized with rock and the boat ramp.

The rock ramp would be located in a section of the Yellowstone River that is straight and relatively narrow. This reach is adjacent to Joe's Island, which is vegetated and not frequently inundated and therefore is relatively stable. The Rock Ramp Alternative is unlikely to have more than minor effects on channel migration and is not likely to be at risk of damage from natural channel migration.

Channel Slope and Substrate Characteristics

The ramp slope would be steeper than the existing channel of the Yellowstone River upstream and downstream of the existing facilities and would not meet BRT guidelines at all times (see Table 4-9).

The Rock Ramp Alternative would not likely affect the vertical or horizontal stability of the channel bed, with the exception of the localized scour hole at the downstream end of the existing rock ramp. This would be filled with rock, as the new, flatter ramp would extend beyond this location, thus eliminating the scour hole. Eliminating the scour hole would result in a moderate benefit by reducing turbulence and providing a more favorable hydraulic condition for fish habitat and passage. Placing rock for the ramp would bury natural channel substrate (cobble) and create a 1,200-foot-long segment of rock in the river. This would be distinctly different from natural characteristics. It would be much longer than natural bedrock riffles in the river and longer than the existing rock ramp of approximately 250 feet. Overall, the Rock Ramp Alternative would have moderate effects on channel slope and substrate characteristics.

4.6.4.3 Bypass Channel Alternative

Hydraulic Conditions of the Yellowstone River and High-Flow Side Channel

The Bypass Channel Alternative is designed to meet the BRT criteria for pallid sturgeon passage for depths, velocities, and flow volume. Flows would split into the bypass channel when the Yellowstone River reaches 7,000 cfs. Some flow to the bypass channel when the Yellowstone River is between 3,000 cfs and 7,000 cfs would occur but would be negligible. At or above 7,000 cfs, this alternative would directly affect the hydraulics and sediment transport in the main channel by reducing flows in the Yellowstone River between the upstream end of the bypass channel and its return point immediately downstream of the Intake Diversion Dam.

Although this alternative would reduce Yellowstone River flows by 14 to 16 percent, detailed analyses conducted for the design of the bypass channel (Reclamation & the Corps 2010, 2015)

indicated that this would have only minor effects on water surface elevations and sediment transport. Flow splits and hydraulic results are summarized in Table 4-21.

TABLE 4-21. PROPOSED FLOW CONDITIONS IN THE YELLOWSTONE BETWEEN BYPASS CHANNEL INLET AND OUTLET FOR THE BYPASS CHANNEL ALTERNATIVE

Discharge at Sidney, Montana USGS Gage (return period)	Flow into the Bypass Channel (cfs)	Hydraulic Conditions in the Yellowstone River		
		Flow Remaining in the Yellowstone River (cfs)	Average Channel Cross-Section Velocities (fps)	Average Channel Depth (feet)
7,000 cfs	1,100	5,900	1.4	14.4
15,000 cfs	2,200	12,800	2.2	15.9
30,000 cfs	4,100	25,900	3.4	18.0
54,200 cfs (2-year)	7,500	46,700	4.9	20.7
74,400 cfs (5-year)	10,700	53,700	5.6	22.1
87,600 cfs (10-year)	12,900	74,700	6.2	23.3
128,300 cfs (100-year)	20,000	108,300	7.4	26.1

This alternative would place the upstream end of the bypass channel at nearly the same location as the existing upstream end of the existing side channel. This confluence area is geomorphically active, so channel banks and bed in the area would be armored to minimize lateral and vertical movement. This would be designed to minimize erosion and scour and allow the channel to persist over time; however, the net result would be a change in natural sediment deposition and erosion dynamics.

Filling in the upper 1.5 miles of the existing side channel would cause a loss of 4 miles of side channel. The new bypass channel would be approximately 2.2 miles in length, replacing much of the lost flow-through habitat. The result would be a minor loss of side channel length, both for the reach and for the entire river. There has been a cumulative loss of 90 miles of side channel length along the entire river from blockages and other factors (Corps and YRCDC 2015), so an additional 2 miles would increase the total loss by 2 percent. Over 2.5 miles of the existing side channel at the downstream end would remain as backwater, though it would be clearly changed in channel type and would likely have reduced potential for channel migration.

The downstream end of the existing side channel would no longer have flowing water (except in floods higher than the 50-year flood event), so there could be reduced velocities and scour that could cause sediment deposition, thus enlarging bars already present in this part of the river. This could lead to the long-term migration of the channel thalweg to the north (left bank), which is a trend that is already ongoing. The bypass channel discharges water throughout the range of flows and may affect downstream conditions that could enhance or counteract this trend, though with negligible consequence.

At the toe of the existing dam along the right bank, there is a scour hole. The bypass channel outlet, or fish entrance, would be immediately upstream of the scour hole. Analysis and physical modeling indicate that the scour hole could persist with the bypass channel in place (Reclamation 2015). If this alternative is advanced, further assessment may be required to finalize the location

of the fish entrance or modify dam and river bank conditions to eliminate the turbulence and eddy causing the scour hole and improve hydraulic conditions for the pallid sturgeon fish passage entrance.

A number of O&M actions are expected periodically during the life of the bypass channel to ensure fish passage. Such O&M actions would include: replacement of riprap on outside bends, sediment removal, channel realignment and debris removal. These actions will likely require a coffer dam be placed at the upstream entrance of the bypass channel completely shutting off flows to the channel. The cofferdam would be temporary and utilized during the summer base flows. When the cofferdam is in place there would be a minor increase in flows in the Yellowstone River through the weir and headworks area. This would be similar to existing flows, thus resulting in only negligible effects.

Overall, there would be minor effects on the main river channel hydraulics from the Bypass Channel Alternative, and moderate effects by essentially replacing the existing side channel with the bypass channel.

Channel Migration Zones

While the Bypass Channel Alternative would result in a 14- to 16-percent flow reduction in the Yellowstone River, this is not expected to result in more than a minor change in channel migration along the main river channel and downstream of the weir. The main river channel is already confined with riprap and natural bank conditions along the left bank through the headworks and dam zone. Along the right bank, Joe's Island is vegetated and reasonably stable. The placement of a sill at the upstream end of the proposed bypass channel would stabilize approximately 100 additional feet of bank line.

The filling of the upper 1.5 miles of the existing side channel would likely substantially reduce the rate of channel migration at the upstream end of this side channel, which is currently geomorphically active. As the side channel under this alternative would only be a backwater channel in its lower half, the ongoing migration of this side channel would cease. Such migration is already limited by bedrock along much of the side channel's length. The new bypass channel would go through the middle of Joe's Island and would be stabilized to prevent more than minor channel migration, in order to ensure persistence of the channel and to meet the BRT criteria. This would essentially eliminate existing side channel migration in and along Joe's Island. An area of approximately 150 acres within the channel migration zone along the existing side channel could be affected.

Overall, this is likely to have a moderate effect on side channel migration on the right-bank. The Yellowstone River main channel would be unaffected except for the upstream end.

Channel Slope and Substrate Characteristics

The Bypass Channel Alternative would slightly raise the weir elevation above existing conditions (replacement weir top elevation of 1,991 feet), but would have negligible effect on channel slope. The bypass channel would have a slope of 0.07 percent, which is slightly steeper than the slope of 0.05 percent in the existing side channel but within the range of slopes in side channels along the Yellowstone River (Reclamation & the Corps 2010). Overall, there would be

negligible effect on the river channel slope, but a moderate effect on the existing side channel slope by replacing the existing side channel with the steeper bypass channel.

The Bypass Channel Alternative would not likely affect the vertical or horizontal stability of the main river channel bed, with the exception of placing additional cobbles and rock upstream and downstream of the replacement weir to provide more gentle slopes up to and over the replacement weir. These might slightly reduce scour. The bypass channel would have several segments of rock installed as grade control to maintain the overall slopes, depths, and velocities. This would be different than the natural substrate of side channels, although a cobble/gravel substrate would be placed on the bed of the bypass channel between the grade controls, creating a partly natural substrate.

Overall, the Bypass Channel Alternative would have moderate effects on channel slope and substrate characteristics.

4.6.4.4 Modified Side Channel Alternative

Hydraulic Conditions of the Yellowstone River and Side Channel

The Modified Side Channel Alternative would substantially modify the existing side channel to meet the BRT criteria for pallid sturgeon passage. To achieve the recommended depths and velocities, the entire existing side channel would be deepened and widened. The channel would receive flows during all flows in the Yellowstone River. Some flow to the modified channel when the Yellowstone River is between 3,000 cfs and 7,000 cfs would occur but would be negligible. At or above 7,000 cfs this alternative would directly affect the hydraulics and sediment transport in the main river channel by reducing flows in the Yellowstone River between the upstream and downstream ends of the existing side channel (distance of nearly 4 miles).

The existing side channel would have suitable depths and velocities for pallid sturgeon passage when the Yellowstone River reaches and exceeds 7,000 cfs. The only exception would be the average velocity at the upstream fish exit, where modeling estimates that flows would be 6.7 fps. However, this velocity is consistent with average velocities in the main Yellowstone River channel and may be representative of the main channel as opposed to the modified side channel, as reported in the one dimensional model. Additional detailed design and analyses, particularly a 2-dimensional analysis, may be warranted if this alternative is carried forward to design. This alternative includes a 150-foot single-span bridge over the modified side channel to minimize encroachment into the channel. Calculations indicate that the hydraulics associated with the proposed bridge would be consistent with the channel hydraulics.

Although this alternative would result in a 13- to 14-percent flow reduction in the Yellowstone River, the new flows would still be within range identified as not having an appreciable effect on hydraulics and sediment transport of the main channel. Table 4-22 summarizes the flow splits and hydraulic conditions in the main channel for this alternative.

A number of O&M actions are expected periodically for the Modified Side Channel Alternative to ensure fish passage. Such O&M actions would include: replacement of riprap, sediment removal, channel realignment and debris removal. These actions will likely require a cofferdam be placed at the upstream entrance of the side channel completely shutting off flows to the

channel. The cofferdam would be temporary and utilized during the summer base flows. When the cofferdam is in place there would be a minor increase in flows in the Yellowstone River through the weir and headworks area. This would be similar to existing flows, thus resulting in only negligible effects.

Overall, the Modified Side Channel Alternative would result in minor effects on the Yellowstone River and moderate effects on the side channel hydraulics.

TABLE 4-22. PROPOSED FLOW CONDITIONS IN THE YELLOWSTONE BETWEEN MODIFIED SIDE CHANNEL INLET AND OUTLET FOR THE MODIFIED SIDE CHANNEL ALTERNATIVE

Discharge at Sidney, Montana USGS Gage (return period)	Flow into the Side Channel (cfs)	Hydraulic Conditions in the Yellowstone River		
		Flow Remaining in the Yellowstone River (cfs)	Average Channel Cross-Section Velocities (fps)	Average Channel Depth (feet)
7,000 cfs	969	6,032	1.9	9.7
15,000 cfs	1,965	13,036	2.9	11.3
30,000 cfs	3,814	26,187	4.1	13.5
54,200 cfs (2-year)	7,052	47,149	5.4	16.2
74,400 cfs (5-year)	10,320	64,081	6.1	18.1
87,600 cfs (10-year)	12,399	75,202	6.5	19.1
128,300 cfs (100-year)	17,372	110,929	8.0	21.3

Channel Migration Zones

While the Modified Side Channel Alternative would result in a 14- to 16-percent flow reduction in the Yellowstone River, this is not expected to result in more than a minor change in channel migration along the main river channel and downstream of the weir. The main river channel is already confined with riprap and natural bank conditions along the left bank through the headworks and dam zone. Along the right bank, Joe’s Island is vegetated and reasonably stable. The placement of a sill at the upstream end of the proposed channel would stabilize approximately 100 feet of bank line.

The modified side channel would have some rock armoring placed to prevent substantial channel migration, although the potential for migration of the channel would be higher than for the Bypass Channel Alternative because more bank line would be allowed to erode. However, it is still likely that this alternative would reduce the rate of side channel migration compared to the existing condition—to approximately 40 acres of the 150-acre channel migration zone.

The downstream confluence of the side channel (or fish entrance) and the main river is geomorphically active. The presence and growth of islands has caused the left bank of the Yellowstone River to migrate laterally. This could change with the Modified Side Channel Alternative, given the increase in the frequency and volume of flows into the side channel. It is possible that the right channel of the river would deepen and widen with the increase in flows, though the existing bar at the mouth of the channel could reform and even enlarge under the new flow and sediment regime.

When flows are not entering the upstream end of the modified side channel, which would be an infrequent occurrence, the downstream end (up to 2,000 feet) would be in backwater from the main channel. This complex morphology could be a deterrent to migrating fish, particularly in attracting fish into the channel. Further analysis would likely be required if this alternative were to advance, including consideration of an alternative outlet for this channel, such as at a location midway between the existing side channel confluence and the Intake Diversion Dam that could be closer to the dam and closer to the river thalweg where pallid sturgeon are likely to be migrating.

Overall, the Modified Side Channel Alternative is likely to result in a moderate effect on channel migration in this reach of the river and associated right-bank floodplain of Joe's Island.

Channel Slope and Substrate Characteristics

The Modified Side Channel Alternative would not change the slope or bed of the main river channel. The modified side channel would have a slope of approximately 0.06 percent, which is slightly steeper than the existing condition (0.07 percent). Overall, there would be no effect on channel slope in the river and only negligible effect on the slope of the side channel.

The Modified Side Channel Alternative would include the continued placement of rock on the Intake Diversion Dam that would continue to be transported by ice and high flows to the boulder field downstream. This would result in a larger volume of rock in the river over time. Only a minor amount of rock would be placed in the modified side channel, primarily at the upstream and downstream ends, which would result in only a minor addition of rock into the river.

Overall, the Modified Side Channel Alternative would have negligible effects on channel slope and minor effects on substrate characteristics.

4.6.4.5 Multiple Pump Alternative

Hydraulic Conditions of the Yellowstone River

The Multiple Pump Alternative would divert flows at five locations:

- Site 1—Near the Intake Diversion Dam
- Site 2—8 miles downstream from Site 1, near Idiom Island
- Site 3—3 miles downstream from Site 2, near Mary's Island
- Site 4—0.2 miles upstream of Savage
- Site 5—0.3 miles downstream of Savage

Each site would pump 275 cfs, for a net diversion of 1,374 cfs. This alternative would increase water volumes remaining in the main channel, which might slightly increase channel depths and velocities over nearly 20 miles downstream of the Intake Diversion Dam (Table 4-23). After the last pumping station, the total diversions would be equal to the No Action Alternative.

TABLE 4-23. DEPTHS AND VELOCITIES IN THE YELLOWSTONE RIVER FOR MULTIPLE PUMP ALTERNATIVE

Discharge at Sidney, Montana USGS Gage (cfs)	No Action Alternative ^a		Multiple Pump Alternative ^a	
	Depth (feet)	Velocity (fps)	Depth (feet)	Velocity (fps)
7,000	10.78	1.17	11.13	1.11
15,000	12.8	2.17	13.25	2.07
30,000	15.21	3.49	15.69	3.39
54,200	17.95	4.88	18.12	4.99
74,400	19.66	5.66	20.03	5.90
87,600	20.73	6.14	21.11	6.41
128,300	23.47	7.49	23.62	7.73

a. HEC-RAS cross section station 27597.18

The removal of the Intake Diversion Dam would affect hydraulic conditions upstream and downstream of the existing weir. Downstream, water depths would increase and velocities would decrease. Upstream, removal of the weir would eliminate backwater effects and reduce depths and increase velocities. It may take a few years for the sediment that has accumulated upstream of the weir to redistribute and move downstream, but it is likely that removal of the weir would return the river channel to be fully within the typical variation of natural channel characteristics and sediment transport, which would allow fish passage by all migratory species.

Overall, the Multiple Pump Alternative would have a major beneficial effect on the river hydraulics, allowing for fish passage.

Hydraulic Conditions in LYP Canal

The irrigation canal system was designed for gravity flow of water from the upstream end at Intake. This alternative would provide water supply from several points along the upper 17 miles of the canal.

As the pumped water would be delivered in the upper portion of the Main Canal maintaining essentially the same volume of flow in the canal, at this time, check structures have not been included. However, if this alternative was to move forward to more detailed design, additional analysis could indicate the need for one or more additional check structure to maintain the water depth and elevations required to deliver water to the lateral canals for distribution to the fields. Main Canal Overall, this alternative would have a minor effect on hydraulic conditions and sediment transport in the LYP canal. Alternatively, in the upstream portion of the LYP canal where water levels are more affected by this alternative, pumping from the canal into laterals may be a better option. Pumping from the Main Canal would have a negligible to minor effect on hydraulic conditions and sediment transport in the LYP canal.

Channel Migration Zones

Removal of the weir for the Multiple Pump Alternative would lower the water surface elevations for all flows through this reach. That would reduce flows into the existing side channel around Joe's Island and also the side channel on the left bank upstream of the headworks. The existing side channel would only begin to receive flows when river flows are at or greater than 35,000 cfs (compared to ~20,000 cfs for existing conditions). The more natural slope and substrate would allow natural channel migration to occur except where rock or resistant banks are present near

the headworks and diversion intake. This migration would be at a reduced rate from historical conditions due to upstream regulation of flows (i.e. in the Bighorn River).

At the location of each of the pumping stations, channel migration would be allowed to occur up to a point where it is close enough to endanger the pumping station screens, at which point a maintenance action could be to install bank protection to prevent further channel migration. The placement of the pumping stations at the edge of or outside the channel migration zone would put the stations at a low risk of being damaged by channel migration for the next several decades.

Overall, the Multiple Pump Alternative is likely to have a negligible effect on channel migration.

Channel Slope and Substrate Characteristics

The Multiple Pump Alternative would change the slope of the main river channel by removal of the dam, bringing the channel slope back to a more natural slope of approximately 0.05 percent. The existing side channel slope would not change. Overall, there would be a major beneficial effect on channel slope in the river and no effect on the slope of the existing side channel.

The Multiple Pump Alternative would remove a substantial proportion of the rock associated with the dam and the boulder field in the immediate vicinity of the dam. This would return the channel substrate to a much more natural condition dominated by cobble and gravel. However, additional rock would be placed at each of the pumping stations to protect them from channel migration.

Overall, the Multiple Pump Alternative would have a moderate effect on channel substrate characteristics.

4.6.4.6 Multiple Pumps with Conservation Measures Alternative

Hydraulic Conditions of the Yellowstone River and High-Flow Side Channel

The Multiple Pumps with Conservation Measures Alternative would include the removal of the existing weir and rock/rubble field, water conservation measures for the LYP irrigation system, groundwater pumping, and alternative energy to power the pumping. It proposes to achieve conservation of 766 cfs and meet the remaining irrigation demand with 608 cfs of gravity flow or pumping. The decreases in diversions would increase flow volumes and depths in the Yellowstone River and have a direct moderate benefit to hydraulics and sediment transport in the Yellowstone River and side channels.

Removal of the Intake Diversion Dam would impact hydraulic conditions upstream and downstream of the existing dam. Downstream, water depths would increase and velocities would decrease. Upstream, removal of the dam would eliminate backwater effects and reduce depths and increase velocities, thus reducing the flows into the existing side channel around Joe's Island and potentially the left bank side channel upstream of the headworks. It may take a few years for the sediment that has accumulated upstream of the weir to redistribute and move downstream, but it is likely that removal of the dam would return the river channel to be fully within the typical variation of natural channel characteristics and sediment transport, which would allow fish passage by all migratory species.

Overall, the Multiple Pumps with Conservation Measures Alternative would have a major beneficial effect on the river hydraulics, allowing for fish passage.

Hydraulic Conditions in LYP Canal

The irrigation canal system was designed for gravity flow of water from the upstream end at Intake. This alternative would require restructuring the LYP canal system to accommodate a water supply from several points along the canal between Intake and the 7th Ranney well facility approximately 60 miles downstream. Additionally, one of the water conservation measures is the potential installation of check structures that could slow water velocities and increase sediment deposition.

Restructuring of the Main Canal would be necessary and is proposed to be done by filling in half the capacity of the canal (i.e. narrowing the canal) to convey the reduced volume of 608 cfs at similar depths and velocities as the existing canal conveys the 1,374 cfs. If this alternative were to move forward for more detailed design, additional analysis may indicate the need for additional check structures. This alternative would have a moderate effect on the hydraulic conditions in the LYP canal.

Channel Migration Zones

Removal of the dam for the Multiple Pumps with Conservation Measures Alternative would lower the water surface elevations for all flows through this reach. That could reduce flows into the existing side channel and side channel on the left bank upstream of the intake. The more natural slope and substrate would allow natural channel migration to occur except where rock or resistant banks are present near the headworks and diversion intake. This migration would be at a reduced rate from historical conditions due to upstream regulation of flows (i.e. in the Bighorn River).

Overall, the Multiple Pumps with Conservation Measures Alternative is likely to have a moderate effect on channel migration.

Channel Slope and Substrate Characteristics

The Multiple Pumps with Conservation Measures Alternative would change the slope of the main river channel by removal of the dam, bringing the channel slope back to a more natural slope of approximately 0.05 percent. The existing side channel slope would not change. Overall, there would be a major effect on channel slope in the river and no effect on the slope of the existing side channel.

The Multiple Pumps with Conservation Measures Alternative would remove a substantial proportion of the rock associated with the dam and the rock rubble field in the immediate vicinity of the dam. This would return the channel substrate to a much more natural condition dominated by cobble and gravel. Overall, the Multiple Pumps with Conservation Measures Alternative would have a moderate effect on channel substrate characteristics.

4.6.5 Cumulative Effects

4.6.5.1 Geographic and Temporal Extent of Analysis

The geographic extent for evaluating cumulative effects on geomorphology includes the lower Yellowstone River and its floodplain (including the LYP) from approximately 2 miles upstream of the Intake Diversion Dam to the confluence with the Missouri River.

4.6.5.2 Methodology for Determining Effects

The methodology for determining effects was an evaluation of the cumulative effects on geomorphology presented in the Yellowstone River CEA (Corps & YRCDC 2015), hydraulic modeling conducted for this study, and an evaluation of the potential for reasonably foreseeable future projects and climate change to affect geomorphology.

4.6.5.3 Past, Present, and Reasonably Foreseeable Future Projects Considered

A list of the past, present, and reasonably foreseeable future projects in the area of potential effect is provided in Section 4.1.4. The net result of the many past projects and ongoing trends have had a moderate to major effect on Yellowstone River geomorphology. The following key reasonably foreseeable future projects and trends could affect geomorphology:

- Crow Irrigation Project (Section 405 of the Crow Settlement Act of 2010)
- Crow Municipal, Rural and Industrial Water Project (Section 406 of the Crow Settlement Act of 2010)
- Yellowtail Storage Allocation (Section 408 of the Crow Settlement Act of 2010)
- Bighorn Streamflow and Lake Level Management Plan (Section 412 of the Crow Settlement Act of 2010)
- Yellowtail Afterbay Power Generation (Section 412 of the Crow Settlement Act of 2010)
- Ongoing trends of bank armoring and other development
- Ongoing trends of climate change

4.6.5.4 No Action Alternative

The No Action Alternative would take no action to provide fish passage at the Intake Diversion Dam and would continue the status quo operation and diversion of 1,374 cfs into the Main Canal. The presence of the Intake Diversion Dam and the diversion of water has slightly contributed to the trend of bank armoring and confinement of the river channel that has reduced channel migration rates. However, the Yellowstone River CEA (Corps & YRCDC 2015) documented that the alteration of river hydrology (reduced peak flows) has had the largest effects on geomorphology, causing a substantial reduction in channel bank-full area, the abandonment of side channels, reduced channel migration rates, reduced recruitment of large wood, reduced floodplain turnover, and loss of mid-channel bars. These effects are most pronounced in the lower river (below the Bighorn River confluence). Specific actions that have blocked or isolated side channels and the use of bank armor have also had major effects in loss of riverine features and reduced rates of channel migration.

The projects associated with the Crow Settlement Agreement could affect flows in the Bighorn River further by withdrawing more water for irrigation and municipal and industrial uses. In comparison to the estimated 3,200 million gallons per day along the Yellowstone River, these additional uses are likely to be minor (less than 1 percent). Climate change predictions also indicate the likelihood of reduced snowpack that could lead to reduced runoff (Reclamation,

2012b; MDNRC 2014), although variability between droughts and extreme precipitation is also likely. Such variability could cause rapid and large changes in channel geomorphology on an episodic basis.

Overall, the No Action Alternative is likely to continue contributing to cumulative effects on geomorphology in the area of analysis, with the addition of minor cumulative effects anticipated from reasonably foreseeable future projects and trends.

4.6.5.5 Rock Ramp Alternative

The Rock Ramp Alternative is intended to provide a suitable surface water route for fish passage during most flows. There would be some flows when depths or velocities may not be suitable for passage, but the overall cumulative effect would be an improvement for the aquatic ecosystem and fish passage. However, placement of 350,000 cubic yards of large rock into the river would increase the quantity of rock in the river by a moderate amount and would reduce or eliminate channel migration for about a half-mile of the river channel.

With the likelihood of climate induced changes there is likely to be a minor reduction in both peak and low flows. The potential for increased variability in precipitation associated with climate change would likely increase the frequency of extreme floods that can cause rapid geomorphic change on an episodic basis.

Overall, for the Rock Ramp Alternative there is likely to be a minor additional cumulative effect on river channel geomorphology and channel migration rates.

4.6.5.6 Bypass Channel Alternative

The Bypass Channel Alternative is intended to provide a suitable surface water route around the dam for fish passage during most flows. There would be some flows when depths or velocities may not be suitable for passage, but the overall cumulative effect would be an improvement for the aquatic ecosystem and fish passage. However, filling in the upper portion of the existing channel would cause another side channel to be blocked. This would further reduce side channel length and area in the river by a moderate amount. It also would reduce channel migration that naturally occurs associated with the existing side channel. Creation of the bypass channel would create a shorter side channel that would be held in place with rock to ensure the maintenance of fish passable conditions.

With the likelihood of climate-induced changes and the potential for other changes in flows due to additional water withdrawals, there is likely to be a minor reduction in peak and low flows. This could generally reduce channel bank-full area and reduce channel migration. The potential for increased variability in precipitation associated with climate change would likely increase the frequency of extreme floods that could cause rapid geomorphic change on an episodic basis.

Overall, for the Bypass Channel Alternative there is likely to be a moderate additional cumulative effect on river channel geomorphology and channel migration rates.

4.6.5.7 Modified Side Channel Alternative

The Modified Side Channel Alternative is intended to provide a suitable and frequently accessible surface water route that bypasses the dam for fish passage during most flows. There

would be some flows when depths or velocities may not be suitable for passage, but the overall cumulative effect would be an improvement for the aquatic ecosystem and fish passage.

Excavation of this existing side channel would change side channel habitat by increasing flows, reducing length, slightly steepening the gradient, adding grade control and some bank armoring, placing a cobble/gravel substrate on the bed, changing the natural formation of this feature, and reducing the natural rate of channel migration in this channel to maintain fish passable conditions.

With the likelihood of climate-induced changes and the potential for other changes in flows due to additional water withdrawals, there is likely to be a minor reduction in peak and low flows. This could generally reduce channel bank-full area and reduce channel migration. The potential for increased variability in precipitation associated with climate change would likely increase the frequency of extreme floods that could cause rapid geomorphic change on an episodic basis.

Overall, for the Modified Side Channel Alternative there is likely to be a moderate additional cumulative effect on river channel geomorphology and channel migration rates.

4.6.5.8 Multiple Pump Alternative and Multiple Pumps with Conservation Measures Alternative

The Multiple Pump Alternative and Multiple Pumps with Conservation Measures Alternative would remove the Intake Diversion Dam. The weir has contributed slightly to cumulative adverse effects on geomorphology of the Yellowstone River with the presence of rock and an obstruction to flows.

With the likelihood of climate-induced changes and the potential for other changes in flows due to additional water withdrawals, there would likely be a minor reduction in peak and low flows. This could generally reduce channel bank-full area and reduce channel migration; but the net effect with these alternatives would be a minor reversal of cumulative effects on geomorphology. For the Multiple Pump Alternative, there would be a minor amount of rock installed to protect the outlets of the fish-return pipes, but the amount would be very small in comparison to the amount of rock that would be removed.

Overall, for the action alternatives that remove Intake Diversion Dam, there is likely to be a minor net reversal of cumulative effects on geomorphology that have occurred.

4.6.6 Actions to Minimize Effects

For any of the action alternatives, the following actions are recommended to minimize effects on the Yellowstone River geomorphology during construction and during long-term operation and maintenance:

- Ensure compliance with the provisions of Section 404 of the Clean Water Act for temporary or permanent discharges of dredge or fill material into waters of the U.S., include minimizing quantities of dredge or fill.
- Design coffer dams to obstruct the least amount of the channel or floodway to minimize the potential for affecting flood flows or ice jams and causing undesirable scour.
- Use additional crews and equipment during construction to minimize duration of in-water work and work within coffer dams to only one season if possible.

- Minimize the placement of rock and remove rock where feasible.

4.7 Water Quality

This section describes the potential effects that the Intake Diversion Dam fish passage alternatives could have on Yellowstone River water quality.

4.7.1 Area of Potential Effect

Impacts resulting from construction, operation, or maintenance of the proposed projects could affect the surface water quality of the Yellowstone River both directly and indirectly. The study area for water quality impacts varies among alternatives and types of effect. In most cases, the study area includes the area of activity within the water column or adjacent to the river, and downstream from that point for approximately 1,000 feet.

How far downstream effects are likely to extend must be evaluated by the type and intensity of effect. For example, small increases in turbidity could diminish rapidly downstream, while larger increases would take more time and distance to diminish. Conversely, if solids were introduced into the river, they would remain in the water until they were physically removed or abated by settling from the water column. Depending on where settling from suspension occurs, quality of slack-water habitat in the river could be affected.

4.7.2 Summary of Potential Effects

Table 4-24 summarizes the potential effects on water quality for each alternative. Details are provided in the following sections.

TABLE 4-24. SUMMARY OF POTENTIAL EFFECTS ON WATER QUALITY FROM EACH ALTERNATIVE

Impact Type	Level of Impact	Impact Description
No Action Alternative		
Construction Effects	No Effect	<ul style="list-style-type: none"> • No construction activities
Operational Effects	Major	<ul style="list-style-type: none"> • Continued presence of fish passage barrier results in failure to meet criteria for aquatic life beneficial uses
	Minor	<ul style="list-style-type: none"> • Continued placement of rock will cause temporary increases in turbidity on an annual basis.
Rock Ramp Alternative		
Construction Effects	Moderate	<ul style="list-style-type: none"> • Temporary increases in turbidity from installation and removal of coffer dams and placement of rock. Increases would occur multiple times over 2 year construction. • Potential for elevated pH from concrete pouring. • Potential for spills from equipment and stockpiled materials.
Operational Effects	Minor	<ul style="list-style-type: none"> • Temporary increases in turbidity from placement or reconfiguration of rock as needed to maintain ramp.
	Major (beneficial)	<ul style="list-style-type: none"> • Improving fish passage could remove 303(d) listing for nonsupport of aquatic life (beneficial)

Impact Type	Level of Impact	Impact Description
Bypass Channel Alternative		
Construction Effects	Moderate	<ul style="list-style-type: none"> • Temporary increase in turbidity from installation and removal of coffer dams during 2 year construction. • Potential for elevated pH from concrete pouring. • Negligible effects during bypass channel installation and removal of coffer dams; excavation of channel will be isolated from river. • Temporary increase in turbidity from first flush of bypass channel. • Negligible risk of contaminants in soils (new surface) for bypass channel due to coarse alluvium.
Operational Effects	Minor	<ul style="list-style-type: none"> • Temporary increases in turbidity from bypass channel repairs, including installation and removal of coffer dams.
	Major (beneficial)	<ul style="list-style-type: none"> • Improving fish passage could remove 303(d) listing for nonsupport of aquatic life (beneficial)
Modified Side Channel Alternative		
Construction Effects	Minor	<ul style="list-style-type: none"> • No activities at Intake Diversion Dam • Negligible effects during existing side channel installation and removal of coffer dams; excavation of channel will be isolated from river. • Temporary increase in turbidity from first flush of channel. • Negligible risk of contaminants in channel sediments (new surface) due to coarse alluvium. • Potential for elevated pH from concrete pouring associated with bridge, but will be isolated from the river.
Operational Effects	Minor	<ul style="list-style-type: none"> • Temporary increases in turbidity from modified side channel repairs, including installation and removal of coffer dams.
	Major (beneficial)	<ul style="list-style-type: none"> • Improving fish passage could remove 303(d) listing for nonsupport of aquatic life (beneficial)
Multiple Pump Alternative		
Construction Effects	Minor	<ul style="list-style-type: none"> • Temporary increase in turbidity from weir and rock removal over one season. • Temporary increases in turbidity associated with installation and removal of coffer dams for construction of feeder channels to pumping stations and first opening of channels. • Low risk of contaminants in soils at feeder channel locations due to coarse alluvium.
Operational Effects	Minor	<ul style="list-style-type: none"> • Temporary increases in turbidity from erosion and transport of sediment accumulated upstream of Intake Diversion Dam. • Temporary increases in turbidity for removal of sediments in feeder channels, typically a few days per year. • Temporary increases in turbidity for removal of sediments from Main Canal.
	Major (beneficial)	<ul style="list-style-type: none"> • Improving fish passage could remove 303(d) listing for nonsupport of aquatic life (beneficial)

Impact Type	Level of Impact	Impact Description
Multiple Pumps with Conservation Measures Alternative		
Construction Effects	Minor	<ul style="list-style-type: none"> • Temporary increase in turbidity from weir and rock removal over one season. • Temporary increases in turbidity in irrigation canal due to placement of check structures. • Potential for increased pH from concrete lining during construction of water conservation measures
Operational Effects	Minor	<ul style="list-style-type: none"> • Temporary increases in turbidity for removal of sediments from Main Canal.
	Major (beneficial)	<ul style="list-style-type: none"> • Improving fish passage could remove 303(d) listing for nonsupport of aquatic life (beneficial)

In 2009, when the initial alternatives were evaluated for fish passage at the Intake Diversion Dam, a series of representative sediment samples were collected at points upstream and downstream of the Intake Diversion Dam to determine if the sediment disturbance would introduce contaminants into the water column (Corps 2009). This analysis was conducted in accordance with the guidance prepared jointly by EPA and the Corps for the evaluation of dredged material proposed for discharge into inland Waters of the United States (1998). Locations were sampled and evaluated for potential contamination via an elutriate analysis. Three samples were taken downstream of the Intake Diversion Dam and five were taken from upstream of the dam (see Figure 4-4). Two of the upstream samples came from an island and the rest were from the river bed.

Results showed that no pesticides or PCBs were in the samples and that, in general, nutrient concentrations in the samples were similar to ambient concentrations in the river. This means that sediment disturbance under any proposed alternative would not be likely to introduce pesticides, PCBs, or nutrients into the water (Corps 2009).

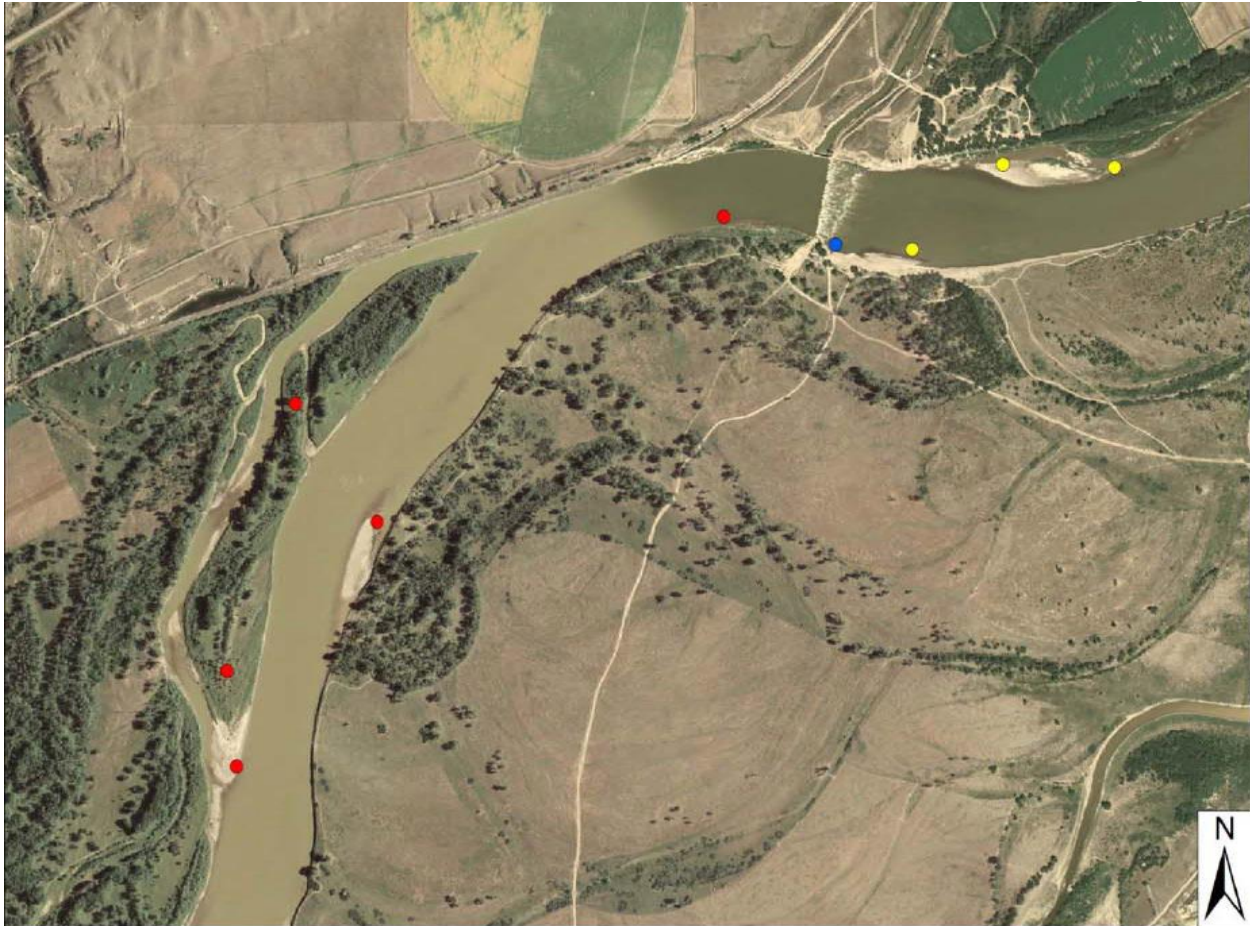

Figure 4-4. Sample Locations for Elutriate Sampling

Arsenic, lead, zinc, iron, manganese, aluminum, and ammonia were detected in one or more samples. Levels were below Montana water quality standards for arsenic, lead, zinc, aluminum, and ammonia. Iron and manganese were present at levels well above state standards. The presence of arsenic, lead, zinc, iron, manganese, and aluminum likely represents a natural condition associated with the geology and soils in the basin (Corps 2009).

4.7.3 Construction Effects

Construction effects on water quality will primarily result from the resuspension of fine sediments into the water column from in-water activities or runoff of sediment from adjacent work zones, resulting in increased turbidity. If pollutants such as metals are adsorbed to the sediment, they could cause a temporary increase in metals in the water column. This risk is low, as levels of metals are generally below state standards or result from natural sources.

Other sources of water quality pollutants could originate from construction equipment should spills occur or from elevated pH associated with concrete pouring. For all alternatives, actions will be taken to avoid, minimize, or contain potential contaminants during construction, including isolating in-water work zones with coffer dams.

4.7.3.1 No Action Alternative

Under the No Action Alternative, no construction would be undertaken and there would be no direct or indirect effects on water quality.

4.7.3.2 Rock Ramp Alternative

Under the Rock Ramp Alternative, construction of a replacement weir, placement of a gently sloping rock ramp consisting of large rocks and boulders, and installation of a temporary bridge or culverts spanning the LYP Main Canal all have the potential to re-suspend or release sediment into the water column.

Construction of the replacement weir would require the placement of at least two temporary cofferdams (first on one side, then the other side of the river), which would divert water around the construction work area. Excavation and dewatering, along with scouring river flows around the cofferdam, would likely re-suspend fine sediment into the water. Rock placement along the length of the rock ramp would also require disturbance to the river bottom and shoreline, and new rock materials may be placed under flowing river conditions. Sediment releases would occur during the placement and removal of the cofferdams and during in-water work on the rock ramp. In-water rock placement would be done when river flows are low, as practicable, to minimize transport of turbid water downstream.

The use of cofferdams would ensure that impacts on water quality are minimized. The construction of the replacement weir would be conducted in the dry to the maximum extent feasible to minimize any potential for leaching of concrete into the water column. There would likely be water within the coffer dammed area from seepage under the cofferdam. If this water is pumped out of the coffer dammed area, it should be pumped to a filtration area on land and not returned into the river. There is some risk of the cofferdams being overtopped during high flows, which could wash turbid or higher pH water into the river.

Overall, the release of sediment into the river would result in minor to moderate temporary effects on river water quality multiple times during the 2-year construction. Increased turbidity would be localized and temporary, since turbidity would settle and decline downstream through mixing and return to ambient area conditions. In addition, the Yellowstone River is naturally turbid, so it would not be substantially different from ambient conditions with the anticipated quantities of sediment during construction.

Access routes and staging or stockpiling areas would disturb soils and remove vegetation, increasing the potential for runoff of sediment into the river. Actions to minimize this potential would include the use of silt fencing, wattles and other containment measures to prevent runoff. Placing box culverts within the Main Canal to create a suitable bridge for transport of rock could temporarily increase sediment in the Main Canal. However, this construction could be completed when the canal is dry or has very low water (e.g., outside of the irrigation season). Sediment would settle out rapidly at low water levels and would result in no effect on water quality in the canal.

The removal of the coffer dams at completion of each segment of replacement weir construction would result in an initial flush of sediment into the river. This would be minimized through rapid removal of the cofferdams. Minor effects would result from localized, temporary increases in turbidity.

Cofferdams would only dewater a portion of the Yellowstone River, allowing flows to pass downstream through the study area throughout the construction period. This would ensure that no dewatering would occur downstream.

Construction materials and equipment would be managed to prevent or minimize the introduction of contaminants into the river. Trucks, graders, and other vehicles would be regularly inspected for leaks and would not be permitted to enter the water. Rocks used to build the rock ramp would be selected from uncontaminated sources and would be placed into the river when flows are low.

Turbidity could increase with the initial flush of spring flows through the study area following construction, but this would occur during the high turbidity runoff in the river. Effects would be minor due to their localized and temporary nature.

4.7.3.3 Bypass Channel Alternative

The Bypass Channel Alternative includes construction of a replacement weir. Effects on water quality would be similar to those described for the replacement weir component of the Rock Ramp Alternative above. Local and temporary increases in turbidity would be minor effects.

Excavation of a new bypass channel would be isolated from the river, with cofferdams used at the upstream and downstream ends of the bypass to keep flows from entering the channel throughout the construction period. Only negligible effects on water quality would result. Construction staging and access would be located on Joe's Island adjacent to the new bypass channel.

Construction materials and equipment would be managed to prevent or minimize the introduction of contaminants into the river. Trucks, graders, and other vehicles would be regularly inspected for leaks and would not be permitted to enter the water. Silt fences and other erosion control measures would prevent sediment and contaminants from washing into the water from staging and access zones. Stockpile areas would not be located in wetlands and would be covered as appropriate during construction to prevent erosion. These areas would be reseeded at the completion of construction to prevent wind and water erosion.

4.7.3.4 Modified Side Channel Alternative

The Modified Side Channel Alternative does not propose changes to the Intake Diversion Dam, so there would be no construction effects on the main river channel at this location.

All proposed construction would occur on Joe's Island, including excavation of the existing side channel, infill of portions of the channel, construction of a new permanent access road, and disposal of excavated materials at an upland disposal site. All work within the side channel would be isolated from the river, with cofferdams constructed at the upstream and downstream ends to ensure water does not enter the channel during the construction season. There would be only minor effects on water quality from the installation and removal of the cofferdams and the first flush of flows down the channel.

Construction materials and equipment would be managed to prevent or minimize the potential introduction of contaminants into the water, resulting in minor effects on water quality.

4.7.3.5 Multiple Pump Alternative

Under the Multiple Pump Alternative, the Intake Diversion Dam would be permanently removed and a reduced volume of gravity flow with pumping stations would provide the water needed for irrigation. The construction period would be about three years.

Construction of the pumping stations would be done during the first three years. The feeder canals connecting the river to the pumping stations would be constructed isolated from the river, using cofferdams or by leaving a “plug” of soil, and then connected to the river at completion. Areas disturbed for the pumping stations would have the potential for runoff of sediment into the river, but the use of silt fences or other isolation measures would prevent or minimize runoff. The final connection of the feeder canals to the river may release sediment into the water column on a localized and temporary basis, but it would affect a small area, resulting in negligible effects on water quality. Feeder canal sites have not been evaluated for contaminants. As many of the sites are on agricultural lands, there is a possibility that pesticides or fertilizers are present in the soils and could enter the water column. Due to the generally coarse alluvium along the river, this potential risk is low.

Removal of the Intake Diversion Dam would be done after completion of the pumping stations, in two phases, where cofferdams are constructed around half of the Intake Diversion Dam at a time, allowing removal work to be isolated from the river without dewatering the entire Yellowstone River. Using temporary cofferdams would have similar but shorter duration effects with minor effects on water quality, as described above for the construction of a replacement weir.

Construction and expansion of power utilities would be conducted well away from the river and would not have a measurable effect on water quality.

4.7.3.6 Multiple Pumps with Conservation Measures Alternative

The Multiple Pumps with Conservation Measures Alternative would remove the Intake Diversion Dam. Minor effects on water quality would result, similar to those described above for the Multiple Pump Alternative.

Water would be provided to the Main Canal through construction of 42 Ranney wells, in groups of six wells at each of seven sites between the headworks of the Main Canal and the town of Sidney. Construction of wells would not require any in-water work and would not have any effect on water quality.

This alternative also would include implementation of water conservation measures, such as lining the Main Canal and laterals, new structures within and extending from the Main Canal, more efficient center pivot sprinklers in agricultural fields, and groundwater pumps. Only construction undertaken within the Main Canal could have an impact on water quality. This work would most likely take place outside the irrigation season when the canal is partially or completely dry. Best management protocols would be implemented to ensure that there would be negligible effects on water quality.

4.7.4 Operational Effects

4.7.4.1 No Action Alternative

Continued operation and maintenance of the Intake Diversion Dam would include replenishment of rocks across the weir crest, which would disturb sediments and result in temporary and localized increases in turbidity. This is not a change from current conditions and would not result in any measureable change in water quality conditions. Fine sediment deposition upstream of the Intake Diversion Dam appears to be minor, likely due to frequent resuspension and transport during high-flow events.

Current water quality trends would be maintained into the future, with most parameters remaining well within state standards. Parameters that are known to exceed state standards would continue to be monitored by the state and other agencies. If the State of Montana determined that any parameter exceedances should be considered a priority—especially if on the CWA 303(d) list of impaired water bodies—then an implementation plan would be developed to abate sources of impairment, complying with any established total maximum daily loads. Current 303(d) listings that do not yet have established total maximum daily loads. Those that may be addressed in the future include chromium, copper, lead, TDS, pH, nitrogen, and phosphorous. Physical impairments that are also 303(d) listed and may warrant future attention include the presence of fish passage barriers, turbidity, and alteration of riparian or littoral vegetative covers.

Conditions affected by climate change include the potential of extreme events (e.g., floods and drought) that could occur on a more frequent basis and likely increased air and water temperatures. These events may alter ambient water quality conditions and need to be considered when implementing water quality management plans. These plans should include enough capacity to address increasing water temperatures, less available precipitation (drought), and less snowpack (lower water storage), all of which affect water quantity.

4.7.4.2 Rock Ramp Alternative

Following construction of the Rock Ramp Alternative, operation and maintenance needs could increase the potential for effects on water quality compared to existing conditions. Annual placement of rock at the weir would no longer be required, but the larger ramp would need maintenance, potentially on an annual basis to ensure fish passage. This could lead to short-term increases in turbidity. Because the Yellowstone River is naturally turbid, this is not expected to be more than a minor and temporary effect.

A direct benefit would be the improvements to fish passage at the Intake Diversion Dam within the new rock ramp. One of the reasons that the Yellowstone River does not meet beneficial uses for aquatic life is due to fish passage barriers; allowing fish to pass over the barrier would result in a major beneficial effect on aquatic life.

4.7.4.3 Bypass Channel Alternative

Construction of a replacement weir for the Bypass Channel Alternative would eliminate the annual placement of rock on the weir crest, but rock would likely need to be periodically (less than annually) placed between the replacement weir and existing weir, overall, reducing the potential for water quality impacts. This alternative would result in permanent loss or change of wetland habitats on Joe's Island. The final configuration of the new bypass channel, infilling of

the existing side channel, and permanent installment of stockpiles and haul roads would change or eliminate a variety of wetland types. Loss of side channel, backwater habitat, and wetlands would have indirect effects on water quality, as these areas provide benefits to aquatic life beneficial uses and to general water quality through trapping of sediment and contaminants.

Operation of the new bypass channel could result in temporary minor increases in turbidity, where the bypass channel joins the Yellowstone River. Initially, the first flush of the channel would scour loose fine sediment and release it downstream. The amount of sediment released into the water would be minimized by the armoring of the channel; a layer of cobble over the streambed and riprap at erodible river bends would reduce the potential for scour. However, these transient increases in turbidity are expected to rapidly mix with the river and not persist downstream. Subsequent high flows through the bypass would be expected to mimic the condition of any other natural side channel, contributing a normal amount of sediment to the water column. The overall effect of increased turbidity would be localized and temporary, representing a minor effect.

No studies have been done to determine contaminant levels of sediment within the proposed bypass channel location and the potential effect of exposing these sediments to the Yellowstone River is unknown.

Typical operation and maintenance activities on the channel would not likely be necessary every year and would include sediment/debris removal or placement of rock at outside bends or at buried sills. The work might require the installation of coffer dams to dewater the work zone, thus reducing the potential for turbidity. Additionally, the use of best management practices such as silt fencing would be employed to avoid and minimize effects on water quality. Riprap and other materials needed for maintenance would be obtained from a clean source and placed in the dry to the extent practicable.

A direct benefit would be the improvements to fish passage at the Intake Diversion Dam with the bypass channel. One of the reasons that the Yellowstone River does not meet beneficial uses for aquatic life is due to fish passage barriers; allowing fish to pass around the barrier would result in a major beneficial effect on aquatic life.

4.7.4.4 Modified Side Channel Alternative

Under the Modified Side Channel Alternative, operation and maintenance of the Intake Diversion Dam, headworks, and Main Canal would remain as under current conditions. Effects on water quality would be the same as described for the No Action Alternative.

As with the Bypass Channel Alternative, operation of the existing side channel would be subject to an initial flush of fine sediment once completed, which would result in slightly higher than normal turbidity. However, this would be rapidly mixed with the river downstream and not persist very far downstream. Subsequent high flows through the channel would be similar to natural levels. The potential increase in turbidity would be minor and temporary.

Operation and maintenance activities would be similar to those required for the bypass channel and would not likely be necessary every year. Actions would include sediment/debris removal or placement of rock at outside bends or at buried sills. The work might require the installation of

cofferdams to dewater the work zone, thus reducing the potential for turbidity. Additionally, the use of best management practices such as silt fencing would be employed to avoid and minimize effects on water quality. Riprap and other materials needed for maintenance would be obtained from a clean source and placed in the dry to the extent practicable.

No sampling has been done, to date, to determine contaminant levels of sediment within the proposed side channel location; however, it is not anticipated that contaminants are present beyond those sampled on Joe's Island, which are generally at levels below state standards.

The Modified Side Channel Alternative would result in the permanent loss of the channel and potential wetlands in the three meanders that would be cut off. However, this net loss would be minimal. An overall major beneficial effect would result to aquatic life beneficial uses, as the side channel would improve fish passage around the Intake Diversion Dam.

4.7.4.5 Multiple Pump Alternative

Removal of the Intake Diversion Dam under the Multiple Pump Alternative would result in a substantial reduction in maintenance needed in the river. Maintenance measures for the headworks and Main Canal would not change from existing conditions.

Operation and maintenance of the new pumping stations would likely require annual removal of sediment accumulated in the feeder canals and possible repairs or cleaning of the fish screens. These activities would likely occur at the beginning of the irrigation season when river flows are naturally turbid (prior to the beginning of runoff) and would only likely cause localized, temporary increases in turbidity. The sediment removed would be disposed of in an upland location and seeded to prevent runoff.

It is likely that occasional repair and replacement of riprap would be required along the river bank near each pumping station. This rock placement would likely occur at low flows to avoid and minimize effects on water quality. These maintenance activities would be conducted with best management practices to avoid and minimize water quality effects. Overall, the operation and maintenance of the Multiple Pump Alternative would likely only result in minor effects on water quality.

The pumping stations and feeder canals might cross or otherwise affect wetlands, resulting in a permanent change or loss of some wetland habitat; however, if this alternatives moves forward for further design, more detailed analysis would be conducted to ensure wetlands are avoided or effects minimized to the greatest extent practicable.

The sediment that has accumulated upstream of Intake Diversion Dam would likely erode and transport downstream over a period of a few years following removal of the weir. This transport of sediment is likely to cause temporary minor increases in turbidity.

A direct benefit would be restoring a natural channel to the river by removal of Intake Diversion Dam and allowing unhindered fish passage. One of the reasons that the Yellowstone River does not meet beneficial uses for aquatic life is due to fish passage barriers; allowing fish to pass over the barrier would result in a major beneficial effect on aquatic life.

4.7.4.6 Multiple Pumps with Conservation Measures Alternative

Removal of the Intake Diversion Dam under the Multiple Pumps with Conservation Measures Alternative would substantially reduce any O&M required in the river (only required at the headworks/screens).

As the Ranney Wells would be located well back from the river bank, there would be no potential for effect on water quality during operation and maintenance activities. As the Ranney Wells would be pumping groundwater that is likely directly connected to the river, they could slightly reduce flows in the river. However, much less water would be diverted for irrigation use in total, so this would be a negligible effect. Leaving more water in the river might slightly reduce thermal heating of the river.

Maintenance of new water conservation features would be conducted generally outside of the irrigation season, thus avoiding the potential for effects on water quality, although sediment removal could be required more frequently and could affect water quality. The effect of substantially reducing leakage and return flows from the irrigation system could reduce wetlands or reduce flows in some tributaries that receive return flows, thus potentially concentrating pollutants in the tributaries.

The sediment that has accumulated upstream of Intake Diversion Dam would likely erode and transport downstream over a period of a few years following removal of the weir. This transport of sediment is likely to cause temporary minor increases in turbidity.

A direct benefit would be restoring a natural channel to the river by removal of Intake Diversion Dam and allowing unhindered fish passage. One of the reasons that the Yellowstone River does not meet beneficial uses for aquatic life is due to fish passage barriers; allowing fish to pass over the barrier would result in a major beneficial effect on aquatic life.

4.7.5 Cumulative Effects

4.7.5.1 Geographic and Temporal Extent of Analysis

Cumulative changes to water quality were evaluated for the length of the Yellowstone River, from headwaters downstream to the Missouri River, and for the duration of the life of the project, a period of 50 years.

4.7.5.2 Methodology for Determining Effects

Cumulative effects on water quality were assessed based on combining the known impairments that have resulted from past actions, the impairments that could be occurring from current projects, and the potential for future impairments.

Water quality is especially subject to cumulative degradation, where the impairment of one parameter may contribute to the impairment of another. Detection of cumulative degradation is possible only with several years of monitoring to identify trends. Substantial cumulative effects would occur if existing water quality impairments were expected to worsen or if new impairments were caused.

4.7.5.3 Past, Present, and Reasonably Foreseeable Future Projects Considered

Past projects and activities that have had an effect on water quality in the Yellowstone River include irrigation, agricultural development, urbanization, industrial discharges, road and railroad construction and maintenance, and alterations to the Yellowstone River, such as construction of dams and irrigation diversions. The following future projects or trends could affect water quality:

- Crow Irrigation Project
- Crow Municipal, Rural and Industrial Water Project
- Crow Storage Allocation
- Yellowtail Afterbay Power Generation
- Continued Oil Development
- Climate Change
- Pipeline Spills

4.7.5.4 No Action Alternative

For the No Action Alternative, the presence of a fish passage barrier that adversely impacts aquatic life and other beneficial uses would continue. Combined potential effects of climate change and the relatively small reductions or changes in timing of flows resulting from the Crow Settlement, the Yellowtail Afterbay Power Generation project, and continued oil development could cause an increase in water temperatures over time and may reduce the volume of peak and low flows. This could cause increased concentrations of pollutants. It would result in a moderate cumulative effect on beneficial uses (fish passage) and a minor cumulative effect on water quality from changes in flow.

4.7.5.5 Rock Ramp Alternative

Construction of the rock ramp to improve fish passage would reduce fish passage barriers along the river, incrementally reducing adverse cumulative effects on aquatic life beneficial uses, causing a moderate beneficial effect. Construction of the replacement weir and operation and maintenance activities would result in minor increases in turbidity, but not at a level that would contribute to cumulative effects.

Combined potential effects of climate change and the relatively small reductions or changes in timing of flows resulting from the Crow Settlement, the Yellowtail Afterbay Power Generation project, and continued oil development could cause an increase in water temperatures over time and may reduce the volume of peak and low flows. This could cause increased concentrations of pollutants. It would result in a moderate cumulative effect on beneficial uses (fish passage) and a minor cumulative effect on water quality from changes in flow.

4.7.5.6 Bypass Channel Alternative

Construction of the bypass channel to improve fish passage would reduce fish passage barriers along the river, incrementally reducing adverse cumulative effects on aquatic life beneficial uses, causing a moderate beneficial effect. Construction of the replacement weir and operation and maintenance activities would result in minor increases in turbidity, but not at a level that would contribute to cumulative effects.

Combined potential effects of climate change and the relatively small reductions or changes in timing of flows resulting from the Crow Settlement, the Yellowtail Afterbay Power Generation project, and continued oil development could cause an increase in water temperatures over time and may reduce the volume of peak and low flows. This could cause increased concentrations of pollutants. It would result in a moderate cumulative effect on beneficial uses (fish passage) and a minor cumulative effect on water quality from changes in flow.

4.7.5.7 Modified Side Channel Alternative

Construction of the bypass channel to improve fish passage would reduce fish passage barriers along the river, incrementally reducing adverse cumulative effects on aquatic life beneficial uses, causing a moderate beneficial effect. Operation and maintenance activities would result in minor increases in turbidity, but not at a level that would contribute to cumulative effects.

Combined potential effects of climate change and the relatively small reductions or changes in timing of flows resulting from the Crow Settlement, the Yellowtail Afterbay Power Generation project, and continued oil development could cause an increase in water temperatures over time and may reduce the volume of peak and low flows. This could cause increased concentrations of pollutants. It would result in a moderate cumulative effect on beneficial uses (fish passage) and a minor cumulative effect on water quality from changes in flow.

4.7.5.8 Multiple Pump Alternative and Multiple Pumps with Conservation Measures Alternative

Removal of the Intake Diversion Dam and installation of pumping stations or Ranney wells would not contribute to adverse cumulative effects on water quality, as construction and operation and maintenance effects would be minor.

Major benefits would result to aquatic life beneficial uses from removal of the fish passage barrier entirely.

4.7.6 Actions to Minimize Effects

Under each alternative, several measures will be undertaken to avoid or minimize water quality impacts. Overall, construction and operation of any alternative are expected not to have greater than minor adverse effects on water quality. In general, the following measures will be employed at all alternatives, as applicable:

- A water quality monitoring program will be established for ensuring that water quality standards are not exceeded or elevated concentrations do not persist during construction activities.
- Equipment for handling and conveying materials during construction will be operated to prevent dumping or spilling the materials into wetlands and waterways.
- Discharges of dredge or fill material into waters of the U.S. will be carried out in compliance with provisions of Section 404 of the Clean Water Act, Corps permit requirements, and requirements contained in the Section 401 water quality certification issued by the Montana Department of Environmental Quality.
- Erosion control measures will be employed where necessary to reduce wind and water erosion. Erosion and sediment controls will be monitored daily during construction for effectiveness, particularly after storm events, and the most effective techniques will be used.

- Silt barriers, fabric mats, or other effective means will be placed on slopes or other eroding areas where necessary to reduce sediment runoff into stream channels and wetlands until vegetation is re-established. This will be accomplished either before or as soon as practical after disturbance activities.
- Contamination of water at construction sites from spills of fuel, lubricants, and chemicals will be prevented by following safe storage and handling procedures in accordance with state laws and regulations.
- Hazardous materials will be handled and disposed of in accordance with a hazardous waste plan.
- In-water work, such as installation and removal of cofferdams, will be done during lowest flows of the river, when practicable, to reduce disturbance of sediment into the water column.
- Quarried materials to be used for construction of the rock ramp will be free of contaminants and prepared to minimize introduction of sediment into the river.
- Any person, agency, or entity, both public and private, initiating construction activity that will cause short-term or temporary violations of state surface water quality standards for turbidity requires a state permit. The purpose of the permit is to provide a short-term water quality turbidity standard for construction activities, so that construction is carried out in accordance with conditions prescribed by the MTDEQ, to protect water quality and to minimize sedimentation. MTDEQ administers the permit, and its concerns regarding water quality, sedimentation, and the Intake Project have been addressed in this EIS.

4.8 Aquatic Communities

This section addresses the potential effects of each alternative on the aquatic community. Effects can be temporary or permanent. Temporary impacts are associated with initial construction or maintenance activities. Temporary impacts may include short-term changes in flows or water quality that affect the aquatic community. Permanent impacts are long-term impacts associated with the final constructed condition of permanent facilities or operation and maintenance activities throughout the period of analysis.

4.8.1 Area of Potential Effect

The area of potential effect for the aquatic community is the Yellowstone River from Cartersville Dam to its mouth at the Missouri River, and then the Missouri River from the Yellowstone River confluence to Lake Sakakawea.

4.8.2 Summary of Potential Effects

Table 4-25 summarizes the potential effects on aquatic communities for each alternative. Details are provided in the following sections.

TABLE 4-25. SUMMARY OF POTENTIAL EFFECTS ON AQUATIC COMMUNITIES FROM EACH ALTERNATIVE

Impact Type	Level of Impact	Impact Description
No Action Alternative		
Construction Effects	No Effect	<ul style="list-style-type: none"> • None
Operational Effects	Major	<ul style="list-style-type: none"> • Intake Diversion Dam would remain barrier to fish passage
	Minor	<ul style="list-style-type: none"> • Rock replenishment would disturb sediment • Entrainment of fish and eggs at headworks screens
Rock Ramp Alternative		
Construction Effects	Moderate	<ul style="list-style-type: none"> • Cofferdams increase velocities at fish screens • Cofferdams increase velocity and could hamper fish migration • Disturbed sediment from excavation and dewatering • Fish avoidance during pile driving and other in-water work
Operational Effects	Moderate	<ul style="list-style-type: none"> • Change in aquatic community due to change in substrate from cobbles to rock • Maintenance of rock ramp could disturb sediment and affect fish, mussels and macroinvertebrates • Entrainment of fish and eggs at headworks screens • Temporary cofferdams for O&M actions can prevent fish passage • Improves fish passage (beneficial)
	Major (beneficial)	
Bypass Channel Alternative		
Construction Effects	Moderate	<ul style="list-style-type: none"> • Cofferdams increase velocities at fish screens • Cofferdams increase velocity and could hamper fish migration • Disturbed sediment from rock placement, excavation and dewatering • Existing side channel isolated by cofferdams and filled • Fish avoidance during pile driving and other in-water work
Operational Effects	Moderate	<ul style="list-style-type: none"> • Rock placement along bends and banks would disturb sediment • Side Channel plug prevents passage • Entrainment of fish and eggs at headworks screens • Temporary cofferdams for O&M actions can prevent fish passage • Improves fish passage (beneficial)
	Major (beneficial)	
Modified Side Channel Alternative		
Construction Effects	Minor	<ul style="list-style-type: none"> • Fish caught in existing side channel • Fish avoidance during in-water work • Existing side channel isolated by cofferdams •
Operational Effects	Minor	<ul style="list-style-type: none"> • Riprap replacement and sediment removal disturb sediment • Entrainment of fish and eggs at headworks screens • Temporary cofferdams for major actions can prevent fish passage • Improves fish passage (beneficial)
	Major (beneficial)	

Impact Type	Level of Impact	Impact Description
Multiple Pump Alternative		
Construction Effects	Minor	<ul style="list-style-type: none"> • Cofferdams increase velocity at fish screen • Cofferdams increase velocity and could hamper fish migration • Sediment disturbed from Intake Diversion Dam removal • Fish avoidance during pile driving and other in-water work
Operational Effects	<p>Minor</p> <p>Major (beneficial)</p>	<ul style="list-style-type: none"> • Entrainment of fish at headworks/screens and pump screens • Surface pumps/screens could injure or entrain fish • Bank stabilization would disturb sediment • Reduced frequency of flows in side channel • Improved substrate/river conditions from removal of rock field (beneficial) • Improved fish passage (beneficial)
Multiple Pumps with Conservation Measures Alternative		
Construction Effects	Minor	<ul style="list-style-type: none"> • Intake Diversion Dam removal could increase sediment • Cofferdams increase velocity at fish screens • Cofferdams increase velocity and hamper fish migration • Fish avoidance during pile driving and other in-water work
Operational Effects	<p>Minor</p> <p>Major (beneficial)</p>	<ul style="list-style-type: none"> • Entrainment of fish at headworks/screens • Reduced return flows from LYP could dry up small tributaries or side channels • Improved substrate/river conditions from removal of rock field (beneficial) • Reduced frequency of flows in side channel • Improved fish passage (beneficial)

4.8.3 Construction Effects

4.8.3.1 No Action Alternative

Fish, Mussels, Macroinvertebrates

The No Action Alternative would not have any new construction elements; therefore, no effects from construction would occur for fish, mussels, and macroinvertebrates. Effects from the ongoing operation and maintenance of the LYP are discussed under Operational Effects.

Aquatic Invasive Species

Continuing present operations would probably have little effect on the spread of most aquatic invasive species. If Asian carp became established in the lower Yellowstone River, the Intake Diversion Dam would not be a barrier to the strong swimming fish. The Intake Diversion Dam would remain an important paddlefish angling area, and remain a high traffic area, and thus an area of increased risk for introduction of aquatic invasive species.

4.8.3.2 Rock Ramp Alternative

Fish

During construction of the Rock Ramp Alternative, coffer dams would be used to isolate various in-river work zones, thus diverting river flows from one side of the main channel to the other and increasing water depths and velocities in the river channel, thus potentially hindering fish

migration further over the existing weir during the 28 months of construction. This is likely to be a moderate effect on the fish community, such as for species such as paddlefish, blue sucker, sauger, channel catfish, and shovelnose sturgeon that migrate upstream, but already have some difficulty passing the existing weir. The existing side channel would remain accessible for fish to use when flows are sufficiently high (greater than 20,000 cfs), although it is not known to what extent fish use the side channel for passage.

Flow velocities at the headworks screens could decrease when the cofferdam is on the north half of the river, but could increase when the cofferdam is on the south half of the river. Increased velocities at the screens could increase the number of fish impinged on the screens of the new headworks.

Excavation and dewatering, along with scouring river flows around the cofferdam, would release sediment into the water. Increases in sedimentation and turbidity could cause a temporary adverse effect on fish populations, especially if it disrupted the spawning season. Most of the fish species in the lower Yellowstone River are adapted to highly turbid water; however, so construction-related effects on turbidity and sedimentation would likely have temporary and minor impacts on fish.

Noise from sheet pile driving for cofferdams may disturb fish and wildlife species. Noise attenuates through water in a straight line and dissipates when it encounters land. Thus, in a meandering river, the distance that noise would propagate is limited to the first bend upstream and downstream of the project area. It is anticipated that any fish within close proximity would immediately flee the area once construction equipment was mobilized to the site and activities such as moving rocks began to occur. Thus, injury is not generally anticipated. To minimize the potential for effects on fish and specifically, pallid sturgeon, no sheet pile driving or other in-river work would occur during the pallid sturgeon migration period (April 15 – July 1) and vibratory driving would be used to the maximum extent practicable. This would also reduce the likelihood of multiple other native fish species being present as several species also have similar migration periods to pallid sturgeon. Overall, noise from pile driving and other in-water work would represent a minor effect on fish species.

Mussels

Construction on the river bank could result in the loss of mussels found in the riverbank. The replacement weir and rock ramp placement could cover mussel beds in the 34-acre footprint above and below the replacement weir. Construction in this area would likely affect a small number of individuals, so the effect would be minor. Increased turbidity can decrease feeding efficiency of mussels, with the increase of inorganic particles with respect to food particles. Increased turbidity could also affect the fish that mussels use as hosts, causing them to avoid the area during construction. Other populations of mussels exist in the area, so effects on this population do not endanger the entire population. The small area affected and the temporary nature of the disturbance would make impacts minor.

Macroinvertebrates

Increased turbidity and suspended sediment could negatively affect macroinvertebrates. Some macroinvertebrates such as flies (*Diptera*), midges (*Chironomidae*) and earthworms (*Oligochaeta*) tolerate sediment suspension. However, the mayflies (*Ephemeroptera*) stoneflies

(*Plecoptera*), and caddisflies (*Trichoptera*) are not tolerant of sediment suspension. Even with actions to minimize effects, there may be short-term effects near construction activities, such as covering insect gills making respiration less efficient, raising water temperatures and thus decreasing dissolved oxygen, and filling interstitial space, thereby limiting refuge areas. These impacts are expected to be localized and temporary, and macroinvertebrate populations should recover quickly. Overall, by minimizing increased suspended solids and turbidity, seeding disturbed banks to minimize erosion, monitoring turbidity, and coordinating activity with fishery experts, long-term construction impacts would be minor.

Aquatic Invasive Species

Construction equipment can transport aquatic invasive species, and excavation can provide a pathway for dispersal and establishment of invasive plants. Aquatic or riparian invasive species that could be present or introduced at this project site include plants such as Russian olive, saltcedar, aquatic hydrilla, and water milfoil. Invasive species such as zebra mussel, quagga mussel, mudsnails, whirling disease, and iridovirus could be connected to equipment from previous uses. If disturbance were to allow the spread of these species, water quality could be severely diminished, agricultural production of surrounding areas could suffer, and ecological health of the entire river system could be jeopardized. With actions to minimize effects, such as inspecting, cleaning and drying all machinery, equipment, and materials and reseeding disturbed bank areas with native vegetation, long-term construction impacts on aquatic invasive species would be minor.

4.8.3.3 Bypass Channel Alternative

Fish

The Bypass Channel Alternative includes the construction of a replacement weir that would result in effects on water quality similar to those described above for the Rock Ramp Alternative; local and temporary increases in turbidity would have minor effects on fish. Increases in sedimentation and turbidity during construction could cause temporary adverse effects on aquatic organisms particularly if it occurred during the spawning season. Effects from increased sediment include reduced fish gill function, increased water temperature from sediment absorbing more sunlight and the resulting decrease in dissolved oxygen; increased nutrient pollution, as well as cavities being filled by sediment that would be otherwise be utilized by egg laying fish. Increased sedimentation can also impact behavior such as decreased vision and predator avoidance/prey capture abilities and decreasing functional feeding group diversity. However, most fish species in the lower Yellowstone River are adapted to highly turbid water, so construction-related effects on fish populations would likely be minor and temporary.

Coffer dams would be used to isolate the in-river work zone for construction of the replacement weir, diverting river flows from one side of the main river channel to the other and increasing water depths and velocities in the river channel, thus potentially hindering fish migration further over the existing weir during the one season of construction for the weir. This is likely to be a moderate effect on the fish community, such as for species such as paddlefish, blue sucker, sauger, channel catfish, and shovelnose sturgeon that migrate upstream, but already have some difficulty passing the existing weir. In addition, the existing side channel would be blocked off with coffer dams and the upper portion would be filled in, thus eliminating this alternate route for fish passage for 18 months until the bypass channel is complete. As the existing side channel

only currently has flows when river flows exceed 20,000 cfs (which does not occur every year), it is likely that blocking the side channel would only reduce accessibility for passage during one runoff season.

Fish remaining in the existing side channel after coffer dams are installed could be injured or killed if not removed before dewatering occurs. Removing fish will require pumps that have intakes screened with no greater than ¼-inch mesh. Pumping will continue until water levels within the contained areas are suitable for salvage of juvenile or adult fish of all species occupying these areas. Fish will be removed by methods approved by the Service and MFWP prior to final dewatering.

When cofferdams are in place for the replacement weir, it is likely that velocities at the headworks screens could decrease when the cofferdam is on the north half of the river, but could increase when the cofferdam is on the south half of the river. Increased velocities could increase the number of fish impinged on the screens of the new headworks.

Noise from sheet pile driving for cofferdams may disturb fish and wildlife species. Noise attenuates through water in a straight line and dissipates when it encounters land. Thus, in a meandering river, the distance that noise would propagate is limited to the first bend upstream and downstream of the project area. It is anticipated that any fish within close proximity would immediately flee the area once construction equipment was mobilized to the site and activities such as moving rocks began to occur. Thus, injury is not generally anticipated. To minimize the potential for effects on fish and specifically, pallid sturgeon, no sheet pile driving or other in-river work would occur during the pallid sturgeon migration period (April 15 – July 1) and vibratory driving would be used to the maximum extent practicable. This would also reduce the likelihood of multiple other native fish species being present as several species also have similar migration periods to pallid sturgeon. Overall, noise from pile driving and other in-water work would represent a minor effect on fish species.

Excavation of a new bypass channel would be conducted with cofferdams used at the up and down stream ends to keep high flows from entering the channel throughout the construction. This would limit the increased sediment in the river and would not impact fish.

Mussels

Filling of the existing side channel would bury mussels that utilize side channel habitat. Giant Floater (*Pyganodon grandis*) are a species that utilizes backwater habitat, but has not been found in the Yellowstone River main stem. Giant Floaters have only been found in three Yellowstone River Tributaries (O'Fallon, Little Porcupine, and Tongue Rivers). Since the existing side channel would not be considered habitat for native mussels, impacts would be minor.

In the main channel, construction on the river bank and replacement weir could result in the loss of mussels. Survey's found Fatmucket densities in the Missouri River and Marias River averaging between 7-8 mussels per hour. The Yellowstone River has a much lower mussel density overall, with survey rates for Fatmuckets averaging around one mussel per hour. The estimated number of mussels between the boat ramp and the Intake Diversion Dam was 24 individuals which is an insignificant number, considering the widespread population as a whole.

Macroinvertebrates

Construction of the replacement weirreplacement weir could disturb sediments and increase turbidity around the Intake Diversion Dam area. Increased turbidity and suspended sediment could negatively affect macroinvertebrates. Some macroinvertebrates tolerate sediment suspension such as flies (*Diptera*), midges (*Chironomidae*) and earthworms (*Oligochaeta*). However, the mayflies (*Ephemeroptera*) stoneflies (*Plecoptera*), and caddisflies (*Trichoptera*) are not tolerant of sediment suspension. Even with actions to minimize effects, there may be short-term effects near construction activities. These impacts are expected to be minor and temporary, and macroinvertebrate populations should recover quickly. Overall, by minimizing increased suspended solids and turbidity, seeding disturbed banks to minimize erosion, monitoring turbidity, and coordinating activity with fishery experts, long-term construction impacts would be minor.

Aquatic Invasive Species

Construction equipment can transport aquatic invasive species such as zebra mussels, quagga mussels, mud snails, whirling disease, iridovirus, and VHS. Excavation can provide a pathway for dispersal and establishment of invasive plants such as Russian olive and saltcedar, which already may be present at the site. With actions to minimize effects, such as inspecting, cleaning and drying all machinery, equipment, and materials as well as reseeding disturbed bank areas with native vegetation, long-term construction impacts on aquatic invasive species would be minor.

4.8.3.4 Modified Side Channel Alternative

Fish

For construction of the Modified Side Channel Alternative, the existing weir would remain as it currently is, so there would be no change for fish that currently pass upstream of the weir. Cofferdams would be installed at the upstream and downstream ends of the existing side channel to facilitate excavation. The cofferdams would immediately eliminate connectivity of the side channel with the river for the 18 months duration of construction, so impacts from introduced sediment and turbidity on water quality would be minor. However, the side channel would be inaccessible to fish for passage around the weir or for rearing and foraging. As the existing side channel only currently has flows when river flows exceed 20,000 cfs (which does not occur every year), it is likely that blocking the side channel would only reduce accessibility for passage during one runoff season which could have a minor effect on fish distribution and populations. The backwater habitat in the lower end of the existing side channel would be inaccessible for foraging throughout the 18 months of construction, which would also likely be a minor effect as other side channels or backwaters in close proximity would be available.

Fish located within the existing side channel would need to be removed prior to dewatering. Removing fish will require pumps that have intakes screened with no greater than ¼-inch mesh. Pumping will continue until water levels within the contained areas are suitable for salvage of juvenile or adult fish of all species occupying these areas. Fish will be removed by methods approved by the Service and MFWP prior to final dewatering.

Overall, with actions to minimize effects, such as minimizing increased suspended solids and turbidity, seeding disturbed banks to minimize erosion, monitoring turbidity, and coordinating

coffer dam construction activity with fishery experts, and using screens no greater than ¼ inch when dewatering, construction impacts to fish in the main channel of the river would be minor.

Mussels

Cofferdams would immediately eliminate connectivity of the side channel with the river for the duration of construction, so impact on native mussels in the main channel by increased turbidity and suspended sediment would be minimal.

Mussels located in the areas of the bend cutoffs would be covered and lost. This area has not been surveyed for mussels, however the only native mussel in the Yellowstone River is the Fatmucket, and it is Montana's most widespread and abundant mussel. The loss of mussels located in the existing side channel areas that are filled would be a minor impact.

Macroinvertebrates

Cofferdams would immediately eliminate connectivity of the side channel with the river for the duration of construction, so impact on macroinvertebrates by increased turbidity and suspended sediment by excavation and/or fill activities would be minimal.

Aquatic Invasive Species

Construction equipment can transport aquatic invasive species, and excavation can provide a pathway for dispersal and establishment of invasive plants. With actions to minimize effects, such as inspecting, cleaning and drying all machinery, equipment, and materials as well as reseeding disturbed bank areas with native vegetation, long-term construction impacts on aquatic invasive species would be minor.

4.8.3.5 Multiple Pump Alternative

Fish

The Multiple Pump Alternative would include removal of the Intake Diversion Dam. Increases in sedimentation and turbidity during Intake Diversion Dam removal could cause temporary adverse effects on fish particularly if it occurred during the spawning season. However, most fish species in the lower Yellowstone River are adapted to highly turbid water, so construction-related sediment and turbidity would have temporary and minor impact on fish populations.

Cofferdams would be used to isolate the in-river work zone for demolition and removal of the Intake Diversion Dam, minimizing water quality effects. Cofferdams would divert river flows from one side of the main river channel to the other and increase water depths and velocities in the river channel, thus potentially hindering fish migration further over the existing weir during the one season of construction for the weir removal. This is likely to be a moderate effect on the fish community, such as for species such as paddlefish, blue sucker, sauger, channel catfish, and shovelnose sturgeon that migrate upstream, but already have some difficulty passing the existing weir.

When cofferdams are in place for weir removal, it is likely that velocities at the headworks screens could decrease when the cofferdam is on the north half of the river, but could increase when the cofferdam is on the south half of the river. Increased velocities could increase the number of fish impinged on the screens at the headworks.

Noise from sheet pile driving for cofferdams may disturb fish and wildlife species. Noise attenuates through water in a straight line and dissipates when it encounters land. Thus, in a meandering river, the distance that noise would propagate is limited to the first bend upstream and downstream of the project area. It is anticipated that any fish within close proximity would immediately flee the area once construction equipment was mobilized to the site and activities such as moving rocks began to occur. Thus, injury is not generally anticipated. To minimize the potential for effects on fish and specifically, pallid sturgeon, no sheet pile driving or other in-river work would occur during the pallid sturgeon migration period (April 15 – July 1) and vibratory driving would be used to the maximum extent practicable. This would also reduce the likelihood of multiple other native fish species being present as several species also have similar migration periods to pallid sturgeon. Overall, noise from pile driving and other in-water work would represent a minor effect on fish species.

Cofferdams or other isolation measures would be necessary at the locations of each proposed pumping station/canal to allow excavation and grading of the new canal prior to connecting to the river. Temporary increased turbidity and suspended sediment would be a minimal impact to fish, as native species are accustomed to a somewhat turbid environment.

Mussels

Intake Diversion Dam removal could introduce sediment and negatively affect mussel beds and fish hosts, but these minor impacts would be short term, and the number of mussels projected to be in the Intake Diversion Dam area is approximately 24, a minor impact. Cofferdams at pumping station/canal sites would allow excavation and grading of the new canal prior to connecting to the river, thus limiting the amount of sediment escaping to the river, minimizing the impact on mussels.

Macroinvertebrates

Intake Diversion Dam removal would likely increase turbidity and suspended sediment, having a potential impact on macroinvertebrates. However, the increase would be temporary, so the effect would be minimal. Cofferdams at pumping station/canal sites would allow excavation and grading of the new canal prior to connecting to the river, thus limiting the amount of sediment escaping to the river, minimizing the impact on macroinvertebrates.

Aquatic Invasive Species

Construction equipment can transport aquatic invasive species, and excavation can provide a pathway for dispersal and establishment of invasive plants. With actions to minimize effects, such as inspecting, cleaning and drying all machinery, equipment, and materials as well as reseeding disturbed bank areas with native vegetation, long-term construction impacts on aquatic invasive species would be minor.

4.8.3.6 Multiple Pumps with Conservation Measures Alternative

Fish

Cofferdams would be used to isolate the in-river work zone for demolition and removal of the Intake Diversion Dam, minimizing water quality effects. Cofferdams would divert river flows from one side of the main river channel to the other and increase water depths and velocities in the river channel, thus potentially hindering fish migration further over the existing weir during the one season of construction for the weir removal. This is likely to be a moderate effect on the

fish community, such as for species such as paddlefish, blue sucker, sauger, channel catfish, and shovelnose sturgeon that migrate upstream, but already have some difficulty passing the existing weir.

When cofferdams are in place for the weir removal, it is likely that velocities at the headworks screens could decrease when the cofferdam is on the north half of the river, but could increase when the cofferdam is on the south half of the river. Increased velocities could increase the number of fish impinged on the screens at the headworks.

Increases in sedimentation and turbidity during Intake Diversion Dam removal could cause temporary adverse effects on fish, particularly if it occurred during the spawning season. However, most fish species in the lower Yellowstone River are adapted to highly turbid water, so construction-related effects on sediment and turbidity would have temporary and minor impacts on fish populations.

Noise from sheet pile driving for cofferdams may disturb fish and wildlife species. Noise attenuates through water in a straight line and dissipates when it encounters land. Thus, in a meandering river, the distance that noise would propagate is limited to the first bend upstream and downstream of the project area. It is anticipated that any fish within close proximity would immediately flee the area once construction equipment was mobilized to the site and activities such as moving rocks began to occur. Thus, injury is not generally anticipated. To minimize the potential for effects on fish and specifically, pallid sturgeon, no sheet pile driving or other in-river work would occur during the pallid sturgeon migration period (April 15 – July 1) and vibratory driving would be used to the maximum extent practicable. This would also reduce the likelihood of multiple other native fish species being present as several species also have similar migration periods to pallid sturgeon. Overall, noise from pile driving and other in-water work would represent a minor effect on fish species.

Construction of the Ranney wells would occur well away from the river outside of the channel migration zone, and so would have no effect on fish.

Construction of the conservation measures would generally occur outside of the irrigation season and would thus, not likely have any effect on fish.

Mussels

Sediment from Intake Diversion Dam removal could impact mussel beds by covering with sediment and affecting the fish used as hosts by larval mussels. These impacts would be short term, and likely affect a minimal number of mussels.

Macroinvertebrates

Intake Diversion Dam removal would likely increase turbidity and suspended sediment, having a potential impact on macroinvertebrates. However, the increase would be temporary, so the effect would be minimal.

Aquatic Invasive Species

Construction equipment can transport aquatic invasive species, and excavation can provide a pathway for dispersal and establishment of invasive plants. With actions to minimize effects, such as inspecting, cleaning and drying all machinery, equipment, and materials as well as

reseeded disturbed bank areas with native vegetation, long-term construction impacts on aquatic invasive species would be minor.

4.8.4 Operational Effects

4.8.4.1 No Action Alternative

Fish

Continued operation and maintenance of the Intake Diversion Dam would continue the ongoing major effect of the dam remaining as a barrier to fish passage, preventing or hindering upstream migration of numerous native fish species. Migrating Paddlefish will continue to aggregate in front of the Intake Diversion Dam. The use of the existing side channel by migrating Pallid Sturgeon has recently been documented, and this alternate route for passage would continue under the No Action Alternative.

Continued operation and maintenance of the Intake Diversion Dam would include replenishment of rocks across the weir crest. The resulting disturbance of sediments and temporary and localized increased in turbidity would not be a change from current conditions and would not result in any new effects on fish. Even if rock replenishment were to cease, the weaker swimming fish or those that avoid turbulence such as the pallid sturgeon, would still not likely be able to pass the structure.

The new headworks structure controls diversions of water into the canal and includes 12 removable rotating drum screens located in the river to minimize entrainment of fish greater than 40 mm long. Monitoring data from 2012-2014 has indicated that entrainment is still occurring but also indicates a change in the species composition and size of entrained fish in 2012 with 99 percent of the larval fish captured in the canal belonging to the Cyprinidae and Catostomidae families (predominantly minnows and carp) and typically in the 4-8 mm size range (Horn and Trimpe 2012). Raw data from 2013 and 2014 monitoring indicates similar results as in 2012.

Operation of the 12 removable rotating drum fish screens involves the screen cylinders rotating against fixed brushes to clean and remove debris that impedes flow through the screen and to remove fish and other aquatic organisms potentially impinged on the screens. This cleaning action would be an ongoing minor adverse effect as it likely injures or kills impinged organisms. In addition, other cleaning of larger debris may be required that would disturb sediments or require temporarily raising the screens, thus potentially causing greater entrainment of fish.

Mussels

Additional rock added as maintenance to the Intake Diversion Dam could increase turbidity and suspended sediment, thus temporarily affecting the mussels on the bottom of the river around the Intake Diversion Dam, and the fish they use as hosts in early stages of development. The total number of mussels in this area is small, so the impact would be minor.

Macroinvertebrates

Additional rock added to the Intake Diversion Dam would disturb sediment around the dam. Increased turbidity and suspended sediment can negatively affect those macroinvertebrates not

tolerant of such environments. This disturbance of sediments would not be a change from current conditions and would not result in any new effect on macroinvertebrates.

Aquatic Invasive Species

Continued rock replacement on the Intake Diversion Dam would continually bring truck traffic and potentially introduce exotic species. This potential disturbance would not be a change from current conditions and would not result in any new effect on aquatic invasive species.

4.8.4.2 Rock Ramp Alternative

Fish

The Rock Ramp Alternative would benefit fish by improving upstream passage. The reduced velocities and greater depths would improve fish passage compared to the No Action Alternative. Velocities over the existing Intake Diversion Dam are 8 feet per second, with depths of about 2.1 to 2.9 feet during flows of 15,000 cfs (median flows for the spring pallid sturgeon migration period (April through June)). Velocities in the notch with the proposed rock ramp at these same flows, would be 5.0 to 7.1 fps, with depths of 7.1 to 5.4 feet. The rock ramp would function like a long riffle, providing passage along with foraging and spawning habitat for a variety of fish species. Improved passage will provide access to approximately 165 miles of Yellowstone River habitat upstream of the Intake Diversion Dam and additional miles on tributaries such as the Powder River.

The Rock Ramp Alternative would improve passage for weaker swimming species, and by the juveniles of species that can already pass the Intake Diversion Dam, such as Sauger. Although Paddlefish can navigate the Intake Diversion Dam, and have been documented using the existing side channel (Rugg et al. 2016), their migration is still impeded somewhat by the existing weir (Firehammer and Scarnecchia 2006; Miller and Scarnecchia, 2008). The rock ramp would allow Paddlefish to migrate more easily upriver and benefit from the likely reduced fishing harvest in front of Intake Diversion Dam. The rock ramp would increase the range of flows in which fish can pass. The length of the rock ramp and the still relatively high velocities could be a problem for some fish (including Pallid Sturgeon), as most species would be required to swim at burst speed for the entire 1,200 feet of the rock ramp. It is also not known if there would be turbulent conditions that might discourage fish use. The existing side channel would continue to provide fish passage at high flows (i.e. Pallid Sturgeon were documented to pass upstream in the existing side channel at flows above 40,000 cfs [Rugg 2014, 2015]).

Maintenance of the rock ramp would require frequent placement or realignment of rock to ensure passage. This would likely require temporary cofferdam construction, which could disturb sediment and increase turbidity thus temporarily impacting fish. Most of the fish species in the lower Yellowstone River are adapted to highly turbid water, however, so maintenance-related effects on turbidity and sedimentation would likely have temporary and minor impacts on fish.

Maintenance of the 12 removable rotating drum fish screens involves the screen cylinders rotating against fixed brushes to clean and remove debris that impedes flow through the screen and to remove fish and other aquatic organisms potentially impinged on the screens. This cleaning action would be an ongoing minor adverse effect as it likely injures or kills impinged organisms. In addition, other cleaning of larger debris may be required that would disturb

sediments or require temporarily raising the screens, thus potentially causing greater entrainment of fish.

Mussels

Additional rock added as maintenance to the rock ramp could potentially increase the footprint on the river bottom, thus permanently affecting the individual mussels on the bottom of the river. The total number of mussels in this area is low, so the impact would be minor.

Macroinvertebrates

The rock ramp would convert approximately 32 acres of native bed materials (silts/sand/gravel) to large stones (riprap). This change in substrate would be highly localized and would change the type of macroinvertebrates present. However, large stones could provide more habitat for macroinvertebrates (a key source of food for fish) by increasing habitat complexity and fostering the growth of periphyton (an important food for macroinvertebrates). Short-term impacts to local populations might occur during construction, such as increased sediment, but the large increase in the amount of interstitial spaces resulting from the placement of stones for ramp construction would likely provide substantial short term improvement for macroinvertebrates. The interstitial spaces could eventually be silted in and negate this habitat boost, but this would be converting back to the original substrate type of low macroinvertebrate biomass production.

Aquatic Invasive Species

Improved fish passage under this alternative would have little effect on the spread of invasive aquatic invertebrates, fish diseases, or fish parasites as mechanisms of spread for invertebrates, parasites, and diseases are not inhibited by the Intake Diversion Dam. If invasive fish such as Asian Carp would become established, they would most likely be able to navigate the Intake Diversion Dam with or without improved passage. If an unknown invasive fish species that was not a strong swimming species became established in the lower Yellowstone River, improved passage at Intake would then increase the risk of dispersal.

Construction equipment used in maintenance to the rock ramp could transport aquatic invasive species, and disturbance can provide a pathway for dispersal and establishment of invasive plants. With actions to minimize effects, such as inspecting, cleaning and drying all machinery, equipment, and materials as well as reseeding disturbed bank areas with native vegetation, long-term impacts on aquatic invasive species would be minor.

4.8.4.3 Bypass Channel Alternative

Fish

Fish passage of all species is anticipated to increase with this alternative. Strong swimming fish such as adult Sauger currently pass upstream at the Intake Diversion Dam. The replacement weir would have slightly reduced velocities and greater depths through the low-flow notch than exists at the existing weir that may slightly facilitate passage by strong swimming fish. Velocities over the Intake Diversion Dam are more than 8 fps with depths of about 2.1 to 2.9 feet during flows of 15,000 cfs. The replacement weir would generally have velocities around 5 fps at 15,000 cfs, except closer to the banks, where velocities would be slightly lower at 5 fps (above 6 fps at flows at or above 30,000 cfs). Depths through the notch would be about 3.5 feet at low flows (7,000 cfs or less). At flows above 30,000 cfs, depths would be greater than 7 feet through the notch.

Passage may increase due to reduced velocities but could still be a barrier to weaker swimming fish like the pallid sturgeon.

The bypass channel would have lower flow velocities (>6 feet/second) under most flow conditions to accommodate weaker swimming fish such as pallid sturgeon and juvenile native fish. Paddlefish would most likely utilize the Bypass Channel and benefit from the non-aggregation in front of the Intake Diversion Dam. The Bypass Channel Alternative would not only increase the range of flows in which fish can pass, but it would provide passable flows in the bypass channel across all seasons, helping to accommodate a wide variety of species that migrate outside of the spring/summer high-flow window.

The entrance of the bypass channel would be just downstream of the current rock rubble field, thus maximizing likelihood of Pallid Sturgeon and other fish finding and utilizing the bypass to move upstream. Improved passage will provide access to approximately 165 miles of Yellowstone River habitat upstream of the Intake Diversion Dam and additional miles on tributaries such as the Powder River.

The construction of the replacement weir would eliminate the need to continuously place rock at the crest of the existing Intake Diversion Dam, reducing the impact to fish from disturbed sediment and increased turbidity.

Operation and Maintenance of the Bypass Channel Alternative would include rock replacement at the bends and along the banks and removal of sediment and debris. The work may be conducted using cofferdams that would temporarily isolate the channel and block access for fish, while reducing the potential for turbidity. Most of the fish species in the lower Yellowstone River are adapted to highly turbid water, so maintenance related effects on turbidity and sedimentation would likely have temporary and minor impacts on fish.

The filling in of the upper half of the existing side channel would eliminate approximately 1.5 miles of channel and change this side channel from a flow-through to a backwater channel. This would impact the organisms that utilize such off-channel habitats of large rivers. The constructed bypass channel has been designed to be within the range of slopes and substrate conditions of natural side channels but may not entirely replace the ecological niche of the natural side-channel. The backwater habitat in the lower end of the existing side channel would remain as backwater habitat available for fish use.

After filling, the natural side-channel will only flow during extreme high-flow events. When a high flows exceeds the 10-year flood event (87,600 cfs), some flows would begin to overtop the bypass channel and the banks of the Yellowstone River. These overtopping flows would flow onto and across Joe's Island and could potentially reach the lower half of the existing side channel, thus creating the potential for "attraction flows" for fish at the downstream end of the existing side channel, but not providing an upstream exit for fish.

Maintenance of the 12 removable rotating drum fish screens involves the screen cylinders rotating against fixed brushes to clean and remove debris that impedes flow through the screen and to remove fish and other aquatic organisms potentially impinged on the screens. This

cleaning action would be an ongoing minor adverse effect as it likely injures or kills impinged organisms. In addition, other cleaning of larger debris may be required that would disturb sediments or require temporarily raising the screens, thus potentially causing greater entrainment of fish.

Mussels

Maintenance of the replacement weir should involve much less rock so impacts to mussels would be minimal. Operation and Maintenance of the Bypass Channel Alternative would include rock replacement at the bends and along the banks. This could bury mussels that have started to utilize side channel habitat (*Giant Floaters*, *Pyganodon grandis*, in particular), thus permanently adversely affected individuals. The number of affected individuals is likely low, so impacts would be minor.

Macroinvertebrates

Rock replacement for maintenance along the bends and banks could disturb sediment and affect macroinvertebrates that are not tolerant of high turbidity. This impact would be localized and temporary and have minimal effect.

The new bypass channel would be armored with a layer of large gravel and cobble. This substrate would provide more habitat for macroinvertebrates as the amount of interstitial spaces resulting from the armor layer would likely provide substantial short term improvement for macroinvertebrates.

Aquatic Invasive Species

Construction equipment used in riprap replacement could transport aquatic invasive species, and disturbance can provide a pathway for dispersal and establishment of invasive plants. With actions to minimize effects, such as inspecting, cleaning and drying all machinery, equipment, and materials as well as reseeding disturbed bank areas with native vegetation, long-term impacts on aquatic invasive species would be minor. If an unknown invasive fish species that was not a strong swimming species became established in the lower Yellowstone River, improved passage at Intake would then increase the risk of dispersal

4.8.4.4 Modified Side Channel Alternative

Fish

Under this alternative, operation and maintenance of the Intake Diversion Dam, headworks, and Main Canal would remain as under current conditions. Effects on fish would be as described under the No Action Alternative. The Intake Diversion Dam will continue to be passage barrier to fish species migrating in the main channel of the Yellowstone River.

The Modified Side Channel Alternative would provide perennial flows that meet the BRT criteria for pallid sturgeon passage depths and velocities. Improved passage through the modified side channel will provide access to approximately 165 miles of Yellowstone River habitat upstream of the Intake Diversion Dam and additional miles on tributaries such as the Powder River. The sinuosity of the side channel is being reduced by cutting off three meander bends to ensure the channel meets the BRT criteria. However, backwater areas will be left where the bend cutoffs occur to provide habitat diversity and minimize the loss of channel length.

The entrance to the bypass channel would be 1.75 miles downstream of Intake Diversion Dam, which is not ideal, as fish may not be able to find the channel. Although, the existing side channel has been documented to be used by Pallid Sturgeon and other fish including Paddlefish, during high flows (>40,000 cfs), full utilization by Pallid Sturgeon and other native fish is still in question, given the large distance between the Intake Diversion Dam and the suitable bypass.

At the downstream end of the side channel, the presence and growth of islands has caused the left bank of the Yellowstone River to migrate laterally. This could change with the Modified Side Channel Alternative, given the increase in the frequency and volume of flows into the modified side channel, although it is not known if this would improve the potential for fish to find the channel, or not.

Operation and maintenance activities would include replacement of riprap along the modified side channel and removal of sediment and debris. Cofferdams might be used to isolate the work area, temporarily blocking access to the side channel. These activities would disturb sediment and temporarily increase turbidity, which can affect fish. Most of the fish species in the lower Yellowstone River are adapted to highly turbid water, so maintenance related effects on turbidity and sedimentation would likely have temporary and minor impacts on fish.

Maintenance of the 12 removable rotating drum fish screens involves the screen cylinders rotating against fixed brushes to clean and remove debris that impedes flow through the screen and to remove fish and other aquatic organisms potentially impinged on the screens. This cleaning action would be an ongoing minor adverse effect as it likely injures or kills impinged organisms. In addition, other cleaning of larger debris may be required that would disturb sediments or require temporarily raising the screens, thus potentially causing greater entrainment of fish.

Mussels

Increased fish use of the modified side channel would increase mussel populations in the modified side channel, as transport of mussel larvae is essentially facilitated by the use of fish as hosts to complete its life history.

Macroinvertebrates

Loss of macroinvertebrate habitat due to bend cutoffs would likely be offset by the new backwater areas. Faster and deeper water flowing through the modified side channel may change the species composition from turbid backwater species to more coldwater species, but this would not be an adverse effect.

Aquatic Invasive Species

Construction equipment used in riprap replacement could transport aquatic invasive species, and disturbance can provide a pathway for dispersal and establishment of invasive plants. With actions to minimize effects, such as inspecting, cleaning and drying all machinery, equipment, and materials as well as reseeding disturbed bank areas with native vegetation, long-term impacts on aquatic invasive species would be minor. If an unknown invasive fish species that was not a strong swimming species became established in the lower Yellowstone River, improved passage at Intake would then increase the risk of dispersal.

4.8.4.5 Multiple Pump Alternative

Fish

The Multiple Pump Alternative would include removal of the Intake Diversion Dam. Fish would greatly benefit from the free flowing river, allowing movement up and downstream by all species and of all age classes. Improved passage will provide access to approximately 165 miles of Yellowstone River habitat upstream of the Intake Diversion Dam and additional miles on tributaries such as the Powder River. The non-aggregation of Paddlefish at the Intake Diversion Dam would benefit the population.

The Multiple Pump Alternative would have an effect on the fish currently using the existing side channel for passage by reducing the frequency of flows into the existing side channel (flows would not occur in the channel until river flows reach 35,000 cfs). This effect would be minor, as the number of fish that currently use the existing side channel for passage is minimal, and the removal of the Intake Diversion Dam would provide ample passage potential.

Removal of the Intake Diversion Dam would result in a substantial reduction in required maintenance in the river, particularly since rock replenishment would no longer be necessary. Maintenance measures for the headworks and Main Canal would not change from existing conditions.

Removal of the Intake Diversion Dam would affect Paddlefish behavior, as they would not congregate downstream of the dam due to an inability to navigate the dam. This would most likely benefit the Paddlefish, as the congregating of individuals made them more easily caught by anglers.

The Multiple Pump Alternative would provide pumped flows into the Main Canal at five locations located 1, 8, 11, 11.2 and 11.5 miles downstream from the Intake Diversion Dam. Operation and maintenance of the pumping stations would require periodic removal of sediment from the feeder canals. This would be done at low water and sediment would be disposed in an upland site, however this action could be a source of added turbidity in the main channel of the river. Impact on fish would be temporary and localized and with actions to minimize effect such as minimizing increased suspended solids and turbidity, seeding disturbed banks to minimize erosion, monitoring turbidity, and coordinating coffer dam construction activity with fishery experts, and using screens no greater than ¼ inch when dewatering, would have only a minor effect, as most of the fish in the Yellowstone River are tolerant of high turbidity.

The pumps stations would be located on the outside bends of the river, which could increase fish entrainment, although the pumps would primarily be used in August and September when river flows are low. A trash rack structure would be constructed at the downstream end of each feeder canal and designed according to the NMFS fish passage facility design criteria. The trash rack is currently designed at 1 inch spacing which will keep the majority of the fish out of the feeder canal. There is still a possibility of fish being impinged on the trash racks depending on velocities in the feeder canals. The slope of the Yellowstone River is too flat to permit the use of a fish return channel or a gravity based pipe, so a fish handling pump is provided downstream of the fish screen to return juveniles to the river. The pump screens will meet the same standards as the headworks screens, designed to not entrain fish smaller than 40 mm.

The bank protection at each pump station would most likely require approximately 1000 feet of riprap installed on the river bank at each site, which could require frequent maintenance. The temporary increase in disturbed sediment from the placement of riprap could affect fish, but with actions to minimize effect, such as the use of silt curtains, reseeding disturbed banks with native vegetation and minimizing the increase of suspended solids, and monitoring turbidity, the impact should be minor.

Maintenance of the 12 removable rotating drum fish screens involves the screen cylinders rotating against fixed brushes to clean and remove debris that impedes flow through the screen and to remove fish and other aquatic organisms potentially impinged on the screens. This cleaning action would be an ongoing minor adverse effect as it likely injures or kills impinged organisms. In addition, other cleaning of larger debris may be required that would disturb sediments or require temporarily raising the screens, thus potentially causing greater entrainment of fish.

Mussels

Periodic removal of sediment from the pumping station feeder canals, and the placement of riprap to stabilize the bank in order to protect the pumping stations would both disturb sediment which could temporarily impact mussels on the main channel bottom. Mussel populations have not been surveyed for in these areas, but the species most likely encountered would be the fatmucket, which is the most widespread and abundant mussel in Montana. With actions to minimize effects, such as minimizing increased suspended solids and turbidity, seeding disturbed banks to minimize erosion, monitoring turbidity, and coordinating activity with fishery experts, impact from maintenance actions on mussel populations would be minor.

Macroinvertebrates

Sediment passes through the rocks of the Intake Diversion Dam and does not substantially build up behind the dam. Therefore, dam removal would not release built up sediment that could otherwise potentially impede macroinvertebrate recovery (Orr et al. 2008; Chiu 2013). The likely remaining substrate of the channel bed would include foundational timber piles and riprap, which would be a suitable substrate with suitable interstitial space to foster macroinvertebrate production.

Periodic removal of sediment from the pumping station feeder canals, and the placement of riprap to stabilize the bank in order to protect the pumping stations would both disturb sediment, increase turbidity and impact macroinvertebrates. The effect would be temporary and localized and only effect those species susceptible to turbidity, such as the mayflies (Ephemeroptera) stoneflies (Plecoptera), and caddisflies (Trichoptera). Overall impacts to macroinvertebrates from operation and management of the Pump Site Alternative, with actions to minimize effect, such as minimizing increased suspended solids and turbidity, seeding disturbed banks to minimize erosion, monitoring turbidity, and coordinating activity with fishery experts, impacts would be minor.

Aquatic Invasive Species

Construction equipment used in riprap replacement could transport aquatic invasive species, and disturbance can provide a pathway for dispersal and establishment of invasive plants. With

actions to minimize effects, such as minimizing increased suspended solids and turbidity, seeding disturbed banks to minimize erosion, monitoring turbidity, and coordinating activity with fishery experts, long-term impacts on aquatic invasive species would be minor. If an unknown invasive fish species that was not a strong swimming species became established in the lower Yellowstone River, improved passage at Intake would then increase the risk of dispersal.

Without the Intake Diversion Dam, paddlefish would most likely not congregate where they have since the dam was built. This would limit the traffic to the area by fishermen, and remove some of the potential risk of introducing aquatic invasive species to the river.

4.8.4.6 Multiple Pumps with Conservation Measures Alternative

Fish

Removal of the Intake Diversion Dam would provide substantial benefits to fish from the free flowing river allowing movement up and downstream by all species and of all age classes. Improved passage will provide access to approximately 165 miles of Yellowstone River habitat upstream of the Intake Diversion Dam and additional miles on tributaries such as the Powder River.

The removal of the dam would affect the existing side channel by reducing the frequency of flows into the side channel (would only receive flows when river flows are >35,000 cfs), and impact fish currently using the side channel for passage. This effect would be minor as removal of the Intake Diversion Dam would substantially improve fish passage through the main river channel, and current use of the side channel for passage appears to be minimal.

It is unclear how the headworks/screens would operate with reduced flows into the Main Canal, but would likely be reconfigured and would still entrain some larval fish and eggs.

Removal of the Intake Diversion Dam would no longer hinder Paddlefish; the non-aggregation of Paddlefish in front of the Intake Diversion Dam would most likely benefit the population by reducing harvest.

For the Multiple Pumps with Conservation Measures Alternative, Ranney wells would be located out of the river floodplain, so maintenance of the well sites would have no effect on fish.

The reduced diversion into the canal of 608 cfs would leave more water in the main channel of the Yellowstone River. This would have a moderate beneficial effect on fish by likely reducing pollutant concentrations and increasing connectivity to side channel habitats.

Mussels

Ranney well sites would be located out of the floodplain, so operation and maintenance procedures would have no effect on mussels in the river.

Macroinvertebrates

Removal of the Intake Diversion Dam would have same effects on macroinvertebrates as described above for the Multiple Pump Alternative. Ranney wells being located out of the

floodplain mean operational and maintenance actions would have no effect on macroinvertebrates in the river.

Aquatic Invasive Species

Similar to the Multiple Pump Alternative, angler pressure would be less due to Paddlefish non-aggregation in front of the Intake Diversion Dam leading to less potential risk of aquatic invasive species introduction. If an unknown invasive fish species that was not a strong swimming species became established in the lower Yellowstone River, improved passage at Intake would then increase the risk of dispersal.

4.8.5 Cumulative Effects

4.8.5.1 Geographic and Temporal Extent of Analysis

Cumulative impacts are considered in the Yellowstone River watershed in Montana from the Cartersville Dam to the mouth into the Missouri River, and the Missouri River up to Lake Sakakawea in North Dakota for the duration of the life of the project, a period of 50 years.

4.8.5.2 Methodology for Determining Effects

Cumulative effects on the aquatic community include the suite of impacts that have resulted, or would result, from the continued and overlapping development for human use. The cumulative effects the aquatic community are determined by assessing the impacts resulting from past projects, current projects, and project that are reasonably expected to occur in the future. These are then combined with the effects assessed above for each proposed alternative to get a sum total of cumulative effects.

4.8.5.3 Past, Present, and Reasonably Foreseeable Future Projects Considered

The Yellowstone River remains the longest un-impounded river in the contiguous United States and has the highest fish species richness in Montana. Past and present actions have impacted the aquatic community. Anthropogenic impacts affecting the Yellowstone River aquatic community include altered hydrograph, altered geomorphology, altered riparian vegetation and wetlands, altered land use, altered connectivity, altered water quality, introduced species, and recreational fishing. New agricultural conversion in the study area continues a trend toward more irrigated agriculture.

Reasonably foreseeable future projects and actions include Missouri River Recovery Management Plan, Fort Peck Dry Prairie Regional Water System Improvements, and Yellowtail Afterbay Hydropower Project, and Crow Irrigation Project 405 and 406) (see section 4.1.3 for descriptions of projects/actions). The Missouri River Recovery Management Plan could modify how river management meets the specific needs of species of concern. Consequently the resources devoted to these species may shift and influence their further protection or lack thereof. Fort Peck Dry Prairie Regional Water System Improvement, the Yellowtail Afterbay Hydropower Project, and the Crow irrigation Project would increase the use of water from the Yellowstone River watershed and further regulate the flows of the river, inherently impacting the aquatic community by limiting the natural processes of the river, such as channel meandering, nutrient exchange with the floodplain, and diverse habitat development and turnover.

General trends considered for the evaluation of the cumulative impact to the aquatic community include further development of Bakken oil fields, increases in pivot irrigation and bank armoring, general urbanization and climate change. The Bakken oil field development, along with general urbanization trends increase the need for water use and flood protection as the Yellowstone River Valley become more developed. Increases in bank armoring and pivot irrigation further reduce channel migration and the formation of aquatic habitats. Climate change could bring changes such as increased drought, more variability in extreme flows (both low and high), and earlier and reduced runoff from reduced snowpack.

4.8.5.4 No Action Alternative

The presence of the Intake Diversion Dam and the diversion of water has contributed to cumulative effects on fish by reducing passage of pallid sturgeon and other species. The Crow Irrigation Project, Yellowtail Afterbay Hydropower Project, and Fort Peck Dray Prairie could incrementally affect the aquatic community by withdrawing more water for irrigation and municipal/industrial uses. Climate change and ongoing trends of use of groundwater for oil and gas development and surface water for municipal purposes could also contribute minor additional cumulative effects. Overall, for the No Action Alternative, there is not likely to be more than minor additional cumulative effects to fish.

The No Action Alternative would not contribute to cumulative effect son mussels, macroinvertebrates, or aquatic invasive species.

4.8.5.5 Rock Ramp Alternative

Under the Rock Ramp Alternative, cumulative effects on fish would be incrementally reduced as passage for migrating fish would be facilitated across the replacement weir. Even with the minor contributions of additional water withdrawals and climate change trends, the Rock Ramp Alternative is not likely to contribute to additional cumulative effects. This alternative will not add to cumulative impacts to mussels, macroinvertebrates, or aquatic invasive species.

4.8.5.6 Bypass Channel Alternative

Under the Bypass Channel Alternative, cumulative effects on fish would be incrementally reduced as passage would be improved substantially. There would also be both the filling of the existing side channel and creation of the new bypass channel, generally balancing area of channel, but reducing natural channel migration. This action, in combination with projects that increase water withdrawals for oil and gas, municipal, or agricultural uses, would continue a trend toward decreasing the potential of the river to create and sustain natural habitats, thus contributing to a minor increase in cumulative effects.

This alternative would not contribute to cumulative effects on mussels, macroinvertebrates, or aquatic invasive species.

4.8.5.7 Modified Side Channel Alternative

Under the Modified Side Channel Alternative, cumulative effects on fish would be incrementally reduced as passage would be improved. The side channel would be changed to provide perennial flows and suitable depths and velocities for fish passage across a wide range of flows, but would have reduced channel migration. This action, in combination with projects that increase water

withdrawals would continue a trend toward decreasing the potential of the river to create and sustain natural habitats, thus contributing to a minor increase in cumulative effects..

Actions under the Modified Side Channel Alternative would not contribute to ongoing or future cumulative effects on mussels, macroinvertebrates, or aquatic invasive species.

4.8.5.8 Multiple Pump Alternative

Under the Multiple Pump Alternative, cumulative effects on fish would be incrementally reduced as removal of the weir and rock rubble field would remove a fish passage barrier. There would be an increased likelihood of entrainment of fish at the pumps, but this is a negligible effect in comparison to the dramatically improved fish passage. Even in combination with projects that increase water withdrawals, this alternative would likely result in a minor net reduction of cumulative effects.

Under the Multiple Pump Alternative, there would be no contribution to cumulative effects on fish, mussels, macroinvertebrates, or aquatic invasive species.

4.8.5.9 Multiple Pumps with Conservation Measures Alternative

Under the Multiple Pumps with Conservation Measures Alternative, cumulative effects on fish would be incrementally reduced as removal of the weir and rock rubble field would remove a fish passage barrier. Even in combination with projects that increase water withdrawals, this alternative would likely result in a minor net reduction of cumulative effects.

This alternative would not contribute to any ongoing or future cumulative effects on mussels, macroinvertebrates, or aquatic invasive species.

4.8.6 Actions to Minimize Effects

4.8.6.1 General

- All work in the river will be performed in a manner to minimize increased suspended solids and turbidity, which may degrade water quality and damage aquatic life outside the immediate area of operation.
- All areas along the bank disturbed by construction will be seeded with native vegetation to minimize erosion.
- All contractors will be required to inspect, clean and dry all machinery, equipment, materials and supplies to prevent spread of Aquatic Nuisance Species.
- Aspects of water quality, including turbidity, will be monitored during construction, and violations of turbidity thresholds will result in temporary shutdown of in-water work.

4.8.6.2 Fish

- To avoid potential impacts, cofferdam construction and in-stream heavy equipment activity will be conducted outside of the pallid sturgeon migration season and minimized as feasible to avoid and or minimize potential impacts.
- All pumps will have intakes screened with no greater than ¼-inch mesh when dewatering cofferdam areas in the river channel. Pumping will continue until water levels within the contained areas are suitable for salvage of juvenile or adult fish occupying these areas.

Fish will be removed by methods approved by the Service and MFWP prior to final dewatering.

- Reclamation will implement a monitoring and adaptive management plan to evaluate the success of any of the alternatives if they were constructed and implement measures to improve success if problems are identified. A draft Monitoring and Adaptive Management Plan is attached as Appendix E.

4.9 Wildlife

This section addresses the potential effects of each alternative on wildlife.

4.9.1 Area of Potential Effect

The area of potential effect for wildlife is described within the discussion for each alternative. In general, the area of potential effect for the No Action Alternative, Rock Ramp Alternative, Bypass Channel Alternative, and Modified Side Channel Alternative includes the area surrounding the Intake Diversion Dam and headworks, Joe’s Island, the existing rock quarry, and interconnecting access roads (note that specifics are defined for each; see discussion below). The area of potential effect for the Multiple Pump Alternative and Multiple Pumps with Conservation Measures Alternative further include the LYP system, pumping sites, and the interconnected access roads in the area. Off-site areas included in each alternative, such as wind farms, commercial rock quarries, and rail lines, are not included in this analysis because they are assumed to already be operating under permit.

4.9.2 Summary of Potential Effects

Table 4-26 summarizes the potential effects on wildlife for each alternative. Details are provided in the following sections.

Projected quantified changes in specific habitat types due each alternative are presented in Section 4.11; *Lands and Vegetation*, below. Non-federally protected wildlife species associated to each habitat are listed in Section 3.8; *Wildlife*, above.

TABLE 4-26. SUMMARY OF POTENTIAL EFFECTS ON WILDLIFE FROM EACH ALTERNATIVE

Impact Type	Level of Impact	Impact Description
No Action Alternative		
Construction Effects	None	NA
Operational Effects	Negligible	<ul style="list-style-type: none"> • Rock extraction from the existing quarry, transport, and deposition for Intake Diversion Dam maintenance. • Maintenance activities in the Main Canal would remove vegetation

Impact Type	Level of Impact	Impact Description
Rock Ramp Alternative		
Construction Effects	Minor	<ul style="list-style-type: none"> Disturbance from construction activities primarily surrounding the access roads. Potential for injury or mortality of wildlife due to construction activities, primarily from vehicle strikes.
Operational Effects	Minor	<ul style="list-style-type: none"> Minor habitat loss and degradation at both poor quality sites surrounding the Intake Diversion Dam, as well as likely high-quality sites along access roads. Disturbance from maintenance activities at existing rock quarry and the various access roads. The maintenance of the headworks and Intake Diversion Dam are anticipated to cause minimal impacts to wildlife. Maintenance activities in the Main Canal would remove vegetation
Bypass Channel Alternative		
Construction Effects	Moderate	<ul style="list-style-type: none"> Disturbance from construction activities to multiple wildlife habitats found on Joe's Island and surrounding the access roads to Glendive.
Operational Effects	Moderate	<ul style="list-style-type: none"> Conversion of wetland, woody riparian, barren land, shrubland, and grassland habitats. Including a diversity of relatively high quality patches. Disturbance from maintenance activities at existing rock quarry and access roads connecting them to maintenance sites. The maintenance of the headworks and Intake Diversion Dam are anticipated to cause minimal impacts to wildlife. Maintenance activities at the bypass channel could remove vegetation Maintenance activities in the Main Canal would remove vegetation
Modified Side Channel Alternative		
Construction Effects	Moderate	<ul style="list-style-type: none"> Disturbance from construction activities to wildlife habitats found on Joe's Island and surrounding the access roads that would be used.
Operational Effects	Moderate	<ul style="list-style-type: none"> Conversion of wetland, woody riparian, barren land, shrubland, and grassland habitats, including a diversity of relatively high quality patches. Disturbance from enhanced public access for recreation. Disturbance from maintenance activities at the existing rock quarry and the access roads enhanced or constructed for this alternative. The maintenance of the headworks and Intake Diversion Dam are anticipated to cause minimal impacts to wildlife. Maintenance activities in the modified side channel could remove vegetation or place fill in wetlands. Main Canal Maintenance activities in the Main Canal would remove vegetation.
Multiple Pump Alternative		
Construction Effects	Moderate	<ul style="list-style-type: none"> Disturbance and removal of vegetation from construction activities to wildlife habitats found around the Intake Diversion Dam, the LYP system, along access roads, and at the five locations of the pump sites.
Operational Effects	Moderate	<ul style="list-style-type: none"> Permanent loss of patches of woody riparian at the pump sites. Disturbance from maintenance activities at the pump sites. Main Canal Maintenance activities in the Main Canal would remove vegetation The maintenance of the headworks is anticipated to cause minimal impacts to wildlife.

Impact Type	Level of Impact	Impact Description
Multiple Pumps with Conservation Measures Alternative		
Construction Effects	Moderate	<ul style="list-style-type: none"> • Disturbance and removal of vegetation from construction activities to wildlife habitats found around the Intake Diversion Dam, the LYP system, along access roads, and at the locations of the pump sites.
Operational Effects	Moderate	<ul style="list-style-type: none"> • Permanent loss of patches of woody riparian at the placement of the pump sites. • The proposed water conservation measures would likely result in a large reduction of wetland habitat supported by seepage or return flows from the irrigation canals. • Disturbance from maintenance activities at pump stations and throughout the LYP system. • Main Canal Maintenance activities in the Main Canal would remove vegetation

4.9.3 Construction Effects

4.9.3.1 No Action Alternative

No effects on wildlife would occur from construction activities under the No Action Alternative, as no construction is proposed.

4.9.3.2 Rock Ramp Alternative

The primary source of impacts to wildlife from the Rock Ramp Alternative would be associated with the large amount of rock and concrete required to be transported to the construction site and deposited into the river to form the rock ramp. This is assuming the rock would be quarried from existing commercial quarries and transported to Glendive by train, and concrete would be produced in Glendive. The potentially large number of truck transport trips between Glendive and the construction site, raise the likelihood for disturbance and harm to wildlife from this alternative. Unlike the low quality habitat present immediately surrounding the Intake Diversion Dam and headworks, habitat surrounding the access roads that would be either be enhanced or constructed is higher in quality and likely hosts a greater diversity of wildlife, increasing the potential for disturbance and/or harm.

All anticipated impacts to wildlife from the Rock Ramp Alternative would be concentrated in Dawson County, Montana, and likely cause the degradation of County-regulated and protected wildlife resources, including; big game winter range, waterfowl nesting areas, habitat for rare or endangered species, and wetlands (see 3.8) (Dawson County, Unknown year; MFWP 2012). Big game winter range for mule deer, white-tailed deer, and pronghorn, which all occur in the project area and would be degraded by the Rock Ramp Alternative, are also protected by the State of Montana (MFWP 2012).

Construction effects would be limited to areas surrounding the Intake Diversion Dam, including the irrigation canal and headworks, but would also extend to Glendive and the access roads connecting it to the construction site. In general, the area around the existing headworks is disturbed and altered by prior human activities and provides only low quality wildlife habitat, precluding its use by most native species. In particular, the staging areas and sites for rock unloading and stockpiling have been substantially degraded by past construction activities and

ongoing maintenance and operations actions. Areas adjacent to and surrounding the access roads include patches of higher quality, more diverse habitat, and constitute a relatively large area, increasing the potential to affect wildlife present in these areas during construction.

Impacts to wildlife would generally result from disturbance and habitat degradation. It is anticipated that specific sources of disturbance would stem from pile driving noise, construction vehicle traffic, heavy equipment operation, vegetation clearing, quarry activities, concrete production and placement, and the general presences of humans. Although these disturbances are anticipated to be restricted to daylight hours and non-winter months, they would nonetheless occur during seasonal periods of peak wildlife use, and last two of the three years of the project. Pile driving noise is unusual and may result in more disturbance to wildlife than other vehicle or equipment noise, thus sensitive resources such as active nests should be identified by a pre-construction survey and protected by fencing and other measures to reduce disturbance.

Wildlife disturbed by the construction activities would be displaced from the area. Disturbance around the access roads may affect a diversity of wildlife, whereas disturbance around the Intake Diversion Dam would likely cause negligible disturbance. Sage grouse, if present, are well known to be sensitive to disturbance by large equipment use and construction activities such as those related to roadwork and rock quarries (summarized in Service 2015). This species, however, is likely not present in the study area (MSGWG 2005) and would not be disturbed by this alternative. In general, it is anticipated that displaced wildlife would move unharmed into adjacent areas.

The Rock Ramp Alternative is not anticipated to cause substantial direct harm to wildlife populations. This is assuming biological surveys identifying wildlife in impact areas would precede construction activities and allow the wildlife present to either be safely displaced from the area or provided a protective buffer. The potential for individuals to be harmed or killed by the movement of equipment remains, especially from vehicle strikes. This potential may be great considering the large number of trucking trips to the construction site from Glendive, as well as the long duration of the proposed project. Wildlife of particular concern from vehicle strikes include various ungulates such as big game species (MFWP 2012), as well as birds protected under the Migratory Bird Treaty Act (MBTA).

4.9.3.3 Bypass Channel Alternative

Loss of a diversity of high-quality habitat patches would be the most substantial effect on wildlife under the Bypass Channel Alternative, while disturbance from construction activities, which would last up to three years, would also result in major impacts.

Joe's Island, which would be fundamentally altered by the Bypass Channel Alternative, is the primary area that would be affected by this alternative, although impacts would also extend beyond the Island to the existing rock quarry, as well as to Glendive and the access roads connecting it to the construction area. This is assuming the rock would be quarried from existing commercial quarries and transported to Glendive by train, and concrete would be produced in Glendive. The potentially large number of truck transport trips between Glendive and the construction site raise the likelihood for disturbance and harm to wildlife from this alternative. Joe's Island and adjacent mainland include all wildlife habitats found in the greater study area. Because they are relatively high in quality, and are anticipated to be subjected to both short-term

and long-term impacts from this action, the resulting effects on wildlife may be locally widespread and substantial, but scaled-down when considering their regional impact.

All anticipated impacts to wildlife from the Bypass Channel Alternative would be concentrated in Dawson County, Montana, and likely cause the degradation of County-regulated and protected wildlife resources, including big game winter range, waterfowl nesting areas, habitat for rare or endangered species, and wetlands (see Section 3.7) (Dawson County, Unknown year; MFWP 2012). Big game winter range for mule deer, white-tailed deer, and pronghorn all of which occur in the project area and would be degraded by the Bypass Channel Alternative, are also protected by the State of Montana (MFWP 2012).

General disturbance from construction activities, wherever they occur, will negatively affect wildlife. Impacts would occur at areas in and around the Intake Diversion Dam, throughout the existing side channel, in and around the bypass channel, and throughout all access roads and staging areas. Disturbance would also extend to Glendive and the connecting access roads that would facilitate the large number of truck transport trips to move rock and concrete to the construction site. It is anticipated that specific sources of disturbance would include pile driving, construction vehicle traffic, heavy equipment operation, vegetation clearing, quarry activities, concrete production and placement, and the general presence of humans. Activities related to excavation, earthmoving, and deposition of rock would be large components of this alternative and cause the most extensive impacts. Although these disturbances are anticipated to be restricted to daylight hours and non-winter months, they would nonetheless occur for most of the anticipated three years of the project, and overlap with the seasonal periods of peak wildlife use. Pile driving noise is unusual and may result in more disturbance to wildlife than other vehicle or equipment noise, thus sensitive resources such as active nests should be identified by a pre-construction survey and protected by fencing and other measures to reduce disturbance.

Wildlife disturbed by the construction activities is anticipated to be displaced from the area unharmed. The wide diversity of habitats that would be disturbed and locally large geographic footprint of the construction area, suggest a wide range of wildlife would be displaced by this alternative. The majority of these effects would occur on Joe's Island, which has a diversity of relatively high quality habitat patches. Because all habitat types identified in the study area would be subjected to construction disturbance, all associated wildlife species have the potential to be effected and displaced by this alternative. Sage grouse, if present, are well known to be sensitive to disturbance by large equipment use and construction activities such as those related to roadwork and rock quarries (summarized in Service 2015). This species, however, is likely not present in the study area (MSGWG 2005) and would not be disturbed by this alternative.

The Bypass Channel Alternative is not anticipated to cause substantial direct harm to wildlife populations, which would reduce their populations at a regional level. This is assuming biological surveys identifying wildlife in impact areas would precede construction activities and allow the wildlife present to either be safely displaced from the area or provided a protective buffer. Potential still remains for individuals to be harmed or killed by the movement of equipment, especially from vehicle strikes. This potential may be great considering the great number of trucking trips to the construction site from Glendive, as well as the long-duration of

the proposed project. Wildlife of particular concern from include various ungulates such as big game species (MFWP 2012), as well as birds protected under the MBTA.

4.9.3.4 Modified Side Channel Alternative

Impacts to wildlife from the existing side channel alternative are anticipated to be similar and comparable to those of the Bypass Channel Alternative, although somewhat less due to the reduced construction footprint, including no changes to the Intake Diversion Dam. Disturbance from construction activities, which would last up to two years, would also result in impacts to wildlife, and habitat degradation and alteration would also occur.

Joe's Island is the primary area that would be affected by this alternative, although impacts would also extend to other sites including the existing rock quarry and the few off-island access roads. Joe's Island and adjacent mainland include all wildlife habitats found in the greater study area. Because they are relatively high in quality and are anticipated to be subjected to both short-term and long-term impacts from this action, the resulting effects on wildlife may be substantial and locally widespread, but only moderate in regional context.

All anticipated impacts to wildlife from the Modified Side Channel Alternative would be concentrated in Dawson County, Montana, and cause the degradation of County-regulated and protected wildlife resources, including big game winter range, waterfowl nesting areas, habitat for rare or endangered species, and wetlands (see Section 3.7) (Dawson County, Unknown year; MFWP 2012). Big game winter range for mule deer, white-tailed deer, and pronghorn, which all occur in the project area and would be degraded by the Modified Side Channel Alternative, are also protected by the State of Montana (MFWP 2012).

General disturbance from construction activities, wherever they occur, will negatively affect wildlife. These would include areas in and around the existing side channel, and throughout all access roads and staging areas. It is anticipated that specific sources of disturbance would result from pile driving, construction vehicle traffic, heavy equipment operation, vegetation clearing, quarry activities, and the general presences of humans. Activities related to excavation, earthmoving, and deposition of rock would be substantial components of this alternative and cause the largest impacts. Although these disturbances are anticipated to be restricted to daylight hours and non-winter months, they would nonetheless occur for most of the anticipated 18 months of the project, and overlap with seasonal periods of peak wildlife use. Pile driving noise is unusual and may result in more disturbance to wildlife than other vehicle or equipment noise, thus sensitive resources such as active nests should be identified by a pre-construction survey and protected by fencing and other measures to reduce disturbance.

Wildlife disturbed by the construction activities are anticipated to be displaced from the area unharmed. The wide diversity of habitats that would be disturbed and locally large geographic footprint of the construction area, suggest a wide range of wildlife would be displaced by this alternative. The majority of these effects would occur on Joe's Island, which has a diversity of relatively high quality habitat patches. Because all habitat types identified in the study area would be subjected to construction disturbance, all associated wildlife species have the potential to be effected and displaced by this alternative. Sage grouse, if present, are well known to be sensitive to disturbance by large equipment use and construction activities such as those related

to roadwork and rock quarries (summarized in Service 2015). This species, however, is likely not present in the study area (MSGWG 2005) and would not be disturbed by this alternative.

Direct harm or mortality of wildlife is not anticipated to be substantial effects under this alternative, as neither are anticipated to be more than potentially likely. This is assuming biological surveys identifying wildlife in construction zones would precede construction activities and allow the wildlife present to either be safely displaced from the area or provided a protective buffer. Potential does still exist, however, for individuals to be harmed or killed by movement of equipment.

4.9.3.5 Multiple Pump Alternative

Construction effects on wildlife are anticipated to occur surrounding the Intake Diversion Dam, throughout the irrigation canal network, at the five pump sites along the Yellowstone River, and throughout the various access roads, which would be used for construction of these features.

Primary impacts to wildlife are expected to result from disturbance and habitat degradation due to construction. It is anticipated that specific sources of disturbance would stem from pile driving, construction vehicle traffic, heavy equipment operation, vegetation clearing, earth moving, concrete production and placement, and the general presences of humans. Although these disturbances are anticipated to be restricted to daylight hours and non-winter months, they would nonetheless occur during seasonal periods of peak wildlife use, be spread throughout the study area, and last all three years of the project. Pile driving noise is unusual and may result in more disturbance to wildlife than other vehicle or equipment noise, thus sensitive resources such as active nests should be identified by a pre-construction survey and protected by fencing and other measures to reduce disturbance.

The general vicinity surrounding the Intake Diversion Dam has been highly altered and disturbed by past and present human activities and currently only provides low-quality wildlife habitat for native species. Assuming the location of the rock spoil site where material removed from the river would be deposited and stored is located in this area, it is assumed to also be restricted to a degraded area. Construction activities in this area, if limited to the degraded sites, would result in only limited disturbance of native wildlife, and would mostly only affect common and/or exotic species typical of human-altered landscapes. In addition, this area would be only marginally more degraded by the proposed action, causing negligible to minor degradation of native wildlife habitat.

Areas adjacent to and surrounding the various access roads, branches of the irrigation network, and pump sites, include patches of higher quality, more diverse habitat, and constitute a relatively large area. This portion of the proposed construction area hosts a diversity of wildlife species, particularly those associated to woody riparian and wetland. Construction activities associated to these features would likely cause a moderate amount of disturbance to native wildlife. The pump sites are described to be sited at locations already degraded by human activities; however, because it is not feasible to place all sites at locations with these characteristics due to engineering limitations, at least some are anticipated to be located in high-quality patches of woody riparian and wetland habitats. Construction at these sites would disturb the highest number and diversity of native wildlife species. The extent of disturbance at any of these sites would be largely determined by construction timing, with spring and early summer

construction potentially effecting the largest number of nesting birds. Construction in areas already altered and degraded by humans is not anticipated to degrade natural wildlife habitat much beyond existing conditions. However, construction in patches of high-quality habitat would substantially degrade these sites, fundamentally decreasing their value to native wildlife.

Wildlife disturbed by the construction activities would be displaced from the area. Disturbance around the access roads, irrigation network, and pumping stations may affect a diversity of wildlife, whereas disturbance around the Intake Diversion Dam would likely cause negligible disturbance. Sage grouse, if present, are well known to be sensitive to disturbance by large equipment use and construction activities such as those related to roadwork and rock quarries (summarized in Service 2015). This species, however, is likely not present in the study area (MSGWG 2005) and would not be disturbed by this alternative. In general, it is anticipated that displaced wildlife would move unharmed into adjacent areas.

The Multiple Pump Alternative is not anticipated to cause substantial direct harm or mortality to wildlife. This is assuming biological surveys identifying wildlife in impact areas would precede construction activities and allow the wildlife present to either be safely displaced from the area or provided a protective buffer. Because areas of woody riparian and wetland may be impacted during the bird breeding season, MBTA-protected resources may have a disproportionate potential to be affected by construction activities. Potential exists for individuals to be harmed or killed by the movement of equipment. This potential may be large considering the extensive network of access roads throughout the action area that would be traversed during the three years of construction. Wildlife of particular concern from vehicle strikes include various ungulates such as big game species (MFWP 2012), small mammals, and birds.

4.9.3.6 Multiple Pumps with Conservation Measures Alternative

Construction effects on wildlife are anticipated to occur surrounding the Intake Diversion Dam, throughout the irrigation canal network, at the seven pump sites along the Yellowstone River, and throughout the various access roads, which would be used for construction of these features.

Primary impacts to wildlife are expected to result from disturbance and habitat degradation due to construction. It is anticipated that specific sources of disturbance would stem from pile driving, construction vehicle traffic, heavy equipment operation, vegetation clearing, earth moving, concrete production and placement, and the general presences of humans. Although these disturbances are anticipated to be restricted to daylight hours and non-winter months, they would nonetheless occur during seasonal periods of peak wildlife use, be spread throughout the study area, and last all 8 years of the project. Pile driving noise is unusual and may result in more disturbance to wildlife than other vehicle or equipment noise, thus sensitive resources such as active nests should be identified by a pre-construction survey and protected by fencing and other measures to reduce disturbance.

The general vicinity surrounding the Intake Diversion Dam has been highly altered and disturbed by past and present human activities and currently only provides low-quality wildlife habitat for native species. Assuming the location of the rock spoil site where material removed from the river would be deposited and stored is located in this area, it is assumed to also be restricted to a degraded area. Construction activities in this area, if limited to the degraded sites, would result in only limited disturbance of native wildlife, and would mostly only affect common and/or exotic

species typical of human-altered landscapes. In addition, this area would be only marginally more degraded by the proposed action, causing negligible to minor degradation of native wildlife habitat.

Areas adjacent to and surrounding the various access roads, branches of the irrigation network, and pump sites, include patches of higher quality, more diverse habitat, and constitutes a relatively large area. This portion of the proposed construction area hosts a diversity of wildlife species, particularly those associated to herbaceous-dominated wetland. Construction activities associated to these features would likely cause a moderate amount of disturbance to native wildlife. The pump sites are described to be sited at locations already degraded by human activities; however, because it is not feasible to place all sites at locations with these characteristics due to engineering limitations, at least some are anticipated to be located in high-quality patches of woody riparian and wetland habitats. Construction at these sites would disturb the highest number and diversity of native wildlife species. The extent of disturbance at any of these sites would be largely determined by construction timing, with spring and early summer construction potentially effecting the largest number of nesting birds. Construction in areas already altered and degraded by humans are not anticipated to degrade natural wildlife habitat much beyond existing conditions. However, construction in patches of high-quality habitat would substantially degrade these sites, fundamentally decreasing their value to native wildlife.

Wildlife disturbed by the construction activities would be displaced from the area. Disturbance around the access roads, irrigation network, and pumping stations may affect a diversity of wildlife, whereas disturbance around the Intake Diversion Dam would likely cause negligible disturbance. Sage grouse, if present, are well known to be sensitive to disturbance by large equipment use and construction activities such as those related to roadwork and rock quarries (summarized in Service 2015). This species, however, is likely not present in the study area (MSGWG 2005) and would not be disturbed by this alternative. In general, it is anticipated that displaced wildlife would move unharmed into adjacent areas.

The Multiple Pumps with Conservation Measures Alternative is not anticipated to cause substantial direct harm or mortality to wildlife. This is assuming biological surveys identifying wildlife in impact areas would precede construction activities and allow the wildlife present to either be safely displaced from the area or provided a protective buffer. Because areas of woody riparian and wetland may be impacted during the bird breeding season, MBTA-protected resources may have a disproportionate potential to be affected by construction activities. Potential exists for individuals to be harmed or killed by the movement of equipment, especially from vehicle strikes. This potential may be large considering the extensive network of access roads throughout the action area that would be traversed during the 8 years of construction. Wildlife of particular concern include various ungulates such as big game species (MFWP 2012), small mammals, and birds.

4.9.4 Operational Effects

4.9.4.1 No Action Alternative

Assuming entrainment and other physiological harm would cause minimal risk to wildlife by the new headworks and fish screens, the size and timing of flows would continue as under current

conditions, and current operation and maintenance will continue to occur, it is anticipated that the No Action Alternative would have negligible impact on wildlife. This projected outcome is founded primarily on the lack of anticipated changes to the location, size, and quality of habitat features that support various wildlife species in the study area. River hydraulics are anticipated to remain the same as under current conditions, eliminating potential habitat alterations related to streamflow. Because operation and maintenance would continue unchanged from what has occurred since 2012 when the new headworks were completed, the physical footprint of existing infrastructure (i.e., Intake Diversion Dam, headworks, roads, and existing rock quarry) would remain unchanged. Continued use of the existing rock quarry would perpetuate wildlife disturbance at the quarry where wildlife habitat is found (i.e., barren land, shrubland, and grassland), but would not exceed disturbance under existing conditions. Additional wildlife disturbance and potential for harm from vehicle collisions would also continue along the 2-mile access road between the existing rock quarry and right (south) abutment, when used to support maintenance activities. Other impacts to wildlife include disturbance and continuing but limited habitat degradation on either end of the Intake Diversion Dam due to operation and maintenance activities. Additional impacts may occur if and when aging infrastructure, such as the trolley system and the Intake Diversion Dam, require additional maintenance or replacement. These foreseen but unscheduled activities would likely cause additional wildlife disturbance and degrade additional wildlife habitat, but would be assumed to not result in substantial negative impacts.

Wildlife habitats likely to be negatively impacted by this alternative would be generally restricted to woody riparian in the area of the Intake Diversion Dam and trolley, barren land at the rock quarry, and grassland and shrubland adjacent to existing access roads. In general, because most of these areas have already been degraded by human activities and collectively total a relatively small area, any impacts to associated wildlife are assumed to be negligible.

4.9.4.2 Rock Ramp Alternative

Maintenance and operation of the new headworks would be the same as that described for the No Action Alternative, above, and cause negligible impacts to wildlife.

The constructed rock ramp of this alternative would require distinctive maintenance likely to be performed on an annual basis. This maintenance may be reduced compared to maintenance activities required of the Intake Diversion Dam. The robust, more durable concrete ramp is less likely to be degraded by ice and high stream flows, reducing the extent and/or frequency of maintenance actions. Once constructed, this may reduce the extent of rock quarrying, transport, and placement that occurs each spring, reducing potential negative impacts to wildlife in the area. Maintenance details associated to the rock ramp, such as specific needs and schedule, have not been specifically identified but maintenance is expected to occur as needed, vary from year-to-year, and retain the potential to disturb and/or harm wildlife.

The rock ramp itself would cause limited alterations to downstream flows, which are not anticipated to be of a scale that would cause substantial changes to downstream wildlife habitats. Several existing access roads would be improved under this action to allow access for trucks and heavy equipment during construction. Assuming most, if not all road improvements would be permanent, road work under this alternative would likely result in long-term impacts by increasing fragmentation of habitat that they cross.

4.9.4.3 Bypass Channel Alternative

The presence of the new bypass channel and associated constructed features are the primary source of long-term impacts to wildlife under the Bypass Channel Alternative. Excavation would mostly occur within upland habitats, fundamentally altering their structure and capacity to host wildlife. Because the bypass channel would convey greater flows than the existing side channel, and would be perennial instead of seasonal, the portion of the Island located between it and the main channel will become somewhat isolated from terrestrial wildlife such as big game species, reducing its utility to support those taxa. In contrast, aerial species such as waterfowl and other birds, as well as bats, may benefit from this same isolation by the creation of this refuge areas.

The filling of the upper section of the existing side channel would result in the loss of the existing riverine habitat in that area, including woody riparian and wetland, as well as adjacent terrestrial habitats reliant on existing hydrology. The lower section of the existing side channel would become a backwater with a largely reduced frequency of inundation relative to current conditions. This would cause changes to vegetation, and the conversion and degradation of existing habitat in and adjacent to the channel. For example, barren land is a prominent feature adjacent to the right streambank of the existing side channel, making it likely to be degraded in quality due to the proposed stream channel alterations. The additional disposal of excavated material in the spoil area would cover and largely eliminate patches of several types of existing upland habitat. Native vegetation would be restored or allowed to reestablish on these disposal sites.

Several existing access roads would be improved under this action, and one that would be constructed along the north side of the river to allow access for heavy equipment during construction would be retained for long-term maintenance. Assuming all road improvements would be permanent, road work under this alternative would likely result in long-term impacts from enhancing the fragmentation of habitats that they cross, because the roads would result in interruptions in otherwise contiguous habitat patches, and would be expected to facilitate vehicle use, increasing likelihood for disturbance and vehicle strikes.

Operation and maintenance activities would be spread through a relatively large and diverse area (specific acreages of loss are provided in Section 4.10), potentially affecting a wide array of wildlife. Maintenance and associated disturbance is likely to occur in all construction areas, where inspections would survey the constructed features for damage from ice and/or the spring freshet, and repairs could occur. Disturbance would extend into the existing rock quarry and access roads used to make needed repairs. Maintenance would also include the periodic removal of sediment deposited in the constructed bypass channel. Maintenance scheduling outside of that for the headworks would be largely as needed, but is anticipated to peak in late winter or early spring following ice melt and reduction in flows. This timing is likely to overlap with peak wildlife activity during the breeding season of spring and summer, increasing the likelihood of wildlife disturbance. The operation and maintenance of the new headworks will continue to occur unchanged under this alternative, and result in the same negligible impacts on wildlife as those discussed under the No Action Alternative.

Although the bypass channel would be built to specifications established to support native fish species, there are several components that would prevent the final design from providing habitat

that would support wildlife after construction, resulting in long-term impacts. These components are explicitly part of the design and collectively intended to ensure the stability of the constructed features. They include the placement of bank armoring riprap at 4 river bends and grade control structures consisting of buried riprap covered by gravel/cobble at the downstream and upstream ends of the bypass channel as well as at two intermediate locations. The fill material placed in the existing side channel would be suitable for the establishment of native upland vegetation. Taken together with the deposition of spoil materials as side cast and in the spoil area under this alternative, approximately 30 acres of relatively high-quality wildlife habitat on Joe's Island would be degraded and/or eliminated by the excavation and deposition of substrate, resulting in a moderate long-term impact on wildlife.

The replacement weir of the Intake Diversion Dam would itself have little effect on wildlife, assuming downstream hydrology and existing habitats would not be substantially altered by its construction. Maintenance of the replacement weir replacement weir may be reduced relative to that of the existing structure. This would benefit wildlife by reducing the ongoing disturbance that occurs annually to repair damage caused by ice and/or high flows. This potential reduction in disturbance relative to existing conditions would also extend into the rock quarry that supplies the materials used for these repairs, which need to be accessed less often compared to existing conditions. This would likely also reduce the potential for harm to wildlife from vehicle strikes during maintenance periods.

4.9.4.4 Modified Side Channel Alternative

The alteration of the existing side channel is the primary source of long-term impacts to wildlife under this alternative. Excavation would occur within within the channel and in some upland habitats. Because the modified side channel would convey greater flows than the existing side channel, and would be perennial instead of seasonal, Joe's Island could become more isolated from terrestrial wildlife such as big game species, potentially reducing its utility to support those taxa. In contrast, aerial species such as waterfowl and other birds, as well as bats, may benefit from this same isolation by the creation of this refuge area. However, the new single-span bridge would also provide year-round recreational access, which could increase human disturbance and potentially negate any benefits to wildlife.

The straightening of the existing side channel, effectively shortening its length, would result in a net loss of riparian habitat, including woody riparian and wetland. This would cause changes to vegetation, and the conversion and degradation of existing habitat in and adjacent to the channel. The disposal of excavated material in the spoil area would cover and alter patches of several types of existing upland habitat, although it would be revegetated. The stream bank armoring of the modified side channel may similarly reduce the reestablishment of natural vegetation. Native vegetation would be restored or allowed to reestablish at these sites. The remainder of the modified side channel would largely be enhanced back to natural conditions.

Existing access roads would be improved and three miles of road would be constructed under this action to allow access for trucks and heavy equipment during construction. Assuming all road improvements would be permanent, road work under this alternative would likely result in long-term impacts from fragmentation of habitats that they cross, because the roads would result in interruptions in otherwise contiguous habitat patches, and would be expected to facilitate vehicle use, increasing likelihood for disturbance and vehicle strikes.

Operation and maintenance activities would be spread through a relatively large and diverse area, potentially affecting a wide array of wildlife. Maintenance and associated disturbance is likely to occur along the length of the channel, where inspections would survey the constructed features for damage from ice and/or the spring freshet, and repairs could occur. Disturbance would include the existing rock quarry and access roads used to make needed repairs. Maintenance would also include the periodic removal of sediment deposited in the modified side channel. Maintenance scheduling outside of that for the headworks would occur on an as-needed basis, and is not likely to be needed annually. The work would typically occur in late summer and fall when the flows are low, thus reducing disturbance during the breeding season.

No alterations are proposed to occur to the existing headworks and Intake Diversion Dam. The operation and maintenance of the new headworks will continue to occur unchanged under this alternative, and result in the same negligible impacts on wildlife as those discussed under the No Action Alternative.

4.9.4.5 Multiple Pump Alternative

The removal of the Intake Diversion Dam would reduce effects on wildlife associated with its annual maintenance. Once the weir and rock rubble field are removed, there would be no further need for extracting rock from the existing quarry or transport of the rock to the staging area next to the trolley system. If the quarry was left undisturbed during the spring and summer, it would provide locally important barren land habitat for wildlife such as nesting raptors and other cliff-dwelling birds, as well as for various reptile species. Reduction or elimination of use of the access roads would also reduce disturbance and the potential for wildlife vehicle strikes associated with existing maintenance. There may also be an opportunity for the access roads to be decommissioned and revegetated. Rock from dam removal could be reused for the pump sites or stockpiled on Joe's Island. If this material is deposited only in areas already disturbed by human activities, there would be no long-term impacts to wildlife.

Long-term impacts to wildlife from the pump sites would include loss of habitat, fragmentation of existing habitat, and continued disturbance from maintenance activities. Although it is the intent for the pump sites to be placed at locations already degraded, it is anticipated that at least some pump sites or feeder canals would cross patches of intact, high-quality riparian or wetland habitat, resulting in removal of vegetation and fragmentation. The relatively high-quality of habitat in these areas, suggests a diversity of wildlife species would be negatively impacted by the habitat loss. Patches of wildlife habitat adjacent to the pump sites would also be degraded by noise and disturbance. Some potential exists for wildlife to become trapped in the feeder canals and unable to move out to upland areas due to hydrology and/or steep banks. It is also unknown if negative effects on wildlife may be caused by the fish screens. As a result, it is conservatively anticipated that wildlife would occasionally be killed in the canals and/or by being entrained into fish screens, but these effects are not anticipated to lead to a substantial reduction of local populations. The pump sites would require extensive maintenance each year, which would disturb any wildlife in the area, displacing them to surrounding locations. The sediment removed from each pump site during maintenance is assumed to be moved away from and deposited offsite to an already disturbed location with low value for wildlife habitat.

The additional power transmission lines needed for this alternative are assumed to generally be buried, but some permanent above-surface infrastructure is expected to be installed. These features, however, would likely not have a large footprint and would be constructed in areas of existing disturbance, such as along roadways. Maintenance activities would be required for the power infrastructure but would be mostly restricted to disturbed sites. Vehicle strikes may occur during transport of maintenance crews and equipment; however, they are anticipated to be infrequent.

4.9.4.6 Multiple Pumps with Conservation Measures Alternative

The removal of the Intake Diversion Dam would reduce effects on wildlife associated with its annual maintenance. Once the weir and rock rubble field are removed, there would be no further need for extracting rock from the existing quarry or transport of the rock to the staging area next to the trolley system. If the quarry were left undisturbed during the spring and summer, it would provide locally important barren land habitat for wildlife such as nesting raptors and other cliff-dwelling birds, as well as for various reptile species. Reduction or elimination of use of the access roads would also reduce disturbance and the potential for wildlife vehicle strikes associated with existing maintenance. There may also be an opportunity for the access roads to be decommissioned and revegetated. Rock from dam removal could be reused or stockpiled on Joe's Island. If this material is deposited only in areas already disturbed by human activities, there would be no long-term impacts to wildlife.

The conservation measures that are part of the Multiple Pumps with Conservation Measures Alternative are intended to reduce water loss from the LYP that occurs through leakage into adjacent native substrate. It would also reduce return flows. The combination of leakage and return flows likely has created or augmented a number of wetlands throughout the system. The reduction in these flows from the conservation measures would likely result in a substantial loss of wetland habitat, eliminating it from wildlife use.

Following the implementation of the proposed conservation measures, maintenance of the LYP would result in ongoing disturbance. This disturbance would be dependent on the maintenance regime required, which has not yet been determined. It is anticipated that impacts from the maintenance of the LYP, post conservation measures, may actually result in a reduction in disturbance over existing conditions due to fewer wildlife species being present due to loss of wetlands and other habitats.

Long-term impacts to wildlife from the pump sites would include loss of habitat, fragmentation of existing habitat, and continued disturbance from maintenance activities. Although it is the intent for the pump sites to be placed at locations already degraded, it is anticipated that at least some pump sites would be placed in patches of intact, high-quality riparian habitat, resulting in their elimination. A diversity of wildlife species could be negatively impacted by the habitat loss. Patches of wildlife habitat adjacent to the pump sites would also be degraded by the continued fragmentation, reducing patch size while increasing exposure to altered sites.

Although wind power has the potential to harm and/or kill various bird and bat species, as well as degrade habitat for all wildlife, it is assumed that the power to operate the pumps would be sourced through seeking a purchase agreement for existing, already permitted wind power sites. It is assumed that any additional required power transmission lines would generally be buried,

but some permanent above-surface infrastructure is expected to be installed. These features, however, would likely not have a large footprint and would be constructed in areas of existing disturbance. Maintenance activities would be required for the power infrastructure but would be mostly restricted to disturbed sites. Vehicle strikes may occur during transport of maintenance crews and equipment, however, they are anticipated to be infrequent.

4.9.5 Cumulative Effects

Wildlife habitat in the study area has been substantially diminished and degraded by agriculture, establishment of various roads and highways, and other development, as well as the Intake Diversion Dam and associated infrastructure. Human disturbance is ongoing in the study area, and further degrades habitat for wildlife.

Most wildlife species in the study area occur in terrestrial environments. Therefore, the modifications that have occurred, or that would occur in the foreseeable future to terrestrial areas such as additional development, bank armoring, or oil and gas development, are those that would cause the most substantial cumulative effects on wildlife.

The area of potential effect for wildlife, as described above, is generally shared by the No Action Alternative, Rock Ramp Alternative, Bypass Channel Alternative, and Modified Side Channel Alternative, and includes the area surrounding the Intake Diversion Dam and headworks, Joe's Island, the existing rock quarry, and interconnecting access roads. Likewise, the area of potential effect for wildlife is also shared by the Multiple Pump Alternative and Multiple Pumps with Conservation Measures Alternative, and includes the LYP, pumping sites, and interconnected access roads in that area, in addition to the areas identified above. Because some of these sites are currently degraded while others are relatively high in quality, cumulative effects would differ according to which are impacted. In addition, relatively rare habitat features would be more sensitive to cumulative impacts than more common habitat features.

In general, much of the upland study area is currently degraded by human use, and provides marginal wildlife habitat. These sites are primarily agriculture-related and were formerly upland habitat such as shrubland and grassland. With one exception, all alternatives of the proposed project would minimally further degrade these areas for wildlife. The Multiple Pumps with Conservation Measures Alternative, however, would result in additional cumulative effects on wildlife through water conservation, which would result in loss of human-induced wetland habitat. This could be a moderate contribution to cumulative effects.

High-quality habitat for wildlife does occur in the study area, with types such as woody riparian, native wetland, native grassland, and native shrubland, all being degraded and/or partially removed from the surrounding area. However, loss of a few acres of these habitat types is relatively small in the context of the upstream/downstream islands and riparian zones that are far larger. Impacts on these habitat patches would result in minor cumulative effects on habitat features important to wildlife at a landscape level. A summary of these features by alternative is as follows:

- **Rock Ramp Alternative**—Cumulative effects from this alternative would be generally restricted to long-term wildlife habitat degradation from the enhancements made to transport the large amount of rock to the construction site. Degraded habitat would

include big game winter range for mule deer, white-tailed deer, and pronghorn, as well as non-protected habitat for other wildlife species such as birds and reptiles, which respond poorly to habitat fragmentation. Assuming the Rock Ramp would require less maintenance than under existing conditions, impacts from operations and maintenance may be reduced over the long-term. Overall, it is anticipated that the Rock Ramp Alternative would only cause minor cumulative effects on wildlife.

- **Bypass Channel Alternative**—Loss of important remnant grassland, shrubland, woody riparian, and wetland habitats would result from this alternative. These habitats have been generally degraded throughout the Yellowstone River system by conversion to agriculture and other forms of development, and are associated to various wildlife species including those with protections. Additional loss of these habitat features would cause cumulative effects that are detectable but not likely measurable on a population level; therefore, it is anticipated that the Bypass Channel Alternative would only cause minor cumulative effects on wildlife.
- **High-Flow Alternative**—Similar to the Bypass Channel Alternative, it would cause the same cumulative effects, resulting in only minor cumulative effects on wildlife.
- **Multiple Pump Alternative**—Loss of mature woody riparian and wetland habitat has resulted in these features being substantially reduced in the Yellowstone River system, although fairly abundant along the lower river. The additional loss of patches of these habitats due to the Multiple Pump Alternative would contribute additional minor cumulative effects on these features and the wildlife associated with them, which include a diversity of species including those with protections. It is anticipated that the Multiple Pump Alternative would therefore result in minor cumulative effects on wildlife.
- **Multiple Pumps with Conservation Measures Alternative**— Loss of mature woody riparian and wetland habitat has resulted in these features being substantially reduced in the Yellowstone River system, although fairly abundant along the lower river. The additional loss of patches of these habitats due to the multiple Ranney wells would contribute additional minor cumulative effects on these features and the wildlife associated with them, which include a diversity of species including those with protections. There would also be the additional loss of irrigation supported wetland in the LYP from the water conservation measures. It is anticipated that the Multiple Pumps with Conservation Measures Alternative would result in minor to moderate cumulative effects on wildlife.

4.9.6 Actions to Minimize Effects

Actions to minimize effects on wildlife are generally shared by all alternatives; however, some specific efforts would be taken to account for differences in area of potential effect due to corresponding differences in affected habitats and associated wildlife species.

It is anticipated that migratory birds may be the single largest group of wildlife that would likely be affected by the alternatives—both short-term and long-term effects. It is imperative for efforts be made to minimize impacts to these species, and to avoid direct impacts to resources protected under the MBTA.

A Migratory Bird Management Plan (Plan) would be created for the proposed project to prevent “take” under the MBTA. The Plan would provide guidelines to modify avian habitat only outside

of the breeding season to discourage nesting activity while minimizing the potential for harassing or harming birds. Other protocol would include adjusting timing of construction, avoiding certain habitats at certain times of year, and/or performing pre-construction breeding avian surveys to identify if any protections are necessary for nesting birds.

General actions to minimize effects on wildlife are as follows:

- Conduct pre-construction survey of the construction areas prior to their disturbance, to document wildlife resources in the area and establish construction buffers around those that are immovable yet sensitive, such as an active bird nest. Monitoring of the sensitive resources would occur periodically to ensure they are not disturbed or harmed by construction activities, and to document if and when they move away from the area.
- A wildlife biologist would provide awareness trainings to the construction crew to educate them on sensitive wildlife resources they may encounter during construction, and provide a vetted protocol to follow when an encounter occurs.
- Areas potentially hazardous to wildlife will be adequately protected (e.g., fenced) to prevent access that could lead to their harm.
- To protect wildlife and their habitats, project-related travel will be restricted to existing roads or proposed new access roads. Drivers should be cognizant of safely avoiding vehicle strikes. Species at particular risk to vehicle strikes include ungulates during crepuscular hours, various bird species, snakes, and small and mid-sized mammals. Driver safety remains paramount, and would be maximized by following this guidance for minimizing vehicle strikes of wildlife.
- Removal and/or degradation of specific habitat features identified as important to wildlife would be minimized to the extent possible. Examples include large snags, patches of mature riparian forest, and native grassland and shrubland habitat.
- Wildlife-proof fencing will be used on revegetated areas, if it is determined that wildlife species and/or livestock are impeding successful vegetation establishment.
- Effort would be made to reestablish native vegetation and habitat comparable to that disturbed and/or destroyed by construction activities. This would include minimizing the establishment of invasive plant species, which greatly degrade the quality of native habitats.

4.10 Federally Listed Species and State Species of Concern

This section addresses the potential effects of each alternative on Federally listed species and state species of concern.

4.10.1 Area of Potential Effect

The area of potential effect for protected fish and wildlife varies by species. In cases of terrestrial species, the footprint of construction, access, and staging comprises the area of potential effect. This means that impacts to terrestrial wildlife will primarily occur as a result of temporary construction activities within the project's limits of construction, but may also result from the permanent change or loss of habitat once the features are completed. For aquatic species, the area of potential effect could include the potential migration corridor and the contiguous population of the species occurring in the Missouri and Yellowstone rivers, which may reach from

Cartersville Diversion Dam at river mile 237 on the Yellowstone River downstream to the confluence with the Missouri River and downstream in the Missouri River to the limits of Lake Sakakawea in North Dakota.

4.10.2 Relationship Between Recovery Goals, Recruitment and This Project

Although pallid sturgeon recovery is not an objective of this project, the project could have an effect on recruitment. Due to the lack of recruitment of wild pallid sturgeon in the Great Plains Management Unit, a key objective for recovery is to increase recruitment of pallid sturgeon to age-1 (Service 2014). This objective increases the importance of the Yellowstone River because it retains the most natural riverine habitats in the Upper Missouri River system and could contribute to increased recruitment in two ways: 1) by potentially increasing the availability of suitable spawning habitats for pallid sturgeon (Jaeger, et al. 2005; Bramblett, et al. 2015); and 2) by providing a much longer distance for drift of free embryo and larval pallid sturgeon and a larger area available for larvae to stop dispersal and seek rearing habitat before reaching Lake Sakakawea, which is currently thought to be unsuitable larval settling habitat due to the fine substrates and low dissolved oxygen levels (Braaten et. al. 2008, 2011; Guy et al. 2015; Bramblett & Scholl 2016). Uncertainty exists related to certain aspects of increased recruitment such as: 1) it is unclear what length of drift distance is actually required for successful recruitment (Braaten, et al. 2012 and 2016 indicate that a range of 200 to 900 kilometers [120 to over 500 miles] of drift distance are needed for successful recruitment depending upon how rapidly the free embryos/larvae drift and if they begin drifting immediately after hatching [passage at Intake Diversion Dam would provide approximately 250 miles of drift distance if spawning occurred at Cartersville Dam]) and (2) the location, quantity and quality of spawning habitat, and (3) the number of pallid sturgeon that would be motivated to migrate upstream to suitable spawning habitats.

However, regardless of the uncertainty of the contribution to recruitment and/or recovery, the Yellowstone River appears to offer the best chance of potentially successful spawning and recruitment for the Great Plains Management Unit and would rapidly help to identify if 250 miles is sufficient drift distance for successful recruitment. At a 5% rate of decline of wild adult pallid sturgeon, if 125 may have been remaining in 2008 (Jaeger et al. 2009), there may be fewer than 90 wild adults still alive in 2016, rapidly diminishing the potential for successful recruitment or recovery of these fish if passage is not provided soon.

4.10.3 Biological Criteria for Success

The Service's BRT recently developed biological criteria for success in improving fish passage for pallid sturgeon at Intake Diversion Dam (Service 2016).

Adult Upstream Passage Criteria

A passage alternative would be considered successful if greater than or equal to 85 percent of motivate adult pallid sturgeon (i.e. fish that move upstream to the entrance of the passage alternative) annual pass upstream of Intake Diversion Dam during the spawning migration period (April 1 – June 15). Migrating adults should pass within a reasonable amount of time and without substantial delay based on an expected unidirectional upstream rate of movement greater than 0.3 km/hour (0.19 miles/hour).

Juvenile Upstream Passage Criteria

The Service acknowledges that upstream passage for juvenile pallid sturgeon is likely biologically important, but that current data are insufficient to understand overall juvenile motivation and evaluate the need for passage to meet life history requirements and maintain viable populations. Thus, field and laboratory studies are recommended and the development of decision criteria to trigger adaptive management options.

Downstream Passage Criteria

1. For the Intake passage project to be successful, mortality of adult pallid sturgeon that encounter Intake Diversion Dam or other design alternative while migrating downstream cannot annually exceed 1% during the first 10 years of project implementation. Adults passing downstream should be monitored for injury or evidence of adverse stress.
2. The Service recommends that post-project monitoring be conducted both at the intake screens, in the irrigation canal, and immediately below the Intake Diversion Dam boulder field to assess potential injury and mortality to free embryos, larvae and young-of-year sturgeon.

4.10.4 Summary of Potential Effects

Table 4-27 summarizes the potential effects on listed species and species of concern for each alternative. Details are provided in the following sections.

TABLE 4-27. SUMMARY OF POTENTIAL EFFECTS ON LISTED SPECIES AND SPECIES OF CONCERN FROM EACH ALTERNATIVE

Impact Type	Level of Impact	Impact Description
No Action Alternative		
Construction Effects	No Effect	<ul style="list-style-type: none"> • N/A
Operational Effects	Major	<ul style="list-style-type: none"> • Continued partial or complete blockage of fish passage • Continued placement of rock and maintenance of LYP • Entrainment of larval fish at headworks
Rock Ramp Alternative		
Construction Effects	Moderate	<ul style="list-style-type: none"> • Noise from pile driving could disturb pallid sturgeon and other species in proximity to the Intake Diversion Dam • Reduced passage from coffer dams for native species such as blue sucker, shovelnose sturgeon, paddlefish, sauger during construction period • Disturbance of riparian habitats during construction
Operational Effects	Major (beneficial) Minor	<ul style="list-style-type: none"> • Improved fish passage for pallid sturgeon and state fish species of concern (beneficial) • Additional placement of rock and temporary increases in turbidity • Entrainment of larval fish at headworks • Little to no additional disturbance to riparian habitats for maintenance

Impact Type	Level of Impact	Impact Description
Bypass Channel Alternative		
Construction Effects	Moderate	<ul style="list-style-type: none"> Noise from pile driving could disturb pallid sturgeon and other species in proximity to the Intake Diversion Dam Side channel not available for access/passage estimated for one runoff season during 28 month construction period Reduced passage from coffer dams for native species such as blue sucker, shovelnose sturgeon, paddlefish, sauger during construction period. Disturbance of riparian and wetland habitats during construction.
Operational Effects	Major (beneficial) Minor	<ul style="list-style-type: none"> Improved fish passage for pallid sturgeon and state fish species of concern (beneficial) Placement of rock and sediment/debris removal cause temporary increases in turbidity Entrainment of larval fish at headworks Little to no additional disturbance to riparian or wetland habitat for maintenance
Modified Side Channel Alternative		
Construction Effects	Minor	<ul style="list-style-type: none"> Side channel not available for access/passage estimated for one runoff season during 18 month construction period Disturbance of riparian and wetland habitats during construction
Operational Effects	Major (beneficial) Minor	<ul style="list-style-type: none"> Improved fish passage for pallid sturgeon and state fish species of concern (beneficial) Placement of rock and sediment/debris removal cause temporary increases in turbidity Entrainment of larval fish at headworks Little to no additional disturbance to riparian or wetland habitat for maintenance
Multiple Pump Alternative		
Construction Effects	Minor	<ul style="list-style-type: none"> Noise from pile driving could disturb pallid sturgeon and other species in proximity to the Intake Diversion Dam Reduced passage from coffer dams for native species such as blue sucker, shovelnose sturgeon, paddlefish, sauger during 6 month dam removal period Disturbance of riparian and wetland habitats during construction
Operational Effects	Major (beneficial) Minor	<ul style="list-style-type: none"> Improved fish passage for pallid sturgeon and state fish species of concern (beneficial) Entrainment of fish at headworks Entrainment of fish at pumping stations Limited disturbance of riparian habitats for maintenance
Multiple Pumps with Conservation Measures Alternative		
Construction Effects	Minor	<ul style="list-style-type: none"> Noise from pile driving could disturb pallid sturgeon and other species in proximity to the Intake Diversion Dam Reduced passage at dam for blue sucker, shovelnose sturgeon, paddlefish, sauger during 6 month dam removal period Disturbance of riparian and wetland habitats during construction

Impact Type	Level of Impact	Impact Description
Operational Effects	Major (beneficial)	<ul style="list-style-type: none"> • Improved fish passage for pallid sturgeon and state fish species of concern (beneficial) • Entrainment of fish at headworks • Limited disturbance of riparian or wetland habitats for maintenance
	Minor	

4.10.5 Construction Effects

4.10.5.1 No Action Alternative

Under the No Action Alternative, no construction would occur and there would be no effects on threatened, endangered, or candidate species, or species of concern. Ongoing and potential future impacts from operation and maintenance of the Intake Diversion Dam are described in the Operational Effects subsection.

4.10.5.2 Rock Ramp Alternative

Under the Rock Ramp Alternative, construction would have minor effects on a variety of protected fish and wildlife. This would primarily be due to construction equipment, activities, and personnel onsite, as well as the alterations of the instream conditions of the Yellowstone River during construction. However, because the site is already relatively well used by recreationists, visitors, and maintenance personnel, the occurrence of rare terrestrial species around the Intake Diversion Dam is unlikely. Effects on protected fish and wildlife will primarily be to aquatic species known to be present in this reach of the Yellowstone River, particularly pallid sturgeon and other state fish species of concern.

Federally Protected Species

Federally protected terrestrial species that may occur in the project area include the least tern, piping plover, and Whooping crane. It is unlikely that northern long-eared bats would be present, since they are very rare and hibernacula are not known to occur in the area. There is no known permanent population of terns, plovers, or cranes within the proposed project footprint for the Rock Ramp Alternative, but each have been observed in the area regularly and recently. If these species did arrive in the area during construction, they would be expected to naturally relocate to avoid disturbance. The construction of this alternative does not occur in areas considered critical habitat for any of the federally protected terrestrial species. Furthermore, though the project reach has been known to support migrating and/or nesting of least tern, piping plover, and whooping crane, the construction and access footprint of the Rock Ramp Alternative is very small in comparison to the surrounding available habitat and generally not located in potentially suitable habitats for these species (i.e. most of the construction footprint is main channel, the adjacent river banks, and grassy or disturbed uplands (including existing dirt roads). Therefore, only minor effects on any of these species would occur, limited to temporary disturbance from noise and human presence.

The effects on federal and state listed species and actions that could be taken to avoid and minimize effects on each of these protected species are provided below.

Northern Long-Eared Bat

Construction of the rock ramp would only have the potential to disturb this bat species if it were found roosting under the existing canal bridge or in trees to be cleared during construction,

which is considered highly unlikely. Pre-construction surveys could be conducted to document if this bat is present. If found onsite, consultation with the Service will determine appropriate actions to protect individuals.

Least Tern

Interior least terns have been regularly reported to use the sandy shorelines of the Yellowstone River for nesting and foraging. Pre-construction surveys could be conducted to identify if any birds/nests are present. If active nests are found, they should be protected during the nesting season with temporary fencing or flagging for a ¼-mile buffer around the nest to prevent access and disturbance.

Piping Plover

As with the least tern, piping plovers have been regularly reported to use the sandy shorelines of the Yellowstone River, including areas near the Intake Diversion Dam. However, effects on plovers could be minimized by conducting pre-construction surveys and by protecting nests with temporary fencing or flagging within ¼ mile of any active plover nests during the nesting season.

Whooping Crane

Whooping cranes are rare visitors to the Yellowstone River corridor and would be unlikely to occur. However, whooping crane sighting reports will be monitored before and during construction to determine if cranes are in the construction area. If any are sighted, construction managers will consult with the Service to determine if any actions to minimize effects are warranted.

Pallid Sturgeon

During construction, there will be few measurable effects on pallid sturgeon. The Intake Diversion Dam is already impassable to pallid sturgeon so the blocking of a portion of the channel by cofferdams does not represent a loss of habitat or change in accessibility to habitat. The existing side channel will remain accessible at high flows. There will likely be temporary and minor increases in turbidity on multiple occasions over the 18 month construction period, but this should rapidly mix and be diluted, and pallid sturgeon are adapted to high turbidity environments.

Noise from sheet pile driving for cofferdams may disturb pallid sturgeon and other fish and wildlife species. Noise attenuates through water in a straight line and dissipates when it encounters land. Thus, in a meandering river, the distance that noise would propagate is limited to the first bend upstream and downstream of the project area.

It is anticipated that any fish within close proximity would immediately flee the area once construction equipment was mobilized to the site and activities such as moving rocks began to occur. Thus, injury is not generally anticipated. To minimize the potential for effects on pallid sturgeon, no sheet pile driving or other in-river work would occur during the pallid sturgeon migration period (April 15 – July 1) and vibratory driving would be used to the maximum extent practicable. As there has been no successful recruitment documented, it is highly unlikely that any larval or juvenile pallid sturgeon would be present near Intake Diversion Dam.

Species of Concern

Wildlife species of concern that are likely to be present in the project area include hoary bat, little brown myotis, bald eagle, black-billed cuckoo, chestnut collared longspur, great blue heron, loggerhead shrike, long-billed curlew, red-headed woodpecker, yellow-billed cuckoo, veery, plains spadefoot, snapping turtle, and spiny softshell. Most of these species are associated with riparian or shoreline habitats and could be present along the Yellowstone River or existing side channel or riparian areas on Joe's Island. The rock ramp construction is primarily confined to disturbed areas at and below the dam. In order to ensure protection of sensitive wildlife species, it is recommended that a pre-construction survey be conducted to identify if any of these species are present. If any are discovered that cannot easily fly or move away, they should be relocated downstream of the construction zone. This will ensure that there are only minor effects on sensitive wildlife species.

Fish species of concern known to be present include blue sucker, paddlefish, sauger, shortnose gar, sicklefin chub, shovelnose sturgeon, and sturgeon chub. These species could be moderately affected during construction as the use of coffer dams and the diversion of water may preclude passage at the dam during the 18-month construction period. The existing side channel would be available for passage around the dam at high flows.

None of the insect species of concern are likely to be present in the rock ramp construction work zone, thus no effects are expected to these species.

None of the plants classified as species of special concern in Montana have been observed in recent years in the project area and are unlikely to be present. However, to ensure protection of rare plants, it is recommended that a survey be conducted prior to construction to identify any plant species of concern in the area. If any are present, they should be fenced off and protected during construction. Pre-construction surveys would ensure that effects on protected plant species would be negligible. If any of these species are discovered in the first survey, additional surveys may need to be conducted each spring as construction is reinitiated.

4.10.5.3 Bypass Channel Alternative

Under the Bypass Channel Alternative, construction of a replacement weir would have similar effects on federal and state protected fish and wildlife as described above for the Rock Ramp Alternative. Resulting in moderate effects on pallid sturgeon from pile driving for cofferdams and moderate effects on state fish species of concern by likely preventing passage over the Intake Diversion Dam during the construction period.

Construction of the bypass channel and stockpile of excavation materials, however, would expand the potential area of impact to Joe's Island, where more types and area of habitat are available. The sections below describe effects of bypass channel construction on federal and state protected species.

Federally Protected Species

Construction of the bypass channel will have a direct effect on species using Joe's Island and the existing side channel habitats, which differ from those that may be present in the main river channel or immediately around the Intake Diversion Dam. Species that may be present at Joe's Island include the northern long-eared bat and pallid sturgeon. Of these species, it is highly

unlikely that northern long-eared bats would be present, since they are very rare in the area and there are no suitable hibernacula within a suitable distance.

For pallid sturgeon, the potential effects of this alternative would be more substantial. There will likely be temporary and minor increases in turbidity on multiple occasions over the 28 month construction period, but this should rapidly mix and be diluted, and pallid sturgeon are adapted to high turbidity environments. Noise from sheet pile driving for cofferdams may disturb pallid sturgeon and other fish and wildlife species. Noise attenuates through water in a straight line and dissipates when it encounters land. Thus, in a meandering river, the distance that noise would propagate is limited to the first bend upstream and downstream of the project area. It is anticipated that any fish within close proximity would immediately flee the area once construction equipment was mobilized to the site and activities such as moving rocks began to occur. Thus, injury is not generally anticipated. To minimize the potential for effects on pallid sturgeon, no sheet pile driving or other in-river work would occur during the pallid sturgeon migration period (April 15 – July 1) and vibratory driving would be used to the maximum extent practicable. As there has been no successful recruitment documented, it is highly unlikely that any larval or juvenile pallid sturgeon would be present near Intake Diversion Dam.

During construction, the existing side channel will be blocked off at the upstream end and about 1.5 mile downstream and filled using materials excavated for the new bypass channel. Because excavated materials need to be deposited almost immediately after excavation begins, it is anticipated that infill of the existing side channel will be concurrent with excavation of the bypass and occur over most of the 28-month construction duration. The bypass channel will be constructed in the dry, with cofferdams at the up and down stream ends of the bypass. This means that there will be a period of time of at least two years, when the bypass channel is not completed and the existing side channel is also blocked, which would likely prevent pallid sturgeon passage upstream of the Intake Diversion Dam. As the existing side channel only begins to receive flows when river flows are above 20,000 cfs, and passage has only been documented at flows above 40,000 cfs (approaching a 2-year flood; Rugg 2014, 2015), which does not occur every year, it is likely that the blockage of the side channel would only prevent passage in one runoff season during construction. To date, only one female and 6 males have been documented to have migrated upstream through the existing side channel, although other non-telemetered fish may have passed in previous years or even in 2014 and 2015. The number of telemetered fish that used the existing side channel represented 50% of the telemetered fish (and only one female) that moved up towards Intake Diversion Dam in 2014 and 14% of the telemetered fish in 2015 (Rugg 2014, 2015). Thus, it is possible that blockage of the existing side channel could prevent 1 or more females from passing upstream. No larval pallid sturgeon have been documented from the likely spawning of the one female that passed upstream in 2014, thus blockage of the existing side channel during construction is unlikely to affect potential recruitment of pallid sturgeon. .

Construction of this alternative would result in a minor adverse effect on pallid sturgeon migration and spawning.

Species of Concern

Wildlife species of concern that are likely to be present in the Bypass Channel Alternative construction area include hoary bat, little brown myotis, bald eagle, black-billed cuckoo, chestnut

collared longspur, great blue heron, loggerhead shrike, long-billed curlew, red-headed woodpecker, yellow-billed cuckoo, veery, plains spadefoot, snapping turtle, and spiny softshell. Most of these species are associated with riparian or shoreline habitats and could be present along the Yellowstone River or existing side channel or riparian areas on Joe's Island. In order to ensure protection of sensitive wildlife species, it is recommended that a pre-construction survey be conducted to identify if any of these species are present. If any are discovered that cannot easily fly or move away, they should be relocated downstream of the construction zone. This will ensure that there are only minor effects on sensitive wildlife species.

Fish species of concern known to be present include blue sucker, paddlefish, sauger, shortnose gar, sicklefin chub, and shovelnose sturgeon, sturgeon chub. These species could be moderately affected during construction as the use of cofferdams and the diversion of water may preclude passage at the dam during the 2-year construction period. Also, the existing side channel would not be available for passage around the dam. Installation of the small cofferdams to isolate the bypass channel and existing side channel would be driven out-of-water and would have only a minor effect on fish in the river.

None of the insect species of concern are likely to be present in the bypass channel construction work zone, thus no effects are expected to these species.

None of the plants classified as species of special concern in Montana have been observed in recent years in the project area and they are unlikely to be present. However, to ensure protection of rare plants, it is recommended that a survey be conducted prior to construction to identify any plant species of concern in the area. If any are present, they should be fenced off and protected during construction. Pre-construction surveys would ensure that effects on protected plant species would be negligible. If any of these species are discovered in the first survey, additional surveys may need to be conducted each spring as construction is reinitiated.

4.10.5.4 Modified Side Channel Alternative

Under the Modified Side Channel Alternative, the Intake Diversion Dam and rock rubble field would remain in place, and there would be no construction effects in the dam area.

Construction undertaken on Joe's Island to modify the existing side channel would require placing cofferdams at the upstream and downstream ends of the existing side channel and excavation within the channel to widen and deepen it. There is a potential for least tern or piping plover to be present on sandbars at the upstream and downstream ends of the channel that could be disturbed by construction activities. A pre-construction survey would be conducted to identify if any of these species are present and implement protection for any active nests that are found. There will also likely be temporary and minor increases in turbidity on multiple occasions over the 18 month construction period, but this should rapidly mix and be diluted and there are few elements with the potential to release turbidity as there will be no change to the existing weir and coffer dams at the side channel will likely be constructed in the dry. Fish species in the river are adapted to high turbidity environments.

Federally Protected Species

During construction, the existing side channel will be blocked off at the upstream and downstream ends for channel widening and deepening for the entire 18-month construction

duration. There are unlikely to be any pallid sturgeon present in the channel when the coffer dams are installed as installation of cofferdams and other in-water work would not occur during the pallid sturgeon migration season (April 15-July 1) and there have been no documented larval pallid sturgeon in the vicinity of the weir. As the existing side channel only begins to receive flows when river flows are above 20,000 cfs, and passage has only been documented at flows above 40,000 cfs (approaching a 2-year flood; Rugg 2014, 2015), which does not occur every year, it is likely that the blockage of the side channel would only prevent passage in one runoff season during construction. To date, only one female and 6 males have been documented to have migrated upstream through the existing side channel, although other non-telemetered fish may have passed in previous years or even in 2014 and 2015. The number of telemetered fish that used the existing side channel represented 50% of the telemetered fish (and only one female) that moved up towards Intake Diversion Dam in 2014 and 14% of the telemetered fish in 2015 (Rugg 2014, 2015). Thus, it is possible that blockage of the existing side channel could prevent 1 or more females from passing upstream. No larval pallid sturgeon have been documented from the likely spawning of the one female that passed upstream in 2014, thus blockage of the existing side channel during construction is unlikely to affect potential recruitment of pallid sturgeon. .

Construction of this alternative would result in a minor adverse effect on pallid sturgeon migration and spawning.

Species of Concern

Wildlife species of concern that are likely to be present in the Modified Side Channel Alternative construction area include hoary bat, little brown myotis, bald eagle, black-billed cuckoo, chestnut collared longspur, great blue heron, loggerhead shrike, long-billed curlew, red-headed woodpecker, yellow-billed cuckoo, veery, plains spadefoot, snapping turtle, and spiny softshell. Most of these species are associated with riparian or shoreline habitats and could be present along the Yellowstone River or existing side channel or riparian areas on Joe's Island. In order to ensure protection of sensitive wildlife species, it is recommended that a pre-construction survey be conducted to identify if any of these species are present. If any are discovered that cannot easily fly or move away, they should be relocated downstream of the construction zone. This will ensure that there are only minor effects on sensitive wildlife species.

Fish species of concern known to be present include blue sucker, paddlefish, sauger, shortnose gar, sicklefin chub, shovelnose sturgeon, and sturgeon chub. These species could be minorly affected during construction as the existing side channel would not be accessible for migration or foraging. However, this will likely only be for one runoff season and the existing side channel is not always accessible every year, thus this will not be a substantial change from existing conditions. Piles needed for the small cofferdams to isolate the existing side channel would be driven out-of-water and would have only a minor effect on fish in the river.

None of the insect species of concern are likely to be present in the existing side channel construction work zone, thus no effects are expected to these species.

None of the plants classified as species of special concern in Montana have been observed in recent years in the project area and are unlikely to be present. However, to ensure protection of rare plants, it is recommended that a survey be conducted prior to construction to identify any plant species of concern in the area. If any are present, they should be fenced off and protected

during construction. Pre-construction surveys would ensure that effects on protected plant species would be negligible. If any of these species are discovered in the first survey, additional surveys may need to be conducted each spring as construction is reinitiated.

4.10.5.5 Multiple Pump Alternative

Federally Protected Species

Under the Multiple Pump Alternative, the Intake Diversion Dam would be removed along with much of the rock rubble field. Effects on fish and wildlife from in-water construction activities at the dam would be similar to those described above for the Rock Ramp Alternative. This would likely result in only minor effects on pallid sturgeon. Noise from sheet pile driving for cofferdams may disturb fish and wildlife species. Noise attenuates through water in a straight line and dissipates when it encounters land. Thus, in a meandering river, the distance that noise would propagate is limited to the first bend upstream and downstream of the project area. It is anticipated that any fish within close proximity would immediately flee the area once construction equipment was mobilized to the site and activities such as moving rocks began to occur. Thus, injury is not generally anticipated. To minimize the potential for effects on fish and specifically, pallid sturgeon, no sheet pile driving or other in-river work would occur during the pallid sturgeon migration period (April 15 – July 1) and vibratory driving would be used to the maximum extent practicable. This would also reduce the likelihood of multiple other native fish species being present as several species also have similar migration periods to pallid sturgeon. Overall, noise from pile driving and other in-water work would represent a minor effect on fish species.

The excavation of the feeder canals to the pumping stations will be done isolated from the river by small coffer dams or by leaving a “plug” of soil at the bank line until the canals are complete and until the final connection is made to the river, thus minimizing the potential for increased turbidity. There would be placement of rock for bank protection and at the outlet of the fish return pipe, but this will be on the bank and not have more than negligible effects on the pallid sturgeon that are unlikely to be in proximity to the pump locations. There are likely to be temporary and small increases in turbidity associated with connection of the feeder canals to the river and placement of rock, but fish in the river are adapted to a turbid environment, thus there would only be minor and temporary effects to fish species.

Additional construction areas are proposed at five pumping sites on the shoreline of the Yellowstone River within 20 miles downstream from the headworks. In general, minor effects are expected to protected plants and animals under this alternative. While the pumping stations would be constructed in or adjacent to agricultural lands, which allow for ease of access and minimal clearing activities, the feeder canals may cross wetlands or strips of riparian vegetation. Species that use riparian forest or wetland habitat could be minorly affected by disturbance during construction. Species such as least tern and piping plover that use sand and gravel bars would not likely be affected as there will not be work in the river for the pumping stations.

Species of Concern

Wildlife species of concern that may be present in the Multiple Pump Alternative multiple construction areas include hoary bat, little brown myotis, bald eagle, black-billed cuckoo, chestnut collared longspur, great blue heron, loggerhead shrike, long-billed curlew, red-headed

woodpecker, yellow-billed cuckoo, veery, plains spadefoot, snapping turtle, and spiny softshell. Most of these species are associated with riparian or shoreline habitats and could be present along the Yellowstone River, remnant side channels or riparian areas. In order to ensure protection of sensitive wildlife species, it is recommended that a pre-construction survey be conducted to identify if any of these species are present at each site. If any are discovered that cannot easily fly or move away, they should be relocated outside of the construction zone. This will ensure that there are only minor effects on sensitive wildlife species.

Fish species of concern known to be present include blue sucker, paddlefish, sauger, shortnose gar, sicklefin chub, shovelnose sturgeon and sturgeon chub. During removal of the dam, passage could be inhibited over the Intake Diversion Dam as coffer dams divert flow from one side of the river to the other and have increased depths and velocities, but this should be short-term, lasting only a few months, thus resulting in only a minor adverse effect. Construction of the pumping stations and feeder canals would have negligible effects on fish as most work will occur isolated from the river, with only the final connection to the canals and placement of riprap occurring adjacent to or in the river.

None of the insect species of concern are likely to be present in the Multiple Pump Alternative construction work zone, thus no effects are expected to these species.

None of the plants classified as species of special concern in Montana have been observed in recent years in the project area and are unlikely to be present. However, to ensure protection of rare plants, it is recommended that a survey be conducted prior to construction at each site to identify any plant species of concern in the area. If any are present, they should be fenced off and protected during construction. Pre-construction surveys would ensure that effects on protected plant species would be negligible.

4.10.5.6 Multiple Pumps with Conservation Measures Alternative

Under the Multiple Pumps with Conservation Measures Alternative, the Intake Diversion Dam and much of the boulder field downstream would be removed. Noise from sheet pile driving for coffer dams may disturb fish and wildlife species. Noise attenuates through water in a straight line and dissipates when it encounters land. Thus, in a meandering river, the distance that noise would propagate is limited to the first bend upstream and downstream of the project area. It is anticipated that any fish within close proximity would immediately flee the area once construction equipment was mobilized to the site and activities such as moving rocks began to occur. Thus, injury is not generally anticipated. To minimize the potential for effects on fish and specifically, pallid sturgeon, no sheet pile driving or other in-river work would occur during the pallid sturgeon migration period (April 15 – July 1) and vibratory driving would be used to the maximum extent practicable. This would also reduce the likelihood of multiple other native fish species being present as several species also have similar migration periods to pallid sturgeon. Overall, noise from pile driving and other in-water work would represent a minor effect on fish species.

Construction of Ranney wells would only occur on land since there is no physical connection of the wells to the Yellowstone River, and therefore no effects would result to aquatic species. As the Ranney wells are proposed to be constructed in agricultural fields or other disturbed areas, none of the wildlife or plant species of concern are likely to be present. However, to ensure

negligible effects, it is recommended that a pre-construction survey be conducted to identify if any of these species are present at each site. If any are discovered that cannot easily fly or move away, they should be relocated outside of the construction zone. Any sensitive plant species discovered should be fenced and protected during construction.

All other construction activities, including water conservation measures, would likely result in only minor effects on federal or state protected species as these species are unlikely to be present within the irrigation system or on farm fields. Minor effects would be ensured through the use of pre-construction surveys and restoration of temporarily disturbed lands following construction.

4.10.6 Operational Effects

4.10.6.1 No Action Alternative

The continued presence of Intake Diversion Dam maintains a fish passage barrier to federally protected pallid sturgeon, as well as at least a partial fish barrier for several state fish species of concern, including blue sucker, Iowa darter, Northern redbelly dace, paddlefish, pearl dace, sauger, shortnose gar, sicklefin chub, and sturgeon chub. Under the No Action Alternative, the presence of the Intake Diversion Dam blocks access to additional potential spawning habitat that may be far enough upstream to allow suitable drift distance for sturgeon larvae to settle out before reaching Lake Sakakawea, thus potentially preventing recruitment in the Great Plains population of pallid sturgeon. This would be a major ongoing effect on listed and sensitive fish species

Previous issues with fish mortality resulting from being entrained by the headworks into the Main Canal have been substantially reduced by the replacement of the headworks and the installation of the new fish screens. Fish screens designed to prevent entrainment of most fish larger than 40 mm were installed in 2011. Monitoring data from 2012-2014 has indicated that entrainment is still occurring, but at significantly reduced rates, and based on the first report from 2012 the numbers of fish entrained may be more correlated to the volume of water in the river than the presence of the screens (Horn and Trimpe 2012). There does appear to have been a change in the species composition and size of entrained fish in 2012 with 99 percent of the larval fish captured in the canal belonging to the Cyprinidae and Catostomidae families (predominantly minnows and carp) and typically in the 4-8 mm size range (Horn and Trimpe 2012). Raw data from 2013 and 2014 monitoring indicates similar results as in 2012. Free embryo or larval pallid sturgeon would likely only be present drifting in the river during July, when about 5% of the river flow is being diverted into the headworks, so it can be anticipated that potentially 5% of the free embryos or larvae could be entrained. However, as pallid sturgeon free embryos would likely be larger than 8 mm by the time they reached the headworks, even fewer might be entrained. Typical mortality of age-0 pallid sturgeon is likely to be 99.9% and the fish have evolved to produce very large numbers of eggs to compensate for the low survival of eggs/free embryos, so the potential entrainment of pallid sturgeon larvae is likely to be a negligible effect to pallid sturgeon recruitment.

Operation and maintenance of the headworks will continue, as will the continued annual rock replenishment at the weir crest, and other ongoing maintenance activities of the irrigation system. These maintenance measures do not reflect a change in current conditions, but represents an ongoing minor adverse effect on listed and sensitive fish species.

Rock replenishment occurs during summer low flows and is not known to pose an immediate direct threat to protected fish or wildlife in the area, since they would easily be able to move away from the activity. Over time, indirect effects of continued rock placement could include the continued accumulation of large rock that is not natural within the river downstream of the dam that may slightly raise the elevation of the river bed and create a larger zone of turbulence, resulting in further limitations on fish passage conditions, damage to aquatic habitat, or a reduction in the availability of habitat.

From a recovery perspective, the No Action Alternative continues the present barrier to pallid sturgeon passage and would not contribute to recovery and may hinder recovery. Adult pallid sturgeon were observed to pass upstream of the Intake Diversion Dam via the existing side channel in 2014 and 2015 (Rugg 2014, 2015) when river flows generally ranged from 40,000 to 70,000 cfs. Pallid sturgeon presumably could have passed through this route in previous years as 2014 was the first year that adult fish were tracked through the side channel (one pallid sturgeon captured upstream of the dam; Wilson and Stewart 1991); however, there has been no documented recruitment of wild pallid sturgeon from the Yellowstone River, to date.

Under No Action, the lack of recruitment of wild pallid sturgeon implies the potential for decline to fewer than 50 wild adults by 2023 (assuming a 5-percent adult mortality per year), which may be too low for effective reproduction. While an estimated 43,000 juvenile hatchery-derived pallid sturgeon are estimated to be present in the Upper Missouri River (Rotella 2015), it is unclear if future recruitment based entirely on hatchery-derived fish will create a sustaining naturally spawning population. Other management actions aimed at promoting recovery of pallid sturgeon may be taken on the Missouri River, but these actions would not address access to habitats in the Yellowstone River.

The No Action Alternative was evaluated using a Fish Passage Connectivity Index (FPCI; Chapter 2 and Appendix D). The resulting index value for an alternative is based on the probability of fish encountering the fish passageway, the potential for the species to use the passageway considering adult swimming performance and hydraulic conditions, and duration of time that the passageway is available during the migration period. The No Action Alternative merited a low index score of 0.08 (out of a maximum scope of 1.0) because there is very little potential for pallid sturgeon and other benthic oriented fish to pass over the existing dam because of its high velocities, shallow depths, and turbulent flows.

If no action were taken, Reclamation would need to reinitiate ESA consultation for their operation and management of the Intake Diversion Dam and the LYP. A future biological opinion would likely require other future activities to reduce the effects on listed species, but these are unknown at this time. Reclamation would continue to conduct monitoring of entrainment at the headworks for the No Action Alternative.

4.10.6.2 Rock Ramp Alternative

Operation and maintenance of the Rock Ramp Alternative would no longer require the placement of rock on top of the weir crest as the replacement weir would be high enough to fully divert the 1,374 cfs water right into the LYP Main Canal down to flows of 3,000 cfs in the river.

However, the new rock ramp will fundamentally alter approximately 1,200 feet downstream of the dam into a large boulder field that is different from natural river characteristics. This would allow colonization of a different suite of macroinvertebrates that may provide diversity in the aquatic food web and is only a small reach of the total river, so is anticipated to only have minor effects on the aquatic food web.

Maintenance of the rock ramp would be necessary on a periodic basis after extreme ice flows that may move rocks and damage the ramp. Additional rock may be placed and/or rock may be moved around on the ramp to improve or maintain passage functions. This maintenance work would be done outside of the pallid sturgeon migration season (April 15-July 1) during low summer flows and might be done by barge or by land-based equipment and may be conducted in-water or with the use of cofferdams. Installation of cofferdams will be more difficult once the ramp is in place as the large rock would make it difficult to install sheet pilings. Maintenance activities would likely generate temporary increases in turbidity and cause turbulent flows or cause diversion of flows from one side of the ramp to the other, temporarily increasing velocities and depths that may preclude fish passage while work is occurring. Maintenance activities at the rock ramp are anticipated to have minor effects on the pallid sturgeon and other sensitive fish species.

Operation and maintenance of the headworks will continue, as will the continued annual rock replenishment at the weir crest, and other ongoing maintenance activities of the irrigation system. These maintenance measures would continue an ongoing minor adverse effect on listed and sensitive fish species.

This alternative would, however, improve passage for pallid sturgeon and other aquatic species. The rock ramp would have a low flow channel and notch through the replacement weir that would facilitate passage of protected fish species upstream and over the newly constructed Intake Diversion Dam. Velocities would not always meet the BRT criteria for the rock ramp (>4 fps) during typical high river runoff (30,000 cfs or greater), which might still present a partial barrier to fish passage and depths are sometimes lower than the criteria. Specifically for pallid sturgeon, the rock ramp also would not have any resting pools or low velocity areas in the primary channel and it may have turbulent flows, thus potentially presenting a passageway that only younger, more vigorous fish would use. However, it is anticipated that many of the pallid sturgeon that approach the dam might use the rock ramp for passage. Currently, a small percentage of the pallid sturgeon in the Yellowstone River use the existing side channel to pass above the Intake Diversion Dam and the rock ramp would still allow this passage to occur. The fish passage benefits would likely provide a major benefit to pallid sturgeon.

The engineered rock ramp would also increase depths and reduce velocities that would allow for sensitive fish species to move upstream, particularly strong-swimming species such as blue sucker, paddlefish, and sauger, providing a major benefit to these species.

Improving fish passage at the Intake Diversion Dam would accomplish several benefits for pallid sturgeon that could contribute to recruitment:

- It would provide access to approximately 165 miles of Yellowstone River habitat upstream of the Intake Diversion Dam and additional miles on tributaries such as the Powder River that are currently inaccessible to the pallid sturgeon;
- There appears to be substantial areas of suitable spawning habitat for pallid sturgeon including bluff pools and other areas of swift water over gravel and cobble substrates (Jaeger et al. 2005, Rugg 2014, 2015; Bramblett et al. 2015);
- If 165 more river miles were accessible for spawning, it would provide longer drift distances and a larger area available for larvae to stop dispersal and seek rearing habitat before reaching Lake Sakakawea (i.e. there would be approximately 250 miles (400 km) of drift distance available if fish spawned near Cartersville Dam). This is longer than the drift distance available between Fort Peck Dam and Lake Sakakawea (a little over 200 miles [340 km]). Lake Sakakawea is currently thought to be unsuitable larval settling habitat due to the fine substrates and low dissolved oxygen levels (Braaten et al. 2008, 2011; Guy et al. 2015; Bramblett & Scholl 2016)

The Rock Ramp Alternative was evaluated using the FPCI (Chapter 2 and Appendix D). The resulting index value for an alternative is based on the probability of fish encountering the fish passageway, the potential for the species to use the passageway considering adult swimming performance and hydraulic conditions, and duration of time that the passageway is available during the migration period. The Rock Ramp Alternative merited a moderate index score of 0.43 (out of a maximum score of 1.0) because there is a high likelihood of fish encountering a passageway that occurs across the entire river, but the ramp would not always be accessible to sturgeon as it does not always meet BRT physical criteria for pallid sturgeon passage as depths are too low at or below 7,000 cfs in the river and velocities are too high above 30,000 cfs. Also there is a lower potential for pallid sturgeon and other benthic oriented fish to pass over the rock ramp because of its relatively high velocities without resting areas, shallower depths that more resemble a riffle or cascade, the likelihood of turbulent flows over the large rock, and the potential reluctance for pallid sturgeon to swim over large rock in general. Rock ramps have typically been designed for fish that readily migrate through riffles.

There are many uncertainties over whether a majority of pallid sturgeon would actually migrate up the rock ramp. If the rock ramp was functional by 2019, then the following assumptions may be valid regarding the wild fish:

- If 76 wild adult pallid sturgeon remain by 2019 and 50 percent are female (38):
 - Approximately 1/3 of those females might spawn in a given year (13 females)
 - 90 percent of those females might migrate up to the Intake Diversion Dam (12 females)
 - If 50 percent of the females were able to pass the rock ramp and 10 percent migrate up the existing side channel, then 7 wild adult females might spawn
- If the fecundity of the females is conservatively 40,000 eggs and if the drift distance was sufficient for a small number of larvae to settle before entering Lake Sakakawea, approximately 35-161 fish might survive to age-1 (based on survival estimates per spawning female summarized in Braaten, et al. 2012, 2016)

This is an example of the potential recruitment from one year of much improved spawning, which could begin to contribute to recovery of the species, although it is highly uncertain that so many female fish would spawn. If this alternative is implemented, Reclamation will implement a Monitoring and Adaptive Management Plan to evaluate the success of the project and to implement adaptive management measures if the BRT biological criteria are not achieved. See Appendix E for specific recommendations for monitoring and adaptive management for this alternative.

Previous issues with fish mortality resulting from being entrained by the headworks into the Main Canal have been substantially reduced by the replacement of the headworks and the installation of the new fish screens. Fish screens designed to prevent entrainment of most fish larger than 40 mm were installed in 2011. Monitoring data from 2012-2014 has indicated that entrainment is still occurring, but at significantly reduced rates, and based on the first report from 2012 the numbers of fish entrained may be more correlated to the volume of water in the river than the presence of the screens (Horn and Trimpe 2012). There does appear to have been a change in the species composition and size of entrained fish in 2012 with 99 percent of the larval fish captured in the canal belonging to the Cyprinidae and Catostomidae families (predominantly minnows and carp) and typically in the 4-8 mm size range (Horn and Trimpe 2012). Raw data from 2013 and 2014 monitoring indicates similar results as in 2012. Free embryo or larval pallid sturgeon would likely only be present drifting in the river during July, when about 5% of the river flow is being diverted into the headworks, so it can be anticipated that potentially 5% of the free embryos or larvae could be entrained. However, as pallid sturgeon free embryos would likely be larger than 8 mm by the time they reached the headworks, even fewer might be entrained. Typical mortality of age-0 pallid sturgeon is likely to be 99.9% (Caroffino et al. 2010; Rotella 2012; Braaten et al. 2016) and the fish have evolved to produce very large numbers of eggs to compensate for the low survival of eggs/free embryos, so the potential entrainment of pallid sturgeon larvae is likely to be a negligible effect to pallid sturgeon recruitment.

It is also anticipated that free embryos or larval pallid sturgeon would be able to drift downstream of the weir and ramp with no difficulty as they would typically be drifting in the deepest part of the channel and would pass through the smoothest part of the ramp without injury. Adult pallid sturgeon have been documented to have passed successfully downstream of the existing weir, so downstream passage past the replacement weir and rock ramp should be even more likely.

Operation and maintenance activities would likely have no effect on wildlife, plant, or insect species as all work would occur at the headworks, on the rock ramp, or along the irrigation canal and associated facilities.

4.10.6.3 Bypass Channel Alternative

Operation and maintenance of the Bypass Channel Alternative would no longer require the placement of rock on top of the weir crest as the replacement weir will be high enough to fully divert the 1,374 cfs water right into the Main Canal down to flows of 3,000 cfs in the river. This will result in much less future maintenance occurring in the river channel as periodic supplementation of rock at the replacement weir will occur much less frequently and require much less rock placement, thus reducing disturbance to fish species in the river. O&M activities would infrequently occur in the bypass channel such as replacement of rock on the outside bends

or at buried sills or removal of sediment and debris. These activities may be conducted using coffer dams that would temporarily block access to the channel. However, maintenance activities would be conducted outside of the pallid sturgeon migration season (April 15-July 1) and would likely occur during summer low flows to minimize effects to fish species. Turbidity may be increased for short periods during maintenance activities, but fish species in the river are adapted to a turbid river environment.

The alternative would improve passage for pallid sturgeon and other aquatic species compared to No Action. The bypass channel is designed to meet the BRT criteria for optimal pallid sturgeon passage and would be accessible over a much wider range of flows than the existing side channel that has only been documented to pass pallid sturgeon when flows exceed 40,000 cfs (approaching a 2-year flood). It is anticipated that a majority of pallid sturgeon that swim up to the weir would encounter the bypass channel as its entrance will be located close to the weir, thus a likely majority of pallid sturgeon would find and could use the channel. Passage upstream would extend the available spawning habitat to pallid sturgeon, potentially up to the Cartersville Diversion Dam, adding over 165 miles of potential spawning habitat and the lower 20 plus miles of tributaries such as the Powder River. Currently, a small percentage of the pallid sturgeon in the Yellowstone River use the existing side channel to pass above the Intake Diversion Dam and the bypass channel would likely allow the majority of the pallid sturgeon to pass upstream. The fish passage benefits would likely provide a major benefit to pallid sturgeon. The existing side channel would be filled at the upstream end and would no longer be accessible for upstream passage, but the greater likelihood of passage in the bypass channel would likely outweigh the benefits of this side channel that a smaller percentage of fish used.

The bypass channel would also allow for sensitive fish species to move upstream, including both stronger and weaker swimming fish, providing a major benefit to these species.

Improving fish passage at the Intake Diversion Dam would accomplish several benefits for pallid sturgeon that could contribute to recruitment:

- It would provide access to approximately 165 miles of Yellowstone River habitat upstream of the Intake Diversion Dam and additional miles on tributaries such as the Powder River that are currently inaccessible to the pallid sturgeon;
- There appears to be substantial areas of suitable spawning habitat for pallid sturgeon including bluff pools and other areas of swift water over gravel and cobble substrates (Jaeger et al. 2005, Rugg 2014, 2015; Bramblett et al. 2015);
- If 165 more river miles were accessible for spawning, it would provide longer drift distances and a larger area available for larvae to stop dispersal and seek rearing habitat before reaching Lake Sakakawea (i.e. there would be approximately 250 miles (400 km) of drift distance available if fish spawned near Cartersville Dam). This is longer than the drift distance available between Fort Peck Dam and Lake Sakakawea (a little over 200 miles [340 km]). Lake Sakakawea is currently thought to be unsuitable larval settling habitat due to the fine substrates and low dissolved oxygen levels (Braaten et al. 2008, 2011; Guy et al. 2015; Bramblett & Scholl 2016)

The Bypass Channel Alternative was evaluated using the FPCI (Chapter 2 and Appendix E). The resulting index value for an alternative is based on the probability of fish encountering the fish

passageway, the potential for the species to use the passageway considering adult swimming performance and hydraulic conditions, and duration of time that the passageway is available during the migration period. The Bypass Channel Alternative merited an index score of 0.67 (out of a maximum score of 1.0) because there is a high likelihood of fish encountering a passageway that occurs immediately downstream of the dam and it would be accessible and meet BRT criteria for pallid sturgeon passage at all flows at or above 7,000 cfs in the river.

There are still many uncertainties over whether a majority of pallid sturgeon would actually pass through the bypass channel as there are no other examples of similar natural-type channels designed for non-jumping benthic fish. However, because it would mimic many of the characteristics of the existing side channel with much more attraction flow, it is reasonable to assume that a majority of fish would find and use the channel. If the bypass channel was functional by 2019, then the following assumptions may be valid regarding the wild fish:

- If 76 wild adult pallid sturgeon remain by 2019 and 50 percent are female (38):
 - Approximately 1/3 of those females might spawn in a given year (13 females)
 - 90 percent of those females might migrate up to the Intake Diversion Dam (12 females)
 - If 85 percent of the females were able to pass through the bypass channel, then 10 wild adult females might spawn
- If the fecundity of the females is conservatively 40,000 eggs and if the drift distance was sufficient for a small number of larvae to settle before entering Lake Sakakwea, approximately 50-230 fish might survive to age-1 (based on survival to age-1 estimates per spawning female summarized in Braaten, et al. 2012, 2016) from a single spawning event.

This is an example of the potential recruitment from one year of much improved spawning, which could begin to contribute to recovery of the species, although it is highly uncertain if this many females would actually spawn. If this alternative is implemented, Reclamation will implement a Monitoring and Adaptive Management Plan to evaluate the success of the project and to implement adaptive management measures if the BRT biological criteria are not achieved. See Appendix E for specific recommendations for monitoring and adaptive management for this alternative.

Previous issues with fish mortality resulting from being entrained by the headworks into the Main Canal have been substantially reduced by the replacement of the headworks and the installation of the new fish screens. Fish screens designed to prevent entrainment of most fish larger than 40 mm were installed in 2011. Monitoring data from 2012-2014 has indicated that entrainment is still occurring, but at significantly reduced rates, and based on the first report from 2012 the numbers of fish entrained may be more correlated to the volume of water in the river than the presence of the screens (Horn and Trimpe 2012). There does appear to have been a change in the species composition and size of entrained fish in 2012 with 99 percent of the larval fish captured in the canal belonging to the Cyprinidae and Catostomidae families (predominantly minnows and carp) and typically in the 4-8 mm size range (Horn and Trimpe 2012). Raw data from 2013 and 2014 monitoring indicates similar results as in 2012. Free embryo or larval pallid sturgeon would likely only be present drifting in the river during July, when about 5% of the

river flow is being diverted into the headworks, so it can be anticipated that potentially 5% of the free embryos or larvae could be entrained. However, as pallid sturgeon free embryos would likely be larger than 8 mm by the time they reached the headworks, even fewer might be entrained. Typical mortality of age-0 pallid sturgeon is likely to be 99.9% and the fish have evolved to produce very large numbers of eggs to compensate for the low survival of eggs/free embryos, so the potential entrainment of pallid sturgeon larvae is likely to be a negligible effect to pallid sturgeon recruitment.

It is also anticipated that free embryos or larval pallid sturgeon would be able to drift downstream of the weir with no difficulty as they would typically be drifting in the deepest part of the channel and would pass through the low-flow notch without injury. Adult pallid sturgeon have been documented to have successfully passed downstream of the existing weir, so passage downstream over the replacement weir or through the bypass channel is likely to be even more feasible.

Operation and maintenance activities at the weir and irrigation canal would likely have no effect on wildlife, plant, or insect species. Operation and maintenance of the bypass channel would utilize existing access routes and would likely have only negligible effects on wildlife, plant, or insect species.

4.10.6.4 Modified Side Channel Alternative

Operation and maintenance of the Modified Side Channel Alternative would require continued placement of rock at the Intake Diversion Dam, resulting in similar minor impacts to fish species as occurs with the No Action Alternative. O&M activities would infrequently occur in the modified side channel such as replacement of rock on the outside bends or at buried sills or removal of sediment and debris. These activities may be conducted using cofferdams that would temporarily block access to the channel. However, maintenance activities would be conducted outside of the pallid sturgeon migration season (April 15-July 1) and would likely occur during summer low flows to minimize effects to fish species. Turbidity may be increased for short periods during maintenance activities, but fish species in the river are adapted to a turbid river environment.

This alternative would improve passage for pallid sturgeon and other aquatic species. The modified side channel is designed to meet the BRT criteria for optimal pallid sturgeon passage and would be accessible over a much wider range of flows than the existing side channel that has only been documented to pass pallid sturgeon when flows exceed 40,000 cfs (approaching a 2-year flood). It is anticipated that more pallid sturgeon would find the modified side channel than under current conditions as there would be 12 to 15 percent of the river flow going through the channel as opposed to the 4 to 6 percent of the flow that was in the channel when pallid sturgeon were tracked passing upstream in 2014 and 2015 (Rugg 2014, 2015). Passage upstream would extend the available spawning habitat to pallid sturgeon, potentially up to the Cartersville Diversion Dam, adding over 165 miles of potential spawning habitat and the lower 20 plus miles of tributaries such as the Powder River. However, due to the entrance to the channel being located approximately 2 miles downstream of the dam, it is not anticipated that the majority of pallid sturgeon would find this route for passage

The modified side channel would also allow for sensitive fish species to move upstream, including both stronger and weaker swimming fish, providing a major benefit to these species.

Improving fish passage at the Intake Diversion Dam would accomplish several benefits for pallid sturgeon that could contribute to recruitment:

- It would provide access to approximately 165 miles of Yellowstone River habitat upstream of the Intake Diversion Dam and additional miles on tributaries such as the Powder River that are currently inaccessible to the pallid sturgeon;
- There appears to be substantial areas of suitable spawning habitat for pallid sturgeon including bluff pools and other areas of swift water over gravel and cobble substrates (Jaeger et al. 2005, Rugg 2014, 2015; Bramblett et al. 2015);
- If 165 more river miles were accessible for spawning, it would provide longer drift distances and a larger area available for larvae to stop dispersal and seek rearing habitat before reaching Lake Sakakawea (i.e. there would be approximately 250 miles (400 km) of drift distance available if fish spawned near Cartersville Dam). This is longer than the drift distance available between Fort Peck Dam and Lake Sakakawea (a little over 200 miles [340 km]). Lake Sakakawea is currently thought to be unsuitable larval settling habitat due to the fine substrates and low dissolved oxygen levels (Braaten et al. 2008, 2011; Guy et al. 2015; Bramblett & Scholl 2016)

The Modified Side Channel Alternative was evaluated using the FPCI (Chapter 2 and Appendix D). The resulting index value for an alternative is based on the probability of fish encountering the fish passageway, the potential for the species to use the passageway considering adult swimming performance and hydraulic conditions, and duration of time that the passageway is available during the migration period. The Modified Side Channel Alternative merited an index score of 0.61 (out of a maximum score of 1.0) because there is a moderate likelihood of fish encountering a passageway so far downstream of the weir, but the channel would be highly accessible and meet BRT criteria for pallid sturgeon passage at all flows at or above 7,000 cfs in the river.

There are still many uncertainties over whether a majority of pallid sturgeon would actually pass through the modified side channel as the channel location is not ideal. However, because it would retain most of the characteristics of the existing side channel with much more attraction flow, it is reasonable to assume that a majority of fish would find and use the channel. If the modified side channel was functional by 2019, then the following assumptions may be valid regarding the wild fish:

- If 76 wild adult pallid sturgeon remain by 2019 and 50 percent are female (38):
 - Approximately 1/3 of those females might spawn in a given year (13 females)
 - 90 percent of those females might migrate up to the Intake Diversion Dam (12 females)
 - If 50 percent of the females were able to find and pass through the modified side channel, then 6 wild adult females might spawn
- If the fecundity of the females is conservatively 40,000 eggs and if the drift distance was sufficient for a small number of larvae to settle before entering Lake Sakakawea, approximately 30-138 fish might survive to age-1 (based on survival to age-1 estimates)

per spawning female summarized in Braaten, et al. 2012, 2016) from a single spawning event.

This is an example of the potential recruitment from one year of much improved spawning, which could begin to contribute to recovery of the species, although it is highly uncertain if this many females would actually spawn in a given year. If this alternative is implemented, Reclamation will implement a Monitoring and Adaptive Management Plan to evaluate the success of the project and to implement adaptive management measures if the BRT biological criteria are not achieved. See Appendix E for specific recommendations for monitoring and adaptive management for this alternative.

Previous issues with fish mortality resulting from being entrained by the headworks into the Main Canal have been substantially reduced by the replacement of the headworks and the installation of the new fish screens. Fish screens designed to prevent entrainment of most fish larger than 40 mm were installed in 2011. Monitoring data from 2012-2014 has indicated that entrainment is still occurring, but at significantly reduced rates, and based on the first report from 2012 the numbers of fish entrained may be more correlated to the volume of water in the river than the presence of the screens (Horn and Trimpe 2012). There does appear to have been a change in the species composition and size of entrained fish in 2012 with 99 percent of the larval fish captured in the canal belonging to the Cyprinidae and Catostomidae families (predominantly minnows and carp) and typically in the 4-8 mm size range (Horn and Trimpe 2012). Raw data from 2013 and 2014 monitoring indicates similar results as in 2012. Free embryo or larval pallid sturgeon would likely only be present drifting in the river during July, when about 5% of the river flow is being diverted into the headworks, so it can be anticipated that potentially 5% of the free embryos or larvae could be entrained. However, as pallid sturgeon free embryos would likely be larger than 8 mm by the time they reached the headworks, even fewer might be entrained. Typical mortality of age-0 pallid sturgeon is likely to be 99.9% and the fish have evolved to produce very large numbers of eggs to compensate for the low survival of eggs/free embryos, so the potential entrainment of pallid sturgeon larvae is likely to be a negligible effect to pallid sturgeon recruitment.

It is also anticipated that free embryos or larval pallid sturgeon would be able to drift downstream of the weir with no difficulty as they are typically drifting in July when flows are relatively high, so depths at the weir would be suitable to pass over any rocks on the crest. Adult pallid sturgeon have been documented to have successfully passed downstream over the existing weir, so it is highly likely they would be able to continue to do so, or through the modified side channel with this alternative.

Operation and maintenance activities at the dam and irrigation canal would likely have no effect on wildlife, plant, or insect species. Operation and maintenance of the modified side channel would utilize existing access routes and would likely have only negligible effects on wildlife, plant, or insect species.

4.10.6.5 Multiple Pump Alternative

This alternative includes complete removal of the Intake Diversion Dam and much of the rock in the river downstream, resulting in a natural river channel that should allow unhindered upstream/downstream passage of any fish species that use the river. This will be a major benefit

to all fish species. This alternative also would have no operation and maintenance activities in the river in the vicinity of the dam except operation and maintenance at the headworks.

The time period when gravity flows occur would be much shortened so the total number of fish entrained through the headworks would be reduced as compared to the existing condition. Thus, this would continue to be a minor effect on the fish species in the river.

At the pumping stations, screens will be installed, but there is also a high likelihood of entraining small fish into these screens, likely resulting in mortality of fish at each pumping station. A fish pump will be installed at the end of each canal to return fish to the river, but there is likely to be some mortality or injury associated with this return. It is difficult to quantify how much entrainment will occur but would be on a smaller scale compared to the existing headworks and thus a likely minor effect on fish species, particularly pallid sturgeon as the pumps would primarily operate in August and September and most larval pallid sturgeon would have drifted past the pump stations in July. Larger fish could become impinged on the trash racks in the feeder canals, but this is likely to be a minor effect as velocities are anticipated to be less than 3 feet/second so most larger fish could swim away.

Removal of sediment and debris from the feeder canals would likely be required on an annual basis, thus causing temporary turbidity and disturbance adjacent to the river and in the feeder canals. This is likely to only cause minor adverse effects on fish species from temporary increases in turbidity.

Operation and maintenance of the pumping stations would utilize access routes developed for construction and would likely have only negligible effects on wildlife, plant, or insect species.

Improving fish passage by removal of the Intake Diversion Dam would accomplish several benefits for pallid sturgeon that could contribute to recruitment:

- It would provide access to approximately 165 miles of Yellowstone River habitat upstream of the Intake Diversion Dam and additional miles on tributaries such as the Powder River that are currently inaccessible to the pallid sturgeon;
- There appears to be substantial areas of suitable spawning habitat for pallid sturgeon including bluff pools and other areas of swift water over gravel and cobble substrates (Jaeger et al. 2005, Rugg 2014, 2015; Bramblett et al. 2015);
- If 165 more river miles were accessible for spawning, it would provide longer drift distances and a larger area available for larvae to stop dispersal and seek rearing habitat before reaching Lake Sakakawea (i.e. there would be approximately 250 miles (400 km) of drift distance available if fish spawned near Cartersville Dam). This is longer than the drift distance available between Fort Peck Dam and Lake Sakakawea (a little over 200 miles [340 km]). Lake Sakakawea is currently thought to be unsuitable larval settling habitat due to the fine substrates and low dissolved oxygen levels (Braaten et al. 2008, 2011; Guy et al. 2015; Bramblett & Scholl 2016)

The Multiple Pump Alternative was evaluated using the FPCI (Chapter 2 and Appendix D). The resulting index value for an alternative is based on the probability of fish encountering the fish passageway, the potential for the species to use the passageway considering adult swimming

performance and hydraulic conditions, and duration of time that the passageway is available during the migration period. The alternative merits a perfect score of 1.0 because it provides unhindered passage past the former dam site via a natural river channel. The existing side channel would only begin to receive flows on less frequent occasions when flows are over 35,000 cfs, thus reducing the potential for migration through this channel.

It is fairly reasonable to assume that a majority of pallid sturgeon would actually pass upstream with Intake Diversion Dam removed. However, because this alternative would take several years to design and implement the population of wild adult pallid sturgeon will continue to decline substantially. If the Multiple Pump Alternative was completed by 2022, then the following assumptions may be valid regarding the wild fish:

- If 66 wild adult pallid sturgeon remain by 2022 and 50 percent are female (33):
 - Approximately 1/3 of those females might spawn in a given year (11 females)
 - 90 percent of those females might migrate through the project site and spawn (10 females)
- If the fecundity of the females is conservatively 40,000 eggs and if the drift distance was sufficient for a small number of larvae to settle before entering Lake Sakakwea, approximately 50-230 fish might survive to age-1 (based on survival to age-1 estimates per spawning female summarized in Braaten, et al. 2012, 2016) from a single spawning event.

This is an example of the potential recruitment from one year of much improved spawning, which could begin to contribute to recovery of the species, although it is highly uncertain if this many females would actually spawn in a given year. If this alternative is implemented, Reclamation will implement a Monitoring and Adaptive Management Plan to evaluate numbers of fish passing and to also evaluate entrainment at both the headworks and pumps. See Appendix E for specific recommendations for monitoring and adaptive management for this alternative.

4.10.6.6 Multiple Pumps with Conservation Measures Alternative

This alternative includes complete removal of the Intake Diversion Dam and much of the rock in the river downstream, resulting in a natural river channel that should allow unhindered upstream/downstream passage of any fish species that use the river. This will be a major benefit to all fish species. This alternative also would have no operation and maintenance activities in the river in the vicinity of the dam except operation and maintenance at the headworks.

The time period when gravity flows occur would be much shortened, however, so the total number of fish entrained through the headworks would be reduced. Thus, this would continue to be a minor effect on the fish species in the river.

Operation and maintenance of the Ranney wells will occur in uplands and would have no effects on fish species. Maintenance of the Ranney wells would utilize access routes developed for construction and would likely have only negligible effects on wildlife, plant, or insect species.

Operation and maintenance of the water conservation measures, irrigation canals and system will likely eliminate or change the conditions in a number of wetlands along the length of the

irrigation system that are supported or augmented by seepage or return flows. This could eliminate habitats for listed or sensitive wildlife species. As the listed and sensitive species are not known to typically use these habitats, the elimination of wetlands would likely result in minor effects.

Improving fish passage by removal of the Intake Diversion Dam would accomplish several benefits for pallid sturgeon that could contribute to recruitment:

- It would provide access to approximately 165 miles of Yellowstone River habitat upstream of the Intake Diversion Dam and additional miles on tributaries such as the Powder River that are currently inaccessible to the pallid sturgeon;
- There appears to be substantial areas of suitable spawning habitat for pallid sturgeon including bluff pools and other areas of swift water over gravel and cobble substrates (Jaeger et al. 2005, Rugg 2014, 2015; Bramblett et al. 2015);
- If 165 more river miles were accessible for spawning, it would provide longer drift distances and a larger area available for larvae to stop dispersal and seek rearing habitat before reaching Lake Sakakawea (i.e. there would be approximately 250 miles (400 km) of drift distance available if fish spawned near Cartersville Dam). This is longer than the drift distance available between Fort Peck Dam and Lake Sakakawea (a little over 200 miles [340 km]). Lake Sakakawea is currently thought to be unsuitable larval settling habitat due to the fine substrates and low dissolved oxygen levels (Braaten et al. 2008, 2011; Guy et al. 2015; Bramblett & Scholl 2016)

The Multiple Pumps with Conservation Measures Alternative was evaluated using the FPCI (Chapter 2 and Appendix D). The resulting index value for an alternative is based on the probability of fish encountering the fish passageway, the potential for the species to use the passageway considering adult swimming performance and hydraulic conditions, and duration of time that the passageway is available during the migration period. The alternative merits a perfect score of 1.0 because it provides unhindered passage past the former weir site via a natural river channel. The existing side channel would only begin to receive flows on less frequent occasions when flows are over 35,000 cfs, thus reducing the potential for migration through this channel.

It is fairly reasonable to assume that a majority of pallid sturgeon would actually pass upstream with Intake Diversion Dam removed. However, because this alternative would take several years to design and implement the population of wild adult pallid sturgeon will continue to decline substantially. If the Multiple Pumps with Conservation Measures Alternative was completed by 2025, then the following assumptions may be valid regarding the wild fish:

- If 57 wild adult pallid sturgeon remain by 2025 and 50 percent are female (29):
 - Approximately 1/3 of those females might spawn in a given year (10 females)
 - 90 percent of those females might migrate through the project site and spawn (9 females)
- If the fecundity of the females is conservatively 40,000 eggs and if the drift distance was sufficient for a small number of larvae to settle before entering Lake Sakakawea, approximately 45-207 fish might survive to age-1 (based on survival to age-1 estimates)

per spawning female summarized in Braaten, et al. 2012, 2016) from a single spawning event.

This is an example of the potential recruitment from one year of much improved spawning, which could begin to contribute to recovery of the species, although it is highly uncertain if this many females would actually spawn in a given year. If this alternative is implemented, Reclamation will implement a Monitoring and Adaptive Management Plan to evaluate numbers of fish passing and to also evaluate entrainment at both the headworks and pumps. See Appendix E for specific recommendations for monitoring and adaptive management for this alternative.

4.10.7 Cumulative Effects

4.10.7.1 Geographic and Temporal Extent of Analysis

Cumulative effects on federally listed species, candidate species, and state species of concern are evaluated for the local resident populations or migrating populations of each species, as applicable, for the duration of the life of the project, a period of 50 years.

4.10.7.2 Methodology for Determining Effects

Determining cumulative effects includes an analysis of all past projects that have occurred in the study area, as well as the ongoing and reasonably foreseeable future projects that may have effects. These effects can be directly to species that are present and/or nesting in the area, or that use the area during migration. In addition, effects can also include degradation of habitat quality or availability. In combination with the effects of the proposed alternatives herein, the sum total of cumulative effects can be evaluated. Cumulative effects are assessed qualitatively and, if they occur, are determined to be negligible, minor, moderate, or major.

4.10.7.3 Past, Present, and Reasonably Foreseeable Future Projects Considered

Projects that have occurred in the past that may contribute to cumulative effects under proposed alternatives include the LYP and other irrigation and agricultural projects in the region, the presence and operation of both large and small dams on the Yellowstone and Missouri rivers, and residential, commercial, and industrial development. Ongoing projects include the Missouri River Management Plan, Crow Settlement changes to operations of the Bighorn River dams and the Yellowtail Afterbay Power Generation project. Other sources of cumulative effects include the ongoing trends of conversions to pivot irrigation, continued bank armoring, spills at pipeline crossings, urbanization, road maintenance, construction, and expansion. The potential effects of climate change will also affect river hydrology and temperatures.

4.10.7.4 No Action Alternative

Under the No Action Alternative, the configuration of the Intake Diversion Dam and appurtenant structures would remain in place. The number and diversity of federally threatened or endangered species, candidate species, or state species of concern, is low overall in the study area. Past and ongoing construction of dams, urbanization, agriculture, and irrigation have combined to reduce habitat quality and quantity for all species that historically utilized the study area. By definition, species that are listed for protection have been the most substantially affected by habitat loss and degradation. The construction of the Intake Diversion Dam and diversion of water for irrigation, along with other dams in the Yellowstone River basin and the Missouri River, have had major effects on the fish and wildlife in the region.

The ongoing operation of the Intake Diversion Dam contributes to the decline of pallid sturgeon and other fish species of concern in the Yellowstone River. The construction of dams and further alteration of river hydrology as a result of urbanization, agriculture, and irrigation have combined to reduce the habitat quality and quantity for listed fish. The continued operation of the Intake Diversion Dam would continue to contribute to these issues, resulting in an ongoing major cumulative effect on pallid sturgeon. It also results in ongoing major cumulative effects on other state listed fish species that have declining populations or populations with unknown capacity for recovery. Overall, the No Action Alternative would have a continued major cumulative effect on listed or sensitive fish species.

Although urbanization and transition of natural habitats to agriculture is occurring relatively slowly in the area, the overall cumulative effect of development has been one of loss of habitat quality and availability. Under the No Action Alternative, terrestrial habitats will continue to be slightly disturbed during operation and maintenance, but overall will not contribute to an increase in cumulative effects. Threatened and endangered species do not use the study area in substantial numbers, there is no critical habitat for any species in the study area, and their use of the area is not declining as a result of the Intake Diversion Dam operation. Species such as least tern and piping plover are occurring regularly each year and may be selecting Yellowstone River habitats when the hydrographs of other rivers in the area are not suitable. Overall the No Action Alternative when combined with other reasonably foreseeable future project would have only a negligible cumulative effect on listed or sensitive wildlife, plant, or insect species.

4.10.7.5 Rock Ramp Alternative

The Rock Ramp Alternative would incrementally reduce cumulative effects on pallid sturgeon and other sensitive fish species relative to current conditions. The construction of a replacement weir with low-flow channel and supporting rock ramp will allow for improved upstream passage of pallid sturgeon and access to an additional 165 miles of potential spawning habitat and the additional lower 20 or more miles of tributaries such as the Powder River. The reasonably foreseeable future projects and trends that affect river flows will only have minor contributions to cumulative effects on river hydrology and water temperatures in the lower river, so the net result should be incremental reversal of cumulative effects.

Effects on terrestrial threatened and endangered species or state listed species of concern will be the same as described above for the No Action Alternative, with only negligible cumulative effects.

4.10.7.6 Bypass Channel Alternative

The Bypass Channel Alternative would incrementally reduce cumulative effects on pallid sturgeon and other sensitive fish species relative to current conditions. The construction of bypass channel will allow for improved upstream passage of pallid sturgeon and access to an additional 165 miles of potential spawning habitat and the additional lower 20 or more miles of tributaries such as the Powder River. The reasonably foreseeable future projects and trends that affect river flows will only have minor contributions to cumulative effects on river hydrology and water temperatures in the lower river, so the net result should be an incremental reversal of cumulative effects.

Effects on terrestrial threatened and endangered species or state listed species of concern will be small and localized, likely resulting in only negligible cumulative effects.

4.10.7.7 Modified Side Channel Alternative

The Modified Side Channel Alternative would incrementally reduce cumulative effects on pallid sturgeon and other sensitive fish species relative to current conditions. The construction of the modified side channel will allow for improved upstream passage of pallid sturgeon and access to an additional 165 miles of potential spawning habitat and the additional lower 20 or more miles of tributaries such as the Powder River. The reasonably foreseeable future projects and trends that affect river flows will only have minor contributions to cumulative effects on river hydrology and water temperatures in the lower river, so the net result should be an incremental reversal of cumulative effects.

Effects on terrestrial threatened and endangered species or state listed species of concern will be small and localized, likely resulting in only negligible cumulative effects.

4.10.7.8 Multiple Pump Alternative

The Multiple Pump Alternative would incrementally reduce cumulative effects on pallid sturgeon and other sensitive fish species relative to current conditions by removing the fish passage barrier and allowing unhindered upstream passage of pallid sturgeon and access to an additional 165 miles of potential spawning habitat and the additional lower 20 or more miles of tributaries such as the Powder River. The reasonably foreseeable future projects and trends that affect river flows will only have minor contributions to cumulative effects on river hydrology and water temperatures in the lower river, so the net result should be an incremental reversal of cumulative effects.

Effects on terrestrial threatened and endangered species or state listed species of concern will be small and localized, likely resulting in only negligible cumulative effects.

4.10.7.9 Multiple Pumps with Conservation Measures Alternative

The Multiple Pumps with Conservation Measures Alternative would incrementally reduce cumulative effects on pallid sturgeon and other sensitive fish species relative to current conditions by removing the fish passage barrier and allowing unhindered upstream passage of pallid sturgeon and access to an additional 165 miles of potential spawning habitat and the additional lower 20 or more miles of tributaries such as the Powder River. The reasonably foreseeable future projects and trends that affect river flows will only have minor contributions to cumulative effects on river hydrology and water temperatures in the lower river, so the net result should be an incremental reversal of cumulative effects.

Effects on terrestrial threatened and endangered species or state listed species of concern would result in a small loss of potential habitat from loss of wetlands associated with the irrigation system and a continuing decline in habitats from other reasonably foreseeable future project, resulting in minor cumulative effects.

4.10.8 Actions to Minimize Effects

A number of measures can be employed to minimize effects on listed and sensitive fish and wildlife species, including:

- Conduct pre-construction surveys within the construction footprint for listed and sensitive wildlife and plant species.
- All surface-disturbing and construction activities will be prohibited from occurring within 0.25 mile of any existing and active least tern or piping plover nest within the dates of May 15 to August 15.
- Whooping crane sighting reports will be monitored by project managers to ensure that no individuals are known to be within the study area during construction, operation, or maintenance activities. If any are sighted within the study area, project managers will consult with the Service regarding appropriate actions.
- Construction activities within the river will not occur during the pallid sturgeon migration season (April 15 – July 1).
- All pumps used in the river during construction will use intakes screened with no greater than ¼” mesh when dewatering cofferdam areas in the river channel. Pumping will continue until water levels within the contained areas are suitable for salvage of any juvenile or adult fish occupying these areas. All fish will be removed by methods approved by the Service and MFWP prior to final dewatering.
- Care will be taken to prevent any petroleum products, chemicals, or other harmful materials from entering the water.
- All work in the waterway will be performed in such a manner to minimize increases in suspended solids and turbidity that could degrade water quality and damage aquatic life outside the immediate area of operation.
- All areas along the bank disturbed or newly created by the construction activity will be seeded with vegetation native to the area for protection against subsequent erosion and the establishment of noxious weeds.
- Clearing vegetation will be limited to that which is absolutely necessary for construction of the project.
- Cofferd dam sheet piles will be installed using vibratory equipment to the extent practicable to minimize noise levels and potential disturbance to fish.
- At the start of pile driving each day, conduct a low-energy ramp up with reduced noise levels to allow fish the opportunity to move from the area within close proximity of the dam.
- A monitoring and adaptive management plan will be implemented for the preferred alternative to document fish passage, entrainment, and success of the project in meeting physical and biological objectives.

4.11 Lands and Vegetation

This section addresses lands and vegetation that may be affected by project alternatives. Lands and vegetation include wetlands, grasslands, woodlands, riparian areas, and noxious weeds.

Construction related to each alternative may impact lands and vegetation on either a temporary or permanent basis. Temporary impacts in general are short term and associated with project construction. Following construction activities and revegetation, the land is expected to return to previous uses in many areas. Permanent impacts are long-term and typically associated with

construction of permanent facilities and the long-term operation and maintenance. Permanent impacts could result in an irreversible commitment of resources.

4.11.1 Area of Potential Effect

The area of potential effect for land and vegetation consists of two areas. The first area comprises the Yellowstone River and its overbanks beginning upstream of the Intake Diversion Dam at the location of the existing side channel confluence, to a point downstream of the Intake Diversion Dam at the downstream confluence of the existing side channel, a distance covering approximately 4 miles. This includes the Joe’s Island, which is bound by the existing side channel and the Yellowstone River.

The second area comprises the Lower Yellowstone Project, which includes the Yellowstone River, the Main Canal, and the floodplain area between the river and canal, from the Intake Diversion Dam to the confluence of the Missouri River, approximately 73 river miles (Figure 1-2). For GIS analysis purposes, this area is limited to the 100-year floodplain plus a 500-meter buffer.

4.11.2 Summary of Potential Effects

Table 4-28 summarizes the potential effects on lands and vegetation for each alternative. Details are provided in the following sections.

TABLE 4-28. SUMMARY OF POTENTIAL EFFECTS ON LANDS AND VEGETATION FROM EACH ALTERNATIVE

Impact Type	Level of Impact	Impact Description
No Action Alternative		
Construction Effects	No Effect	<ul style="list-style-type: none"> • None
Operational Effects	Minor	<ul style="list-style-type: none"> • Rock replenishment will continue disturbance on Joe’s Island and continue filling in riverine habitat
Rock Ramp Alternative		
Construction Effects	Minor	<ul style="list-style-type: none"> • Temporary impact to grasslands from staging/access
Operational Effects	Moderate	<ul style="list-style-type: none"> • Permanent rock fill in river for rock ramp. • Rock ramp maintenance will disturb access/staging areas and continue to filling in riverine habitat
Bypass Channel Alternative		
Construction Effects	Moderate	<ul style="list-style-type: none"> • Placement of riprap and temporary coffer dams disturb riverine habitat • Sediment disposal and access roads will temporarily impact grasslands • Increased risk of invasive species spread
Operational Effects	Moderate	<ul style="list-style-type: none"> • Permanent fill in side channel and wetlands • Grassland converted to channel due to excavation of channel • Maintenance activities could impact riparian areas from disturbance for access/staging

Impact Type	Level of Impact	Impact Description
Modified Side Channel Alternative		
Construction Effects	Moderate	<ul style="list-style-type: none"> • Portions of side channel filled by bend cutoffs • Excavation and spoil area will impact grasslands, spread noxious weeds • Filling of cutoff and excavation of access roads will impact riparian areas • Disposal of sediment in grassland
Operational Effects	Minor	<ul style="list-style-type: none"> • Rock placement will continue rock fill in riverine habitat • Maintenance activities disturb riparian areas
Multiple Pump Alternative		
Construction Effects	Minor	<ul style="list-style-type: none"> • Construction of pumping stations will fill wetlands • Temporary structures for Intake Diversion Dam removal will temporarily disturb riverine habitat • Construction of pumps will impact grasslands • Pump construction will impact riparian areas • Bank stabilization will impact wetlands, and riparian areas
Operational Effects	Minor	<ul style="list-style-type: none"> • Disposal of sediment from canals will impact grasslands • Placement of supplemental riprap will disturb riparian habitat and place additional fill in riverine habitat
Multiple Pumps with Conservation Measures Alternative		
Construction Effects	Minor	<ul style="list-style-type: none"> • Cofferdams temporarily disturb riverine habitat • Installation of check structures could impact fringe wetlands along canal • Main and lateral canal linings or conversion could eliminate wetlands supported by canal seepage • Disposal of Intake Diversion Dam demolition material will impact grasslands
Operational Effects	Minor Major	<ul style="list-style-type: none"> • Maintenance of access roads, distribution lines, and pumps could impact grasslands • Loss of numerous wetlands from reduced seepage and return flows

4.11.3 Construction Effects

4.11.3.1 No Action Alternative

The No Action Alternative would have no construction effects on wetlands, grasslands, woodlands, riparian areas, or noxious weeds in the study area as no construction would occur.

4.11.3.2 Rock Ramp Alternative

Under this alternative, construction of a replacement weir, placement of a sloping rock ramp comprised of un-grouted boulder and cobble-sized rocks, and installation of a temporary bridge structure spanning the Main Canal will all have the potential to affect the lands and vegetation.

Wetlands

Approximately 57 acres of riverine habitat are located within the construction area footprint and could be impacted.

Of these, 24 acres of riverine habitat in the construction area would be temporarily impacted during project construction activities. A cofferdam will be constructed to allow construction to occur isolated from the river channel. This temporary impact on the riverine habitat will be minimal, as the low quality riverine habitat present at the Intake Diversion Dam area prior to the disturbance would be converted to a rocky substrate. There will be temporary effects on velocities and depths as the river is diverted from one side to the other with coffer dams (see Surface Water section).

Grasslands

Approximately 25 acres of Great Plains Mixed Grass Prairie and 6 acres of Great Plains Sand Prairie are located within the construction footprint and would be temporarily impacted during project construction. The majority of grassland impacts will be from the construction staging and stockpile areas between the canal and BNSF Railroad. These effects will be minor, due to a temporary loss of functionality, but as areas are reseeded and re-contoured post construction, they will return to a relatively natural grassland state.

Woodlands and Riparian Areas

Approximately 8 acres of riparian habitat are located within the construction footprint and could be impacted. The majority of the riparian area is forested and located on the south side of the Intake Diversion Dam, where construction staging will take place. These acres would be temporarily impacted during project construction by removal of trees and shrubs. Overall, if this area is replanted with native trees and shrubs, long-term construction impacts to woodlands and riparian areas would be moderate.

Noxious weeds

This alternative has a relatively small overall footprint compared to the Bypass Channel and Modified Side Channel Alternatives. Ground disturbance associated with construction activities could provide a pathway for dispersal and establishment of invasive plants including salt cedar. Overall, if disturbed areas are replanted with native species immediately after construction to minimize the spread of invasive species, long-term construction impacts to noxious weeds would be minor.

4.11.3.3 Bypass Channel Alternative

As with the Rock Ramp Alternative, this alternative includes the construction of a replacement weir, but adds the excavation of a new bypass channel, and filling of the upstream portion of the existing side channel.

Wetlands

Impacts to wetlands adjacent to the Yellowstone River would include the construction of the replacement weir upstream of the Intake Diversion Dam, excavation of the bypass channel and bank modifications near the downstream entrance to the bypass channel, and filling of upstream portions of the existing side channel. A total of approximately 34 riverine wetland acres would be permanently filled or excavated/converted to riverine channel, and will be discussed under operational effects.

Grasslands

The placement of excavated material into the waste pile site would temporarily impact approximately 75 acres of Great Plains Mixed Grass Prairie. In addition, other miscellaneous construction activities would temporarily impact minor amounts of grassland.

Excavation for the new channel and haul roads will permanently impact approximately 50 acres of grassland, and temporarily impact another 300 acres. Overall, impacts to these grassland areas would be offset through immediate planting with native grass species. Construction impacts to grasslands are considered minor.

Riparian Areas and Woodlands

Approximately 57 acres of riparian forest and 7 acres of riparian scrub/shrub are within the construction area footprint. The filling of the upper end of the existing side channel will permanently remove approximately 38 acres of Riparian Forest. The remaining riparian forest acres and all of the riparian scrub shrub acres will be eliminated during excavation of the new channel or disturbed from grading for access and haul roads.

Permanent impacts of approximately 18 acres of forested riparian and approximately 7 acres of riparian scrub shrub would occur due to conversion of riparian habitat to riverine habitat in order to construct the bypass channel. This conversion of riparian habitat is a trade-off due to the gain in ecological benefits of providing fish passage.

All temporary and permanent impacts to riparian habitat are considered moderate. Although mature trees and shrubs will be removed during construction, these areas will be fully restored through the proposed actions to minimize effects. Therefore, effects will be temporal. Furthermore, functional aspects of this habitat are provided in adjacent riparian areas and woodlands, reducing the effect on riparian and woodland dependent species.

Noxious weeds

The Bypass Channel Alternative would have a moderate effect on noxious weeds. This alternative has a large construction footprint that will remove or disturb large areas of native vegetation, and there is a great opportunity for this alternative to affect the spread of noxious weeds. Pathways of invasive vegetation are initiated by disturbance by the creation of bare soil in which pioneering weeds can gain a foothold. Then building materials, equipment, and worker's boots can introduce and spread the seeds of invasive vegetation. Joe's Island already has a large infestation of leafy spurge that could spread by construction activities. Overall, if disturbed areas are replanted with native species immediately after construction, equipment is inspected and cleaned daily, and replacement seed is certified as weed free, long-term construction impacts to noxious weed would be minimized.

An invasive species management plan will outline a concerted effort to minimize the spread of invasive species such as leafy spurge and autumn olive.

4.11.3.4 Modified Side Channel Alternative

Wetlands

Approximately 1.5 acres of palustrine emergent wetlands are within the estimated disturbance footprint. Approximately 0.75 acre of palustrine emergent wetland will be permanently filled by the bend cutoffs. The rest of the palustrine emergent wetlands will be in the footprint of the modified side channel and will be converted to riverine channel habitat. Additionally, newly created backwater areas will create about 8 acres that will likely become vegetated emergent wetlands. Overall, construction impacts to wetlands would be minor.

Grasslands

Within the estimated disturbance footprint for the Modified Side Channel Alternative, approximately 62 acres of Great Plains Mixed Grass Prairie will be excavated for channel widening. Approximately 80 acres will be temporarily disturbed in the spoil area. Approximately 83 acres of Great Plains Sand Prairie will be permanently impacted due to excavation for the channel cutoff sections. Approximately 3 acres of Great Plains Badlands will be permanently impacted by excavation for channel widening. The excavation of the bend cutoffs would convert 27 acres to riverine type habitat. Overall, temporary impacts to grassland areas would be offset through immediate planting with native grass species. Construction impacts to grasslands are considered moderate.

Riparian Areas and Woodlands

Of the approximately 90 acres of Great Plains Floodplain within the estimated disturbance footprint, approximately 14 acres are Riparian Forested and 9 acres are Riparian Scrub Shrub. Approximately 7 acres of the Riparian Forest will be permanently impacted by the filling of the cutoff areas or construction of the access road. The other 7 acres of Riparian Forested that are disturbed will be a permanent conversion to riverine from the excavation and widening of the existing side channel.

Approximately 9 acres of the Riparian Scrub Shrub will be permanently excavated by access road construction and bend cutoff areas.

All temporary and permanent impacts to riparian habitat are considered moderate and would be minimized by immediately replanting with native vegetation after construction or would be offset by creation of additional habitat associated with the modifications of the existing side channel.

Noxious weeds

This alternative has a large construction footprint resulting in the removal of vegetation or other disturbance over a large area, and there is an opportunity for this alternative to affect the spread of noxious weeds. Pathways of invasive vegetation are initiated by disturbance, by the creation of bare soil in which pioneering weeds can gain a foothold. Then building materials, equipment, and workers can introduce and spread the seeds of invasive vegetation. Joe's Island already has a large infestation of leafy spurge that could spread by construction activities. Overall, if disturbed areas are replanted with native species immediately after construction, equipment is inspected and cleaned daily, and replacement seed is certified as weed free, long-term construction impacts to noxious weed would be moderate.

4.11.3.5 Multiple Pump Alternative

Wetlands

The combined construction footprint of all 5 pumping stations and the attached access roads, can potentially permanently impact approximately 0.1 acre of palustrine emergent wetlands, and approximately 0.5 acre of palustrine scrub shrub wetlands. Approximately 0.6 acre of riverine habitat will also be permanently impacted. Minimizing disposal of material in aquatic systems, minimizing discharge at unavoidable crossings, and minimizing compaction of wetland soils will help to avoid and/or minimize impacts to these wetland resources.

Removal of the Intake Diversion Dam will require the construction of temporary earthen and sheet pile cofferdams for half of the river width at a time. This structure would temporarily impact riverine habitat, but impact would be minor as it would be removed immediately after demolition. These will be temporary structures and have temporary impacts as the channel bottom will return to a more natural state, post Intake Diversion Dam removal that would be a net benefit to the riverine ecosystem.

Grasslands

Construction of the pumps will permanently convert approximately 2 acres of Great Plains Mixed Grass Prairie, along with approximately 0.1 acre of Great Plains Sand Prairie to pumping stations. Overall, with restoring similar native species immediately following construction, conserving/recycling topsoil, preventing erosion and sedimentation, controlling noxious weeds, and monitoring and reseeding appropriately grassland impacts would be minor.

Woodlands and Riparian Areas

Approximately 29 acres of Great Plains Floodplain are within the pump site's limits of construction. Of that, pump construction will potentially permanently convert approximately 10 acres of forested riparian habitat, as well as approximately two acres of riparian scrub shrub habitat to feeder canals or pumping stations. All temporary and permanent impacts to riparian habitat are considered moderate and would be addressed by minimizing disposal of waste material, topsoil, debris, excavated material or other construction related materials within riparian areas; avoiding woodland and riparian areas when constructing permanent facilities; restoring woodland and riparian areas with native species; replacing native trees and shrubs with similar native species; and by establishing willows along any areas disturbed along the river or new channels/canals to provide wildlife habitat and channel stability.

Noxious Weeds

Construction of the pumps can potentially introduce invasive weeds via construction equipment, and by the creation of bare soil in which pioneering weeds can gain a foothold. Overall, if disturbed areas are replanted with native species immediately after construction, equipment is inspected and cleaned daily, and replacement seed is certified as weed free, long-term construction impacts to noxious weed would be minor.

4.11.3.6 Multiple Pumps with Conservation Measures Alternative

Wetlands

Intake Diversion Dam removal will require installation of earthen and sheet pile coffer dams in the river channel to prevent water flow into the work site. These will be temporary structures and

have temporary minor impact on riverine habitat as the channel bottom will return to a more natural state after Intake Diversion Dam removal for a long-term beneficial effect on the riverine ecosystem.

Ranney wells will be installed in upland agricultural fields on mostly already established access roads. Gravel access roads will be built within each site between the Ranney Wells. Construction of these access roads could impact 0.5 acre of riverine habitat. These impacts are located on canal laterals within the Ranney Well sites, so impact wetlands would be minimal.

Converting lateral canals to pipe will require compacted fill which could potentially impact fringe palustrine emergent wetlands along the canals by direct filling or by loss of hydrology.

Grasslands

The 7 sites of 70 acres for the Ranney Wells will be located on primarily cultivated agricultural land, so construction impact to native grasslands will be minimal.

Intake Diversion Dam demolition material will be placed in the spoil area, and impact approximately 75 acres of Great Plains Mixed Grass Prairie. This will be a minor temporary impact as after reseeding, the area should not change in classification or function. There will be other dam materials, such as wood, rebar, and other materials which will be hauled off-site and disposed of properly.

Riparian Areas and Woodlands

The Multiple Pumps with Conservation Measures Alternative involves the installment of Ranney wells and construction of access roads at sites that are predominantly cultivated agricultural fields outside of the channel migration zone. Within the Ranney Well site boundaries, there are approximately 1.2 acres of Riparian Forested and 0.2 acres of Riparian Scrub Shrub cover that could be impacted. These areas are located mainly at the border of the Ranney Well sites, so avoidance and minimization measures would keep impact to a minimum.

Noxious Weeds

Weeds could be introduced to well construction areas on equipment, and could colonize and spread on bared disturbed soils. Overall, if disturbed areas are replanted with native species immediately after construction, equipment is inspected and cleaned daily, and replacement seed is certified as weed free, long-term construction impacts to noxious weed would be minor.

4.11.4 Operational Effects

4.11.4.1 No Action Alternative

Wetlands

The continued operation and maintenance of the Intake Diversion Dam would include replenishment of rocks across the weir crest. The placing of rocks and subsequent movement of rocks downstream due to current and ice would continue to fill riverine habitat. The current 5 acre footprint of rock would expand as it was added for operation and maintenance of the Intake Diversion Dam. The effect of this slow increase of rock footprint in the river channel would be permanent and ongoing, but minor.

Grasslands

The continued operation and maintenance of the Intake Diversion Dam will have no additional effects on grasslands beyond what already occurs from stockpiling and staging for placement of rock on the dam.

Woodlands and Riparian Areas

The continued operation and maintenance of the Intake Diversion Dam will have no effect on woodlands and riparian areas.

Noxious Weeds

Ongoing disturbances associated with maintenance could spread noxious weeds if not actively managed. With current management to insure maintenance actions do not contribute to the spread of weeds, continued operation and maintenance of the Intake Diversion Dam will have no effect on potential noxious weed encroachment.

4.11.4.2 Rock Ramp Alternative

Wetlands

The replacement weir would be built 40 feet upstream and mostly over the old rock field, so this would increase the total footprint of the replacement weir by approximately 3 acres.

The addition of rock to build the rock ramp downstream from the replacement weir would fill approximately 30 acres of riverine habitat including the river bottom. After completion of the rock ramp, the riverine habitat would be converted to a coarse mostly riprap substrate with a steeper slope than the natural river slope (0.04 percent). This would be a moderate effect, changing velocity, depths, slope, and substrate of the river for approximately 1,600 feet across the entire width of the river.

For operation and maintenance actions on the rock ramp and replacement weir, temporary access would occur on existing access routes, thus effects on wetlands would be negligible. The impacts would be minor to riverine habitat associated with temporary disturbance by placing rock. The need for rock replenishment would be substantially reduced from the existing condition resulting in less frequent maintenance activities.

Grasslands

The operation and maintenance of the rock ramp and replacement weir will have only a negligible temporary impact on grasslands as rocks for ramp maintenance are moved and stored prior to placement in existing access areas.

Woodlands and Riparian Areas

The operation and maintenance of the rock ramp and replacement weir would have no effect on woodlands and riparian areas.

Noxious weeds.

Ground disturbance for operational activities such as temporary access for repair actions could provide a pathway for dispersal and establishment of invasive plants. Methods to minimize the spread of invasive species include replanting disturbed areas with native species immediately

after construction, inspecting and cleaning equipment daily, and certifying replacement seed is as weed free, long-term construction impacts to noxious weed would be minor.

4.11.4.3 Bypass Channel Alternative

Wetlands

Permanent moderate impacts to wetlands adjacent to the Yellowstone River would include the construction of the replacement weir upstream of the Intake Diversion Dam, excavation of the bypass channel and bank modifications near the downstream entrance to the bypass channel, and filling of upstream portions of the existing side channel.

A total of approximately 34 riverine wetland acres would be permanently filled or excavated/converted to riverine channel.

Replacement weir construction would result in approximately 3 acres of fill being placed in the river directly upstream of the Intake Diversion Dam. This temporary impact on the riverine habitat will be minimal, as the low quality riverine habitat present at the Intake Diversion Dam area prior to the disturbance would be converted to a rocky substrate. There will be temporary effects on velocities and depths as the river is diverted from one side to the other with cofferdams (see Surface Water section).

Bank modifications by the Intake Diversion Dam and near the downstream entrance of the bypass channel would result in approximately 10 acres of fill being placed in the Yellowstone River where the current eddy forms on the south bank. The remaining 21 acres of riverine habitat would be filled by plugging the existing side channel. These acres will be offset by the approximate 72 acres of riverine habitat that will be created by the excavation of the new channel.

A total of approximately 1 acre of palustrine emergent wetlands would be permanently filled by the proposed plug of the upstream portion of the existing side channel. This acre of palustrine emergent wetlands will be offset by the development of new wetland habitat along the proposed new bypass channel.

The existing side channel below the proposed channel plug would not be directly affected by construction activities but could be indirectly affected by the elimination of upstream flows due to the channel plug. Although the channel will no longer convey water, it will still be backwatered from the Yellowstone River during spring runoff. The channel in these back water areas will have little to no velocity, which should encourage the growth of wetland vegetation.

For operation and maintenance actions on the replacement weir and bypass channel, temporary access would occur on existing access routes, thus effects on wetlands would be negligible. The impacts would be minor to riverine habitat associated with temporary disturbance by placing rock. The need for rock replenishment would be substantially reduced from the existing condition resulting in less frequent maintenance activities.

Periodic replacement of riprap along the banks and bottom of the bypass channel could have temporary impacts on riverine habitat and adjacent wetlands by placement of riprap. The area of impact would be minimal and infrequent as the rock is designed to withstand expected velocities.

Bypass channel maintenance may require a temporary cofferdam for removal of accumulated sediment. Temporary cofferdams could temporarily impact riverine habitat and wetlands, but the impact would be minor.

Grasslands

Permanent impacts would occur as a result of excavation of the new channel and construction of the access and haul roads. Excavation of the new channel would result in the conversion of approximately 50 acres of mostly Great Plains Sand Prairie and Great Plains Mixed Grass Prairie to riverine or riparian habitat. The filling of the existing side channel would create another approximate 70 acres of grassland.

Sediment removal from the bypass channel could impact grassland as disposal of sediment would lead to temporary disturbance and increased footprint of the spoils area. This impact would be minor, as seeding with native species would occur immediately after placement of materials.

Woodlands and Riparian Areas

The Bypass Channel Alternative will have moderate effect on woodlands and riparian areas. Approximately 57 acres of Riparian Forested and 7 acres of Riparian Scrub/Shrub are within the construction area footprint. The filling of the upper end of the existing side channel will lead to the permanent conversion of approximately 38 acres of Riparian Forest to upland. The remaining Riparian Forested acres and all of the Riparian Scrub/Shrub acres will be eliminated during excavation of the new channel.

Permanent impacts of approximately 18 acres of forested riparian and approximately 7 acres of Riparian Scrub Shrub would occur due to conversion of riparian habitat to riverine habitat in order to construct the bypass channel. Riparian habitat is on the decline and is a crucial component to a healthy river system.

All temporary and permanent impacts to riparian habitat are considered moderate due to the removal of mature trees and shrubs in an important ecosystem. Efforts to avoid and minimize effects could include replanting with native trees and shrubs immediately following construction.

Periodic replacement of riprap along the banks and bottom of the bypass channel could also temporarily remove riparian habitat. The area of impact would be minimal and any areas of vegetation removal/disturbed would be immediately replanted, resulting in overall minor impacts.

Noxious Weeds

Ground disturbance for operational activities could provide a pathway for dispersal and establishment of invasive plants. Actions such as replanting disturbed areas with native species immediately after construction, inspecting and cleaning equipment daily, and certifying

replacement seed is as weed free, will minimize long-term construction impacts to noxious weeds.

4.11.4.4 Modified Side Channel Alternative

Wetlands

The continued operation and maintenance of the Intake Diversion Dam would include replenishment of rocks across the weir crest, the same as for the No Action Alternative. The placing rocks and subsequent movement of rocks downstream due to current and ice would continue to fill riverine habitat over time. The current 5 acre footprint of rock would expand as it was added for operation and maintenance of the Intake Diversion Dam. The effect of this slow increase of rock footprint in the river channel would be permanent but minor.

Possible replacement of riprap along the modified side channel could temporarily impact wetlands and or riverine habitat, but result in the designed channel condition intended to maintain appropriate depths and velocities for fish passage.

Removal of sediment or debris from the upstream and downstream confluence areas could temporarily impact wetland or riverine habitat by placement of cofferdams or channel disturbance. It is anticipated that these activities would be rare and only occur if they caused an adverse effect on fish passage.

Grasslands

Disposal of sediment will likely be in grassland habitat at the disposal site. Reseeding and re-contouring fill will make this a temporary minor effect.

Woodlands and Riparian Areas

Possible replacement of riprap along the modified side channel could impact woodlands and riparian areas. Actions to minimize effects would include immediately replanting of disturbed areas, thus resulting in minor and temporary effects.

Noxious weeds.

Ground disturbance for operational activities could provide a pathway for dispersal and establishment of invasive plants. Actions such as replanting disturbed areas with native species immediately after construction, inspecting and cleaning equipment daily, and certifying replacement seed is as weed free, will minimize long-term construction impacts to noxious weeds.

4.11.4.5 Multiple Pump Alternative

Wetlands

Long-term maintenance of pumping sites would have minimal effect on wetlands. However, stabilization of the Yellowstone River banks to protect the pumping stations could have a continuing minor effect on riverine habitat along the river. This would require periodic placement of rock to maintain the feeder canal openings. This work would be done at low water to minimize direct impacts to the river.

Grasslands

Disposal of sediment removed from the feeder canals would likely take place at an upland grassland sites (assumed disposal to be within 1 mile of each site). This would be a minor temporary impact to grasslands, as the sites would remain upland grassland and with levelling and reseeding, would return to normal ecological function. Stabilization of the banks in order to protect the pumping stations, and the maintenance of bank protection thereafter could temporarily impact grasslands by the construction of temporary haul roads and staging areas. These impacts would be temporary and minor.

Riparian Areas and Woodlands

Long-term maintenance within the pump site area would have no effect on riparian and wooded areas. However, the permanent placement of rock on the banks in order to protect the pumping stations, and the maintenance of bank protection thereafter, could moderately impact riparian and wooded areas and prevent the long-term natural succession of the riparian areas protected behind the bank protection. All temporary and permanent impacts to riparian areas are considered moderate and would be offset by replanting disturbed areas with native trees and shrubs.

Noxious Weeds

Ground disturbance for operational activities such as bank stabilization could provide a pathway for dispersal and establishment of invasive plants. Actions such as replanting disturbed areas with native species immediately after construction, inspecting and cleaning equipment daily, and certifying replacement seed is as weed free, will minimize long-term construction impacts to noxious weed.

4.11.4.6 Multiple Pumps with Conservation Measures Alternative

Wetlands

Losses of wetlands identified in the “Construction Impacts” section, above, would continue during operations, making this loss permanent. Maintenance practices of the headworks and pumping sites will have no additional impact to wetlands. Maintenance of the access roads and distribution lines could impact wetlands, and minimization measures would be employed. There would likely be a number of wetlands that are sustained by groundwater or surface water flows from the irrigation system that would be eliminated for the Multiple Pumps with Conservation Measures Alternative. However, these wetlands cannot be quantified at this time, and if this alternative were to move forward to more detailed design, the entire irrigation system would need to be surveyed for wetlands.

Grasslands

Long-term routine maintenance of the headworks and pumping sites will have minimal impact on grassland as pumping sites are located on agricultural fields. Maintenance of the access roads, distribution line, and pumps could impact small portions of grasslands adjacent to cultivated fields. Effects are expected to be temporary and minor.

Riparian Areas and Woodlands

Losses of riparian areas and woodlands identified in the “Construction Impacts” section, above, would continue during operations, making this loss permanent. Long-term routine maintenance of the headworks and pumping sites will have no effect on riparian areas and woodlands.

Maintenance of the access roads and distribution lines could impact riparian areas, and minimization measure would be employed.

Noxious Weeds

Equipment used for maintenance activities would provide a potential source for the spread of noxious weeds. Actions such as replanting disturbed areas with native species immediately after construction, inspecting and cleaning equipment daily, and certifying replacement seed is as weed free, will minimize long-term construction impacts to noxious weed.

4.11.5 Cumulative Effects

4.11.5.1 Geographic and Temporal Extent of Analysis

The geographical extent would be the floodplain of the Yellowstone River from the Intake Diversion Dam to the confluence with the Missouri River because effects on land and vegetation would be limited to that area, and for the duration of the life of the project, a period of 50 years.

4.11.5.2 Methodology for Determining Effects

Cumulative effects on land use and vegetation include the suite of impacts that have resulted, or will result, from the continued and overlapping development for human use. The cumulative effects on land use and vegetation are determined by assessing the impacts resulting from past projects, current projects, and project that are reasonably expected to occur in the future. These are then combined with the effects assessed above for each proposed alternative to get a sum total of cumulative effects.

4.11.5.3 Past, Present, and Reasonably Foreseeable Future Projects Considered

Past and present actions that have impacted the land and vegetation include agriculture and irrigation; both of which have become more dominant in the study area since 1950. Historical records show much of the Yellowstone River floodplain in the early 1900s consisting of abundant stands of cottonwood timber and shrubs with extensive herds of wild ungulates. By 1950, most of the large-scale conversion to agricultural development had occurred, but between 1950 and 2001 over 6,800 acres of woody riparian vegetation was converted to another use, 80 percent of which was for irrigated agriculture (Corps 2015).

Channel migration is critical to creating and maintaining riparian and wetland habitat within the river corridor. Maintaining riparian and wetland habitat is largely attributed to channel migration. Estimates of wetland loss range from one-quarter to one-third of its historic extent. Reductions in channel forming flows puts long-term viability of the riparian and wetland communities at risk (Corps 2015).

Recent agricultural economics in the study area is likely to continue the trend toward more conversion of unirrigated agricultural lands to irrigation. These recent land use conversions have also replaced areas of formerly natural riparian land cover to agricultural uses. The LYP provides part of this impetus to convert to irrigated agriculture.

Reasonably foreseeable future projects and actions that could affect the lands and vegetation in the study area include the Yellowtail Afterbay Hydropower Project (see section 4.1.3 for descriptions of projects/actions). The Yellowtail Afterbay Hydropower Project could increase the

use of water from the Yellowstone River watershed and further regulate the flows of the river, resulting in a further reduction of natural riparian and floodplain vegetation turnover.

General regional trends considered include further development of Bakken oil fields, increases in pivot irrigation and bank armoring, general urbanization and climate change. The Bakken oil field development, along with general urbanization trends could increase land use conversions from natural habitat to other uses as the Yellowstone River Valley become more developed. Increases in bank armoring and pivot irrigation further restrict channel migration and the natural formation of floodplain and riparian habitats. Climate change could bring changes such as increased drought, which could increase irrigation needs and potentially cause riparian and wetlands to transition to upland habitats if water is less available to support these native plant communities.

4.11.5.4 No Action Alternative

Under the No Action Alternative, effects that would contribute to cumulative impacts would include the continued operation and maintenance of the Intake Diversion Dam.

Continued modification of flows of the Yellowstone River for diversion into the LYP, the use of additional water for oil and other development would continue to incrementally impact water availability to downstream habitats, which could continue to result in minor cumulative impacts to wetlands and riparian or woodlands over time.

These actions would have no additional cumulative effect on grasslands, since activities do not occur on grasslands or affect noxious weed presence.

4.11.5.5 Rock Ramp Alternative

Under the Rock Ramp Alternative, the loss of wetland and riverine habitat by the rock ramp footprint would have a minor contribution to the longer term trends of removing the natural functions of the river. The disturbance of construction and maintenance on the surrounding vegetation, if not controlled, could contribute minor effect on the ongoing spread of noxious weeds throughout the basin.

4.11.5.6 Bypass Channel Alternative

Under the Bypass Channel Alternative, the conversion of the existing side channel to a backwater channel will affect the natural channel migration and formation of wetland and floodplain habitats, continuing a trend that has been occurring all along the river. This effect would be minor, but will continue this trend. While the bypass channel, itself will off-set the loss of the flow-through function of the existing side channel, it will be maintained in the design configuration and natural channel migration will be discouraged.

The permanent conversion of grassland to the bypass channel will result in a loss of 50 acres of grassland that was already disturbed from various recreational uses of Joe's Island. The filling of the existing side channel will create 70 new acres of grassland, thus generally off-setting the net loss and likely creating more natural native grassland through planting of native species. The cumulative result will be negligible.

The considerable footprint of disturbance for the Bypass Channel Alternative could contribute a moderate cumulative effect on the ongoing spread of noxious weeds throughout the basin.

4.11.5.7 Modified Side Channel Alternative

Under the Modified Side Channel Alternative, the maintenance action of armoring of the modified side channel banks would have a minor contribution to the ongoing trend of limiting the natural meandering of the river channel. This will limit the channels ability to migrate and develop wetlands and riparian areas. Backwater areas will be specifically designed for wetland establishment, which may succeed to riparian areas in the future.

The loss of riparian acres would contribute to the ongoing cumulative effect from increases in urbanization, bank stabilization, irrigation, and water use along the Yellowstone River. The cumulative effect would be minor, but would continue this trend.

The large disturbance footprint of the Modified Side Channel Alternative could contribute to the ongoing trend of the spread of noxious weeds throughout the basin.

These actions would not contribute to any ongoing or future cumulative effect on grasslands, as the grassland impacted on Joe's Island have been already disturbed by other various recreational uses.

4.11.5.8 Multiple Pump Alternative

Under the Multiple Pump Alternative, bank stabilization necessary for pump site protection from a meandering river would contribute to the ongoing cumulative effects of limiting the natural meandering of the river. An incremental decrease in channel migration potential will limit the development and stability of wetlands and riparian areas along the river. Considering the space between each pump site, and the length of channel needed, this cumulative effect would be moderate.

These actions would not contribute to any ongoing or future cumulative effect on grasslands or noxious weeds.

4.11.5.9 Multiple Pumps with Conservation Measures Alternative

Under the Multiple Pumps with Conservation Measures Alternative, because activities will occur outside of the river floodplain, actions would not contribute to any ongoing or future cumulative effects on wetlands, or riparian areas. The Multiple Pumps with Conservation Measures Alternative would not contribute to any ongoing or future cumulative effect on grasslands, as the majority of the footprint for the Ranney Wells would be located on cultivated agricultural land. The disturbance to grasslands for the well installation and access road construction could contribute to the ongoing cumulative effect of noxious weed spread throughout the Yellowstone Basin. The effect would be minor, but would increase this trend.

4.11.6 Actions to Minimize Effects

The following actions would minimize general effects for all alternatives:

- Before construction begins, Reclamation and the Corps will meet with the Service and the appropriate state wildlife agencies to determine a procedure to minimize impacts to lands and vegetation. A reconnaissance survey of construction easements will be

conducted to identify and verify wetlands, grasslands, woodlands, and riparian areas subject to disturbance and/or destruction in the Intake Project area during construction activities.

- All areas temporarily impacted during construction will be replanted with native vegetation immediately after construction.
- Disturbance of vegetation will be minimized through construction site management (e.g., using previously disturbed areas and existing access routes when feasible and designating limited equipment/materials storage yards and staging areas). It will be limited to that which is absolutely necessary for construction of the Intake Project.
- Areas outside of the project footprint will be fenced or flagged for protection from disturbance.
- Erosion control measures will be employed where necessary to reduce wind and water erosion. Erosion and sediment controls will be monitored daily during construction for effectiveness and only effective techniques will be used.
- No permanent or temporary structures will be located in any floodplain, riparian area, wetland or stream that would interfere with floodwater movement, except for those described in the EIS.

The following actions would minimize effects on wetlands for all alternatives:

- For the Multiple Pumps with Conservation Measures Alternative, when considering the placement of Ranney Wells, prior to beginning construction through Conservation Reserve Program lands or program wetlands, the Natural Resources Conservation Service, Consolidated Farm Services Agency, and respective landowners will be consulted to ensure that landowner eligibility in farm subsidy programs (if applicable) will not be jeopardized and that Sodbuster or Swampbuster requirements will not be violated by construction.
- The disposal of waste material, topsoil, debris, excavated material or other construction related materials within any wetland, drainage way, stream or aquatic system would be minimized to the extent possible.
- Discharges of fill material associated with unavoidable crossings of wetlands or intermittent streams will be minimized to the maximum extent practicable.
- Low pressure equipment or pressure-spreading mats will be used as feasible to minimize compaction of wetland soils during construction.
- Rock quarry materials will come from approved upland sites.

The following actions would minimize effects on grasslands for all alternatives:

- Grasslands temporarily affected during construction will be restored with similar native species immediately following construction.
- Topsoil will be removed and conserved from the bypass channel construction site. Topsoil not returned to the bypass channel banks will be used to cover fill sites and then seeded.
- Two methods of seeding should be utilized for reclamation areas. Seeds will either be drilled or broadcast based on the species being planted. Drill seeding is recommended for most grasses and large-seeded shrubs and forbs that need to be planted at least ¼ inch deep. Drill seeding is preferred for soil to seed contact, positive depth control, proper seeding rate (once calibrated), and minimum amount of seed usage. Broadcast seeding is

recommended for very small and fluffy seeds that need to be planted 1/16 to 1/8 inches deep. Modern range drills may be capable of drill and broadcast seeding.

- Areas requiring re-vegetation will be seeded and mulched during the first appropriate season after redistribution of topsoil. If reseeding cannot be accomplished within 10 days of topsoil replacement, erosion control measures will be implemented to limit soil loss. Local native grass species would be used.
- Seeding should take place the first appropriate season following topsoil replacement. Seeding between October 15 and April 15 is the most effective throughout Montana because late winter/early spring is the most reliable period for moist soil conditions. In general, fall seeding (between October 15 and when the frost line is deeper than four to six inches) in eastern Montana has been more successful than spring seeding. Some seed may require cold stratification to germinate. However, spring seeding may be considered if timing of construction warrants.
- Vegetation and soil removal will be accomplished in a manner that will prevent erosion and sedimentation.
- Noxious weeds will be controlled, as specified under state law, within the construction footprint during and following construction. Herbicides will be applied in accordance with labeled instructions and state, federal, and local regulations.
- All construction equipment will be cleaned and inspected prior to mobilizing to the project site to prevent transport of noxious weed seeds and fragments.
- Grass seeding will be monitored for at least three years. Where grasses do not become adequately established, areas will be reseeded with appropriate species.

The following actions would minimize effects on woodlands, shrublands and riparian areas for all alternatives:

- The disposal of waste material, topsoil, debris, excavated material or other construction related materials within riparian areas would be minimized to the extent possible. Woodland and riparian areas will be avoided where practical when constructing permanent facilities.
- Woodland and riparian areas impacted by the Intake Project will be restored with native species.
- Native trees and shrubs will be replaced with similar native species.
- Willows will be established, as feasible, along any areas disturbed along the river or new channels/canals to provide wildlife habitat and channel stability.

The following actions would minimize noxious weed effects for all alternatives:

- All contractors will be required to inspect, clean and dry all machinery, equipment, materials and supplies to prevent spread of either aquatic or terrestrial noxious weeds.
- All areas disturbed or newly created by the construction activity will be seeded with vegetation immediately after construction for protection against subsequent erosion and noxious weed establishment.
- All equipment tracks and tires working on Joe's Island or other noxious weed infested areas will be cleaned daily to reduce potential transportation to an uninfested site.
- The contractor will prepare an integrated weed plan to be approved by the Corps. It will identify best management practices to control the spread or introduction of any noxious weeds or plants. The weed plan will be implemented throughout construction.

- Seed would be certified as cheatgrass and weed free and “blue tag;” this is especially important in areas where weedy or invasive species are already present.

4.12 Recreation

Impacts to recreation resources are characterized as alterations or diminished accessibility to the lands and facilities used for recreation. The types of impacts that a project may cause include:

- Changes to the availability or quality of existing recreational opportunities in the study area.
- Construction or operational activities of the project that would cause long-term disruption of established recreational facilities.

4.12.1 Area of Potential Effect

For the purposes of this analysis, the study area for recreation resources is defined as the river-adjacent and irrigation canal-adjacent recreation areas and facilities between the Intake Diversion Dam and the confluence with Missouri River. Recreation-related resources and facilities further from the river are not likely to be impacted by construction or operation of a project that is within or adjacent to the river channel and canal.

4.12.2 Summary of Potential Effects

Table 4-29 summarizes the potential effects on recreation for each alternative. Details are provided in the following sections.

TABLE 4-29. SUMMARY OF POTENTIAL EFFECTS ON RECREATION FROM EACH ALTERNATIVE

Impact Type	Level of Impact	Impact Description
No Action Alternative		
Construction Effects	No Effect	<ul style="list-style-type: none"> • No construction, no effect
Operational Effects	No Effect	<ul style="list-style-type: none"> • No changes to operations, no effect
Rock Ramp Alternative		
Construction Effects	Moderate	<ul style="list-style-type: none"> • Adjacent construction reduces quality and access, may reduce visitation • Closure of the boat ramp is a significant effect, but addressed via actions to minimize effects to less than significant.
Operational Effects	Moderate	<ul style="list-style-type: none"> • Reduced fishing quality at FAS riverfront • Closure of the boat ramp is a significant effect, but addressed via actions to minimize effects to less than significant. • Effects on Glendive Chamber’s caviar program and concessionaire program
Bypass Channel Alternative		
Construction Effects	Moderate	<ul style="list-style-type: none"> • General effects are minor to moderate; adjacent construction reduces quality and access, may reduce visitation • Effects on Glendive Chamber’s caviar program and concessionaire program

Impact Type	Level of Impact	Impact Description
Operational Effects	Moderate	<ul style="list-style-type: none"> • New navigable channel around the Intake Diversion Dam • Upstream migration and new spawning areas may benefit recreational fishery • Some reduction in fishing success at FAS due to fish able to move upstream • Effects on Glendive Chamber's caviar program and concessionaire program
Modified Side Channel Alternative		
Construction Effects	Minor	<ul style="list-style-type: none"> • Construction area has minimal impact on FAS, and low impact on Joe's Island, other than access via road over the modified side channel
Operational Effects	Moderate	<ul style="list-style-type: none"> • New navigable channel around the Intake Diversion Dam • Upstream migration and new spawning areas may benefit recreational fishery, though BRT has concerns about success • Some reduction in fishing success at FAS due to fish able to move upstream • Effects on Glendive Chamber's caviar program and concessionaire program
Multiple Pump Alternative		
Construction Effects	Moderate	<ul style="list-style-type: none"> • Adjacent construction reduces quality and access, may reduce visitation • Effects on Glendive Chamber's caviar program and concessionaire program • Intake Diversion Dam removal initiates permanent changes fishing likelihood of success at FAS
Operational Effects	Moderate	<ul style="list-style-type: none"> • Boater access benefits (upstream access) • Upstream migration and new spawning areas may benefit recreational fishery • Some reduction in fishing success at FAS due to fish able to move upstream • Effects on Glendive Chamber's caviar program and concessionaire program
Multiple Pumps with Conservation Measures Alternative		
Construction Effects	Moderate	<ul style="list-style-type: none"> • Adjacent construction reduces quality and access, may reduce visitation • Effects on Glendive Chamber's caviar program and concessionaire program • Intake Diversion Dam removal initiates permanent changes fishing likelihood of success at FAS
Operational Effects	Moderate	<ul style="list-style-type: none"> • Boater access benefits (upstream access) • Upstream migration and new spawning areas may benefit recreational fishery • Some reduction in fishing success at FAS due to fish able to move upstream • Effects on Glendive Chamber's caviar program and concessionaire program

4.12.3 Construction Effects

4.12.3.1 No Action Alternative

The No Action Alternative does not include construction activity. The alternative includes the continued operation of the LYP using the existing diversion headworks (constructed 2010-2012) and the Intake Diversion Dam. Because there would be no construction, the No Action Alternative would have no construction related effects on recreation.

4.12.3.2 Rock Ramp Alternative

The Rock Ramp Alternative's construction is limited to the left and right banks at the Intake Diversion Dam (Figure 2-3). The alternative would not physically impact the Intake FAS property, but its proximity to the recreation area would result in adverse construction effects. Construction activities may require temporary closure of the Intake FAS for brief period, but in general, it is assumed that the Intake FAS would remain accessible throughout the construction period. However, due to heavy use of the access roads leading to and on Joe's Island for construction of the Rock Ramp Alternative, Joe's Island would be closed for the duration of the construction period, about 2 years. This would have relatively minor recreation impacts.

General Activities

Minor to moderate direct effects of construction on recreation would include noise, dust, and construction equipment that would temporarily reduce quality of the recreation experience at Intake FAS. Affected activities would include picnicking, camping, walking/hiking, and swimming and other day use activities. Impacts on air quality, noise, aesthetics, and the general outdoor recreation experience, which includes desire for quiet natural surroundings, would be minor moderate, as the construction of the Rock Ramp Alternative would occur directly in front of the Intake FAS. In addition, visitors to the Intake FAS may experience some minor delays or congestion accessing the site along Canal Road during periods of heavy construction activity despite inclusion of a temporary bridge across the irrigation canal for construction traffic. These effects could result in temporary reductions in visitors to the site.

Impacts on other less common activities such as ice fishing would be temporary in nature. Ice fishing opportunities may be reduced near the Intake Diversion Dam, and anglers may choose to fish elsewhere during construction. Additionally, because the Yellowstone River is designated as part of the Lewis and Clark National Historic Trail, construction activities would have temporary and minor adverse effects on the aesthetic quality along the trail. However, since no interpretive infrastructure exists at the site, effects on the trail would be minor and not significant. Construction effects on the trail would be similar for all action alternatives.

Hunting, Fishing, and Boating

The quantity and quality of hunting and fishing opportunities near the Intake Diversion Dam during construction would be affected. Due to closure of Joe's Island, hunters would need to find a substitute area in the study area for upland hunting. However, this effect would be minor, as Joe's Island is neither regionally unique nor a high-use hunting area. At Intake FAS, the quality of fishing at the site would be diminished due to construction activities in the close proximity, and anglers may choose to fish elsewhere.

The paddlefish season is the peak recreation season for Intake FAS, and it is expected that construction activities would be minimized during the paddlefish season. A reduced catch at Intake FAS during the paddlefish season could have both beneficial and adverse effects in the study area. Beneficial effects might include a prolonged paddlefish season, as catch quotas are met more slowly. Adverse effects could include reduced revenue from the Yellowstone Caviar program and impacts to the concession operators at the Intake FAS, as anglers may be more dispersed on the river and less likely to transport their catch to the program's processing facility. See the Socio-economic discussion in section 3.x for details.

Impacts on ice fishing would be temporary in nature. Ice fishing opportunities may be reduced near the Intake Diversion Dam, and anglers may choose to fish elsewhere during construction.

Summary

The Rock Ramp Alternative would have adverse effects on recreation resources in the study area during construction, most of which are concentrated at the Intake FAS and Joe's Island. Temporary effects on the quantity and quality of recreation during construction are determined to be minor to moderate and less than significant.

4.12.3.3 Bypass Channel Alternative

The bulk of the construction of the Bypass Channel Alternative would take place over 2 years on the right bank of the river on Joe's Island, but there would be construction activity on the left bank during construction of the replacement weir (Figure 2-4) which would last approximately six months. As such, this alternative would not physically impact the Intake FAS, but its proximity to the recreation area could result in adverse construction effects, and certain construction activities may require temporary closure of the FAS. As with the Rock Ramp Alternative, there would be heavy use of the access roads leading to Joe's Island and the adjacent disposal area, Joe's Island would be closed for the duration of the construction period, resulting in relatively minor recreation impacts to users who would need to utilize substitute public lands.

General Activities

Impacts to the Intake FAS are likely to be minor for general activities such as picnicking, camping, walking/hiking, and swimming and other day use activities. Construction-related noise, dust, and construction equipment may temporarily reduce the quality of the recreation experience at Intake FAS, but the source of these impacts would be just upstream of the Intake Diversion Dam. There would likely be some minor delays or congestion accessing the site along Canal Road during period of heavy use of the construction access road on the north side of the river despite inclusion of a temporary bridge across the irrigation canal for construction traffic. These effects could result in temporary reductions in visitors to the site.

Impacts on other less common activities such as swimming will be similar to the Rock Ramp Alternative.

Hunting, Fishing, and Boating

The quantity and quality of hunting and fishing opportunities during construction may be affected, though likely to a lesser degree than the Rock Ramp Alternative. At Intake FAS, the quality of fishing at the site may be diminished during construction due to activities upstream of the Intake Diversion Dam and at the mouth of the bypass channel. While these effects would be

less substantial than for the Rock Ramp Alternative, anglers may choose to fish elsewhere if the presence of nearby construction appears to impact fishing success. The boat ramp would remain open under the Bypass Channel Alternative.

Closure of Joe's Island for the duration of construction would make the area inaccessible to all users during the construction period. Hunters, hikers, or wildlife viewers would need to find substitute sites during the construction period, which may be a minor to moderate impact. However, the proximity of substitute sites, such as Elk Island WMA, would make these adverse effects not significant.

The paddlefish season is the peak recreation season for Intake FAS, and it is expected that construction activities would be minimized during the paddlefish season. There would likely be less of an impact to snagging opportunities at Intake FAS since the boat ramp and shore-fishing areas would remain open during construction, with the exception of shore fishing on the Joe's Island, due to closure of the island. Thus, the alternative may still result in a somewhat reduced catch at Intake FAS during the paddlefish season, which could extend the season or result in anglers utilizing other fishing locations.

Adverse effects of reduced paddlefish catch at Intake FAS would be similar to, though likely lesser than, those for the Rock Ramp Alternative.

Summary

The Bypass Channel Alternative would have a variety of adverse effects on recreation resources in the study area during construction, most of which are concentrated at Intake FAS and Joe's Island. Temporary effects on the quantity and quality of recreation from the presence of construction activities are determined to minor to moderate, and less than significant. To minimize these effects, an action to minimize effects is included which would substantially reduce construction activities during the paddlefish season.

4.12.3.4 Modified Side Channel Alternative

Like the Bypass Channel Alternative, the Modified Side Channel Alternative includes construction primarily on the right bank of the river on Joe's Island over an 18-month period, and would include closure of the island for the duration. This alternative does not include replacement of the Intake Diversion Dam, and as such, would not require construction on the left bank of the river (Figure 2-6). Due to the alignment of the modified side channel's upstream and downstream connection with the river, any construction activity would be approximately a mile from the Intake FAS. Thus for this alternative, recreation impacts at the FAS would be minimal.

General Activities

Given the distance from construction activities, impacts to the Intake FAS are likely negligible. Closure of Joe's Island would have only minor adverse effects due to the availability of substitute public lands in the study area.

Effects on less common activities such as swimming or ice fishing would be negligible, as the construction includes minimal overlap with existing recreation areas.

Hunting, Fishing, and Boating

The Modified Side Channel Alternative is expected to have fewer and less severe effects on the quantity and quality of hunting and fishing opportunities during construction as compared to the Bypass Channel Alternative or the Rock Ramp Alternative.

As with other alternatives, hunters would be unable to access Joe's Island and would need to use substitute sites in the study area.

Effects on fishing at the Intake FAS would be negligible because access to the site would be unaffected, and construction activities would be a mile or more away from the site. There may be a minor effect on fishing due to the inability to fish from the shore on Joe's Island during construction.

The Modified Side Channel Alternative would likely have negligible to minor adverse effects on the paddlefish season. The Intake FAS and boat ramp would be fully operational during construction, and adverse effects on paddlefish catch at Intake are not expected during the construction period.

Summary

The Modified Side Channel Alternative would have a minor overall effect on recreation resources in the study area during construction, most of which are concentrated at Joe's Island. Effects on the quantity and quality of recreation from construction are judged to be temporary and less than significant. Of the proposed action alternatives, the Modified Side Channel Alternative would have the least impact on recreation during construction.

4.12.3.5 Multiple Pump Alternative

The Multiple Pump Alternative is the first of the two action alternatives which include construction features at multiple sites along the river and includes removal of the Intake Diversion Dam (Figure 2-10). Overall construction would take about 3 years, but dam removal would take about 6 months. Due to use of the area access roads for removal of the Intake Diversion Dam, Joe's Island would be closed for the duration of the dam removal, and there would be relatively minor recreation impacts.

The Multiple Pump Alternative includes construction at five different pump sites within the study area, one in Dawson County adjacent to the Intake Diversion Dam, and four along the river in southern Richland County, the furthest north being just upstream of Elk Island. Not including access road rights of way and piping to the Main Canal, the construction area for each pump site occupies between 4 and 11 acres of land depending on the necessary size of the feeder canal. Of the five pump sites, only the furthest upstream site, located at Intake FAS, would have direct recreation effects. The remaining four pump sites are located on privately owned lands or lands not accessible for recreation and so would have negligible direct effects.

Construction for the pump site located at Intake FAS occupies nearly all of the designated day use area at the FAS, overlaps portions of the parking lot, and is located in such close proximity to the boat ramp that it would be closed during construction. Construction would likely require temporary closure of Intake FAS while pipe is installed between the pump house and irrigation canal, which would cut off the only access to the site from Highway 16.

General Activities

Impacts to the Intake FAS are likely to be moderate to major for general activities such as picnicking, camping, walking/hiking, and swimming and other day use activities. The source of construction-related noise, dust, and construction equipment would be in close proximity to recreation areas when the pumping station is under construction, which would substantially reduce the quality of the recreation experience at Intake FAS. Some day use activities could be temporarily provided in the campground, but they may be congestion issues during the busy season, and the quality of the campground experience would be substantially diminished due the close proximity of the pumping station. Additionally, there would likely be some minor delays or congestion accessing the site along Canal Road during periods of heavy use of the construction access road on the north side of the river despite inclusion of a temporary bridge across the irrigation canal for construction traffic. These effects would be expected to result in temporary reductions in visitors to the site.

Hunting, Fishing, and Boating

There would be no effects on hunting from the alternative because hunting is not allowed at the Intake FAS.

Minor to moderate adverse effects on fishing would occur during construction. Removal of the existing Intake Diversion Dam would be accomplished in two phases, one-half at a time. This could have adverse effects on fishing opportunities due to water quality and channel disturbances that might reduce fish presence near the Intake FAS. Construction of the pump facility would not impact fishing quality until the final step of connecting the feeder canal to the river, which could have minor temporary effects adjacent to the connection location. However, general proximity to pumping station construction may make the Intake FAS a less attractive fishing destination.

Like other alternatives it is expected that construction activities would be minimized during the paddlefish season. Effects on the paddlefish season during construction would be minor until dam removal was initiated. Earthwork during dam removal could alter water quality and reduce the quality of fishing opportunities at the site. Once the Intake Diversion Dam is at least partially removed, fish would be able to continue upstream past the Intake FAS, which could reduce the likelihood of success when fishing from Intake. Thus, the alternative may result in a somewhat reduced catch at Intake FAS during the paddlefish season in the final construction phase, which could extend the season or result in anglers utilizing other fishing locations.

Adverse effects of reduced paddlefish catch at Intake FAS would be similar to that for other alternatives during construction.

Summary

The Multiple Pump Alternative would have moderate to major adverse effects on recreation resources in the study area during construction, most of which are concentrated at Intake FAS. Temporary effects on the quantity and quality of recreation from the presence of construction activities are determined to be moderate, and loss of the boat ramp would be a significant impact. To mitigate these effects, an action to minimize effects is included which would substantially reduce construction activities during the paddlefish season and to initiate consultation to relocate the boat ramp. This would lessen effects to less than significant.

4.12.3.6 Multiple Pumps with Conservation Measures Alternative

The Multiple Pumps with Conservation Measures Alternative also includes construction features at multiple sites along the river and includes removal of the Intake Diversion Dam (Figure 2-21). The Multiple Pumps with Conservation Measures Alternative includes construction at seven different 70-acre sites within the study area where a field of Ranney wells would be installed. The well sites have been identified in a manner to ensure the sites are outside the channel migration zone and are located on agricultural lands. As such, construction on the sites would have negligible effects on recreation. However, dam removal would affect recreation at Intake FAS, and would require closure of Joe's Island for a period of six months.

General Activities

Impacts to the Intake FAS are likely to be negligible until dam removal is initiated. During dam removal, effects would be minor to moderate for general activities such as picnicking, camping, walking/hiking, and swimming and other day use activities. Construction-related noise, dust, and construction equipment may temporarily reduce the quality of the recreation experience at Intake FAS. There would likely be some minor delays or congestion accessing the site along Canal Road during periods of heavy use of the construction access road on the north side of the river despite inclusion of a temporary bridge across the irrigation canal for construction traffic. These effects could result in temporary reductions in visitors to the site.

Hunting, Fishing, and Boating

As in other alternatives, Joe's Island would be closed during construction, resulting in a minor adverse effect on hunting. Use of the Intake FAS boat ramp would be preserved throughout construction.

The quality fishing opportunities during construction would be experience minor to moderate adverse effects during dam removal. As with the Multiple Pump Alternative, dam removal would be accomplished in two phases, one half at a time, which could have adverse effects on fishing opportunities due to water quality and channel disturbances that might reduce fish activity near the Intake FAS.

Like other alternatives it is expected that construction activities would be minimized during the paddlefish season. Effects on the paddlefish season during construction would be minor until dam removal was initiated. During dam removal, effects would be similar to those for the Multiple Pump Alternative.

Adverse effects of reduced paddlefish catch at Intake FAS would be similar to that for other alternatives during construction.

Summary

The Multiple Pumps with Conservation Measures Alternative would have minor to moderate adverse effects on recreation resources in the study area during the dam removal portion of construction at the Intake FAS. Temporary effects on the quantity and quality of recreation from the presence of construction activities are determined to be minor to moderate and less than significant, though effects on fishing from dam removal do continue during operation in some cases. To mitigate these effects, an action to minimize effects is included which would substantially reduce construction activities during the paddlefish season.

4.12.4 Operational Effects

4.12.4.1 No Action Alternative

Operation of the project under the No Action Alternative would continue as it does in the existing condition. The headworks and Intake Diversion Dam would continue to provide irrigation water for the LYP and regular and routine O&M would continue as it does presently. The No Action Alternative would not affect recreation resources in the study area. Recreation in the study area, and specifically at Intake FAS, would continue in the future as they do in the existing condition. The types of available recreation resources within the study area are expected to remain mostly unchanged throughout the period of analysis. Recreation within the study area would continue to be focused on river-related and upland outdoor recreation and growth in recreation participation would increase in to proportion to population within the study area. Future effects of climate change on the river, including earlier and lower level of runoff from snowmelt, and decreased flows in later summer, could shift ideal river conditions for certain activities such as fishing or boating toward earlier in the season. The effect of climate change on recreation is similar for all action alternatives.

The No Action Alternative would not result in any beneficial or adverse operational effects on Recreation.

4.12.4.2 Rock Ramp Alternative

The operation of the Rock Ramp Alternative would not be substantially different from the operation of the No Action Alternative from the perspective of effects on recreation. The constructed features of the alternative are largely within the river, and access to Intake FAS and Joe's Island is preserved.

However, the quality of fishing and boating opportunities along the river in front of the FAS would experience substantial adverse effects. The shallow waters of the rock ramp would result in permanent closure of the existing boat ramp, and may reduce fishing success for some species on the shore at the FAS, especially during the paddlefish season. Paddlefish would still be expected to stack up at the foot of the rock ramp, but this location could not be easily accessed by shore fishermen. With changes in the location of fishing opportunities, and a potential reduction in the availability of fish at the downstream end of the Intake Diversion Dam, use of the Intake FAS may be reduced. As during construction, reduced availability and success of paddlefishing at Intake may result in a short-term period of reduced revenue for the Glendive Chamber of Commerce. Both a drop in participation in the caviar program and an extended fishing season may increase labor costs and contribute to lower returns from the program.

In order to mitigate the loss of the boat ramp, Reclamation would consult with MFWP in order to site and relocate the boat ramp, as noted in the list of actions to minimize effects. While the Rock Ramp Alternative is intended to support fish passage, the extent to which upstream improvement in the recreational fishery would offset reduced opportunities at Intake FAS is uncertain. Additionally, the Rock Ramp Alternative does not provide for upstream passage for boaters. As it relates the Lewis and Clark National Historic Trail, this may result in minor adverse effects to the recreational experience along this portion of the trail, but would be less than significant as the existing condition does not provide for passage explicitly either.

Overall, the operational effects of the Rock Ramp Alternative on recreation would be minor to moderate depending on activity, with the exception of impacts on the Intake FAS boat ramp, which would be significant. In order to mitigate the loss of the boat ramp, Reclamation would consult with MFWP in order to site and relocate the boat ramp, as noted in the list of actions to minimize effects. This would reduce the effect to less than significant.

4.12.4.3 Bypass Channel Alternative

From the perspective of effects on recreation, the operation of the Bypass Channel Alternative would result in mostly beneficial effects.

Beneficial effects on recreation from the Bypass Channel Alternative include the creation of additional channel area that would be open for recreation use, including boating. A navigable bypass channel would also provide boaters easier access to the upstream side of the Intake Diversion Dam from the Intake FAS boat ramp, and boater access along the Lewis and Clark National Historic Trail. Visitation to Joe's Island may also increase in the short term as visitors explore the new channel. Boater access benefits would be substantial as compared to the existing condition.

The bypass channel could also improve fishing opportunities upstream of the Intake Diversion Dam. Paddlefish would still be expected to stack up downstream of the Intake Diversion Dam, but would also have the opportunity to move further upstream. Paddlefish could potentially travel as far upstream as the Cartersville irrigation dam, at Forsythe (River Mile 238.6). Upstream spawning by paddlefish could result in an increase in paddlefishing opportunities upstream of Intake over the long term, which would in turn increase visitation and use of upstream fishing access sites. In the short term, beneficial effects may be minor to moderate as anglers monitor and adapt to changes in the recreational fishery.

With changes in the location of fishing opportunities, and a potential reduction in the availability of fish at the downstream end of the Intake Diversion Dam, use of the Intake FAS may be reduced. The Bypass Channel Alternative would result in an approximately 75-acre reduction in upland area on Joe's Island from construction of the channel, which would result in minor, negligible impacts to the availability of opportunity for hunting, wildlife viewing and other recreational activities that require upland habitat, and a minor increase in surface water areas available for fishing, boating, or other related activities at the site. Overall, the adverse operational effects of the Bypass Channel Alternative on recreation would be minor and less than significant, while there would be moderate beneficial effects, especially related to greatly improved ability of boaters to move past the Intake Diversion Dam.

4.12.4.4 Modified Side Channel Alternative

From the perspective of effects on recreation, the Modified Side Channel Alternative is expected to have some of the same effects on recreation as the Bypass Channel Alternative, but the effects of the alternative on the recreational fishery include additional uncertainty. The downstream entrance to the modified side channel is located about 1.6 river miles downstream of the Intake Diversion Dam. While the Modified Side Channel Alternative would meet requirements for flow, depths, and velocities, there has been concern that fish may not routinely utilize the modified side channel. As such, this analysis assumes the Modified Side Channel Alternative would be moderately successful in attracting fish to move through the channel. Fishing

opportunities at Intake may remain much the same as they are now, with minor to moderate reductions in likelihood of success as a result of the proportion of the fish that do utilize the modified side channel. Thus, the operational effects of the Modified Side Channel Alternative on recreation are determined to be minor to moderately adverse, since Intake FAS would still provide a viable and successful FAS and general operation of the boat ramp and Intake Diversion Dam would remain the same.

4.12.4.5 Multiple Pump Alternative

From the perspective of effects on recreation, the operation of the Multiple Pump Alternative would result in a range of both beneficial and adverse operational effects.

Beneficial effects on recreation from the alternative include improved boater access to areas upstream of Intake and along the Lewis and Clark National Historic Trail via the main channel rather than a side channel, and potential for improved longer term fishing opportunities upstream of the Intake Diversion Dam due to new availability of upstream spawning areas for resident fish species. However, loss of the boat ramp due to pumping station location may directly offset this benefit.

With the Intake Diversion Dam removed, paddlefish would likely pass the Intake FAS more quickly and not congregate in front of the FAS, which would adversely affect the likelihood of success for anglers at the site. Paddlefish could potentially travel as far upstream as the Cartersville irrigation dam, at Forsythe (River Mile 238.6). Upstream spawning by paddlefish could result in a major increase in paddlefishing opportunities upstream of Intake over the long term, which would in turn increase regional and statewide visitation and use of upstream fishing access sites in the study area. In the short term, beneficial effects may be minor to moderate as anglers monitor and adapt to changes in the recreational fishery and may further increase over time. With changes in the location of fishing opportunities, use of the Intake FAS may be reduced.

Due to the location of the pump site at the Intake FAS, the existing day use area would be mostly eliminated. Due to its proximity to the pumping station, the Intake FAS boat ramp would remain closed following construction. In order to mitigate the loss of the boat ramp, Reclamation would consult with MFWP in order to site and relocate the boat ramp, as noted in the list of actions to minimize effects. Similar to loss of the boat ramp, an action to minimize effects is included Reclamation and MFWP to consult and evaluate in-kind replacement of the day use facilities.

Overall, the operational effects of the Multiple Pump Alternative on recreation would be significant in the short terms due to loss of the Intake boat FAS, with potential for long-term beneficial effects with the replacement of the boat ramp facility at a new location and increased opportunities for fishing along a larger portion of the river. This would result in less-than-significant effects.

4.12.4.6 Multiple Pumps with Conservation Measures Alternative

The operation of the Multiple Pumps with Conservation Measures Alternative would result in a range of both beneficial and adverse effects on recreation.

Beneficial effects on recreation from the alternative include improved boater access to areas upstream of Intake and along the Lewis and Clark National Historic Trail via the main channel rather than a side channel, and potential for improved longer term fishing opportunities upstream of the Intake Diversion Dam due to new availability of upstream spawning areas for resident fish species.

With the Intake Diversion Dam removed, paddlefish would likely pass the Intake FAS more quickly and not congregate in front of the FAS, which would adversely affect the likelihood of success for anglers at the site. Paddlefish could potentially travel as far upstream as the Cartersville irrigation dam, at Forsythe (River Mile 238.6). Upstream spawning by paddlefish could result in a major increase in paddlefishing opportunities upstream of Intake over the long term, which would in turn increase visitation and use of upstream fishing access sites. In the short term, beneficial effects may be minor to moderate as anglers monitor and adapt to changes in the recreational fishery.

Overall, the operational effects of the Multiple Pumps with Conservation Measures Alternative on recreation would be moderately adverse in the short term, with potential for long-term beneficial effects. The effects would be less than significant.

4.12.5 Cumulative Effects

4.12.5.1 Geographic and Temporal Extent of Analysis

The geographic extent considered for Recreation cumulative effects is the same as the study area for the consideration of construction and operational effects. The cumulative effects analysis considered a 50-year horizon for consistency with the period of analysis in the evaluation of alternatives.

4.12.5.2 Methodology for Determining Effects

A cumulative effect can be described as an impact on the environment which results from the incremental impact of the action when added to other past, present, and reasonably foreseeable future actions. In addition, they may be defined as two or more individual effects, which, when considered together, are considerable or which compound or increase other environmental impacts. Cumulative effects can result from individually minor but collectively significant actions taking place over time. An integral part of the cumulative effects analysis involves determining whether effects from the project would contribute to ongoing or foreseeable resource trends. Where effects from the project contribute to regional resource trends, there is a potential for a cumulative effect. The cumulative effects analysis does not assess all expected environmental impacts from regional projects but only those resulting from the project and other past, present, and reasonably foreseeable future actions.

4.12.5.3 Past, Present, and Reasonably Foreseeable Future Projects Considered

Section 4.1.4 discusses past, present, and reasonably foreseeable future projects which were considered in the evaluation of cumulative effects. The projects identified as relevant to the consideration of recreation included:

- Missouri River Recovery Management Plan
- Climate Change
- Montana Paddlefish Regulations

- Spills at Oil/Gas/Brine Water Pipeline Crossings
- Urbanization

4.12.5.4 No Action Alternative

The No Action Alternative would not substantially alter or interact with any foreseeable future projects in the study area. While several of the cumulative projects may have beneficial or adverse effects, the No Action Alternative would not contribute to these effects.

4.12.5.5 Rock Ramp Alternative

Changes in the river fishery brought about by this project and continued implementation of the Missouri River Recovery Management Plan would likely result in an increase in fish stock, including paddlefish, and a spreading out of fish stock along the Yellowstone as far upstream as the Carterville Diversion Dam. These changes could also result in changes to the Montana Paddlefish Regulations, either expanding or contracting seasons. These changes could have a minor to moderate impact, generally beneficial, to recreational fishing.

Climate change could result in increased river temperature and changes in snowmelt and river flow that, in turn, could adversely affect fish volumes and the river fishery.

Spills of oil, gas, or brine water into the river could have short-term effects on recreational fishing in proximity of, and downstream from, the spill.

Increased urbanization, most likely in Glendive and Sidney if and when oil prices return to higher levels, could result in increased demand for river recreation, including fishing, as well as boating and hunting.

Cumulative effects of the Rock Ramp Alternative are expected to be minimal (less than significant) and, on balance, beneficial.

4.12.5.6 Bypass Channel Alternative

Changes in the river fishery brought about by this project and continued implementation of the Missouri River Recovery Management Plan would likely result in an increase in fish stock, including paddlefish, and a spreading out of fish stock along the Yellowstone as far upstream as the Carterville Diversion Dam. The new channel around Joe's Island could provide additional boating and fishing opportunities. These changes could also result in changes to the Montana Paddlefish Regulations, either expanding or contracting seasons. These changes could have a minor to moderate impact, generally beneficial, to recreational fishing.

Cumulative effects related to climate change, spills, and increased urbanization are similar to that for the Rock Ramp Alternative.

Cumulative effects of the Bypass Channel Alternative are expected to be minimal (less than significant) and, on balance, beneficial.

4.12.5.7 Modified Side Channel Alternative

Cumulative effects of the Modified Side Channel Alternative are similar to that for the Rock Ramp Alternative and are expected to be minimal (less than significant) and, on balance, beneficial.

4.12.5.8 Multiple Pump Alternative

Changes in the river fishery brought about by this project and continued implementation of the Missouri River Recovery Management Plan would likely result in an increase in fish stock and a spreading out of fish stock along the Yellowstone as far upstream as the Cartersville Diversion Dam. These changes could also result in changes to the Montana Paddlefish Regulations, either expanding or contracting seasons. These changes could have a minor to moderate impact, generally beneficial, to recreational fishing. The removal of the Intake Diversion Dam would see the greatest change in geographic dispersion of the fishery.

Cumulative effects related to climate change, spills, and increased urbanization are similar to that for the Rock Ramp Alternative.

The opening up of the river could also result in increased boating along the Yellowstone, including both individual recreational boaters as well as organized float trips from the Cartersville Diversion Dam to the confluence with the Missouri.

Cumulative effects of the Multiple Pump Alternative on recreation are expected to be, on balance, moderately beneficial.

4.12.5.9 Multiple Pumps with Conservation Measures Alternative

Cumulative effects of the Multiple Pumps with Conservation Measures Alternative on recreation are similar to those for the Multiple Pump Alternative and are expected to be, on balance, moderately beneficial.

4.12.6 Actions to Minimize Effects

The following actions would be implemented to avoid, minimize, or mitigate adverse impacts on recreation resources in the study area as a result of project construction. Because the action alternatives involve similar types of construction activities, a number of actions to minimize effects have been identified that would apply to all the alternatives. Additional alternative-specific actions to minimize effects are provided in the following subsections.

Actions to minimize effects which apply to all alternatives are summarized in the bullets below.

- Contractor would grade, on an as needed basis, all dirt or gravel roads within or leading to the construction zone, on both sides of the river, except in areas with historic properties.
- Contractor would use “flaggers” during periods of time when large volumes of vehicles cross the entrance road to the campground and picnic/day use area.
- The MFWP would designate access corridors around or through the construction area when the limits of construction interfere with existing access to recreation sites or the river.
- Construction activities would be minimized during the paddlefishing season in order to mitigate effects on Intake FAS during its peak recreation period.

- Contractor would implement dust abatement activities on all dirt or gravel roads within or leading to the construction zone, on both sides of the river for alternatives including activity on Joe's Island.
- A communication plan would be developed to alert visitors of current access restrictions, closures, and ongoing construction activities. The construction contractor would clearly post and sign any areas within any designated construction zones. Signs would include warnings limiting or prohibiting certain recreational uses within the zone, such as swimming, fishing, boating, hiking, camping, etc.

4.12.6.1 Rock Ramp Alternative

Additional actions to minimize effects identified for the Rock Ramp Alternative include:

- The construction contractor, Reclamation, and the MFWP would identify a "portage" route around or through the construction zone to allow boaters to hand-carry or drag their boats past the construction zone during construction.
- Reclamation and the MFWP would meet to evaluate and coordinate closures at the FAS and Joe's Island to recreational use, including closure of construction zones to swimming, fishing, boating, hiking, camping, hunting, etc. on one or both sides of the river.
- Reclamation and the MFWP would evaluate, and the Corps would construct, a new boat ramp at a suitable location downstream of the rock ramp to provide continued boater access at Intake FAS.

4.12.6.2 Bypass Channel Alternative

Additional actions to minimize effects identified for the Bypass Channel Alternative include:

- Reclamation and the MFWP would meet to evaluate and coordinate closures at the FAS and Joe's Island to recreational use, including closure of construction zones to swimming, fishing, boating, hiking, camping, hunting, etc. on one or both sides of the river.

4.12.6.3 Modified Side Channel Alternative

Additional actions to minimize effects identified for the Modified Side Channel Alternative include:

- Reclamation and the MFWP would meet to evaluate and coordinate closures of Joe's Island to recreational use, including closure of construction zones to swimming, fishing, boating, hiking, camping, hunting, etc.

4.12.6.4 Multiple Pump Alternative

Additional actions to minimize effects identified for the Multiple Pump Alternative include:

- Reclamation and the MFWP would meet to evaluate and coordinate closures at the FAS to recreational use, including closure of construction zones to swimming, fishing, boating, hiking, camping, hunting, etc.
- Reclamation and the MFWP would meet to evaluate replacement of day use facilities at Intake FAS which would be lost due to pump site construction, either via expansion of the Intake FAS or in-kind replacement in the area.

4.12.6.5 Multiple Pumps with Conservation Measures Alternative

Additional actions to minimize effects identified for the Multiple Pumps with Conservation Measures Alternative include:

- Reclamation and the MFWP would meet to evaluate and coordinate closures at the FAS to recreational use, including closure of construction zones to swimming, fishing, boating, hiking, camping, hunting, etc.
- Development of a communication plan to alert visitors of current access restrictions, closures, and ongoing construction activities.

4.13 Visual Resources

This section addresses the potential effects of each alternative on visual resources.

4.13.1 Area of Potential Effect

The study area for visual resource impacts varies between alternatives. In general, for action alternatives, the study area for visual resources would include areas where construction activities can be observed or where permanent changes to the area resulted from the alternative. For the No Action Alternative, it would include those areas where operation and maintenance activities could be observed.

4.13.2 Summary of Potential Effects

Table 4-30 summarizes the potential effects on visual resources for each alternative. Details are provided in the following sections.

TABLE 4-30. SUMMARY OF POTENTIAL EFFECTS ON VISUAL RESOURCES FROM EACH ALTERNATIVE

Impact Type	Level of Impact	Impact Description
No Action Alternative		
Construction Effects	No Effect	• No construction
Operational Effects	No Effect	• No change from current conditions
Rock Ramp Alternative		
Construction Effects	Moderate	• Length of construction period of two years with a variety of viewer groups that use the area
Operational Effects	Minor	• Slight visual change through expansion of rock ramp and replacement weir
Bypass Channel Alternative		
Construction Effects	Moderate	• Length of construction period of two years • Variety of viewer groups that use the area
Operational Effects	Negligible	• Few viewer groups at Joe's Island and little visual change from previous condition at the Intake Diversion Dam, where most viewer groups occur
Modified Side Channel Alternative		
Construction Effects	Minor	• Few viewer groups at Joe's Island, though extensive visual changes for up to three years
Operational Effects	Negligible	• Few viewer groups at Joe's Island
Multiple Pump Alternative		
Construction Effects	Moderate	• Length of construction period of three years with a variety of viewer groups that use the area

Impact Type	Level of Impact	Impact Description
Operational Effects	Minor	<ul style="list-style-type: none"> • Introduction of pump houses into agricultural landscape • New pump house at Intake FAS • Beneficial visual improvements resulting from removal of Intake Diversion Dam
Multiple Pumps with Conservation Measures Alternative		
Construction Effects	Moderate	<ul style="list-style-type: none"> • Length of construction period of three years for Intake Diversion Dam removal and a variety of viewer groups that use the area • Minor effects from construction of wells since viewer groups are minimal
Operational Effects	Minor	<ul style="list-style-type: none"> • Introduction of Ranney wells into agricultural landscape • Beneficial visual improvements resulting from removal of Intake Diversion Dam

4.13.3 Construction Effects

4.13.3.1 No Action Alternative

Under this alternative, no construction would occur and therefore no effect on visual condition would result in the short-term to the study area. Natural ecological processes, and their interaction with the Intake Diversion Dam, would continue as they have since construction of the project. Ice floes, floods, drought, or other natural variations in river flows would continue to incrementally change the shoreline of the Yellowstone River and its riparian habitat conditions, including the effects of potential climate change.

4.13.3.2 Rock Ramp Alternative

Construction of the Rock Ramp Alternative would take an estimated two years. During this time, a variety of construction equipment would be visible on a seasonal basis to local populations and visitors to the study area. Construction activities would be observed during periods when river flows are suitable in the spring, summer, and fall.

As the replacement weir is built, temporary construction equipment and materials would be introduced into the environment, including pile drivers and other fixed construction equipment in and near the river, a coffer dam in the river channel that would divert water around construction to allow construction to take place in dry conditions, silt curtains and other measures to mitigate impacts, and a new but temporary Main Canal bridge. Mobile equipment would move throughout the study area, including haul trucks, graders, and other construction vehicles.

A small stockpile area and two construction staging areas would be cleared of vegetation, but would be reseeded when construction is complete. Access and haul roads are already present and would not need improvement. Following construction, flows would be returned to normal in the Yellowstone River.

There are a variety of viewer groups to the area, primarily including recreationists, and the lengthy construction period and ongoing construction would result in moderate effects on visual condition.

4.13.3.3 Bypass Channel Alternative

Construction of the replacement weir for the Bypass Channel Alternative would result in changes to visual conditions that would be similar to those described under the Rock Ramp Alternative. These include the temporary presence of mobile and fixed construction equipment onsite for an estimated two years, which would vary with season and would be experienced by a variety of viewer groups. Once construction was complete, most areas disturbed for replacement weir construction would be returned to pre-construction conditions via reseeding and equipment removal.

This alternative includes additional construction areas within Joe's Island. This means that more construction equipment would be present in a larger area. Components of construction that would further alter visual condition include the construction or improvement of haul roads, placement of the quarry extent, a staging area on Joe's Island, the placement of spoils on Joe's Island, and adding fill material to the existing channel. Tempering the effect of this increased construction area is the fact that the Joe's Island is less visible to visitors at the Intake Diversion Dam. There are no homes on the island and visitors are limited to recreationists. Overall, construction of the Bypass Channel Alternative is expected to have a moderate and less than significant effect on visual conditions.

4.13.3.4 Modified Side Channel Alternative

The Modified Side Channel Alternative does not include modifications to the Intake Diversion Dam, and there would be no effect on visual conditions at this location.

Construction to reconfigure the existing side channel is estimated to take approximately 18 months and would occur entirely on Joe's Island or just to the south of it. During construction, the presence and intensity of construction equipment and use would fluctuate with the season, much like with other alternatives described above. Vehicles would access the site, construction equipment would be present onsite, new roads and staging areas would be created, the existing side channel would be modified with graders, and a stockpile site would slowly grow to the south of Joe's Island. Staging areas would be temporary and would be reseeded following completion of the project. Construction equipment, including coffer dams, would be removed once the project was completed, allowing natural flows to return to the modified side channel.

Because the existing side channel is the southern boundary of Joe's Island and due to the lengthy construction process, Joe's Island would be closed to the public for the duration of construction. This would result in a minor and less than significant effect, since the viewer groups that would observe these activities would be excluded from the site, and viewers from the Intake Diversion Dam area would have very limited view of construction activities.

4.13.3.5 Multiple Pump Alternative

During construction, the weir crest that forms the Intake Diversion Dam would be removed in halves. As the first half of the Intake Diversion Dam is removed, the other half of the river remains free flowing. Cofferdams would keep water out of the construction areas. Pumping stations constructed in additional areas would increase the number of viewer groups to observe construction activities.

Viewer groups that may witness construction could include recreationists at the Intake Diversion Dam boat ramp or across the river on Joe's Island, homeowners or owners of agricultural lands near the pump sites, or passersby in vehicles on local access roads. Once construction is complete, sites around the pumps would be reseeded or returned to agricultural uses. As a result, as with other alternatives that require extended construction (up to three years) within the Intake Diversion Dam area that would be visible to a variety of viewer groups, effects on visual resources would be moderate but less than significant.

4.13.3.6 Multiple Pumps with Conservation Measures Alternative

Construction activities for this alternative would take approximately 8 years, during which time equipment and personnel would periodically be present at the Intake Diversion Dam, at the seven pump field sites, at sites where power sources are constructed, and where water conservation measures are implemented.

Removal of the Intake Diversion Dam would occur as described above for the Multiple Pump Alternative, resulting in a moderate effect on the visual condition. At each of the seven proposed Ranney Well construction sites, a total of six wells would be constructed at a distance of 1,000 feet from the Yellowstone River shoreline. Exact siting of the six wells would be determined through drilling and pumping tests prior to construction. Sites have been selected that have access roads and do not require additional grading or clearing. Most sites are visible by limited viewer groups, such as local residents, land owners, or workers in the area. In addition, visual effects resulting from construction of Ranney Wells would be temporary and therefore the overall effect would be minor and less than significant.

Conservation measures would reduce the evaporation and loss of irrigation water as it travels from river to field. Conservation measures would be constructed within the Main Canal, at laterals along the canal, within individual farm fields where more efficient sprinklers can be used, and where groundwater pumps can augment water supply. Construction efforts for these measures would be minimal and have few viewer groups, resulting in minor effects on visual conditions.

Finally, power delivery would need to be configured through extension of existing power lines. Construction of a windmill is also proposed under this alternative, but it is not clear where it would be situated or how large it would be. Therefore, the visual effects of construction of a new windmill would be assessed as part of a separate NEPA document.

4.13.4 Operational Effects

4.13.4.1 No Action Alternative

Although regular operation and maintenance of the Intake Diversion Dam and Main Canal headworks results in minor effects on visual condition, the No Action Alternative would not result in a change to this status. The primary maintenance activity at the Intake Diversion Dam is the replacement of rock on the crest using the existing cableway. The resulting aesthetic alteration is an increase in the elevation of the Intake Diversion Dam rock weir and increased ripples on the surface of the river. These visual changes have occurred yearly on average since the construction of the Intake Diversion Dam and would not represent a significant change from existing conditions.

Visual condition of the newly constructed headworks is expected to alter over time, as vegetation becomes established in areas that were cleared for construction. The Main Canal would continue to be cleared of vegetation for flow maintenance purposes and would not result in a significant change in the visual condition of the channel.

Other maintenance activities would result in the presence of trucks and personnel onsite. Levels of maintenance frequency or intensity would not significantly increase under the no action alternative.

At a future date, the existing cableway would likely require replacement. New towers and cableway would be built in the same location and with the same dimensions of height and width. Any substantial changes to the design would require environmental evaluation for impacts at that time.

Continued fish passage issues related to operation of the Intake Diversion Dam and headworks would need to be addressed under the No Action Alternative. Fish passage would need to be introduced in some manner at the Intake Diversion Dam in order to achieve Reasonable and Prudent Actions to improve pallid sturgeon populations. At that time, visual impacts to the area would have to be assessed along with proposed means to provide fish passage.

4.13.4.2 Rock Ramp Alternative

Permanent changes to the visual condition would include the replacement weir at a location 40 feet upstream of the current Intake Diversion Dam, the new rock ramp, removal of the old cableway and construction of a new cableway upstream, and the introduction of riprap and fill material to the river channel. Although the composition of the visual components of the area would be slightly expanded or reorganized, the overall effect would be minor.

The larger area of riffles resulting from the expanded boulder field would make the most obvious visual change, but would not substantially alter the existing visual character of the area. Low water levels often result in riffles over the boulder field already and at high flows, rocks would be covered. The area would retain the general visual character of being a man-made structure with a seasonally varying above-water profile. The relocation of the replacement weir and cableway from downstream to upstream would not pose a significant change to aesthetic character of the area in comparison to existing conditions, since it would not introduce new components to the landscape.

Operation of the new rock ramp would not require additional attention beyond that already existing for the current Intake Diversion Dam. Rocks would still need to be replenished annually at the Intake Diversion Dam weir as a result of displacement by ice floes and floods. A new cableway would ensure less maintenance is needed in comparison to the deteriorating cableway that is currently in place. Engineering of the rock ramp and appropriately sized boulder placement would ensure that no additional maintenance is needed from current levels. This means that the operation and maintenance of the area under this alternative would not result in changes to the normally expected presence of trucks in the area, and therefore not affect visual conditions.

4.13.4.3 Bypass Channel Alternative

New permanent features include the bypass channel with armoring, infill of the existing side channel, placement of spoils, and access roads. The new bypass channel would receive a portion of the Yellowstone River flow on a year round basis. The existing side channel is currently filled only during higher flows. In general, the overall visual condition would not change, since one side channel is replaced with another, with the new one operating similarly to the old one. Over time, revegetation would obscure traces of channel construction, eventually approaching a more natural appearance. However, riprap at the four bends would almost always be visible, and invert armoring would be visible during low or no flow. The existing side channel would be plugged at the upstream end, ensuring that it would remain dry during most conditions. Exceptionally high floods would rarely cause the existing side channel to fill. Similarly, changes in topography are not expected to substantially change the overall appearance of the habitats along Joe's Island.

Materials excavated from the construction of the new bypass channel that are not needed for infill of the existing side channel, would be disposed of to the south of the existing side channel, ultimately creating as many as six permanent low elevation mounds. These mounds would be exposed sand and soil and other debris that is excavated from the creation of the new bypass channel. Though the mounds would be permanent, seeding would ensure they eventually blend into the landscape with appropriate vegetation.

Despite new features, the effect on visual condition would be negligible for a couple of reasons. First, the number of observers affected would be very small. Few people use Joe's Island, there are no permanent homes on the island, and the change would not be visible from the areas on the north side of Yellowstone River that are typically used for recreation. Second, the overall change in topography would not substantially change the visual appearance of the area. Each of the new features would become part of the floodplain habitat in the area and, over time and with revegetation, would begin to look like part of the natural environment.

No changes in maintenance of the headworks and canal are expected. However, because the replacement weir would preclude the need for the boulder field, the usual annual maintenance required to replenish the rocks would be eliminated and the cableway could be removed permanently. Over time, the presence of the boulder field would diminish in profile, as ice floes and floods continue to erode the rocks. The boulder field would be less visible, the cableway would be gone, and the replacement weir would occupy less area than the existing Intake Diversion Dam.

Although maintenance needs for the replacement weir would be reduced from current needs, the new bypass channel would require annual or as needed maintenance to ensure stability of bed and banks. The tradeoff would result in no change to visual effects resulting from future operation and maintenance.

4.13.4.4 Modified Side Channel Alternative

New permanent features of this alternative would include an access road along the north bank of the existing side channel, haul road from stockpile site to access road, a bridge over the existing side channel, and reshaping of the existing side channel. Visually, changes to the existing side channel would naturalize over time as fill areas become revegetated and newly excavated areas become more like natural channel. In addition, the stockpile mounds would revegetate and

become low elevation, upland topography that blends in with the surrounding habitat. Though there would be some less natural looking components to the modified side channel, particularly where rip rap has been placed, the overall result of the modifications to visual condition would be negligible. This is due in large part to revegetation of the exposed areas, but is also the result of the limited viewer groups that use the area. After construction, Joe's Island would be reopened to the public. New haul roads would remain onsite after construction, but because there are already a number of access roads on Joe's Island, they would not result in a change to visual character of the area.

4.13.4.5 Multiple Pump Alternative

Following construction, permanent additions to the local landscape would include five pump houses. The visible portion of these structures would be a prefabricated steel building with a footprint of 40 by 25 feet, extending to a height of 14 feet. All other portions of the pumps would be below ground or below the water surface of the Yellowstone River. The overall visual effect of the new pump houses is considered minor, since few viewer groups would see them and since they cover a very small overall area.

This alternative requires the installation of substations and powerlines to provide enough power to pump water out of the river and into the canal. A total of 29,500 feet of new power lines would be needed to connect pumps to existing power sources.

A change to the visual conditions would occur where the Intake Diversion Dam is removed; resulting in lowering of the surface elevation of the Yellowstone River, with no dam to back up water. Though the boulder field would not be removed, sediment and rocks would be flushed downstream and ice floes and floods would eventually erode away large rocks. Some rocks would remain indefinitely and a riffle would generally always be visible at this site during low flows. However, there would be no need for rock replenishment along the Intake Diversion Dam weir crest, substantially reducing the amount of operation and maintenance in this area and providing a beneficial visual effect for visitors to the area.

In contrast, the five new pump sites would require regular maintenance activities. Sediment buildup removal, fish screen cleaning, and power line and back-up power supply maintenance would all be new additions to the maintenance schedule. New viewer groups would be exposed to maintenance activities, including homeowners, agricultural land owners, or workers in these areas. However, maintenance would not likely be needed more than annually or biannually, and would include minimal equipment or trucks and personnel. For this reason, maintenance of the new pump sites would result in only minor effects on visual conditions.

If the Yellowstone River migrates sideways at any of the pumping station sites, it would be necessary to relocate the pump or to heavily armor the sites. Armoring would represent a moderate visual effect, since it would alter the visual character of the river, but would only be viewed by limited groups.

Minor visual changes would occur at the Main Canal, where the pipes conveying water from the pumps would discharge through rectangular outlets up to fourteen feet high. Periodic maintenance would be needed to ensure these outlets are cleared and stable. Other operation and maintenance of the Main Canal and headworks would not change from existing conditions.

4.13.4.6 Multiple Pumps with Conservation Measures Alternative

Completion of the Multiple Pumps with Conservation Measures Alternative would result in the permanent removal of the Intake Diversion Dam and permanent introduction of 42 Ranney Wells throughout the Yellowstone River floodplain. Visual benefits to the Intake Diversion Dam area would be the same as described for the Multiple Pump Alternative above.

Construction of 42 wells would result in a minor change to the landscape where they are sited, and would be viewed by few viewer groups, resulting in an overall minor effect on visual condition. Ranney Wells final configuration results in an above-ground concrete round. These low profile structures would not be easily visible except from the immediate vicinity. Each well field has been sited where ground is level and additional clearing is not needed. All but Site #4 are within agricultural fields, which would be returned to agricultural use after construction is completed. Site #4 is adjacent to the small town of Knife, which could potentially increase the viewer groups in the area, except that the site here is also agricultural and would not be accessed except by landowners or workers.

Conservation measures would have only very minor effects on visual conditions. Changes to the Main Canal and lateral channels would not change their visual character from an unvegetated industrial appearance. Groundwater pumps would be low-profile and located in areas not readily visible by any viewer groups except maintenance personnel onsite.

Finally, power lines would be a permanent addition to provide power to Ranney Wells.

4.13.5 Cumulative Effects

4.13.5.1 Geographic and Temporal Extent of Analysis

Cumulative visual changes would be evaluated for the local landscape of the Yellowstone River, from the Intake Diversion Dam, downstream to the most distant proposed pumping station, and for the duration of the life of the project, a period of 50 years.

4.13.5.2 Methodology for Determining Effects

Visual condition would be cumulatively affected if the landscape was altered dramatically enough to change the natural environmental character, when combined with all other previous, current, and future projects. In areas of urban, residential, or agricultural development, the natural condition has already been cumulatively compromised. Along the Yellowstone River, visual condition would be cumulatively affected if areas of natural environmental condition were widely converted to developments, changing native or mostly native floodplain or riparian habitat into human developments.

4.13.5.3 Past, Present, and Reasonably Foreseeable Future Projects Considered

Past projects that have had an effect on the visual character of the Yellowstone River corridor in the project area include irrigation, agricultural development, urbanization, road construction and maintenance, and alterations to the Yellowstone River, such as construction of dams and irrigation diversions.

4.13.5.4 No Action Alternative

Under the No Action Alternative there are minor cumulative effects on visual character. Although the continued operation and maintenance of the Intake Diversion Dam, headworks, and irrigation canal would not result in changes to visual effects from current conditions, its presence along the Yellowstone River combines with other development to result in a cumulative effect on visual character. Instead of the natural flowing river, there are flow barriers, diversions into irrigation canals, and recreational features. In contrast, the Intake Diversion Dam, constructed in 1909, has become a consistent feature of the area, and has only experienced visual improvements since that time, such as replacement of the headworks and maintenance of associated recreation areas.

4.13.5.5 Rock Ramp Alternative

The presence of the Intake Diversion Dam represents a minor visual effect that has been in place for over 100 years. Reconfiguration of the rock ramp and construction of the replacement weir would not result in a significant change to the appearance of the area around the Intake Diversion Dam. Other reasonably foreseeable future projects would not affect the same visual resources as this alternative, therefore there would be no cumulative impacts to visual resources.

4.13.5.6 Bypass Channel Alternative

Reconfiguration of the Intake Diversion Dam would not result in cumulative effects on visual conditions. Similarly, the conversion of floodplain habitat to riverine side channel, and from existing side channel to floodplain habitat does not contribute to cumulative effects on visual conditions. Impacts to visual resources would be similar to those occurring under the Rock Ramp Alternative.

4.13.5.7 Modified Side Channel Alternative

As with the Bypass Channel Alternative, slight changes to the alignment and dimensions of the existing side channel, in combination with other reasonably foreseeable future projects, would not result in cumulative effects on visual conditions. Impacts to visual resources would be similar to those occurring under the Rock Ramp Alternative.

4.13.5.8 Multiple Pump Alternative

Removal of the Intake Diversion Dam would result in slight improvements to visual conditions and would incrementally reduce the cumulative impact of changes to visual character in the area. Additionally, although the construction of seven pumping stations throughout the study area would introduce new features into the landscape, pumping stations are proposed for areas already extensively altered for the purposes of agriculture. Therefore, this alternative, in combination with other reasonably foreseeable future projects, would not result in cumulative impacts to visual conditions.

4.13.5.9 Multiple Pumps with Conservation Measures Alternative

Removal of the Intake Diversion Dam would result in slight improvements to visual conditions and would incrementally reduce the cumulative impact of changes to visual character in the area. Again, well sites are proposed for areas that are already extensively altered by agriculture, and contributes no change to cumulative visual effects. Therefore, this alternative, in combination with other reasonably foreseeable future projects, would not result in cumulative impacts to visual conditions.

4.13.6 Actions to Minimize Effects

Under each alternative, several measures would be undertaken to ensure the avoidance and minimization of visual effects. Overall, construction and operation of each alternative are expected not to have greater than moderate visual effects, and most effects would be minor or negligible.

In general, the following measures would be employed for all alternatives, where applicable;

- Minimize footprints of construction as much as possible to limit areas of effect.
- Restrict construction or staging from using areas that are subject to erosion.
- Minimize haul and access road use and improve those roads that would become permanent.
- Strategize construction schedule to minimize truck, equipment, and personnel presence.
- Minimize footprint of clearing and grubbing to protect as much existing vegetation as possible.
- Minimize stream crossings and restore shoreline or instream habitat that are damaged.
- Mulch and reseed areas that are cleared after construction is complete to facilitate return to vegetated conditions.
- Limit operation and maintenance to annual or emergency basis to reduce onsite equipment and personnel.
- For new facilities and structures, design to minimize visual intrusion when feasible;
 - Bury distribution powerlines or flow lines in or adjacent to access roads;
 - Camouflage structures/facilities to reduce visual intrusions and painting of above-ground structures not requiring safety coloration an environmental color two shades darker than the surrounding environment;
 - During implementation of vegetation treatments, create irregular margins around treatment areas to better maintain existing scenic character of the landscape;
 - Use repetition of form, line, color, and texture to blend facilities with the surrounding landscape.

4.14 Transportation

Transportation impacts are characterized by impacts to related services, program, plans, and infrastructure. The types of impacts that a project may cause include:

- Changes in performance of the transportation network such as delays and congestion both during and after construction.
- Effects on transportation safety for users or change in risk to infrastructure.
- Changes in traffic patterns, including quantity or location.
- Changes in the ability to provide adequate emergency access.

4.14.1 Area of Potential Effect

For the purposes of this analysis, the study area for transportation resources is defined as transportation facilities in proximity to the river and irrigation canal between the Intake Diversion Dam and the confluence with Missouri River. Transportation-related resources and facilities further from the river are not likely to be impacted by construction or operation of a

project that is within or adjacent to the river channel and canal. This is the same study area for Transportation discussed in the Affected Environment chapter of this report.

4.14.2 Summary of Potential Effects

Table 4-31 summarizes the potential effects on transportation for each alternative. Details are provided in the following sections.

TABLE 4-31. SUMMARY OF POTENTIAL EFFECTS ON TRANSPORTATION FROM EACH ALTERNATIVE

Impact Type	Level of Impact	Impact Description
No Action Alternative		
Construction Effects	No Effect	<ul style="list-style-type: none"> No construction, no effect
Operational Effects	No Effect	<ul style="list-style-type: none"> No changes to operations, no effect
Rock Ramp Alternative		
Construction Effects	Moderate	<ul style="list-style-type: none"> Minor impacts to infrastructure on Highway 16; moderate to major impacts on Roads 551 and 303; and minor impacts from worker commute. Impacts on Roads 551 and 303 would be mitigated through post-construction rehabilitation Moderate congestion on Highway 16 from construction vehicles, addressed with action to minimize effect Moderate parking impacts at Intake FAS, addressed with action to minimize effect
Operational Effects	Minor	<ul style="list-style-type: none"> Possible beneficial effects from improved access roads on Joe's Island and at Intake FAS
Bypass Channel Alternative		
Construction Effects	Moderate	<ul style="list-style-type: none"> Minor impacts to infrastructure and minor impacts from worker commute Minor congestion on Highway 16 / Joe's Island, addressed with action to minimize effect Moderate parking impacts at Intake FAS, addressed with action to minimize effect
Operational Effects	Minor	<ul style="list-style-type: none"> Possible beneficial effects from improved access roads on Joe's Island and at Intake FAS
Modified Side Channel Alternative		
Construction Effects	Minor	<ul style="list-style-type: none"> Minor impacts to infrastructure and minor impacts from worker commute Moderate to substantial effects on Highway 16 / Joe's Island, addressed with action to minimize effect
Operational Effects	Minor	<ul style="list-style-type: none"> Possible beneficial effects from improved access roads on Joe's Island and at Intake FAS

Impact Type	Level of Impact	Impact Description
Multiple Pump Alternative		
Construction Effects	Moderate	<ul style="list-style-type: none"> • Minor effects on local roads near sites • Moderate effect on parking supply at Intake FAS, but addressed with action to minimize effect • No beneficial effects (no new/upgraded public roads)
Operational Effects	Moderate	<ul style="list-style-type: none"> • Moderate effect on parking supply at Intake FAS • Added staff with more traffic on local roads • No beneficial effects (no new/upgraded public roads)
Multiple Pumps with Conservation Measures Alternative		
Construction Effects	Minor	<ul style="list-style-type: none"> • Minor effects on local roads near sites • Moderate effect on parking supply at Intake FAS, • No beneficial effects (no new/upgraded public roads)
Operational Effects	Moderate	<ul style="list-style-type: none"> • No beneficial effects (no new/upgraded public roads) • Moderate effect on parking supply at Intake FAS • Added staff with more traffic on local roads

4.14.3 Construction Effects

Effects on transportation would occur for the roadway network. No components of construction for any of the alternatives are expected to affect public transportation, railroads, or airports.

4.14.3.1 No Action Alternative

The No Action Alternative does not include construction activity. This alternative includes the continued operation of the LYP using the existing diversion headworks and the Intake Diversion Dam. Because there would be no construction, the No Action Alternative would have no construction related effects on transportation.

4.14.3.2 Rock Ramp Alternative

Transportation related effects from construction of the Rock Ramp Alternative would occur for a period of 1.5 years. This alternative would require delivery and removal of construction equipment and materials to staging areas on the left and right banks of the river adjacent to the Intake Diversion Dam. The staging and stockpile areas on the left bank would be accessed from the Highway 16 and Road 551. The staging area on the right bank is accessible via rural road County Road 303 from Glendive to Joe’s Island, and then via construction haul route. Joe’s Island would be closed for the duration of construction, but Intake FAS would remain open.

While construction workers may need to commute to the site via Highway 16, the additional volume of personal vehicles (30) would have a negligible effect on traffic along the highway during peak commute times. However, the presence of slower-moving construction equipment or materials vehicles along the two-lane (one each direction) Highway 16 could result in some traffic delays. Construction traffic on County Road 303 would be slow, but would impact only a few local residents, as there is no through-traffic.

Construction of the Rock Ramp Alternative requires a substantial quantity of large rock. The current design assumes the rock will be purchased from quarries in Wyoming or Minnesota and conveyed to Glendive by rail before being trucked to the construction site. Transportation of rock by rail is not expected to result in adverse effects on the railroad, as the local and regional rail

network has the capacity needed to handle temporary increases. It is estimated that delivery of 450,000 tons (300,000 cubic yards) of riprap rock will require 25,000 truckloads from Glendive. It is assumed that the left and right bank staging areas would each receive half the volume, or about 12,500 trucks each over a 12-month period (6 months per year). This is equivalent to just under 100 trucks per day in each direction on each of the two routes or ten to twelve trucks per hour in each direction, assuming an 8- to 10-hour workday. Because the construction area is not immediately adjacent to Highway 16, no temporary lane closures would be required. Trucking rock between Glendive and Intake by truck could result in minor delays along Highway 16 and moderate delays on Road 303, though the latter has very low traffic volumes.

In Glendive itself, there would be up to 20 to 24 trucks per hour in each direction from the BNSF railyard via North Merrill Avenue (I-94 Business) to I-94 for two six-month construction seasons. North Merrill is a four-lane facility that serves downtown Glendive, as well as the railyard. Impacts on traffic congestion and delays would be minor to moderate.

Based on the quantity of construction traffic, wear and tear on Highway 16 would be negligible to minor. However, unpaved Roads 551 (between Highway 16 and Intake FAS) and 303 (between Glendive and Joe's Island) may be substantially affected by high volumes of construction traffic carrying heavy loads. These two roads may experience both minor deterioration in level of service and moderate to major (significant) physical deterioration from wear and tear. Wear and tear to the North Merrill Avenue in Glendive would be negligible to minor.

Parking demand near the FAS would also be impacted during construction, with construction vehicles and construction worker vehicles. This could result in a moderate to major (significant) effect on parking availability at Intake FAS.

Several measures would be implemented to mitigate the construction effects on transportation quality and infrastructure. Delivery and removal of material and equipment from the construction area would be scheduled to avoid peak traffic times along Highway 16 and Road 303. Secondly, the contractor would utilize only designated routes and access points to the construction area and would designate parking areas for workers and construction vehicles outside of the Intake FAS parking lot, in order to maintain public recreational parking at the site. Further, the contractor would maintain Roads 551 and 303 throughout construction, and perform post-construction rehabilitation, such that the roads are serviceable for public traffic to Intake FAS and to residents along Road 303 during construction and are left in equal or improved condition after construction. Flaggers may be used as needed on Highway 16 to facilitate truck access to and from the site. Finally, the contractor would post signs along Highway 16, Canal Road, Joe's Island, and at Intake FAS to alert drivers to construction traffic issues and provide access information to the public. With these measures, adverse impacts to transportation would be minor and localized along designated construction routes. With mitigation, effects on transportation quality and infrastructure, and FAS parking, would be less than significant.

In addition to these measures and unique to this alternative, an abandoned BNSF siding track just north of Intake could be reinstated for delivery of riprap to the west side of the river, reducing construction truck traffic on Highway 16.

4.14.3.3 Bypass Channel Alternative

Transportation related effects from construction of the Bypass Channel Alternative would occur for a period of 2 years. This alternative would require delivery and removal of construction equipment and materials to staging areas on the left and right banks of the river adjacent to the Intake Diversion Dam. The staging and stockpile areas on the left bank would be accessed from the Highway 16 and Road 551. The staging area on the right bank is accessible via County Road 303 from Glendive to Joe's Island, and then via a construction haul route. Joe's Island would be closed for the duration of construction, but Intake FAS would remain open. It is assumed that the majority of construction related traffic, including workers commuting to and from the site, would utilize access roads to Joe's Island from Glendive, since the bypass channel portion of the construction would occur on Joe's Island. The replacement weir would require construction activity on the left and the right banks, however.

While construction workers may need to commute to the site via Highway 16, the additional volume of personal vehicles (30) would have a negligible effect on traffic along the highway during peak commute times. However, the presence of slower-moving construction equipment or materials vehicles along the two-lane (one each direction) Highway 16 could result in some traffic delays. Construction traffic on County Road 303 would be slow, but would impact only a few local residents, as there is no through-traffic.

The current design assumes that concrete for replacement weir construction and all rock will be trucked from Glendive. It is estimated that rock delivery (85,000 tons or 57,000 cubic yards) will require 4,700 truckloads from Glendive, and concrete delivery will require 680 truckloads. It's assumed that the left and right bank staging areas would each receive half the volume of delivered concrete (340 truckloads), and the right bank would receive all of the delivered rock. The rock delivery would occur over a twelve month period (two six month seasons), which would result in about 36 trucks per day, or three to four per hour. Because the construction area is not adjacent to the highway, no temporary lane closures would be required on Highway 16. The movement of the rock between Glendive and Intake by truck could result in moderate congestion and delays along Road 303. Concrete deliveries would occur over a shorter period of time and would have negligible to minor effects on delays on Highway 16 and Roads 551 and 303.

Based on the quantity of construction traffic discussed above, wear and tear on Highway 16 would be negligible to minor. However, unpaved Road 551 (between Highway 16 and Intake FAS) and unpaved Road 303 (between Glendive and Joe's Island) may be moderately affected by high volumes of construction traffic carrying heavy loads. The roads may experience both minor deterioration in quality of service and moderate to major physical deterioration from wear and tear.

Parking demand near the Intake FAS would also be impacted during construction, with the presence of construction vehicles and construction worker personal vehicles. This could result in a moderate to major effect on parking availability at Intake FAS. Several measures would be implemented to mitigate the construction effects on transportation quality and infrastructure as discussed under the Rock Ramp Alternative above. With these actions, adverse impacts to transportation would be less than significant and localized along designated construction routes.

4.14.3.4 Modified Side Channel Alternative

Transportation related effects from construction of the Modified Side Channel Alternative would occur for a period of 1.5 years. The alternative would require delivery and removal of construction equipment and materials to construction and staging areas on Joe's Island only, as this alternative does not include replacement of the Intake Diversion Dam. Staging and stockpile areas on Joe's Island would be accessed from the rural Road 303 from Glendive to Joe's Island, and then via access roads and construction haul routes. Some construction vehicles may need to access the west side of the river at Intake, though vehicle counts using Highway 16 would be minimal. Joe's Island would be closed for the duration of construction, but Intake FAS would remain open.

The additional volume of personal vehicles from construction workers (30) would have a negligible effect on traffic along highways and access roads. However, the presence of construction equipment or materials vehicles along unpaved Roads 551 and 303 could result in adverse physical effects. Road 303 is relatively low traffic, so congestion impacts would be minor.

The current design assumes that all rock will be trucked from Glendive. It is estimated that rock delivery will require 3,025 truckloads from Glendive. It is assumed that the right bank staging areas would receive all of the delivered rock via Roads 551 and 303.

Road 303 between Glendive and Joe's Island may be substantially affected by high volumes of construction traffic carrying heavy loads (approximately 106 trips per day in each direction for the peak twenty days). Given the rural nature of the road and likely low existing traffic volumes, this would represent a moderate to substantial increase in volumes during the heaviest hauling period. The road may experience moderate to major physical deterioration from wear and tear. It is assumed that materials from dam removal would be disposed of on Joe's Island, resulting in no truck trips on the haul routes to Glendive or other locations.

Several measures would be implemented to mitigate the construction effects on transportation quality and infrastructure as discussed under the Rock Ramp Alternative above. With these actions to minimize effects, adverse impacts to transportation would be less than significant and localized along designated construction routes.

4.14.3.5 Multiple Pump Alternative

This alternative includes constructing five pump sites along the left bank of the river as well as dam removal. Joe's Island would be closed for the duration of construction. Four of the pump sites would be developed on private land or public lands not currently accessible for public use. One site, near the Intake Diversion Dam, intersects the day use area at Intake FAS and has some overlap with the parking lot, which could be a minor to moderate adverse effect on the parking supply at Intake FAS.

Transportation related effects from construction would occur for a period of 2 years for the construction of the five pumping stations, and for 6 months for dam removal. The alternative would require delivery and removal of construction equipment and materials to each of the five sites, as well as to a staging area near the Intake Diversion Dam which would be used for dam removal. Like other alternatives, Highway 16 and Road 303 would be the main roads used for

delivery of equipment and materials, with additional use of local roadways for access to pump sites #2 through #5. The alternative requires a total of 885 truckloads of concrete for fish screen and pumping station construction, averaging 20-30 trips per day. Further, the alternative includes 5,770 truckloads of excavated material which will be trucked from the individual pump sites to the spoils area adjacent to Joe's Island. The 100-220 round trips per day (up to 440 one way trips) during the peak twenty days compares to average daily traffic (ADT) of 4,480 on Highway 16, or about a 10-percent increase in traffic for that period. A portion of the peak trips will be accessing the right bank, using Road 303, reducing the increase on Highway 16. Typical capacity for a two lane "rural highway" is up to 3,200 passenger cars per hour (FHWA 2016). While truck traffic and terrain would result in a lower hourly capacity, traffic delays would not likely be due to traffic volumes but truck speeds, especially when merging onto and exiting Highway 16. Overall effects would be minor and temporary.

Construction at each site would include construction of an access road from a nearby existing roadway to the pumping station location. Construction of these access roads may require a short duration road closure to cut clear, grub, and grade the existing shoulder to create an intersection for the access road. However, site the construction would be staged to allow closure of only one lane, which results in temporary and minor effects.

While construction workers may need to commute to the sites via Highway 16 and other local roads, the additional volume of personal vehicles (25) would have a negligible effect on traffic in the study area. The presence of slower-moving construction equipment or materials vehicles would be dispersed among the five pump sites, but may have minor to moderate effects along Highway 16 as disposal trucks travel to Joe's Island.

Several measures would be implemented to mitigate the construction effects on transportation quality and infrastructure as discussed under the Rock Ramp Alternative above. In addition, final design of the alternative would be refined to eliminate any adverse impact to the parking lot at the Intake FAS. With these actions, adverse impacts to transportation would be diminished.

4.14.3.6 Multiple Pumps with Conservation Measures Alternative

The alternative includes seven Ranney Well sites along the left bank of the river as well as dam removal. All seven of the pump sites would be developed on private lands currently in agricultural use. Implementation of the alternative would require coordination with landowners to identify suitable construction rights of way on the site. However, impacts to public infrastructure would be minimal.

Transportation related effects from construction would occur for a period of 8 years, with the dam removal portion accomplished in six months. The alternative would require delivery and removal of construction equipment and materials to each of the seven sites, as well as to a staging area near the Intake Diversion Dam which would be used for dam removal. Like other alternatives, relevant roads include Highway 16, Road 551, and Road 303, as well as various local roads to each well site. Because construction activities would be dispersed along the river between Intake and Fairview, only minor congestion and delay effects would be realized on local roadways leading to individual sites.

Dam removal would require 3,025 truckloads of material (fill, bedding stone, and riprap) in order to build the cofferdam, and it is assumed the north and south banks would each receive half of these deliveries. Peak daily truck traffic would be 105 round trips for a period of 20 days for fill placement. Assuming most of this traffic would be using Highway 16, the 210 one-way trips are approximately 5 percent of the average daily traffic on Highway 16 north of Glendive. Disposal of material would include an additional 1,880 truck trips to Joe's Island, with half the truckloads originating on the left bank, and half on the right. Overall, impacts related to dam removal would be minor on Highway 16 and related primarily to truck speeds which may impact speeds of other vehicles. Impacts on the local roads on the east side of the river would also be minor given low overall traffic volumes. While construction workers may need to commute to the sites via Highway 16 and other local roads, the additional volume of personal vehicles (90) would have a negligible effect on traffic in the study area.

Several measures would be implemented to mitigate the construction effects on transportation quality and infrastructure as discussed under the Rock Ramp Alternative above. With these actions to minimize effects, adverse impacts to transportation would be diminished.

4.14.4 Operational Effects

Trends in railroad use in the study area are largely dependent on developments in the oil and gas industry. If the oil and gas industry continues to experience a period of little to no growth in the region, major BNSF investment in the rail line along the river is not anticipated.

Similarly, no major expansions of regional or local airports are anticipated over the period of analysis. Public transportation services provided at the County level will continue to be funded based on immediate demand, which is expected to grow in proportion to population.

4.14.4.1 No Action Alternative

Operation of the No Action Alternative would continue as it does in the existing condition. The headworks and Intake Diversion Dam would continue to provide irrigation water for the LYP and regular and routine O&M would continue as it does presently. The No Action Alternative would not affect transportation resources in the study area.

Transportation resources in the study area are not expected to change substantially over the period of analysis, aside from continued maintenance of infrastructure. In 2012, the Montana Department of Transportation published the *MT 16 / MT 200 Glendive to Fairview Corridor Planning Study* which assessed existing and projected traffic along the corridor. The study found that average annual daily traffic had increased rapidly in response to the oil and gas boom, and that it was showing signs of leveling off in 2012. The report included some roadway resurfacing and improvement options (passing opportunities, transitions, intersections) which would help maintain consistent level of service through 2035, but no funding for major projects was secured (Montana Department of Transportation 2012). With the current slowdown in the oil and gas industry, it is expected that traffic demands in the corridor would return to slow growth in proportion to population change and general economic expansion over the period of analysis.

The No Action Alternative does not result in any beneficial or adverse operational effects on Transportation resources.

4.14.4.2 Rock Ramp Alternative

Operation of the Rock Ramp Alternative would have little effect on transportation resources. Regular maintenance of the Rock Ramp Alternative may require some trucking of rock on Highway 16 or Road 303 since the riprap rock in the quarry near Joe's Island is not suitable, but these activities would be performed occasionally and would have a negligible effect on traffic. Other O&M activities would be performed much as they are in the existing condition and utilize access roads and haul routes built during construction.

Access roads and haul routes on Joe's Island would remain after construction and would be accessible to the public, providing a minor beneficial effect. In summary, there would be only minor adverse transportation effects.

4.14.4.3 Bypass Channel Alternative

Operation of the Bypass Channel Alternative would have little effect on transportation resources. Regular maintenance of the replacement weir and bypass channel would utilize access roads and haul routes built during construction. Other O&M activities would be performed much as they are in the existing condition, with intermittent delivery or disposal of materials for maintenance that would have a negligible effect on traffic conditions in the study area. Rock used for O&M would not be sourced from the quarry near Joe's Island, and would be trucked from Glendive.

Access roads and haul routes on Joe's Island would remain after construction and would be accessible to the public, providing a minor beneficial effect. In summary, there would be only minor adverse transportation effects.

4.14.4.4 Modified Side Channel Alternative

Operation of the Modified Side Channel Alternative would have little effect on transportation resources. Regular maintenance of the new channel would utilize access roads and haul routes built during construction. Other O&M activities would be performed much as they are in the existing condition, with intermittent delivery or disposal of materials for maintenance that would have a negligible effect on traffic conditions in the study area.

Access roads and haul routes on Joe's Island would remain after construction and would be accessible to the public, providing a minor beneficial effect. In summary, there would be only minor adverse transportation effects.

4.14.4.5 Multiple Pump Alternative

Operation of the Multiple Pump Alternative would have negligible effects on regional transportation resources in the study area. Four of the five pump sites would be developed on private land or public lands not currently accessible for public use. Operation of one site, near the Intake Diversion Dam, may have some effects on transportation resources at Intake FAS.

The current design for the pump site near Intake FAS intersects the day use area at Intake FAS and has some overlap with the parking lot, which could be a minor to moderate adverse effect on the parking supply. However, it is assumed that final design of the pump site would adjust the alignment of the pumping station and the construction area to preserve the full parking area for the Intake FAS. Thus, the effects on the parking supply are assumed to be minor, contingent upon the action to minimize effects by refining the design.

At each pump site, O&M activities would consist of intermittent delivery or disposal of materials for maintenance that would have a negligible effect on traffic conditions in the study area. In summary, there would be only minor adverse transportation effects.

4.14.4.6 Multiple Pumps with Conservation Measures Alternative

Operation of the Multiple Pumps with Conservation Measures Alternative would have little effect on transportation resources. O&M activities would be limited to the Ranney well arrays, which are located on private lands. Traffic to and from the well sites for O&M would have a negligible impact on traffic in the study area. Other O&M activities would be performed much as they are in the existing condition and result in no net effect. In summary, there would be only minor adverse transportation effects.

4.14.5 Cumulative Effects

4.14.5.1 Geographic and Temporal Extent of Analysis

The geographic extent considered for transportation cumulative effects is the same as the study area for the consideration of construction and operational effects. The cumulative effects analysis considered a 50-year horizon for consistency with the period of analysis in the evaluation of alternatives.

4.14.5.2 Methodology for Determining Effects

A cumulative effect can be described as an impact on the environment which results from the incremental impact of the action when added to other past, present, and reasonably foreseeable future actions. In addition, it may be defined as two or more individual effects, which, when considered together, are considerable or which compound or increase other environmental impacts. Cumulative effects can result from individually minor but collectively significant actions taking place over time. An integral part of the cumulative effects analysis involves determining whether effects from the project would contribute to ongoing or foreseeable resource trends. Where effects from the project contribute to regional resource trends, there is a potential for a cumulative effect. The cumulative effects analysis does not assess all expected environmental impacts from regional projects but only those resulting from the project and other past, present, and reasonably foreseeable future actions.

4.14.5.3 Past, Present, and Reasonably Foreseeable Future Projects Considered

Section 4.1 discusses past, present, and reasonably foreseeable future projects which were considered in the evaluation of cumulative effects. The projects identified as relevant to the consideration of transportation included:

- Agriculture and irrigation
- Bakken Oil Fields and Fracking
- Dam Safety
- Spills at Pipeline Crossings
- Urbanization
- Montana 16 Improvements

Nearly all of the effects of the alternatives are short-term and related to construction of the project. Existing activities, including agriculture, ranching, and irrigation would continue, as

would oil-related activities. Urbanization, especially at Sidney and Glendive, would be long-term in nature and would not likely have any impacts associated with increased traffic volumes during project construction. Should there be a spill at a pipeline crossing or in a pipeline adjacent to the river, there could be minor overlap of construction and spill clean-up activities, though traffic impacts of these multiple projects would be short-term and minimal. There are no known dam safety issues along the Yellowstone River, so it is unlikely that there would be an overlap in safety repairs and project construction activities.

The MT 16 / MT 200 planning study, as mentioned earlier, contains several roadway resurfacing and improvement options (passing opportunities, transitions, intersections), though funding is not currently in place for these. It is highly unlikely that these improvements will be made before or during construction of the fish passage project. Thus, there would be no cumulative construction effects related to the two projects.

4.14.5.4 No Action Alternative

The No Action Alternative would not substantially alter or interact with any foreseeable future projects in the study area. There are no cumulative effects associated with the No Action Alternative.

4.14.5.5 Rock Ramp Alternative

The Rock Ramp Alternative would have negligible to minor long terms impacts on transportation trends and infrastructure, and so would not substantially alter or interact with any foreseeable future projects in the study area. There are no cumulative effects associated with the Rock Ramp Alternative.

4.14.5.6 Bypass Channel Alternative

The Bypass Channel Alternative would have negligible to minor long terms impacts on transportation trends and infrastructure, and so would not substantially alter or interact with any foreseeable future projects in the study area. There are no cumulative effects associated with the Bypass Channel Alternative.

4.14.5.7 Modified Side Channel Alternative

The Modified Side Channel Alternative would have negligible to minor long terms impacts on transportation trends and infrastructure, and so would not substantially alter or interact with any foreseeable future projects in the study area. There are no cumulative effects associated with the Modified Side Channel Alternative.

4.14.5.8 Multiple Pump Alternative

The Multiple Pump Alternative would have negligible to minor long terms impacts on transportation trends and infrastructure, and so would not substantially alter or interact with any foreseeable future projects in the study area. There are no cumulative effects associated with the Multiple Pump Alternative.

4.14.5.9 Multiple Pumps with Conservation Measures Alternative

The Multiple Pumps with Conservation Measures Alternative would have negligible to minor long terms impacts on transportation trends and infrastructure, and so would not substantially

alter or interact with any foreseeable future projects in the study area. There are no cumulative effects associated with the Multiple Pumps with Conservation Measures Alternative.

4.14.6 Actions to Minimize Effects

The measures listed below would be implemented to avoid, minimize, or mitigate adverse impacts on transportation resources in the study area as a result of project construction. Because the action alternatives involve similar types of construction activities, a number of actions to minimize effects have been identified that would apply to all the alternatives. Additional alternative-specific actions to minimize effects are provided in the following subsections.

Actions to minimize effects which apply to all alternatives are summarized in the bullets below.

- Delivery and removal of material and equipment from the construction area will be scheduled to avoid peak traffic times along Highway 16 and other local roadways.
- Contractor would designate construction routes and access points and utilize only these routes.
- Parking areas for construction workers would be designated to avoid parking impacts at existing public facilities such as Intake FAS or in the vicinity of construction areas.
- Contractor would post informational signage at key intersections to advise the public about active construction areas and traffic issues.
- Contractor would maintain Road 551, Road 303, and other roads along construction haul routes throughout construction, and perform post-construction rehabilitation, such that the roads are serviceable for public traffic to Intake FAS and to residents along Road 303 during construction and are left in equal or improved condition after construction.
- (Multiple Pump Alternative Only) Final design of the alternative would be refined to eliminate any adverse impact to the parking lot at the Intake FAS.
- (Rock Ramp Alternative Only) An abandoned BNSF siding track just north of Intake could be reinstated for delivery of riprap to the west side of the river, reducing construction truck traffic on Highway 16.

4.15 Noise

This section discusses the effects of the noise levels that may occur with implementation of the Proposed Project alternatives.

4.15.1 Area of Potential Effect

The Project is located within a rural, sparsely populated area in the northwestern area of the State of Montana. The existing ambient noise environment in the immediate vicinity of the Project sites is mainly made up of natural sounds, vehicle noise associated with route 16 and with small community roadway segments located near the Yellowstone River. There is also a BNSF railway that runs adjacent to the Yellowstone River.

Areas of potential effect include residential homes and the First Congregational Church located in Dawson County as well as residential homes located within Richland County; the towns of Knife River, Crane, and Fairview, and the City of Sydney.

The potential significance of the operational related noise impacts are defined by comparing the project related noise levels at the adjacent residential land use areas to the EPA outdoor noise guidelines of 55 dBA L_{DN} as well as increases to the existing ambient noise levels. If project-related operational noise impacts to the adjacent residential property lines exceed the 55 dBA L_{DN} noise guidelines established by the EPA or increase the existing ambient noise levels by 10 dBA or greater, then noise mitigation would be required.

The potential significance of the construction related noise impacts are defined by comparing the project related noise levels at the adjacent residential land use areas to the FTA construction noise criteria of 80 dBA during the nighttime period and 70 dBA during the nighttime period as well as increases to the existing ambient noise levels. If the project-related construction noise impacts to the adjacent property lines exceed 80 dBA during the daytime period or 70 during the nighttime period of increase the existing ambient noise levels by 15 dBA or greater, then noise mitigation would be required.

Ambient noise levels for the project area and surrounding community is based on reference data from similar types of land uses and communities. No ambient noise monitoring data was collected within the vicinity of the project site or surrounding communities.

4.15.2 Summary of Potential Effects

Table 4-32 summarizes the potential noise effects for each alternative. Details are provided in the following sections. For the noise evaluation, the definition of significance is as follows:

- **Minor**—Effects result in a detectable change, but the change would be slight.
 - Operational Effect—3 dBA or less increase to the existing ambient noise levels.
 - Construction Effect—10 dBA or less increase to the existing ambient noise levels.
- **Moderate**—Effects would result in a clearly detectable change, with measurable effects.
 - Operational Effect—10 dBA or less increase to the existing ambient noise levels.
 - Construction Effect—10 to 15 dBA increase to the existing ambient noise levels.
- **Major**—Effects would be readily apparent with substantial consequences.
 - Operational Effect—10 dBA or greater increase to the existing ambient noise levels or above 55 dBA L_{DN} per EPA noise guidelines.
 - Construction Effect—15 dBA or greater increase to the existing ambient noise levels or above 80 dBA for the daytime period and 70 dBA for the nighttime period per the FTA construction guidelines.

TABLE 4-32. SUMMARY OF POTENTIAL NOISE EFFECTS FROM EACH ALTERNATIVE

Impact Type	Level of Impact	Impact Description
No Action Alternative		
Construction Effects	No Effect	<ul style="list-style-type: none"> • No construction would occur.
Operational Effects	No Effect	<ul style="list-style-type: none"> • No changes to the existing noise levels.

Impact Type	Level of Impact	Impact Description
Rock Ramp Alternative		
Construction Effects	Major	<ul style="list-style-type: none"> • Sheet piling operations result in noise levels ranging from 62 dBA Leq to 66 dBA Leq at residential homes. • Construction of the rock ramp results in noise levels ranging from 45 dBA Leq to 56 dBA Leq at residential homes. • Noise levels from the sheet piling and construction operations will exceed the FTA noise guidelines.
Operational Effects	Minor	<ul style="list-style-type: none"> • Noise levels from general operation and maintenance of the Rock Ramp Alternative would not be audible at the nearest residential homes and would result in negligible effects on the existing environment. • Noise levels from the major operation and maintenance actions would be below the EPA guideline threshold of 55 dBA L_{DN} for outdoor activity interference and annoyance.
Bypass Channel Alternative		
Construction Effects	Major	<ul style="list-style-type: none"> • Sheet piling operations result in noise levels ranging from 58 dBA Leq to 66 dBA Leq at residential homes. • Construction of the bypass channel results in noise levels ranging from 37 dBA Leq to 54 dBA Leq at residential homes. • Noise levels from the sheet piling operations and construction will exceed the FTA noise guidelines.
Operational Effects	Minor	<ul style="list-style-type: none"> • Noise levels from the general operation and maintenance of the Bypass Channel Alternative would not be audible at the nearest residential homes and would result in negligible effects on the existing environment. • Noise levels from the major operation and maintenance actions would be below the EPA guideline threshold of 55 dBA L_{DN} for outdoor activity interference and annoyance.
Modified Side Channel Alternative		
Construction Effects	Major	<ul style="list-style-type: none"> • Modification and construction of the bypass channel result in noise levels ranging from 35 dBA Leq to 46 dBA Leq at residential homes. • Construction of the cofferdams includes sheet piling operations that result in noise levels ranging from 48 dBA Leq to 51 dBA Leq at residential homes. • Noise levels from the sheet piling operations will exceed the FTA noise guidelines.
Operational Effects	Minor	<ul style="list-style-type: none"> • The Modified Side Channel operation and maintenance activities may require heavy machinery such as dump trucks, front end loaders, and excavators. • Noise levels from these operation and maintenance activities at the residential homes range from 31 dBA Leq to 39 dBA Leq. • The noise levels from the operation and maintenance activities would be below the EPA guideline threshold of 55 dBA L_{DN} for outdoor activity interference and annoyance.

Impact Type	Level of Impact	Impact Description
Multiple Pump Alternative		
Construction Effects	Major	<ul style="list-style-type: none"> • Noise levels from the construction of the pumping stations range from 33 dBA Leq to 58 dBA Leq at residential homes. • Noise levels from the removal of the existing dam range from 44 dBA Leq to 55 dBA Leq at residential homes. • Noise levels from the construction of the pumping stations and removal of the existing dam will exceed the FTA noise guidelines.
Operational Effects	Major	<ul style="list-style-type: none"> • The noise levels from the pumping stations operations range from 37 dBA Leq to 51 dBA Leq at residential homes. • The noise levels from the backup generator operations will range from 47 dBA Leq to 63 dBA Leq residential homes. • The largest maintenance requirement for this alternative would be sediment removal, which results in noise levels ranging from 41 dBA Leq to 51 dBA Leq residential homes. • Noise levels from the operations of the pumps and backup generators will exceed the EPA noise guidelines.
Multiple Pumps with Conservation Measures Alternative		
Construction Effects	Major	<ul style="list-style-type: none"> • Noise levels from the construction of the Ranney wells range from 41 dBA Leq to 56 dBA Leq at residential homes • Noise levels from the removal of the existing dam range from 44 dBA Leq to 53 dBA Leq at residential homes. • Noise levels from the construction of the Ranney wells and removal of the existing dam will exceed the FTA noise guidelines.
Operational Effects	Major	<ul style="list-style-type: none"> • The noise levels from the pumping stations operations range from 37 dBA Leq to 51 dBA Leq at residential homes. • The noise levels from the backup generator operations will range from 47 dBA Leq to 63 dBA Leq residential homes. • The largest maintenance requirement for this alternative would be sediment removal, which results in noise levels ranging from 41 dBA Leq to 51 dBA Leq residential homes. • Noise levels from the operations of the backup generators will exceed the EPA noise guidelines.

4.15.3 Construction Effects

Noise levels resulting from construction activities vary greatly depending on: the type of equipment; the specific equipment model; the operations being performed; and the overall condition of the equipment. The EPA (1971) has published data on the average sound levels (L_{eq}) for typical construction phases. Following the EPA method, predicted, calculated from the acoustic center of the project site to the closest noise sensitive areas. These calculations conservatively assume all equipment operating concurrently onsite for the specified construction phase and no sound attenuation for ground absorption or onsite shielding by the existing buildings or structures.

4.15.3.1 No Action Alternative

Under the No Action Alternative, there would be no construction; therefore, there would be no noise effects on the sensitive receptors.

4.15.3.2 Rock Ramp Alternative

The Rock Ramp Alternative would replace the existing rock-and-timber crib structure at the Intake Diversion Dam with a concrete weir and a shallow-sloped, un-grouted boulder and cobble rock ramp. The replacement concrete weir would be located downstream of the new headworks and approximately 40 feet upstream of the Intake Diversion Dam. The concrete weir would be constructed as a cast-in-place reinforced concrete wedge spanning the entire width of the Yellowstone River channel. The construction of the concrete weir would require approximately 540 sheet piles that would be installed using a pile driving system. Existing residential homes are located approximately 1,200 feet to 2,000 feet from the construction of the replacement weir. It is assumed that the sheet piling would occur for 12 minutes per hour and the remainder of a given hour will be used to set the sheets. The maximum noise levels from the sheet pile driving operations would be 101 dBA at 50 feet (FHWA 2006) and would result in noise levels at the residential homes ranging from 62 dBA L_{eq} to 66 dBA L_{eq} . The sheet pile driving will occur for a total of 16 days. The sheet pile driving will be below the FTA construction noise criterion thresholds, but will result in increases to the existing ambient noise levels by more than 15 dBA during both the daytime and nighttime periods. Therefore, noise levels from sheet pile driving operations will result in a major impact on the existing environment. Impacts would be reduced by implementation of proposed actions to minimize effects.

A rock ramp would also be constructed downstream of the replacement weir by placing rock and fill material in the river channel to shape the ramp, followed by placement of rock riprap. Approximately 450,000 tons of rock riprap and 75,000 tons of fill material would be needed to construct the ramp. A temporary crossing would be constructed across the current Main Canal to prevent damage to the existing county bridge from heavy equipment use. The new crossing would use six, 10-foot by 10-foot box culverts with sufficient width and length to bridge the existing canal. Table 4-33 summarizes the construction equipment necessary to complete the rock ramp.

TABLE 4-33. ROCK RAMP CONSTRUCTION EQUIPMENT AND SOUND PRESSURE LEVELS

Equipment	Quantity	Operation Usage Percentage	Maximum Sound Pressure Level at 50 feet (dBA)
Dump Truck	2	40%	84
Grader	2	40%	85
Excavator	2	40%	85
Drill	1	20%	85
Compactor	1	20%	80
Water Truck	1	40%	84
Front End Loader	1	40%	80
Crane	2	16%	85
Sheet Pile Driving	1	20%	101

Source: FHWA 2009

The construction of the rock ramp would be completed over a two-year period. The construction of the rock ramp would result in noise levels at the residential homes ranging from 45 dBA L_{eq} to 56 dBA L_{eq} . The noise levels from the construction of the rock ramp will be below the FTA construction noise criterion thresholds, but will result in increases to the existing ambient noise

levels by more than 15 dBA during both the daytime and nighttime periods. Therefore, noise levels from construction of the rock ramp will result in a major impact on the existing environment. Impacts would be reduced by implementation of proposed actions to minimize effects.

4.15.3.3 Bypass Channel Alternative

This alternative includes constructing a bypass channel on Joe's Island from the inlet of the existing side channel to just downstream of the existing dam and boulder field. It would also replace Intake Diversion Dam with a concrete weir to raise the surface elevation of the river in front of the proposed bypass channel as well as the irrigation headworks. Construction work and the main elements of this alternative would be located primarily on Joe's Island.

The construction of the bypass channel would require the excavation and removal of approximately 869,000 cubic yards of earthen material from Joe's Island. The excavated material would be disposed in three locations including in the upstream portion of the existing side channel, in the spoil area of the south side of the new channel, and placed as side cast on the left bank of the bypass channel. The excavation and construction of the bypass channel will utilize similar equipment as the Rock Ramp Alternative. Homes are located approximately 1,800 feet to 8,800 feet from the construction of the bypass channel. The excavation and construction of the bypass would result in noise levels at the residential homes ranging from 37 dBA L_{eq} to 53 dBA L_{eq} . The noise levels from the construction of the bypass channel will be below the FTA construction noise criterion thresholds, but will result in increases to the existing ambient noise levels by more than 15 dBA for the nighttime period. Therefore, noise levels from construction of the bypass channel will result in a major impact on the existing environment. Impacts would be reduced by implementation of proposed actions to minimize effects.

This alternative includes the construction of cofferdams at the upstream entrance and downstream exit to protect the work zone as well as a channel plug constructed at the upstream end of the bypass. The cofferdams and channel plug will consist of sheet piles driven below grade. Existing residential homes are located approximately 2,000 feet to 2,900 feet from the sheet pile driving activities. Noise levels at the residential homes from sheet pile driving activities would range from 58 dBA L_{eq} to 62 dBA L_{eq} . Similar to the Rock Ramp Alternative sheet pile driving will occur for a total of 16 days.

Also, included in this alternative is a replacement weir located just upstream from the existing rock weir. This weir would be constructed approximately 40 feet upstream of the existing dam. The replacement weir structure would consist of a cantilevered structural wall created by a deep foundation of driven piles. The replacement weir would require approximately 680 cubic yards of concrete, which would be trucked from Glendive and pumped to the site. Noise levels from the pile driving activities would be similar to the Rock Ramp Alternative and would range from 62 dBA L_{eq} to 66 dBA L_{eq} at the residential homes. Similar to the Rock Ramp Alternative the sheet pile driving will occur for a total of 16 days.

Noise levels from the replacement weir concrete pours would range from 42 dBA L_{eq} to 54 dBA L_{eq} . The noise levels from the replacement weir concrete pours may be audible at the residential homes, but will be below the EPA noise guidelines. The noise levels from the replacement weir concrete pours will be below the FTA construction noise criterion thresholds, but will result in

increases to the existing ambient noise levels by more than 15 dBA for the nighttime period. Therefore, noise levels from the replacement weir concrete pours will result in a major impact on the existing environment. Impacts would be reduced by implementation of proposed actions to minimize effects.

The noise levels from the construction of the bypass channel, cofferdams at the upstream entrance and downstream, and raised concrete weir will exceed the FTA construction noise criterion thresholds, but will result in increases to the existing ambient noise levels by more than 15 dBA for the nighttime period. Therefore, noise levels from construction of the bypass channel will result in a major impact on the existing environment. Impacts would be reduced by implementation of proposed actions to minimize effects.

4.15.3.4 Modified Side Channel Alternative

This alternative includes modifying the existing side channel consisting of 6,000 feet of new channel at three bend cutoffs and lowering the existing channel. This alternative also includes the construction of one 150-foot single span bridge and 5,300 feet of bank protection. The modification and construction of the existing side channel would require the excavation and removal of approximately 1.19 million cubic yards of earthen material and placement of 362,000 cubic yards of material to partially fill three bend cutoffs. The modification and construction of the existing side channel will utilize similar equipment as the Rock Ramp Alternative. Existing residential homes are located approximately 4,000 feet to 6,000 feet from the modified side channel construction area. The modification and construction of the bypass channel would result in noise levels at the residential homes ranging from 35 dBA L_{eq} to 46 dBA L_{eq} . The noise levels from the construction of the modified side channel will be below the FTA construction noise criterion thresholds, but will result in increases to the existing ambient noise levels by more than 15 dBA during the nighttime period. Therefore, noise levels from construction of the modified side channel will result in a major impact to the existing environment. Impacts would be reduced by implementation of proposed actions to minimize effects.

This alternative includes the construction of cofferdams at the upstream entrance and downstream confluence of the modified side channel to protect the work zone. The cofferdams will consist of sheet piles driven below grade. Existing residential homes are located approximately 7,000 feet to 9,000 feet from the sheet pile driving activities. Noise levels at the residential homes from sheet pile driving activities would range from 48 dBA L_{eq} to 51 dBA L_{eq} . Similar to the Rock Ramp Alternative sheet pile driving will occur for a total of 16. The sheet pile driving will be below the FTA construction noise criterion thresholds, but will result in increases to the existing ambient noise levels by more than 15 dBA during the nighttime period. Therefore, noise levels from sheet pile driving operations will result in a major impact on the existing environment. Impacts would be reduced by implementation of proposed actions to minimize effects.

4.15.3.5 Multiple Pump Alternative

This alternative proposes removing the Intake Diversion Dam and constructing five pumping stations on the Yellowstone River to deliver water to the Lower Yellowstone Project. The pumping stations would be constructed at various locations along the Lower Yellowstone Project between the Intake Diversion Dam and Savage. The pumping station would incorporate three

submersible pumps with an additional pump provided for redundancy. A prefabricated steel building would be constructed over each wet well to house the motors and control. The pumps would be operated by 480V motors and standby generators would be provided at each site as a backup power source during any power outage. At each pumping station a feeder canal would be constructed incorporating a fish screen structure at the downstream end of each feeder canal. The power demand for the pumps would exceed the capacity of the existing power system in this area, requiring uprating of existing powerlines and the extension of existing powerlines to provide 3-phase, 480 volt power to each of the sites. New powerlines would be 3 phase, 480 volt underground powerlines with 4/0 conductors. Existing sub-stations would also be uprated to meet the power demands required. The construction of the pumping stations will utilize similar equipment as the Rock Ramp Alternative identified in Table 4-33. Existing residential homes are located approximately 1,000 feet to 5,000 feet from the pumping stations construction areas. The construction of the pumping stations would result in noise levels at the residential homes ranging from 33 dBA L_{eq} to 58 dBA L_{eq} .

Under this alternative the existing intake dam located near pumping station site 1 will be removed. The existing dam structure consists of timber frame filled with riprap and riprap apron downstream. For the removal, only the portion of the dam that is above the adjacent ground elevation would be demolished and removed, while the foundation with timber piles and downstream apron would remain. The removal of the existing dam would utilize similar construction as the pumping station construction. The noise levels for the construction equipment at 50 feet is presented in Table 4-33. Existing residential homes are located approximately 1,500 feet to 1,700 feet from the dam removal area. The removal of the existing dam would result in noise levels at the residential homes ranging from 44 dBA L_{eq} to 55 dBA L_{eq} .

The noise levels from the construction of the pumping stations and removal of the existing weir will be below the FTA construction noise criterion thresholds, but will result in increases to the existing ambient noise levels by more than 15 dBA during both the daytime and nighttime periods. Therefore, noise levels from construction of the pumping stations will result in a major impact on the existing environment. Impacts would be reduced by implementation of proposed actions to minimize effects.

4.15.3.6 Multiple Pumps with Conservation Measures Alternative

The Multiple Pumps with Conservation Measures Alternative includes four primary components including implementation of water conservation measures, pumping, gravity diversions through the exiting headworks, and use of wind energy to offset pumping costs. Water conservation measures consist of the installation of check structures, flow measuring devices, lateral pipe, concrete lining of the Main Canal and laterals, and groundwater pumps. The construction of the Multiple Pumps with Conservation Measures Alternative will utilize similar equipment as the Rock Ramp Alternative, which are presented in Table 4-33. Existing residential homes are located approximately 1,200 feet to 2,000 feet from the Ranney well construction areas. The construction of the Ranney well components would result in noise levels at the residential homes ranging from 41 dBA L_{eq} to 56 dBA L_{eq} .

Similar to the Multiple Pump Alternative, under the Multiple Pumps with Conservation Measures Alternative the existing intake dam will be removed. The existing dam structure consists of timber frame filled with riprap and riprap apron downstream. For the removal, only

the portion of the dam that is above the adjacent ground elevation would be demolished and removed, while the foundation with timber piles and downstream apron would remain. The removal of the existing dam would utilize similar construction as the pumping station construction. Existing residential homes are located approximately 1,500 feet to 1,700 feet from the dam removal area. The removal of the existing dam would result in noise levels at the residential homes ranging from 44 dBA L_{eq} to 53 dBA L_{eq} .

The noise levels from the construction of the components and the removal of existing dam will be below the FTA construction noise criterion thresholds, but will result in increases to the existing ambient noise levels by more than 15 dBA during both the daytime and nighttime periods. Therefore, noise levels from construction of the Ranney well components will result in a major impact on the existing environment. Impacts would be reduced by implementation of proposed actions to minimize effects.

4.15.4 Operational Effects

4.15.4.1 No Action Alternative

Under the No Action Alternative, Reclamation would continue with the current operations of the dam and headworks to divert water from the Yellowstone River for irrigation purposes. The operations include the continued diversion of up to 1,374 cfs through the screened headworks structure. The screens will continue to be operated as designed with them being down during the irrigation season and raised during non-irrigation season. The new headworks structure controls diversions of water into the canal and includes 12 removable rotating drum screens located in the river to minimize entrainment of fish greater than 40 mm long. Operational maintenance would occur which includes the placement of 1 to 2 feet of rock on the crest of the dam. Typically, rock is placed in late July or early August during seasonal low flow. Rock is quarried from private land about two miles southeast of the Intake Diversion Dam and hauled and stockpiled near the right abutment on Joe's Island. The rock is stockpiled with a loader, dumped into a skid, and hauled across the river and dumped in the river by the overhead trolley cableway. Under the No Action Alternative there will be no changes in the existing operations; therefore, there will be no changes to the existing noise levels. The No Action Alternative will result in noise levels with negligible effects due to no changes to the existing operations.

4.15.4.2 Rock Ramp Alternative

The Rock Ramp Alternative would replace the existing rock-and-timber crib structure at the Intake Diversion Dam with a concrete weir and a shallow-sloped, un-grouted boulder and cobble rock ramp. Like the No Action Alternative, the Rock Ramp Alternative operational activities would include operation of the headworks, supplemental pumps, and conveyance system. Maintenance of these facilities would be included as well, such as maintenance of the headworks screens and gates, maintenance and inspection of the canal, and maintenance of associated access roads. Maintenance for this alternative also includes repairs to the replacement weir and rock ramp including rock replacement. The general operation and maintenance would require minimal noise producing equipment including small pumps and vehicles. Noise levels from the general operation and maintenance of the Rock Ramp Alternative would not be audible at the nearest residential homes and would result in negligible effects on the existing environment.

For major operation and maintenance actions on the replacement weir and rock ramp would require construction of temporary access. These major actions would require dump trucks as well

heavy machinery such as a front end loader and excavator. Noise levels from these major actions at the residential homes range from 44 dBA L_{eq} to 53 dBA L_{eq} . These major action would be conducted during the daytime period only. The noise levels from the major operation and maintenance actions would be below the EPA guideline threshold of 55 dBA L_{DN} for outdoor activity interference and annoyance. The noise levels from the major operation and maintenance actions will result in minor effect on the existing environment because the noise levels will be below the EPA guidelines and will be considered short-term in duration.

4.15.4.3 Bypass Channel Alternative

This alternative includes constructing a bypass channel on Joe's Island and the replacement of the Intake Diversion Dam with a concrete weir to raise the surface elevation of the river in front of the proposed bypass channel as well as the irrigation headworks. Like the No Action Alternative, the Bypass Channel Alternative operational activities would include operation of the headworks, supplemental pumps, and conveyance system. Maintenance of these facilities would be included as well, such as maintenance of the headworks screens and gates, maintenance and inspection of the canal, and maintenance of associated access roads. Maintenance for this alternative also includes repairs to the replacement weir and rock ramp including rock replacement. The general operation and maintenance would require minimal noise producing equipment including small pumps and vehicles. Noise levels from the general operation and maintenance of the Bypass Channel Alternative would not be audible at the nearest residential homes and would result in negligible effects on the existing environment.

For major operation and maintenance actions on the replacement weir and bypass channel would require construction of temporary access. These major actions would require dump trucks as well heavy machinery such as a front end loader and excavator. Noise levels from these major actions at the residential homes range from 40 dBA L_{eq} to 45 dBA L_{eq} . These major action would be conducted during the daytime period only. The noise levels from the major operation and maintenance actions would be below the EPA guideline threshold of 55 dBA L_{DN} for outdoor activity interference and annoyance. The noise levels from the major operation and maintenance actions will result in minor effect on the existing environment because the noise levels will be below the EPA guidelines and will be considered short-term in duration.

4.15.4.4 Modified Side Channel Alternative

The High-Flow Alternative consists of the modification and construction of a modified side channel including 6,000 feet of new channel at three bend cutoffs and lowering the existing channel. Operation and maintenance activities specific to the Modified Side Channel Alternative include periodic inspection and possible replacement of riprap along the modified side channel; and removal of sediment or debris from the upstream and downstream confluence areas with the Yellowstone River and the modified side channel. Periodic inspections would be performed on the vehicular road and bridge. These operation and maintenance activities may require heavy machinery such as dump trucks, front end loaders, and excavators. Noise levels from these operation and maintenance activities at the residential homes range from 31 dBA L_{eq} to 39 dBA L_{eq} . Operation and maintenance activities would be conducted during the daytime period only. The noise levels from the operation and maintenance activities would be below the EPA guideline threshold of 55 dBA L_{DN} for outdoor activity interference and annoyance. The noise levels from the operation and maintenance activities will result in minor effect on the existing environment.

4.15.4.5 Multiple Pump Alternative

This alternative proposes removing the Intake Diversion Dam and constructing five pumping stations on the Yellowstone River to deliver water to the Lower Yellowstone Project. The pumping stations would be constructed at various locations along the Lower Yellowstone Project between the Intake Diversion Dam and Savage. Based on the size of the pumps it is assumed that the noise levels from the pumping station operations would be 77 dBA at 50 feet. The nearest residential homes are located approximately 1,000 feet to 5,000 feet from the pumping stations. The noise levels at these homes from the pumping stations operations will range from 37 dBA L_{eq} to 51 dBA L_{eq} . The pumping stations operating noise levels will exceed the EPA guideline threshold of 55 dBA L_{DN} for outdoor activity interference and annoyance, and will result in a 10 dBA or greater increase to the existing ambient noise levels. The noise level from operation of the pumps will result in a major impact. Impacts would be reduced by implementation of proposed actions to minimize effects.

Each of the pumping sites will incorporate emergency backup generators. The generator sizes will range from 500 kW at site 1 to 2,000 kW at Site 5. The generators will operate during power outages to provide backup power to the pumps. Based on the size of the backup generators it is assumed that the noise levels from the generators would range from 87 dBA at 50 feet for 500 kw generator to 89 dBA at 50 feet for 2000 kw generator (CAT 2016). The nearest residential homes are located approximately 1,000 feet to 5,000 feet from the backup generators. The noise levels at these homes from the backup generator operations will range from 47 dBA L_{eq} to 63 dBA L_{eq} . The noise levels from the generator operations will be periodic, but will result in a noise increase greater than 10 dBA to the existing ambient level and will exceed the EPA guideline threshold of 55 dBA L_{DN} . The noise level from operation of the backup generators will result in a major impact. Impacts would be reduced by implementation of proposed actions to minimize effects.

The largest maintenance requirement for this alternative would be sediment removal. The feeder canals would collect the majority of the sediment being deposited in the system and would require annual sediment removal. The sediment removal would be completed with a small excavator, which would result in levels ranging from 41 dBA L_{eq} to 51 dBA L_{eq} . The noise levels from the sediment removal maintenance activities would be below the EPA guideline threshold of 55 dBA L_{DN} for outdoor activity interference and annoyance. The noise levels from the sediment removal maintenance activities will result in minor effect on the existing environment.

4.15.4.6 Multiple Pumps with Conservation Measures Alternative

The Multiple Pumps with Conservation Measures Alternative includes four primary components including implementation of water conservation measures, pumping, gravity diversions through the exiting headworks, and use of wind energy to offset pumping costs. The operational noise levels for the Multiple Pumps with Conservation Measures Alternative are similar to Multiple Pump Alternative. The pumps are the primary operational noise sources under the Multiple Pumps with Conservation Measures Alternative. The nearest residential homes are located approximately 1,000 feet to 5,000 feet from the pumping stations. The noise levels from the pumping stations operations will range from 37 dBA L_{eq} to 51 dBA L_{eq} . The pumping stations operating noise levels will exceed the EPA guideline threshold of 55 dBA L_{DN} for outdoor activity interference and annoyance, and will result in a 10 dBA or greater increase to the

existing ambient noise levels. The noise level from operation of the pumps will result in a major impact. Impacts would be reduced by implementation of proposed actions to minimize effects.

Each of the pumping Sites will incorporate emergency backup generators. The generator sizes will range from 500 kW at site 1 to 2,000 kW at Site 5. The generators will operate during power outages to provide backup power to the pumps. Based on the size of the backup generators it is assumed that the noise levels from the generators would range from 87 dBA at 50 feet for 500 kw generator to 89 dBA at 50 feet for 2000 kw generator (CAT 2016). The nearest residential homes are located approximately 1,000 feet to 5,000 feet from the backup generators. The noise levels at these homes from the backup generator operations will range from 47 dBA L_{eq} to 63 dBA L_{eq} . The noise levels from the generator operations will be periodic, but will result in a noise increase greater than 10 dBA to the existing ambient level and will exceed the EPA guideline threshold of 55 dBA L_{DN} . The noise level from operation of the backup generators will result in a major impact. Impacts would be reduced by implementation of proposed actions to minimize effects.

Similar to the Multiple Pump Alternative, the largest maintenance requirement for this alternative would be sediment removal. The feeder canals would collect the majority of the sediment being deposited in the system and would require annual sediment removal. The sediment removal would be completed with a small excavator, which would result in levels at the closest homes ranging from 41 dBA L_{eq} to 51 dBA L_{eq} . The noise levels from the sediment removal maintenance activities would be below the EPA guideline threshold of 55 dBA L_{DN} for outdoor activity interference and annoyance. The noise levels from the sediment removal maintenance activities will result in minor effect on the existing environment.

This alternative also proposes wind turbines to supply power to the pumping stations. This component would require either partnering with a planned wind farm or construction of wind turbines as part of the project. Typically a wind farm requires several years of study for siting and permitting. That analysis is beyond the scope of this EIS, and would be carried out separately.

4.15.5 Cumulative Effects

4.15.5.1 Geographic and Temporal Extent of Analysis

Cumulative effects for noise were evaluated for a 5 miles radius around the project area. Noise sources located 5 miles or greater away do not result in a cumulative impact.

4.15.5.2 Methodology for Determining Effects

The cumulative effect for noise was evaluated by determine foreseeable future projects and their distance from the proposed project alternatives. Projects located 5 miles or greater away from the proposed project alternatives were considered not to result in a cumulative impact. Projects located within the 5 mile radius were further evaluated to determine the potential noise and resultant cumulative effect.

4.15.5.3 Past, Present, and Reasonably Foreseeable Future Projects Considered

Based on Section 4.1.3 none of the Foreseeable Future Projects presented are located within the 5 mile radius of the proposed project Alternatives. Therefore, no cumulative effects are expected for noise.

4.15.6 Actions to Minimize Effects

4.15.6.1 Rock Ramp Alternative

To reduce the noise impact from the construction of the rock ramp alternative mitigation measures will be implemented. The mitigation measures will include the following.

- Equipment and trucks used for project construction will utilize the best available noise control techniques (e.g., improved mufflers, equipment redesign, use of intake silencers, ducts, engine enclosures and acoustically-attenuating shields or shrouds) wherever feasible.
- Stationary noise sources will be located as far from adjacent receptors as possible and will be muffled and enclosed within temporary sheds, incorporate insulation barriers or other measures to the extent feasible.
- Impact tools (e.g., jack hammers, pavement breakers, and rock drills) used for project construction will be hydraulically or electrically powered wherever possible to avoid noise associated with compressed air exhaust from pneumatically-powered tools. However, where use of pneumatically powered tools is unavoidable, an exhaust muffler on the compressed air exhaust shall be used; this muffler can lower noise levels from the exhaust by up to about 10 dBA. External jackets on the tools themselves will be used where feasible. This could achieve a reduction of 5 dBA. Quieter procedures will be used such as drilling rather than impact equipment whenever feasible.
- Sheet piling and heavy construction equipment operations will be limited to daytime weekday periods only.
- Sheet piling operations will incorporate a three sided sound barrier wall that will enclose the sheet piling when residences are within 1 mile of the sheet piling. The sound barrier wall will have an overall minimum height 15 feet.

With the incorporation of the mitigation measures the noise impacts from the construction of the rock ramp will be reduced to a negligible impact during the nighttime period. The construction of the rock ramp will result in a 10 to 15 dBA increase during the daytime period, which will result in a moderate impact. The incorporation of the sound barrier will result in a 12 to 15 dB reduction in the sheet piling operational noise levels. The noise levels at the nearest residence will result in moderate impact from the sheet piling operations with the incorporation of the sound barrier.

4.15.6.2 Bypass Channel Alternative

To reduce the noise impact from the construction of the bypass channel alternative mitigation measures will be implemented. The bypass channel alternative mitigation measures will be the same as the mitigation measures presented within the rock ramp alternative.

With the incorporation of the mitigation measures the noise impacts from the construction of the rock ramp will be reduced to a negligible impact during the nighttime period. The noise levels at

the nearest residence will result in moderate impact from the sheet piling operations with the incorporation of the sound barrier.

4.15.6.3 Modified Side Channel Alternative

To reduce the noise impact from the construction of the Modified Side Channel Alternative a mitigation measure limiting the sheet piling and heavy construction equipment to daytime weekday periods only will be implemented. With the incorporation of this mitigation measure the noise impacts from the construction of the modified side channel alternative will be reduced to a negligible impact during the nighttime period.

4.15.6.4 Multiple Pump Alternative

To reduce the noise impact from the construction of the Multiple Pump Alternative mitigation measures will be implemented. The Multiple Pump Alternative mitigation measures will be the same as the mitigation measures presented within the rock ramp alternative, but will not include mitigation for sheet piling operations since sheet piling is not anticipated for this alternative.

With the incorporation of the mitigation measures the noise impacts from the construction of the Multiple Pump Alternative will be reduced to a negligible impact during the nighttime period. The construction of the Multiple Pump Alternative will result in a 10 to 15 dBA increase during the daytime period, which will result in a moderate impact.

The operation of the Multiple Pump Alternative incorporates pumps. To reduce the noise impact from the operations of the pumps a sound enclosure will be incorporated. The sound enclosure will be designed to provide a minimum overall noise reduction of 20 dBA. With the incorporation of the sound enclosure the noise levels from the operations of the pumps will result in a 10 dBA or less increase to the existing ambient noise level and will be below the EPA threshold of 55 dBA L_{DN} , which will result in a moderate impact.

The operation of the Multiple Pump Alternative sites incorporate a backup emergency generator. To reduce the noise impact from the operations of the emergency generators a sound enclosure will also be incorporated. The sound enclosure will be designed to provide a minimum overall noise reduction of 30 dBA. With the incorporation of the sound enclosure the noise levels from the operations of the backup emergency generators will result in a 10 dBA or less increase to the existing ambient noise level and will be below the EPA threshold of 55 dBA L_{DN} , which will result in a moderate impact.

4.15.6.5 Multiple Pumps with Conservation Measures Alternative

To reduce the noise impact from the construction of the Multiple Pumps with Conservation Measures Alternative mitigation measures will be implemented. The Multiple Pumps with Conservation Measures Alternative mitigation measures will be the same as the mitigation measures presented within the Multiple Pump Alternative.

With the incorporation of the mitigation measures the noise impacts from the construction of the Multiple Pumps with Conservation Measures Alternative will be reduced to a negligible impact during the nighttime period. The construction of the Multiple Pumps with Conservation Measures Alternative will result in a 10 to 15 dBA increase during the daytime period, which will result in a moderate impact.

The operation of the Multiple Pumps with Conservation Measures Alternative incorporates pumps. Mitigation measures for the pumps are presented within the Multiple Pump Alternative. With the incorporation of the sound enclosure the noise levels from the operations of the pumps will result in a 10 dBA or less increase to the existing ambient noise level and will be below the EPA threshold of 55 dBA L_{DN}, which will result in a moderate impact.

The operations of the Multiple Pumps with Conservation Measures Alternative pump sites incorporate a backup emergency generator. Mitigation measures for the backup emergency generators are presented within the Multiple Pump Alternative. With the incorporation of the sound enclosure the noise levels from the operations of the backup emergency generators will result in a 10 dBA or less increase to the existing ambient noise level and will be below the EPA threshold of 55 dBA L_{DN}, which will result in a moderate impact.

4.16 Social and Economic Conditions

Impacts to social and economic conditions were characterized by impacts to population and demographics, the local and regional economy, residential and commercial development, and public services and infrastructure. The types of impacts that a project may cause included:

- Induced population growth in an area, either directly or indirectly;
- Inducing or accelerating development in an undeveloped area; and
- Causing residents, businesses, or employees to be displaced.

4.16.1 Area of Potential Effect

The social and economic area of potential effect included counties that have social and economic links to the region that would be directly impacted by the alternative actions. The study area included Dawson, McCone, Prairie, Richland, Roosevelt, and Wibaux Counties in Montana and McKenzie and Williams Counties in North Dakota. Figure 3-30 shows the location of these counties in relation to the LYP. This is the same study area for Social and Economic Conditions as was discussed in the Affected Environment chapter of this report.

4.16.2 Summary of Potential Effects

Table 4-34 summarizes the potential effects on social and economic conditions for each alternative. Details are provided in the following sections.

TABLE 4-34. SUMMARY OF POTENTIAL EFFECTS ON SOCIAL AND ECONOMIC CONDITIONS FROM EACH ALTERNATIVE

Impact Type	Level of Impact	Impact Description
No Action Alternative		
Construction Effects	No Effect	• No construction, no effect
Operational Effects	No Effect	• No net effect because No Action is the baseline, despite new O&M estimate being greater than current LYP assessment rate.
Rock Ramp Alternative		
Construction Effects	Moderate	• Regional benefits from construction spending outweigh minor adverse recreation revenue effects

Impact Type	Level of Impact	Impact Description
Operational Effects	Minor	<ul style="list-style-type: none"> • O&M savings • Potential for long term recreation-related revenue increase
Bypass Channel Alternative		
Construction Effects	Moderate	<ul style="list-style-type: none"> • Regional benefits from construction spending
Operational Effects	Minor	<ul style="list-style-type: none"> • O&M savings • Potential for long term recreation-related revenue increase
Modified Side Channel Alternative		
Construction Effects	Moderate	<ul style="list-style-type: none"> • Regional benefits from construction spending
Operational Effects	Minor	<ul style="list-style-type: none"> • Minor O&M increase • Potential for long term recreation-related revenue increase
Multiple Pump Alternative		
Construction Effects	Moderate	<ul style="list-style-type: none"> • Regional benefits from construction spending outweigh minor adverse recreation revenue effects
Operational Effects	Major Minor	<ul style="list-style-type: none"> • Regional benefits from O&M spending • Adverse effect if O&M is funded by the LYP Board of Control • Potential for long term recreation-related revenue increase
Multiple Pumps with Conservation Measures Alternative		
Construction Effects	Moderate	<ul style="list-style-type: none"> • Highest Regional benefits from construction
Operational Effects	Minor to Major	<ul style="list-style-type: none"> • Regional benefits from O&M spending, but local adverse effect if O&M is funded by the LYP Board of Control • 608 cfs is less than current crop demands (1,150 cfs) and may have a major effect on agriculture • Potential for long term recreation-related revenue increase • Loss of prime farmland or farmland of statewide significance, depending on location of Ranney wells

4.16.3 Methodology

4.16.3.1 General and Direct Physical Effects

While the study area is the eight-county area, physical effects which may induce social and economic impacts would occur within the LYP, especially near the Intake Diversion Dam on either side of the river. For each alternative, the components of construction and operations which may affect social and economic resources are described and considered, including population, development, and displacement. This section also considered economic effects related to the paddlefish season in the study area.

4.16.3.2 Regional Economic Effects

The eight-county regional impacts from construction and O&M expenditures for each alternative were analyzed using the IMPLAN (impact analysis for planning) regional economic model. The eight-county region has a gross regional product of nearly \$12.7 billion dollars (IMPLAN's 2014 estimate). The IMPLAN model analysis represents a means of measuring the flow of commodities and services among industries, institutions, and final consumers within an economy (or study area) stemming from a change in one or more industries (the additional of construction and O&M expenditures in this case). IMPLAN captures all monetary market transactions in an economy, accounting for inter-industry linkages and availability of regionally produced goods and services. Results are presented in terms of four main metrics: total output, value added, labor

income, and employment. These metrics are different ways of summarizing economic activity in the region, and are not additive. Definitions are provided below.

- Industry output is a duplicative metric which includes the gross receipts for all goods and services sold at each level of production, not just final goods and services. For example, total output for the production of a ten-dollar loaf of bread would sum the ten dollar final sale price, the seven dollar sale price of flour, the four dollar sale price of wheat grain, and one dollar of original labor to produce the wheat, or a total output of \$22 dollars. Output is the broadest measure of economic activity in a regional economy.
- Value added is non-duplicative metric and measures the incremental value added to the economy at each level of production. In the simplified bread example, the initial dollar of labor to make wheat is wholly value added. An additional 3 dollars of value is added by the sale of wheat grains to a mill for 4 dollars. The mill adds another 3 dollars of value by the sale of flour to a bakery for 7 dollars. Finally, the bakery adds another 3 dollars of value by making bread and selling the loaf for 10 dollars. Thus, the total value added is the same as the value of final goods or services: $\$1 + (\$4 - \$1) + (\$7 - \$4) + (\$10 - \$7) = \10 . Repeated for all final goods and services in the regional economy, value added is equivalent to gross regional product.
- Labor income represents wages in the regional economy, including the sum of employee compensation and proprietor income. Labor income is one of the principal components of value added at each level of production.
- Lastly, employment is measured by the total number of jobs, whether full or part time jobs. Employment as reported by IMPLAN is therefore different from an estimate of full-time-equivalent jobs.

The results for the four main metrics described above are predicted in term of direct, indirect, and induced effects for the affected industries within a study area. Direct effects refer to the response of a given industry based on final demand for that industry. Indirect effects refer to changes resulting from the iterations of industries purchasing from other industries caused by the direct economic effects. Induced economic effects refer to changes caused by the expenditures associated with new household income generated by direct and indirect economic effects. Using the bread example again, direct effects of increased demand for bread would include increased revenue for bakeries. Indirect effects would include increased revenue for flourmills and wheat farmers. Induced effects would be increased spending by employee households at local businesses as a result of additional income earned working to meet the increased direct and indirect demand.

The primary input variable for an IMPLAN analysis is the dollar change in purchases of products or services in the region, which represent a change in final demand. Industries respond to meeting demands directly or indirectly by supplying goods and services to meet final demand changes. For this study, the changes in final demand are represented by the spending of construction funds or O&M funds within the eight-county study area. The expenditure inputs to IMPLAN must be assigned an industry sector. Construction of alternatives was assigned to Sector 58 Construction of other nonresidential structures. O&M expenditures were assigned to Sector 62 Maintenance and repair construction of nonresidential structures. Table 4-35 summarizes the construction cost and O&M expenditure inputs to IMPLAN. For more detailed cost information, see Appendix B.

TABLE 4-35. YELLOWSTONE IMPLAN INPUTS

	No Action	Rock Ramp	Bypass Channel	Modified Side Channel	Multiple Pump	Multiple Pumps with Conservation Measures
Construction Cost	-	\$90.5 M	\$57.0 M	\$54.5 M	\$132.0 M	\$477.9 M
Duration (months)	-	24	24	18	36	96
Annual O&M	\$2.6 M	\$2.8 M	\$2.8 M	\$2.9 M	\$5.0 M	\$4.4 M

NOTE: See Appendix C for detailed cost information.

The IMPLAN models takes into account that for a given alternative, different proportions of construction cost would be expended within the eight-county area depending upon the nature of the alternative, such as the types of materials and equipment that are required. This is referred to as the local purchase percentage. IMPLAN adjusts for this, and regional impacts only reflect expenditures within the region. IMPLAN results represent the total effect of an expenditure, and do not adjust for the length of construction. In order to present an average annual regional economic effect for each alternative, the IMPLAN results were divided by the length of the construction period for each alternative.

For each alternative, the cost estimates were reviewed to generate the local purchase percentage. The local purchase percentage was 38 percent for the Rock Ramp Alternative, 78 percent for the Bypass Channel Alternative, 55 percent for the Modified Side Channel Alternative, 53 percent for the Multiple Pump Alternative, and 75 percent for the Multiple Pumps with Conservation Measures Alternative. The substantial variation in the local purchase percentage is driven principally by the differences in the quantity and types of materials and equipment required for the alternatives. The Rock Ramp Alternative requires the purchase of large quantities of rock that is not available locally, and would be purchased from out of state, whereas the major component of the Bypass Channel Alternative requires much less material to be purchased. The Modified Side Channel Alternative uses more riprap than the Bypass Channel Alternative due in part to the different approach to construction of the replacement weir. The Multiple Pump Alternative requires the purchase of pumps and related equipment from outside the region. For the Multiple Pumps with Conservation Measures Alternative, the Ranney wells represent a large equipment purchase, but much of the remaining expenditures are met within the region. Because it is anticipated that construction will be Federally funded and will not require a local cost share, all construction spending in the eight-county region is counted as an increase in final demand.

For O&M expenditures, it was assumed that the local purchase percentage would be 100 percent for all alternatives. Both total and average annual effects are presented. It's important to note that the analysis presents the magnitude of effect associated with the anticipated OM&R expenditures for each alternative. However, if OM&R funding is sourced from within the regional economy, a substantial portion of the impacts associated with the funding may represent intra-regional transfers, and not new final demand in the regional economy. The proportion of funds which represent transfers would be dependent upon funding mechanism for OM&R, and is outside the scope of this analysis. As such, the OM&R-based impacts may be considered a maximum level of effect as presented.

Regional economic effects were not estimated for changes in recreation and tourism spending. Gross estimates of revenue effects on recreation and tourism from the alternatives would be

subject to substantial uncertainty. During construction of a project, recreationists would likely have multiple substitute resources available, and spending pattern changes may largely be a transfer within the regional economy. In terms of operational effects, there is insufficient data available to quantify growth in visitation, recreation, and tourism beyond what would have occurred in the No Action Alternative. Similarly, available data does not provide enough information to quantify the difference between regional long-term operational beneficial effects and any localized long-term adverse effects, or the extent to which adverse effects locally are simply transfers of benefit elsewhere in the 8-county region.

4.16.3.3 Effects of O&M on Farm Income

The impact of O&M costs associated with the alternatives on net farm revenue was analyzed. In the existing condition, farmers in the LYP are annually assessed \$40 per irrigated acre in order to cover LYP O&M costs. Under the alternatives, it was assumed that future O&M expenditures would be passed on to the irrigators in the form of a revised assessment rate. This analysis estimated the effect of the revised assessment rate for each alternative on the net income of LYP farmers. Note that the analysis used a revised No Action Alternative O&M estimate as provided by the most recent cost estimates for the project as explained further below.

The steps in the analysis included estimation of gross and net farm income for the LYP, translation of total net farm income to net farm income per typical farm operation, and comparison of this typical net farm income to revised O&M assessment rates.

Total net farm income was estimated based upon LYP farm characteristics, including crop acreage, crop yield, prices, production cost, and the number of LYP operations. Crop acreages were obtained from the 2013 LYP Crop Census (Lower Yellowstone Project Board of Control 2013). Crop prices for Montana and North Dakota were obtained from the National Agricultural Statistics Service to generate a 5-year average market price. Crop yields were also obtained from the National Agricultural Statistics Service. Five years of irrigated crop yields for Richland County, Montana, and McKenzie County, North Dakota were used to generate average yields by crop (National Agricultural Statistics Service 2015a and National Agricultural Statistics Service 2015b and National Agricultural Statistics Service 2016). Production cost was estimated as the ratio of gross income to net income as reported for Richland County and McKenzie County by the USDA's Census of Agriculture program. The County-wide data source included both irrigated and dryland farming. However, review of the dataset and comparison to previous estimates of net farm income in the study area showed only minor differences in the resulting ratio of gross to net income, on the order of just 1-2% difference in net income per acre. This approach was determined to provide a reasonable estimate of net income as a proportion of gross revenue without the needed for detailed crop budgets specific to the study area. For Richland County, four years of data were available (2014, 2012, 2010, and 2007). For McKenzie County, two years were available (2012 and 2007). Weighting Richland and McKenzie data by the proportion of LYP acreage in Montana and North Dakota, it was estimated that production cost accounted for about 75 percent of gross income in the LYP, not including the O&M assessment (Census of Agriculture 2016). Table 4-36 summarizes the resulting estimate of gross farm income.

TABLE 4-36. ESTIMATED FARM INCOME

Crops	Acres ^a	Yield ^b	Price (\$) ^b	Gross Revenue (\$)
Beets	20,160	27.9 (tons/acre)	\$59.69	\$33,621,000
Wheat	13,017	65.1 (bushels/acre)	\$6.96	\$5,896,000
Barley	6,994	92.8 (bushels/acre)	\$5.31	\$3,445,000
Corn	4,690	142.1 (bushels/acre)	\$5.54	\$3,692,000
Alfalfa, Hay	7,113	4.56 (tons/acre)	\$103.30	\$3,350,000
Grass (for hay)	2,493	4.56 (tons/acre)	\$83.90	\$953,900
Soy Bean	691	28.9 (tons/acre)	\$11.69	\$233,400
Total	55,158	–	–	\$51,191,000

a. LYP 2013 Crop Census (Lower Yellowstone Project Board of Control 2013)

b. National Agricultural Statistics Service and Census of Agriculture, (Census of Agriculture 2016, National Agricultural Statistics Service 2015a, National Agricultural Statistics Service 2015b, and National Agricultural Statistics Service 2016)

Based on the estimated ratio of gross to net income, net farm income for the LYP is estimated at \$12.9 million, or a net farm income per acre of \$234.79, not including the LYP assessment. The 2013 LYP crop census reported on 232 operations with irrigated land for an average irrigated acres per operation of 238 acres. The typical annual net farm income per operation was therefore \$55,821, before accounting for the LYP assessment. With the existing \$40 per acre assessment, estimated net farm income would be \$46,311.

O&M cost for each alternative was developed as part of the cost estimates as described in Appendix B. These estimates provide the basis for the assumed LYP assessment that would be associated with each alternative. The assessment would be applied to all irrigated acreage and is paid from the net income of the farmers. Development of future O&M for each alternative included development of O&M needs for the No Action Alternative. As shown in Table 4-37, the estimated O&M for the No Action Alternative was \$47.92 per acre, which was greater than the \$40 per acre assessment in the existing condition. The larger O&M cost for the No Action reflects the most recent cost estimate for O&M of the new headworks and existing weir. Therefore, this analysis used the \$47.92 per acre value as the baseline for comparison of action alternatives to the No Action Alternative in order to provide a fair comparison. The O&M per acre shown in the table is equivalent to the assumed LYP assessment for each alternative. Thus the baseline net farm income for the No Action is the \$234.79 per acre, less the \$49.72 assessment, giving a net income per acre inclusive of the LYP assessment of \$186.87, and an estimated net income per farm of \$44,429.

Note that the presentation of income per farm is an average derived from estimated revenue for the entire area and a simple average for farm size based on the number of operators. In reality, farm size in the study area, and therefore farm income, is variable. According to the 2013 LYP Crop Census, 19% of operations have less than 10 irrigated acres, 24.6% have between 10 and 40 acres, 25.9% have between 40 and 200 acres, 12.9% have between 200 and 500 acres, 12.1% have between 500 and 1,000 acres, and just 5.6% have over 1,000 acres. Thus, while the average farm size of 238 acres is used to estimate the income effects on a typical farm operation in the study area, it does not account for farm-specific traits which would affect a farms adaptability to changes in O&M cost. This analysis is not intended to explicitly estimate income change for every farm operation in the study area, but rather to provide a means of comparing the expected changes in O&M spending that will be borne by LYP farmers under each of the alternatives.

TABLE 4-37. O&M BY ALTERNATIVE

Alternative	Annual O&M	Annual O&M per Acre
No Action	\$2.64 M	\$47.92
Rock Ramp	\$2.84 M	\$51.49
Bypass Channel	\$2.80 M	\$50.75
Modified Side Channel	\$2.91 M	\$52.70
Multiple Pump	\$5.03 M	\$91.27
Multiple Pumps with Conservation Measures	\$4.39 M	\$79.52

4.16.4 Construction Effects

4.16.4.1 No Action Alternative

The No Action Alternative does not include construction activity. The alternative includes the continued operation of the LYP using the existing diversion headworks (constructed 2010-2012) and the Intake Diversion Dam. Because there would be no construction, the No Action Alternative would have no construction related effects on social and economic conditions.

4.16.4.2 Rock Ramp Alternative

General

Construction of the Rock Ramp Alternative is expected to take about two years. Construction would not displace residences or preclude development during the construction period, as the project site is limited to the river and existing public lands. Similarly, no effects on agricultural revenues are expected during construction, the project area does not include any agricultural lands, and construction is not expected to affect delivery of irrigation water.

Construction would affect the Intake FAS, but as described in the recreation consequences section (Section 4.12), these effects would be less than significant. There would be no adverse effects on the provision of emergency services during construction. Public access to the Intake FAS and Joe’s Island would be closed when construction activities could pose a public safety risk and supported by a communication plan as noted in the Actions to Minimize Effects.

As noted in recreation, the construction contractor would minimize construction activities during the paddlefish season from mid-May into June. However, because the Rock Ramp Alternative requires construction along much of the riverfront at Intake FAS, the quality of paddlefish snagging at Intake may be moderately to greatly reduced during construction, causing a larger proportion of anglers to fish elsewhere along the river. Reduced opportunity at Intake could have a variety of economic effects. A slower catch could lengthen the season, possibly increasing recreation and tourism related revenue to local businesses. Conversely, fewer fish caught at Intake could reduce angler participation in the Yellowstone Caviar processing/roe harvest program, which would reduce funds received by the Glendive Chamber of Commerce. Effects on concession operators at Intake FAS, and their sub-contractors, may be mixed. Fewer anglers at the site per day may reduce revenue. A longer season could offset the reduction in daily revenue with additional revenue days, though labor costs would increase as well. Because construction would affect just two paddlefish seasons, and because and adverse effects at Intake may be

absorbed by beneficial effects elsewhere along the river, adverse economic effects on paddlefish season and related recreation and tourism revenues is determined to be minor and less than significant.

Regional Effect of Construction Expenditure

Approximately \$34.3 million of the \$90.5 million Rock Ramp Alternative construction cost would be captured in the regional economy. This expenditure would support a total of 247 direct, indirect, and induced jobs for a total of \$19.2 million in labor income, \$25.5 million in value added impact (gross regional product), and \$45.2 million in total output. Construction of the Rock Ramp Alternative would represent an increase in gross regional product of about 0.2 percent. Table 4-38 summarizes these regional economic effects in total, and Table 4-39 presents average annual effects over the two-year construction period.

TABLE 4-38. ROCK RAMP, TOTAL REGIONAL EFFECTS OF CONSTRUCTION

Impact Type	Employment	Labor Income	Value Added	Output
Direct	183	\$15,480,000	\$18,662,000	\$34,309,000
Indirect	34	\$2,364,000	\$4,212,000	\$6,512,000
Induced	30	\$1,354,000	\$2,637,000	\$4,353,000
Total	247	\$19,197,000	\$25,510,000	\$45,174,000

TABLE 4-39. ROCK RAMP, AVERAGE ANNUAL REGIONAL EFFECTS OF CONSTRUCTION

Impact Type	Employment	Labor Income	Value Added	Output
Direct	92	\$7,740,000	\$9,331,000	\$17,154,500
Indirect	17	\$1,182,000	\$2,106,000	\$3,256,000
Induced	15	\$677,000	\$1,318,500	\$2,176,500
Total	124	\$9,598,500	\$12,755,000	\$22,587,000

4.16.4.3 Bypass Channel Alternative

General

Construction of the Bypass Channel Alternative is expected to take about two years. Like the Rock Ramp Alternative, construction would not have any effects on population, development, or agriculture. Effects on the Intake FAS would be similar in nature to those for the Rock Ramp Alternative, but would be reduced and minor overall for the Bypass Channel Alternative. The effect is reduced for the Bypass Channel Alternative because the construction area for the alternative is focused on Joe’s Island and just upstream of the Intake FAS during weir replacement. Construction would not reduce the quantity of shore fishing opportunities on the left bank. Right bank opportunities may still be reduced, however, as construction of the bypass channel would include closure of Joe’s Island. Because the quality and quantity of paddlefishing opportunities at Intake will experience only minor adverse effects during the two years of construction, any adverse economic effects on the Yellowstone Caviar program and concessions operators would be minimal and not significant. Closure of Joe’s Island during construction could result in minor adverse effects from reduced participation in hunting, hiking, or other users of Joe’s Island. However, the proximity of substitute sites, such as Elk Island WMA,

recreationists are not likely to forgo participation in these activities within the region due to closures near Intake. As such, recreation and tourism related impacts from closure of Joe’s Island would be minimally adverse and not significant.

Regional Effect of Construction Expenditure

Approximately \$44.6 million of the \$57.0 million Bypass Channel Alternative construction cost would be captured in the regional economy. This expenditure would support a total of 322 direct, indirect, and induced jobs for a total of \$25.0 million in labor income, \$33.2 million in value added impact (gross regional product), and \$58.8 million in total output. Construction of the Bypass Channel Alternative would represent an increase in gross regional product of about 0.26 percent. Table 4-40 summarizes these regional economic effects in total, and Table 4-41 presents average annual effects over the two-year construction period.

TABLE 4-40. BYPASS CHANNEL, TOTAL REGIONAL EFFECTS OF CONSTRUCTION

Impact Type	Employment	Labor Income	Value Added	Output
Direct	239	\$20,131,000	\$24,271,000	\$44,620,000
Indirect	45	\$3,074,000	\$5,477,000	\$8,469,000
Induced	39	\$1,761,000	\$3,429,000	\$5,661,000
Total	322	\$24,967,000	\$33,177,000	\$58,750,000

TABLE 4-41. BYPASS CHANNEL, AVERAGE ANNUAL REGIONAL EFFECTS OF CONSTRUCTION

Impact Type	Employment	Labor Income	Value Added	Output
Direct	120	\$10,065,500	\$12,135,500	\$22,310,000
Indirect	23	\$1,537,000	\$2,738,500	\$4,234,500
Induced	20	\$880,500	\$1,714,500	\$2,830,500
Total	161	\$12,483,500	\$16,588,500	\$29,375,000

4.16.4.4 Modified Side Channel Alternative

General

Construction of the Modified Side Channel Alternative is expected to take about 1.5 years. Social and economic effects during construction would be very similar to those for the Bypass Channel Alternative, though due to the shorter construction period, construction related effects would be lessened overall. Social and economic effects of the Modified Side Channel Alternative construction would be minimal and not significant.

Regional Effect of Construction Expenditure

Approximately \$30.2 million of the \$54.5 million Modified Side Channel Alternative construction cost would be captured in the regional economy. This expenditure would support a total of 218 direct, indirect, and induced jobs for a total of \$16.9 million in labor income, \$22.5 million in value added impact (gross regional product), and \$39.8 million in total output. Construction of the Modified Side Channel Alternative would represent an increase in gross regional product of about 0.18 percent. Table 4-42 summarizes these regional economic effects in total, and Table 4-43 presents average annual effects over the 1.5-year construction period.

TABLE 4-42. MODIFIED SIDE CHANNEL, TOTAL REGIONAL EFFECTS OF CONSTRUCTION

Impact Type	Employment	Labor Income	Value Added	Output
Direct	162	\$13,638,000	\$16,442,000	\$30,227,000
Indirect	30	\$2,082,000	\$3,710,000	\$5,737,000
Induced	26	\$1,193,000	\$2,323,000	\$3,835,000
Total	218	\$16,913,000	\$22,475,000	\$39,799,000

TABLE 4-43. MODIFIED SIDE CHANNEL, AVERAGE ANNUAL REGIONAL EFFECTS OF CONSTRUCTION

Impact Type	Employment	Labor Income	Value Added	Output
Direct	108	\$9,092,000	\$10,961,333	\$20,151,333
Indirect	20	\$1,388,000	\$2,473,333	\$3,824,667
Induced	17	\$795,333	\$1,548,667	\$2,556,667
Total	145	\$11,275,333	\$14,983,333	\$26,532,667

4.16.4.5 Multiple Pump Alternative

General

Construction of the Multiple Pump Alternative is expected to take three years to complete. Like other alternatives, no effects would occur on population, development, or agriculture. The alternative includes construction activities at five pump sites along the river. Installation of the pump site just upstream of Intake FAS, and the removal of the existing weir during the last six months of the construction period, would result in economic effects.

Construction of the pumping station near the Intake Diversion Dam is currently sited on top of the Intake FAS day use area. Construction of the pumping station would likely result in closure of the boat ramp to public use, and could result in reduced parking area. Additionally, the proximity of construction activities would reduce the quality of the recreation experience at the site. Taken together, these factors would likely result in moderate reduction in visitation throughout the year, which would reduce campsite fee revenue.

As noted for other alternatives, construction activity would be minimized during the paddlefish season. Construction of the pumping station may result in boat ramp closure, but shore fishing on the left bank and from Joe’s Island would be unaffected. During the first two years of construction, there would be only minor effects on revenues associated with paddlefishing. Because shore fishing outnumbers anglers using boats, the decrease in visitation from unavailability of the boat ramp would have only minor adverse effects on concessionaire revenues and participation in the Yellowstone Caviar program. Dam removal would occur over six months during the third year of construction, and would have moderate effects on paddlefishing. Like for the Rock Ramp Alternative, in-progress construction activities could reduce the quality of fishing from the Intake FAS and result in a longer season with more fish caught elsewhere on the river. Because and adverse effects at Intake may be absorbed by beneficial effects elsewhere along the river, overall adverse economic effects on paddlefish season and related revenues is determined to be minor and less than significant.

Regional Effect of Construction Expenditure

Approximately \$70.6 million of the \$132.0 million Multiple Pump Alternative construction cost would be captured in the regional economy. This expenditure would support a total of 509 direct, indirect, and induced jobs for a total of \$39.5 million in labor income, \$52.5 million in value added impact (gross regional product), and \$92.9 million in total output. Construction of the Multiple Pump Alternative would represent an increase in gross regional product of about 0.41 percent. Table 4-44 summarizes these regional economic effects in total, and Table 4-45 presents average annual effects over the three-year construction period.

TABLE 4-44. MULTIPLE PUMP ALTERNATIVE, TOTAL REGIONAL EFFECTS OF CONSTRUCTION

Impact Type	Employment	Labor Income	Value Added	Output
Direct	377	\$31,839,000	\$38,386,000	\$70,569,000
Indirect	70	\$4,862,000	\$8,663,000	\$13,395,000
Induced	61	\$2,786,000	\$5,423,000	\$8,953,000
Total	509	\$39,486,000	\$52,471,000	\$92,917,000

TABLE 4-45. MULTIPLE PUMP ALTERNATIVE, AVERAGE ANNUAL REGIONAL EFFECTS OF CONSTRUCTION

Impact Type	Employment	Labor Income	Value Added	Output
Direct	126	\$10,613,000	\$12,795,333	\$23,523,000
Indirect	23	\$1,620,667	\$2,887,667	\$4,465,000
Induced	20	\$928,667	\$1,807,667	\$2,984,333
Total	170	\$13,162,000	\$17,490,333	\$30,972,333

4.16.4.6 Multiple Pumps with Conservation Measures Alternative

General

Construction of the Multiple Pumps with Conservation Measures Alternative is expected to take eight years to complete. Like the Multiple Pump Alternative, dam removal would occur over a six-month period in the final year of construction. The Multiple Pumps with Conservation Measures Alternative includes construction at seven sites along the river. None of these sites overlap the Intake FAS, and so no effects are expected on revenues associated with Intake FAS or paddlefishing during the first seven years of construction. During the eighth year, effects would be equivalent to those described for the final year of construction of the Multiple Pump Alternative, which are minor adverse effects that are less than significant.

The unique aspect of the Multiple Pumps with Conservation Measures Alternative is that the seven sites for well installation are located on active agricultural lands. Each site is 70 acres. At the current level of design, it is assumed that the 490 acres needed for installation of Ranney Well fields would be mostly unfarmed during the eight-year construction period, but may be farmable again prior to the end construction. During the construction period, drilling and pump tests would need to be conducted on each site in order to identify specific well locations. After siting and well installation, lands might be able to be returned to active farming while canal and lateral modification, wind turbine installation, and dam removal are still ongoing. Following

construction, an access easement would be maintained in order to allow maintenance of the wells and pumps.

Due to the uncertainties in timing of construction, the conservative assumption was made that all 490 acres would not be farmed for eight seasons. Based on the calculations shown above in the *Methodology* section, an acre of irrigated land can net approximately \$186.87 per year (including the LYP assessment). Thus, the opportunity cost of using 490 acres of active farmland for well construction is approximately \$91,566 dollars per year, or 0.89 percent of the estimated annual LYP net farm income. It was assumed that the landowner would not be required to pay the LYP assessment for lands not farmable during construction, and that the assessment would be addressed in the project real estate costs or landowner lease agreements. Further landowner compensation may be required if construction activities prevent the landowner from maintaining proper soil and water retainment levels which could impact crop yields in years following the construction period. While the lost revenue is not negligible, it will be more than offset in terms of gross regional product by the infusion of construction expenditures into the regional economy, and therefore is not a significant effect.

Regional Effect of Construction Expenditure

Approximately \$357.1 million of the \$477.9 million Multiple Pumps with Conservation Measures Alternative construction cost would be captured in the regional economy. This expenditure would support a total of 2,575 direct, indirect, and induced jobs for a total of \$199.8 million in labor income, \$265.5 million in value added impact (gross regional product), and \$470.1 million in total output. Construction of the Multiple Pumps with Conservation Measures Alternative would represent an increase in gross regional product of about 2.1 percent. Table 4-46 summarizes these regional economic effects in total, and Table 4-47 presents average annual effects over the eight-year construction period.

TABLE 4-46. MULTIPLE PUMPS WITH CONSERVATION MEASURES, TOTAL REGIONAL EFFECTS OF CONSTRUCTION

Impact Type	Employment	Labor Income	Value Added	Output
Direct	1,909	\$161,096,000	\$194,220,000	\$357,058,000
Indirect	356	\$24,598,000	\$43,830,000	\$67,773,000
Induced	310	\$14,095,000	\$27,439,000	\$45,300,000
Total	2,575	\$199,789,000	\$265,489,000	\$470,130,000

TABLE 4-47. MULTIPLE PUMPS WITH CONSERVATION MEASURES, AVERAGE ANNUAL REGIONAL EFFECTS OF CONSTRUCTION

Impact Type	Employment	Labor Income	Value Added	Output
Direct	239	\$20,137,000	\$24,277,500	\$44,632,250
Indirect	45	\$3,074,750	\$5,478,750	\$8,471,625
Induced	39	\$1,761,875	\$3,429,875	\$5,662,500
Total	322	\$24,973,625	\$33,186,125	\$58,766,250

4.16.4.7 Summary of Regional Economic Construction Effects

Table 4-48 provides a summary of the total regional economic effects in the preceding sections. Table 4-49 provides a summary table for the same effects on an average annual basis over each alternative's construction period length. As shown in the tables, the action alternatives result in a range of regional economic effects in proportion to their total construction cost and length of construction period. Because of its relatively high cost and long construction period, the Multiple Pumps with Conservation Measures Alternative would result in substantially higher levels of employment and value added impact than the other action alternatives, with nearly double the annual contribution to the gross regional product (value added) as the Bypass Channel Alternative. Further, these annual effects would persist for eight years of construction. The Bypass Channel Alternative would result in the second highest annual level of beneficial impact, contributing \$15 million in gross regional product and supporting 150 jobs during each of the two years of construction. However, the Multiple Pump Alternative would have a greater impact overall because its construction period would last three years, rather than two.

TABLE 4-48. SUMMARY OF TOTAL REGIONAL EFFECTS OF CONSTRUCTION BY ALTERNATIVE

Alternative	Impact Type	Employment	Labor Income	Value Added	Output
Rock Ramp	Total	247	\$19,197,000	\$25,510,000	\$45,174,000
Bypass Channel	Total	322	\$24,967,000	\$33,177,000	\$58,750,000
Modified Side Channel	Total	218	\$16,913,000	\$22,475,000	\$39,799,000
Multiple Pump	Total	509	\$39,486,000	\$52,471,000	\$92,917,000
Multiple Pumps with Conservation Measures	Total	2,575	\$199,789,000	\$265,489,000	\$470,130,000

TABLE 4-49. SUMMARY OF ANNUAL REGIONAL EFFECTS OF CONSTRUCTION BY ALTERNATIVE

Alternative	Impact Type	Employment	Labor Income	Value Added	Output
Rock Ramp (2 years)	Total	124	\$9,598,500	\$12,755,000	\$22,587,000
Bypass Channel (2 years)	Total	161	\$12,483,500	\$16,588,500	\$29,375,000
Modified Side Channel (1.5 years)	Total	145	\$11,275,333	\$14,983,333	\$26,532,667
Multiple Pump (3 years)	Total	170	\$13,162,000	\$17,490,333	\$30,972,333
Multiple Pumps with Conservation Measures (8 years)	Total	322	\$24,973,625	\$33,186,125	\$58,766,250

4.16.5 Operational Effects

4.16.5.1 No Action Alternative

Future Without Project Condition

Socioeconomic trends in the study area do not indicate major shifts or socioeconomic changes during the period of analysis. The U.S. Department of Agriculture projects that the national agricultural industry will remain a stable and slow-growth industry (U.S. Department of Agriculture 2016). It projects that through 2025, crop prices will rise at a moderate rate, and net farm income will remain above pre-2007 levels. U.S. sugar production will rise over the next decade, but beet sugar production will peak around 2019 in response to competition from cane

sugar producers and imported Mexican sugar. The Department of Agriculture still expects sugar beet acreage to exceed sugarcane acreage through 2025, but expects that cane sugar production will exceed beet sugar production in 2022. Within the study area, sugar beets are likely to continue to be the most valuable crop in the LYP.

Under the No Action Alternative, it was assumed that the LYP would continue to supply water for irrigated agriculture throughout the period of analysis. Over the period of analysis, it is assumed that any increased water demand from more intensive farming, drier soil condition, or increased irrigated acreage would need to be met using the existing water right. The LYP Board of Control could submit a request to the state for an expanded water right, but this would be fairly lengthy process. Historical data shows that diversion for irrigation is typically maximized throughout the growing season. As such, the ability of the LYP to irrigate additional acreage over the period analysis would be a function of the success of conservation measures, like conversion to sprinklers, rationing, and other policies and programs that could be performed under the existing water right. In short, changes in agriculture under the No Action Alternative will likely include conversion of dryland farming or pastureland to higher value irrigated farmland as measures are implemented to use the existing LYP water right more efficiently.

Climate change will also be factor in agricultural trends in the LYP. Current analyses indicate that climate change may result in earlier and lower levels of runoff from snowmelt, and decreased flows in later summer. Such changes could potentially result in less water available later in the summer, which may shift growing seasons to earlier in the year or have an adverse effect on yields.

Operation and Maintenance

Operation and maintenance under the No Action Alternative would continue much as it does in the existing condition. Operational activities for this alternative include operation of the headworks for irrigation, including five supplement pumps. Maintenance activities include maintenance of the headworks (gates and screens), rock placement on the Intake Diversion Dam, maintenance of the canal and associated components (including access roads), and maintenance of the rock placement trolley system. Costs estimates developed for this study also include replacement or rehabilitation of the trolley system and Intake Diversion Dam in the No Action Alternative, as further described in the Cost Appendix B.

Regional Effects of O&M Expenditures

The annual O&M for the No Action Alternative is \$2.64 million. This annual expenditure would support a total of 19 direct, indirect, and induced jobs for a total of \$1.40 million in labor income, \$1.87 million in value added impact (gross regional product), and \$3.55 million in total output. Table 4-50 summarizes these regional economic effects. As noted in Section 4.16.3.2, these results may include intra-regional transfers due to funding of O&M from within the regional economy.

TABLE 4-50. NO ACTION, AVERAGE ANNUAL REGIONAL EFFECTS OF O&M

Impact Type	Employment	Labor Income	Value Added	Output
Direct	13	\$1,094,000	\$1,318,000	\$2,643,000
Indirect	4	\$204,000	\$363,000	\$585,000
Induced	2	\$99,000	\$192,000	\$317,000
Total	19	\$1,397,000	\$1,873,000	\$3,545,000

4.16.5.2 Rock Ramp Alternative

General

Operation of the Rock Ramp Alternative would not displace residences or preclude development during the period of analysis. Similarly, there would be no direct or indirect effects on agriculture.

Economic impacts related to recreation and tourism may occur as a result of the alternative. The alternative would result in closure of the existing boat ramp at the Intake FAS and would result in reduced quality of fishing at the site (see Recreation Section 4.12.3.2). Reduced catch at Intake FAS could result in paddlefish seasons increasing in length on average. In the short term, fee revenues and Yellowstone Caviar revenues may be reduced, but extended seasons could be beneficial to other local businesses supporting the recreation, tourism, and accommodation industries. Over the long term, the adverse effect is likely minor, and may become a net benefit, as both anglers and the Glendive Chamber of Commerce would adapt to changed conditions and make use of new upstream fishing opportunities as a result of increased fish passage.

Regional Effects of O&M Expenditures

The annual O&M for the Rock Ramp Alternative is \$2.84 million. This annual expenditure would support a total of 20 direct, indirect, and induced jobs for a total of \$1.50 million in labor income, \$2.01 million in value added impact (gross regional product), and \$3.81 million in total output. Table 4-51 summarizes these regional economic effects. As noted in Section 4.16.3.2, these results may include intra-regional transfers due to funding of O&M from within the regional economy.

TABLE 4-51. ROCK RAMP, AVERAGE ANNUAL REGIONAL EFFECTS OF O&M

Impact Type	Employment	Labor Income	Value Added	Output
Direct	14	\$1,176,000	\$1,417,000	\$2,840,000
Indirect	4	\$219,000	\$390,000	\$629,000
Induced	2	\$106,000	\$206,000	\$341,000
Total	20	\$1,501,000	\$2,013,000	\$3,809,000

4.16.5.3 Bypass Channel Alternative

General

Operation of the Bypass Channel Alternative would not affect development or agriculture. Unlike the Rock Ramp Alternative, the Bypass Channel Alternative may have minor benefits effects on recreation-related revenues during operation. Due to the location of the bypass channel inlet, Intake FAS would remain a viable location for paddlefish snagging while the new side

channel could grow the fishery into upstream areas, potentially inducing additional recreation. Improved upstream and downstream boater access could also result in minor recreation revenue increases in the region, and would provide opportunity for boat-based tourism services to operate more easily in the area, providing potential for minor to moderate tourism benefits. Overall, the operational effects would likely be minor and beneficial.

Regional Effects of O&M Expenditures

The annual O&M for the Bypass Channel Alternative is \$2.80 million. This annual expenditure would support a total of 20 direct, indirect, and induced jobs for a total of \$1.48 million in labor income, \$1.98 million in value added impact (gross regional product), and \$3.75 million in total output. Table 4-52 summarizes these regional economic effects. As noted in Section 4.16.3.2, these results may include intra-regional transfers due to funding of O&M from within the regional economy.

TABLE 4-52. BYPASS CHANNEL, AVERAGE ANNUAL REGIONAL EFFECTS OF O&M

Impact Type	Employment	Labor Income	Value Added	Output
Direct	14	\$1,159,000	\$1,396,000	\$2,799,000
Indirect	4	\$216,000	\$384,000	\$620,000
Induced	2	\$104,000	\$203,000	\$336,000
Total	20	\$1,479,000	\$1,984,000	\$3,754,000

4.16.5.4 Modified Side Channel Alternative

General

The economic effects of the Modified Side Channel Alternative during operation would be very similar to those for the Bypass Channel Alternative, which would be minor and beneficial.

Regional Effects of O&M Expenditures

The annual O&M for this alternative is \$2.91 million. This annual expenditure would support a total of 21 direct, indirect, and induced jobs for a total of \$1.54 million in labor income, \$2.06 million in value added impact (gross regional product), and \$3.90 million in total output.

Table 4-53 summarizes these regional economic effects. As noted in Section 4.16.3.2, these results may include intra-regional transfers due to funding of O&M from within the regional economy.

TABLE 4-53. MODIFIED SIDE CHANNEL, AVERAGE ANNUAL REGIONAL EFFECTS OF O&M

Impact Type	Employment	Labor Income	Value Added	Output
Direct	14	\$1,203,000	\$1,450,000	\$2,907,000
Indirect	4	\$224,000	\$399,000	\$644,000
Induced	2	\$108,000	\$211,000	\$349,000
Total	21	\$1,536,000	\$2,060,000	\$3,899,000

4.16.5.5 Multiple Pump Alternative

General

Like the other alternatives, the Multiple Pump Alternative would not affect development or agriculture. Due to removal of the existing weir, the alternative may have moderate adverse effects on the Yellowstone Caviar program in the short term. Without the existing weir, the success rate of paddlefish snagging at Intake FAS may be substantially reduced, which would result in a decreased program revenue. However, reduced catch at Intake could result in paddlefish seasons increasing in length, which may be beneficial to other local businesses in the recreation, tourism, and accommodations industries. Over the long term, the adverse effect is likely minor, with potential for moderate beneficial effects. Existing recreation services would adapt to changed conditions and make use of new upstream-to-downstream access and additional fishing and boating opportunities resulting from dam removal, and there would be opportunity for new additional recreation and tourism services as well, such as float trips and other boating services.

Regional Effects of O&M Expenditures

The annual O&M for the Multiple Pump Alternative is \$5.03 million. This annual expenditure would support a total of 36 direct, indirect, and induced jobs for a total of \$2.66 million in labor income, \$3.57 million in value added impact (gross regional product), and \$6.75 million in total output. Table 4-54 summarizes these regional economic effects. As noted in Section 4.16.3.2, these results may include intra-regional transfers due to funding of O&M from within the regional economy.

TABLE 4-54. MULTIPLE PUMP ALTERNATIVE, AVERAGE ANNUAL REGIONAL EFFECTS OF O&M

Impact Type	Employment	Labor Income	Value Added	Output
Direct	25	\$2,084,000	\$2,511,000	\$5,034,000
Indirect	7	\$388,000	\$691,000	\$1,114,000
Induced	4	\$188,000	\$366,000	\$604,000
Total	36	\$2,660,000	\$3,568,000	\$6,752,000

4.16.5.6 Multiple Pumps with Conservation Measures Alternative

General

Operational effects of the Multiple Pumps with Conservation Measures Alternative on agriculture would likely be major. This alternative proposes to supply 608 cfs of water to the LYP. Analysis indicates LYP crop water demands are approximately 1,150 cfs at times of peak evapotranspiration (see section 2.3.8.7). The exact scope and extent of impacts this would have

on LYP agriculture, as well as the impacts on ability to pay LYIP assessments to afford O&M expenditures, is unknown. However, because O&M operational costs can be estimated, an analysis of the O&M expenditures has been provided as one means of comparison with other alternatives.

Regional Effects of O&M Expenditures

The annual O&M for the Multiple Pumps with Conservation Measures Alternative is \$4.39 million. This would support a total of 31 direct, indirect, and induced jobs for a total of \$2.32 million in labor income, \$3.11 million in value added impact (gross regional product), and \$5.88 million in total output. Table 4-55 summarizes these regional economic effects. As noted in Section 4.16.3.2, these results may include intra-regional transfers due to funding of O&M from within the regional economy.

TABLE 4-55. MULTIPLE PUMPS WITH CONSERVATION MEASURES, AVERAGE ANNUAL REGIONAL EFFECTS OF O&M

Impact Type	Employment	Labor Income	Value Added	Output
Direct	22	\$1,816,000	\$2,188,000	\$4,386,000
Indirect	6	\$338,000	\$602,000	\$971,000
Induced	4	\$164,000	\$319,000	\$526,000
Total	31	\$2,318,000	\$3,109,000	\$5,883,000

4.16.5.7 Effects of O&M Expenditures on LYP Net Farm Income

As noted in the *Methodology* section, the impact of O&M costs associated with the alternatives on net farm revenue was analyzed. In the existing condition, farmers in the LYP are assessed \$40 per irrigated acre in order to cover LYP O&M costs. Under the No Action Alternative, it is assumed that the assessment would increase to \$47.92 dollars per acre, which was used as the baseline for comparison. The O&M cost per acre for the action alternatives was then compared to the No Action Alternative cost to estimate the change in O&M that would be expected relative to the No Action Alternative baseline. Table 4-56 summarizes this calculation. Based on an estimated typical net farm income of \$44,429 (including the LYP assessment) and an average of 238 irrigated acres per farm (see *Methodology* section), Table 4-57 summarizes the annual change in net farm income that is expected for each alternative as compared to the No Action Alternative.

TABLE 4-56. CHANGE IN O&M PER ACRE BY ALTERNATIVE

Alternative	Annual O&M	Annual O&M per Acre	Change compared to the No Action	% Change
No Action	\$2.64 M	\$47.92	\$0	0%
Rock Ramp	\$2.84 M	\$51.49	+ \$3.57	+7.5%
Bypass Channel	\$2.80 M	\$50.75	+ \$2.83	+5.9%
Modified Side Channel	\$2.91 M	\$52.70	+ \$4.79	+10.0%
Multiple Pump	\$5.03 M	\$91.27	+ \$43.35	+90.5%
Multiple Pumps with Conservation Measures	\$4.39 M	\$79.52	+ \$31.60	+65.9%

TABLE 4-57. CHANGE IN TYPICAL NET FARM INCOME BY ALTERNATIVE

Alternative	Annual Change in Net Farm Income for a Typical Operation	% Change in Net Farm Income for a Typical Operation
No Action	\$0	0%
Rock Ramp	-\$849	-1.9%
Bypass Channel	-\$672	-1.5%
Modified Side Channel	-\$1,138	-2.6%
Multiple Pump	-\$10,306	-23.2%
Multiple Pumps with Conservation Measures	-\$7,513	-16.9%

As shown in the table, all of the action alternatives would increase the cost of O&M, and the LYP assessment, above that of the No Action, which translates into additional cost for farmers, and a decrease in net farm income. The Rock Ramp Alternative, the Bypass Channel Alternative, and the Modified Side Channel Alternative would all result in a decrease in net farm revenue under 3%, with the Bypass Channel Alternative having the least impact, at 1.5%. Both the Multiple Pump Alternative and the Multiple Pumps with Conservation Measures Alternative would result in more substantial decreases in net farm revenue, at 23% and 17%, respectively. The effects per farm operation can be scaled up to the whole LYP, as shown in Table 4-58.

Cost associated with the additional power necessary for the Multiple Pump and Multiple Pumps with Conservation Measure alternative could be less if an increase in the Contract Rate of Delivery (CROD) is requested and approved. Approval of such a request would result in Reclamation taking an action to amend the LYIP Project Use Power Contracts to increase of the CROD which would reduce the estimated O&M cost per acre.

If Congress authorized a trust fund dedicated to purchasing power or for the purposes of funding the O&M of a pump system, the cost per acre assessed for the Multiple Pumps and Multiple Pumps with Conservation Measures could decrease, lessening the impact to the net farm income.

TABLE 4-58. CHANGE IN NET FARM INCOME BY ALTERNATIVE, ALL LYP

Alternative	Annual Change in Net Farm Income, All LYP	% Change in Net Farm Income, All LYP
No Action	\$0	0%
Rock Ramp	-\$197,000	-1.9%
Bypass Channel	-\$156,000	-1.5%
Modified Side Channel	-\$264,000	-2.6%
Multiple Pump	-\$2,391,000	-23.2%
Multiple Pumps with Conservation Measures	-\$1,743,000	-16.9%

4.16.6 Cumulative Effects

4.16.6.1 Geographic and Temporal Extent of Analysis

The geographic extent considered for social and economic conditions cumulative effects is the same as the study area for the consideration of construction and operational effects. The

cumulative effects analysis considered a 50-year horizon for consistency with the period of analysis in the evaluation of alternatives.

4.16.6.2 Methodology for Determining Effects

A cumulative effect can be described as an impact on the environment which results from the incremental impact of the action when added to other past, present, and reasonably foreseeable future actions. In addition, they may be defined as two or more individual effects, which, when considered together, are considerable or which compound or increase other environmental impacts. Cumulative effects can result from individually minor but collectively significant actions taking place over time. An integral part of the cumulative effects analysis involves determining whether effects from the project would contribute to ongoing or foreseeable resource trends. Where effects from the project contribute to regional resource trends, there is a potential for a cumulative effect. The cumulative effects analysis does not assess all expected environmental impacts from regional projects but only those resulting from the project and other past, present, and reasonably foreseeable future actions.

4.16.6.3 Past, Present, and Reasonably Foreseeable Future Projects Considered

Section 4.1.4 discusses past, present, and reasonably foreseeable future projects which were considered in the evaluation of cumulative effects. The projects identified as relevant to the consideration of recreation included:

- Missouri River Recovery Management Plan
- Climate Change
- Montana Paddlefish Regulations
- Spills at Oil/Gas/Brine Water Pipeline Crossings
- Urbanization

4.16.6.4 No Action Alternative

The No Action Alternative would not substantially alter or interact with any foreseeable future projects in the study area. While several of the cumulative projects may have beneficial or adverse effects, the No Action Alternative would not contribute to these effects.

4.16.6.5 Rock Ramp Alternative

From an economic perspective, the cumulative effects of the Rock Ramp Alternative and the aforementioned projects would be potential for increased recreation-related revenues from an expanded and improved fishery. The Missouri River Recovery Management Plan would continue to contribute to improvement of the fishery, and Montana Paddlefish Regulations would be adjusted as needed to preserve the resource as conditions change. Urbanization would contribute to increased recreation use as well. Climate change and spills of oil, gas, or brine water into the river would have minor adverse effects on revenues, but on net, economic benefits would be minor to moderately beneficial for local businesses near population recreation areas. Cumulative economic effects of the Rock Ramp Alternative are expected to be minimal (less than significant) and, on balance, beneficial.

4.16.6.6 Bypass Channel Alternative

Cumulative effects of the Bypass Channel Alternative would be similar to those for the Rock Ramp Alternative, but may be marginally more beneficial, as the new channel around Joe's Island could provide additional boating and fishing opportunities. Cumulative effects of the

Bypass Channel Alternative are expected to be minimal (less than significant) and, on balance, beneficial.

4.16.6.7 Modified Side Channel Alternative

Cumulative effects of the Modified Side Channel Alternative are similar to that for the Bypass Channel Alternative and are expected to be minimal (less than significant) and, on balance, beneficial.

4.16.6.8 Multiple Pump Alternative

The removal of the existing weir would see the greatest change in geographic dispersion of the fishery, and could result in minor recreation-related revenue benefits throughout more of the study area. Additionally, new there may be new opportunities for recreation-related services in the absence of the existing weir, such as guided river trips. Otherwise, cumulative effects would be similar to those of the Bypass Channel Alternative or the Modified Side Channel Alternatives. Cumulative effects of the Multiple Pump Alternative on recreation are expected to be, on balance, moderately beneficial.

4.16.6.9 Multiple Pumps with Conservation Measures Alternative

Cumulative effects of the Multiple Pumps with Conservation Measures Alternative on recreation are similar to those for the Multiple Pump Alternative and are expected to be, on balance, moderately beneficial.

4.16.7 Actions to Minimize Effects

The following actions would be implemented to avoid, minimize, or mitigate adverse impacts on social and economic resources in the study area as a result of project construction. Because the action alternatives involve similar types of construction activities, the identified actions to minimize effects would apply to all the alternatives, unless otherwise noted.

- Construction activities would be minimized during the paddlefishing season in order to mitigate effects on Intake FAS during its peak recreation period.
- A communication plan would be developed to alert visitors of current access restrictions, closures, and ongoing construction activities. The construction contractor would clearly post and sign any areas within any designated construction zones. Signs would include warnings limiting or prohibiting certain recreational uses within the zone, such as swimming, fishing, boating, hiking, camping, etc.
- Under the Multiple Pumps with Conversation Measures alternative, siting efforts for the Ranney wells will consider farmland classification and attempt to avoid or minimize use of prime farmland or farmland of statewide significance.

4.17 Environmental Justice

Federal Executive Order 12898 directs federal agencies to identify and address disproportionately high and adverse human health or environmental effects of their programs, policies, and activities on minority and low-income populations. Such effects may include ecological, cultural, human health, economic, or social impacts on minority communities, low-income communities, or Indian tribes when those impacts are interrelated to impacts on the

natural or physical environment. The following bullets summarize considerations when identifying potential environmental justice concerns.

- Is there an adverse effect on an environmental justice community?
- Is the effect disproportionate? Does it appreciably exceed effects on the general population or other appropriate comparison group?

4.17.1 Area of Potential Effect

The study area for the environmental justice evaluation is the same as that of the social and economic conditions discussion, which includes six counties in Montana and two in North Dakota, as shown in Figure 3-30. This is the same study area for Environmental Justice as was discussed in the Affected Environment chapter of this report.

As described in the Affected Environment chapter (Section 3.16), the characterization of environmental justice in the study area noted three populations which may be susceptible to disproportionate impacts by a federal action. Prairie County, Montana had the highest unemployment rate (7.8 percent) of all the counties in the study area. Roosevelt County, Montana and McKenzie County, North Dakota both had poverty rates above the statewide rates, and poverty appears to be much higher among the American Indian populations in these counties. Outside of these areas, communities in the study area appear to be largely similar to typical communities at the regional and state levels, and do not represent environmental justice communities.

4.17.2 Summary of Potential Effects

Table 4-59 summarizes the potential environmental justice effects for each alternative. Details are provided in the following sections.

TABLE 4-59. SUMMARY OF POTENTIAL ENVIRONMENTAL JUSTICE EFFECTS FROM EACH ALTERNATIVE

Impact Type	Level of Impact	Impact Description
No Action Alternative		
Construction Effects	No Effect	• No construction, no effect
Operational Effects	No Effect	• No change to existing, no effect
Cumulative Effects	No Effect	• No construction, no effect
Rock Ramp Alternative		
Construction Effects	No Effect	• No direct or indirect effects on environmental justice communities
Operational Effects	No Effect	• No direct or indirect effects on environmental justice communities
Cumulative Effects	No Effect	• No contributions to cumulative effects on environmental justice communities
Bypass Channel Alternative		
Construction Effects	No Effect	• No direct or indirect effects on environmental justice communities
Operational Effects	No Effect	• No direct or indirect effects on environmental justice communities
Cumulative Effects	No Effect	• No contributions to cumulative effects on environmental justice communities
Modified Side Channel Alternative		
Construction Effects	No Effect	• No direct or indirect effects on environmental justice communities

Impact Type	Level of Impact	Impact Description
Operational Effects	No Effect	<ul style="list-style-type: none"> No direct or indirect effects on environmental justice communities
Cumulative Effects	No Effect	<ul style="list-style-type: none"> No contributions to cumulative effects on environmental justice communities
Multiple Pump Alternative		
Construction Effects	No Effect	<ul style="list-style-type: none"> No direct or indirect effects on environmental justice communities
Operational Effects	No Effect	<ul style="list-style-type: none"> No direct or indirect effects on environmental justice communities
Cumulative Effects	No Effect	<ul style="list-style-type: none"> No contributions to cumulative effects on environmental justice communities
Multiple Pumps with Conservation Measures Alternative		
Construction Effects	No Effect	<ul style="list-style-type: none"> No direct or indirect effects on environmental justice communities
Operational Effects	No Effect	<ul style="list-style-type: none"> No direct or indirect effects on environmental justice communities
Cumulative Effects	No Effect	<ul style="list-style-type: none"> No contributions to cumulative effects on environmental justice communities

4.17.3 Construction Effects

4.17.3.1 No Action Alternative

The No Action Alternative does not include construction activity. The alternative includes the continued operation of the LYP using the existing diversion headworks (constructed 2010-2012) and the Intake Diversion Dam. Because there would be no construction, the No Action Alternative has no construction related effects which raise environmental justice concerns.

4.17.3.2 Rock Ramp Alternative

Based on the limits of construction and construction haul routes for the Rock Ramp Alternative, any direct effects would be generally limited to the left and right banks of the river near the Intake Diversion Dam. No environmental justice communities were identified at or adjacent to the construction area. Any direct adverse effects of construction that occur during construction would not represent a disproportionately high and adverse effect on an environmental justice community within the study area. In the same way, indirect adverse effects of construction would not be biased against environmental justice communities. The Rock Ramp Alternative has no construction related effects which raise environmental justice concerns.

4.17.3.3 Bypass Channel Alternative

Based on the limits of construction and construction haul routes for the Bypass Channel Alternative, any direct effects would generally occur near the Intake Diversion Dam and on Joe's Island. There are no environmental justice communities located at or adjacent to the construction site. Any direct adverse effects of construction that occur during construction would not represent a disproportionately high and adverse effect on an environmental justice community within the study area. In the same way, indirect adverse effects of construction would not be biased against environmental justice communities. The Bypass Channel Alternative has no construction related effects which raise environmental justice concerns.

4.17.3.4 Modified Side Channel Alternative

With similar limits of construction as the Bypass Channel Alternative, any direct effects of the Modified Side Channel Alternative would generally occur at and adjacent to the Intake Diversion Dam and on Joe's Island. There are no environmental justice communities located at or adjacent

to the construction site or along the haul roads. Any direct adverse effects of construction that occur during construction would not represent a disproportionately high and adverse effect on an environmental justice community within the study area. In the same way, indirect adverse effects of construction would not be biased against environmental justice communities. The Modified Side Channel Alternative has no construction related effects which raise environmental justice concerns.

4.17.3.5 Multiple Pump Alternative

The Multiple Pump Alternative includes construction at five different pump sites within the study area, one in Dawson County adjacent to the Intake Diversion Dam, and four along the river in southern Richland County, the furthest downstream being just upstream of Elk Island (Figure 2-10). While construction of this alternative would involve activities in two counties, none of the pump sites or the haul routes are within or adjacent to environmental justice communities. Any direct adverse effects of construction that occur during construction would not represent a disproportionately high and adverse effect on an environmental justice community within the study area. In the same way, indirect adverse effects of construction would not be biased against environmental justice communities. The Multiple Pump Alternative has no construction related effects which raise environmental justice concerns.

4.17.3.6 Multiple Pumps with Conservation Measures Alternative

Similar to the Multiple Pump Alternative, the Multiple Pumps with Conservation Measures Alternative includes multiple construction sites along the river (Figure 2-21). The Multiple Pumps with Conservation Measures Alternative includes seven Ranney Well sites, beginning with a site near the Intake Diversion Dam, and ending with a site about two-thirds of the way between Sidney and Fairview. While construction of the alternative would involve activities in two counties, none of the pump sites or the haul routes are within or adjacent to environmental justice communities. Any direct adverse effects of construction that occur during construction would not represent a disproportionately high and adverse effect on an environmental justice community within the study area. In the same way, indirect adverse effects of construction would not be biased against environmental justice communities. The Multiple Pumps with Conservation Measures Alternative has no construction related effects which raise environmental justice concerns.

4.17.4 Operational Effects

None of the alternatives would likely take agricultural lands out of production, consistent with the Project's purpose. Thus, there would be no effects on seasonal farm worker communities.

4.17.4.1 No Action Alternative

Operation of the No Action Alternative would continue as it does in the existing condition. The headworks and Intake Diversion Dam would continue to provide irrigation water for the LYP and O&M would continue as it does presently on the Intake Diversion Dam, headworks, and LYP canal and associated diversion structures. As such, there would be no new adverse operational effects from the alternative, and no disproportionately high and adverse effect on an environmental justice community within the study area.

4.17.4.2 Rock Ramp Alternative

Operation of the Rock Ramp Alternative would include continued operation and maintenance of the headworks and LYP canal. It would also include maintenance of the new rock ramp and replacement weir. The O&M required for the Rock Ramp Alternative would not be substantially different from the O&M of the No Action Alternative, other than the magnitude of expenditure. The differences in O&M cost would be borne largely by landowners within the LYP, and not the study area at large. Landowners within the LYP do not represent an environmental justice community. As such, there may be adverse operational effects from the alternative in terms of irrigation district taxes, but these effects would not constitute a disproportionately high and adverse effect on an environmental justice community within the study area.

4.17.4.3 Bypass Channel Alternative

Operation of the Bypass Channel Alternative would include continued operation and maintenance of the headworks and LYP canal. It would also include maintenance of the bypass channel and replacement weir. The O&M required for the Bypass Channel Alternative would not be substantially different from the O&M of the No Action Alternative, other than the magnitude of expenditure. The differences in O&M cost would be borne largely by landowners within the LYP, and not the study area at large. Landowners within the LYP do not represent an environmental justice community. As such, there may be adverse operational effects from the alternative in terms of irrigation district taxes, but these effects would not constitute a disproportionately high and adverse effect on an environmental justice community within the study area.

4.17.4.4 Modified Side Channel Alternative

Like other action alternatives, operation of the Modified Side Channel Alternative would include continued operation and maintenance of the headworks and LYP canal. It would also include maintenance of the modified side channel and the Intake Diversion Dam. The O&M required for the Modified Side Channel Alternative would not be substantially different from the O&M of the No Action Alternative, other than the magnitude of expenditure. The differences in O&M cost would be borne largely by landowners within the LYP, and not the study area at large. Landowners within the LYP do not represent an environmental justice community. As such, there may be adverse operational effects from this alternative in terms of irrigation district taxes, but these effects would not constitute a disproportionately high and adverse effect on an environmental justice community within the study area.

4.17.4.5 Multiple Pump Alternative

The Multiple Pump Alternative includes continued operation and maintenance of the headworks and LYP canal, but also includes O&M for the five pump sites, and excludes O&M for the Intake Diversion Dam, since the existing weir would be removed as part of this alternative. Removal of the existing weir would result in a greater variety of operational impacts compared to alternatives which leave the Intake Diversion Dam in place. However, these impacts would not constitute a disproportionately high and adverse effect on an environmental justice community within the study area. Dam removal may result in a higher magnitude of recreational impacts in the study area such as adversely affecting likelihood of fishing success at the Intake fishing access site, countered by a likely increase in paddlefishing opportunities upstream of Intake in the long-term. These effects would not disproportionately affect environmental justice

communities. As such, there may be negligible or minor adverse operational effects from this alternative, but these effects would not raise environmental justice concerns.

4.17.4.6 Multiple Pumps with Conservation Measures Alternative

Like the Multiple Pump Alternative, the Multiple Pumps with Conservation Measures Alternative includes removal of the Intake Diversion Dam and continued operation and maintenance of the headworks and LYP canal. It also includes O&M for seven Ranney Well sites. Removal of the dam will result in a greater variety of operational impacts compared to alternatives which leave the dam in place. However, no effects associated with dam removal have been identified which would constitute a disproportionately high and adverse effect on an environmental justice community within the study area. Similar to other alternatives, differences in O&M cost are borne by LYP landowners. Dam removal may result in a higher magnitude of recreational impacts in the study area as discussed under the Multiple Pump Alternative, but would not disproportionately affect environmental justice communities. As such, there may be negligible or minor adverse operational effects from this alternative, but these effects would not raise environmental justice concerns.

4.17.5 Cumulative Effects

4.17.5.1 Geographic and Temporal Extent of Analysis

The geographic extent considered for Environmental Justice cumulative effects is the same as the study area for consideration of construction and operational effects. The cumulative effects analysis considered a 50-year horizon for consistency with the period of analysis in the evaluation of alternatives.

4.17.5.2 Methodology for Determining Effects

A cumulative effect can be described as an impact on the environment which results from the incremental impact of the action when added to other past, present, and reasonably foreseeable future actions. In addition, they may be defined as two or more individual effects, which, when considered together, are considerable or which compound or increase other environmental impacts. Cumulative effects can result from individually minor but collectively significant actions taking place over time. An integral part of the cumulative effects analysis involves determining whether effects from the project would contribute to ongoing or foreseeable resource trends. Where effects from the project contribute to regional resource trends, there is a potential for a cumulative effect. The cumulative effects analysis does not assess all expected environmental impacts from regional projects but only those resulting from the project and other past, present, and reasonably foreseeable future actions.

4.17.5.3 Past, Present, and Reasonably Foreseeable Future Projects Considered

Section 4.1.4 discusses past, present, and reasonably foreseeable future projects which were considered in the evaluation of cumulative effects. The projects identified as relevant to the consideration of environmental justice included:

- Agriculture and irrigation
- Missouri River Recovery Management Plan
- Bakken Oil Fields and Fracking
- Pivot Irrigation and Bank Armoring
- Spills at Oil/Gas/Brine Water Pipeline Crossings

None of the alternatives being considered would result in effects which raise environmental justice community concerns. The location of the constructed features for the alternatives do not impact environmental justice communities directly, and indirect effects on ecological, cultural, human health, economic, or socio-cultural resources in the study area would not be universally adverse and would not be biased against any of the identified environmental justice communities. As such, the project alternatives do not have environmental justice impacts in and of themselves and would not contribute to cumulative effects related to environmental justice.

4.17.6 Actions to Minimize effects

Based on the evaluation of environmental consequences, none of the alternatives would result in environmental justice impacts, and none of the alternatives would require actions to minimize effects.

4.18 Historic Properties

This section addresses impacts on cultural resources, including prehistoric and historic archaeological sites, structures, and buildings. Native American consultations regarding traditional cultural properties, sacred sites, and other tribal concerns are ongoing. Impact analysis focuses on the implementation of the alternatives described in Chapter 2. As cultural resources are non-renewable resources, any direct impact is considered permanent.

The Corps and Reclamation would consult with Tribes and SHPO regarding historic and cultural resources per Section 106 of the NHPA. Unevaluated or cultural resources with unresolved NRHP-eligibility statuses within the selected alternative's APE would be reviewed to determine whether they meet the criteria of eligibility for listing on the NRHP. NRHP-eligible resources within the selected alternative's APE that cannot be avoided would require consultation to determine appropriate mitigation.

Potential impacts on cultural resources could occur if an alternative were to have an adverse effect on historic properties under Section 106 of the NHPA (36 CFR 800). Impacts on non-historic properties may also occur if concerns are voiced by consulted parties. Tables 3-45 and 3-46 list the surveys covering the APE of each alternative and the cultural resources recorded in each, respectively. The cultural resource sensitivity of unsurveyed portions of the APEs is assessed by considering the environmental and cultural contexts of the region (discussed in Sections 3.16.4 and 3.16.5, respectively) as well as the survey coverage of the study area of each alternative and the patterning of previously recorded sites in each study area. Further, study area resources mapped in SHPO's database as adjacent to an APE may extend into the APE, particularly archaeological resources. Therefore, the potential for direct impacts on those resources must also be considered.

4.18.1 Area of Potential Effect

For the purposes of this EIS, the APE is dependent upon the alternative analyzed. Under each alternative, the APE encompasses the surfaces and depths of ground disturbance and new construction. The APE also includes "off-site" project areas, such as rock quarry sources. The APE of the Bypass (417.7 acres), High-Flow (643.7 acres), and Rock Ramp (127 acres)

alternatives are restricted to the area of maximum disturbance at the Intake Diversion Dam and Joe’s Island. The Multiple Pump Alternative (8.7 acres) and Multiple Pumps with Conservation Measures Alternative (492.7 acres) are restricted to localized areas of maximum disturbance at the Intake Diversion Dam and downstream sites.

4.18.2 Summary of Potential Effects

Table 4-60 summarizes the potential effects on historic properties for each alternative. Details are provided in the following sections.

TABLE 4-60. SUMMARY OF POTENTIAL EFFECTS ON HISTORIC PROPERTIES FROM EACH ALTERNATIVE

Impact Type	Level of Impact	Impact Description
No Action Alternative		
Construction Effects	No Effect	<ul style="list-style-type: none"> • No effect
Operational Effects	Major	<ul style="list-style-type: none"> • Ground disturbance in unsurveyed portions of rock quarry may impact unrecorded cultural resources or unidentified features associated with known historic properties within the quarry (24DW0295 and 24DW0296).
Rock Ramp Alternative		
Construction Effects	Major	<ul style="list-style-type: none"> • Impact to structure of Intake Diversion Dam as a result of installation of temporary cofferdams and potential removal of existing dam crest to accommodate construction of the rock ramp. • Impact to the Brailey Sub Camp as a result of the use of proposed stockpile and construction staging areas. • Impact to potential historic properties as a result of construction activities within unsurveyed portions of the APE.
Operational Effects	Major	<ul style="list-style-type: none"> • Ground disturbance in unsurveyed portions of rock quarry may impact unrecorded cultural resources or unidentified features associated with known historic properties within the quarry (24DW0295 and 24DW0296).
Bypass Channel Alternative		
Construction Effects	Major	<ul style="list-style-type: none"> • Impact to Intake Diversion Dam features as a result of moving historic buildings. • Potential impact to dam as a result of coffer dam installation for bypass channel and replacement weir construction. • Impact to Lower Yellowstone Project quarry and prehistoric lithic scatter as a result of widening haul/access road. • Impacts to prehistoric lithic scatters within stockpile and staging areas. • Potential impacts to subsurface cultural resources within the Bypass Channel as a result of excavation.
Operational Effects	Major	<ul style="list-style-type: none"> • Ground disturbance in unsurveyed portions of rock quarry may impact unrecorded cultural resources or unidentified features associated with known historic properties within the quarry (24DW0295 and 24DW0296).

Impact Type	Level of Impact	Impact Description
Modified Side Channel Alternative		
Construction Effects	Major	<ul style="list-style-type: none"> • Impact to Lower Yellowstone Project quarry and prehistoric lithic scatter as a result of backwater area excavation and widening County Road 303. • Impacts to prehistoric lithic scatters within stockpile area. • Potential impacts to subsurface cultural resources within the Bypass Channel as a result of excavation.
Operational Effects	Major	<ul style="list-style-type: none"> • Ground disturbance in unsurveyed portions of rock quarry may impact unrecorded cultural resources or unidentified features associated with known historic properties within the quarry (24DW0295 and 24DW0296).
Multiple Pump Alternative		
Construction Effects	Major	<ul style="list-style-type: none"> • Impact to Intake Diversion Dam as a result of its removal. • Impacts to the Main Canal, Northern Pacific Railroad, and Savage Headquarters Camp as a result of discharge pipe, feeder canal, and fish return pipe installation at multiple pumping station sites. • Impact to potential historic properties as a result of construction activities within unsurveyed portions of the APE.
Operational Effects	No Effect	<ul style="list-style-type: none"> • No effect
Multiple Pumps with Conservation Measures Alternative		
Construction Effects	Major	<ul style="list-style-type: none"> • Impact to Intake Diversion Dam as a result of its removal. • Impacts to the Main Canal as a result of irrigation system modifications. • Impacts to potential historic properties as a result of unknown locations for pump-canal pipelines and windmill. • Impact to potential historic properties as a result of construction activities within unsurveyed portions of the APE.
Operational Effects	No Effect	<ul style="list-style-type: none"> • No effect

Direct major impacts on cultural resources are anticipated under each proposed alternative. The Rock Ramp, Bypass Channel, and High-Flow alternatives would have direct major impacts during both construction and operation and maintenance phases. The No Action Alternative would have direct major impacts during the maintenance phase only. The Multiple Pump Alternative and Multiple Pumps with Conservation Measures Alternative would only have direct major impacts under the construction phase. However, all impacts could be mitigated to minor to moderate direct impacts.

Major impacts are those that equate to an adverse effect under Section 106 of the NHPA (i.e., direct impact on an NRHP-listed or –eligible historic property). Minor to moderate impacts may occur if a major impact can be mitigated. The resulting level of impact post-mitigation is dependent upon consultation. Negligible impacts equate to impacts on resources that are considered not eligible for listing on the NRHP. No effect would occur if a resource can be avoided or if no identified or potential cultural resources are within the APE.

4.18.3 Construction Effects

4.18.3.1 No Action Alternative

Under the No Action Alternative, no new construction would occur. Therefore, no effects on cultural resources would occur as a result of construction.

4.18.3.2 Rock Ramp Alternative

The Rock Ramp Alternative would replace portions of the Intake Diversion Dam with a concrete weir and a boulder and cobble rock ramp. The APE of the Rock Ramp Alternative includes five NRHP-eligible cultural resources: 24DW0287 (Main Canal Lower Yellowstone Reclamation Project), 24DW0298 (Old Cameron and Brailey Sub Camp), 24DW0419 (Northern Pacific Railroad), 24DW0443 (Lower Yellowstone Irrigation Project Diversion Dam & Associated Features), and 24DW0447 (Lower Yellowstone Irrigation Project Headworks Camp/Gate Tender Residence).

Direct, major impacts are anticipated during construction under this alternative as a result of the installation of the temporary coffer dam and use of the construction staging and stockpile areas. Under this alternative most of the Intake Diversion Dam (24DW0443) would be preserved in place and buried beneath the new rock ramp. However, part of the existing dam crest might be removed and rock moved to accommodate construction of the ramp. Additionally, the eastern/downstream extent of the proposed cofferdams would be installed within the resource boundaries of the dam, likely impacting the structure, an adverse effect under Section 106 of the NHPA. The construction staging and stockpile areas are within the recorded boundaries of Old Cameron and Brailey Sub Camp (24DW0298). Use of these areas within the historic property would constitute an adverse effect under Section 106 of the NHPA. Both of these adverse effects would be direct, major impacts under NEPA.

Twenty percent of the APE under the Rock Ramp Alternative has not been previously surveyed for cultural resources. The majority of this area is within the river channel, within the stockpile area, and at the northern extent of the maximum disturbed area associated with alternative (between the Main Canal and the railroad). Survey within the river channel would not likely be possible and the area is unlikely to include cultural resources other than the Lower Yellowstone Project-related features already recorded there. Unrecorded cultural resources and potential historic properties may exist within the other unsurveyed areas. Resources within the study area of the Rock Ramp Alternative include nine prehistoric sites, two multicomponent sites, and seven historic sites. The prehistoric sites are primarily lithic scatters while the historic sites are dominated by dug-out features. The multicomponent sites include lithic scatters with a historic quarry and a petroglyph panel. These are the potential site types that may occur within the unsurveyed portions of the Rock Ramp Alternative APE. Four of the sites in the study area are NRHP-eligible, while five have either unresolved or unevaluated NRHP statuses. This indicates a moderate potential for historic properties in the study area and APE. Disturbance of these potential resources by Rock Ramp Alternative construction activities would be considered adverse effects under Section 106 of the NHPA and direct, major impacts under NEPA.

The proposed rock unload area and haul roads (including the temporary bridge) on the northern side of the river pass are within the documented boundaries of the Main Canal (24DW0287), the Headworks Camp/Gate Tender Residence (24DW0447), and the Northern Pacific Railroad

(24DW0419). Although each of these resources are considered historic properties, the Rock Ramp Alternative is not expected to have an impact on the resources. Although one of the haul roads enters the southeastern portion of the boundaries of 24DW0447, the area does not appear to include any of the recorded features of the site. Further, this portion of the site is within the area of the newly reconstructed headworks. Therefore and since no other components of the alternative are proposed within the 24DW0447 boundaries, impacts on site are not anticipated. Similarly, although the temporary bridge would be constructed over the 24DW0287, impacts on the resource are not anticipated. The temporary bridge would be immediately adjacent to an existing bridge and within an area that was likely disturbed during construction of the existing bridge. Additionally, since the bridge would be temporary and assuming the bridge abutments at the canal would be removed and the area restored to pre-construction conditions, impacts on 24DW0287 are not anticipated. (Although a separate section of haul road passes over the southern boundary of 24DW0287 near the headworks, this area is adjacent to the newly constructed headworks and the historic canal has been filled at this location.) The rock unload area is within the recorded site boundaries of 24DW0419. Although the tracks would be utilized to import the rock necessary to construct the rock ramp, the imported rock would be unloaded adjacent to the track. Therefore, use of the rock unload area is not anticipated to impact the site.

Construction of the Rock Ramp Alternative could have adverse effects under the NHPA and major direct impacts under NEPA. Implementation of proposed actions to minimize effects would reduce the effects to a minor to moderate level.

4.18.3.3 Bypass Channel Alternative

The Bypass Channel Alternative would construct a new bypass channel across Joe's Island and replace the Intake Diversion Dam with a new upstream concrete weir (while leaving the historic dam in place). The APE of the Bypass Channel Alternative includes five resources of varying NRHP-eligibility:

- Three NRHP-eligible resources: 24DW0296 (Lower Yellowstone Irrigation Project quarry and prehistoric lithic scatter), 24DW0430 (prehistoric lithic scatter), and 24DW0443 (Lower Yellowstone Irrigation Project Diversion Dam & Associated Features);
- One NRHP-ineligible resource: 24DW0431 (historic dug-out and refuse scatter); and
- One resource with unresolved or undetermined NRHP eligibility: 24DW0442 (prehistoric lithic scatter).

Direct, major impacts are anticipated during construction under this alternative as a result of the excavation of the bypass channel and use of the stockpile area and haul roads. The alignment of the bypass channel would require relocation of the historic south rocking tower and boiler building on Joe's Island, both of which are features of 24DW0443. Although the structure and building would not be destroyed, their removal from their historic location and setting would be considered adverse effects under Section 106 of the NHPA. This impact was considered under the previous Draft and Supplemental EAs in 2010 and 2013. Mitigation for the impact was agreed upon in the June 2010 Memorandum of Agreement (see Section 3.16.2.1), which resulted in documentation of the buildings and structures. The parties to the Memorandum were to consult and determine if any additional or different mitigation was warranted. Until the

Memorandum is re-initiated and the additional consultations completed, the potential for direct, major impacts remains.

The proposed locations of the cofferdams at the upstream entrance and downstream exit of the bypass channel as well as the around the replacement weir is unclear at this time. Although impacts at the upstream entrance are not anticipated due to a lack of recorded cultural resources there, impacts at the downstream exit may occur if the coffer dam is placed over and into the existing dam. Impacts related to this would be similar to those described for the coffer dams under the Rock Ramp Alternative. One of the haul/access roads to be improved passes through the northern boundary of 24DW0296. Although the road is existing, widening of it within the site boundaries may result in adverse effects under Section 106 of the NHPA. Sites 24DW0430, 24DW0431, and 24DW0442 are within the footprint of the stockpile area. Site 24DW0431 is also partially within the staging area, however impacts to this NRHP-ineligible resource would not be considered adverse under Section 106. While capping of sites 24DW0430 and 24DW0442 could be considered beneficial and protective impacts, it also makes access to the resources difficult for future study or traditional use. Further, if construction equipment were to drive across the sites while depositing materials or otherwise disturb the sites, it would be considered an adverse effect under Section 106 of the NHPA. The above described adverse effects would also be considered direct, major impacts under NEPA.

Excavation of the channel would be extensive. Although the entirety of the construction footprint has been surveyed for cultural resources (outside of active river channels), there is potential for intact subsurface archaeological resources to exist within this alluvial island. Disturbance of these potential historic properties would be considered an adverse effect under Section 106 of the NHPA and a direct, major impact under NEPA.

Construction of the Bypass Channel Alternative could have adverse effects under the NHPA and major direct impacts under NEPA. Implementation of proposed actions to minimize effects would reduce the effects to a minor to moderate level.

4.18.3.4 Modified Side Channel Alternative

The Modified Side Channel Alternative would modify the existing side channel by deepening and realigning the channel. The APE of the Modified Side Channel Alternative includes five resources of varying NRHP-eligibility:

- Two NRHP-eligible resources: 24DW0296 (Lower Yellowstone Irrigation Project quarry and prehistoric lithic scatter) and 24DW0430 (prehistoric lithic scatter);
- Two NRHP-ineligible resources: 24DW0299 (historic dug-out) and 24DW0431 (historic dug-out and refuse scatter); and
- One unevaluated resource: 24DW0442 (prehistoric lithic scatter).

Direct, major impacts are anticipated during construction under this alternative as a result of the excavation for the realigned channel and use of the stockpile area and access roads.

Excavation of the modified side channel would be extensive. Although the entirety of the realignments have been surveyed for cultural resources, there is potential for intact subsurface archaeological resources to exist within the undisturbed alluvial sediments of this depositional island. Disturbance of these potential historic properties would be considered an adverse effect

under Section 106 of the NHPA and a direct, major impact under NEPA. Like the Bypass Channel Alternative, sites 24DW0430, 24DW0431, and 24DW0442 are within the footprint of the stockpile area. Under the High-Flow Alternative, impacts on these sites as a result of the stockpile area would be the same as under the Bypass Channel Alternative.

The most northern backwater area extends into the boundary of Site 24DW0296. In addition, County Road 303 passes through the site. Any excavation of the backwater area or improvements to County Road 303 within this part of the historic property may result in adverse effects under Section 106 of the NHPA. One of the new access roads on Joe's Island passes through a portion of Site 24DW0299; however, since this site is not eligible for listing on the NRHP, impacts to the site are not considered adverse. The above described adverse effects would also be considered direct, major impacts under NEPA.

Fifty-six percent of the Modified Side Channel Alternative's APE has not been previously surveyed for cultural resources, including the area of the existing channel and the northern extent of the proposed alternative channel (downstream of the most northern backwater area). Survey within the existing channel would not likely be possible and the area is unlikely to include cultural resources. Unrecorded cultural resources and potential historic properties may exist within the other unsurveyed areas along the banks of the proposed channel and access road. Resources within the study area of the Modified Side Channel Alternative include nine prehistoric sites, one multicomponent site, and nine historic sites. The prehistoric sites are primarily lithic scatters. The multicomponent site includes a prehistoric lithic scatter and a historic petroglyph panel. The historic sites are primarily features of the Lower Yellowstone Project, but also includes the Northern Pacific Railroad, dug-outs, and a log structure. With the exception of the railroad, these are considered the potential site types that may occur within the unsurveyed portions of the Modified Side Channel Alternative APE. Six of the sites in the study area are NRHP-eligible, while four have unresolved or undetermined NRHP eligibilities. This indicates a moderate potential for historic properties within the study area and unsurveyed portions of the APE. Disturbance of these potential resources by Modified Side Channel Alternative construction activities would be considered adverse effects under Section 106 of the NHPA and direct, major impacts under NEPA.

Construction of the Modified Side Channel Alternative could have adverse effects under the NHPA and major direct impacts under NEPA. Implementation of proposed actions to minimize effects would reduce the effects to a minor to moderate level.

4.18.3.5 Multiple Pump Alternative

The Multiple Pump Alternative would remove the Intake Diversion Dam and construct pumping stations along the western bank of the Yellowstone River. Each pumping station would include a feeder canal, a fish screen structure, a concrete wet well and a steel housing building at each pump, a discharge pipeline from the pump to the Main Canal, a concrete outlet structure and rip-rap at each Main Canal discharge point, and access roads. The alternative would also likely require restructuring of the historic Lower Yellowstone Irrigation system, including installation of additional check structures, in order to accommodate water supply from multiple points. The APE of the Multiple Pump Alternative includes four NRHP-eligible cultural resources: 24DW0443 (Lower Yellowstone Irrigation Project Diversion Dam & Associated Features), 24RL0204/24DW0287 (Main Canal Lower Yellowstone Reclamation Project), 24RL0230

(Northern Pacific Railroad), and 24RL0209 (Lower Yellowstone Irrigation Project Savage Reclamation/Headquarters Camp).

Direct, major impacts are anticipated during construction under this alternative as a result of the removal of the Intake Diversion Dam and anticipated necessary modifications to the Lower Yellowstone Project. Removal of the Intake Diversion Dam (24DW0443) would constitute an adverse effect under Section 106 of the NHPA and a direct, major impact under NEPA. Modifications to the irrigation system, including construction of new check dams, installation of diversion pipe outfalls, and placement of rip-rap at the discharge points within the Main Canal (24RL0204/24DW0287) may result in similar impacts. Similarly, the feeder canal and fish return pipe at Site 3 pass through what appear to be laterals included in the site boundaries of the Main Canal (24RL0204). While the fish return pipe could be directionally bored beneath the laterals, the feeder canal would result in open excavation across the laterals, destroying those portions of the historic property. This too would be considered an adverse effect under Section 106 of the NHPA. Discharge pipes at Sites 3, 4, and 5 pass across the site boundaries of the Site 24RL0230 (Northern Pacific Railroad). At Sites 4 and 5 the pipe also passes through Site 24RL0209 (Savage Headquarters Camp). The construction methodology (i.e. directionally bore vs. open trench) for the discharge pipes is unclear at this time. Open trenching across the railroad and the headquarters camp, both historic properties, would constitute an adverse effect under Section 106 of the NHPA. All of the above adverse effects would be direct, major impacts under NEPA.

Seventy-three percent of the Multiple Pump Alternative's APE has not been previously surveyed for cultural resources, primarily in Sites 2 through 5. Unrecorded cultural resources and potential historic properties may exist within these unsurveyed areas. Resources within the study area of the Multiple Pump Alternative include eight prehistoric sites, one multicomponent site, and 25 historic sites. The prehistoric sites are primarily lithic scatters. The multicomponent site is the Lower Yellowstone Diversion Dam rock quarry and prehistoric lithic scatter. The historic sites include buildings, bridges, dug-outs, historic refuse scatters, features associated with the Lower Yellowstone Project, the Northern Pacific Railroad, and the Cabin-Creek Williston Pipeline. With the exception of the railroad and pipeline, these are considered the potential site types that may occur within the unsurveyed portions of the Multiple Pump Alternative APE. Eighteen of the sites in the study area are NRHP-eligible, while six are unevaluated or have unresolved NRHP-eligibility status. This indicates a high potential for historic properties within the study area and unsurveyed portions of the APE. Disturbance of these potential resources by Multiple Pump Alternative construction activities would be considered adverse effects under Section 106 of the NHPA and direct, major impacts under NEPA.

Construction of the Multiple Pump Alternative could have adverse effects under the NHPA and major direct impacts under NEPA. Implementation of proposed actions to minimize effects would reduce the effects to a minor to moderate level.

4.18.3.6 Multiple Pumps with Conservation Measures Alternative

The Multiple Pumps with Conservation Measures Alternative would remove the Intake Diversion Dam and construct check structures within the Lower Yellowstone Irrigation system, as well as flow measuring devices. In addition, the alternative proposes to convert the some of the system's laterals to pipe, line the rest of the laterals and the Main Canal, convert flood irrigation to center pivot sprinkler irrigation, control over checking, install groundwater pumps

(Ranney wells), and utilize a windmill to provide power to the system. The APE of the Multiple Pumps with Conservation Measures Alternative includes four NRHP-eligible cultural resources: 24DW0443 (Lower Yellowstone Irrigation Project Diversion Dam & Associated Features), 24RL0204 (Main Canal Lower Yellowstone Reclamation Project), 24RL0230 (Northern Pacific Railroad), and 24RL0321 (Cabin-Creek Williston Pipeline).

Direct, major impacts are anticipated during construction under this alternative as a result of the removal of the Intake Diversion Dam as well as the proposed modifications to the Lower Yellowstone Project. Removal of the Intake Diversion Dam (24DW0443) would constitute an adverse effect under Section 106 of the NHPA and a direct, major impact under NEPA. Modifications to the irrigation system, including piping laterals and lining the Main Canal and laterals would likely result in similar impacts.

Two components of this alternative are unclear at this time: where pipes would be placed between the Ranney wells and the canal and where the proposed windmill would be located. Therefore it is unclear if either component would impact historic properties and result in adverse effects under Section 106 of the NHPA and major, direct impacts under NEPA.

Ninety-five percent of the Multiple Pumps with Conservation Measures Alternative's APE has not been previously surveyed for cultural resources. Unrecorded cultural resources and potential historic properties may exist within these unsurveyed areas. Resources within the study area of the Multiple Pumps with Conservation Measures Alternative include nine prehistoric sites, one multicomponent site, and 37 historic sites. The prehistoric sites are primarily lithic scatters, but also include an earth lodge village site. The multicomponent site is the Lower Yellowstone Diversion Dam rock quarry and prehistoric lithic scatter. The historic sites include buildings, bridges, dug-outs, historic refuse scatters, a historic petroglyph panel, features associated with the Lower Yellowstone Project, a stage station, a Works Progress Administration pumping project, the Great Northern and Northern Pacific Railroads, and the Cabin-Creek Williston Pipeline. With the exception of the railroads and pipeline, these are considered the potential site types that may occur within the unsurveyed portions of the Multiple Pumps with Conservation Measures Alternative APE. Twenty of the sites in the study area are NRHP-eligible, while 10 are unevaluated or have unresolved NRHP-eligibility status. This indicates a high potential for historic properties within the study area and unsurveyed portions of the APE. Disturbance of these potential resources by Multiple Pump Alternative construction activities would be considered adverse effects under Section 106 of the NHPA and direct, major impacts under NEPA.

The Ranney Well fields associated with the potential pumps at Sites 2 through 7 are either adjacent to or include one more or more of the above historic properties. The Northern Pacific Railroad (24DW0419/24RL0230) is adjacent to Sites 2 through 4 and Site 7 and a lateral of the Main Canal (24RL0204) is adjacent to Site 6. Installation of the groundwater pumps at these well fields is not anticipated to impact the adjacent historic properties. The Main Canal (24RL0204) passes through the well fields at Sites 5 and 7, while the Cabin Creek-Williston Pipeline passes through Sites 6 and 7. It is not anticipated that the wells would be installed within the site boundaries of the resources. Therefore, no effects on these resources at these locations are anticipated.

Construction of the Multiple Pumps with Conservation Measures Alternative could have adverse effects under the NHPA and major direct impacts under NEPA. Implementation of proposed actions to minimize effects would reduce the effects to a minor to moderate level.

4.18.4 Operational Effects

4.18.4.1 No Action Alternative

Under the O&M of the No Action Alternative, rock would continue to be quarried from the rock quarry on the opposite side of the river for use in maintaining and rocking the dam. Sites 24DW0295 and 24DW0296 are within the boundaries of the quarry. Site 24DW0438 is immediately adjacent to the southern boundary of the quarry. Further, the quarry has only been partially surveyed by Surveys DW 6 12536, DW 6 2401, and ZZ 6 23753 between 1980 and 2000.

The NRHP-eligibility of Site 24DW0295, a prehistoric lithic scatter and campsite with historic features, is unresolved. The site is therefore considered a potential historic property. Site 24DW0296, the Lower Yellowstone Diversion Dam rock quarry and prehistoric lithic scatter, is NRHP-eligible. Both sites are limited to the northern portion of the modern quarry area. Reclamation has indicated these sensitive areas are avoided by current quarrying activities (David Trimble, personal communication 2016). Therefore, impacts on 24DW0295 and 24DW0296 are not anticipated.

Site 24DW0438, a prehistoric lithic scatter, is not eligible for listing on the NRHP. Therefore, even if the adjacent site extends into the quarry, impacts on the site would not be considered adverse under Section 106 of the NHPA.

Since the entirety of the quarry area has not been previously surveyed for cultural resources, quarrying within unsurveyed areas may result in impacts on unrecorded cultural resources that represent potential historic properties. Further, the quarrying may result in impacts on areas associated with the historic properties of 24DW0295 and 24DW0296. These impacts would be considered adverse effects under Section 106 of the NHPA and a direct, major impact under NEPA.

Operation of the No Action Alternative could have adverse effects under the NHPA and major direct impacts under NEPA. Implementation of proposed actions to minimize effects would reduce the effects to a minor to moderate level.

4.18.4.2 Rock Ramp Alternative

Under the Rock Ramp Alternative, the rock quarry currently used for maintaining the dam would continue to be utilized. Therefore, operational effects related to the quarry would be the same as those described for the No Action Alternative.

4.18.4.3 Bypass Channel Alternative

Operational effects under the Bypass Channel Alternative would be similar to those described for the Rock Ramp Alternative.

4.18.4.4 Modified Side Channel Alternative

Operational effects under the Modified Side Channel Alternative would be similar to those described for the Rock Ramp Alternative.

4.18.4.5 Multiple Pump Alternative

Providing rock materials used to maintain the alternative components would be imported from an established commercial rock quarry other than the current quarry used for maintaining the dam, no operational effects are anticipated under the Multiple Pump Alternative.

4.18.4.6 Multiple Pumps with Conservation Measures Alternative

Operational effects under the Multiple Pumps with Conservation Measures Alternative would be similar to those described for the Multiple Pump Alternative.

4.18.5 Cumulative Effects

4.18.5.1 Geographic and Temporal Extent of Analysis

To determine which other actions should be included in a cumulative impacts analysis, the regions of influence must first be defined. For cultural resources, these regions should not be limited to only the geographic areas of resources addressed by the alternatives, but they should also take into account the distances that cumulative impacts may travel and the regional characteristics of cultural resources and historic landscapes. Since this EIS addresses alterations to a widespread historic irrigation system within the lower Yellowstone River valley in eastern Montana and is within an area of unique prehistoric patterns and early historic western expansion, the region of influence for cultural resources in evaluating cumulative impacts is considered to be primarily in the river valley, but also secondarily considers eastern Montana.

The timeframe of the cumulative impact analysis for cultural resources incorporates the sum of the effects of past, present, and future actions combined with the anticipated effects of the proposed alternatives.

4.18.5.2 Methodology for Determining Effects

This analysis considers past, present, and future actions consistent with the proposed alternatives analyzed in this EIS. Cumulative impacts were determined by 1) determining the above geographic and temporal extent of analysis; 2) determining what past, present, and reasonably foreseeable actions and trends are likely to affect cultural resources and their impacts; 3) considering the baseline conditions of cultural resources described in Section 3.16 and the anticipated impacts on those resources, as described in Section 4.16; and 4) considering the incremental contribution of each alternative's impact to the overall regional and temporal pattern of impacts on cultural resources.

4.18.5.3 Past, Present, and Reasonably Foreseeable Future Projects Considered

Those past, present, and reasonably foreseeable projects and trends in the cumulative analysis area considered likely to contribute to the cumulative impact on cultural resources are listed below and described in Section 4.1.3:

- Agriculture and Irrigation
- Fort Peck Dry Prairie Regional Water System Improvements
- Crow Irrigation Project (Section 405 of Crow Settlement Act 2010)

- Crow Municipal, Rural and Industrial Water Project (Section 406 of Crow Settlement Act 2010)
- Yellowtail Afterbay Power Generation (Section 412 of Crow Settlement Act of 2010)
- Montana SR-16 Improvements
- The Bakken Oil Fields and Fracking
- Climate Change
- Dam Safety
- Spills at Oil/Gas/Brine Water Pipeline Crossings
- Urbanization

4.18.5.4 All Alternatives

All alternatives are anticipated to have major direct impacts on cultural resources, which would contribute to the cumulative removal, destruction, and general loss of intact representations of the region's prehistory and history. However, with the proposed actions to minimize effects, these major cumulative impacts are anticipated to be limited to negligible. Therefore, the project is not anticipated to have cumulative impacts requiring additional mitigation.

4.18.6 Actions to Minimize Effects

All mitigations are suggested and proposed pending consultation with the SHPO and other interested parties, as appropriate. Agreed upon mitigations would be documented in a Memorandum of Agreement and appropriate study plans (i.e. data recovery plan or research design). The Advisory Council on Historic Preservation would also be notified of any adverse effects determinations under the NHPA.

4.18.6.1 Rock Ramp Alternative

MM-CR-01: Impacts on Intake Diversion Dam (24DW0443) may be mitigated to minor or moderate through detailed recording of the structure. Engineering drawings and photographs of the dam would be filed with the SHPO and National Archives. If engineering drawings and photographs are unavailable, the dam would be recorded in accordance with the Historic American Buildings Survey and the Historic American Engineering Record.

MM-CR-02: Impacts on the Old Cameron and Brailey Sub Camp (24DW0298) may be mitigated to no effect through avoidance. If avoidance is infeasible, impacts may be mitigated to moderate through data recovery of the archaeological site under an approved research design.

MM-CR-03: Potential impacts on unidentified cultural resources in unsurveyed portions of the APE may be reduced to no effect through avoidance of unsurveyed areas. If avoidance is infeasible, impacts may be mitigated to minor or moderate by surveying such areas within the APE. Additional mitigation measures may be necessary to avoid impacts on newly identified resources/potential historic properties as a result of the survey.

4.18.6.2 Bypass Channel Alternative

Potential impacts on Intake Diversion Dam (24DW0443) may be mitigated through implementation of MM-CR-01 under the Rock Ramp Alternative, above.

Potential impacts on unidentified cultural resources in unsurveyed portions of the APE may be mitigated through implementation of MM-CR-03 under the Rock Ramp Alternative, above.

MM-CR-04: Impacts on the south rock tower and boiler building, part of 24DW0443, as a result of necessary relocation would be mitigated to no effect if the buildings can be returned to their original locations after construction. If return of the buildings is infeasible, impacts may be mitigated to moderate by identifying a party willing and able to adopt the historic buildings with appropriate preservation covenants. Additionally, impacts would be reduced by reinitiating and finalizing the June 2010 Memorandum of Agreement.

MM-CR-05: Impacts on 24DW0296 may be mitigated to no effect through avoidance (i.e. not widening the access road through the site). If avoidance is infeasible, impacts may be mitigated to minor or moderate through monitoring of the archaeological site under an approved monitoring plan

MM-CR-06: Impacts on 24DW0430 and 24DW0442 may be mitigated to no effect through avoidance (i.e. not stockpiling materials on top of or driving through the sites). If avoidance is infeasible, impacts may be mitigated to moderate through consultation to resolve the NRHP-eligibility of 24DW0442 and conducting data recovery at 24DW0430 (and 24DW0442 if determined NRHP-eligible) under an approved research design.

MM-CR-07: Potential impacts on unidentified subsurface archaeological resources may be mitigated to minor or moderate by surveying deep excavation areas (i.e. proposed channels) using subsurface probes combined with a geo-archaeological study under an approved study plan. Additional mitigation measures may be necessary to avoid impacts on newly identified resources/potential historic properties as a result of the survey.

4.18.6.3 Modified Side Channel Alternative

Potential impacts on unidentified subsurface archaeological resources may be mitigated through implementation of MM-CR-07 under the Bypass Channel Alternative, above.

Impacts on 24DW0430 and 24DW0442 may be mitigated through implementation of MM-CR-06 under the Bypass Channel Alternative, above.

Impacts on 24DW0296 may be mitigated through implementation of MM-CR-05 under the Bypass Channel Alternative, above.

Potential impacts on unidentified cultural resources in unsurveyed portions of the APE may be mitigated through implementation of MM-CR-03 under the Rock Ramp Alternative, above.

4.18.6.4 Multiple Pump Alternative

Impacts on Intake Diversion Dam (24DW0443) may be mitigated through implementation of MM-CR-01 under the Rock Ramp Alternative, above.

Potential impacts on unidentified cultural resources in unsurveyed portions of the APE may be mitigated through implementation of MM-CR-03 under the Rock Ramp Alternative, above.

MM-CR-08: Impacts on Lower Yellowstone Irrigation canal and laterals (24RL0204/24DW0287) may be mitigated to minor or moderate through detailed recording of the structure. Engineering drawings and photographs of the canal, laterals, and associated features would be filed with the SHPO and National Archives. If engineering drawings and photographs are unavailable, the system would be recorded in accordance with the Historic American Buildings Survey and the Historic American Engineering Record.

MM-CR-09: Impacts on sites 24RL0230 (Northern Pacific Railroad) and 24RL0209 (Savage Headquarters Camp) may be mitigated to no effect through avoidance, either entirely or through directional boring. If avoidance is infeasible, impacts may be mitigated to minor or moderate through detailed recording of the sites. Engineering drawings and photographs of the railroad and buildings and structures at the Headquarters Camp would be filed with the SHPO and National Archives. If engineering drawings and photographs are unavailable, the sites would be recorded in accordance with the Historic American Buildings Survey and the Historic American Engineering Record.

4.18.6.5 Multiple Pumps with Conservation Measures Alternative

Impacts on the Intake Diversion Dam (24DW0443) may be mitigated through implementation of MM-CR-01 under the Rock Ramp Alternative, above.

Impacts on the Lower Yellowstone Irrigation canal and laterals (24RL0204/24DW0287) may be mitigated through implementation of MM-CR-08 under the Multiple Pump Alternative, above.

Potential impacts on unidentified cultural resources in unsurveyed portions of the APE and alternative component locations not yet planned may be mitigated through implementation of MM-CR-03 under the Rock Ramp Alternative, above.

4.19 Indian Trust Assets

This section addresses impacts on ITAs, including interests, assets, and lands. Native American consultations regarding ITAs and other tribal concerns are ongoing. Impact analysis focuses on the implementation of the alternatives described in Chapter 2.

As described in Section 3.18, tribal interests and ITAs are identified primarily through consultations with federally recognized Indian tribes on a government-to-government basis. Tribal governments, along with the BIA and the Interior Office of the Special Trustee for American Indians, are sources for identifying Indian trust and treaty rights. Initial contacts have been made by the Corps; however responses have not yet been received. Therefore, Reclamation's consultations conducted for the 2010 and 2015 EAs are relied upon here. No ITAs were identified as a result of those consultations. Coordination through agency tribal liaisons and other established programs will continue. Tribes and other parties would be engaged to identify interests in the Project area that may be impacted by the proposed alternatives.

Impacts on ITAs could occur if an alternative were to:

- Conflict with land uses, management, and economic well-being of adjacent or nearby reservations, trust lands, restricted Indian allotments, and federally tribal-dependent Indian communities;
- Conflict with the exercise of off-reservation treaty and reserved rights, including grazing rights, hunting and fishing rights, gathering rights and interests, and water rights;
- Conflict with federal trust responsibilities to tribes and individual Indians regarding real property, physical assets, or intangible property rights; or
- Conflict with existing court decisions, laws, policies, executive orders, and agency agreements with tribes regarding land and resource use.

The trust responsibility requires that all federal agencies take all actions reasonably necessary to protect this trust. As federal agencies, the Corps and Reclamation would carry out their activities in a manner that protects these assets and avoids adverse impact when possible. When impacts to such assets cannot be avoided, the agencies would provide appropriate actions to minimize effects or compensation. Assets can be real property, physical assets, or intangible property rights. Examples of ITAs include lands, minerals, hunting, fishing and gathering rights, and water rights.

4.19.1 Area of Potential Effect

For the purposes of this EIS, the area of potential effect is dependent upon the alternative analyzed. Under each alternative, the area for ITAs encompasses the footprint of each proposed alternative as well as downstream areas affected by the alternative.

4.19.2 Summary of Potential Effects

No ITAs have been identified through past or present consultations with tribes. Therefore, none of the alternatives are expected to impact ITAs, either through construction or operation.

4.19.3 Construction Effects

4.19.3.1 No Action Alternative

No ITAs have been identified. Therefore, no effects on ITAs would occur as a result of construction under the No Action Alternative.

4.19.3.2 Rock Ramp Alternative

No ITAs have been identified. Therefore, no effects on ITAs would occur as a result of construction under the Rock Ramp Alternative.

4.19.3.3 Bypass Channel Alternative

No ITAs have been identified. Therefore, no effects on ITAs would occur as a result of construction under the Bypass Channel Alternative.

4.19.3.4 Modified Side Channel Alternative

No ITAs have been identified. Therefore, no effects on ITAs would occur as a result of construction under the High-Flow Alternative.

4.19.3.5 Multiple Pump Alternative

No ITAs have been identified. Therefore, no effects on ITAs would occur as a result of construction under the Multiple Pump Alternative.

4.19.3.6 Multiple Pumps with Conservation Measures Alternative

No ITAs have been identified. Therefore, no effects on ITAs would occur as a result of construction under the Multiple Pumps with Conservation Measures Alternative.

4.19.4 Operational Effects

4.19.4.1 No Action Alternative

No ITAs have been identified. Therefore, no effects on ITAs would occur as a result of operation and maintenance under the No Action Alternative.

4.19.4.2 Rock Ramp Alternative

No ITAs have been identified. Therefore, no effects on ITAs would occur as a result of operation and maintenance under the Rock Ramp Alternative.

4.19.4.3 Bypass Channel Alternative

No ITAs have been identified. Therefore, no effects on ITAs would occur as a result of operation and maintenance under the Bypass Channel Alternative.

4.19.4.4 Modified Side Channel Alternative

No ITAs have been identified. Therefore, no effects on ITAs would occur as a result of operation and maintenance under the High-Flow Alternative.

4.19.4.5 Multiple Pump Alternative

No ITAs have been identified. Therefore, no effects on ITAs would occur as a result of operation and maintenance under the Multiple Pump Alternative.

4.19.4.6 Multiple Pumps with Conservation Measures Alternative

No ITAs have been identified. Therefore, no effects on ITAs would occur as a result of operation and maintenance under the Multiple Pumps with Conservation Measures Alternative.

4.19.5 Cumulative Effects

4.19.5.1 Geographic and Temporal Extent of Analysis

To determine which other actions should be included in a cumulative impacts analysis, the regions of influence must first be defined. For ITAs, these regions should not be limited to only the geographic areas of resources addressed by the alternatives, but they should also take into account the distances that cumulative impacts may travel and the regional characteristics of ITAs. Since this EIS addresses alterations to a widespread historic irrigation system within the lower Yellowstone River valley in eastern Montana and is within an area of unique prehistoric patterns and early historic western expansion, the region of influence for ITAs in evaluating cumulative impacts is considered to be primarily in the river valley, but also secondarily considers eastern Montana.

The timeframe of the cumulative impact analysis for ITAs incorporates the sum of the effects of past, present, and future actions combined with the anticipated effects of the proposed alternatives.

4.19.5.2 Methodology for Determining Effects

This analysis considers past, present, and future actions consistent with the proposed alternatives analyzed in this EIS. Cumulative impacts were determined by 1) determining the above geographic and temporal extent of analysis; 2) determining what past, present, and reasonably foreseeable actions and trends are likely to affect ITAs and their impacts; 3) considering the baseline conditions of ITAs described in Section 3.17 and the anticipated impacts on those resources, as described in Section 4.17; and 4) considering the incremental contribution of each alternative's impact to the overall regional and temporal pattern of impacts on ITAs.

4.19.5.3 Past, Present, and Reasonably Foreseeable Future Projects Considered

Those past, present, and reasonably foreseeable projects and trends in the cumulative analysis area considered likely to contribute to the cumulative impact on cultural resources are listed below and described in Section 4.1.3:

- Agriculture and Irrigation
- Missouri River Recovery Management Plan
- Fort Peck Dry Prairie Regional Water System Improvements
- Crow Irrigation Project (Section 405 of Crow Settlement Act 2010)
- Crow Municipal, Rural and Industrial Water Project (Section 406 of Crow Settlement Act 2010)
- Storage Allocation (Section 408 of Crow Settlement Act of 2010)
- Streamflow and Lake Level Management Plan (Section 412 of Crow Settlement Act of 2010)
- Yellowtail Afterbay Power Generation (Section 412 of Crow Settlement Act of 2010)
- Montana SR-16 Improvements
- The Bakken Oil Fields and Fracking
- Climate Change
- Dam Safety
- Montana Paddlefish Regulations
- Spills at Oil/Gas/Brine Water Pipeline Crossings
- Urbanization

4.19.5.4 All Alternatives

No ITAs have been identified. Therefore, the proposed alternatives are not expected to contribute to the cumulative impacts on ITAs.

4.19.6 Actions to Minimize Effects

No ITAs have been identified. Therefore, the proposed alternatives are not expected to impact ITAs and no actions to minimize effects are necessary. However the Corps will continue to consult with the BIA and tribes to identify potential ITAs and any adverse effects on them.

4.20 Summary of Effects

Table 4-61 provides a summary of the construction and operational effects that were described in each resource section.

This page intentionally left blank

TABLE 4-61. SUMMARY INTAKE DIVERSION DAM FISH PASSAGE ALTERNATIVE CONSTRUCTION AND OPERATIONAL EFFECTS

Resource Area	No Action	Rock Ramp	Bypass Channel	Modified Side Channel	Multiple Pump	Multiple Pumps with Conservation Measures
Climate Change	Construction Effects: No Effect	Construction Effects: Minor <ul style="list-style-type: none"> Possible delays in construction due to extreme flows or weather conditions. 	Construction Effects: Minor <ul style="list-style-type: none"> Possible delays in construction due to extreme flows or weather conditions. 	Construction Effects: Minor <ul style="list-style-type: none"> Possible delays in construction due to extreme flows or weather conditions. 	Construction Effects: Minor <ul style="list-style-type: none"> Possible delays in construction due to extreme flows or weather conditions. 	Construction Effects: Minor <ul style="list-style-type: none"> Possible delays in construction due to extreme flows or weather conditions.
	Operational Effects: Moderate <ul style="list-style-type: none"> Risk of not reliably providing irrigation water right due to climate conditions. Risk of further reduced passage over weir with lower flows. 	Operational Effects: Moderate <ul style="list-style-type: none"> Risk of not reliably providing irrigation water right due to climate conditions. Risk of reduced fish passage over weir with lower flow.s 	Operational Effects: Moderate <ul style="list-style-type: none"> Risk of not reliably providing irrigation water right due to climate conditions. 	Operational Effects: Moderate <ul style="list-style-type: none"> Risk of not reliably providing irrigation water right due to climatic conditions. 	Operational Effects: Moderate <ul style="list-style-type: none"> Risk of not reliably providing irrigation water right due to climatic conditions. 	Operational Effects: Moderate <ul style="list-style-type: none"> Risk of not reliably providing irrigation water right due to climatic conditions.
Air Quality	Construction Effects: No Effect	Construction Effects: Negligible <ul style="list-style-type: none"> Construction activities might have short-term negligible effects on local air quality from excavation, hauling, and construction of the alternative in the area of the Intake Diversion Dam and Joe’s Island. 	Construction Effects: Negligible <ul style="list-style-type: none"> Construction activities might have short-term negligible effects on local air quality from excavation, hauling, and construction of the alternative in the area of the Intake Diversion Dam and Joe’s Island. 	Construction Effects: Negligible <ul style="list-style-type: none"> Construction activities might have short-term negligible effects on local air quality from excavation, hauling, and construction of the alternative in the area of the Intake Diversion Dam and Joe’s Island. 	Construction Effects: Negligible <ul style="list-style-type: none"> Construction activities might have short-term negligible effects on local air quality from excavation, hauling, and removal of the Intake Diversion Dam; in the areas of the 5 pumping sites; and in areas of new power infrastructure. 	Construction Effects: Negligible <ul style="list-style-type: none"> Construction activities might have short-term negligible effects on local air quality from excavation, hauling, and removal of the Intake Diversion Dam; in the areas of the 7 well sites; and in areas of new power infrastructure.
	Operational Effects: Negligible <ul style="list-style-type: none"> Negligible effects from ongoing regular maintenance activities. 	Operational Effects: Negligible <ul style="list-style-type: none"> Negligible effects on local air quality from maintenance of the rock ramp in the area of the Intake Diversion Dam and Joe’s Island. 	Operational Effects: Negligible <ul style="list-style-type: none"> Negligible effects on local air quality from maintenance of the bypass channel in the area of the Intake Diversion Dam and Joe’s Island. 	Operational Effects: Negligible <ul style="list-style-type: none"> Negligible effects on local air quality from maintenance of the modified side channel in the area of the Intake Diversion Dam and Joe’s Island. 	Operational Effects: Negligible <ul style="list-style-type: none"> Negligible effects on local air quality from maintenance and operation of the 5 pumping sites (including canals) and new power infrastructure. 	Operational Effects: Negligible <ul style="list-style-type: none"> Negligible effects on local air quality from maintenance and operation of the 7 well sites.

Resource Area	No Action	Rock Ramp	Bypass Channel	Modified Side Channel	Multiple Pump	Multiple Pumps with Conservation Measures
Surface Water Hydrology and Hydraulics	<p><u>Construction Effects: No Effect</u></p>	<p><u>Construction Effects: Moderate</u></p> <ul style="list-style-type: none"> Increased water surface elevations from temporary coffer dams, including for flood flows. Changed depths and velocities at headworks screens when coffer dams are in place. Increased depths and velocities in river channel when coffer dams are in place. 	<p><u>Construction Effects: Moderate</u></p> <ul style="list-style-type: none"> Increased water surface elevations from temporary coffer dams, including for flood flows. Changed depths and velocities at headworks screens when coffer dams are in place. Increased depths and velocities in river channel when coffer dams are in place. Blockage of flows into existing side channel for likely one runoff season during 28-month construction. 	<p><u>Construction Effects: Moderate</u></p> <ul style="list-style-type: none"> Blockage of flows into existing side channel for likely one runoff season during 18-month construction. Limited change to ice flows while channel is blocked. 	<p><u>Construction Effects: Minor to Moderate</u></p> <ul style="list-style-type: none"> Increased water surface elevations from temporary coffer dams, including for flood flows. Changed depths and velocities at headworks screens when coffer dams are in place. Increased depths and velocities in river channel when coffer dams are in place. Excavation of feeder canals/connection to river. 	<p><u>Construction Effects: Moderate</u></p> <ul style="list-style-type: none"> Increased water surface elevations from temporary coffer dams, including for flood flows. Changed depths and velocities at headworks screens when coffer dams are in place. Increased depths and velocities in river channel when coffer dams are in place.
	<p><u>Operational Effects: Minor</u></p> <ul style="list-style-type: none"> Ongoing placement of rock to slightly higher elevations to ensure irrigation diversions with overall slight trend of declining river flows. 	<p><u>Operational Effects: Moderate</u></p> <ul style="list-style-type: none"> Reduced velocities over replacement weir and rock ramp compared to existing conditions. 	<p><u>Operational Effects: Minor to Major</u></p> <ul style="list-style-type: none"> Slightly reduced flow volumes and velocities over replacement weir compared to existing conditions. Loss of existing side channel and side channel migration and change to backwater channel at lower end. Replacement of side channel function with new bypass channel. 	<p><u>Operational Effects: Minor to Major</u></p> <ul style="list-style-type: none"> Slightly reduced flow volumes in main channel. Ongoing return flows from Main Canal Increased frequency, depths, and velocities of flows in existing side channel. 	<p><u>Operational Effects: Major</u></p> <ul style="list-style-type: none"> Slightly increased flow volumes from existing intake to about 20 miles downstream (beneficial). Return of main channel to natural river hydraulics with removal of dam (beneficial). Reduced frequency of flows into existing side channel. 	<p><u>Operational Effects: Moderate to Major</u></p> <ul style="list-style-type: none"> Increased flow volumes in river due to reduced diversions (beneficial). Return of main channel to natural river hydraulics with removal of dam (beneficial). Reduced frequency of flows into existing side channel Reduced irrigation diversion flow volumes and reliability. Decreased return flows from irrigation system. Decreased velocities in Main Canal from check structures.

Resource Area	No Action	Rock Ramp	Bypass Channel	Modified Side Channel	Multiple Pump	Multiple Pumps with Conservation Measures
Groundwater Hydrology	Construction Effects: No Effect	Construction Effects: Negligible <ul style="list-style-type: none"> Construction activities might have short-term negligible effects on localized shallow groundwater levels that are in connection with the River alluvium. 	Construction Effects: Negligible <ul style="list-style-type: none"> Construction activities might have short-term negligible effects on very localized shallow groundwater levels that are in connection with the River alluvium. 	Construction Effects: Negligible <ul style="list-style-type: none"> Construction activities might have short-term negligible effects on very localized shallow groundwater levels that are in connection with the River alluvium. 	Construction Effects: Negligible <ul style="list-style-type: none"> Construction activities might have short-term negligible effects on very localized shallow groundwater levels that are in connection with the River alluvium. 	Construction Effects: Negligible <ul style="list-style-type: none"> Construction activities might have short-term minor effects on localized shallow groundwater levels that are in connection with the River alluvium at the Ranney well sites.
	Operational Effects: Minor <ul style="list-style-type: none"> Ongoing seepage from irrigation system into shallow aquifer 	Operational Effects: Minor <ul style="list-style-type: none"> If the fishing access site is removed, the public water supply well would require removal. This would constitute a minor effect. Negligible effects on localized shallow groundwater levels that are in connection with the River alluvium in the vicinity of the rock ramp and the replacement weir. 	Operational Effects: Minor <ul style="list-style-type: none"> Minor effects on localized shallow groundwater levels that are in connection with the River alluvium in the vicinity of Joe's Island. 	Operational Effects: Minor <ul style="list-style-type: none"> Minor effects on localized shallow groundwater levels that are in connection with the River alluvium in the vicinity of Joe's Island. 	Operational Effects: Minor <ul style="list-style-type: none"> If the fishing access site is removed, the public water supply well would require removal. Negligible effects on localized shallow groundwater levels that are in connection with the River alluvium in the vicinity of the pumping stations. Minor localized effects on shallow groundwater levels that are in connection with the River alluvium in the vicinity of the removed Intake Diversion Dam and modified feeder canal. 	Operational Effects: Major <ul style="list-style-type: none"> If the fishing access site is removed, the public water supply well would require removal. This would constitute a minor effect. If the fishing access site well remains in place, pumping at Site #1 could have potentially major effects. Additional hydrogeological characterization would be necessary. Potentially major effects on localized shallow groundwater levels that are in connection with the River alluvium in the vicinity of the well site stations. Additional hydrogeological characterization would be necessary. Minor localized effects on shallow groundwater levels that are in connection with the River alluvium in the vicinity of the removed Intake Diversion Dam and modified feeder canal.
Geomorphology	Construction Effects: No Effect	Construction Effects: Minor <ul style="list-style-type: none"> Scour from coffer dams/flow diversion of main channel. Risk of flooding/scour at existing side channel. Risk of scour of staging/stockpiling areas. 	Construction Effects: Minor to Moderate <ul style="list-style-type: none"> Scour from coffer dams/flow diversion of main channel. Work zone within CMZ. Blockage of side channel flows during one runoff season during construction. 	Construction Effects: Negligible <ul style="list-style-type: none"> Blockage of side channel during one runoff season during construction. 	Construction Effects: Negligible <ul style="list-style-type: none"> Scour from coffer dams/flow diversion of main channel. 	Construction Effects: Negligible <ul style="list-style-type: none"> Scour from coffer dams/flow diversion of main channel.
	Operational Effects: Minor <ul style="list-style-type: none"> Ongoing placement of rock increases rock in the river and changes substrate conditions. 	Operational Effects: Moderate <ul style="list-style-type: none"> Large volume of rock in river and changed slope for ramp. Placement of additional rock. 	Operational Effects: Minor to Moderate <ul style="list-style-type: none"> Reduced flows/sediment transport in main channel. Shorter and slightly steeper bypass channel compared to existing side channel with additional rock. Loss of existing side channel and side channel migration. Placement of additional rock to prevent channel migration. 	Operational Effects: Minor to Moderate <ul style="list-style-type: none"> Reduced side channel migration. Reduced flows/sediment transport in main channel. Increased flows/sediment transport and additional rock in modified side channel. Placement of additional rock to prevent channel migration. 	Operational Effects: Minor to Major <ul style="list-style-type: none"> Return of river hydraulics/sediment transport to natural conditions (beneficial). Limited change to channel migration. Potential for decreased velocity in Main Canal and increased sediment deposition. 	Operational Effects: Minor to Major <ul style="list-style-type: none"> Return of river hydraulics/sediment transport to natural conditions (beneficial). Limited change to channel migration. Potential for decreased velocity in Main Canal and increased sediment deposition.

Resource Area	No Action	Rock Ramp	Bypass Channel	Modified Side Channel	Multiple Pump	Multiple Pumps with Conservation Measures
Water Quality	Construction Effects: No Effect	Construction Effects: Moderate <ul style="list-style-type: none"> Temporary increases in turbidity from installation and removal of coffer dams and placement of rock. Increases would occur multiple times over 2 year construction. Potential for elevated pH from concrete pouring. Potential for spills from equipment and stockpiled materials. 	Construction Effects: Moderate <ul style="list-style-type: none"> Temporary increase in turbidity from installation and removal of coffer dams during 2 year construction. Potential for elevated pH from concrete pouring. Negligible effects during bypass channel install/removal of coffer dams; excavation of channel will be isolated from river. Temporary increase in turbidity from first flush of bypass channel. Negligible risk of contaminants in soils (new surface) for bypass channel due to coarse alluvium. 	Construction Effects: Minor <ul style="list-style-type: none"> No activities at Intake Diversion Dam. Negligible effects during modified channel install/removal of coffer dams; excavation of channel will be isolated from river. Temporary increase in turbidity from first flush of channel. Negligible risk of contaminants in channel sediments (new surface) due to coarse alluvium. Potential for elevated pH from concrete pouring associated with bridge, but will be isolated from the river. 	Construction Effects: Minor <ul style="list-style-type: none"> Temporary increase in turbidity from Intake Diversion Dam and rock removal over one season. Temporary increases in turbidity associated with coffer dams install/removal for construction of feeder channels to pumping stations and first opening of channels. Low risk of contaminants in soils at feeder channel locations due to coarse alluvium. 	Construction Effects: Minor <ul style="list-style-type: none"> Temporary increase in turbidity from Intake Diversion Dam and rock removal over one season. Temporary increases in turbidity in irrigation canal due to placement of check structures. Potential for increased pH from concrete lining during construction of water conservation measures
	Operational Effects: Minor to Major <ul style="list-style-type: none"> Continued presence of fish passage barrier results in failure to meet criteria for aquatic life beneficial uses. Continued placement of rock will cause temporary increases in turbidity on an annual basis. 	Operational Effects: Minor to Major <ul style="list-style-type: none"> Temporary increases in turbidity from placement or reconfiguration of rock as needed to maintain ramp. Improving fish passage could remove 303(d) listing for nonsupport of aquatic life (beneficial). 	Operational Effects: Minor to Major <ul style="list-style-type: none"> Temporary increases in turbidity from replacing rock, sediment removal, use of coffer dams. Improving fish passage could remove 303(d) listing for nonsupport of aquatic life (beneficial). 	Operational Effects: Minor to Major <ul style="list-style-type: none"> Temporary increases in turbidity from replacing rock, sediment removal, use of coffer dams. Improving fish passage could remove 303(d) listing for nonsupport of aquatic life (beneficial). 	Operational Effects: Minor to Major <ul style="list-style-type: none"> Temporary increases in turbidity for removal of sediments in feeder channels, typically a few days per year. Improving fish passage could remove 303(d) listing for nonsupport of aquatic life (beneficial). 	Operational Effects: Minor to Major <ul style="list-style-type: none"> No effects from operation of wells and water conservation measures. Improving fish passage could remove 303(d) listing for nonsupport of aquatic life (beneficial).
Aquatic Communities	Construction Effects: No Effect	Construction Effects: Minor <ul style="list-style-type: none"> Coffer dams increase velocities at fish screens. Disturbed sediment from excavation and dewatering. Increased velocities in river when coffer dams are in place may hinder fish passage. Fish avoidance during construction work. 	Construction Effects: Moderate <ul style="list-style-type: none"> Coffer dams increase velocities at fish screens. Disturbed sediment from rock placement, excavation and dewatering. High-flow side channel shut off. Increased velocities in river when coffer dams are in place may hinder fish passage. Fish avoidance during construction work. 	Construction Effects: Minor <ul style="list-style-type: none"> Fish handling or stranding in side channel during construction. Fish avoidance during in-water work Existing side channel isolated by cofferdams 	Construction Effects: Minor <ul style="list-style-type: none"> Coffer dam increase velocities at fish screen. Sediment disturbed from dam removal. Increased velocities in river when coffer dams are in place may hinder fish passage. Fish avoidance during construction work. 	Construction Effects: Minor <ul style="list-style-type: none"> Dam removal could increase sediment. Coffer dams increase velocities at fish screens. Increased velocities in river when coffer dams are in place may hinder fish passage. Fish avoidance during construction work.
	Operational Effects: Minor to Major <ul style="list-style-type: none"> Dam would remain barrier to fish passage. <ul style="list-style-type: none"> Rock replenishment would disturb sediment. Entrainment of fish and eggs into headworks screens 	Operational Effects: Moderate to Major <ul style="list-style-type: none"> Maintenance of rock ramp could disturb sediment and affect fish and mussels and macroinvertebrates. Entrainment of fish and eggs into headworks screens Improved fish passage (beneficial) 	Operational Effects: Moderate to Major <ul style="list-style-type: none"> Rock placement along bends and banks would disturb sediment. Side channel plug would limit passage. Entrainment of fish and eggs into headworks screens Improved fish passage (beneficial) 	Operational Effects: Minor to Major <ul style="list-style-type: none"> Riprap replacement and sediment removal disturb sediment. Entrainment of fish and eggs into headworks screens Improved fish passage (beneficial) 	Operational Effects: Minor to Major <ul style="list-style-type: none"> Unhindered fish passage (beneficial) Fish pumps damage fish. Bank stabilization would disturb sediment. 	Operational Effects: Minor to Major <ul style="list-style-type: none"> Unhindered fish passage (beneficial).

Resource Area	No Action	Rock Ramp	Bypass Channel	Modified Side Channel	Multiple Pump	Multiple Pumps with Conservation Measures
Wildlife	Construction Effects: No Effect	Construction Effects: Minor <ul style="list-style-type: none"> Disturbance from construction activities to wildlife habitats primarily surrounding the access roads. Potential for injury or mortality of wildlife due to construction activities, primarily from vehicle strikes. 	Construction Effects: Moderate <ul style="list-style-type: none"> Disturbance from construction activities to wildlife habitats found on Joe's Island and surrounding the access roads to Glendive. 	Construction Effects: Moderate <ul style="list-style-type: none"> Disturbance from construction activities to wildlife habitats found on Joe's Island and surrounding the access roads that would be used. 	Construction Effects: Moderate <ul style="list-style-type: none"> Disturbance from construction activities to wildlife habitats at Intake Diversion Dam, the LYP system, along access roads, and at the locations of the pump sites. Construction could degrade high-quality habitat patches for wildlife. 	Construction Effects: Moderate <ul style="list-style-type: none"> Disturbance from construction activities to wildlife habitats at Intake Diversion Dam, the LYP system, along access roads, and at the locations of the pump sites. Construction could degrade high-quality habitat patches for wildlife.
	Operational Effects: Negligible <ul style="list-style-type: none"> Most impacts would be associated to rock extraction from the existing quarry, transport, and deposition for Intake Diversion Dam maintenance. 	Operational Effects: Minor <ul style="list-style-type: none"> Degraded habitat would include poor quality sites surrounding the Intake Diversion Dam, as well as likely high-quality sites along access roads. Disturbance from maintenance activities at existing rock quarry sourcing materials, and the various access roads. The maintenance of the headworks and reconstructed Intake Diversion Dam are anticipated to cause minimal impacts to wildlife. Maintenance activities in Main Canal would remove vegetation. 	Operational Effects: Moderate <ul style="list-style-type: none"> Habitat loss and degradation to wetland, woody riparian, barren land, shrubland, and grassland habitats. Conversion from these habitats would largely preclude use by existing wildlife assemblages. Lost/degraded habitat would include a diversity of relatively high quality patches. Disturbance from maintenance activities at existing rock quarry and access roads connecting them to maintenance sites. The maintenance of the headworks and reconstructed Intake Diversion Dam are anticipated to cause minimal impacts to wildlife. Maintenance activities at bypass channel and Main Canal would remove vegetation. 	Operational Effects: Moderate <ul style="list-style-type: none"> Habitat loss and degradation to wetland, woody riparian, barren land, shrubland, and grassland habitats. Conversion from native conditions would largely reduce use by existing wildlife assemblages. Lost/degraded habitat would include a diversity of relatively high quality patches. Disturbance from enhanced public access for recreation. Disturbance from maintenance activities at the existing rock quarry and access roads. The maintenance of the headworks and Intake Diversion Dam (potentially reduced from existing conditions) are anticipated to cause minimal impacts to wildlife. Maintenance activities at side channel and Main Canal would remove vegetation. 	Operational Effects: Moderate <ul style="list-style-type: none"> Habitat loss and degradation to patches of woody riparian, adjoining patches would be fragmented. Lost/degraded habitat could include a diversity of relatively high quality patches. Disturbance from maintenance activities at the pump sites and throughout the LYP system. 	Operational Effects: Moderate <ul style="list-style-type: none"> Habitat loss and degradation of human-induced wetlands edging the LYP system, and patches of woody riparian may be removed and lost through the placement of the pump sites, adjoining patches would be fragmented. Lost/degraded habitat could include a diversity of relatively high quality patches. The proposed water conservation measures would result in a large reduction of wetland habitat, likely eliminating these areas from wildlife use. Disturbance from maintenance activities at multiple locations, particularly throughout the LYP system.
Federally Listed Species and State Species of Concern	Construction Effects: No Effect	Construction Effects: Moderate <ul style="list-style-type: none"> Noise from pile driving could disturb pallid sturgeon and other species. Reduced passage at dam for blue sucker, shovelnose sturgeon, paddlefish, sauger during construction period. Disturbance of riparian habitats during construction. 	Construction Effects: Moderate <ul style="list-style-type: none"> Noise from pile driving could disturb pallid sturgeon and other species Side channel not available for access/passage for one runoff season during 28-month construction period. Reduced passage for blue sucker, shovelnose sturgeon, paddlefish, sauger during construction period. Disturbance of riparian and wetland habitats during construction. 	Construction Effects: Minor <ul style="list-style-type: none"> Side channel not available for access/passage for one runoff season during 18-month construction period. Disturbance of riparian and wetland habitats during construction. 	Construction Effects: Minor <ul style="list-style-type: none"> Noise from pile driving could disturb pallid sturgeon and other species. Reduced passage at dam for blue sucker, shovelnose sturgeon, paddlefish, sauger during 6 month dam removal period. Disturbance of riparian and wetland habitats during construction. 	Construction Effects: Minor <ul style="list-style-type: none"> Noise from pile driving could disturb pallid sturgeon and other species. Reduced passage at dam for blue sucker, shovelnose sturgeon, paddlefish, sauger during 6 month dam removal period. Disturbance of riparian and wetland habitats during construction.

Resource Area	No Action	Rock Ramp	Bypass Channel	Modified Side Channel	Multiple Pump	Multiple Pumps with Conservation Measures
	<p>Operational Effects: Major</p> <ul style="list-style-type: none"> Continued partial or complete blockage of fish passage. Continued placement of rock and maintenance of LYP. Entrainment of larval fish at headworks. 	<p>Operational Effects: Minor to Major (beneficial)</p> <ul style="list-style-type: none"> Improved fish passage for pallid sturgeon and state fish species of concern (beneficial). Additional placement of rock temporary increases in turbidity. Little to no additional disturbance to riparian habitats for maintenance. Entrainment of larval fish at headworks. 	<p>Operational Effects: Minor to Major (beneficial)</p> <ul style="list-style-type: none"> Improved fish passage for pallid sturgeon and state fish species of concern (beneficial). Additional placement of rock and temporary increases in turbidity. Little to no additional disturbance to riparian or wetland habitat for maintenance. Entrainment of larval fish at headworks. 	<p>Operational Effects: Minor to Major (beneficial)</p> <ul style="list-style-type: none"> Improved fish passage for pallid sturgeon and state fish species of concern (beneficial). Additional placement of rock and temporary increases in turbidity. Little to no additional disturbance to riparian or wetland habitat for maintenance. Entrainment of larval fish at headworks. 	<p>Operational Effects: Minor to Major (beneficial)</p> <ul style="list-style-type: none"> Unhindered fish passage (beneficial) Entrainment of fish at headworks. Entrainment of fish at pumping station. Limited disturbance of riparian habitats for maintenance. 	<p>Operational Effects: Minor to Major (beneficial)</p> <ul style="list-style-type: none"> Unhindered fish passage (beneficial) Entrainment of fish at headworks. Limited disturbance of riparian or wetland habitats for maintenance.
Lands and Vegetation	<p>Construction Effects: No Effect</p>	<p>Construction Effects: Minor</p> <ul style="list-style-type: none"> Temporary disturbance of grasslands from staging/access. 	<p>Construction Effects: Moderate</p> <ul style="list-style-type: none"> Placement of riprap and temporary coffer dams disturb riverine habitat. Sediment disposal and access roads will temporarily impact grasslands. Increased risk of invasive species spread. 	<p>Construction Effects: Moderate</p> <ul style="list-style-type: none"> Emergent wetlands filled by bend cutoffs. Excavation and spoil area will impact grasslands, spread noxious weeds. Filling of cutoff and excavation of access roads will impact riparian areas. Disposal of sediment in grassland. 	<p>Construction Effects: Minor</p> <ul style="list-style-type: none"> Construction of pumping stations will fill wetlands. Temporary structures for dam removal will temporarily disturb riverine habitat. Construction of pumps will impact grasslands. Pump construction will impact riparian areas. Bank stabilization will impact wetlands, and riparian areas. 	<p>Construction Effects: Minor</p> <ul style="list-style-type: none"> Coffer dams temporarily disturb riverine habitat. Installation of check structures could impact fringe wetlands along canal. Main and lateral canal linings or conversion could eliminate wetlands supported by canal seepage. Disposal of dam demolition material will impact grasslands.
	<p>Operational Effects: Minor</p> <ul style="list-style-type: none"> Rock replenishment will continue disturbance on Joe's Island and continue filling in riverine habitat. 	<p>Operational Effects: Moderate</p> <ul style="list-style-type: none"> Riverine habitat permanently filled for rock ramp. Rock ramp replenishment/maintenance will disturb access/staging areas and contribute to filling in riverine habitat. 	<p>Operational Effects: Moderate</p> <ul style="list-style-type: none"> Riverine and emergent wetlands permanently filled. Grassland converted to channel due to excavation of channel. Maintenance activities could impact riparian areas from disturbance for access/staging. 	<p>Operational Effects: Minor</p> <ul style="list-style-type: none"> Rock placement will continue filling in riverine habitat. Placement of riprap in channel could disturb riparian areas. 	<p>Operational Effects: Minor</p> <ul style="list-style-type: none"> Disposal of sediment from canals will impact grasslands. Placement of supplemental riprap will disturb riparian habitat and place additional fill in riverine habitat. 	<p>Operational Effects: Minor to Major</p> <ul style="list-style-type: none"> Loss of wetlands created or augmented by seepage or return flows from LYP. Maintenance of access roads, distribution lines, and pumps could impact grasslands.

Resource Area	No Action	Rock Ramp	Bypass Channel	Modified Side Channel	Multiple Pump	Multiple Pumps with Conservation Measures
Recreation	Construction Effects: No Effect	Construction Effects: Moderate <ul style="list-style-type: none"> General effects are minor to moderate; adjacent construction reduces quality and access, may reduce visitation. Closure of the boat ramp is a significant effect, but addressed via actions to minimize effects to less than significant. 	Construction Effects: Moderate <ul style="list-style-type: none"> General effects are minor to moderate; adjacent construction reduces quality and access, may reduce visitation. Effects on Glendive Chamber's caviar program and concessionaire program moderate. 	Construction Effects: Minor <ul style="list-style-type: none"> Construction area has minimal impact on FAS, and low impact on Joe's Island, other than access via road over the modified side channel. 	Construction Effects: Moderate <ul style="list-style-type: none"> General effects are minor to moderate; adjacent construction reduces quality and access, may reduce visitation. Effects on Glendive Chamber's caviar program and concessionaire program moderate. Dam removal initiates permanent changes fishing likelihood of success at FAS. 	Construction Effects: Moderate <ul style="list-style-type: none"> General effects are minor to moderate; adjacent construction reduces quality and access, may reduce visitation. Effects on Glendive Chamber's caviar program and concessionaire program moderate. Dam removal initiates permanent changes fishing likelihood of success at FAS.
	Operational Effects: No Effect	Operational Effects: Moderate <ul style="list-style-type: none"> Reduced fishing quality at FAS riverfront. Closure of the boat ramp is a significant effect, but addressed via actions to minimize effects to less than significant. Effects to Glendive Chamber's caviar program and concessionaire program. 	Operational Effects: Moderate <ul style="list-style-type: none"> New navigable channel around the dam. Upstream migration and new spawning areas may benefit recreational fishery. Some reduction in fishing success at FAS due to fish able to move upstream. Effects on Glendive Chamber's caviar program and concessionaire program. 	Operational Effects: Moderate <ul style="list-style-type: none"> New navigable channel around the dam. Upstream migration and new spawning areas may benefit recreational fishery, though BRT has concerns about success. Some reduction in fishing success at FAS due to fish able to move upstream, but BRT uncertain modified side channel would perform well, so likely still good fishing at Intake FAS. Effects on Glendive Chamber's caviar program and concessionaire program. 	Operational Effects: Moderate <ul style="list-style-type: none"> Boater access benefits (upstream access). Upstream migration and new spawning areas may benefit recreational fishery. Some reduction in fishing success at FAS due to fishing able to move upstream. Effects on Glendive Chamber's caviar program and concessionaire program. 	Operational Effects: Moderate <ul style="list-style-type: none"> Boater access benefits (upstream access). Upstream migration and new spawning areas may benefit recreational fishery. Some reduction in fishing success at FAS due to fishing able to move upstream. Effects on Glendive Chamber's caviar program and concessionaire program.
Visual Resources	Construction Effects: No Effect	Construction Effects: Moderate <ul style="list-style-type: none"> Length of construction period of three years with a variety of viewer groups that use the area. 	Construction Effects: Moderate <ul style="list-style-type: none"> Length of construction period of three years. Variety of viewer groups that use the area. 	Construction Effects: Minor <ul style="list-style-type: none"> Few viewer groups at Joe's Island, though extensive visual changes for up to three years. 	Construction Effects: Moderate <ul style="list-style-type: none"> Length of construction period of three years with a variety of viewer groups that use the area. 	Construction Effects: Moderate <ul style="list-style-type: none"> Length of construction period of three years for Intake Diversion Dam removal and a variety of viewer groups that use the area. Minor effects from construction of wells since viewer groups are minimal.
	Operational Effects: No Effect <ul style="list-style-type: none"> No change from current conditions. 	Operational Effects: Minor <ul style="list-style-type: none"> Slight visual change through expansion of rock ramp and replacement weir. 	Operational Effects: Negligible <ul style="list-style-type: none"> Few viewer groups at Joe's Island and little visual change from previous condition at the Intake Diversion Dam, where most viewer groups occur. 	Operational Effects: Negligible <ul style="list-style-type: none"> Fewer groups at Joe's Island. 	Operational Effects: Minor <ul style="list-style-type: none"> Introduction of pump houses into agricultural landscape New pump house at Intake FAS Visual improvements resulting from removal of Intake Diversion Dam. 	Operational Effects: Minor <ul style="list-style-type: none"> Introduction of Ranney wells into agricultural landscape Visual improvements resulting from removal of Intake Diversion Dam.

Resource Area	No Action	Rock Ramp	Bypass Channel	Modified Side Channel	Multiple Pump	Multiple Pumps with Conservation Measures
Transportation	Construction Effects: No Effect	Construction Effects: Moderate <ul style="list-style-type: none"> Minor impacts to infrastructure on Highway 16; moderate to significant impacts on Roads 551 and 303; and minor impacts from worker commute. Impacts on Roads 551 and 303 would be mitigated through post-construction rehabilitation. Moderate congestion on Highway 16 from construction vehicles, addressed with action to minimize effect. Moderate parking impacts at Intake FAS, addressed with action to minimize effect. 	Construction Effects: Moderate <ul style="list-style-type: none"> Minor impacts to infrastructure and minor impacts from worker commute. Minor congestion on Highway 16 / Joe's Island, addressed with action to minimize effect. Moderate parking impacts at Intake FAS, addressed with action to minimize effect. 	Construction Effects: Minor <ul style="list-style-type: none"> Minor impacts to infrastructure and minor impacts from worker commute. Moderate to substantial effects on Highway 16 / Joe's Island, addressed with action to minimize effect. 	Construction Effects: Moderate <ul style="list-style-type: none"> Minor effects on local roads near sites. Moderate effect on parking supply at Intake FAS No beneficial effects (no new/upgraded public roads). 	Construction Effects: Minor <ul style="list-style-type: none"> Minor effects on local roads near sites. No beneficial effects (no new/upgraded public roads).
	Operational Effects: No Effect	Operational Effects: Minor <ul style="list-style-type: none"> Possible beneficial effects from improved access roads on Joe's Island and at Intake FAS. 	Operational Effects: Minor <ul style="list-style-type: none"> Possible beneficial effects from improved access roads on Joe's Island and at Intake FAS. 	Operational Effects: Minor <ul style="list-style-type: none"> Possible beneficial effects from improved access roads on Joe's Island and at Intake FAS. 	Operational Effects: Moderate <ul style="list-style-type: none"> Moderate effect on parking supply at Intake FAS. No beneficial effects (no new/upgraded public roads). Added staff with more traffic on local roads. 	Operational Effects: Moderate <ul style="list-style-type: none"> Moderate effect on parking supply at Intake FAS. No beneficial effects (no new/upgraded public roads). Added staff with more traffic on local roads.

Resource Area	No Action	Rock Ramp	Bypass Channel	Modified Side Channel	Multiple Pump	Multiple Pumps with Conservation Measures
Noise	<u>Construction Effects: No effect</u>	<u>Construction Effects: Major</u> <ul style="list-style-type: none"> Noise levels from the sheet piling operations result in noise levels ranging from 62 dBA Leq to 66 dBA Leq at residential homes. Noise Levels from the construction of the rock ramp result in noise levels ranging from 45 dBA Leq to 56 dBA Leq at residential homes. Noise levels from the sheet piling and construction operations will exceed the FTA noise guidelines. 	<u>Construction Effects: Major</u> <ul style="list-style-type: none"> Noise levels from the sheet piling operations result in noise levels ranging from 58 dBA Leq to 66 dBA Leq at residential homes. Noise Levels from the construction of the bypass channel result in noise levels ranging from 37 dBA Leq to 54 dBA Leq at residential homes. Noise levels from the sheet piling operations and construction will exceed the FTA noise guidelines. 	<u>Construction Effects: Major</u> <ul style="list-style-type: none"> Noise levels from the modification and construction of the bypass channel result in noise levels ranging from 35 dBA Leq to 46 dBA Leq at residential homes. Noise levels from the construction of the cofferdams includes sheet piling operations that result in noise levels ranging from 48 dBA Leq to 51 dBA Leq at residential homes. Noise levels from the sheet piling operations will exceed the FTA noise guidelines. 	<u>Construction Effects: Major</u> <ul style="list-style-type: none"> Noise levels from the construction of the pumping stations range from 33 dBA Leq to 58 dBA Leq at residential homes. Noise levels from the removal of the existing dam range from 44 dBA Leq to 55 dBA Leq at residential homes. Noise levels from the construction of the pumping stations and removal of the existing dam will exceed the FTA noise guidelines. 	<u>Construction Effects: Major</u> <ul style="list-style-type: none"> Noise levels from the construction range from 41 dBA Leq to 56 dBA Leq at residential homes. Noise levels from the removal of the existing dam range from 44 dBA Leq to 53 dBA Leq at residential homes. Noise levels from the construction and removal of the existing dam will exceed the FTA noise guidelines.
	<u>Operational Effects: Negligible</u> <ul style="list-style-type: none"> There will be no changes in the existing operations; therefore, there will be no changes to the existing noise levels. 	<u>Operational Effects: Minor</u> <ul style="list-style-type: none"> Noise levels from the general operation and maintenance of the Rock Ramp Alternative would not be audible at the nearest residential homes and would result in negligible effects on the existing environment. The noise levels from the major operation and maintenance actions would be below the EPA guideline threshold of 55 dBA L_{DN} for outdoor activity interference and annoyance. 	<u>Operational Effects: Minor</u> <ul style="list-style-type: none"> Noise levels from the general operation and maintenance of the Bypass Channel Alternative would not be audible at the nearest residential homes and would result in negligible effects on the existing environment. The noise levels from the major operation and maintenance actions would be below the EPA guideline threshold of 55 dBA L_{DN} for outdoor activity interference and annoyance. 	<u>Operational Effects: Minor</u> <ul style="list-style-type: none"> The Modified Side Channel operation and maintenance activities may require heavy machinery such as dump trucks, front end loaders, and excavators. Noise levels from these operation and maintenance activities at the residential homes range from 31 dBA Leq to 39 dBA Leq. The noise levels from the operation and maintenance activities would be below the EPA guideline threshold of 55 dBA L_{DN} for outdoor activity interference and annoyance. 	<u>Operational Effects: Major</u> <ul style="list-style-type: none"> The noise levels from the pumping stations operations range from 37 dBA Leq to 51 dBA Leq at residential homes. The noise levels from the backup generator operations will range from 47 dBA Leq to 63 dBA Leq residential homes. The largest maintenance requirement for this alternative would be sediment removal, which results in noise levels ranging from 41 dBA Leq to 51 dBA Leq residential homes. Noise levels from the operations of the pumps and backup generators will exceed the EPA noise guidelines. 	<u>Operational Effects: Major</u> <ul style="list-style-type: none"> The noise levels from the pumping stations operations range from 37 dBA Leq to 51 dBA Leq at residential homes. The noise levels from the backup generator operations will range from 47 dBA Leq to 63 dBA Leq residential homes. The largest maintenance requirement for this alternative would be sediment removal, which results in noise levels ranging from 41 dBA Leq to 51 dBA Leq residential homes. Noise levels from the operations of the backup generators will exceed the EPA noise guidelines.
Social and Economic Conditions	<u>Construction Effects: No Effect</u>	<u>Construction Effects: Moderate</u> <ul style="list-style-type: none"> Regional benefits from construction spending outweigh minor adverse recreation revenue effects. 	<u>Construction Effects: Moderate</u> <ul style="list-style-type: none"> Regional benefits from construction spending. 	<u>Construction Effects: Moderate</u> <ul style="list-style-type: none"> Regional benefits from construction spending. 	<u>Construction Effects: Moderate</u> <ul style="list-style-type: none"> Regional benefits from construction spending outweigh minor adverse recreation revenue effects. 	<u>Construction Effects: Moderate</u> <ul style="list-style-type: none"> Highest regional benefits from construction due to high cost.

Resource Area	No Action	Rock Ramp	Bypass Channel	Modified Side Channel	Multiple Pump	Multiple Pumps with Conservation Measures
	<u>Operational Effects: No Effect</u> <ul style="list-style-type: none"> No net effect because no action is the baseline, despite new O&M estimate being greater than current LYP assessment rate. 	<u>Operational Effects: Minor</u> <ul style="list-style-type: none"> O&M savings. Potential for long term recreation-related revenue increase. 	<u>Operational Effects: Minor</u> <ul style="list-style-type: none"> O&M savings. Potential for long term recreation-related revenue increase. 	<u>Operational Effects: Minor</u> <ul style="list-style-type: none"> Minor O&M increase. Potential for long term recreation-related revenue increase. 	<u>Operational Effects: Minor to Major</u> <ul style="list-style-type: none"> Regional benefits from O&M spending, but local adverse effect if O&M is funded by the LYP Board of Control. Potential for long term recreation-related revenue increase. 	<u>Operational Effects: Minor to Major</u> <ul style="list-style-type: none"> Regional benefits from O&M spending, but local adverse effect if O&M is funded by the LYP Board of Control. Potential for long term recreation-related revenue increase. 608 cfs is less than current crop demands (1,150 cfs) and may have a major effect on agriculture Loss of prime farmland, depending on location of Ranney wells.
Environmental Justice	<u>Construction Effects: No Effect</u>	<u>Construction Effects: No Effect</u> <ul style="list-style-type: none"> No direct or indirect effects on environmental justice communities. 	<u>Construction Effects: No Effect</u> <ul style="list-style-type: none"> No direct or indirect effects on environmental justice communities. 	<u>Construction Effects: No Effect</u> <ul style="list-style-type: none"> No direct or indirect effects on environmental justice communities. 	<u>Construction Effects: No Effect</u> <ul style="list-style-type: none"> No direct or indirect effects on environmental justice communities. 	<u>Construction Effects: No Effect</u> <ul style="list-style-type: none"> No direct or indirect effects on environmental justice communities.
	<u>Operational Effects: No Effect</u>	<u>Operational Effects: No Effect</u> <ul style="list-style-type: none"> No direct or indirect effects on environmental justice communities. 	<u>Operational Effects: No Effect</u> <ul style="list-style-type: none"> No direct or indirect effects on environmental justice communities. 	<u>Operational Effects: No Effect</u> <ul style="list-style-type: none"> No direct or indirect effects on environmental justice communities. 	<u>Operational Effects: No Effect</u> <ul style="list-style-type: none"> No direct or indirect effects on environmental justice communities. 	<u>Operational Effects: No Effect</u> <ul style="list-style-type: none"> No direct or indirect effects on environmental justice communities.
Historic Properties	<u>Construction Effects: No Effect</u>	<u>Construction Effects: Major</u> <ul style="list-style-type: none"> Impact to structure of Intake Diversion Dam as a result of installation of temporary coffer dams and potential removal of existing dam crest to accommodate construction of the rock ramp. Impact to the Brailey Sub Camp as a result of the use of proposed stockpile and construction staging areas. Impact to potential historic properties as a result of construction activities within unsurveyed portions of the APE. 	<u>Construction Effects: Major</u> <ul style="list-style-type: none"> Impact to Intake Diversion Dam features as a result of moving historic buildings. Potential impact to dam as a result of coffer dam installation for bypass channel and replacement weir construction. Impact to Lower Yellowstone Project quarry and prehistoric lithic scatter as a result of widening haul/access road. Impacts to prehistoric lithic scatters within stockpile and staging areas. Potential impacts to subsurface cultural resources within the Bypass Channel as a result of excavation. 	<u>Construction Effects: Major</u> <ul style="list-style-type: none"> Impact to Lower Yellowstone Project quarry and prehistoric lithic scatter as a result of backwater area excavation and widening County Road 303. Impacts to prehistoric lithic scatters within stockpile area. Potential impacts to subsurface cultural resources within side channel as a result of excavation. 	<u>Construction Effects: Major</u> <ul style="list-style-type: none"> Impact to Intake Diversion Dam as a result of its removal. Impacts to the Main Canal, Northern Pacific Railroad, and Savage Headquarters Camp as a result of discharge pipe, feeder canal, and fish return pipe installation at multiple pumping station sites. Impact to potential historic properties as a result of construction activities within unsurveyed portions of the APE. 	<u>Construction Effects: Major</u> <ul style="list-style-type: none"> Impact to Intake Diversion Dam as a result of its removal. Impacts to the Main Canal as a result of irrigation system modifications. Impacts to potential historic properties as a result of unknown locations for pump-canal pipelines and windmill. Impact to potential historic properties as a result of construction activities within unsurveyed portions of the APE.
	<u>Operational Effects: Major</u> <ul style="list-style-type: none"> Ground disturbance in unsurveyed portions of rock quarry may impact unrecorded cultural resources or unidentified features associated with known historic properties within the quarry (24DW0295 and 24DW0296). 	<u>Operational Effects: Major</u> <ul style="list-style-type: none"> Ground disturbance in unsurveyed portions of rock quarry may impact unrecorded cultural resources or unidentified features associated with known historic properties within the quarry (24DW0295 and 24DW0296). 	<u>Operational Effects: Major</u> <ul style="list-style-type: none"> Ground disturbance in unsurveyed portions of rock quarry may impact unrecorded cultural resources or unidentified features associated with known historic properties within the quarry (24DW0295 and 24DW0296). 	<u>Operational Effects: Major</u> <ul style="list-style-type: none"> Ground disturbance in unsurveyed portions of rock quarry may impact unrecorded cultural resources or unidentified features associated with known historic properties within the quarry (24DW0295 and 24DW0296). 	<u>Operational Effects: No Effect</u>	<u>Operational Effects: No Effect</u>
Indian Trust Assets	<u>Construction Effects: No Effect</u>	<u>Construction Effects: No Effect</u>	<u>Construction Effects: No Effect</u>	<u>Construction Effects: No Effect</u>	<u>Construction Effects: No Effect</u>	<u>Construction Effects: No Effect</u>
	<u>Operational Effects: No Effect</u>	<u>Operational Effects: No Effect</u>	<u>Operational Effects: No Effect</u>	<u>Operational Effects: No Effect</u>	<u>Operational Effects: No Effect</u>	<u>Operational Effects: No Effect</u>

5 Agency, Public, and Tribal Coordination

This chapter describes public involvement activities and agency consultation and coordination, and acknowledges the people who have been involved with this NEPA process.

5.1 Public Involvement

Reclamation and the Corps are undertaking the preparation of an EIS under the requirements of NEPA (42 U.S.C. 4321 et seq.; 43 CFR 1500-1508; 43 CFR 46). The implementation regulations of NEPA and the lead agencies require a formal scoping process when initiating an EIS process. The lead agencies use scoping to involve other federal agencies, state, local and tribal governments, stakeholders, and the public in a) providing input on the purpose and need for the project, b) identifying issues of concern, and c) providing input on the range of alternatives to be analyzed in the EIS.

Reclamation and the Corps have undertaken a robust outreach effort as part of scoping to engage the public in the EIS process. The outreach efforts consisted of several parts. A federal Notice of Intent and Scoping Notice was published in the Federal Register on January 4, 2016. The Notice of Intent discussed the project's purpose, project location, regulatory background, and environmental process to date, and provides information on the scoping comment period and public meeting.

A postcard announcing the scoping process and scoping meeting was mailed to the entire stakeholder list. The Corps drafted a news release and distributed it to local and regional media. The news release was also posted on the Corps and Reclamation websites.

Reclamation and the Corps held a public scoping meeting and invited agencies, tribes, non-governmental organizations, and the public to participate in an open exchange of information and to provide comments on the proposed scope of the EIS. The public scoping meeting was held in Glendive, Montana on January 21, 2016 at the Dawson County High School Auditorium to provide information to the public as to the alternatives being considered and issues to be addressed in the EIS and to answer questions. The meeting ran from 6 p.m. to 8 p.m. and was attended by 65 people plus representatives of the two lead agencies and the consultant team. Scoping poster boards were prepared and used at the scoping meeting to provide information on the project's purpose, alternatives under consideration, and the NEPA process. Handouts discussing the process and alternatives were handed out at the scoping meeting.

A project website, established by Reclamation, was updated to include the Notice of Intent, the Press Release, the posters used at the scoping meeting, the handout on alternatives, a NEPA handout, and a public comment form. The website is found at:

<http://www.usbr.gov/gp/mtao/loweryellowstone/>.

As part of the scoping process, the public was given the opportunity to provide written comments during the scoping period (January 4 through February 18, 2016) to identify issues and effects that should be addressed in the EIS, as well as reasonable alternatives to improve fish passage at the Intake Diversion Dam. A summary of the comments is provided in Section 1.7.

5.2 Agency and Tribal Involvement

5.2.1 Scoping

A meeting with interested agencies was held on the same day as the scoping meeting (January 21, 2016) at the Dawson County Chamber of Commerce and Agriculture in Glendive. Interested agencies were given the opportunity to provide written comments during the scoping period to identify issues and effects that should be addressed in the EIS, as well as reasonable alternatives to improve fish passage at the Intake Diversion Dam. Formal scoping comments were received from the following agencies:

- U.S. Environmental Protection Agency
- Lower Yellowstone Project Board of Control
- Sidney Water Users Irrigation District.

The agency meeting in January was attended by representatives from the Corps, Reclamation, Montana Fish, Wildlife and Parks, and the LYP Board of Control.

5.2.2 Cooperating Agencies

As part of an earlier environmental review processes, which resulted in the issuance of an EA in 2010, Reclamation and the Corps established a Cooperating Agency Team to facilitate communication among state and federal agencies. The team met frequently and exchanged information throughout the NEPA process. Cooperating agencies provided information based upon their special expertise or jurisdiction related to the Intake Project, assisted with analyses, and reviewed draft documents and analyses.

With the decision to prepare an EIS, the lead agencies again sent out requests to appropriate agencies to participate in the NEPA process as a cooperating agency.

The following agencies have agreed to participate in the EIS effort as cooperating agencies:

- Montana Fish, Wildlife and Parks
- Montana Department of Natural Resources and Conservation
- Lower Yellowstone Project Board of Control
- U.S. Fish and Wildlife Service
- Western Area Power Administration

The U.S. Environmental Protection Agency, while declining to be a cooperating agency, expressed a desire to remain involved where possible.

5.2.3 Tribal Involvement

The relationship between the federal government and tribes is defined in the U.S. Constitution.

Article 1, Section 8 gives Congress the authority to regulate “commerce with foreign nations, and among the several states, and with the Indian tribes.” Until 1871, this relationship with individual tribes was enumerated through treaties, from which the concept of the “trust relationship” originated. According to the Supreme Court decision in *Cherokee Nation v. Georgia* (1831), Indian tribes are considered to constitute “domestic, dependent nations” whose “relationship to the United States resembles that of a ward to his guardian.” This decision established the doctrine of federal trusteeship—the trust relationship—in Indian affairs.

All federal agencies, including Reclamation and the Corps, have a government-to-government relationship with tribes. Federally recognized tribes are to be respected as sovereign governments and federal agencies have a trust responsibility to respect this sovereignty by protecting and maintaining rights reserved by or granted to tribes or individual Indians by treaties, federal court decisions, statutes, and executive orders. The sovereignty of tribes and this trust relationship have been affirmed through treaties, court decisions, legislation, regulations, and policies.

The result is that federal agencies are to assess the impacts of their activities on trust assets, to protect and conserve ITAs to the extent possible. The ITAs are discussed in Chapter 3 and 4 of this EIS.

In furtherance of the government to government relationship, the Corps and Reclamation reached out to each tribe along the Lower Yellowstone and Missouri Rivers, seeking their input on concerns “that uniquely or significantly affect your Tribe, related to the project.” Specifically, information on ITAs, Traditional Cultural Properties, and other resources of tribal concern was requested. The tribes that were contacted are:

- Apsaalooke (Crow) Nation
- Assiniboine and Sioux Tribes of Fort Peck
- Blackfeet Tribe
- Cheyenne River Sioux Tribe
- Chippewa Cree Tribe of Rocky Boy’s
- Crow Creek Sioux Tribe
- Eastern Shoshone Tribe
- Flandreau Santee Sioux Tribe
- Gros Ventre and Assiniboine Tribes of Fort Belknap
- Iowa Tribe of Kansas and Nebraska
- Kickapoo Tribe in Kansas
- Lower Brule Sioux Tribe
- Northern Arapaho Tribe
- Northern Cheyenne Tribe
- Oglala Sioux Tribe
- Omaha Tribe of Nebraska
- Ponca Tribe of Nebraska
- Prairie Band Potawatomi Nation
- Rosebud Sioux Tribe
- Sac and Fox Nation of Missouri in Kansas and Nebraska
- Santee Sioux Tribe of Nebraska

- Sisseton-Wahpeton Oyate
- Spirit Lake Sioux Tribe
- Standing Rock Sioux Tribe
- Three Affiliated Tribes
- Turtle Mountain Band of Chippewa Indians
- Winnebago Tribe of Nebraska
- Yankton Sioux Tribe

5.2.4 ESA Consultation

Since the pallid sturgeon was listed in 1990, Reclamation has been consulting with the Service related to the O&M of the Intake Diversion Dam. More recently, the Corps has been participating in this consultation relative to the proposed fish passage improvements. In 2015, Reclamation submitted a Biological Assessment for the *Interim and Future Operations and Maintenance of the Lower Yellowstone Irrigation Project and Construction of Fish Passage Facilities*.

On July 10, 2015, Reclamation received a Biological Opinion from the Service stating that the Lower Yellowstone Project and construction of a fish passage project would not cause jeopardy, but was likely to adversely affect pallid sturgeon due to the presence of the Intake Diversion Dam without an alternate passage route during the 2-3 years of construction, potential future entrainment/impingement of free embryos and larvae at the headworks screens and physical presence of the replacement weir and bypass channel. The design of the bypass channel is based on the best available science, but as there is not a similar precedent, there are still uncertainties about the ultimate effectiveness in providing pallid sturgeon passage. Therefore, the recommended reasonable and prudent measure (RPA) to minimize effects was to implement a monitoring and adaptive management plan that would document the performance of the replacement weir and bypass channel and take measures to improve its success if the performance did not meet desired criteria.

This Biological Opinion was part of the Preliminary Injunction issued in 2015 to halt the implementation of the proposed fish passage improvement project. As part of this current analysis a new Biological Assessment is being prepared by the Corps and Reclamation and a draft is included as Appendix D. Consultation will continue until a final Biological Opinion is issued in late 2016. Construction will not proceed until the Biological Opinion is complete and consultation is concluded.

5.3 Documentation, Coordination and Compliance with Other Applicable Laws, Regulations, and Policies

Analysis and implementation of the Intake Project requires consistency, coordination, and compliance with multiple federal and state laws, regulations, executive orders, and policies. The following are applicable to the Intake Project.

5.3.1 Archaeological Resource Protection Act of 1979

This act protects archaeological resources on federal and tribal lands and requires a permit to remove archaeological resources from these lands. Permits may be issued to educational or scientific institutions only if the removal would increase knowledge about archaeological resources. Compliance with this law would be accomplished through actions to minimize effects for all of the alternatives (see Chapter 4 “Cultural Resources” section).

5.3.2 Clean Water Act of 1977 (as amended)

The Clean Water Act (CWA) is the principal law governing pollution control and water quality of navigable waterways of the United States. Section 402 of the act establishes a National Pollution Discharge Elimination System permitting program to regulate the point source discharge of pollutants into waters of the United States. Both Montana and North Dakota administer state-level programs pursuant to authority delegated by the EPA.

Section 404, administered by the Corps with oversight from EPA, regulates the placement of dredged or fill materials into waters of the United States. The Corps issues nationwide permits on a state, regional, or nationwide basis for similar activities that cause only minimal adverse environmental effects both individually and cumulatively. Individual permits may also be issued for specific activities on specific water bodies under Section 404.

Of specific note, the Corps does not issue itself a CWA permit to authorize its own discharges of dredged or fill material into Waters of the United States, but conducts an equivalent analysis under the Section 404(b)(1) guidelines and other substantive requirements of the CWA. In following ER 1105-2-100 and other pertinent planning regulations, the Corps applies the Economic and Environmental Principles and Guidelines for Water and Related Land Resources Implementation Studies. A 404(b)(1) analysis has been prepared (Appendix C).

Montana State Water Quality Certification Permit (Section 401) would also be required. Section 401, administered by the MTDEQ, allows states to review and approve, condition, or deny all federal permits or licenses that might result in a discharge to state waters, including wetlands. States make their decisions to deny, certify, or condition permits or licenses primarily by ensuring the activity will comply with state water quality standards. In addition, states look at whether the activity will violate effluent limitations, new source performance standards, toxic pollutants, and other water resource requirements of state law or regulation. The Section 401 review allows for better consideration of state-specific concerns. A 401 Water Quality Certification would be obtained from MTDEQ, if appropriate.

5.3.3 Floodplain Management Assessment

The floodplain management assessment is conducted in accordance with the National Flood Insurance Program (NFIP) as outlined in Title 44 of the Code of Federal Regulations (44 CFR). The proposed project modifications are compared to the effective Federal Emergency Management Agency (FEMA) floodplain data for the project area, which is located in Dawson County, to determine any adverse impacts.

According to FEMA documents, Dawson County, Montana participates in the NFIP and the

Intake Diversion Dam is located on FEMA Map Panel 3001400009B, dated April 1978. The entire Yellowstone River floodplain is delineated as Zone A at this location, which by FEMA definition, indicates a geographical area shown on a Flood Hazard Boundary Map or a Flood Insurance Rate Map that reflects the severity or type of flooding in the area, for a 1-percent chance occurrence flood event.

5.3.4 Farmland Protection Policy Act of 1995

The purpose of this act is to ensure that impacts to prime or unique farmlands are considered in federal projects. It requires federal agencies to consider alternative actions that could lessen impacts and to ensure that their actions are compatible with state, local government, and private programs to protect prime and unique farmland. The Natural Resources Conservation Service is responsible for administering this act. Farmlands were considered in the Intake Project analysis using the key indicators of changes in farm acreage and production. Prime and unique farmlands would be protected to the extent possible during implementation of the Intake Project consistent with the act (see Section 4.11).

5.3.5 Fish and Wildlife Coordination Act of 1958 (as amended)

The Fish and Wildlife Coordination Act (FWCA, 48 Stat. 401, as amended; 16 U.S.C. 661 et seq.) provides a procedural framework for the orderly consideration of fish and wildlife conservation measures to be incorporated into federal projects and federally permitted or licensed water resource development projects. Agencies that construct, permit, or license projects impacting a water body must consult with the Service and the state agency having jurisdiction over fish and wildlife resources, MFWP. Full consideration must be given to the recommendations made through this consultation process.

Section 2 states that fish and wildlife conservation shall receive equal consideration with other project purposes and will be coordinated with other features of water resource development projects. The FWCA specifically authorizes the Secretary of the Interior to prepare a report and provide recommendations on the fish and wildlife aspects of projects, including mitigation. The FWCA report provides input to preparation of draft environmental impact statements. Reclamation normally appends FWCA reports to NEPA documents. However, both the Service and MFWP are cooperating agencies and have been working closely with the Corps and Reclamation since 1994 to initiate and implement studies and surveys, gather and analyze data, and contribute to reports. This continuous input into the decision-making process reduces the need for a technical 2(b) FWCA report to prevent or reduce the adverse impacts to fish and wildlife.

5.3.6 Migratory Bird Treaty Act and Executive Order 13186 (January 2001)

Under the provisions of this act it is unlawful to pursue, hunt, take, capture or kill any migratory birds except as permitted by regulations issued by the Service.

Migratory birds include all native birds in the United States with the exception of non-migratory species managed by states. The Service has defined “take” to mean “pursue, hunt, shoot, wound, kill, trap, capture, or collect, or attempt to pursue, hunt, shoot, wound, kill, trap, capture or collect” any migratory bird or any part, nest, or egg of any migratory bird (50 CFR Section 10.12). Executive Order (EO) 13186 requires that each Federal agency taking actions that have, or are likely to have, a measurable negative effect on migratory bird populations is directed to

develop and implement, with the Service, measures that shall promote the conservation of migratory bird populations.

Project level compliance with this law would be accomplished through specific actions to minimize effects for all of the action alternatives (see Section 4.9.6).

5.3.7 Native American Graves Protection and Repatriation Act (Public Law 101-601)

This act establishes federal policy with respect to Native American burials and graves located on federal or tribal lands. Federal agencies are required to consult with and obtain the concurrence of the appropriate tribes with respect to activities that may result in the disturbance and/or removal of burials and graves from federal lands or lands held in trust for a tribe. To ensure compliance with the Act, the Corps and Reclamation would consult with the tribes if any unanticipated discoveries are made during the construction phase of the Intake Project. Project level compliance with this law would be accomplished through specific actions to minimize effects for all of the action alternatives (see Sections 4.18.6 and 4.19.6).

5.3.8 National Historic Preservation Act of 1966 (as amended in 2006)

The act establishes protection of historic properties as federal policy in cooperation with states, tribes, local governments, and the public. Historic properties are those buildings, structures, sites, objects, and districts, or properties of traditional religious and cultural importance to Native Americans, determined to be eligible for inclusion in the National Register of Historic Places. Section 106 of the act requires federal agencies to consider the effects of proposed actions on historic properties and gives the Advisory Council on Historic Preservation an opportunity to comment. Reclamation is responsible for consultation with the SHPO and/or Tribal Historic Preservation Offices, tribes, applicants, interested parties, and local governments regarding federal undertakings. Compliance with this law would be accomplished through specific actions to minimize effects for all of the action alternatives (see Section 4.18.6).

5.3.9 Rivers and Harbors Appropriation Act of 1899

Under Section 10 of the act, the construction of any structure in or over any navigable water of the United States, the excavating from or depositing of material in such waters, or the accomplishment of any other work affecting the course, location, condition, or capacity of such waters is unlawful unless the work has been recommended by the Chief of Engineers and authorized by the Secretary of the Army. This Project would be implemented with design measures deemed compatible with the act.

5.3.10 Executive Order 13112 for Invasive Species

In 1999, an EO was issued to prevent the introduction of invasive species and to provide for their control. It directs federal agencies to identify applicable actions and to use programs and authorities to minimize the economic, ecological, and human health impacts caused by invasive species. To meet the intent of this order, the Intake Project includes actions to prevent and control the spread of invasive species (see Sections 4.8.6 and 4.11.6).

5.3.11 Executive Order 11988 Assessment

Executive Order 11988 (Floodplain Management) requires federal agencies to avoid developments on floodplains whenever possible or to minimize potential harm to the floodplains.

The intent of the proposed project is to re-establish self-sustaining shallow water habitat for fish and wildlife along the Yellowstone River. In order to be compliant with Executive Order 11988, federal investment in the proposed project modifications must not result in any actions or activities which would adversely impact existing structures, and in particular, critical facilities such as hospitals, schools, power generating plants, etc. Review of the project location indicates no existing structures which could be adversely impacted.

5.3.12 Other Executive Orders

Executive Order 11990 (Protection of Wetlands) directs federal agencies to avoid destruction, loss, or degradation of wetlands. Executive Order 13007 (Indian Sacred Sites) orders federal agencies to accommodate Indian tribes' requirements for access to and ceremonial use of sacred sites on public lands and to avoid damaging the physical integrity of such sites. Executive Order 12898 (Environmental Justice) directs federal agencies to identify and address disproportionately high and adverse human health or environmental effects on minority populations and low income populations. Compliance with these orders was considered in the development of action alternatives in this EIS (see Sections 4.11 and 4.17).

5.3.13 State Water Rights

Montana waters belong to the state, with ownership on behalf of all state citizens. Because water belongs to the state, water rights holders do not own the water; they have a right to use the water within state guidelines. Water rights in Montana are guided by the prior appropriation doctrine, or first in time, first in right. A person's right to use a specific quantity of water depends on when the use first began. The first person to use water from a specific source established the first right, the second established a right to the remaining water and so on. Water rights holders are limited to the amount of water that can be beneficially used. Beneficial uses of water include agricultural purposes, domestic, fish and wildlife, industrial, mining, municipal, power, and recreational uses.

The Montana Water Use Act passed July 1, 1973, changed water rights administration by requiring a statewide adjudication process on all water right claims existing at that time. Adjudication is a judicial decision that determines the quantity and priority date of all existing water rights in a basin. It also established a permit system for obtaining water rights for new or additional water developments, created an authorization system for changing water rights and a centralized records system, and provided a system to reserve water for future consumptive uses and maintain minimum instream flows for water quality and fish and wildlife. Senate Bill 76 and House Bill 22 further defined the adjudication process and established a funding mechanism to complete statewide adjudication in 2015.

The Lower Yellowstone Irrigation District #1, Intake Irrigation District, Savage Irrigation District, and Reclamation hold the following unadjudicated water rights in the state of Montana totaling 1,374 cfs:

- 1,000 cfs Statement of Claim
- 300 cfs Statement of Claim
- 18 cfs Statement of Claim
- 42 cfs Statement of Claim
- 14 cfs Provisional Permit (Savage Irrigation District).

5.3.14 Montana Environmental Policy Act

State agencies on the Cooperating Agency Team provided input for compliance with the Montana Environmental Policy Act (MEPA). MEPA was passed in 1971 instituting a policy requiring state agencies to consider the environmental, social, cultural and economic impacts of proposals prior to project approval. The purpose of MEPA is to foster state government decisions that are informed, accountable, open to public participation, and balanced. MEPA gives a community the ability to provide input into decision-making and helps resolve issues before they become a problem. The agencies may adopt the Intake EIS completed by the co-leads or complete further documentation as they see fit to comply with the MEPA process.

5.3.15 Stream Protection Act

Any agency or subdivision of federal, state, county, or city government proposing a project that may affect the bed or banks of any stream in Montana for any project including the construction of new facilities or the modification, operation, and maintenance of an existing facility that may affect the natural existing shape and form of any stream or its banks or tributaries must comply with this act. The purpose of the act is to protect and preserve fish and wildlife resources and to maintain streams and rivers in their natural or existing state. Their concerns regarding fish, wildlife, and riverine environments have been addressed in this document. A stream protection permit would be obtained for the Intake Project from the MFWP, the agency who administers the law, prior to construction.

5.3.16 Short-Term Water Quality Standards for Turbidity (318)

Any person, agency, or entity, both public and private, initiating construction activity that will cause short-term or temporary violations of state surface water quality standards for turbidity requires a state permit. The purpose of the permit is to provide a short-term water quality turbidity standard for construction activities, so that construction is carried out in accordance with conditions prescribed by the MTDEQ, to protect water quality and to minimize sedimentation. MTDEQ administers the permit, and its concerns regarding water quality, sedimentation, and the Intake Project are addressed in the “Water Quality” section in this EIS.

5.3.17 Montana Land-use License of Easement on Navigable Waters

Any entity proposing a project on lands below the low water mark of navigable waters requires a state license. Projects include the construction, placement, or modification of a structure or improvements in, over, below, or above a navigable stream. The purpose of the law is to protect riparian area and the navigable status of the water body and to provide for the beneficial use of state lands for public and private purposes in a manner that will provide revenues without harming the long-term capability of the land or restricting the original commercial navigability. The MDNRC administers the law, and its concerns are addressed in chapter four “Land and Vegetation” and “Recreation” sections in this EIS.

5.3.18 Stormwater Discharge General Permits

Any person, agency, or entity, either public or private, proposing a construction, industrial, mining, or other defined activity that has a discharge of storm water into surface waters must obtain a permit. Under the authority of the Montana Water Quality Act, permit authorization is typically obtained under a Montana Pollutant Discharge Elimination System “General Permit.” A permit is generally required for construction activity that will disturb one or more acres, including clearing, grading, and excavating activities.

The purpose of the law is to prevent degradation of surface waters from pollutants such as sediment, waste materials, industrial chemicals or materials, heavy metals, and petroleum products; to protect existing water quality, and to implement and monitor the effectiveness of Best Management Practices (erosion and sediment controls, etc.) used to reduce pollutant loads. The MTDEQ administers the permit, and the agency's concerns regarding water quality, sedimentation, and the overall project have been addressed in Chapter 4, "Geomorphology," "Surface and Groundwater Hydrology," and "Lands and Vegetation" sections in this EIS.

5.3.19 401 Water Quality Certification for Other Federal Permits & Licenses

Under Section 401 of the federal Clean Water Act, states and tribes can review and approve, condition, or deny all federal permits or licenses that might result in a discharge to state or tribal waters, including wetlands. The major federal licenses and permits subject to Section 401 are Section 402 and 404 permits (in non-delegated states), Federal Energy Regulatory Commission hydropower licenses, and Rivers and Harbors Act Section 9 and 10 permits. States and tribes may choose to waive their Section 401 certification authority.

States and tribes make their decisions to deny, certify, or condition permits or licenses primarily by ensuring the activity will comply with state water quality standards. In addition, states and tribes look at whether the activity will violate effluent limitations, new source performance standards, toxic pollutants, and other water resource requirements of state/tribal law or regulation. The Section 401 review allows for better consideration of state-specific concerns. Their concerns have been addressed in Chapter 4, "Surface Water Quality" and "Lands and Vegetation" sections in this EIS.

List of Preparers

Name	Contribution	Education/Licenses/ Certifications	Years of Experience
T. R. Andrade Project Manager Tetra Tech, Inc.	Air Quality	B.S. Environmental Engineering M.S. Environmental Engineering	19
Peggy Bailey, P.E. Senior hydraulic engineer Tetra Tech, Inc.	Surface Water	B.S. Civil & Environmental Engineering Professional Engineer	30+
Jeff Barna Research Ecologist Tetra Tech, Inc.	Wildlife Resources	B.S. Biology M.S. Ecology and Evolutionary Biology	19
Sandy Barnum Corps of Engineers	Cultural Resources	BA Sociology/Anthropology, MA Anthropology, MA Museum Studies; RPA	28
Jennifer W. Beardsley Natural Resource Specialist Reclamation	Environmental Compliance Oversight, Technical Review	B.S. Chemistry	24
Gerold Benock Supervisory Engineer Reclamation	Technical Review	M.S. Agricultural Engineering	35
James Brower Manager Lower Yellowstone Irrigation Project	Technical Review	Associates of Science Degree in Irrigation Design and Technology Cornell Pump School Graduate Berkley Pump School Graduate Nelson Irrigation Applications Program	20
James Carney Water Resources Economist Tetra Tech, Inc.	Socioeconomics, Transportation, Recreation, Environmental Justice	B.A. Environmental Economics	8
Chou Cha Civil Engineer Reclamation	Technical Review	B.S. Civil Engineer, P.E.	20
Douglas Epperly Supervisory Environmental Specialist Reclamation	Environmental Compliance Oversight, Technical Review	B.S. Forestry	30

Lower Yellowstone Intake Diversion Dam Fish Passage Project, Montana
Environmental Impact Statement
May 2016

Name	Contribution	Education/Licenses/ Certifications	Years of Experience
Patrick J. Erger Supervisory Hydrologist Reclamation	Technical Review	B.S. Agricultural Engineering M.S. Agricultural Engineering	23
Scott Estergard Senior Water Resources Planner Tetra Tech, Inc.	Project Manager Principal EIS Author	M. Eng. Water Resources B.S. Biology	20
Chris Fassero Corps of Engineers	PM	MUP	20
Jim Forseth Civil Engineer Reclamation	Technical Review	B.S. Civil Engineering	20
Kevin Fowler Senior Acoustical Engineer Tetra Tech, Inc.	Noise	B.A. Audio and Acoustics	10+
Bill Fullerton, P.E. Program Manager Tetra Tech, Inc.	Technical Review	M.S. Civil Engineering B.S. Civil Engineering Professional Engineer	32
Shawn Higley Vice President WWC Engineering	Technical Review	BSCE, MSCE University of Wyoming Professional Engineer (MT, WY, ID, ND, CO, TX, NM, KS, UT, NV) Professional Hydrologist	24
Erin King Archaeologist Tetra Tech, Inc.	Cultural Resources	M.A. Registered Professional Archaeologist	15
Tara Kinsey Lead Repayment Specialist Reclamation	Technical Review	B.S. Economics B.S. Finance	17
Chuck Kirchner Senior Environmental Planner Tetra Tech, Inc.	Technical Review EIS Section Author: Purpose and Need; Agency, Public and Tribal Coordination	B.P.A. (Public Affairs) M.A. Urban Affairs	40
Eric Laux Corps of Engineers	Chief, Environmental Section	BA Biology, MS Fisheries Biology; PMP	19
Dale Lentz Civil Engineer Reclamation	Technical Review	B.S., M.S. Civil Engineering, P.E.	12
Merri Martz Senior Biologist Tetra Tech, Inc.	Climate Senior Biologist Oversight, ESA Consultation, Alternatives Evaluation	M.M.A. Wetland Ecology Professional Wetland Scientist	25
Terry Matuska Corps of Engineers	Geotechnical Engineer	AAS Civil Technology B.S. Civil Engineering, E.I.T.	31

Lower Yellowstone Intake Diversion Dam Fish Passage Project, Montana
Environmental Impact Statement
May 2016

Name	Contribution	Education/Licenses/ Certifications	Years of Experience
Curtis Miller Corps of Engineers	Hydraulic Engineer	B.S. Civil Engineering/M.S. Environmental Engineering; PE	14
Rachel Miller Senior Geologist/ Hydrogeologist Tetra Tech, Inc.	Groundwater, Air Quality	B.S. Geology M.S. Water Resources Science Professional Geologist	17
David Munro Senior Ecologist Tetra Tech, Inc.	Technical Review	M.A. Natural Resource Management BA, Psychology	19
Gary Norenberg Corps of Engineers	Cost Engineer	Certified Cost Consultant	32
Lyle Peterson Corps of Engineers	Structural Engineer	B.S. Civil Engineering, PE,	27
Joshua Phillips, P.E.	Alternative Design	B.S. Civil Engineering, Professional Engineer	18
Steven Piper Economist Reclamation	Technical Review	B.S. Economics M.S. Agricultural Economics PhD Economics	30
Rob Plotnikoff Senior Aquatic Ecologist Tetra Tech, Inc.	Technical Review	M.S. Aquatic Biology B.S. Biology	26
Dan Portman Technical Editor Tetra Tech, Inc.	Document Preparation, Editorial Review		36
Kim Prill Outdoor Recreation Planner Reclamation	Technical Review	B.S. SocioEconomics M.Ed. Communications	24
Ridge Robinson Program and Project Manager, Senior Planner/Economist Tetra Tech, Inc.	Program Manager Technical Review	BS, Economics BA, Administrative Management	25
Jennifer Salak Corps of Engineers	Public Outreach Specialist	B.S. Environmental Science and Policy/M.S. Management & Public Affairs	15
Jung Suh, P.E.	Alternative Design	MS, Civil and Environmental Engineering, BA, Civil Engineering, Professional Engineer	17
Chris Svendsen Corps of Engineers	Hydraulic Engineer	PE	10
Sara Townsend Biologist Tetra Tech, Inc.	Visual Resources, Threatened and Endangers Species and Species of Concern, Water Quality	B.S. Watershed Science M.S. Wildlife Ecology and Conservation	20

Lower Yellowstone Intake Diversion Dam Fish Passage Project, Montana
Environmental Impact Statement
May 2016

Name	Contribution	Education/Licenses/ Certifications	Years of Experience
David Trimpe Natural Resource Specialist Reclamation	Environmental Compliance Oversight, Technical Review	B.S. Wildlife and Fisheries	7
Tiffany Vanosdall Corps of Engineers	PM/Lead Plan Formulator	BS Biology/Chemistry, MS Aquatic Ecology; PMP	18
Scott Vose Tetra tech, Inc.	Cost Engineering, Economics (CE/ICA)	BA Economics	9
Cathi Warren Corps of Engineers	Tribal Consultation Specialist	BA History/Anthropology/Nati ve American Studies, MA History/Native American Studies	12
Chris Weber Environmental Scientist Tetra Tech, Inc.	Land/Vegetation, Aquatic Resources	M.S. Natural Resources and Environment	17
Lyle Zevenbergen, P.E., Ph.D. Program Manager/Hydraulic Engineer Tetra Tech, Inc.	Geomorphology	Ph.D. Earth M.S. Hydraulic Engineering B.S. Civil Engineering Professional Engineer	32

Distribution List

Mary Beth Artz
1708 E Bryan Ave
Salt Lake City, UT 84108

McCrystie Adams
Defenders of Wildlife
535 16th Street, Suite 310
Denver, CO 80202

Joel Albert
102 14th Ave NW
Mandan, ND 58554

Jill Albertson
Savage, MT 59262

ROBERT ALBIN
624 10th St SE
Sidney, MT 59270

Richard Albin
1371 22nd Ave NW
Sidney, MT 59270

Robert & Sheree Albin
33791 COUNTY ROAD 131
Sidney, MT 59270

Scott Albin
33792 Co Rd 131
Sidney, MT 59270

Richard Albin
1372 22nd Ave NW
Sidney, MT 59270

Scott Albin
12281 CR 350
Sidney, MT 59270

Ralph Allard
408 2nd St NE
Sidney, MT 59270

John Almond
4918 162nd NE
Redmond, WA 98052

David Andersen
724 Lincoln Ave NW
Sidney, MT 59270
Orin E Anderson
11939 Hwy 16
Sidney, MT 59270

Sandra Angel
PO Box 937
Sidney, MT 59270

Hugo J Asback
13048 Hwy 200
Fairview, MT 59221

Gene & Tanya Asbeck
35339 COUNTY ROAD 130
SIDNEY, MT 59270-4239

Glen Asbeck
1398 11th Ave SW
Sidney, MT 59270

Harvey Asbeck
2792 160th Ave NW
Fairview, MT 59221

Patrick Asbeck
13048 HIGHWAY 200
Fairview, MT 59221

Russel Asteinbeisser
34629 CR 120
Sidney, MT 59270

Robert A Atchison
PO Box 288
Sidney, MT 59270

Lower Yellowstone Intake Diversion Dam Fish Passage Project, Montana
Environmental Impact Statement
May 2016

William Ault
34707 COUNTY ROAD 120
Sidney, MT 59270-6367

Jim & Cathy Basta
33630 CR 103
Savage, MT 59262

Donna R Ault
34705 Co Rd 120
Sidney, MT 59270

Max Baucus
United States Congress
222 N. 32nd Street
Billings, MT 59101

Mike Backes
PO Box 1630
Miles City, MT 59201

Nancy Baue
13781 Co Rd 340
Fairview, MT 59221

Robert J Badt
2452 Red River Dr
Sidney, MT 59270

Mark Baumler
Montana Historical Society
P.O. Box 201201
Helena, MT 59620-1201

Robert J Badt
P.O. Box 209
Savage, MT 59262

Dirk Baxter
19339 CITATION RD
EAGLE RIVER, AK 99577-8487

Gary Bahn
Sunrise Equipment
35537 CR 133
Sidney, MT 59270

James Beiber
3221 Highway 58
Fairview, MT 59221

Trent Baker
Brennan's Wave
201 W. Main, Ste. 201
Missoula, MT 59802

Randy Bell
7225 Jellison Rd
Billings, MT 59101

Marty Bakken
2289 GREEN BRIAR RD
Billings, MT 59105

Robert Bell
203 14th St SE
Sidney, MT 59270

Tony Barone
708 7th Ave SW
Sidney, MT 59270

Raymond Bell
Bell Ridge Farms
1101 11th Ave SW
Sidney, MT

Perry Bartel
402 35th Ave NW
Sidney, MT 59270

Ryan Bell
35056 Hwy 23
Sidney, MT 59270

Jim Basta
33630 Co Rd 103
Savage, MT 59262

Devin Bell
1101 11th ST SW
Sidney, MT 59270

Todd Basta
33649 Co Rd 104
Savage, MT 59262

Jeff Berger
13309 65TH ST NW
WILLISTON, ND 58801

Ron Berry
2942 Cheney Cr Rd
Cartwright, ND 58838

Shawn Berry
2901 Cheney Cr Rd
Cartwright, ND 58838

Harlow Bieber
3591 159 Ave NW
Fairview, MT 59221

Jeff Bieber
16071 33rd St NW
Fairview, MT 59221

Linda Bieber
103 9th Ave SW
Sidney, MT 59270

Rick Blanksma
833 LEWIS AVE
Billings, MT 59101

Larry Bond
35140 Co Rd 125
Sidney, MT 59270

Larry & Brenda Bond
35463 Co Rd 129
Sidney, MT 59270

Rodney M. Bordeaux
Rosebud Sioux Tribe
P.O. Box 430
Rosebud, SD 57570-0430

Vickie Borg
1398 15TH ST SW
SIDNEY, MT 59701-2534

Scott Bosse
American Rivers
321 E. Main St. Ste 408

Keith Bostrom
522 7th Street
Sindey,, MT 59270

Arthur Bouchard
PO Box 217
Lambert, MT 59243

Bud Bouchard
34234 Co Rd 120
Sidney, MT 59270

Evah Bouchard
12754 Hwy 200
Sidney, MT 59270

Ron Bowchard
Box 21
Lambert, MT 59243

George & Shirley Boyce
34901 Hwy 200
Sidney, MT 59270

William Boyer
12843 Co Rd 355
Sidney, MT 59270

Robert Bramblet
Montana State University
113 E Lewis Hall
Bozeman, MT 59715

Richard Brannon
Northern Arapaho Tribe
P.O. Box 396
Fort Washakie, WY 82514

Amanda Breitbach
Glendive Ranger-Review
119 W. Bell
Glendive, MT 59330

Greg Breuer
Crop Production Servives
PO Box 405
Fairview, MT 59221

David Brien
Turtle Mountain Band of Chippewa
P.O. Box 900
Belcourt, ND 58316

Lower Yellowstone Intake Diversion Dam Fish Passage Project, Montana
Environmental Impact Statement
May 2016

Joe Brings Plenty
Cheyenne River Sioux Tribe
P.O. Box 590
Eagle Butte, SD 57625

Kenneth Brose
793 Hwy 16
Glendive, MT 59330

Stacey & Mindy Brower
34515 CR 115
Savage, MT 59262

Steve Brown
Helena Chemical
904 E. Mian St
Sidney, MT 59270

Bruce Browne
16122 33rd St NW
Fairview, MT 59221
Lance Brunsvold
1452 11th Ave SW #5
Sidney, MT 59270

Donna Burnett
14446 SE BONNIE WAY
Portland, OR 97230

Doug Buxbaum
Dawson County Commission
207 West Bell Street
Glendive, MT 59330

Brian Buxbaum
13595 CR 356
Fairview, MT 59221

Edward Buxbaum
34256 Co Rd 107
Savage, MT 59262

Robert Buxbaum
13318 Hwy 200
Fairview, MT 59221

Scott Buxbaum
16041 34th St NW
Fairview, MT 59221

Donald Byer
318 W MAIN ST
SIDNEY, MT 59270-4038

Donald & Roger Byer
108 2ND ST NE
Sidney, MT 59270

Steve Cadue
Kickapoo Tribe in Kansas
P.O. Box 2890
Horton, KS 66439

Leon Campbell
Iowa Tribe of Kansas and Nebraska
3345 Thunder Road, No. B
White Cloud, KS 66094-04028

James Campbell
34852 Co Rd 121B
Sidney, MT 59270

Garey Candee
35296 Co Rd 131
Fairview, MT 59221

Richard Carlson
Sidney Sugars
308 5th Ave SE
Sidney, MT 59270

Barry Carpenter
115 2ND ST SE
Sidney, MT 59270

Barry Carpenter
201 W Main
Sidney, MT 59270

Vance Carsten
LYIP
12993 Highway 200
Sidney, MT

Garrick Carter
10398 CR 340
Savage, MT 59262

Edmundo Castro Castro
16091 36th St NW
Fairview, MT 59221

Andrew Cayko
15891 32nd St NW
Fairview, MT 59221

Daniel Cayko
PO Box 53
Fairview, MT 59221

Francis Cayko
1015 7TH AVE SW APT 207
Sidney, MT 59270

Nickie Cayko
375 Fire Ln
Anaconda, MT 59711

Richard Cayko
3691 158th Ave NW
Fairview, MT 59221

Terry Cayko
15852 36th ST NW
Fairview, MT 59221

Tim Cayko
15951 Hwy 200
Fairview, MT 59221

Todd Cayko
3252 159th Ave NW
Fairview, MT 59221

Tony Chamberlain
PO BOX 887
SIDNEY, MT 59270

Ethan Chamberlain
1364 14th ST SW
Sidney, MT 59270

Marion Christensen
34948 Co Rd 140
Fairview, MT 59221

Larry Christensen
Tri County Implement Inc.
417 25th Ave NW
Sidney, MT 59270

Tami Christensen
Tri County Implement Inc., & City of Sidney
2429 W Holley
Sidney, MT 59270

Ernie Clifton
601 S Central Ave
Sidney, MT 59270

Jacqueline Cloidt
154 Amber Valley Drive
Orinda, CA 94563

Janet Cole
PO BOX 1030
CALIENTE, NV 89008-1030

Conrad Conradsen
10761 Co Rd 344
Savage, MT 59262

Harlan Conradsen
10757 Hwy 16
Savage, MT 59262

Troy D Conradsen
Triple C Farms
34127 C R 107
Savage, MT 59262

Conrad Conradsen
10761 CR 344
Savage, MT 59262

Shawn Conradsen
34187 CR 107
Savage, MT 59262

Albert Cooley
Rt 1 Box 173
Grand Forks, ND 58201

Pete Council
12775 Co Rd 352
Sidney, MT 59270

Robert Cournoyer
Yankton Sioux Tribe
P.O. Box 248
Marty, SD 57361

Lower Yellowstone Intake Diversion Dam Fish Passage Project, Montana
Environmental Impact Statement
May 2016

Lyle Courtnage
Magic City Fly Fishers
PO Box 21693
Billings, MT 59104

Sherrie Dardis
11294 Hwy 16
Savage, MT 59262

Robert Crandall
35001 Co. Rd 122
Sidney, MT 59270

Katie Dasinger
Richland Eco Development
1060 S. Central Ave, Ste 3
Sidney, MT 59270

Stacy Creek
Stockman Bank
101 S Central Ave
Sidney, MT 59270

Arne Degn
1830 Westwood Dr
Billings, MT 59102

Dana & Kay Crosby
315 8th Ave SW
Sidney, MT 59270

Michael Denowh
34753 Co Rd 127
Sidney, MT 59270

Brady Cullen
The Nature Conservancy
821 SE 14th Avenue
Portland, OR 97219

Tim Denowh
3244 155th Ave NW
Cartwright, ND 58838

Bill Cundiff
35058 LR 129
Sidney, MT

Albert Dige
102 BONAVENTURE DR
Billings, MT 59102

Buck G Dabill
10362 COUNTY ROAD 342
Savage, MT 59262

Arnold Dige
1013 Lincoln Ave NW
Sidney, MT 59270

Merle Daniel
805 4th St
Sidney, MT 59270

Russell Dige
996 Lincoln Ave NW
Sidney, MT 59270

Dale Danielson
16081 30th St NW
Fairview, MT 59221

Julia Doney
Gros Ventre and Assiniboine Tribe of Ft.
Belknap
Rural Route 1, Box 66
Harlem, MT 59526-9705

Doug Danielson
16071 30th St NW
Fairview, MT 59221

Gordon Donohoe
624 S Berry Pine Rd
Rapid City, SD 57702

Dale Danielson
Danielson Farms
16081 30th St. NW
Fairview, MT 59221

Richard Dore
2693 Hwy 200
Sidney, MT 59270

Virginia Dardis
11292 Hwy 16
Savage, MT 59262

Ryan Dore
12905 CR 350
Sidney, MT 59270

Janet Duda
PO Box 467
Fairview, MT 59221

Mike Dunn
925 3rd Ave SE
Sidney, MT 59270

Chris & Walter Durfey
11303 CR 345
Savage, MT 59262

Keith Dynneser
13102 CR 342
Sidney, MT 59270

Keith Dynneson
13115 Co Rd 342
Sidney, MT 59270

Sherman Dynneson
12784 HIGHWAY 200
Sidney, MT 59270

Christopher & Joyce Eckhoff
11463 HIGHWAY 16
Savage, MT 59262

Joyce Eckhoff
1501 N Central Ave
Sidney, MT 59270

Joyce Eckhoff
1501 N. Central Ave
Sidney, MT 59270

Joan Eldridge
16111 37th St NW
Fairview, MT 59221

JOAN E ELDRIDGE
3702 HIGHWAY 58
FAIRVIEW, MT 59221

Archer Ellweing
PO Box 333
Sidney, MT 59270

ROGER S EMERY
2144 S CENTRAL AVE
Sidney, MT 59270

Elaine & Harold Emly
34992 Hwy 23
Sidney, MT 59270

Teresa Erickson
Northern Plains Resource Council
220 South 27th Street, Suite A
Billings, MT 59101

Kenny & Renee Erickson
12300 COUNTY ROAD 351
Sidney, MT 59270-6305

Margaret Erickson
790 Lincoln Ave NW
Sidney, MT 59270

Wes Erickson
13345 Hwy 200
Fairview, MT 59221

Todd Erickson
2097 Bitterroot Dr
Sidney, MT 59270

Jonetta Erickson
546 35th Ave NW
Sidney, MT 59270

Torbin Erikstrup
35216 Co Rd 128
Sidney, MT 59270

Wayne Eschenbacher
11235 Hwy 16
Savage, MT 59262

Donn Eskridge
PO Box 45
Crane, MT 59217

Scott Estergard
Tetra Tech
3030 N 3rd St., #200
Phoenix, AZ 85012

Ron Etzel
LYIP
Box 102
Savage, MT 59262

Lower Yellowstone Intake Diversion Dam Fish Passage Project, Montana
Environmental Impact Statement
May 2016

City of Fairview
PO Box 426
Fairview, MT 59221

Darrell Finsaas
16112 35th St NW
Fairview, MT 59221

Edward Falkenhagen
2992 160th Ave. N.W. #536
Fairview, MT 59221

Orvin Finsaas
15952 28th St NW
Fairview, MT 59221

Buxbaum Family Trust
PO Box 433
Fairview, MT 59221

Darrell Finsaas
16112 35th St. NW
Fairview, MT 59221

Bruce Farling
Montana Trout Unlimited
P.O. Box 7186
Missoula, MT 59807
Payette Farms
104 Interstate Ave. N
Fairview, MT 59221

Gabriel Fischer
11338 Hwy 16
Savage, MT 59262

Gabriel Fischer
34314 COUNTY ROAD 111
Savage, MT 59262

Daniel T. Farr
Sidney Public Schools
1107 11th Street SW
Sidney, MT 59270

Donna Fisser
1072 Duna Dr
Laramie, WY 82072

Dean Faulkner
35133 Co Rd 124
Sidney, MT 59270

Charles Flynn
15962 Hwy 200
Fairview, MT 59221

Rick Fehrs
1728 Orange Ave E
St. Paul, MN 55106

Eldean Flynn
2641 Cheney Creek Rd
Cartwright, ND 58838

Edward Ferguson
3118 Ramada Dr
Billings, MT 59102

David Frandsen
12645 Hwy 200
Sidney, MT 59270

Clinton Filler
16101 38th St NW
Fairview, MT 59221

Connie Frandsen
12613 CR 351
Sidney, MT 59270

Tim Fine
701 2nd St NE
Sidney, MT 59270

John M Franklin
34611 Hwy 200
Sidney, MT 59270

Marvelle Fink
35009 Co Rd 126
Sidney, MT 59270

Jon Franz
Franz Ranch
13221 Cr 339
Sidney, MT 59270

Don Franz
Franz Construction Inc
PO Box 1046
Sidney, MT 59270

Ray Franz
Franz Ranch
13221 CR 330
Sidney, MT 59270

Kayla M Freeman
Quinnell Electric
PO Box 131
Savage, MT 59262

Brett French
Billings Gazette
401 North Broadway
Billings, MT 59101

Brandon Fuhrman
Box 124
Sidney, MT 59270

Codly Fulton
Agri Industries
1775 S. Central Ave
Sidney, MT 59270

John Gable
PO Box 854
Sidney, MT 59270

Thomas Gable
13249 Co Rd 356
Fairview, MT 59221

John Gable
Box 854
Sidney, MT 59270

Brian Galik
Gallik and Bremer, P.C.
777 East Main Stree, Suite 203
Bozeman, MT 59711-0070

Lisa Garder
Garder Trenching
11685 CR 350
Sidney, MT 59270

Tracy Garland
611 2nd St NE
Sidney, MT 59270

Bryan Gartner
702 11th St SE
Sidney, MT 59270

Art Gehnert
108 2nd Cottonwood Grv
Glendive, MT 59330

Chip Gifford
Johnson Hardware
PO Box 1006
Sidney, MT 59270

Bob Gilbert
Montana Walleyes Unlimited
P.O. Box 1228
Sidney, MT 59270

Debra Gilbert
121 3rd Ave NW
Sidney, MT 59270

Jake Godfrey
12218 Co Rd 348
Sidney, MT 59270

Jake Godfrey
12218 CR 348
Sidney, MT 59270

Martha Gorder
PO Box 1268
Sidney, MT 59270

Shane Gorder
11685 Cir 350
Sidney, MT 59270

Julie Goss
Richland County Conservation District
2745 West Holly St
Sidney, MT 59270

Julie Goss
2745 W. Holly St
Sidney, MT 59270
Thomas Graves

Lower Yellowstone Intake Diversion Dam Fish Passage Project, Montana
Environmental Impact Statement
May 2016

Mid-West Electric Consumers Association
4350 Wadsworth Blvd, Suite 330
Wheat Ridge, CO 80033

Chris P Griffith
Stockman Bank
35090 CR 129
Sidney, MT 59270

Bud Groskinsky
34851 Co Rd 120Z
Sidney, MT 59270

Ronald Gross
15882 Hwy 200
Fairview, MT 59221

Douglas Gullikson
12441 Co Rd 352
Sidney, MT 59270

James Gullikson
3492 157th Ave NW
Cartwright, ND 58838

Doug Gullikson
15592 30th St NW
Cartwright, ND 58838

Jim Gullikson
3492 15th Ave NW
Cartwright, ND 58838

Rachel Gunderson
Sidney Sugars
399 12th Ave SW
Sidney, MT 59270

Ronald Gurney
12533 Co Rd 352
Sidney, MT 59270

Russell Gurney
11457 Hwy 16
Savage, MT 59262

Joe Gutkoski
Montana River Action Network
304 N. 18th Ave
Bozeman, MT 59715

Joe Gutkoski
Montana River Action
304 N 18th Avenue
Bozeman, MT 59715

Tom Hafele
PO Box 121
Savage, MT 59262

Philip Hafeman
33454 CR 114
Savage, MT 59262

Jeff Hagener
Montana Fish, Wildlife and Parks
1420 East Sixth Avenue
Helena, MT 59620-0701

Barbara Hagler
2830 Providence Pl
Billings, MT 59101

Brent Hagler
10896 Co Rd 344
Savage, MT 59262

Joanne Hagler
10898 Co Rd 344
Savage, MT 59262

Wade Hagler
10924 Co Rd 344
Savage, MT 59262

Brent Hagler
10896 CR 344
Savage, MT 59262

ROGER HALL
PO BOX 17082
MISSOULA, MT 59808-7082
Daniel & Teresa Halley
PO BOX 558
SIDNEY, MT 59270-0558

Greg Hallsten
MT Department of Environmental Quality
1520 East 6th Ave
Helena, MT 59620-0901

David Halvorson
704 3RD ST SE
SIDNEY, MT 59270-4721

Bill & Marcy Hamburg
PO Box 84
Savage, MT 59262

Ken Hanna
Walleyes Forever
PO Box 21852
Billings, MT 59104

Arnold Hansen
207 2nd Ave NW
Sidney, MT 59270

Robert & Betty Hansen
835 Amethyst Dr
Santa Maria, CA 93455

Mary Hanson
Montana Land Reliance
P.O. Box 171
Billings, MT 59103-0171

Linda Hanson
402 7th St SE
Sidney, MT 59270

Rick Haraldson
216 14th Ave SW
Sidney, MT 59270

Boyd Hardy
13265 Hwy 200
Fairview, MT 59221
David Hardy
3131 160th Ave NW
Fairview, MT 59221

JW Hardy
3162 160th Ave NW
Fairview, MT 59221

Mark Hardy
818 9TH ST SW
SIDNEY, MT 59270-4812

Boyd Hardy
31265 Hwy 200
Fairview, MT 59221

Philip Harley
3291 160th Ave NW
Fairview, MT 59221

Howard Harmon
11297 COUNTY ROAD 345
Savage, MT 59262

Howard Harmon
PO Box 41
Crane, MT 59217

David & Kathleen Harris
PO Box 1
Crane, MT 59217

John Hart
Montana Environmental Information Center
P.O. Box 1184
Helena, MT 59601

Clarence Hartle
12076 Hwy 16
Sidney, MT 59270

Randi Hass
PO Box 172
Sidney, MT 59270

Dave Haverkamp
34719 Co Rd 119
Sidney, MT 59270

Arvin Heinle
16032 35th St NW
Fairview, MT 59221

Dale Helm
10898 W 30th Place
Lake Wood, CO 80215

Don Helm
15942 35th St NW
Fairview, MT 59221

Lower Yellowstone Intake Diversion Dam Fish Passage Project, Montana
Environmental Impact Statement
May 2016

Jill Helmuth
Bartlett & West, Inc.
Box 250
Watford City, ND 58854

Bill Henderson
PO Box 1050
Sidney, MT 59270

Thomas Henderson
PO Box 62
Crane, MT 59217

Doug Hill
Walleyes Unlimited (Mon-Dak) Chapter
304 4th Street SE
Sidney, MT 59270

Howard Hill
818 5th St SE
Sidney, MT 59270

Howard Hill
35554 CR 133
Fairview, MT 59221

Chris Hillesland
1517 6th St SE
Sidney, MT 59270

Donald Hillman
35362 COUNTY ROAD 129
SIDNEY, MT 59270-4256

Charles Hillman
35362 CR 129
Sidney, MT 59270

Cathy Hintz
2405 W. Holly St
Sidney, MT 59270

Ron His Horse Is Thunder
Standing Rock Sioux Tribe
Admin. Service Center, Bldg #1,
North Standing Rock Avenue
Fort Yates, ND 58538

FRED D Hoeger
PO Box 480
Terry, MT 59349

Kenneth Hoff
12675 Co Rd 352
Sidney, MT 59270

Steve Hoffman
Montana Audubon
P.O. Box 595
Helena, MT 59624

Venture Holding Company
409 14th St SW
Great Falls, MT 59404

Rankin Holmes
Montana Water Trust
140 S. 4th St. West, Unit 1
Missoula, MT 59801

James Holst
803 14th St SE
Sidney, MT 59270

Jessica Hoon
City of Sidney
720 22nd Ave NW
Sidney, MT 59270

John C. Hoon
270 5th Ave S
Savage, MT 59262

Travis Horton
Upper Basin Pallid Sturgeon Recovery
Workgroup
1420 East Sixth Avenue
P.O. Box 200701
Helena, MT 59620-0701

John Houle
Chippewa Cree Tribe of the Rocky Boys'
Reservation
Rural Route 1, Box 544
Box Elder, MT 59521-9724

Rhonda Hunter
13988 CR 347
FAIRVIEW, MT 59221

Dale Hurley
15852 33rd St NW
Fairview, MT 59221

Rodney Hurley
14479 COUNTY ROAD 355
Fairview, MT 59221

Vess E Hurley
PO BOX 200
Fairview, MT 59221

Dale Hurley
15852 33 ST SW
Fairview, MT 59221

Ty Hurley
35531CR 147
Fairview, MT 59221

John Hutter
3152 Hwy 58
Fairview, MT 59221

Hugh Hutton
12794 Hwy 200
Sidney, MT 59270

Kat Imhoff
The Nature Conservancy of Montana
32 S. Ewing, Suite 215
Helena, MT 59601

Mark iSzler
505 Lincoln Ave S
Sidney, MT 59270

Dale & Mark Iversen
35201 Co Rd 128
Sidney, MT 59270

Kenneth Iversen
35188 Co Rd 128
Sidney, MT 59270

Mark Iversen
35193 Co Rd 126
Sidney, MT 59270

Marlow Iversen
PO Box 158
Savage, MT 59262

Ruth Iversen
35177 Co Rd 128
Sidney, MT 59270

William Iversen
35205 Co Rd 128
Sidney, MT 59270

Bill Iversen
35205 CR 128
Sidney, MT 59270

Dick Iversen
13749 CR 332
Culbertson, MT 59218

Neil Iversen
PO Box 1166
Williston, ND 58802

Kathleen A Iverson
35193 C R 126
Sidney, MT 59270

Albert Jackson
907 14th St SE
Sidney, MT 59270

Michael Jandreau
Lower Brule Sioux Tribe
187 Oyate Circle
Lower Brule, SD 57548-0187

Harry & Lucille Jensen
735 6th St NE
Sidney, MT 59270

Michael Jepsen
11110 Co Rd 345
Savage, MT 59262

JH Farms LLC
4653 E Iona Rd
Idaho Falls, ID 83401

JLDM, LLC
13705 Co Rd 351
Fairview, MT 59221

Lower Yellowstone Intake Diversion Dam Fish Passage Project, Montana
Environmental Impact Statement
May 2016

Kirk Johnson
3041 Cheney Creek Rd
Cartwright, ND 58838

Cassey Johnson
1045 15th St SW - Apt D
Sidney, MT 59270

Henry Johnson
Richland County Commission
201 West Main
Sidney, MT 59270

April Johnston
American Wildlands
321 East Main, Suite 418
Bozeman, MT 59715

Collins Johnson
PO Box 354
Fairview, MT 59221

Justin Jones
Mon-Dak Walleyes Unltd
2502 3rd St. NW
Sidney, MT 59270

Kirk Johnson
3041 Cheney Road
Cartwright, ND 58838

Clifford Jones
PO Box 1489
Sidney, MT 59270

Richard Johnson
16112 36th St NW
Fairview, MT 59221

Randy Jones
1101 Sunflower Ln
Sidney, MT 59270

Terry Johnson
PO BOX 249
MISSION, SD 57555-0249

Kjeld Jonssen
34379 CR 110
Savage, MT 59262

Warren Johnson
P.O. Box 354
Fairview, MT 59221

KJELD B Jonsson
34379 Co Rd 110
Savage, MT 59262

Josh Johnson
Interstate Engineering
PO Box 648
Sidney, MT 59270

George Jordan
United States Fish and Wildlife Service
2900 4th Ave N Suite 301
Billings, MT 59101

Theresa Johnson
Country Lane Farms
15932 29th Ave NW
Fairview, MT 59221

R Jorensen
Box 117
Crane, MT 59214

Calvin Johnson
34172 CR 131
Sidney, MT 59270

Dave Jorgensen
10986 Co Rd 342
Savage, MT 59262

Anita Johnson
3041 Cheny Creek Rd
Cartwright, ND 58838

Jon Jorgensen
11375 Co Rd 345
Savage, MT 59262

Hubert Johnson
PO Box 351
Sidney, MT 59270

Dee Jorgensen
John & Dee Farming, INC
11375 CR 345
Savage, MT 59262

Lanette Jorgensen
10986 CR 342
Savage, MT 59262

Keri D Jorgensen
AJNK, Inc.
11297 CR 345
Savage, MT 59262

Don & Christine Josephson
1998 BITTERROOT DR
Sidney, MT 59270

Steve Joslin
12751 Co Rd 353
Sidney, MT 59270

Cathy Juhas
US Army Corps of Engineers
P.O Box 2256
Billings, MT 59103

Garth N. Kallevig
Stockman Bank
101 South Central Ave
Sidney, MT 59270

Brent Kallevig
Box 55
Sidney, MT 59270

Arlene Karst
16052 30th St NW
Fairview, MT 59221

Donald Karst
PO Box 225
Fairview, MT 59221

Jim Karst
16032 Hwy 200
Fairview, MT 59221

Justin Karst
3211 Hwy 58
Fairview, MT 59221

Richard Karst
3171 160 Ave NW
Fairview, MT 59221

Virgil Karst
16082 30th St NW
Fairview, MT 59221

Ted Karst
16022 30th St NW
Fairview, MT 59221

Scott R Keibel
806 2nd St. SW #4
Sidney, MT 59270

Scot R Keig
806 2nd St SW, #4
Sidney, MT 59270

Lloyd Keller
34743 Co Rd 119N
Sidney, MT 59270

Aaron Kessel
35010 HIGHWAY 23
Sidney, MT 59270

Allen Kessler
316 Valley Rd
Fairfield, AL 35064

Key Rocky Mtn
TAX DEPARTMENT
HOUSTON, TX 77010

Gary Kindopp
140 Orchard Lane
Billings, MT 59102

Ken Kios
Box 27
Trenton, ND 58853

Cathy Kirkpatrick
Senator Walsh office
112 W. Towne St
Glendive, MT 59330

William R Kirschner
PO Box 79
Sidney, MT 59270

Lower Yellowstone Intake Diversion Dam Fish Passage Project, Montana
Environmental Impact Statement
May 2016

Jeff Klempel
34984 Co Rd 122E
Sidney, MT 59270

Jeremy Klempel
35146 Co Rd 126
Sidney, MT 59270

Kent Klose
3032 160 Ave NW
Fairview, MT 59221

Kent Klose
15981 35th St NW
Fairview, MT 59221

Ken Klose
Klose Farms
3072 160 Ave
Fairview, MT 59221

Vernon Klose
3032 160th Ave NW
Fairview, MT 59221

Ken Knels
16061 33rd St NW
Fairview, MT 59221

Larry Knels
555 EL PASO ST
BILLINGS, MT 59101-6868

Rep. Austin Knudsen
MT House of Representatives
PO Box 624
Culbertson, MT 59218
Stacy Kober
Agri Industries, Inc.
941 14th St. SW
Sidney, MT 59270

Gene Koch
12776 Co Rd 352
Sidney, MT 59270

Don Kopecky
PO Box 90
Sidney, MT 59270

Lenny Kortez
Helena Chemical
904 E. Main Street
Sidney, MT 59270

Chad Kostelecky
34575 CR 117
Sidney, MT 59270

Betty Kringen
12118 Hwy 16
Sidney, MT 59270

Randal Kringen
2700 Lincoln Ave SE
Sidney, MT 59270

Randy & Suzie Kringen
2508 LINCOLN AVE S
SIDNEY, MT 59270

Gary L LaCasse
PO BOX 67
PLENTYWOOD, MT 59254-0067

Doug Lang
629 9th Ave SW
Sidney, MT 59270

Denise Lang
312 2nd Ave SE
Sidney, MT 59270

Bob Lange
33649 Co Rd 109
Savage, MT 59262

Lucy Langwald
2892 160th Ave NW
Fairview, MT 59221

Tim Langwald
3781 Hwy 58
Fairview, MT 59221

Lowell Larson
316 44th Ave So
Moorhead, MN 56560

Alan Larson
32589 CR 137
Lambert, MT 58243

Dennis Latka
34954 Hwy 23
Sidney, MT 59270

Dereke Lawrance
12755 Co Rd 352
Sidney, MT 59270

Matt Ler
10743 COUNTY ROAD 340
Savage, MT 59262

Lloyd Lester
3752 Hwy 58
Fairview, MT 59221

William Lewis
34134 Hwy 201
Fairview, MT 59221

David Linde
34880 COUNTY ROAD 132
FAIRVIEW, MT 59221-9445

David G. Linde
34880 CR 132
Fairview, MT 59221

Bill D Lindsay, Sr
Agri Industries
311 21st Ave NW, Lot 10
Sidney, MT 59270

John Little
Montana Fish, Wildlife and Parks
Industrial Site West
Miles City, MT 59301

Tom Lorenz
34839 Co Rd 122
Sidney, MT 59270

Joel Lorenz
Lorenz Concrete
13346 Hwy 200
Fairview, MT 59221

Rick Lovec
121 7th Ave SW
Sidney, MT 59270

Linda Lovgren
Lovgren Marketing Group
809 N 96 St, #2
Omaha, NE 68114

Dennis Lowery
Sidney Rental
12108 CR 350
Sidney, MT 59270

Chuck Lowman
12749 Co Rd 352
Sidney, MT 59270

Charles Lowman
1249 CR 352
Sidney, MT 59270

Scott Ludwig
117 7th Ave SW
Sidney, MT 59270

Robert Lunderby
12348 Co Rd 351
Sidney, MT 59270

Steve Lunderby
12344 Co Rd 351
Sidney, MT 59270

Steve Lunderby
Lunderby Feedlots
12314 CR 351
Sidney, MT 59270

Gary Malsam
PO Box 393
Fairview, MT 59221

Tami Maltese
113 West Main St
Sidney, MT 59270

Walter Manlitt
110 12th Ave SW
Sidney, MT 59270

Lower Yellowstone Intake Diversion Dam Fish Passage Project, Montana
Environmental Impact Statement
May 2016

Forrest Markle
35361 Co Rd 128
Sidney, MT 59270

David McMillen
1675 W. Holly St
Sidney, MT 59270

Randy Marmon
16061 39th St NW
Fairview, MT 59221

Craig McPherson
82 Road 555
GLENDDIVE, MT 59330-1937

Marion Martin
15942 34th St NW
Fairview, MT 59221

MDU
PO Box 5650
Bismarck, ND 58501
Davis Meehan
1420 W Holly
Sidney, MT 59270

Monte Martin
3621 160 Ave NW
Fairview, MT 59221

Alan Mehl
11361 Hwy 16
Crane, MT 59217

Yellowstone River Conservation District
Council
1371 Rimtop Dr
Billings, MT 59105

Pat Micheletto
33878 Co Rd 101
Savage, MT 59262

Yellowstone River Conservation District
Council
P.O. Box 148
Livingston, MT 59047

Carl Miller
2902 161 Ave NW
Fairview, MT 59221

Brian McDanold
Glendive Walleyes Unltd
407 Chestnut
Glendive, MT 59330

Daniel Miller
122 Glenwood Ave
Glendive, MT 59330

David McDonald
PO Box 265
Sidney, MT 59270

Daniel Miller
3765 HIGHWAY 58
Fairview, MT 59221

Doreen McDonald
319 7th Ave SW
Sidney, MT 59270

Thomas Miller
8700 SILA PL
Rapid City, SD 57702-9084

Robert McGinnis
1515 Sunflower Ln
Sidney, MT 59270

Toby Miller
2912 161 St Ave NW
Fairview, MT 59221

Brian McGinnis
814 Lincoln Ave NW
Sidney, MT 59270

Greg Miller
323 23rd Ave NW
Sidney, MT 59270

Jerry McMillen
10090 Hwy 261
Sidney, MT 59270

Gary Mindt
13128 Hwy 200
Fairview, MT 59221

Clyde & Duane Mitchell
11843 Hwy 16
Sidney, MT 59270

Everett Mitchell
PO Box 338
Glendive, MT 59330

Duane Mitchell
221 S. Lincoln Ave
Sidney, MT 59270

Lee Moore
PO Box 604
Baker, MT 59313

Matthew Moore
PO BOX 542
BAKER, MT 59313-0542

Cheryl Murphy
295 Bitterroot Rd
Miles City, MT 59301

William Nankivel
35338 Co Rd 131
Fairview, MT 59221

Gerald & Mary Ellen Navratil
12026 Hwy 16
Sidney, MT 59270

Keith Nelson
34469 Co Rd 110
Savage, MT 59262

John M Nelson
210 4th Ave SW
Sidney, MT 59270

Linda Nelson
Valley Garage, Inc.
PO Box 177
Savage, MT 59262

Don Netzer
12127 Co Rd 348
Sidney, MT 59270

Charlene Netzer
12127 County Road 348
Sidney, MT 59270

Don Netzer
12127 CR 348
Sidney, MT 59270

Sheila Neu
PO Box 123
Fairview, MT 59221

Fe Neumann
883 3RD AVE SE
Sidney, MT 59270

Mike Newton
Montana Walleyes Unlimited
316 Chestnut Avenue
Glendive, MT 59330

Peggy Newton
Dawson County Conservation District
102 Fir Street
Glendive, MT 59330

Rex Niles
329 JIB CT
LAKESIDE, MT 59922-9746

Del Nollmeyer
34461 Co Rd 112
Savage, MT 59262

Marlin Norby
15932 29th St NW
Fairview, MT 59221

Palmer Norby
12255 Co Rd 350
Sidney, MT 59270

Rocky Norby
35244 Co Rd 126
Sidney, MT 59270

Harvey Noteboom
16037 West Sandia Park Dr
Surprise, AZ 85374

Lower Yellowstone Intake Diversion Dam Fish Passage Project, Montana
Environmental Impact Statement
May 2016

Cindy Nygard
LYIP
1998 Goldenrod Ln
Sidney, MT 59270

Jerry Nypen
Lower Yellowstone Irrigation District
2327 Lincoln Avenue Southeast
Sidney, MT 59270

Leonard Odenbach
604 Rock Spring Rd
Naperville, IL 60565

Joel Olson
12924 Co. Rd. 353
Sidney, MT 59270

Andy Olson
Box 33
Crane, MT 59217

Highland Operating LLC
PO Box 5103
Enid, OK 73702-5103

Zoe Opie
Big Horn Alliance
PO Box 7884
Fort Smith, MT 59305

Steve Ortiz
Prairie Band of Potawatomi Nation
16281 Q Road
Mayetta, KS 66509

Mitchell Parker
Omaha Tribe of Nebraska
P.O. Box 368
Macy, NE 68039-0368

David Parsheill
224 Mitchell St
Deerlodge, MT 59722

Allyn Partin
35190 Cty Rd 127
Sidney, MT 59270

Lyle Partin
35184 Cty Rd 127
Sidney, MT 59270

Allyn Partin
35190 CR 127
Sidney, MT 59270

Lyle E. Partin
Montana Dakota Utilities
35184 County Road 127
Sidney, MT 59270

Katherine Paschke
Sweetwater Retirement Apt 206;
3140 Sweet Water Drive
Billings, MT 59102

Tom Pavek
1911 14th ST SW
Sidney, MT 59270

Charlotte Payette
104 Interstate Ave. N
Fairview, MT 59221

Myra Pearson
Spirit Lake Dakotah Nation
P.O. Box 359
Fort Totten, ND 58335

Kent Pedersen
McKenzie County SCD
1952 136th Ave NW
Arnegard, ND 58835

James Pesek
14514 Hwy 200
Alexander, ND 58831

Lyle E. Peters
11390 CR 345
Savage, MT 59262

Maria Peters
1148 Safflower Ln
Sidney, MT 59270

Kermit Petersen
1411 22nd Ave NW
Sidney, MT 59270

GAIL PETERSON
35052 COUNTY ROAD 123
SIDNEY, MT 59270-6307

Darren & Jeffry Peterson
57 Franklin Pl
Montclair, NJ 07042

Gale Peterson
PO Box 788
Sidney, MT 59270

Gene Peterson
PO Box 93
Crane, MT 59217

Lyle Peterson
1600 S EAGLE RIDGE DR #112
RENTON, WA 98055

Lynn Barry Peterson
2822 3rd St NW
Sidney, MT 59270

Vernon Peterson
11196 Co Rd 344
Savage, MT 59262

Roger Peterson
1707 14th St SW
Sidney, MT 59270

Lynn Peterson
282 3rd St NW
Sidney, MT 59270

Mathew Pilcher
Winnebago Tribe of Nebraska
P.O. 687
Winnegabo, NE 68071-0687

Plainview Farms LLP
3164 160th Ave NW
Fairview, MT 59221

Bing Poff
101 7th Ave NW
Sidney, MT 59270

Vanessa Pooch
Sidney Sugars
321 W Main Street
Sidney, MT 59270

Ivan D. Posey
Eastern Shoshone Tribe
P.O. Box 538
Fort Washakie, WY 82514

Stephen Potts
United States Environmental Protection Agency
10 West 15th St., Suite 3200
Helena, MT 59626

Elwin Prevost
33862 Co Rd 101
Savage, MT 59262

Fred Prevost
26 Rd 555
Glendive, MT 59330

GEORGE PREVOST
33161 COUNTY ROAD 128
LAMBERT, MT 59243

Walter Prevost
33713 Co Rd 100
Savage, MT 59262

Wilma Prevost
PO Box 32
Savage, MT 59262

Rodney Prewitt
815 3rd St NE
Sidney, MT 59270

Arlen & Lonnie PRICE
2397 S CENTRAL AVE
Sidney, MT 59270

Dale Price
34373 Co Rd 111
Savage, MT 59262

Donald Provost
Lower Yellowstone Electric
3200 W Holly St
Sidney, MT 59270

Lower Yellowstone Intake Diversion Dam Fish Passage Project, Montana
Environmental Impact Statement
May 2016

Arline Pust
11151 Hwy 16
Savage, MT 59262
Dan Pust
11 Rd 240
Glendive, MT 59330

Doug Pust
11199 Hwy 16
Savage, MT 59262

Steve Pust
11153 Hwy 16
Savage, MT 59262

Emagene Quinnell
Quinnell Electric
PO Box 114
Savage, MT 59262

Howard Rambur
34790 Co Rd 118
Sidney, MT 59270

Gordan Rambur
Montana Turf N Wheels
1055 Red River
Sidney, MT 59270

Cheryl Rankin
Sidney Millwork Co
34451 CR 112
Savage, MT 59262

Ellen Rasmussen
35390 Co Rd 147
Fairview, MT 59221

Kerry Rasmussen
34539 CR 128
Sidney, MT 59270

Robert Rauschendorfer
PO BOX 4
Sidney, MT 59270

Greg Rauschendorfer
31256 CR 143
Poplar, MT 59255

Redfren
Billings Walleyes Unltd
PO Box 1891
Billings, MT 59103

Beth Redlin
1500 N Central Ave
Sidney, MT 59270

Beth Redlin
1128 8th Ave NW
Sidney, MT 59270

Holly Redman
PO Box 115
Crane, MT 59217

John R Redman
11733 Hwy 261
Sidney, MT 59270

Patte Redmond
PO Box 985
Sidney, MT 59270

Kim Rehbein
11800 CR 348
Sidney, MT 59270

Denny Rehberg
United States House of Representatives
1201 Grande Avenue, Suite 1
Billings, MT 59102

Gerhard Reichenbach
2772 162 Ave NW
Fairview, MT 59221

Walt Reichenbach
35184 Co Rd 124
Sidney, MT 59270

Richard Reidel
3242 Hwy 58E
Fairview, MT 59221

Earl Reidle
3341 Hwy 58
Fairview, MT 59221

Becky D Reidle
Reidle Farms
1023 Lincoln Ave NW
Sidney, MT 59270

Linda Reisig
31111th St SE
Sidney, MT 59270

Tom Reiter
Montana Pike Masters
3827 River Rd
Laurel, MT 59044

Ted Reitz
35284 Co Rd 129
Sidney, MT 59270

Ted Reitz
35284 CR 129
Sidney, MT 59270

John Reynolds
1204 14th St. SW
Sidney, MT 59270

George Rice
122 ROAD 555
GLENDDIVE, MT 59330-9318

Lillian Riedel
16042 HIGHWAY 200
Fairview, MT 59221

Sam Ritter
35269 Co Rd 127
Sidney, MT 59270

Dave & Bobbie Roberts
201 Dry Creek Rd
Wibaux, MT 59353

JB Roberts
919 13th St SW
Sidney, MT 59270

Jim Robinson
Department of Natural Resources and
Conservation
P.O. Box 201601
Helena, MT 59620-1601

Jay Rosaaen
12601 COUNTY ROAD 333
LAMBERT, MT 59243-9403

Jay Rosaaen
12601 CR 333
Lambert, MT 59243

Stan Rosaaer
Niehenke Welding
312 N. Central Ave
Sidney, MT 59270

JEAN Rosendale
1954 HIGHWAY 16
GLENDDIVE, MT 59330-9218

Kevin Roth
1634 Aster Ct
Sidney, MT 59270

Deb Rowe
12107 Christina Ct
Fredrickson, VA 22407

Margaret Rowley
826 Pine Forest Trail
PORT ORANGE, FL 32129.00-7790

Joe Russell
48 Spring Tree Rd
Great Falls, MT 59404

Fred Rykman
North Dakota Fish & Game
100 N. Mismarck Expressway
Bismarck, ND 58501

JERRY SATRA
216 15th Ave SW
Sidney, MT 59270

Dennis Scarnecchia
University of Idaho - Department of Fish &
Wildlife Resources
PO Bo 441136
Moscow , ID 83844

Lower Yellowstone Intake Diversion Dam Fish Passage Project, Montana
Environmental Impact Statement
May 2016

Charlie Schaubel
12922 Hwy 200
Sidney, MT 59270

Fred Schmitt
35241 Co Rd 127
Sidney, MT 59270

Lonnie Schipman
12335 Co Rd 351
Sidney, MT 59270

Gary Schor
11065 Hwy 16
Savage, MT 59262

Dirk Schlothauer
HD Farms, Inc.
15942 30th St. NW
Fairview, MT 59221

Luella Schow
Security Abstract Co
106 2nd St SW
Sidney, MT 59270

Dirk Schlothauer
15942 30th St NW
Fairview, MT 59221

Dennis Schroeder
Miles City Walleyes Unltd
817 S Custer
Miles City, MT 59301

Don Schlothauer
PO Box 474
Fairview, MT 59221

Charlote Schroeder
PO BOX 52
CRANE, MT 59217-0052

Harold Schlothauer
15922 30th St NW
Fairview, MT 59221

Vernon Schroeder
PO Box 25
Crane, MT 59217

Ken Schlothauer
2891 160 Ave NW
Fairview, MT 59221
Casey Schlothauer
2851 160th Ave NW
Fairview, MT 59221

Gary Schuepp
1399 22 Ave NW
Sidney, MT 59270

Kim Schlothauer
Blue Carriage Farm
7851 160th Ave NW
Fairview, MT 59221

Claire Schultz
318 11th Ave SW
Sidney, MT 59270

Dan Schumacker
35173 Co Rd 129W
Sidney, MT 59270

Dennis Schmierer
PO Box 124
Savage, MT 59262

Randall & Patti JO Searer
34518 COUNTY ROAD 115
Savage, MT 59262

LeeRoy Schmierer
PO Box 92
Savage, MT 59262

Ben Sedlacek
16072 35th St NW
Fairview, MT 59221

Charity Schmierer
10598 Hwy 16
Savage, MT 59262

Gary Sedlacek
16042 35th St NW
Fairview, MT 59221

Craig Seeve
10837 Co Rd 340
Savage, MT 59262

Chris Seeve
91 Morgan Creek Lane
Bozeman, MT 59718

John Seitz
Seitz Insurance
1204 2nd Ave NE
Sidney, MT 59270

Dave & John Seitz
114 2nd Ave SE
Sidney, MT 59270

William J & Philip Seitz
PO Box 326
Sidney, MT 59270

Jamie Selting
35501 CR 131
Fairview, MT 59221

Michael I. Selvage
Sisseton-Wahpeton Sioux Tribe
P.O. Box 509
Agency Village, SD 57262-0509

Janet Sergent
301 14th Ave SW
Sidney, MT 59270

Linda Severson
12908 Co Rd 353
Sidney, MT 59270

Craig Sharpe
Montana Wildlife Federation
P.O. Box 1175
Helena, MT 59624

Willie Sharpe
Blackfeet Nation
P.O. Box 850
Browning, MT 59417

Ned Shinniel
11499 Highway 16
Savage, MT 59262

Sidney Public Schools
121 5th St SW
Sidney, MT 59270

Harold Simard
PO Box 787
Glendive, MT 59330

Edward Simmons
PO Box 211
Fairview, MT 59221

H. Jay Sisel
3213 3rd Ave NE
Sidney, MT 59270
Henning Skov
35167 CR 128
Sidney, MT 59270

Thomas Sluiter
11650 N FORK RD
POLEBRIDGE, MT 59928-9791

Geri Small
Northern Cheyenne Tribe
P.O. Box 128
Lame Deer, MT 59043

Doug Smith
DS Farms
6047 CR 1011
Bainville, MT 59212

Eugene Sondeno
13695 Co Rd 356
Fairview, MT 59221

Eugene Sondeno
PO BOX 321
Fairview, MT 59221

Matt Sondero
34693 R 117
Sidney, MT 59270

Gary Sorensen
506 3rd St NE
Sidney, MT 59270

Lower Yellowstone Intake Diversion Dam Fish Passage Project, Montana
Environmental Impact Statement
May 2016

Harold Sorensen
11199 HIGHWAY 16
SAVAGE, MT 59262

James Steffen
10203 Co Rd 340
Savage, MT 59262

Harold Sorensen
117 10th Ave SW
Sidney, MT 59270

James F Steffen
10230 COUNTY ROAD 340
SAVAGE, MT 59262-9455

Nate Sorensen
10459 Co Rd 340
Savage, MT 59262

Bill Steinbeisser
35154 Co Rd 128
Sidney, MT 59270

Lyle Sponheim
3651 Hwy 58
Fairview, MT 59221

Craig Steinbeisser
11812 Co Rd 348
Sidney, MT 59270

Scott Staffanson
34704 Co Rd 122
Sidney, MT 59270

Craig Steinbeisser
PO Box 1315
Sidney, MT 59270

Scott Staffanson
34704 CR 122
Sidney, MT 59270

David Steinbeisser
35166 Co Rd 128
Sidney, MT 59270

A. T. Stafne
Assiniboine and Sioux Tribes of Fort Peck
P.O. Box 1027
Poplar, MT 59255

Joe Jr Steinbeisser
690 22nd Ave NW
Sidney, MT 59270

LaVondra Stanley
Sidney Chamber of Commerce & Agriculture
909 S. Central Avenue
Sidney, MT 59270

John Steinbeisser
1599 9TH AVE SW
Sidney, MT 59270

Teresa Stedman
Norby Inc.
715 9th Ave SW
Sidney, MT

Don Steinbeisser
Lower Yellowstone Irrigation Commission
11918 CT 348
Sidney, MT 59270

Sabrina K Steer
252 77th
Delano, MN 55328

Larry & Paula Steinbesser
35258 CR 130
Sidney, MT 59270

Mike Steffan
12550 Co Rd 351
Sidney, MT 59270

Don Steineisser, Jr.
11812 CR 348
Sidney, MT 59270

Chadd Steffec
321 W. Main Street
Sidney, MT

Jim Steinheisser
33974 CR 127
Sidney, MT 59270

Garry Steinley
12838 Co Rd 353
Sidney, MT 59270

Louis Stepan
PO Box 376
Helena, MT 59601

Robbie Stepan
3213 Hwy 58
Fairview, MT 59221

Michael Steppe
12706 Co Rd 353
Sidney, MT 59270

Mark Stermitz
Crowley Fleck
305 South 4th Street
Missoula, MT 59801-2701

Leon Stevenson
34705 Co Rd 122
Sidney, MT 59270

Leonard Stevenson
34705 CR 122
Sidney, MT 59270

Henry Stip
808 9th Ave SW
Sidney, MT 59270

Russell Stotts
35081 Co Rd 123T
Sidney, MT 59270

Jane Strasheim
109 Lincoln Ave So
Sidney, MT 59270

Marvin Strasheim
12520 Co Rd 352
Sidney, MT 59270

Rick Strohmyer
Department of Natural Resources and
Conservation
321 Main Street
Miles City, MT 59301

Bill Struckman
11217 Co Rd 344
Savage, MT 59262

Bradley Strupp
PO Box 22
Crane, MT 59217

Tim Stubstad
35223 Co Rd 127
Sidney, MT 59270

Lora Sundheim
2811 Niehenke Dr
Sidney, MT 59270

Diane Swanson
Box 1207
Sidney, MT 59270

Joyce Sweley
35178 Co Rd 127
Sidney, MT 59270

George B Swenson
954 Linoln Ave NW
Sidney, MT

Brett Swift
American Rivers - Northwest Regional Office
320 SW Stark St., Suite 412
Portland, OR 97204

Gene Terland
Bureau of Land Management
5001 Southgate Drive
Billings, MT 59101

Jon Tester
United States Congress
122 West Towne
Glendive, MT 59330

Casey Thiel
1807 S. Central
Sidney, MT 59270

Lester Thompson
Crow Creek Sioux Tribe
P.O. Box 50
Fort Thompson, SD 57339-0050

Lower Yellowstone Intake Diversion Dam Fish Passage Project, Montana
Environmental Impact Statement
May 2016

George Thurman
Sac and Fox Nation of Missouri in Kansas and
Nebraska
305 North Main Street
Reserve, KS 66434

Jeff Tiberi
Montana Association of Conservation Districts
501 North Sanders
Helena, MT 59601

Don Tiffany
201 Georgetown Dr
Glendive, MT 59330

Patricia Tjelde
35359 Co Rd 129
Sidney, MT 59270

Mark Tombre
10477 Co Rd 342
Savage, MT 59262

Wade Tombre
10436 Co Rd 342
Savage, MT 59262

Joe Topp
12281 Cr 347c
Sidney, MT 59270

Kim Trangmoe
Glendive Chamber of Commerce and
Agriculture
808 North Merrill
Glendive, MT 59330

Roger Trudell
Santee Sioux Nation
108 Spirit Lake Avenue, West
Niobrara, NE 68760

Long Family Trust
5928 S VAN GORDON ST
Littleton, CO 80127

Michelle Ueruaga
Law Office of Michelle Uberuaga Z
PO Box 711
Livingston, MT 59047

Lori Utter
1602 Bitterroot Dr
Sidney, MT 59270

Jeff Van den Noort
Montana Chapter of the Sierra Club
P.O. Box 231
Missoula, MT 59806

Wade VanEvery
12877 Co Rd 353
Sidney, MT 59270

Carl Venne
Crow Nation
P.O. Box 159
Crow Agency, MT 59022

Richard Verhasselt
10814 Co Rd 340
Savage, MT 59262

Terry Verhasselt
35019 Co Rd 122
Sidney, MT 59270

High Plains Veterinary Clinic Inc
1010 10th Ave SE
Sidney, MT 59270

William Voss
35379 Co Rd 131
Fairview, MT 59221

Jeffrey W. Waddell
12282 Western St
Sidney, MT 59270

Craig Wagner
1 Fairground Road
Glendive, MT 59330

Steve Walls
416 35th Ave NW
Sidney, MT 59270

John Wardell
EPA Region 8 Montana Office
Federal Building, 10 W 15th St, Ste 3200
Helena, MT 59626

George Watts
712 7th Ave SW
Sidney, MT 59270

James Watts
13209 Co Rd 354F
Fairview, MT 59221

Mike Weber
PO Box 447
Fairview, MT 59221

Marcus Wells
Three Affiliated Tribes
404 Frontage Road
New Town, ND 58763

Joshua Weston
Flandreau Santee Sioux Tribe
P.O. Box 283
Flandreau, SD 57028
Dennis Wick
35252 Co Rd 127
Sidney, MT 59270

WILDCAT MINERALS LLC
Wildcat Minerals LLC
Box 18311
Golden, CO 80402

Burt Williams
The Nature Conservancy
2721 2nd Ave North
Billings, MT 59101

Neil Williams
516 9th Ave SW
Sidney, MT 59270

Lynda Williams
1202 Cedar
Sidney, MT 59270

Terry Wink
3026 Morledge St
Billings, MT 59102

Rebecca Wodder
American Rivers - National Office
1101 14th Street NW, Suite 1400
Washington, DC 20005

Larry Wright
Ponca Tribe of Nebraska
P.O. Box 288
Niobrara, NE 68760

Judy Wyman
305 8th Ave NE
Sidney, MT 59270

Larry Wyman
814 6th Ave SE
Sidney, MT 59270

Anne Yates
Montana Department of Natural Resources and
Conservation
1625 11th Ave
Helena, MT 59601

John Yellow Bird Steele
Oglala Sioux Tribe
P.O. Box 2070
Pine Ridge, SD 57770

James Young
PO BOX 588
SIDNEY, MT 59270

Loren H Young
Loren Young Inc
13705 CT 351
Fairview, MT 59221

Dan Young
Richald Co Conservation District
13689 CR 352
Fairview, MT 59221

Gregory Zadow
35201 Co Rd 127
Sidney, MT 59270

Zenergy Inc
1600 S Yale Ave
Tulsa, OK 74131

Lisa Ziler
12647 CR 350
Sidney, MT 59270

Lower Yellowstone Intake Diversion Dam Fish Passage Project, Montana
Environmental Impact Statement
May 2016

Bill Zimmerman
903 11th St Sw
Sidney, MT 59270

Parks & Fish Wildlife
PO BOX 200701
HELENA, MT 59620-0701

Oneok
BAKKEN PIPELINE LLC
100 W 5TH ST
TULSA, OK 74103-4279

ND Game & Fish
100 N Bismarck Expressway
Bismarck, ND 58501

A&M Structuring 7 LLC
13819 60TH ST NW
WILLISTON, ND 58801

Gavilon Grain LLC
11th Con Agra Drive
Omaha, NE 68102

Meridian Pacific
1801 Tiburon Blvd, Ste 800
Tiburon, CA 94920

Green Gable Inc
12026 HIGHWAY 16
SIDNEY, MT 59270-6334

Western Catering Service. Inc.
600 S MAIN ST
BUTTE, MT 59701-2534

Headington Oil LP
PO Box 870849
Mesquite, TX 75187

Josh
Coffee Commercial LLC
2944 GREGORY DR S
BILLINGS, MT 59102-0500

J & S Farms, LLC
12 Stoney Acres Ln
Glendive, MT 59330

Watco Companies, LLC
315 West 3rd St
Pittsburg, KS 66762

Mongoose Trucking & Hot Shot LLC
727 N Waco Suite 400
Wichita, KS 67203

Custom Fencing & Welding, Inc.
34609 HIGHWAY 200
Sidney, MT 59270

MPEG Land Development LLC
2825 3RD AVE N STE 600
BILLINGS, MT 59101-1961

Montana Convention of 7th Day Adventist
2475 S CENTRAL AVE
Sidney, MT 59270

NST IP LLC
527 MARQUETTE AVE, SUITE 500
MINNEAPOLIS, MN 55402

Eagle Oilfield Services, LLC
225 14TH ST SE
SIDNEY, MT 59270-6310

Oakland Fischer LLC
15341 31ST ST NW
CARTWRIGHT, ND 58838-9641

XTO Engery, Inc.
810 HOUSTON ST
FORT WORTH, TX 76102-6203

Pheasant Run Apartments LLC
151 LOWER LUTHER RD
RED LODGE, MT 59068-9534

Exploration Drilling
12653 Co Rd 352
Sidney, MT 59270

Northwest Pipe Fittings INC
33 S 8TH ST W
BILLINGS, MT 59102-5840

Prrewitt & Company LLC
756 10TH AVE SE
Sidney, MT 59270

Red Rock Power Inc
PO BOX 725
HAVRE, MT 59501-0725

Richland County
201 W MAIN ST
SIDNEY, MT 59270-4035

Ridgeview 20 LLC
1801 TIBURON BLVD,
TIBURON, CA 94920

Savage Farm LLC
PO BOX 1408
Hamilton, MT 59840

C & M Oilfield Service LLC
PO BOX 164
BAKER, MT 59313-0164

KC Transport LLC
35212 COUNTY ROAD 127
Sidney, MT 59270

Banner Transportation Company
P.O. Box 3866
Enid, OK 73702

Western Outfield Supply Co
3404 STATE RD
BAKERSFIELD, CA 93308-4538

Montana Fish Wildlife & Parks
1420 E 6th Ave
Helena, MT 59601

Yellowstone Farms LLC
2901 CHENEY CREEK RD
CARTWRIGHT, ND 58838-9742

Anaconda Sportsmens Club
#2 Cherry
Anaconda, MT 59711

Applied Geomorphology, Inc.
211 N. Grand - Suite C
Bozeman, MT 59715

Art Gehnert
1089 2nd Cottonwood Grove
Glendive, MT 59330

Big Blackfoot Riverkeeper
35701 Nine Mile Prairie Road
Greenough, MT 59823

Randy
Blackfoot Challenge
PO Box 103
Ovando, MT 59854

Clark Fork River Coalition
PO Box 7593
Missoula, MT 59807

Craig Wagner
Fairgrounds Road
Glendive, MT 59330

Custer Rod & Gun Club
PO Box 303
Miles City, MT 59301

Glendive Chamber of Commerce
808 N. Merrill
Glendive, MT 59330

Hubert Fisheries Consulting, LLC
1063 Colina Drive
Laramie, WY 82702-5014

Miller Ecological Consultants, Inc.
2111 S. College Ave, Unit D
Fort Collins, CO 80525

Montana Association of Conservation Districts
1101 11th Ave
Helena, MT 59601

Montana Partners for Fish & Wildlife
PO Box 66
Ovando, MT 59854

Nature Conservancy
PO Box 8316
Missoula, MT 59807

Northern Plains Resource Council
220 South 27th Street, Ste A
Billings, MT 59101

Lower Yellowstone Intake Diversion Dam Fish Passage Project, Montana
Environmental Impact Statement
May 2016

Ravalli Co. Fish & Game Assoc.
PO Box 238
Hamilton, MT 59840

Miles City Star
P.O. Box 1216
Miles City, MT 59301

Riverbed Engineering, LLC
102 Third St - PO Box 2979
Pagosa Springs, CO 81147

Sidney Herald
310 2nd Avenue NE
Sidney, MT 59270

Rosebud-Treasure Wildlife Assoc.
PO Box 262
Forsyth, MT 59327

Minot Daily News
P.O. Box 1150
Minot, ND 58702

Sidney Chamber of Commerce
909 S Central Ave
Sidney, MT 59270

Bismarck Tribune
P.O. Box 5516
Bismarck, ND 58506

Sierra Club
PO Box 1290
Bozeman, MT 59771

Williston Herald
14 West 4th Street
Williston, ND 58802

Trout Headwaters Inc.
PO Box 222
Livingston, MT 59047

Dawson County Economic Development
Council
313 West Valentine
Glendive, MT 59330

Western Area Power Administration
PO Box 35800
Billings, MT 59107

KDN Farms, Inc.
34469 CR 110
Savage, MT 59262

Great Falls Tribune
205 River Drive South
Great Falls, MT 59405

Comradsen Brothers, Inc.
RR 2
Savage, MT 59252

Shannon
PO Box 1401
Sidney, MT 59270

Index

- access roads, xxx, xxxi, 2-38, 2-54, 2-62, 2-63, 2-75, 3-67, 3-133, 3-171, 4-16, 4-17, 4-18, 4-19, 4-20, 4-21, 4-25, 4-63, 4-74, 4-75, 4-76, 4-139, 4-140, 4-141, 4-142, 4-143, 4-144, 4-145, 4-146, 4-147, 4-148, 4-149, 4-150, 4-151, 4-152, 4-153, 4-154, 4-156, 4-186, 4-187, 4-190, 4-191, 4-192, 4-197, 4-205, 4-206, 4-208, 4-221, 4-223, 4-224, 4-228, 4-229, 4-232, 4-233, 4-234, 4-236, 4-248, 4-267, 4-285, 4-286, 4-287, 4-302, 4-303, 4-304, 4-306
- actions to minimize effects, 1-14, 1-16, 1-17, 4-15, 4-17, 4-18, 4-19, 4-20, 4-63, 4-64, 4-70, 4-71, 4-72, 4-73, 4-120, 4-122, 4-123, 4-124, 4-125, 4-126, 4-129, 4-131, 4-132, 4-134, 4-135, 4-156, 4-161, 4-189, 4-203, 4-211, 4-212, 4-213, 4-216, 4-217, 4-218, 4-233, 4-235, 4-239, 4-243, 4-244, 4-245, 4-246, 4-247, 4-249, 4-250, 4-274, 4-280, 4-284, 4-286, 4-287, 4-288, 4-289, 4-290, 4-292, 4-295, 4-297, 4-305, 5-5, 5-7
- agriculture, xxvi, 3-46, 3-47, 3-63, 3-64, 3-79, 3-97, 3-102, 3-118, 3-133, 3-146, 3-152, 3-157, 3-179, 3-180, 3-206, 4-3, 4-136, 4-154, 4-155, 4-182, 4-198, 4-227, 4-238, 4-255, 4-261, 4-263, 4-267, 4-268, 4-270, 4-308
- Air Quality, xxiv, xxxiii, 3-9, 3-12, 3-13, 4-7, 4-13, 4-14, 4-23, 4-298, 1, 3, 13, 23, 27
- Airports, 3-142
- Aquatic Communities, xxxiv, 1-21, 3-53, 3-210, 4-116, 4-117, 4-301
- Aquatic Invasive Species, 3-63, 4-119, 4-120, 4-122, 4-124, 4-125, 4-126, 4-127, 4-129, 4-131, 4-132, 4-135, 4-136, 14, 19
- aquifers, 3-28, 3-30, 3-31, 3-32, 3-37, 3-52, 3-53
- Archaeological Resource Protection Act, 1-14, 3-169, 5-5
- Bakken Oil Fields, 4-6, 4-80, 4-237, 4-280, 4-291, 4-297
- best management practices, 3-67, 4-111, 4-112, 4-202
- Bighorn River, 3-20, 3-22, 3-54, 3-64, 4-5, 4-58, 4-98, 4-99, 4-100, 4-101, 4-182
- Biological Opinion, 4-4, 5-4, 24
- Biological Review Team, 2-27, 2-32, 2-50, 2-58, 3-43, 8
- boating, 3-124, 3-127, 3-131, 3-132, 3-146, 4-211, 4-212, 4-215, 4-216, 4-217, 4-218, 4-270, 4-274
- Bridge, 2-64, 3-127, 3-128, 3-132, 3-185, 3-186, 3-187, 3-188, 3-194, 3-195, 3-197
- Cabin-Creek Williston Pipeline, 4-288, 4-289
- cableway, xxx, 2-26, 2-41, 3-134, 3-136, 3-170, 4-20, 4-74, 4-222, 4-223, 4-224, 4-247
- Cartersville Diversion Dam, 1-1, 1-6, 2-24, 3-53, 3-60, 3-75, 4-157, 4-173, 4-176, 4-216
- Channel Migration, 3-41, 4-89, 4-91, 4-93, 4-95, 4-97, 4-99
- check structures, xxxii, 1-21, 2-37, 2-63, 2-80, 2-85, 2-94, 2-98, 2-100, 4-19, 4-34, 4-97, 4-99, 4-105, 4-187, 4-247, 4-287, 4-288, 4-299, 4-301, 4-304
- Clean Water Act, xxiii, 1-14, 1-19, 2-106, 2-4, 2-5, 3-45, 3-51, 4-60, 4-103, 4-115, 5-5, 5-10
- Climate change, 3-7, 4-6, 4-13, 4-24, 4-58, 4-101, 4-137, 4-198, 4-215, 4-267, 4-273
- contamination, 3-28, 3-35, 3-36, 3-37, 3-38, 3-53, 4-64, 4-70, 4-71, 4-72, 4-73, 4-74, 4-75, 4-76, 4-77, 4-79, 4-82, 4-105
- cooperating agencies, 1-11, 2-32, 2-35, 3-169, 5-2, 5-6
- Cost Estimates, 2-102
- County Road 303, 2-62, 3-19, 3-189, 4-51, 4-230, 4-232, 4-282, 4-286, 4-308

- crop requirements, *xxix, 1-6, 2-38*
- Crow Irrigation Project, *4-4, 4-58, 4-100, 4-114, 4-136, 4-137, 4-291, 4-297*
- Crow Municipal, *4-4, 4-58, 4-100, 4-114, 4-291, 4-297*
- Crow Settlement Act, *4-4, 4-5, 4-58, 4-100, 4-291, 4-297*
- cultural resources, *2-106, 2-107, 3-168, 3-169, 3-171, 3-192, 3-200, 3-201, 4-2, 4-280, 4-281, 4-282, 4-283, 4-285, 4-286, 4-287, 4-288, 4-289, 4-290, 4-291, 4-292, 4-293, 4-294, 4-297, 4-308, 4-309*
- Cumulative Effects, *vii, x, xi, xii, xiii, xiv, xv, xvi, xvii, xviii, xix, xx, xxiii, xxv, 1-6, 1-21, 3-22, 3-38, 3-39, 3-47, 3-110, 3-118, 4-10, 4-13, 4-23, 4-57, 4-58, 4-80, 4-100, 4-113, 4-136, 4-154, 4-181, 4-197, 4-214, 4-226, 4-237, 4-251, 4-272, 4-275, 4-276, 4-279, 4-291, 4-296, 21*
- dam removal, *2-98, 2-107, 4-16, 4-134, 4-152, 4-153, 4-159, 4-208, 4-209, 4-210, 4-233, 4-234, 4-235, 4-246, 4-247, 4-264, 4-270, 4-279, 4-301, 4-303, 4-304*
- Dawson County, *3, xxvi, xxxvi, 1-1, 1-15, 1-20, 3-14, 3-20, 3-32, 3-33, 3-34, 3-41, 3-43, 3-64, 3-96, 3-99, 3-100, 3-104, 3-106, 3-107, 3-112, 3-124, 3-142, 3-144, 3-174, 3-184, 3-185, 3-187, 3-188, 3-189, 3-193, 3-194, 3-199, 4-142, 4-143, 4-145, 4-208, 4-240, 4-277, 5-1, 5-2, 5-6, 4, 19, 32, 6, 7, 21, 28*
- design criteria, *1-10, 2-50, 2-59, 2-62, 2-68, 3-43, 3-134, 4-133*
- economy, *2-26, 3-152, 3-153, 3-159, 4-253, 4-255, 4-256, 4-257, 4-261, 4-262, 4-264, 4-265, 4-267, 4-268, 4-269, 4-270, 4-271*
- Endangered Species Act, *iii, xxiii, xxvii, 1-4, 1-12, 2-43, 2-48, 2-55, 2-64, 2-79, 2-100, 2-106, 3-53, 3-76, 4-2*
- Entrainment, *2-27, 2-43, 2-48, 2-55, 2-64, 2-79, 2-100, 3-60, 4-117, 4-118, 4-158, 4-159, 4-160, 4-302, 4-304, 8*
- Environmental Justice, *ix, xix, xxxv, 1-17, 3-162, 3-168, 4-274, 4-275, 4-279, 4-308, 5-8, 1, 23*
- erosion, *1-19, 2-28, 2-51, 2-52, 2-63, 3-42, 3-46, 3-49, 3-118, 3-120, 3-123, 3-172, 4-29, 4-30, 4-31, 4-32, 4-33, 4-34, 4-54, 4-56, 4-83, 4-86, 4-88, 4-89, 4-90, 4-92, 4-105, 4-108, 4-116, 4-120, 4-122, 4-123, 4-133, 4-134, 4-135, 4-138, 4-185, 4-191, 4-201, 4-202, 4-227, 5-10*
- excavation, *2-50, 2-63, 3-171, 3-181, 3-192, 4-9, 4-14, 4-15, 4-16, 4-17, 4-18, 4-31, 4-32, 4-33, 4-63, 4-69, 4-70, 4-87, 4-88, 4-104, 4-108, 4-117, 4-120, 4-123, 4-124, 4-125, 4-126, 4-144, 4-145, 4-151, 4-162, 4-163, 4-164, 4-166, 4-186, 4-188, 4-189, 4-190, 4-193, 4-194, 4-195, 4-244, 4-245, 4-282, 4-285, 4-286, 4-287, 4-293, 4-298, 4-301, 4-304, 4-308*
- Executive Order 11988, *iv, xxi, 1-17, 5-8*
- Executive Order 11990, *5-8*
- Executive Order 12898, *3-162, 4-274, 23*
- Executive Order 13007, *3-169, 5-8*
- Executive Order 13112, *iv, xxi, 1-17, 5-8*
- Executive Order 13186, *iv, xxi, 1-16, 5-6*
- Farmland Protection Policy Act, *iv, xxi, 1-15, 5-6*
- farms, *xxvii, 1-6, 1-7, 2-26, 2-71, 3-52, 3-102, 3-145, 3-159, 3-181, 3-182, 4-3, 4-139, 4-259*
- federally listed species, *xxviii, 4-181*
- Fish and Wildlife Coordination Act, *iv, xxi, xxiii, 1-15, 5-6*
- fish migration, *1-22, 2-37, 2-43, 2-46, 2-53, 4-117, 4-118, 4-119, 4-121, 4-124, 4-125*
- fish screens, *xxix, 1-9, 1-10, 2-23, 2-26, 2-33, 2-35, 2-38, 2-41, 2-68, 2-77, 2-91, 2-101, 3-26, 3-134, 4-4, 4-37, 4-112, 4-117, 4-118, 4-127, 4-128, 4-130, 4-132, 4-134, 4-148, 4-152, 4-172, 4-175, 4-177, 4-301, 11*
- Fishing, *viii, x, xxiii, 2-54, 2-107, 3-34, 3-124, 3-127, 3-128, 3-131, 3-186, 3-206, 4-63, 4-205, 4-206, 4-207, 4-209, 4-210, 4-213, 9, 13, 14*
- fishing access site, *3-98, 3-127, 4-61, 4-62, 4-64, 4-72, 4-73, 4-74, 4-75, 4-76, 4-77, 4-79, 4-81, 4-279, 4-300*

- Floodplain Management Assessment, *iv, xxi, 1-15, 5-5*
- floodplains, 1-17, 3-26, 3-70, 3-73, 3-110, 3-114, 3-115, 3-118, 5-8
- flow characteristics, 2-43, 2-3
- flow conditions, xxix, 1-6, 2-29, 2-38, 2-52, 2-61, 2-68, 3-27, 3-40, 3-42, 4-38, 4-129
- Fort Peck Dam, xxviii, 1-7, 1-8, 2-24, 3-56, 3-88, 3-90, 3-106, 3-131, 4-57, 4-58, 4-171, 4-174, 4-176, 4-179, 4-180, 20
- Geomorphology, vi, xii, xxxiv, 1-12, 1-21, 3-38, 4-84, 4-85, 4-300, 5-10, 4, 31
- Glendive Chamber of Commerce, 3-124, 3-132, 4-211, 4-260, 4-268, 28, 31
- Glendive, Montana, xxvi, 1-1, 1-7, 1-11, 1-20, 3-132, 4-80, 5-1, 28
- Grasslands, viii, 3-68, 3-71, 3-119, 3-129, 4-187, 4-188, 4-189, 4-191, 4-192, 4-193, 4-194, 4-196, 4-197, 4-201
- gravity flow, 1-21, 2-26, 2-36, 2-74, 2-75, 2-94, 3-180, 4-12, 4-52, 4-55, 4-97, 4-98, 4-99, 4-109
- haul road, 2-63, 4-224, 4-284
- Highway 16, 2-53, 3-36, 3-124, 3-139, 3-140, 3-144, 3-197, 4-208, 4-229, 4-230, 4-231, 4-232, 4-233, 4-234, 4-235, 4-236, 4-239, 4-306, 25
- Home Value, *ix, 3-152*
- hunting, 3-65, 3-67, 3-70, 3-87, 3-99, 3-124, 3-127, 3-128, 3-129, 3-131, 3-132, 3-146, 3-152, 3-153, 3-155, 3-156, 3-172, 3-173, 3-174, 3-175, 3-176, 3-177, 3-178, 3-179, 3-201, 3-202, 3-203, 3-204, 3-205, 3-206, 4-205, 4-206, 4-207, 4-209, 4-210, 4-212, 4-215, 4-217, 4-218, 4-261, 4-294, 4-295
- hydrology, 1-12, 3-14, 3-20, 3-22, 3-38, 3-102, 3-106, 3-115, 4-26, 4-35, 4-37, 4-39, 4-44, 4-45, 4-49, 4-50, 4-53, 4-55, 4-57, 4-61, 4-75, 4-76, 4-82, 4-100, 4-150, 4-151, 4-152, 4-182, 4-183, 4-184, 4-191
- hydropower, 2-36, 3-8, 4-5, 4-59, 5-10
- Ice jams, 4-55, 4-56
- IMPLAN, xxiii, 4-255, 4-256
- Indian Trust Assets, ix, xx, xxxv, 1-13, 3-200, 3-202, 3-207, 3-210, 4-294, 4-309
- Joe's Island, viii, xxvii, xxx, 2-41, 2-46, 2-48, 2-54, 2-55, 2-58, 2-62, 2-63, 3-14, 3-19, 3-38, 3-40, 3-44, 3-54, 3-67, 3-75, 3-112, 3-114, 3-119, 3-124, 3-127, 3-130, 3-131, 3-132, 3-133, 3-136, 3-137, 3-171, 3-180, 3-194, 4-13, 4-14, 4-16, 4-17, 4-18, 4-20, 4-26, 4-29, 4-30, 4-31, 4-32, 4-33, 4-34, 4-45, 4-47, 4-51, 4-60, 4-62, 4-70, 4-71, 4-75, 4-76, 4-81, 4-86, 4-87, 4-88, 4-89, 4-91, 4-93, 4-95, 4-96, 4-97, 4-98, 4-108, 4-110, 4-112, 4-130, 4-139, 4-140, 4-141, 4-143, 4-144, 4-145, 4-151, 4-152, 4-153, 4-154, 4-162, 4-163, 4-164, 4-165, 4-185, 4-186, 4-189, 4-190, 4-199, 4-200, 4-202, 4-204, 4-205, 4-206, 4-207, 4-208, 4-210, 4-211, 4-212, 4-215, 4-217, 4-219, 4-220, 4-221, 4-223, 4-224, 4-229, 4-230, 4-231, 4-232, 4-233, 4-234, 4-235, 4-236, 4-244, 4-247, 4-248, 4-260, 4-261, 4-263, 4-274, 4-276, 4-277, 4-281, 4-284, 4-285, 4-286, 4-298, 4-300, 4-302, 4-304, 4-305, 4-306
- Lake Sakakawea, xxviii, xxix, 1-1, 1-8, 2-23, 2-24, 3-53, 3-55, 3-56, 3-60, 3-75, 3-88, 3-90, 3-91, 3-94, 4-57, 4-58, 4-116, 4-136, 4-157, 4-168, 4-171, 4-174, 4-176, 4-179, 4-180
- least tern, 3-76, 3-81, 3-82, 3-83, 4-160, 4-161, 4-164, 4-167, 4-182, 4-184
- Lower Yellowstone Irrigation Districts, 2-96, 3-157
- macroinvertebrates, 3-53, 3-59, 3-62, 3-89, 3-105, 4-117, 4-119, 4-120, 4-122, 4-123, 4-125, 4-126, 4-127, 4-129, 4-131, 4-134, 4-136, 4-137, 4-138, 4-170, 4-302
- Main Canal, xxx, xxxi, xxxii, 1-1, 1-4, 1-7, 1-9, 2-25, 2-26, 2-33, 2-35, 2-38, 2-40, 2-41, 2-42, 2-43, 2-46, 2-47, 2-53, 2-55, 2-64, 2-66, 2-74, 2-76, 2-78, 2-80, 2-82, 2-83, 2-84, 2-94, 2-95, 2-97, 2-99, 2-5, 3-14, 3-19, 3-20, 3-24, 3-25, 3-37, 3-38, 3-75, 3-88, 3-124, 3-134, 3-135, 3-137, 3-157, 3-170, 3-180, 3-181, 3-182, 3-183, 3-185, 3-192, 3-193, 3-194, 3-195, 3-196, 3-198, 4-3, 4-4, 4-12, 4-17, 4-19, 4-26, 4-27, 4-28, 4-29, 4-30, 4-33, 4-34, 4-37, 4-

- 39, 4-44, 4-45, 4-46, 4-47, 4-49, 4-52, 4-53, 4-55, 4-56, 4-57, 4-58, 4-60, 4-61, 4-62, 4-63, 4-75, 4-85, 4-97, 4-99, 4-100, 4-105, 4-107, 4-109, 4-111, 4-112, 4-131, 4-133, 4-135, 4-140, 4-141, 4-168, 4-170, 4-172, 4-173, 4-174, 4-177, 4-185, 4-187, 4-208, 4-220, 4-221, 4-222, 4-225, 4-243, 4-247, 4-282, 4-283, 4-284, 4-287, 4-288, 4-289, 4-299, 4-300, 4-303, 4-308, 18
- McKenzie County, 3-27, 3-29, 3-31, 3-32, 3-33, 3-34, 3-35, 3-54, 3-64, 3-77, 3-78, 3-79, 3-86, 3-91, 3-92, 3-100, 3-112, 3-122, 3-127, 3-152, 3-157, 3-162, 3-163, 3-166, 3-167, 3-168, 3-186, 4-7, 4-258, 4-275, 20, 17, 30
- MDNRC, xxiv, 1-7, 1-11, 1-19, 2-86, 3-8, 3-28, 4-6, 4-37, 4-101, 5-10
- Migratory Bird Treaty Act, *iv, xxi, xxiv, 1-16, 3-93, 3-97, 4-143, 5-6*
- Missouri River, *v, vii, xxvi, xxvii, xxviii, xxix, 1-1, 1-5, 1-7, 1-8, 1-13, 2-24, 2-25, 2-26, 2-38, 2-41, 2-74, 3-14, 3-19, 3-20, 3-24, 3-31, 3-39, 3-40, 3-45, 3-53, 3-54, 3-55, 3-56, 3-61, 3-64, 3-75, 3-81, 3-82, 3-83, 3-85, 3-86, 3-87, 3-88, 3-89, 3-90, 3-94, 3-99, 3-100, 3-102, 3-104, 3-105, 3-106, 3-108, 3-110, 3-112, 3-116, 3-117, 3-124, 3-128, 3-129, 3-131, 3-137, 3-139, 3-140, 3-142, 3-181, 3-203, 3-205, 3-207, 4-4, 4-26, 4-35, 4-37, 4-57, 4-58, 4-59, 4-60, 4-84, 4-100, 4-113, 4-116, 4-122, 4-136, 4-157, 4-169, 4-182, 4-185, 4-197, 4-203, 4-215, 4-216, 4-228, 4-273, 4-280, 4-297, 6, 8, 9, 17, 18, 20, 24, 29*
- Monitoring, *vi, xxi, xxviii, 2-23, 2-24, 2-42, 2-43, 2-48, 2-55, 2-64, 2-79, 2-100, 2-102, 2-5, 3-13, 3-33, 3-56, 4-127, 4-139, 4-156, 4-168, 4-172, 4-174, 4-175, 4-177, 4-179, 4-181, 23*
- Montana Fish, Wildlife, and Parks, *3, 1-5, 1-11*
- MTDEQ, *xxiv, 1-19, 2-4, 3-9, 3-13, 3-34, 3-35, 3-36, 3-37, 3-45, 3-46, 3-47, 3-50, 3-52, 3-113, 4-64, 4-72, 4-73, 4-74, 4-75, 4-76, 4-77, 4-79, 4-116, 5-5, 5-9, 5-10*
- mussels, *3-53, 3-61, 3-62, 3-63, 3-86, 4-117, 4-119, 4-120, 4-122, 4-123, 4-125, 4-126, 4-127, 4-128, 4-131, 4-134, 4-136, 4-137, 4-138, 4-302*
- National Historic Preservation Act, *iv, xxi, xxiv, 1-16, 3-168, 5-7*
- Native American Graves Protection and Repatriation Act, *iv, xxi, 1-16, 3-169, 5-7*
- native fish, *3, xxvi, xxvii, xxviii, 1-6, 1-8, 1-12, 2-23, 2-101, 2-6, 3-64, 4-120, 4-122, 4-124, 4-126, 4-129, 4-132, 4-150, 4-166, 4-168*
- Natural Resources Conservation Service, *xxiv, 1-15, 2-79, 4-201, 5-6, 22*
- Northern Pacific Railroad, *3-179, 3-193, 3-196, 3-198, 4-282, 4-283, 4-284, 4-286, 4-287, 4-288, 4-289, 4-294, 4-308*
- Noxious weeds, *viii, 3-122, 4-188, 4-189, 4-190, 4-193, 4-196, 4-202*
- operation and maintenance, *xxix, xxx, 1-21, 2-26, 2-29, 2-36, 2-37, 2-39, 2-40, 2-41, 2-42, 2-47, 2-54, 2-96, 4-1, 4-15, 4-17, 4-20, 4-21, 4-22, 4-23, 4-25, 4-35, 4-60, 4-74, 4-75, 4-76, 4-77, 4-78, 4-82, 4-102, 4-110, 4-111, 4-112, 4-113, 4-114, 4-115, 4-116, 4-119, 4-126, 4-127, 4-131, 4-136, 4-148, 4-150, 4-152, 4-160, 4-178, 4-180, 4-182, 4-185, 4-192, 4-193, 4-194, 4-195, 4-199, 4-218, 4-222, 4-223, 4-224, 4-225, 4-226, 4-228, 4-241, 4-242, 4-248, 4-249, 4-278, 4-279, 4-283, 4-296, 4-307*
- paddlefish, *3-56, 3-105, 3-125, 3-131, 3-132, 4-6, 4-119, 4-121, 4-124, 4-125, 4-135, 4-158, 4-159, 4-162, 4-164, 4-165, 4-167, 4-168, 4-171, 4-205, 4-207, 4-208, 4-209, 4-210, 4-211, 4-212, 4-213, 4-214, 4-215, 4-255, 4-260, 4-263, 4-268, 4-269, 4-270, 4-303, 6, 20*
- Permits, *iii, iv, xxi, 1-12, 1-14, 1-18, 1-19, 5-5, 5-10*
- planning studies, *xxix, 2-27, 2-28, 2-30, 2-33*
- Prairie County, *3-163, 3-166, 3-168, 4-275*
- public involvement, *5-1*
- Purpose and Need, *iii, vi, xxvii, 1-1, 1-6, 1-21, 2-101, 2*
- Railroads, *ix, 3-36, 3-142, 4-289*

- Ranney wells, xxxii, 2-87, 2-98, 2-99, 2-107, 4-19, 4-35, 4-55, 4-78, 4-88, 4-109, 4-115, 4-126, 4-135, 4-136, 4-155, 4-168, 4-180, 4-191, 4-192, 4-210, 4-219, 4-242, 4-255, 4-257, 4-274, 4-288, 4-305, 4-308
- Relocation, 2-37, 20
- Richland County, 3, 3-32, 3-33, 3-34, 3-64, 3-77, 3-80, 3-94, 3-96, 3-97, 3-100, 3-101, 3-102, 3-105, 3-106, 3-107, 3-108, 3-112, 3-140, 3-144, 3-159, 3-186, 3-187, 3-188, 3-189, 3-190, 3-191, 3-195, 3-196, 3-197, 3-199, 4-208, 4-240, 4-258, 4-277, 9, 14, 31, 19
- Roosevelt County, 3-162, 3-163, 3-166, 3-167, 3-168, 4-275
- Safe Drinking Water Act, 3-27, 3-35, 4-4
- Savage Irrigation District, xxvii, 1-1, 1-4, 1-7, 3-20, 3-157, 5-9
- scoping, v, 1-11, 1-12, 1-13, 1-20, 1-21, 2-29, 2-32, 2-33, 2-34, 2-36, 2-79, 2-80, 3-207, 5-1, 5-2
- shrublands, 3-71, 3-75, 3-94, 3-95, 3-98, 3-135, 4-202
- staging, 2-48, 2-61, 2-62, 2-63, 2-98, 3-75, 3-80, 3-133, 3-170, 3-171, 4-16, 4-17, 4-18, 4-29, 4-31, 4-32, 4-63, 4-85, 4-86, 4-87, 4-107, 4-108, 4-142, 4-143, 4-145, 4-152, 4-153, 4-156, 4-186, 4-187, 4-188, 4-192, 4-196, 4-200, 4-220, 4-221, 4-227, 4-230, 4-231, 4-232, 4-233, 4-234, 4-281, 4-282, 4-283, 4-285, 4-300, 4-304, 4-308
- State Species of Concern, viii, xiv, xxxiv, 3-75, 3-92, 3-210, 4-156, 4-303
- surface water quality, 1-18, 3-47, 4-103, 4-116, 5-9
- The Nature Conservancy, xxix, 1-5, 2-26
- Transportation, viii, xvii, xxxv, 1-12, 1-21, 2-100, 3-112, 3-137, 3-138, 3-139, 3-140, 3-142, 3-152, 3-153, 3-155, 3-156, 4-5, 4-228, 4-230, 4-231, 4-232, 4-233, 4-234, 4-235, 4-236, 4-306, 1, 31, 7
- Turbidity, iv, xxi, 1-18, 3-49, 4-108, 4-173, 4-175, 5-9
- Water Rights, iv, x, xxi, 1-18, 1-21, 2-88, 3-206, 3-207, 5-8, 13
- Wells, vi, 2-30, 2-87, 2-89, 3-27, 3-32, 3-33, 3-37, 3-52, 3-184, 4-57, 4-113, 4-191, 4-192, 4-200, 4-201, 4-221, 4-225, 4-226, 29
- Wibaux County, 3-32, 3-33, 3-64, 3-99, 3-166
- Williams County, 3-64, 3-128, 3-148, 3-152, 3-166, 3-167, 30
- wind power, 2-79, 2-96, 4-153, 20
- wind turbines, xxxii, 2-96, 3-81, 3-95, 3-96, 3-100, 4-15, 4-251, 6
- Zoning, viii, 3-112, 11, 30

References

- Aaberg, Stephen A., Rebecca R. Hanna, Chris Crofutt, Jayme Green, and Marc Vischer. 2006. Miles City Field Office Resource Management Plan (RMP) and Environmental Impact Statement (EIS) – Class I Overview of Paleontological & Cultural Resources in Eastern Montana, Volume 1. Contract, Aaberg Cultural Resource Consulting Service, Miles City: U.S. Department of the Interior, Bureau of Land Management, Miles City Field Office. Accessed January 14, 2016. www.blm.gov/mt/st/en/fo/miles_city_field_office/rmp/docs.html.
- Aadland, L. 2010. Reconnecting Rivers: Natural channel design in dam removals and fish passage. Minnesota Dept. Nat. Res., Fergus Falls, MN., pp.196
- Adams, S. R., J. J. Hoover, and K. J. Killgore. 1999. Swimming performance of juvenile pallid sturgeon, *Scaphirhynchus albus*. *Copeia* 802-807.
- Aikens, C. Melvin, Thomas J. Connolly, and Dennis L. Jenkins. 2011. Oregon Archaeology. Corvallis, Oregon: Oregon State University Press.
- Allen, E., E. Bulliner, C. Elliot, and R. Jackson. 2016. Characterizing spawning habitat substrate on the lower Yellowstone River. USGS Blog. Comprehensive Sturgeon Research Project. Available at: <http://www.usgs.gov/blogs/csrp/>
- Amtrak. 2016. Amtrak Thruway Connecting Services Multiply Your Travel Destinations. Accessed January 14, 2016. https://www.amtrak.com/thruway-connecting-services-multiply-your-travel-destinations?WT.z_va_evt=redirect&WT.z_va_topic=Route%20and%20Destination%20Information&WT.z_va_unit=Thruway%20Service&WT.z_va_group=Route%20Details.
- ArcGIS. 2016. Map search for wellhead protection areas in McKenzie County using ArcGIS online mapping tool. Accessed February 2016: www.arcgis.com/home/webmap/viewer.html?webmap=293a6576bfca4b33bda08ab274e84202&extent=-104.1495,45.9117,-96.8545,49.0763.
- Atkinson, S.J. and A.R. Dood. 2006a. Montana Interior Least Tern Management Plan. Montana Fish, Wildlife and Parks. Bozeman, Montana.
- Atkinson, S.J. and A.R. Dood. 2006b. Montana Piping Plover Tern Management Plan. Montana Fish, Wildlife and Parks. Bozeman, Montana. With input from the Montana Piping Plover Recovery Committee.
- Backes, K. M., W. M. Gardner, D. Scarnecchia, and P. A. Stewart. 1994. Lower Yellowstone River Pallid Sturgeon Study IV and Missouri River Creel Survey. Montana Department of Fish, Wildlife and Parks, Fisheries Division, Miles City, Montana.

Backes, M. 2014. Personal email concerning Pallid Sturgeon Update on the Yellowstone River, sent Mon, Jun 23, 2014 at 3:28 p.m.

Bacon, L.M. 1996. Nesting Ecology of the Interior Least Tern on the Yellowstone River, Montana. Bozeman, Montana: Thesis, Montana State University.

Barbour, M. T., J. Gerritsen, B. D. Snyder, J. B. Stribling. 1999. Rapid Bioassessment Protocols For Use in Streams and Wadeable Rivers: Periphyton, Benthic Macroinvertebrates, and Fish, Second Edition. EPA, Washington D.C.

Belant, J., Biggins, D., Garelle, D., Griebel, R.G. & Hughes, J.P. 2015. *Mustela nigripes*. The IUCN (International Union for Conservation of Nature and Natural Resources) Red List of Threatened Species. Available at dx.doi.org/10.2305/IUCN.UK.2015-4.RLTS.T14020A45200314.en.

Belica, L.T. and N.P. Nibbelink. 2006. Mountain Sucker (*Catostomus platyrhynchus*): a technical conservation assessment. USDA Forest Service, Rocky Mountain Region.

Berg, R. K. 1981. Fish populations of the wild and scenic Missouri River, Montana. Fed. Aid to Fish & Wildl. Restor. Proj. FW-3-R Job I-A. 242 pp.

Bergman, H.L., A.M. Boelter, K. Parady, C. Fleming, T. Keevin, D.C. Latka, C. Korschgen, D.L. Galat, T. Hill, G. Jordan, S. Krentz, W. Nelson-Stasny, M. Olson, G.E. Mestl, K. Rouse, and J. Berkley. 2008. Research Needs and Management Strategies for Pallid Sturgeon Recovery. Proceedings of a Workshop held July 31-August 2, 2007, St. Louis, Missouri. Final Report to the U.S. Army Corps of Engineers. William D. Ruckelshaus institute of Environment and Natural Resources, University of Wyoming, Laramie.

Berry, Jodi. 2015. Richland County Transportation Service. Accessed January 5, 2016. www.richland.org/index.aspx?NID=416.

Braaten, P. J. and D. B. Fuller, L. D. Holte, R. D. Lott, W. Viste, T. F. Brandt, R. G. Legare. 2008. Drift Dynamics of Larval Pallid Sturgeon in a Natural Side Channel of the Upper Missouri River, Montana. *North American Journal of Fisheries Management* 28:808-826.

Braaten, P.J., B. Fuller, R.D. Lott, M. P. Ruggles, and R. J. Holm. 2010. Spatial distribution of drifting passed sturgeon larvae in the Missouri River inferred from two net designs and multiple sampling locations. *North American Journal of Fisheries Management* 30: 1062-1074.

Braaten, P. J., Fuller, D. B., Lott, R. D., Haddix, T. M., Holte, L. D., Wilson, R. H., Bartron, M. L., Kalie, J. A., DeHaan, P. W., Ardren, W. R., Holm, R. J. and Jaeger, M. E. 2012. Natural growth and diet of known-age pallid sturgeon (*Scaphirhynchus albus*) early life stages in the upper Missouri River basin, Montana and North Dakota. *Journal of Applied Ichthyology*, 28: 496–504

Braaten, P.J., C.M. Elliott, J.C. Rhoten, D.B. Fuller, B.J. McElroy. 2014. Migrations and swimming capabilities of endangered pallid sturgeon (*Scaphirhynchus albus*) to guide passage designs in the fragmented Yellowstone River. *Restoration Ecology* 1-10.

Braaten, P.J., D.B Fuller, L.D. Holte, R.D. Lott, W. Viste, T.F. Brandt, and R.G. Legare. 2008. Drift Dynamics of Larval Pallid Sturgeon and Shovelnose Sturgeon in a Natural Side Channel of the Upper Missouri River, Montana. *North American Journal of Fisheries Management* 808–826.

Braaten, P.J., D.B. Fuller, R.D. Lott, and G.R. Jordan. 2009. An estimate of the historic population size of adult pallid sturgeon in the upper Missouri Rive Basin, Montana and North Dakota. *Journal of Applied Ichthyology* 25: 2-7.

Braaten, P.J., D.B. Fuller, R.D. Lott, M.P. Ruggles, T.F. Brandt, R.G. Legare, and R.J.Holm. 2012. An experimental test and models of drift and dispersal process of pallid sturgeon (*Scaphirhynchus albus*) free embryos in the Missouri River. *Environmental Biology of Fish* 93: 377-392.

Braaten, P.J., S.E. Campana, D. B. Fuller, R. D. Lott, R. M. Bruch, and G. R. Jordan. 2015. Age estimations of wild pallid sturgeon (*Scaphirhynchus albus*, Fores & Richardosn 1905) based on pectoral fin spines, otoliths and bomb radiocarbon: inferences on recruitment in the dam-fragmented Missouri River. *J. Appl. Ichthol.* 31: 821-829.

Bramblett, R. G. 1996. Habitats and Movements of Pallid and Shovelnose Sturgeon in the Yellowstone and Missouri Rivers, Montana and North Dakota. Unpublished Ph.D. Thesis. Montana State University, Bozeman, Montana.

Bramblett, R.G. and E.A. Scholl. 2016. The spatial and temporal extent of the suspected hypoxic zone in the headwaters of Lake Sakakawea. Prepared for Montana Fish, Wildlife, and Parks. Montana State University, Bozeman, MT.

Bramblett, R.G. and R.G. White. 2001. Habitat Use and Movements of Pallid and Shovelnose Sturgeon in the Yellowstone and Missouri Rivers in Montana and North Dakota. *Transactions of the American Fisheries Society* 130:1006-1025.

Brower, James. 2016. O&M Assumptions, Intake. Email message and attachments.

Brown, C.J.D. 1971. *Fishes of Montana*. Montana State University, Bozeman, MT.

Buckley, J., and B. Kynard. 1981. Artificial spawning and rearing of shortnose sturgeon (*Acipenser brevirostrum*) from the Connecticut River. *Prog. Fish-Cult.* 43(2):74-76.

Campbell, R. E. 1992. Status of the mountain sucker, *Catostomus platyrhynchus*, in Canada. *Canadian Field-Naturalist* 106(1):37-35.

Canadian Wildlife Service (CWS) and U.S. Fish and Wildlife Service (Service). 2007. International recovery plan for the whooping crane (*Grus americana*). Third Revision. Canada's Recovery of Nationally Endangered Wildlife (RENEW) and the Service, Albuquerque, New Mexico.

Census of Agriculture. 2016. "Census Publications." USDA Census of Agriculture 2012 and 2007. Accessed March 15, 2016. <http://www.agcensus.usda.gov/Publications/>.

- Cha, Chou and R. Christensen. 2008. Intake Diversion Dam Trashrack Appraisal Study for Intake Headworks, Lower Yellowstone Project – Montana – North Dakota. Bureau of Reclamation. February 2008.
- Cha, Chou, and B. Zelenaka. 2008. Intake Diversion Dam, Preliminary Power Demand and Consumption for a Pumping Plant Alternative, Lower Yellowstone Project – Montana – North Dakota. Bureau of Reclamation. November 2008.
- Chase, Katherine J. 2014. Streamflow Statistics for Unregulated and Regulated Conditions for Selected Locations on the Yellowstone, Tongue, and Powder Rivers, Montana, 1928-2002. Scientific Investigations Report 2013-5173, Version 1.1, U.S. Geological Survey.
- Collins, C.P, and T.D. Reynolds. 2005. Ferruginous Hawk (*Buteo regalis*): A Technical Conservation Assessment. Prepared for the USDA Forest Service, Rocky Mountain Region, Species Conservation Project.
- Connecticut Botanical Society. 2015. Nannyberry (Sweet Viburnum) *Viburnum lentago* L. Available at www.ct-botanical-society.org/Plants/view/681.
- Cowardin, L. M., V. Carter, F. C. Golet, E. T. LaRoe. 1979. Classification of Wetlands and Deepwater Habitats of the United States. U. S. Department of the Interior, Fish and Wildlife Service, Washington, D.C.
- Dames, H. R., T. G. Coon and J. R. Robinson. 1989. Movements of channel and flathead catfish between the Missouri River and a tributary, Perche Creek. *Trans. Amer. Fish. Soc.* 118:670679.
- Dawson County. 2010. User's Guide for Subdivisions; City of Glendive, Community of Richey, and Dawson County. City/County Planning Department, Glendive, MT. October 2010. Available at www.dawsoncountymontana.com/departments/planning/docs/user_s_guide_to_subdivisions.pdf.
- Dawson County. 2011. Dawson County Community Airport. Accessed January 14, 2016. www.dawsoncountymontana.org/departments/airport/index.php.
- Dawson County. Unknown year. Part III; Information Required For Environmental Assessment under the Subdivision and Platting Act. Dawson County, Montana; Subdivisions/Certificate of Surveys, Subdivision Regulations. Available at www.dawsoncountymontana.com/departments/planning/docs/EA_Joint_form.pdf.
- DeLonay, A.J., Jacobson, R.B., Annis, M.L., Braaten, P.J., Chojnacki, K.A., Elliott, C.M., Fuller, D.B., Haas, J.D., Haddix, T.M., McElroy, B.J., Mestl, G.E., Papoulias, D.M., Rhoten, J.C., Wildhaber, M.L. 2014. Ecological Requirements for Pallid Sturgeon Reproduction and Recruitment in the Missouri River—Annual Report 2011. USGS Open-File Report 2014–1106, 96 p.
- DeMallie, Raymond J., ed. 2001. Handbook of North American Indians, Plains. Vol. 13. Washington: Smithsonian Institution.

- Dick, Timothy A. 1993. Lower Yellowstone Project. Contract, U.S. Bureau of Reclamation. Accessed January 28, 2015.
www.usbr.gov/projects//ImageServer?imgName=Doc_1305121676198.pdf.
- Driscoll, F.G. 1986. Groundwater and Wells Second Edition. Johnson Screens St. Paul, Minnesota.
- Dryer, Mark and Sandvol, Alan. 1993. "Recovery Plan for the Pallid Sturgeon (*Scaphirhynchus albus*)" Endangered Species Bulletins and Technical Reports (U.S. Fish and Wildlife Service). Paper 34. Accessed at
<http://digitalcommons.unl.edu/cgi/viewcontent.cgi?article=1034&context=endangeredspeciesbul>
1
- DTM Consulting and Applied Geomorphology, Inc. (AGI). 2009. Yellowstone River Channel Migration Zone Mapping, Final Report. Prepared for the Yellowstone River Conservation District Council. Bozeman, MT.
- DTM Consulting, Inc. 2009. "Banks and Flow Lines of the Yellowstone River, 1950-2001" (ESRI personal geodatabase) Montana State Library
- DTM Consulting. 2013. Yellowstone River Land Use Mapping and Analysis: Final Report. Bozeman, Montana: DTM Consulting.
- Edwards, E. A. 1983. Habitat suitability index models: longnose sucker. Western Energy and Land Use Team, U.S. Fish and Wildlife Service, FWSOBS-82/10.35, Fort Collins, CO. 22 pp.
- Edwards, E. A., H. Li, and C. B. Schreck. 1983. Habitat suitability index models: longnose dace. Western Energy and Land Use Team. U.S. Fish and Wildlife Service, Fort Collins, CO 13 pp.
- Elliot, C., R. Jacobson, and C. Hickcox. 2015. Habitat surveys of 2015 pallid sturgeon spawning patches on the Yellowstone River. USGS Blog. Comprehensive Sturgeon Research Project. Pp. 5.
- Fetter, C.W. 1994. Applied Hydrogeology Third Edition. Macmillan College Publishing Company, Inc.
- Firehammer, J. A. and D. L. Scarnecchia. 2006. Spring Migratory Movements by Paddlefish in Natural and Regulated River Segments of the Missouri and Yellowstone Rivers, North Dakota and Montana. Transactions of the American Fisheries Society 135:200–217, 2006.
- Fork Peck Tribes. 2014. Fort Peck Assiniboine & Sioux Tribal History. February 1. Accessed February 2, 2016. www.fortpecktribes.org/tribal_history.html.
- Fraser, R, K. Van Voast, and G. Benock. 2016. Memo to David Trimpe: Lower Yellowstone Irrigation Project Water Right Summary. March 21, 2016.
- Fuller, D. B. 2012. in DeLonay, A.J., Jacobson, R.B., Annis, M.L., Braaten, P.J., Chojnacki, K.A., Elliott, C.M., Fuller, D.B., Haas, J.D., Haddix, T.M., McElroy, B.J., Mestl, G.E.,

Papoulias, D.M., Rhoten, J.C., Wildhaber, M.L. In press. Ecological requirements for pallid sturgeon reproduction and recruitment in the Missouri River: Annual report 2011: U.S. Geological Survey Open-File Report.

Fuller, D. B., M. E. Jaeger, M. Webb. 2008. Spawning and Associated Movement Patterns of Pallid Sturgeon in the Lower Yellowstone River. Upper Basin Pallid Sturgeon Recovery Workgroup 2007 Annual Report. Upper Basin Workgroup, U.S. Fish and Wildlife Service, Bozeman, Montana.

Gardner, W.M. 1996. Missouri River pallid sturgeon inventory. July 1995 – June 1996, Montana. Project #: F-78-R-2. Statewide fisheries investigations. Montana Fish Wildlife and Parks. Lewistown, MT.

Gerrity, P.C. 2005. Habitat use, diet, and growth of hatchery-reared juvenile pallid sturgeon and indigenous shovelnose sturgeon in the Missouri River above Fort Peck Reservoir. Masters Thesis, Montana State University, Bozeman, MT.

Gerrity, P.C., C.S. Guy, and W.M. Gardner. 2006. Juvenile pallid sturgeon are piscivorous—a call for conserving native cyprinids. *Trans. Amer. Fish. Soc.* 135: 604-609.

Glendive-Dawson City County Planning Board. 2013. Dawson County/Glendive Growth Policy. Available: www.dawsoncountymontana.com/departments/planning/docs/GP_Final.pdf.

Graham, P.J., R.F. Penkal, and L. Peterman. 1979. Aquatic studies of the Yellowstone River. Montana Fish and Game Report REC-ERC-79-8, Helena, Montana.

Gurgens, C., Russell, D. F. and Wilkens, L. A. 2000. Electrosensory avoidance of metal obstacles by the paddlefish. *Journal of Fish Biology.* 57: 277–290.

Guy, C.S., H.B. Treanor, K.M. Kappenman, E.A. Scholl, J.E. Ilgen and M.A.H. Webb. 2015. Broadening the regulated-river management paradigm: a case study of the forgotten dead zone hindering pallid sturgeon recovery. *Fisheries* 40(1): 6-14.

Hadley, G.L. and J.J. Rotella. 2009. Upper basin pallid sturgeon survival estimation project. Final Report. 34 p.

Heist, E.J., M. Saltzgeber, J. Geltz, and P. Hedrick. 2009. Genetic Management Plan for Captive-Reared Pallid Sturgeon Broodstock. Contract No. 08-UGPR-56 report to USDOE, WAPA, Billings, Montana. 22pp.

Helfrich, L.A., C. Liston, S. Hiebert, M. Albers, and K. Frazer. 1999. Influence of Low-Head Diversion Dams on Fish Passage, Community Composition, and Abundance in the Yellowstone River, Montana. *Rivers* 7:21–32.

Helm, Andrew. 2016. Conversation with Scott Estergard, Tetra Tech regarding potential for installation of project wind turbines at Montana Dakota Utilities facilities. April 22, 2016.

Henry T. Falvey & Associates, Inc. Critique of Pumping Plan. April 9, 2009.

- Hiebert, S., R. Wydoski, and T. Parks. 2000. Fish Entrainment at the Lower Yellowstone Diversion Dam, Intake Canal, Montana 1996-1998. Bureau of Reclamation Denver Office and Montana Area Office.
- Hier, William. 2016. Personal communication to James Brower. "Pivot Counts."
- Holas, Marcia. 2013. Urban Transportation District of Dawson County. October 12. Accessed January 5, 2016. www.dawsoncountytransit.com/index.htm.
- Hoover, J.J., J. Collins, K. A. Boysen, A. W. Katzenmeyer and K. J. Killgore. 2011. Critical swimming speeds of adult shovelnose sturgeon in rectilinear and boundary layer flow. *Applied Ichthyology*. 27 (2011), 226–230.
- Hyannis Air Service, Inc. (Cape Air). 2016. Montana Destinations. Accessed January 14, 2016. https://www.capeair.com/where_we_fly/montana.html.
- Intergovernmental Panel on Climate Change (IPCC). 2013. Summary for Policymakers. In: *Climate Change 2013: The Physical Science Basis. Contribution of Working Group I to the Fifth Assessment Report of the Intergovernmental Panel on Climate Change*. Stocker, T.F., D. Qin, G.-K. Plattner, M. Tignor, S.K. Allen, J. Boschung, A. Nauels, Y. Xia, V. Bex and P.M. Midgley (eds). Cambridge University Press, Cambridge, United Kingdom, and New York, NY, USA. Accessed January 22, 2016. www.ipcc.ch/report/ar5/wg1/
- Ireland, S. C., R. C. P. Beamesderfer, V. L. Paragamian, V. D. Wakkinen, and J. T. Siple. 2002. Success of hatchery-reared juvenile white sturgeon (*Acipenser transmontanus*) following release in the Kootenai River, Idaho, USA. *Journal of Applied Ichthyology* 18:642– 650.
- Jackson, D. C. 1995. Distribution and stock structure of blue catfish and channel catfish in macrohabitats along riverine sections of the Tennessee-Tombigbee Waterway. *N. Amer. J. Fish. Manage.* 15:345-853.
- Jaeger, M., T. Watson, A. Ankrum, M. A. Nelson, J. Rotella, G. Jordan, S. Camp. 2008. Assessment of Pallid Sturgeon Restoration Efforts In The Yellowstone River; Annual Report for 2007. Upper Basin Pallid Sturgeon Recovery Workgroup 2007 Annual Report. Upper Basin Workgroup, U.S. Fish and Wildlife Service, Bozeman, MT.
- Jaeger, M. T. Watson, A. Ankrum, M. Nelson, J. Rotella, G. Jordan, S. Camp. 2008. Assessment of Pallid Sturgeon Restoration Efforts in the Lower Yellowstone River, Annual Report for 2007. Montana Fish, Wildlife & Parks.
- Jaeger, M., A. Ankrum, T. Watson, G. Hadley, J. Rotella, G.R. Jordan, R. Wilson, S. Camp, T. Thatcher, and K. Boyd. 2009. Pallid sturgeon management and recovery in the Yellowstone River. Unpublished report, Montana Fish Wildlife and Parks, Glendive, MT.
- Jaeger, M., M. Nelson, G. Jordan, and S. Camp. 2005. Assessment of the Yellowstone River for Pallid Sturgeon Restoration Efforts; Annual Report for 2005. In Yvette Converse (ed) Upper Basin Pallid Sturgeon Recovery Workgroup 2005 Annual Report. Upper Basin Workgroup, Bozeman Fish Technology Center, Bozeman, Montana.

Jaeger, M., M. Nelson, G. Jordan, and S. Camp. 2005a. Assessment of the Yellowstone River for Pallid Sturgeon Restoration Efforts. Annual Report for 2005.

Jaeger, M., T. Watson, and M. Nelson. 2006. Assessment of the Yellowstone River For Pallid Sturgeon Restoration Efforts Annual Report for 2006. Montana Fish, Wildlife & Parks.

Jaeger, M.E., A.V. Zale, T.E. McMahon, B.J. Schmitz. 2005b. Seasonal Movements, Habitat Use, Aggregation, Exploitation, and Entrainment of Saugers in the Lower Yellowstone River: An Empirical Assessment of Factors Affecting Population Recovery. *North American Journal of Fisheries Management* 1550–1568.

Jaeger, M.E., G.R. Jordan, and S. Camp. 2004. Assessment of the Suitability of the Yellowstone River for Pallid Sturgeon Restoration Efforts; Annual Report for 2004. In K. McDonald [ed.] *Upper Basin Pallid Sturgeon Recovery Workgroup 2004 Annual Report*. Helena, Montana.

Jean, C. and S. Crispin. 2001. Inventory of Important Biological Resources in the Upper Yellowstone River Watershed. Report to the Environmental Protection Agency. Montana Natural Heritage Program, Helena Montana. 26 pp. plus appendices.

Johnson, W. C., M. D. Dixon, M. L. Scott, L. Rabbe, G. Larson, M. Volke and B. Werner. 2012. Forty Years of Vegetation Change on the Missouri River Floodplain. *BioScience*. Volume 62, Issue 2Pp. 123-135.

Jones, G.P. and G.M. Walford. 1995. Major riparian vegetation types of eastern Wyoming. Wyoming Department of Environmental Quality, 245 p.

Jones, Stephanie L. 2010. Sprague's Pipit (*Anthus spragueii*) Conservation Plan. U.S. Department of the Interior, Fish and Wildlife Service.

Jones, W. M. 2001. Ecologically significant wetlands in the upper Yellowstone River watershed, including the Boulder, Clark's Fork Yellowstone, Shields, and Stillwater River drainages. Draft report to the Montana Department of Environmental Quality. Montana Natural Heritage Program, Helena, MT.

Jordan, George. 2008. Summary of the Biological Review Team's comments on Lower Yellowstone River Irrigation Project Fish Screening Preliminary Design. March 13, 2008. https://www.usbr.gov/gp/mtao/loweryellowstone/summary_of_biological_review_teams_comments_of_fish_screening_preliminary_design_march_2008.pdf

Jordan, G.R., R.A. Klumb, G.A. Wanner and W.J. Stancill. 2006. Post-stocking movements and habitat use of hatchery-reared juvenile pallid sturgeon in the Missouri River below Fort Randall Dam, South Dakota and Nebraska. *Transactions of the American Fisheries Society* 135: 1499:1511.

Jungwirth, M., S. Schwutz, and S. Weiss. 1998. Fish migration and fish bypasses. Fishing News Books, London.

Klungle, M. M. and M.W. Baxter. 2005. Upper Missouri and Yellowstone Rivers Pallid Sturgeon Study 2004 Report. Report Submitted to Western Area Power Administration, Grant Agreement No. 94-BAO-709. Montana Fish, Wildlife & Parks, Fort Peck, Montana.

Klungle, M.M and M.W. Baxter. 2005. Lower Missouri and Yellowstone Rivers Pallid Sturgeon Study, 2004 Report. Montana Department of Fish, Wildlife, and Parks, Fort Peck, MT. Submitted to Western Area Power Administration, Grant Agreement No. 94-BAO-709.

Kordecki, Cynthia, Mary McCormick, Carrie F. Jackson, and Jennifer Bales. 2000. Lower Yellowstone Irrigation Project, 1996 and 1997 Cultural Resources Inventory, Dawson and Richland Counties, Montana and McKenzie County, North Dakota. Contract, University of North Dakota, Department of Anthropology, Anthropology Research and Renewable Technologies, Inc., Billings, Montana: U.S. Bureau of Reclamation, Montana Area Office.

Kudray, G.M. and T. Schemm. 2006. Yellowstone River Wetland/Riparian Change Detection Pilot Study. Montana Natural Heritage Program, Natural Resource Information System, Montana State Library.

Kulbeth, David, and Meg Coleman. 2014. Bakken fuels North Dakota's oil production growth. U.S. Energy Information Administration. August 4. Accessed January 13, 2016. www.eia.gov/todayinenergy/detail.cfm?id=17391.

Kurobe T., E. MacConnell, C. Hudson, T. S. McDowell, F. O. Mardones and R. P. Hedrisk. 2011. Iridovirus Infections among Missouri River Sturgeon: Initial Characterization, Transmission, and Evidence for Establishment of a Carrier State. *Journal of Aquatic Animal Health* Volume 23, Issue 1.

Kynard, B. 1993. Fish behavior important for fish passage. In *Fish passage: Policy and technology Sympos.*, Bioeng. Sect., AFS, pp. 129-134.

Kynard, B., D. Pugh, E. Henyey, and T. Parker. 2002. Preliminary comparison of pallid and shovelnose sturgeon for swimming ability and use of fish passage structure. Final Rep. USACOE, Omaha Dist., Omaha, NE. pp. 30.

Kynard, B., E. Parker, D. Pugh, and T. Parker. 2007. Use of Laboratory Studies to Develop a Dispersal Model for Missouri River Pallid Sturgeon Early Life Intervals. *Journal of Applied Ichthyology* 23:365–374.

Kynard, B.; Pugh, D.; Parker, T. 2011: Passage and behaviour of cultured Lake Sturgeon in a prototype side-baffle fish ladder: I. Ladder hydraulics and fish ascent. *J. Appl. Ichthyol.* 27: 77-88.

Kynard, B.; Pugh, D.; Parker, T. 2012. Passage and behavior of Connecticut River shortnose sturgeon in a prototype spiral fish ladder with a note on passage of other fish species. *WSCS Spec. Publ. No. 4.* pp. 277–296.

Kynard, B., M. Horgan, and M. Kieffer. 2008. Habitats used by shortnose sturgeon in two Massachusetts rivers, with notes on estuarine Atlantic sturgeon: a hierarchical approach. *Trans. Amer. Fish. Soc.* 129: 487-503.

Kynard, B., M. Horgan, D. Pugh, E. Henyey, T. Parker. 2008. Using juvenile sturgeons as a substitute for adults: a new way to develop fish passage for large fish. *Amer. Fish Soc. Sympos.* 61: 1-23.

Kynard, B., M. Kieffer, M. Horgan, B. E. Kynard, M. Burlingame, and P. Vinogradov. 2012. Seasonal movements among river reaches, migration strategies, and population structure of the divided Connecticut River shortnose sturgeon population: the effects of Holyoke Dam. pp. 1-49. *In* Life history and behaviour of Connecticut River shortnose sturgeon and other sturgeons. *World Sturgeon Cons. Soc. Spec. Publ.* #4.

Layne Heavy Civil. 2016. Memo from Andrew Smith, P.E. Submitted with information from DOW and NRDC.

Licht, D.S., and L.E. Huffman. 1996. Gray Wolf Status in North Dakota. *DigitalCommons@University of Nebraska-Lincoln U.S. Fish & Wildlife Publications.*

Licht, D.S., and S.H. Fritts. 1994. Gray wolf (*Canis lupus*) occurrences in the Dakotas. *American Midland Naturalist* 132(1):74-81.

Lippi, J.C., T.H. Deluca, S.V. Harrar, and S.W. Running. 2012. Impacts of climate change on August stream discharge in the Central-Rocky Mountains. *Climatic Change* 997-1014.

Lower Yellowstone Project Board of Control. 2009. Conservation Plan – Lower Yellowstone Irrigation Project. Electronic, Bureau of Reclamation (BOR-0017430).

Lower Yellowstone Project Board of Control. 2013. pers. comm. LYP 2013 Total Crop Census. Personal Communication via email, February 9 2016.

Luna, T. 2010. Mat Saltbush Shrubland — Inter-Mountain Basins Mat Saltbush Shrubland. *Montana Field Guide*. Available: FieldGuide.mt.gov/displayES_Detail.aspx?ES=5203.

Luna, T. and L.K. Vance. 2010a. Great Plains Mixedgrass Prairie — Northwestern Great Plains Mixedgrass Prairie. *Montana Field Guide*. Available: FieldGuide.mt.gov/displayES_Detail.aspx?ES=7114.

Luna, T. and L.K. Vance. 2010b. Great Plains Sand Prairie — Western Great Plains Sand Prairie. *Montana Field Guide*. Available: FieldGuide.mt.gov/displayES_Detail.aspx?ES=7121.

Lund, D.F. 2015. Public Land data Map: Montana State Library. Map Request Number: 16MS L0001. Available: ftp://geoinfo.msl.mt.gov/Documents/Maps/Collections/100K_PublicLand/2015/100K_pub2015_GLENDIVE.pdf.

Lutey, Tom. 2015. BNSF to spend \$124 million on Montana track in 2015. Billings Gazette, February 25: Wbillingsgazette.com/news/state-and-regional/montana/bnsf-to-spend-million-on-montana-track-in/article_2c79d723-0c3e-5c00-a3fe-d693e037fe94.html.

Mala, Cynthia A, Melanie L Johnson, and Chadwick Kramer. 1999. Facts and Profiles: Indians in North Dakota. North Dakota Indian Affairs. November. Accessed January 14, 2016. www.nd.gov/indianaffairs/image/cache/NDIAC_Facts_and_Profiles.pdf.

McDonald, D., N.M. Korfanta, and S.J. Lantz. 2004. The Burrowing Owl (*Athene cunicularia*): A Technical Conservation Assessment. Prepared for the USDA Forest Service, Rocky Mountain Region, Species Conservation Project.

McIntyre, C., L. Vance, T. Luna. 2010. Great Plains Closed Depressional Wetland — Western Great Plains Closed Depressional Wetland. Montana Field Guide. Available: FieldGuide.mt.gov/displayES_Detail.aspx?ES=9252.

McKenzie County. 2013. McKenzie County Comprehensive Plan. Adopted in 2013. Available at county.mckenziecounty.net/DepartmentsDisplay/Planning-Zoning.

McKoy, K.P. 2013. Survey and Inventory of Streams: Tongue River. Job Progress Report F-78-R3 Warmwater.

Mech, L.D. 1995. The Challenge and Opportunity of Recovering Wolf Populations. *Conservation Biology* 9(2):1-9.

Mefford, B. and Z. Sutphin. 2008. Intake Diversion Dam Fish Screens: Evaluation of fish screens for protecting early life stages of pallid sturgeon. Bureau of Reclamation, Water Resources Research Laboratory.

Mefford, B., R. Christensen, and A. Glickman. 2000. Intake Diversion Dam, Yellowstone River, Montana: Fish Protection and Passage Concept Study Report. Bureau of Reclamation, Water Resources Research Laboratory.

Meredith, E., and Wheaton, J. 2011. Salt cedar and Russian olive in Treasure County, Montana: Transpiration rates and soil salt concentrations: Montana Bureau of Mines and Geology Report of Investigation 21, 78 p.

Miller, S. E. and D. L. Scarnecchia. 2008. Adult paddlefish migrations in relation to spring river conditions of the Yellowstone and Missouri rivers, Montana and North Dakota, USA. *J. Appl. Ichthyol.* 24 (2008), 221–228.

Montana Aquatic Nuisance Species (ANS) Tech Committee. 2002. Montana ANS Management Plan.

Montana Audubon Society. 2011. Our Birds Call This Home; A Guide to Living with Birds along Montana's Rivers and Streams. November 2011. Available at mtaudubon.org/birds-science/iba/featured-montana-ibas/riverine-ibas/.

Montana Audubon Society. 2016. Montana Important Bird Areas; Riverine IBAs. Accessed: 19 January 2016. Available at mtaudubon.org/birds-science/iba/featured-montana-ibas/riverine-ibas/.

Montana Bureau of Mines and Geology (MBMG). 2000. Groundwater Resources of the Lower Yellowstone River Area: Dawson, Fallon, Prairie, Richland, and Wibaux Counties, Montana. Part A – Descriptive Overview and Basic Data. Larry N. Smith et al.

Montana Bureau of Mines and Geology (MBMG). 2016a. Ground Water Information Center webpage – Water Well statistics for Dawson, Richland, and Wibaux Counties, Montana. mbmgwic.mtech.edu/sqlserver/v11/reports/CountyStatistics.asp? Accessed January 2016.

Montana Climate Office. 2016. Montana Climate Atlas Maps. Accessed January 28, 2016. Available at mco.maps.arcgis.com/home/. University of Montana.

Montana Department of Agriculture. 2015. Weed list for the state of Montana. Available: agr.mt.gov/agr/Programs/Weeds/PDF/2015WeedList.pdf.

Montana Department of Commerce. 2013. Census & Economic Information Center. MT State & County Population Projections. April. Accessed January 5, 2016. ceic.mt.gov/Population/PopProjections_StateTotalsPage.aspx.

Montana Department of Environmental Quality (MTDEQ). 2012. Circular DEQ-7 Montana Numeric Water Quality Standards. Water Quality Planning Bureau, Water Quality Standards Section, October. Available at pubs.usgs.gov/sir/2004/5113/.

Montana Department of Environmental Quality (MTDEQ). 2013a. Department Circular DEQ-12A Montana Base Numeric Nutrient Standards. Available at pubs.usgs.gov/sir/2004/5113/.

Montana Department of Environmental Quality (MTDEQ). 2013b. Priceless Resources – A Strategic Framework for Wetland and Riparian Area Conservation and Restoration in Montana 2013–2017. Helena, Montana.

Montana Department of Environmental Quality (MTDEQ). 2014. Final Water Quality Integrated Report. 305(b) and 303(d) Documents Final Integrated Reports. Available at deq.mt.gov/wqinfo/cwaic/reports.mcp.

Montana Department of Environmental Quality (MTDEQ). 2015a. State of Montana Air Quality Monitoring Network Plan, May 2015. deq.mt.gov/Portals/112/Air/AirMonitoring/Documents/2015_NETWORK_PLAN_DRAFT.pdf. Accessed January 29, 2016.

Montana Department of Environmental Quality (MTDEQ). 2015b. Bridger Poplar Pipeline Response. After Action Review 1/17/15-4/10/15.

Montana Department of Environmental Quality (MTDEQ). 2016a. Burning Restrictions web page: deq.mt.gov/Air/airquality/burnrestrictions, accessed February 2016.

Montana Department of Environmental Quality (MTDEQ). 2016b. Air Quality for Sidney, Montana Station. svc.mt.gov/deq/todaysair/, accessed January 13, 2016.

Montana Department of Environmental Quality (MTDEQ). 2016c. Source Water Protection search webpage: svc.mt.gov/deq/dst/#/app/swp. Accessed January 2016.

Montana Department of Environmental Quality (MTDEQ). 2016d. Source Water Protection search City of Glendive Source Water Delineation and Assessment Report, March 17, 2003: deq.mt.gov/Portals/112/Water/WPB/NRISReports/mt0000229.pdf. Accessed January 2016.

Montana Department of Environmental Quality (MTDEQ). 2016e. Source Water Protection search City of Sidney Source Water Delineation and Assessment Report, July 22, 2003: deq.mt.gov/Portals/112/Water/WPB/NRISReports/mt0000330.pdf. Accessed January 2016.

Montana Department of Environmental Quality (MTDEQ). 2016f. Source Water Protection search Intake Fishing Access Site Source Water Delineation and Assessment Report, February 20, 2002: deq.mt.gov/Portals/112/Water/WPB/NRISReports/MT0042451.pdf. Accessed January 2016.

Montana Department of Natural Resources and Conservation (MDNRC). 2014. Yellowstone River Basin Water Plan 2014. State of Montana. Available at dnrc.mt.gov/divisions/water/management/state-water-plan.

Montana Department of Natural Resources and Conservation. 2016. General Abstract, Water Right Number 42M 97792-00 Provisional Permit.

Montana Department of Natural Resources and Conservation (MDNRC). 2016a. Water Rights Bureau – Controlled Ground Water Areas webpage. dnrc.mt.gov/divisions/water/water-rights/controlled-groundwater-areas. Accessed January 2016.

Montana Department of Natural Resources and Conservation (MDNRC). 2016b. Map of Montana Controlled Ground Water Areas dated September 2010: dnrc.mt.gov/divisions/water/water-rights/docs/new-appropriations/basinclose-cgw_map.pdf. Accessed January 2016.

Montana Department of Natural Resources and Conservation (MDNRC). 2016c. Groundwater Application For Beneficial Water Use Permit, Accessed online March 23, 2016 at http://dnrc.mt.gov/divisions/water/water-rights/docs/forms/600-gw-u3-2016-_fillable.pdf

Montana Department of Transportation. 2013. 2013 – 2014 Montana Highway Map. Montana Department of Transportation. July 31. Accessed January 5, 2016. www.mdt.mt.gov/travinfo/docs/2013-2014-mt-highway-map.pdf.

Montana Department of Transportation. 2015. Traffic Data Maps – Statewide Traffic Count Site Map. Montana Department of Transportation. Accessed January 5, 2016. www.mdt.mt.gov/publications/datastats/traffic_maps.shtml.

Montana Department of Transportation. 2016. Public Transportation. Montana Department of Transportation. Accessed January 5, 2016. www.mdt.mt.gov/travinfo/public_trans.shtml.

Montana Fish, Wildlife and Parks (MFWP). 2012. Subdivision Recommendations for Subdivision Development in Montana; Appendix C.2. Big Game Winter Range. Available at fwp.mt.gov/fishAndWildlife/livingWithWildlife/buildingWithWildlife/subdivisionRecommendations/.

Montana Fish, Wildlife and Parks (MFWP). 2014. Aquatic Invasive Species Locations in Montana – 2014. Found at fwp.mt.gov/fishAndWildlife/species/ais/speciesId/default.html.

Montana Fish, Wildlife and Parks (MFWP), Montana Department of Environmental Quality (MDEQ), and Montana DPHHS. 2014. Montana Sport Fishing Consumption Guidelines. Montana Sport Fishing Consumption Chart. Available at <https://dphhs.mt.gov/Portals/85/publichealth/documents/FCS/FishConsumptionPamphletforWEB2014FNL.pdf>.

Montana Fish, Wildlife and Parks (MFWP). 2016a. Fishing – Visit a Fishing Access Site. Accessed January 16, 2016. fwp.mt.gov/fishing/searchFas.html.

Montana Fish, Wildlife and Parks (MFWP). 2016c. Fishing Access Site; Site Detail: Intake Dam Fishing Access Site on the Yellowstone River. Accessed 6 January 2016. Available at fwp.mt.gov/fishing/siteDetail.html?id=283784.

Montana Fish, Wildlife and Parks (MFWP). 2016d. MFISH – Montana Fisheries Information System. Accessed January 7, 2016. fwp.mt.gov/fishing/mFish/.

Montana Fish, Wildlife and Parks (MFWP). 2016e. Montana Field Guide. Montana Natural Heritage Program. Available at fieldguide.mt.gov/.

Montana Fish, Wildlife and Parks (MFWP). 2016b. Fish & Wildlife – Wildlife Management Areas – Visit a WMA Site. Accessed January 14, 2016. fwp.mt.gov/fishAndWildlife/wma/.

Montana Natural Heritage Program (MTNHP). 2013. Montana Land Cover/Land Use Theme. Helena, Montana. Available: http://mslapps.mt.gov/Geographic_Information/Data/DataList/datalist_Details?did=%7B1C91607B-A788-4B23-B1BA-53EED2842D03%7D.

Montana Natural Heritage Program (MTNHP). 2015a. Montana's species of concern and special status species database search results. Data package from Martin Miller, Helena, Received December 27, 2015.

Montana Natural Heritage Program (MTNHP). 2015b. The Montana Wetland and Riparian Framework. Helena, MT. Available: http://mslapps.mt.gov/Geographic_Information/Data/DataList/datalist_Details?did=%7B5015e70b-e38e-46a7-9ce3-e47cb9587e07%7D.

- Montana Sage Grouse Work Group (MSGWG). 2005. Management Plan and Conservation Strategies for Sage Grouse in Montana – Final. Revised: February 1, 2005.
- Montana State Library. 2014. Montana Cadastral Framework. July 10. Accessed January 20, 2016:
mslapps.mt.gov/Geographic_Information/Data/DataList/datalist_Details?did=%7B35524afc-669b-4614-9f44-43506ae21a1d%7D
- Montana State Library. 2015a. Montana Cadastral Mapping web page. Accessed December 14 and 16, 2015: svc.mt.gov/msl/mtcadastral/
- Montana State Library. 2015b. Montana County Boundaries. Digital Library – Geographic Information Clearinghouse. September 24. Accessed December 19, 2015.
mslapps.mt.gov/Geographic_Information/Data/DataList/datalist_Details?did=%7BB3682ED8-1D68-41F8-BAE6-14149C527EE4%7D.
- Montana State Library. 2016. Montana Department of Natural Resources and Conservation Water Right Query System web page. Accessed January 11 and 13, 2016:
<http://wr.msl.mt.gov/default.aspx>
- Montana Weed Control Association. 2015. Available: mtweed.org/weed-identification/.
- National Academy of Sciences (NAS). 2001. Riparian Areas Functions and Strategies for Management. National Academy Press, Washington, DC.
- National Agricultural Statistics Service. 2014. 2014 National Cropland Data Layer. Electronic Database, U.S. Department of Agriculture.
- National Agricultural Statistics Service. 2015. Montana Field Office Annual Statistics Bulletin. December 18. Accessed January 20, 2016.
www.nass.usda.gov/Statistics_by_State/Montana/Publications/Annual_Statistical_Bulletin/.
- National Agricultural Statistics Service. 2015a. “Annual Statistics Bulletin.” Montana Field Office. Accessed March 02, 2016.
http://www.nass.usda.gov/Statistics_by_State/Montana/Publications/Annual_Statistical_Bulletin/
- National Agricultural Statistics Service. 2015b. “North Dakota Statistics: County Estimates.” North Dakota Field Office. Accessed March 02, 2016.
http://www.nass.usda.gov/Statistics_by_State/North_Dakota/index.php.
- National Agricultural Statistics Service. 2016. “Quick Stats 2.0.” Quick Stats Tools. Accessed March 02, 2016. http://www.nass.usda.gov/Quick_Stats/.
- National Audubon Society (Audubon). 2016. Important Bird Areas (GIS database). Accessed 19 January 2016. Available at: netapp.audubon.org/IBA/State/US-MT.
- National Park Service. 2016. Fort Union Trading Post National Historic Site. January 16. Accessed January 18, 2016. www.nps.gov/fous/index.htm.

Natural Resources Conservation Service (NRCS). 1914. Montana: Average Length of Freeze-Free Season. Accessed January 28, 2016. Available at https://efotg.sc.egov.usda.gov/references/public/MT/Average_Freeze_MT_683.

NatureServe. 2015. NatureServe Explorer: An Online Encyclopedia of Life. explorer.natureserve.org/index.htm.

Nesser, J. A., G. L. Ford, C. L. Maynard, D. S. Page-Dumroese. 1997. Ecological Units of the Northern Region: Subsections. USDA, Forest Service.

Newell, R.L. 1977. Aquatic Invertebrates of the Yellowstone River Basin, Montana: Montana Department of Natural Resources and Conservation Technical Report No. 5, Yellowstone Impact Study.

North Dakota Department of Agriculture. 2015. North Dakota County and City Listed Noxious Weeds. Available: www.nd.gov/ndda/files/resource/12-1-15CityCountyNoxiousWeedsList.pdf

North Dakota Department of Health (NDDOH). 2016. Source Water Protection Program web page. Accessed February 2016: www.ndhealth.gov/WQ/GW/sourcewater.htm

North Dakota Department of Mineral Resources. 2015. North Dakota Drilling and Production Statistics. November. Accessed January 14, 2016. www.dmr.nd.gov/oilgas/stats/historicalbakkenoilstats.pdf.

North Dakota Department of Transportation. 2015. Local Bus & Transit Services. Accessed January 6, 2016. <https://www.dot.nd.gov/divisions/localgov/local-bus-transit-services.htm>.

North Dakota Department of Transportation. 2015a. Bus, Transit, and Taxi Services. North Dakota Department of Transportation. Accessed January 5, 2016. <https://www.dot.nd.gov/divisions/localgov/transit.htm>.

North Dakota Department of Transportation. 2015b. Traffic Information and Counts – Interactive Transportation Information Map. North Dakota Department of Transportation. Accessed January 5, 2016. www.dot.nd.gov/road-map/traffic/.

North Dakota Game and Fish Department (NDGF). 2012a. Gray Wolf. North Dakota Game and Fish Department. gf.nd.gov/wildlife/fish-wildlife/id/mammals/carnivores/wolf.

North Dakota Game and Fish Department (NDGF). 2012b. Wildlife Management Area Guide. Accessed January 16, 2016. gf.nd.gov/wma/listing.

North Dakota Geological Survey (NDGS) 1985. Geology of McKenzie County, North Dakota. North Dakota Geological Survey, Bulletin 80, Part 1. www.swc.nd.gov/info_edu/reports_and_publications/county_groundwater_studies/pdfs/McKenzie_Part_I.pdf.

North Dakota Natural Heritage Program (NDNHP). 2016. Yellowstone River/McKenzie and Williams County Request for Species of Concern and Special Status Species. Letter from North

Dakota Parks and Recreation Department, Natural Resource Program, Received January 25, 2016.

North Dakota State Historical Society. 2013. Fort Buford State Historic Site. Accessed January 13, 2016. history.nd.gov/historicsites/buford/index.html.

North Dakota State University. 2015. Selecting a Sprinkler Irrigation System. NDSU Extension Service. North Dakota State University. Fargo, North Dakota. September 2015.

North Dakota State Water Commission & Office of the State Engineer (NDSWC&OSE). 2016. Water well database search: www.swc.state.nd.us/info_edu/map_data_resources/groundsurfacewater/. Accessed February 2016.

North Dakota State Water Commission. 2013. County Boundaries. North Dakota GIS Hub Data Portal. April. Accessed December 19, 2015. www.nd.gov/gis/apps/DataDownload/?clipping=Full&coord=ND83-SF&format=SHAPE&layers=NDHUB.COUNTIES.

Peterson, D. A., K. A. Miller, T. T. Bartos, M. L. Clark, S. D. Porter, and T. L. Quinn. 2004. Water Quality in the Yellowstone River Basin Wyoming, Montana, and North Dakota, 1999-2001. Cheyenne, WY: USGS.

Pflieger, W. L. 1975. The Fishes of Missouri. Missouri Dept. of Conservation. Jefferson City, Missouri.

Pflieger, W. L. and T. B. Grace. 1985. Changes in the fish fauna of the lower Missouri River, 1940-1983. Symposium on community and evolutionary ecology of North America stream fishes, Knoxville, TN, pp 166-177.

Pick, T. 2013. Long-Term Strategy For Russian Olive And Saltcedar Management. Yellowstone River Conservation District Council.

Progressive Railroading. 2011. Rail News: Short Lines & Regionals – BNSF, Yellowstone Valley modify lease agreement for Montana Line. June 15. Accessed January 7, 2016. www.progressiverailroading.com/short_lines_regionals/news/BNSF-Yellowstone-Valley-modify-lease-agreement-for-Montana-line--26937.

Propst, D. L. and C. A. Carlson 1986. The distribution and status of warmwater fishes in the Platte River drainage, Colorado. *SW Nat.* 31(2):149-167.

Reclamation and U.S. Army Corps of Engineers (Corps). 2009. Public Scoping Summary Report, Intake Diversion Dam Modification, Lower Yellowstone Project, Montana, Environmental Impact Statement. Dakotas Area Office, Bureau of Reclamation.

Reclamation and U.S. Army Corps of Engineers (Corps). 2010. Intake Diversion Dam Modification, Lower Yellowstone Project, Montana, Final Environmental Assessment. Report and Appendixes.

Reclamation and U.S. Army Corps of Engineers (Corps). 2015. Intake Diversion Dam Modification, Lower Yellowstone Project, Montana, Final Supplement to the 2010 Environmental Assessment. Including all attachments.

Reclamation. 1992. Lower Yellowstone Project, Montana. Main Canal Sections. (Excerpt from Scanned Documents)

Reclamation. 1997a. Water Resources Research Laboratory. Water Measurement Manual (3rd Edition, Reprinted 2001), in cooperation with U.S. Department of Agriculture.

Reclamation. 1997b. Literature Summaries for Key Fish Species. Fish Passage and Protection Program in the Yellowstone River Basin, Montana. Denver, Colorado.

Reclamation. 2002a. Canal-Lining Demonstration Project, Year 10, Final Report (R-02-03). Boise, Idaho.

Reclamation. 2002b. Value Engineering Final Report: Intake Diversion Dam Fish Protection and Passage Concept Design, Lower Yellowstone Project. Bureau of Reclamation, Technical Service Center, Denver, Colorado.

Reclamation. 2004. Intake Diversion Dam, Fish Protection and Passage Concept Study Report II, Lower Yellowstone Project, Yellowstone River, Montana. U.S. Bureau of Reclamation Technical Services Center, Denver, Colorado.

Reclamation. 2005. Value Engineering Final Report: Lower Yellowstone Fish Passage Alternatives Value Planning Study. Bureau of Reclamation, Technical Service Center, Denver, Colorado. August 10, 2015.

Reclamation, 2012. Site Inventory and Hydropower Energy Assessment of Reclamation Owned Conduits. Supplement to the "Hydropower Resource Assessment at Existing Reclamation Facilities Report". U.S. Department of the Interior Bureau of Reclamation Power Resources Office Denver, Colorado. March 2012

Reclamation, 2012a. Reclamation's NEPA Handbook. Bureau of Reclamation. February 2012. Online at http://www.usbr.gov/nepa/docs/NEPA_Handbook2012.pdf.

Reclamation. 2012b. Climate Change Analysis for the Missouri River Basin. Technical Memorandum No. 86-68210-2012-03. U.S. Department of the Interior, Bureau of Reclamation, Technical Service Center, Denver, CO.

Reclamation. 2012c. Project Details – Lower Yellowstone Project. February 1. Accessed January 28, 2015. www.usbr.gov/projects/Project.jsp?proj_Name=Lower+Yellowstone+Project.

Reclamation. 2013. Lower Yellowstone Fish Passage Alternatives Planning Study. June – September, 2013.

- Reclamation. 2016a. West-Wide Climate Risk Assessments: Hydroclimate Projections. Technical Memorandum No. 86-68210-2016-01. Denver, CO.
- Reclamation. 2016b. SECURE Water Act Section 9503(c) – Reclamation Climate Change and Water 2016. Prepared for the U.S. Congress, Denver, CO.
- Reinhold, A.M., Bramblett, R.G., and Zale, A.V. 2014. Anthropogenic habitat change effects on fish assemblages of the middle and lower Yellowstone River. Montana Cooperative Fishery Research Unit, Montana State University-Bozeman. Montana Fish, Wildlife and Parks University Research Completion Report Series Number 2014-01.2.
- Richland County, Montana. 2007. Richland county Growth Policy. Available: www.richland.org/DocumentCenter/View/35.
- Richland County. 2015. Richland County Growth Policy Update. Richland County. September 2015. Available at www.richlandplan.com/assets/150408_gp_richland.pdf.
- Rugg, M. 2014. Lower Yellowstone River Pallid Sturgeon Progress Report. Montana Fish, Wildlife and Parks. Glendive, MT.
- Rugg, M. 2015. Lower Yellowstone River Pallid Sturgeon Progress Report. Montana Fish, Wildlife and Parks. Glendive, MT.
- Rugg, M., E. Best, D. Trimpe, C. Bollman, K. McKoy, and M. Backes. 2016. Missouri River Natural Resources Committee Poster Presentation.
- Ryce, E. 2011. Aquatic Invasive Species Management in Montana. Montana Fish Wildlife and Parks. yellowstonerivercouncil.org/news/wordpress-content/uploads/2011/03/Aquatic-Invasive-Species-Management-in-Montana.pdf.
- Scarnecchia, D. L., L. F. Ryckman, Y. Lim, G. J. Power, B. J. Schmitz, and J. A. Firehammer. 2007. Life History and the Costs of Reproduction in Northern Great Plains Paddlefish (*Polyodon spathula*) as a Potential Framework for Other Acipenseriform Fishes. *Reviews in Fisheries Science* 211–263.
- Shafer, M., D. Ojima, J.M. Antle, D. Kluck, R.A. McPherson, S. Petersen, B. Scanlon, and K. Sherman. 2014. Chapter 19: Great Plains, Climate Change Impacts in the United States: The Third National Climate Assessment. doi:10.7930/JOD798BC, U.S. Global Change Research Program.
- Shannon, Ph.D., George W. 2016. Interview by Erin M. King, MA, RPA. Regional Archaeologist, U.S. Bureau of Reclamation, Great Plains Region. January 6 and 12.
- Shuland, D. 2016. Email to David Trimpe, Bureau of Reclamation, pertaining to banking agreements and wind power. March 31, 2016.
- Simon, A. F. D. Shields, R. Ettema, C. Alonso, M. Marshall-Garsjo, A. Curini and L. Steffen. 1999. Channel Erosion on the Missouri River, Montana between Fort Peck Dam and the North

Dakota Border. Oxford, Mississippi: USDA-Agricultural Research Service National Sedimentation Laboratory.

Sloulin Field International Airport. 2016. Airport Relocation Documents. Accessed January 14, 2016. www.flywilliston.net/Relocation.

Smith, L.H., John I. LaFave, T.W. Patton, J.C. Rose, and D.P. McKenna. 2000. Groundwater Resources of the Yellowstone River Area: Dawson, Fallon, Prairie, Richland, and Wibaux Counties, Montana. Part A – Description Overview and Basic Data. Montana Bureau of Mines and Geology.

Smith, Larry N. 1998. Thickness of Unconsolidated Deposits, Lower Yellowstone River Area; Dawson, Fallon, Prairie, Richland and Wibaux Counties, Montana. Montana Groundwater Assessment Atlas No. 1, Part B, Map 2. December 17, 1998

Stagliano, D. 2010. Freshwater Mussels in Montana: Comprehensive Results from 3 years of SWG Funded Surveys. Helena, MT: Montana Natural Heritage Program. mtnhp.org/reports/Mussel_Booklet.pdf.

Steffensen, K.D., L.A. Powell, and J.D. Koch. 2010. Assessment of hatchery-reared pallid sturgeon survival in the lower Missouri River. *North American Journal of Fisheries Management* 30: 671-678.

Stewart, P.A. 1986, 1988, 1990, 1991. Fish Management Surveys. Federal Aid in Fish Restoration, Project F-30-R-22, Montana Department of Fish, Wildlife & Parks.

Steyermark, J.A. 1963. *Flora of Missouri*. Iowa State University Press. Ames, Iowa. 1728 pp.

Stuart, Jason. 2015. Paddlefish Season Comes to a Close. *Glendive Ranger Review*. June 03. Accessed January 20, 2016. www.rangerreview.com/news/paddlefish-season-comes-close.

Suhr, J. (1999). "The choosing by advantages decision making system." *Quorum*, Westport, CT, US, 304 pp.

Teeter, J.H., R.B. Szamier, and M.V.L. Bennett. 1980. Ampullary electroreceptors in the sturgeon *Scaphirhynchus platyrhynchus*. *J. Comp. Physiol.* 138:213-223.

Tetra Tech. 2015. Technical Memorandum from Kirk Miller and Jim Maus Tetra Tech MMI to Mr. Scott Estergard Tetra Tech DIV; Re: DRAFT Yellowstone River Diversion Desktop Hydrogeologic Review. Dated December 18, 2015.

Tetra Tech. 2016a. Tetra Tech Memorandum to Tiffany Vanosdall, Corps of Engineers Omaha District – Ranney Well Preliminary Design Review. Dated January 15, 2016.

Tetra Tech. 2016b. Review of Collection Well Assumptions Yellowstone River Diversion Desktop Hydrogeologic Review. Dated January 14, 2016.

- Tetra Tech. 2016c. Revised Review of Collection Well Assumptions Yellowstone River Diversion Desktop Hydrogeologic Review. January 27.
- Thatcher, T. and B. Swindell. 2013. Yellowstone River Land Use Mapping and Analysis: Final Report. DTM Consulting Inc. Bozeman, Montana.
- Todd, D.K. 1980. Groundwater Hydrology Second Edition. John Wiley and Sons Inc.
- Toom, Dennis L., Mitzi Rossillon, Mary McCormick, and Michael A. Jackson. 2011. Headworks Camp (24DW447) Historic Site Archeological Excavations, Dawson County, Montana. Contract, Anthropology Research, University of North Dakota and Renewable Technologies, Inc., Billings, MT: U.S. Bureau of Reclamation, Great Plains Regional Office.
- Travel Montana. 2015. Sidney-Richland Airport. Accessed January 12, 2016. www.travelmt.com/mt_sites_11367_Sidney-Richland+Airport.html.
- Trimpe, David. 2014. Interview by Author's Name Here. U.S. Bureau of Reclamation, Montana.
- Tuthill, Andrew M., Carr, Meredith L. 2012. Evaluation of Ice Impacts on Bypass Channel at Intake Dam on Lower Yellowstone River. U. S. Army Corps of Engineers, Cold Regions Research and Engineering Laboratory. Hanover, NH.
- U.S. Army Corps of Engineers (Corps) and Yellowstone River Conservation District Council (YRCDC). 2015. Yellowstone River Cumulative Effects Analysis and Appendices. U.S. Army Corps of Engineers Omaha District, NE.
- U.S. Army Corps of Engineers (Corps). 2002. Lower Yellowstone River Intake Dam Fish Passage Alternatives Analysis. Omaha District. Omaha, Nebraska.
- U.S. Army Corps of Engineers (Corps). 2006. Final Report, Lower Yellowstone Project Fish Passage and Screening, Preliminary Design Report, Intake Diversion Dam, Appendix B, Hydrology. Final Report.
- U.S. Army Corps of Engineers (Corps). 2008. Lower Yellowstone Project Fish Screening and Sediment Sluicing Preliminary Design Report, Final Report. Omaha District. Omaha, Nebraska.
- U.S. Army Corps of Engineers (Corps). 2009. Lower Yellowstone Project Fish Passage and Screening, 60% Design Report, Rock Ramp and Screened Headworks, Intake Diversion Dam. Draft Report.
- U.S. Army Corps of Engineers (Corps). 2010. Lower Yellowstone Irrigation Project-Intake Dam, Rating Curves, Intake Screens/Gate. Design Report.
- U.S. Army Corps of Engineers (Corps). 2014a. Lower Yellowstone Intake Trip Report 14 March 2014.
- U.S. Army Corps of Engineers (Corps). 2014b. HEC-RAS Model Calibration/Verification (memorandum). 23pp. July 30, 2014

U.S. Army Corps of Engineers (Corps). 2015a. Lower Yellowstone Intake Dam-Model Calibration Report.

U.S. Army Corps of Engineers (Corps). 2015b. Intake Diversion Dam Modifications, Lower Yellowstone, Montana, Bypass Channel 90% Design, Hydraulics Appendix. Draft Report. January 2015.

U.S. Army Corps of Engineers (Corps). 2015c. Lower Yellowstone Intake Bypass Channel Floodplain Evaluation. Draft Report.

U.S. Army Corps of Engineers (Corps). 2015d. Intake Diversion Dam Modification. Lower Yellowstone Project, Montana. Final Supplemental to the 2010 Final Environmental Assessment.

Main CanalU.S. Census Bureau. 2015a. 2010-2014 American Community Survey 5-Year Estimates. Accessed December 19, 2015. <https://www.census.gov/programs-surveys/acs/data.html>.

U.S. Census Bureau. 2015b. County Business Patterns. Accessed January 5, 2016. www.census.gov/econ/cbp/.

U.S. Department of Agriculture. 2012. 2012 Census of Agriculture, Volume 1, Chapter 2: County Level. Census of Agriculture. Accessed January 6, 2016. www.agcensus.usda.gov/Publications/2012/Full_Report/Volume_1,_Chapter_2_County_Level/.

U.S. Department of Agriculture. 2016a. USDA Natural Resources Conservation Service Web Soil Survey, Suitabilities and Limitations for Use. Database search at: <http://websoilsurvey.sc.egov.usda.gov/App/WebSoilSurvey.aspx>

U.S. Department of Agriculture. 2016b. USDA Prime Farmland Definitions. Available at: http://www.nrcs.usda.gov/wps/portal/nrcs/detail/pr/soils/?cid=nrcs141p2_037285

U.S. Department of the Interior. 2012. Interior Board of Indian Appeals. Trenton Indian Service Area v. Great Plains Regional Director, Bureau of Indian Affairs, 54 IBIA 298. April 03. Accessed February 02, 2016. <https://www.oha.doi.gov/ibia/Ibiadecisions/54ibia/54ibia298.pdf>.

U.S. Energy Information Administration (EIA). 2011. Emissions of Greenhouse Gases in the United States 2009. DOE/EIA-0573(2009). March. [www.eia.gov/environment/emissions/ghg_report/pdf/0573\(2009\).pdf](http://www.eia.gov/environment/emissions/ghg_report/pdf/0573(2009).pdf). Accessed January 22, 2016.

U.S. Environmental Protection Agency (EPA). 1974. Information on Levels of Environmental Noise Requisite to Protect Public Health and Welfare with an Adequate Margin of Safety

U.S. Environmental Protection Agency (EPA). 2001. Technical Fact Sheet: Final Rule for Arsenic in Drinking Water. EPA 815-F-00-016. Office of Water 4607.

U.S. Environmental Protection Agency (EPA). 2015a. EPA Action on Montana's Numeric Nutrient Criteria and Variance Rules. Office of Ecosystems Protection and Remediation.

U.S. Environmental Protection Agency (EPA). 2015b. Summary of Executive Order 12898 – Federal Actions to Address Environmental Justice in Minority Populations and Low-Income Populations. November 16. Accessed February 02, 2016. www.epa.gov/laws-regulations/summary-executive-order-12898-federal-actions-address-environmental-justice.

U.S. Environmental Protection Agency (EPA). 2016. Air Quality Monitoring Station. EPA Interactive webpage. <www.epa.gov/airquality/airdata/ad_maps.html>.

U.S. Environmental Protection Agency (EPA). 2016a. EPA Region 8 Sole Source Aquifer Program webpage. www.epa.gov/region8/sole-source-aquifer-program. Accessed January 2016.

U.S. Environmental Protection Agency (EPA). 2016b. EPA Safe Drinking Water Search webpage for the State of Montana: iaspub.epa.gov/enviro/sdw_form_v3.create_page?state_abbr=MT. Accessed January 2016.

U.S. Fish and Wildlife Service (Service). 1967. Office of the Secretary Native Fish and Wildlife Endangered Species. Federal Register 32(48):4001.

U.S. Fish and Wildlife Service (Service). 1970. Endangered and Threatened Wildlife and Plants; Notice of Proposed Rulemaking (Endangered Species Conservation). Federal Register 35:6069.

U.S. Fish and Wildlife Service (Service). 1978. Reclassification of the Gray Wolf in the United States and Mexico, with Determination of Critical Habitat in Michigan and Minnesota. Federal Register 43(47)9607-9613.

U.S. Fish and Wildlife Service (Service). 1985a. Endangered and Threatened Wildlife and Plants; Interior Population of the Least Tern Determined to be Endangered. Federal Register 50(102):21784-21792.

U.S. Fish and Wildlife Service (Service). 1985b. Endangered and Threatened Wildlife and Plants; Determination of Endangered and Threatened Status for Piping Plover. Federal Register 50(238):50726-50734.

U.S. Fish and Wildlife Service (Service). 1990. Recovery Plan for the Interior Population of the Least Tern (*Sterna antillarum*). Twin Cities, Minnesota.

U.S. Fish and Wildlife Service (Service). 1993. Recovery Plan for the Pallid Sturgeon (*Scaphirhynchus albus*). Region 6, U.S. Fish and Wildlife Service, Denver, Colorado.

U.S. Fish and Wildlife Service (Service). 2000. Biological Opinion on the Operation of the Missouri River Main Stem Reservoir System, Operation and Maintenance of the Missouri River Bank Stabilization and Navigation Project and Operation of the Kansas River System. Denver, Colorado and Ft. Snelling, Minnesota.

U.S. Fish and Wildlife Service (Service). 2001. Updated Status Review of Sicklefin and Sturgeon Chub in the United States. U.S. Fish and Wildlife Service Region 6. Denver, Colorado.

U.S. Fish and Wildlife Service (Service). 2003. Amendment to Biological Opinion on the Operation of the Missouri River Main Stem Reservoir System, Operation and Maintenance of the Missouri River Bank Stabilization And Navigation Project and Operation of the Kansas River reservoir system. U.S. Fish and Wildlife Service.

U.S. Fish and Wildlife Service (Service). 2007. Pallid sturgeon (*Scaphirhynchus albus*) 5-year review summary and evaluation. U.S. Fish and Wildlife Service, Billings, MT.

U.S. Fish and Wildlife Service (Service). 2008. Pallid Sturgeon (*Scaphirhynchus albus*) Range-wide Stocking and Augmentation Plan. Prepared by the Pallid Sturgeon Recovery Team, Denver, CO.

U.S. Fish and Wildlife Service (Service). 2009. A System for Mapping Riparian Areas in the Western United States. Division of Habitat and Resource Conservation.

U.S. Fish and Wildlife Service (Service). 2010. Endangered and Threatened Wildlife and Plants; Review of Native Species That Are Candidates for Listing as Endangered or Threatened; Annual Notice of Findings on Resubmitted Petitions; Annual Description of Progress on Listing Actions; Notice. Federal Register 80(247):80583-80614.

U.S. Fish and Wildlife Service (Service). 2011. Endangered and threatened Wildlife and Plants: Reissuance of Final Rule to Identify the Northern Rocky Mountain Population of Gray Wolf as a Distinct Population Segment and to Revise the List of Endangered and Threatened Wildlife. Federal Register 76 (87): 25990-25992.

U.S. Fish and Wildlife Service (Service). 2013a. Black-footed Ferret Draft Recovery Plan, Second Revision. Region 6, Denver, Colorado.

U.S. Fish and Wildlife Service (Service). 2013b. Endangered and Threatened Wildlife and Plants; Listing the Northern Long-Eared Bat as an Endangered Species. Federal Register 78(231): 61045-61080.

U.S. Fish and Wildlife Service (Service). 2014. Revised Recovery Plan for the Pallid Sturgeon (*Scaphirhynchus albus*). Prepared by the Pallid Sturgeon Recovery Coordinator, Montana Fish and Wildlife Conservation Office, Billings, Montana for the Mountain Prairie Region, Denver, Colorado.

U.S. Fish and Wildlife Service (Service). 2014a. Northern Long-Eared Bat Interim Conference and Planning Guidance. U.S. Fish and Wildlife Service Regions 2, 3, 4, 5, and 6.

U.S. Fish and Wildlife Service (Service). 2014b. Endangered and Threatened Wildlife and Plants; Threatened Species Status for the Rufa Red Knot. Federal Register 79(238):73705-73748.

U.S. Fish and Wildlife Service (Service). 2014c. Rufa Red Knot Background Information and Threats Assessment. Supplement to Federal Register Final Threatened Status for the Rufa Red Knot. U.S. Fish and Wildlife Service Northeast Region, Pleasantville, New Jersey.

U.S. Fish and Wildlife Service (Service). 2014d. U.S. Fish & Wildlife Service Revised Recovery Plan for the Pallid Sturgeon (*Scaphirhynchus albus*). Billings, Montana: Pallid Sturgeon Recovery Coordinator, U.S. Fish and Wildlife Service, Montana Fish and Wildlife Conservation Office.

U.S. Fish and Wildlife Service (Service). 2014e. Endangered and Threatened Wildlife and Plants; Threatened Status for Dakota Skipper and Endangered Status for Poweshiek Skipperling; Final Rule. Federal Register 70(206):63672-63748.

U.S. Fish and Wildlife Service (Service). 2015a. Black-footed Ferret (*Mustela nigripes*). Endangered Species, Mammals, Mountain-Prairie Region. Available at www.fws.gov/mountain-prairie/es/blackFootedFerret.php.

U.S. Fish and Wildlife Service (Service). 2015b. Endangered and Threatened Wildlife and Plants; Reinstatement of Final Rules for the Gray Wolf in Wyoming and the Western Great Lakes in Compliance with Court Orders. Federal Register 80 (34): 9218-9229.

U.S. Fish and Wildlife Service (Service). 2015c. Endangered and Threatened Wildlife and Plants; Threatened Species Status for the Northern Long-Eared Bat with 4(d) Rule. Federal Register 80(63):17973-18033.

U.S. Fish and Wildlife Service (Service). 2015d. Endangered and Threatened Wildlife and Plants; Review of Native Species That Are Candidates for Listing as Endangered or Threatened; Annual Notice of Findings on Resubmitted Petitions; Annual Description of Progress on Listing Actions. Federal Register 75(217):69222-69294.

U.S. Fish and Wildlife Service (Service). 2015e. Dakota Skipper (*Hesperia dacotae*) Fact Sheet. U.S. Fish and Wildlife Service Midwest Region.

U.S. Fish and Wildlife Service (Service). 2016a. List of threatened and endangered species that may occur in your proposed project location, and/or may be affected by your proposed project (Montana). Letter from Montana Ecological Field Office, Helena, Received January 19, 2016.

U.S. Fish and Wildlife Service (Service). 2016b. List of threatened and endangered species that may occur in your proposed project location, and/or may be affected by your proposed project (North Dakota). Letter from North Dakota Ecological Field Office, Bismarck, Received January 19, 2016.

U.S. Fish and Wildlife Service (Service). 2016c. Environmental Conservation Online System (ECOS). Available at ecos.fws.gov/ecp/.

U.S. Fish and Wildlife Service (Service). 2016d. Gray wolf (*Canis lupus*). Accessed January 6, 2016. ecos.fws.gov/.

U.S. Fish and Wildlife Service (Service). 2016e. Species profile for Gray Wolf (*Canis lupus*). Available at ecos.fws.gov/tess_public/profile/speciesProfile.action?sPCODE=A00D.

U.S. Fish and Wildlife Service (Service). 2016f. Endangered and Threatened Wildlife and Plants; 4(d) Rule for the Northern Long-Eared Bat. Federal Register 81(9):1900-1922.

U.S. Forest Service (USFS). 2016. Ecoregions and Ecosystem Provinces of the U.S. Available at www.fs.fed.us/land/ecosysmgmt/colorimagemap/ecoreg1_provinces.html.

U.S. Geological Survey (USGS). 1956. Geology and Groundwater Resources of the Lower Yellowstone River Valley, Between Glendive and Sidney, Montana. Geological Survey Water-Supply Paper 1355.

U.S. Geological Survey (USGS). 1998. Organic Compounds and Trace Elements in Fish Tissue and Bed Sediment from Streams in the Yellowstone River Basin, Montana and Wyoming. Water Resources Investigations Report 00-4190. Available at pubs.usgs.gov/wri/wri004190/pdf/wri004190.pdf.

U.S. Geological Survey (USGS). 2002. U.S. Geological Survey. 2002. Preliminary Comparison of Pallid and Shovelnose Sturgeon for Swimming Ability and Use of Fish Passage Structure. Turner Falls, MA: S.O. Conte Anadromous Fish Research Center, U.S. Geological Survey, Biological Resources Division.

U.S. Geological Survey (USGS). 2004. Water-Quality Assessment of the Yellowstone River Basin, Montana and Wyoming – Water Quality of Fixed Sites, 1999-2001. National Water-Quality Assessment Program, U.S. Geological Survey. Available at pubs.usgs.gov/sir/2004/5113/.

U.S. Geological Survey (USGS). 2016a. USGS 06329500 Yellowstone River Near Sidney MT. Available at nwis.waterdata.usgs.gov.

U.S. Geological Survey (USGS). 2016b. White-Nose Syndrome Threatens the Survival of Hibernating Bats in North America. Fort Collins Science Center. Available at <https://www.fort.usgs.gov/science-feature/123>.

U.S. Global Change Research Program. 2014. 2014 National Climate Assessment. J.M. Melillo, Terese (T.C.) Richmond, and G.W. Yohe (eds). nca2014.globalchange.gov/system/files_force/downloads/low/NCA3_Climate_Change_Impacts_in_the_United%20States_LowRes.pdf?download=1. Accessed July 3, 2014.

U.S. Government Publishing Office. 2016a. Electronic Code of Federal Regulations. 40 CFR 50. National Primary and Secondary Ambient Air Quality Standards. www.ecfr.gov/cgi-bin/text-idx?SID=d28bd175f925ef6ca0d4510ba73f3d2f&mc=true&node=pt40.2.50&rgn=div5

U.S. Government Publishing Office. 2016b. Electronic Code of Federal Regulations. 40 CFR 80. Regulation of Fuels and Fuel Additives. www.ecfr.gov/cgi-bin/text-idx?SID=d28bd175f925ef6ca0d4510ba73f3d2f&mc=true&node=pt40.17.80&rgn=div5

U.S. Government Publishing Office. 2016c. Electronic Code of Federal Regulations. 40 CFR 81. Designation of Areas for Air Quality Planning Purposes. www.ecfr.gov/cgi-bin/text-idx?SID=d28bd175f925ef6ca0d4510ba73f3d2f&mc=true&node=pt40.18.81&rgn=div5

U.S. Government Publishing Office. 2016d. Electronic Code of Federal Regulations. 40 CFR 86. Control of Emissions from New and In-Use Highway Vehicles and Engines. www.ecfr.gov/cgi-bin/text-idx?SID=d28bd175f925ef6ca0d4510ba73f3d2f&mc=true&node=pt40.19.86&rgn=div5

U.S. Government Publishing Office. 2016e. Electronic Code of Federal Regulations. 40 CFR 89. Control of Emissions from New and In-Use Nonroad Compression-Ignition Engines. www.ecfr.gov/cgi-bin/text-idx?SID=d28bd175f925ef6ca0d4510ba73f3d2f&mc=true&node=pt40.20.89&rgn=div5

U.S. Government Publishing Office. 2016f. Electronic Code of Federal Regulations. 40 CFR 90. Control of Emissions from Nonroad Spark-Engines at or below 19 kilowatts. www.ecfr.gov/cgi-bin/text-idx?SID=d28bd175f925ef6ca0d4510ba73f3d2f&mc=true&node=pt40.20.90&rgn=div5

U.S. Government Publishing Office. 2016g. Electronic Code of Federal Regulations. 40 CFR 93. Determining Conformity of Federal Actions to State or Federal Implementation Plans. www.ecfr.gov/cgi-bin/text-idx?SID=d28bd175f925ef6ca0d4510ba73f3d2f&mc=true&node=pt40.20.93&rgn=div5

U.S. Government Publishing Office. 2016h. Electronic Code of Federal Regulations. 40 CFR 98. Mandatory Greenhouse Gas Reporting. www.ecfr.gov/cgi-bin/text-idx?SID=d28bd175f925ef6ca0d4510ba73f3d2f&mc=true&node=pt40.21.98&rgn=div5

U.S. Government Publishing Office. 2016i. Electronic Code of Federal Regulations. 40 CFR 1039. Control of Emissions from New and In-Use Nonroad Compression-Ignition Engines. www.ecfr.gov/cgi-bin/text-idx?SID=d28bd175f925ef6ca0d4510ba73f3d2f&mc=true&node=pt40.33.1039&rgn=div5

U.S. Government Publishing Office. 2016j. Electronic Code of Federal Regulations. 40 CFR 1048. Control of Emissions from New, Large Nonroad Spark-Ignition Engines. www.ecfr.gov/cgi-bin/text-idx?SID=d28bd175f925ef6ca0d4510ba73f3d2f&mc=true&node=pt40.33.1048&rgn=div5

U.S. Government Publishing Office. 2016k. Title 42 USC Chapter 85. § 7401 et seq. Clean Air Act of 1990 (Pub. L. 101-549). www.gpo.gov/fdsys/pkg/USCODE-2008-title42/pdf/USCODE-2008-title42-chap85.pdf

University of Nebraska. 2016. The Journals of the Lewis and Clark Expedition Online. Nebraska Edition of the Lewis and Clark journals edited by Gary E. Moulton. Available at lewisandclarkjournals.unl.edu/index.html.

Value Management Strategies, Inc. 2013. Final Value Engineering Study Report: Lower Yellowstone Bypass Channel & Intake Weir Raise, Lower Yellowstone River Near Glendive, Montana. April 2013

Vance, L.K., C. McIntyre, T. Luna. 2010b. Great Plains Riparian — Northwestern Great Plains Riparian. Montana Field Guide. Available: FieldGuide.mt.gov/displayES_Detail.aspx?ES=9326.

Vance, L.K., C. McIntyre, T. Luna. 2010c. Great Plains Floodplain — Northwestern Great Plains Floodplain. Montana Field Guide. Available: FieldGuide.mt.gov/displayES_Detail.aspx?ES=9159.

Vance, L.K., T. Luna, and S.V. Cooper. 2010a. Big Sagebrush Steppe — Inter-Mountain Basins Big Sagebrush Steppe. Montana Field Guide. Available: FieldGuide.mt.gov/displayES_Detail.aspx?ES=5454.

Vance, L.K., T. Luna. 2010a. Great Plains Ponderosa Pine Woodland and Savanna — Northwestern Great Plains – Black Hills Ponderosa Pine Woodland and Savanna. Montana Field Guide. Available: FieldGuide.mt.gov/displayES_Detail.aspx?ES=4280

Vance, L.K., T. Luna. 2010b. Great Plains Wooded Draw and Ravine — Western Great Plains Wooded Draw and Ravine. Montana Field Guide. Available: FieldGuide.mt.gov/displayES_Detail.aspx?ES=4328

Vance, L.K., T. Luna. 2010c. Great Plains Badlands — Western Great Plains Badlands. Montana Field Guide. Available: FieldGuide.mt.gov/displayES_Detail.aspx?ES=3114.

Vincent, William B. 2009a. Test Drilling Near the Lower Yellowstone Diversion Dam and Canal, Dawson County, Montana. Contract, Unknown Publisher.

Vincent, William B. 2009b. Intake Diversion Dam Modification, Lower Yellowstone Project. Section 106 Consultation, Unknown Publisher.

Walsh, Noreen E. 2014. Bypass Channel Hydraulics and Physical Performance Objectives. Letter, Denver: U.S. Fish and Wildlife Service.

Walsh, S. J. and B. M. Burr. 1985. Biology of the stonecat, *Noturus flavus* (Siluriformes: Ictaluridae), in Central Illinois and Missouri streams and comparisons with Great Lakes populations and congeners. *Ohio J. Sci.* 85(3):85-96.

Wanner, G. A., and R. A. Klumb. 2009. Length-Weight Relationships for Three Asian Carp Species in the Missouri River. National Invasive Species Council.

Welker, T.L. and D.L. Scarnecchia. 2004. Habitat use and population structure of four native minnows (family cyprinidae) in the upper Missouri and lower Yellowstone Rivers, North Dakota (USA). *Ecology of Freshwater Fish* 8-22.

Welker, T.L. and D.L. Scarnecchia. 2006. River alteration and niche overlap among three native minnows (Cyprinidae) in the Missouri River hydrosystem. *Journal of Fish Biology* 1530–1550.

Western Regional Climate Center (WRCC). 2016a. Montana Climate Narrative. January. Accessed January 28, 2016. Available at www.wrcc.dri.edu/narratives/MONTANA.htm.

Western Regional Climate Center (WRCC). 2016b. Glendive Climate Summary. January 28. Accessed January 28, 2016. Available at www.wrcc.dri.edu/cgi-bin/cliMAIN.pl?mt3581.

Western Regional Climate Center (WRCC). 2016c. Climate description for the state of Montana: www.wrcc.dri.edu/narratives/MONTANA.htm. Period of Record monthly climate summaries for Glendive, MT and Sidney, MT: www.wrcc.dri.edu/cgi-bin/cliMAIN.pl?mtsidn and www.wrcc.dri.edu/cgi-bin/cliMAIN.pl?mt3581. Accessed January 2016.

Western Regional Climate Center (WRCC). 2016d. Wind speed averages by month for Glendive and Sidney airports, Montana. Accessed January 2016: www.wrcc.dri.edu/climatedata/climtables/westwind/

White, R.G. and B. Mefford. 2002. Assessment of Behavior and Swimming Ability of Yellowstone River Sturgeon for Design of Fish Passage Devices. Montana State University-Bozeman : Montana Cooperative Fishery Research Unit, and Water Resources Research Laboratory.

White, R.G., and R.G. Bramblett. 1993. The Yellowstone River: Its Fish and Fisheries. Bozeman, Montana: U.S. Fish and Wildlife Service, Montana Cooperative Fishery Research Unit.

Wiggins, D.A. 2006. Baird's Sparrow (*Ammodramus bairdii*): A Technical Conservation Assessment. Prepared for the USDA Forest Service, Rocky Mountain Region.

Wildhaber M.L., DeLonay, A.J., Papoulias, D.M., Galat, D.L., Jacobson, R.B., Simpkins, D.G., Braaten, P.J., Korschgen, C.E., and Mac, M.J. 2007. A Conceptual Life-History Model for Pallid and Shovelnose Sturgeon: U.S. Geological Survey Circular 1315.

Wildhaber, M.L., D.M. Papoulias, A.J. Delonay, D.E. Tillitt, J.L. Bryan, M.L. Annis and J.A. Allert. 2005. Gender identification of shovelnose sturgeon using ultrasonic and endoscopic imagery and the application of the method to the pallid sturgeon. *Journal of Fish Biology* 67: 114-132.

Wildman, L., P. Parasiewicz, C. Katopodis and U. Dumont. 2011. An illustrative handbook on nature-like fishways – summarized version. *American Rivers*. Available at: <http://www.americanrivers.org/newsroom/resources/an-illustrative-handbook-on-nature-like-fishways-summarized-version/>

Williams County. 2012. Williams County Comprehensive Plan 2035. Williams County, North Dakota. Adopted December 2012. Available at www.williamsnd.com/usrfiles/WilliamsCountyCompPlan.pdf.

Wuellner, M.R. and C. Guy. 2008. Status Assessment of Burbot in Montana: Importance of a Standardized Sampling Protocol. *Intermountain Journal of Sciences*. Vol 14, No. 4 p.61-77.

Yellowstone Township. 2012. Zoning Ordinance, Yellowstone Township, McKenzie County, North Dakota. Found at county.mckenziecounty.net/usrfiles/Yellowstone_Twp_Zoning_Ordinance.pdf.

Lower Yellowstone Intake Diversion Dam Fish Passage Project, Montana
Environmental Impact Statement
May 2016

Zelt, R. B., G. K. Boughton, K. A. Miller, J. P. Mason, and L. M. Gianakos. 1999.
Environmental setting of the Yellowstone River Basin, Montana, North Dakota, and Wyoming.
U.S. Geological Survey, Water-Resources Investigation Report 98-4269. Cheyenne, WY.