

# Ocean Thermal Energy Conversion: Assessing Potential Physical, Chemical and Biological Impacts and Risks

June 22 – 24, 2010

National Oceanic and Atmospheric Administration  
National Ocean Service  
Office of Ocean and Coastal Resource Management

Coastal Response Research Center  
University of New Hampshire



## FOREWORD

The Coastal Response Research Center, a partnership between the National Oceanic and Atmospheric Administration (NOAA) Office of Response and Restoration (ORR) and the Environmental Research Group at the University of New Hampshire (UNH), develops new approaches to marine environmental response and restoration through research and synthesis of information. In 2010, the center partnered with NOAA's Office of Ocean and Coastal Resource Management (OCRM) to host a workshop to assess the potential physical, chemical and biological impacts of Ocean Thermal Energy Conversion (OTEC) development in Hawaii. As the primary licensing agency for OTEC projects, NOAA OCRM sponsored this workshop, developed the agenda and workshop goals, and was integral in the synthesis of information obtained from the workshop.

The workshop, held June 22-24, 2010 in Honolulu, Hawaii, focused on how to assess the potential physical, chemical and biological impacts and risks associated with development of OTEC in the waters surrounding Hawaii. The report is designed to serve as a resource for NOAA OCRM and governmental decision makers, as well as the OTEC community.

I hope you find the report interesting. If you have any comments, please contact me. I look forward to hearing from you.



Nancy E. Kinner, Ph.D.  
UNH Co-Director, Coastal Response Research Center  
Professor of Civil/Environmental Engineering

## **Acknowledgements**

The Coastal Response Research Center gratefully acknowledges the CRRC authors of this report: Joseph J. Cunningham III, Zachary E. Magdol, and Nancy E. Kinner. The Center acknowledges the time and effort provided by the participants of the workshop, whose contributions have been synthesized into this report. The workshop was planned by an organizing committee consisting of: Whitney Blanchard, Eugene Bromley, Alan Everson, Helen Farr, Steve Frano, Alison Hammer, Stephanie Kavanaugh, Kerry Kehoe, Donald MacDonald, Michael Parke, Mike Reed, and Dwight Trueblood. The Coastal Response Research Center staff for this meeting consisted of: Nancy Kinner, Kathy Mandsager, Joseph Cunningham, Zachary Magdol, Michael Curry, Chris Wood, Nate Little, Adria Fichter, and Heather Ballestero. In addition, the Center acknowledges the thoughtful input and comments received from the reviewers of the draft report: Suzanne Bass, Whitney Blanchard, Marie Bundy, Glenn Cada, Kerry Kehoe, Donald MacDonald, Bruce Mundy, Michael Parke, Mike Reed, Amy Scholik-Schlomer, Hudson Slay, and Dwight Trueblood.

### **Citation:**

Coastal Response Research Center. 2010. Ocean Thermal Energy Conversion: Assessing Potential Physical, Chemical and Biological Impacts and Risks. University of New Hampshire, Durham, NH, 39 pp and appendices.

## Table of Contents

|   |    |
|---|----|
| Foreword.....   | 1  |
| Acknowledgements .....                                  | 2  |
| Executive Summary .....                                 | 4  |
| I. Introduction .....                                   | 8  |
| II. OTEC Background.....                                | 9  |
| A. Principles and History of OTEC.....                  | 9  |
| B. Environmental.....                                   | 10 |
| C. Regulatory Considerations .....                      | 12 |
| III. Workshop Purpose and Scope .....                   | 14 |
| IV. Workshop Organization and Structure .....           | 15 |
| V. Breakout Group Reports .....                         | 16 |
| A. Warm Water Intake .....                              | 16 |
| B. Cold Water Intake .....                              | 19 |
| C. Discharge .....                                      | 23 |
| D. Physical Presence, Construction, and Accidents ..... | 26 |
| E. Noise and Electromagnetic Fields .....               | 29 |
| VI. Baseline Assessment, Monitoring and Modeling .....  | 32 |
| VII. Conclusions .....                                  | 32 |
| VIII. References Cited .....                            | 37 |

### Appendices:

- A: Workshop Agenda
- B: Participant List
- C: Breakout Questions
- D: Breakout Groups
- E: Participant OTEC Primer
- F: Breakout Group Notes and Session Reports
- G: Workshop Powerpoint Presentations
- H: NOAA OTEC Diagram

## EXECUTIVE SUMMARY

Ocean Thermal Energy Conversion (OTEC), a process by which energy from natural temperature differentials in the ocean are converted to mechanical and electrical energy, is a renewable energy source that has experienced a resurgence in interest in recent years. As the lead licensing agency for OTEC facilities under the *Ocean Thermal Energy Conversion Act* (OTECA), NOAA's Office of Ocean and Coastal Resource Management (OCRM) is responsible for evaluating the potential impacts and risks that the construction, installation, and operation of an OTEC facility poses to the environment. To understand these risks, a thorough understanding of the magnitude and extent of likely physical, chemical and biological impacts is required. In order to aid NOAA OCRM in the permitting process, a workshop was held to identify: 1) the baseline data and monitoring requirements needed to assess the potential physical, chemical and biological impacts related to the construction, installation and operation of a OTEC facility; 2) technology and methods to measure impacts; 3) research needed to adequately determine the degree of potential impacts; and 4) approaches to mitigate and/or avoid the impacts within the operational and design parameters of an OTEC system. The findings and recommendations of this report are based on assumed potential environmental impacts and should not be exclusively relied upon.

While it is certain that physical, chemical and biological impacts will occur during the installation and operation of an OTEC facility, the magnitude and extent of these impacts are not known. This workshop did not reach any conclusions in regards to cumulative or secondary impacts which, at this point in time, are largely undeterminable without long-term monitoring and additional research. It was recognized at the workshop that potential cumulative and secondary impacts may be more significant from an ecosystem perspective than immediate localized impacts from OTEC operations given expected operational lifetime of 25 - 40 years.

In order to better understand the risks that these impacts represent, a minimum temporal baseline is required prior to installation that includes monitoring for presence and abundance of large and small biota, as well as the physical and chemical characteristics of seawater in the region. For certain impacts, a longer baseline may be desired in order to capture multi-year variability. This will provide scientists and engineers with a better understanding of potential impacts and a basis for comparison to changes in the marine environment and ecosystem. Monitoring for changes to this baseline should occur during the installation and operation phase, and will provide information on how the facility is impacting the local environment. Many physical, chemical, and biological criteria should be monitored, including, but not limited to: temperature; salinity; dissolved oxygen; pH; trace metals; and abundance, diversity, mortality and behavioral changes in plankton, fish, marine mammals, turtles, and other biota.

Tables 1, 2, and 3 show specific information needed for baseline assessment, monitoring strategies, and modeling methods. The information contained in these tables, while useful, should not be relied upon exclusively in reaching conclusions regarding the development of baseline data, monitoring plans, sampling frequency and analytical methods. The extent and depth of discussion of the information contained in the tables varied among the break-out groups which developed them, and the information presented does not necessarily represent the consensus of the break-out groups.

**Table 1: Baseline Assessment**

| Category                   | Impact                                       | Baseline Data Needed  | Minimum duration for Baseline Data  | Justification of duration   |
|----------------------------|--|---|---|---|
| Fisheries and Corals       | Entrainment                                  | Larval community surveys to cover all management unit species (MUS); biota density at intake and discharge depth; specific catch and effort information for site (i.e., grids, interviews with fishermen)                   | Varies with spawning season. 4-5 locations for more data over 1 year          | Inter-year variation can be significant and would require long sampling duration to capture; multiple sampling locations required |
|                            | Impingement                                  |   |   |   |
|                            | Physical Damage to Shallow Corals            | Community structure of corals, including size and frequency of species. Spatial and temporal survey of species within region.   | 1 year and after hurricane  |   |
|                            | Physical Damage to Deepwater Corals          | Survey of sub-bottom profiling; bathy structure and composition data; optical imagery   | 1 survey/map is sufficient  |   |
| Oceanography               | Oxygen, Temperature, Salinity, and Nutrients | Climatological data with spatial and temporal coverage of the region where the model anticipates the plume will be located. Sampling over a range of frequencies to capture variability. Intensive sampling at one location | 1 – 3 years   | Duration will depend upon variability in data; if little variation, shorter duration required                                     |
|                            | Trace elements and EPA regulated substances  | Need background concentrations of baseline EPA regulated trace elements/regulated substances, OTEC facility construction materials (e.g. Ti, Al), antifouling agents and plasticizers                                       | Quarterly for 1 year  | Unlikely to have significant temporal or spatial variability  |
| Marine Mammals and Turtles | Entrainment/Impingement                      | Distribution, abundance and diving depth  | 1 year assuming normal conditions   |   |
|                            | Migratory pattern shift                      | Distribution, abundance and movement patterns, satellite tracking data  | 1 year assuming normal conditions and control sites are adequate              |   |
|                            | Entanglement                                 | Some data from the Hawaii marine debris program, however not the same as entanglement with mooring or transmission lines  |   |   |
|                            | Behavioral changes                           | Species diving depths, basic distribution and abundance, "habitat use maps"   | 1 year adequate as long as sample size is sufficient for statistical analyses |   |
|                            | Attractant/Repellant                         | Distribution, abundance and diving depth  |   |   |
| Plankton                   | Bacteria                                     | Spatial and temporal abundance and distribution; fate after entrainment   | 2 years at multiple locations. If data is variable, increase duration         | Need to ensure temporal, seasonal, and spatial variations are captured  |
|                            | Phytoplankton and Zooplankton                |   | Several samplings in one location   |   |
|                            | Eggs/Larvae                                  |   |   |   |
|                            | Micronekton                                  |   |   |   |

**Table 2: Monitoring Strategies**

| Category                   | Impact  | What should be monitored?  | How should this be monitored?  | How often?   |
|----------------------------|---|--|--|--|
| Fisheries and Corals       | Entrainment                                     | Water at intakes, fishery catch and effort, status of fishery stocks, control sites, density and type of all MUS, eggs/larvae density and type; effect of light on biota | Net collection and plankton tows; intake flow rate; multiple control sites, fishery catch data and interviews with fishermen; stock assessment; experimental fishing | Increase according to expectation of density of eggs and larvae for different periods of the year; diel 24 hr assessments; life history: monthly; interview fishermen: as needed |
|                            | Impingement                                     | Biota on screens, fishery catch and effort, status of fishery stocks, control sites, all MUS. eggs/larvae density and type   | Bongo nets; plankton tows; intake flow rate; use of multiple control sites, fishery catch data and interviews with fishermen; stock assessment                       |  |
|                            | Physical Damage to Shallow Corals               | Community structure and baseline parameters of corals, including size and frequency of species   | Diver surveys to evaluate community abundance and composition  | Once during baseline and once after construction is complete   |
|                            | Physical Damage to Deepwater Corals             |  | Submersible, ROV or towed camera surveys along route   |  |
| Oceanography               | Oxygen, Temperature, Salinity and Nutrients     | Spatial and temporal monitoring of dissolved oxygen, temperature, salinity and nutrients within the plume and in the vicinity  | Appropriate use of combinations of CTD casts; gliders; fixed moorings; monitoring needed at the discharge  | Sampling over a range of frequencies to capture variability.   |
|                            | Trace Elements and EPA regulated substances     | Spatial and temporal monitoring of trace metals, EPA regulated substances, and OTEC facility fluids and components (e.g. Ti and Al).                                     | Measurement of concentrations in discharge plume and surrounding area; in accordance with EPA methods  | Once a month at discharge; quarterly for receiving waters  |
| Marine Mammals and Turtles | Entrainment/Impingement                         | Distribution, abundance, CWP flow  | Acoustic sensors, flow monitoring  | Continuous, automatic  |
|                            | Migratory pattern shift                         | Migratory pathways (abundance and distribution)  | Autonomous acoustic recorder, aerial/visual surveys  | Continuous, automatic  |
|                            | Entanglement                                    | Marine debris in region  | Visual survey  | Daily at surface, quarterly at depth   |
|                            | Behavioral changes (i.e., Attractant/Repellant) | Presence, diversity and behavior   | acoustics and visual   | Acoustics: continuous; visual: 1/season for 4 years  |
| Plankton                   | Bacteria  | Fate after entrainment (i.e., live/deceased abundance), community composition, population density  | Acoustics to measure density; advanced molecular techniques for composition; three sampling stations surrounding OTEC facility plus control                          | Dependent on baseline information  |
|                            | Phytoplankton and Zooplankton                   |  |  |  |
|                            | Eggs/Larvae                                     |  |  |  |
|                            | Micronekton                                     |  |  |  |

**Table 3: Modeling Methods**

| <b>Category</b>                   | <b>Impact</b>                                   | <b>What existing models can be used?</b>  | <b>Improvements to existing models</b>  | <b>New models</b>   |
|-----------------------------------|---|---|---|---|
| <b>Fisheries and Corals</b>       | <b>Entrainment</b>                              | Empirical Transport Model (ETM), Adult Equivalent Loss Model (AELM), Fecundity Hindcast (FH)  | Addition of life history for species of concern   | Include current patterns and intake draw field; comprehensive ecosystem-based model of the area near site |
|                                   | <b>Impingement</b>                              | Estimated catch blocks, Fisheries models  |   |   |
|                                   | <b>Physical Damage to Shallow Corals</b>        | Use existing cable laying software to optimize route  |   |   |
| <b>Oceanography</b>               | <b>Oxygen, nutrients, temperature, salinity</b> | EFDC model; HIROMS model input; Ocean observing models; Discharge plume model   | Further developed and peer reviewed. Modify to be an assimilative model; incorporate bio-geochemical components; validate by field experiments, including near field current measurements |   |
|                                   | <b>Trace elements</b>                           | Not necessary/applicable in this situation.   | Not applicable/necessary  | Not applicable/necessary  |
| <b>Marine Mammals and Turtles</b> | <b>Behavioral changes</b>                       | Acoustic propagation/animal movement models (acoustical integration model (AIM); marine mammal movement and behavior model (3MB); NMFS TurtleWatch          | Integrate animal behavior; modification for different species; validation   |   |
| <b>Plankton</b>                   | <b>Bacteria</b>                                 | Chlorophyll models from 20yrs hindcast; data set diurnal and seasonality for 4 years off Kahe (1, 5, 15 yrs offshore); use HiROMand existing current models | Fate of organic carbon  |   |
|                                   | <b>Micronekton</b>                              | Models available in University of Hawaii reports  |   |   |



## I. INTRODUCTION

As one of the most remote island chains in the world with few sources of local energy, the islands of Hawaii are home to some of the most expensive fossil fuel based energy in the world. Gasoline is, on average, 20% more expensive than in the continental United States, and electricity is typically twice as expensive than most of the nation. With few local energy sources, Hawaii is dependent on external sources for the bulk of its energy needs. The volatile economics and shrinking supply of petroleum have led to increased energy costs, and intensified the search for local, renewable energy alternatives. Although typically more expensive, renewable energy sources have many advantages, including increased national energy security, decreased carbon emissions, and compliance with renewable energy mandates and air quality regulations. Further, Hawaii is home to several strategic military bases with high energy demands that would greatly benefit from a more secure, reliable source of energy independent of the volatile fossil-fuel based economy.

The oceans are natural collectors of solar energy and absorb a tremendous amount of heat from solar radiation daily. One method of extracting this energy is ocean thermal energy conversion (OTEC), which converts thermal energy into kinetic energy via turbines. The turbines can then be used to drive generators, producing electricity. Expectations for OTEC were high following the passage of the *Ocean Thermal Energy Conversion Act of 1980* (OTECA), and was forecast to generate > 10,000 megawatts electrical (MWe) of energy by 1999. However, as oil prices declined in the late 1980's and 1990's, interest in OTEC and other renewable energy sources declined. Recently, the volatility of the petroleum industry and renewable energy mandates has led to renewed interest in OTEC. Interest is especially strong in islands such as Hawaii that seek to offset their high-cost fossil fuel based energy with locally-generated renewable energy. Because of this, Hawaii is likely to be the first location for demonstration and future commercial development of OTEC.

As the primary licensing agency for OTEC, NOAA's Office of Ocean and Coastal Resource Management (OCRM) must evaluate the risk that the construction, installation, and operation of an OTEC facility poses to the environment. In order to understand these risks, a thorough understanding of the magnitude and extent of likely physical, chemical and biological impacts is required. This can only be done through scientifically robust field monitoring and comparison to baseline conditions. Baseline conditions are those which exist in the environment prior to construction and operation of a facility. These data are obtained by conducting physical, biological and chemical monitoring.

In order to aid NOAA OCRM in the permitting process, a workshop was held to identify: 1) how to assess potential physical, chemical and biological impacts related to the installation and operation of a OTEC facility; 2) appropriate methods and technology to measure impacts of an OTEC facility; 3) research needed to adequately assess impacts; and 4) approaches to mitigate and/or avoid the impacts within the operational and design parameters of an OTEC system, and identify if potential impacts will trigger additional regulation (i.e., Endangered Species Act). With this information, NOAA OCRM can gain a better understanding of the type and quantity of baseline data that is required of permit

applicants, as well as what monitoring strategies and tools can be used to adequately capture potential OTEC-related impacts.

## II. OTEC BACKGROUND

### A. Principles and History of OTEC

In the waters surrounding Hawaii and many other tropical and subtropical locales, intense sunlight and long days result in significant heating of the upper 35 to 100 m of the ocean, yielding comparatively warm (27 - 29°C) oceanic surface waters. Below this warm layer the temperature decreases to an average of about 4.4°C (Avery, 1994). This temperature differential represents a significant amount of potential energy, which, if harnessed, is a renewable source of energy. One potential method to extract this energy is OTEC.

There are two major OTEC facility designs: open-cycle, and closed-cycle. Open-cycle facilities were not discussed at this workshop, as it is generally agreed the first demonstration and commercial offshore facilities will be a closed-cycle design. A description and discussion of open-cycle design is included in the previous report: Technical Readiness of Ocean Thermal Energy Conversion (CRRC, 2010).

In a closed-cycle facility, both the warm and cold water pass through heat exchangers which transfer the heat to the working fluid, usually a liquid with a low boiling point (i.e., ammonia), which then vaporizes and condenses, driving a turbine and converting thermal energy into mechanical energy (Figure 1). While closed-cycle facilities are more complex than open-cycle, they are significantly more efficient and result in greater net energy production.

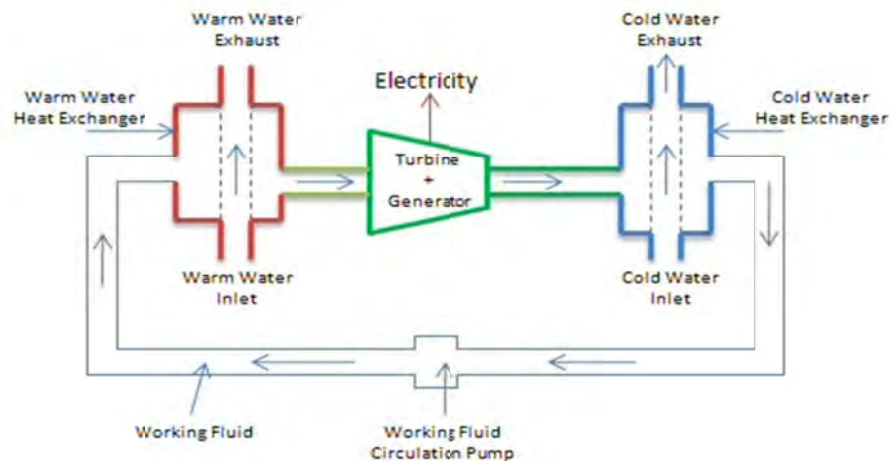

Figure 1: Principles of operation of a closed-cycle OTEC facility

One of the most important considerations when planning an OTEC facility is location. Large differences ( $\Delta > 20^{\circ}\text{C}$ ) in temperature between the cold water intake and the warm water intake are required. As a result, the facility must be located in a region with access to warm surface waters and deep, cold water. An OTEC facility can be located on land if adjacent to a narrow shelf or a rapid decrease in depth, however, the long length

of the cold water intake pipe needed to reach the required temperature differential may make this impractical in most locations. Alternatively, an offshore, floating, moored, facility with a vertical cold water intake pipe may be more practical. Floating platforms can be located above deep water as long as they can be adequately moored, and the power cable can be connected to a land-based power grid for electricity transmission.

The concept of energy extraction from naturally-occurring temperature gradients in large bodies of water dates back to the late 1800s, however, construction of the first operational OTEC facility did not occur until 1930 off the coast of Cuba. This facility produced a net 22 kilowatts electrical (kWe) for 11 days before the facility was destroyed in a storm. The next major milestone came in 1979 when a project dubbed “mini-OTEC” was launched, and marked the first successful operation of a closed-cycled OTEC facility. Mini-OTEC produced a net 15 kWe for three months before its planned shutdown, and was widely considered a success. The next major advancement in OTEC came in 1980 – 1981 with the experimental OTEC-1 facility. This facility was designed as a platform to test various OTEC-related technologies, and was not designed to generate electricity. OTEC-1 reached several important milestones, including successful deployment of a 670 m long cold water pipe, and mooring in 1,370 m of water in the waters off Hawaii. The cold water pipe from OTEC-1 was subsequently re-used for a land-based facility on the island of Hawai’i, which successfully operated from 1993 – 1998, and produced a net 103 kW, and still holds the world record for OTEC output (Vega L. A., 2002/2003).

Although the focus of OTEC is typically on production of electricity, several co-generation products are possible, including desalinization of seawater, mariculture, liquid fuels production (e.g., hydrogen and ammonia), and seawater air conditioning (i.e., SWAC), all of which would add to the economic viability of OTEC and further reduce dependence on fossil fuels.

## **B. Environmental**

As with all energy projects, there are concerns about the potential environmental impacts of OTEC’s widespread implementation. OTEC is unique in that very large flows of water are required to efficiently operate. It is estimated that 3-5 m<sup>3</sup>/sec of warm surface water and a roughly equivalent amount of cold water from the deep ocean are required for each MWe of power generated (Myers *et al.*, 1986). Therefore, for a small commercial sized facility (i.e., 40 MWe), this requires flows of 120 – 500 m<sup>3</sup>/sec (i.e., between 2 and 11 billion gallons per day).

In July 1981, NOAA issued the Final Environmental Impact Statement (EIS) for commercial OTEC licensing. Based on information available at the time, potential impacts were divided into three categories: major effects, minor effects and potential effects from accidents (Table 4).

**Table 4: OTEC Effects Categories From NOAA’s Final EIS (NOAA, 1981).**

| Category                                 | Stressor  | Effect  |
|--|---|---|
| <b>Major Effects:</b>                    | Platform presence                                     | Biota attraction  |
|  | Withdrawal of surface and deep ocean waters           | Organism entrainment and impingement                              |
|  | Discharge of waters                                   | Nutrient redistribution resulting in increased productivity       |
|  | Biocide release                                       | Organism toxic response   |
| <b>Minor Effects:</b>                    | Protective hull-coating release                       | Concentration of trace metals in organism tissues                 |
|  | Power cycle erosion and corrosion                     | Effect of trace constituent release                               |
|  | Installation of coldwater pipe and transmission cable | Habitat destruction and turbidity during dredging                 |
|  | Low-frequency sound production                        | Interference with marine life                                     |
|  | Discharge of surfactants                              | Organism toxic response   |
|  | Open-cycle plant operation                            | Alteration of oxygen and salt concentrations in downstream waters |
| <b>Potential Effects from Accidents:</b> | Potential working fluid release from spills and leaks | Organism toxic response   |
|  | Potential oil releases                                |   |

In 1986, NOAA’s National Marine Fisheries Service (NMFS) built upon the 1981 EIS and developed a report entitled “The Potential Impact of Ocean Thermal Energy Conversion (OTEC) on Fisheries” (Myers *et al.*, 1986). This report attempted to quantify the impact of an OTEC facility to marine biota, and estimated losses due to entrainment (i.e., entering the system through an intake) and impingement (i.e., held against a surface by water flow). The report concluded that:

“The potential risk to fisheries of OTEC operations is not judged to be so great as to not proceed with the early development of OTEC. Due to the lack of a suitable precedent, there will remain some level of uncertainty regarding these initial conclusions until a pilot plant operation can be monitored for some period of time. In the meantime, further research on fisheries should be undertaken to assure an acceptable level of risk regarding the larger commercial OTEC deployments” (Myers *et al.*, 1986).

While the NOAA NMFS report provides an overview of the types of impacts that could be expected, it did little to quantify the magnitude of the impact, as the estimates generated were speculative and relied on now outdated techniques and methods. An example of this is the entrainment and impingement estimates, which were generated

using an average composite of biomass in the Hawaii region. This technique ignored the ability of the facility to act as a fish attractant, thus increasing the concentration of organisms subject to entrainment and impingement.

Some impacts may be minimized or mitigated through changes in operational or design parameters. However, the feasibility of design modifications due to environmental concerns needs to be weighed against the efficiency of energy production. Mitigation measures that result in substantial reductions in the efficiency of an OTEC facility could cause a project to be economically unviable, and thus cancelled.

While the easiest to identify impacts may be direct (i.e., biota directly killed through entrainment or impingement), cumulative and secondary ecosystem impacts may be much more of a concern and are much more difficult to assess. Cumulative and secondary ecosystem impacts will likely require careful long-term monitoring to distinguish effects, and may be impossible to fully evaluate due to ecosystem complexity.

### **C. Regulatory Considerations**

The construction, installation and operation of an OTEC facility in U.S. waters will need to comply with many state and federal regulations. Under the *Ocean Thermal Energy Conversion Act* (OTECA), an OTEC facility developer must obtain necessary authorizations from NOAA and the U.S. Coast Guard (USCG) in order to construct and operate an OTEC facility. Apart from the USCG authorization, all other federal license and permit requirements are incorporated into the NOAA OTECA license. In addition to federal authorization, OTECA also provides approval authority to those states whose waters are adjacent to federal waters for which an OTEC facility has been proposed. States also have authority under the *Coastal Zone Management Act* to review OTECA licenses.

Regulatory drivers include both direct and indirect impacts to biota and water quality, as well as food-chain and ecosystem impacts. Although a regulation does not directly require protection of smaller organisms (i.e., prey species), if the absence of these organisms impacts protected species then they must be protected as well. Some of the federal regulations applicable to the construction, installation and operation of an OTEC facility identified at this workshop include:

*Clean Water Act* (CWA): The requirements of the *Clean Water Act* apply to several aspects of an OTEC facility, including any changes to the chemical and thermal composition of the discharge plume, cold and warm water intakes, as well as installation of the mooring and transmission lines on the seabed.

*Magnuson-Stevens Fishery Conservation and Management Act* (MSFCMA): The Magnuson-Stevens Act requires review of any federal authorization for an activity that may adversely affect “essential fish habitat” which includes “those waters and substrate necessary to fish for spawning, breeding, feeding, or growth to maturity.”

*Endangered Species Act (ESA):* The *Endangered Species Act* regulates any activity affecting threatened and endangered plants and animals and the habitats and ecosystems in which they are found. The law requires federal agencies, in consultation with the U.S. Fish and Wildlife Service and/or the NOAA Fisheries Service, to ensure that actions they authorize, fund, or carry out are not likely to jeopardize the continued existence of any listed species or result in the destruction or adverse modification of designated critical habitat of such species. The law prohibits any action that causes a "taking" of any listed species of endangered fish or wildlife. Several species listed in the ESA inhabit the region surrounding Hawaii where the first OTEC facility is likely to be built, including numerous species of whales and sea turtles, as well as the Hawaiian Monk Seal.

*Marine Mammal Protection Act (MMPA):* The *Marine Mammal Protection Act* establishes requirements to prevent marine mammal species and population stocks from declining beyond the point where they cease to be significant functioning elements of ecosystems of which they are a part. Any aspect of an OTEC facility which harms or influences the behavior of a marine mammal will be regulated under the MMPA.

*Migratory Bird Treaty Act (MBTA):* The *Migratory Bird Treaty Act* protects migratory birds and establishes Federal responsibilities for the protection of nearly all species of birds, their eggs and nests. The MBTA makes it illegal for people to "take" migratory birds, their eggs, feathers or nests. Take is defined in the MBTA to include by any means or in any manner, any attempt at hunting, pursuing, wounding, killing, possessing or transporting any migratory bird, nest, egg, or part thereof. A migratory bird is any species or family of birds that live, reproduce or migrate within or across international borders at some point during their annual life cycle. Migratory birds may use an OTEC facility as a resting point during migration, requiring the facility to comply with the MBTA.

*National Environmental Policy Act (NEPA):* The *National Environmental Policy Act* requires federal agencies to incorporate environmental values into the decision making process through consideration of the short and long term environmental impacts of any decision. OTECA requires that an environmental impact statement be developed for each license. Greatly complicating this requirement is the statutory timeframe established under OTECA for reviewing license applications of 356 days. In order to complete a defensible NEPA analysis within the OTECA timeframe, it will be imperative that license applicants conduct thorough baseline assessments prior to the submission of a license application.

Additional federal and regulations apply to OTEC facilities beyond those discussed above and the discussions at the workshop.

### III. WORKSHOP PURPOSE AND SCOPE

This workshop was preceded by a workshop in 2009 (CRRC, 2010) which focused on the technical readiness of OTEC given advancements since the mid-1980s. The technical readiness workshop found that there have been significant advancements in the design and fabrication of the OTEC components and subsystems since the 1980's. The report concluded that construction, installation, and operation of a demonstration (i.e.,  $\leq 10$  MWe) closed-cycle OTEC facility is technically feasible. Experience gained from a demonstration system would greatly aid in the understanding of the challenges associated with a larger commercial facility. Despite being technically feasible, the extent of design and operational changes required to limit environmental impacts remain unclear. Compounding that uncertainty is the lack of knowledge of the impacts and risks of OTEC. The type and magnitude of potential impacts are largely unknown and must be reasonably ascertained prior to the commitments to design, construct and authorize an OTEC facility. As a next step in establishing the regulatory feasibility OTEC, a second workshop was held to develop a better understanding of impacts and risks of construction, installation and operation of an OTEC facility, as well as to identify the baseline and monitoring requirements to assess potential impacts.

When evaluating environmental impacts, it is important to consider the scale and overall effect of the impact (i.e., an impact may be devastating to a local population, but inconsequential to the species or ecosystem). Workshop participants were not given specific guidance or limitations on scale or greater effects of the impact, however, most participants focused on localized impacts with some consideration for ecosystem-level impacts.

In order to provide the workshop participants with common design assumptions, the workshop Organizing Committee (OC) limited discussion to a floating, closed-cycle, moored OTEC facility producing electricity transmitted to shore via an undersea cable, with both demonstration (e.g., 5 MWe) and commercial scale (e.g., 100 MWe) facilities being considered. Discussions at the workshop were limited to electrical generation, and did not include any co-generation of potable water or liquid fuels. Table 5 outlines the characteristics given to participants prior to the workshop:

This report is a qualitative analysis of the potential environmental impacts, monitoring and baseline assumptions, and is meant to inform NOAA OCRM, regulatory agencies and stakeholders. This report is not an exhaustive ecological analysis, nor does it claim to identify every potential environmental impact associated with OTEC. The workshop participants expressed their individual opinions and ideas during the sessions; this report is not the participants' consensus advice to NOAA, but does summarize information gained by NOAA as a result of the workshop. This report does not consider economic, military, technical and social impacts and/or constraints, and is not part of the decision and permitting process for an OTEC facility within U.S. waters.

**Table 5: OTEC Facility Characteristics**

|                               | 5 MWe   | 100 MWe               |
|-------------------------------|---|-----------------------|
| Type of Facility              | Demonstration                                     | Commercial            |
| Location                      | 3 – 4 miles (4.8 – 6.4 km) offshore Hawaii        |                       |
| Warm Water Intake Depth       | 20 m  |                       |
| Warm Water Intake Temperature | 25°C  |                       |
| Warm Water Intake Flow        | 25 m <sup>3</sup> /s                              | 500 m <sup>3</sup> /s |
| Warm Water Intake Velocity    | 0.15 m/s  |                       |
| Warm Water Intake Antifouling | Intermittent Chlorination (50 – 70 mg/L for 1 hr) |                       |
| Cold Water Intake Depth       | 800 – 1000 m                                      |                       |
| Cold Water Intake Temperature | 5°C   |                       |
| Cold Water Pipe Diameter      | 2 – 4 m   | 10 m                  |
| Cold Water Intake Flow        | 25 m <sup>3</sup> /s                              | 500 m <sup>3</sup> /s |
| Cold Water Intake Velocity    | 2.5 m/s   |                       |
| Cold Water Intake Antifouling | None  |                       |
| Discharge                     | Combined or Separate, Depth to be Determined      |                       |

#### IV. WORKSHOP ORGANIZATION AND STRUCTURE

The workshop, held in Honolulu, Hawaii on June 22 – 24<sup>th</sup>, 2010, consisted of plenary sessions where invited speakers discussed their experiences with OTEC and gave their opinions on the state of the technology and potential environmental impacts. Participants for this workshop were selected from a variety of fields and expertise, and included members from State and Federal government, academia, industry, and non-government organizations with expertise in policy, engineering, biology, ecology, and oceanography.

Five breakout groups discussed potential impacts from key OTEC sources, including: 1) warm water intake; 2) cold water intake; 3) discharge (including biocides and working fluid leaks); 4) physical presence, construction, and accidents; and 5) noise and electromagnetic fields. The workshop agenda (Appendix A), participants (Appendix B), discussion questions (Appendix C), and breakout groups (Appendix D) were identified and developed by the organizing committee comprised of members of government and , academia (Appendix B). As preparation, each participant was given an “OTEC Primer”, containing historical and technical background information on OTEC, as well as a summary of potential impacts identified in the 1981 EIS and 1986 NMFS reports (Appendix E).

The workshop participants were divided into the five groups based upon their expertise by the organizing committee. Each breakout group identified: additional potential impacts not identified in the 1981 EIS and 1986 NMFS reports (summarized in the OTEC primer); prioritized impacts in a regulatory context; the baseline assessments, monitoring strategies and modeling methods needed to develop quantifiable levels of impact and risk; the best available technologies and methods to assess OTEC impacts and



risks; additional research needed to assess potential biological impacts; and ways in which potential physical, chemical and biological impacts can be avoided, minimized or mitigated within the operational and design parameters of an OTEC system. This report summarizes the group discussions on potential biological, chemical and physical impacts of OTEC.

## **V. BREAKOUT GROUP REPORTS**

### **A. Warm Water Intake**

The warm water intake group examined the potential physical, chemical and biological impacts from the warm water intake system. The warm water intake system consists of the warm water intake pipe, intake screening, and any component with which warm water comes into contact with. The warm water intake is likely to be in relatively shallow water in an effort to capture the warmest water while at the same time avoiding surface disturbances such as wind and waves. Due to its relatively shallow depth, the principal impacts from the warm water intake system are likely to be entrainment and impingement.

Entrainment, when an organism or particle passes through screening or filters and enters the warm water intake system, mostly affects small organisms that lack adequate mobility to escape the intake current. Classes of biota likely to become entrained in the warm water intake include: phytoplankton, zooplankton (including microzooplankton, meroplankton (e.g., larvae), ichthyoplankton and possibly macrozooplankton), as well as small fish. Once entrained, the biota may be subjected to mechanical and shear stresses from the intake pumps, periodic chemical stresses from the application of anti-fouling biocides, and temperature stress. The impact due to entrainment will vary with the intake screen mesh size, intake velocity and flow rate, survivability characteristics of organisms, and biological community composition and abundance in the region. For the warm-water intake discussions, it was assumed that there would be a low survival rate for organisms entrained.

Impingement, when an organism is held against a surface by water flow or becomes stuck within a structure, is more likely to affect larger organisms. Classes of biota likely to become impinged against the warm water intake screening include macrozooplankton, cnidarians, small fish, and larger weak or sick fish. Healthy juvenile and adult sea turtles are unlikely to become entrained or impinged in the warm water intake, however, it is possible that sick or weakened individuals could. The magnitude, size and type of impinged organism would depend on the screen mesh size and design, intake velocity and flow, community composition and abundance of biota present in the area.

If the magnitude of the direct effect (e.g., injury or death due to impingement, entrainment) is large enough, there are likely to also be indirect impacts, such as changes in the food web and behavior (i.e., shifting from predation to scavenging). The warm water intake system may also potentially impact diel migrations of micronekton, and may alter their local distribution and abundance. This will have a direct impact on the

micronekton and their primary predators. The group concluded that 100% mortality of impinged or entrained organisms is likely.

### Baseline Assessments, Monitoring Strategies and Modeling Methods

Some baseline physical, chemical and biological data for the past 30 years exists for the waters surrounding Hawaii (i.e., Hawaii Ocean Time Series (HOT), National Energy Laboratory of Hawaii Authority (NELHA)), and fisheries data, and can be used for initial assessments, however, additional monitoring will be required using current methods and technology to confirm the validity of the historical data. Monitoring strategies will depend upon likelihood and magnitude of the potential impact, with frequent, high resolution monitoring of high priority groups (i.e., endangered species), and infrequent monitoring of groups unlikely to be impacted. As a starting point, plankton should be sampled at least monthly and analyzed for abundance and community composition using visual identification or advanced molecular techniques. Monitoring strategies and modeling should be tailored to ensure that impacts from the warm water intake are fully understood. Biological modeling should be included in the assessment of impacts, and models such as Ecopath with Ecosim, adult equivalent loss (AEL), empirical transport model (ETM), fecundity hindcast (FH), and modification of other existing power plant models should be considered to accurately estimate the impacts to biota from an OTEC warm water intake.

### Assessment of OTEC Impacts and Risk

In order to determine the impact of the warm water intake, multiple technologies are required. To assess micronekton and ichthyoplankton impacts, a multiple opening and closing net environmental sensing system (MOCNESS) should be used. These sampling devices are deployed by boat and contain multiple openings at varying depths in order to sample the water column. The use of an acoustic Doppler current profiler (ADCP) can determine particle movement at multiple depths, and would allow continuous assessment of micronekton. Numerous remote sensing technologies exist, including video plankton recording, satellite imaging, and ocean observing systems (OOS) that may allow monitoring of plankton and some nekton. The Natural Energy Laboratory of Hawaii Authority (NELHA) and Kahe power plant both operate pipes similar in size to the pipe required for a 10 MWe OTEC warm water pipe, and examination of entrainment and impingement from these facilities, as well as additional biomass sampling, would provide a better understanding of the sampling requirements and likely impacts due to entrainment and impingement. Advanced molecular techniques (e.g., molecular biology, metagenetics) should be used to characterize plankton and microbial species and their relative abundance relative to a baseline. Table 6 summarizes likelihood, significance, and regulatory implications of potential impacts resulting from the warm water intake system.

**Table 6: Prioritization of Impacts in a Regulatory Context for the Warm Water Intake System**

| Impacted Population              | Regulatory Driver?        | Is it Likely? | Significance?   | Unique to OTEC?  | Regulatory Priority |
|----------------------------------|---------------------------|---------------|-----------------|--|---------------------|
| <b>Entrainment:</b>              |                           |               |                 |  |                     |
| Phytoplankton + Bacteria         | MSFCMA                    | Yes           | Unknown         | No for demonstration plant<br>Yes for commercial scale | Yes                 |
| Zooplankton + Meroplankton       | MSFCMA                    | Yes           | Unknown         | No for demonstration plant<br>Yes for commercial scale | Yes                 |
| Benthos (eggs and larvae)        | ESA (possibly for corals) | Unknown       | High, if listed | No for demonstration plant<br>Yes for commercial scale | Yes                 |
| Fish (indirect impacts)          | MSFCMA                    | Yes           | Unknown         | No for demonstration plant<br>Yes for commercial scale | Yes                 |
| Eggs and larvae (direct impacts) | ESA, MSFCMA               | Yes           | High            | No for demonstration plant<br>Yes for commercial scale | Yes                 |
| Micronekton (indirect impacts)   | MSFCMA                    | Yes           | Unknown         | Yes  | Yes                 |
| Micronekton (direct impacts)     | ESA, MSFCMA               | Yes           | High            | No for demonstration plant<br>Yes for commercial scale | Yes                 |
| <b>Impingement:</b>              |                           |               |                 |  |                     |
| Macrozooplankton (adults)        | MSFCMA                    | No            | Low             | No for demonstration plant<br>Yes for commercial scale | No                  |
| Fish                             | ESA, MSFCMA               | Yes           | Unknown         | No   | Yes                 |
| Sea Turtles                      | ESA                       | No            | High, if listed | No   | Yes                 |
| Diving Sea Birds                 | ESA, MBTA                 | No            | Unknown         | No   | No                  |
| Micronekton                      | MSFCMA                    | Yes           | Unknown         | Yes  | Yes                 |

*MSFCMA - Magnuson-Stevens Fishery Conservation and Management Act*

*EFH – Essential Fish Habitat*

*ESA – Endangered Species Act*

*MBTA – Migratory Bird Treaty Act*

## Additional Research and Data Gaps

In order to better understand the potential impacts of the warm water intake system, interdisciplinary research is required. Data gaps include: general biota stock structure; early life history studies; quantitative spatial (including water column) and temporal data on abundance and distribution of all biota; mortality of larval and juvenile fish; factors affecting recruitment and compensation for mortality; and effects of cold water shock once discharged on biota at the OTEC-relevant temperature ranges. Research requirements are similar for entrainment and impingement, and include: updating site specific baseline ecosystem studies, quantification of biota entering the system compared to the total available resource, analysis of larval abundance and distribution, mortality resulting from the warm water intake system, update of existing stock assessments based upon larval mortality, quantification of swimming speed of both fish and micronekton to assess entrainment and impingement potential.

## Mitigation of Impacts

In order to reduce potential physical, chemical and biological impacts of the warm water intake system, it is important to design the warm water intake to reduce the likelihood of entrainment and impingement. For larger organisms like fish, this can be done by increasing the size of the pipe opening to reduce intake velocities, however, the preferred method of minimizing entrainment and impingement for all species is through careful selection of intake depth, mesh size, and location. The group concluded that intake mesh size and design is likely to be plant-specific, and could be tailored to minimize biological impacts. Minimizing lighting on the facility would reduce attraction and should be considered. Deterrent strategies, such as high intensity strobe lights and sound should be considered to repel sensitive species (i.e., juvenile and adult fish). The practicality of these methods will need to be carefully evaluated since some of these mitigation methods could reduce the efficiency of the OTEC facility. Decreased intake velocity and changes to the depth may substantially reduce efficiency of energy production.

## **B. Cold Water Intake**

The cold water intake group examined the potential physical, chemical and biological impacts of the cold water intake system. Like the warm water intake, entrainment and impingement are likely to be the primary impacts from the cold water intake system. However, due to the depth of the cold water pipe intake (e.g., 1000 m) the biomass concentration is anticipated to be less than at the warm water intake. Mesopelagic microzooplankton would likely be entrained, however, not enough is known about deep-water ecosystems to determine if this would include meroplankton or ichthyoplankton. Entrained organisms would be subject to extreme pressure changes on the order of 100 atmospheres (1,422 PSI), mechanical and shear stress from the intake pumps and water flow, as well as extreme temperature changes. Impingement of organisms in the cold water intake is likely to be limited to macrozooplankton and small fish. However, because it is anticipated the debris screens would be located on the surface (to aid in cleaning) rather than at the deep water intake, mortality is most likely to be caused by extreme pressure changes associated with entrainment prior to impingement. A low survival rate is anticipated. The large volume of seawater transported by the cold water intake system

will likely entrain a significant amount of microorganisms. Those that survive will be ultimately released either via a cold water return or mixed return at a much shallower depth. This disruption in vertical stratification could disrupt the community composition and ecological functions, possibly resulting in disruptions to the local food web.

Subsea currents and associated shearing forces will cause the cold water pipe to oscillate on the order of one pipe diameter. This will create noise and vibration, which may impact organisms. The magnitude and nature of this impact is unknown. These oscillations, caused by fluid movement around the pipe, are also likely to shed vortices, which also create an unknown impact.

The ocean is not homogeneous, and some locations will be more sensitive than others. Site selection will affect the type and magnitude of the impact. For example, submarine canyons, while potentially thermodynamically ideal for placement of the cold water intake, contain organisms endemic to that environment and may be unable to survive if disruptions (i.e., change in currents, temperature, chemical characteristics) occur. The distance between the bottom of the cold water pipe and the seafloor will also be a consideration in the site selection. Impacts resulting from material selection and pipe cleaning may also occur, however, these cannot be predicted without further design and maintenance information.

#### Baseline Assessments, Monitoring Strategies and Modeling Methods

In order to develop an acceptable baseline, a mooring sampling system could be used to sample at the depth of the intake. Sampling would need to occur at least monthly for one year, however, this will likely collect too little data (i.e., under sample). Baseline sampling should occur at day and night to capture diurnal movements, and should be conducted in permanent sampling grids so that once the OTEC facility begins operation, long term impacts can be assessed. Intensive, multi-depth hourly trawls should be considered for periods of up to 5 days to capture vertical movements. Climate patterns (e.g., El Niño, La Niña) should also be considered when developing monitoring strategies.

While studies exist that characterize organisms present at the depth of the cold water intake, these studies used methods that are now considered obsolete with the advent of advanced molecular techniques. In addition, there is some evidence that conditions have changed since the publication of many of these studies, and their findings may differ from current conditions. While these studies can be used for an initial baseline, further sampling and analysis are needed to validate these results prior to their use in any models.

The cold water intake should be closely monitored for impingement, and water in the intake should be sampled frequently ( $> 2/\text{day}$ ) and analyzed using molecular methods to gain a better understanding of what species and quantity of organisms are being entrained.

## Assessment of OTEC Impacts and Risks

In order to assess the impact of the cold water intake and risk to species in the region, the type and abundance of organisms present must be known. To assess the micronekton and ichthyoplankton at depth, a MOCNESS sampling device should be used. Remote sensing using passive acoustic arrays, hyperspectral satellite monitoring, cameras placed at the intake, and autonomous underwater vehicles (AUVs) can be used to monitor larger organisms in the region. The 1986 NOAA NMFS report relied on visual identification of plankton and microorganisms to determine impacts. Detection capabilities have advanced considerably since then and now allow positive identification using molecular techniques. Abundance and community composition should be analyzed with these techniques to provide the best possible data. Continual monitoring of the seawater being transported by the cold water pipe is desirable for demonstration plants, as grab and composite samples may not adequately define the impacts. Bioluminescent system monitors or photomultiplier tubes can also be used to detect organisms in the region, however, cannot be the sole method of detection as they only target organisms with bioluminescent properties. Optical particle counters can be considered for continuous monitoring, however, additional analysis is required, as particle counters cannot easily distinguish between inorganic and organic particles.

In order to gain a better understanding of localized changes to seawater chemistry, water in the vicinity of the cold water pipe intake should be analyzed for numerous constituents, including: nitrogen (e.g., nitrate, nitrite, ammonia); phosphorous, phosphate, silica, pH, and dissolved gasses. Significant changes in the source water may indicate shifts in subsea currents and stratification. Table 5 summarizes likelihood, significance, and regulatory implications of potential impacts resulting from the cold water intake system.

## Additional Research and Data Gaps

The majority of data gaps associated with impacts to the cold water pipe focus on the presence and abundance of species at the depth of the intake. Additional research is needed to quantify mesopelagic biota, and gain a better understanding of their behavior. Once the organisms present at depth are characterized and their role in the ecosystem and food web better understood, improved models of the impact the cold water pipe system will be possible. Research should also investigate the fate of entrained organisms. Further investigation of foraging patterns of endangered species in the region should be considered, as well as archival tagging and acoustic monitoring to better understand their presence at these depths.

## Mitigation of Impacts

The best way to mitigate potential impacts of the cold water intake system without affecting operational efficiency is to prevent the impacts from occurring through careful site selection. Locations that have deep water corals, submarine canyons, high abundance of prey communities, and locations with high currents should be avoided. To minimize impacts, the intake should have a vertical orientation and at a depth which optimizes the reduction of impacts to organisms.

**Table 7: Prioritization of Impacts in a Regulatory Context for the Cold Water Intake System**

| <b>Impact Population</b> | <b>Affected Organism/Process</b>            | <b>Regulatory Driver?</b> | <b>Is It Likely?</b>                | <b>Significance?</b> | <b>Unique to OTEC?</b> | <b>Regulatory Priority</b> |
|--------------------------|---|---------------------------|-------------------------------------|----------------------|------------------------|----------------------------|
| Marine Mammals           | Whales                                      | MMPA                      | Unknown                             | High                 | Yes                    | Yes                        |
| Endangered species       | Leatherback turtles                         | ESA                       | No                                  | High                 | Yes                    | Yes                        |
|                          | Monk seals, small cetaceans                 | ESA, MMPA, MSFCMA         | No                                  | High                 | Yes                    | No                         |
| Fish                     | Pelagic Adults (tunas, billfish and sharks) | MSFCMA                    | Unknown                             | Low                  | No                     | No                         |
|                          | All except for coral (larvae and eggs)      | MSFCMA                    | No                                  | Low                  | No                     | No                         |
|                          | Bottom fish, coral reef, crustacean         | MSFCMA, ESA               | No                                  | Low                  | No                     | No                         |
|                          | Precious Coral                              | MSFCMA, ESA               | No for adults<br>Unknown for larvae | Unknown              | Yes                    | Yes                        |
| Prey                     | Prey for marine mammals                     | ESA                       | Unknown                             | Unknown              | Yes                    | Varies with species        |
|                          | Prey for turtles                            | ESA                       | Yes                                 | Low                  | Yes                    | Yes                        |
|                          | Prey for pelagic and bottom fish species    | MSFCMA                    | Unknown                             | Unknown              | Yes                    | Yes                        |

*MSFCMA – Magnuson-Stevens Fishery Conservation and Management Act      ESA- Endangered Species Act*

*MMPA- Marine Mammals Protection Act*

### C. Discharge

The discharge group examined the potential physical, chemical and biological impacts of the discharge from the OTEC facility, including biocides and working fluid leaks. After water from the cold water and warm water pipes has passed through heat exchangers and heat has been extracted, the water is returned to the ocean via discharge pipes. Discharge configurations may include individual cold and warm water return pipes, or a combined return where the cold and warm water are mixed and returned above the thermocline. If a combined discharge is selected, the temperature and salinity of the water released would be an average of the cold and warm water discharge. This water would sink to a depth of comparable density, which will vary with location. This may result in localized changes to the temperature and currents, in addition to the plume-induced currents. The discharge pipe will be at a depth below the warm water intake in order to ensure the effluent discharge is not re-circulated into the warm water intake which would reduce the overall efficiency of the facility.

The depth of discharge is crucial and will affect the magnitude and extent of impacts. Organisms that survive the entrainment process may ultimately die if they are released at an unsuitable depth. Organisms in the vicinity of the discharge may be entrained in this plume (i.e., secondary entrainment). The cold water discharge will contain dissolved gasses and nutrients transported from the deep. If released close to the surface, the change in pressure will cause release of some of the gasses, and will likely change the chemistry of the surrounding water. Dissolved carbonates in the discharge may change the pH in the local receiving water, potentially inhibiting the shell production of foraminifera and veliger larvae. Some concern has been expressed over dissolved carbonates released in the form of CO<sub>2</sub> into the atmosphere in this process and thus increasing global carbon dioxide emissions. While possible, the magnitude of the release would depend upon the depth and density of the discharge.

Nutrients in the discharge may enhance primary productivity, decrease dissolved oxygen levels, or cause toxic algal blooms (i.e., similar to coastal upwelling). Dead organisms in the discharge plume may act as food source, attracting fish to the vicinity of the plume. The discharge water may also contain particulates and dissolved constituents from erosion and corrosion of facility components, living or dead entrained organisms, biocide from anti-fouling treatment, nutrients, and potentially small working fluid releases from normal operations. The discharge may contain low concentrations of contaminants, however this will vary with the age, design, construction material, and maintenance of the facility, as well as the overall quality of ocean water in the region (i.e., turbid water will result in greater erosion). The toxicity of these contaminants will vary with concentration, exposure, bioavailability and bioaccumulation potential. The toxicity, water chemistry, and secondary entrainment impacts addressed above apply to separate and combined discharges.

Biological impacts associated with the plume will might include: acute or chronic toxicity; behavioral changes; reduced fecundity; attraction or repulsion from the OTEC facility; and changes to the local ecosystem structure.



## Baseline Assessments, Monitoring Strategies and Modeling Methods

Monitoring frequency will be dependent on the variability in the data collected, and is difficult to predict without further site-specific information. However, monitoring should be continuous during construction and installation, as well as the first year of operation for the demonstration plant. The region should be monitored for an additional 3 – 5 years thereafter to ensure there are no significant changes in the chemical or physical characteristics of the water column. While 20 years of Hawaii Ocean Time series (HOT) data exists, it was collected monthly and not necessarily at locations under consideration for OTEC, and therefore, is not suitable as a sole source of baseline data and information. The baseline should be measured at specific sites surrounding the proposed OTEC facility location and continue after operation of the demonstration plant commences to better capture any changes. The sampling design for monitoring and assessment should be statistically robust and use the best available and practical technologies. For anticipated discharge flows, there are research plume models (e.g., Makai OTEC plume model) that can predict the fate and transport of the discharge plume. Model development must include spatial and temporal components and include multiple constituents (e.g., temperature, nutrients, dissolved oxygen, salinity).

## Assessment of OTEC Impacts and Risks

The assessment of impacts and risks from the discharge pipe are dependent upon accurate measurements of the physical and chemical characteristics of seawater, as well as direct measurements of the biological impacts in the region. Direct measurement of the biological impacts can be accomplished through various monitoring technologies including optical plankton counters, fluorometers, and collection of samples via AUVs, gliders, ships and stationary mooring sampling devices. Assessment of chemical and physical impacts can be made via frequent sampling and analysis of seawater collected with buoyant drifters. Sensors used should be equipped to monitor: nitrate, including other surrogates, hydroacoustics to measure changes in transition layers, *in situ* ultraviolet sensors (ISUS), acoustic receivers on gliders, and dissolved inorganic carbon (DIC) and optical characteristics. Temperature changes can be measured using remote loggers, conductivity, temperature and depth (CTD) systems, and gliders. Direct impacts to biota due to changes in the chemical and physical characteristics of the seawater can be measured through chronic and acute bioassays. Table 8 summarizes the likelihood, significance, and regulatory implications of potential impacts resulting from the discharge from an OTEC facility.

**Table 8: Prioritization of Impacts in a Regulatory Context for the Discharge Plume**

| <b>Impact</b>                                    | <b>Regulatory Driver?</b> | <b>Is it Likely?</b>     | <b>Significance?</b> | <b>Unique to OTEC?</b> | <b>Regulatory Priority</b> |
|--|---------------------------|--------------------------|----------------------|------------------------|----------------------------|
| Oxygen   | CWA                       | Yes                      | Low                  | No                     | Unknown                    |
| Nutrient Upwelling                               | CWA                       | Yes                      | Unknown              | Yes                    | Unknown                    |
| CO <sub>2</sub> , pH, Dissolved inorganic Carbon | CWA                       | Unknown                  | Unknown              | Unknown                | Unknown                    |
| Ammonia Release                                  | CWA                       | Yes                      | Low                  | Yes                    | No                         |
| Metals   | CWA                       | Yes (Low concentrations) | Low                  | No                     | No                         |
| Anti-biofouling Agents                           | CWA                       | Yes                      | Unknown              | No                     | Unknown                    |
| Salinity   |                           | Yes                      | Low                  | No                     | No                         |
| Temperature Changes                              | CWA                       | Yes                      | High                 | No                     | Unknown                    |
| Ciguatoxin                                       |                           | Unknown                  | Low-medium           | Unknown                | Unknown                    |
| Fish and Fish Habitat                            | MSFCMA                    | Yes                      | Medium               | Yes                    | Yes                        |
| Zooplankton                                      | MSFCMA                    | Unknown                  | Low                  | Yes                    | No                         |
| Microzooplankton                                 | MSFCMA                    | Unknown                  | Low                  | Yes                    | No                         |
| Microorganisms                                   | MSFCMA                    | Unknown                  | Unknown              | Yes                    | Unknown                    |
| Benthic Effects                                  | MSFCMA                    | Yes                      | Low                  | No                     | No                         |
| Threatened and Endangered Species                | ESA                       | Yes                      | Low                  | No                     | Yes                        |

*CWA- Clean Water Act    ESA- Endangered Species Act*

*MSFCMA – Magnuson-Stevens Fishery Conservation and Management Act*

### Additional Research and Data Gaps

Additional research is needed to validate plume models, specifically using inert tracers to model plume fate and behavior. This will provide a better understanding of the fate and behavior of chemical and physical constituents of the plume, and how they may impact the region. In order to better understand the impact to the microbial and nanoplankton communities, advanced microbial and molecular techniques should be used to characterize the communities present at the discharge depth. In addition, an in-depth characterization of the biological community should be conducted at intake and discharge depths.

### Mitigation of Impacts

Potential impacts can be mitigated by reducing the effect of the discharge through greater dilution or elimination of the causative agents. Dilution can be increased through changes in depth of the pipe, addition of diffusers, enhanced mixing (e.g., creation of turbulent mixing), or use of multiple pipes. Elimination of the impact can also be accomplished through minimizing: biocide use, temperature changes in plume, release of working fluids, and selection of construction materials that reduce the release of toxic compounds. From an environmental standpoint, a mixed discharge is preferable because it results in a plume that is closer in temperature to the receiving water, minimizing temperature effects in the region surrounding the discharge plume.

## **D. Physical Presence, Construction, and Accidents**

The physical presence, construction, and accidents group examined the potential physical, chemical and biological impacts associated with the physical presence, construction, and accidents associated with an OTEC facility. Construction impacts will vary with: location and design of the facility, extent of construction that takes place at sea, type and installation method of the power cable, and type of mooring selected. The platform will likely be built at a shore-based facility and towed to the site. The cold water pipe may be constructed on land and towed to the site, or constructed/manufactured on-site. The most disruptive aspects of installation are likely to be the placement of anchors, moorings and power cables. The installation and presence of these components may require blasting, drilling and excavation of the seafloor, and could disrupt benthic and pelagic communities, including deep corals and crustaceans, vertebrate fish, marine mammals, sea birds, sea turtles, invertebrates, and microbial communities. In particular, the installation and presence of the power cable will: increase suspended sediment, disturb or destroy coastal resources and coral reefs, as well as alter the behavior of invertebrate and vertebrate in the region. The installation of these components will disrupt habitat heterogeneity, and may have secondary long-term impacts to the ecosystem. Construction, installation and vessel traffic activities are likely to generate noise, and may disrupt movement and communication of fish, marine mammals and reptiles (e.g., whales, dolphins, sea turtles) in the area. Platform lighting may disrupt the normal behavioral patterns of sea birds, turtles, marine mammals, plankton, squid and fish in the region.

Noise and EMF generated during construction and operation of an OTEC facility are addressed in Section E, Noise and EMF.

The physical presence of the platform will most likely serve as a fish attraction device (FAD). This may increase the number of impinged and entrained organisms, and could change local migratory patterns. Accidental release of chemicals, while unlikely, has the possibility of disrupting all life within the plume and in the region surrounding the facility. Direct toxicity, chemical oxidation, and indirect toxicity (i.e., drop in pH increases certain metals, causing toxic effects) can potentially result from a chemical release.

When examining potential impacts due to physical presence, construction and accidents, it is important to take into consideration the size of the system (i.e., the physical size of a 100 MWe plant is much larger than a demonstration 10 MWe facility). Different size plants will likely have significantly different impacts. The component type will also play a significant role in the type of impact (i.e., a drilled mooring could be disruptive to the benthos, but all mooring/anchors can potentially impact deep sea corals and other biota). Table 9 summarizes likelihood, significance, and regulatory implications of potential impacts resulting from physical presence, construction and accidents.

#### Baseline Assessments, Monitoring Strategies and Modeling Methods

The baseline assessment may be seasonally dependent, and sampling should take this into consideration. Benthic site surveys should be conducted pre and post-construction to evaluate the impact to the seafloor and the biota that inhabit it. Pre-construction surveys can also be used to avoid particularly sensitive habitats (e.g., deep water corals). Water column assessments should vary in temporal and spatial scales, and should continue for a minimum of three years. Assessments should include sampling via trawl nets, collection and reporting of downed birds to the U.S. Fish and Wildlife Service, as well as multiple surveys to monitor changes in distribution, habitat use, frequency and abundance of marine mammals.

#### Assessment of OTEC Impacts and Risks

Technology and methods to assess the impact and risk of the physical presence and construction of an OTEC facility should include remote sensing (submersibles, multi-beam side scan sonar, ROV, AUV), satellite telemetry of tagged biota, and visual and genetic surveys to identify any potential shifts in community composition. Many impacts are likely to be similar to those observed during construction and installation of oil platforms and offshore windfarms, and techniques and methods used to monitor impacts could be used to assess impacts and risk at an OTEC facility.

**Table 9: Prioritization of Impacts in a Regulatory Context for Physical Presence, Construction, and Accidents**

| <b>OTEC Component/Activity/Event</b>  | <b>Impacted Resource</b> | <b>Potential Impact</b>                                    | <b>Regulatory Driver?</b> | <b>Is it Likely?</b> | <b>Significance?</b> | <b>Unique for OTEC?</b> | <b>Regulatory Priority</b> |
|---|--------------------------|--|---------------------------|----------------------|----------------------|-------------------------|----------------------------|
| <b>Construction of Anchors and Dragging of Anchors and Cables</b>                   | Deep Coral               | Destruction  | MSFCMA<br>ESA, CRCA       | Yes                  | High                 | No                      | Yes                        |
|   | Benthic Invertebrates    | Destruction, Displacement                                  | MSFCMA                    | Yes                  | Low                  | No                      | No                         |
| <b>Power Cable- Installation</b>  | Corals                   | Disturbance or Destruction                                 | CWA,ESA<br>MSFCMA         | Yes                  | Low                  | No                      | Yes                        |
| <b>OTEC Physical Presence (Platform, pipe, mooring cable, anchors, power cable)</b> | Other Protected Species  | Behavioral alteration                                      | ESA                       | Unknown              | Unknown              | Unknown                 |                            |
|   | Mobile Invertebrates     | Behavioral alteration                                      | MSFCMA                    | Unknown              |                      | No                      |                            |
|   | Turtles                  | Behavioral alteration, Entanglement, collision             | ESA                       | No                   | Low                  | No                      | Yes                        |
|   | Marine Mammals           | Behavioral alteration, Collision, entanglement, attraction | ESA, MMPA                 | Unknown              | Medium/<br>High      | Yes                     | Yes                        |
|   | Fish                     | behavioral alteration, habitat displacement                | MSFCMA                    | Unknown              |                      | No                      | Yes                        |
|   | Birds                    | behavioral alteration, landing and nesting                 | MBA, ESA                  | Yes                  | Low                  | No                      | No                         |
| <b>Lighting</b>   | Birds                    | behavioral disturbance                                     | MBA, ESA                  | Site Specific        | High                 | No                      | Yes                        |
|   | Mobile Invertebrates     | behavioral disturbance                                     |                           | Species specific     | Unknown              | No                      | Unknown                    |
|   | Turtles (Hatchlings)     | behavioral disturbance, attraction                         | ESA                       | No                   | High                 | No                      | Yes                        |
|   | Fish                     | behavioral disturbance: attractant or avoidance            | MSFCMA, EFH               | Yes                  | Low                  | No                      | Yes                        |

*EFH - Essential Fish Habitat      ESA - Endangered Species Act  
CRCA - Coral Reef Conservation Act    MMPA - Marine Mammal Protection Act    MBA - Migratory Bird Act  
CWA – Clean Water Act    MSFCMA – Magnuson-Stevens Fishery Conservation and Management Act*

## **E. Noise and Electromagnetic Fields**

The noise and electromagnetic fields group examined the potential physical, chemical and biological impacts associated with the production of noise and electromagnetic fields associated with an OTEC facility. The generation of noise and electromagnetic fields (EMF) are of concern due to the large number of marine organisms that regularly use acoustics (e.g., dolphins, whales, fish) and electromagnetic fields (e.g., sharks, turtles) for communication, detection of prey/predators, and navigation.

There are likely to be impacts associated with noise and electromagnetic fields, however, the magnitude and extent of the impact is not known and will likely depend on many factors. Sources of construction-related noise are likely to include: deployment of moorings, anchors and the power cable; deployment of the cold water pipe; and associated boat traffic. Sources of operational noise include turbines, pumps, discharge turbulence, cable strum (both mooring and power cable), cold water pipe vibration, boat traffic, and frictional noise from water movements. To date, very little direct measurements of the noise associated with OTEC facilities exist. The impact of noise will vary with receptor and exposure (i.e., magnitude, temporal, spatial, spectral), and will most likely manifest themselves as a physiological or behavioral impacts. Physiological impacts could include: hearing damage and loss (e.g., permanent threshold shift (PTS); temporary threshold shift (TTS)) and, in some species, could lead to death through inability to complete basic biological functions (e.g., echolocation for prey detection in dolphins). Behavioral changes may include local or widespread changes in movement (e.g., attractant, deterrent), communication difficulty due to masking, and changes in feeding and breeding habits (e.g., larval recruitment). If these behavioral changes persist, an ecosystem level impact may occur, potentially resulting in localized changes to community structure and food web dynamics.

Electromagnetic field generation is likely limited to the power cable, with the section that is suspended between the seafloor and the platform most likely to cause impacts. The receptivity and sensitivity to EMF is unknown for many species. Sensitive species (i.e., sea turtles, sharks) are most likely to be impacted, and if exposed, are likely to exhibit changes in behavior, including attraction and avoidance.

### Baseline Assessments, Monitoring Strategies and Modeling Methods

A baseline assessment of ambient noise can be determined prior to construction with stationary monitoring equipment. Monitoring should continue throughout the construction, installation and operational phase using the same equipment and locations to facilitate comparison. Autonomous broadband acoustic recorders coupled with validated acoustic propagation models can be used to determine the range of impact. Pre- and post-monitoring of species abundance, behavior and distribution will be required to validate models and laboratory tests.

## Assessment of OTEC Impacts and Risk

Sound and EMF are relatively easy to monitor and model using acoustic and EMF monitoring equipment positioned on stationary buoys, however effort is required to filter out extraneous sounds. Impacts to biota from noise and EMF are more difficult to quantify, and frequent monitoring for behavioral changes and physiological damage would be required during construction and operation to ensure the impact to the biota is understood. Changes to behavior and physiological damage for smaller species can be assessed in the lab or aquaculture cage studies, while tagging and telemetry using passive acoustic monitoring devices can be used for larger organisms. Table 10 summarizes likelihood, significance, and regulatory implications of potential impacts resulting from acoustics and EMF.

## Additional Research and Data Gaps

In order to better understand the magnitude and type of impact likely to occur, additional research is needed to better understand the tolerance thresholds of marine organisms for sound and electromagnetic fields. While some animals have been widely studied, little is known about the response to sound and electromagnetic fields by the majority of biota that exist in the open ocean. In addition, further research is needed to understand the role sound has on larval recruitment, and if OTEC-related sounds will impact it.

## Mitigation of Impacts

The most effective way to prevent or limit noise and EMF impacts is to reduce exposure. This can be accomplished through careful site selection to avoid sensitive species, or through a reduction in the sound or EMF generated. Little can be done to reduce the impact of sound once it is generated, and mitigation efforts should focus on reducing the amount generated, or shifting it to a frequency that is less harmful. Acoustic deterrent devices can be used to repel animals from the area, however, this will increase the overall level of noise and may have unintended impacts on other species. EMF size and strength can be reduced through shielding. This can be accomplished on the seafloor by burying the cable. Shielding is more difficult on the riser section of the power cable (i.e., from the seafloor to the OTEC facility). Shielding is typically heavy, and current platform-power cable connections may not be able to support the additional weight.

**Table 10: Prioritization of Impacts in a Regulatory Context for Noise and Electromagnetic Fields**

| Impact Source                 | Impacted Resource                                 | Potential Impact                             | Regulatory Driver?              | Is it Likely? | Significance? | Unique for OTEC? | Regulatory Priority                                 |
|-------------------------------|---|--|---------------------------------|---------------|---------------|------------------|---|
| <b>Low Frequency Noise</b>    | Baleen whales, sea turtles, pinnipeds, fish, rays | Masking, threshold shift, behavioral changes | ESA if listed<br>MMPA<br>MSFCMA | Unknown       | High          | No               | Yes, if endangered or protected species is impacted |
| <b>High Frequency Noise</b>   | Toothed whales                                    |  |                                 |               |               |                  |   |
| <b>Electromagnetic Fields</b> | Sharks, sea turtles                               | Behavioral changes                           |                                 |               |               |                  |   |

*ESA- Endangered Species Act      MMPA- Marine Mammal Protection Act*

*MSFCMA – Magnuson-Stevens Fishery Conservation and Management Act*



## **VI. BASELINE ASSESSMENTS, MONITORING STRATEGIES AND MODELING METHODS**

On the final day of the workshop, the participants were divided into four groups: Fisheries and Corals (Table 11 – 13); Marine Mammals (Table 14 – 16); Oceanography (Table 17 – 19); and Plankton (Table 20 – 22). Each group was asked to identify: 1) baseline data needed and minimum baseline duration; 2) monitoring strategies and methods; and 3) modeling strategies and methods. Each group was asked to fill out the following tables. All groups assumed a minimum baseline duration of 1 year; deviations from this are noted and justified in the tables. The 1 year timeframe was chosen as a starting point, not an acceptable minimum, and should not be relied upon as such. Sampling frequency and specific methods were not addressed, and will need to be addressed in a fully developed monitoring plan at a later time.

## **VII. CONCLUSIONS**

The 1981 EIS and 1986 NMFS report identified numerous potential impacts related to the construction and operation of an OTEC facility in Hawaiian waters. The participants of this workshop concurred with these potential impacts, and were able to expand the list based upon 25+ years of knowledge and experience gained in similar fields. The results of this workshop show that physical, chemical and biological impacts of an OTEC plant in Hawaiian waters are likely to occur during the installation and operation of an OTEC facility. However, due to a lack of appropriate field data, the magnitude and extent of these impacts are not known. In order to gain a better understanding of the risk installation and operation of an OTEC facility represents, a baseline consisting of a minimum of one year of data is required prior to construction and installation. While in some cases one year may be sufficient, unusual weather, currents, high sample variability and other factors may require longer baseline sampling, and in many circumstances, a longer baseline may be desired in order to capture multi-year variability and annual variations. Baseline and monitoring data collected should include the abundance and community composition of large and small biota, as well as the physical and chemical characteristics of seawater in the region. Examples of parameters that should be monitored include, but are not limited to: temperature; salinity; dissolved oxygen; pH; trace metals; and abundance, diversity, and behavioral changes to plankton, fish, marine mammals, turtles, and other biota. Sampling frequency during this baseline should be constituent specific, and follow a sampling plan designed to adequately capture natural variations and cycles. It is worth repeating that this report is not an exhaustive ecological analysis, nor does it claim to identify every potential environmental impact associated with OTEC or provide a detailed baseline and monitoring sampling plan.

An environmental baseline assessment must be conducted prior to the project installation. Once construction, installation and operation of the facility commences, baseline parameters should be monitored for deviations to provide information on how the facility is impacting the local environment. Once likely impacts are established, steps can be taken to ameliorate these impacts through careful site selection, modifications to the facility, or changes to facility size or scope. Secondary and indirect impacts are not likely to be immediately evident, and long-term monitoring, possibly for the life of the facility, may be required. These impacts have the potential to play a large role in ecosystem-level impacts of an OTEC facility, and further research is needed to quantify the risk involved and develop better methods of detection.

**Table 11: Baseline Assessment for Fisheries and Corals**

| Impact                                     | Baseline Data Needed   | Minimum duration for Baseline Data  | Justification of duration   |
|--|--|---|---|
| <b>Entrainment</b>                         | Larval community surveys to cover all management unit species; density at intake and discharge depth; More specific catch and effort information for site (i.e., grids, interviews with fishermen) | Varies with spawning season of MUS species. 5 control sites for more data over 1 year | Inter-year variation can be significant and would require long sampling duration to capture; multiple sampling locations required |
| <b>Impingement</b>                         |  |   |   |
| <b>Physical Damage to Shallow Corals</b>   | Community structure of corals, including size and frequency of species. Spatial and temporal survey of species within region.  | 1 year and after hurricane  |   |
| <b>Physical Damage to Deepwater Corals</b> | Survey of sub-bottom profiling; bathy structure and composition data; optical imagery  | 1 survey/map is sufficient  |   |

**Table 12: Monitoring Strategies for Fisheries and Corals**

| Impact                                     | What should be monitored?   | How should this be monitored?  | How often?  |
|--|---|--|---|
| <b>Entrainment</b>                         | Water at intake, fishery catch and effort, status of fishery stocks, control sites, density and type of all management unit species (MUS), eggs/larvae density and type; effect of light on biota | Net collection and Plankton tows; intake flow rate; multiple control sites, Fishery catch data and interviews w/ fishermen; Stock assessment; experimental fishing | Increase according to expectation of density of eggs and larvae for different periods of the year; diel 24/hr assessments; life history: monthly; interview fishermen: as needed; |
| <b>Impingement</b>                         | Biota on screens, fishery catch and effort, status of fishery stocks, control sites, all management unit species (MUS). Density and type of eggs and larvae                                       | Bongo nets; plankton tows; intake flow rate; use of multiple control sites, fishery catch data and interviews w/ fishermen; stock assessment                       |   |
| <b>Physical Damage to Shallow Corals</b>   | Community structure and baseline parameters of corals, including size and frequency of species  | Diver surveys to evaluate community abundance and composition  | Once during baseline and once after construction is complete  |
| <b>Physical Damage to Deepwater Corals</b> |   | Submersible, ROV or towed camera surveys along route   |   |

**Table 13: Modeling Methods for Fisheries and Corals**

| Impact                                   | What existing models can be used?  | Improvements to existing models                 | New models  |
|--|--|---|---|
| <b>Entrainment</b>                       | Empirical transport model (ETM), Adult equivalent loss model (AELM), Fecundity hindcast (FH) | Addition of life history for species of concern | Include current patterns and intake draw field; comprehensive ecosystem based model of the area near site |
| <b>Impingement</b>                       | Estimated catch blocks, fisheries models   |   |   |
| <b>Physical Damage to Shallow Corals</b> | Use existing cable laying software to optimize route   |   |   |

**Table 14: Baseline Assessment for Oceanography**

| Impact  | Baseline Data Needed  | Minimum duration for Baseline Data | Justification of duration   |
|---|---|------------------------------------|---|
| <b>Oxygen, Temperature, Salinity, and Nutrients</b> | Climatological data needed. Need spatial and temporal coverage of in the region where the model anticipates the plume will be located. Sampling over a range of frequencies to capture variability. Intensive sampling at one location. | 1 – 3 years                        | Duration will depend upon variability in data; if little variation, shorter duration required |
| <b>Trace elements and EPA regulated substances</b>  | Background concentrations of baseline EPA “hot list” compounds, OTEC facility construction materials (e.g. Fe, Ti, Al), and antifouling agents and plasticizers.  | Quarterly for 1 year               | Unlikely to have significant temporal or spatial variability                                  |

**Table 15: Monitoring Strategies for Oceanography**

| Impact  | What should be monitored?  | How should this be monitored?   | How often?   |
|---|--|---|--|
| <b>Oxygen, Temperature, Salinity and Nutrients</b>                        | Spatial and temporal monitoring of DO, temperature, salinity and nutrients within the plume and in the vicinity.   | Appropriate use of combinations of CTD casts; gliders; fixed moorings; monitoring needed at the discharge | Sampling over a range of frequencies to capture variability. |
| <b>Trace Elements</b>   | Spatial and Temporal monitoring of trace metals and OTEC facility fluids and components, EPA hot list plus system materials (e.g. Ti and Al). Seasonal profiles. | In accordance with appropriate EPA sampling and analysis methods  | Once a month at discharge; quarterly for receiving waters    |
| <b>EPA regulated substances (e.g., anti-fouling agents, plasticizers)</b> | Concentration in Discharge plume   | In accordance with appropriate EPA sampling and analysis methods  | Once a month at discharge; quarterly for receiving waters    |

**Table 16: Modeling Strategies for Oceanography**

| Impact  | What existing models can be used?   | Improvements to existing models   | New models?              |
|---|---|---|--------------------------|
| <b>Oxygen, nutrients, temperature, salinity</b> | EFDC model; HIROMS model input; ocean observing models; discharge plume model | Model should be further developed and peer reviewed. Modify to be an assimilative model. Should incorporate bio-geochemical components. Needs to be validated by field experiments, including near field current measurements |                          |
| <b>Trace elements</b>                           | Not necessary/applicable in this situation.                                   | Not applicable/necessary  | Not applicable/necessary |

**Table 17: Baseline Assessment for Marine Mammals and Turtles**

| Impact                         | Baseline Data Needed  | Minimum Duration for Baseline Data  | Justification of duration |
|--------------------------------|---|---|---------------------------|
| <b>Entrainment/Impingement</b> | Distribution, abundance and diving depth  | 1 year assuming normal conditions   |                           |
| <b>Migratory pattern shift</b> | Distribution, abundance and movement patterns, satellite tracking data  | 1 year assuming normal conditions and control sites are adequate              |                           |
| <b>Entanglement</b>            | Existing data from Hawaii Marine Debris Program, however not necessarily relevant to entanglement in transmission and mooring lines |   |                           |
| <b>Behavioral changes</b>      | Species diving depths, basic distribution and abundance, "habitat use maps"   | 1 year adequate as long as sample size is sufficient for statistical analyses |                           |
| <b>Attractant/Repellant</b>    | Distribution, abundance and diving depth  |   |                           |

**Table 18: Monitoring Strategies for Marine Mammals and Turtles**

| Impact   | What should be monitored?                       | How should this be monitored?                       | How often?  |
|--|---|---|---|
| <b>Entrainment/Impingement</b>                         | Distribution, abundance, changes to CWP flow    | Acoustic sensors, flow monitoring                   | Continuous, automatic   |
| <b>Migratory pattern shift</b>                         | Migratory pathways (abundance and distribution) | Autonomous acoustic recorder, aerial/visual surveys | Continuous, automatic   |
| <b>Entanglement</b>                                    | Marine debris in region                         | Visual survey                                       | Daily at surface, quarterly at depth                            |
| <b>Behavioral changes (i.e., Attractant/Repellant)</b> | Presence, diversity and behavior                | Acoustics and visual                                | Acoustics: continuous;<br>Visual: Once per season for 4 seasons |

**Table 19: Modeling Strategies for Marine Mammals and Turtles**

|                           | What existing models can be used?  | Improvements to existing models   | New models? |
|---------------------------|--|---|-------------|
| <b>Behavioral changes</b> | Acoustic propagation/animal movement models (AIM, 3MB); NMFS TurtleWatch | Integrate animal behavior; Modification for different species; validation |             |

**Table 20: Baseline Assessment for Plankton**

| Impact                        | Baseline Data Needed  | Minimum duration for Baseline Data                                    | Justification of duration   |
|-------------------------------|---|---|---|
| Bacteria                      | Spatial and temporal abundance and distribution; fate after entrainment | 2 years at multiple locations. If data is variable, increase duration | Need to ensure temporal (diel), seasonal, and spatial variations are captured |
| Phytoplankton and Zooplankton |   | Multiple sampling events in one location                              |   |
| Eggs/Larvae                   |   |   |   |
| Micronekton                   |   |   |   |

**Table 21: Monitoring Strategies for Plankton**

| Impact                        | What should be monitored?   | How should this be monitored?  | How often?                        |
|-------------------------------|---|--|-----------------------------------|
| Bacteria                      | Fate after entrainment (i.e., live/deceased abundance), community composition, population density | Acoustics to measure density; advanced molecular techniques for composition; Three sampling stations surrounding OTEC facility plus control. | Dependent on baseline information |
| Phytoplankton and Zooplankton |   |  |                                   |
| Eggs/Larvae                   |   |  |                                   |
| Micronekton                   |   |  |                                   |

**Table 22: Modeling Strategies for Plankton**

| Impact      | What existing models can be used?  | Improvements to existing models | New models? |
|-------------|--|---------------------------------|-------------|
| Bacteria    | Chlorophyll models from 20yrs hindcast; data set diurnal and seasonality for 4 years off Kahe (1, 5, 15 yrs offshore); use HiROM and existing current models | Fate of organic Carbon          |             |
| Micronekton | Models available in University of Hawaii reports   |                                 |             |

## VIII. REFERENCES CITED

1. Avery, W. C. 1994. *Renewable Energy from the Ocean: A Guide to OTEC*. New York: Oxford University Press.
2. Coastal Response Research Center. 2010. Technical Readiness of Ocean Thermal Energy Conversion (OTEC).  
[http://www.crrc.unh.edu/workshops/otec\\_technology\\_09/otec1\\_final\\_report\\_full.pdf](http://www.crrc.unh.edu/workshops/otec_technology_09/otec1_final_report_full.pdf)
3. Myers, E.P. Hoss, D.E. Matsumoto, W.M. Peters, D.S. Seki, M.P. Uchida, R.N. Ditmars, J.D. and Paddock. R.A. 1986. The Potential Impact of Ocean Thermal Energy Conversion (OTEC) on Fisheries. NOAA Technical Report NMFS 40. 33pp. <http://spo.nwr.noaa.gov/tr40opt.pdf>
4. NOAA Office of Ocean Minerals and Energy. 1981. Final Environmental Impact Statement for Commercial Ocean Thermal Energy Conversion (OTEC) Licensing. 284pp.
5. Vega, L. A. 2002/2003. Ocean Thermal Energy Conversion Primer. *Marine Technology Society Journal* 6(4) , 25-35.

# **APPENDIX**

**APPENDIX A:**  
**WORKSHOP AGENDA**



# OCEAN THERMAL ENERGY CONVERSION:

Assessing Potential Physical, Chemical and Biological Impacts and Risks

June 22-24, 2010  
Ala Moana Hotel, Honolulu, HI

## Agenda

### Monday, June 21

|        |   |
|--------|---|
|        | Hotel Check-in  |
| 6:00pm | Dinner Meeting (Organizing Committee, Presenters, Recorders only) |

### Tuesday, June 22

|         |  |   |
|---------|--|---|
| 8:15am  | <i>Continental Breakfast &amp; Registration</i>  |   |
| 8:45am  | Welcome<br><i>Coastal Response Research Center<br/>Department of Navy<br/>Department of Energy<br/>NOAA Ocean &amp; Coastal Resource Management</i>  | Nancy Kinner<br>Andy Knox<br>Mike Reed<br>Kerry Kehoe |
| 9:10am  | Workshop Background, Goals & Outcomes  | Nancy Kinner  |
| 9:20am  | Participant Introductions  |   |
| 9:45am  | Workshop Structure & Logistics   | Facilitators  |
| 10:00am | <i>Break</i>   |   |
| 10:15am | <i>Presentations:</i>  |   |
|         | OTEC Retrospective   | Luis Vega   |
|         | OTEC System Overview   | Laurie Meyer  |
|         | OTEC Plume Modeling  | Patrick Grandelli                                     |
|         | OTEC Site Assessments  | Fred Arnold   |
|         | OTEC Impacts <ul style="list-style-type: none"><li>o <i>Potential Physical, Chemical and Biological Impacts</i></li><li>o <i>Potential OTEC Impacts in the Hawaiian Marine Environment</i></li></ul> | Don MacDonald<br>Michael Parke                        |
| 12:00pm | <i>Lunch</i>   |   |
| 1:00 pm | Breakout Session I (Questions 1, 2 & 3)  |   |
| 3:30pm  | Breakout Session I Reports   |   |
| 5:00pm  | <i>Adjourn</i>   |   |
| 6:30pm  | <i>Dinner</i> & Cash Bar begin at 6:30   |   |



### Wednesday, June 23

|         |   |
|---------|---|
| 8:15am  | <i>Continental Breakfast</i>  |
| 8:45am  | Review/Recalibrate  |
| 9:00am  | Breakout Session II (Questions 4 & 5)<br><i>Break ( as needed in group)</i> |
| 12:00pm | <i>Lunch</i>  |
| 12:45pm | Breakout Session III (Questions 6 &7)                                       |
| 2:45pm  | <i>Break</i>  |
| 3:00pm  | Breakout Session II and III Reports   |
| 5:00pm  | <i>Adjourn (Dinner on your own)</i>   |

### Thursday, June 24

|         |   |
|---------|---|
| 8:15am  | <i>Continental Breakfast</i>              |
| 8:45am  | Review/Recalibrate                        |
| 9:00am  | Breakout Session IV (New Breakout Groups) |
| 10:30am | <i>Break</i>                              |
| 10:45am | Breakout Session IV Reports               |
| 11:45am | Synthesis / Next Steps / Closing Remarks  |
| 12:30pm | <i>Adjourn</i>                            |

**APPENDIX B:**  
**PARTICIPANT LIST**

# OCEAN THERMAL ENERGY CONVERSION:

## Assessing Potential Physical, Chemical and Biological Impacts and Risks

### Participants

Margaret Akamine  
NOAA, NMFS, PIRO  
Margaret.akamine@noaa.gov

Steve Amaral  
Alden Lab  
amaral@aldenlab.com

Frederick Arnold  
NAVFAC ESC  
frederick.arnold@navy.mil

Robin Baird  
Cascadia Research Collective  
RWBaird@cascadiaresearch.org

Suzanne Bass  
NOAA, General Counsel for Ocean Services  
Suzanne.Bass@noaa.gov

Cameron Black  
State of Hawaii  
Business, Economic Development & Tourism  
Cameron.B.Black@dbedt.hawaii.gov

Whitney Blanchard\*  
NOAA, OCRM  
whitney.blanchard@noaa.gov

Eugene Bromley\* (absent)  
U.S. EPA  
bromley.eugene@epamail.epa.gov

Jocelyn Brown-Saracino  
U.S. Dept of Energy  
jocelyn.brown-saracino@ee.doe.gov

Marie Bundy  
NOAA, NOS/OOCRM  
Marie.Bundy@noaa.gov

Glenn Cada  
Oak Ridge National Laboratory  
cadagf@ornl.gov

Francisco Chavez  
Monterey Bay Aquarium Research Institute  
chfr@mbari.org

Christina Comfort  
University of Hawaii  
christina.comfort@gmail.com

Eric DeCarlo  
University of Hawaii, SOEST  
edecarlo@soest.hawaii.edu

Bonnie DeJoseph  
NOAA  
bonnie.dejoseph@noaa.gov

Todd Ericksen  
Hawaii Institute of Marine Biology, SOEST  
ericksen@hawaii.edu

Alan Everson\*  
NOAA, NMFS/PIR  
alan.everson@noaa.gov

Helen Farr\*  
NOAA  
Helen.Farr@noaa.gov

Adam Frankel  
Marine Acoustics  
adam.frankel@marineacoustics.com

Steve Frano\*  
NOAA, OCRM  
Steve.Frano@noaa.gov

Greg Gebhardt  
NAVFAC HI OPHP63  
gregory.gebhardt@navy.mil

Simon Geerlofs  
U.S. Dept of Energy  
simon.geerlofs@pnl.gov

*\*Denotes Workshop Organizing Committee Member*

Page 1

# OCEAN THERMAL ENERGY CONVERSION:

## Assessing Potential Physical, Chemical and Biological Impacts and Risks

Andrea Gill  
State of Hawaii  
Business, Economic Development & Tourism  
AGill@dbedt.hawaii.gov

Erica Goetze  
University of Hawaii, SOEST  
egoetze@soest.hawaii.edu

Pat Grandelli  
Makai Ocean Engineering  
pat.grandelli@makai.com

Alison Hammer\*  
NOAA  
alison.hammer@noaa.gov

Stacy Hargrove  
NOAA, NMFS/PIFSC  
stacy.hargrove@noaa.gov

Peter Havens  
Sound & Sea Technology  
phavens@soundandsea.com

Kim Holland  
Hawaii Institute of Marine Biology  
kholland@hawaii.edu

Don Hubner  
NOAA, NMFS, PIR  
donald.hubner@noaa.gov

Shari Ishikawa  
NAVFAC Pacific  
Shari.ishikawa@navy.mil

Stephen Kajirua  
Florida Atlantic University, Biological Sciences  
kajiura@fau.edu

David Karl  
University of Hawaii, Dept of Oceanography  
dkarl@hawaii.edu

Stephanie Kavanaugh\*  
NOAA  
stephanie.kavanaugh@noaa.gov

Kerry Kehoe\*  
NOAA, OCRM  
kerry.kehoe@noaa.gov

Christopher Kelley  
University of Hawaii, SOEST  
ckelley@hawaii.edu

Andrew Knox  
NAVFAC HQ  
andrew.knox1@navy.mil

John Kornuc  
NAVFAC Engineering Service Ctr  
john.kornuc@navy.mil

Marc Lammers  
Hawaii Institute of Marine Biology  
lammers@hawaii.edu

Jayne Lefors  
NOAA, NMFS/PIR  
jayne.lefors@noaa.gov

Charles Littnan  
NOAA/NMFS/PIFSC  
charles.littnan@noaa.gov

Donald MacDonald\*  
NOAA Special Projects  
donald.macdonald@noaa.gov

Kimberly Maison  
NOAA, NMFS  
kimberly.maison@noaa.gov

José Marti  
Offshore Infrastructure  
jmarti@offinf.com

Laurie Meyer  
Lockheed Martin, UCSD  
laurie.e.meyer@lmco.com

Lt. Doug Miller  
U.S. Coast Guard  
douglas.j.miller@uscg.mil

*\*Denotes Workshop Organizing Committee Member*

Page 2

# OCEAN THERMAL ENERGY CONVERSION:

## Assessing Potential Physical, Chemical and Biological Impacts and Risks

Charles Morgan  
Planning Solutions, Inc  
cmorgan@psi-hi.com

Bruce Mundy  
NOAA, NMFS/PIFSC  
bruce.mundy@noaa.gov

Lisa Munger  
University of Hawaii  
lmunger@hawaii.edu

William Munslow  
Lockheed Martin MS2, Undersea Systems  
william.d.munslow@lmco.com

Erin Oleson  
NOAA, NMFS/PIFSC  
erin.oleson@noaa.gov

Steve Oney  
Ocean Engineering & Energy Systems  
sony@ocees.com

Patrick Opay  
NOAA, NMFS  
patrick.opay@noaa.gov

Michael Parke\*  
NOAA, NMFS/PIFSC  
michael.parke@noaa.gov

Jim Potemra  
University of Hawaii  
jimp@hawaii.edu

Brian Powell  
University of Hawaii, Manoa  
Dept of Oceanography  
powellb@hawaii.edu

Carol Raifsnider  
Tenera Environmental  
craifsnider@tenera.com

Mike Reed\*  
U.S. Dept of Energy  
michael.reed@ee.doe.gov

Greg Rocheleau  
Makai Ocean Engineering  
greg.rocheleau@makai.com

John Rooney  
NOAA, NMFS/PIFSC  
john.rooney@noaa.gov

Kathleen Ruttenberg  
University of Hawaii, SOEST  
kcr@soest.hawaii.edu

Frank Sansone  
University of Hawaii, SOEST  
sansone@soest.hawaii.edu

John Sato  
NAVFAC Pacific  
john.sato@navy.mil

Amy Scholik-Schlomer  
NOAA, NMFS/OPR  
amy.scholik@noaa.gov

Robert Schroeder  
NOAA, NMFS/PIR  
robert.schroeder@noaa.gov

Tomas See  
NAVFAC Pacific  
tomas.see@navy.mil

Nate Sinclair  
NAVFAC  
nate.sinclair@navy.mil

Hudson Slay  
U.S. EPA  
Slay.Hudson@epamail.epa.gov

Andrey Suntsov  
NOAA, NMFS/PIFSC  
andrey.suntsov@noaa.gov

Florence Thomas  
Hawaii Institute of Marine Biology  
fithomas@hawaii.edu

*\*Denotes Workshop Organizing Committee Member*

Page 3

# OCEAN THERMAL ENERGY CONVERSION:

## Assessing Potential Physical, Chemical and Biological Impacts and Risks

Tim Tricas  
Hawaii Institute of Marine Biology  
tricas@hawaii.edu

Dwight Trueblood\*  
NOAA/CICEET  
dwight.trueblood@noaa.gov

Joe Van Ryzin  
Makai Ocean Engineering  
joe.vanryzin@makai.com

Luis Vega  
University of Hawaii  
National Marine Renewable Energy Center  
luisvega@hawaii.edu

Eric Vetter  
University of Hawaii, SOEST  
evetter@hpu.edu

Kevin Weng  
University of Hawaii, SOEST  
kevin.weng@hawaii.edu

### Coastal Response Research Center Staff:

Nancy Kinner\*  
Coastal Response Research Center  
nancy.kinner@unh.edu

Joseph Cunningham\*  
Coastal Response Research Center  
joseph.cunningham@unh.edu

Zachary Magdol\*  
Coastal Response Research Center  
zachary.magdol@unh.edu

Kathy Mandsager\*  
Coastal Response Research Center  
kathy.mandsager@unh.edu

Heather Ballesterro  
Coastal Response Research Center  
heather.ballesterro@unh.edu

Mike Curry  
Coastal Response Research Center  
mat26@unh.edu

Adria Fichter  
Coastal Response Research Center  
aap26@unh.edu

Nate Little  
Coastal Response Research Center  
nhz22@unh.edu

Chris Wood  
Coastal Response Research Center  
cbt7@unh.edu

*\*Denotes Workshop Organizing Committee Member*

Page 4

**APPENDIX C:**  
**BREAKOUT GROUP QUESTIONS**



# OCEAN THERMAL ENERGY CONVERSION:

## Assessing Potential Physical, Chemical and Biological Impacts and Risks

### Breakout Session Questions

- **Breakout Session I: Biological Impacts and Receptors – June 22**
  1. What possible impacts are missing from our list? (Refer to handout)
  2. What are the best available technologies to assess OTEC impacts and risks?
  3. What baseline assessments, monitoring strategies and modeling methods are needed to develop quantifiable levels of impact and risk for OTEC facilities?
- **Breakout Session II: Baseline – June 23, AM**
  4. What is the geographic extent of the population/community to which impacts should be related (e.g., Pacific Ocean [whales], U.S. waters surrounding Hawaii [phytoplankton], waters around Oahu, or waters between Barbers Point and Diamond Head)?
  5. What additional research is needed in order to assess potential biological impacts of OTEC facilities?
- **Breakout Session III: Moving Forward – June 23, PM**
  6. How can potential physical, chemical and biological impacts be avoided, minimized or mitigated within the operational and design parameters of an OTEC system?
  7. What are potential tradeoffs between biological impacts and operational efficiency?

---

### Breakout Session IV: Integration - June 24 [Note: New Group Assignments]

#### *Groups 1- 4 - Integration of Baseline and Monitoring Data and Information Needs*

- What is the geographic extent of the population to which impacts should be related (e.g., Pacific Ocean [whales], U.S. waters surrounding Hawaii [phytoplankton] waters around Oahu, or waters between Barbers Point and Diamond Head)?
- For your group, determine baseline, monitoring, and modeling data needed for understanding the potential environmental impacts associated with an OTEC facility.
- Assign (High, Low, or Medium) priority to each data need and note why this level of priority is being assigned.
- Identify what further research is needed.

#### *Group 5 – Integration of Regulatory Needs*

- Based on what was discussed on Days 1 & 2, what else may be needed above and beyond baseline assessment, monitoring strategies, and modeling methods to assess the biological impacts of an OTEC facility?

#### *Group 6 – Integration of OTEC Facility Design and to Avoid, Minimize and Mitigate Environmental Impacts*

- Based on what was discussed previously (Days 1 & 2 of workshop), how might the OTEC facility design be adjusted to avoid, minimize or mitigate biological impacts without compromising the operational viability of an OTEC facility?



# OCEAN THERMAL ENERGY CONVERSION:

Assessing Potential Physical, Chemical and Biological Impacts and Risks

## REVISED QUESTIONS – DAY 3

For 5-10 MWe demonstration plant:

### Baseline data

1. What is the baseline data needed?
2. What is the optimum duration to collect this data? (1 year minimum)
  - a. Justify this duration

### Monitoring (in order to detect an impact)

1. What should be monitored?
2. How should this be monitored?
3. How frequent should this be monitored?

### Modeling

1. What existing models can be used?
2. What improvements can be made to these models?
  - a. Data needs
  - b. Additional parameters
3. What new models needed?

**APPENDIX D:**  
**BREAKOUT GROUPS**

# OCEAN THERMAL ENERGY CONVERSION:

Assessing Potential Physical, Chemical and Biological Impacts and Risks

## Breakout Groups

| Group A: Warm Water Intake<br>(Carnation Room)   | Group B: Cold Water Intake<br>(Garden Lanai Room)  | Group C: Discharge (includes biocide & working fluid leaks)<br>(Anthurium Room)   |
|--|--|---|
| Facilitator: Alison Hammer   | Facilitator: Alan Everson  | Facilitator: Michael Parke  |
| Content Lead: Kerry Kehoe  | Content Lead: Donald MacDonald   | Content Lead: Dwight Trueblood  |
| <i>Recorder: Christopher Wood</i>  | <i>Recorder: Adria Fichter</i>   | <i>Recorder: Heather Ballestero</i>   |
| Margaret Akamine<br>Steve Amaral<br>Cameron Black<br>Erica Goetze<br>Pat Grandelli<br>Stacy Hargrove<br>Don Hubner<br>Jayne Lefors<br>Carol Raifsnider<br>Kathleen Ruttenberg<br>Andrey Suntsov<br>Luis Vega<br>Kevin Weng | Suzanne Bass<br>Steve Frano<br>Andrea Gill<br>Peter Havens<br>David Karl<br>Charles Littnan<br>Bruce Mundy<br>Bill Munslow<br>Jim Potemra<br>Mike Reed<br>Bob Schroeder<br>Joe Van Ryzin | Robin Baird<br>Marie Bundy<br>Glenn Cada<br>Francisco Chavez<br>Chris Kelley<br>John Kornuc<br>José Martí<br>Brian Powell<br>Greg Rocheleau<br>Frank Sansone<br>Tomas See<br>Nate Sinclair<br>Hudson Slay |

| Group D: Physical Presence, Construction, Accidents & Emergency Response<br>(Pakalana Room)   | Group E: Noise & Electromagnetic Field<br>(Carnation Room)   |
|---|--|
| Facilitator: Stephanie Kavanaugh  | Facilitator: Zachary Magdol  |
| Content Lead: Whitney Blanchard   | Content Lead: Joseph Cunningham  |
| <i>Recorder: Nate Little</i>  | <i>Recorder: Mike Curry</i>  |
| Fred Arnold<br>Eric DeCarlo<br>Helen Farr<br>Greg Gebhardt<br>Simon Geerlofs<br>Andy Knox<br>Kim Maison/Patrick Opay<br>Laurie Meyer<br>Doug Miller<br>Charles Morgan<br>Erin Oleson<br>John Rooney/Bonnie DeJoseph<br>John Sato<br>Florence Thomas | Jocelyn Brown-Saracino<br>Christina Comfort<br>Todd Ericksen<br>Adam Frankel<br>Kim Holland<br>Shari Ishikawa<br>Stephen Kajiura<br>Marc Lammers<br>Lisa Munger<br>Steve Oney<br>Amy Scholik-Schlomer<br>Tim Tricas<br>Eric Vetter |



# OCEAN THERMAL ENERGY CONVERSION:

Assessing Potential Physical, Chemical and Biological Impacts and Risks

## DAY 3 REVISED GROUPS

### Group 1 – Oceanography - *Pakalana*

Stephanie Kavanaugh, Facilitator  
Dwight Trueblood, Facilitator/Table  
Nate Little (notes)  
Whitney Blanchard  
Fred Arnold  
Eric DeCarlo  
Peter Havens  
Jim Potemra  
Frank Sansone  
John Kornuc  
Andy Knox  
Doug Miller  
Mike Reed  
Tomas See  
Hudson Slay  
Pat Grandelli  
Jose Marti  
Charles Morgan  
Nate Sinclair

### Group 3 – Fisheries & Coral – *Garden Lanai*

Alan Everson, Facilitator  
Alison Hammer, Facilitator/Table  
Adria Fichter (notes)  
Christina Comfort  
Stephen Kajiura  
Kim Holland  
Chris Kelley  
Carol Raifsnider  
Bob Schroeder  
Tim Tricas  
Kevin Weng  
Aydee Camunas-Zielke  
Emily Lindow  
Charles Kaaiai  
Henry Curtis  
Suzanne Bass  
Cameron Black  
Helen Farr  
Steve Frano  
Laurie Meyer  
Joe Van Ryzin

### Group 2 – Plankton- *Anthurium*

Michael Parke, Facilitator  
Heather Ballesterio (Table)  
Chris Wood (notes)  
Steve Amaral  
Marie Bundy  
Glenn Cada  
Francisco Chavez  
Erica Goetze  
Kerry Kehoe  
Bruce Mundy  
John Rooney  
Kathleen Ruttenberg  
Andrey Suntsov  
Florence Thomas  
Eric Vetter  
Simon Geerlofs  
Don MacDonald  
Greg Rocheleau  
Luis Vega

### Group 4 - Mammal/Turtle – *Gardenia Room*

Joseph Cunningham, Facilitator  
Zachary Magdol, Facilitator/Table  
Mike Curry (notes)  
Midori Akamine  
Adam Frankel  
Stacy Hargrove  
Charles Littnan  
Kimberly Maison  
Erin Oleson  
Amy Scholik-Schlommer  
Sandy Causey  
Steve Lindemann  
Jocelyn Brown  
Andrea Gill  
Shari Ishikawa  
Jayne Lefors  
John Sato

**APPENDIX E:**  
**PARTICIPANT OTEC PRIMER**

# **Ocean Thermal Energy Conversion (OTEC) Workshop**

## **Assessing Potential Physical, Chemical and Biological Impacts and Risks**

### **A Primer**

Ocean thermal energy conversion (OTEC), the concept of extracting energy from the ocean by utilizing the temperature differential between the surface and deep oceanic waters, was first proposed by the nineteenth century French scientist Jacques-Arsène d'Arsonval in 1881. It was another Frenchman, Georges Claude, who made the first attempts to put the concept into practice in the first half of the twentieth century. Between 1928 and 1930 Claude built the first OTEC electrical generating facility at Matanza Bay, Cuba. The facility only operated for 11 days generating sufficient power to light forty 500 watt bulbs during a demonstration; however backers were not sufficiently impressed to finance a proposed 25 megawatt plant (Chiles, 2009). In 1934, using mostly his own money, Claude made his second attempt at a commercial scale OTEC facility. This one was a plant ship for the production of ice off the coast of Brazil. Before the cold water pipe could be completed a storm sank it and the project had to be cancelled due to lack of funds.

Jumping ahead to the 1970's and the Arab oil embargo; oil prices soared as did interest in alternative energy sources, including OTEC. In 1979 a project called Mini-OTEC, operating off of a US Navy barge, successfully generated 50 kilowatts of electricity in waters off Hawaii and a Japan sponsored 100 kilowatt land-based plant was operated on the island nation of Nauru and a 40 megawatt plant was proposed at Kahe Point, Hawai'i. Oil prices dropped followed by interest and federal funding in alternative energy sources. In the intervening years no OTEC facility of any size was constructed but limited research into design of such a facility continued. Back in the 70's and 80's the push for alternative energy sources was largely based on the direct cost of generating electricity, e.g., the cost of a barrel of oil. Today the renewed interest in alternative energy, particularly renewable energy resources is fueled not only by the direct cost of oil but also the indirect costs of utilizing oil and coal as energy sources. These indirect costs include relying on foreign fuel suppliers and pollution emissions, particularly CO<sub>2</sub>.

With this renewed interest in renewable energy resources work has been revived on developing a demonstration/pilot facility large enough (5-10 MW) that data obtained from its operation could be reasonably scaled up to a commercial size facility (100 MW or greater). The most likely location, within U. S. territory, for both the first demonstration/pilot facility and the first commercial facility is in Hawai'i. Therefore, this workshop will focus on the potential impacts of 5-10 MW and 100 MW facilities operating in Hawaiian waters, however, keeping in mind that any licensing regulations ultimately written will have to take into account conditions at other sites throughout the United States and its territories.

There are two major design options for an OTEC electrical generating facility: an open-cycle system where flash evaporated surface seawater is used to drive the turbines and is then cooled and condensed by deep seawater; and a closed cycle system where the turbines are driven by a working fluid (currently ammonia is the most likely) heated to gas by warm surface seawater and then cooled and condensed by cold deep seawater. Either type of OTEC facility can be installed in any one of three basic locations: on land, on an off-shore moored floating platform, and on a ship. The only key engineering requirement for the location of such a facility is the accessibility of warm surface water and cold deep water with a temperature differential of at least 20° C.

The major potential for environmental impact which is unique to OTEC results from the large volumes of water required to operate such a facility. It is estimated that from 3-5 m<sup>3</sup>/sec of warm surface water and a roughly equivalent amount of cold deep water are required for each megawatt of power generated (Myers *et al.*, 1986). This translates to 300-500 m<sup>3</sup>/sec for a 100 MW plant, or 26-43 million m<sup>3</sup>/day of just warm water. To put this into perspective a 2200 MW coastal nuclear power plant operating at full capacity uses 111 m<sup>3</sup>/sec (9.6 million m<sup>3</sup>/day) (Ferry-Graham, *et al.*, 2008) of cooling water approximately one sixth of the minimum total predicted water requirements for a 100 MW OTEC plant (Table 1). It has been stated that a 400 MW OTEC plant would require the equivalent of 20% of the average annual flow of the Mississippi River. From an environmental perspective the major difference between the open-cycle and closed-cycle OTEC operating systems is that the freshwater produced by evaporating the warm seawater in an open-cycle system could be used as a by-product resulting in a lower volume of warm water discharge with an elevated salinity. Secondly, the open-cycle system would not pose a potential risk from leakage or spillage of a toxic working fluid.

**Table 1. Warm water intake volumes for various sized OTEC facilities with the Natural Energy Laboratory of Hawai'i (NELHA) and San Onofre Nuclear Power Plant as references.**

| Facility                       | Million Gal/day | Gal/min    | Ft <sup>3</sup> /Sec | m <sup>3</sup> /sec | m <sup>3</sup> /min | Million m <sup>3</sup> /day |
|--------------------------------|-----------------|------------|----------------------|---------------------|---------------------|-----------------------------|
| NELHA 40 in CW                 | 19              | 13,400     | 30                   | 0.8                 | 51                  | 0.07                        |
| NELHA 55 in CW                 | 39              | 27,000     | 60                   | 1.7                 | 102                 | 0.15                        |
| 5MW plant min                  | 342             | 237,750    | 530                  | 15.0                | 900                 | 1.30                        |
| 5MW plant max                  | 571             | 396,250    | 883                  | 25.0                | 1,500               | 2.16                        |
| 100MW plant min                | 6,847           | 4,755,000  | 10,593               | 300.0               | 18,000              | 25.92                       |
| 100MW plant max                | 11,412          | 7,925,000  | 17,655               | 500.0               | 30,000              | 43.20                       |
| 400MW plant min                | 27,389          | 19,020,000 | 42,373               | 1,200.0             | 72,000              | 103.68                      |
| 400MW plant max                | 45,648          | 31,700,000 | 70,621               | 2,000.0             | 120,000             | 172.80                      |
| San Onofre Nuclear Power Plant | 2,580           | 1,791,667  | 3,991                | 113.0               | 6,782               | 9.77                        |

The closed-cycle system is currently considered the most likely design for the first OTEC facilities, therefore, the discussions at this workshop will focus on the potential environmental impacts of a closed cycle system with either a 5 MW or 100 MW generating capacity. Approximations of key operational and critical parameters of concern for a demo or commercial OTEC facility in Hawaiian waters are listed below; more precise descriptions of these parameters would be dependent on a specific facility design.

- Type
  - Floating platform
  - Anchoring system, to be determined
  - End product: Electricity to be transmitted to shore via cable
  
- Location
  - 3-4 miles offshore (depending on depth contours and temperature profile)



- Warm water intake
  - Depth approximately 20 meters
  - Temperature 25° C
  - Volume
    - 5 MW - ~25 m<sup>3</sup>/sec
    - 100 MW - ~500 m<sup>3</sup>/sec
  - Antifouling treatment: Probably intermittent chlorination
  
- Cold water intake
  - Depth approximately 800 - 1000 meters
  - Temperature 5° C
  - Diameter
    - 5MW – ~2-4 m
    - 100 MW – ~10 m
  - Volume
    - 5 MW - ~25 m<sup>3</sup>/sec
    - 100 MW - ~500 m<sup>3</sup>/sec
  - Antifouling treatment: None
  
- Discharge water
  - Combined warm and cold water discharge, or
  - Separate warm and cold water discharge.
  - Discharge depth – to be determined.

The **potential** impacts to biological communities resulting from the construction and operation of a closed-cycle OTEC facility, roughly broken down by component/stressor, include but are not limited to the following:

- Warm water intake
  - Entrainment
    - Phytoplankton and zooplankton (including microzooplankton, meroplankton, ichthyoplankton and possibly some macrozooplankton) and possibly some small vertebrate fish would be entrained in the warm water intake where they would be subjected to mechanical stresses from the intake pumps, periodic chemical stresses from the application of anti-fouling biocide and a mild temperature stress produced by a temperature reduction of 2-3° C unless a combined discharge is used then the temperature reduction would be approximately 10° C.
      - Quantity taken in is a function of the water volume taken in and screen mesh size.
      - Percent survival unknown.
  - Impingement



- Dead organisms in the discharge plume may act as fish food, attracting fish to the vicinity of the plume.
  - Planktonic organisms which are in the area of the discharge plume may be entrained in the plume (referred to as secondary entrainment) thus being exposed to toxins.
  - Potential for biomagnification of toxins thus impacting higher trophic level organisms.
- Cold water discharge may be deeper than the warm water discharge or in some proposed designs be above the warm water. It will contain erosion and corrosion products from the facility components, possibly some working fluid which has leaked out during normal operations, and the remains of entrained organisms. It should not contain any biocide, but it will contain dissolved gasses and nutrients from the deep. Its temperature, salinity and density will be different from the surrounding water into which it is discharged and will thus sink below the discharge point with sinking rate to a large extent dependent on the discharge location with respect to the warm water discharge.
    - Potential toxic effects from erosion and corrosion products and working fluid both singly and in combination.
    - Nutrients in the discharge may enhance primary productivity or cause toxic algal blooms. If rapid sinking occurs it may nullify any potential impact.
    - Concern has been expressed over dissolved gases in the discharge with respect to atmospheric release of green-house gases, but again this is dependent on the rate of sinking which is dependent on the discharge location, particularly with respect to the warm water discharge.
    - The higher dissolved CO<sub>2</sub> in the discharge may change the pH in the local receiving water inhibiting the shell production of foraminifera and veliger larvae. If rapid sinking occurs it may nullify any potential impact.
    - Dead organisms in the discharge plume may act as fish food, attracting fish to the vicinity of the plume.
    - Planktonic organisms which are in the area of the discharge plume may be subject to secondary entrainment in the plume thus being exposed to toxins and carried to depths which are unsuitable to their survival.
    - Potential for biomagnification of toxins thus impacting higher trophic level organisms.
- Combined discharge
    - A combined discharge would consist of water with an average temperature difference of approximately 10° C from both the warm water intake (10° C cooler) and the cold water intake (10° C warmer) with density and salinity also being an average of the two intake water masses. This water would sink to a depth of comparable density. It will contain erosion and corrosion products from the facility components, biocide from anti-fouling treatment, and possibly some working fluid which has leaked out during normal operations. It will also include the living or dead entrained organisms.

- Potential toxic effects from erosion and corrosion products, biocide and working fluid both singly and in combination.
  - Nutrients in the discharge may enhance primary productivity or cause toxic algal blooms, depending on depth of discharge and sinking rate.
  - Concern has been expressed over dissolved gases in the discharge with respect to atmospheric release of green-house gases, but again any release would be dependent on discharge depth and sinking rate.
  - The higher dissolved CO<sub>2</sub> in the discharge may change the pH in the local receiving water inhibiting the shell production of foraminifera and veliger larvae. Rapid sinking may nullify any potential impact.
  - Surviving entrained organisms and secondarily entrained organisms may be carried to unsuitable depths for their survival.
  - Dead organisms in the discharge plume may act as fish food, attracting fish to the vicinity of the plume.
  - Potential for biomagnification of toxins thus impacting higher trophic level organisms.
- Chemical Effects
    - As previously mentioned the discharge water will contain corrosional and erosional products, biocide from the heat exchangers, and possibly leaked working fluid. In addition the platform will release biocides from the antifouling paint and there is always the potential of a working fluid or biocide spill. These contaminants may act singularly or in combination on exposed biota.
      - Direct toxicity to exposed organisms.
      - Biomagnification of toxins with toxicity to higher trophic level organisms including humans.
- Construction and Physical Presence of Facility
    - Construction impacts at the site will depend on exactly how much of the construction will be done on-site. The platform will likely be built at a shore based facility and towed to the site; the cold water pipe may be constructed elsewhere and towed to the site or constructed/manufactured on-site.
      - Placement of anchors and transmission cable would disrupt/destroy benthic communities.
      - Construction activities could disrupt movements of marine mammals and reptiles in the area.
      - Could marine organisms be trapped, due to disorientation, in the cold water pipe as it is constructed/manufactured on site?
    - Physical Presence
      - Platform would most likely act as a fish attraction device (FAD).
        - Could increase the number of impinged and entrained organism.
        - Could change local migratory patterns of marine organism.
      - Lights at night would act as a bird attractant.

- Anchor and transmission cables may pose a risk of entanglement to marine mammals.
  - Anchors may change local bottom habitat type from soft to hard and thus change the local benthic community composition.
  - Cold water pipe?
- Acoustical and Electromagnetic Field (EMF)
    - Noise from plant operation will be principally from the water pumps and the generators. Additional noise would be generated by the actual movement of the water through the system and out the discharge.
      - Possible impact on marine mammal echolocation and communication.
    - EMF generation would occur around the transmission cable. In most if not all situations high power underwater transmission cables run entirely along the bottom or are even buried in the sediments; the transmission cable from a floating OTEC facility will be partially suspended in the water column (from the platform to the bottom).
      - Interference with marine organisms that use electric fields for prey detection (e.g., sharks) or magnetic fields for navigation.

As stated above, these are **potential** impacts, and they may not be the sole **potential** impacts of the construction and operation of an OTEC facility. Hopefully by the end of this workshop we will have an idea of how to determine the real impacts.

### **Past Evaluations**

Prior to the passage of OTECA the U. S. Department of Energy produced an environment assessment for an OTEC test platform (DOE, 1979b). Since little data existed on the potential impacts of the proposed platform they developed a list of the type of data needed to evaluate the impact of the test platform. This list includes necessary baseline data, monitoring data during operations and post operational data requirements (see attachment 1).

OTECA was enacted August 3, 1980; in July 1981 NOAA issued the Final Environmental Impact Statement (EIS) for Commercial Ocean Thermal Energy Conversion (OTEC) Licensing (NOAA, 1981). This document addressed all three siting locations for OTEC facilities: land based, offshore moored platform and open-water ship. It goes on to state “Evaluation of potential environmental impacts associated with commercial OTEC development is presently a matter of speculation . . .” Several other reports are cited which have made preliminary assessments of the potential environmental effects associated with OTEC plants: DOE OTEC Environmental Development Plan (DOE, 1979a), the DOE. Environmental Assessment for OTEC (DOE, 1979b) which was supplemented for OTEC-I (Sinay-Friedman, 1979), a DOE draft of the OTEC Programmatic EA (Sands, 1980), a site- and design-specific EA which was prepared for the proposed second deployment of Mini-QTEC (Donat et al., 1980), and a generic EA for the 40-MWe OTEC Pilot Plant Program (Sullivan et al., 1980).

Based on the available data at the time NOAA classified the potential environmental effects of OTEC into three categories: major effects, minor effects and potential effects from accidents (Table 2). In addition to determining potential impacts of an OTEC facility they also recommended possible mitigation measures as well as research needs (see attachment 2).

**Table 2 OTEC effects categories from NOAA’s final EIS (NOAA, 1981).**

| Category | Stressor                                 | Effect  |   |
|----------|--|---|---|
| In       | <b>Major Effects:</b>                    | Platform presence                                     | Biota attraction  |
|          |  | Withdrawal of surface and deep ocean waters           | Organism entrainment and impingement                              |
|          |  | Discharge of waters                                   | Nutrient redistribution resulting in increased productivity       |
|          |  | Biocide release                                       | Organism toxic response   |
|          | <b>Minor Effects:</b>                    | Protective hull-coating release                       | Concentration of trace metals in organism tissues                 |
|          |  | Power cycle erosion and corrosion                     | Effect of trace constituent release                               |
|          |  | Implantation of coldwater pipe and transmission cable | Habitat destruction and turbidity during dredging                 |
|          |  | Low-frequency sound production                        | Interference with marine life                                     |
|          |  | Discharge of surfactants                              | Organism toxic response   |
|          |  | Open-cycle plant operation                            | Alteration of oxygen and salt concentrations in downstream waters |
|          | <b>Potential Effects from Accidents:</b> | Potential working fluid release from spills and leaks | Organism toxic response   |
|          |  | Potential oil releases                                | Organism toxic response   |

1986 NOAA’s National Marine Fisheries Service published a report entitled “The Potential Impact of Ocean Thermal Energy Conversion (OTEC) on Fisheries” (Myers *et al.*, 1986). This report benefited from some of the research proposed by the 1981 EIS and was able to generate some actual numbers for biomass losses due to entrainment and impingement. However, the report goes on to state that these numbers are still speculative; for example the warm water intake entrainment and impingement numbers were based on average biomass concentrations derived from various reports for both Hawaii and Puerto Rico, however, if the facility acts as a fish attractant the concentration of organisms subject to entrainment and impingement could be significantly higher. The report concluded that “the potential risk to fisheries of OTEC operations is not judged to be so great as to not proceed with the early development of OTEC. Due to the lack of a suitable precedent, however, there will remain some level of uncertainty regarding these initial conclusions until a pilot plant operation can be monitored for some period of time. In the meantime, further research on fisheries should be undertaken to assure an acceptable level of risk regarding the larger commercial OTEC deployments.”

For more detailed information on these past evaluations of OTEC it is recommended that the NMFS report (Myers *et al.*, 1986) be consulted, since unlike the EA (DOE, 1979) and EIS (NOAA, 1981) cited above, which are both a few hundred pages long, the NMFS report is less than 40 pages including references.

**References**

Chiles, J.R. 2009. The Other Renewable Energy. *Invention and Technology*, Winter 2009, pp24-35. <http://clubdesargonautes.org/energie/chiles.pdf>

Donat, J.R., M.D. Sands, S.M. Sullivan, and M. Smookler. 1980. Draft environmental assessment for the Mini-OTEC second deployment. Interstate Electronics Corporation, Anaheim, CA. 180 pp.

Ferry-Graham, Lara, M. Dorin, and P. Lin. 2008. Understanding Entrainment at Coastal Power Plants: Informing a Program to Study Impacts and Their Reduction. California Energy Commission, PIER Energy-Related Environmental Research Program. CEC-500-2007-120.

Myers, E.P., D.E. Hoss, W.M. Matsumoto, D.S. Peters, M.P. Seki, R.N. Uchida, J.D. Ditmars and R.A. Paddock. 1986. The Potential Impact of Ocean Thermal Energy Conversion (OTEC) on Fisheries. NOAA Technical Report NMFS 40. 33pp. <http://spo.nwr.noaa.gov/tr40opt.pdf>

NOAA Office of Ocean Minerals and Energy. 1981. Final Environmental Impact Statement for Commercial Ocean Thermal Energy Conversion (OTEC) Licensing. 284pp.

Sands, M.D., ed. 1980. Ocean thermal energy conversion draft programmatic environmental assessment. Prepared for U.S. Department of Energy, Contract No. W-7405-ENG-48. Interstate Electronics Corporation, Anaheim, CA.

Sinay-Friedman, L. 1979. Supplement to the draft environmental impact assessment ocean thermal energy conversion (OTEC) preoperational ocean test platform. TRW, Defense and Space Systems Group. 250 pp.

Sullivan, S.M., M.D. Sands, J.R. Donat, P. Jepsen, M. Smookler, J.F. Villa. 1980. Draft environmental assessment, ocean thermal energy conversion . (OTEC) pilot plants. Prepared under subcontract to Lawrence Berkeley Laboratory, Berkeley, CA. Subcontract No. 4504210. Interstate Electronics Corporation, Anaheim, CA.

United States Department of Energy. 1979a. Environmental development plan. Ocean thermal energy conversion. Assistant Secretary for Energy Technology, Assistant Secretary for Environment. Washington, D.C. 48 pp.

United States Department of Energy. 1979b. Environmental assessment, ocean thermal energy conversion (OTEC) program. Preoperational ocean test platform. U.S. DOE, Assistant Secretary for Energy Technology, Washington, D.C. 20545. DOE/EA-0062. 381 pp.

## **ATTACHMENTS**



# ATTACHMENT 1

**ENVIRONMENTAL ASSESSMENT**  
**Ocean Thermal Energy Conversion (OTEC) Program**  
**Preoperational Ocean Test Platform**  
**Volume 1 of 2**  
**U.S. Department of Energy DOE/EA-0062**  
**1979**  
**(pages 4-29 to 4-33)**

## Baseline Data

### Biological

- Phytoplankton and zooplankton should be identified and species quantified.
- Food chain interactions should be determined.
- Microbiology assays should be determined (qualitative and quantitative).
- Biomass/productivity rates with chlorophyll-a and C<sup>14</sup> should be estimated.
- Impingeable and entrainable organisms in the water column should be identified.
- Micronekton and nekton density rates through the study sites.

### Chemical (support to the above include):

- Particulate and dissolved organic carbon
- Dissolved micronutrients (ammonia, nitrate, nitrite, ortho-phosphate, silicates).
- Total nitrogen
- Residual chlorine and chlorine derivatives
- Carbonate equilibrium (alkalinity, pH).
- Trace metals (titanium, aluminum, copper, lead, etc
- Water column profiles of dissolved oxygen, salinity and temperature.

### Physical

- Temporal/spatial current patterns
- Wave height and direction and frequency of occurrence
- Vertical density structure
- Transmissivity.
- Deep scattering layer.
- Mixed layer depth.
- Dye dispersion studies.

## On-Site Monitoring

### Biological

- Impingeable and entrainable organisms in the vicinity of the intakes (including fish)
- Limited biological sampling for phytoplankton and zooplankton to determine percent mortality
- Micronekton and nekton density around the platform
- In situ bioassay with phyto- and zooplankton

## **Chemical**

- Micronutrients (ammonia, nitrate, nitrite, orthophosphate, silicates, total nitrogen).
- Particulate and dissolved organic carbon
- Temperature, salinity, alkalinity, dissolved oxygen and pH profiles
- Transparency (transmissivity).
- Residual chlorine and chlorine derivatives (monochloramine and dichloramine)
- Water samples should be taken from the water in the cold and warm water pipes, and outfall, and various points in the water column

## **Physical**

- Wave height and period.
- Transmissivity.
- Current speed and direction.
- Radiation.
- Deep scattering layer.

## **Meteorological**

- Air temperature.
- Barometric pressure.
- Wind speed and direction.
- Radiation •
- Humidity •

## **Post Operation Site Survey**

- Same parameters as baseline

**ATTACHMENT 2**  
**Final Environmental Impact Statement for Commercial Ocean Thermal Energy Conversion (OTEC) Licensing**  
**NOAA Office of Ocean Minerals and Energy**  
**1981**  
**(Pages 4-40 to 4-41)**

**TABLE 4-8. POTENTIALLY ADVERSE ENVIRONMENTAL IMPACTS AND MITIGATING MEASURES**

| Issue                               | Community Affected   |  |   |  |  | Mitigating Measures (Ranked by Effectiveness)   | Research Needs  |
|-------------------------------------|--|--|---|--|--|---|---|
|                                     | Plankton   | Nekton   | Benthos   | Threatened and Endangered Species                                    | Man's Activities   |   |   |
| Biota Attraction and Avoidance      | Increased number of organisms due to attraction to lights. | Increased number of organisms due to attraction to structure and lights.   | Colonization of exposed structures.   | Possible avoidance of area due to human presence and noise.          | Increased fishing.<br>Loss of desired faunal diversity.                      | Site away from breeding and nursery grounds.<br>Reduce lights and noise to minimum needed for safe operation.<br>Reduce attraction surfaces   | Site evaluation studies to determine ecological sensitivity of areas.<br>Determine biota attraction and avoidance to different platform configurations and lighting systems.                          |
| Organism Entrainment                | Reduction in population size.                              | Reduction in population size due to mortality of eggs and larvae.<br>Potential reduction in food resources.                      | Reduction in population size due to mortality of planktonic larval stages.  | Possible reduction in food resources.                                | Potential decrease in fishery resources.                                     | Site intakes away from ecologically sensitive areas.<br>Site intakes at depths that will entrain the least number of organisms.<br>Reduction in through-plant shear forces.   | Site evaluation studies to determine ecological sensitivity of area.<br>Determine vertical distribution of local populations.<br>Entrainment mortality studies that determine plant induced mortality |
| Organism Impingement                | None.  | Reduction in population size due to mortality of juveniles and adults.   | None.   | None.  | Potential reduction in fishery resources.                                    | Use velocity caps to achieve horizontal flow fields.<br>Use fish return system.<br>Site intakes at depths that will impinge the least number of organisms.<br>Reduce intake velocities.   | Site evaluation studies to determine ecological sensitivity of area, and size, structure, and vertical distribution of fish populations.<br>Impingement mortality prevention studies                  |
| Biocide Release                     | Reduction in population size.                              | Decreased metabolic activity and plume avoidance by adults.<br>Reduction in population size due to mortality of eggs and larvae. | Reduction in population size due to mortality of planktonic larval stages.<br>Chronic or acute effects on adults. | Possible avoidance of plume.<br>Possible reduction of food resource. | Potential reduction of fishery resources.<br>Decreased aesthetics.           | Discharge below photic zone.<br>Use alternate methods for biofouling control.<br>Rapid dilution through use of diffusers.<br>Site specific biocide release schedule and concentration.<br>Site discharges away from ecologically sensitive areas. | Site evaluation studies to determine ecological sensitivity of area<br>Acute and chronic toxicity and bioassay studies on representative organisms.   |
| Nutrient Redistribution             | Increased productivity.                                    | Potentially increased food resource.   | Potentially increased food resource.  | Potentially increased food resource.                                 | Potential increase in fishery resource.<br>Potentially decreased aesthetics. | Discharge into photic zone.<br>Discharge below photic zone.   | Determine discharge plume stabilization depth and downstream mixing rate so that physical models can be calibrated.   |
| Sea-Surface Temperature Alterations | None.  | None.  | None.   | None.  | Potential climatic alterations.  | Discharge below the thermocline.  | Monitor temperature density profiles from OTEC discharges to calibrate predictions.   |

**APPENDIX F:**

**RECORDERS NOTES AND REPORT OUTS**

## **APPENDIX F: GROUP A**

## **OTEC II: RECORDER NOTES: GROUP A**

### **Breakout Session I: Biological Impacts and Receptors**

1. What possible impacts are missing from our list? (Refer to handout)

ENTRAINMENT:

- Indirect impacts, meaning a lost forage resource in the trophic web
  - (1) Shifting from predation to scavenging
- Bacteria
- Cycles of abundance and scarcity with fish – how do we address this?
  - (1) Seasonal changes
- Diel migrations
  - (1) Micronekton (night time only)

IMPINGEMENT:

- Sea turtle hatchling impingement is not likely based on the depth of the warm water intake (~25 m)
- Sick or weakened juvenile turtle impingement is a possibility
- Cumulative, or long term, impacts (eg. 30% intake blockage over a period of time)
- Diel migrations
  - (1) Micronekton (night time only)

2. What are the best available technologies to assess OTEC impacts and risks?

- In terms of micronekton and ichthyoplankton, MOCNESS (multiple opening and closing net environmental sensing system)
  - (1) Vessel equipped with a specialized net with multiple openings that can be opened and closed at different depths to survey a water column for densities of organisms
- Simpler sampling methods, eg. Nekton net, bongo net
- Acoustic Doppler Current Profiler (ADCP) – allows one to see particles
  - (1) To determine source water
  - (2) To survey densities of organisms (micronekton)
- Biomass sampling at NELHA of the warm water intake system (opportunity to gather information) – impingement related

- Ship-based sampling at ~20 m, referencing a 20 year time series data set from HOT Station 1 near Kahe – data of opportunity
- Examination of the entrainment and impingement data from the Kahe power plant
- Biological modeling
  - (1) Ecopath with Ecosim – ecosystem based modeling
- To model entrainment effects ETM (empirical transport model)
  - (1) Sample source water around and at the intake
  - (2) Entrainment models: AEL (adult equivalent loss) and FH (fecundity hindcast) –Modifying existing power plant models
- 50 years of fishery data can be used to assess impacts to establish a baseline
- Video Plankton Recording – phytoplankton and zooplankton
- Satellite and Remote Sensing
- Can quantify the difference between/compare the attraction to a site before and after the construction or placement of a system – FAD (fish aggregating device)
- OOS – Ocean Observing System

3. What baseline assessments, monitoring strategies and modeling methods are needed to develop quantifiable levels of impact and risk for OTEC facilities?

- 
- Can make estimates of how many groups of species are present and how many of those groups will be killed by entrainment or impingement
- Assume everything that is impinged or entrained dies
- What percentage of a resource relevant to the HI stock will be killed
  - (1) Determine a threshold
- Develop monitoring strategies for high priority groups
- Start with current data (from the past 30 or so years) as baseline data
- As a basis of comparison, using the previous EIS' and existing data and then conduct a one-year study for baseline measurements (ecosystem-wide) using contemporary methods
- Using the EIS, fish study, and the Harrison study, update the data from the last 30 years, and evaluate

|                    | <b>Impact</b>                    | <b>Best Available Technology</b> | <b>Baseline assessment</b>        | <b>Monitoring strategies</b> | <b>Modeling methods</b> |
|--------------------|----------------------------------|----------------------------------|-----------------------------------|------------------------------|-------------------------|
| <b>ENTRAINMENT</b> | Phytoplankton                    |                                  |                                   |                              |                         |
|                    | Plankton                         |                                  | Species abundance and composition | Monthly sampling             |                         |
|                    | Fish Larvae                      |                                  |                                   |                              |                         |
|                    | Bacteria                         |                                  |                                   |                              |                         |
|                    | Micronekton                      |                                  |                                   |                              |                         |
|                    | Cycles of abundance and scarcity |                                  |                                   |                              |                         |
|                    | Vertebrate fish                  |                                  |                                   |                              |                         |
| <b>IMPINGEMENT</b> | Sea turtles                      |                                  |                                   |                              |                         |
|                    | Micronekton                      |                                  |                                   |                              |                         |
|                    | Cumulative Impacts               |                                  |                                   |                              |                         |
|                    |                                  |                                  |                                   |                              |                         |



## OTEC II: RECORDER NOTES: GROUP A

### Breakout Session II: Baseline

#### 4. Prioritize the impacts in a regulatory context:

- i) Fish (and habitat, including deep water corals) --MSA
  - ii) Marine Mammals (and habitat) --MMPA
  - iii) Endangered Species (and habitat, including shallow water corals) --ESA
  - iv) Clean Water Act (w.r.t. nutrients)
- Indirect Impact: loss of foraging opportunities or a decrease of predators (food web impacts), which would count as degradation of EFH
  - Direct Impact: mortality

| <b>Impacted Population</b>   | <b>Regulatory Driver?</b>                | <b>Likely?</b> | <b>Significant?</b> | <b>Unique to OTEC?</b>  | <b>Regulatory Priority? (Y, N)</b> |
|--|--|----------------|---------------------|---|------------------------------------|
| <b>Entrainment:</b>  |  |                |                     |   |                                    |
| Phytoplankton + Bacteria<br>--Essential Fish Habitat (EFH), could be a driver as an indirect impact                  | -MSA/EFH                                 | Yes            | Unknown             | <u>No</u> for pilot plant (10 MWe)<br><u>Yes</u> for commercial scale | Yes                                |
| Zooplankton + Meroplankton (without direct impacts)<br>--  | -MSA/EFH                                 | Yes            | Unknown             | <u>No</u> for pilot plant (10 MWe)<br><u>Yes</u> for commercial scale | Yes                                |
| Benthos (eggs & larvae, with direct impacts)<br>--gametes of endangered species could be affected (e.g. black coral) | -ESA (possibly for corals)               | Unknown        | Yes, if listed      | <u>No</u> for pilot plant (10 MWe)<br><u>Yes</u> for commercial scale | Yes, if listed                     |
| Fish<br>--indirect impacts   | -MSA/EFH                                 | Yes            | Unknown             | <u>No</u> for pilot plant (10 MWe)<br><u>Yes</u> for commercial scale | Yes                                |
| Fish (eggs & larvae)<br>--direct impacts, mortality  | -ESA, if listed (none in HI)<br>-MSA/EFH | Yes            | Yes                 | Same as above   | Yes                                |
| Micronekton<br>--indirect impacts  | -MSA/EFH                                 | Yes            | Unknown             | Yes   | Yes                                |
| Micronekton<br>--direct impacts  | -ESA if listed (none in HI)<br>-MSA/EFH  | Yes            | Yes                 | <u>No</u> for pilot plant (10 MWe)<br><u>Yes</u> for commercial scale | Yes                                |
| <b>Impacted Population</b>   | <b>Regulatory</b>                        | <b>Likely?</b> | <b>Significant?</b> | <b>Unique to OTEC?</b>  | <b>Regulatory</b>                  |

|  | <b>Driver?</b>              | (assuming 8 mm mesh, 0.15 m/s)    |                         |   | <b>Priority? (H, M, L)</b> |
|--|-----------------------------|-----------------------------------|-------------------------|---|----------------------------|
| <b>Impingement:</b>  |                             |                                   |                         |   |                            |
| Macrozooplankton (adults)<br>--need to quantify available resource<br>--indirect impact, if mortality affects food chain<br>--direct impact, not a concern | -MSA/EFH                    | No                                | Probably not            | <u>No</u> for pilot plant (10 MWe)<br><u>Yes</u> for commercial scale | Low                        |
| Fish<br>--   | -MSA/EFH<br>-ESA, if listed | Juvenile, or small schooling fish | Unknown                 | No  | Medium, High if listed     |
| Sea Turtles<br>--species specific  | -ESA                        | No                                | Yes, because of listing | No  | High                       |
| Diving Sea Birds<br>--   | -ESA<br>-MBTA               | No                                | Unknown                 | No  | Low                        |
| Micronekton<br>--  | -MSA/EFH                    | Yes                               | Unknown                 | Yes   | Medium                     |

**Acronyms:**

MSA – Magnuson-Stevens Act

EFH – Essential Fish Habitat

ESA – Endangered Species Act

MBTA – Migratory Bird Treaty Act

**5. What additional research is needed in order to assess potential biological impacts of OTEC facilities?**

**i) Technologies to conduct research**

- Need to look at a cross-cutting, interdisciplinary, baseline study (ecosystem study) for the entire OTEC site
- Quantify (by group/species) what is entering the system compared to the total available resource
- Collect new baseline Physical, Chemical, and Biological data
- Utilize cultural knowledge of existing resources
- Compare new studies to Kahe Point studies

| <b>Impact</b>   | <b>Additional Research Needed</b>   | <b>Technology</b> | <b>Existing Data</b><br>(see 1986 NMFS Technical Report 40) |
|---|---|-------------------|---|
| <b>Entrainment:</b>   |   |                   |   |
| Phytoplankton + Bacteria (indirect)   | --update site specific ecosystem studies (baseline)<br>--quantify (by group/species) what is entering the system compared to the total available resource |                   |   |
| Zooplankton + Meroplankton (indirect)   | --perform an ecosystem study  |                   |   |
| Benthos (eggs & larvae, direct impacts)   | --analysis of habitat, and larval distribution  |                   |   |
| Fish<br>--indirect impacts  | --perform an ecosystem study  |                   |   |
| Fish (eggs & larvae)<br>--direct impacts, mortality<br>-- small fish, e.g. adult nehu | --larval distribution (presence), then;<br>--update existing stock assessments using larvae mortality data  |                   |   |

|                                   |   |  |   |
|-----------------------------------|---|--|---|
| Micronekton<br>--indirect impacts | --perform an ecosystem study  |  |   |
| Micronekton<br>--direct impacts   | --quantify swimming speed (by group/species) --quantify (by group/species) what is entering the system compared to the total available resource |  |   |
| <b>Impingement:</b>               |   |  |   |
| Macrozooplankton (adults)         | --N/A   |  |   |
| Fish                              | --see entrainment<br>--quantify swimming speed (by group/species)   |  | --stock assessment models of commercially harvested species |
| Sea Turtles (hatchlings)          | --summarize existing knowledge, if relevant   |  | --NOAA and USF&W long-term data sets                        |
| Diving Sea Birds                  | --summarize existing knowledge, if relevant   |  | --USF&W data sets   |
| Micronekton                       | --see entrainment   |  |   |

# **RECORDERS NOTES: GROUP A**

## **Breakout Session III: Moving Forward**

### **6. How can potential physical, chemical and biological impacts be avoided, minimized or mitigated within the operational and design parameters of an OTEC system?**

- Optimum size?
  - (1) Commercially viable system, about 100 MWe
- Design parameters:
  - (1) Intake screen size area
  - (2) Mesh size
  - (3) Intake velocities
  - (4) Intake depth
  - (5) Flow rate and direction (horizontal vs. vertical)
  - (6) Temperature differential through heat exchanger
  
- Siting (within 10-15 miles of land)
- Aim for horizontal intake flow to avoid entrainment
- Flow rate and temperature differential played off of each other to maximize economic and performance efficiency
- Avoid cavitation (pumps)
- Try to maintain hull cleanliness
- Deterrent strategies (behavioral deterrent strategies) could be considered to repel organisms (juvenile and adult fish)
  - (1) Light (high intensity, strobe)
  - (2) Sound
- Screen mesh size is OTEC plant specific

### **7. What are potential tradeoffs between biological impacts and operational efficiency?**

- Operational Efficiency = Net Power Output vs. Maximum Potential Design Energy Output
- At what point do we lose functionality of the system?

| <b>Impact</b>                                       | <b>Avoid, minimize, mitigate strategies</b>  | <b>Potential tradeoffs</b>  |
|---|--|---|
| <b>Entrainment:</b>                                 | - Keeping intake velocities less than or equal to the ambient (sweeping) current velocity will minimize impingement and entrainment  | -Decreasing velocity requires larger intake screen and plant size   |
| Phytoplankton + Bacteria                            | -Too small to filter<br>-Study site-specific depth of intake w.r.t. vertical distribution of plankton  | -The deeper the intake, the less efficient the plant  |
| Zooplankton + Meroplankton (indirect impacts)       | -Too small to filter<br>-Study site-specific depth of intake w.r.t. vertical distribution of plankton  | -The deeper the intake, the less efficient the plant  |
| Benthos (eggs & larvae, with direct impacts)        | -Too small to filter<br>-Study site-specific depth of intake w.r.t. vertical distribution of plankton  | -The deeper the intake, the less efficient the plant  |
| Fish<br>--indirect impacts                          | NA, because any improvements to the below will decrease indirect impacts   |   |
| Fish (eggs & larvae)<br>--direct impacts, mortality | -Smaller mesh size to avoid entrainment<br>-Study site-specific depth of intake w.r.t. vertical distribution of fish<br>-Reduce velocity to avoid entrainment<br>-Deterrent strategies (light, sound)<br>-Avoiding operation during spawning seasons | -Increase possible impingement<br>-The deeper the intake, the less efficient the plant<br>-Decreasing velocity requires larger intake area<br>-Deterrents could become an unintentional attractant<br>-Decreases facility operation |
| Micronekton<br>--direct impacts                     | -Avoid night time operation  | -Decreases facility operation   |
| Micronekton<br>--indirect impacts                   | NA, because any improvements to the above will decrease indirect impacts   |   |
| <b>Impingement:</b>                                 | --   | --  |
| Macrozooplankton (adults)                           | -Larger mesh size to avoid impingement<br>-Study site-specific depth of intake w.r.t. vertical distribution of plankton  | -Will increase entrainment<br>-The deeper the intake, the less efficient the plant<br>-Decreasing velocity requires larger intake area  |

|                          |  |  |
|--------------------------|--|--|
|                          | <ul style="list-style-type: none"> <li>-Reduce velocity to avoid impingement</li> <li>-Deterrent strategies (light, sound)</li> </ul>  | -Deterrents could become an unintentional attractant   |
| Fish                     | <ul style="list-style-type: none"> <li>-Larger mesh size to avoid impingement</li> <li>-Study site-specific depth of intake w.r.t. vertical distribution of fish</li> <li>-Reduce velocity to avoid impingement</li> <li>-Deterrent strategies (light, sound)</li> </ul> | <ul style="list-style-type: none"> <li>-Increase possible entrainment</li> <li>-The deeper the intake, the less efficient the plant</li> <li>-Decreasing velocity requires larger intake area</li> <li>-Deterrents could become an unintentional attractant</li> </ul> |
| Sea Turtles (hatchlings) | Unknown  | -Placing the intake pipe at shallower depths could impact hatchlings   |
| Diving Sea Birds         | <ul style="list-style-type: none"> <li>-Unknown</li> <li>-Minimize facility lighting that shines directly into the water</li> </ul>  | Unknown  |
| Micronekton              | <ul style="list-style-type: none"> <li>-Avoid night time operation</li> <li>-Minimize facility lighting that shines directly into the water</li> <li>-Reduce intake velocity</li> </ul>  | <ul style="list-style-type: none"> <li>-Decreases facility operation</li> <li>-</li> <li>-Decreasing velocity requires larger intake area</li> </ul>   |



REPORT OUT – GROUP A - DAY 1  
Breakout Session I: Report

Warm Water Intake

### Question 1: Missing Impacts

ENTRAINMENT:

- Indirect impacts, meaning a lost forage resource in the trophic web
  - Shifting from predation to scavenging
- Bacteria
- Cycles of abundance and scarcity with fish – how do we address this?
  - Seasonal changes
- Diel migrations (Micronekton -- night time only)

### Question 1: Missing Impacts

IMPINGEMENT:

- Sea turtle hatchling impingement is not likely based on the depth of the warm water intake (~25 m)
  - Sick or weakened juvenile turtle impingement is a possibility
- Cumulative, or long term, impacts (eg. 30% intake blockage over a period of time)
- Diel migrations
  - Micronekton (night time only)

### Question 2: Best Available Technologies

- Plankton Sampling
- Acoustic Doppler Current Profiler (ADCP)
- Biomass sampling
- Ship-based sampling
- Take advantage of existing data sets, Kahe, HOT 1, Commercial Fisheries
- Biological modeling
  - Ecosystem based modeling
- Entrainment models
- Video Plankton Recording – phytoplankton and zooplankton
- Satellite and Remote Sensing
- Quantify difference between/compare the attraction to a site before and after the construction or placement of a system – FAD (fish aggregating device)
- OOS – Ocean Observing System, current modelling

### Question 3: Assessments, Monitoring, Modeling

- Understand the size of the resource and what portion of that resource will be impacted

- Develop monitoring strategies for high priority groups

- Start with current data (from the past 30 or so years) as baseline data

- As a basis of comparison, use existing data and then conduct a one-year study for baseline measurements (ecosystem-wide) using contemporary methods

## **Breakout Session III: Moving Forward**

### **6. How can potential physical, chemical and biological impacts be avoided, minimized or mitigated within the operational and design parameters of an OTEC system?**

- Design parameters:
  - (1) Intake screen size area
  - (2) Mesh size
  - (3) Intake velocities
  - (4) Intake depth
  - (5) Flow rate and direction (horizontal vs. vertical)
  - (6) Temperature differential through heat exchanger
  
- Siting (within 10-15 miles of land)
  
- Deterrent strategies (behavioral deterrent strategies) could be considered to repel organisms (juvenile and adult fish)
  - (1) Light (high intensity, strobe)
  - (2) Sound

### **7. What are potential tradeoffs between biological impacts and operational efficiency?**

- Operational Efficiency = Net Power Output vs. Maximum Potential Design Energy Output
  
- At what point do we lose functionality of the system?

# Entrainment:

| Impact  | Avoid, minimize, mitigate strategies   | Potential tradeoffs   |
|---|--|---|
| Entrainment:  | - Keeping intake velocities less than or equal to the ambient (sweeping) current velocity will minimize impingement and entrainment  | -Decreasing velocity requires larger intake screen and plant size   |
| Phytoplankton + Bacteria                            | -Too small to filter<br>-Study site-specific depth of intake w.r.t. vertical distribution of plankton  | -Deeper intakes make plant less efficient   |
| Zooplankton + Meroplankton (indirect impacts)       | -Too small to filter<br>-Study site-specific depth of intake w.r.t. vertical distribution of plankton  | -Deeper intakes make plant less efficient   |
| Benthos (eggs & larvae, with direct impacts)        | -Too small to filter<br>-Study site-specific depth of intake w.r.t. vertical distribution of plankton  | -Deeper intakes make plant less efficient   |
| Fish<br>--indirect impacts                          | NA, because any improvements to the above will decrease indirect impacts   |   |
| Fish (eggs & larvae)<br>--direct impacts, mortality | -Smaller mesh size to avoid entrainment<br>-Study site-specific depth of intake w.r.t. vertical distribution of fish<br>-Reduce velocity to avoid entrainment<br>-Deterrent strategies (light, sound)<br>-Avoiding operation during spawning seasons | -Increase possible impingement<br>-Deeper intakes make plant less efficient<br>-Slower velocity requires larger intake area<br>-Deterrents could be unintentional attractant<br>-Decreases facility operation |
| Micronekton<br>--direct impacts                     | -Avoid night time operation  | -Decreases facility operation   |
| Micronekton<br>--indirect impacts                   | NA, because any improvements to the above will decrease indirect impacts   |   |

## Impingement:

| Impact                    | Avoid, minimize, mitigate strategies   | Potential tradeoffs   |
|---------------------------|--|---|
| Macrozooplankton (adults) | <ul style="list-style-type: none"> <li>-Larger mesh size to avoid impingement</li> <li>-Study site-specific depth of intake w.r.t. vertical distribution of plankton</li> <li>-Reduce velocity to avoid impingement</li> <li>-Deterrent strategies (light, sound)</li> </ul> | <ul style="list-style-type: none"> <li>-Will increase entrainment</li> <li>-Deeper intakes make plant less efficient</li> <li>-Slower velocity requires larger intake area</li> <li>-Deterrents could become an unintentional attractant</li> </ul>             |
| Fish                      | <ul style="list-style-type: none"> <li>-Larger mesh size to avoid impingement</li> <li>-Study site-specific depth of intake w.r.t. vertical distribution of fish</li> <li>-Reduce velocity to avoid impingement</li> <li>-Deterrent strategies (light, sound)</li> </ul>     | <ul style="list-style-type: none"> <li>-Increase possible entrainment</li> <li>-The deeper the intake, the less efficient the plant</li> <li>-Slower velocity needs larger intake area</li> <li>-Deterrents could become an unintentional attractant</li> </ul> |
| Sea Turtles (hatchlings)  | Unknown  | <ul style="list-style-type: none"> <li>-Placing the intake pipe at shallower depths could impact hatchlings</li> </ul>  |
| Diving Sea Birds          | <ul style="list-style-type: none"> <li>-Unknown</li> <li>-Minimize facility lighting that shines directly into the water</li> </ul>  | Unknown   |
| Micronekton               | <ul style="list-style-type: none"> <li>-Avoid night time operation</li> <li>-Minimize facility lighting that shines directly into the water</li> <li>-Reduce intake velocity</li> </ul>  | <ul style="list-style-type: none"> <li>-Decreases facility operation</li> <li>-</li> <li>-Slower velocity needs larger intake area</li> </ul>   |

## REPORT OUT – GROUP A – DAY 3

## Impacts From Warm Water Intake

- “Impacts” need to be assessed with a view towards an eventual regulatory determination
- What is the likelihood, degree, and significance of the “impact?”
- How much confidence can be placed in what we know or can assess about impacts?

## What the NMFS 1986 Study Found:

- Impingement may be to the level of being ecologically important
- Primary entrainment will be important due to the large number of entrained organisms

## Impingement

- Flow: velocity and volume
  - Lowering intake velocities may require larger intakes with greater volumes
- Abundance of organisms

### Impingement: Affected Organisms

- Unlikely that fish over 10 cm will be impinged (at velocity of 0.25-0.30 m/s)
- Generally of the micronekton size (2-20 cm)
  - Includes fish, microplanktonic crustaceans, cephalopods, and gelatinous organisms
- Impingement rates estimated to be negligible compared to other fishery pressures

### Primary Entrainment

- Entrained organisms subject to—
  - Changes in temperature
  - Changes in pressure
  - Shear and acceleration forces
  - Abrasion and collision

### Information and Data Gaps Research Needs

- Stock structure
- Early life history studies
- Quantitative spatial (including water column) and temporal information on abundance and distribution of tropical fish in early life stages
- Natural mortality of larvae and juvenile fish
- More information on factors affecting recruitment and compensation for mortalities
- Cold water shock on young tropical fish at the temperature ranges of OTEC

## **APPENDIX F: GROUP B**



## **OTEC II: RECORDER NOTES: GROUP B**

### **Breakout Session I: Biological Impacts and Receptors**

Small 5-10MWe

4Meter diameter pipeline for small facility, made of fiberglass, wall thickness ~6inches  
Intake velocity 2.5m/s

Large – 100MWe

Fiberglass, Diameter 10meters, Intake velocity ~4m/s,

No screening on the intake right now

Intake at least 100m off the bottom, trade off with longer mooring lines

Scope: Cold water pipe, starts at bottom and what point to we cut off? Construction as well as operation?

Focusing in on the operation of the cold water pipe, organisms that are entrained and impinged, screens, and follows to the discharge of this water

Feasibility of this pipe actually staying in place?

Dynamic motion of this pipe studied previously at the OTEC 1 conference

1. What possible impacts are missing from our list? (Refer to handout)

(Talking about both small and large scale facilities)

- Pipe is oscillating (on the order of 1 diameter), and the intake will oscillate. Creating a noise or vibrational output from this oscillation. What is the speed and nature of this movement? What organisms will be impacted by this movement?
- Microorganisms, stratified vertically. Mixing genomes with OTEC, might be better off killing them all, instead of mixing them. Not sure what the impacts will be because of this mixing.
- Fluids moving around the cylinder, creating vortex shedding. What kind of impact would that create?
- Taking into account the physical location of pipe. Not simply a homogeneous ocean. Areas, such as submarine canyons that are important to certain organisms. Impact of site selection.
- Biological communities settling on the pipe? At 500 feet, lots of organism growing. Down near the intake, organisms on the anchoring lines
- Marine mammals not going to be very attracted to this pipe
- Fish attraction is a potential concern (already listed in the table)
- Lantern fish, vertically migrating, rat tails, are going to be at that depth. Most likely would not move off the bottom and towards the pipe. Can't think of a fish that would "hang out" near the end of the pipe
- Materials, fiber glass pipe, other pipes are considered. Impact of the material picked for the pipe

- Variety of invertebrates that might use the pipe as a habitat
2. What are the best available technologies to assess OTEC impacts and risks?
- Open and closing mooring systems that can take samples at discrete depths (nets). Different types of sensors available
  - Long term impacts of the OTEC placement, monitoring the impact. Autonomous underwater vehicles (gliders), could be used for the monitoring. Long term assessment of environmental impacts, nitrate sensors, apex float. Nitrate intrusion paper in Nature. June 2010.
  - Univ. of Hawaii developing the capability of satellite launching. Second mission is ocean color mission. Could focus this satellite on Hawaii, and the OTEC facility. Hyperspectral. Could look at broad range of environmental impacts. 1 optical depth, penetration.
  - Passive acoustic array, to get presence, absence. Put out multiple monitors to triangulate the location.
  - Put a camera down at the end of the pipe.(need illumination that might attract things to the pipe) How do you assess the number of organisms that you are going entrain/impinge?
  - Develop some sort of sub-sampling technology. Can not sample the entire volume of water.
  - Need baseline data, to see what is there. Need monitoring data for the pilot plant. Need to closely monitor the first commercial plant as well.
  - What kind of molecular tests are recommended?
    - (1) Genetic techniques to determine what the organisms are (non-specific)
  - Might tend to overcollect ex zooplankton., dropping (current might move them away)
  - Acoustic tests that can monitor
  - Small off-set pipe that could collect some of the water. (subsample)
  - Filter a percentage of the water at the platform and test there? (simpler at the platform)
  - Plankton net in the sub-pipe to minimize the energy impact on the plant
  - Organisms not surviving the pressure differential?

- Combination of different sampling techniques
- Modified Hardy-continuous plankton sampler
- Modified plankton net, dropped down from above, sitting vertically in the water
- Hydro-acoustic surveys, that could help with topographic impacts
- Submersibles and ROVs, might be too expensive with low returns
- Assessment, for flow coming in horizontally versus vertically? What does the intake velocity have to be and orientation to keep organisms out? Need to know what that is there, needs to be kept out.
- Need baseline study to determine what is there to keep out of the plant. How large the impact is depends on what populations are there
- Need baseline data, and pilot study
- Most fish won't know to swim away from the pipe because it is so big
- Are the current models applicable? Models are not addressing biological impacts.
- Moccus picks of zooplankton, can go up to lantern fishes (sizes vary). Monitoring the area around the pipe
- Bioluminescent system monitors you could get running account of organisms. Photomultiplier tube. Get this combined with some sampling to correlate. Would be able to see cycles, or seasons.
- Optical particle counters
- Want to be able to passively collect data
- Growth on pipe in the upper region, might need to do hull cleaning job.
  -

3. What baseline assessments, monitoring strategies and modeling methods are needed to develop quantifiable levels of impact and risk for OTEC facilities?
  - Would want to have a mooring in place to get a baseline assessment of the data.
  - How long do you need the baseline to be? (might be undersampling by doing monthly) Minimum of a year to get seasonality
  - The data-collectors could be sub-surface

- Baseline assessment: video monitoring with an ROV to look at larger organisms. Sample day and night to see the variation.
- Open and closing net sampling should be done day and night as well
- Permanent tracts so that it could be repeated. To understand variations further than a year
- Transects for presence/absence High frequency acoustic recording package for marine mammals. Beaked whales range (800-2000m)
- Climate variability changes, El Nino, La Nina, cycle. Do we need to look through a strong El Nino to get a baseline? Something to consider
- Any chance that sea turtle might get stuck in the pipe, going to be a problem. Public perception. Maybe a simple grate. Increase area, to decrease velocity, to help ensure organisms are not stuck on the grate. Vibration of the pipe, might create problems with grate. Grate could be made of fiberglass as well. Would want to know that the grate is necessary before we recommend it.
- Might be able to put large structure at the intake and make it accessible from the surface. (want to make sure it is necessary before we recommend it )
- Recurring issue among developing technology: many uncertainties. Opportunity to come up with enhanced way to move through those issues and turn them into testable hypotheses that could be put into a pilot program. This might occur and we have an answer to it
- Archival tagging on the endangered species. Can quantify the habitats of the animals
- Tows, mid-water trawls at least for a year, maybe monthly
- Intensive, hourly samples for 36 hours, might be necessary to look at vertical movement
- How long before the plant is to be built should we be sampling? ASAP
- Is the Kahai study still valid or usable? Conditions have changed and need to be re-looked at. What can be taken from previous studies?
- OTEC 1, Big Island, 3, 48inch pipes dropped into 1000meters, run through heat exchanger. Might be sampling data available.
- Tow net, 100meters off bottom to get best representative data for that point in time. Would need to do that repeatedly to get daily component and seasonal component.
- Might want to get out acoustic devices soon
- Need deep sea-winchs for this sampling. Where can we get a ship that has these. NOAA or special built ship. Might want to consider the special built ship, that is needed frequently, dedicated to OTEC research
- Partnership with Hawaii Responder
- 
- 
-

## OTEC II: RECORDER NOTES: GROUP A

### Breakout Session II: Baseline

#### 4. Prioritize the impacts in a regulatory context:

- i) Fish (and habitat, including deep water corals) --MSA
  - ii) Marine Mammals (and habitat) --MMPA
  - iii) Endangered Species (and habitat, including shallow water corals) --ESA
  - iv) Clean Water Act (w.r.t. nutrients)
- Indirect Impact: loss of foraging opportunities or a decrease of predators (food web impacts), which would count as degradation of EFH
  - Direct Impact: mortality

| <b>Impacted Population</b>   | <b>Regulatory Driver?</b>                | <b>Likely?</b> | <b>Significant?</b> | <b>Unique to OTEC?</b>  | <b>Regulatory Priority? (Y, N)</b> |
|--|--|----------------|---------------------|---|------------------------------------|
| <b>Entrainment:</b>  |  |                |                     |   |                                    |
| Phytoplankton + Bacteria<br>--Essential Fish Habitat (EFH), could be a driver as an indirect impact                  | -MSA/EFH                                 | Yes            | Unknown             | <u>No</u> for pilot plant (10 MWe)<br><u>Yes</u> for commercial scale | Yes                                |
| Zooplankton + Meroplankton (without direct impacts)<br>--  | -MSA/EFH                                 | Yes            | Unknown             | <u>No</u> for pilot plant (10 MWe)<br><u>Yes</u> for commercial scale | Yes                                |
| Benthos (eggs & larvae, with direct impacts)<br>--gametes of endangered species could be affected (e.g. black coral) | -ESA (possibly for corals)               | Unknown        | Yes, if listed      | <u>No</u> for pilot plant (10 MWe)<br><u>Yes</u> for commercial scale | Yes, if listed                     |
| Fish<br>--indirect impacts   | -MSA/EFH                                 | Yes            | Unknown             | <u>No</u> for pilot plant (10 MWe)<br><u>Yes</u> for commercial scale | Yes                                |
| Fish (eggs & larvae)<br>--direct impacts, mortality  | -ESA, if listed (none in HI)<br>-MSA/EFH | Yes            | Yes                 | Same as above   | Yes                                |
| Micronekton<br>--indirect impacts  | -MSA/EFH                                 | Yes            | Unknown             | Yes   | Yes                                |
| Micronekton<br>--direct impacts  | -ESA if listed (none in HI)<br>-MSA/EFH  | Yes            | Yes                 | <u>No</u> for pilot plant (10 MWe)<br><u>Yes</u> for commercial scale | Yes                                |
| <b>Impacted Population</b>   | <b>Regulatory</b>                        | <b>Likely?</b> | <b>Significant?</b> | <b>Unique to OTEC?</b>  | <b>Regulatory</b>                  |

|  | <b>Driver?</b>              | (assuming 8 mm mesh, 0.15 m/s)    |                         |   | <b>Priority? (H, M, L)</b> |
|--|-----------------------------|-----------------------------------|-------------------------|---|----------------------------|
| <b>Impingement:</b>  |                             |                                   |                         |   |                            |
| Macrozooplankton (adults)<br>--need to quantify available resource<br>--indirect impact, if mortality affects food chain<br>--direct impact, not a concern | -MSA/EFH                    | No                                | Probably not            | <u>No</u> for pilot plant (10 MWe)<br><u>Yes</u> for commercial scale | Low                        |
| Fish<br>--   | -MSA/EFH<br>-ESA, if listed | Juvenile, or small schooling fish | Unknown                 | No  | Medium, High if listed     |
| Sea Turtles<br>--species specific  | -ESA                        | No                                | Yes, because of listing | No  | High                       |
| Diving Sea Birds<br>--   | -ESA<br>-MBTA               | No                                | Unknown                 | No  | Low                        |
| Micronekton<br>--  | -MSA/EFH                    | Yes                               | Unknown                 | Yes   | Medium                     |

**Acronyms:**

MSA – Magnuson-Stevens Act

EFH – Essential Fish Habitat

ESA – Endangered Species Act

MBTA – Migratory Bird Treaty Act

**5. What additional research is needed in order to assess potential biological impacts of OTEC facilities?**

**i) Technologies to conduct research**

- Need to look at a cross-cutting, interdisciplinary, baseline study (ecosystem study) for the entire OTEC site
- Quantify (by group/species) what is entering the system compared to the total available resource
- Collect new baseline Physical, Chemical, and Biological data
- Utilize cultural knowledge of existing resources
- Compare new studies to Kahe Point studies

| <b>Impact</b>   | <b>Additional Research Needed</b>   | <b>Technology</b> | <b>Existing Data</b><br>(see 1986 NMFS Technical Report 40) |
|---|---|-------------------|---|
| <b>Entrainment:</b>   |   |                   |   |
| Phytoplankton + Bacteria (indirect)   | --update site specific ecosystem studies (baseline)<br>--quantify (by group/species) what is entering the system compared to the total available resource |                   |   |
| Zooplankton + Meroplankton (indirect)   | --perform an ecosystem study  |                   |   |
| Benthos (eggs & larvae, direct impacts)   | --analysis of habitat, and larval distribution  |                   |   |
| Fish<br>--indirect impacts  | --perform an ecosystem study  |                   |   |
| Fish (eggs & larvae)<br>--direct impacts, mortality<br>-- small fish, e.g. adult nehu | --larval distribution (presence), then;<br>--update existing stock assessments using larvae mortality data  |                   |   |



|                                   |   |  |   |
|-----------------------------------|---|--|---|
| Micronekton<br>--indirect impacts | --perform an ecosystem study  |  |   |
| Micronekton<br>--direct impacts   | --quantify swimming speed (by group/species) --quantify (by group/species) what is entering the system compared to the total available resource |  |   |
| <b>Impingement:</b>               |   |  |   |
| Macrozooplankton (adults)         | --N/A   |  |   |
| Fish                              | --see entrainment<br>--quantify swimming speed (by group/species)   |  | --stock assessment models of commercially harvested species |
| Sea Turtles (hatchlings)          | --summarize existing knowledge, if relevant   |  | --NOAA and USF&W long-term data sets                        |
| Diving Sea Birds                  | --summarize existing knowledge, if relevant   |  | --USF&W data sets   |
| Micronekton                       | --see entrainment   |  |   |

# **RECORDERS NOTES: GROUP A**

## **Breakout Session III: Moving Forward**

### **6. How can potential physical, chemical and biological impacts be avoided, minimized or mitigated within the operational and design parameters of an OTEC system?**

- Optimum size?
  - (1) Commercially viable system, about 100 MWe
- Design parameters:
  - (1) Intake screen size area
  - (2) Mesh size
  - (3) Intake velocities
  - (4) Intake depth
  - (5) Flow rate and direction (horizontal vs. vertical)
  - (6) Temperature differential through heat exchanger
  
- Siting (within 10-15 miles of land)
- Aim for horizontal intake flow to avoid entrainment
- Flow rate and temperature differential played off of each other to maximize economic and performance efficiency
- Avoid cavitation (pumps)
- Try to maintain hull cleanliness
- Deterrent strategies (behavioral deterrent strategies) could be considered to repel organisms (juvenile and adult fish)
  - (1) Light (high intensity, strobe)
  - (2) Sound
- Screen mesh size is OTEC plant specific

### **7. What are potential tradeoffs between biological impacts and operational efficiency?**

- Operational Efficiency = Net Power Output vs. Maximum Potential Design Energy Output
- At what point do we lose functionality of the system?

| <b>Impact</b>                                       | <b>Avoid, minimize, mitigate strategies</b>  | <b>Potential tradeoffs</b>  |
|---|--|---|
| <b>Entrainment:</b>                                 | - Keeping intake velocities less than or equal to the ambient (sweeping) current velocity will minimize impingement and entrainment  | -Decreasing velocity requires larger intake screen and plant size   |
| Phytoplankton + Bacteria                            | -Too small to filter<br>-Study site-specific depth of intake w.r.t. vertical distribution of plankton  | -The deeper the intake, the less efficient the plant  |
| Zooplankton + Meroplankton (indirect impacts)       | -Too small to filter<br>-Study site-specific depth of intake w.r.t. vertical distribution of plankton  | -The deeper the intake, the less efficient the plant  |
| Benthos (eggs & larvae, with direct impacts)        | -Too small to filter<br>-Study site-specific depth of intake w.r.t. vertical distribution of plankton  | -The deeper the intake, the less efficient the plant  |
| Fish<br>--indirect impacts                          | NA, because any improvements to the below will decrease indirect impacts   |   |
| Fish (eggs & larvae)<br>--direct impacts, mortality | -Smaller mesh size to avoid entrainment<br>-Study site-specific depth of intake w.r.t. vertical distribution of fish<br>-Reduce velocity to avoid entrainment<br>-Deterrent strategies (light, sound)<br>-Avoiding operation during spawning seasons | -Increase possible impingement<br>-The deeper the intake, the less efficient the plant<br>-Decreasing velocity requires larger intake area<br>-Deterrents could become an unintentional attractant<br>-Decreases facility operation |
| Micronekton<br>--direct impacts                     | -Avoid night time operation  | -Decreases facility operation   |
| Micronekton<br>--indirect impacts                   | NA, because any improvements to the above will decrease indirect impacts   |   |
| <b>Impingement:</b>                                 | --   | --  |
| Macrozooplankton (adults)                           | -Larger mesh size to avoid impingement<br>-Study site-specific depth of intake w.r.t. vertical distribution of plankton  | -Will increase entrainment<br>-The deeper the intake, the less efficient the plant<br>-Decreasing velocity requires larger intake area  |

|                          |  |  |
|--------------------------|--|--|
|                          | <ul style="list-style-type: none"> <li>-Reduce velocity to avoid impingement</li> <li>-Deterrent strategies (light, sound)</li> </ul>  | -Deterrents could become an unintentional attractant   |
| Fish                     | <ul style="list-style-type: none"> <li>-Larger mesh size to avoid impingement</li> <li>-Study site-specific depth of intake w.r.t. vertical distribution of fish</li> <li>-Reduce velocity to avoid impingement</li> <li>-Deterrent strategies (light, sound)</li> </ul> | <ul style="list-style-type: none"> <li>-Increase possible entrainment</li> <li>-The deeper the intake, the less efficient the plant</li> <li>-Decreasing velocity requires larger intake area</li> <li>-Deterrents could become an unintentional attractant</li> </ul> |
| Sea Turtles (hatchlings) | Unknown  | -Placing the intake pipe at shallower depths could impact hatchlings   |
| Diving Sea Birds         | <ul style="list-style-type: none"> <li>-Unknown</li> <li>-Minimize facility lighting that shines directly into the water</li> </ul>  | Unknown  |
| Micronekton              | <ul style="list-style-type: none"> <li>-Avoid night time operation</li> <li>-Minimize facility lighting that shines directly into the water</li> <li>-Reduce intake velocity</li> </ul>  | <ul style="list-style-type: none"> <li>-Decreases facility operation</li> <li>-</li> <li>-Decreasing velocity requires larger intake area</li> </ul>   |

REPORT OUT – GROUP A - DAY 1  
Breakout Session I: Report

Warm Water Intake

Question 1: Missing Impacts

ENTRAINMENT:

- Indirect impacts, meaning a lost forage resource in the trophic web
  - Shifting from predation to scavenging
- Bacteria
- Cycles of abundance and scarcity with fish – how do we address this?
  - Seasonal changes
- Diel migrations (Micronekton -- night time only)

Question 1: Missing Impacts

IMPINGEMENT:

- Sea turtle hatchling impingement is not likely based on the depth of the warm water intake (~25 m)
  - Sick or weakened juvenile turtle impingement is a possibility
- Cumulative, or long term, impacts (eg. 30% intake blockage over a period of time)
- Diel migrations
  - Micronekton (night time only)

Question 2: Best Available Technologies

- Plankton Sampling
- Acoustic Doppler Current Profiler (ADCP)
- Biomass sampling
- Ship-based sampling
- Take advantage of existing data sets, Kahe, HOT 1, Commercial Fisheries
- Biological modeling
  - Ecosystem based modeling
- Entrainment models
- Video Plankton Recording – phytoplankton and zooplankton
- Satellite and Remote Sensing
- Quantify difference between/compare the attraction to a site before and after the construction or placement of a system – FAD (fish aggregating device)
- OOS – Ocean Observing System, current modelling

### Question 3: Assessments, Monitoring, Modeling

- Understand the size of the resource and what portion of that resource will be impacted

- Develop monitoring strategies for high priority groups

- Start with current data (from the past 30 or so years) as baseline data

- As a basis of comparison, use existing data and then conduct a one-year study for baseline measurements (ecosystem-wide) using contemporary methods

## **Breakout Session III: Moving Forward**

### **6. How can potential physical, chemical and biological impacts be avoided, minimized or mitigated within the operational and design parameters of an OTEC system?**

- Design parameters:
  - (1) Intake screen size area
  - (2) Mesh size
  - (3) Intake velocities
  - (4) Intake depth
  - (5) Flow rate and direction (horizontal vs. vertical)
  - (6) Temperature differential through heat exchanger
  
- Siting (within 10-15 miles of land)
  
- Deterrent strategies (behavioral deterrent strategies) could be considered to repel organisms (juvenile and adult fish)
  - (1) Light (high intensity, strobe)
  - (2) Sound

### **7. What are potential tradeoffs between biological impacts and operational efficiency?**

- Operational Efficiency = Net Power Output vs. Maximum Potential Design Energy Output
  
- At what point do we lose functionality of the system?

# Entrainment:

| Impact  | Avoid, minimize, mitigate strategies   | Potential tradeoffs   |
|---|--|---|
| Entrainment:  | - Keeping intake velocities less than or equal to the ambient (sweeping) current velocity will minimize impingement and entrainment  | -Decreasing velocity requires larger intake screen and plant size   |
| Phytoplankton + Bacteria                            | -Too small to filter<br>-Study site-specific depth of intake w.r.t. vertical distribution of plankton  | -Deeper intakes make plant less efficient   |
| Zooplankton + Meroplankton (indirect impacts)       | -Too small to filter<br>-Study site-specific depth of intake w.r.t. vertical distribution of plankton  | -Deeper intakes make plant less efficient   |
| Benthos (eggs & larvae, with direct impacts)        | -Too small to filter<br>-Study site-specific depth of intake w.r.t. vertical distribution of plankton  | -Deeper intakes make plant less efficient   |
| Fish<br>--indirect impacts                          | NA, because any improvements to the above will decrease indirect impacts   |   |
| Fish (eggs & larvae)<br>--direct impacts, mortality | -Smaller mesh size to avoid entrainment<br>-Study site-specific depth of intake w.r.t. vertical distribution of fish<br>-Reduce velocity to avoid entrainment<br>-Deterrent strategies (light, sound)<br>-Avoiding operation during spawning seasons | -Increase possible impingement<br>-Deeper intakes make plant less efficient<br>-Slower velocity requires larger intake area<br>-Deterrents could be unintentional attractant<br>-Decreases facility operation |
| Micronekton<br>--direct impacts                     | -Avoid night time operation  | -Decreases facility operation   |
| Micronekton<br>--indirect impacts                   | NA, because any improvements to the above will decrease indirect impacts   |   |



## Impingement:

| Impact                    | Avoid, minimize, mitigate strategies   | Potential tradeoffs   |
|---------------------------|--|---|
| Macrozooplankton (adults) | <ul style="list-style-type: none"> <li>-Larger mesh size to avoid impingement</li> <li>-Study site-specific depth of intake w.r.t. vertical distribution of plankton</li> <li>-Reduce velocity to avoid impingement</li> <li>-Deterrent strategies (light, sound)</li> </ul> | <ul style="list-style-type: none"> <li>-Will increase entrainment</li> <li>-Deeper intakes make plant less efficient</li> <li>-Slower velocity requires larger intake area</li> <li>-Deterrents could become an unintentional attractant</li> </ul>             |
| Fish                      | <ul style="list-style-type: none"> <li>-Larger mesh size to avoid impingement</li> <li>-Study site-specific depth of intake w.r.t. vertical distribution of fish</li> <li>-Reduce velocity to avoid impingement</li> <li>-Deterrent strategies (light, sound)</li> </ul>     | <ul style="list-style-type: none"> <li>-Increase possible entrainment</li> <li>-The deeper the intake, the less efficient the plant</li> <li>-Slower velocity needs larger intake area</li> <li>-Deterrents could become an unintentional attractant</li> </ul> |
| Sea Turtles (hatchlings)  | Unknown  | <ul style="list-style-type: none"> <li>-Placing the intake pipe at shallower depths could impact hatchlings</li> </ul>  |
| Diving Sea Birds          | <ul style="list-style-type: none"> <li>-Unknown</li> <li>-Minimize facility lighting that shines directly into the water</li> </ul>  | Unknown   |
| Micronekton               | <ul style="list-style-type: none"> <li>-Avoid night time operation</li> <li>-Minimize facility lighting that shines directly into the water</li> <li>-Reduce intake velocity</li> </ul>  | <ul style="list-style-type: none"> <li>-Decreases facility operation</li> <li>-</li> <li>-Slower velocity needs larger intake area</li> </ul>   |

## REPORT OUT – GROUP A – DAY 3

## Impacts From Warm Water Intake

- “Impacts” need to be assessed with a view towards an eventual regulatory determination
- What is the likelihood, degree, and significance of the “impact?”
- How much confidence can be placed in what we know or can assess about impacts?

## What the NMFS 1986 Study Found:

- Impingement may be to the level of being ecologically important
- Primary entrainment will be important due to the large number of entrained organisms

## Impingement

- Flow: velocity and volume
  - Lowering intake velocities may require larger intakes with greater volumes
- Abundance of organisms

### Impingement: Affected Organisms

- Unlikely that fish over 10 cm will be impinged (at velocity of 0.25-0.30 m/s)
- Generally of the micronekton size (2-20 cm)
  - Includes fish, microplanktonic crustaceans, cephalopods, and gelatinous organisms
- Impingement rates estimated to be negligible compared to other fishery pressures

### Primary Entrainment

- Entrained organisms subject to—
  - Changes in temperature
  - Changes in pressure
  - Shear and acceleration forces
  - Abrasion and collision

### Information and Data Gaps Research Needs

- Stock structure
- Early life history studies
- Quantitative spatial (including water column) and temporal information on abundance and distribution of tropical fish in early life stages
- Natural mortality of larvae and juvenile fish
- More information on factors affecting recruitment and compensation for mortalities
- Cold water shock on young tropical fish at the temperature ranges of OTEC

## **APPENDIX F: GROUP C**

# OTEC II: RECORDERS NOTES: GROUP C

## Breakout Session I: Biological Impacts and Receptors

1. What possible impacts are missing from our list? (Refer to handout)
  - Horizontal distribution of plume (nutrient laden cold water, potential toxins) in shallow water, what would be possible impacts-ensure it stays in deep water.
    - (1) There are some background nitrate levels
    - (2) Modeling studies from the 80's, plume dilutes quickly (nutrients and nitrates); expect it to stay in density layer
    - (3) Introduce denser water at less dense levels
    - (4) 2deg warming of colder water and 2deg cooling of warm water
    - (5) Plume could effect coral reefs or temperature regime
    - (6) Model tells us what will happen or suggests it? Relationship between model and reality then can gage how we can use it to predict. Need fine scale models (process study)
  - Vertebrate fish (all stages)
  - Pelagic invertebrates (all stages, e.g., squid, mollusks)
  - Pelagic fishes (all stages)
  - Benthic invertebrates (benthic and larval stages)
    - (1) Pelagic spawners
    - (2) Water has to make it down 800m
    - (3) Discharge may reach the slope, possible that the plume could move horizontally to benthic zone
    - (4) What thresholds of the plume are reaching the coast; expect it to be extremely diluted
    - (5) State discharge standards (state waters 30miles)
    - (6) Putting out artificial reef, what will grow on pipe will be benthic organisms, e.g., anemones.
  - Benthic fishes
  - Backscatter layer (important to tuna)
  - Small leaks of working fluid into water
  - Maintenance chemical contamination in effluent?
    - (1) Biofouling have to physically pull out heat exchanger
    - (2) Closed system shouldn't have to open it, but may be exceptions (refer to 1)
  - Nutrients (nitrogen, phosphorus, silica)
  - Trace metals
  - Trace elements
  - Complete Dissolved inorganic carbon (DIC) system
  - Particulate and dissolved organic carbon
  - Biocide reaction products
  - Coral impacts

- Coral larvae
- Chemicals that can be leached or dissolved from components that contact sea water (fiber glass)
- Discharge of dead and injured animals serves as an attractant/pollutant
- Microbial food web impacts
  - (1) Heterotrophic bacterial communities
- Temperature differential on fish communities (some fish look for these temp differentials, large predatory fish, e.g., tuna and mahi mahi)
- Bleaching from stressed (from temperature change) coral reef if the plume moves horizontally
- Fish aggregating devices (residual socioeconomic effects)
- Process that causes impact (DIC will impact organisms through pH)
- Ocean acidification

**2. What are the best available technologies to assess OTEC impacts and risks?**

- Monitoring technologies including towed instrument packages, optical plankton counters, Fluorometers
- Platforms
  - (1) Moorings
  - (2) AUVs
  - (3) Gliders
  - (4) Ships
- Baseline assessment, impact prediction, then monitoring at location
  - (1) Temporal component-3-5years after commencement
- Nutrient, DIC, some optical, some current data are available at present for prospective site.
- Monitoring frequency is dependent upon variability
- Utilize current monitoring programs
- HOT data
- Gliders
- Breakdown products as tracers
- Tradeoff between spatial coverage and topical resolution
- Buoyant drifters with high powered batteries
  - (1) nitrate sensors
  - (2) surrogates
- Organisms-hydroacoustics for deep transition layer
- Acoustic travel times for density and backscatter using instrumentation added onto the platform
- Having receivers on gliders (acoustic receivers, In-situ ultraviolet sensor (ISUS))
- Indicator species-bioassays
  - (1) Chronic and acute
- Collect animals
- Monitoring endpoints-where plume water meets ambient water
  - (1) Identify variables for that interface (e.g., temp, nitrates, microbes)
  - (2) Can't be a snapshot assessment

- DO (order of magnitude difference between warm and cold water)
  - (1) At openings of discharge pipes
  - (2) What is coming into the pipes
- pH
- Nitrates
- CTD casts and water sampling
- Biological-plankton nets, trawl for midwater fish
- Modeling
- Acoustic methods for monitoring large animals
- Genomic advances for biologic species
- Simrad EK 60 for analyzing backscatter layer
- Bioassays
- Understand cost of these tools; cost vs effectiveness
- Analytical techniques to measure CO<sub>2</sub>, methane, etc.
  - (1) Open cycle plants were estimated to emit more gasses than coal plants, according to 1980s report. Estimates have changed now and are much less for closed systems.
- Higher resolution numerical models
  - (1) Depends on geographical location
  - (2) Matching resolution of monitoring to what you're trying to monitor
  - (3) Complexity issue –add more parameters to the model
- Temporal issues- is it feasible to monitor these changes with ships
  - (1) Slow changes, ship would be adequate
  - (2) Fast changes, ships would not be adequate
  - (3) Analysis of variability Ocean systems sensitivity experiments (OSSE)
- SIPPER- optical plankton imagery towed sensor

**3. What baseline assessments, monitoring strategies and modeling methods are needed to develop quantifiable levels of impact and risk for OTEC facilities?**

- Baseline vs post operational monitoring
- 20 years of Hawaii Ocean Time-Series (HOT) data for baseline?
  - (1) Monthly data
  - (2) This is not the HOT site, this is the calibration site
- Range and temporal frequency needed for each impact
- Best available and/or practical technologies In-situ.
- Baseline could be done at a specific site, monitoring is then a 3D problem, but still need to measure variability. Don't need to monitor all of these in 3D for a baseline. E.g., pH
- Statistically robust sampling design for monitoring and assessment
- Find the proxy and use it to predict (nitrates then use for silicates)
- Baseline should be exhaustive at a specific site (vertical profile).
  - (1) HOT site has limited data set
- Good vertical characterization then use a few key parameters to model 3D.
- Possible sampling: OTEC site is center of a cross- one to the east, west, north, south. All of these sampling sites are outside the range of the plume.
  - (1) Only in a homogenous environment

(2) Random sampling within an area adds to statistical rigor

■



Impacts and associated baseline, monitoring and modeling information

| <b>Impact</b>   | <b>Best Available or Most appropriate Technologies</b>              | <b>Baseline assessment</b>  | <b>Monitoring strategies</b>   | <b>Modeling methods</b>   |
|---|---|---|--|---|
| Temperature changes   | Temp loggers, CTD systems, gliders                                  | Casts, gliders, and loggers out at certain sites, continuous measurements | Continuous measurements (gliders for the first year-monitors in 3D); 100m mixing zone rule | Calibrate model with data; use models to decipher where to monitor                            |
| Nitrates<br>Phosphates<br>Silicates   | Nitrogen isotope analysis, water samples backed by in-situ sampling | Rosette casts, gliders, methodology to give variability estimate          | Rosette casts, gliders, methodology to give variability estimate                           | How they will be distributed; calibrate model with other parameters to give strength to model |
| pH-DIC  |   |   |  |   |
| CO <sub>2</sub>   |   |   |  |   |
| Oxygen  |   |   |  |   |
| Ammonia   |   |   |  |   |
| Metals  |   |   |  |   |
| Biocides  |   |   |  |   |
| Biological organisms<br>Fish<br>Zooplankton<br>Bacteria<br>Microzooplankton |   |   |  |   |
| Trace elements (e.g., Ca)   |   |   |  |   |
| biocides and metals need to be separated out based on source                |   |   |  |   |
| Salinity  |   |   |  | Most  |

|  |  |  |  |                                   |
|--|--|--|--|-----------------------------------|
|  |  |  |  | important for<br>present<br>model |
|--|--|--|--|-----------------------------------|

## OTEC II: RECORDER NOTES: GROUP C

### Breakout Session II: Baseline

1. Prioritize the impacts in regulatory context

| Impact   | 100m  | 200m  | Impact Priority   | Notes  |
|--|---|---|---|--|
| Oxygen   | Ambient: 5mL/L<br>discharge: 3mL/L<br>As plume sinks<br>(70m in less than<br>an hour) dilution<br>factor of 4.<br>zooplankton<br>should be tolerant | Ambient: 4mL/L<br>or less<br>Discharge: 3mL/L     | Medium in<br>shallow waters<br>Low in deep<br>waters<br><br>Low impact on<br>zooplankton<br>Fish and mammal<br>impacts unknown? |  |
| Nutrients:<br>Dissolved Inorganic<br>Nitrogen<br>Phosphate<br>Silicate | Potential<br>phytoplankton<br>stimulation   | Low potential for<br>phytoplankton<br>stimulation | Medium<br><br>Research can<br>determine   | Persistent,<br>especially when<br>not in ambient<br>water  |
|  |   |   |   |  |
| CO <sub>2</sub><br>pH-DIC  |   |   | Low   | Near surface can<br>effect<br>zooplankton and<br>increase impacts.   |
|  |   |   |   |  |
| Ammonia (working<br>fluid)   |   |   | Low   | If it leaks,<br>concern will<br>increase   |
|  |   |   |   |  |
| Metals   |   |   | Low   |  |
| Anti-biofouling<br>agents  |   |   | Low   | They degrade<br>Don't need high<br>levels; long<br>persistence but<br>small<br>concentrations-<br>well below<br>statutory limits |
| Biological organisms   |   |   |   | Need most<br>research in this<br>area.<br>Impact of a small<br>plant may not   |

|                               |  |  |  |   |
|-------------------------------|--|--|--|---|
|                               |  |  |  | have a high impact but may increase with many plants<br>Water column signature of plant is low.   |
| Trace elements (e.g., Ca, Fe) | Potential phytoplankton stimulation            | Low potential for phytoplankton stimulation    | Medium<br><br>Research can determine                             |   |
|                               |  |  |  |   |
| Salinity                      |  |  | Low  |   |
| Temperature changes           | Potentially an issue with 16deg water          |  | Low-Medium   | Temperature change exists within the plume  |
| Ciguatoxin                    |  |  | Low-medium   | When sediments are disturbed and stimulate a dinoflagellate bloom   |
| Fish and fish habitat         |  |  | Medium<br><br>Research needed (relating to other trophic levels) | Large habitat; 500m radius is a fraction of that habitat. A potential impact could be introducing altered food source from another area (intake pipe). e.g., Tuna species looking for specific temp and density profile. Unknown effects of plume on fish attraction. |
| Zooplankton                   | No noticeable stimulation of population growth | No noticeable stimulation of population growth | Low<br><br>Area of research                                      | Low impacts on natural population, potential concern with addition of   |

|                                   |   |   |          |  |
|-----------------------------------|---|---|----------|--|
|                                   |   |   |          | zooplankton species from intake pipe area in the discharge                 |
| Microzooplankton                  | Possible change in community structure. | Possible change in community structure. | Low      | Significant temp differential will lead to a more likely population change |
| Microorganisms                    |   |   | Unknown  | Research needed  |
| Benthic Effects                   |   |   | Very Low |  |
| Threatened and endangered species |   |   | Low      | Seals, whales, turtles   |
|                                   |   |   |          |  |

## 2. What are the available technologies to assess the impacts?

- Literature survey
- Vertical sampling for zooplankton
- Video imaging (Shadowed Image Particle Profiling Evaluation Recorder SIPPER technology)
  - i. For larval eggs
- Biology
  - i. Collection of water- traditional ways
  - ii. Cameras
  - iii. Genetically based probes
- Collect small and larger specimens
  - i. Traditional collection techniques
    1. Trawl
    2. Traps
    3. Tagging
  - ii. Non traditional
    1. New acoustic techniques to monitor megafauna
  - iii. After catching-experiment with them to monitor biological responses to altered physical and chemical parameters
    1. Bioassays
- Physical
  - i. Glider surveys to determine plume dispersal, Temp and salinity
  - ii. Tracer techniques
    1. injected tracers, e.g., fluorescein
    2. In conjunction with a field sample
  - iii. Nested surveys with biological sampling for far field impacts
  - iv.
- Chemical
  - i. Glider/AUV surveys to determine plume dispersal, nitrate and oxygen

- ii. Ship based surveys for chemicals of concern
    - 1. Tie in with glider physical surveys
- Testing throughout pipeline/process (intake, heat exchange, discharge)
  - i. Before and after
  - ii. Influent and effluent (mass balance) using natural energy lab Hawaii (NELHA): heat exchanger test system
    - 1. Review NELHA data
    - 2. Use data to predict what will happen-make comparisons with control sites.
    - 3. Validate NELHA
- Sampling frequency (baseline for control site (HOT calibration site?) and location)
  - i. Diel
  - ii. Seasonal
  - iii. Annual
- Sampling frequency for operational monitoring
  - i. Diel
  - ii. Seasonal
  - iii. Annual
  - iv. Refined for what the variability is that's measured depending on baseline and operational conditions.
  - v. Iterative design

Monitor what goes into the system and biological response.

### **3. What additional research is needed in order to assess potential biological impacts of OTEC facilities?**

- Calibrate plume models, specifically using inert tracers in tracer studies for all identified impacts.
  - i. Past tracer studies to duplicate?
  - ii. Everything discussed here is dependent upon plume model
  - iii. Design: mixing rate under natural rate (SFX 6 injection, measure dissipation).  
Similar hydraulic parameters
- Identify what the community is at discharge depth (e.g., microbial communities and zooplankton) 50-300m
  - i. Literature-what has been recorded at those depths, what is missing, how to sample
- Characterize biological community of both the intake water and the discharge water.
- Seasonal sampling and monitoring
- Note: water masses change over decadal scales offshore Hawaii
- Which of species of significance exist or use habitat at specified depths
- Larval stages of regulated species-any concerns?
- Experimental movement of water masses
- In addition to collecting animals going into pipe-find out if they can survive in pipe and at the depth of the discharge.
- Expand models to include nutrient enhancement and biological modeling components.
  - i. Start with phytoplankton modeling

- ii. Limiting nutrients
- iii. Uptake rates

•

**Breakout Session III: Moving Forward**

**6. How can potential physical, chemical and biological impacts be avoided, minimized or mitigated within the operational and design parameters of an OTEC system?**

- **Design parameter-change in depth (100 to 200m)**
- Diffusers on outlet pipe for discharge plume
- Multiple pipes
  - (1) 4-6 different discharge pipes in design due to modular design
- **Enhance mixing**
  - (1) Turbulent mixing is better option over diffusive mixing
    - (a) Anything less than 1mm in size will not be disturbed unless incredibly turbulent. Anything that can fit inside the eddies should be fine. Microzooplankton and bacteria won't be impacted by turbulence. Larger fish larvae may be impacted.
  - (2) Depth
  - (3) horizontal mixers (?)
- Enhance dilution with deeper discharge?
- Want plume to get down to a certain depth then disperse horizontally
  - (1) Tradeoffs
- Cohesive plume that disperses or multiple plumes that cause turbulent mixing at pipe end.
- Turbulent mixers
  - (1) Diffusion vs turbulent mixing
    - (a) Turbulent mixing increases undesirable secondary entrainment –low risk, yet possible negative impact on biological side
    - (b) Model with thorough physical and biological model
    - (c) More of a benefit from turbulent mixing
- Dilutes cold water by factor of 2 and keeps warm water from being re-circulated
- Ways to oxygenate water efficiently? Address in EIS
  - (1) Aeration on conventional turbine-very expensive
    - (a) Change diffuser hole sizes
  - (2) Logistical problems
- Faster mixing, reduce exposure times
  - (1) Small volumes compared to open ocean
- Release of working fluid

- Tradeoffs- deeper the discharge, .....
- No screens on deep water, shallow water will have them.
- **Screen size**
- Desirable to remove as many biological species in intake and heat exchanger.
  - (1) Need to know filtering system
  - (2) Diameter of heat exchanger has to be smaller than intake screen
    - (a) Mechanical methods
  - (3) Heat exchangers have to be bare metal-biocides are for removal of biofilms on surface
- Maintain flow
- Use scrapers, etc to clean screens
- Improve organisms getting through to discharge.
  - (1) Assumption: there ARE screens
- How are biological species screened for (size ranges)
  - (1) How do we reduce amount of organisms in discharge?
  - (2) Scrape screen- stored on platform, put into discharge,
- **Mixed discharge is preferable from an environmental standpoint**
  - (1) Engineering standpoint it will be more difficult
  - (2) If you don't mix, supposedly you are only altering warmer and colder water by 2 degrees (decrease and increase)
    - (a) Marginal benefit with these differentials
- If planning on throwing biomass waste into discharge – should look into **collecting biomass waste on platform and disposing periodically, especially cold water.**
  - (1) May not be economically feasible
  - (2) Small amount of material (organics added)
  - (3) Concern at injecting organic material at depth
    - (a) Is a dilute environment down there
    - (b) Needs to be studied- mass balance
- Need more information on screening
- Oxygen levels in discharge vs. oxygenating water-economic feasibility
  - (1) Oxygen differentials are not great enough for serious consideration (3-5 mL/L)
- Biocide, anti-fouling- don't want to use more chlorine than necessary (cost wise and biological)
  - (1) Statutory requirement
  - (2) Absolute volumes- can less be used? No. regulated
-



**7. What are potential tradeoffs between biological impacts and operational efficiency?**

- Heat exchanger efficiency
- Pipe length design issues-increased cost of construction
  - (1) Deeper intake pipe-colder water, higher oxygen, bigger temperature differential
- Power block efficiency
- Tradeoff of depth of discharge vs. required monitoring for impacts
  - (1) Monitoring effort and depth of pipe
    - (a) Closer to surface-more monitoring (due to gradient differences)
    - (b) Deeper-monitoring is reduced
- Neutralize after chlorine use?
  - (1) Chlorine generated on site (electrolytically)
  - (2) Take into account regulations
- Are there ways to reduce/eliminate living organisms in discharge that are operationally efficient?
- Is there something you can do to eliminate X from being an issue and including it in the EIS?
- Chemically -minimal alterations may impact biology
-

Notes:

- Mitigation
  - Find appropriate depth for discharge based on physical parameters. Thus you won't be concerned about certain things (e.g., temp)
  - Assume discharge will be optimized to mitigate impacts
  - Dilution numbers
- If the water is released and mixed that reaches a level of X then the impacts will be at a level of y. Depth of release should take these into account.
  - Nitrate levels-what levels will be a problem and at what depth. Different signatures at different depths.
  - If mixing gives you a concentration less than x
- Depth of discharge is not a major concern for engineering, more a cost issue.
- Physical sampling design would change if the discharge parameters are near ambient water
- 1.5 warm water to 1 cold water
- Mixed water may be chemically similar but not temp or density
- D
- Discharge pipe as close to economically feasible to where water is neutrally buoyant.
  - Org. C concerns
- Currents and effects on plume
  - Difference in nitrate concentration at equilibrium depth-500ft away is no different than ambient
  - Plume sinks, it won't get dispersed as quickly. Within 500m radius there is potential for slight accumulation
- Plan for absolute worst-monitor first, set up criteria for least possible dilution
- Discharge pipe down to 250m may be unrealistic, if it dilutes so quickly it may be unnecessary
- What levels above ambient are significant and above worrying about.
- Discharge concentration, lifespan, and impacts
- Ambient water-discharge with different characteristics; what is the endpoint, at what point do we cease monitoring? Dispersing up to a certain limit. Optimize design based on optimal depth.
- Biological phenomenon measured at high resolution (existing).
- What are the impacts based on an optimization of discharge-allowing cost considerations, to allow discharge at a less than optimum depth. Tradeoffs between discharge depths and sampling procedures
- Optimize discharge so affected area is as small as possible. Function of depth of pipe, etc
- Primary thing is to build pilot plant. Find optimal depth and put at e.g., 250 depth then monitor. Stop monitoring parameters e.g., DO, temp, sal, then cut pipe off for a shallower discharge depth? –not that easy.

- Monitor off of Kahe where plant will be a little ways offshore. Basic question of whether models are realistic or not. Research to verify results of model. Need to repeat this over different conditions.
- Exact depths are not crucial at present
- What are acceptable discharge concentrations
  - Can't get to these then what are the impacts (prioritized)
- Can we come up with conceptual model scenario (assumption: worst case scenario) where you discharge 20mM of nitrates at set temp, etc, what will happen
  - Oxygen and pH are negligible
  - pH will be buffered quickly
  - Change in primary productivity concerns
- Table: one column-Discharge in lower part of photic zone, other column-optimize to 250.
  - Prioritize impacts
- Highest levels of nutrients at DON and DOP: surface waters increase and decrease with depth
- Move closer to the photic zone, impacts may be increased
- Low oxygen near mouth of discharge pipe
- Temporal and spatial concerns
- Side note: coral growth on discharge pipe

## **OTEC II: RECORDER NOTES: GROUP C**

### **Breakout Session III: Moving Forward**

6. **How can potential physical, chemical and biological impacts be avoided, minimized or mitigated within the operational and design parameters of an OTEC system?**
- **Design parameter-change in depth (100 to 200m)**
  - Diffusers on outlet pipe for discharge plume
  - Multiple pipes
    - (1) 4-6 different discharge pipes in design due to modular design
  - **Enhance mixing**
    - (1) Turbulent mixing is better option over diffusive mixing
      - (a) Anything less than 1mm in size will not be disturbed unless incredibly turbulent. Anything that can fit inside the eddies should be fine. Microzooplankton and bacteria won't be impacted by turbulence. Larger fish larvae may be impacted.
    - (2) Depth
    - (3) horizontal mixers (?)
  - Enhance dilution with deeper discharge?
  - Want plume to get down to a certain depth then disperse horizontally
    - (1) Tradeoffs
  - Cohesive plume that disperses or multiple plumes that cause turbulent mixing at pipe end.
  - Turbulent mixers
    - (1) Diffusion vs turbulent mixing
      - (a) Turbulent mixing increases undesirable secondary entrainment –low risk, yet possible negative impact on biological side
      - (b) Model with thorough physical and biological model
      - (c) More of a benefit from turbulent mixing
  - Dilutes cold water by factor of 2 and keeps warm water from being re-circulated
  - Ways to oxygenate water efficiently? Address in EIS
    - (1) Aeration on conventional turbine-very expensive
      - (a) Change diffuser hole sizes
    - (2) Logistical problems
  - Faster mixing, reduce exposure times
    - (1) Small volumes compared to open ocean
  - Release of working fluid
  - Tradeoffs- deeper the discharge, .....
  - No screens on deep water, shallow water will have them.
  - **Screen size**
  - Desirable to remove as many biological species in intake and heat exchanger.
    - (1) Need to know filtering system
    - (2) Diameter of heat exchanger has to be smaller than intake screen
      - (a) Mechanical methods

- (3) Heat exchangers have to be bare metal-biocides are for removal of biofilms on surface
- Maintain flow
- Use scrapers, etc to clean screens
- Improve organisms getting through to discharge.
  - (1) Assumption: there ARE screens
- How are biological species screened for (size ranges)
  - (1) How do we reduce amount of organisms in discharge?
  - (2) Scrape screen- stored on platform, put into discharge,
- **Mixed discharge is preferable from an environmental standpoint**
  - (1) Engineering standpoint it will be more difficult
  - (2) If you don't mix, supposedly you are only altering warmer and colder water by 2 degrees (decrease and increase)
    - (a) Marginal benefit with these differentials
- If planning on throwing biomass waste into discharge – should look into **collecting biomass waste on platform and disposing periodically, especially cold water.**
  - (1) May not be economically feasible
  - (2) Small amount of material (organics added)
  - (3) Concern at injecting organic material at depth
    - (a) Is a dilute environment down there
    - (b) Needs to be studied- mass balance
- Need more information on screening
- Oxygen levels in discharge vs. oxygenating water-economic feasibility
  - (1) Oxygen differentials are not great enough for serious consideration (3-5 mL/L)
- Biocide, anti-fouling- don't want to use more chlorine than necessary (cost wise and biological)
  - (1) Statutory requirement
  - (2) Absolute volumes- can less be used? No. regulated
- 

## 7. What are potential tradeoffs between biological impacts and operational efficiency?

- Heat exchanger efficiency
- Pipe length design issues-increased cost of construction
  - (1) Deeper intake pipe-colder water, higher oxygen, bigger temperature differential
- Power block efficiency
- Tradeoff of depth of discharge vs. required monitoring for impacts
  - (1) Monitoring effort and depth of pipe
    - (a) Closer to surface-more monitoring (due to gradient differences)
    - (b) Deeper-monitoring is reduced
- Neutralize after chlorine use?

(1) Chlorine generated on site (electrolytically)

(2) Take into account regulations

- Are there ways to reduce/eliminate living organisms in discharge that are operationally efficient?
- Is there something you can do to eliminate X from being an issue and including it in the EIS?
- Chemically -minimal alterations may impact biology
-

## Breakout Session III: Report

Group Name

## Question 5: Additional Research

- Modeling
  - Calibrate plume model
  - Expand model to include
    - Phytoplankton
    - Limiting nutrients
    - Uptake rates
- Baseline
  - ID Ambient Discharge Community
  - Seasonal diel, seasonal and annual
  - Vertical profiles
  - Characterize existing biological community
- Monitoring

## Question 4: Impact prioritization

- Medium Impact
  - Oxygen
  - Nutrients
  - Trace elements
  - Fish and fish habitat
- Microorganisms (unknown)
- Low Impact
  - CO2
  - Salinity
  - Temperature
  - pH-DIC
  - Amonia (working fluid)
  - Metals
  - Antibiofouling
  - Zooplankton, Microzooplankton
  - Benthic effects
  - Threatened and endangered spp

## **APPENDIX F: GROUP D**



## **OTEC II: RECORDERS NOTES: GROUP D**

### **Breakout Session I: Biological Impacts and Receptors**

#### **1. What possible impacts are missing from our list? (Refer to handout)**

- i) Construction
  - a. What construction are we referring to? Specifications on size, system, etc. are required?
    - Fundamental size of platform...
    - Not dealing with a project specific design, but rather a large-scale design.
  - b. What parameters are there that may be more helpful?
    - 8 or 12 point mooring system
  - c. Difference in impact from 8 vs. 12 point mooring system?
  - d. How is this system different from existing, already permitted systems?
    - May be a question of technology, location, etc.
    - Depends on what you are regulating, whether that be a platform, barge, etc.
  - e. Will scale of OTEC plant change what or to what extent these impacts are?
  - f. Types of Anchors
    - Gravity
    - Drag Embedment
      - (i) Broke loose rather than dragging
    - Drilled Anchor
      - (i) Smallest footprint but more disruptive during installation
  - g. How deep are barges/facilities going to be? Is there benthos of concern at 1,000 m?
    - Yes, deep water corrals are becoming extremely important
      - (i) Knowledge of presence is important
      - (ii) Find spots with no coral or assess/collect data in potential regions
        1. There are monitoring crews that do that work
  - h. Other impacts in benthos community/environment.
    - Coral
  - i. What are lengths of mooring lines?
    - Potential of whales, turtles, etc. from running into cables
    - Nylon or steel wire
    - Stiffer the material the less chance of entanglement
- ii) We should organize based on resource rather than activity...changing organization aspect
  - a. We may change site or system based on resource impacted.
  - b. We should include more structures into existing components included in provided table. We should develop the given list.
  - c. Resource needs to be defined
    - Anything that may be impacted

- iii) Moved on to table and began discussing how to organize table.
  - iv) Focus on providing a list of impacts and then refine
  - v) Discussion of what should be included.
    - a. Weapons, geological hazards, hurricanes
    - b. Decided to be put as a component?
  - vi) Started moving on with table
  - vii) Each organism in water has specific bacterial community – didn't go anywhere
2. What are the best available technologies to assess OTEC impacts and risks?
- i) Construction
  - ii) Physical Presence
  - iii) Accidents & Emergency Response
  - iv) Never touched upon**
3. What baseline assessments, monitoring strategies and modeling methods are needed to develop quantifiable levels of impact and risk for OTEC facilities?
- i) Construction
  - ii) Physical Presence
  - iii) Accidents & Emergency Response
  - Never touched upon**

Impacts and associated baseline, monitoring and modeling information

| <b>OTEC Component/Activity/Event</b> | <b>Impact</b>        | <b>Best Available Technologies</b> | <b>Baseline assessment</b> | <b>Monitoring strategies</b> | <b>Modeling methods</b> |
|--------------------------------------|----------------------|------------------------------------|----------------------------|------------------------------|-------------------------|
| Construction of Anchors              | Coral                |                                    |                            |                              |                         |
|                                      | Deep Sea Crustaceans |                                    |                            |                              |                         |
|                                      | Vertebrate Fish      |                                    |                            |                              |                         |
|                                      | Marine Mammals       |                                    |                            |                              |                         |
|                                      | Sea Turtles          |                                    |                            |                              |                         |
|                                      | Invertebrates        |                                    |                            |                              |                         |
|                                      | Bacteria             |                                    |                            |                              |                         |
|                                      | Hard Substrate       |                                    |                            |                              |                         |
| Dragging of Anchors                  |                      |                                    |                            |                              |                         |
|                                      |                      |                                    |                            |                              |                         |
|                                      |                      |                                    |                            |                              |                         |
|                                      |                      |                                    |                            |                              |                         |
|                                      |                      |                                    |                            |                              |                         |

## **OTEC II: RECORDERS NOTES: GROUP D**

### **Breakout Session II: Baseline**

- We came out of yesterday with a large list of impacts but we need to prioritize.
- Talking about OTEC unique category. Because it's unique to OTEC it does not affect significance.
- Construction/Installation should be lumped. It is not unique to OTEC.
- Should lighting considerations be condensed? We decided to wait until we got to that issue.
- Should we include benthic invertebrates that were not included in the updated table?
  - o Only included deep coral
  - o Discussion as to why or why not to include benthic invertebrates
  - o We did
- Construction of anchors/dragging of anchors and cables: Coral reefs
  - o Went through table
  - o Priority on where to site but not for research
    - Yes – it will trigger a regulatory driver
  - o What is reality of an anchor dragging?
    - Likely during a hurricane
- Discussion on what is the definition of priority.
  - o We could give context of priority for each impact
  - o Is it a priority for a regulatory driver is what's important. We will discuss research needs later.
  - o Unique to OTEC is very important
- Will you need to take another look between initial assessment and installation?
  - o For coral – most likely not
- Discussion of power cable location and installation.
  - o Directionally drilled horizontally from shore to shelf
  - o Laid on sea floor - trenched (may or may not)
  - o Hanging from platform
- OTEC Physical Presence – Other Protected Species
  - o Unique to OTEC
    - Hawaiiin islands have a unique ecosystem
      - Have small resident populations, ceteceans
  - o What is behavioral alteration?
    - MMPA
    - Trawlers – dolphins follow trawlers which changes social structures and causes changes in population structure
  - o Baseline assessment
    - May be seasonally dependent
    - Little surveying has been done of Oahu due to various reasons
    - What are the surveying requirements in regards to time?
    - Surveys on South and West coasts of Oahu are recommended but varies by species.

- Mitigation strategies
    - In aquaculture – feeding techniques have been used
    - None determined
    - Site selection may be an issue in near-shore locations
    - How far do species range?
      - 50-60 km off shore
  - Two ESA listed sea birds – Newall shearwaters and Hawaiiin petrels
  - Worked on table for Birds – Physical presence and lighting
  - Turtles
    - Feeding Habits – Hatchlings feed on jellyfish, shrimp
    - Hawksbills will feed on fish
    - Unique to Hawaii
      - Hawaiian green turtle – not a genetically unique species
    - Turtles in pelagic environment
4. Prioritize the impacts in a regulatory context.
- i) Does it trigger a regulatory driver?
  - ii) Is it likely?
  - iii) Is it significant?
  - iv) Is it unique?
  - v) Is it a priority?
5. What additional research is needed in order to assess potential biological impacts of OTEC facilities?
- i) What technologies are required to conduct the research?

## OTEC II: RECORDERS NOTES: GROUP D: MASTER PRIORITY LIST

### Mammals/Turtles

|                              |
|------------------------------|
| Permanent Threshold Shift    |
| Temporary Threshold Shift    |
| Change in movement           |
| Attractant/repellant         |
| Localized change in behavior |
| Masking                      |
| Larval recruitment           |

- Entrainment/Impingement of:
  - Whales (Listed whales, example. Beaked and sperm whales)
  - Leatherback turtles
  - Monk Seals, small cetaceans, and other turtle species
  - Prey for marine mammals (Indirect)
  - Prey for turtles (Indirect)
  
- Behavioral alteration, such as changes in migratory patterns, of both due to the physical presence (platform, pipes, mooring cable, anchors, and power cables) of an OTEC facility.
- Indirect entanglement of both from derelict fishing gear caught on OTEC components.
- Collision of both into OTEC components.
- Indirect attraction of both due to food sources accumulating in the vicinity or on an OTEC facility.
- Attraction of turtles (especially hatchlings) due to lighting from an OTEC facility.
  
- Impingement of Sea Turtles
  - Direct impact, mortality (ESA if listed)

## **Fisheries/Corals**

|                              |
|------------------------------|
| Permanent Threshold Shift    |
| Temporary Threshold Shift    |
| Change in movement           |
| Attractant/repellant         |
| Localized change in behavior |
| Masking                      |
| Larval recruitment           |

- Entrainment/Impingement of:
  - Whales (Listed whales, example. Beaked and sperm whales)
  - Leatherback turtles
  - Monk Seals, small cetaceans, and other turtle species
  - Prey for marine mammals (Indirect)
  - Prey for turtles (Indirect)
  
- Disturbance and/or destruction of deep corals due to installation of anchors as well as dragging of anchors and/or cables.
- Disturbance and/or destruction of deep corals or coral reefs due to installation of power cables.
  
- Entrainment of Benthos (eggs & larvae)
  - Direct impact on gametes of endangered species (e.g. black coral)
- Entrainment of Fish
  - Indirect impact affecting essential fish habitat (food source)
- Entrainment of Fish (eggs & larvae)
  - Direct impact, mortality
- Impingement of Fish
  - Direct impact, mortality (ESA, if listed)

## **Plankton**

|  |
|--|
| Oxygen   |
| Nutrients (dissolved inorganic nitrogen, phosphorus, silicate) |
| Trace elements   |
| Temperature changes  |

- *Entrainment of Phytoplankton, Bacteria, Zooplankton, and Meroplankton*
  - *Indirect impact on essential fish habitat (food source)*
- *Entrainment of Micronekton*
  - *Indirect impact on essential fish habitat (food source)*
  - *Direct impact, mortality (ESA, if listed)*
- *Impingement of Micronekton*
  - *Indirect impact on essential fish habitat (food source)*
  - *Direct impact, mortality (ESA, if listed)*



## **Oceanography**

Oxygen

Nutrients (dissolved inorganic nitrogen, phosphorus, silicate)

Trace elements

Temperature changes

| OTEC Component/Activity/Event                              | Potentially Impacted Resource             | Potential Impact                            | Best Available Technologies | Baseline assessment | Monitoring strategies | Modeling methods |
|--|---|---|-----------------------------|---------------------|-----------------------|------------------|
| Construction of Anchors and Dragging of Anchors and Cables | Deep Coral                                | destruction                                 |                             |                     |                       |                  |
|  | Deep Sea Crustaceans                      | destruction                                 |                             |                     |                       |                  |
|  | Vertebrate Fish                           | disturbance                                 |                             |                     |                       |                  |
|  | Marine Mammals                            | disturbance                                 |                             |                     |                       |                  |
|  | Sea Turtles                               | disturbance                                 |                             |                     |                       |                  |
|  | Invertebrates                             | disturbance                                 |                             |                     |                       |                  |
|  | Bacteria                                  | disturbance                                 |                             |                     |                       |                  |
|  | Hard Substrate/Habitat                    | destruction                                 |                             |                     |                       |                  |
|  | Heterotrophic Community                   | disturbance                                 |                             |                     |                       |                  |
|  | Chemoautotrophic Community                | disturbance                                 |                             |                     |                       |                  |
|  | Habitat Heterogeneity                     | disturbance                                 |                             |                     |                       |                  |
|  | Historical Sites                          | destruction                                 |                             |                     |                       |                  |
| Mooring Cables (Installation and presence in water column) | Marine Mammals                            | collision, altering behavior                |                             |                     |                       |                  |
|  | Sea Turtles                               | collision, altering behavior                |                             |                     |                       |                  |
|  | Vertebrate Fish                           | altering behavior                           |                             |                     |                       |                  |
|  | Mobile Invertebrates                      | altering behavior                           |                             |                     |                       |                  |
|  | Submarines                                | collision and entanglement                  |                             |                     |                       |                  |
|  | Fishing Activity                          | collision and entanglement                  |                             |                     |                       |                  |
|  | Sea Birds                                 | collision and altering behavior             |                             |                     |                       |                  |
|  | Sessile Invertebrates                     | recruitment and settling                    |                             |                     |                       |                  |
|  | Algae                                     | recruitment and settling                    |                             |                     |                       |                  |
| Power Cable (Installation and Presence)                    | Water Quality                             | suspended sediment, contamination           |                             |                     |                       |                  |
|  | Coastal resources (sand, beaches, etc)    | disturbance or destruction                  |                             |                     |                       |                  |
|  | Coral Reefs                               | disturbance or destruction                  |                             |                     |                       |                  |
|  | Vertebrates                               | behavioral alteration                       |                             |                     |                       |                  |
|  | Invertebrates                             | behavioral alteration                       |                             |                     |                       |                  |
|  | Protected Species                         | behavioral alteration and entanglement      |                             |                     |                       |                  |
|  | as above (mooring cables)                 |   |                             |                     |                       |                  |
| Platform/Pipe (Installation and Physical Presence)         | Water Quality                             | chemical discharges and spills              |                             |                     |                       |                  |
|  | Vertebrates                               |   |                             |                     |                       |                  |
|  | Invertebrates                             |   |                             |                     |                       |                  |
|  | Sea Birds                                 |   |                             |                     |                       |                  |
|  | Marine Mammals                            |   |                             |                     |                       |                  |
|  | Turtles                                   |   |                             |                     |                       |                  |
|  | Crustaceans                               |   |                             |                     |                       |                  |
|  | as above (mooring cables)                 |   |                             |                     |                       |                  |
|  | Food Chain Effects                        |   |                             |                     |                       |                  |
|  | Increased Vessel Traffic                  | same as above                               |                             |                     |                       |                  |
|  | Marine Mammals                            | strikes                                     |                             |                     |                       |                  |
| Lighting   | Sea Birds                                 | behavioral disturbance                      |                             |                     |                       |                  |
|  | Squids                                    | behavioral disturbance                      |                             |                     |                       |                  |
|  | Turtles                                   | behavioral disturbance                      |                             |                     |                       |                  |
|  | Vertebrate Fish                           | behavioral disturbance                      |                             |                     |                       |                  |
|  | Marine Mammals                            | behavioral disturbance                      |                             |                     |                       |                  |
|  | Plankton                                  | behavioral disturbance, increased predation |                             |                     |                       |                  |
| Accidents/Emergency Response/Hazards                       |   |   |                             |                     |                       |                  |
| Accidental Spills (Chlorine)                               | Water Quality                             |   |                             |                     |                       |                  |
|  | All biotic activity in upper water column |   |                             |                     |                       |                  |
| Accidental Spills (Ammonia)                                |   |   |                             |                     |                       |                  |
| MARPOL   |   |   |                             |                     |                       |                  |
| Geological Hazards   |   |   |                             |                     |                       |                  |
| Hurricanes   |   |   |                             |                     |                       |                  |
| Disturbance of ordnance                                    |   |   |                             |                     |                       |                  |
| Historical Sites   |   |   |                             |                     |                       |                  |



## **OTEC II: RECORDERS NOTES: GROUP D**

### **Breakout Session III: Moving Forward**

6. How can potential physical, chemical and biological impacts be avoided, minimized or mitigated within the operational and design parameters of an OTEC system?
  -
  
7. What are potential tradeoffs between biological impacts and operational efficiency?
  - Should we go through the table or have a general discussion?
    - (1) Looking back at question 6 – avoid, minimize, mitigate
      - (a) Avoidance – never realize impact
      - (b) Minimize – chose different design
      - (c) Mitigate – resolve impact
  - Created column in table entitled “Operational Impact” for each impact and its avoidance, minimization, and mitigation strategy that was discussed as we made the table.
  - There will be diesel fuel stored on board the platform
    - (1) How much?
      - (a) 2 MWe or 5 MWe diesel generator – 6,000 to 10,000 gallons of diesel fuel
  - Construction materials are potential hazards

Notes: We did discuss possible delays in construction due to marine mammal presence.

## **APPENDIX F: GROUP E**

## **OTEC II: RECORDERS NOTES: GROUP E**

### **Breakout Session I: Biological Impacts and Receptors**

1. What possible impacts are missing from our list? (Refer to handout)
  - Sources of noise: turbines are most likely the largest sources of noise during operation
  - Construction/installation related noise should be considered as well
  - Consideration of cable strum from the mooring
    - (1) Work has been done on acoustic signatures of anchored FADs
  - Vibration should be considered

Operational sources of noise and vibration (any mechanical disturbances)

**SOUND INCLUDES PRESSURE & PARTICLE MOTION**

- Turbine
- Pumps
- Generators
- Friction noise from water movement
- Support vessels
- Discharge turbulence
- Mooring cable strum
- Transmission cable strum, supported mid water column with a buoy and fixed on the bottom
- Vibration from cold water pipe
- Response to accidents/repairs

Construction sources of noise

- Deployment
  - Platform construction
  - Mooring/anchoring (drilling?)
  - Cable laying (drilling?)
- Support vessels

EMF sources

- Power cable during normal operation or if there is a break

Biological impacts

Physiological responses of noise

- PTS – Permanent threshold shift
  - TTS – Temporary threshold shift
- These two affects would need to be assessed as far as magnitude is concerned to understand the risk
- Naval research has looked at standards and levels for PTS and TTS
  - Sea turtle acoustics does have some research for adverse impacts

Stress responses

### Behavioral responses

- Localized changes to movement
- Ecosystem dynamics
- Masking (masking the normal sound perception at the most basic level i.e. communication)
- Larval recruitment

### Ecosystem level responses

- If the short term behavioral response persists it may induce an ecosystem level response

### Perception vs. impact of normal behavior

- Attraction
- Avoidance
  - PTS, TTS

### EMF Impacts of the generating plant

- For EMF sensitive animals, e.g. turtles, there may be localized impacts at the source
- Most likely sources of impact are localized changes in behavior
  - Attraction
  - Repel
- Magnetic sensitivity and reception remains to be demonstrated for many species (not turtles)

### EMF impacts of the power cable

- Attraction/repel (including benthic species)

## 2. What are the best available technologies to assess OTEC impacts and risks?

### Lab studies vs. in-situ

### Pre and post monitoring of species abundance and distribution

- Acoustic modeling of the generated sound field
- Passive acoustic monitoring for marine mammals and fish, acoustic monitoring would need to be put in place pre, post, and during construction (
- Aqua culture cage studies (entrainment of associated species)
- Lab studies for behavioral and physiological thresholds
  - For sea turtles, lab studies have been done
- In-situ studies for populations (changes in population, abundance and temporal dynamics)
- Telemetry utilizing acoustic monitoring devices

- For the bottom cable, visual surveys would need to be completed along with EMF monitoring equipment
    - Look at previous studies where cable was laid (wind farms, offshore oil industry)
  - In-situ studies of the behavioral changes of the key species (before and after construction)
3. What baseline assessments, monitoring strategies and modeling methods are needed to develop quantifiable levels of impact and risk for OTEC facilities?
- Baseline assessment of ambient noise
  - Monitoring of operation noise
  - Autonomous broadband acoustic recorder (Cornell, Green Ridge) which would be tethered
    - HIMB/NOAA has completed some baseline assessment in Hawaii of acoustic/EMF
    - Marine Acoustics study for the NPS
  - Baseline assessment of EMF on-shore and sub sea
  - Pre and post monitoring of species abundance, behavior, and distribution (constant sampling cycle, at least an annual cycle)
    - Protected species and critical fish habitats
    - HIMB has completed some baseline assessment in Hawaii of fish movements and residency
  - Identification of control sites
  - There are readily available validated acoustic propagation models which are applicable to this situation (PE, Bellhop, OAML) -Adam Frankel
  - There are existing animal exposure models as well (AIM, 3MB)



## OTEC II: RECORDERS NOTES: GROUP E

### Breakout Session II: Baseline

#### 4. Prioritize the impacts in regulatory context.

If low frequency: baleen whales (masking, threshold shift), sea turtles, pinnipeds (Hawaiian monk seal), all fish and sharks, rays, will also affect toothed whales to a different degree

If high frequency: add tooth whales to above list

Dependent upon OTEC system characterization

(Referring to Janota and Thomson JASA OTEC study on pen drive)

- Masking will reduce the effectiveness of communication of all species in that communication band
- Construction phase impacts could be related to oil industry, the only difference would be the cold water pipe (construction and placement)
  - Largest noise expected from anchoring installation
- 

#### 5. What additional research is needed in order to assess potential biological impacts of OTEC facilities?

- Predict source characteristics, amplitude and frequency, from this a prediction can be made for an affected area and species
- Model acoustic fields
- Record ambient acoustic levels
  - Available system include: Cornell popup, Aural, HARP, EAR, Loggerhead, and more. These can be installed on moorings for measuring ambient levels. It may need to be separate, or added to the mooring to sort out outside noise (flow noise over actual device). Hydrophones (magnitude) or accelerometers (vector) are the two potential sensors.
- Sound thresholds for marine mammals are more established than for turtles and fish
- Some studies found that acoustic cues are potentially important to larval fish for recruitment and some invertebrates

Should look at the coupling of the electric generator to ground through seawater, the EMF is an unknown. However, for AC connections some data from offshore wind farms could be available.

- What are the available technologies to conduct this research?

Mitigation:

Burying the power cable can greatly reduce EMF

## OTEC II: RECORDERS NOTES: GROUP E

### Breakout Session III: Moving Forward

6. How can potential biological impacts be avoided, minimized or mitigated within the operational and design parameters of an OTEC system?
  - Any measure taken to reduce the stimulus level will reduce the overall impact
  - Or measures can be taken to reduce the exposure level
    - Bubble nets (common practice for pile driving), may not be feasible to maintain for long-term
    - Acoustic deterrent devices
    - Sonar detection of marine mammals prior to construction
  - If the power cable is buried, the EMF effects can be reduced (1 meter)
    - Ideal scenario would be 2-phase AC, however, 3-phase AC is better than a DC power cable
    - If the power cable can be buried all of the way into a substation, near shore effects could be minimized
  - If the pump were housed in a dry chamber instead of flooded with anti-vibration mounts MAYBE
  - Placement of a sacrificial zinc anode where a shark can't bite it
  - Reduce size and number of turbines and pumps
  - Magnitude of the mitigation effort will reflect the magnitude of the stimulus
  - Frequency range for receptors ranges from 7 Hz to 200 kHz
  - Different types of coupling produces different sound impacts
  - Construction and demolition scheduling taking into account seasonal presence of sensitive animals
  - Site selection to minimize exposure
    - Avoid submarine canyons
    - Essential fish habitat designations would be important when citing
    - Avoid spawning/breeding/refuge habitats
  - Cold water pipe vibration needs to be minimized (fix vs. gimbaled will be considered)
  - NMFS acoustic thresholds (contact Amy Scholik)
    - Worst case scenario (minimum threshold level) 120 db re 1 micropascal (RMS) received level for marine mammals. Onset of behavioral harassment.
- Recommendations for engineers:
  - Review ATOC 75 Hz center frequency, 30 Hz bandwidth, source level = 195 db re 1 micropascal at 1 meter, operated for 20 minutes out of every 4 hours. Commissioned by Scripps Institute of Oceanography
  - Oil production platforms could be a good surrogate, broadband and continuous
  - 5 year plan from MMS for oil platform development
  - Continued communication between engineers, management, and biologists (stakeholders)

7. What are potential tradeoffs between biological impacts and operational efficiency?
  - Burying a power cable at depths is problematic and expensive
  - Ideal scenario would be 2-phase AC, however, 3-phase AC is better than a DC power cable
  - Site selection to avoid exposure (animal absence vs. optimal location site)
  - Construction and decommissioning season

## OTEC II: REPORT OUT: GROUP E Breakout Session I: Report

### Noise and EMF

## Background and Sound Sources

SOUND INCLUDES PRESSURE & PARTICLE MOTION!

Determining Source Levels is a critical data need

### Operational Sound Sources

- Turbine, Pumps, Generators
- Friction noise from water movement, Discharge turbulence
- Support vessels
- cable strum (Transmission and Mooring)
- Vibration from cold water pipe
- Response to accidents/repairs

### Construction Sound Sources

- Platform construction
- Mooring/anchoring (drilling?)
- Cable laying (drilling?)
- Support vessels

## Question 1: Potential Impacts of Sound

- Physiological responses of noise
  - PTS – Permanent threshold shift
  - TTS – Temporary threshold shift
  - These two affects would need to be assessed as far as magnitude is concerned to understand the risk
  - Naval research has looked at standards and levels for PTS and TTS
  - Sea turtle acoustics does have some research for adverse impacts
  - Stress responses
- Behavioral responses
  - Localized changes to movement
  - Ecosystem dynamics
  - Masking (masking the normal sound perception at the most basic level i.e. communication)
  - Larval recruitment
- Ecosystem level responses
  - If the short term behavioral response persists it may induce an ecosystem level response

## Question 1: Potential Impacts of EMF

- EMF Impacts of the generating plant
  - For EMF sensitive animals, e.g. turtles, there may be localized impacts at the source
  - Most likely sources of impact are localized changes in behavior
    - Attraction
    - Repel
  - Magnetic sensitivity and reception remains to be demonstrated for many species (not turtles)
- EMF impacts of the power cable
  - Attraction/repel (including benthic species)

### Question 2: Best Available Technologies

- Lab studies vs. in-situ
- Acoustic modeling of the generated sound field
- Autonomous Acoustic Recorders (ambient and MM)
- Telemetry utilizing acoustic monitoring devices
- Lab studies for behavioral and physiological thresholds (done for sea turtles)
- Visual surveys would need to be completed along with EMF monitoring equipment
- Look at previous studies where cable was laid (wind farms, offshore oil industry)

### Question 3: Assessments, Monitoring, Modeling

- Acoustic Field and Animal exposure Predictive Modeling
- Acoustic Measurements and in situ surveys before, during and after construction
  - HIMB/NOAA has completed some baseline assessment in Hawaii of acoustic/EMF
  - Marine Acoustics study for the NPS

### Question 3: continued

- Pre and post monitoring of species abundance, behavior, and distribution (constant sampling cycle, at least an annual cycle)
  - Protected species and critical fish habitats
  - HIMB has completed some baseline assessment in Hawaii of fish movements and residency
- Identification of control sites

## OTEC II: REPORT OUT: GROUP E

DAY II?

### Question 4: Prioritize Impacts

- All acoustically sensitive species are susceptible (marine mammals, fish, turtles)
- Acoustic thresholds defined only for Marine Mammals
- OTEC system acoustic characteristics need to be determined
- Construction noise, cable EMF, and pump noise are the sources we are the most concerned about

### Acoustic Process

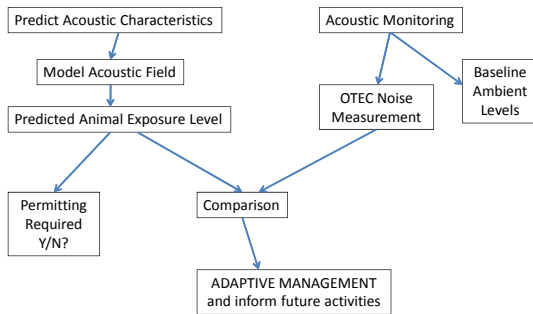

### Research Needs

- Predictions of animal exposure level
- Literature search and SOPs
- Research needed on behavioral responses to charged power cables
- Research needs for invertebrates, monitoring needs

### Available Technologies

- Hydrophone (amplitude) or accelerometer (vector quantity) as sensor
- Autonomous hydrophone data recorder systems are numerous and readily available (e.g. Cornell pop-ups, Aurals, EARs, HARPs)

### Question 6: Avoid, minimize, mitigate

- Reduce the Source Level of the platform to reduce the Impact
- Site Selection: When possible, site away from animal concentrations
- Timing: When possible, schedule construction activities when sensitive species are not present

### Recommendations for Engineers

- Data Sources:
  - ATOC, Oil production platforms as surrogate for OTEC platforms, five years MMS plans
- Continued Communication between engineers, managers, biologists and other stakeholders

### Question 7: Trade-offs

- Burying power cable reduces EMF effect, but it may be difficult and costly
- Site selection to avoid exposure (animal absence vs. optimal location site)
- Construction and decommissioning season

**APPENDIX F:**  
**FISHERIES AND CORALS GROUP**



| Impact   | Baseline:   |  |   | Monitoring:  |   |   | Modeling:   |  |  |
|--|---|--|---|--|---|---|---|--|--|
|  | Baseline Data Needed  | Optimum duration to collect Baseline Data (mins-1 yr)  | Justification of duration   | What should be monitored?  | How should this be monitored?   | How often?  | What existing models can be used?   | Improvements to existing models (e.g., data needs, additional parameters)  | New models?  |
| <b>Entrainment</b>   | Larval community survey to cover all mangrove unit species; density at intake depth and discharge depth. More specific catch and effort information for site - grids, interview fishermen.  | Depends on spawning season of MUS species. (Power plants: Minimum of 1 survey a month for a year, 24 hour period. 6, 4 hour cycles). Might want to sample more. <b>2 year minimum</b> for hydro kinetic, tidal energy. Developers - concerned about how long take, 4-5 control points for more data over 1 year. | Inter-year variation (one year could be off year) will be huge if sampling at single point. | Source water monitoring: monitoring at intake depth/location; fishery catch and effort at area; fishery independent monitoring to obtain status of stocks in region; include control sites to monitor changes in fish density at region (how many larvae); all management unit species (MUS) eggs/larvae density and type (where identifiable); understand if light is an attractant or deterrent. | Collecting with nets: plankton tows for eggs; flow rate at intake area; use a light comparison; large vessel; anchor research platform at site? (might trigger EIS); Multiple sites so have control areas as well so vessel is best way. Fisheries data - take life history samples of fish, various life stages; Fishermen data - use catch data of area and interview fishermen; Stock assessment; Experimental fishing for fishery independent data. | Increase according to expectation of density of eggs and larvae for different periods of the year; larvae do vertical migration on daily basis do diel 24hr assessments; life history; monthly; interview fishermen; as needed; | Empirical Transport Model (ETM) - requires source densities and current info to determine how long fish are susceptible to entrainment used as a predictor; Adult Equivalent Loss Model (AELM) and Fecundity Hindcast (FH) - require life history mortality rates, FH is number of females; Modeling larval dispersal model being developed by UH to backtrack type of larvae being sucked in; Boehret and Mandy study 1994 Tuna Larval densities by depth; Leis - fish larvae studies and citations; 80s data EIS / powerplant | life history for species of concerns; MUS  | overlay current patterns; intake draw field; comprehensive ecosystem based model of the area near site |
| <b>Impingement</b>   | Same as entrainment. To predict impingement need to know what is there. Use existing data sources fine tune grid data. Otter trawl to catch bigger species.   | same as entrainment  | Inter-year variation (one year could be off year) will be huge if sampling at single point. | same as entrainment, but different methods   | same as entrainment: use bongo net;   | same as entrainment   | estimated catch blocks, use any fisheries data have for adults;   | deploy fish aggregation device near preferred site. Replicates at reasonable distance for variability; use existing UH FAD (kim holland, kevin wang) | info about fish swim speeds at different life stages   |
| <b>Physical Damage to Shallow Corals (100 m; transmission cable)</b>                       | use existing cable data: community structure of corals in area including size/frequency of species; route survey thru reef; directional drilling at 100 ft; Investigate use of existing cable corridor; use of existing data on bathy and coral composition from pac fisheries center | 1 year and after Hurricane   | n/a   | baseline parameters of coral communities, size & structure;  | 2 data points (existing) from developer: 100 ft or less do diver surveys on size & freq & species composition; use rebreather technology up to 100 m; ROV, AUV, submersible for >100m; video surveys for beyond SCUBA depth;  | once during baseline: once at post installation   | use existing cable laying software to predict and design route  | n/a  | n/a  |
| <b>Physical Damage to Deepwater Corals (physical damage from line and anchoring issue)</b> | survey of sub-bottom profiling; bathy structure and composition data; optical imagery   | not relevant, snapshot won't change much   | n/a   | n/a; 1 time survey; re-inspection after deployment   | Submersible, ROV or towed camera surveys along route to determine presence & density of DW corals   | once during baseline: once at post installation   | n/a   | n/a  | no   |

**APPENDIX F:**  
**OCEANOGRAPHY GROUP**

| Oceanography  |   |  |  |  |  |  |  |  |   |
|---|---|--|--|--|--|--|--|--|---|
| Impact  | Baseline:   |  |  | Operational Monitoring:  |  |  | Modeling:                                    |  |   |
|   | Baseline Data Needed  | Optimum duration to collect Baseline Data (min=1 yr)                             | Justification of duration  | What should be monitored?  | How should this be monitored?  | How often?   | What existing models can be used?            | Improvements to existing models (e.g., data needs, additional parameters)  | New models?                                       |
| Oxygen  | Yes. Climatological data needed. Need spatial & temporal coverage of the plume. Sampling over a range of frequencies to capture variability. Vertical and horizontal data coverage needed. Periodic 3D coverage. Intensive sampling at one location.  | Sufficient to capture temporal variability at the site. Range: 1 year to 3 years | Need to capture natural variability on an annual scale.                    | 3D grid of Dissolved Oxygen. Use existing long-term monitoring control site (e.g. HOT1)  | Appropriate use of combinations of CTD casts; Gliders; fixed moorings; monitoring needed at the discharge                                  | Sampling over a range of frequencies to capture variability.   | Use EFDC model. Also need HIROMS model input | Need to adapt to be an assimilative model. Needs to incorporate biogeochemical components. Needs to be validated by field experiments, including near field current measurements                                   | Add a biogeochemical component to the EFDC model. |
| Nutrients (dissolved inorganic nitrogen, phosphorus, silicate)  | Yes. Climatological data needed. Need spatial & temporal coverage of the plume. Sampling over a range of frequencies to capture variability. Vertical and horizontal data coverage needed. Periodic 3D coverage. Intensive sampling at one location. Less frequent sampling needed as with O2 | Sufficient to capture temporal variability at the site. Range: 1 year to 3 years | Need to capture natural variability on an annual scale.                    | 3D grid of nutrients. Use existing long-term monitoring control site (e.g. HOT1)   | Appropriate use of combinations of CTD/rosette casts; Gliders for nitrate if practical; fixed moorings; monitoring needed at the discharge | Sampling over a range of frequencies to capture variability.   | Use EFDC model. Also need HIROMS model input | Need to adapt to be an assimilative model. Needs to incorporate biogeochemical components. Needs to be validated by field experiments, including near field current measurements                                   | Add a biogeochemical component to the EFDC model. |
| Trace elements  | Trace metals to measure - EPA hot list plus Fe & system materials (e.g. Ti & Al). Can use existing data plus seasonal profiles (error on the side of caution).  | Four times a year for one year.  | Defensible baseline. Not likely to have large-scale short-term variability | Trace metals to measure - EPA hot list plus system materials (e.g. Ti & Al). Seasonal profiles (error on the side of caution). | Very carefully - trace metal clean protocols.  | Sampling once a month of the intake and discharge waters would be optimal. Receiving waters quarterly. | Not necessary/applicable in this situation.  | Not applicable/necessary   | Not applicable/necessary                          |
| Temperature & Salinity  | Yes. Climatological data needed. Need spatial & temporal coverage of the plume. Sampling over a range of frequencies to capture variability. Vertical and horizontal data coverage needed. Periodic 3D coverage. Intensive sampling at one location.  | Sufficient to capture temporal variability at the site. Range: 1 year to 3 years | Need to capture natural variability on an annual scale.                    | 3D grid of temperature and salinity. Use existing long-term monitoring control site (e.g. HOT1)                                | Appropriate use of combinations of CTD casts; Gliders are great for Temperature; fixed moorings; monitoring needed at the discharge        | Sampling over a range of frequencies to capture variability.   | Use EFDC model. Also need HIROMS model input | Need to adapt to be an assimilative model. Needs to be validated by field experiments. Needs to be validated by field experiments, including near field current measurements. Need independent peer review of EFDC |   |
| EPA regulated substances (e.g., antifouling, plasticizers from pipes, other chemicals used). Ammonia is covered in nutrients. |   |  |  | Measure in the discharge flow.   | Samples from the discharge pipe.   |  |  |  |   |

**APPENDIX F:**  
**MARINE MAMMALS AND TURTLES GROUP**

|                |   | Marine Mammals & Turtles  |  |                           |  |  |   |   |   |     |
|----------------|---|---|--|---------------------------|--|--|---|---|---|-----|
|                |   | Baseline:   |  |                           | Monitoring:  |  |   | Modeling:   |   |     |
| Impact         | Baseline Data Needed  | Optimum duration to collect Baseline Data (min=1 yr)                            | Justification of duration  | What should be monitored? | How should this be monitored?                                | How often?   | What existing models can be used?   | Improvements to existing models (e.g., data needs, additional parameters) | New models?   |     |
| Marine Mammals | Entrainment (CW intake)   | species diving depths, basic distribution and abundance                         | 1 year assuming normal conditions                                |                           | distribution and abundance, CWP flow                         | acoustic sensors, flow monitoring (gauges)   | continuous, automatic   | N/A   | N/A   | N/A |
|                | Impingement (CW intake)   | species diving depths, basic distribution and abundance                         | 1 year assuming normal conditions                                |                           | distribution and abundance, CWP flow                         | acoustic sensors, flow monitoring (gauges)   | continuous, automatic   | N/A   | N/A   | N/A |
|                | Migratory pattern shift (physical presence)                                 | abundance and dist. And movement patterns                                       | 1 year assuming normal conditions and control sites are adequate |                           | migratory pathways (abund. And dist.)                        | autonomous acoustic recorder, aerial/visual surveys  | continuous, automatic   | N/A, (existing data)  | N/A   | N/A |
|                | Entanglement (concentration of derelect marine debris)                      | HI marine debris program, existing data   | existing data  |                           | marine debris (in area and attached to OTEC system)          | visual survey  | daily at surface, quart. At depth   | N/A   | N/A   | N/A |
|                | Behavioral changes (Noise/EMF, physical presence)                           | species diving depths, basic distribution and abundance, "habitat use maps"     | 1 year adeq. As long as surveying statistically sig.             |                           | presence and behavior  | acoustics and visual   | acoustics-contin.; Visual-conditional to baseline data (potentially coupled with marine debris surveys) | acoustic prop. Models, AIM, 3MB   | integrate animal behavior, validating model may be needed (if noise is large) | N/A |
|                | Attractant/Repellant (Noise/EMF, physical presence)                         | species diving depths, basic distribution and abundance, "habitat use maps"     | 1 year adeq. As long as surveying statistically sig.             |                           | presence and behavior  | acoustics and visual   | acoustics-contin.; Visual-conditional to baseline data (potentially coupled with marine debris surveys) | acoustic prop. Models, AIM, 3MB   | integrate animal behavior, validating model may be needed (if noise is large) | N/A |
| Turtles        | Entrainment/Impingement (from WW & CW intake, of weak or young sea turtles) | basic distribution and abundance  | existing data (WW-existing power plants; CW-species' studies)    |                           | distribution and abundance, CWP flow                         | WW- monitoring of screens(video); CW-flow monitoring   | WW- daily; CW-continuous flow monitoring  | N/A   | N/A   | N/A |
|                | Migratory pattern shift - green turtles (physical presence)                 | dist. And abundance; satellite tracking data                                    | existing   |                           | seasonal presence/abs  | satellite tracking, seasonal visual surveys  | seasonal (nesting season); if location off big island consider hawksbill                                | N/A   | N/A   | N/A |
|                | Entanglement (physical presence)  | HI marine debris program, existing data   | existing data  |                           | marine debris (in area and attached to OTEC system)          | visual survey  | daily at surface, quart. At depth   | N/A   | N/A   | N/A |
|                | Behavioral changes (Noise/EMF, physical presence)                           | pres/abundance, diversity, some existing data (offshore oil indust. Literature) | 1 year assuming normal conditions                                |                           | changes in presence, abundance, diversity                    | visual and aerial; could incorporate with marine debris daily monitoring; tagging (using acoustic receivers) | at least once per season (4 seasons)  | NMFS TurtleWatch  | modify model for different species  | N/A |
|                | Attractant/Repellant (Noise/EMF, physical presence)                         | pres/abundance, diversity, some existing data (offshore oil indust. Literature) | 1 year assuming normal conditions                                |                           | changes in presence, abundance, diversity, <b>clustering</b> | visual and aerial; could incorporate with marine debris daily monitoring; tagging (using acoustic receivers) | at least once per season (4 seasons)  | NMFS TurtleWatch  | modify model for different species  | N/A |

**APPENDIX F:**  
**PLANKTON GROUP**

PLANKTON

| Impact               | Baseline:  |   |   | Monitoring:                    |  |                               | Modeling:  |   |                                  |
|----------------------|--|---|---|--------------------------------|--|-------------------------------|--|---|----------------------------------|
|                      | Baseline Data Needed   | Optimum duration to collect Baseline Data (min=1 yr)                                      | Justification of duration   | What should be monitored?      | How should this be monitored?  | How often?                    | What existing models can be used?  | Improvements to existing models (e.g., data needs, additional parameters) | New models?                      |
| <b>Bacteria</b>      | At least a vertical distribution, horizontal distribution, fate of organisms | Several samplings in one place. 2 years and if data is very different, continue sampling. | High frequency because you don't want to miss the flux. Want to catch seasonal variability.                   | live/dead, population density, | acoustics for density. 1km radius, three stations (upstream, downstream, at plant; or 3 random sites; control site; sites within plume) for statistical rigor, | Based on baseline information | chlorophyll models from 20yrs hindcast ; data set diurnal and seasonality for 4 years off kahe (1, 5, 15 yrs offshore); use HiROMand existing current models | Fate of organic Carbon  | Physical oceanography to predict |
| <b>Phytoplankton</b> | At least a vertical distribution, horizontal distribution, fate of organisms | Several samplings in one place.   | High frequency because you don't want to miss the flux.   | live/dead, population density, |  | Based on baseline information |  |   |                                  |
| <b>Zooplankton</b>   | At least a vertical distribution, horizontal distribution, fate of organisms | Several samplings in one place.   | High frequency because you don't want to miss the flux. Spacial variation (horizontal grid) using a km extent | live/dead, population density, | acoustics for density  | Based on baseline information |  |   |                                  |
| <b>Eggs/Larvae</b>   | At least a vertical distribution, horizontal distribution, fate of organisms | Several samplings in one place.   | High frequency because you don't want to miss the flux.   | live/dead, population density, |  | Based on baseline information |  |   |                                  |
| <b>Micronekton</b>   | At least a vertical distribution, horizontal distribution, fate of organisms | Several samplings in one place.   | High frequency because you don't want to miss the flux.   | live/dead, population density, | acoustics for density  | Based on baseline information | UH dissertations   |   |                                  |

**APPENDIX G:**  
**POWERPOINT PRESENTATIONS**



# Welcome

## *OTEC: Assessing Potential Physical, Chemical & Biological Impacts & Risks*



Coastal Response Research Center

1

## *OTEC: Assessing Potential Physical, Chemical & Biological Impacts & Risks*

June 22 - 24, 2010

Nancy E. Kinner  
Coastal Response Research Center  
(CRRC)  
UNH Co-Director



Coastal Response Research Center

2

## Workshop Logistics and CRRC Overview



Coastal Response Research Center

3

16° C (61° F)

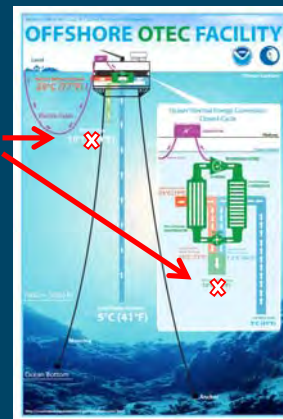

Coastal Response Research Center

4

## LOGISTICS

- **Fire Exits**
- Restrooms
- Location of breakout rooms
- Parking
- Dining - breakfasts, lunches (Tuesday and Wednesday) & snacks
- Evening Dinner Tuesday Night:
  - Location: The Willow's Restaurant (walking is an option; directions on registration desk)
  - Cash bar available - 6:30 pm
  - Buffet Dinner
- Evening Dinner Wednesday Night - On Your Own
- If you have any questions - check with staff at registration table



### MEETING ROOM FLOOR PLANS



## LOGISTICS

- Fire Exits
- **Restrooms**
- Location of breakout rooms
- Parking
- Dining - breakfasts, lunches (Tuesday and Wednesday) & snacks
- Evening Dinner Tuesday Night:
  - Location: The Willow's Restaurant (walking is an option; directions on registration desk)
  - Cash bar available - 6:30 pm
  - Buffet Dinner
- Evening Dinner Wednesday Night - On Your Own
- If you have any questions - check with staff at registration table



### MEETING ROOM FLOOR PLANS



## LOGISTICS

- Fire Exits
- Restrooms
- **Location of breakout rooms**
- Parking
- Dining - breakfasts, lunches (Tuesday and Wednesday) & snacks
- Evening Dinner Tuesday Night:
  - Location: The Willow's Restaurant (walking is an option; directions on registration desk)
  - Cash bar available - 6:30 pm
  - Buffet Dinner
- Evening Dinner Wednesday Night - On Your Own
- If you have any questions - check with staff at registration table



## LOGISTICS

- Parking: See Kathy for validation
- Dining - breakfasts, lunches (Tuesday and Wednesday) & snacks
- Evening Dinner Tuesday Night:
  - Location: The Willow's Restaurant (walking is an option; directions on registration desk)
  - Cash bar available - 6:30 pm
  - Buffet Dinner
- Evening Dinner Wednesday Night - On Your Own
- If you have any questions - check with staff at registration table



## KEY CRRC STAFF

- Nancy Kinner - UNH Co-Director
- Joe Cunningham - Group Lead / Research Engineer II
- Zach Magdol - Group Lead / Research Engineer I
- Kathy Mandsager - Program Coordinator
- Heather Ballestero - Graduate Student/Recorder
- Mike Curry - Graduate Student/Recorder
- Adria Fichter - Graduate Student/Recorder
- Nate Little - Graduate Student/Recorder
- Chris Wood - Graduate Student/Recorder



## CRRC OVERVIEW



Coastal Response Research Center

13

## CRRC CREATION

- NOAA's Office of Response and Restoration (ORR)/UNH spill partnership in 2004
- Co-Directors:
  - UNH - Nancy Kinner
  - NOAA - Amy Merten



Coastal Response Research Center

14

## OVERALL MISSION

- Develop new approaches to response and restoration through research/synthesis of information
- Serve as a resource/hub for NOAA, NOS (National Ocean Service) and other agencies
- Transform research results into practice
- Educate students who will pursue careers in response and restoration



Coastal Response Research Center

15

## OUTREACH EFFORTS

- 21 workshops on hot topics to identify research priorities and partners (Examples Below)
  - Dispersed Oil: Efficacy and Effects
  - Submerged Oil: State of the Practice
  - Human Dimensions of Spills
  - Integrated Modeling
  - PAH Toxicity
  - Environmental Response Data Standards
  - Opening the Arctic Seas: Envisioning Disasters & Framing Solutions
  - NRDA in Arctic Waters: The Dialogue Begins
  - Dispersant Use in Deepwater Horizon Spill
- **OTEC Technical Readiness**



Coastal Response Research Center

16

Coastal Response Research Center  
Website

[www.crrc.unh.edu](http://www.crrc.unh.edu)



17

## Workshop Background, Objectives and Outcomes



Coastal Response Research Center

18

## BACKGROUND FOR TODAY'S MEETING

- NOAA's Office of Ocean and Coastal Resource Management (OCRM) licensing of OTEC
- David Kennedy, recent OCRM Director, on CRRC Advisory Board
- OCRM Senior Policy Analyst David Kaiser affiliated with CRRC at UNH
- CRRC experience hosting workshops



Coastal Response Research Center

19

## CRRC/OCRM Partnership

- CRRC hosting two OTEC workshops for OCRM
  - November 2009: Technical Aspects
  - June 2010: Assessing Potential Physical, Chemical and Biological Impacts
- Format: Plenary Sessions and Breakout Groups
- Participants representing a spectrum of industry, public sector, academia, and NGOs



Coastal Response Research Center

20

## KEY CONCEPT

- Bring diverse expertise and perspectives to the table
- Dialogue on:
  - Where we are?
  - Where do we want to be?
  - How do we get there?



## PLANNING COMMITTEE

Whitney Blanchard, NOAA OCRM  
Eugene Bromley, USEPA  
Alan Everson, NOAA, NMFS  
Helen Farr, NOAA, OCRM  
Kerry Kehoe, NOAA, OCRM  
Nancy Kinner, UNH, CRRC  
Don MacDonald, NOAA  
Scott Medeiros, USCG  
Doug Miller, USCG  
Michael Parke, NOAA  
Mike Reed, US DoE  
Dwight Trueblood, NOAA, CICEET  
Alison Hammer & Stephanie Kavanaugh, NOAA (Facilitators)



## MEETING PURPOSE

- One of several forums on OTEC
- Gather information for NOAA and DOE
  - Help meet their OTEC licensing and permitting responsibilities
- Ensure development of commercial scale OTEC facility is environmentally acceptable prior to licensing



## MEETING OBJECTIVES

- Identify potential physical, chemical and biological impacts of OTEC
- Identify baseline and monitoring data needed to evaluate impacts of operating OTEC
- Identify research needs if they exist
- Determine how OTEC designs can be adjusted to avoid, minimize, mitigate impacts
  - Without endangering functional viability



## ASSUMPTIONS

- First likely OTEC facility:
  - Closed cycle
  - Offshore
  - Floating & moored
  - Producing electricity transmitted to shore via submarine cable



## Definitions for this Workshop

- Small OTEC Facility = 5-10 MWe
- Large OTEC Facility = 100 MWe
- Operational Efficiency =  
$$\frac{\text{Net Power Output}}{\text{Max Potential Design Energy Output}}$$



## MEETING STRUCTURE

- Plenary Session Talks - Today AM
  - Retrospective
  - System Overview
  - Plume Modeling
  - Site Assessments
  - Potential Physical, Chemical, and Biological Impacts (General & Hawaiian)
- Breakout Sessions I, II, III, IV and Report Outs
- Synthesis/Next Steps



## BREAKOUT SESSIONS I, II, III

- Groups:
  - Warm Water Intake
  - Cold Water Intake
  - Discharge (including biocides & working fluid)
  - Physical Presence, Construction, Accidents, Emergency Response
  - Noise and Electromagnetic Fields



## BREAKOUT SESSION QUESTIONS

- Breakout Session I
  - What possible impacts are missing from our list?
  - What are the best available technologies to assess OTEC impacts and risks?
  - What baseline assessments, monitoring strategies and modeling methods are needed to develop quantifiable levels of impact and risk for OTEC facilities?



## BREAKOUT SESSION QUESTIONS

- Breakout Session II
  - What is the geographic extent of the population/community to which impacts should be related (e.g., Pacific Ocean [whales], U.S. waters surrounding Hawaii [phytoplankton], waters around Oahu, or waters between Barbers Point and Diamond Head)?
  - What additional research is needed in order to assess potential biological impacts of OTEC facilities?



## BREAKOUT SESSION QUESTIONS

- Breakout Session III
  - How can potential physical, chemical and biological impacts be avoided, minimized or mitigated within the operational and design parameters of an OTEC system?
  - What are potential tradeoffs between physical, chemical and biological impacts and operational efficiency?



## BREAKOUT SESSION IV

- New Groups:
  - Oceanography
  - Plankton
  - Fisheries
  - Mammals/Turtles/Birds





## BREAKOUT SESSION IV QUESTIONS

- Question
  - For your focus topic, determine baseline, monitoring, and modeling data needed for understanding the potential environmental impacts associated with an OTEC facility.
  - Identify what further research is needed.
  - Assign (High, Low, or Medium) priority to each data need and note why this level of priority is being assigned.



## BREAKOUT SESSION IV

- Group 5: Regulatory
- Question:
  - Based on what was discussed on Days 1 & 2, what else may be needed above and beyond baseline assessment, monitoring strategies, and modeling methods to assess the biological impacts of an OTEC facility?



## BREAKOUT SESSION IV

- Group 6: Engineering
- Question:
  - Based on what was discussed previously (Days 1 & 2 of workshop), how might the OTEC facility design be adjusted to avoid, minimize or mitigate physical, chemical and biological impacts without compromising the operational viability of an OTEC facility?



## MEETING OUTCOMES

- CRRC will prepare a workshop report
  - Posted on CRRC website
  - Electronic version to all participants
- Enable NOAA to make better informed decisions in developing OTEC commercial license requirements
- Assist DOE in developing permitting requirements for OTEC demonstration facilities



## MEETING REPORT

- Report contents include:
  - Introduction and workshop history
  - Workshop organization and structure
  - Summary of breakout group reports
  - Research and development needs
  - Conclusions
- Appendices:
  - Participant list
  - Breakout group questions
  - Recorders notes from breakout sessions
  - Group report out presentations
  - Plenary slide presentations



Coastal Response Research Center

37

## QUESTIONS?



Coastal Response Research Center

38

Coastal Response Research Center  
Website

[www.crrc.unh.edu](http://www.crrc.unh.edu)



39

## PARTICIPANT INTRODUCTIONS

- Name
- Affiliation
- Expertise



Coastal Response Research Center

40

Potential Environmental Impacts  
of an  
OTEC Facility

Don MacDonald

Effects Categories from NOAA's Final  
EIS in 1981

**Major Effects**

- Platform presence
  - Biota attraction
- Withdrawal of surface and deep ocean waters
  - Organism entrainment and impingement
- Discharge of waters
  - Nutrient redistribution resulting in increased productivity
- Biocide release
  - Organism toxic response

Effects Categories from NOAA's  
Final EIS in 1981

**Minor Effects**

- Protective hull-coating release
  - Concentration of trace metals in organism tissues
- Power cycle erosion and corrosion
  - Effect of trace constituent release
- Implantation of coldwater pipe and transmission cable
  - Habitat destruction and turbidity during dredging

Effects Categories from NOAA's  
Final EIS in 1981

**Minor Effects(cont'd)**

- Low-frequency sound production
  - Interference with marine life
- Discharge of surfactants
  - Organism toxic response
- Open-cycle plant operation
  - Alteration of oxygen and salt concentrations in downstream waters

### Effects Categories from NOAA's Final EIS in 1981

#### Potential Effects from Accidents

- Potential working fluid release from spills and leaks
  - Organism toxic response
- Potential oil releases
  - Organism toxic response

### Water Intakes Entrainment

- |   |  |
|---|--|
| <ul style="list-style-type: none"> <li>• Warm water                             <ul style="list-style-type: none"> <li>• Phytoplankton</li> <li>• Microzooplankton</li> <li>• Macrozooplankton                                     <ul style="list-style-type: none"> <li>– Some Adults</li> <li>– Eggs &amp; Larvae</li> </ul> </li> <li>• Benthos                                     <ul style="list-style-type: none"> <li>– Eggs &amp; Larvae</li> </ul> </li> <li>• Vertebrate Fish                                     <ul style="list-style-type: none"> <li>– Eggs &amp; Larvae</li> </ul> </li> </ul> </li> </ul> | <ul style="list-style-type: none"> <li>• Cold water                             <ul style="list-style-type: none"> <li>• Microzooplankton</li> <li>• Macrozooplankton                                     <ul style="list-style-type: none"> <li>– Some Adults</li> <li>– Eggs &amp; Larvae</li> </ul> </li> <li>• Benthos                                     <ul style="list-style-type: none"> <li>– Eggs &amp; Larvae</li> </ul> </li> <li>• Vertebrate Fish                                     <ul style="list-style-type: none"> <li>– Eggs &amp; Larvae</li> </ul> </li> </ul> </li> </ul> |
|---|--|

### Water Intakes Impingement

- |   |  |
|---|--|
| <ul style="list-style-type: none"> <li>• Warm water                             <ul style="list-style-type: none"> <li>• Macrozooplankton</li> <li>• Vertebrate Fish</li> <li>• Benthos?                                     <ul style="list-style-type: none"> <li>• Eggs &amp; Larvae</li> </ul> </li> <li>• Sea turtles                                     <ul style="list-style-type: none"> <li>• Hatchlings</li> </ul> </li> </ul> </li> </ul> | <ul style="list-style-type: none"> <li>• Cold water                             <ul style="list-style-type: none"> <li>• Macrozooplankton</li> <li>• Benthos?                                     <ul style="list-style-type: none"> <li>• Eggs &amp; Larvae</li> </ul> </li> <li>• Vertebrate Fish</li> </ul> </li> </ul> |
|---|--|

### Impingement and Entrainment Estimates for 40 MW OTEC Facility

| Parameter   | Units             | Warm Water Intake    | Cold Water Intake |
|---|-------------------|----------------------|-------------------|
| Depth   | m                 | 20                   | 750-1000          |
| Flow Rate   | m <sup>3</sup> /s | 120-200              | 120               |
| Flow Velocities<br>Outside of intake<br>In pipe     | m/s               | 0.25-0.30<br>1.5-2.5 | 1.5-2.5           |
| Average Impingeable Biomass                         | mg/m <sup>3</sup> | 2.1                  | 3.8               |
| Daily Biomass Impinged                              | kg live wt        | 20-35                | 40-65             |
| Impingement mortality                               | percent           | ?                    | 100               |
| Zooplankton Entrained                               | kg C              | 20-34                | 2-4               |
| Entrainable Phytoplankton<br>(as Chlorophyll-a)     | mg/m <sup>3</sup> | 0.05-0.25            |                   |
| Daily Phytoplankton Entrained<br>(as Chlorophyll-a) | kg                | 0.5-4.3              |                   |
| Entrainment mortality                               | percent           | ?                    | 100               |

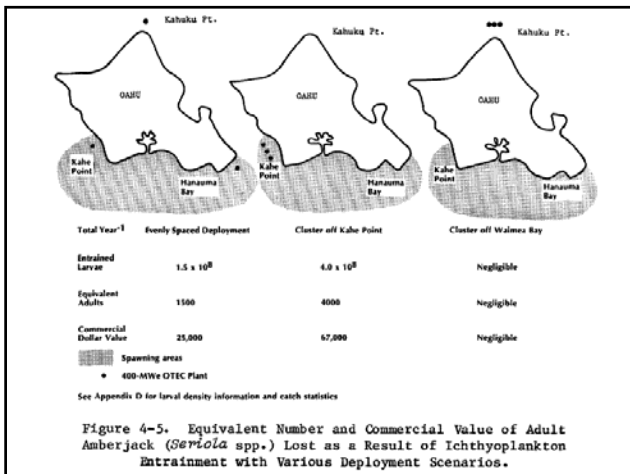

### Comparison of Percent Commercial Catch Lost for Three Location Scenarios

| Species                                | 400 MW OTEC locations | % Hawaiian Commercial Catch Lost by Weight |
|--|-----------------------|--|
| Seriola spp. (amberjack)               | 3 off Kahe Pt         | 70   |
|  | 3 off Waimea Bay      | 0  |
|  | 3 around Oahu         | 30   |
| Abudefduf abdominalis (sergeant major) | 3 off Kahe Pt         | 670  |
|  | 3 off Waimea Bay      | 30   |
|  | 3 around Oahu         | 260  |
| Thunnus albacores (yellowfin)          | 3 off Kahe Pt         | 10   |
|  | 3 off Waimea Bay      | 0  |
|  | 3 around Oahu         | 20   |

“These estimates of impingeable biomass are based on the assumption that larger organisms can detect and avoid the intake screens.”

- ### Cycle Water Release Characteristics
- Separate
    - Below ambient temperature
    - Corrosion products
    - Working fluid from leaks
    - Dead organisms
  - Warm water
    - Antifouling chemicals
  - Cold water
    - Increased nutrients and CO<sub>2</sub>
    - Reduced pH
  - Combined
    - All the above

## Cycle Water Release Concerns

### Secondary Entrainment

- Phytoplankton
- Microzooplankton
- Macrozooplankton
- Benthos
  - Eggs & Larvae
- Vertebrate Fish
  - Eggs & Larvae

## Cycle Water Release Concerns



- Physico-Chemical Effects
  - Nutrient enrichment
    - Phytoplankton blooms
      - Increased productivity
      - Toxic alga blooms
  - Reduced shell formation
  - Current changes

## Installation and Physical Presence

- Component
  - Transmission cables
    - Installation - Destruction of benthic community
    - Physical presence - Entanglement of marine mammals & sea turtles
  - Anchoring system
    - Installation - Destruction of benthic community
    - Physical presence - Entanglement of marine mammals & sea turtles
  - Platform
    - Installation - Change benthic substrate
  - Platform
    - Installation - Noise, chemical releases
    - Physical presence - Fish attractant, toxic releases
  - Cold water pipe
    - Installation
    - Physical presence

## Noise and Electromagnetic Fields

- Noise
  - Source
    - Pumps & generators
    - Water movement through cold water pipe
    - Discharge turbulence
  - Impact
    - Disrupt marine mammal behavior
- EMF
  - Source
    - Transmission cable
  - Impact
    - Disrupt marine mammal and vertebrate fish behavior





*Hawaii OTEC Pilot Plant Site Assessment  
and Survey*

22 June, 2010



NAVFAC Engineering Service Center

Fred Arnold  
805 982-1205  
frederick.arnold@navy.mil

### *Project Overview*

- Funded by ONR Alternate Energy Program.
- Objectives, Goals, and Tasking
  - Conduct engineering technical assessment of three candidate Navy sites.
  - Collect high-resolution survey data to support technical assessment.
  - Provide technical site data to LMCO for preliminary design of Pilot Plant.
  - Collaborate with NOAA to collect data to help define environmental baseline.
  - Provide Navy with technical assessment and supporting information for Hawaiian OTEC way forward discussion.



### *Project Methodology*

Three Navy sites to be assessed.

- Pacific Missile Range Facility (PMRF), Kaua'i
- Joint Base Pearl Harbor – Hickam, Oahu
- Marine Corps Base Hawaii, Kaneohe Bay, Oahu

Process

- Compile existing data of areas of interest into a comprehensive Desktop Study (DTS).
- Conduct assessment and select the best technical site from DTS data.
- Conduct ocean survey of the identified best site.
- Provide data to and assist Navy Region Hawaii in selecting pilot plant location.

### Navy Sites Considered

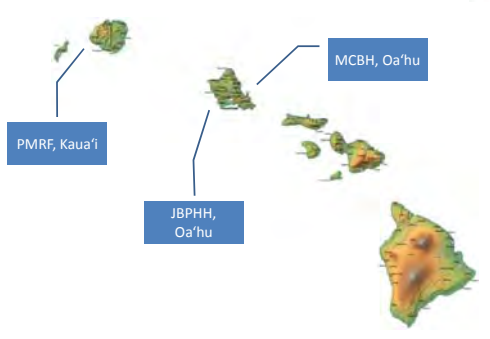

The map shows the Hawaiian Islands with three specific sites highlighted by blue boxes and leader lines: PMRF, Kaua'i (on the island of Kauai), JBPHH, Oa'ahu (at the northern tip of Oahu), and MCBH, Oa'ahu (at the western tip of Oahu).

**NAVFAC** **OTEC Hawaii – Site Assessment Process**

- Developed Site Evaluation Matrix to establish criteria and weights for evaluation
- Grouped factors for evaluation into categories
- Vetted the matrix and criteria with Navy, OTEC-LM Team
- Selected six sites for evaluation
  - Two each at PMRF, Kaneohe, and Pearl Harbor
  - Deepwater Site (1100m) and preferred anchoring site at each location
  - Criteria at all sites was min 20 Deg C Temp Differential)

**NAVFAC** **OTEC Hawaii – Site Assessment Matrix**

| Factor Category         | Description   | Overall Net Weights |
|-------------------------|---|---------------------|
| Platform Siting Factors | Mooring and anchoring, thermal resource depth, metocean conditions, currents, proximity to support base, compatibility with local commercial and military operations, etc | 65%                 |
| Shore-landing Factors   | Shore-landing sites, length of HDD drill, proximity to grid, hazards, environmental permitting, etc   | 9%                  |
| Cable Routing           | Cable route length, cost, permitting, cable route hazards, environmental permitting, etc  | 12%                 |
| General Factors         | Historical and cultural considerations, NAVFAC project requirements compatibility, baseload, electrical infrastructure compatibility, etc                                 | 14%                 |

**NAVFAC** **Evaluation Summary**

|                     | PH - A       | PH-B         | MCBH-A       | MCBH-B      | PMRF-A       | PMRF-B       |
|---------------------|--------------|--------------|--------------|-------------|--------------|--------------|
| Platform Siting     | 3900         | 3859         | 3690         | 3662        | 3410         | 3357         |
| Shore-landing       | 528          | 528          | 392          | 392         | 409          | 409          |
| Cable Routing       | 500          | 500          | 619          | 590         | 639          | 730          |
| General Factors     | 900          | 780          | 740          | 710         | 500          | 470          |
| <b>Total Points</b> | <b>5828</b>  | <b>5667</b>  | <b>5441</b>  | <b>5354</b> | <b>4958</b>  | <b>4966</b>  |
| <b>Total %</b>      | <b>92.5%</b> | <b>90.0%</b> | <b>86.4%</b> | <b>85%</b>  | <b>78.7%</b> | <b>78.8%</b> |

**Highest Scoring Site**

Results presented to Commander Navy Region Hawaii, December 2009

**NAVFAC** **Pearl Harbor – Site “A” Survey Plan**

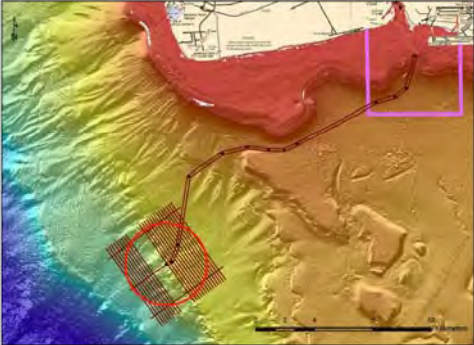



8



**Acquired Data Summary**

- **Sea Floor Mapping:**
  - Multibeam Sonar System (MBSS) Bathymetry
  - Side-scan Sonar
  - Sub-bottom profiles
- **Sediments Core Samples – Coring**
  - Gravity Core Attempts: 10 attempts at four site locations
  - Successful core samples: 3 Full Cores (10 ft) ; 3 Partial Cores (2-3 ft)
  - Harpoon Cone Penetrometer (CPT):
    - Equipment Failure – No Samples Obtained
- **CTD and Water Samples**
  - Four CTD casts were conducted at three sites
    - OTEC site at 1100 meters;
    - Site 1 (2 casts)
    - Site 3, west of the OTEC site in 1500 meters of water
- **Current Measurement Mooring**
  - 6-7 month deployment
  - Full-depth ADCP and CTP measurements

**OTEC Hawaii Coring/CTD Sites and Buoy Location**

**Preliminary Sediment Analysis**

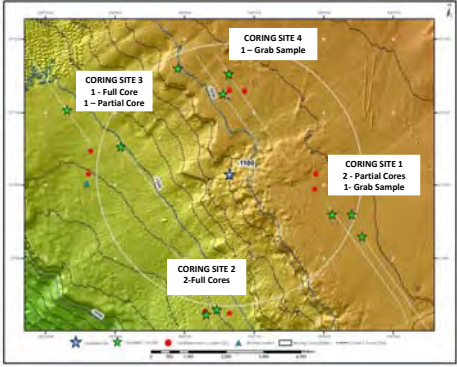
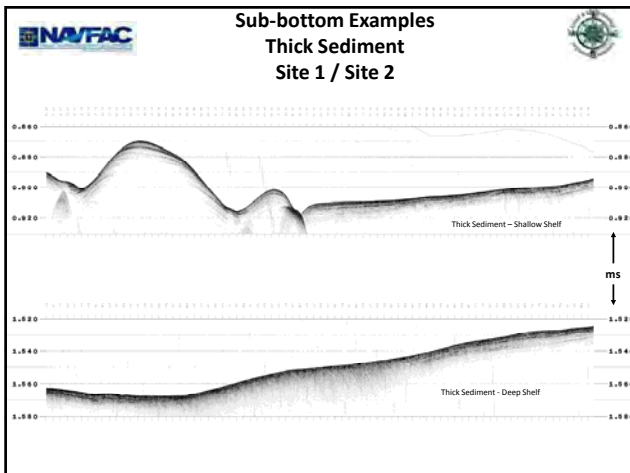
**Example Core Results (preliminary):**

- Site 3 - Lower Plateau
- Water Content and Shear Strength
- Sediment Characteristics:
  - Low-plasticity silt and fine sand
  - Shear strength increasing with depth
- Laboratory analysis of core in progress

**Preliminary Conclusions:**

- Sediment recovered confirms significant regional presence of sediment as interpreted from sub-bottom profile data.
- Sediment characteristics compatible with conventional drag embedment anchors

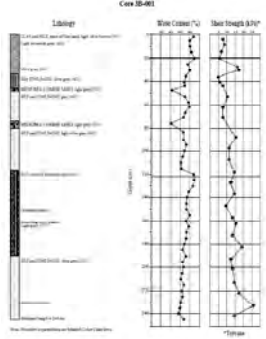

**NAVFAC**

**Phase 2**  
**ADCP Current Measurement**  
**String**

*Nominal 6-month measurement period*

| Depth (m) | Instrument | Sampling Rate | Measurements |
|-----------|------------|---------------|--------------|
| 20        | 37SM       | 30s           | CTP          |
| 50        | 37SMP      | 150s          | CT           |
| 80        | 37SMP      | 150s          | CT           |
| 130       | 37SMP      | 150s          | CTP          |
| 180       | 37SMP      | 150s          | CT           |
| 230       | 37SMP      | 150s          | CT           |
| 330       |            |               |              |
| 450       |            |               |              |
| 500       | ADCP       | 20min         | TP           |
| 650       |            |               |              |
| 850       | 37SM       | 30s           | CTP          |
| 1000      | 37SM       | 30s           | CTP          |
| 1050      |            |               |              |

Labels in diagram:  
 Surface mooring Bar  
 Temperature, Conductivity, and Pressure sensor  
 Temperature and Conductivity sensor along length  
 40" dia ADCP Buoy (Nortek and Dredport being 75 kHz ADCP)  
 Temperature and Conductivity sensor along length  
 Temperature, Conductivity, and Pressure sensor  
 Draft Automatic Release  
 Anchor Weight

↑ RDI 75 kHz Workhorse Longrangers  
 600m Range (LMCO/Makai)  
 ↓

13

**NAVFAC**

**ADCP Current Mooring Deployment**

14

**NAVFAC**

**Survey Data Processing**

- Core sediment samples
  - Field level analysis of selected cores (3) completed on deck
  - Soils lab analysis in process at UH
    - Soil strength, water content, and lithography completed on all samples.
    - Remaining soils analysis by 15 July
- By mid-July:
  - Integrated mosaic processing of high resolution bathymetry and sidescan data available
  - Updated sub-bottom sonar profiles geo-located
  - CTD and water sample reports
  - Evaluating options for generating sediment contour plots (Isopac)
- Survey Reports:
  - Towed Survey, sediment analysis, CTD, and water sample analysis – 15 July
  - Compilation of ADCP and CTD data (Mooring String) – 31 December

15

**NAVFAC**

**Next Steps**

**Additional Core Samples:**

- Evaluating alternative coring approaches to secure sediment samples on upper plateau:
- Objective is to secure sediment samples in the upper plateau in a mid-summer cruise if feasible.
- Alternative is to combine additional sediment coring with mooring recovery in mid-November

**Instrumentation Buoy Retrieval:**

- Mid November planned retrieval

**Final Report:**

- September 2010

16

## OTEC Overview



**OTEC**  
Ocean Thermal Energy Conversion

**Workshop on Ocean Thermal Energy Conversion (OTEC):  
Assessing Potential Physical, Chemical and Biological Impacts  
and Risks**

June 22, 2010

## Anatomy of an OTEC System

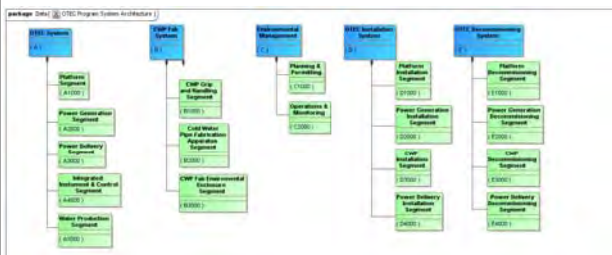

**OTEC**  
Ocean Thermal Energy Conversion

Rev 5  
2 June 2010

OTEC Environmental Workshop, June 2010

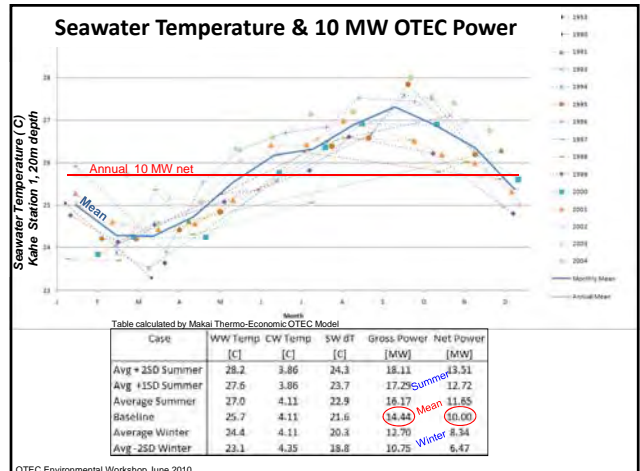
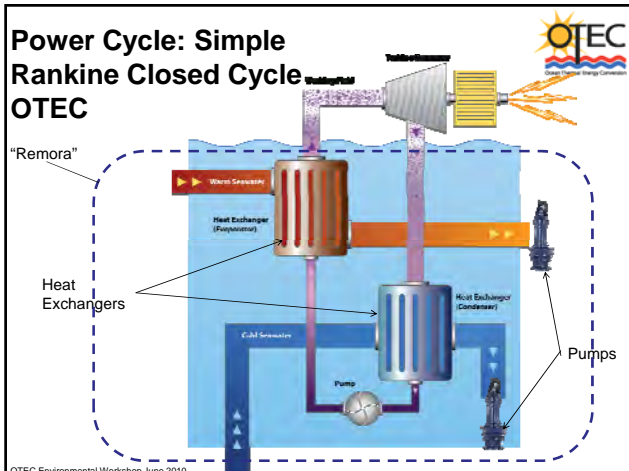

### Gross Power vs Net Power



- **Gross Power** 14.44 MW =>Avg. **Net Power:** 10 MW
- **Key Parasitic Loads**
  - CW Pumps: 2.24 MW
  - WW Pumps: 1.31 MW
  - Ammonia Pumping: 0.18 MW
  - Topsides Load: 0.4 MW

| Typical Component Efficiencies |                  |
|--------------------------------|------------------|
| – Turbo-generator:             | 80%              |
| – Power Cable:                 | 97%              |
| – Seawater Pumps:              | 75%              |
| – Power Cable:                 | Variable 94%-97% |
| – Transformers:                | Variable 98%-99% |

OTEC Environmental Workshop, June 2010

### 10 MWnet Pilot Plant

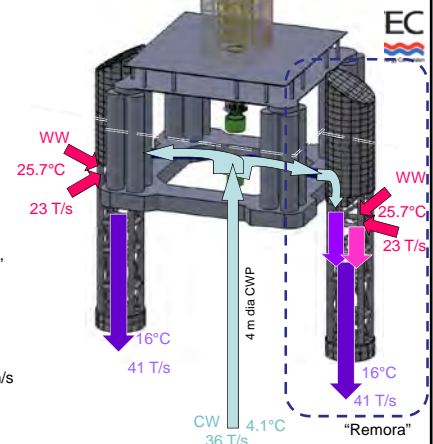

14.4 MW<sub>gross</sub> power

WW inlet at 20m deep  
Screen velocity = 0.15m/s

CW intake at 1000m deep,  
~100m above seabed  
CWP velocity = 2.5m/s

Two discharges at 70 – 90m (TBR) depth with 1 m/s downward velocity

WW: 25.7°C, 23 T/s  
CW: 4.1°C, 36 T/s  
Discharge: 16°C, 41 T/s

4 m dia CWP

EC

“Remora”

OTEC Environmental Workshop, June 2010

### Flow Summary 100 MWnet

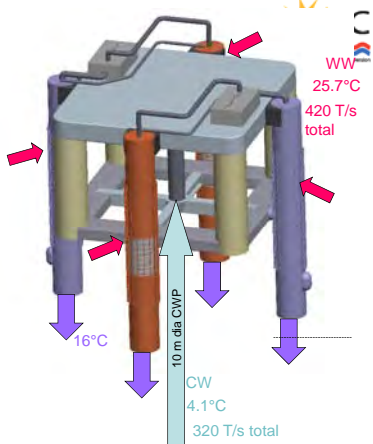

~140 MW<sub>gross</sub> power

WW inlet at 20-30m deep  
Screen velocity = 0.15m/s

CW intake at 1000 - 1200m deep  
Intake ~100m above seabed

Discharges at 70 – 90m (TBR) depth

WW: 25.7°C, 420 T/s total  
CW: 4.1°C, 320 T/s total  
Discharge: 16°C

10 m dia CWP

EC

OTEC Environmental Workshop, June 2010

### What's in a Remora?

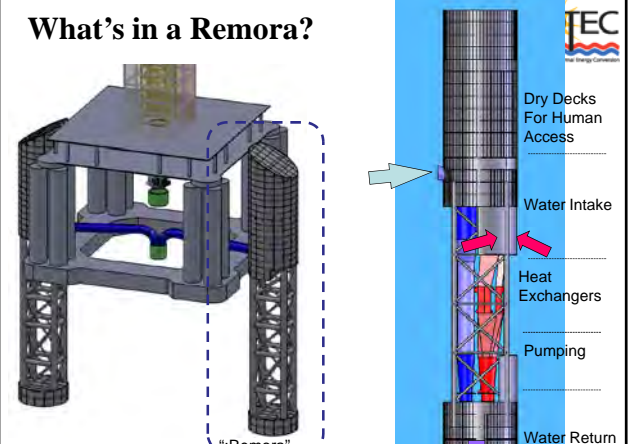

Dry Decks For Human Access

Water Intake

Heat Exchangers

Pumping

Water Return

“Remora”

2/16/10 0930

### Evaporators



- 6 identical "batteries" per Remora
- A3003 brazed aluminum
- Biofouling controlled via hypochlorite treatment
  - Periodic - 1 hour per day
  - Concentration - 70ppb
- Water Flow: 23 tonne/s
- Heat Transfer area: 17111 m<sup>2</sup>

OTEC Environmental Workshop, June 2010

### Condensers

Two 4.3m dia x 7m tall Shell & Tube HX per Remora

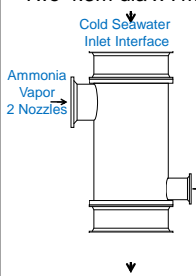

**Material:** Titanium (pending more corrosion test data for Al alloys)  
**Form Factor:** Enhanced Tubes (either twisted or spirally indented)  
**Heat Transfer Area:** 22407 m<sup>2</sup>  
**Water Flow:** 18.3 tonne/s  
**Biofouling control:** N/A



Swirling Flow Enhances Heat Transfer Coefficient on Both Sides without Corresponding Increase in Pressure Drop

Tube support baffles are not required, making compact design

OTEC Environmental Workshop, June 2010

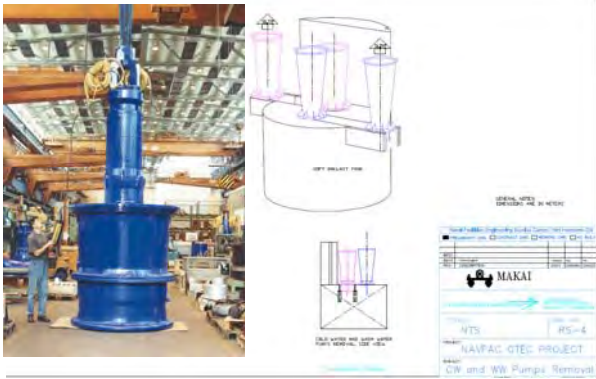
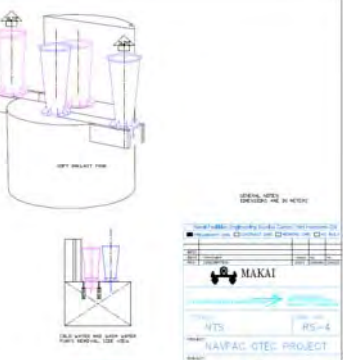

### Seawater Pumps

OTEC Environmental Workshop, June 2010

### Ammonia System

- Minimal valves in seawater
- Redundant pumps within sealed pods
- Full system "charge" approximately 16,000 gallons (10MW plant) NH<sub>3</sub>

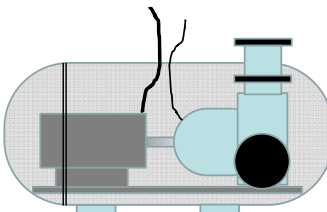
OTEC Environmental Workshop, June 2010

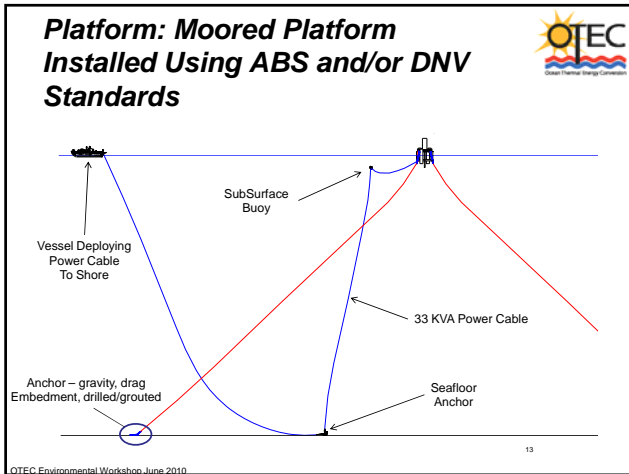

## Potential OTEC Impacts in the Hawaiian Marine Environment

Michael Parke  
NOAA Pacific Islands Fisheries Science  
Center

## Operational Impacts

- Discharge
  - Biostimulation/Inhibition
  - Effects on Fishery Life History
  - Effects on Coral Reefs
  - Physical Impacts
  - Chemical Impacts
  - Regional Impacts
- Impacts to Endangered Species
- Acoustic and Electromagnetic Effects

## Discharge - Biostimulation/Inhibition

- Elevated levels of dissolved inorganic nutrients, primarily phosphate, nitrate and silicate expected to promote blooms of photosynthetic organisms if discharged and contained within the upper ocean or in coastal waters.
  - Changes to microbiology of area/organisms under plume influence
  - Changes to phytoplankton stock composition/concentration and activity rates
  - Changes to zooplankton stock composition/concentration and activity i.e. diel migration
  - Changes to ichthyoplankton stock composition/concentration and activity rates
  - Promotion of harmful algal blooms
  - Promotion of ciguatoxin-producing algae
  - Eggs and larvae movement and layering
- Impacts of elevated levels of dissolved carbon dioxide if discharge contacts the atmosphere.

## Discharge - Impact on Fisheries Life History

- Greater primary production and/or truncated trophic relationships
- Changes to recruitment, mortality, larval ecology
- Changes to temporal and spatial distribution of the early life stages
- Loss of resiliency in complex food webs
- Increase/decrease in fish production
- Changes to taxonomic composition, standing crop, stock structure, age distribution, fecundity, and production
- Dinoflagellate blooms either harm fish populations or make fish inedible
- Need data at multiple spatial and temporal scales



## Discharge - Impacts on Fisheries

- Commercial
  - No longline activity in proposed region, but may impact seasonal opelu and ahi fisheries
  - Impact largely on recruitment
- Recreational
  - Close to numerous small boat harbors
  - May serve as very large FADS
  - May increase/reduce effort/harvest
  - May increase productivity
  - May increase entrainment and or morbidity of eggs, larvae, or juveniles
  - May cause increase in bioaccumulation of toxins
- Changes to Maximum Sustainable Yield (MSY), due to inability to compensate for entrainment or impingement losses, and potential increase in effort

## Coral Reefs

- While few deep-water coral resources have been catalogued at the proposed site, inshore coral reefs in the area are extensive and in relatively good condition.
- Provide habitat for numerous fishery resources, at least during some portion of the individual species' life cycle.
- Impacts on reef fishery habitats may be of greater importance than direct impact on the species themselves (eggs, larvae, adults).
- Physical destruction of coral reefs can sometimes lead to an increase in invasive species and the incidence of ciguatera poisoning.

## Physical Impacts - Discharge

- Vertical motion and dilution of the effluent plume dependent upon the density of the discharge, the configuration of the discharge outlet, the vertical receiving water density gradients, and the presence of currents
- Movement of water mass into the photic zone or upwelled close to shore as a result of Eckman transport
- Impacts of plume settlement on benthos
- Impacts of long or short trajectories for dilution
- Changes to local stratification in terms of salinity and temperature, trace metal concentrations, lower pH of the local ecosystem, and subsequent biological impacts

## Regional Effects

- Effects of large mixed discharge plume in a density stratified environment
- Possible changes to ambient circulation, thermocline/halocline, and concentration/distribution of effluent and water column constituents
- Chemical and biogeochemical impacts of closely spaced commercial OTEC systems can interfere and alter the ocean temperature profile with possible negative environmental consequences
- Impacts from OTEC plumes and operations on nearby uses (aquaculture and recreational uses)



## Endangered Species

- Marine mammals
  - Hawaiian monk seal *Monachus schauinslandi*
  - Humpback whale *Megaptera novaeangliae*
  - False Killer Whale *Pseudorca crassidens*
  - Sperm Whale *Physeter macrocephalus*
  - Sei whale *Balaenoptera borealis* E
  - Cuvier's Beaked Whale *Ziphius cavirostris*
  - Fin whale *Balaenoptera physalus*
  - Spenn whale *Physeter calodoli*
- Sea Turtles
  - Loggerhead sea turtle *Caretta caretta*
  - Green sea turtle *Chelonia mydas*
  - Leatherback sea turtle *Dermochelys coriacea*
  - Hawksbill sea turtle *Eretmochelys imbricata*
  - Olive Ridley sea turtle *Lepidochelys olivacea*
- Birds
  - Newel's shearwater *Puffinus auricularis newelli*
  - Hawaiian dark-rumped petrel *Pterodroma phaeopygia sandwichensis*

## Existing Data from Recent Work

- Hawaiian Ocean Observing System (HIOOS & PACIOOS)
- HURL, HMRG, PIBHMG mapping and benthic characterization work
- Long-term monitoring programs at UH, including HOTS, HF Radio oceanography, internal tides, etc
- USGS studies of geology and dredge spoils
- Microbiology, plankton, plume, circulation, hydrodynamic modeling, benthos characterization as part of Mamala Bay sewage effluent work
- EISs from Hukilau Farms, Barbers Point Harbor, Kahe Power Plant, Ko Olina, etc.
- NOAA and State of Hawaii coral mapping work and characterization of damage from *Casitas* and *Port Royal* groundings

Question: Is the information from this work at the appropriate temporal and spatial resolution? How much is in usable form?

## Intake - Impingement

- Occurs when organisms too large to pass through the intake screen, are pulled against it, and are unable to escape due to the intake current velocity. Causes ecological (loss of a large number of organisms), operational (reduction in cooling water flow), and cost problem (removal and disposal of organisms). Schooling fishes are especially susceptible, and impingement mortalities may involve millions of individuals. Unknown impacts on endangered species such as monk seals and young sea turtles.
- Impingement rates will depend on intake location and velocity, time of day/season, behavior characteristics of the populations of organisms associated with the plant site the year.
- Plant may serve as a fish-attracting device and concentrate organisms where they are in danger of being impinged or entrained.
- Impinged organisms generally fall into the micronekton size category (2-20 cm) and include fishes, macroplanktonic crustaceans, cephalopods, and gelatinous organisms such as coelenterates, salps, and ctenophores. Micronekton are an important intermediate step in the food chain between the zooplankton and commercially important fishes.

## Intake - Primary Entrainment

- Any organism small enough to pass through the intake screens will be entrained in the seawater flowing through the heat exchangers (primary entrainment).
- Organisms subjected to thermal and mechanical stresses as a result of changes in pressure and temperature, shear and acceleration forces, abrasion, and collision with structures.
- Organisms subjected to biocides used to clean the surfaces of the heat exchangers, anticorrosion agents, and corrosion products.

## Intake - Secondary Entrainment

- Secondary entrainment refers to the capture of organisms in discharge waters (effluent plume) as a result of turbulent mixing or behavioral responses.
- The rate at which organisms are entrained in this manner will depend on the discharge flow rate, the near-field dilution, and the average population density along the near-field trajectory of the plume.

## Acoustical and Electromagnetic Field (EMF)

- Noise from plant operation will be principally from the water pumps and the generators. Additional noise would be generated by the actual movement of the water through the system and out the discharge.
- Possible impact on marine mammal echolocation and communication, and on certain coral reef organisms.
- Interference with marine organisms sensitive to electric fields.

## Trace Metals and Biocides



- Variety of toxic metals leached in small amounts through heat exchangers
- Biocides include chlorine and other toxic agents
- Ammonia most common working fluid
- Need to determine risks of bioaccumulation and toxicity during normal operations and in event of spill

## U.S. Department of Energy Wind and Water Power Program



*Michael C. Reed*  
Chief Engineer – Water Power Technologies  
Wind and Water Power Program  
Energy Efficiency and Renewable Energy (EERE)

### U.S. Department of Energy Water Power Program

**Develop and employ novel technologies, improved operational procedures, and rigorous analysis to assess the potential extractable energy from domestic rivers, estuaries and ocean waters and help industry harness this renewable, emissions-free resource through environmentally sustainable and cost-effective electric generation.**

2 | Wind and Water Power Program eere.energy.gov

### Ocean Thermal Energy



- OTEC represents the most significant global water power resource and one of the largest renewable energy resources available.
  - Very conservative estimates place the practically available resource at 3-5 TW, greater than projected global electric power consumption in 2025 (projected at 2.7 TW)<sup>1</sup>.
- Ocean thermal systems provide stable and predictable power output, and are thus ideally suited for base load applications.
  - Near-shore ocean thermal resources are often concentrated in areas where electricity prices are highest and power is generated from the most polluting sources (esp. diesel). In the US, prime OTEC resource locations include Hawaii, Florida, and many military bases.
  - Offshore resources are even more extensive, and will be harnessed and exported by the country that develops the best technologies first.

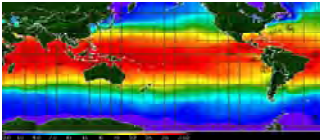

<sup>1</sup> Nihous, "A Preliminary Assessment of Ocean Thermal Energy Resources," ASME, 2007.

3 | Wind and Water Power Program eere.energy.gov

### Current DOE OTEC Technology Development Research Efforts



**DOE had an active OTEC program through the 1980's.**

**Current OTEC efforts more limited but include:**

- OTEC Resource Assessment
- Potential Impacts of OTEC Intakes on Aquatic Organisms
- Life Cycle Cost Analysis for OTEC Facilities
- OTEC "Mist Lift" Open Cycle Design
- Modular OTEC Heat Exchangers
- OTEC Power Cables



4 | Wind and Water Power Program eere.energy.gov



### DOE OTEC Research through National Marine Renewable Energy Centers



#### National Marine Renewable Energy Center of Hawaii:

•The University of Hawaii in Honolulu, HI, established a center to facilitate the development and implementation of commercial wave energy systems in their state and to assist the private sector in moving **ocean thermal energy conversion systems beyond proof-of-concept to pre-commercialization, long-term testing.**



### DOE Responsibilities under the OTEC Act (1980)



- Gives the Secretary of Energy authority to approve OTEC demonstration projects
- Unique role for DOE – mainly an R&D institution
- DOE is working closely with NOAA to develop an approval process for demonstration projects but has not finalized a process yet
- DOE has yet to receive any OTEC demonstration project applications



### NOAA OTEC Environmental Workshop, June 2010

#### OTEC Plumes

Pat Grandelli, P.E.  
Greg Rocheleau

**Makai Ocean Engineering, Inc.**  
PO Box 1206  
Makai Pier, Kailua, Hawaii 96734  
www.makai.com

[Pat.Grandelli@makai.com](mailto:Pat.Grandelli@makai.com)

Makai Ocean Engineering, Inc. Otec Plume

### Next Few Minutes

- Makai
  - Earlier OTEC Projects
  - 80MW CW project
- Plume Modeling
  - Situation
  - OTEC Hydrodynamic Model.
  - 100 MW - currents
  - 100 MW - 2 discharge depths
  - Video
  - 10 MW Results
  - Mixed vs unmixed discharge
  - Three 100 MW plants

### Makai Ocean Engineering - 1973

- Subsea Pipes & Subsea Software
- Mini-OTEC Pipe, Mooring & layout
- Four pipes at NELHA
- Other Studies
- ONR 2005 -> Today
- Another CW project - during question time

Mini-OTEC 1978

NELHA 55" Pipe 2001

250 kW OTEC 1993-1998

### OTEC Plume Model

- Ongoing development funded by CEROS

#### Regional Modeling Studies of 100MW Capacity OTEC Thermal Plumes off West Oahu

Makai Ocean Engineering, Inc.

PO Box 1206  
Makai Pier, Kailua, Hawaii 96734  
www.makai.com

Pat Grandelli, P.E.  
Greg Rocheleau  
[Pat.Grandelli@makai.com](mailto:Pat.Grandelli@makai.com)

June 2010  
Approved for Public Release, Distribution Unlimited

This effort is sponsored by the Defense Advanced Research Projects Agency and the National Defense Center of Excellence for Research in Ocean Sciences. Content of the information does not necessarily reflect the position or the policy of the Federal Government or the State of Hawaii. No official endorsement should be inferred.

Makai Ocean Engineering, Inc. Otec Plume



### OTEC Design Overview:

What arrangement of:

- Temperature
- Intake depth & velocity
- Discharge depth & velocity

can be operated in a sustainable manner?

Sustainability = No thermal resource degradation  
Sustainability = No adverse nutrient redistribution

**Major Flows**

One 100 MW plant:  
400 m<sup>3</sup> /sec Warm SW  
320 m<sup>3</sup> /sec Deep SW

1000 MW:  
2/3 of cubic km per day



**Density of OTEC Intake & Discharge Seawater**

Warm intake water is cooled, becomes more dense.  
Cold deep intake water is warmed, becomes less dense.

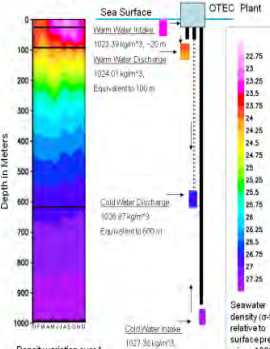

Sea Surface  
Warm Water Intake: 1023.39 kg/m<sup>3</sup>, -20 m  
Warm Water Discharge: 1024.01 kg/m<sup>3</sup>, Equivalent to 100 m  
Cold Water Discharge: 1029.87 kg/m<sup>3</sup>, Equivalent to 1000 m  
Cold Water Intake: 1027.36 kg/m<sup>3</sup>, From 1000 ft deep of Oahu (2007)

Density variation over 1 year period 100-km North of Oahu (2007)

Seawater density (σ-t) relative to surface pressure minus 1000 kg/m<sup>3</sup>

**Otec Hydrodynamic Model**

- Sophisticated model: Discharge plume, intake flow, geometry, density, & mixing
- Nest the OTEC model inside the dynamic OOS-developed Hawaii Regional Ocean Model

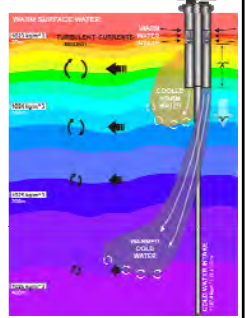
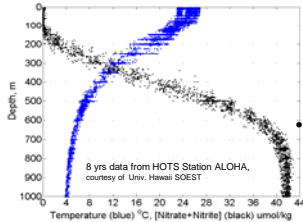
Use to define the plant(s) geometry, power & spacing for sustainable & economic operation.

- Nitrate is limiting nutrient in the photic zone, high levels may cause algal blooms
- Need 40:1 to 20:1 dilution of deep water to reach ambient levels at 100-200m deep

Makai Ocean Engineering, Inc. Otec Plume Lockheed Spar 1975

### Otec Hydrodynamic Model

- Sophisticated model: Discharge plume, intake flow, geometry, density, & mixing
- Nest the OTEC model inside the dynamic OOS-developed Hawaii Regional Ocean Model

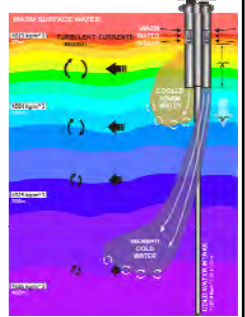
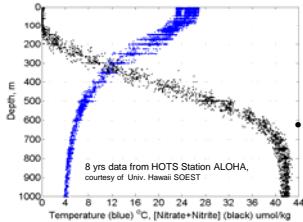
Use to define the plant(s) geometry, power & spacing for sustainable & economic operation.

- Nitrate is limiting nutrient in the photic zone, high levels may cause algal blooms
- Need 40:1 to 20:1 dilution of deep water to reach ambient levels at 100-200m deep

Makai Ocean Engineering, Inc. Otec Plume

### OTEC Plume Modeling Technique

- Nested within University of Hawaii Regional Ocean Model (HiROM)
- EFDC domain forced with Temperature, Salinity, U,V, and Z<sub>surface</sub>
- Coupled with near-field plume model

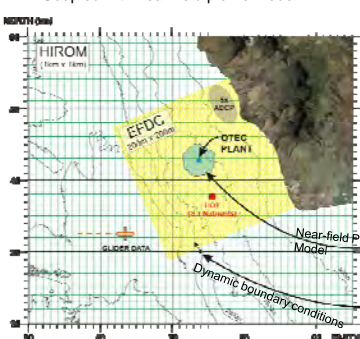
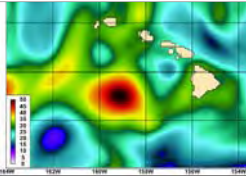
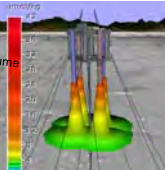
Makai Ocean Engineering, Inc. Otec Plume

### Effects of Current on Near-Field Plume

- Increases in current strength (0-70cm/s) cause a significant increase in the mixing and entrainment of near-field plumes, resulting in shallower terminal depths with a greater dilution

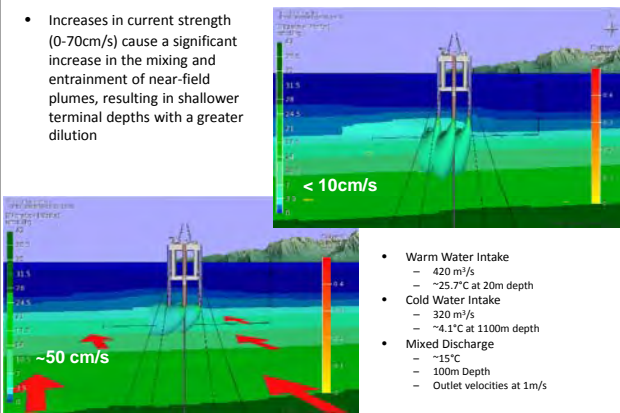

- Warm Water Intake
  - 420 m<sup>3</sup>/s
  - ~25.7°C at 20m depth
- Cold Water Intake
  - 320 m<sup>3</sup>/s
  - ~4.1°C at 1100m depth
- Mixed Discharge
  - ~15°C
  - 100m Depth
  - Outlet velocities at 1m/s

Makai Ocean Engineering, Inc. Otec Plume

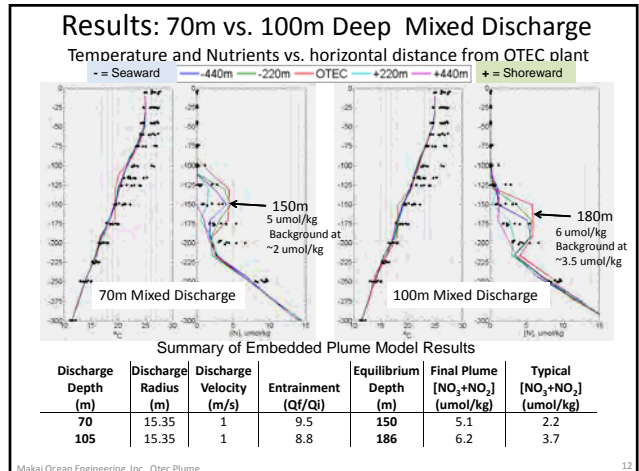
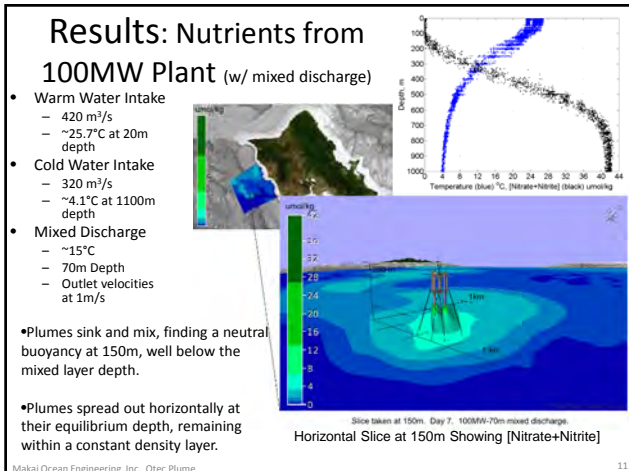
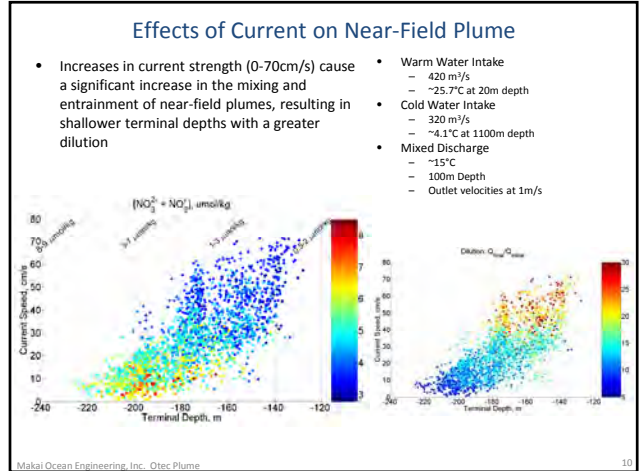
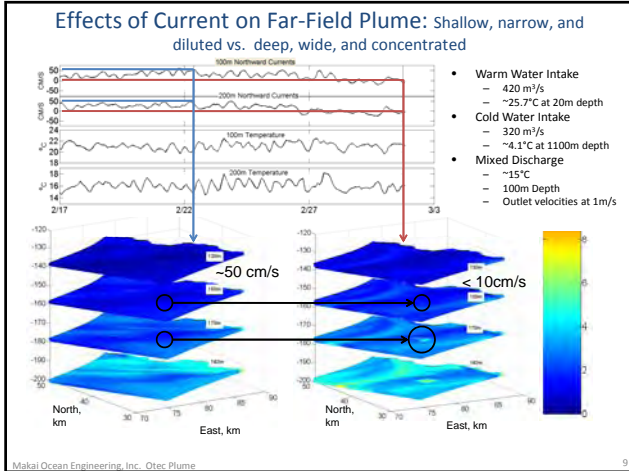

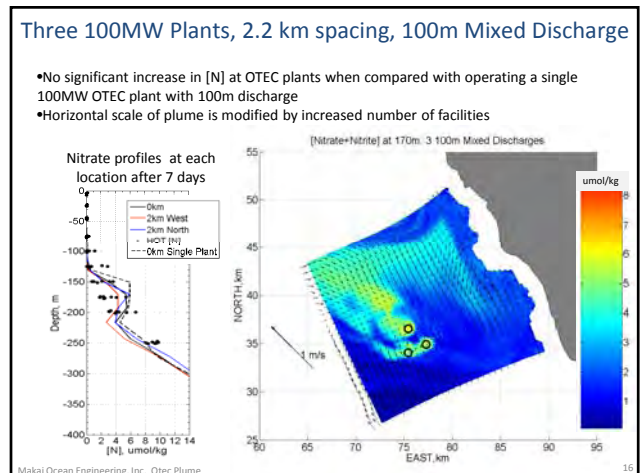
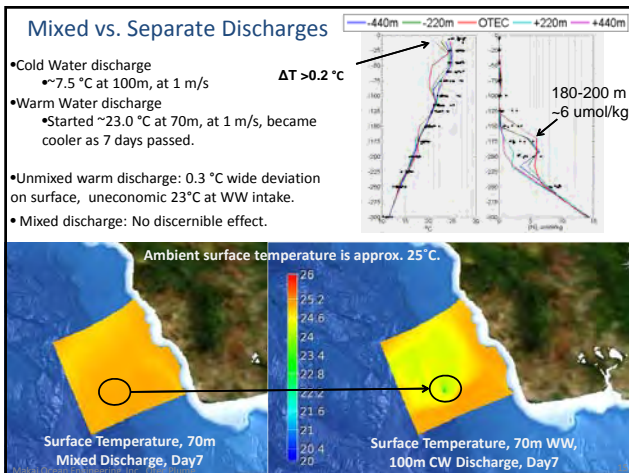
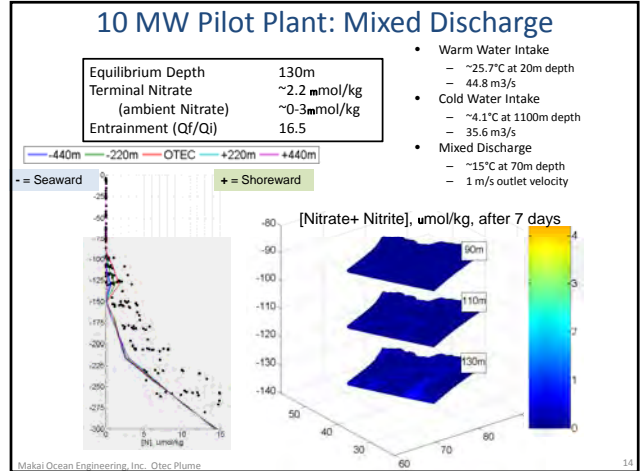
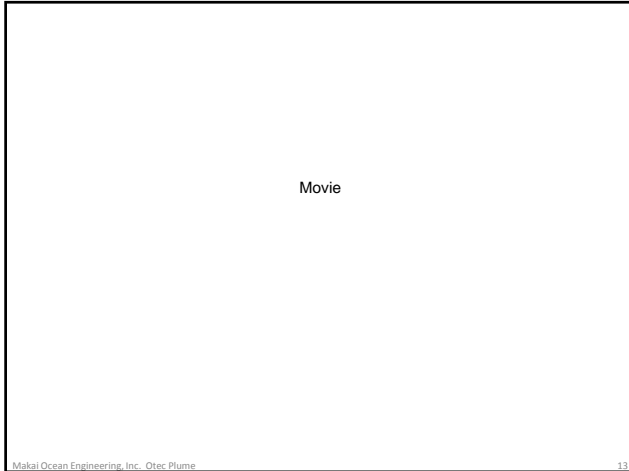



### Conclusions & Questions

- A realistic, dynamic plume model has been developed for single and multiple offshore OTEC plants.
- The plume model is helping us make design decisions.
- Designs for mixed discharge plumes seem more sustainable (T & N) than unmixed discharge plumes.
- Mixed discharge OTEC plants will raise nutrient levels, but remain below the photic zone and within natural variability.
- Further biogeochemical modeling would be useful.

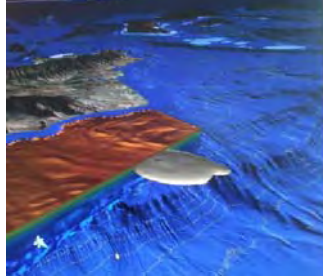

Thank you for attending. Questions?

### 2040 A Massive Energy Source ?

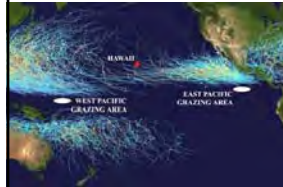

TABLE 1: HYDROGEN PRODUCTION FROM DOMESTIC RESOURCES TO PRODUCE 40 MILLION SHORT TONS OF HYDROGEN FUEL FOR 150 MILLION VEHICLES

| Resource                                     | Needed for Hydrogen Annually | Resource | Footprint Required        |
|--|------------------------------|----------|---------------------------|
| <b>Reforming and / or Partial Oxidation</b>  |                              |          |                           |
| Natural Gas                                  | 95 million tons              | 49 years | 400 plants                |
| Coal   | 310 million tons             | 89 years | 280 plants                |
| Biomass                                      | 400-800 million tons         | n/a      | 400 - 600 plants          |
| <b>Water Electrolysis or Thermo-Chemical</b> |                              |          |                           |
| Wind   | 555 GW <sub>e</sub>          | n/a      | North Dakota Class 3 Wind |
| Solar  | 740 GW <sub>e</sub>          | n/a      | 3750 sq. miles            |
| Nuclear (electrolysis)                       | 216 GW <sub>e</sub>          | n/a      | 200 plants                |
| Nuclear (thermo-chemical)                    | 300 GW <sub>e</sub>          | n/a      | 125 plants                |
| Above information is condensed from [3].     |                              |          |                           |
| OTEC   | 216 GW <sub>e</sub>          | n/a      | 500 - 1000 plants         |

- Similar vision as 1980 OTEC Act

### 1998 Cornell University – Cayuga Lake, NY

- 1.6m dia pipe,
- Use 1.2 m<sup>3</sup>/sec
- Saves 20MW
- Rejects 4 hr of sunlight to Lake
- Electric power plant on same lake
- Awards galore
- 2004 Permit Renewal ???

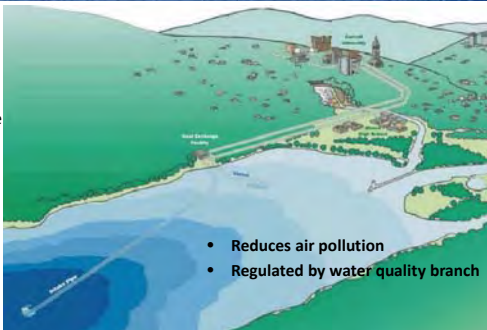

- Reduces air pollution
- Regulated by water quality branch

## OTEC Environmental Impact: Historical Perspective

Luis A. Vega, Ph.D.  
Hawai'i National Marine Renewable Energy Center  
Hawai'i Natural Energy Institute  
University of Hawai'i

OTEC Potential Environmental Impact  
HINMREC-HINEI-UH

1



## ISOMETRIC CUTAWAY OF THE OTEC-1 TEST PLATFORM, A CONVERTED NAVY T-2 TANKER

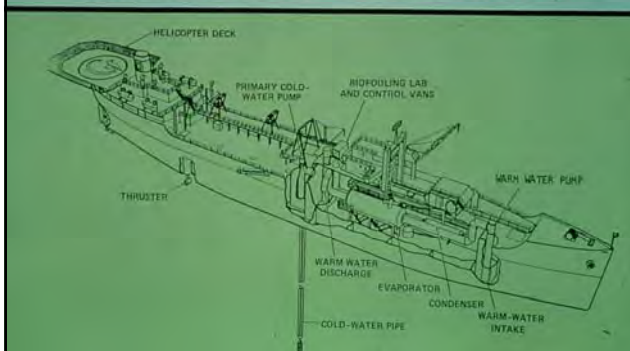

## 210 kW OC-OTEC Experimental Plant

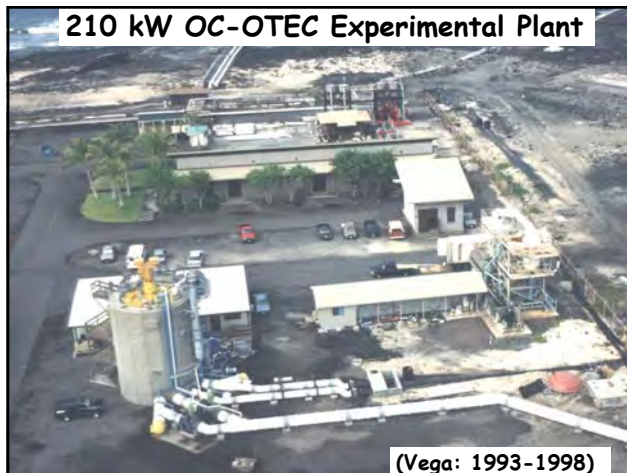



Desalinated Water Production (Vega: '94-'98)

### 50 kW CC-OTEC (NH<sub>3</sub>) Test Apparatus



(Vega: 1999)



OTEC Potential Environmental Impact HINMREC-HNEI-UH

7

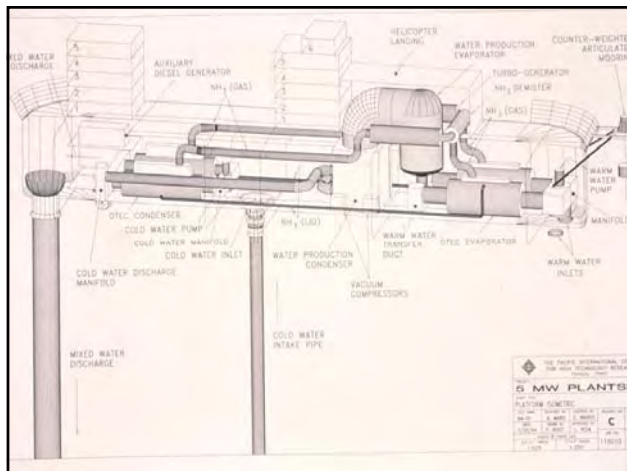

## Conclusion: Major Issue

- Utilizing ocean water drawn from ~ 1,000 m depths is the only activity that differentiates OTEC from well established regulated industrial activities;
- Major Question: What would be the effect of the OTEC water returned below the photic zone?
- The only way to evaluate this major OTEC differentiator is to obtain field data with a pilot/demonstration/pre-commercial plant sized at ~ 5 to 10 MW;
- Firstly, NOAA/DOE must concentrate in developing the monitoring protocol for evaluating the environmental impact of OTEC operations before embarking into considering all potential OTEC designs.

OTEC Potential Environmental Impact  
HINMREC-HNEI-UH

9

## Demonstration Plant (OTEC Act)

*“a test platform which will not operate as an OTEC facility or plantship after conclusion of the testing period”.*

**An EIS could be required** if *“there are other permits to be obtained that are considered a major federal action”.*

OTEC Potential Environmental Impact  
HINMREC-HNEI-UH

10

## Conclusion: EIS a MUST

- An EIS and related permits et al will have to be obtained/secured;
- The 1981 Baseline EIS along with References 2 and 3 (next page) need to be updated, however, Table-of-Contents are complete;
- Artificial Upwelling: There is a misconception that OTEC will biostimulate the photic zone but OTEC designs should not provide a *“sustainable flow of relatively nutrient rich deep water over a wide ocean swath and within the photic zone”*.

OTEC Potential Environmental Impact  
HINMREC-HNEI-UH

11

## References

(1) NOAA July 1981, *Final EIS for Commercial OTEC Licensing*;

(2) NOAA Technical Report NMFS 40, June 1986, Myers et al *The Potential Impact of Ocean Thermal Energy Conversion (OTEC) on Fisheries*

*...Due to the lack of a suitable precedent, however, there will remain some level of uncertainty regarding these initial conclusions until a pilot plant operation can be monitored for some period of time...*

(3) NOAA Technical Memorandum, John Harrison, February 1987, *The 40 MW, OTEC Plant at Kahe Point, Oahu, Hawaii: A Case Study of Potential Biological Impacts* [NB uses marine causeway]

OTEC Potential Environmental Impact  
HINMREC-HNEI-UH

12

## Phytoplankton Pigment Concentration

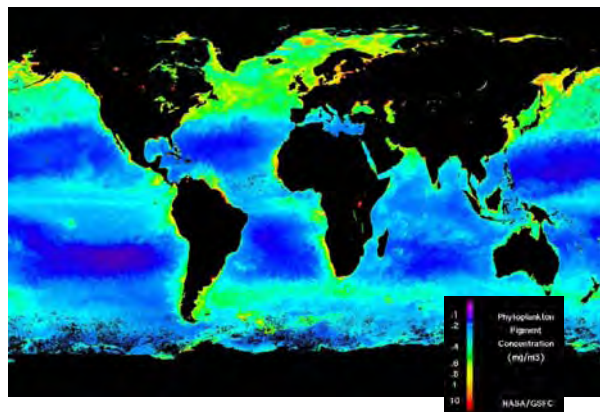

## Euphotic Zone: Tropical Oceans

- The euphotic zone: layer in which there is sufficient light for photosynthesis;
- Conservative Definition: 1 % light-penetration depth (e.g., 120 m in Hawaii);
- Practical Definition: biological activity requires radiation levels of at least 10 % of the sea surface value (e.g., 60 m in Hawaii);
- Is 1990's "Practical Definition" valid in 2010?

OTEC Potential Environmental Impact  
HINMREC-HNEI-UH

14

## OTEC Return Water

- Mixed seawater returned at 60 m depth → dilution coefficient of 4 (i.e., 1 part OTEC effluent is mixed with 3 parts of the ambient seawater) → equilibrium (neutral buoyancy) depths below the photic zone;
- Marine food web should be minimally affected and sea surface temperature anomalies should not be induced.

OTEC Potential Environmental Impact  
HINMREC-HNEI-UH

15

## Construction

OTEC Construction phase:

- similar to construction of power plants; shipbuilding; and, offshore platforms;

OTEC Potential Environmental Impact  
HINMREC-HNEI-UH

16

## Operations

- Unique to OTEC is the movement of seawater streams and the effect of passing such streams through the components before returning them to the ocean;
- Losses of plankton, fish eggs and larvae, as well as juvenile fish, due to impingement and entrainment may reduce fish populations (site and flow dependent).

OTEC Potential Environmental Impact  
HINMREC-HNEI-UH

17

## Operations

- CC-OTEC handling of hazardous substances is limited to the working fluid (NH<sub>3</sub>) and the biocide (Cl<sub>2</sub>, evaporator biofouling);
- None for OC-OTEC

OTEC Potential Environmental Impact  
HINMREC-HNEI-UH

18

## Operations

- Use of Cl<sub>2</sub> and NH<sub>3</sub> similar to other human activities;
- Cl<sub>2</sub> biocide for OTEC Evaporator is < 5% of EPA Limit;
- *Allowable working fluid and biocide emissions from OTEC will difficult to detect.*

OTEC Potential Environmental Impact  
HINMREC-HNEI-UH

19

## CO<sub>2</sub> Outgassing

- CO<sub>2</sub> out-gassing from the seawater used for the operation of an OC-OTEC plant is < 0.5% the amount released by fuel oil plants;
- The value is even lower in the case of a CC-OTEC plant.

OTEC Potential Environmental Impact  
HINMREC-HNEI-UH

20



### Environmental Impact

- OTEC can be an environmentally benign alternative for the production of electricity and desalinated water in tropical islands
- Potentially detrimental effects can be mitigated by proper design

### 1990's Major Question:

Can OTEC have an impact on the environment below the photic zone and, therefore, long-term significance in the marine environment?

### Annex: Eddies & Internal Waves

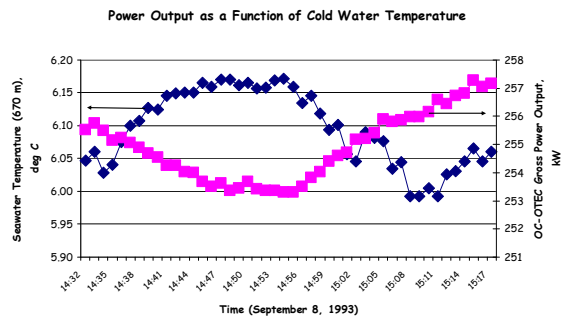

1-minute avrg./1-sec samples :  $\lambda \sim 3,500\text{m}$ ;  $P \sim 60$  minutes;  $H \sim 50$  m

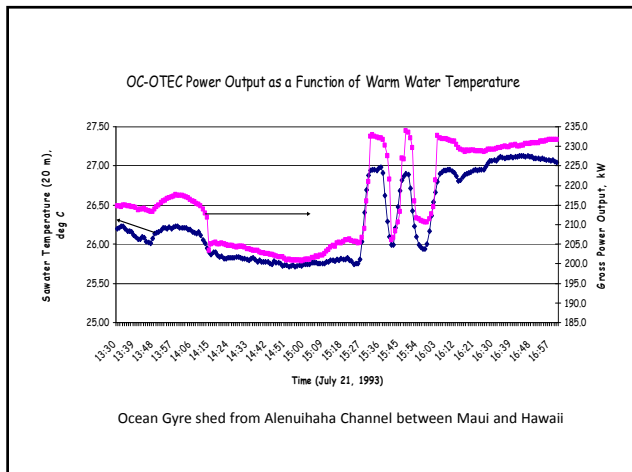

August 2008 Temp. Differential

OTEC Potential Environmental Impact  
HINMREC-HNEI-UH 26

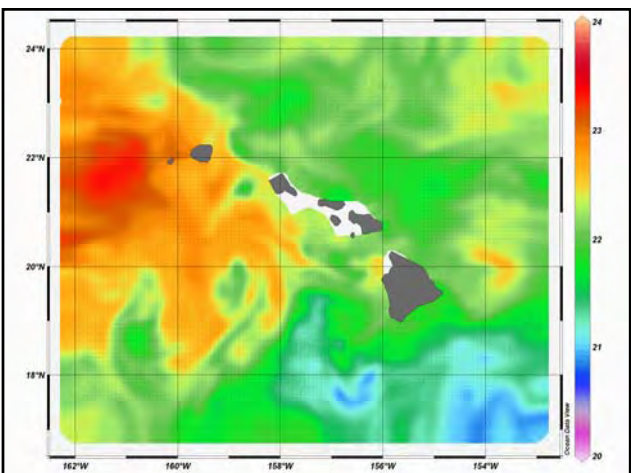
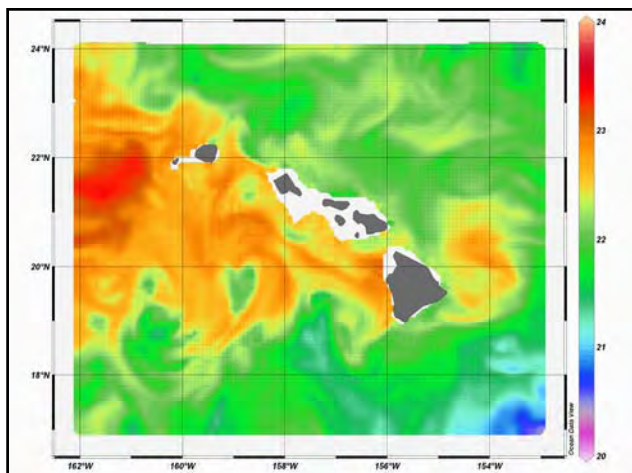



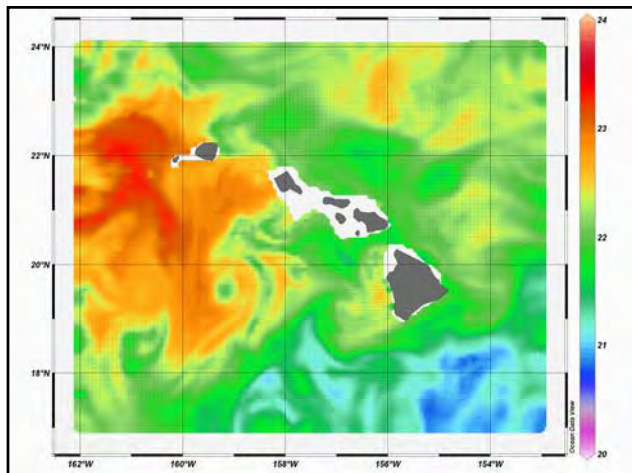
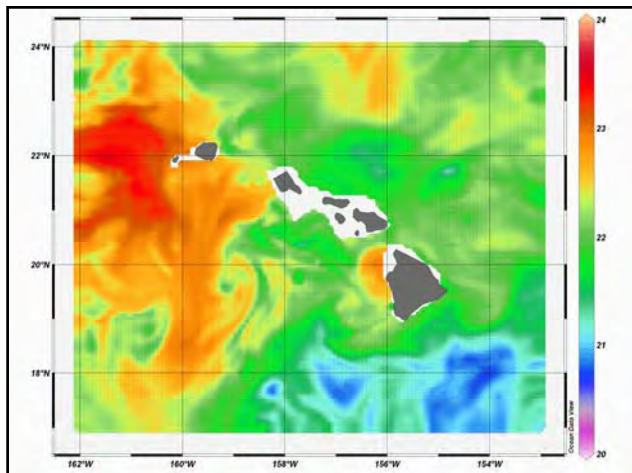
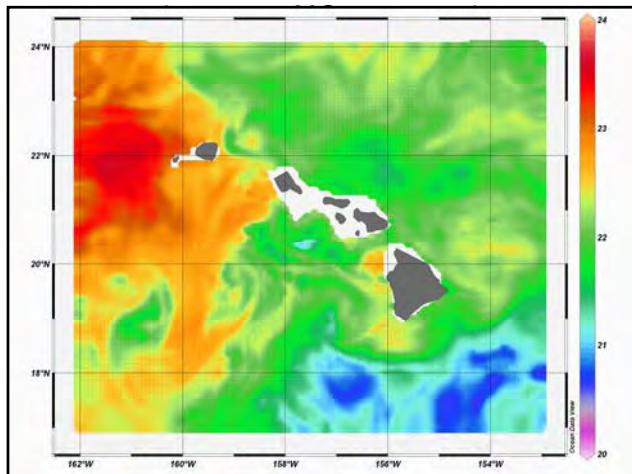
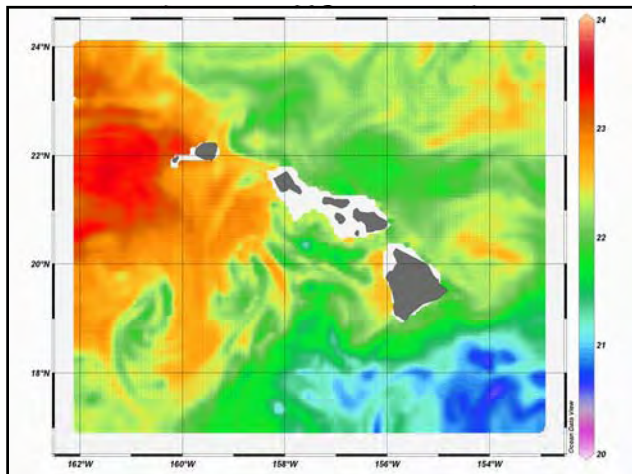

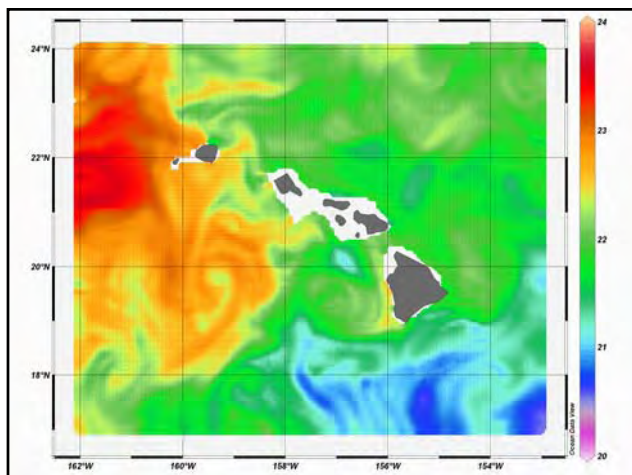
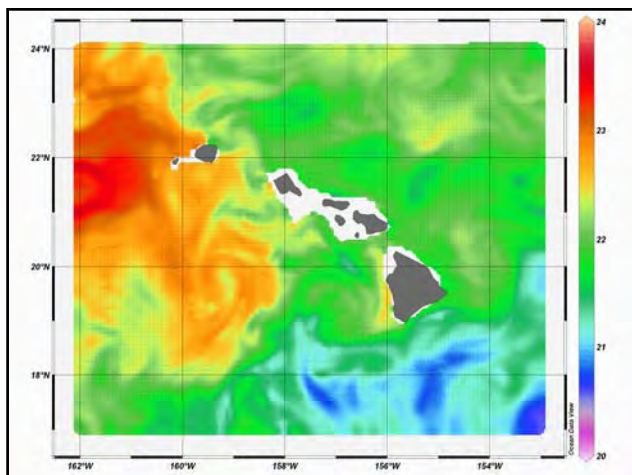
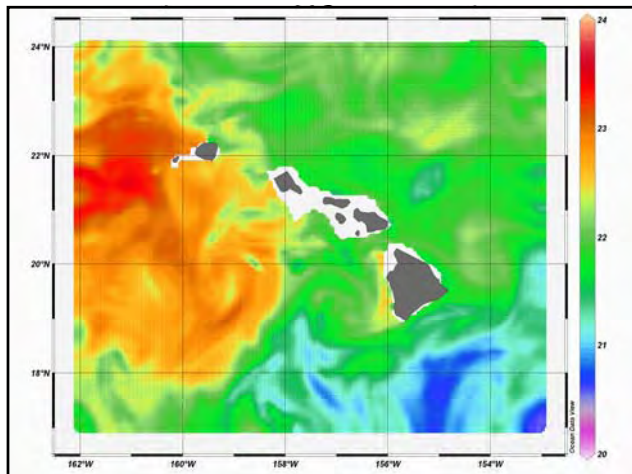
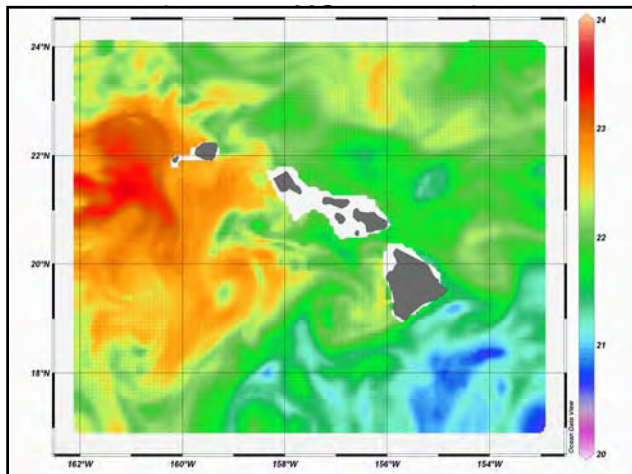

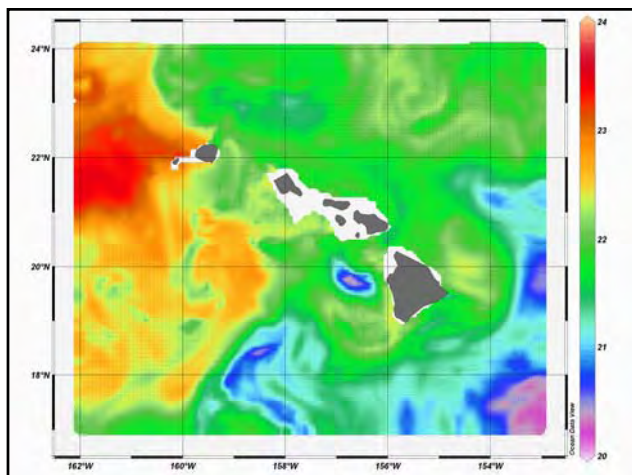
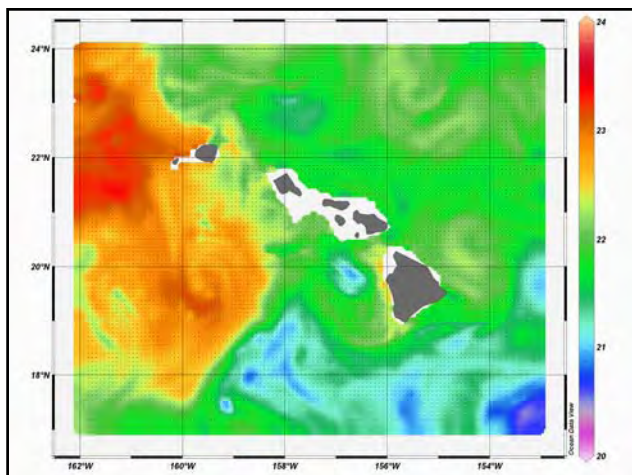
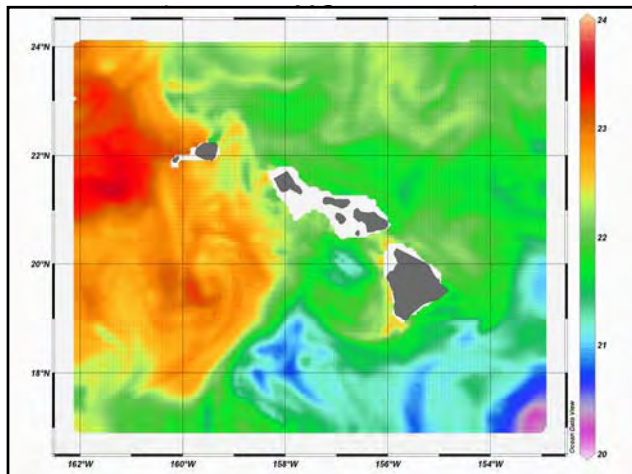
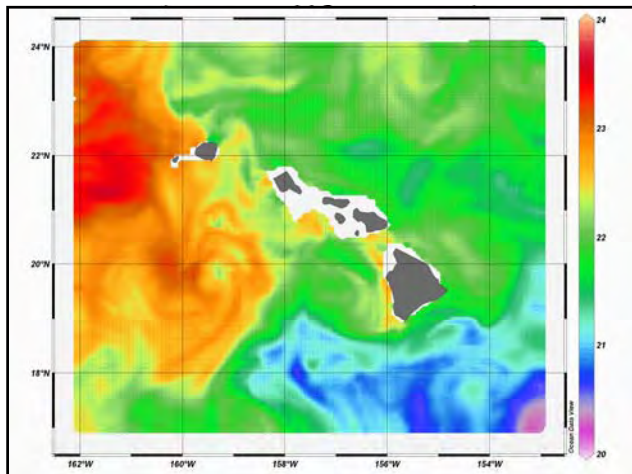



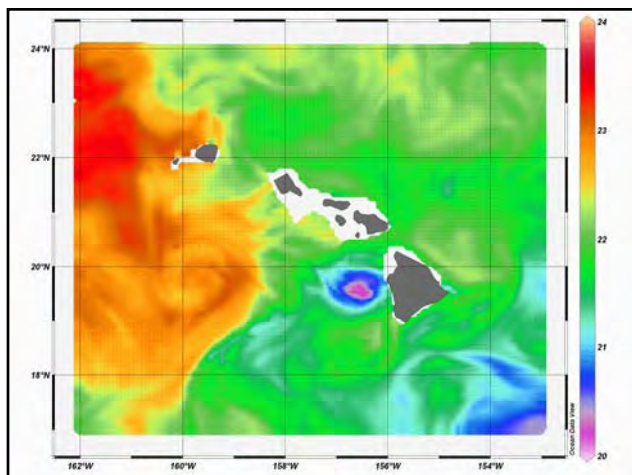
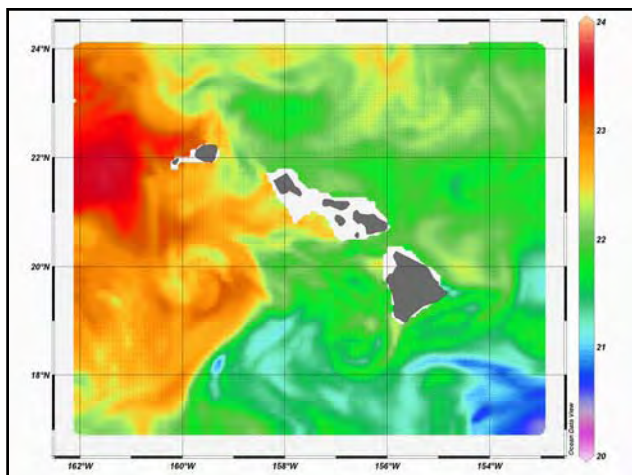
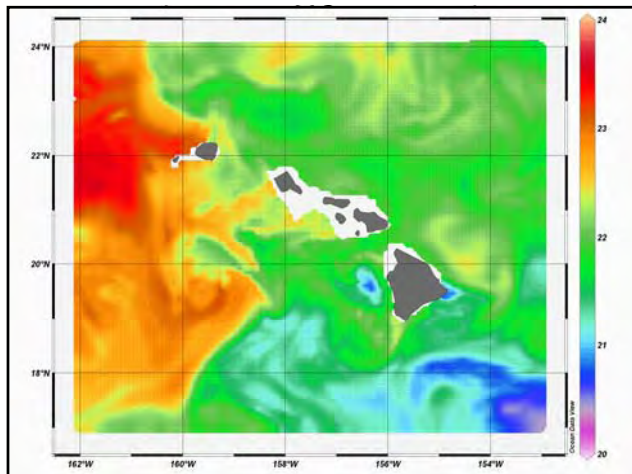
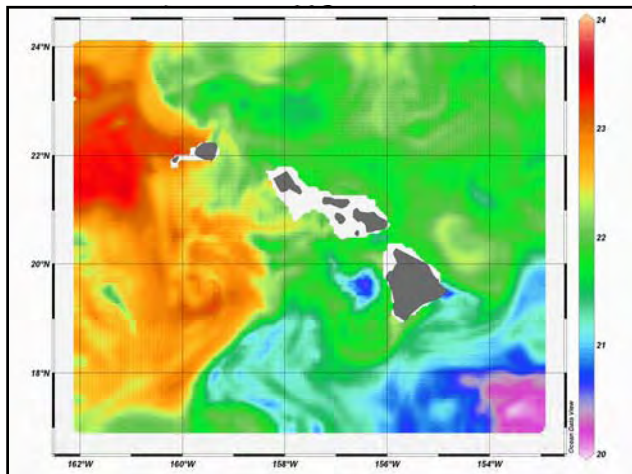

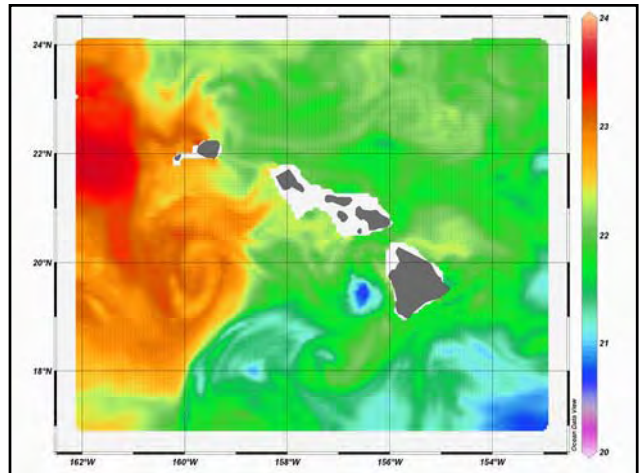
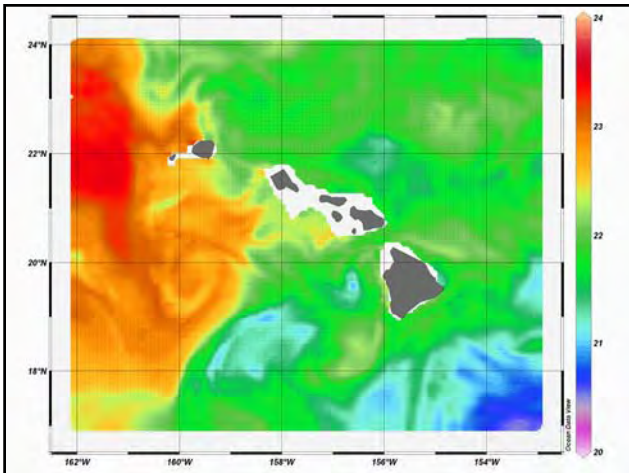
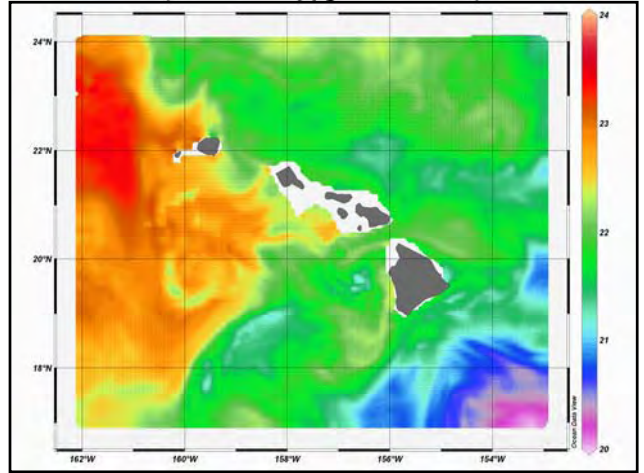
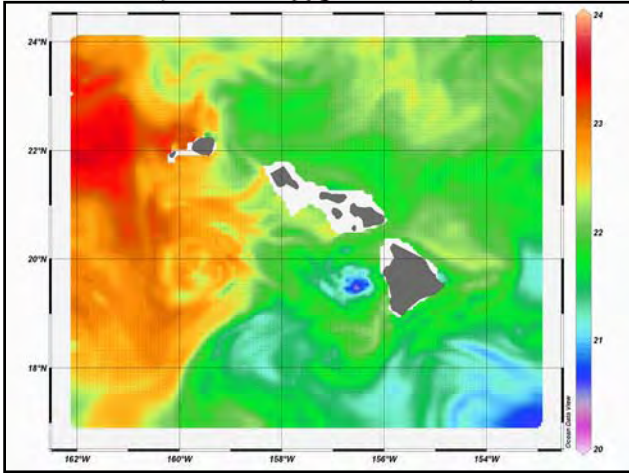

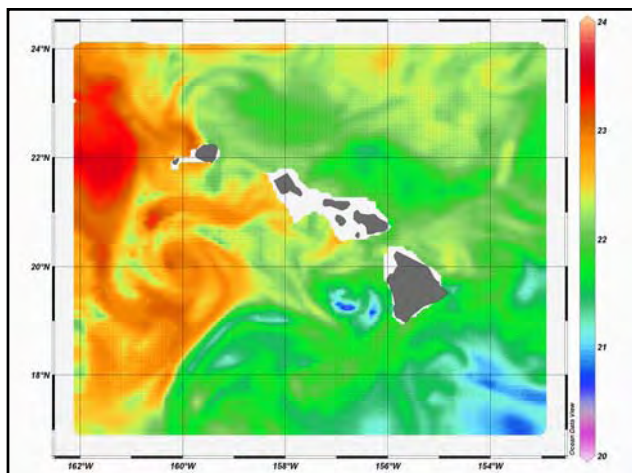
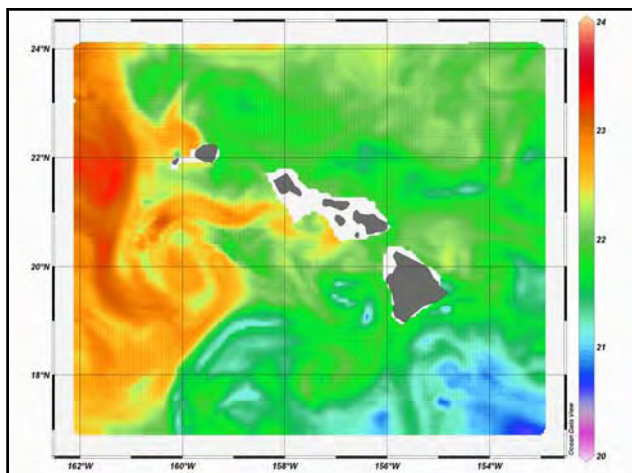
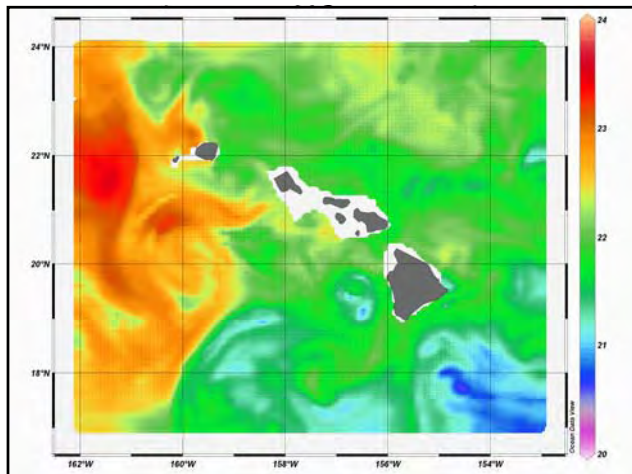
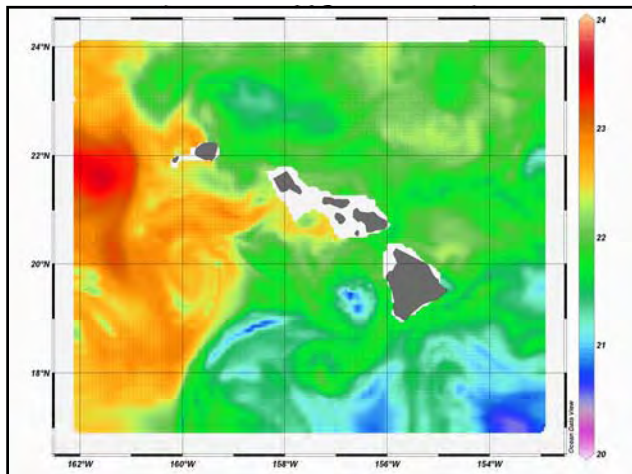



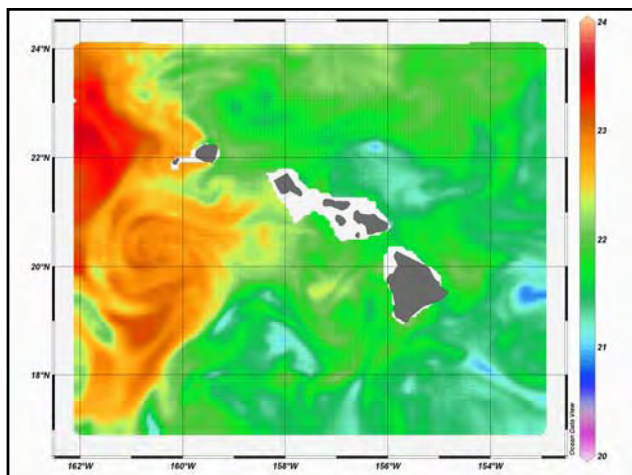
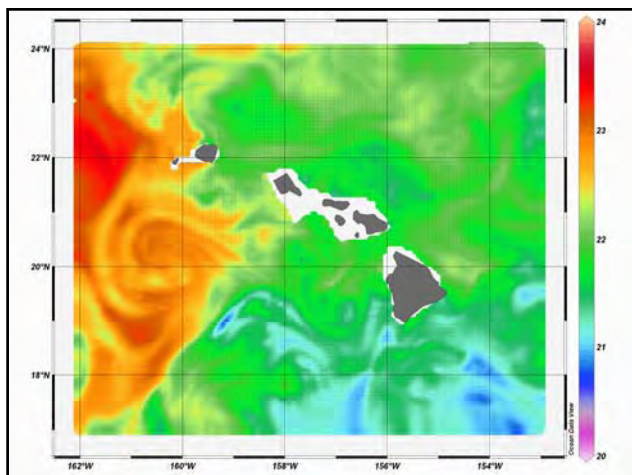
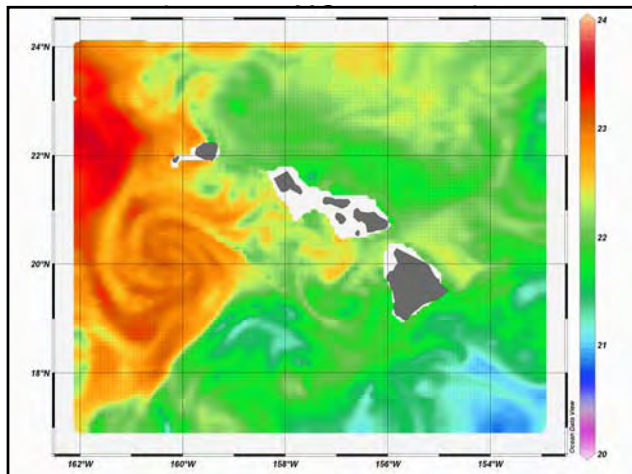
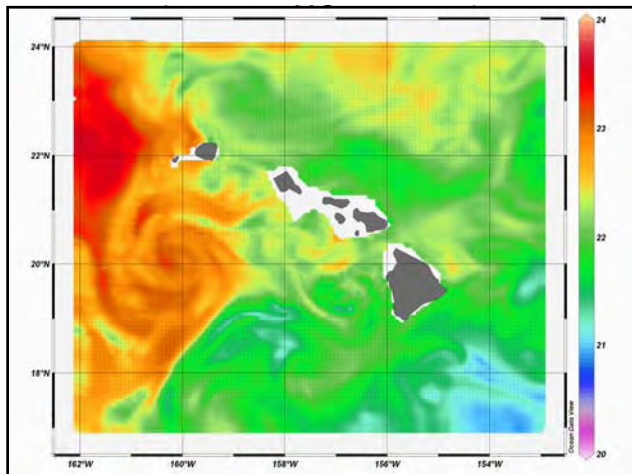

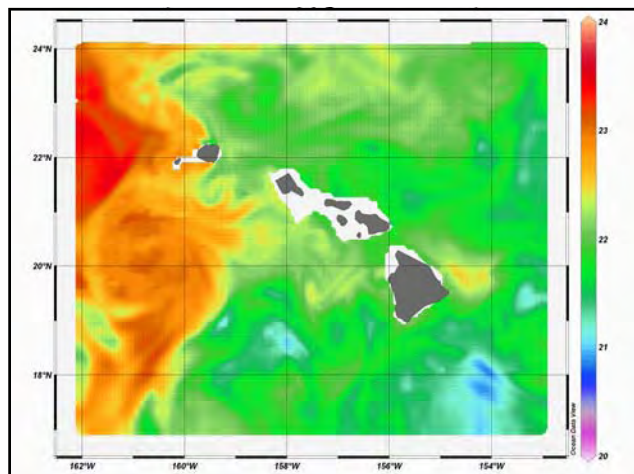



# **APPENDIX H:**

## **OTEC Handout**

# OFFSHORE OTEC FACILITY



Warm Water Intake  
25°C (77°F)

Ocean Surface

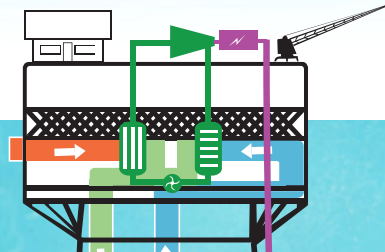

Discharge  
16°C (61°F)

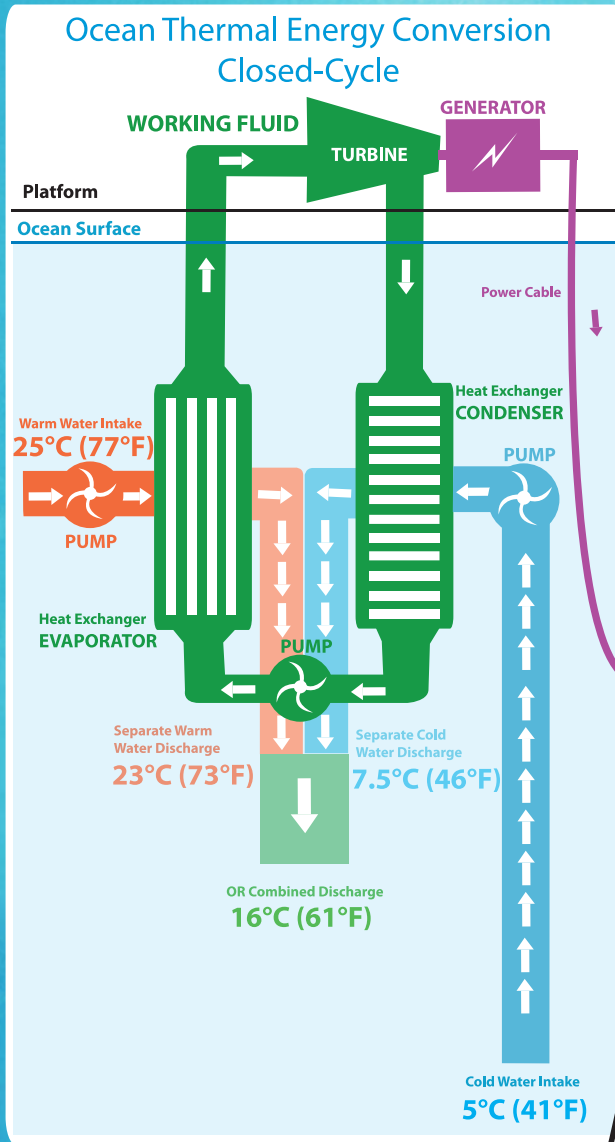

1000 m (3300 ft)

Cold Water Intake  
5°C (41°F)

Mooring Line

Power Cable to Shore

Ocean Bottom

Anchor