

# Technical Readiness of Ocean Thermal Energy Conversion (OTEC)

**November 3 – 5, 2009**

National Oceanic and Atmospheric Administration  
National Ocean Service  
Office of Ocean and Coastal Resource Management

Coastal Response Research Center  
University of New Hampshire



## FOREWORD

The Coastal Response Research Center, a partnership between the National Oceanic and Atmospheric Administration (NOAA) Office of Response and Restoration (ORR) and the University of New Hampshire (UNH), develops new approaches to marine environmental response and restoration through research and synthesis of information. In 2009, the center partnered with NOAA's Office of Ocean and Coastal Resource Management (OCRM) to host a series of workshops to gather information about Ocean Thermal Energy Conversion (OTEC). The Ocean Thermal Energy Conversion Act of 1980 (OTECA) designates NOAA as the lead licensing agency for OTEC projects. All federal authorizations, with the exception of those of the U.S. Coast Guard, are to be issued under the NOAA license and within the procedural timeframes of OTECA. As the primary licensing agency, NOAA OCRM sponsored these workshops, developed the agenda and workshop goals, and were integral in the synthesis of information obtained from the workshop.

The first workshop, held in November, 2009 at the University of New Hampshire in Durham, NH, aimed to assess the technical readiness of key components of OTEC technology. This report provides a qualitative analysis of the technical readiness of seven key components of OTEC technology: cold water pipe, platform/pipe interface, heat exchangers, platform, pumps and turbines, power cable, and platform mooring. The report is designed to serve as a resource for NOAA OCRM and governmental decision makers, as well as the OTEC community to summarize the current state of technical readiness and identify key research needs.

I hope you find the report interesting and exploring the discussion insightful. If you have any comments, please contact me. I look forward to hearing from you.

Sincerely,



Nancy E. Kinner, Ph.D.  
UNH Co-Director, Coastal Response Research Center  
Professor of Civil/Environmental Engineering

## Acknowledgements

The Coastal Response Research Center gratefully acknowledges the CRRC authors of this report: Joseph J. Cunningham, Zachary E. Magdol, and Nancy E. Kinner. The Center acknowledges the time and effort provided by the participants in the workshop, whose contributions have been synthesized into this report. In addition, the Center acknowledges the thoughtful input and comments received from the reviewers of the draft report: Whitney Blanchard (NOAA), Kerry Kehoe (NOAA), Peter Pandolfini (John Hopkins University), and Avram Bar-Cohen (University of Maryland).

The following individuals helped plan this workshop: Roger Bagbey (Inspired Systems); Hoyt Battey (US DOE); Whitney Blanchard (NOAA-OCRM); Brian Cable (NAVFAC); Kerry Kehoe (NOAA-OCRM); Andrew Knox (NAVFAC); Dallas Meggitt (Sound and Sea Technology); Mike Reed (US DOE); Susan Skemp (FAU Center for Ocean Energy Technology); William Tayler (NAVFAC); and Iris Ioffreda (OLA Consulting). The Center staff for this meeting consisted of: Nancy Kinner, Kathy Mandsager, Joseph Cunningham, Zachary Magdol, Michael Curry, Chris Wood, Nate Little, Adria Fichter, Marcel Kozlowski, Heather Ballestero, and Michaela Bogosh. The Center also gratefully acknowledges Roger Bagbey, Whitney Blanchard, Rick Driscoll, Matt Gove, Dallas Meggitt, Mike Reed, and Andy Knox for serving as group leaders. Cover images courtesy Natural Renewable Energy Lab (NREL) and Joseph Cunningham.

### Citation:

Coastal Response Research Center. 2010. Technical Readiness of Ocean Thermal Energy Conversion (OTEC). University of New Hampshire, Durham, NH, 27 pp and appendices.

## Table of Contents

Foreword.....	1
Acknowledgements.....	2
I. Executive Summary.....	4
II. Introduction.....	5
III. Workshop History and Limitations.....	7
IV. Workshop Organization and Structure.....	8
V. Breakout Group Reports.....	9
A. Platforms.....	9
B. Platform Mooring.....	10
C. Platform/Pipe Interface.....	12
D. Heat Exchangers.....	15
E. Pumps and Turbines.....	18
F. Power Cable.....	20
G. Cold water Pipe.....	22
VI. Research and Development Needs.....	24
VII. Conclusions.....	25
VIII. References Cited.....	26

### Appendices:

- A. Workshop Agenda
- B. Participant List
- C. Breakout Questions
- D. Breakout Groups
- E. Breakout Group Notes and Report Outs
- F. Powerpoint Presentations

## I. EXECUTIVE SUMMARY

Ocean Thermal Energy Conversion (OTEC) is a technology that dates back to the late 1800's and makes use of temperature differences between surface and deep ocean waters to drive a heat engine, and extract energy via the Rankine cycle. While pilot scale plants (< 1 MWe) have successfully generated energy, a combination of technical and economic feasibility limitations tempered investment and interest in OTEC. However, the decreasing supply, and increasing costs, of fossil fuels, advancements in OTEC technology, renewable energy mandates, and energy security concerns have resulted in a resurgence in interest in OTEC for tropical locations.

As the lead licensing agency for OTEC, NOAA's Office of Ocean and Coastal Resource Management (OCRM), in cooperation with the Coastal Response Research Center (CRRRC), held the first in a series of workshops to determine the technical readiness of seven major components of OTEC: (1) cold water pipe; (2) heat exchangers; (3) platform/pipe interface; (4) platform; (5) power cable; (6) platform mooring system; and (7) pumps and turbines. The first workshop, discussed in this report, sought to gather information on the technical readiness of OTEC and evaluate advancements to the technology since the last major attempt, OTEC-1 in 1980.

The qualitative analysis of the technical readiness of OTEC by experts at this workshop suggest that a < 10 MWe floating, closed-cycle OTEC facility is technically feasible using current design, manufacturing, deployment techniques and materials. The technical readiness and scalability to a > 100 MWe facility is less clear. Workshop participants concluded that existing platform, platform mooring, pumps and turbines, and heat exchanger technologies are generally scalable using modular designs (several smaller units to achieve the total capacity needed), however, the power cable, cold water pipe and the platform/pipe interface present fabrication and deployment challenges for  $\geq$  100 MWe facilities, and further research, modeling and testing is required. The experience gained during the construction, deployment and operation of a  $\leq$  10 MWe facility will greatly aid the understanding of the challenges associated with a  $\geq$  100 MWe facility, and is a necessary step in the commercialization and development of OTEC.

## II. INTRODUCTION

The decreasing supply, and increasing cost, of fossil-fuel based energy has intensified the search for renewable alternatives. Although traditionally more expensive, renewable energy sources have many incentives, including increased national energy security, decreased carbon emissions, and compliance with renewable energy mandates and air quality regulations. In remote islands where increased shipping costs and economies of scale result in some of the most expensive fossil-fuel based energy in the world, renewable energy sources are particularly attractive. Many islands, including Guam and Hawaii, contain strategic military bases with high energy demands that would greatly benefit from an inexpensive, reliable source of energy independent of the fossil-fuel based economy.

The oceans are natural collectors of solar energy and absorb billions of watts of energy from the sun in the form of solar radiation daily. In the tropical latitudes, intense sunlight and longer days result in significant heating of the upper 35 to 100 m of the oceans, yielding comparatively warm (27 - 29°C) oceanic surface waters. Below this warm layer the temperature gradually decreases to an average of about 4.4°C. When the second law of thermodynamics is considered, this temperature differential represents a significant amount of potential energy which, if extracted, would be a completely renewable source of energy.

One method of extracting this energy is Ocean Thermal Energy Conversion (OTEC). OTEC facilities take advantage of the Rankine cycle, a process which converts thermal energy into kinetic energy via turbines. The turbines can then be used to drive generators, producing electricity. There are two major OTEC facility designs: open-cycle, and closed-cycle. In an open-cycle OTEC facility seawater is used as a working fluid. Warm surface water is exposed to a vacuum, causing it to boil and generate steam. The cold water from deep in the ocean is then pumped through a condenser, causing the steam to condense (Figure 1). This constant vaporization and condensation is used to drive a turbine, converting thermal energy into mechanical energy. The open-cycle process has the added advantage of creating fresh water as a byproduct.

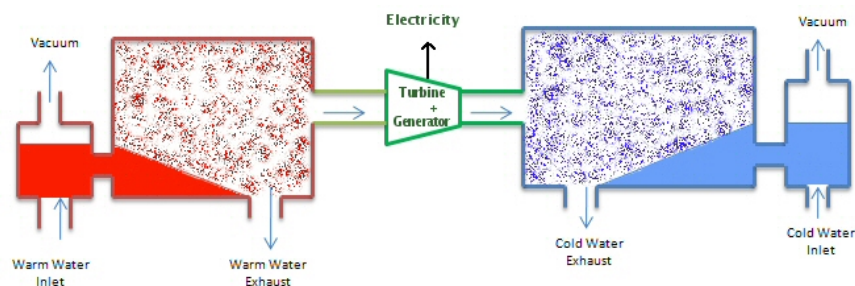

Figure 1: Principles of operation of an open-cycle OTEC Facility

In a closed-cycle facility, a working fluid with a low boiling point (i.e., ammonia) is used in place of seawater. Both the warm and cold water are passed through heat exchangers which transfer the heat to the working fluid, which then vaporizes and condenses as in the open-cycle facility, driving a turbine and converting thermal energy into mechanical energy (Figure 2). While closed-cycle facilities are more complex, they are significantly more efficient and result in greater output due to the greater efficiency of the working fluid.

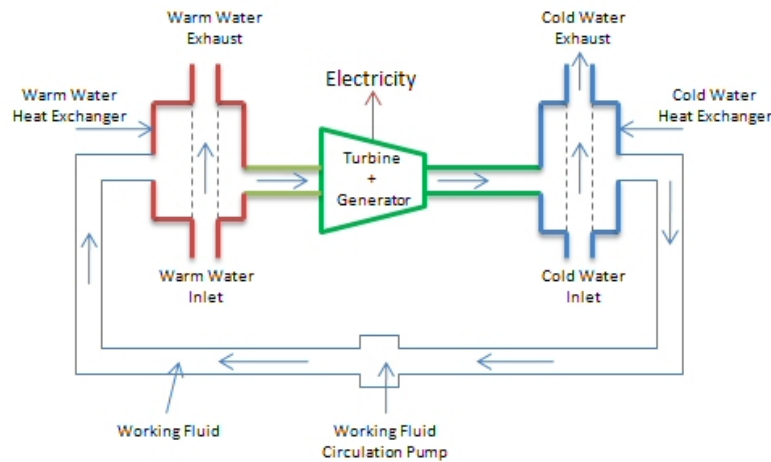

Figure 2: Principles of operation of a closed-cycle OTEC facility

Development of OTEC dates back to the late 1800s, however the first attempt at constructing an operational OTEC facility did not occur until 1930 off the coast of Cuba, and produced a net 22 kilowatts (kWe)<sup>1</sup> for 11 days before it was destroyed in a storm. The next major milestone came in 1979 when a project dubbed “mini-OTEC” was launched, and marked the first successful operation of a closed-cycled OTEC facility. Mini-OTEC produced a net 15 kWe for 3 months before the planned shutdown, and was widely considered a success. The next major advancement in OTEC came in 1980 – 1981 with the experimental OTEC-1 facility. This facility was not designed to generate electricity, rather, it was designed as a platform to test various OTEC-related technologies. OTEC-1 reached several milestones, including successful deployment of a 670 m long cold water pipe, and mooring in 1,370 m of water. Subsequently, numerous small-scale (< 1 megawatts (MWe)<sup>2</sup>) experimental facilities have been constructed by Japan and India, and a land-based OTEC facility on the island of Hawai’i, with mixed success. The land-based facility on the island of Hawai’i successfully operated from 1993 to 1998, and produced a net 103 kW, and still holds the world record for OTEC output (Vega L. A., 2002/2003).

One of the most important considerations when planning an OTEC facility is location. Large differences (> 20°C) in temperature between the cold water intake and the warm water intake are required, and as a result, the facility must be located in a region with access to warm surface waters and deep, cold water. An OTEC facility can be

<sup>1</sup> kWe = 1,000 joules of electrical energy produced per second

<sup>2</sup> MWe = 1,000,000 joules of electrical energy produced per second

located on land if adjacent to a shelf or rapid decrease in depth, however, the long length of the cold water intake pipe needed to reach the required temperature differential may make this impractical in most locations. Alternatively, an offshore, floating, moored, facility with a vertical cold water intake pipe may be more practical. Technological advancements in the offshore oil industry have made floating OTEC platforms a possibility. Floating platforms can be located virtually anywhere above deep water as long as they can be adequately moored, and the power cable can reach a land-based power grid for electricity generation.

Although the focus of OTEC is typically on production of electricity, the energy produced has the potential to be used for numerous co-products, including desalinization, mariculture, hydrogen production, and air-conditioning, all of which would add to its economic viability and further reduce dependence on fossil fuels.

OTEC facilities are complex and house many components working together to produce energy. The quantity and magnitude of these components will vary with the size of the facility, however, will typically consist of: a platform, used as a base for all OTEC operations; a cold water pipe, used to draw cold water from below the thermocline; a warm water pipe, used to draw warm water from near the surface; warm and cold water discharge pipes, which are used to return the cold and warm water after heat has been extracted; working fluid, used as a heat transfer medium; heat exchangers (closed-cycle only), evaporators and condensers, used to transfer heat between cold and warm waters and the working fluid; a platform/pipe interface, which couples the cold and warm water pipes and platform; a power cable, which transfers electricity back to a shore-based electrical grid; a platform mooring system, which ensures that the OTEC facility remains stable and in the same location; pumps, which draw water through the cold and warm water pipes; and turbines and generators, which are used to convert thermal energy into electricity.

Expectations for OTEC were high following the passage of the Ocean Thermal Energy Conversion Act of 1980 (OTECA), and OTEC was forecast to generate > 10,000 MWe of energy by 1999. A combination of economic and technical feasibility factors brought development of the technology to a near standstill by the mid-1980s, and the technology has never proceeded past the pilot plant stage. Recently, decreasing availability and increased cost of fossil fuels, advancements in OTEC technology, and interest in renewable alternatives have once again led to a resurgence in interest in OTEC as a potential solution to the energy needs of many island and equatorial nations.

### **III. WORKSHOP HISTORY AND LIMITATIONS**

Due, in part, to increased interest by the U.S. Navy and the issuance of several recent contracts to industry to increase research and development on OTEC components, NOAA's Office of Ocean and Coastal Resource Management (OCRM), in cooperation with the Coastal Response Research Center (CRRC), held the first in a series of workshops focused on OTEC. The first workshop, discussed in this report, sought to



gather information on the technical readiness of OTEC and evaluate advancements to the technology since the last major attempt, OTEC-1 in 1980.

In order to provide the workshop participants with common assumptions for the design of an OTEC facility, the Organizing Committee (OC) limited discussion to a floating, closed-cycle, moored OTEC facility producing electricity transmitted to shore via an undersea cable. The OC acknowledged that the first OTEC facility constructed was likely to be  $\leq 10$  MWe, however, commercially successful OTEC facilities would likely be  $\geq 100$  MWe, and are the expressed goal of the OTEC industry. The OC selected closed-cycled for evaluation at this workshop, as they believed the first  $\geq 100$  MWe OTEC facilities will use a closed-cycle design due to its greater efficiency. The discussions at the workshop were limited to electrical generation. The technical feasibility of additional applications for OTEC (i.e., potable water, seawater air conditioning) were not discussed. While an operational OTEC facility will contain many components, the OC decided to limit discussion to seven components: (1) platforms; (2) platform mooring system; (3) platform/pipe interface; (4) heat exchangers; (5) pumps and turbines; (6) power cable; and (7) cold water pipe. Discussion was limited to these components because they were viewed as critical and a potentially limiting technical factor to the success of OTEC.

It should be made clear that this report is a qualitative analysis of the state of the technology, and is meant to inform NOAA OCRM. This report is not an exhaustive engineering analysis, nor is it an independent appraisal of the technology. This report does not take into account economic, environmental and social impacts and/or constraints, and is not part of the decision and permitting process for OTEC by OCRM in the United States.

#### **IV. WORKSHOP ORGANIZATION AND STRUCTURE**

The workshop, held at the University of New Hampshire from November 3 – 5, 2009, consisted of plenary sessions where invited speakers discussed their experiences with OTEC and gave their views on the state of the technology. Seven breakout groups further discussed key components of the technology: platforms; platform mooring system; platform/pipe interface; heat exchangers; pumps and turbines; power cable; and the cold water pipe. The workshop agenda (Appendix A), participants (Appendix B), discussion questions (Appendix C), and breakout groups (Appendix D) were identified and developed by an organizing committee comprised of members of government, academia and industry.

The workshop participants were divided into the seven groups based upon their expertise. Each breakout group identified: the state of the art technology; changes to the technology since 1980; the component life cycle of the technology (design, fabrication and construction; deployment and installation; operation and maintenance; decommissioning, excluding environmental implications), scalability to  $\geq 100$  MWe, challenges; risks and cost drivers; and research and development needs for their respective OTEC component. This report summarizes the group discussions for each

OTEC component, research recommendations, and general conclusions on the technical readiness of OTEC.

## V. BREAKOUT GROUP REPORTS

### A. Platforms

The Platforms group examined the technical readiness of existing platform technology for an OTEC application. The group members were:

Andy Knox, NAVFAC Engineering Service Center  
John Halkyard, John Halkyard & Associates  
Ed Horton, Horton Deep Water Development  
Jonathan Ross, OTEC International/Alion Science & Technology  
Ian Simpson, American Bureau of Shipping  
Rob Varley, Lockheed Martin

#### State-of-the-Art Technologies:

Changes in offshore platforms have primarily been driven by the petroleum industry. Since the 1980's, there has been improved meteorological and oceanographic data gathering methods, which has led to more reliable and weather-resistant platform designs. In addition, improved analytical tools allow for optimized and cost-effective platform construction. The group identified three platform designs as being most feasible for OTEC application: semi-submersible, spar, and ship shape (monohull). All three have been validated in other industries (e.g., offshore oil, windfarms) and there are no significant additional manufacturing, operating, or deployment challenges associated with their use in an OTEC application.

Semi-submersible platforms have standard offshore rig fabrication procedures. There are fewer qualified manufacturing facilities for spar platforms than semi-submersible and monohull. Monohull manufacturing uses a Floating, Production, Storage, and Off-loading Unit (FPSO) for construction. Spar platforms present the most difficulties for installation because they require deepwater work. Spars are also more difficult to operate than the other two platform types.

Operation and maintenance (O&M) procedures for these platforms are well established, and typically include maintenance of machinery and removal of biological growth on the submerged sections. Relocating platforms can present some difficulties especially with the spar configuration. Spar platforms need to be disassembled and reassembled for relocation. However, the spar configuration is most favorable for the cold water pipe attachment because there is less motion at the joint. Decommissioning of platforms is regularly performed in other industries and should not cause significant challenges for OTEC facilities. Overall, the life cycle of a platform for an OTEC facility is straightforward and has well-established procedures.

Challenges, Risks, and Cost Drivers:

There are few challenges associated with using currently available platform technology for OTEC application. The following table compares risks associated with the three platform configurations.

Table 1.

<b>Platform Type</b>	<b>Motion/ survivability risk</b>	<b>Arrangement difficulty</b>	<b>Cost</b>	<b>Technical Readiness</b>
Semi- submersible	Small	Medium	Medium	High
Spar	Small	High	Medium-High	Medium
Ship shape/monohull	Medium	Low	Low	High

The major cost driver for platforms is size and adaptability to OTEC application. Platforms need to house a significant amount of equipment for an OTEC application, and larger platforms significantly increase the cost and difficulty of fabrication and deployment.

Research and Development:

Because platforms are well established, the majority of research and development goals are efficiency and cost related. Development of simpler, lower cost manufacturing and deployment techniques will reduce overall OTEC costs and improve the economic feasibility of the plant. Because OTEC platform technology is transferred from other industries, standards must be developed for platforms specific to OTEC facilities.

**B. Platform Mooring**

The Platform Mooring group examined the technical readiness of existing platform mooring technology for an OTEC facility. The group members were:

- Rick Driscoll, Florida Atlantic University Center for Ocean Energy Technology
- Fred Arnold, NAVFAC Engineering Service Center
- Helen Farr, NOAA Ocean Coastal Resource Management
- Mark Greise, Sound & Sea Technology
- Kunho Kim, American Bureau of Shipping, Energy Project Development
- Gerritt Lang, NAVFAC Engineering Service Center
- Pete Lunde, SBM Offshore, NV

### State-of-the-Art Technologies:

The most important advancement from 1980 to the present is the significant progress made in deep water moorings in sand and rock bottoms. In 1980, the depth limit was ~305 m, but within the past 10 years advancements in synthetic materials has allowed numerous moorings at depths up to 3,000 m. Advancements in software have allowed precise models to be created that facilitate optimization of platform mooring systems, and the widespread use of GPS and underwater acoustic systems (e.g., SONAR) allows precise placement of mooring components.

Assuming that an OTEC platform is not significantly different than platforms currently in use in the offshore oil industry, mooring technology is mature and has been demonstrated in more challenging and demanding environments. The key driver will be optimization to make it economically viable in the environment in which it is deployed. The group reported that appropriate mooring technology exists for numerous vessel sizes, loads and bottom types, however it is very site specific and the mooring system would need to be custom designed using existing components (anchors, pilings). Mooring lines for all components currently exist for depths to 3,000 m. Electrical conductor can be embedded into mooring line in order to combine the mooring and power cable, however this presents a new set of issues and design challenges that may not be economically viable. Equipment currently exists to deploy mooring systems, however it may need to be modified based on location and economics. Software models exist for mooring systems, however they would need to be modified to address the intricacies of an OTEC plant (i.e., Does fluid flow in pipeline have a significant impact on the model?). Increasing availability of GPS coupled high resolution SONAR has provided a more detailed view of the seafloor and allows precise placement of moorings.

Design, fabrication, and construction of the platform mooring components (anchors, mooring lines, hardware/terminations, integrity monitoring instrumentation) were identified as either commercially available off-the-shelf, or requiring minimal customization. The amount of customization and difficulty may increase with increasing platform size, weight, bottom slope and exotic seafloor characteristics. Mobilization and deployment of mooring components were identified as simple without significant challenges, however some minor modification to equipment may be required. Monitoring component performance during installation and use was also identified as relatively simple with few challenges and high reliability.

Operation of the platform mooring is not complex and very reliable; existing technology is suitable. Maintenance of the platform mooring system is technically simple, with the primary focus on mitigating the impact of marine fouling on equipment and periodic replacement/repair of integrity monitoring instrumentation.

Decommissioning of the platform mooring as a system was identified as technically feasible and routine, however, labor intensive and expensive.

### Challenges, Risks, and Cost Drivers:

One of the most important challenges with the platform mooring is preventing marine fouling of the mooring line and hardware. Excessive fouling may impact the integrity of the mooring lines, and increase drag resulting in higher loading. Most platform moorings are near shore, while OTEC platforms are likely to be in very deep water and are exposed to high sea conditions, which may present design challenges. Another significant challenge will be the requirement to disconnect and recover the moorings in case of extreme storms.

Mobilization and deployment were identified as the riskiest part of the platform mooring life cycle. Potential issues include: inability to deploy effectively and safely, significant delay in startup, additional costs, or complete system failure.

Cost drivers include need for spare components, site conditions, weather, water depth, installation complexity, material costs, performance requirements, installation risk and insurance, labor costs, permitting and regulations, removal and decommissioning costs and requirements. Cost savings could be realized through mooring optimization (single point vs. multipoint), coordination and optimization of platform design, less stringent motion and survivability requirements, citing, mitigating high cost factors, and the ability to self-install.

### Research and Development Needs:

The Platform Mooring group identified several research topics, including: Adaptation of codes and standards to reflect OTEC systems, mooring systems on high slope bottoms, techniques requiring minimal equipment for mooring and power cable installation, optimized anchoring systems for volcanic rock, and new paradigms and designs relevant to OTEC needs.

## **C. Platform/Pipe Interface**

The Platform/Pipe Interface group examined the technical readiness of existing platform/pipe interface technology. The group members were:

Dallas Meggitt, Sound & Sea Technology  
Mark Brown, Sound & Sea Technology  
Dennis Cooper, Lockheed Martin  
Pat Grandelli, Makai Ocean Engineering  
Dennis How, NAVFAC Engineering Service Center  
Manuel Laboy, Offshore Infrastructure Associates, Inc.  
Susan Skemp, FAU Center for Ocean Energy Technology

### State-of-the-Art Technologies:

One of the most significant advances since 1980 is experience working in open ocean deep water environments and advanced modeling technology. Sensor and modeling technology has matured and now gives a better understanding of sustained loading, allowing optimized designs. Advances in materials science have produced lighter, stronger, and more durable materials that can be incorporated into the platform/pipe interface, allowing larger pipes to be used. Several experimental OTEC plants have been constructed since 1980, and while most either failed or were shut down for various reasons, numerous lessons have been learned from those experiences, including important design considerations and failure points related to the pipe/platform interface.

The pipe/platform interface group concluded that the technology to create a interface suitable for a  $\geq 100$  MWe facility ( $\sim 10$  m diameter CWP) is not currently available, but experience with smaller 1 m diameter pipes has demonstrated that the technologies are viable. There are generally three accepted platform pipe interface designs: a flex pipe attached to a surface buoy, a fixed interface, and an interface with a gimbal. The off-shore oil industry routinely handles multiple risers up to 1 m diameter at substantial depths ( $> 305$  m), and the technology used can likely be adapted to OTEC and scaled to larger diameters.

Design, fabrication and construction of a platform/pipe interface for a  $\geq 100$  MWe facility will require significant testing and modeling, and may require two to four years before it is ready for installation. Fixed and gimbale interfaces are easier to design and manufacture, while flex interfaces are more complex and more difficult to design and manufacture. Construction of the interface is not technically challenging, and could be completed rapidly, however, mobilization and deployment is difficult and has been the failure point in several OTEC projects. The effort required and probability of success of mobilization and deployment depends greatly upon the type and size of the cold water pipe, platform type, and interface. While some experience exists for smaller pipes, larger interfaces ( $> 1$  m CWP) will require custom installation and it is unclear what special requirements or problems may occur. Vertical build interfaces are easier to deploy than horizontal. Horizontal build interfaces are difficult for fixed and gimbale interfaces. The ability to detach the CWP adds complexity and cost to the interface.

Operation and maintenance of the interface is relatively simple for a fixed interface, but substantially more involved for gimbale and flex interfaces. The gimbale interface requires periodic lubrication and cleaning, while the flex interface requires frequent repair as it has several connection and fatigue points.

The fixed interface has the highest scalability followed by the gimbale. The flex interface is probably not feasible for  $\geq 100$  MWe facilities due to the size of the cold water pipe. Current design and deployment technologies are likely scalable to  $\geq 100$  MWe, however the group noted that a interface for a  $\leq 10$  MWe facility should be successfully fabricated and deployed prior to attempting anything larger, as unforeseen difficulties may arise with increasing pipe size.

### Challenges, Risks, and Cost Drivers:

There are numerous challenges with the platform/pipe interface. The most significant is the lack of experience with interfaces holding pipes larger than 1 m diameter. A significant amount of design, fabrication, and modeling will be required to develop an interface for a  $\geq 100$  MWe OTEC facility. The biggest challenge will be to design an interface that is able to couple and decouple the CWP, and withstand the forces of an open ocean environment and storm events.

Risks associated with the platform/pipe interface include complete failure, resulting in loss of the pipe and significant production delays, as well as partial failure, resulting in degraded performance due to leakage. If the interface fails, it will be difficult and expensive to repair *in situ*, especially if the pipe is lost.

Cost drivers include: choice of materials, and the design and fabrication process for not only the interface, but also the cold water pipe and the platform. Local climate, currents and wave patterns will dictate the design loading and will have a significant impact on cost. Tradeoffs between relative motion of the CWP vs. the platform and complexity of the system will also impact costs, as well the ability to couple/decouple the CWP.

### Research and Development Needs:

The research and development needs include: modeling of failure modes, expanded remote monitoring, low cost buoyancy, OTEC system modeling, deep oceanographic data collection, data mining, and processing, supply chain integration, and improvement in composite materials.

The CWP and pipe/platform interface groups are closely linked and present some difficulties in design and installation. Because the platform/pipe interface for a hanging CWP has only been demonstrated for  $\leq 1$  m diameter pipes, the scalability is unclear and there are significant unknowns. Research should focus on increasing the size of the platform/pipe interface to accommodate pipes used in  $\geq 100$  MWe facilities. The conditions of the open ocean and deep-sea currents cause numerous stresses on the CWP and interface, and until significantly larger sizes of these components are built and used successfully, they will remain the biggest hurdle to successful  $\geq 100$  MWe OTEC facilities.

#### **D. Heat Exchangers:**

The Heat Exchangers group examined the technical readiness of existing heat exchanger technology for an OTEC facility. The group members were:

Whitney Blanchard, NOAA Ocean and Coastal Resource Management  
Avram Bar-Cohen, University of Maryland, Department of Mechanical Engineering  
Desikan Bharathan, National Renewable Energy Laboratory  
Yunho Hwang, University of Maryland, Department of Mechanical Engineering  
Laurie Meyer, Lockheed Martin  
C.B. Panchal, E3Tec Service, LLC  
Nate Sinclair, NAVFAC Engineering Service Center

#### State-of-the-Art Technologies:

Heat exchangers (HX) have improved in many ways since the 1980s driven primarily by other industries (e.g., aerospace, power plant, petroleum, cryogenic, liquefied natural gas (LNG), geothermal). Typical 1980 HX designs were plain tube, shell and tube, and plate and frame. Stainless steel was typically used. The open cycle and hybrid cycle OTEC facility concepts were developed in the 1980s, but HXs for these applications were not designed or validated. Today HX have an improved heat transfer coefficients mainly due to the use of new and modified materials. Titanium is more cost effective today, plastics have been developed for HX use, and aluminum-alloying techniques have improved. Surface enhancements have been developed (e.g., roughing). Fabrication practices have also improved: extrusion, aluminum brazing, welding techniques, quality control, instrumentation, and coating processes. More of the HX fabrication process is automated and, therefore, has improved capacity for large HXs.

HXs have been validated for closed cycle applications and designed for hybrid cycle application. Direct contact condensers are currently operational for geothermal applications. Flash evaporators have been demonstrated and mixed working fluid cycle HXs have been developed. This discussion focuses on heat exchangers for a closed cycle OTEC facility. The most appropriate working fluids for OTEC are propylene and ammonia, with an emphasis on the latter due to its thermodynamic properties and extensive experience with similar applications. Shell and tube, plate and frame, and aluminum plate-fin are the three HX types most suited and ready for OTEC.

The group discussed the life cycle of three different types of HXs that could be used for an OTEC facility: shell and tube, plate and frame and aluminum plate-fin. The time frame for commercial manufacturing for OTEC use for all three of these HX types is two to three years.

Shell and tube HXs are typically constructed of titanium, carbon steel, stainless steel, copper-nickel, or aluminum. Complexity and cost of HX installation would vary with platform design; an HX integrated into the platform would likely need to be done while



the platform is being constructed. The size of these HXs is important because of the limited space on an OTEC platform. The manifold design for shell and tube HXs depends on the platform configuration. The largest shell and tube HX currently available would result in 5 MWe (net OTEC power), however, they can be installed in modules, creating greater net power output. Manufacturing of shell and tube HXs is relatively labor intensive, but integrating them into the OTEC facility is low cost compared to the alternatives. The HX is constructed on shore and then floated to the OTEC facility. There are some issues with transportation due to the large size of shell and tube HXs; special equipment is needed.

O&M of shell and tube HX is easy and there are performance data to validate performance. These HXs degrade slowly and need few repairs. They are replaced once they surpass their service life, usually limited by material degradation (e.g., corrosion, pitting). It is necessary to monitor the HX for leaks. Some of this monitoring is visual, and therefore, there needs to be space for personnel to inspect HXs. There are detectors in the exhaust water to detect ammonia (i.e., the working fluid). Chlorination is necessary to decrease biofouling in the “warm” (i.e. evaporators) water portion of the HX. There are well-established guidelines for personnel safety when handling shell and tube HXs. These O&M processes and guidelines/codes come from other industries using shell and tube HXs (e.g., process industry, refrigeration industry, power plants). American Society of Mechanical Engineers (ASME) developed most of these codes.

Shell and tube HXs can be easily scaled to  $\geq 100$  MWe facilities with a modular design. Decommissioning these HXs is labor intensive and there are environmental risks associated with the release of the working fluid. However, there are existing industry standards for decommissioning. There is salvage value in the metals and ammonia as both can be recycled.

Plate and frame HXs are constructed of stainless steel or titanium. Manufacturing is easy because it consists of a completely automated welding process. One complicating factor is there the large plate size of plate and frame HXs needed for OTEC facilities. Installation of the HXs into the OTEC facility is difficult because of the complex piping system and expensive valving required. Each individual plate and frame HX is transported to the OTEC site. Plate and frame HXs are less flexible than shell and tube for OTEC because they require more ventilation. However, the plate and frame HXs are less expensive than the shell and tube. With the necessary piping and manifolding system, the costs of the two types of HXs are equivalent.

Many of the O&M processes for plate and frame HXs are the same as the shell and tube HX. However, there are some added difficulties. Plate and frame HXs cannot be submerged because gaskets are not fully welded and have to be dry. The HXs can be repaired by replacing the individual plates. Personnel safety is similar to that of shell and tube HXs, but also includes confined space entry. Plate and frame HXs have limited scalability. To scale up to a  $\geq 100$  MWe, the number and size of plates required would greatly increase. Decommissioning plate and frame HXs has the same procedures and issues as shell and tube.

Aluminum plate fin HXs are fabricated with brazed aluminum and mostly used in the cryogenic and LNG industries. They have a modular design similar to shell and tube, but with lower power output per module. Due, in part, to surface area to volume ratio constraints, each module has an effective upper thermodynamic limit of approximately 2 MWe, requiring the use of multiple modules for plants  $\geq 2$  MWe. Aluminum plate fin have a lower integration cost because the brazed aluminum units can be assembled on site. The units can fit inside a standard shipping container, presenting fewer transportation issues.

O&M for aluminum plate fin HXs is similar to that of shell and tube and plate and frame. O&M practices unique to plate fin HXs include: monitoring for aluminum corrosion and the need for offsite repair. Plate fin HXs are scalable because of their modular design. There is data validating performance for aluminum plate fin HXs; the Department of Energy (DOE) has test data for these HXs. Decommissioning practices for plate fin are the same as the other two HXs.

#### Challenges, Risks, and Cost Drivers:

There are risks associated with working fluids leaking from the HXs because of potential environmental damage, and the negative impact on turbine efficiency. There needs to be more data collected on biofouling of HXs. The biggest challenge is the limited economic incentive for HX manufacturers to optimize HX design/fabrication for OTEC facilities. The temperature difference between the “warm” and “cold” water ( $\Delta T$ ) is relatively small compared to other applications for HXs. The challenge is to design an HX that can handle large flows, have a high heat transfer coefficient, and be easily integrated into an OTEC facility.

#### Research and Development Needs:

Research and development on HXs for OTEC application aims to improve heat transfer without incurring a large pressure drop. Improvements to HX design will increase the cost effectiveness of the entire OTEC plant. Research areas include: materials, enhanced surface, and fabrication techniques. Many of these areas have already been the subject of much research but OTEC requires further improvements and validation. Surface enhancements will increase surface area, turbulence and mixing, thereby increasing the heat transfer capacity. Research into materials includes greater extraction processes, qualification of aluminum alloys for the lifetime of an OTEC plant, and the use of plastics.

## E. Pumps and Turbines

The Pumps and Turbines group examined the technical readiness of existing pump and turbine technology for an OTEC facility. The group members were:

Michael Reed, Department of Energy  
Alexandra DeVisser, NAVFAC Engineering Service Center  
Leslie Kramer, Lockheed Martin Missiles and Fire Control  
Donald MacDonald, NOAA Coastal and Ocean Resource Management  
Peter Pandolfini, Johns Hopkins University, Applied Physics Lab  
Orlando Ruiz, Offshore Infrastructure Associates, Inc.

### State-of-the-Art Technologies:

Compared to other components of the OTEC facility, pump and turbine technology is the most advanced with respect to technical readiness. There have not been any revolutionary breakthroughs in the design of pumps and turbines in the past 30 years, however, there have been some changes since the 1980s that have improved performance including use of lightweight and lower friction materials. Electronic monitoring is now available that can examine the health and status of pumps and turbines, helping to decrease O&M costs.

The petroleum industry has more than 30 years of experience with pumps and turbines in harsh environments, such as offshore facilities. Axial flow turbines are able to support large MWe production and these units are commercially available. Toshiba (Tokyo, Japan), GE Rotoflow (Fairfield, CT), Mitsubishi (Cypress, California), Elliott Turbomachinery (Jeannette, PA) and Hitachi (Tokyo, Japan) manufacture suitable turbines. For a 10 MWe facility, two radial flow turbines each rated at 7-8 MW gross power could be used. Increasing the number of turbines improves reliability and net power production. This is relatively easy to do because of the modular design used in OTEC facilities.

Cold and warm water pumps for an OTEC facility would be axial flow impeller design mounted on the platform. These pumps are highly efficient (87-92%), and are commercially available from numerous vendors. A 100 MWe facility would require pumps capable of moving approximately 200 m<sup>3</sup>/s of cold water and 400 m<sup>3</sup>/s of cold water (Vega L. , 1995). Multiple-pump solutions of this size are available off-the-shelf, and could integrate into a  $\geq 100$  MWe OTEC facility. The OTEC working fluid pumping system would require feed pumps and recycle pumps. For the  $\geq 100$  MWe facility, 8 working fluid pumps and 8 recycle pumps would be required. These pumps are commercially available and have a relatively low cost, however, they require significant maintenance. There is a large design database available for these pumps.

Turbines for OTEC applications are commercially available. Materials suitable for these turbines include steel, carbon steel and chromium. Large turbines are a challenge,

however, this can be mitigated by using a modular design. There are well-established manufacturing practices for 5-10 MWe turbines (e.g., forging, machining, and casting). Turbines are very adaptable to a platform environment and could easily be integrated into an OTEC system. Ammonia turbines are reliable, but there is little data in their use at this scale. There are some manufacturers of ammonia turbines; mainly for the refrigeration industry. There is an 18-24 month lead-time for delivery of these turbines.

O&M procedures for turbines of this sort are well established and do not to present any extra difficulties. Routine inspection is required along with periodic repair. There are few unique safety concerns for personnel working on turbines on OTEC facilities; however, it is important to note that a leak of the working fluid (e.g., ammonia) may present safety issues. Some of the monitoring can be done using electronic sensors without disrupting plant performance and avoiding potential risk to personnel. The pumps and turbines would likely last the life of the OTEC plant (30 years).

Turbines would likely be installed in modular fashion for a  $\geq 100$  MWe OTEC facility. They should be reliable because they are a very well established technology that is already in use in similar conditions and because it is relatively easy to provide redundancy. Typically twice the number of turbines needed are installed. This redundancy allows for regular maintenance without compromising the plant performance. Decommissioning the turbines is straightforward and protocols and procedures exist. 85-90% of the materials can be recycled.

Pumps for OTEC application are also available with a 12-18 month lead-time. The maximum impeller diameter for a pump is  $\sim 2.1$  m. There is a range of design configurations available from multiple vendors. Similar to OTEC turbines, the pumping system would use  $n+1$  redundancy. The main materials used in pump fabrication are carbon steel, stainless steel, copper, and insulating material.

Access to pumps on an OTEC platform can complicate and increase the cost of O&M because in some designs they are submerged. It is critical to have spare working fluid pumps available at the facility. The overall performance of the plant relies heavily on proper operation of pumps and turbines. Pumps are scalable to a  $\geq 100$  MWe OTEC facility because they can be installed modularly. Pumps are also highly reliable.

#### Challenges, Risks, and Cost Drivers:

Turbines have very low operational risks, however, if they do fail OTEC performance is greatly hindered. It is important to have spare parts readily available to maintain turbines and pumps. There is a risk of foreign objects damaging the turbine blades. Electronic monitoring must be able to detect any potential internal damage. Cost drivers are turbine and pump efficiency. Currently, turbines and pumps are  $\sim 80$ -90% efficient. Improving efficiency will result in higher net power output of the OTEC facility.

### Research and Development Needs:

There are few R&D needs for pumps and turbines for OTEC application because they are commercially available. Any improvements will decrease the cost and allow the plant to operate more efficiently. The main research area is condition-based maintenance: remote sensing for turbine and pump performance. Other research areas are associated with open cycle OTEC facilities that operate at much lower pressure than closed cycle systems. This presents unique challenges for pump and turbine design. R&D is needed to improve lower pressure turbine and pumps.

### **F. Power Cable**

The power cable group was asked to examine the technical readiness of the power cable technology for an OTEC facility. The group members were:

Matt Gove, NOAA Ocean Coastal Resource Management  
Koeunyi Bae, Lockheed Martin Maritime Systems & Sensors  
Warren Bartel, NAVFAC Engineering Service Center  
Lee Brisse, Sound & Sea Technology  
Steiner Dale, Florida State Univ, Ctr for Advanced Power Systems  
Dave Tietje, Science Applications International Corp (SAIC)

### State-of-the-Art Technologies:

One of the biggest advances since 1980 in power cables is associated with production and installation of high voltage undersea cables. There are currently 10 sea crossing alternating current (AC) cables ranging from 90 kV – 500 kV, and 20 direct current (DC) cables up to 500 kV in use; the majority has been installed within the last 10 years. The increase in offshore wind farms has led to a better understanding of cable dynamics, and connections up to 50 kV are common. Significant progress has been made in understanding cable dynamics, primarily driven by needs of the offshore oil drilling and wind farm community, which use similar sized cables. Platform-cable connections are now standard and routine up to 50 kV.

The group concluded that the technology to create power cables systems (cable, splicing, terminations) suitable for use with OTEC facilities exists, however there are several limitations. The most notable is that while cables are available up to 500 kV, there is a larger selection at lower voltages (< 100 kV) and OTEC plants design may be limited by power cable availability. Cables under 20 miles long are likely to be AC and use single phase > 69 kV, or three phase < 69 kV. Cables longer than 20 miles are likely to be DC in order to reduce transmission losses. DC cables are currently available up to 500 kV, however have the disadvantage of requiring conversion between AC and DC on both ends, resulting in significant energy loss. Codes and standards exist for cable construction, including Institute of Electrical and Electronic Engineers (IEEE), International Electrotechnical Commission (IEC), and American Petroleum Institute (API). To protect the cable during installation and throughout its 30 year expected

lifespan, it will likely have steel armoring, adding a significant amount of weight and strain.

For cables less than 500 kV, design and fabrication were identified as either commercially available off the shelf, or requiring minimal customization. For cables greater than 500 kV, no commercial product exists and significant effort would be required to design and manufacture an appropriate cable. For OTEC facilities larger than 10 MWe, design and fabrication of the cable termination on the platform side will require a custom design and be the most technically challenging part of the power cable system. Mobilization and deployment of the cable is difficult, but well understood. The depth, seafloor characteristics, weight of cable, and required route will affect the difficulty and cost of mobilization and deployment.

Operation and maintenance of the cable is routine and well understood. Maintenance of the power cable system includes periodic marine growth removal, full cable inspection, and annual maintenance of substations using divers and ROVs, where appropriate. In the event damage to the cable is discovered, repair is possible in shallow water, but very difficult in deep (> 500 feet) water, and may require replacement of the cable.

The power cable system will be difficult to scale to a 100 MWe OTEC facility due to capacity limitations and ability to design and fabricate a platform-side termination interface. A 10 MWe plant is unlikely to use the same cable type and design as a 100 MWe plant, and a completely new design will likely be required. Power cable design is also affected by the mooring system; individual mooring types may require significantly different power cable systems.

#### Challenges, Risks, and Cost Drivers:

One area identified by the group as a challenge is the cable termination interface on the platform side. While standard for  $\leq 10$  MWe plants, the larger and heavier power cables required by  $\geq 100$  MWe OTEC plants will increase fatigue, bending and the stress and strain on the cable and the cable-platform interface and pose significant technological and engineering challenges. Further analysis and modeling is needed, however, the group noted that software already exists to complete this analysis. In addition, the extreme depths at which the cables will be located may present challenges with respect to hydrostatic pressure, and additional testing and modeling may be required. Cost drivers include size and type of cable required, design sea conditions, seafloor characteristics, cost of materials, exchange rate, and required cable routing.

#### Research and Development Needs:

The primary research need identified by the group was development of a dynamic cable for an OTEC facility > 10 MWe that can withstand repetitive bending and have more dielectric capabilities. Lighter armoring and conductor materials are needed to reduce weight, which will also reduce the stress and strains on the cable.

## G. Cold Water Pipe

The Cold Water Pipe group examined the technical readiness of existing cold water pipe (CWP) technology for an OTEC facility. The group members were:

Roger Bagbey, Inspired Systems, LLC  
Robert Bonner, NAVFAC, Engineering Services Center  
Kerry Kehoe, NOAA Office of Ocean and Coastal Resource Management  
Alan Miller, Lockheed Martin  
James Roney, Consultant  
Phil Sklad, Oak Ridge National Lab  
William Tayler, NAVFAC, Shore Energy Office  
Luis Vega, Hawaii Natural Energy Institute  
James Anderson, Sea Solar Power  
David Kaiser, NOAA Office of Ocean and Coastal Resource Management

### State-of-the-Art Technologies:

In the 1980s, materials considered for CWP construction included E-glass/vinyl ester, steel, and/or concrete, and typically had a synthetic foam core sandwich design. Currently, CWP materials include: R-glass/vinyl ester, fiberglass, and carbon fiber composite. The design has improved; proprietary designs have been developed including the hollow pultruded core sandwich. Fabrication of the CWP will likely include vacuum assisted resin transfer molding (VARTM) and large protrusion processes. VARTM allows sandwich core manufacturing and/or stepwise manufacturing. The large protrusion process allows hollow core manufacturing which helps mitigate pressure issues at depths in the water column. There have also been improvements in computational tools and structural monitoring of CWPs (e.g., cameras, sensors, robotic devices).

The design, construction, and deployment of a CWP for a  $\leq 10$  MWe facility is fairly well understood, however has only been successfully completed at  $\leq 1$  MW (e.g., OTEC-1). The fabrication methods required for construction of a  $\leq 10$  MWe CWP ( $\sim 7$  m diameter) are currently available, and can likely be scaled to construct a pipe suitable for a  $\geq 100$  MWe facility ( $\sim 10$  m diameter). The CWP can be deployed *in situ* with a stepwise fabrication or as one whole pipe. The latter would be fabricated on shore and towed to the platform. Both of these methods have been developed and validated for a CWPs suitable for a  $\leq 10$  MWe plant ( $\sim 7$  m), however have only been successfully demonstrated on a much smaller scale ( $< 2$  m diameter). Construction and deployment of a CWP for a  $\geq 100$  MWe CWP have not been attempted.

Studies have shown that biofouling on the interior and exterior of the CWP will not significantly impact the performance of the OTEC plant (C.B. Panchal, 1984). Smooth interior surfaces of the CWP achieved by coatings and additives mitigate biofouling. The CWP is designed to last the lifetime of the facility, and with current engineering knowledge and methods may approach 30 years. Fiber optics will be used to monitor CWP performance and detect any damage. Fiber optics is a well-understood technology that is regularly used in the offshore oil industry. The offshore oil industry

also has experience in repairing structures at depth. There are existing monitoring methods to analyze ageing, saturation, and fatigue.

Emergency preparedness is a key issue for the CWP of an OTEC facility. The design may include the ability to detach the CWP from the platform prior to a large storm event in order to prevent damage and/or loss. This significantly complicates the design of the platform/pipe interface and is likely to increase complexity and cost. The CWP from OTEC-1 was successfully recovered and re-used from a depth of 1,371 m in 1982, and suggests that recovery and decommissioning (i.e., disposal or recycling) of the CWP will use established procedures used previously in OTEC, as well as the oil industry, and should not present any significant technological challenges.

#### Challenges, Risks, and Cost Drivers:

The challenges and risks associated with a  $\leq 10$  MWe CWP are fairly well understood. Transportation, deployment, and decoupling of a single piece pipe is difficult, and would require towing it from shore. Conversely, segmented pipes, while easier to deploy, risk failure at the many joints required. The CWP is vulnerable to severe storm events that may exceed design limits, cause damage and/or failure. The increased CWP size required for a  $\geq 100$  MWe facility introduces some challenges, primarily due to lack of experience with pipes in that size class. While previous OTEC pilot and experimental plants have successfully constructed and deployed CWPs, there is little experience with a CWP larger than 2 m.

The major cost drivers for the CWP are the materials used in fabrication and the deployment techniques. Deployment of the CWP is equipment and labor intensive, and will be greatly affected by labor, fuel and equipment costs.

#### Research and Development Needs:

CWP research and development on CWPs for both  $\leq 10$  MWe and  $\geq 100$  MWe facilities should address material and equipment cost effectiveness. Research on alternative designs (e.g. flexible CWP) should be conducted. A full demonstration of large CWP (i.e., suitable for  $\geq 100$  MWe) production, delivery, and installation is needed. In addition, there must be a minimum of a one year operational record of CWP at a  $\leq 10$  MWe facility prior to scaling up to a  $\geq 100$  MWe facility.

The CWP and its interface with the platform are the most complex components on the OTEC plant. The CWP is unique to OTEC facilities, and nothing on the same size scale has been attempted in oceanic environments. There are numerous risks associated with these technologies. Many of these risks should be studied further with the goal of validating the CWP and interface design.



## VI. RESEARCH AND DEVELOPMENT NEEDS

At the conclusion of the workshop, the groups reconvened and developed the following general list of research and development needs to improve the technical readiness of OTEC.

### Heat Exchanger

- Enhanced heat transfer through an increase in surface area, turbulence, mixing without pressure drop validated performance
- Advancement in materials (aluminum alloys, plastics, *low cost* titanium)
- Improved fabrication techniques (bonding, brazing, welding, extrusion, etc.)

### Power Cable

- Development of dynamic cable greater than 30 MWe
- Development of a platform-cable interface that can withstand repetitive bending and have better dielectric capabilities.
- Lightweight armoring and conductor

### Cold Water Pipe

- Improve cost effectiveness of materials/equipment
- Full demonstration of pipe production, delivery and installation

### Pumps and Turbines

- Low pressure steam for open cycle
- Lower cost of compressors for maintaining vacuum (centrifugal)
- Condition-based maintenance sensing and turbine performance optimization
- Condition-based maintenance sensing for pumps

### Platform Moorings

- Investigate/be flexible to new paradigms and designs relevant to OTEC needs
- Optimization of platform moorings for OTEC needs
- Investigate effective anchoring systems in volcanic rock
- Investigate techniques that require minimal equipment for mooring & power cable installation
- Investigate effective mooring systems on high slope bottoms
- Adapt codes and standards to reflect OTEC systems

### Platform/Pipe Interface

- Develop low cost buoyancy
- Analytical simulation specific to OTEC
- Find and adapt existing technologies and analysis tools to structural analysis and simulation
- Better modeling of failure modes

### Platform

- Low cost manufacturing techniques (i.e., innovation, quality control)
- Developing OTEC standards based on cost/risk

### General

- Large scale testing of subsystems
- Trade off studies need to be performed relative to the location of water production (onshore vs. offshore, water production)
- Compile standards from other industries and adapt to OTEC

## **VII. CONCLUSION**

It should be made clear that this report is a qualitative analysis of the state of the technology, and is meant to inform NOAA OCRM. This report is not an exhaustive engineering analysis, nor is it an independent appraisal of the technology. This report does not take into account economic, environmental and social impacts and/or constraints, and is not part of the decision and permitting process for OTEC by OCRM in the United States.

The qualitative analysis of the technical readiness of OTEC by experts at this workshop suggest that a < 10 MWe floating, closed-cycle OTEC facility is technically feasible using current design, manufacturing, deployment techniques and materials. The technical readiness and scalability to a > 100 MWe facility is less clear. Workshop participants concluded that existing platform, platform mooring, pumps and turbines, and heat exchanger technologies are generally scalable using modular designs (several smaller units to achieve the total capacity needed), however, the power cable, cold water pipe and the platform/pipe interface present fabrication and deployment challenges for  $\geq$  100 MWe facilities, and further research, modeling and testing is required. The experience gained during the construction, deployment and operation of a  $\leq$  10 MWe facility will greatly aid the understanding of the challenges associated with a  $\geq$  100 MWe facility, and is a necessary step in the commercialization and development of OTEC.

## VIII. REFERENCES CITED

1. C.B. Panchal, H. S. (1984). Biofouling and Corrosion studies at the Seacoast Test Facility in Hawaii. *DE84-014643; CONF-840930-1*, (pp. 364-369).
2. Vega, L. A. (2002/2003). Ocean Thermal Energy Conversion Primer. *Marine Technology Society Journal* 6(4) , 25-35.
3. Vega, L. (1995). Ocean Thermal Energy Conversion. In *Encyclopedia of Energy Technology and the Environment* pp. 2104-2119. New York, NY: John Wiley & Sons, Inc.
4. W. H. Avery, W. C. (1994). *Renewable Energy from the Ocean: A Guide to OTEC*. New York: Oxford University Press.

# **Appendix A**

## Meeting Agenda

November 3-5, 2009  
New England Center  
University of New Hampshire, Durham, NH

## Tuesday, November 3

08:15	Continental Breakfast	New England Center, Great Bay Room
08:45	Welcome	Nancy Kinner, Jan Nisbet, and NOAA
	Department of Navy Department of Energy NOAA	William Tayler Mike Reed Kerry Kehoe
09:20	Background & Workshop Goals/Outcomes	Nancy Kinner
09:30	OTEC Timeline & Participant Introductions	Iris Ioffreda, Facilitator
10:30	<i>Break</i>	
10:45	Plenary Session: Setting the Stage	
	A. Cold Water Pipe	<i>Alan Miller</i>
	B. Heat Exchangers	<i>Avram Bar-Cohen</i>
	C. Platform Mooring	<i>Frederick "Rick" Driscoll</i>
	D. Platform/Pipe Interface	<i>Patrick Grandelli</i>
	E. Pumps & Turbines	<i>Peter Pandolfini</i>
	F. Platforms	<i>Edward Horton</i>
	G. Power Cable	<i>Steiner Dale</i>
	H. Cycle/Auxiliary Uses	<i>C.B. Panchal</i>
	I. Overall System & Program	<i>Luis Vega</i>
11:45	Workshop Structure & Logistics	Iris Ioffreda
12:00	<i>Lunch</i>	
13:00	Breakout Session I	Breakout Discussion Groups
15:30	Plenary Session I: Group Reports	(10 minutes each)
17:00	Adjourn	
18:30	Shuttle to Dinner	Portsmouth



### Wednesday, November 4

08:30	Continental Breakfast	New England Center, Great Bay Rm
09:00	Overview and Review/Recalibrate	Iris Ioffreda
09:15	Panel Discussion: Cycle and Auxiliary Uses: Today and the Future	
10:15	Breakout Session II	Breakout Discussion Groups
12:15	<i>Lunch</i>	
12:45	Breakout Session III	Breakout Discussion Groups
15:00	Plenary Session: Group Reports	(10 minutes each)
17:00	Adjourn ( <i>Dinner on your own</i> )	

---

### Thursday, November 5

08:30	Continental Breakfast	New England Center, Great Bay Rm
09:00	Overview/Review	Iris Ioffreda
09:15	Panel Discussion on OTEC as a System	
10:30	<i>Break</i>	
10:45	Discussion of OTEC as a System	
12:00	<i>Lunch</i>	
13:00	Plenary Session: Synthesis and Next Steps	Iris Ioffreda
14:30	Closing Remarks	Iris Ioffreda & Organizing Committee
15:30	Adjourn	

# **Appendix B**

## Participant List

# OTEC Technology Workshop

## Workshop Participants

James Anderson  
Sea Solar Power  
jim@seasolarpower.com

Frederick Arnold  
NAVFAC Engineering Service Center  
frederick.arnold@navy.mil

Koeunji Bae  
Lockheed Martin Maritime Systems & Sensors  
koeunji.bae@lmco.com

Roger Bagbey\*\*  
Inspired Systems, LLC  
rbagbey@inspiredsys.com

Avram Bar-Cohen  
University of Maryland, Mechanical Engineering  
abc@umd.edu

Warren Bartel  
NAVFAC Engineering Service Center  
warren.bartel@navy.mil

Hoyt Battey\*\*  
US Department of Energy  
hoyt.battey@ee.doe.gov

Desikan Bharathan  
National Renewable Energy Laboratory (NREL)  
desikan.bharathan@nrel.gov

Whitney Blanchard\*\*  
NOAA Ocean Coastal Resource Management  
whitney.blanchard@noaa.gov

Robert Bonner  
NAVFAC Engineering Service Center  
robert.bonner@navy.mil

Lee Brissey  
Sound & Sea Technology  
lbrissey@soundandsea.com

Mark Brown  
Sound & Sea Technology  
mbrown@soundandsea.com

Brian Cable\*\*  
NAVFAC  
brian.cable@navy.mil

Joseph Cunningham  
Coastal Response Research Center  
joseph.cunningham@unh.edu

Steiner Dale  
Florida State Univ, Ctr for Advanced Power Systems  
dale@caps.fsu.edu

Alexandra DeVisser  
NAVFAC Engineering Service Center  
alexandra.devisser@navy.mil

Frederick "Rick" Driscoll  
FAU Ctr for Ocn Energy Technology  
rdriscol@oe.fau.edu

Helen Farr  
NOAA Ocean Coastal Resource Management  
helen.farr@noaa.gov

Mathew Gove  
NOAA Ocean Coastal Resource Management  
matt.gove@noaa.gov

Patrick Grandelli  
Makai Ocean Engineering  
pat.grandelli@makai.com





Mark Greise  
Sound & Sea Technology  
mgreise@soundandsea.com

George Hagerman  
Virginia Tech Advanced Research Institute  
hagerman@vt.edu

John Halkyard  
John Halkyard & Associates  
jhalkyard@aol.com

Edward Horton  
Horton Deep Water Dev  
ed.horton@hortondeepwater.com

Dennis How  
NAVFAC Engineering Service Center  
dennis.how@navy.mil

Yunho Hwang  
University of Maryland, Dept of Mechanical  
Engineering  
yhhwang@umd.edu

Iris Ioffreda\*\*  
OLA Consulting  
irisi@aol.com

David Kaiser  
NOAA Ocean Coastal Resource Management  
david.kaiser@noaa.gov

Kerry Kehoe\*\*  
NOAA Ocean Coastal Resource Management  
kerry.kehoe@noaa.gov

Kunho Kim  
American Bureau of Shipping, Energy Project  
Development  
kkim@eagle.org

John King  
NOAA Ocean Coastal Resource Management  
john.king@noaa.gov

Nancy Kinner\*\*  
Coastal Response Research Center  
nancy.kinner@unh.edu

Andrew Knox\*\*  
NAVFAC Engineering Service Center  
andrew.knox1@navy.mil

Leslie Kramer  
Lockheed Martin Missiles & Fire Control  
leslie.d.kramer@lmco.com

Manuel Laboy  
Offshore Infrastructure Associates, Inc.  
mlaboy@offinf.com

Gerritt Lang  
NAVFAC Engineering Service Center  
gerritt.lang@navy.mil

Dennis Loria  
LORIA Emerging Energy Consulting, LLC  
dennis@loriaeec.com

Pete Lunde  
SBM Offshore, NV  
pete.lunde@sbmoffshore.com

Donald MacDonald  
NOAA Special Projects  
donald.macdonald@noaa.gov

Kathy Mandsager  
Coastal Response Research Center  
kathy.mandsager@unh.edu

Dallas Meggitt\*\*  
Sound & Sea Technology  
dmeggitt@soundandsea.com

Laurie Meyer  
Lockheed Martin  
laurie.e.meyer@lmco.com

Alan Miller  
Lockheed Martin  
alan.miller@lmco.com

C.B. Panchal  
E3Tec Service, LLC  
cpanchal@msn.com

Peter Pandolfini  
Johns Hopkins University, Applied Physics Lab  
peter.pandolfini@jhuapl.edu

Michael Reed\*\*  
U.S. Department of Energy  
michael.reed@ee.doe.gov

James Roney  
Consultant  
jimroneyss@yahoo.com

Jonathan Ross  
OTEC International/Alion Science & Technology  
jmross@alionscience.com

Orlando Ruiz  
Offshore Infrastructure Associates, Inc.  
oeruiz@offinf.com

Ian Simpson  
American Bureau of Shipping, Offshore  
Technology & Business Development  
isimpson@eagle.org

Nate Sinclair  
NAVFAC Engineering Service Center  
nate.sinclair@navy.mil

Susan Skemp\*\*  
FAU Ctr for Ocn Energy Technology  
sskemp@fau.edu

Phil Sklad  
Oak Ridge National Lab (ORNL)  
balltripdl@ornl.gov

William Tayler\*\*  
NAVFAC  
william.tayler@navy.mil

Dave Tietje  
Science Applications International Corp (SAIC)  
emil.d.tietje.iii@saic.com

Robert Varley  
Lockheed Martin  
robert.varley@lmco.com

Luis Vega  
Hawaii Natural Energy Institute (HNEI)  
luisvega@hawaii.edu

Donna Wieting  
NOAA Ocean Coastal Resource Management  
donna.wieting@noaa.gov

# **Appendix C**

## **Breakout Questions**

# OTEC Technology Workshop

## Breakout Discussion Topics

### For Each Individual Component:

*(These questions will be used in each of the 7 breakout sessions.)*

#### *Breakout Session I:*

- 1) What are the state-of-the-art technologies for the technical component?

#### *Breakout Session II:*

- 2) What processes (e.g., equipment, personnel) of the technology are associated with:
  - i. fabrication, deployment, construction, and installation;
  - ii. operation (including monitoring) and maintenance (including cleaning, repair, and replacement);
  - iii. monitoring component performance;
  - iv. personnel safety and emergency preparedness; and
  - v. decommissioning?
- 3) What risks are associated with failure with these processes?

#### *Breakout Session III:*

- 4) Are the technologies associated with this component viable? What are the economic factors associated with these technologies? What are the hurdles/limiting factors associated with these technologies?
- 5) What is the development time frame for the technologies associated with this component?

---

### System Questions:

*(These questions will be addressed in the Panel Sessions.)*

- What are the performance metrics that must be demonstrated prior to commercial development? What is the development time frame (e.g., today, 1–2 yr, 5–10 yr) for a commercial OTEC system?
- What are the potential failures that could lead to the shutdown of an OTEC system?
- What processes/diagnostics are needed to detect, monitor and reduce these risks?
- What are the flexibilities in the OTEC system's components that could minimize environmental impacts?



## **Appendix D**

### **Breakout Groups**

# OTEC Technology Workshop

## Discussion Groups

### A. Cold Water Pipe

(Berkshire Room)

Roger Bagbey, Group Lead

*Mike Curry, Recorder*

Jim Anderson

Robert Bonner

Kerry Kehoe

Alan Miller

James Roney

Phil Sklad

Bill Tayler

Luis Vega

### B. Heat Exchangers

(Penobscot Room)

Whitney Blanchard, Group Lead

*Zachary Magdol, Recorder*

Avram Bar-Cohen

Desikan Bharathan

Yunho Hwang

Laurie Meyer

C. B. Panchal

Nate Sinclair

### C. Platform Mooring

(Windsor Room)

Rick Driscoll, Group Lead

*David Gaylord, Recorder*

Fred Arnold

Helen Farr

Mark Greise

Kunho Kim

Gerritt Lang

Pete Lunde

### D. Platform/Pipe Interface

(Kennebec Room)

Dallas Meggitt, Group Lead

*Nate Little, Recorder*

Mark Brown

Brian Cable

Dennis Cooper

Pat Grandelli

Dennis How

Manuel Laboy

Susan Skemp

### E. Pumps and Turbines

(Great Bay Room, West)

Mike Reed, Group Lead

*Adria Fichter/Marcel Kozlowski, Recorder*

Alexandra DeVisser

Les Kramer

Dennis Loria

Donald MacDonald

Peter Pandolfini

Orlando Ruiz

### F. Platform

(Charles Room)

Andy Knox, Group Lead

*Heather Ballestero, Recorder*

John Halkyard

Ed Horton

Jonathan Ross

Ian Simpson

Rob Varley

### G. Power Cable

(Great Bay Room, East)

Matt Gove, Group Lead

*Chris Wood/Michaela Bogosh, Recorder*

Koeunyi Bae

Warren Bartel

Lee Brissey

Steiner Dale

Dave Tietje



## **Appendix E**

### **Breakout Group Notes and Report Outs**

## **APPENDIX E:**

Coldwater Pipe Group



## Breakout Discussion Topics

### **Breakout Session I:**

**Tuesday, November 3: 13:00-15:30**

What are the state-of-the-art technologies for the technical component?

Very important to discern between land-based and sea-based OTEC plants.

Requirements need to be set out to understand material properties needed.

- Buckling from ext. pressure, bending fatigue from platform motions, vibration strain (sheared current), core collapse from 1000m pressures, corrosion (30 year design life), behavior in service, weight-positive but not excessive,
- Biofouling issues? Inside doesn't have biofouling issues due to a lack of growth, but still may be issues with outside weight problems
- Fatigue may be largest problem with respect to pipe life

\*Possibility of nano-tube for future? Or carbon fiber?

- New stimulus coming for low cost carbon fiber plant for low cost materials

Best pipe - 2m HDPE, but not being constructed by industry

More recent work done with more practical materials as far as cost, structural materials,

\*CWP very likely to be a sandwich pipe, possibility of fiberglass, how do we construct it may be the larger problem?

Reliability?

- Failure usually at the joints of large composite materials, need ONE piece
- Cross currents and platform rocking cause stress
- Is the CWP design for a 100 year storm?
- Can we realistically temporarily remove the pipe in an emergency? What happens if a storm approaches?  
BIG issues

Who is actually doing work besides Lockheed and gov't?

## Breakout Discussion Topics

\*One of the largest problems with the CWP includes DEPLOYMENT.

- Fabrication directly off of the platform could be the best option

What is the technological readiness of the CWP technologies?

\*What's new at the table?

- High strength fiberglass-substantial fatigue strength and cost effective
- Vinyl Ester resins-tough, corrosion resistant, experience

Fabrication processes?

- VARTM, vacuum assisted resin transfer molding, now standard. Allows sandwich core manufacturing and also stepwise manufacturing
- Large protrusion processes, allows for hollow core manufacturing to try and combat pressure issues at depth

Four main materials to look at. (not steel and reinforced concrete)

- Fiberglass, carbon fiber composite (possible price update), steel, HDPE
- Steel: AH36 shipbuilding steel  
Possibility of new steel, but FATIGUE problems
- HDPE pipe worked in principal, but low cost manufacturing didn't

Moored platform was what is generally looked at, but there's a thought of TLPs with membrane CWP.

\*CWP Design

- Double wall hollow core composite sandwich
- Continuous face sheets
- Modern fiberglass with excellent fatigue resistance and seawater resistance

\*CWP Deployment

- In-situ stepwise fabrication and deployment (about 80 39' steps)
- Continuous fabric to produce one piece CWP

## Breakout Discussion Topics

### \*CWP Fabrication

- Most off the shelf fabrication techniques have a major issue
- Liquid resin infusion seems to be an acceptable process, ordinary RTM vs. VARTM (used for production of large wind turbine blades), pilot step-wise VARTM CWP work piece completed in Dec. 2008

Available technologies are out there, rough quotations and specs are available.

- Materials identified
- Engineering methodology available

Issues of concern don't include wind in a floating platform, but heave may concern  
Carbon fiber may soon be a viable option with new cost considerations

\*Engineering knowledge is available to create a CWP for a 30 year design life.

Do we have a design today for a 5-10 MW CWP? Yes. But not for 400 km off shore.

Weather is a large concern for CWP depending upon location. De-coupling the pipe when a storm comes through is a possible solution.

Environmental concerns are many. Design of the CWP is available.

Three state of the art viable designs should be put on a timetable. If the most simple design is set in motion, others will be helped.

Should near term and long term designs be different?

Capital cost for a 5-10 MW OTEC plant expected \$150 million or less.

## Breakout Discussion Topics

### **Breakout Session II:**

**Wednesday, November 4: 10:15-12:15**

- 1) What processes (e.g., equipment, personnel) of the technology are associated with:
  - i. Fabrication, deployment, construction, and installation;
  - ii. Operation (including monitoring) and maintenance (including cleaning, repair, and replacement);
  - iii. Monitoring component performance;
  - iv. Personnel safety and emergency preparedness; and
  - v. Decommissioning?
  
- 2) What risks are associated with failure with these processes?

#### Notes:

Assume floating offshore, 5-10 MW scalable to 100MW, moored, power cable to shore, potential relocation for todays breakout session

- Scalability issues work in both directions when thinking about CWP
- Challenges involved in relocation issues for the CWP

## Breakout Discussion Topics

### **Breakout Session III:**

**Wednesday, November 4: 12:45-15:00**

- 1) Are the technologies associated with this component viable? What are the economic factors associated with these technologies? What are the hurdles/limiting factors associated with these technologies?
- 2) What is the development time frame for the technologies associated with this component?

GROUP DID NOT ANSWER

## Cold Water Pipe GROUP B

What are the state of the art technologies?

### The CWP must meet a number of requirements

Quantifiable technical drivers:	Anticipated quantitative loading	Dominant driver?	Met in LM design?	Basis
Buckling from net external pressure	7.5 psi suction inside CWP at top	Yes	Yes	FEA
Bending fatigue from platform motions, including knockdown for long-term seawater immersion	Approx. +/- 4 degrees of pitch or roll, plus surge and sway motions	Yes	Yes	Prelim. HARP analysis (10 MW plant) + prelim. test data on fatigue after high-pressure seawater conditioning to saturation
Buckling from platform motions	Same as preceding	No	Yes	FEA
Fatigue from Vortex-Induced Vibration (VIV)	Sheared current profile, approx. 4 fps surface velocity	No	Yes	Several analyses indicate no excitation of CWP in sheared currents
Tensile failure from clump weight and streaming current	CWP + clump weight, current profile	No	Yes	Bending and tension strain calculations
Core collapse from high pressure at 1000m depth	1500 psi	Yes	Yes	Venting of hollow core eliminates net pressure on core
Wet weight must be positive but not excessive	CWP & clump weight	Yes	Yes	CWP wet density is same as fiberglass/vinyl ester laminate
Corrosion	30-year immersion in seawater at depths to 1000m	Yes	Yes	Industry experience with fiberglass/vinyl ester composites
<i>Also:</i>				
Behavior in service must be very reliable	CWP is single point of failure for OTEC plant	Yes	Yes	One-piece CWP eliminates maintenance / repair / failure of joints
Deployment must be low-risk	Very large consideration - Previous OTEC failures have been dominated by CWP deployment	Yes	Yes	Fabrication directly from the platform eliminates large risks associated with transport, assembly, upending, etc.
Cost must fit within OTEC plant budget profile	Electricity cost <= \$0.25/kwh for 100 MW OTEC plant in Hawaii	Yes	Yes	Minimum-cost design through optimization. Materials costs from supplier quotes; recurring fabrication costs from large wind turbine blade BBS.

- **FIRST GENERATION BASELINE: FRP-Sandwich per NOAA/DOE 1980s Design and At-Sea Testing, with horizontal towing and upending in-situ; Gimbals connected.**

- \*CWP very likely to be a sandwich pipe, possibility of fiberglass, how do we construct it may be the larger problem?
- Reliability?
- Failure usually at the joints of large composite materials, need ONE piece
- Cross currents and platform rocking cause stress
- Is the CWP design for a 100 year storm?
- Can we realistically temporarily remove the pipe in an emergency? What happens if a storm approaches?

- \*One of the largest problems with the CWP includes DEPLOYMENT.
- Fabrication directly off of the platform could be the best option
- \*What's new at the table?
- High strength fiberglass-substantial fatigue strength and cost effective
- Vinyl Ester resins-tough, corrosion resistant, experience
- Fabrication processes?
- VARTM, vacuum assisted resin transfer molding, now standard. Allows sandwich core manufacturing and also stepwise manufacturing
- Large protrusion processes, allows for hollow core manufacturing to try and combat press

- Available technologies are out there, rough quotations and specs are available.
- Materials identified
- Engineering methodology available
- Weather is a large concern for CWP depending upon location. De-coupling the pipe when a storm comes through is a possible solution.
- Three state of the art viable designs should be put on a timetable. If the most simple design is set in motion, others will be helped.

## Cold Water Pipe

Life cycle considerations:  
Manufacturability, operability,  
reliability, logistics, scalability

## Baseline Parameters for Workshop OTEC Discussions

- Offshore
- Floating
- Moored
- Cable to shore
- 5-10 MWe scalable to commercial scale
- Potentially relocatable

## Manufacturability

1. Fabrication: Variety of methods currently available to fabricate up to 12 m I.D. pipes
  - 1.1: Some methods commercially available
  - 1.2: Some methods under validation
2. Deployment: Variety of methods available
  - 2.1: On shore manufacture of CWP tow to platform for installation
  - 2.2: In-situ manufacture of entire CWP

## Manufacturability

- 3 Installation: attachment to platform
  - 3.1 Scalable Method which was demonstrated in OTEC 1 (Gimbal required)
  - 3.2 Aerospace technologies applied to conceptual method to create a strong and robust termination
  - 3.3 Oil field technologies can be applied



## Manufacturability

### 4 O & M

- Bio-fouling is not a concern on the interior
- Smooth surfaces on exterior address most concerns with bio-fouling
- Existing technologies in coatings and additives to inhibit exterior bio fouling

## Operability

### Monitoring component performance

- Existing well understood technologies will be applied such as fiber optics
- Repair at depth is a proven capability for like materials and structures based on oil field experience

### Decommissioning

- Within understanding based on offshore industry experience-no technological challenges

## Reliability

- Within the technological capability to design a pipe that matches the design life of the plant
- There are known testing methods to address the combined effects of ageing, saturation, and fatigue

## Logistics

- See manufacturability

### Scalability

- Able to scale to 10-12 m I.D. pipe using physics based, well understood engineering practices

### Why OTEC? Why now?

Group A: Cold Water Pipe

### Cold Water Pipe

	Then	Now	Benefit
Materials	E-glass/Vinylester Steel, concrete	1. R-glass/vinyl ester Carbon fiber composite 2. E-glass/vinylester	1. Higher fatigue strength; better reliability and lower cost 2. Still viable, additional validation has been done
Designs	Syntactic foam core sandwich	1. Hollow pultruded core sandwich and other proprietary designs 2. Syntactic foam core sandwich	1. Much lower cost, less labor intensive and greater consistency 2. Still viable, additional validation has been done
Practices		Off-shore industry experience	Lower cost and better reliability, more design flexibility

### Cold Water Pipe

	Then	Now	Benefit
Fabrication	Filament winding	VARTM process	In-situ, continuous pipe
Technology		Computational tool development Improved structural monitoring (cameras, sensors, robotic devices)	Higher precision, lower testing cost More reliability, less labor, less risk

**Summary:**

Due to advances in computational capability, composite materials, fabrication methods, and the vast experience of the offshore industry, there is a high level of confidence that we can construct and maintain a reliable, cost efficient cold water pipe.

### Risks

	On Shore	In-situ
Fabrication	Low	Medium
Assembly	Low	Low*
Deployment-Towing	Medium	N/A
Deployment-Upending	Low	N/A
Deployment-attachment	Med.-Low	Low
Operations	Low	Low
Planned Detachment	Low	Low
Reattachment	Med.-Low	Med.-Low
Recovery after failure	High	High
Relocation	High	High
Decommissioning	Low	Low

### Cost Drivers/Potential savings

	On Shore	In-situ
Fabrication	Materials, labor	Materials, labor
Assembly	Labor/equipment	
Deployment-Towing	Requires flotilla	
Deployment-Upending		
Deployment-attachment	Analytical tools	Analytical tools
Operations		
Planned Detachment		
Reattachment		
Recovery after failure		
Relocation		
Decommissioning		

### Question 4 and 5

- Technologies are viable for the CWP
- Economic factors: Refer to cost drivers
- Hurdles: OTEC & CWP validation
- Hurdles: needs a minimum of one year operational record with plant that is big enough to be scaled to commercial size plants

## **APPENDIX E:**

Heat Exchangers

## Breakout Discussion Topics

### **Breakout Session I:**

**Tuesday, November 3: 13:00-15:30**

**What are the state-of-the-art technologies for the technical component?**

#### **Heat Exchangers**

4 or 5 specific requirements for OTEC HX  
Not necessarily off the shelf  
e.g. low delta T

Closed Cycle HX:

Working fluid other than water, Material compatibility

Ammonia issues: toxicity,

Ammonia benefits: heat transfer coefficient, zero GHG

R-22 – not viable because of environmental concerns (GHG) and thermodynamics are not advantageous (lower performance) pumping cost greatly increased with R-22

Propylene

Based on: Performance, Cost, Environmental issues ammonia is best. propylene as replacement/alternative

Ammonia leaks can be problematic (parking lot issue)

Aluminum appropriate with both propylene and NH<sub>3</sub>

Scale up issue for ammonia HX

Low delta T

Pressure drop important

COP ratio of heat transferred to amount invested

Parameters: gross power to net power ratio (similar to COP)

1.3-1.4 for gross power to net power ratio, not to exceed 1.5. this is an overall system ratio, how do we figure out a parameter for HX only

## Breakout Discussion Topics

CW HX lose ~30% compared to warm water HX lose ~50%

Use system metric and apply to HX (gross power to net power ratio)

From GP to NP ratio obtain pressure drop metric

OTEC HX, delta T 3-4 whereas conventional HX delta T 30-40

No one has accepted challenge to design/construct a highly productive, low cost, HX with low delta T because there hasn't been a need

100 MW plant- can HX be built cost effectively

### Corrosion and biofouling control

Do we have data to get a biofouling and corrosion coefficient

Biofouling in warm water is manageable

Certain Aluminum alloy is feasible for OTEC to avoid corrosion

Need to proactively deal with fouling- chlorination is the only feasible/cost effective way to mitigate fouling

Chlorination concerns (*parking lot*)

### Manufacturability

In sea water

HX does not necessarily add significant weight to platform

Can sometimes be treated as neutrally buoyant

Weight is important but not critical

### HX integration with platform

Manifolding

Volume is an issue

## Breakout Discussion Topics

### State of the art HX:

State of the art vs. off the shelf

We must define what we mean by “state of the art”

State of the art: something that can be manufactured today

Off the shelf: can be purchased today

Shell and tube

Plate and frame

Aluminum plate fin

Spiral HX not used because of small delta T

Evaporator materials:

Defined; aluminum alloys,

ASME codes for HX

Will new codes need to be made for OTEC HX?

ASME codes pretty much cover

Are there additional regulations for HX on platforms

May develop new standards

Do we need a test standard (biofouling) – data needs to be collected

Codes for NH<sub>3</sub> systems and codes for HX they need to be merged for whole system

Flashing systems: (used for open cycle- *parking lot*)

## Breakout Discussion Topics

### **Summary:**

#### Design basis/considerations:

Working fluid

Low  $\Delta T$ , low pressure drop: performance parameter, gross to net power ratio

Material compatibility

Manufacturability

Biofouling/Corrosion

System Integration

ASME Codes for safety not for performance

Standards for working fluid

Need to be some kind of code for system

No codes for testing OTEC HX for system

HX platform integration: may need to discuss with platform group



## Breakout Discussion Topics

### **Breakout Session III:**

**Wednesday, November 4: 12:45-15:00**

- 1) Are the technologies associated with this component viable? What are the economic factors associated with these technologies? What are the hurdles/limiting factors associated with these technologies?
- 2) What is the development time frame for the technologies associated with this component?

## Breakout Discussion Topics

Need to come up with good spec but the materials, manufacturing processes, test capabilities, are out there to construct

Technology for OTEC HX exists, need investment for R&D to optimize HX for OTEC

5-10 MWe plant could use existing state-of-the-art (custom design) HX but for commercial scale need a more optimized HX

Pilot plant will use customized HX

No real hurdles for 5-10 MWe

Commercial scale needs a more viable/optimized HX

Economic factors/drivers:

Materials, manufacturing, assembly/integration, logistics, O&M

Low deltaT drives large size of HX. Translates to cost driver

HX design type/configuration (efficient use of material)

What are the hurdles?

HX industry not motivated to provide optimized units to meet OTEC needs

Technical hurdles:

Time to test and evaluate different designs

Qualifying aluminum manufacturing processes

Chlorination is accepted process for coastal power plants will it be acceptable for OTEC?

recognition that it will continue to be acceptable (5 years time)

What research can be done to get over technical hurdles?

*Parking lot:*

Chlorination/ biofouling

## Breakout Discussion Topics

concentration is lower than coastal power plants, however total amount per kW-hr is higher for OTEC (due to higher flow rates)  
plume study, local biology,  
recognize impact (need go-ahead from EPA)  
open water vs. coastal waters very different  
(part of cost)

Get HX industry involved

Funding

Pilot plant will help

Engage vendor community (e.g. HX industry)

What is the development time frame for the technologies associated with HXs?

5 MWe- 10 month delivery time

Spec development- 2 month

12-18 months assuming design exists and processes established (for 5-10 MWe plant)

Commercial Design: 1 year

Commercial Manufacturing: 2-3 years

Technical Readiness, Manufacturing:

TRL (technical readiness level); high for all HX types (plate fin, less than 9; 5)

Bet

Small scale dominated by: platform and CWP cost

Large scale dominated by: HX cost

## Breakout Discussion Topics

State-of-the-art Heat Exchanger comparison table

<b>HX Type</b>	<b>Shell and tube</b>	<b>Plate frame</b>	<b>Aluminum Plate Fin</b>	<b>Common</b>
<b>Material</b>	Titanium (power plant condensers), carbon steel (process industry), stainless steel (high pressure), copper-nickel (corrosion issue), aluminum (refrig. Industry)	stainless steel, titanium (process industry) cannot use aluminum	brazed aluminum (cryogenic and LNG plants)	
<b>Installation/ Deployment</b>	Simple, do-able Cannot be used in vertical evaporator Size and weight; weight not limiting, size important in terms of configuration/manifold Specific to platform design	Difficult complex piping system expensive valving less flexible for OTEC confined space-ventilation system	Easy to manifold in modular system Easier from a handling perspective	
<b>Scalability</b>	Easy to scale up Modular design- 100 MWe -- 10 MWe modules	Limited Size and number of plates Not use gasket	Easy to scale up	
<b>Performance data and design</b>	Lots of performance data; need enhanced tube	Lots of data High pressure drop HX	Lots of data DOE test data	
<b>Field O&amp;M</b>	Easiest A lot of experience with these HX “Degrades gracefully” Cleaning: prevent biofouling- chlorination, sodium hypochlorite (warm water only) <b>Repair:</b> plugging	Difficult; gaskets not fully welded Has to be dry; cannot be submerged <b>Repair:</b> replace individual plates <b>Replacement:</b> replace individual HX <b>Monitoring:</b> leaking in	Monitoring aluminum corrosion Does not degrade gracefully Modular design - pull and replace <b>Repair:</b> can't repair on site. Take module out. Fraction of performance is	Personnel Safety: Divers for submerged HX Dry dock PPE requirements (for inspection) in confined space- active ventilation is required Labor requirements: training for ammonia

## Breakout Discussion Topics

	<p><b>Replacement:</b> degraded past service life. Major operation, plant will have power loss, large cost (equipment, labor)</p> <p><b>Monitoring:</b> leaks, monitor pressure of ammonia side. Need accessibility for visual inspection. Detector in exhaust water to find presence of NH<sub>3</sub>. measure pressure and temp.</p> <p><b>Personnel Safety:</b> divers, PPE</p>	<p>air- through gasket. Include monitoring water</p> <p><b>Personnel Safety:</b> Confined space requirements, ventilation- ammonia leak- need PPE</p> <p>Decommissioning:</p>	<p>lost</p> <p>:</p>	<p>handling, confined space, Decommissioning: key handling of ammonia. Platforms designed so that HX can be decommissioned without removing/destroying entire system. Cost of decomm.: recycling.</p> <p>Decommissioning ammonia system can take a long time to get rid of all NH<sub>3</sub></p> <p><i>Use industry standards for cleaning NH<sub>3</sub> out of HXs</i></p> <p>Ammonia is resalable after decommissioning- transfer to barge for sale</p>
<p><b>Manufacturability (MRL)</b></p>	<p>Largest at this point, 5 MWe (net OTEC power); 6 m shell diameter</p> <p>Can be modular</p> <p>Process: manually intensive</p> <p>Titanium could have issues for large plant</p> <p>MRL: 7</p>	<p>Easy: automated welding</p> <p>Plate size is an issue (OTEC needs large)</p> <p>MRL: 8</p>	<p>Modular;</p> <p>Current extrusion and brazing limit size of modules (2 MWe)</p> <p>MRL: 6</p>	
<p><b>Relative Cost</b></p>	<p>High: labor intensive; integration: low cost</p>	<p>HX cheaper but add pipes/manifolding; ammonia side esp</p>	<p>Potential lower cost (R&amp;D in progress)</p> <p>lower in cost for integration</p>	
<p><b>Logistics</b></p>	<p>Issues with transporting, special transportation is needed.</p> <p>Build on shore- float to plant, depending on</p>	<p>ship individual HXs and plumb in</p>	<p>modular brazed units shipped and assembled on site- not difficult. Can go in shipping container.</p> <p>Already doing this kind of</p>	

## Breakout Discussion Topics

	location of plant. Equipment requirements; large cost. 5 MW plant; diameter 6 m, road transport can be done, limited import		thing for LNG industry, including offshore.	
<b>TRL</b>	8	8	5	

What risks are associated with failure?

Ammonia safety- leaks

Maintain HX to prevent leaks

Codes and standards for re Frid. industry are applicable to OTEC

Coastal ammonia facilities – codes, handling (e.g. ports, barge transp.,

Leak in piping system- need sensors (refridg. Standards)

Sensors needed for air and water leakage

Redundancy to mitigate NH3 leak

Ammonia pump could fail – need standby (redundancy)

Do redundant pumps go above/beyond existing standards?

No clear codes for water-NH3 systems

Periodically change/calibrate sensors

Low temp and pressure make for safer system than other industries

Tanks exposed to tropical sunlight- need to be designed to consider this

Risk of failure: lower performance- cost issue

Biofouling

Chlorination failure

Water leaking into ammonia (affecting turbine performance)

Chloride into ammonia may affect turbine

Pump failure

Filters/ mist eliminator

Leaking from one side to the other; turbine performance

## Breakout Discussion Topics

What are the cost drivers? What are possible cost-savings? What research could be done on cost reduction?

Materials, manufacturing, assembly/integration, logistics, O&M

Size/amount of material, operating in sea water

Low deltaT drives large size of HX. Translates to cost driver

HX design type/configuration (efficient use of material)

Design configurations

Enhanced surfaces

No identical applications (not off-the-shelf)

What are possible cost-savings?

### R&D: (OTEC optimization)

Enhanced heat transfer (increasing SA, turbulence, mixing, validated performance)

Material (aluminum alloys, plastics, *low cost* titanium)

Fabrication techniques (bonding, brazing, welding, extrusion, etc.)

## Breakout Discussion Topics

LUV

Life, u-value, cost

Pilot plant will help build investment in OTEC

Different type of investment (other than R&D)

Risk factors:

Water leak into ammonia reduces power, affects turbine efficiency

Chloride into ammonia may affect turbine

If pump fails

Does the platform group need to join HX group?

Questions from larger group after reportout I:

LUV factor

L-life

U-value

V-cost

HX performance along with overall performance

Would you be able to get quote from manufacturer for HX design for OTEC



## Breakout Discussion Topics

What changes have occurred in materials, designs, practices, fabrication, manufacturing, and technology between 1980 and today to make OTEC feasible to pursue on a commercial scale?

	1980s	Today
<b>Materials</b>	<ul style="list-style-type: none"> <li>• stainless steel</li> <li>• low volume/high cost of titanium</li> </ul>	<ul style="list-style-type: none"> <li>• Titanium cost effectiveness (aerospace and automobile industries)</li> <li>• Titanium: developing improved processes (power plant condenser)</li> <li>• Thermally enhanced plastics</li> <li>• Aluminum: alloying improved (aerospace industry)</li> <li>• Aluminum: more choices</li> </ul>
<b>Designs</b>	<ul style="list-style-type: none"> <li>• Plain tubes/Some enhanced tubes</li> <li>• shell and tube</li> <li>• Plate frame</li> </ul>	<ul style="list-style-type: none"> <li>• Potential new HX designs</li> <li>• Plastic or foam HX new emerging techniques (improving efficiency in processing industry)</li> <li>• Surface enhancements</li> <li>• Improved heat transfer coeff. without incurring pressure drop penalty</li> </ul>
<b>Practices - Performance Prediction</b>		<ul style="list-style-type: none"> <li>• High speed/low cost capability of computing</li> <li>• Improved analytical and design modeling techniques</li> </ul>
<b>Fabrication</b>		<ul style="list-style-type: none"> <li>• Extrusions have improved</li> <li>• Aluminum brazing technology (cryogenic, LNG)</li> </ul>

## Breakout Discussion Topics

		<ul style="list-style-type: none"> <li>• Improved welding techniques (for sea water applications; petro industry, LNG, oil, ships, power plant condensers)</li> <li>• Improved instrumentation/quality control</li> <li>Improved coating processes</li> </ul>
<b>Manufacturing</b>		<ul style="list-style-type: none"> <li>• Improved capability/tooling (petro industry, LNG)</li> <li>• Capacity for larger HX</li> <li>• greater automation</li> </ul>
<b>Technology</b> <b>- Cycle development</b>	<ul style="list-style-type: none"> <li>• Open cycle concept</li> <li>• Hybrid cycle concept developed</li> </ul>	<ul style="list-style-type: none"> <li>• Open cycle performance validation</li> <li>• Hybrid cycle design</li> <li>• Direct contact condensers operational (geothermal application)</li> <li>• Flash evaporators demonstrated</li> <li>• Mixed working fluid cycle developed (demonstrated in geothermal)</li> </ul>

# Heat Exchangers

## Reportout II

### Materials, Installation, Scalability, Performance

HX Type	Shell and tube	Plate frame	Aluminum Plate Fin
<b>Material</b>	Aluminum, Titanium, Stainless steel, Copper-nickel	Stainless steel, titanium	Brazed aluminum
<b>Installation/Deployment</b>	Simple; size important in terms of configuration/manifold	Difficult; complex piping system, expensive valving, less flexible for OTEC	Easy to manifold in modular system, easy handling
<b>Scalability</b>	Easy; Modular design- 100 MWe -- 10 MWe modules	Limited; Size and number of plates	Easy to scale up
<b>Performance data and design</b>	Lots of performance data; need enhanced tube	Lots of data High pressure drop HX	Lots of data DOE test data

- ### Operability
- Repair
    - Shell and tube: plugging
    - Plate-frame: replace individual plates
    - Plate-fin: cannot repair on-site
  - Replacement
    - Shell and tube: degrades past service life (major operation )
    - Plate-frame: replace individual HX
    - Plate-fin: replace module
  - Decommissioning
    - Key: handling ammonia
    - Platform designed so that HX can be decommissioned without destroying whole system
    - Materials are resalable including NH3
    - Use industry standards for clean NH3 out of HX
  - Personnel Safety
    - PPE/confined space entry for dry HXs
    - Divers for submerged HXs
    - Ammonia handling

<b>Manufacturability (MRL)</b>	modular Process: manually intensive <b>MRL: 7</b>	Easy: automated welding Plate size is an issue <b>MRL: 8</b>	Modular; <b>MRL: 6</b>
<b>Relative Cost</b>	High: labor intensive; integration: low cost	HX cheaper but add pipes/manifolding; ammonia side esp.	Potential lower cost (R&D in progress) lower in cost for integration
<b>Logistics</b>	<b>Issues with transportation Build on shore-float to plant</b>	<b>ship individual HXs and plumb in</b>	<b>modular brazed units shipped and assembled on site</b>
<b>TRL</b>	8	8	5

### What risks are associated with failure?

- Ammonia safety- leaks
  - Codes and standards for refig. industry are applicable to OTEC
  - Leak in piping system- need sensors (refrig. Standards)
  - Sensors needed for air and water leakage
  - Ammonia pump could fail – need standby (redundancy)
  - No clear codes for water-NH<sub>3</sub> systems
  - Periodically change/calibrate sensors
- Low temp and pressure make for safer system than other industries
- Risk of failure: lower performance - cost issue
  - Biofouling
  - Corrosion

### What are the cost drivers?

- Low deltaT drives cost (large size required)
  - Materials
  - Assembly/integration
  - Manufacturing
  - Logistics
  - O&M

### What are possible cost-savings?

- Performance enhancements (reduce size of HX)
  - Surfaces (increasing SA, turbulence, mixing)
  - Configuration
  - Surface treatments
  - Optimization
- Cost Reduction
  - Materials (e.g. plastics, different alloys)

### What are the hurdles?

- HX industry not motivated to provide optimized units to meet OTEC needs
- Time to test and evaluate different designs
- Qualifying aluminum manufacturing processes
- Chlorination acceptable

What is the development time frame for the technologies associated with HXs?

- 5 MWe (12-18 month)
- Commercial Design: 1 year
- Commercial Manufacturing: 2-3 years

## **APPENDIX E:**

### Platform Mooring

## GROUP C BRAINSTORMING SESSION

Differences between OTEC development and typical offshore development?

- More cost sensitive
  - What suggestions can be made to other groups that will reduce the costs of mooring
- Initial developments will be near shore (10<sup>1</sup> miles or less), deep water (1000 m) installations
- Sensitive bottom habitats
- Tropical conditions
- Marine growth issues
- More open exposure to sea conditions
- Loose moorings and you'll be on the beach fairly quickly
- Different platform dynamics
- Large mass of pipe and interactions with vessel\*
  - Another group dealing with that
  - Pendulation
  - Are strikes required on the cold water pipe to prevent vortex induced motion?
- Mooring to cold water pipe?
- Near shore currents
  - Possible higher standards and more inspection?
  - Or higher safety factor?
- Need some data on current
- Downstream of the pipe, what are the effects on the cables?
- What the coupling is and where is it between the platform and the cold water pipe?
- What type of structure is best for OTEC? Relates to what type of mooring is appropriate.
- Can the codes evaluating current mooring be applied directly to OTEC mooring?

- Depending on the production method of OTEC, how hazardous is the ammonia and how close is it to the shore, will this drive new standards?
- Do you require additional SF for moorings depending on OTEC production methods?
- For future commercial is there a product that will be off-loaded that will affect the mooring system, with non-weathering system will additional structure systems affect the mooring?
- Some areas that are envisioned for plant installation do not have the infrastructure capabilities
- Design of mooring system and extra equipment will have to consider
- How many risers are required? assumed 1 but you may want more than 1
- Single point mooring will require swivel for power cable
- Is there a single point mooring advantage for some locations?
- Are their percentages of allowable motions available?
- 

\* Deal with other groups but may affect mooring costs



## Breakout Discussion Topics

### **Breakout Session I:**

**Tuesday, November 3: 13:00-15:30**

What are the state-of-the-art technologies for the technical component?

- Anchors/Piles
  - Anchor technology exists but very site specific.
  - Well developed technology for a variety of conditions (vessel size, loads, bottom types) installation costs and methods may need to be changed to meet the costs drivers of OTEC as well as local and environmental conditions that may be new.
  - New anchors or piles do not need to be designed, current technologies may be modified.
  - Anchors may be leased for demonstration projects
- Mooring Lines
  - All of the components exist, for up to 10,000 ft.
  - For plants within the next decade the current mooring technologies are probably efficient in terms of materials, supplies, size, etc.
  - If the conductor is embedded into the mooring line there may be new issues
  - Method of attaching power cable if a single point mooring systems is used, it can likely be done but there would be new design challenges taking a combined mooring power cable system.
  - Tropical conditions promote more marine growth
- Hardware/terminations
  - Fatigue of the chain for long life,
  - operation to periodically adjust the mooring lines may be required to be

## Breakout Discussion Topics

- available on the vessel
- Shallow water and marine fouling impact on equipment lifespan and load, and maintenance cycle
- Equipment to support the high power cables such as slip rings, strain reliefs, terminations
- Integrity monitoring instrumentation
  - Design a system that can be replaced in a period
- Service and inspection
- Installation equipment/vessels
  - Exist but may need to be modified based on location and economics
- Codes and standards
  - Review and modification for site specific conditions and hazards
- Demobilization/recovery/restoration
  - Exist but may need to be modified based on location
- Analysis modeling tools
  - Well developed with a strong practical backing however they need modification in order to accurately model OTEC plant.
  - Does fluid flow in pipeline have a significant impact on the model?
- Test requirements
- Met ocean data and site survey
  - Couple year data collection program
- Geotechnical site survey
- Staging area/facilities and support facilities and proximity
- Mooring design

## Breakout Discussion Topics

- Allow the genesis of the mooring system to be driven by the requirements of the platform and the cold water pipe instead of platforms and designs that are already existing, out of the box thinking may be required to break existing paradigms
- Cost effective
- Requirement for disconnect in case of extreme storm/typhoon and hardware involvement, consideration needs to be made for the power cable
- Single point mooring
  - Fouling
  - Termination
  - Surface area
  - Photec zone
- What is the life requirement for the demonstration system?
  - Detailed requirement of the entire demo system
- Permitting
  - General rules and regulations are in place but have been rescinded

Mooring technology is mature and has been demonstrated in more challenging and demanding environments, it's a matter of detailing and optimization to make it economic and viable in the environment for which it's deployed. Assuming that the OTEC platform is not significantly different than systems that exist today.

We are assuming a compliant mooring system which will not affect the surface motion and wave frequency response of the platform.

Does the cold water pipe de-couple?

## Breakout Discussion Topics

### **Breakout Session III:**

**Wednesday, November 4: 12:45-15:00**

- 1) Are the technologies associated with this component viable? What are the economic factors associated with these technologies? What are the hurdles/limiting factors associated with these technologies?
- 2) What is the development time frame for the technologies associated with this component?

## Platform Mooring

### Session 2

- Mooring technology is mature and has been demonstrated in more challenging and demanding environments, it's a matter of detailing and optimization to make it economic and viable in the environment for which it's deployed.
- Key driver that will affect the evolution of OTEC mooring systems is cost.

### Question 1

- Manufacturability
  - Achievable with COTS or custom products
  - Low to no risk
- Mobilization & Deployment
  - Achievable with COTS or custom products
  - Highest risk, high cost, most opportunity for cost savings

### Question 1

- Operability
  - No special technology required
  - Existing techniques sufficient, slight modification may be required
- Reliability
  - No major issues

### Question 1

- Logistics
  - Existing techniques and systems are sufficient
- Scalability
  - Yes
  - Some consideration for size and location
  - Cost driver

### What risks are associated with failure with these processes?

- Manufacturing quality and testing to mitigate unexpected failures.
- Reduced confidence in the system.
- Risk of inability to deploy effectively & safely.
- Significant delay in startup
- Additional costs
- System failure
- Not accurately identifying risk and defining risk mitigation
- Limitation on overall size & placement of OTEC

### Question 3:

What are the cost drivers for this component? What are possible cost-savings? What research could be done on cost reduction?

- **Cost Drivers:**
- Spares;
- Site conditions; location; water depth
- installation, vessel time
- material costs
- required performance
- installation risk & insurance
- labor cost
- permitting & regulations
- removal and decommissioning costs & requirements

- **Cost Savings:**
- Mooring optimization (single point vs. multi point mooring)
- Coordination of Optimization of design of platform
- Less stringent motion and survivability requirements
- Citing
- Identifying the high cost factors and mitigate them
- Optimize the cost of vessel & transportation
- Self installing

## Platform Mooring

### Session 1

- Mooring technology is mature and has been demonstrated in more challenging and demanding environments, it's a matter of detailing and optimization to make it economic and viable in the environment for which it's deployed.
- Key driver that will affect the evolution of OTEC mooring systems is cost.

## Components

- |  |   |
|--|---|
| <ul style="list-style-type: none"> <li>• Anchors/Piles</li> <li>• Mooring Lines</li> <li>• Hardware/terminations</li> <li>• Integrity monitoring instrumentation</li> <li>• Service and inspection</li> <li>• Installation equipment/vessels</li> <li>• Codes and standards</li> <li>• Demobilization/recovery/restoration</li> <li>• Analysis modeling tools</li> </ul> | <ul style="list-style-type: none"> <li>• Test requirements</li> <li>• Met ocean data and site survey</li> <li>• Geotechnical site survey</li> <li>• Staging area/facilities and support facilities and proximity</li> <li>• Mooring design</li> <li>• Single point mooring</li> <li>• What is the life requirement for the demonstration system?</li> <li>• Permitting</li> </ul> |
|--|---|

## Technical Advances

- Mooring technology has developed significantly since OTEC 1 based on offshore oil advances
  - Deeper water moorings
  - Materials
  - Analysis tools
  - Maintenance systems
  - Installation and positioning capabilities



## Assumptions

- The OTEC platform is not significantly different than systems that exist today.
- A compliant mooring system will not affect the surface motion and wave frequency response of the platform.

## Questions

- What are the differences between conventional oil platform requirements and those of OTEC plants?
- Can a single point mooring be considered?
- What type of structure is best for OTEC? Relates to what type of mooring is appropriate.
- How is the platform coupled to the pipe and is there any direct interaction with the cable and what about disconnection?
- Do you require additional safety factor for moorings depending on OTEC production methods?

## Components

- |  |  |
|--|--|
| • Anchors/Piles                        | • Test requirements  |
| • Mooring Lines                        | • Met ocean data and site survey                               |
| • Hardware/terminations                | • Geotechnical site survey                                     |
| • Integrity monitoring instrumentation | • Staging area/facilities and support facilities and proximity |
| • Service and inspection               | • Mooring design   |
| • Installation equipment/vessels       | • Single point mooring   |
| • Codes and standards                  | • What is the life requirement for the demonstration system?   |
| • Demobilization/recovery/restoration  | • Permitting   |
| • Analysis modeling tools              |  |



## Platform Mooring

Day 3  
Priorities



## What is the State of the Art

- Moorings
  - Materials, design, fabrication have advanced to enable moorings to 10k feet, far exceeding the 1k foot limit of 1980, required OTEC mooring depth is 3k + feet
- Infrastructure
  - Industry has developed which routinely designs and installs mooring systems in depth up to 10k feet
- Comprehensive codes and standards now exist for deep water moorings

## Positioning

- In 1980 positioning of surface and subsurface assets was inadequate for deep water, far from shores for placements. Present technology is sufficient to meet OTEC requirements.
  - Satellite positioning and shipboard dynamic positioning allows positioning of surface assets within 1 meter anywhere on the planet, efficiently installed anchor systems
  - Underwater acoustic system has advanced accuracy of placement of underwater assets

## Materials

Synthetic Mooring lines have increased mooring depths to greater than 10k feet today

- High strength to weight ratio, neutrally buoyant materials such as polyester, kevlar, spectra, etc
- High strength steel for use in mooring wire and chain



## Anchor

- General advances in anchor technology have led to increased capacities in wide ranged bottom types

## Design Analysis Tools

- Advances in software enable deep water moorings to be accurately modeled and analyzed
  - Validated by field installations in deep water
  - Allows optimization of the system
  - Broad range of commercially available, industry verified software

## Installation and Operation

- Dynamically positioned installation vessels are commonly available
- Under water equipment advances allow safe and effective installation, inspection, maintenance, and recovery in deep water

# Platform Mooring

Day 3

Research Needs

# Research Needs

- Investigate and be flexible to new paradigms and designs relevant to OTEC needs
- Investigate effective anchoring systems in volcanic rock
- Investigate techniques that require minimal equipment for mooring & power cable installation
- Investigate effective mooring systems on high slope bottoms
- Increase the fidelity of tools to improve capability to allow overall system optimization
- Advance codes and standards to reflect OTEC systems

## **APPENDIX E:**

Platform/Pipe Interface

## **Breakout Session II: GROUP D**

### **Wednesday, November 4: 10:15-12:15**

**Discuss the entire life cycle that needs to be considered for each component.**

**Address the following:**

- 1) manufacturability,**
- 2) operability,**
- 3) reliability,**
- 4) logistics,**
- 5) scalability**

**with respect to:**

- **fabrication, deployment, construction, and installation;**
- **operation and maintenance (including cleaning, repair, and replacement);**
- **monitoring component performance;**
- **personnel safety and emergency preparedness; and**
- **decommissioning?**
- **What risks are associated with failure with these processes?**
- **What are the cost limiting factors for this component? What are possible costs-savings? What research could be done on cost reduction?**

Comments or Questions

- Decommissioning
  - o pipe/platform interface may need be detachable and able to be reattached
  - o What do you do with the pipe?
- Initial pilot off Oahu
  - o Can it be moved?

TLR

- Need to attach pipe to platform
  - o Rigid or Gimbal? (Design Decision)
- CWP needs to be detachable at least one time
- CWP Optionally able to be reattached – dependent on relocation area
- Need to have some level of pipe recovery
- Survivable for duration of plant life
  - o Corrosion, etc
- Must be able to attach 4m pipe
- Interface may need angle of motion (Design Consideration)
- Interface Sealant
- Compatible with CWP construction

## Manufacturing

- Design issue but not a factor of “can we build it?”
- Gimbal

## Operability

- Performance
- Are there issues with making this work?

## Reliability

- Reliable over the design life (20 yrs)?
- Which is most likely to be accommodating to an extreme event?
- Not solely longevity

## Ship-Shape

- Makes relocation more realistic

## Logistics

- Depends on fabricating on vs. off
- Personnel Safety and Emergency preparedness
  - o Fixed = safer?
- Fixed
  - o Vertical
    - Oil industry uses existing technologies (for 1m pipe)
  - o Horizontal
- Gimbal
  - o Horizontal

## Maintainability

- Fixed
- Gimbal
  - o Lubrication
  - o Materials
- Flex
  - o Involves hose
  - o Hose wears out two reconnections

## Scalability

- 4 to 10m

## Risk

- Install/Deinstall vs. Operation
  - o Deinstallation easier with self-supporting pipe
  - o Likelihood of self-supporting buoyant pipe?
- Probability of Failure
  - o Loss of Pipe
  - o Leakage



- Fixed
- Gimbal
  - o Moving parts

Pipe that will hold itself up and one that won't

- Self-supporting Pipe
  - o OTEC 1
  - o using buoyancy and weight
  - o Easier for horizontal build
- Hanging Pipe
  - o Fundamental issue – heavy
  - o May or may not need dead weight at bottom

Decommissioning

- Large driver
- Self-supporting pipe better
- Can you attach flotation on to a hanging pipe?
- Will the handling system be able to raise and lower the pipe?
- Interface must be detachable
- Can we detach dead weight?

Relocation

- if we build heavy pipe, then new pipe must be built
- if we build self supporting vertical or horizontal pipe, then save those costs

## **Breakout Session III:GROUP D**

### **Wednesday, November 4: 12:45-15:00**

- What are the cost limiting factors for this component? What are possible costs-savings? What research could be done on cost reduction?
- Are the technologies associated with this component viable? What are the economic factors associated with these technologies? What are the hurdles/limiting factors associated with these technologies?
- What is the development time frame for the technologies associated with this component

#### Off-Shore Industry

- A lot of technology has already been developed
- A lot of knowledge exists that should be tapped into

Someone needs to discuss operations

Risks in a horizontal build pipe are greater than a vertical build pipe

#### Manufacturing Orientation

##### Horizontal

- Implies self-supporting and manufactured on land

##### Vertical

- Implies configured on platform

#### Cost Drivers

- Gimbal vs. Fixed
- Relative motion of pipe vs. platform
- Complexity of handling system
- Buoyancy costs
- Trade-off between land fabrication vs. platform fabrication

Decommissioning is bigger driver than relocation

#### Technologies viable

- Dimensions and material are issues

What is the time frame associated with developing an interface?

- 2 years or less
- Depends on path taken (maybe 2 years or less)
- 2 years
- 2 years
- Custom equipment: 2 years or less
- Design is associated with pipe and platform: 3 years
- Custom pouring, forging: 3-4 years

- We are not considering a developing stage

Is this a development time frame?

- manufacturing time would be shorter than proposed

**Breakout Session IV: GROUP D**  
**Thursday, November 5: 9:15-15:00**

1. Now and then
  - a. Hydromechanical Structure – not sure if bounds have been made
  - b. Know how to do deep water work
  - c. 20 years of deep water experience
  - d. It is an industry – deep water: didn't exist before
    - i. Industrial base
    - ii. Code
    - iii. Standards
    - iv. Control Technologies - handling
    - v. Better understood
  - e. Data collection and analysis
  - f. Sensor technology – know the loads
  - g. No cheap buoyancy
  - h. Material
    - i. Composite improvements (materials and processes)
2. Research priorities
  - a. Three previously mentioned
  - b. Want to expand
    - i. Electrical Modeling
    - ii. System wearing
      1. Does technology today provide us acceptable risk?
      2. Analytical simulation specific to OTEC
  - c. Modeling failure mode

## Group D: Platform/Pipe Interface

“Where it all comes together”

The Coastal Response Research Center



## Baseline Parameters for Workshop OTEC Discussions

- Offshore
- Floating
- Moored
- Cable to shore
- 5-10 MWe scalable to commercial scale
- Potentially relocatable

The Coastal Response Research Center



## Interface Requirements

- Need to attach pipe to platform
  - Rigid or Gimbal? (Design Decision)
- CWP needs to be detachable at least one time
- CWP Optionally able to be reattached – dependent on relocation area
- Need to have some level of pipe recovery
- Survivable for duration of plant life
  - Corrosion, etc
- Must be able to attach 4m pipe
- Interface may need angle of motion (Design Consideration)
- Interface Sealant
- Compatible with CWP construction

The Coastal Response Research Center



## CWP Manufacturing Orientations

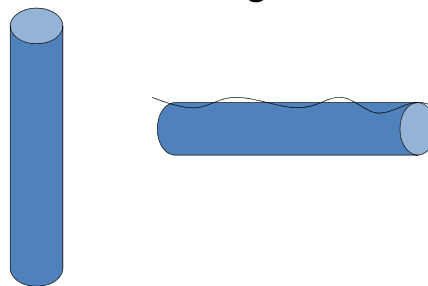

The Coastal Response Research Center



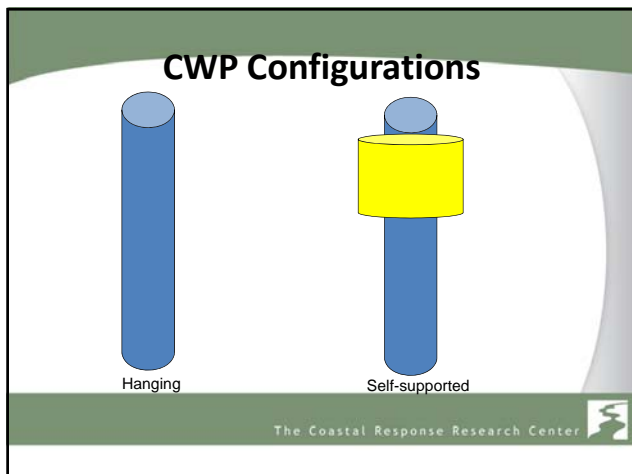

### Life Cycle Considerations

		Fixed	Gimbal	Flex
<b>Manufacturability</b>		G	G	Y
<b>Operability</b>		G	G	G
<b>Reliability</b>		Y <sup>1</sup>	G	G
<b>Logistics</b>	Vertical Build	Y	G	Y
	Horizontal Build	R	R	G
<b>Maintainability</b>		G	Y	R
<b>Scalability</b>		G	Y	R

<sup>1</sup>Dependent on platform but also imposes risk on to CWP

The Coastal Response Research Center

- ### Risks
- If interface detaches with hanging pipe, then the pipe sinks
  - If interface detaches with self-supporting pipe, then the pipe is available to be reconnected
  - If interface leaks, then performance degradation
  - If interface leaks, then repair is difficult
  - If horizontal build, then installation and deinstallation logistics are more complicated
  - If vertical build, then handling system failure could result in loss of pipe
- The Coastal Response Research Center

- ### What are the cost drivers for the interface?
- Gimbal vs. Fixed (Flex not scalable)
  - Decommissioning
  - Relative motion of pipe vs. platform, especially during fabrication
  - Complexity of handling system
  - Buoyancy costs
  - Trade-off between land fabrication vs. platform fabrication
  - Coupling/Decoupling
- The Coastal Response Research Center

### What are possible costs-savings?

- Refined analysis and model tests
- Utilize existing technologies
  - Scalable technologies
- Material choices
  - More robust
  - Corrosion
- Manufacturing process selection
- Relocatable pipe
- Economy of scale

The Coastal Response Research Center



### What research could be done on cost reduction?

- Find and adapt existing technologies and analysis tools
- Material selection
- Buoyancy

The Coastal Response Research Center



### Are the technologies viable? What are the economic factors? What are the limitations?

- Technologies are viable and have been demonstrated at various scales
  - Dimensions and material are issues
- Cost
- Limitations are manageable with current knowledge

The Coastal Response Research Center



### What is the development time frame?

- 1 to 2 years for requirements development to include analysis and model tests
- 1 to 2 years to delivery

The Coastal Response Research Center



Group D:  
Platform/Pipe Interface

“Where it all comes together”

Then and Now

- Hydromechanical Structure
- Lack of deep water industry and experience
- Limited analytical capabilities and capacities
- Limited sensor technology
- Lack of dynamic underwater cables
- Limited survey technology
- Established deep water industry
  - Industrial base
  - Code
  - Standards
  - Control Technologies (handling) Better understood
- Improvement in Composites
  - Materials
  - Processes
- Improved analytical capabilities and capacity
- Environmental awareness
- Improved Sensor technology
- Development of underwater tools
- Underwater construction techniques
- Deep dynamic cables
- Survey Technology
- Improved engineering process
  - Configuration management

OTEC Then



OTEC Then





### OTEC Now

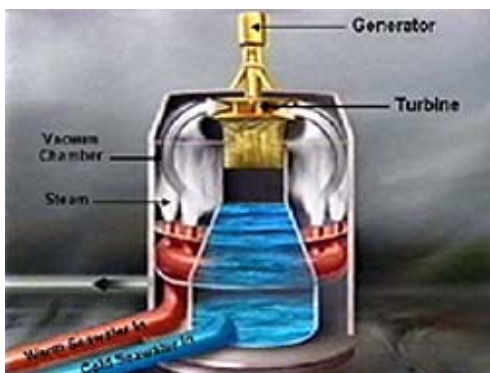
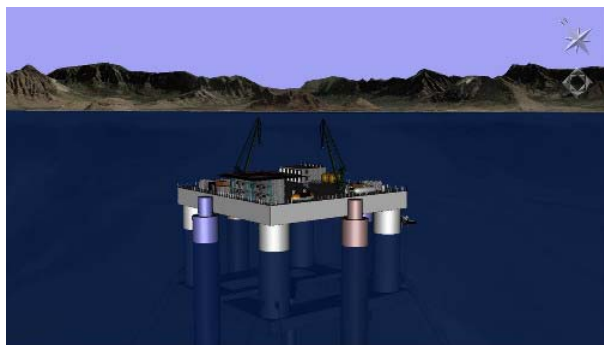



Heavy Lift



Spar



Spar

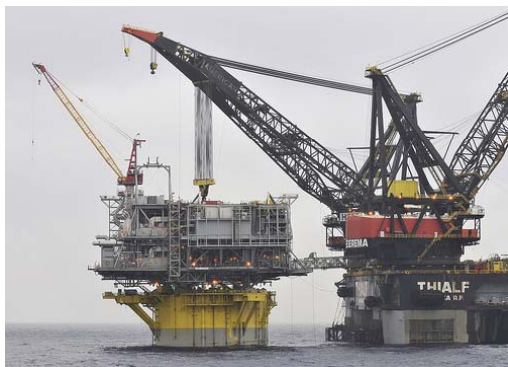

FPSO

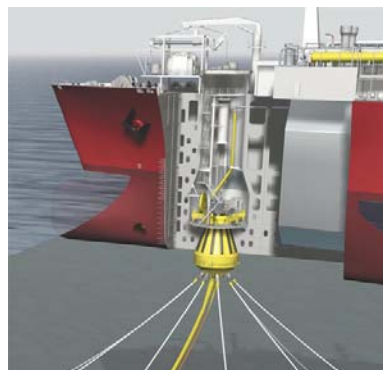

Bathymetry Then

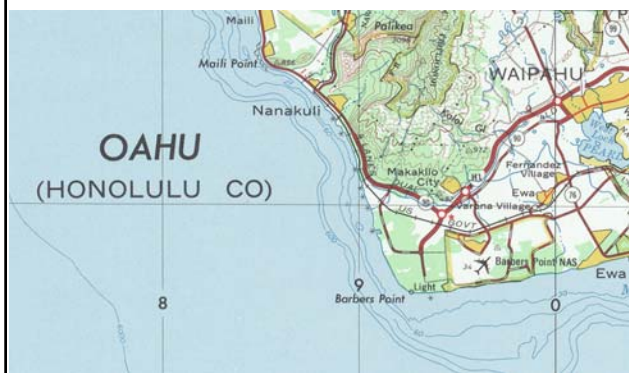

Bathymetry Now

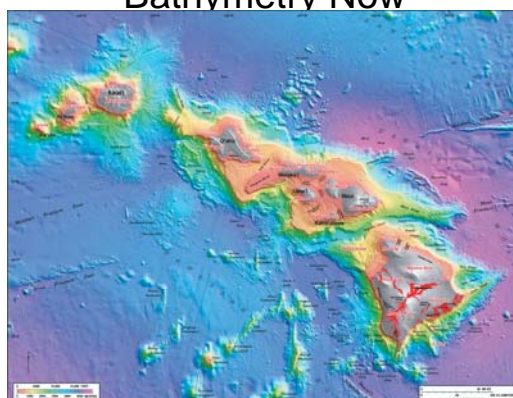

### Platforms Then

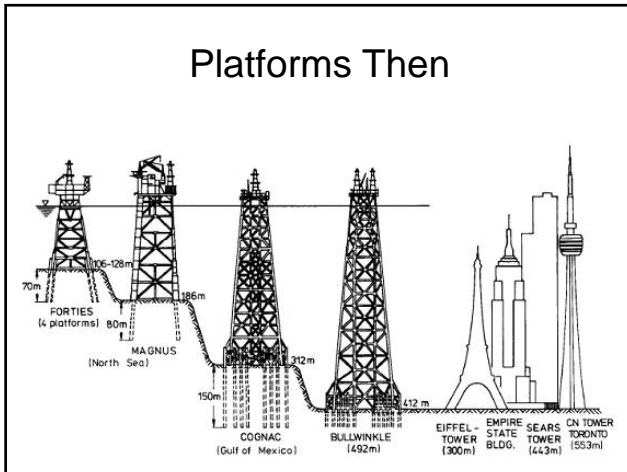

### Platforms Now

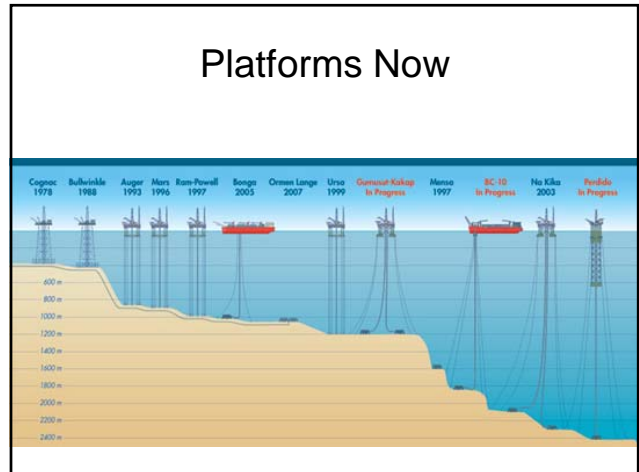

### Research Requirements

- OTEC system modeling
  - Dynamic coupled structural modeling of CWP interface
  - Mesoscale hydrodynamic modeling
- Deep oceanographic data collection, data mining, and processing
- Strengthening the “weakest link”
  - Defining and modeling failure modes
- Supply chain integration

### Glomar Explorer Gimbal

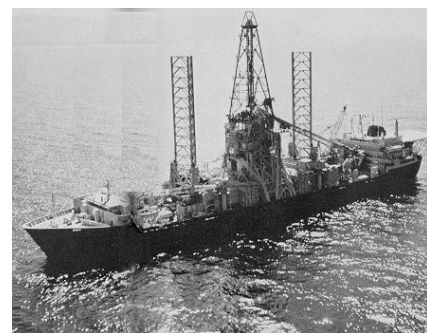

GROUP D		Fixed	Gimbal	Flex
<b>Manufacturability</b>		G	G	Y
<b>Operability</b>		G	G	G
<b>Reliability</b>		Y <sup>1</sup>	G	G
<b>Logistics</b>	<b>Vertical Build</b>	Y	G	Y
	<b>Horizontal Build</b>	R	R	G
<b>Maintainability</b>		G	Y	R
<b>Scalability</b>		G	Y	R

<sup>1</sup>Dependent on platform but also imposes risk on to CWP

## **APPENDIX E:**

### Pumps and Turbines

### Day III/Session IV: Changes since 1980: Pumps and Turbines

- Pumps and Turbines have been ready for 30 years
- No revolutionary breakthrough in pump/turbine; all advances evolutionary
- Electronics starting to be introduced into pumps/turbines to monitor health and status; most advances will be in outage management/condition based management
- Ammonia is probably the most practical working fluid
- Move toward a desire to create a sustainable system where system can function without external hydrocarbon inputs making it less susceptible to shifts in hydrocarbon availability and cost.
- Pumps exist today for a 10 mW; for a 100 mW commercial scale pumps would need to be ganged together
- Seaborne environment (roll, pitch, yaw) has proven out turbine machinery over worse or equivalent situations.
- Petroleum industry has 30 years of additional experience working in increasingly harsh environments (due to less conveniently available oil) and much has been learned about operations, methods and materials.
- OTEC-style plant in India that produces Freshwater – more expensive than traditional desalinization methods, however operational and works.
- Many attempts since 1980; 250 kW open cycle at NELHA, 1996-2000 50 kW Hx Testing (NEHLA), 2005 Diego Garcia Feasibility Study, 2006 OTEC Study Makai SBIR, 2007-2008 10 MW Pilot Plant Design by Lockheed Martin.
-

## Breakout Discussion Topics

### **Breakout Session I: GROUP E**

**Tuesday, November 3: 13:00-15:30**

What are the state-of-the-art technologies for the technical component?



## Breakout Discussion Topics

## Breakout Discussion Topics

### **Breakout Session II:**

**Wednesday, November 4: 10:15-12:15**

- 1) What processes (e.g., equipment, personnel) of the technology are associated with:
  - i. Fabrication, deployment, construction, and installation;
  - ii. Operation (including monitoring) and maintenance (including cleaning, repair, and replacement);
  - iii. Monitoring component performance;
  - iv. Personnel safety and emergency preparedness; and
  - v. Decommissioning?
  
- 2) What risks are associated with failure with these processes?

Notes:

#### **What are the components: (turbines)**

Blades, some form of stainless steel

Casing, welded or cast steel

Rub strips, stainless steel

Shafts, low alloy steel

Sleeve bearing, no fatigue limit

#### **Manufacturability:**

Turbine rotor (7-8MW) single piece forging, not changeable, no erosion or foreign object damage

Open die-press forging

Not too difficult to forge, limits would be tip speed goes up, centrifugal stress goes up, adds cost

Okay for 5-10MW, lots of experience, forging capability exists, manufacturing exists

Oil getting into the system through seals of the rotating equipment

Need to minimize seal leakage (should be a state-of-the art technology)

## Breakout Discussion Topics

Leakage should be working fluid out, not oil in  
Most manufacturers would know how to handle this

Ammonia turbines reliability, don't have a database yet  
Some manufacturers have ammonia turbines as a standard product (What are the applications for these? Refrigerant..  
Talking about radial flow turbines

Scalability would be on a modular basis

Capital cost for 10MW prototype huge compared to the cost for the 100MW

There are other issues for multiple turbines: all the piping, valving, shafts etc.  
Assessment needs to be completed

### **Blades:**

The blades on the roto-flow turbine, machined and non-removable  
Axial, blades are replaceable individually  
Can be: Forged, machined, or cut out of plate with wire EDM and machined  
Reliability and manufacturability: Depend on the process

Dynamic testing needs to be done (risk reduction activity)

### **Scalability:**

What limits the size and speed is the blade tip speed, need to be subsonic

Axial Flow turbine, can add stages, but get more energy taken out on the last few stages

Reliability is there for these turbines

### **Logistics:**

Maintenance aspect: have redundancy, in a small plant have at least 3 turbines, maybe 4, assume there are 2 operating  
At these sizes the turbines shouldn't be too expensive, might pay to have an extra turbine or inventory parts  
Manufacturers have repair services

## Breakout Discussion Topics

However with ammonia, might have to have inventory of parts for 1 turbine set  
Can always get the parts but there is a lead time, would want back up  
What is the periodic shut-down, 1 annual inspection, 1<sup>st</sup> inspection is ~5 years

Don't have a database on ammonia turbines, would want to inspect

Invasive vs. noninvasive monitoring

Noninvasive: ensures do not mess up the turbine through inspection  
Sensors are being put in

Plant will be shut-down for other maintenance issues

The potential of erosion blades

Density of ammonia less than the density of water

In some steam-turbine, lots of erosion, but almost no fatigue failures

Don't think that will be a problem with ammonia, because of the lower density, might be harder to cavitate  
(Liquid droplet erosion)

Ammonia will form a bubble, but won't have the same impact as water

We are not sure whether liquid droplet erosion will occur against a steel substrate in an ammonia environment at high speeds.

Need to set-up a whole materials list for what you are going to need in inventory

When you have an outage for some other reason, what do we go and do for the turbines?

Turbine is not going to be driving the shutdown

Need a set of critical parts for the turbines, not a full turbine as extra

Need to have multiple turbines so you can shut down part of the plant (Allows modularity)

If you shut down one turbine you are shutting down two heat exchangers

Do not want stagnant water in your heat exchangers

On the pump side, would make sense to have an extra pump

Always have multiple pumps, need excess capacity

## Breakout Discussion Topics

### **Risks:**

Expect turbine to be the most reliable component  
Environment is inert and the machine design practices are good

Risk reduction: having spare parts available

Foreign object damage off the pump that could damage the turbine  
Failure of a valve or pump or strainer, weld icicles could break off which might not come off in the flush

Radiography will be done, ultra-sonics as well, surface inspection from the outside  
Mitigation to this risk is training welders and having automated machinery

Oil leak into the ammonia side would: impact the performance, might get cavitation or erosion  
Would change out the working fluid

Platform motion probably will not have additional stress on the turbines  
Most ships powered by steam turbines, motion not a problem

### **Cost Drivers:**

Operational mode, spare part inventory  
Life cycle: 30 years, so why skimp on capital cost?  
Changing types of stainless steel might not save that much money

Lead times for large turbines could be on the order of a year – 18months

### **Pumps:**

Axial flow for large water pumps  
Components:  
Structure, motor, shaft, impeller, substation

Maximum size limit on some of these pumps for the larger plant, driving towards multiple pumps

Might want to have two oversized pumps each would be able to the whole flow-rate

## Breakout Discussion Topics

560,000kg/sec for 100MW, warm water pump

460,000 kg/sec for 100MW, cold water pump

Problem with submersible pump, if something goes wrong have to pull it out. Need to be able to do that easily  
Non-submersible can fix

Wide range of configurations for these pumps

Need to consider both submersible and non

Pumps are basically available.

Might not be quite off the shelf, but close enough, always something that needs to be tweaked

Databases are there

Several vendors would be able to manufacture these pumps

Warm water pump issue with the organisms

Did not seem to be a problem when talking to pump manufacturers

Lot of pump manufacturers of different quality

Depending on what they are doing, operability and reliability differs

Logistics: double the pumping in case of bypass

Pumps are pretty reliable

Pump manufacturer will have a design that is almost what you need and it will just be a tweak

In terms of reliability, operability, manufacturability, pumps are pretty standard

**Operation and Maintenance:** submersibles will have to be inspected more frequently

Circuit performance is monitored

Typically pumps are not highly sensitive to erosion, corrosion

Have a wide variety of materials to pick to prevent erosion and corrosion

## Breakout Discussion Topics

Materials are not high cost drivers

### **Mitigation:**

Redundancy

Spare parts inventory for non-submersible pumps

For submersibles would need a spare pump

If something happens to the submersible pump would ship back to the manufacturer

Life Cycle should be the primary driver

Should spend according to the life cycle

Lead times: ~ 1 year – 18 months

If they are using air-cooled generators could get corrosion and shorting out

### **Decommissioning:**

Turbines shaft/rotor- carbon steel or low alloy steel

Turbine blades- 12% chromium stainless steel or higher alloy steel

Turbine casing- carbon steel

Misc. parts- bearings (babbit) – can be re-melted, valves and seals – stainless steel

### **Pumps:**

Casings – carbon steel (may have epoxy coating or other corrosion protection)

Impeller- stainless steel

Motor- combination of copper, solder, insulation material; non-metallic material,

Shaft casing- carbon steel

Conclusion: > 85-90% recyclable materials

Contaminants associated with decommissioning- oils + solvents

## Breakout Discussion Topics

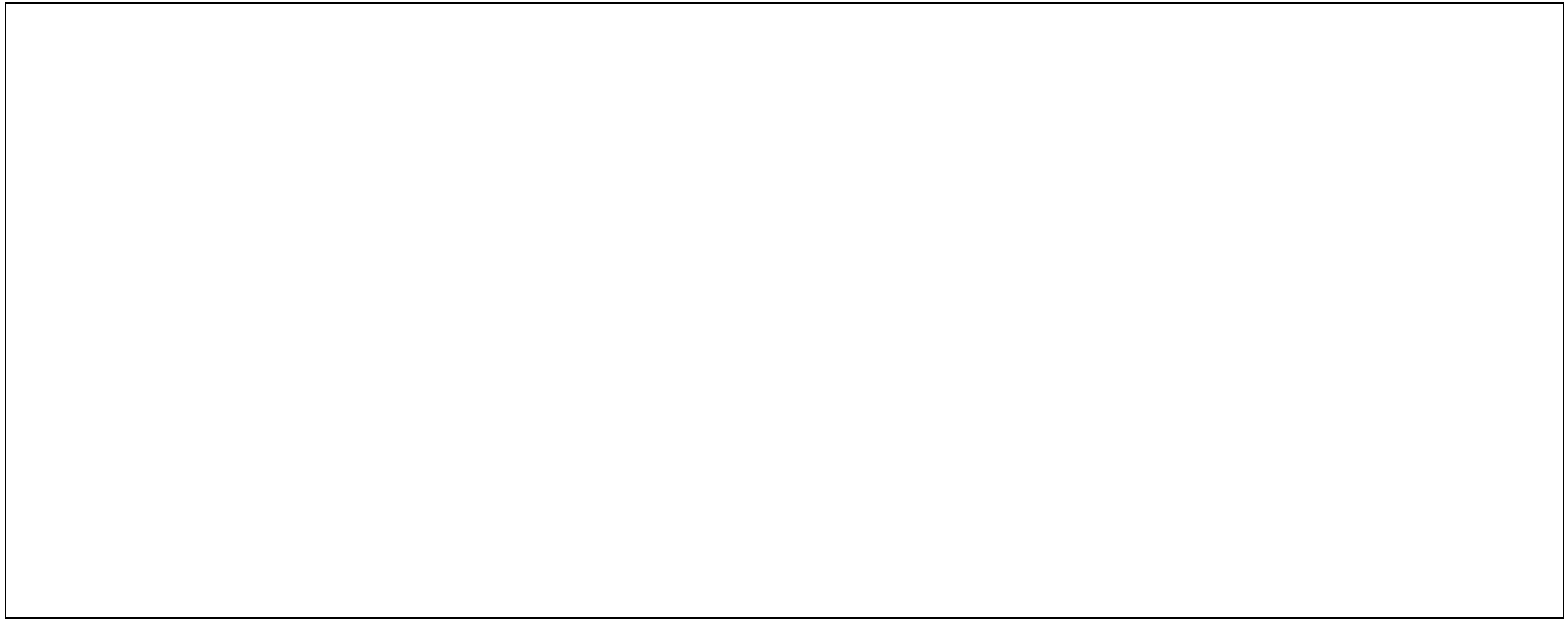
A large, empty rectangular box with a thin black border, intended for participants to write down their breakout discussion topics. The box is centered on the page and occupies most of the lower half of the document.



## Breakout Discussion Topics

### Life Cycle-

	<b>Turbines</b>
<b>manufacturability</b>	Not difficult at 5-10 MW and larger outputs up to 100 MW. Standard manufacturing practices in existence (forging, machining & casting).
<b>operability</b>	Fully adaptable to platform environment
<b>reliability</b>	Most reliable component in the system. Long periods between routine inspections.
<b>logistics</b>	Stock critical spares (rotors, seals, bearings, etc.) Periodic inspections opportunities during downtimes caused by other components. 18-24 month lead time to delivery.
<b>scalability</b>	5-10 MW Turbine (radial flow) has size limit. Larger size axial turbines, add blade length or number of blade stages to achieve greater output or efficiency.

	<b>Water Pumps</b>
<b>manufacturability</b>	Max impeller diameter 7ft. Wide range of design base configurations available from multiple vendors.
<b>operability</b>	Warm water pump issue with organisms.
<b>reliability</b>	Pumps have proven high reliability. Multiple or oversize pumps to sustain operation.
<b>logistics</b>	Depot repair for submersible pumps; organic partial repair potential for non-submersible. 12-18 month lead time.
<b>scalability</b>	Maximum size limit on some of these pumps for the larger plant, driving towards multiple pumps.

	<b>Working Fluid Pumps</b>
<b>manufacturability</b>	Wide range of design base configurations available from multiple vendors.
<b>operability</b>	Ammonia pumps are self lubricating.
<b>reliability</b>	Pumps have proven high reliability. Multiple pumps to sustain operation.
<b>logistics</b>	12-18 month lead time. Critical spares necessary.
<b>scalability</b>	No scaling issues. Scaling is achieved through module replication.

### Assumptions:

-Closed cycle operating system

## Breakout Discussion Topics

### **Decommissioning:**

#### **Turbines-**

Turbines shaft/rotor- carbon steel or low alloy steel

Turbine blades- 12% chromium stainless steel or higher alloy steel

Turbine casing- carbon steel

Misc. parts- bearings (babbit) – can be re-melted, valves and seals – stainless steel

#### **Pumps-**

Casings – carbon steel (may have epoxy coating or other corrosion protection)

Impeller- stainless steel

Motor- combination of copper, solder, insulation material; non-metallic material,

Shaft casing- carbon steel

Conclusion: > 85-90% recyclable materials

Contaminants associated with decommissioning- oils + solvents

### **Viability of technologies:**

All commercially available technology that can be altered to fit these requirements.

### **Economic factors:**

All components are technologically mature. All pumps and turbines 80-90% efficient.

### **Limiting factors:**

None

### **Development time frame:**

Required custom modifications:

18-24 months for turbine

6 -12 months for pumps

Dependent on size of unit.

## Breakout Discussion Topics

## Breakout Discussion Topics

### **Breakout Session III:**

**Wednesday, November 4: 12:45-15:00**

- 1) Are the technologies associated with this component viable? What are the economic factors associated with these technologies? What are the hurdles/limiting factors associated with these technologies?
- 2) What is the development time frame for the technologies associated with this component?

#### **Viability of technologies:**

All commercially available technology that can be altered to fit these requirements.

#### **Economic factors:**

All components are technologically mature. All pumps and turbines 80-90% efficient.

#### **Limiting factors:**

None

#### **Development time frame:**

Required custom modifications:

18-24 months for turbine

6 -12 months for pumps

Dependent on size of unit.

## Breakout Discussion Topics

### **Foreign object damage from heat exchanger piping:**

How will FOD such as slag or welding residue be eradicated from the system prior to operation? Should not be a problem with adequately trained welders, quality control and non-destructive testing.

If not adequately addressed, severe damage to turbines and pumps will result.

Influent screen to prevent damage.

### **Roll, pitch and yaw of the platform and how it affects alignment of turbine and pumps:**

Efficiency vs. allowable movement?

Ships & platforms already deployed at sea with turbines (30 year design life)– operational design for 0.06G with max of 0.15

Survival design 0.5G (kinematic and gravitational effects)

Bearings overdesigned to handle the shock loads.

### **Concern: Working fluid (ammonia) contaminated with oil-**

More of an issue for heat exchangers (fouling).

Prevention + monitoring – maintaining seals

Removal-

## Breakout Discussion Topics

### **Breakout Session I:**

**Tuesday, November 3: 13:00-15:30**

What are the state-of-the-art technologies for the technical component?

Components:

Cold water pump

Warm water pump

Working Fluid pump

Turbines

Vacuum pump for open cycle

Les- concern with open cycle, turbines subject to salt water corrosion from material standpoint

Open cycle - forces you to use more expensive materials and processes

Reference Guam OTEC Assessment, Avery

Discuss state-of-the-art technologies for 10MW and 100MW TURBINES

Turbine Closed Cycle:

Operating Parameters (Guam OTEC Makai study)

Axial flow turbines for larger gross MW requirements

4 – 16\$ million for 4 units

### **Options:**

Radial flow turbines, less available from manufacturers for higher MW

Smaller turbines commercially available

Practical limit on the physical size of the turbine for ammonia applications

Operation trade-off in terms of size

Have to stage the start-up of the turbines

## Breakout Discussion Topics

State of the art for radial flow turbines: machined from one piece of metal, has to do with the size of metal you can get  
Reasonable limit, to make these turbines

Axial flow turbines:

Control issues, different valve system, bypass

Sizable,

Vendors make a lot of smaller turbines and the development cost for larger turbines would be big

### **For a 10MW facility:**

2 radial flow turbines each at 7 – 8 MW (gross)

Would get modularity, redundancy, reliability

Some would look at increased number of smaller turbines

4 radial flow turbines, high-speed

Need to add a gear-box, parasitic losses associated with this, and increased cost

These options are commercially available

Toshiba, GE Rotoflow, Mitsubishi, Elliott, Hitachi

Costs: 4- 16million for 4 units

10million for 2 units 10MW

### **State – of – the –art**

Closer to 25MW size

### **100MW options:**

Add modules, not going any larger in terms of turbine size

Trade-study recommended: axial, radial, modules, cost

## Breakout Discussion Topics

Unique requirements for ammonia instead of steam

Market need: turbines in this size range need to be designed specifically for ammonia

Control valves to designed to ensure less pressure loss upstream of the turbine

Easier design, but fewer bidders

1<sup>st</sup> product engineering

Ammonia turbines are specialty items and require development

### **Pumps:**

State of the Art:

Types: Submersible or non-submersible

High efficiency pump with high efficiency motors

These pumps commercially available

Price might need to come down

Enough demand in the market to develop higher efficiency motors (OTEC funding would not be necessary)

8 coldwater and 8 warm water pumps 200,000gpm each (OTC Design) for 100MW

100MW

460,000 kg/sec coldwater

209,000gpm (Makai, OTEC)

560,000 kg/sec for warm water

255,000gpm warm water

The number of pumps, varies depending on vendor

Efficiencies: 87 – 92%

Submersible, axial flow impeller design



## Breakout Discussion Topics

10MW

2 cold water pumps would be available as state of the art today

Available from 2 vendors ~9month to a year lead time

### **Working Fluid Pump (ammonia): NH<sub>3</sub>**

Parameters:

OTC

8 working fluid feed pumps (1 operating, 1 standby)

2 per heat exchanger

8 recycle pumps

Total: 16 pumps

These pumps are commercially available and inexpensive

Lowest cost hardware in the system

Require more maintenance

Limited application for hybrid cycles in offshore projects

Would need to transport the water to shore (economical?)

How far offshore is it?

What will it cost to ship the water back to mainland?

Or produce the water onshore using the power produced from OTEC

A study needs to be completed to determine offshore vs. onshore water production

Vacuum pump: commercially available at this scale

## Breakout Discussion Topics

Closed Cycle	Operating Parameters:	State – of – the Art Technologies	
Turbine	<p>100 MW (135MW)            Inlet ammonia temp is 21 C = 69.8 F            Outlet ammonia temp is 9.7 C = 49.46 F            Pressure in: 890 kPa = 129.1 psi            Pressure out: 609 kPa = 88.3psi            Flow rate: 3566 kg/s            Efficiency not listed            (Guam OTEC Makai study)</p> <p>20 MW            Inlet temp: 69.6 F            Pressure inlet: 127.9 psia            Exit Pressure: 90.8 psia            Exit temp: 50.9 F  <u>(Baseline Designs of Moored and Grazing 40-MW OTEC Pilot Plants</u> George and Richards June 1980 JHU/ APL SR – 80-1A</p>		
Cold Water Pump	Flow rate: Operation efficiency: Motor efficiency: Head:		
Warm Water Pump			

# Breakout Discussion Topics

Working Fluid Pump			

## Breakout Discussion Topics

<b>Topic</b>	<b>State of the Art</b>	<b>Engineering Challenge</b>	
<b>Processes</b>			
<b>Fabrication</b>			
<b>Deployment</b>			
<b>Construction</b>			
<b>Installation</b>			
<b>OMR&amp;R</b>			
<b>Environmental Monitoring</b>			
<b>Safe Operating Procedures</b>			

## Breakout Discussion Topics

<b>Decommissioning</b>			
<b>RISKS ASSOCIATED WITH PROCESS FAILURE</b>			
<b>COMPONENT VIABILITY</b>			
<b>ECONOMIC FACTORS</b>			
<b>HURDLES/LIMITING FACTORS</b>			
<b>DEVELOPMENT TIME FRAME</b>			

## Breakout Discussion Topics

### **Breakout Session II:**

**Wednesday, November 4: 10:15-12:15**

- 1) What processes (e.g., equipment, personnel) of the technology are associated with:
  - i. Fabrication, deployment, construction, and installation;
  - ii. Operation (including monitoring) and maintenance (including cleaning, repair, and replacement);
  - iii. Monitoring component performance;
  - iv. Personnel safety and emergency preparedness; and
  - v. Decommissioning?
  
- 2) What risks are associated with failure with these processes?

Notes:

## Breakout Discussion Topics

<b>Topic</b>	<b>State-of-the-art:</b>	<b>Engineering Challenge</b>
PROCESSES:		
<i>Fabrication</i>		
<i>Deployment</i>		
<i>Construction</i>		
<i>Installation</i>		
<i>OMR&amp;R</i>		
<i>Environmental Monitoring</i>		
<i>Safe Operating Procedures</i>		
<i>Decommissioning</i>		
<i>Risks Associated with Process Failure</i>		
<i>Component Viability</i>		
<i>Economic Factors</i>		
<i>Hurdles/Limiting Factors</i>		
<i>Development Time Frame</i>		

## Breakout Discussion Topics

### **Breakout Session III:**

**Wednesday, November 4: 12:45-15:00**

- 1) Are the technologies associated with this component viable? What are the economic factors associated with these technologies? What are the hurdles/limiting factors associated with these technologies?
- 2) What is the development time frame for the technologies associated with this component?



## Pumps & Turbines

	Turbines
<b>manufacturability</b>	Not difficult at 5-10 MW and larger outputs up to 100 MW. Standard manufacturing practices in existence (forging, machining & casting).
<b>operability</b>	Fully adaptable to platform environment
<b>reliability</b>	Most reliable component in the system. Long periods between routine inspections.
<b>logistics</b>	Stock critical spares (rotors, seals, bearings, etc.) Periodic inspections opportunities during downtimes caused by other components. 18-24 month lead time to delivery.
<b>scalability</b>	5-10 MW Turbine (radial flow) has size limit. Larger size axial turbines, add blade length or number of blade stages to achieve greater output or efficiency.

**Assumptions:**  
-Closed cycle operating system

The Coastal Response Research Center 

## Pumps & Turbines

	Water Pumps
<b>manufacturability</b>	Max impeller diameter 7ft. Wide range of design base configurations available from multiple vendors.
<b>operability</b>	Warm water pump issue with organisms.
<b>reliability</b>	Pumps have proven high reliability. Multiple or oversize pumps to sustain operation.
<b>logistics</b>	Depot repair for submersible pumps; organic partial repair potential for non-submersible. 12-18 month lead time.
<b>scalability</b>	Maximum size limit on some of these pumps for the larger plant, driving towards multiple pumps.

**Assumptions:**  
-Closed cycle operating system

The Coastal Response Research Center 

## Pumps & Turbines

	Working Fluid Pumps
<b>manufacturability</b>	Wide range of design base configurations available from multiple vendors.
<b>operability</b>	Ammonia pumps are self lubricating.
<b>reliability</b>	Pumps have proven high reliability. Multiple pumps to sustain operation.
<b>logistics</b>	12-18 month lead time. Critical spares necessary.
<b>scalability</b>	No scaling issues. Scaling is achieved through module replication.

**Assumptions:**  
-Closed cycle operating system

The Coastal Response Research Center 

## Decommissioning

**Turbines-**

- Turbines shaft/rotor- carbon steel or low alloy steel
- Turbine blades- 12% chromium stainless steel or higher alloy steel
- Turbine casing- carbon steel
- Misc. parts- bearings (babbit) – can be re-melted, valves and seals – stainless steel

**Pumps-**

- Casings – carbon steel (may have epoxy coating or other corrosion protection)
- Impeller- stainless steel
- Motor- combination of copper, solder, insulation material; non-metallic material,
- Shaft casing- carbon steel

**Conclusion-**

- > 85-90% recyclable materials
- Contaminants associated with decommissioning- oils + solvents

The Coastal Response Research Center 

## Viability of technologies

All commercially available technology that can be altered to fit these requirements.

**Economic factors:**

- All components are technologically mature. All pumps and turbines 80-90% efficient.

**Limiting factors:**

- None

**Development time frame:**

- Required custom modifications:
  - 18-24 months for turbine
  - 6-12 months for pumps
- Dependent on size of unit.



## Pumps and Turbines

Breakout Session 1: State-of-the-Art Technologies

## Assumptions:

- Closed cycle leading contender for near term commercialization

### References:

- Guam OTEC Feasibility Assessment
- Baseline Designs of Moored and Grazing 40-MW OTEC Pilot Plants
- Renewable Energy From the Ocean
- OTC Study

## Components Addressed:

- Turbines
- Pumps
  - Cold Water Pump
  - Warm Water Pump
  - Working Fluid Feed Pumps
  - Vacuum Pump (Open/Hybrid Cycles)

## Turbines

- Reviewed Operating Parameters for 30 year period and remained consistent
- Ammonia turbines are specialty items and require additional development time
- Optimization for ammonia working fluid is desirable
- Radial Flow for 10MW
  - 2 per plant
  - 7 - 8 MW gross each turbine
  - Commercially Available, multiple vendors
- Axial Flow for 100MW
  - Trade study recommended to optimize size for NH<sub>3</sub>
- For all power levels multiple turbines are required for modularity, reliability, redundancy, operation and maintenance

### Cold/Warm Water Pumps

- Axial Flow impeller design
- Submersible vs. non
- High efficiency pumps with high efficiency motors
- 87-92% efficiency possible in some configurations
- Commercially available
- Multiple vendors

### Working Fluid Pumps

- Feed pumps
- Recycle pumps
- One of the lowest cost items in the system
- Commercially available
- Large Design database established

### Vacuum Pumps

- Needed for Hybrid Cycle
- Commercially adaptable database
- Currently used in conventional sea water cooled nuclear and fossil plants for start-up
- Trade off studies need to be performed relative to the location of water production (onshore vs. offshore)

## **APPENDIX E:**

### Pumps and Turbines

### Day III/Session IV: Changes since 1980: Pumps and Turbines

- Pumps and Turbines have been ready for 30 years
- No revolutionary breakthrough in pump/turbine; all advances evolutionary
- Electronics starting to be introduced into pumps/turbines to monitor health and status; most advances will be in outage management/condition based management
- Ammonia is probably the most practical working fluid
- Move toward a desire to create a sustainable system where system can function without external hydrocarbon inputs making it less susceptible to shifts in hydrocarbon availability and cost.
- Pumps exist today for a 10 mW; for a 100 mW commercial scale pumps would need to be ganged together
- Seaborne environment (roll, pitch, yaw) has proven out turbine machinery over worse or equivalent situations.
- Petroleum industry has 30 years of additional experience working in increasingly harsh environments (due to less conveniently available oil) and much has been learned about operations, methods and materials.
- OTEC-style plant in India that produces Freshwater – more expensive than traditional desalinization methods, however operational and works.
- Many attempts since 1980; 250 kW open cycle at NELHA, 1996-2000 50 kW Hx Testing (NEHLA), 2005 Diego Garcia Feasibility Study, 2006 OTEC Study Makai SBIR, 2007-2008 10 MW Pilot Plant Design by Lockheed Martin.
-

## Breakout Discussion Topics

### **Breakout Session I: GROUP E**

**Tuesday, November 3: 13:00-15:30**

What are the state-of-the-art technologies for the technical component?

## Breakout Discussion Topics



## Breakout Discussion Topics

### **Breakout Session II:**

**Wednesday, November 4: 10:15-12:15**

- 1) What processes (e.g., equipment, personnel) of the technology are associated with:
  - i. Fabrication, deployment, construction, and installation;
  - ii. Operation (including monitoring) and maintenance (including cleaning, repair, and replacement);
  - iii. Monitoring component performance;
  - iv. Personnel safety and emergency preparedness; and
  - v. Decommissioning?
  
- 2) What risks are associated with failure with these processes?

Notes:

#### **What are the components: (turbines)**

Blades, some form of stainless steel

Casing, welded or cast steel

Rub strips, stainless steel

Shafts, low alloy steel

Sleeve bearing, no fatigue limit

#### **Manufacturability:**

Turbine rotor (7-8MW) single piece forging, not changeable, no erosion or foreign object damage

Open die-press forging

Not too difficult to forge, limits would be tip speed goes up, centrifugal stress goes up, adds cost

Okay for 5-10MW, lots of experience, forging capability exists, manufacturing exists

Oil getting into the system through seals of the rotating equipment

Need to minimize seal leakage (should be a state-of-the art technology)

## Breakout Discussion Topics

Leakage should be working fluid out, not oil in  
Most manufacturers would know how to handle this

Ammonia turbines reliability, don't have a database yet  
Some manufacturers have ammonia turbines as a standard product (What are the applications for these? Refrigerant..  
Talking about radial flow turbines

Scalability would be on a modular basis

Capital cost for 10MW prototype huge compared to the cost for the 100MW

There are other issues for multiple turbines: all the piping, valving, shafts etc.  
Assessment needs to be completed

### **Blades:**

The blades on the roto-flow turbine, machined and non-removable  
Axial, blades are replaceable individually  
Can be: Forged, machined, or cut out of plate with wire EDM and machined  
Reliability and manufacturability: Depend on the process

Dynamic testing needs to be done (risk reduction activity)

### **Scalability:**

What limits the size and speed is the blade tip speed, need to be subsonic

Axial Flow turbine, can add stages, but get more energy taken out on the last few stages

Reliability is there for these turbines

### **Logistics:**

Maintenance aspect: have redundancy, in a small plant have at least 3 turbines, maybe 4, assume there are 2 operating  
At these sizes the turbines shouldn't be too expensive, might pay to have an extra turbine or inventory parts  
Manufacturers have repair services

## Breakout Discussion Topics

However with ammonia, might have to have inventory of parts for 1 turbine set  
Can always get the parts but there is a lead time, would want back up  
What is the periodic shut-down, 1 annual inspection, 1<sup>st</sup> inspection is ~5 years

Don't have a database on ammonia turbines, would want to inspect

Invasive vs. noninvasive monitoring

Noninvasive: ensures do not mess up the turbine through inspection  
Sensors are being put in

Plant will be shut-down for other maintenance issues

The potential of erosion blades

Density of ammonia less than the density of water

In some steam-turbine, lots of erosion, but almost no fatigue failures

Don't think that will be a problem with ammonia, because of the lower density, might be harder to cavitate  
(Liquid droplet erosion)

Ammonia will form a bubble, but won't have the same impact as water

We are not sure whether liquid droplet erosion will occur against a steel substrate in an ammonia environment at high speeds.

Need to set-up a whole materials list for what you are going to need in inventory

When you have an outage for some other reason, what do we go and do for the turbines?

Turbine is not going to be driving the shutdown

Need a set of critical parts for the turbines, not a full turbine as extra

Need to have multiple turbines so you can shut down part of the plant (Allows modularity)

If you shut down one turbine you are shutting down two heat exchangers

Do not want stagnant water in your heat exchangers

On the pump side, would make sense to have an extra pump

Always have multiple pumps, need excess capacity

## Breakout Discussion Topics

### **Risks:**

Expect turbine to be the most reliable component  
Environment is inert and the machine design practices are good

Risk reduction: having spare parts available

Foreign object damage off the pump that could damage the turbine  
Failure of a valve or pump or strainer, weld icicles could break off which might not come off in the flush

Radiography will be done, ultra-sonics as well, surface inspection from the outside  
Mitigation to this risk is training welders and having automated machinery

Oil leak into the ammonia side would: impact the performance, might get cavitation or erosion  
Would change out the working fluid

Platform motion probably will not have additional stress on the turbines  
Most ships powered by steam turbines, motion not a problem

### **Cost Drivers:**

Operational mode, spare part inventory  
Life cycle: 30 years, so why skimp on capital cost?  
Changing types of stainless steel might not save that much money

Lead times for large turbines could be on the order of a year – 18months

### **Pumps:**

Axial flow for large water pumps  
Components:  
Structure, motor, shaft, impeller, substation

Maximum size limit on some of these pumps for the larger plant, driving towards multiple pumps

Might want to have two oversized pumps each would be able to the whole flow-rate

## Breakout Discussion Topics

560,000kg/sec for 100MW, warm water pump

460,000 kg/sec for 100MW, cold water pump

Problem with submersible pump, if something goes wrong have to pull it out. Need to be able to do that easily  
Non-submersible can fix

Wide range of configurations for these pumps

Need to consider both submersible and non

Pumps are basically available.

Might not be quite off the shelf, but close enough, always something that needs to be tweaked

Databases are there

Several vendors would be able to manufacture these pumps

Warm water pump issue with the organisms

Did not seem to be a problem when talking to pump manufacturers

Lot of pump manufacturers of different quality

Depending on what they are doing, operability and reliability differs

Logistics: double the pumping in case of bypass

Pumps are pretty reliable

Pump manufacturer will have a design that is almost what you need and it will just be a tweak

In terms of reliability, operability, manufacturability, pumps are pretty standard

**Operation and Maintenance:** submersibles will have to be inspected more frequently

Circuit performance is monitored

Typically pumps are not highly sensitive to erosion, corrosion

Have a wide variety of materials to pick to prevent erosion and corrosion

## Breakout Discussion Topics

Materials are not high cost drivers

### **Mitigation:**

Redundancy

Spare parts inventory for non-submersible pumps

For submersibles would need a spare pump

If something happens to the submersible pump would ship back to the manufacturer

Life Cycle should be the primary driver

Should spend according to the life cycle

Lead times: ~ 1 year – 18 months

If they are using air-cooled generators could get corrosion and shorting out

### **Decommissioning:**

Turbines shaft/rotor- carbon steel or low alloy steel

Turbine blades- 12% chromium stainless steel or higher alloy steel

Turbine casing- carbon steel

Misc. parts- bearings (babbit) – can be re-melted, valves and seals – stainless steel

### **Pumps:**

Casings – carbon steel (may have epoxy coating or other corrosion protection)

Impeller- stainless steel

Motor- combination of copper, solder, insulation material; non-metallic material,

Shaft casing- carbon steel

Conclusion: > 85-90% recyclable materials

Contaminants associated with decommissioning- oils + solvents

## Breakout Discussion Topics

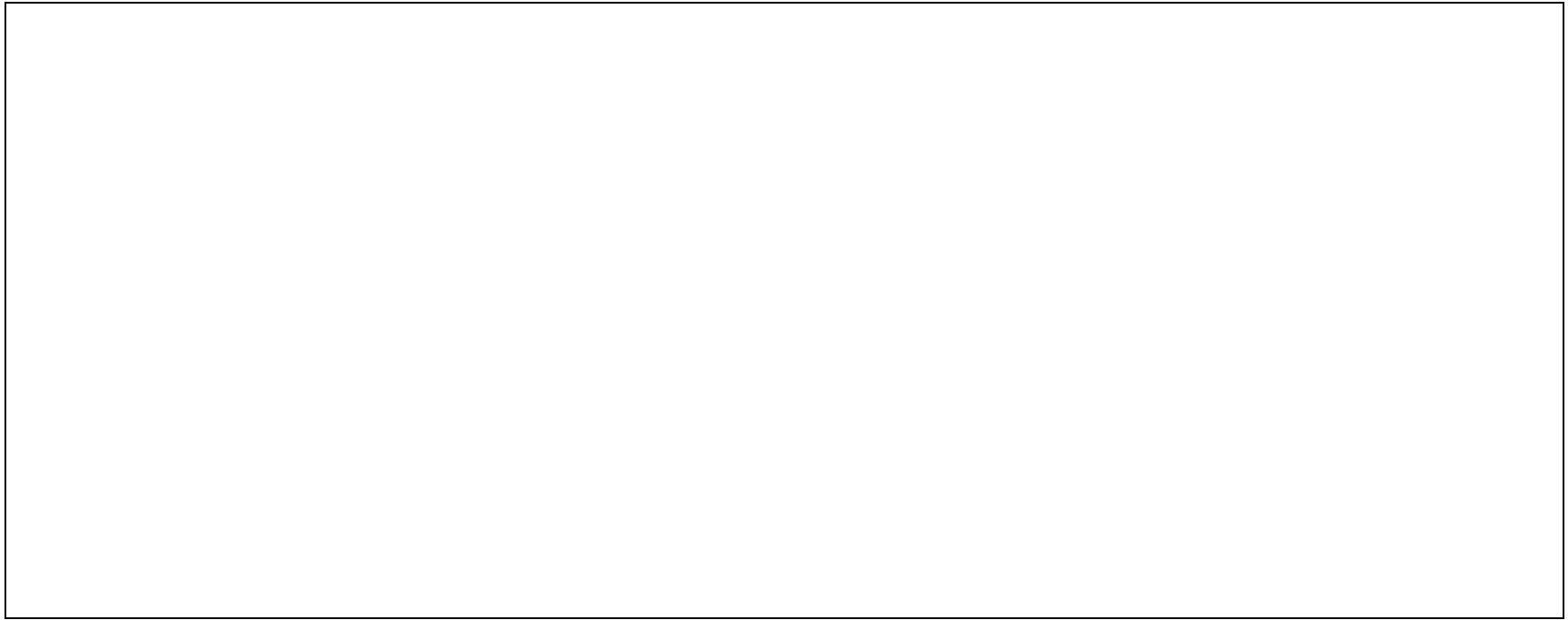
A large, empty rectangular box with a thin black border, intended for participants to write down their breakout discussion topics. The box is centered on the page and occupies most of the lower half of the document.

## Breakout Discussion Topics

### Life Cycle-

	<b>Turbines</b>
<b>manufacturability</b>	Not difficult at 5-10 MW and larger outputs up to 100 MW. Standard manufacturing practices in existence (forging, machining & casting).
<b>operability</b>	Fully adaptable to platform environment
<b>reliability</b>	Most reliable component in the system. Long periods between routine inspections.
<b>logistics</b>	Stock critical spares (rotors, seals, bearings, etc.) Periodic inspections opportunities during downtimes caused by other components. 18-24 month lead time to delivery.
<b>scalability</b>	5-10 MW Turbine (radial flow) has size limit. Larger size axial turbines, add blade length or number of blade stages to achieve greater output or efficiency.

	<b>Water Pumps</b>
<b>manufacturability</b>	Max impeller diameter 7ft. Wide range of design base configurations available from multiple vendors.
<b>operability</b>	Warm water pump issue with organisms.
<b>reliability</b>	Pumps have proven high reliability. Multiple or oversize pumps to sustain operation.
<b>logistics</b>	Depot repair for submersible pumps; organic partial repair potential for non-submersible. 12-18 month lead time.
<b>scalability</b>	Maximum size limit on some of these pumps for the larger plant, driving towards multiple pumps.

	<b>Working Fluid Pumps</b>
<b>manufacturability</b>	Wide range of design base configurations available from multiple vendors.
<b>operability</b>	Ammonia pumps are self lubricating.
<b>reliability</b>	Pumps have proven high reliability. Multiple pumps to sustain operation.
<b>logistics</b>	12-18 month lead time. Critical spares necessary.
<b>scalability</b>	No scaling issues. Scaling is achieved through module replication.

### Assumptions:

-Closed cycle operating system



## Breakout Discussion Topics

### **Decommissioning:**

#### **Turbines-**

Turbines shaft/rotor- carbon steel or low alloy steel

Turbine blades- 12% chromium stainless steel or higher alloy steel

Turbine casing- carbon steel

Misc. parts- bearings (babbit) – can be re-melted, valves and seals – stainless steel

#### **Pumps-**

Casings – carbon steel (may have epoxy coating or other corrosion protection)

Impeller- stainless steel

Motor- combination of copper, solder, insulation material; non-metallic material,

Shaft casing- carbon steel

Conclusion: > 85-90% recyclable materials

Contaminants associated with decommissioning- oils + solvents

### **Viability of technologies:**

All commercially available technology that can be altered to fit these requirements.

### **Economic factors:**

All components are technologically mature. All pumps and turbines 80-90% efficient.

### **Limiting factors:**

None

### **Development time frame:**

Required custom modifications:

18-24 months for turbine

6 -12 months for pumps

Dependent on size of unit.

## Breakout Discussion Topics

## Breakout Discussion Topics

### **Breakout Session III:**

**Wednesday, November 4: 12:45-15:00**

- 1) Are the technologies associated with this component viable? What are the economic factors associated with these technologies? What are the hurdles/limiting factors associated with these technologies?
- 2) What is the development time frame for the technologies associated with this component?

#### **Viability of technologies:**

All commercially available technology that can be altered to fit these requirements.

#### **Economic factors:**

All components are technologically mature. All pumps and turbines 80-90% efficient.

#### **Limiting factors:**

None

#### **Development time frame:**

Required custom modifications:

18-24 months for turbine

6 -12 months for pumps

Dependent on size of unit.

## Breakout Discussion Topics

### **Foreign object damage from heat exchanger piping:**

How will FOD such as slag or welding residue be eradicated from the system prior to operation? Should not be a problem with adequately trained welders, quality control and non-destructive testing.

If not adequately addressed, severe damage to turbines and pumps will result.

Influent screen to prevent damage.

### **Roll, pitch and yaw of the platform and how it affects alignment of turbine and pumps:**

Efficiency vs. allowable movement?

Ships & platforms already deployed at sea with turbines (30 year design life)– operational design for 0.06G with max of 0.15

Survival design 0.5G (kinematic and gravitational effects)

Bearings overdesigned to handle the shock loads.

### **Concern: Working fluid (ammonia) contaminated with oil-**

More of an issue for heat exchangers (fouling).

Prevention + monitoring – maintaining seals

Removal-

## Breakout Discussion Topics

### **Breakout Session I:**

**Tuesday, November 3: 13:00-15:30**

What are the state-of-the-art technologies for the technical component?

Components:

Cold water pump

Warm water pump

Working Fluid pump

Turbines

Vacuum pump for open cycle

Les- concern with open cycle, turbines subject to salt water corrosion from material standpoint

Open cycle - forces you to use more expensive materials and processes

Reference Guam OTEC Assessment, Avery

Discuss state-of-the-art technologies for 10MW and 100MW TURBINES

Turbine Closed Cycle:

Operating Parameters (Guam OTEC Makai study)

Axial flow turbines for larger gross MW requirements

4 – 16\$ million for 4 units

### **Options:**

Radial flow turbines, less available from manufacturers for higher MW

Smaller turbines commercially available

Practical limit on the physical size of the turbine for ammonia applications

Operation trade-off in terms of size

Have to stage the start-up of the turbines

## Breakout Discussion Topics

State of the art for radial flow turbines: machined from one piece of metal, has to do with the size of metal you can get  
Reasonable limit, to make these turbines

Axial flow turbines:

Control issues, different valve system, bypass

Sizable,

Vendors make a lot of smaller turbines and the development cost for larger turbines would be big

### **For a 10MW facility:**

2 radial flow turbines each at 7 – 8 MW (gross)

Would get modularity, redundancy, reliability

Some would look at increased number of smaller turbines

4 radial flow turbines, high-speed

Need to add a gear-box, parasitic losses associated with this, and increased cost

These options are commercially available

Toshiba, GE Rotoflow, Mitsubishi, Elliott, Hitachi

Costs: 4- 16million for 4 units

10million for 2 units 10MW

### **State – of – the –art**

Closer to 25MW size

### **100MW options:**

Add modules, not going any larger in terms of turbine size

Trade-study recommended: axial, radial, modules, cost

## Breakout Discussion Topics

Unique requirements for ammonia instead of steam

Market need: turbines in this size range need to be designed specifically for ammonia

Control valves to designed to ensure less pressure loss upstream of the turbine

Easier design, but fewer bidders

1<sup>st</sup> product engineering

Ammonia turbines are specialty items and require development

### **Pumps:**

State of the Art:

Types: Submersible or non-submersible

High efficiency pump with high efficiency motors

These pumps commercially available

Price might need to come down

Enough demand in the market to develop higher efficiency motors (OTEC funding would not be necessary)

8 coldwater and 8 warm water pumps 200,000gpm each (OTC Design) for 100MW

100MW

460,000 kg/sec coldwater

209,000gpm (Makai, OTEC)

560,000 kg/sec for warm water

255,000gpm warm water

The number of pumps, varies depending on vendor

Efficiencies: 87 – 92%

Submersible, axial flow impeller design

## Breakout Discussion Topics

10MW

2 cold water pumps would be available as state of the art today

Available from 2 vendors ~9month to a year lead time

### **Working Fluid Pump (ammonia): NH<sub>3</sub>**

Parameters:

OTC

8 working fluid feed pumps (1 operating, 1 standby)

2 per heat exchanger

8 recycle pumps

Total: 16 pumps

These pumps are commercially available and inexpensive

Lowest cost hardware in the system

Require more maintenance

Limited application for hybrid cycles in offshore projects

Would need to transport the water to shore (economical?)

How far offshore is it?

What will it cost to ship the water back to mainland?

Or produce the water onshore using the power produced from OTEC

A study needs to be completed to determine offshore vs. onshore water production

Vacuum pump: commercially available at this scale



## Breakout Discussion Topics

Closed Cycle	Operating Parameters:	State – of – the Art Technologies	
Turbine	<p>100 MW (135MW)            Inlet ammonia temp is 21 C = 69.8 F            Outlet ammonia temp is 9.7 C = 49.46 F            Pressure in: 890 kPa = 129.1 psi            Pressure out: 609 kPa = 88.3psi            Flow rate: 3566 kg/s            Efficiency not listed            (Guam OTEC Makai study)</p> <p>20 MW            Inlet temp: 69.6 F            Pressure inlet: 127.9 psia            Exit Pressure: 90.8 psia            Exit temp: 50.9 F  <u>(Baseline Designs of Moored and Grazing 40-MW OTEC Pilot Plants</u> George and Richards June 1980 JHU/ APL SR – 80-1A</p>		
Cold Water Pump	Flow rate: Operation efficiency: Motor efficiency: Head:		
Warm Water Pump			

# Breakout Discussion Topics

Working Fluid Pump			

## Breakout Discussion Topics

<b>Topic</b>	<b>State of the Art</b>	<b>Engineering Challenge</b>	
<b>Processes</b>			
<b>Fabrication</b>			
<b>Deployment</b>			
<b>Construction</b>			
<b>Installation</b>			
<b>OMR&amp;R</b>			
<b>Environmental Monitoring</b>			
<b>Safe Operating Procedures</b>			

## Breakout Discussion Topics

<b>Decommissioning</b>			
<b>RISKS ASSOCIATED WITH PROCESS FAILURE</b>			
<b>COMPONENT VIABILITY</b>			
<b>ECONOMIC FACTORS</b>			
<b>HURDLES/LIMITING FACTORS</b>			
<b>DEVELOPMENT TIME FRAME</b>			

## Breakout Discussion Topics

### **Breakout Session II:**

**Wednesday, November 4: 10:15-12:15**

- 1) What processes (e.g., equipment, personnel) of the technology are associated with:
  - i. Fabrication, deployment, construction, and installation;
  - ii. Operation (including monitoring) and maintenance (including cleaning, repair, and replacement);
  - iii. Monitoring component performance;
  - iv. Personnel safety and emergency preparedness; and
  - v. Decommissioning?
  
- 2) What risks are associated with failure with these processes?

Notes:

## Breakout Discussion Topics

<b>Topic</b>	<b>State-of-the-art:</b>	<b>Engineering Challenge</b>
PROCESSES:		
<i>Fabrication</i>		
<i>Deployment</i>		
<i>Construction</i>		
<i>Installation</i>		
<i>OMR&amp;R</i>		
<i>Environmental Monitoring</i>		
<i>Safe Operating Procedures</i>		
<i>Decommissioning</i>		
<i>Risks Associated with Process Failure</i>		
<i>Component Viability</i>		
<i>Economic Factors</i>		
<i>Hurdles/Limiting Factors</i>		
<i>Development Time Frame</i>		

## Breakout Discussion Topics

### **Breakout Session III:**

**Wednesday, November 4: 12:45-15:00**

- 1) Are the technologies associated with this component viable? What are the economic factors associated with these technologies? What are the hurdles/limiting factors associated with these technologies?
- 2) What is the development time frame for the technologies associated with this component?

## Pumps & Turbines

	Turbines
<b>manufacturability</b>	Not difficult at 5-10 MW and larger outputs up to 100 MW. Standard manufacturing practices in existence (forging, machining & casting).
<b>operability</b>	Fully adaptable to platform environment
<b>reliability</b>	Most reliable component in the system. Long periods between routine inspections.
<b>logistics</b>	Stock critical spares (rotors, seals, bearings, etc.) Periodic inspections opportunities during downtimes caused by other components. 18-24 month lead time to delivery.
<b>scalability</b>	5-10 MW Turbine (radial flow) has size limit. Larger size axial turbines, add blade length or number of blade stages to achieve greater output or efficiency.

**Assumptions:**  
-Closed cycle operating system

The Coastal Response Research Center 

## Pumps & Turbines

	Water Pumps
<b>manufacturability</b>	Max impeller diameter 7ft. Wide range of design base configurations available from multiple vendors.
<b>operability</b>	Warm water pump issue with organisms.
<b>reliability</b>	Pumps have proven high reliability. Multiple or oversize pumps to sustain operation.
<b>logistics</b>	Depot repair for submersible pumps; organic partial repair potential for non-submersible. 12-18 month lead time.
<b>scalability</b>	Maximum size limit on some of these pumps for the larger plant, driving towards multiple pumps.

**Assumptions:**  
-Closed cycle operating system

The Coastal Response Research Center 

## Pumps & Turbines

	Working Fluid Pumps
<b>manufacturability</b>	Wide range of design base configurations available from multiple vendors.
<b>operability</b>	Ammonia pumps are self lubricating.
<b>reliability</b>	Pumps have proven high reliability. Multiple pumps to sustain operation.
<b>logistics</b>	12-18 month lead time. Critical spares necessary.
<b>scalability</b>	No scaling issues. Scaling is achieved through module replication.

**Assumptions:**  
-Closed cycle operating system

The Coastal Response Research Center 

## Decommissioning

**Turbines-**

- Turbines shaft/rotor- carbon steel or low alloy steel
- Turbine blades- 12% chromium stainless steel or higher alloy steel
- Turbine casing- carbon steel
- Misc. parts- bearings (babbit) – can be re-melted, valves and seals – stainless steel

**Pumps-**

- Casings – carbon steel (may have epoxy coating or other corrosion protection)
- Impeller- stainless steel
- Motor- combination of copper, solder, insulation material; non-metallic material,
- Shaft casing- carbon steel

**Conclusion-**

- > 85-90% recyclable materials
- Contaminants associated with decommissioning- oils + solvents

The Coastal Response Research Center 



## Viability of technologies

All commercially available technology that can be altered to fit these requirements.

**Economic factors:**

- All components are technologically mature. All pumps and turbines 80-90% efficient.

**Limiting factors:**

- None

**Development time frame:**

- Required custom modifications:
- 18-24 months for turbine
- 6-12 months for pumps
- Dependent on size of unit.



## Pumps and Turbines

Breakout Session 1: State-of-the-Art Technologies

## Assumptions:

- Closed cycle leading contender for near term commercialization

### References:

- Guam OTEC Feasibility Assessment
- Baseline Designs of Moored and Grazing 40-MW OTEC Pilot Plants
- Renewable Energy From the Ocean
- OTC Study

## Components Addressed:

- Turbines
- Pumps
  - Cold Water Pump
  - Warm Water Pump
  - Working Fluid Feed Pumps
  - Vacuum Pump (Open/Hybrid Cycles)

## Turbines

- Reviewed Operating Parameters for 30 year period and remained consistent
- Ammonia turbines are specialty items and require additional development time
- Optimization for ammonia working fluid is desirable
- Radial Flow for 10MW
  - 2 per plant
  - 7 - 8 MW gross each turbine
  - Commercially Available, multiple vendors
- Axial Flow for 100MW
  - Trade study recommended to optimize size for NH<sub>3</sub>
- For all power levels multiple turbines are required for modularity, reliability, redundancy, operation and maintenance

### Cold/Warm Water Pumps

- Axial Flow impeller design
- Submersible vs. non
- High efficiency pumps with high efficiency motors
- 87-92% efficiency possible in some configurations
- Commercially available
- Multiple vendors

### Working Fluid Pumps

- Feed pumps
- Recycle pumps
- One of the lowest cost items in the system
- Commercially available
- Large Design database established

### Vacuum Pumps

- Needed for Hybrid Cycle
- Commercially adaptable database
- Currently used in conventional sea water cooled nuclear and fossil plants for start-up
- Trade off studies need to be performed relative to the location of water production (onshore vs. offshore)

## **APPENDIX E:**

Platforms

## Breakout Discussion Topics

### **Breakout Session I: GROUP F**

**Tuesday, November 3: 13:00-15:30**

What are the state-of-the-art technologies for the technical component?

### **Platform**

- Aimed towards offshore platforms for this workshop
- Differences between open and closed cycle systems
  - Closed cycle: The working fluid (typically ammonia) is in a closed system and is evaporated/condensed using heat exchangers. The evaporated working fluid powers the turbine generator.
    - Pumping around 10,000 gallons seawater/second/MWe
    - Ammonia (working fluid) will make up about 30% of the payload
  - Open cycle: The warm seawater is the working fluid and is flash evaporated using a vacuum. Steam generated by the vacuum powers the turbine generator.
    - Must pump much more water to generate similar amounts of electricity as closed cycle systems
- Location, size, and volume of the system components on the platform are the driving issues of platform design
- The design of the platform depends on the entire system
- There most likely will not be one standard design for OTEC platforms due to location, ocean conditions, size of the OTEC system, what kind of system (open vs. closed), etc.
- Options for platform shapes are:
  - Semi-submersible platform
  - Spar
  - Ship shape

## Breakout Discussion Topics

TYPE	MOTION/ SURVIVABILITY RISK	ARRANGEMENT DIFFICULTY	COST	TECHNICAL MATURITY
SEMI SUBMERSIBLE	SMALL	MEDIUM	MEDIUM	HIGH
SPAR	SMALL	HIGH	MEDIUM-HIGH	MEDIUM
SHIP SHAPE	MEDIUM	LOW	LOW	HIGH

-Need to consider transportation of the structure

-Need to consider deck installation

-Platform TRL = 9

-Mission Condition TRL = ? (hasn't been done before on the scale we're interested in)

-For similar situations (floating platforms/oil rigs) = 9

-Offshore oil rig requirements far exceed the requirements for OTEC

## Breakout Discussion Topics

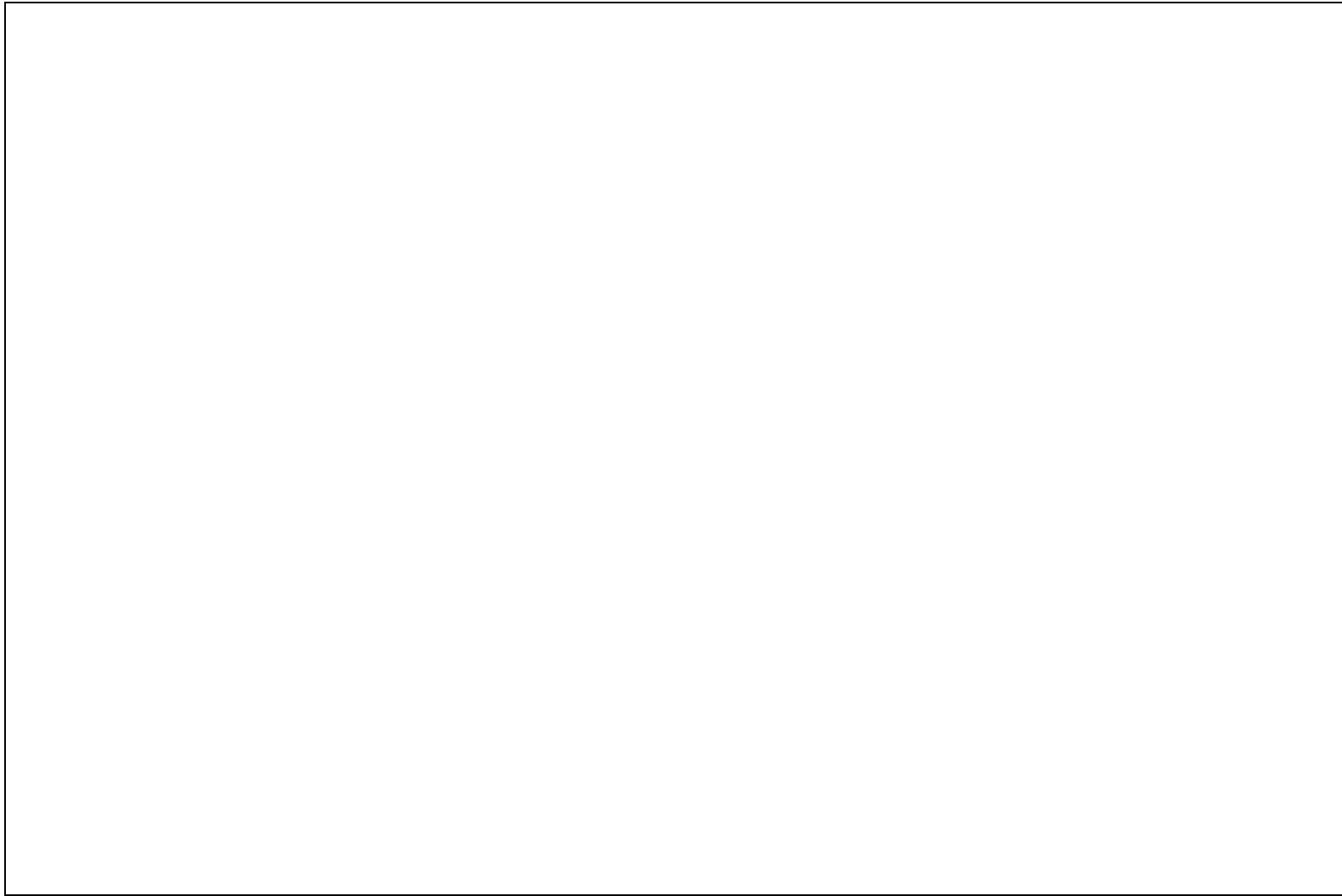
A large, empty rectangular box with a thin black border, intended for users to write or list breakout discussion topics. The box is centered on the page below the title.

## Breakout Discussion Topics

### **Breakout Session II:**

**Wednesday, November 4: 10:15-12:15**

- 1) What processes (e.g., equipment, personnel) of the technology are associated with:
  - i. Fabrication, deployment, construction, and installation;
  - ii. Operation (including monitoring) and maintenance (including cleaning, repair, and replacement);
  - iii. Monitoring component performance;
  - iv. Personnel safety and emergency preparedness; and
  - v. Decommissioning?
  
- 2) What risks are associated with failure with these processes?

- Relocatability is an issue depending on the type of platform (difficult with a spar platform)
- Strive for maximum versatility with minimum costs
  - Standardize OTEC design so that it is more or less repeatable
  
- Make Semi-Submersible platform design a baseline



## Breakout Discussion Topics

<b>Topic</b>	<b>Engineering or Operating Challenges for OTEC (failure risks)</b>
PROCESSES:	
<i>Fabrication</i>	State-of-the-art
<i>Deployment</i>	State-of-the-art
<i>Construction</i>	N/A
<i>Installation (integration and commissioning)</i>	-Deck equipment modules sized for lifting capability at integration site -Floating draft less than depth at integration site
<i>OMR&amp;R</i>	State-of-the-art
<i>Monitoring</i>	State-of-the-art
<i>Safe Operating Procedures</i>	State-of-the-art
<i>Decommissioning</i>	State-of-the-art
<i>Component Viability</i>	Little or no risk of component failure under standard operating conditions
<i>Economic Factors</i>	
<i>Hurdles/Limiting Factors</i>	
<i>Development Time Frame</i>	

## Breakout Discussion Topics

<b>Topic: Semi-submersible</b>	<b>Manufacturability</b>	<b>Operability</b>	<b>Reliability</b>	<b>Logistics</b>	<b>Scalability</b>
PROCESSES:					
<i>Fabrication</i>	Semi-Submersible: Standard offshore rig fabrication Spar: Fewer qualified manufacturing facilities Monohull: Acceptable FPSO Construction	--	High	Less than established offshore industry	No issues
<i>Deployment</i>	N/A	N/A	High	Standard heavy-lift ships sufficient up to 20,000 tons Spar: ~165 m length limitation	Adequate for 20,000 ton total weight (hull and equipment)
<i>Construction</i>	(Assumed same as fabrication) Spar: Outfitting with OTEC equip is more complicated Monohull: Ship is more amenable to installation of internal OTEC equip	--	--	--	--
<i>Installation (Integration)</i>	Quayside deck	Local lift	High (if the	Wet-tow to	Standard oil rig

## Breakout Discussion Topics

<i>and commissioning)</i>	commissioning <b>Spar: Requires deepwater for deck installation and heavy lift or float over</b>	capacity for integration may be an issue (eg. pacific islands)	equipment is available)	final site (short distance) or dry-tow (long distance)	techniques
<i>OMR&amp;R</i>		Routine/ Standard maintenance (simpler than typical oil rig) <b>Spar: More Difficult to access</b> Monohull: Greater response to sea states		Close to shore	
<i>Monitoring</i>		Performance monitoring			Monohull: Instrumentation advised to monitor fatigue
<i>Safe Operating Procedures</i>		Meet regulatory and company HSE operating requirements	High		
<i>Decommissioning</i>	In accordance with current practices <b>Spar: Harder</b>	N/A	High	Transporting to desired location for disposal	N/A
<i>Relocation</i>	NA	Consistent	High	Requires new	NA

## Breakout Discussion Topics

		with Normal Practices <b>Spar: Difficult, may not be cost effective</b>		moorings; <b>Spar: Extensive disassembly + reassembly</b>	
	Manufacturability	Operability	Reliability	Logistics	Scalability

\*Based on Semi-Submersible platform design

### **COST:**

- Consistent with normal marine practice
- Bulk steel plus labor
- Making the hull the simplest it can be (minimal equipment within) will keep costs down
- Design to manufacture
  - work with the shipyard
- FEED design (front-end engineering design)
- Suppose a 100 Million dollar project, steel would be about 2,000 \$/ton (for just materials, no labor)
- Standardization of design will significantly lower costs from the first to the second design
  - learning curve and non-recurring costs
- The pound per facility for OTEC will be less than the pound per facility for other platform type rigs (oil industry)

-Since OTEC is a fundamentally different system than normal oil rig platforms, can we go about designing and building a platform a different way to reduce costs significantly?

4 Key Factors:

- Standardization**
- Mass Production**
- Progressive Innovation**
- Versatility**

**Standards for offshore oil requirements for semisubs and spars currently exist; standards for OTEC would need to be developed**

## Breakout Discussion Topics

### **Session III:**

OTEC machinery not different than equipment currently used on ships/platforms/subs

Spar is most favorable for attachment of CWP due to less motion on attachment point relative to surface.

	Semi-Submersible
Cost Limiting Factors/cost drivers?	Labor rates/productivity Outfitting (equipment in hull) Steel costs Transportation
Possible Cost Savings?	Design for inexpensive manufacturing; Minimize internal equipment; optimize schedule
What Research can be done on Cost Reduction	Low cost manufacturing techniques, materials; developing OTEC standards based on cost/risk

## Breakout Discussion Topics

Are Technologies viable?	Yes
What are the associated economic factors?	
What are the hurdles/limitations?	
What is the development Time?	

## Breakout Discussion Topics

## Breakout Discussion Topics

### **Breakout Session III:**

**Wednesday, November 4: 12:45-15:00**

- 1) Are the technologies associated with this component viable? What are the economic factors associated with these technologies? What are the hurdles/limiting factors associated with these technologies?
- 2) What is the development time frame for the technologies associated with this component?



# Changes In Platform Technology Since 1980

- **1980**
  1. Required offshore OTEC depth of 3000ft is considered technically challenging for offshore oil industry
  2. Floating production systems were at infant technology
  3. Limited software was available and data was not validated
  4. Limited ability to predict impact of extreme weather
  5. Platforms were designed to very conservative standards due to uncertainties in extreme storm conditions and calculation accuracy
- **Today**
  1. Floating production platforms at 3000ft considered routine from a technical standpoint
  2. There are about 200 floating production systems
  3. Computer software and experimental facilities for design are in use and have been validated
  4. Meteorological/ oceanographic data gathering capability is more sophisticated
  5. Improved tools and oceanographic data allows design of more cost effective platforms

# Platform Group

## Day II Discussion

# Challenges and Risks

Topic	Engineering or Operating Challenges for OTEC (failure risks)
PROCESSES:	
<i>Fabrication</i>	State-of-the-art
<i>Deployment</i>	State-of-the-art
<i>Construction</i>	N/A
<i>Installation (integration and commissioning)</i>	-Deck equipment modules sized for lifting capability at integration site -Floating draft less than depth at integration site
<i>OMR&amp;R</i>	State-of-the-art
<i>Monitoring</i>	State-of-the-art
<i>Safe Operating Procedures</i>	State-of-the-art
<i>Decommissioning</i>	State-of-the-art
<i>Component Viability</i>	Little or no risk of component failure under standard operating conditions

# Processes

Topic: Semi-submersible	Manufacturability	Operability	Reliability	Logistics	Scalability
PROCESSES:					
<i>Fabrication</i>	Semi-Submersible: Standard offshore rig fabrication Spar: Fewer qualified manufacturing facilities Monohull: Acceptable FPSO Construction	--	High	Less than established offshore industry	No issues
<i>Deployment</i>	N/A	N/A	High	Standard heavy-lift ships sufficient up to 20,000 tons Spar: ~165 m length limitation	Adequate for 20,000 ton total weight (hull and equipment)
<i>Construction</i>	(Assumed same as fabrication) Spar: Outfitting with OTEC equip is more complicated Monohull: Ship is more amenable to installation of internal OTEC equip	--	--	--	--

# Processes

Topic: Semi-submersible	Manufacturability	Operability	Reliability	Logistics	Scalability
PROCESSES:					
<i>Installation (Integration and commissioning)</i>	Quayside deck commissioning Spar: Requires deepwater for deck installation and heavy lift or float over	Local lift capacity for integration may be an issue (eg. pacific islands)	High (if the equipment is available)	Wet-tow to final site (short distance) or dry-tow (long distance)	Standard oil rig techniques
<i>OMR&amp;R</i>		Routine/ Standard maintenance (simpler than typical oil rig) Spar: More Difficult to access Monohull: Greater response to sea states		Close to shore	
<i>Monitoring</i>		Performance monitoring			Monohull: Instrumentation advised to monitor fatigue

## Processes

Topic: Semi-submersible	Manufacturability	Operability	Reliability	Logistics	Scalability
PROCESSES:					
<i>Safe Operating Procedures</i>		Meet regulatory and company HSE operating requirements	High		
<i>Decommissioning</i>	In accordance with current practices <i>Spar: Harder</i>	N/A	High	Transporting to desired location for disposal	N/A
<i>Relocation</i>	NA	Consistent with Normal Practices <i>Spar: Difficult, may not be cost effective</i>	High	Requires new moorings; <i>Spar: Extensive disassembly + reassembly</i>	NA
	Manufacturability	Operability	Reliability	Logistics	Scalability

## Economic Drivers

	Semi-Submersible/ Spar/ Monohull
Cost Limiting Factors/cost drivers?	Labor rates/productivity Outfitting (equipment in hull) Steel costs Transportation
Possible Cost Savings?	Design for inexpensive manufacturing; Minimize internal equipment; optimize schedule
What Research can be done on Cost Reduction	Low cost manufacturing techniques, materials; developing OTEC standards based on cost/risk
Are Technologies viable?	Yes

## Semi-Submersible Used for Oil and Gas Drilling



## Ship Shape



“Red Hawk” Spar Platform



## **APPENDIX E:**

Power Cable

## Breakout Discussion Topics

### **Breakout Session I:**

**Tuesday, November 3: 13:00-15:30**

What are the state-of-the-art technologies for the technical component?

- Ocean cable technology known, manufactures have the necessary cables
- Armoring the cable (steel) –
- trench closer to shore, water jets, plowing
- directional drilling, shore landings
- Pressure is a problem b/c of the depth
- AC cable within 20 miles – copper conductor, polyethylene insulation
- Cables must survive for 30 plus years
- Termination technology on platform side is a challenge
- Problem with motion of suspended cable from bottom of the ocean to the platform, fatigue, bending stress/strain
- Need modeling for connection of the cable and for the dynamics of the cable
- Cable length > 20 Km solution is DC
- Potential corrosion issue with steel armor on cable
- Larger availability in lower voltage
- Cables available up to 500 kV
- Splicing technology is known

Companies Available today

- Subocean
- JDR Cable Systems
- Seabed Power
- ABB
- Nexans
- Sumitomo
- Siemens
- South bay
- General Cables

## Breakout Discussion Topics

- Falmat
- Parker Scancorp
- Prysmian Cables and Systems: long cable up to 500 kV (NY, NJ)

## Breakout Discussion Topics

- Mechanical



## Breakout Discussion Topics

### **Breakout Session II:**

**Wednesday, November 4: 10:15-12:15**

- 1) What processes (e.g., equipment, personnel) of the technology are associated with:
  - i. Fabrication, deployment, construction, and installation;
  - ii. Operation (including monitoring) and maintenance (including cleaning, repair, and replacement);
  - iii. Monitoring component performance;
  - iv. Personnel safety and emergency preparedness; and
  - v. Decommissioning?
  
- 2) What risks are associated with failure with these processes?

Notes:

## Breakout Discussion Topics

<b>Topic</b>	<b>State-of-the-art:</b>	<b>Engineering Challenge</b>
PROCESSES:		
<i>Fabrication</i>		
<i>Deployment</i>		
<i>Construction</i>		
<i>Installation</i>		
<i>OMR&amp;R</i>		
<i>Environmental Monitoring</i>		
<i>Safe Operating Procedures</i>		
<i>Decommissioning</i>		
<i>Risks Associated with Process Failure</i>		
<i>Component Viability</i>		
<i>Economic Factors</i>		
<i>Hurdles/Limiting Factors</i>		
<i>Development Time Frame</i>		

## Breakout Discussion Topics

### **Breakout Session III:**

**Wednesday, November 4: 12:45-15:00**

- 1) Are the technologies associated with this component viable? What are the economic factors associated with these technologies? What are the hurdles/limiting factors associated with these technologies?
- 2) What is the development time frame for the technologies associated with this component?

### Day 3 – GROUP G

What changes have occurred in materials, designs, practices, fabrication, manufacturing, and technology between 1980 and today to make OTEC feasible to pursue on a commercial scale?

- Today: 10 sea crossing AC cables from 90 kV-to500 kV
- 20 DC cables up to 500 kV
- Majority have occurred in last 10 years
- Availability of remote resources and interconnection of grids
  - US: east coast NY/NJ
  - From Canada to NJ
- Dynamics cables: technology driven by offshore wind farming
  - Off shore oil drilling
  - Common connection by 13.6kV up to 50 kV
  - Connection at platform are standard and routine, sock rigid connection run through tube, secured at top
  - Length, width, diameter are function of cable
  - Swivel joint done on top side like fixed connection
- Offshore wind floating platforms
  - Individual cables to shore

### R and D

- High power dynamic cable greater than 30 MW

# State of the Art

- Available Technologies

- Codes and standards for cable construction

- IEEE and IEC

- ABS, DNV, and API

- Many manufactures

- Larger availability with lower voltage

- Armoring: Steel

- In water cable transition (platform to ocean bottom)

- Can be computer modeled

- Software readily available

# State of the Art cont.

- Cable Voltage rating up to 500 kV
  - AC
    - Single Phase is 69 kV and up
    - Three phase cable below 69 kV
    - AC within 20 miles of shore
  - DC
    - Available up to 400 kV today
    - Has to be converted on both ends
- Standard Splicing Technology
  - Typ. done in factory
- Standard Shore Landing
  - Directional drilling
  - Trenching
- Proven Durability
- Corrosion

# Manufacturers

- JDR Cable Systems
- ABB
- Nexans
- Sumitomo
- Siemens
- South bay
- General Cables
- Falmat
- Parker Scancorp

# Challenges Specific to OTEC

- Applicable standards specifically for OTEC
- Hydrostatic pressure
- Large vertical riser cable
- Mechanical termination technology at the platform
- Modeling
  - Connection of cable
  - Mechanical dynamics of the cable
- Cable Installation



# POWER CABLE

## DAY 2 – Breakouts II and III

POWER CABLE – Day 2

## Assumptions

- Offshore
  - Less than 20 miles
  - Water depth 1,200 m or less
- Floating
- Moored
  - Cable and termination design depends on dynamics and azimuth constraints on platform and mooring configuration
  - Potential requirement to disconnect for weather drives complexity
- Potentially Relocatable (platform)
  - Not applicable for cable
  - Interconnect design depends on location
- 5-10 MW to commercial scale (100 MW)
  - Three phase AC cable, up to 10 MW
  - Three single phase AC cables, 100 MW
  - Cable includes power and communication controls
  - Cable includes own diagnostic system, fiber optic for temperature sensing

POWER CABLE – Day 2

## Breakout II – Manufacturability

- Fabrication
  - Cable: Commercially available
  - Termination: Custom design b/c of motion
    - Fatigue testing required
- Deployment
  - Difficult but well understood
    - Difficult on steep shelf
  - Issue with depth b/c of limited experience
  - Handling the weight of cable
  - Cable site survey and route planning necessary
- Installation
  - Need sufficient space for platform substation
  - AC equipment requires less space

POWER CABLE – Day 2

## Breakout II – Operability

- Operation
  - Fully automated and controlled from shore
  - Enclosed environmentally controlled substation
    - Keep out salt water and humidity
    - Dry type oil free transformer
- Maintenance
  - Cleaning
    - Periodic marine growth (diver), and full cable inspection
    - Annual maintenance of substation
  - Cable Repair
    - Standard practice in shallow water
    - More difficult in power cables in deep water
    - Splice requires mobilization of ship
  - Replacement
    - Leave adequate time to order new cable
    - Depends on location of fault

POWER CABLE – Day 2

### Breakout II – Reliability

- Monitoring performance
  - Fiber optics to monitor temperature
  - Online methods for monitoring partial discharges in cable insulation
  - Location of cable faults done with injected voltage pulse
- Fatigue Mitigation
  - Control of abrasion on cable at the sea floor and sea junction near platform
  - Strumming suppression?
  - Flexing fatigue (bend strain relief and/or flotation)
- Personnel Safety and Emergency Preparedness
  - National Electric Safety Code or international equivalent
  - OSHA
- Decommissioning
  - Recovery of cable depends on environmental permit agreement

POWER CABLE – Day 2

### Breakout II – Logistics

- Specialized ships needed for repair and deployment
- Shore landing equipment e.g.
  - Horizontal directional drilling (HDD)
  - Trenching
- Utility interconnect study needs to be done to establish shore side transmission capacity

POWER CABLE – Day 2

### Breakout II – Scalability

- Cables are commercially available from 10 kV to 500 kV
- Unlikely using same type of cable from 10MW plant to 100 MW plant
- Should cable be planned for future upgrade on the platform?

POWER CABLE – Day 2

### Breakout II – Life Cycle

- Risks from Failure?
  - Failure to comply with terms and conditions of contractual obligations
  - Not generating revenue for lack of power generation
  - Downtime could be long
    - Lack of repair ship
    - Time to find fault location
    - Long lead time for ordering new cable

POWER CABLE – Day 2

### Breakout II – Life Cycle

- Cost limiting factors?
  - Material costs such as copper and steel
  - Shortage of cable manufacturing capability
  - Limited number of cable laying ships
  - Weather and location
  - Scheduling of ships
  - Survivability mitigation (burying or trenching, micro tunneling)

POWER CABLE – Day 2

### Breakout II – Life Cycle cont.

- Cost savings?
  - Tagging on to existing orders
  - Location closer to shore landing means less cable
  - Distance to shore from interconnect should be shorter
  - Overhead line from shore to utility connection
- Research for cost reduction?
  - Reducing weight with use of different materials
  - Flexible connection and termination to platform
  - Fatigue testing

POWER CABLE – Day 2

### Breakout III

- Technologies viable?
  - Cable
    - TRL-8/9
    - MRL-9/10
  - Cable connection at platform
    - TRL and MRL-5? Depending on requirements (like mooring, platform dynamics, quick disconnect) and needs further study
    - Custom solution
    - Site specific
- Economic factors?
  - Exchange rate
  - Cost of materials

POWER CABLE – Day 2

### Breakout III cont.

- Hurdles or limiting factors?
  - Cable route
  - Limited supplier of armored cable
  - Riser Cable
  - Flexible connection to platform
  - Availability of ship

POWER CABLE – Day 2

### Breakout III

- Development time frame?
  - 2-3 years
    - Driven by OTEC system level modeling, simulation and design
  - Cable connection to platform
  - Integrated platform mooring cable simulation
  - Normal design and development time frame for pilot plant

*POWER CABLE - Day 2*

# **Appendix F**

## Powerpoint Presentations

 **OTEC** Technology Workshop

# Welcome

The Coastal Response Research Center 

## Logistics

- Fire Exits
- Restrooms on this level
- Map of conference center in packets – location of breakout rooms
- Dining – breakfasts & snacks (outside meeting rooms)
- Lunch:
  - Hot/Cold Buffet
  - Dining Room (on this level)
  - Reserved seating
- Evening Dinner:
  - Shuttle – pick up outside New England Center at 6:30 pm
  - Mahalos Catering at The Pearl in downtown Portsmouth
  - Cash bar available (beer and wine)
  - If you have any questions – check with staff at registration table

The Coastal Response Research Center 

## Key CRRC Staff

- Nancy Kinner – UNH Co-Director
- Kathy Mandsager – Program Coordinator
- Joseph Cunningham – Research Engineer
- Zachary Magdol – Engineer

The Coastal Response Research Center 

## Center Creation

- NOAA's Office of Response and Restoration (ORR)/UNH spill partnership in 2004
- Co-Directors:
  - UNH – Nancy Kinner
  - NOAA – Amy Merten
- Funding for oil spill research decreasing
  - Government
  - Private sector
- Many research needs exist regarding spill response, recovery and restoration

The Coastal Response Research Center 

## Overall Mission

- Develop new approaches to response and restoration through research/synthesis of information
- Serve as a resource for ORR, NOAA and other agencies
- Serve as a hub for spill research, development and technical transfer for ALL stakeholders
  - Spill community (U.S and internationally)

The Coastal Response Research Center



## Specific Center Missions

- Conduct and oversee basic and applied research and outreach on spill response and restoration
- Transform research results into practice
- Encourage strategic partnerships to achieve mission
- Conduct outreach to improve preparedness and response
- Create an educational program for new approaches to spill response and restoration
  - Educate/train students who will pursue careers in spill response and restoration
  - Internships with agencies, laboratories

The Coastal Response Research Center



## Outreach Efforts

- Workshops on hot topics to identify research priorities and partners
  - Dispersed Oil: Efficacy and Effects
  - Submerged Oil: State of the Practice
  - Human Dimensions of Spills
  - Dispersed Oil Research Forum
  - Integrated Modeling
  - PAH Toxicity
  - Environmental Response Management Application (ERMA™)
  - Environmental Response Data Standards
  - HEA Metrics Workshop
  - Opening the Arctic Seas: Envisioning Disasters & Framing Solutions

The Coastal Response Research Center



 OTEC Technology Workshop

## Background/ Goals/Outcomes

The Coastal Response Research Center



## CRRC/OCRM Partnership

- NOAA's Office of Ocean and Coastal Resource Management (OCRM) licensing of OTEC
- OCRM Director David Kennedy on CRRC Advisory Board
- OCRM Senior Policy Analyst David Kaiser affiliated with CRRC at UNH
- CRRC experience hosting workshops

The Coastal Response Research Center



## OTEC Workshop

- CRRC hosting two OTEC workshops for OCRM
  - November, 2009: Technical Aspects
  - 2010: Environmental Impacts and Risks
- Format: Plenary Sessions and Breakout Groups
- Participants representing a spectrum of industry, public sector, academia, and NGOs
  - OTEC experts
  - Related experts
    - e.g., platforms, power cable, mooring

The Coastal Response Research Center



## Key Concept

- Bring diverse expertise and perspectives to the table
- Dialogue on:
  - Where we are?
  - Where do we want to be?
  - How do we get there?

The Coastal Response Research Center



## Overall Goal

**To Understand Technical Readiness of Commercial Scale OTEC System**

The Coastal Response Research Center





## Specific Foci

- State-of-the-art of OTEC Technology
- Technical feasibility
- Time frame for commercial development

The Coastal Response Research Center

## Technical Components to be Discussed (Breakout Groups)

- Cold Water Pipe
- Heat Exchangers
- Platform
- Platform Mooring
- Platform/Pipe Interface
- Pumps and Turbines
- Power Cable

The Coastal Response Research Center

## Plenary Panel Discussions

- Cycle and Auxiliary Uses
- OTEC as a System

The Coastal Response Research Center

## Agenda

### Tuesday AM

09:20	Background & Workshop Goals/Outcomes	Nancy Kinner
09:30	OTEC Timeline & Participant Introductions	Iris Ioffreda, Facilitator
10:30	Break	
10:45	Plenary Session: Setting the Stage	
A.	Cold Water Pipe	Alan Miller
B.	Heat Exchangers	Avram Bar-Cohen
C.	Platform Mooring	Frederick "Rick" Driscoll
D.	Platform/Pipe Interface	Patrick Grandelli
E.	Pumps & Turbines	Peter Pandolfini
F.	Platforms	Edward Horton
G.	Power Cable	Steiner Dale
H.	Cycle/Auxiliary Uses	C.B. Panchal
I.	Overall System & Program	Luis Vega
11:45	Workshop Structure & Logistics	Iris Ioffreda

The Coastal Response Research Center

### Agenda Tuesday PM

13:00	Breakout Session I	Breakout Discussion Groups
15:30	Plenary Session I: Group Reports	(10 minutes each)
17:00	Adjourn	
18:30	Shuttle to Dinner	Portsmouth

The Coastal Response Research Center

### Agenda Wednesday AM

09:00	Overview and Review/Recalibrate: Iris Ioffreda	
09:15	Panel Discussion: Cycle and Auxiliary Uses: Today and the Future	
10:15	Breakout Session II	
12:15	Lunch	

The Coastal Response Research Center

### Agenda Wednesday PM

12:45	Breakout Session III	Breakout Discussion Groups
15:00	Plenary Session: Group Reports	(10 minutes each)
17:00	Adjourn (Dinner on your own)	

The Coastal Response Research Center

### Agenda Thursday

09:00	Overview/Review Iris Ioffreda	
09:15	Panel Discussion on OTEC as a System	
10:30	Break	
10:45	Discussion of OTEC as a System	
12:00	Lunch	
13:00	Plenary Session: Synthesis and Next Steps: Iris Ioffreda	
14:30	Closing Remarks: Iris Ioffreda & Organizing Committee	
15:30	Adjourn	

The Coastal Response Research Center

## Breakout Questions for Each Component

### Session I:

- What are the state-of-the-art technologies for the technical component?

The Coastal Response Research Center



## Breakout Questions for Each Component

### Session II:

- What processes (e.g., equipment, personnel) of the technology are associated with:
  - fabrication, deployment, construction, and installation;
  - operation and maintenance (including cleaning, repair, and replacement);
  - monitoring component performance;
  - personnel safety and emergency preparedness; and
  - decommissioning?
- What risks are associated with failure with these processes?

The Coastal Response Research Center



## Breakout Questions for Each Component

### Session III:

- Are the technologies associated with this component viable? What are the economic factors associated with these technologies? What are the hurdles/limiting factors associated with these technologies?
- What is the development time frame for the technologies associated with this component?

The Coastal Response Research Center



## Panel Discussion Questions: OTEC as a System

- What are the performance metrics that must be demonstrated prior to commercial development? What is the development time frame (e.g., today, 1-2 yr, 5-10 yr) for a commercial OTEC system?
- What are the potential failures that could lead to the shutdown of an OTEC system?
- What processes/diagnostics are needed to detect, monitor and reduce these risks?
- What are the flexibilities in the OTEC system's components that could minimize environmental impacts?

The Coastal Response Research Center



## Workshop Outcomes

- Report compiling information gathered at workshops (**NOT** recommendations)
- Report Contents:
  - Introduction
  - Workshop organization and structure
  - Information gathered
    - By component
    - As system
  - Synthesis of workshop results
  - Possible research topics
  - Appendices – (e.g., participants, slides, relevant references)

The Coastal Response Research Center



## CRRC's Role as Workshop Host

- CRRC is a Neutral Party
  - No oil or OTEC in NH waters
- Expertise - engineering and scientific based discussion
- Academia is safe place to have frank and open discussion
- Academia approach garners public trust
  - Peer review approach
- CRRC brings all parties to table

The Coastal Response Research Center



**Coastal Response Research Center**

[www.crrc.unh.edu](http://www.crrc.unh.edu)

The Coastal Response Research Center



## Participant Introductions

- **Name**
- **Affiliation**
- **Technical Expertise**

The Coastal Response Research Center



## Workshop Structure

The Coastal Response Research Center

## Intended Outcomes

To understand technical readiness of commercial scale OTEC system

The Coastal Response Research Center

## This Workshop is NOT:

- A decision making meeting
- Looking to define one "best" technology
- Asking for disclosure of proprietary information or design specs
- Focused on environmental impacts
- Focused on regulatory challenges
- About the process to get a license for commercial OTEC
- It IS focused on technical, engineering issues!

The Coastal Response Research Center

## Workshop Structure

- Mostly in small groups. Three breakout sessions per topic. Reports to large group on Monday and Tuesday afternoons.
- Small group facilitators will manage the discussion and help the group develop report outs.
- Each small group has an assigned note-taker.
- Success in the small groups will come from active participation by all, and allowing all to have a voice.
- Issues that are relevant but not within scope of this workshop will be captured on a "Parking Lot."
- Nancy Kinner and Iris Ioffreda will be floaters.

The Coastal Response Research Center

### What Do You See?

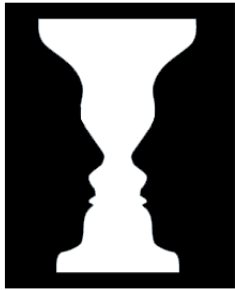

The Coastal Response Research Center



the OLDE HERETIK DELI™



**Serving  
Sacred  
Cow  
DAILY**

*be sure to visit all our new locations!*

**NOW OPEN IN NEW DELHI!**

### Your Role

- What will I take away?
- What will I contribute?
- What do I need to and not do to make both those things happen?

The Coastal Response Research Center

## Ground Rules

- Be fully present (which includes turn off ringtones for cell phones and blackberries)
- Honor time schedules
- Speak openly and honestly and only for yourself
- Allow everyone an opportunity to express their views
- Ask questions and listen for understanding



# This Workshop is NOT:

- A decision making meeting
- Looking to define one “best” technology
- Asking for disclosure of proprietary information or design specs
- Focused on environmental impacts
- Focused on regulatory challenges
- About the process to get a license for commercial OTEC
  
- It IS focused on technical, engineering issues!







# Workshop Structure

The Coastal Response Research Center

## Intended Outcomes

To understand technical readiness of commercial scale OTEC system

The Coastal Response Research Center

## This Workshop is NOT:

- A decision making meeting
- Looking to define one “best” technology
- Asking for disclosure of proprietary information or design specs
- Focused on environmental impacts
- Focused on regulatory challenges
- About the process to get a license for commercial OTEC
- It IS focused on technical, engineering issues!

The Coastal Response Research Center

## Workshop Structure

- Mostly in small groups. Three breakout sessions per topic. Reports to large group on Monday and Tuesday afternoons.
- Small group facilitators will manage the discussion and help the group develop report outs.
- Each small group has an assigned note-taker.
- Success in the small groups will come from active participation by all, and allowing all to have a voice.
- Issues that are relevant but not within scope of this workshop will be captured on a “Parking Lot.”
- Nancy Kinner and Iris Ioffreda will be floaters.

The Coastal Response Research Center

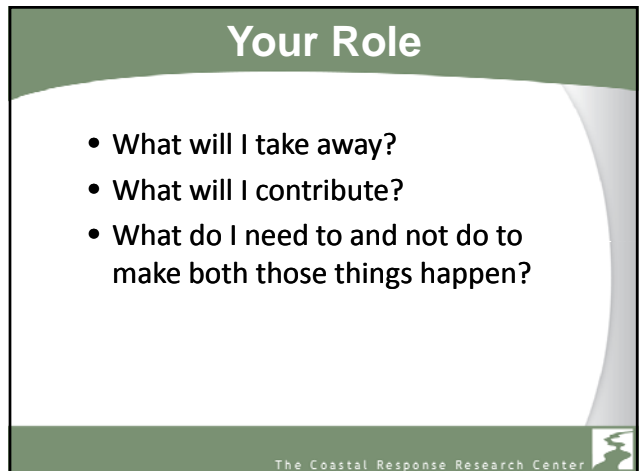

## Ground Rules

- Be fully present (which includes turn off ringtones for cell phones and blackberries)
- Honor time schedules
- Speak openly and honestly and only for yourself
- Allow everyone an opportunity to express their views
- Ask questions and listen for understanding



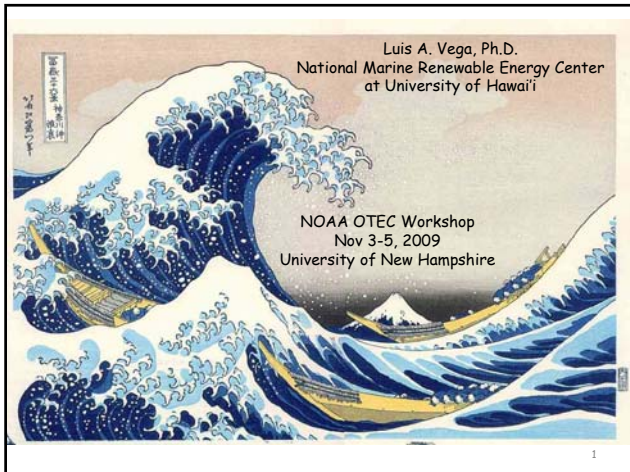

## Workshop Objectives

- Are commercialization challenges:
  - (i) Technical,
  - (ii) Engineering,
  - (iii) Development costs?
- OTEC Development Roadmap

2

## USA OTEC: Development Schedule (Assumption)

	← YEARS →					
	1 to 5	6 to 10	11 to 15	16 to 20	21 to 25	26 to ∞
<b>USA OTEC DEVELOPMENT</b>						
Pre-Commercial Plant (> 5 MW)		Ops				
Electricity (Desal Water) Plants in Hawaii and USA Territories: ~ 20 x 100 MW Plants	Prelim Design		Ops	Ops	→	→
NH3/H2 Plantships Supplying all States				Prelim Design		Ops →

3

## OTEC: The Challenge

- **Major Challenge** is not technical but rather **financing of a capital intensive technology without an operational record**;
- If plant > 50 MW, cost of electricity (\$/kWh) would be **cost competitive**;  
 → How do you get more than  $\frac{1}{3}$  Billion Dollars for a 100 MW plant without a "track record" and without invoking national security, global warming, environmental credits, etc.?
- **Without operational records** from a **pre-commercial plant** (~ 5 MW) financing of commercial sized plants (> 50 MW) is **highly doubtful**;

4

## OTEC Pre-Commercial Plant

- **Federal funding required for pre-commercial plant** (~ \$120M to \$150M);
- **Pre-Commercial Plant** would take **5-years** from the go-ahead to deliver electricity to the grid;
- Pre-Commercial Plant must operate for at least one year **before finalizing engineering and environmental-impact mitigation design aspects** of the commercial size plant;
- The **Commercial Plant** would take **another 4 to 5-years** to deliver electricity to the grid;

5

## Economics Summary

Because **OTEC is capital intensive** electricity **cost-competitiveness** if **Size > 50 MW & > 15-year Life-Cycle.**

6

**1st Plant and 10th Plant  
Capital Cost Estimates**

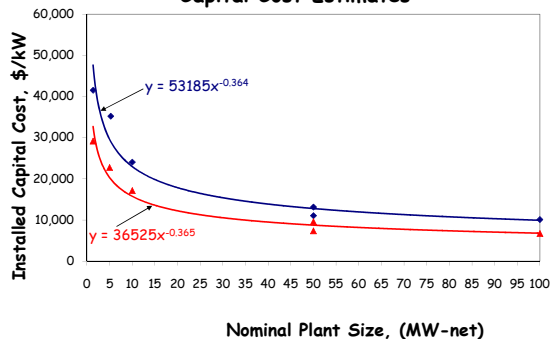

7

**Cost of Electricity Production for 1st Plant and 10th Plant  
[ COE = CC + OMR&R ]**

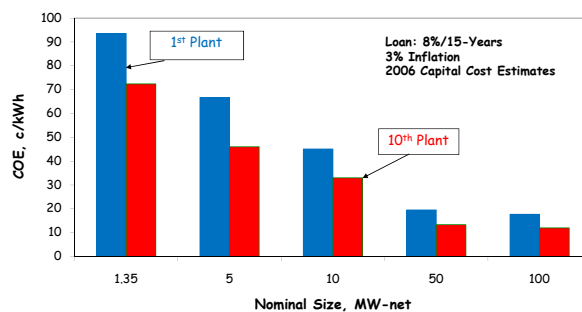

8

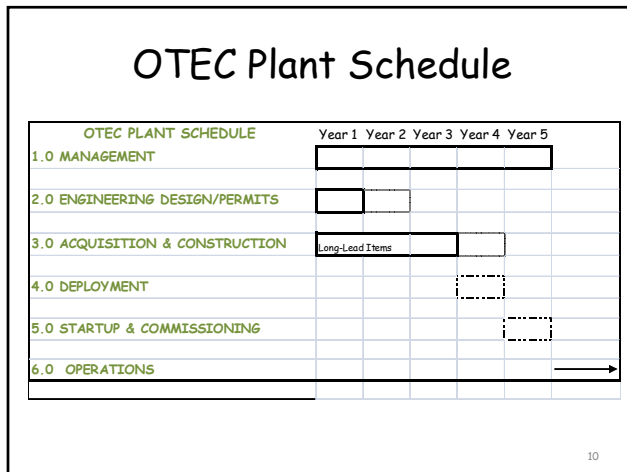
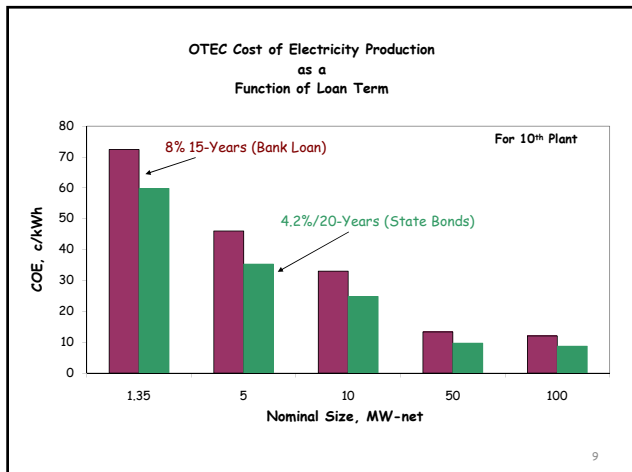

### OTEC Plant Schedule

- Detailed-Engineering-Design ~ one-year; Permits ~ two-years;
- **Major components are long-lead-items**, requiring 12 to 24+ months for delivery, and are **available from established industry**;
- As much as **5-years** after-receipt-of-order (ARO) is required before delivering **electricity to grid**.

### Workshop Objectives

- Are commercialization challenges:
  - (i) *Technical*;
  - (ii) *Engineering*;
  - (iii) **Development costs**
- OTEC Development Roadmap (see p. 3)

**NAVFAC**  
Naval Facilities Engineering Command

## Navy Ocean Energy Program

Bill Tayler  
Director, Energy Development  
NAVFACENGCOM, Public Works

Ocean Thermal Energy Conversion (OTEC) Technology Workshop  
University of New Hampshire, Durham NH  
November 3, 2009

**NAVFAC**  
Naval Facilities Engineering Command

### Things that Keep Us Up at Night

- 80% of world's fuel travels by ocean
- 90% of world's trade travels through choke points
- Navy's fuel cost in 2007 was \$1.2B, in 2008 it was \$5.1B
- U.S. imports 57% of energy needs
- Piracy adds \$1M to shipping costs/trip
- Cost to refill a DDG-51: \$1.8M in 2008, \$643K in 2009
- FBCF \$400/gal

**Impact to military readiness**

page number 2

**NAVFAC**  
Naval Facilities Engineering Command

### Recent Guidance from Administration

- On October 14, 2009, the Secretary of the Navy established five Department of the Navy (DoN) Energy Targets:
  - The lifecycle energy cost of platforms, weapons systems, and buildings, the fully-burdened cost of fuel in powering these, and contractor energy footprint will be mandatory evaluation factors used when awarding contracts.
  - The Navy will demonstrate a Green strike group of nuclear vessels and ships using biofuel in local operations by 2012. By 2016, the Navy will sail a "Great Green Fleet" composed of nuclear ships, surface combatants with hybrid electric power systems using biofuel, and aircraft flying only on biofuels.
  - By 2015, the Department of the Navy (DoN) will reduce petroleum use in the commercial fleet of 50,000 vehicles by 50 percent by phasing in a composite fleet of flex fuel, hybrid electric, and neighborhood electric vehicles.
  - By 2020, at least half of the DoN's shore-based energy requirements will come from alternative sources.
  - By 2020, half of total DoN energy consumption will come from alternative sources.

page number 3

**NAVFAC**  
Naval Facilities Engineering Command

### What do we want?/ What do we bring to the table?

- What do we want? "Operational Independence"
  - Long term goal: For island locations obtain reliable & affordable power, water and cooling from ocean resources – power purchase agreement
  - Short term goal: Partner with industry to expedite commercialization of ocean power with emphasis on OTEC
- What do we bring?
  - funding
  - sponsor for SBIR and Congressional Adds
  - long term contracts (stability)
  - land, infrastructure support, security
  - we pay our bills → favorable financing terms
  - assistance expediting permitting
  - with DOE & NOAA, help to bring industry together

page number 4

**NAVFAC** OTEC Opportunities

Navy first looking at Diego Garcia, Hawaii & Guam

page number  
Courtesy: NASA Jet Propulsion Laboratory

**NAVFAC** Island Requirements

- Reliable electric power supply to meet mission (no grid for reliability)
- Eliminate vulnerable fuel oil supply
- Adequate, potable water supply
- Refrigeration/cooling
- Reduce/eliminate environmental impacts

page number 6

**NAVFAC** Role of US Navy in supporting OTEC

- OTEC offers hope as potential long term baseload technology for island locations, with further benefits from renewable fuel and potable water generation
  - Problem- expanding OTEC to required scale and competitive pricing requires technological and commercial advances
  - For OTEC to assist in meeting Navy goals, OTEC commercialization needs to speed up**
- Navy plans to partner with DOE, NOAA and industry to advance the technology
  - Navy has multiple OTEC and other ocean energy R&D investments designed to commercialize promising technologies and encourage eventual private investment for large scale projects

page number 7

**NAVFAC** Navy OTEC projects

- Navy OTEC Projects
  - Evaluate and test high efficiency, low cost heat exchanger configurations for commercial OTEC system
  - OTEC Key Component and System Design: Provide system and CWP/platform interface component design for floating OTEC
  - Conduct survey in private sector to identify maturity levels for ocean energy devices/systems
  - Determine technical feasibility of synthetic fuel production from floating OTEC
  - Determine technical & economic feasibility of on shore & offshore OTEC systems at GUAM Naval facility
  - Conduct OTEC surveys to identify most suitable NAVY/USMC site in Hawaii
  - Identify wave, tidal, ocean current, and thermal ocean energy resources at Naval/USMC facilities world-wide

page number 8





## OTEC Power Cycles and Auxiliary Uses

C.B. Panchal  
 E<sup>3</sup>Tec Service, LLC  
 Phone: 443-812-5930  
[cpanchal@msn.com](mailto:cpanchal@msn.com)

## OTEC Power Cycles

- Closed Cycle: leading power cycle; ammonia or hydrocarbon working fluid; single stage or multi-stage
- Open Cycle: originally pursued by Westinghouse and 210 kW Prototype system tested at NELHA, Hawaii
- Hybrid Cycle for co-production of power and desalinated water: pursued by Westinghouse (large scale plants) and Argonne National Lab (small land-based plants)
- Ammonia-Water Absorption Power Cycle: Pursued for Geothermal power and being considered for OTEC
- Mist-lift Cycle: Prototype unit tested; no significant development work pursued
- Salinity-Gradient Cycle: Concept developed

## Rankine-Cycle – Single vs Multi-Stage Cycle

Effective utilization of seawater temperature difference without high costs of heat exchangers is key to the overall economics of OTEC plants

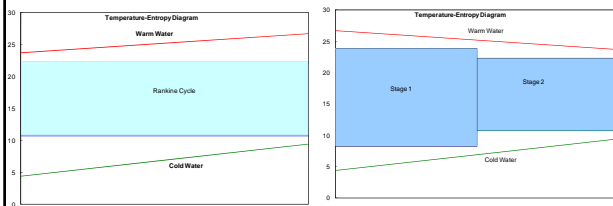

## Ammonia-Water Absorption Power Cycle

Heat/Mass transfer resistances that would produce non-equilibrium conditions limit the thermodynamic advantages of ammonia-water absorption power cycle

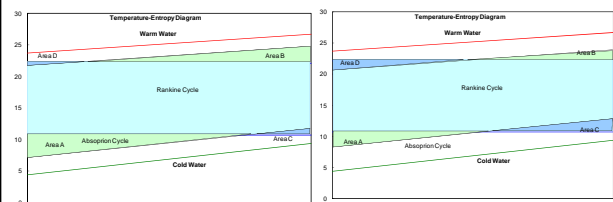

## Open Cycle

Large scale low-pressure turbine is a key component to be developed for commercial viability of OC-OTEC plants

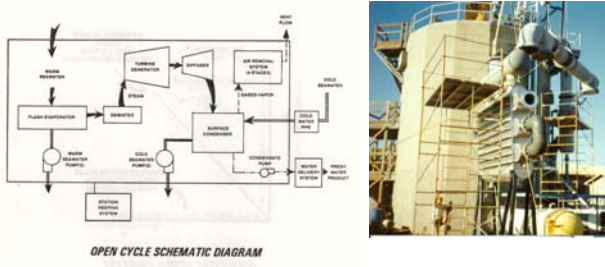

E3Tec Service, LLC

5

## Hybrid Cycles for Coproduction of Power and Desalinated Water

- Integrated Hybrid Cycle
- Combined (Parallel or in-Series) Hybrid Cycle

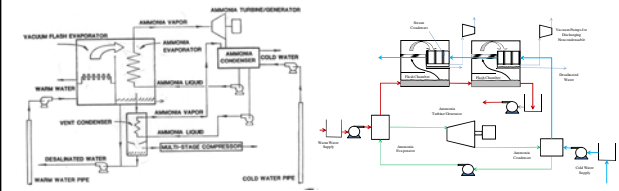

On-Board Reverse Osmosis (RO) is an option for at-sea production of desalinated water

E3Tec Service, LLC

6

## OTEC Plantships for Ammonia Production

- Ammonia is being considered as the hydrogen carrier for renewable energy sources – wind, remote PV, and OTEC
- Global impact of OTEC Plantships – Four Strategic Regions

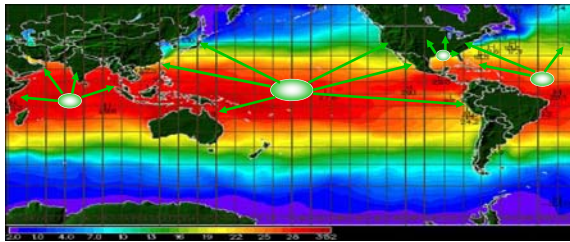

E3Tec Service, LLC

7

## Other Auxiliary Uses and Products

- Cold-water can be used for air-conditioning at selected sites
- Mariculture seems attractive; however, limited to land-based plants with additional requirements of seawater quality for downstream use of seawater for mariculture
- Micro-Algae is being pursued for small OTEC plants for favorable island sites

E3Tec Service, LLC

8

## Technology Status

- 1<sup>st</sup> Generation of Commercial OTEC plants will most likely be designed based on closed cycle with ammonia as the working fluid
- Hybrid cycle would be considered for sites with critical water requirements
- Towards the end of federal funding in 1980s, aluminum was qualified for OTEC heat exchangers and biofouling became manageable; however, further development work could not be continued to develop OTEC-optimized modular aluminum heat exchangers
- Multi-stage Rankine cycle requires the development of modular high-performance heat exchangers that can be easily integrated with out significant engineering

## Technology Status

- Ammonia-water absorption cycles have potentials in 2<sup>nd</sup> or 3<sup>rd</sup> generation of OTEC plants with the development of high-performance of heat/mass transfer exchangers
- There are critical technical issues to demonstrate the viability of the mist-lift cycle for large OTEC plants due to the uncertainty of the two-phase flow in large riser pipe
- Haber-Bosch is commercial ammonia synthesis process hydrocarbon as feedstock
- Innovative solid-state ammonia synthesis process has been proposed with significantly improved energy efficiency
- Technical and economic viability of OTEC micro-algae based fuel need to be evaluated

## Path Forward

### Five-Step Commercialization Goals

1. Global displacement of petroleum-based fuels (diesel and fuel oil) for power generation specifically in the island market
2. At-sea production of desalinated water for regions of critical water shortages
3. Displacement of carbon-based production of fertilizer ammonia
4. Hydrogen supply to allow economic processing of heavy crude oils and upgrading oil sands
5. Ammonia-fuel-based distributed energy to displace natural-gas for power generation

 NOAA OTEC Technology workshop  
 Nov. 3-5, 2009  
 Plenary session 5-minute overviews of OTEC major sub-systems  

## Cold Water Pipe

 Dr. Alan K. Miller  
 Lockheed Martin Corporation  
 OTEC program, Technology development  
 CWP sub-system Lead

1



 OTEC's biggest challenge: A very large single\* Cold Water Pipe is required  
  
 The CWP for a full-scale 100 MW OTEC plant is 10m / 33 ft in diameter  
  
 \*Multiple CWP's require unacceptable pumping power

2

 The CWP must meet a number of requirements

Quantifiable technical drivers:	Anticipated quantitative loading	Dominant driver?	Met in LM design?	Basis
Buckling from net external pressure	7.5 psi suction inside CWP at top	<b>Yes</b>	Yes	FEA
Bending fatigue from platform motions, including knockdown for long-term seawater immersion	Approx. +/- 4 degrees of pitch or roll, plus surge and sway motions	<b>Yes</b>	Yes	Prelim. HARP analysis (10 MW plant) + prelim. test data on fatigue after high-pressure seawater conditioning to saturation.
Buckling from platform motions	Same as preceding	No	Yes	FEA
Fatigue from Vortex-Induced Vibration (VIV)	Sheared current profile, approx. 4 ips surface velocity	No	Yes	Several analyses indicate no excitation of CWP in sheared currents
Tensile failure from clump weight and atmospheric current	CWP + clump weight, current profile	No	Yes	Bending and tension strain calculations
Core collapse from high pressure at 1000m depth	1500 psi	<b>Yes</b>	Yes	Venting of hollow core eliminates net pressure on core
Wet weight must be positive but not excessive	CWP & clump weight	<b>Yes</b>	Yes	CWP wet density is same as fiberglass/vinyl ester laminate
Corrosion	30-year immersion in seawater at depths to 1000m	<b>Yes</b>	Yes	Industry experience with fiberglass/vinyl ester composites
<i>Also:</i>				
Behavior in service must be very reliable	CWP is single point of failure for OTEC plant	<b>Yes</b>	Yes	One-piece CWP eliminates maintenance / repair / failure of joints
Deployment must be low-risk	Very large consideration - Previous OTEC failures have been dominated by CWP deployment	<b>Yes</b>	Yes	Fabrication directly from the platform eliminates large risks associated with transport, assembly, upending, etc.
Cost must fit within OTEC plant budget profile	Electricity cost <= \$0.25/wh for 100 MW OTEC plant in Hawaii	<b>Yes</b>	Yes	Minimum-cost design through optimization. Materials costs from supplier quotes; recurring fabrication costs from large wind turbine blade data

3

 To meet these requirements, a number of top-level choices must first be made

- Material (fiberglass? steel? HDPE? membrane?.....)
- Architecture (monolithic? sandwich?)
- If a sandwich, what type of core (foam? honeycomb? balsa? hollow laminate?)
- One-piece? Assembled from separately fabricated lengths using mechanical or bonded joints?
- Fabrication method and location (on-shore? from the platform?)
- Deployment method
- Rigidly attached to platform? Gimballed?

4



## Issues and path forward

There is no available "off the shelf" CWP solution that meets all of the requirements at the required size scale.

Relevant existing technology ingredients are available (some developed in recent decades), but they must be synthesized into a new CWP solution.

Careful judgment and quantitative optimization are necessary to choose the best ingredients and integrate them into the new solution.

Thorough development, prove-out, and scale-up are necessary to retire the risks.

Within Lockheed Martin's OTEC program, the ingredients for our baseline CWP have been chosen, the selected fabrication process has been proven out in the laboratory, and scale-up validation is now underway with the help of DoE funding (under their AWPP program) and US Navy funding (under NavFac's OTEC program).

These activities (now ongoing) will bring the OTEC CWP to a state of technological readiness for commercial deployment.

5

# Horton Deepwater Development Systems

E. Horton, President

16420 Park Ten Place, Suite 240  
Houston, TX 77084 USA  
www.HortonDeepwater.com

Horton Deepwater Development Systems can design floating Platforms for the OTEC Industry to suit any water depth in any condition.

The Offshore Oil Industry has developed floating systems for A vast variety of Applications, Loads and Purpose.

## Deepwater Platforms



The OTEC Industry can have confidence that we can provide a Floating System to Support their needs.

OTEC's Challenge will be to Provide an Economic Energy Source from the Ocean where Appropriate.

# Horton Deepwater Development Systems

E. Horton, President

16420 Park Ten Place, Suite 240  
Houston, TX 77084 USA  
[www.HortonDeepwater.com](http://www.HortonDeepwater.com)

Horton Deepwater Development Systems can design floating Platforms for the OTEC Industry to suit any water depth in any condition.

The Offshore Oil Industry has developed floating systems for A vast variety of Applications, Loads and Purpose.

## Deepwater Platforms



The OTEC Industry can have confidence that we can provide a Floating System to Support their needs.

OTEC's Challenge will be to Provide an Economic Energy Source from the Ocean where Appropriate.



## Platform Moorings

Frederick R. Driscoll  
 Department of Ocean and Mechanical Engineering  
 and  
 Center for Ocean Energy Technology  
 Florida Atlantic University

June 10, 2010



## Moorings: Passive Mechanical Station Keeping and Motion Mitigation Systems

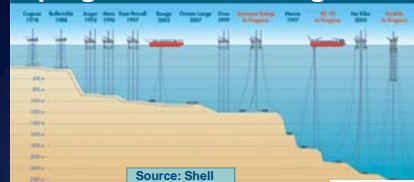

Source: Shell

### Major Components:

- Load handling equipment and terminators
- Mooring lines (ropes, chains, and equipment)
- Anchors

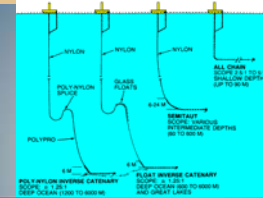

## Designs are Site Specific and Mission Driven

### A Few Design Considerations

- Site and Metocean Characteristics
- Design and Analysis Tools
- Performance, Dynamics and Stability
- Line Weight, Strength, Fatigue, Creep, Torque, Bend, Vibration, Fouling, Availability, Cost, Durability/Longevity
- Line Load Handling, Tensioning, and Termination
- Deployment, Inspection, Maintenance and recovery
- Available and Capability of Deployment Assets
- Safety, Standards and Best Practices
- And of Course ... Permitting, Rules and Regulations

## One Last Consideration

The components are big, really really really big!



They want us to recover what???

**NREL National Renewable Energy Laboratory**  
A national laboratory of the U.S. Department of Energy  
 Office of Energy Efficiency & Renewable Energy  
 Innovation for Our Energy Future

### Ocean Thermal Energy Conversion (OTEC)



Presented at:  
 The OTEC Workshop  
 UNH, Durham

-----  
 Dr. Mark L. Swinson,  
 Chief Scientist, SMDC  
 Edward B. Kline,  
 General Engineer, SMDC

Desikan Bharathan, Principal Engineer, National Renewable Energy Laboratory, Golden, CO 80401

November 4, 2009

NREL is operated by Midwest Research Institute • Battelle

1

**NREL National Renewable Energy Laboratory**  
A national laboratory of the U.S. Department of Energy  
 Office of Energy Efficiency & Renewable Energy  
 Innovation for Our Energy Future

### Humanity's Top Ten Problems for next 50 years\*

1. ENERGY
2. WATER
3. FOOD
4. ENVIRONMENT
5. POVERTY
6. TERRORISM & WAR
7. DISEASE
8. EDUCATION
9. DEMOCRACY
10. POPULATION



**OTEC is poised to offer solutions!  
 In dramatic ways**

\*from R.E.Smalley's presentations

November 4, 2009

2

**NREL National Renewable Energy Laboratory**  
A national laboratory of the U.S. Department of Energy  
 Office of Energy Efficiency & Renewable Energy  
 Innovation for Our Energy Future

### The blue planet – where the Ocean is the largest solar collector !



165,000 TW of sunlight hit the earth

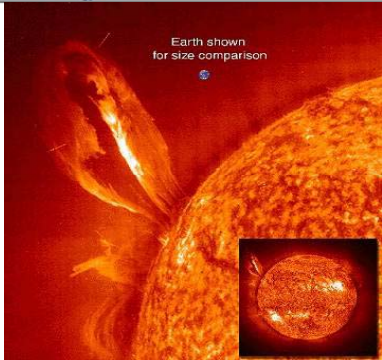

Earth shown for size comparison

November 4, 2009

3

**NREL National Renewable Energy Laboratory**  
A national laboratory of the U.S. Department of Energy  
 Office of Energy Efficiency & Renewable Energy  
 Innovation for Our Energy Future

### Prior OTEC R&D efforts - achievements

- OTEC
  - Operation of resource pipes and pumps have been proven reliable over long periods of time at NELHA.
  - Ocean resource has been proven to be "reliable and sustainable."
  - Systems have been proven to produce:
    - » electricity
    - » water;
    - » food;
    - » air-conditioning;
    - » high-value bio-medicals.

November 4, 2009

4

NREL National Renewable Energy Laboratory  
A national laboratory of the U.S. Department of Energy  
 Office of Energy Efficiency & Renewable Energy  
 Innovation for Our Energy Future

## Open-Cycle OTEC System

### Cut-away Illustration

November 4, 2009 5

NREL National Renewable Energy Laboratory  
A national laboratory of the U.S. Department of Energy  
 Office of Energy Efficiency & Renewable Energy  
 Innovation for Our Energy Future

## Components of the OC-OTEC system

November 4, 2009 6

NREL National Renewable Energy Laboratory  
A national laboratory of the U.S. Department of Energy  
 Office of Energy Efficiency & Renewable Energy  
 Innovation for Our Energy Future

## Vacuum system

November 4, 2009 7

NREL National Renewable Energy Laboratory  
A national laboratory of the U.S. Department of Energy  
 Office of Energy Efficiency & Renewable Energy  
 Innovation for Our Energy Future

## Cost and Research implications

- Almost **half** the cost is associated with the cold-water pipe and pumping resource.
  - Substantial potential exists to reduce this cost with further R&D.
- Open-cycle turbine stands to be made of alternative materials for cost reduction and longevity in corrosive environment.
  - Material advances in plastics and composites will advance turbine design and fabrication.
- Multiple product production can be established incrementally.

November 4, 2009 8

# Power Cables

## OTEC Technology Workshop

November 3-5, 2009

Steinar Dale

Center for Advanced Power Systems  
Florida State University

# Power Cables OTEC Technology Workshop

- **Factors**
  - Generation nameplate capacity
  - Cable length -Distance from shore and to grid connection
  - AC or DC
  - Cable voltage
  - Robustness of on-shore grid system (weak systems)
  - Cable laying route on sea bottom and trenching needs
  - Size and weight of the power generation and conditioning plant
  - Black-start requirements
- **Similar applications**
  - Oil drilling platforms powered from shore (North Sea)
  - Offshore wind farms
  - Sea cable connections –existing and planned
- **Types of Cables**
  - XLPE
  - Mass Impregnated
  - HTS?
- **Environment**
  - The high voltage equipment must be protected from the ocean environment (salt water, dampness/condensation, corrosion)



Troll-A oil platform in the North Sea and cable laying ship (ABB)



HVDC Light Module on Troll-A platform (ABB)



Cable laying ship

# Power Cables OTEC Technology Workshop

Nysted offshore wind farm, Denmark



Transformer unit (33 kV/132 kV) for the aggregation of the 72 wind turbines of the park, 165 MW

ABB Review 2/2007

Power Cables  
 OTEC Technology Workshop



400-kV XLPE cable. The copper conductor is divided into five segments to reduce skin effect losses.

Source: ABB Review



HVDC Light™ extruded submarine cable, with double armoring (80 kV rating)



Submarine cable for the 600 MW, 450kV Baltic Cable HVDC link between Germany and Sweden (Nexans)



American Superconductor

Superconducting cable 132 kV

Power Cables  
 OTEC Technology Workshop

- The most powerful HVDC submarine
- cables to date are rated 700 to 800 MW
- at 450 to 500 kV. The longest of these
- are the the 580 km NorNed link between Norway and The Netherlands
- in service in 2008.



Source: Statkraft



Flat submarine cable

Source: ABB

## Power Cables

# OTEC Technology Workshop

November 3-5, 2009

Steinar Dale

Center for Advanced Power Systems  
Florida State University

## Power Cables OTEC Technology Workshop

- **Factors**
  - Generation nameplate capacity
  - Cable length -Distance from shore and to grid connection
  - AC or DC
  - Cable voltage
  - Robustness of on-shore grid system (weak systems)
  - Cable laying route on sea bottom and trenching needs
  - Size and weight of the power generation and conditioning plant
  - Black-start requirements
- **Similar applications**
  - Oil drilling platforms powered from shore (North Sea)
  - Offshore wind farms
  - Sea cable connections –existing and planned
- **Types of Cables**
  - XLPE
  - Mass Impregnated
  - HTS?
- **Environment**
  - The high voltage equipment must be protected from the ocean environment (salt water, dampness/condensation, corrosion)



Troll-A oil platform in the North Sea and cable laying ship (ABB)



HVDC Light Module on Troll-A platform (ABB)



Cable laying ship

## Power Cables OTEC Technology Workshop

Nysted offshore wind farm, Denmark



Transformer unit (33 kV/132 kV) for the aggregation of the 72 wind turbines of the park, 165 MW

ABB Review 2/2007

Power Cables  
 OTEC Technology Workshop



400-kV XLPE cable. The copper conductor is divided into five segments to reduce skin effect losses.

Source: ABB Review



HVDC Light™ extruded submarine cable, with double armoring (80 kV rating)



Submarine cable for the 600 MW, 450kV Baltic Cable HVDC link between Germany and Sweden (Nexans)



American Superconductor

Superconducting cable 132 kV

Power Cables  
 OTEC Technology Workshop

- The most powerful HVDC submarine
- cables to date are rated 700 to 800 MW
- at 450 to 500 kV. The longest of these
- are the the 580 km NorNed link between
- Norway and The Netherlands
- in service in 2008.



Source: Statkraft



Flat submarine cable

Source: ABB

## Seawater Heat Exchangers

Avram Bar-Cohen  
ME Department – UMD

CRRC- NOAA OTEC Technology Workshop

University of New Hampshire  
November 2009

## Heat Exchanger Technology

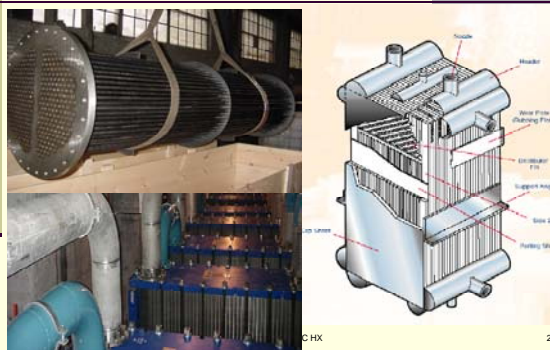

## Heat Exchanger Fundamentals

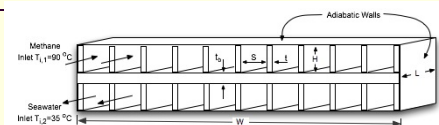

$$q = UA \Delta T_{lm} \quad \Delta p = \left( f \frac{L}{D_h} + K_{L,entry} + K_{L,exit} \right) \frac{\rho U^2}{2}$$

$$UA = \frac{1}{\frac{1}{n_o A_{i,m} h_m} + \frac{t_b}{k A_b} + \frac{1}{n_o A_{i,w} h_w}} \quad f = f(Re, l/D, \epsilon/D)$$

$$h = h(Re, Pr, l/d, k)$$

Nov '09

ABC OTEC HX

3

## Seawater Heat Exchanger Issues

- **Applications**  
OTEC, desalination, coastal powerplants, gas/oil processing
- **Corrosion Resistance**  
titanium, copper-nickel, aluminum, plastics, ceramics, (coatings)
- **Biofouling**
- **Thermal Conductivity**
- **Density**
- **Material Cost**
- **Manufacturability; Manufacturing Cost**

Nov '09

ABC OTEC HX

4



## Polymer Heat Exchangers

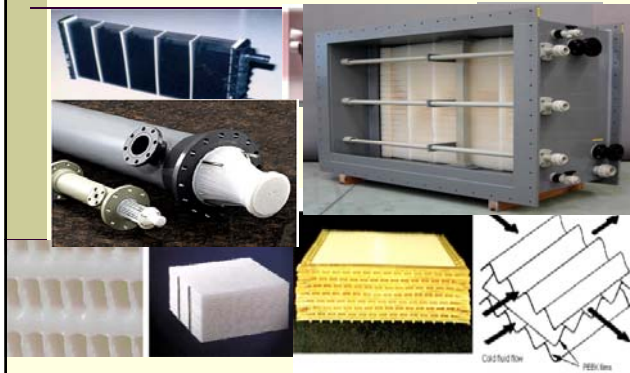

## Material Conductivity Effect

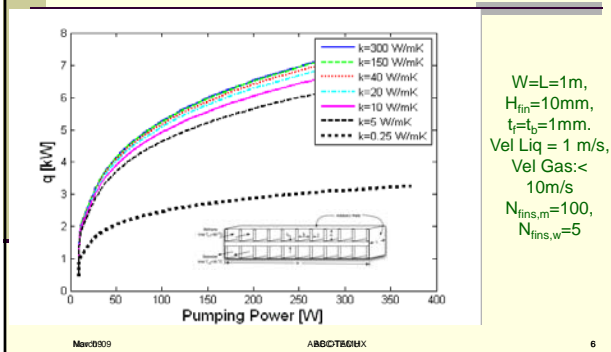

## Mass-Specific Heat Transfer Coefficients

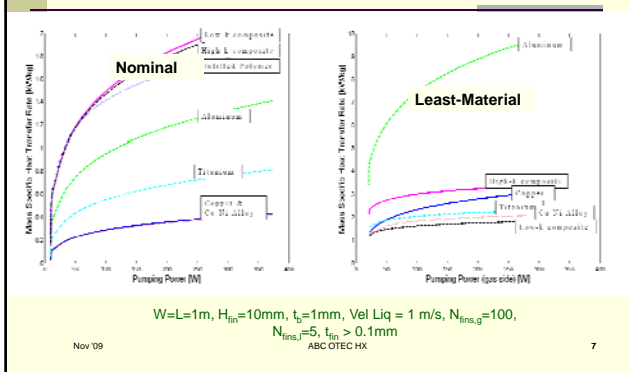

## Total Coefficient of Performance

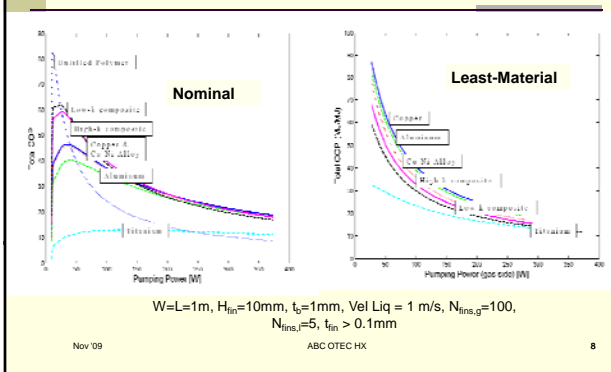

## Laboratory X-Flow PHX Prototype



Nov 09

ABCOTEC HX

9

## Session IV:

What changes have occurred in materials, designs, practices, fabrication, manufacturing, and technology between 1980 and today to make OTEC feasible to pursue on a commercial scale?

## Summary of Improvements Since 1980s

- **Materials:**
  - New materials
    - e.g., composites, synthetics
  - Higher Strength
  - More reliable
  - Lower cost

## Summary of Improvements Since 1980s

- **Design:**
  - Vastly improved computing capability
  - New analytical methods
  - Vastly improved modeling methods
- **Fabrication:**
  - Improved extrusion methods
  - Welding advances
  - Aluminum brazing advances
  - Coatings improvements
  - Advances in QC

## Summary of Improvements Since 1980s

- **Manufacturing:**
  - Automation vastly improved
  - Improved tooling
- **Sensor Development:**
  - In situ health and Status Monitoring methods

## Summary of Improvements Since 1980s

- **MET OCEAN:**
  - Real Time Data
    - Satellite technology
    - Ocean observing network
  - Weather prediction modeling
- **Development of Deepwater Oil and Gas Industry**

## Summary of Improvements Since 1980s

- **New Bathymetric and Geopositioning Techniques**
- **Codes / Standards Development**
  - e.g., deepwater industry
- **Cable Design and Construction Vastly Improved**

## Advances in Cold Water Pipe

	Then	Now	Benefit
Materials	E-glass/Vinylester Steel, concrete	1. R-glass/vinyl ester Carbon fiber composite 2. E-glass/vinylester	1. Higher fatigue strength; better reliability and lower cost 2. Still viable, additional validation has been done
Designs	Syntactic foam core sandwich	1. Hollow pultruded core sandwich and other proprietary designs 2. Syntactic foam core sandwich	1. Much lower cost, less labor intensive and greater consistency 2. Still viable, additional validation has been done
Practices		Off-shore industry experience	Lower cost and better reliability, more design flexibility

## Advances in Cold Water Pipe

	Then	Now	Benefit
Fabrication	Filament winding	VARTM process	In-situ, continuous pipe
Technology		Computational tool development Improved structural monitoring (cameras, sensors, robotic devices)	Higher precision, lower testing cost More reliability, less labor, less risk

### Summary:

Due to advances in computational capability, composite materials, fabrication methods, and the vast experience of the offshore industry, there is a high level of confidence that we can construct and maintain a reliable, cost efficient cold water pipe.

## Advances in Heat Exchangers

- Materials
  - Titanium cost effectiveness (aerospace and automobile industries)
  - Titanium: developing improved processes (power plant condenser)
  - Thermally enhanced plastics
  - Aluminum: alloying improved (aerospace industry)
  - Aluminum: more choices
- Designs
  - Potential new HX designs
  - Plastic or foam HX new emerging techniques (improving efficiency in processing industry)
  - Surface enhancements
  - Improved heat transfer coeff. without incurring pressure drop penalty

## Advances in Heat Exchangers

- Practices/Performance
  - Materials
    - High speed/low cost capability of computing
    - Improved analytical and design modeling techniques
  - Fabrication
    - Extrusions have improved
    - Aluminum brazing technology (cryogenic, LNG)
    - Improved welding techniques (for sea water applications; petro industry, LNG, oil, ships, power plant condensers)
    - Improved instrumentation/quality control
    - Improved coating processes

## Advances in Heat Exchangers

- Manufacturing
  - Improved capability/tooling (petro industry, LNG)
  - Capacity for larger HX
  - greater automation
- Technology/Cycle Development
  - Open cycle performance validation
  - Hybrid cycle design
  - Direct contact condensers operational (geothermal application)
  - Flash evaporators demonstrated
  - Mixed working fluid cycle developed (demonstrated in geothermal)

## Advances in Platform Mooring

- Moorings
  - Materials, design, fabrication have advanced to enable moorings to 10k feet, far exceeding the 1k foot limit of 1980, required OTEC mooring depth is 3k + feet
  - Comprehensive codes and standards now exist for deep water moorings
- Infrastructure
  - Industry has developed which routinely designs and installs mooring systems in depth up to 10k feet

## Advances in Platform Moorings

- Positioning
  - In 1980 positioning of surface and subsurface assets was inadequate for deep water, far from shores for placements. Present technology is sufficient to meet OTEC requirements.
  - Satellite positioning and shipboard dynamic positioning allows positioning of surface assets within 1 meter anywhere on the planet, efficiently installed anchor systems
  - Underwater acoustic system has advanced accuracy of placement of underwater assets

## Advances in Platform Moorings

- Materials
  - Synthetic Mooring lines have increased mooring depths to greater than 10k feet today
  - High strength to weight ratio, neutrally buoyant materials such as polyester, kevlar, spectra, etc
  - High strength steel for use in mooring wire and chain

## Advances in Platform Mooring

- Anchors
  - General advances in anchor technology have led to increased capacities in wide ranged bottom types
- Installation and Operation
  - Dynamically positioned installation vessels are commonly available
  - Under water equipment advances allow safe and effective installation, inspection, maintenance, and recovery in deep water
- Design Analysis Tools
  - Advances in software enable deep water moorings to be accurately modeled and analyzed
    - Validated by field installations in deep water
    - Allows optimization of the system
    - Broad range of commercially available, industry verified software

## Advances in Platform Pipe Interface

- Established deep water industry
  - Industrial base
  - Code
  - Standards
  - Control Technologies (handling)
  - Better understood
- Improvement in Composites
  - Materials
  - Processes

## Advances in Platform Pipe Interface

- Improved analytical capabilities and capacity
- Environmental awareness
- Improved Sensor technology
- Development of underwater tools
- Underwater construction techniques
- Deep dynamic cables
- Survey Technology
- Improved engineering process
  - Configuration management

## Advances in Platform

- |  |  |
|--|--|
| <ul style="list-style-type: none"> <li>■ <b>1980</b></li> <li>1. Required offshore OTEC depth of 3000ft is considered technically challenging for offshore oil industry</li> <li>2. Floating production systems were at infant technology</li> <li>3. Limited software was available and data was not validated</li> <li>4. Limited ability to predict impact of extreme weather</li> <li>5. Platforms were designed to very conservative standards due to uncertainties in extreme storm conditions and calculation accuracy</li> </ul> | <ul style="list-style-type: none"> <li>■ <b>Today</b></li> <li>1. Floating production platforms at 3000ft considered routine from a technical standpoint</li> <li>2. There are about 200 floating production systems</li> <li>3. Computer software and experimental facilities for design are in use and have been validated</li> <li>4. Meteorological/ oceanographic data gathering capability is more sophisticated</li> <li>5. Improved tools and oceanographic data allows design of more cost effective platforms</li> </ul> |
|--|--|

## Advances in Pumps and Turbines

- Pumps and Turbines have been ready for 30 years
- No revolutionary breakthrough in pump/turbine; all advances evolutionary
- Electronics starting to be introduced into pumps/turbines to monitor health and status; most advances will be in outage management/condition based management
- Move toward a sustainable system that can function without external hydrocarbon inputs
- Seaborne environment (roll, pitch, yaw) has proven out turbine machinery over worse or equivalent situations.
- Petroleum industry has 30 years of additional experience working in increasingly harsh environments and much has been learned about operations, methods and materials.
- OTEC-style plant in India that produces Freshwater – more expensive than traditional desalinization methods, however operational and works.
- Many attempts since 1980: 250 kW open cycle at NELHA, 1996-2000 50 kW Hx Testing (NEHLA), 2005 Diego Garcia Feasibility Study, 2006 OTEC Study Makal SBIR, 2007-2008 10 MW Pilot Plant Design by Lockheed Martin.

## Advances in Power Cable

- Today: 10 sea crossing AC cables from 90 kV-to500 kV
- 20 DC cables up to 500 kV
- Majority have occurred in last 10 years
- Availability of remote resources and interconnection of grids
  - US: east coast NY/NJ
  - From Canada to NJ
- Dynamics cables: technology driven by offshore wind farming
  - Off shore oil drilling
  - Common connection by 13.6kV up to 50 kV
  - Connection at platform are standard and routine, sock rigid connection run through tube, secured at top
  - Length, width, diameter are function of cable
  - Swivel joint done on top side like fixed connection
- Offshore wind floating platforms
  - Individual cables to shore

## OTEC Then



## OTEC Then



## OTEC Now





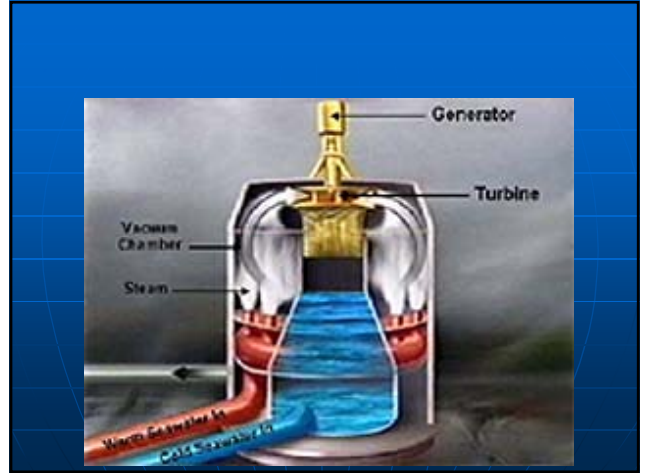

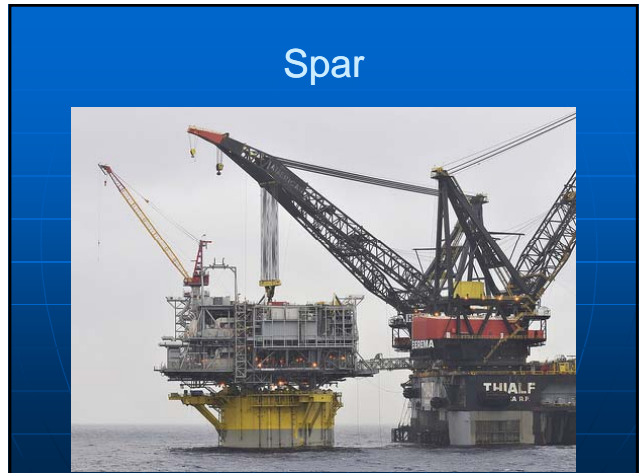
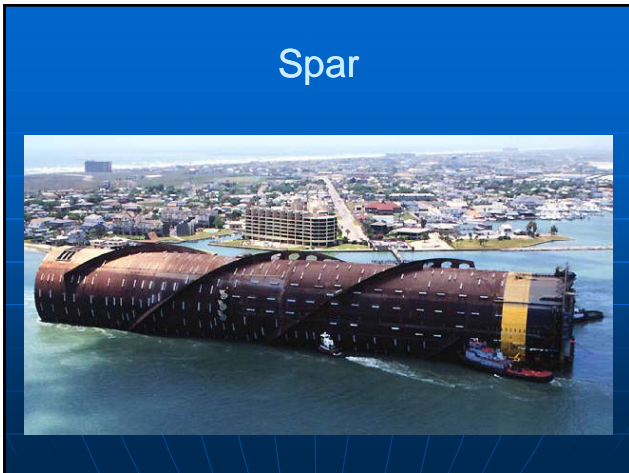

### FPSO

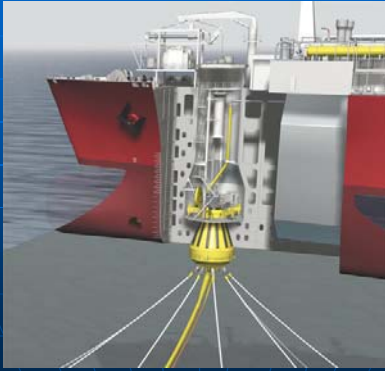

### Bathymetry Then

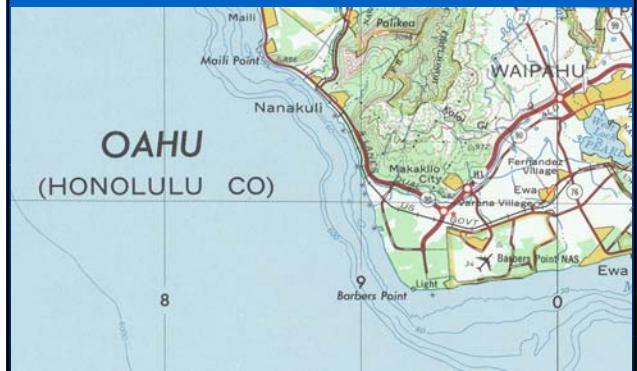

### Bathymetry Now

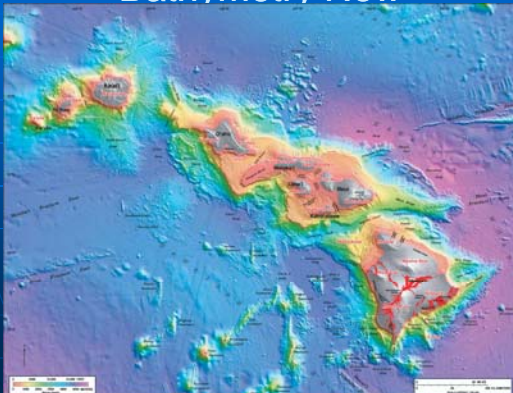

### Platforms Then

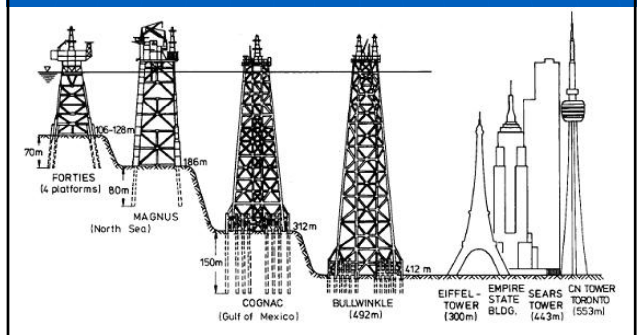

## Platforms Now

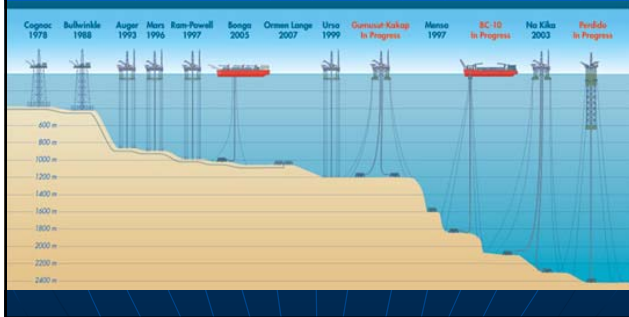

## Glomar Explorer Gimbal



## Other Uses of OTEC Technology

Fresh Water  
Mariculture  
H2  
Cooling

## SeaWater Air Conditioning (SWAC)

- It exists today in Stockholm
- It may exist tomorrow in Honolulu



"HALF AN OTEC"

## Power Plant Cooling

Cold seawater as a heat sink

**Existing:** Many proposed OTEC plants are sited near existing power plants for transmission connections

**Innovative:**

OTEC technology and Concentrating Solar Power plants can have mutually beneficial combinations

## OCW as a heat sink for CSP

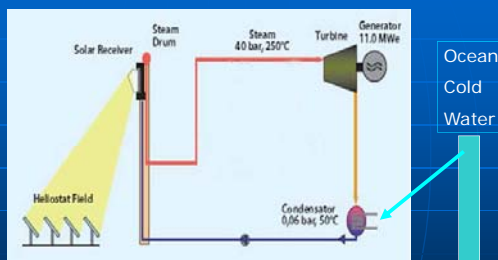

Efficiency!!

## CA Concentrating Solar

- California Coast to Mojave

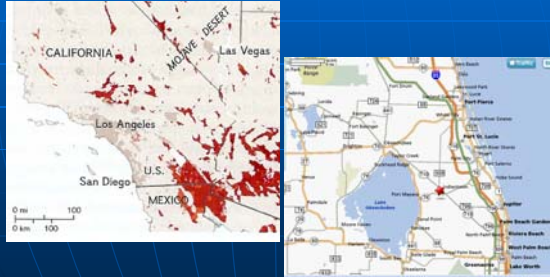

## SOTEC

Concentrating Solar Augmentation of OTEC

