



**Neighbor to Neighbor**

**ENERGY CHALLENGE**

Small Changes. **BIG RESULTS.**

## Neighbor to Neighbor Energy Challenge

Listening to the Consumer Behavior Analysis Workshop

December 2, 2010

SCA/CWF Training Session

**Kat Donnelly**

EMpower Devices/MIT

# Understanding the participant requires...

a complete inventory of needs/benefits

a sense of overall structure and organization

15.821 Listening to the Customer

a sense of what's general to the market and what's special to some segments

a sense of relative importance

15.822 Strategic Market Measurement



**Neighbor to Neighbor**  
**ENERGY CHALLENGE**  
Small Changes. **BIG RESULTS.**

# The Research Questions



The  
Questions

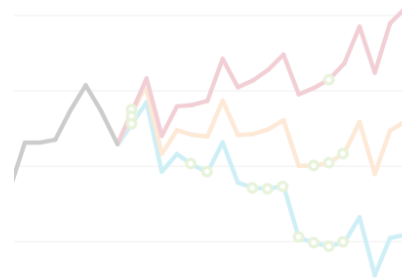

The  
Research



The  
Workshop



# Today's Research Area

## *Behavioral Research*

- Goal: Better understand individual and social characteristics.
- Primary Research: Examine behavioral triggers, such as scripts, tabling interaction, etc..
- Secondary Research: Understand the key factors driving the participants to participate:
  - is it community group or town incentive,
  - is it personal relationship?
  - is it other intrinsic or social motivator that takes place in your script?
  - Etc.

# Future Research Area

## *Behavioral Research*

- Goal: Identify the most effective (meaning achieving the broadest participation within a town):
  - community outreach strategies,
  - different dispersion/rollout strategies,
  - different demo/psychographic groups.
- Primary: Learn about persistence of behaviors, effectiveness of messaging type and timing, etc. defined by response rates, close rates, etc. Analyze:
  - Specific calls-to-action
  - Participation in the Challenge,
  - Willingness to provide utility account #, HES, CTCEO, and deeper retrofits w/ or w/out financing (i.e. HES follow-on measures).
- Secondary: Identify “typical” paths through the food chain, as well as trends that can be gleaned from those paths.
  - What are the best ways to get the indifferent and skeptics on board?



Neighbor to Neighbor  
**ENERGY CHALLENGE**  
Small Changes. **BIG RESULTS.**

# Future Research Area

## *Social Networking Research*

- Goal: Use social network analysis to determine influencers, influenced, and spread of ideas, norms, and the N2N challenge through the communities and their social networks
  - How do the influencers impact the spread of the program influence in our communities?
  - What are the system leverage points that make the technology cheaper and increase adoption of technologies and behaviors?
  - Can the Technology Pilot be used to test some of these network structure questions?
- How does the online social network promote (social) visibility of individual behaviors to others?
  - How do network density, network closure, and size influence prosocial behaviors in on- and off-line communities? (Coleman vs. Burt...or Both)
- How can we harness the power of our participants to improve our program and technology designs?



Neighbor to Neighbor  
**ENERGY CHALLENGE**  
Small Changes. **BIG RESULTS.**

# Future Research Area

## *Home Energy Solutions Research*

- Goal: Determine how applying behavioral strategies to the program design will affect the success of HES and follow-on measures
- Analyzed impacts
  - Food Chain Impacts: What Pre-HES outreach strategies promote participation and follow on? What is the best follow up process to lead to further participation?
  - Energy Impact: What are the long-term energy savings of HES actions
  - Cost-effectiveness: lifetime value of a kWh, participant acquisition cost, etc.
- Major HES treatment aspects
  - Student Conservation Association “Ambassadors”: Do they increase improvements and investments pre- and post-HES visit? What about action apart from the HES visit (e.g., Targeted neighborhood Student Conservation Association door-to-door or block party, and then contractor follow up.)
  - What are the best strategies for communicating HES assessment scoring (“yardstick”)? How should they be presented (“kitchen table wrap-up”)?



**Neighbor to Neighbor**  
**ENERGY CHALLENGE**  
Small Changes. **BIG RESULTS.**

# The Analysis Approach

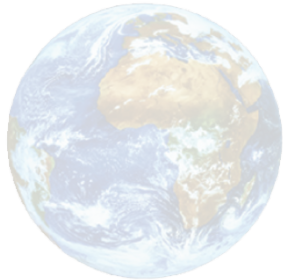

The  
Questions

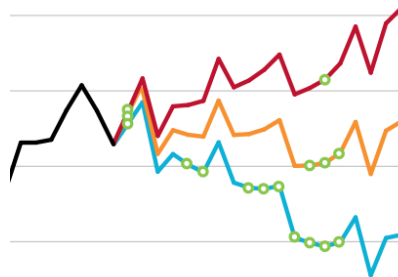

The  
Method



The  
Workshop







Neighbor to Neighbor  
**ENERGY CHALLENGE**  
Small Changes. **BIG RESULTS.**

# Listening to the Voice of the Participant Objectives

- Appreciate qualitative (rather than purely quantitative research)
- Learn how to get quick participant input, skipping the market research middleman
  - We are the marketing researchers!
- Do a Voice of the Participant project from your real data



Neighbor to Neighbor  
**ENERGY CHALLENGE**  
Small Changes. **BIG RESULTS.**

# Voice of the Participant Assumptions

- Participants live in a different world, speak a different language
- Customers can express needs (or ‘symptoms’ of needs) not solutions
- The ‘pool’ of needs is finite
- Needs can be grouped into strategic ‘bundles’ which drive competition



Neighbor to Neighbor  
**ENERGY CHALLENGE**  
Small Changes. **BIG RESULTS.**

# Our philosophy to marketing research

- Think of it as self-education
- Slow down / add structure to the process
- Small numbers / high quality
- Provide motivation
- Search for expertise

# The **Art** and **Science** of Listening to the Voice of the Customer

Applied  
Marketing  
Science, Inc.

Bob Klein  
President





## Imagine that you run a movie theater

- ❖ 12 screens, many employees, and very successful
- ❖ You are going on a three month trip around the world
- ❖ Every Monday morning, your staff will fax you a report so that you can be sure that everything is going well
- ❖ What's in the report?





# Movie Theater Management Reports

- ❖ Ticket sales
  - by feature
  - by time of day
  - both number and dollars
  - adult, kids, senior
- ❖ Concession sales
  - by day
  - by item
  - units and dollars
- ❖ Labor/work force data
  - hours and dollars
  - by class of worker
- ❖ Profit reports
  - by feature
  - by day of week





## Imagine that you are going to the movies

- ❖ The movie you want to see is playing in several different theaters
- ❖ All are about equal distance from your home
- ❖ How do you decide which theater you will go to?





# Movie Theater Customer Needs

- ❖ Good popcorn
  - hot
  - fresh
  - not greasy
- ❖ No sticky floors
- ❖ Easy parking
- ❖ Comfortable seats
- ❖ Big screens and good sound
- ❖ Clean restrooms
- ❖ No ads, but more “Coming Attractions”
- ❖ A good view from anywhere in the theater







## "What we have here is a failure to communicate"

- ❖ Good popcorn
  - Hot
  - Fresh
  - Not greasy
- ❖ No sticky floors
- ❖ Easy parking
- ❖ Comfortable seats
- ❖ Big screens and good sound
- ❖ Clean restrooms
- ❖ No ads, but more "Coming Attractions"
- ❖ A good view from anywhere in the theater



- ❖ Ticket sales
  - by feature
  - by time of day
  - both number and dollars
- ❖ Concession sales
  - by day
  - by item
  - both units and dollars
- ❖ Labor/workforce data
  - hours and dollars
  - by class of worker
- ❖ Profit reports
  - by feature
  - by day of the week



Neighbor to Neighbor  
**ENERGY CHALLENGE**  
Small Changes. **BIG RESULTS.**

# The VOCALYST® Process

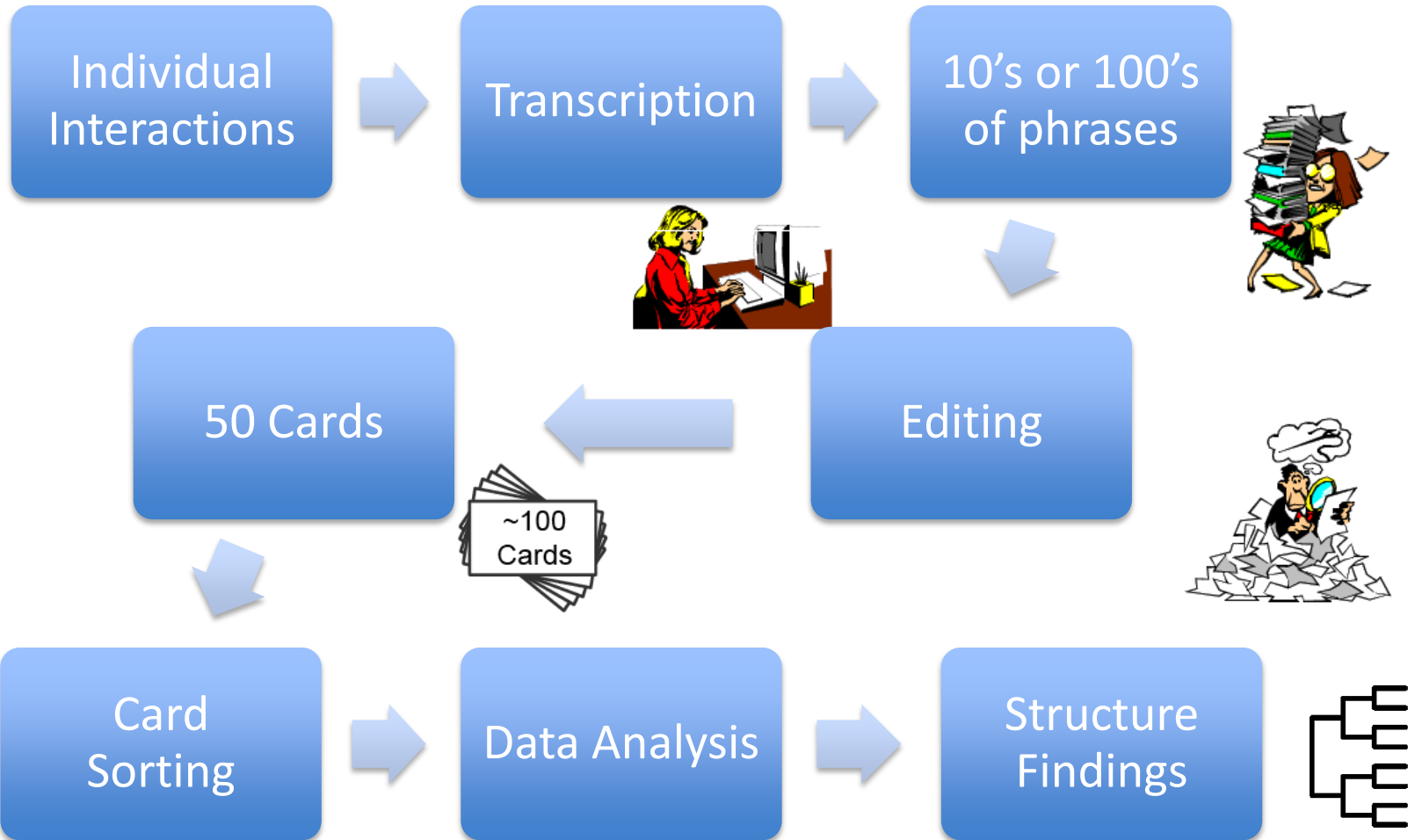



## Results from VOCALYST®

- ❖ Customer words and phrases organized into a hierarchy
- ❖ Customer generated ideas
  - Performance measures
  - Target values
  - New Features
  - Problems and Solutions
- ❖ Prioritization of the elements of the Voice of the Customer
- ❖ Identification of the key elements that will make a difference to customers

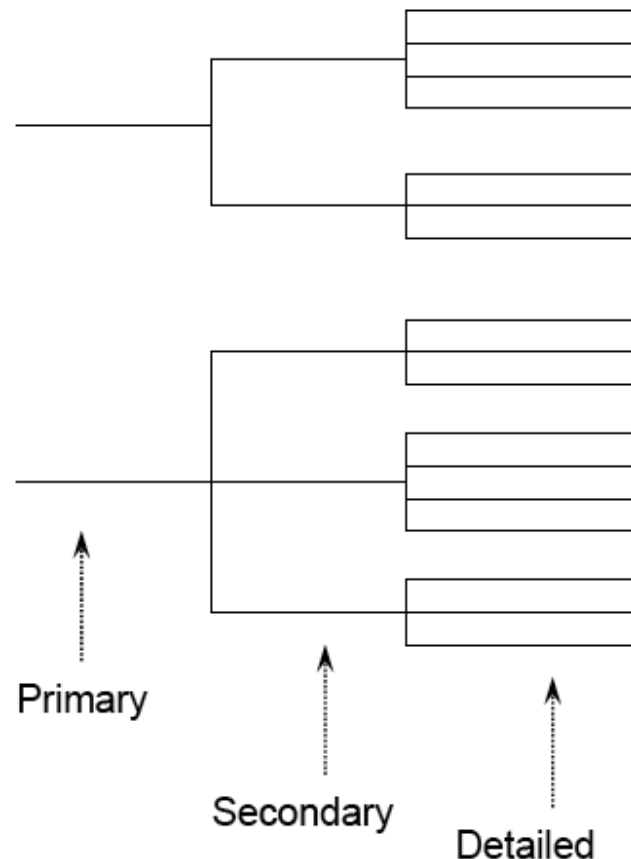

# ILLUSTRATION OF A " VOICE OF THE CUSTOMER" THE VOICE OF THE CONFERENCE ATTENDEE

## RELEVANT CONTENT

### Relevant Information I'll Be Able To Use

- \* Ideas/concepts I'll be able to use after conference ends
- \* Materials to do a good job disseminating info back home
- \* Helps me investigate a subject more deeply after ward
- \* Back to work and say "now I know how to solve problem"
- \* Learn enough of relevance to make it worthwhile
- \* You get your money's worth
- \* Get information pertinent to my job
- \* Programs and exhibits relevant to my job

### Quality Speakers

- \* Speakers that add value beyond their handouts
- \* Don't just tell you results but show how they got them
- \* There's an opportunity to interact with speakers outside
- \* Don't find out that the one speaker I wanted canceled

### Quality Presentations

- \* Presentations not just platforms for people to sell books
- \* Presentations are interesting - don't put me to sleep
- \* Practical ideas, not just concepts and theories
- \* Present current information and new ideas
- \* Information beyond obvious- not just general knowledge

### Don't Feel You're Missing Anything

- \* Phones accessible and available when I need to make a call
- \* Easy to stay in touch with my office
- \* Can get info on sessions even if you can't go to them all
- \* Don't feel like you're missing anything cause can't see all
- \* I feel that my attendance is appreciated



# Affinity Diagram Example

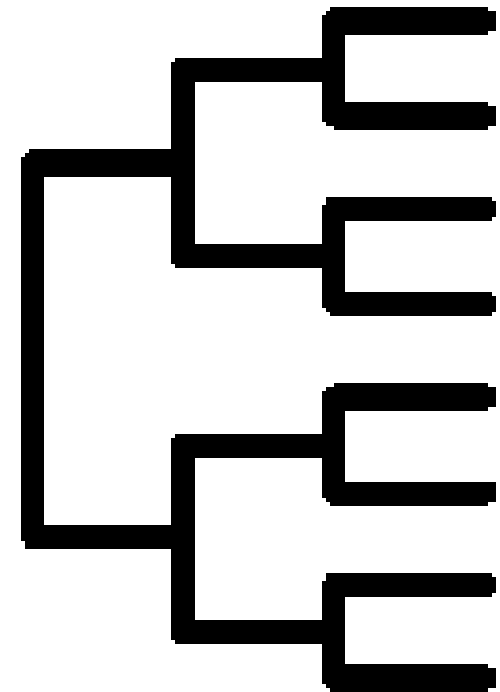
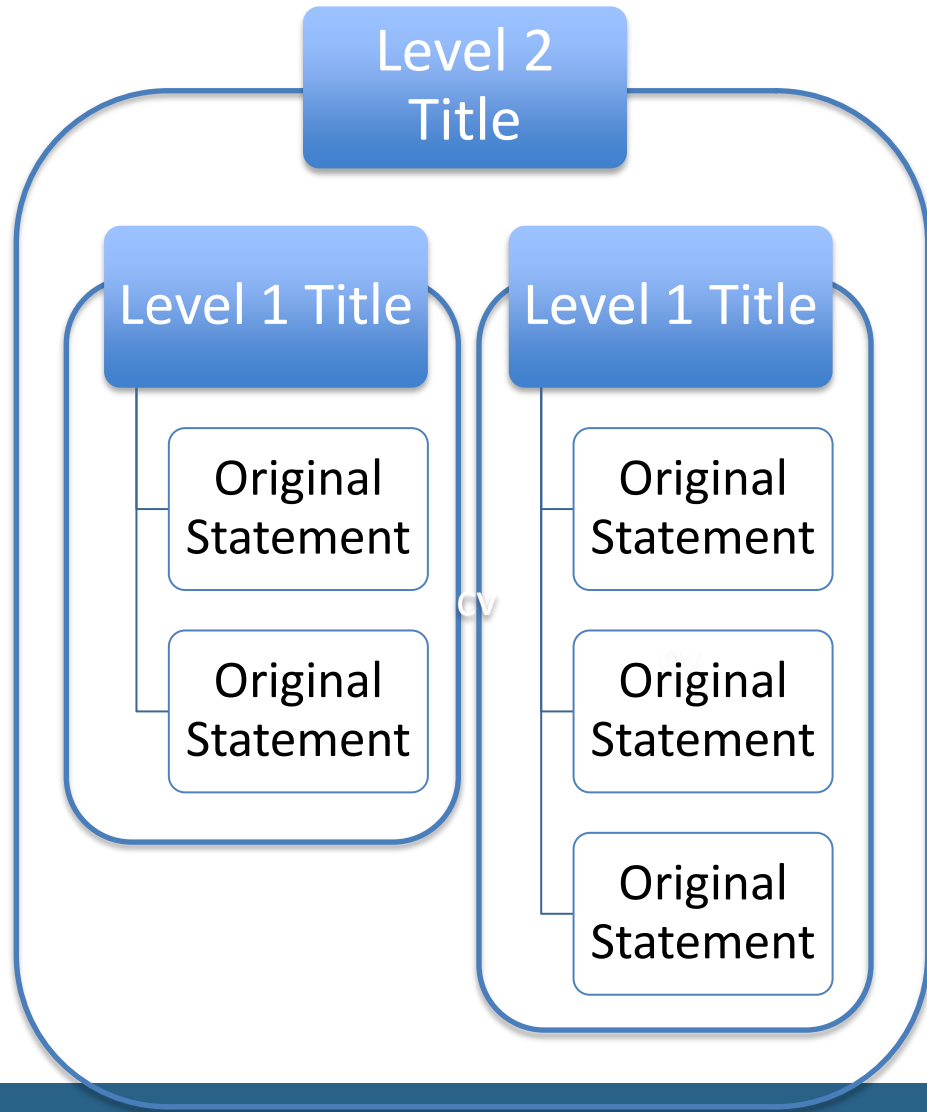



## Where do you get your best ideas?

- ❖ When are you the most creative? When do you have your best ideas?

Quick Exercise:

Please tell me when and where your best ideas come from?

- ❖ Did anyone say:

“At a professionally facilitated one-day brainstorming meeting that was scheduled 3 months in advance so everyone that needed to be there could make it.”

- Yet, when you think of brainstorming or creative problem solving, don't you schedule a meeting? Hire (or schedule) a facilitator? Arrange for the facilities? (and the food!). Set up a budget for travel? Etc.



Neighbor to Neighbor  
**ENERGY CHALLENGE**  
Small Changes. **BIG RESULTS.**

# Ethnographic Observation

- Requires careful observations, extensive documentation, and sophisticated coding and editing
- Especially helpful for
  - Tracing complex participant activities (using software, moving along the food chain, etc.)
  - Understanding complicated process results
  - Detecting new trends



Neighbor to Neighbor  
**ENERGY CHALLENGE**  
Small Changes. **BIG RESULTS.**

# Why do people do what they do in the shower? Listening to the Voice of the Customer



Harry West, Design Continuum

Slide from: Drazen Prelec's 15.821 MIT MBA Class: Listening to the Customer





Neighbor to Neighbor  
**ENERGY CHALLENGE**  
Small Changes. **BIG RESULTS.**

# Is there an opportunity to see what people really do in the shower?

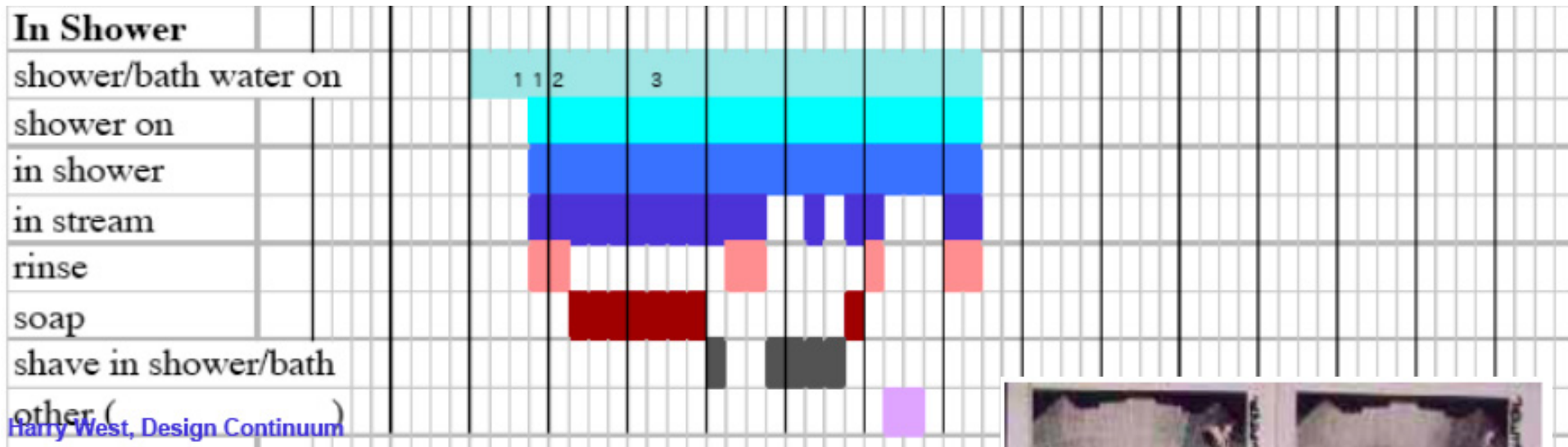

Slide from: Drazen Prelec's 15.821 MIT MBA Class: Listening to the Customer



Neighbor to Neighbor  
**ENERGY CHALLENGE**  
Small Changes. **BIG RESULTS.**

# Why do people do what they do in the shower? Listening to the Voice of the Customer

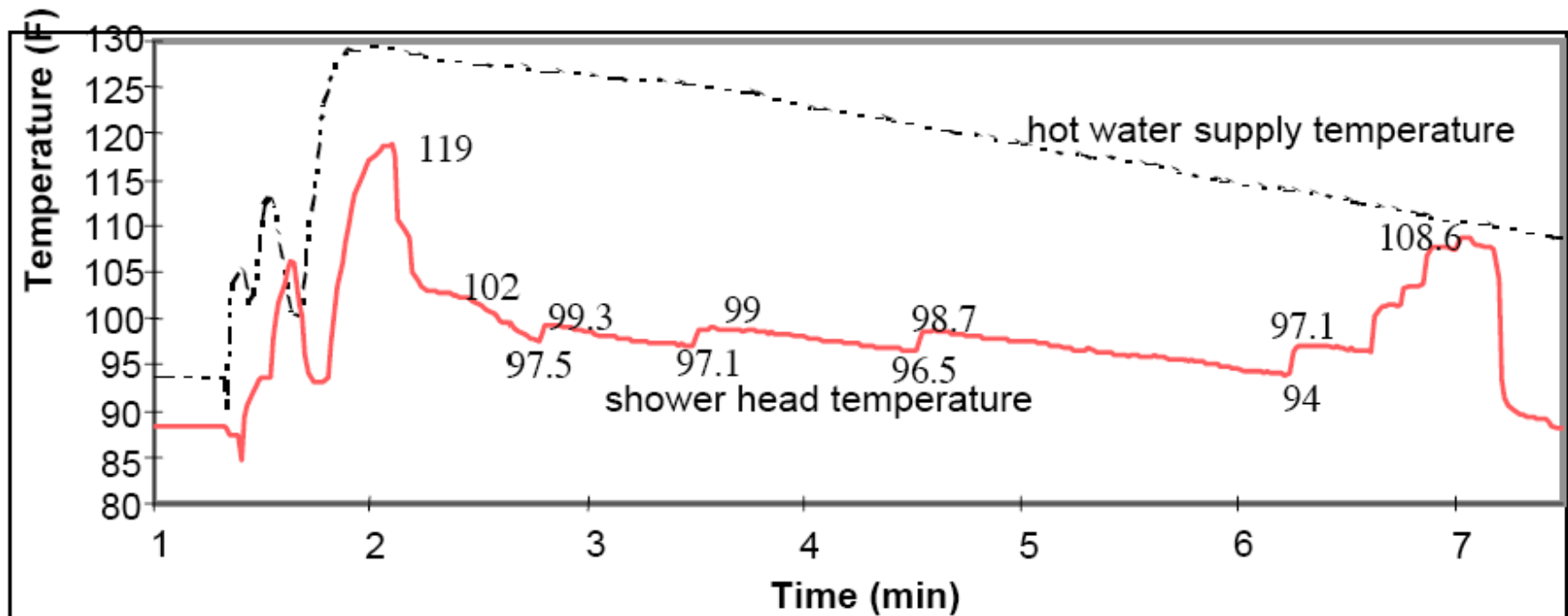

Harry West, Design Continuum

Slide from: Drazen Prelec's 15.821 MIT MBA Class: Listening to the Customer

# How the experience ladders up to support their values

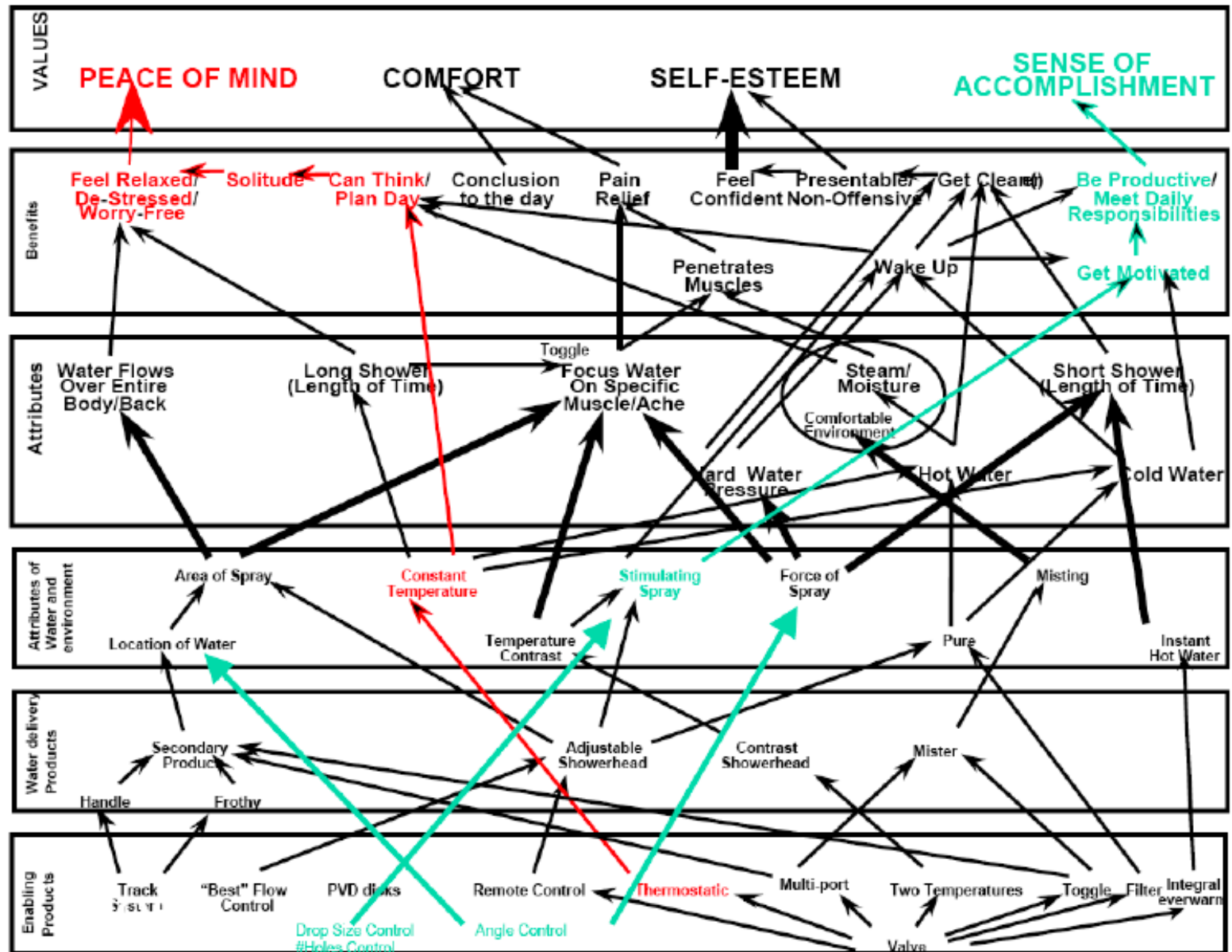



## Moen revolution shower head

To comply with US energy conservation standards, Moen could not simply change the force of the water stream.

Noting the range of preferences, designers first worked with engineers to "design the water" (droplet shape and size, frequency, distribution) and user interface well before the showerhead itself. The resulting mechanism takes ordinary water, spins each drop, and then twirls the entire stream; this shower environment envelops users with larger drops moving at higher velocities so that they increased movement of the water drops creates the perception of more water and higher pressure.

Designers avoided traditional radial dial controls around the showerhead as findings showed they are difficult to rotate with soapy hands and force users to reach into the water stream for adjustments. Instead, they chose to create a "clocking system" dial located below the shower stream, enabling the user to select a desired position visually via familiar clock settings that are easy to see and adjust with limited visibility and slippery hands.





**Neighbor to Neighbor**  
**ENERGY CHALLENGE**  
Small Changes. **BIG RESULTS.**

# The Workshop Exercises



The  
Questions

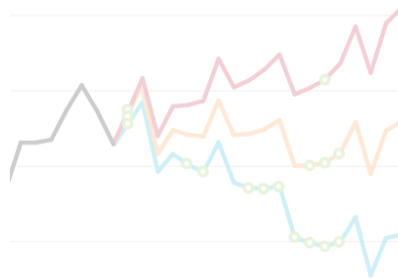

The  
Research



The  
Workshop





Neighbor to Neighbor  
**ENERGY CHALLENGE**  
Small Changes. **BIG RESULTS.**

# The Approach

1. Create the Research ?'s & Priorities (30 min)
2. Find the Voices in the Raw Data (30 min)
3. Sort (“Scrub”) the Raw Data (30 min)
4. Generalize the Data (30 min)
5. Categorize the Data (30 min)
6. Create the Output (30 min)
7. Code the Data (1 hour)



Neighbor to Neighbor  
**ENERGY CHALLENGE**  
Small Changes. **BIG RESULTS.**

# 1a. Create the Key Research Question(s)

- Select your Row
- Brainstorm on Key Research Question for your row:
  - What are the barriers to \_\_\_\_\_ ?
  - What are the weaknesses of \_\_\_\_\_ ?
  - What are the primary factors influencing \_\_\_\_\_ ?
  - What are the customer's greatest concerns regarding \_\_\_\_\_ ?



Neighbor to Neighbor  
**ENERGY CHALLENGE**  
Small Changes. **BIG RESULTS.**

# What's a good analysis topic?

→ fits the GUIDE acronym!

- **Generates** participants needs
- **Understand** participant's point of view
- **Identify** program approaches that need improvement
- **Describe** the participant's decision process
- **Explore** the participant's perceptions





Neighbor to Neighbor  
**ENERGY CHALLENGE**  
Small Changes. **BIG RESULTS.**

## 1b. Create the Top 3 Dimensions (S15 from Voices)

- Two to Three dimensions to serve as the basis for your research
- Make sure you have a clear, concise question for each dimension

# Today's Research Area

## *Behavioral Research*

- Goal: Better understand individual and social characteristics.
- Primary Research: Examine behavioral triggers, such as scripts, tabling interaction, rewards.
- Secondary Research: Understand the key factors driving the participants with the deepest reductions in energy usage and/or adoption of clean energy:
  - is it community group or town incentive,
  - is it personal relationship?
  - is it other intrinsic or social motivator that takes place in your script?
  - Etc.



Neighbor to Neighbor  
**ENERGY CHALLENGE**  
Small Changes. **BIG RESULTS.**

# Today's Research Area Continued

## *Behavioral Research*

- Goal: Identify the most effective (meaning achieving the broadest participation within a town):
  - community outreach strategies,
  - different dispersion/rollout strategies,
  - different demo/psychographic groups.
- Primary: Learn about persistence of behaviors, effectiveness of messaging type and timing, etc. defined by response rates, close rates, etc. Analyze:
  - Specific calls-to-action
  - Participation in the Challenge,
  - Willingness to provide utility account #, HES, CTCEO, and deeper retrofits w/ or w/out financing (i.e. HES follow-on measures).
- Secondary: Identify “typical” paths through the food chain, as well as trends that can be gleaned from those paths.
  - What are the best ways to get the indifferent and skeptics on board?



Neighbor to Neighbor  
**ENERGY CHALLENGE**  
Small Changes. **BIG RESULTS.**

## 2. Finding the Voices in the raw election data

- As a team: Open the Raw Data excel file and select two rows
- Two team members will Scrub each row

Highlight findings (“voices”) that identify:  
Issues,  
Needs,  
Problems,  
Concerns,  
Images,  
Solutions

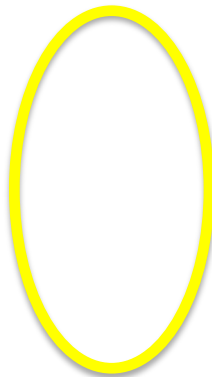
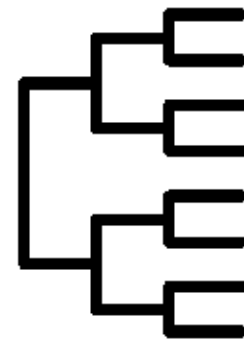



Neighbor to Neighbor  
**ENERGY CHALLENGE**  
Small Changes. **BIG RESULTS.**

## 2. Finding the Voices in the raw election data

- Individuals: Transcribe Exactly on Post It (or Type) each important statement. If it is a customer quote, put it in quotes.
  - Add brackets or ...
  - Print legibly
  - Code each note for Location in what Cell (Row, Column)

Highlight findings (“voices”) that identify:  
Issues, Needs, Problems, Concerns  
Images, Solutions

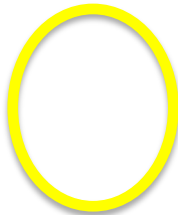
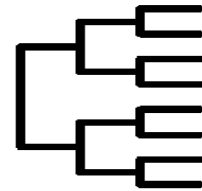



Neighbor to Neighbor  
**ENERGY CHALLENGE**  
Small Changes. **BIG RESULTS.**

## 2. Finding the Voices in the raw election data

- If completely filling the note, you may need multiple notes
- Can use different colored Post-It Notes for each key dimension
- It is best to sort statements one dimension at a time.

Highlight findings (“voices”) that identify:  
Issues, Needs, Problems, Concerns  
Images, Solutions

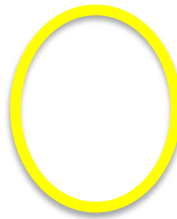
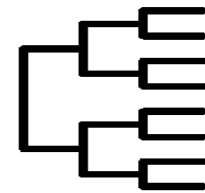



Neighbor to Neighbor  
**ENERGY CHALLENGE**  
Small Changes. **BIG RESULTS.**

### 3. Sorting the raw data

Start with...

Piles of Post-It Notes, with  
Participant Voices\*

Cleaned up notes (for  
reference)

End with...

10-15 scrubbed statements

Deeper group understanding  
of the participant's world

**\*A “voice” = “direct quote”**

Source: Prelec Lecture

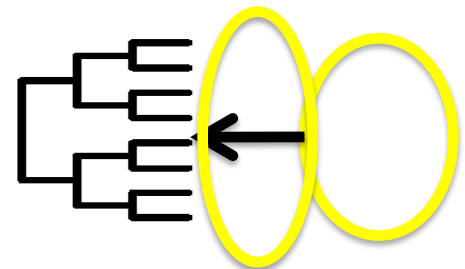



Neighbor to Neighbor  
**ENERGY CHALLENGE**  
Small Changes. **BIG RESULTS.**

## 3a. Sorting the raw data:

### Identifying the Strongest Characteristics

- Team member 1 reads a voice and puts it on the wall
- If someone else has a similar voice, they stack it on top of the first one
  - Otherwise, start a new pile
- When TM 1 has finished their pile, TM 2 begins with their voices

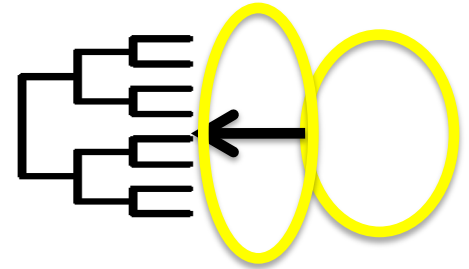





Neighbor to Neighbor  
**ENERGY CHALLENGE**  
Small Changes. **BIG RESULTS.**

## 3b. Sorting the raw data:

### Identifying the Strongest Characteristics

1. Physically line each pile up in a separate column
2. Each team member reads through all of the notes. Places a red dot on any Post It that seems important. (bottom right)
3. If more than 30 notes, go through the marketing process with a second red dot
4. If more than 15 notes, each team member picks up 4 notes
5. Final Check: Look over unselected notes to see if they add to the 360 degree view

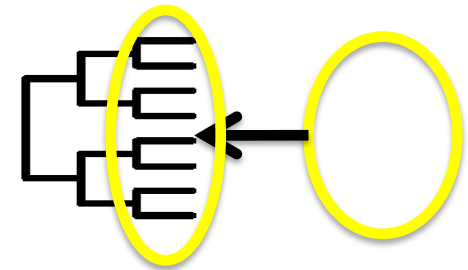



Neighbor to Neighbor  
**ENERGY CHALLENGE**  
Small Changes. **BIG RESULTS.**

## 4a. Generalizing the Data

### Turn Voices into Needs or Benefits

- Enter the key voices (narrowing down from one pile of Post-It Notes) in the excel spreadsheet (Tab 4a):
  - Pull out Key Items (Scratch Pad for key items)
  - Write a need or “requirement” statement in the bottom of the sheet (Scrubbed statement)
    - Identify a need that motivates the original voice
    - Avoid solutions
    - Be concrete and specific
    - Use multi-valued language
    - Use positive, action-oriented language

Original Statement - the Customer's Voice

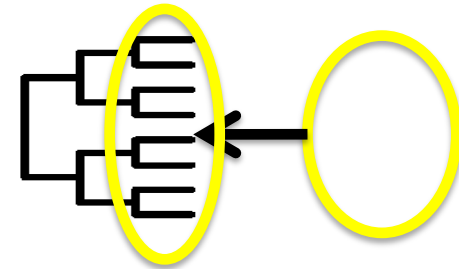

Scratchpad for Key Items

Scrubbed Statement (expressing an underlying benefit or need)



Neighbor to Neighbor  
**ENERGY CHALLENGE**  
Small Changes. **BIG RESULTS.**

## 4b. Generalizing the Data

### Turn Voices into Needs or Benefits

- Write a need or “requirement” statement in the bottom of the sheet (Scrubbed statement)
  - Identify a need that motivate the original voice
  - Avoid solutions
  - Be concrete and specific
  - Use multi-valued language
  - Use positive, action-oriented language

Original Statement – the Customer's Voice

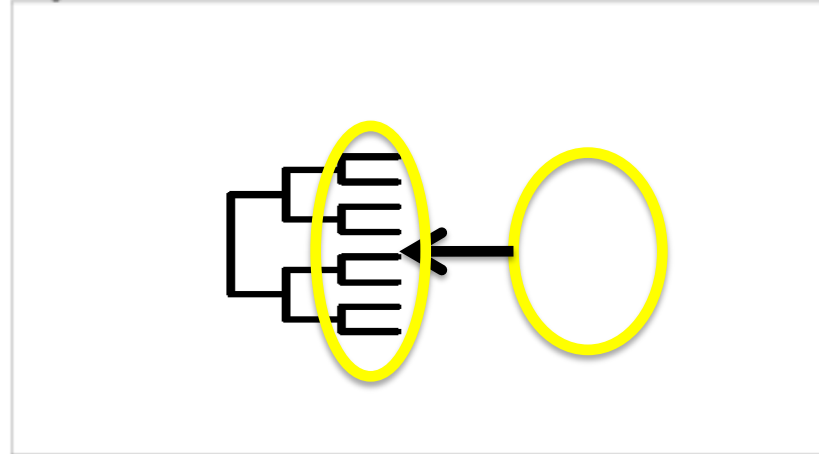

Scratchpad for Key Items

Blank scratchpad area for key items.

Scrubbed Statement (expressing an underlying benefit or need)

Blank area for the scrubbed statement, highlighted with a yellow border.



Neighbor to Neighbor  
**ENERGY CHALLENGE**  
Small Changes. **BIG RESULTS.**

## 5a. Categorizing the Data Create Level 1 Groupings

- Work as a team of 4
- Group the 15 statements into small clusters that reflect a common, yet fairly concrete, theme.
- Try to keep themes at a low level of abstraction, only one rung up from the Post Its
- Keep moving the notes around until you have 5-10 groups

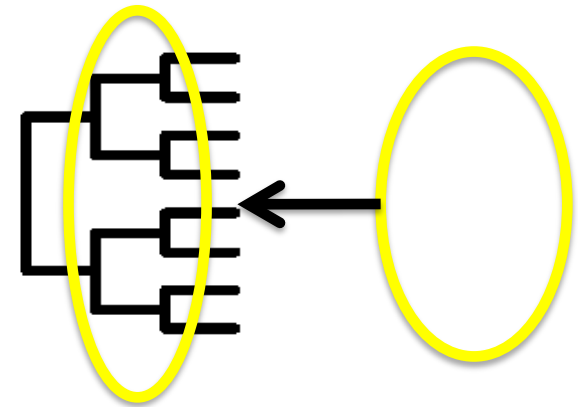



## 5a. Categorizing the Data Create Level 1 Groupings

- Begin by writing the key question in the upper left corner of two side by side flipchart pages
- Group the Post It notes into one, two, or three notes with common themes
- Do not group in cause and effect: i.e., this note caused that note
- Look for subtle distinctions between the groups
- Keep moving the notes around, can always move back
- Should end up with 3 to 5 level 1 groupings

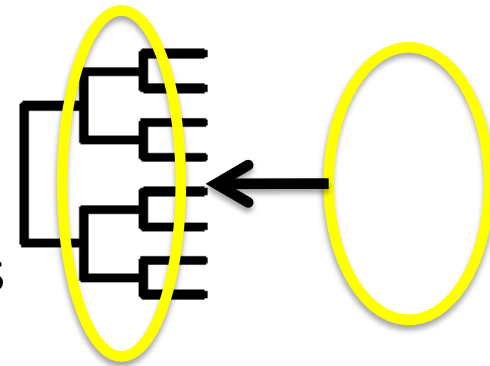



## 5b. Categorizing the Data Create Level 1 Titles

- Write a summary title sentence that captures the common theme in each group
- Titles should be fairly specific
- Start with key words or phrases that reflect what the statements have in common
- Use action verbs
- Print the title in a different color and place it at the top of your Level 1 Grouping
- One of the notes may work well as a title (draw a box around it)
- Check if all of your Post Its are in the right Level 1 Grouping

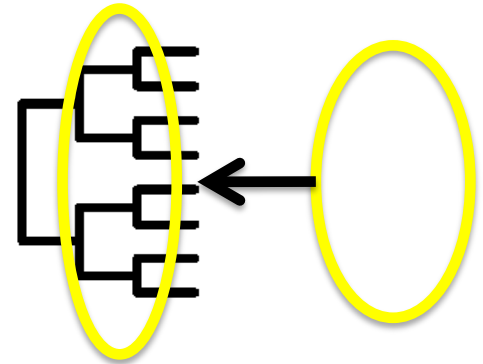



Neighbor to Neighbor  
**ENERGY CHALLENGE**  
Small Changes. **BIG RESULTS.**

## 5c. Categorizing the Data Create Level 2 Groupings

- Work as a team of 4
- Group the Level 1 titles (only) into common themes
- Try to keep themes one rung up from the Level 1 groupings (one, two, or three Level 1 titles per Level 2 group)
- Focus on the key questions
- Can move titles around into different Level 2 groups until comfortable with result (3 to 6 Level 2 groupings)

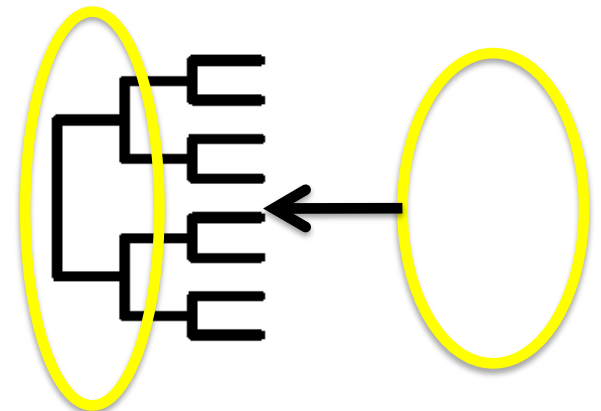

Source: Voices into Choices Textbook



Neighbor to Neighbor  
**ENERGY CHALLENGE**  
Small Changes. **BIG RESULTS.**

## 5d. Categorizing the Data Create Level 2 Titles

- Write a summary title sentence that captures the common theme in each grouping
- Titles should capture overall themes that will help you identify the big picture
- Start with key words or phrases that reflect what the Level 1 titles have in common
- Use action verbs
- Print the title in a different color and place it at the top of your Level 2 Groupings
- Check if all of your Level 1 titles are in the right Level 2 grouping
- Level 2 titles may remain alone

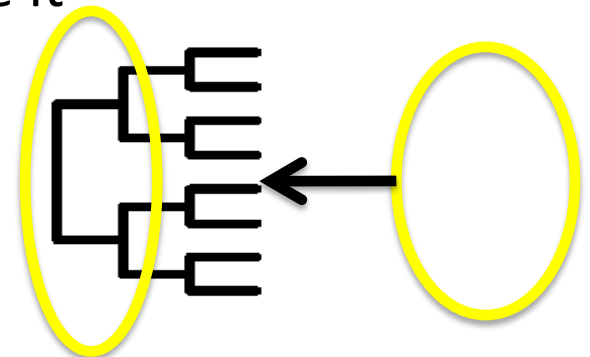

Source: Voices into Choices Textbook





# 5c. Layout Affinity Diagram

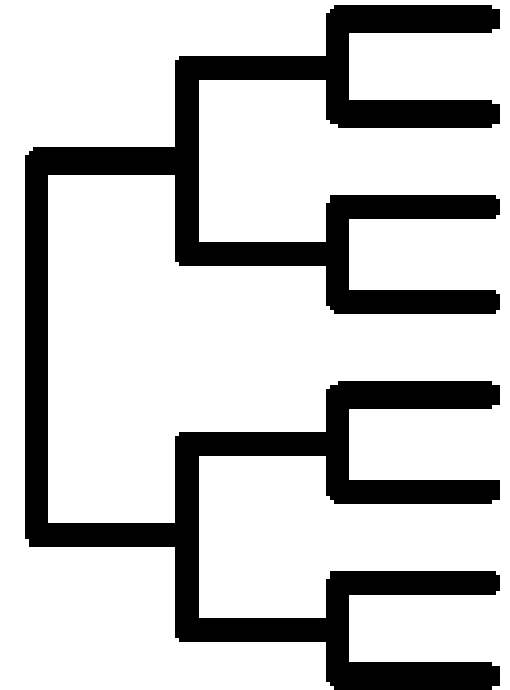
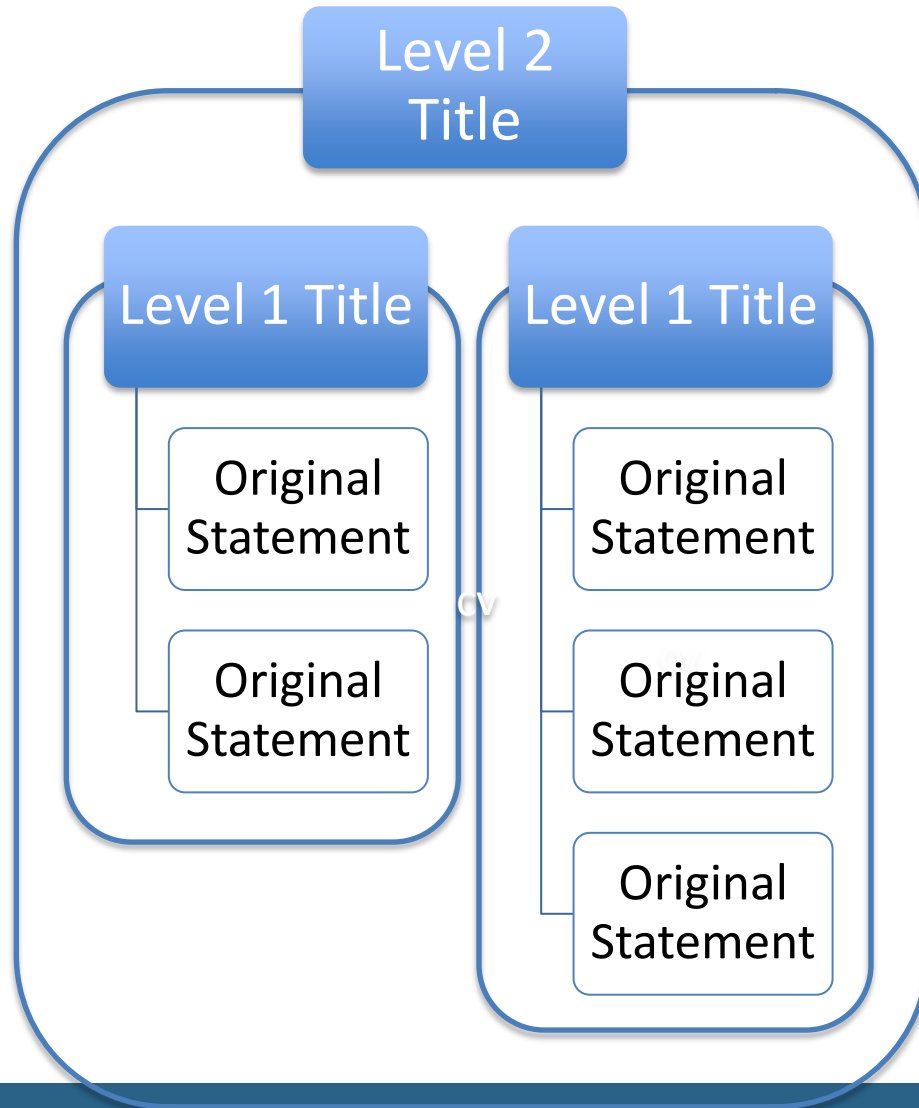



Neighbor to Neighbor  
**ENERGY CHALLENGE**  
Small Changes. **BIG RESULTS.**

## 6. Create the Output

- Brainstorm the Potential Output (in real-time)
- Some potential sections:
  - Affinity Diagram and Written Description
  - Brainstorm Ideas to help respond to the issues identified in the analysis and begin organizing them
  - Evaluation of Ideas and Recommended Actions
  - Develop an Action plan for Implementation



# 7. Coding the Data

- In your team, go back to your original row.
- Think about how you might categorize and code each cell
- Some potential sections:
  - Affinity Diagram and Written Description
  - Brainstorm Ideas to help respond to the issues identified in the analysis and begin organizing them
  - Evaluation of Ideas and Recommended Actions
  - Develop an Action plan for Implementation



Neighbor to Neighbor  
**ENERGY CHALLENGE**  
Small Changes. **BIG RESULTS.**

# Next Steps

- Fill this in at the workshop



Neighbor to Neighbor  
**ENERGY CHALLENGE**  
Small Changes. **BIG RESULTS.**

# Next Steps

- Fill this in at the workshop