



**Federal Energy Regulatory Commission
Office of Energy Projects**

January 2015

Gulf South Pipeline Company, LP

Docket No. CP15-517-000

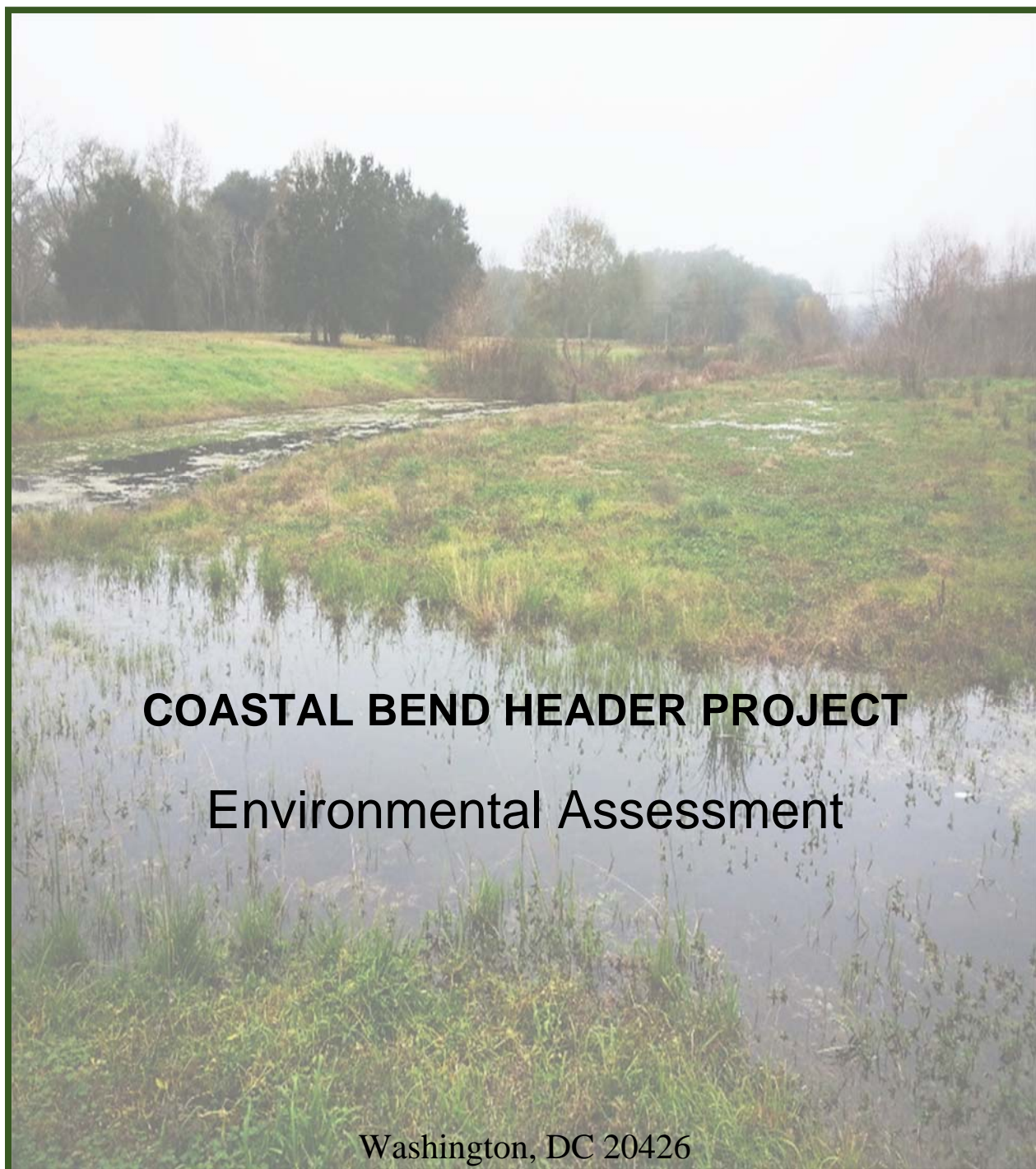

**COASTAL BEND HEADER PROJECT
Environmental Assessment**

Washington, DC 20426

FEDERAL ENERGY REGULATORY COMMISSION

WASHINGTON, D.C. 20426

OFFICE OF ENERGY PROJECTS

In Reply Refer To:
Gulf South Pipeline Company, LP
Coastal Bend Header Project
Docket No. CP15-517-000

TO THE PARTY ADDRESSED:

The staff of the Federal Energy Regulatory Commission (FERC or Commission) has prepared an environmental assessment (EA) for the Coastal Bend Header Project, proposed by Gulf South Pipeline Company, LP (Gulf South) in the above-referenced docket. Gulf South requests authorization to construct and operate certain natural gas pipeline facilities in various counties in Texas to expand the capacity of its pipeline system to 1.42 billion cubic feet per day to provide firm transportation service to the Freeport LNG Development, L.P. (Freeport LNG) terminal located on Quintana Island near Freeport, Texas.

The EA assesses the potential environmental effects of the construction and operation of the Coastal Bend Header Project in accordance with the requirements of the National Environmental Policy Act (NEPA). The FERC staff concludes that approval of the proposed project, with appropriate mitigating measures, would not constitute a major federal action significantly affecting the quality of the human environment.

The proposed Project includes the following facilities in Texas:

- install approximately 66-miles of new 36-inch-diameter pipeline lateral from Wharton County, Texas to the existing Freeport Liquefied Natural Gas Stratton Ridge meter site in Brazoria County;
- construct one new gas-fired 83,597 horsepower (hp) Wilson Compressor Station in Wharton County;
- construct one new electric motor-driven 26,400-hp Brazos Compressor Station in Fort Bend County;
- construct one new electric motor-driven 10,700-hp North Houston Compressor Station in Harris County;
- install piping modifications at the existing Goodrich Compressor Station in Polk County to allow for bi-directional flow; and
- install additional gas-fired 15,748-hp compressor unit and modifications at the former Magasco Compressor Station in Sabine County to allow for bi-directional flow.

The FERC staff mailed copies of the EA to federal, state, and local government representatives and agencies; elected officials; environmental and public interest groups; Native American tribes; potentially affected landowners and other interested individuals and groups; libraries in the project area; and parties to this proceeding. In addition, the EA is available for public viewing on the FERC's website (www.ferc.gov) using the eLibrary link. A limited number of copies of the EA are available for distribution and public inspection at:

Federal Energy Regulatory Commission
Public Reference Room
888 First Street NE, Room 2A
Washington, DC 20426
(202) 502-8371

Any person wishing to comment on the EA may do so. Your comments should focus on the potential environmental effects, reasonable alternatives, and measures to avoid or lessen environmental impacts. The more specific your comments, the more useful they will be. To ensure that the Commission has the opportunity to consider your comments prior to making its decision on this project, it is important that we receive your comments in Washington, DC on or before February 28, 2016.

For your convenience, there are three methods you can use to file your comments with the Commission. In all instances, please reference the project docket number (CP15-517-000) with your submission. The Commission encourages electronic filing of comments and has expert staff available to assist you at 202-502-8258 or efiling@ferc.gov.

- (1) You can file your comments electronically using the [eComment](#) feature located on the Commission's website (www.ferc.gov) under the link to [Documents and Filings](#). This is an easy method for submitting brief, text-only comments on a project;
- (2) You can also file your comments electronically using the [eFiling](#) feature on the Commission's website (www.ferc.gov) under the link to [Documents and Filings](#). With eFiling, you can provide comments in a variety of formats by attaching them as a file with your submission. New eFiling users must first create an account by clicking on "[eRegister](#)." You must select the type of filing you are making. If you are filing a comment on a particular project, please select "Comment on a Filing"; or
- (3) You can file a paper copy of your comments by mailing them to the following address:

Kimberly D. Bose, Secretary
Federal Energy Regulatory Commission
888 First Street NE, Room 1A
Washington, DC 20426

Any person seeking to become a party to the proceeding must file a motion to intervene pursuant to Rule 214 of the Commission's Rules of Practice and Procedures (18 CFR 385.214).¹ Only intervenors have the right to seek rehearing of the Commission's decision. The Commission grants affected landowners and others with environmental concerns intervenor status upon showing good cause by stating that they have a clear and direct interest in this proceeding which no other party can adequately represent. **Simply filing environmental comments will not give you intervenor status, but you do not need intervenor status to have your comments considered.**

Additional information about the project is available from the Commission's Office of External Affairs, at **(866) 208-FERC**, or on the FERC website (www.ferc.gov) using the eLibrary link. Click on the eLibrary link, click on "General Search," and enter the docket number excluding the last three digits in the Docket Number field (i.e., CP15-517). Be sure you have selected an appropriate date range. For assistance, please contact FERC Online Support at FercOnlineSupport@ferc.gov or toll free at (866) 208-3676, or for TTY, contact (202) 502-8659. The eLibrary link also provides access to the texts of formal documents issued by the Commission, such as orders, notices, and rulemakings.

In addition, the Commission offers a free service called eSubscription that allows you to keep track of all formal issuances and submittals in specific dockets. This can reduce the amount of time you spend researching proceedings by automatically providing you with notification of these filings, document summaries, and direct links to the documents. Go to www.ferc.gov/docs-filing/esubscription.asp.

¹ See the previous discussion on the methods for filing comments.

TABLE OF CONTENTS

Coastal Bend Header Project
Environmental Assessment

	<u>Page</u>
1.0 PROPOSED ACTION.....	1
1.1 Introduction	1
1.2 Purpose and Need	1
1.3 Public Review and Comments.....	1
1.4 Proposed Facilities.....	4
1.4.1 Pipeline Facilities	4
1.4.2 Aboveground and Appurtenant Facilities.....	9
1.5 Non-jurisdictional Facilities	10
1.6 Land Requirements.....	11
1.7 Construction Procedures.....	14
1.7.1 General Pipeline Construction Procedures	14
1.7.2 Special Pipeline Construction Procedures	16
1.7.3 Aboveground Facility Construction Procedures.....	20
1.8 Operation, Maintenance, and Safety Controls.....	21
1.9 Permits, Approvals, and Regulatory Consultations.....	22
2.0 ENVIRONMENTAL ANALYSIS.....	25
2.1 Geology and Soils.....	25
2.1.1 Geologic Setting and Impacts.....	25
2.1.2 Soil Setting and Impacts	29
2.2 Water Resources and Wetlands	37
2.2.1 Groundwater Resources.....	37
2.2.2 Surface Water Resources.....	41
2.2.3 Wetlands.....	47
2.3 Fish, Vegetation, and Wildlife.....	49
2.3.1 Fisheries Resources	49
2.3.2 Vegetation	52
2.3.3 Wildlife.....	60
2.3.4 Migratory Birds	62
2.3.5 Protected, Threatened, and Endangered Species	64
2.4 Cultural Resources.....	68
2.4.1 Consultation.....	68
2.4.2 Overview and Inventory Results	70
2.4.3 NRHP Unanticipated Discovery Plan	71
2.4.4 Compliance with NHPA.....	71
2.5 Land Use, Recreation, and Aesthetics	72
2.5.1 Land Use.....	72
2.5.2 General Impacts on Existing Land Uses.....	75
2.5.3 Residential Areas and Planned Developments	78
2.5.4 Public Land, Recreation, and Other Designated Areas	82
2.5.5 Coastal Zone Management Areas.....	84
2.5.6 Contaminated Sites.....	84

2.5.7	Visual Resources	84
2.6	Socioeconomics.....	87
2.6.1	Existing Socioeconomic Conditions.....	87
2.6.2	Socioeconomic Impacts.....	88
2.6.3	Environmental Justice	90
2.7	Air Quality.....	91
2.7.1	Regulatory Status	91
2.7.2	Impacts and Mitigation.....	101
2.8	Noise.....	107
2.8.1	Applicable Noise Regulations	107
2.8.2	Noise Sensitive Areas and Ambient Sound Levels	108
2.8.3	Noise Impacts	111
2.9	Reliability and Safety	116
2.9.1	Safety Standards	117
2.9.2	Pipeline Accident Data.....	121
2.9.3	Impacts on Public Safety	123
2.10	Cumulative Impacts.....	125
2.10.1	Cumulative Impact Analysis Area.....	126
2.10.2	Past, Present, and Reasonably Foreseeable Projects	126
2.10.3	Resource-Specific Cumulative Impacts.....	133
2.10.4	Conclusions on Cumulative Impacts	143
3.0	ALTERNATIVES	145
3.1	No-Action Alternative.....	145
3.2	System Alternatives.....	145
3.3	Route Alternatives	146
3.4	Route Variations.....	149
3.5	Aboveground Facility Alternatives	154
4.0	CONCLUSIONS AND RECOMMENDATIONS.....	157
5.0	REFERENCES.....	163
6.0	LIST OF PREPARERS.....	173

LIST OF APPENDICES

Appendix A: Topographic Maps of Pipeline Route and Aboveground Facilities
Appendix B: Construction Typicals
Appendix C: Non-jurisdictional Facility Maps
Appendix D: Plan for Containment of Inadvertent Release of Drilling Mud during Horizontal Direction Drilled Wetland and Waterbody Crossings
Appendix E: Waterbody Crossings
Appendix F: Plan and Profile for Horizontal Directional Drill Crossings
Appendix G: Site-specific Exceptions to the FERC Procedures
Appendix H: Revegetation Plan
Appendix I: Wetlands Affected by the Coastal Bend Header Project
Appendix J: Exotic and Invasive Species Control Plan
Appendix K: Plan for the Unanticipated Discovery of Historic Properties and Human Remains during Construction

Appendix L: Temporary and Permanent Access Roads for the Coastal Bend Header Project

Appendix M: Summary of Land Use Impacts (acres)

Appendix N: Residential Construction Implementation Plan

Appendix O: Site-specific Residential Crossing Drawings

Appendix P: Fugitive Dust Control Plan

Appendix Q: Aboveground Facility Alternatives Maps

LIST OF TABLES

Table 1.3-1	Issues Identified in Comments on the Coastal Bend Header Project	3
Table 1.4-1	Summary of Project Facilities	5
Table 1.4-2	Location of Co-located Pipeline and Non-Jurisdictional Power Line Facilities.....	6
Table 1.5-1	Non-jurisdictional Facilities Required by the Project	11
Table 1.6-1	Summary of Land Requirements for the Project	13
Table 1.7-1	Proposed Locations of Horizontal Directional Drill Operations	18
Table 1.7-2	Estimated Peak Construction Employment by Compressor Station.....	21
Table 1.9-1	Federal and State Permits and Approvals.....	23
Table 2.1-1	Mineral Resource Extraction Sites Located Within the Project Workspace	27
Table 2.1-2	Characteristics of Soils Crossed by the Proposed 36-Inch Header Pipeline (in miles)	30
Table 2.1-3	Characteristics of Soils Underlying Proposed Aboveground Facilities (in acres).....	31
Table 2.2-1	Source Water Protection Areas within One Mile of the Project Workspace.....	38
Table 2.2-2	Water Wells within 150 feet of the Project Workspace.....	39
Table 2.2-3	303(d) Listed Impaired Surface Waterbodies Crossing the 36-Inch Header Pipeline.....	42
Table 2.2-4	Proposed Hydrostatic Test Water Source and Discharge Locations for Pipeline Facilities.....	43
Table 2.2-5	Proposed Volumes of Water for Horizontal Directional Drill Operations	43
Table 2.2-6	Characteristic Wetland Plant Species in the Project Area	47
Table 2.2-7	Wetlands Affected by the 36-inch Header Pipeline	49
Table 2.3-1	Characteristic Land Use and Plant Species of the Major Vegetation Cover Types in the Project Area	53
Table 2.3-2	Construction and Operation Impacts on Vegetation Cover Types (Acres)	56
Table 2.3-3	Common Wildlife Species in the Project Area.....	60
Table 2.3-4	Birds of Conservation Concern within Bird Conservation Region 37	63
Table 2.3-5	Federally Listed Species in the Project Counties	65
Table 2.5-1	Summary of Proposed Contractor/Pipe Yards for the Project.....	73
Table 2.5-2	Structures Occurring within 50 feet of the Construction Right-of-Way	81
Table 2.6-1	Select Social and Economic Characteristics of the Study Area.....	87
Table 2.6-2	Minority Presence and Poverty in the Study Area.....	90
Table 2.7-1	National Ambient Air Quality Standards	92
Table 2.7-2	Measured Ambient Concentrations of Criteria Pollutants in the Region	95
Table 2.7-3	Comparison of Emissions for the Project to General Conformity Thresholds	100
Table 2.7-4	Summary of Potential Construction Emissions from the Project (tons).....	102
Table 2.7-5	Summary of Potential Operational Emissions from the Project (tons per year).....	103
Table 2.7-6	Potential Emission Rates Associated with the Wilson Compressor Station.....	104

Table 2.7-7 Emissions Associated with Proposed Meter and Regulator Stations	105
Table 2.7-8 Summary of Emissions from Pipeline Operations.....	105
Table 2.7-9 Modeled and Background 1-Hour NO ₂ Concentration Comparison to NAAQS.....	107
Table 2.8-1 Ambient Sound Levels Near Compressor Sites.....	109
Table 2.8-2 Ambient Sound Levels Near Meter and Regulator Stations.....	110
Table 2.8-3 Ambient Sound Levels Near HDD Entry and Exit Points.....	111
Table 2.8-4 Noise Levels of Major Construction Equipment	112
Table 2.8-5 Ambient Sound Levels Near HDD Entry and Exit Points.....	114
Table 2.8-6 Operational Noise Levels Near Compressor Sites.....	115
Table 2.8-7 Ambient Sound Levels and Operational Sound Levels Near Meter and Regulator Stations	116
Table 2.9-1 U.S. Department of Transportation Minimum Depth of Cover Standards	119
Table 2.9-2 High Consequence Areas Crossed by the Project.....	120
Table 2.9-3 Class Locations Crossed by the Project.....	120
Table 2.9-4 Natural Gas Transmission Pipeline Significant Incidents by Cause, 1994-2013 ¹	122
Table 2.9-5 Outside Forces Incidents by Cause, 1994-2013 ¹	123
Table 2.9-6 Injuries and Fatalities - Natural Gas Transmission Pipelines	124
Table 2.9-7 Nationwide Accidental Deaths ¹	125
Table 2.10-1 Cumulative Impact Analysis Areas and Rationale	126
Table 2.10-2 Projects Potentially Contributing to Cumulative Impacts	128
Table 2.10-3 Cumulative Projects Evaluated by Resource.....	134
Table 3.3-1 Pipeline Route Alternative Comparison for the Coastal Bend Header Project	148
Table 3.4-1 Quantitative Comparison of Proposed Route and Southern Alternative B Route	153
Table 3.4-2 Quantitative Comparison of Proposed Route and Deviation 14A	154

LIST OF FIGURES

Figure 1.4-1 Project Overview Map	7
Figure 1.4-2 Proposed 36-inch Pipeline Map	8
Figure 2.10-1 Cumulative Projects	130
Figure 3.3-1 Alternatives and Variations.....	147
Figure 3.4-1 Southern Alternative B Route	151
Figure 3.4-2 Deviation 14A	152

ACRONYMS AND ABBREVIATIONS

2-EH	2-Ethylhexanol
ACT	Alabama-Coushatta Tribe of Texas
APE	area of potential effects
API	American Petroleum Institute
ATWS	additional temporary workspace
BCC	Birds of Conservation Concern
BCR	Bird Conservation Region
BMP	best management practice
BSFC	brake-specific fuel consumption values
CAA	Clean Air Act
Certificate	Certificate of Public Convenience and Necessity
CFR	Code of Federal Regulations
CH ₄	methane
CO	carbon monoxide
CO ₂	carbon dioxide
CO ₂ e	carbon dioxide-equivalent
Commission	Federal Energy Regulatory Commission
CWA	Clean Water Act
dB	decibel
dBA	decibel on the A-weighted scale
DOT	U.S. Department of Transportation
DOW	DOW Chemical Company
EA	environmental assessment
ECD	erosion control device
EI	Environmental Inspector
EPA	U.S. Environmental Protection Agency
ESA	Endangered Species Act
ESSS	Ecologically Significant Stream Segment
FDCP	Fugitive Dust Control Plan
FEMA	Federal Emergency Management Agency
FERC	Federal Energy Regulatory Commission
Freeport LNG	Freeport LNG Development, L.P.
GCRA	Global Change Research Act
GHG	greenhouse gas
Gulf South	Gulf South Pipeline Company, LP
GWP	Global Warming Potential
HAP	hazardous air pollutant
HCA	high consequence area
HDD	horizontal directional drill
hp	horsepower
HPL	Houston Pipeline Co.
IPCC	Intergovernmental Panel on Climate Change
kV	kilovolt
L _{dn}	day-night average sound level
LED	light-emitting diode
L _{eq}	A-weighted equivalent sound level
LHC-9	Light Hydrocarbon 9
M&R	meter and regulator

MACT	Maximum Achievable Control Technology
MBTA	Migratory Bird Treaty Act
MLV	mainline valve
MMBtu/hr	million British Thermal Units per hour
MP	milepost
mph	miles per hour
N ₂ O	nitrous oxide
NAAQS	National Ambient Air Quality Standards
NEPA	National Environmental Policy Act
NESHAP	National Emission Standards for Hazardous Air Pollutants
NGA	Natural Gas Act
NGPL	Natural Gas Pipeline Company, LLC
NHPA	National Historic Preservation Act
NO ₂	nitrogen dioxide
NOI	<i>Notice of Intent to Prepare an Environmental Assessment for the Planned Coastal Bend Header Project and Request for Comments on Environmental Issues</i>
NO _x	nitrogen oxide
NPS	National Park Service
NRCS	National Resources Conservation Service
NRHP	National Register of Historic Places
NSA	noise-sensitive area
NSPS	New Source Performance Standards
NSR	New Source Review
NWI	National Wetlands Inventory
NWR	National Wildlife Refuge
OEP	Office of Energy Projects
O ₂	oxygen
PBR	Permit by Rule
PEM	palustrine emergent
PFO	palustrine forested
PHMSA	Pipeline and Hazardous Material Safety Administration
Plan	<i>Upland Erosion Control, Revegetation, and Maintenance Plan</i>
PM ₁₀	particulate matter sized 10 microns or smaller
PM _{2.5}	particulate matter sized 2.5 microns or smaller
ppb	parts per billion
ppm	parts per million
Procedures	<i>Wetland and Waterbody Construction and Mitigation Procedures</i>
Project	Coastal Bend Header Project
PSD	Prevention of Significant Deterioration
PSS	palustrine scrub shrub
PTE	potential to emit
RRC	Railroad Commission of Texas
RV	recreational vehicle
SHPO	State Historic Preservation Officer
SIP	State Implementation Plan
SO ₂	sulfur dioxide
SPCC	Spill Prevention, Control, and Countermeasure Plan
SSA	sole-source aquifer
SWPA	source water protection area
SWPPP	Stormwater Pollution Prevention Plan
TAC	Texas Administrative Code

TCEQ	Texas Commission on Environmental Quality
TGPL	Tennessee Gas Pipeline Co. LLC
THC	Texas Historical Commission
TPWD	Texas Parks and Wildlife Department
tpy	tons per year
TSA	Transportation Security Administration
TWDB	Texas Water Development Board
USACE	U.S. Army Corps of Engineers
USCB	U.S. Census Bureau
USDA	U.S. Department of Agriculture
USGS	U.S. Geological Survey
USFWS	U.S. Fish and Wildlife Service
USGCRP	U.S. Global Change Research Program
VAC	volt alternating current
VOC	volatile organic compound
WRP	Wetland Reserve Program
$\mu\text{g}/\text{m}^3$	micrograms per cubic meter

This page intentionally left blank.

1.0 PROPOSED ACTION

1.1 INTRODUCTION

The staff of the Federal Energy Regulatory Commission (Commission or FERC) has prepared this environmental assessment (EA) to assess the environmental effects of the natural gas pipeline facilities proposed by Gulf South Pipeline Company, LP (Gulf South). We¹ prepared this EA in compliance with the requirements of the National Environmental Policy Act of 1969 (NEPA), Title 40 of the Code of Federal Regulations, Parts 1500-1508 [40 CFR 1500-1508], and with the Commission's implementing regulations under 18 CFR 380.

On June 12, 2015 Gulf South filed an application with the Commission pursuant to Section 7(c) of the Natural Gas Act (NGA), and Section 157.5 of the Commission's Regulations for a Certification of Public Convenience and Necessity (Certificate) authorizing the construction and operation of approximately 66 miles of new 36-inch-diameter pipeline, one new gas-fired compressor station, seven meter and regulator (M&R) interconnects and appurtenant facilities, and two electric motor-driven compressor stations. Gulf South would also modify piping at one existing compressor station and add a new gas-fired compressor unit to another existing station to increase capacity on Gulf South's existing Index 129 Legacy System (herein referred to as the Legacy System facilities). The proposed Project is referred to as the Coastal Bend Header Project (Project).

The EA is an important and integral part of the Commission's decision on whether to issue Gulf South a Certificate to construct and operate the proposed facilities. Our principal reasons in preparing this EA are to:

- Identify and assess potential impacts on the natural and human environment that could result from implementation of the proposed action;
- Identify and recommend reasonable alternatives and specific mitigation measures, as necessary, to avoid or minimize project-related environmental impact; and
- Facilitate public involvement in the environmental review process.

1.2 PURPOSE AND NEED

Gulf South states that the purpose of the Project is to expand the capacity of its pipeline system to 1.42 billion cubic feet per day to provide firm transportation service to the Freeport LNG Development, L.P. (Freeport LNG) terminal located on Quintana Island near Freeport, Texas (in Brazoria County).

Under Section 7(c) of the NGA, the Commission determines whether interstate natural gas transportation facilities are in the public convenience and necessity and, if so, grants a Certificate to construct and operate them. The Commission bases its decisions on technical competence, financing, rates, market demand, gas supply, environmental impact, long-term feasibility, and other issues concerning a proposed project.

1.3 PUBLIC REVIEW AND COMMENTS

On October 30, 2014, Gulf South filed a request to use the Commission's pre-filing process, and it was approved on November 5, 2014. The Project received a pre-filing docket number (PF15-4-000) to place information relevant to the Project into the public record. The pre-filing process was designed to allow stakeholders, including the public, to have input into a proposed natural gas transmission project

¹ "We," "us," and "our" refer to the environmental staff of the Office of Energy Projects.

Proposed Action

before an application was filed with the Commission. Gulf South began its public outreach activities in September 2014 as part of a comprehensive stakeholder outreach strategy in order to identify and resolve potential issues by stakeholders in a timely fashion. In September 2014, Gulf South began communicating with public and elected officials about the proposed Project, and facilitated stakeholder involvement through informal meetings, one-on-one discussions, written materials, and other means of communication.

As part of the pre-filing process, Gulf South hosted three public open houses and mailed Project information to potentially affected landowners. Two public open houses were held on January 20 and 22, 2015 in proximity to the proposed pipeline corridor and new gas-fired compressor station, and a third open house was held on February 19, 2015 in proximity to a new electric-powered compressor station in Harris County. The public open houses provided an opportunity for Gulf South to explain the Project to the public and provide an overview of the public involvement opportunities and environmental review process pursuant to FERC guidelines. FERC staff attended the public open houses and provided information about participating in the Commission's environmental proceedings. Input received during the open houses was considered by Gulf South for its Project development and subsequent filing of its formal Application with FERC in June 2015.

On March 4, 2015, during the pre-filing process, FERC issued a *Notice of Intent to Prepare an Environmental Assessment for the Planned Coastal Bend Header Project and Request for Comments on Environmental Issues* (NOI). The NOI included a 30-day comment period and instructed parties on how to comment on the planned Project, and was mailed to federal, state, and local government representatives and agencies; elected officials; Native American tribes; potentially affected landowners and other interested individuals and groups; and libraries in the Project area. As a result of modifications to some of the planned pipeline alignments, FERC issued a supplemental NOI that included a 30-day comment period on May 20, 2015 inviting newly affected landowners to comment on the Project. FERC received eight comments in response to the NOI and the supplemental NOI. In addition to comments from the public, written comments were received from two federal and two state agencies: U.S. Army Corps of Engineers (USACE), U.S. Fish and Wildlife Service (USFWS), Texas Parks and Wildlife Department (TPWD), and Texas Historical Commission.

During the pre-filing process, Gulf South incorporated a total of 22 route variations to address site-specific concerns, including issues raised by landowners, sensitive resources, and constructability issues. As a result, Gulf South was able to minimize impacts on protected resources, as well as on farming operations and residential development while designing the proposed pipeline alignment. The 22 route variations improved the proposed pipeline and were incorporated into the proposed route as part of their application.

Table 1.3-1 summarizes the environmental issues identified through the scoping process and during pre-filing. Substantive environmental issues raised by commenters are addressed in applicable sections of the EA.

In its comments filed on the NOI, the Sierra Club raised the issue of the Project's need relative to natural gas extraction, abundance of supply, demands downstream, including in other countries, and related impacts. The scope of this EA discusses the environmental impacts of constructing and operating the Coastal Bend Header facilities, under the NGA and NEPA review requirements, relating to only natural gas facilities that are involved in interstate commerce. Thus the facilities associated with the production or extraction of natural gas are not under FERC's jurisdiction. Because potential downstream users, beyond the volumes of gas being proposed to serve the Freeport LNG terminal cannot be identified at this time, it is not possible to consider impacts of end use beyond the terminal; however we considered the cumulative impacts of the existing and future approved facilities at the Freeport LNG terminal in section 2.10. Further, the impacts of end use in foreign, likely non-adjacent, countries is beyond the scope of a project.

Table 1.3-1 Issues Identified in Comments on the Coastal Bend Header Project	
Issue/Summary of Comment	EA Section Addressing Comment
Proposed Action – Concerns about purpose and need, land requirements for proposed action, co-locating pipeline alongside existing pipelines, restoration of right-of-way, hydrostatic testing procedures, inspection and maintenance of facilities on right-of-way land, and need for an environmental impact statement instead of an EA.	1.0
Geology and Soils – Impacts on topsoil and potential to impact agricultural operations and soils.	2.1
Water Resources and Wetlands – Impacts on wetlands, impacts on surface waters from waterbody crossings, impacts on wetland habitats, and impacts on well water.	2.2
Fish, Wildlife, and Vegetation – Impacts on wildlife species, threatened and endangered species, and state candidate and listed species; impacts on sensitive habitat (Columbia Bottomlands, woodland forests, wildlife refuges); impacts on migratory birds, loss of forests and old growth trees, undisturbed lands, and vegetation; invasive species.	2.3
Cultural Resources – Impacts on culturally significant and historical areas; impacts on tribal lands.	2.4
Land Use, and Aesthetics – Impacts on farming operations (including impacts on drainage), ranching, recreation, future land use, and visual impacts.	2.5
Socioeconomics – Impacts on farming operations and loss of crop yields; creation of temporary jobs; concerns about exporting a local resource and property values.	2.6
Air Quality – Impacts from greenhouse gas emissions; climate change impacts; public health concerns from air pollution.	2.7
Noise – Short-term impacts during construction; long-term noise impacts from compressor stations.	2.8
Reliability and Safety – Potential damage to existing pipelines.	2.9
Route Alternatives and Variations – Concerns over locations of pipeline variations with respect to landowner interests and changes in proposed routes.	3.0

The Commission will also consider non-environmental issues, including project need, in its review of Gulf South's application. A Certificate will be granted if the facilities and service, environmental impacts, long-term feasibility and other issues demonstrate that the Project is required by the Public Convenience and Necessity. Assessing environmental impacts and mitigation development are important factors in the overall public interest determination.

The Sierra Club also requested that an environmental impact statement, rather than an EA be prepared for this proposal. The Commission's regulations under 18 CFR 306(b) state that "if the Commission believes that a proposed action...may not be a major federal action significantly affecting the quality of the human environment, an EA, rather than an environmental impact statement, will be prepared first. Depending on the outcome of the EA, an environmental impact statement may or may not be prepared." In preparing this EA, we are fulfilling our obligation under NEPA to consider and disclose the environmental impacts of the Project. As noted above, this EA addresses the impacts that occur on a wide range of resources should the Project be approved and constructed. Based on our analysis, the extent and content of comments received during the scoping period, and considering that portions of the Project components would be collocated with existing facilities, we conclude that the impacts associated with this Project can be sufficiently mitigated to support a finding of no significant impact, and thus, an EA is warranted.

Proposed Action

1.4 PROPOSED FACILITIES

The Project, summarized below and in table 1.4-1, consists of the following facilities:

- approximately 66 miles of new 36-inch-diameter natural gas pipeline in Wharton and Brazoria counties;
- one new gas-fired compressor station (Wilson Compressor Station) in Wharton County;
- seven M&R interconnects and appurtenant facilities in Wharton and Brazoria Counties;
- two new electric motor-driven compressor stations (Brazos Compressor Station and North Houston Compressor Station) in Fort Bend and Harris Counties;
- piping modifications at Gulf South's existing Goodrich Compressor Station in Polk County; and
- a new gas-fired compressor unit and piping modifications at the site of Gulf South's previously abandoned Magasco Compressor Station in Sabine County.

The locations of the Project facilities are shown on figure 1.4-1 and figure 1.4-2. All of the proposed facilities would be owned and operated by Gulf South. Gulf South plans to start construction (subject to Commission approval) in the fourth quarter of 2016 at the compressor stations and the first quarter of 2017 for the pipeline, with a projected in-service date of April 2018.

1.4.1 Pipeline Facilities

The new header pipeline would commence at a new interconnect with Tennessee Gas Pipeline Company, LLC (TGPL) northwest of Hungerford in Wharton County and would terminate in Brazoria County at the existing Freeport LNG Stratton Ridge meter site near Clute, for delivery to the Freeport LNG terminal. Refer to appendix A for topographic maps of the pipeline route. Approximately 36 percent (23.65 miles) of the proposed header pipeline would be co-located adjacent to existing pipeline and power line rights-of-way or roadways. Areas where the pipeline is not proposed to be co-located with existing rights-of-way were primarily due to constructability issues (e.g., crossing of streams, wetlands, or areas with land use constraints). Efforts were also made to minimize impacts on protected resources and residential developments. Table 1.4-2 summarizes the location of co-located pipeline facilities and associated non-jurisdictional facilities. Non-jurisdictional facilities are further discussed below in section 1.5.

Contractor/Pipe Yards

During construction of the pipeline, the contractor would require ATWS outside the proposed construction right-of-way for the storage of pipe and equipment necessary for the construction of the Project facilities. The contractor/pipe yards would be located at various points along the length of the header pipeline alignment with convenient and safe access to the Project workspace. Gulf South primarily selected locations that had been previously disturbed by human activity but do not have an ongoing land use that would preclude use for the duration of the construction phase. Six contractor/pipe yards are proposed totaling approximately 77.2 acres (Gulf South, June 2015a). Two of the six pipe yards, (pipe yards 1 and 6) are vegetated with grasses and contain some trees; the remaining pipe yards selected are already graded and cleared. All areas used for contractor/pipe yards would be restored to pre-construction conditions after the Project is completed, unless otherwise agreed upon with the landowner and submitted to FERC for review and approval.

Table 1.4-1 Summary of Project Facilities			
Facility	County	Milepost Locations	Description
Pipeline Facilities			
36-inch Header Pipeline	Wharton	0.00–27.73	Install approximately 66 miles of new 36-inch-diameter pipeline.
	Brazoria	27.73–65.61	
Aboveground Facilities			
Wilson Compressor Station	Wharton	20.66	Install a new gas-fired compressor station facility with approximately 83,597 horsepower (hp).
TGPL ^a M&R Station	Wharton	0.00	Install M&R station interconnect at intersection of header pipeline and existing TGPL pipeline.
Transco M&R Station	Wharton	4.72	Install M&R station interconnect at intersection of header pipeline and existing Transco pipeline.
NGPL ^b M&R Station	Wharton	6.36	Install M&R station interconnect at intersection of header pipeline and existing NGPL pipeline.
Gulf South Index 129 M&R Station	Wharton	16.12	Install M&R station interconnect at intersection of header pipeline and the Legacy System facilities.
HPL ^c -Energy Transfer M&R Station	Wharton	17.64	Install M&R station interconnect at intersection of header pipeline and existing HPL-Energy Transfer pipeline.
Enterprise M&R Station	Wharton	20.66	Install M&R station interconnect at intersection of header pipeline and the existing Enterprise pipeline within the Wilson Compressor Station.
Stratton Ridge M&R Station	Brazoria	65.61	Install M&R station interconnect at terminus of header pipeline at the Freeport LNG Stratton Ridge meter site.
Mainline Valves and Other Ancillary Facilities	Wharton	0.00; 11.61; 16.12; 20.66	Install four new mainline valve assemblies along the new 36-inch-diameter header pipeline. Install two pig launchers and two pig receivers along the new 36-inch-diameter header pipeline. A pig launcher and receiver would also be installed at the Gulf South Index 129 M&R Station to facilitate inspection of the Legacy System facilities.
	Brazoria	36.22; 51.16; 58.95; 65.61	
Legacy System Facilities (Index 129)			
Brazos Compressor Station	Fort Bend	127.30 ^d	Install a new electric motor-driven compressor station facility with approximately 26,400 hp. A pig launcher and receiver would also be installed at the Brazos Compressor Station to facilitate inspection of the Legacy System facilities.
North Houston Compressor Station	Harris	169.10 ^d	A new electric motor-driven compressor station facility with approximately 10,700 hp.
Goodrich Compressor Station ^e	Polk	220.00 ^d	Piping modifications at existing compressor station to allow for station flow reversal.
Magasco Compressor Station ^e	Sabine	293.80 ^d	Piping modifications at former compressor station to allow for station flow reversal and install one gas-fired compressor unit with approximately 15,748 hp.
^a TGPL = Tennessee Gas Pipeline Co. LLC ^b NGPL = Natural Gas Pipeline Co. LLC ^c HPL = Houston Pipeline Co. ^d Milepost is associated with Index 129. ^e Project activities would occur within the property boundary of existing and former aboveground facilities owned by Gulf South.			

Proposed Action

**Table 1.4-2
Location of Co-located Pipeline and Non-Jurisdictional Power Line Facilities**

Company	Right-of-Way Type	Begin Milepost	End Milepost	Length (miles)
Energy Transfer	Pipeline	0.00	3.53	3.53
Enterprise	Pipeline	10.28	10.74	0.46
Enterprise	Pipeline	11.05	11.62	0.57
Enterprise	Pipeline	12.67	13.40	0.73
Kinder Morgan	Pipeline	13.40	13.59	0.19
Enterprise	Pipeline	13.59	14.95	1.36
Enterprise	Pipeline	15.50	15.92	0.42
Enterprise	Pipeline	16.77	20.82	4.05
Enterprise	Pipeline	20.94	21.45	0.51
CenterPoint	Power line	24.82	25.24	0.42
Gulfmark	Pipeline	25.24	25.43	0.19
Energy Transfer	Pipeline	25.75	25.85	0.10
Enterprise	Pipeline	34.50	35.30	0.80
Kinder Morgan	Pipeline	41.55	43.41	1.86
Seadrift	Pipeline	43.41	45.08	1.67
Seadrift	Pipeline	50.78	51.65	0.87
Seadrift	Pipeline	52.29	53.09	0.80
Seadrift	Pipeline	56.37	56.59	0.22
Seadrift	Pipeline	58.34	58.65	0.31
CenterPoint	Power line	59.16	63.75	4.59
Total Co-location				23.65
CenterPoint = CenterPoint Energy Energy Transfer = Energy Transfer Partners, LP Enterprise = Enterprise Products Partners, LP Gulfmark = Gulfmark Energy, Inc. Kinder Morgan = Kinder Morgan, Inc. Seadrift = Seadrift Pipeline Corporation				

**Figure 1.4-1
Project Overview Map**

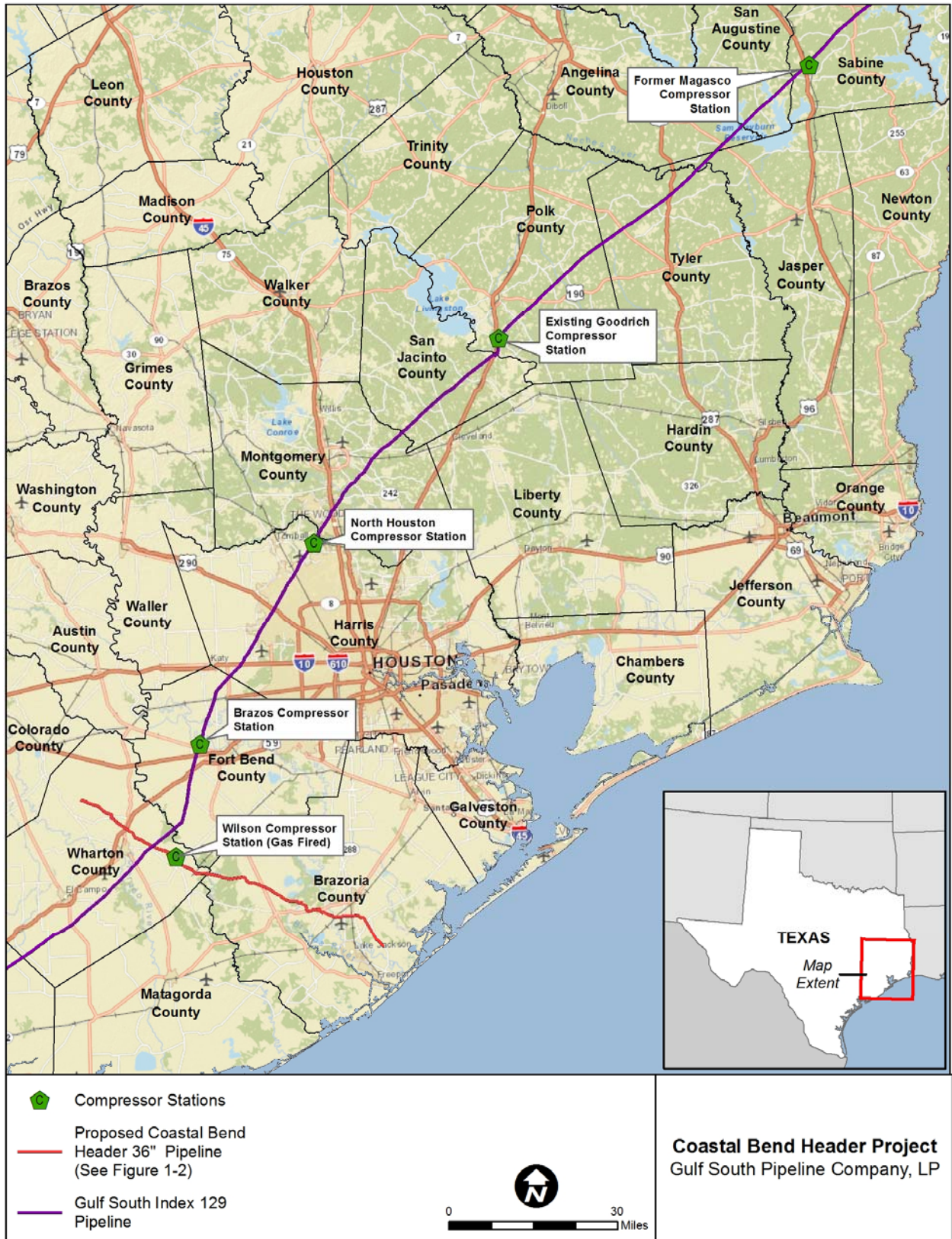
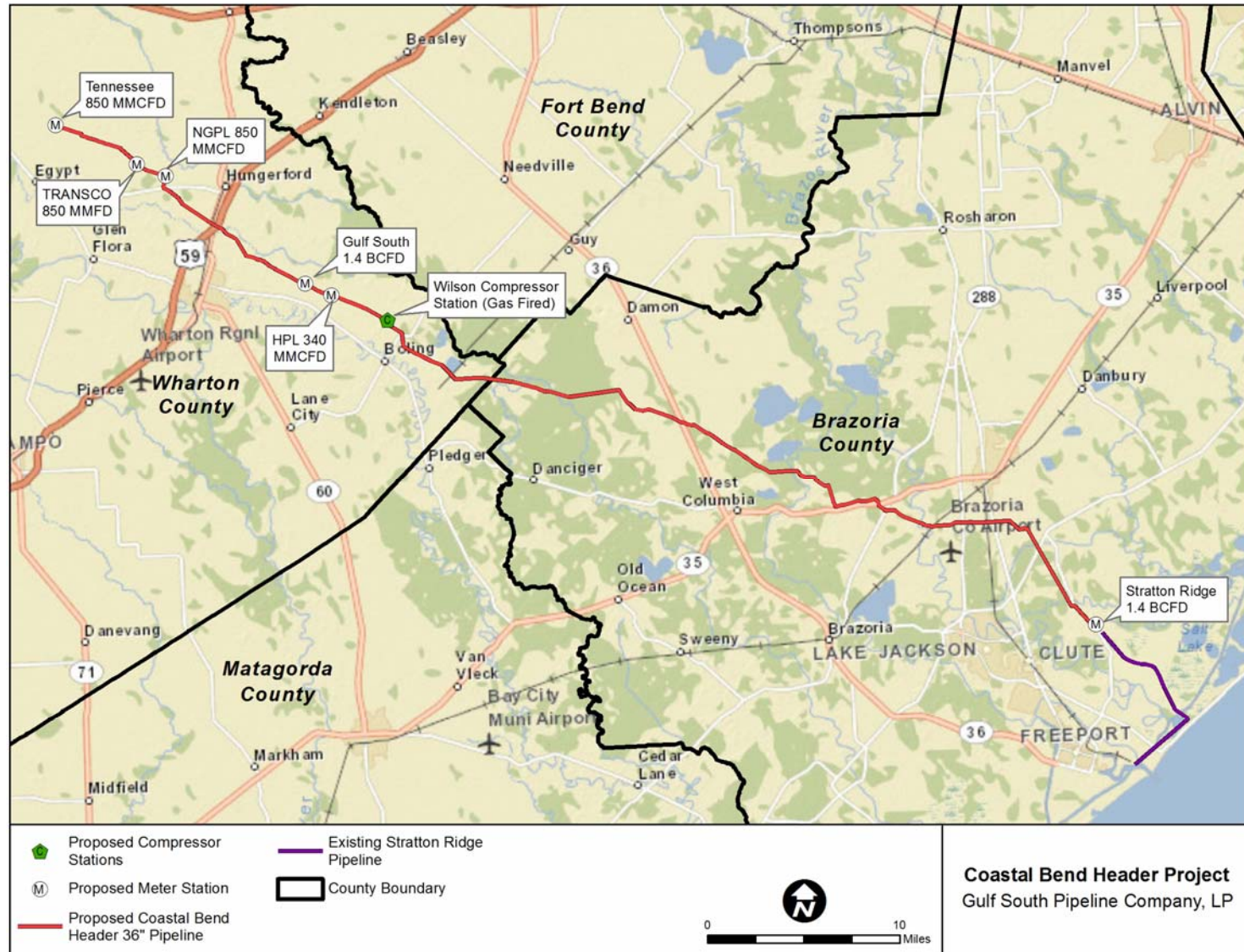

Figure 1.4-2
Proposed 36-inch Pipeline Map



Additional Temporary Workspace

Where necessary, Gulf South would utilize additional temporary workspace (ATWS) outside of the construction right-of-way to facilitate specialized construction procedures, such as horizontal directional drilling (HDD) and bores; railroad, road, wetland, waterbody, and foreign utility line crossings; areas where topsoil segregation is required; tie-ins with existing pipeline facilities; and pipeline crossovers. ATWS proposed for pipeline construction would require about 123.7 acres. These areas disturbed by construction would be allowed to revert back to pre-existing conditions following construction activities, resulting in no permanent impacts on these areas. No ATWS requirements are anticipated for construction of the aboveground facilities.

1.4.2 Aboveground and Appurtenant Facilities

Aboveground facilities include one new header supply gas-fired compressor station (Wilson Compressor Station), seven M&R stations, and other ancillary facilities. The Project would also include the construction and operation of two new electric-powered compressor stations (Brazos Compressor Station and North Houston Compressor Station), piping modifications at Gulf South's existing Goodrich Compressor Station, and piping modifications and installation of a new gas-fired compressor unit at Gulf South's former Magasco Compressor Station to increase capacity on the existing Legacy System facilities (i.e., Index 129 shown in figure 1.4-1). Each of these facilities is described in more detail below. Gulf South already owns the Magasco Compressor Station site.

Compressor Stations

The new gas-fired compressor station, Wilson Compressor Station, would be located in Wharton County. This station would generate approximately 83,500 nominal horsepower (hp) of compression. Two new electric compressor stations, Brazos Compressor Station and North Houston Compressor Station, would be located along Index 129 in Fort Bend and Harris counties, respectively. The Brazos Compressor Station would generate approximately 26,400 hp of compression and the North Houston Compression Station would generate approximately 10,700 hp of compression. Gulf South would acquire and own the parcels of land for the station construction and operation at all three sites. The proposed Wilson Compressor Station site is approximately 27.9 acres, while the proposed Brazos Compressor Station and North Houston Compressor Station sites are approximately 29.7 and 12.9 acres, respectively.

Meter and Regulator Stations

Gulf South proposes to construct a new M&R station at each of seven interconnects with other gas pipelines along the new 36-inch-diameter header pipeline route. Refer to table 1.4-1 for the complete list of the M&R station names and location by milepost (MP). Typically, M&R stations include inlet piping, a filter separator, meter and regulator skids, overpressure protection, outlet piping, a gas chromatograph building, a remote terminal unit building, communications tower and equipment, a permanent access road, and fencing with a vehicle gate and a pedestrian gate. The Enterprise M&R station at MP 20.66 would be constructed entirely within the Wilson Compressor Station site, so potential impacts associated with the construction and operation of the M&R station are included in the impact acreage associated with Wilson Compressor Station. Construction and operation of the other six M&R stations would require a total of approximately 17.1 acres.

Proposed Action

Valves and Ancillary Facilities

Gulf South proposes to construct four mainline valves (MLVs), which are referred to as MLV1, MLV2, MLV3, and MLV4, along the proposed 36-inch-diameter header pipeline. MLVs are typically located away from populated areas to allow for safe and rapid evacuation of the pipeline, if necessary. Pig launchers and receivers are constructed along the pipeline to facilitate in-line inspections to ensure the integrity of the pipeline. MLVs and other ancillary facilities would be constructed within the permanent pipeline easement and would be enclosed by fencing. The pig launchers and/or pig receivers at MP 0.00, MP 16.12, MP 20.66, and MP 65.61 would be within the facility boundaries of the proposed TGPL M&R station, Wilson Compressor Station, and Stratton Ridge M&R station, respectively. A pig launcher and receiver are also proposed to be located within the facility boundary of the Brazos Compressor Station. Overall, the impacts associated with the construction and operation of the pig launchers/receivers are included in the total impact acreages of the respective facilities in which they are located: MLV1 (MP 11.61), MLV2 (MP 36.22), MLV3 (MP 51.16), and MLV4 (MP 58.95). Each MLV would require an approximately 50-foot by 50-foot fenced gravel area. Construction and operation of the four MLVs would require a total of approximately 0.3 acre.

Existing Aboveground Facilities

Gulf South also plans to modify the existing Goodrich Compressor Station, in Polk County; and construct new facilities at the site of a former compressor station, the Magasco Compressor Station, located along Index 129 in Sabine County, that was previously abandoned and removed. Gulf South is proposing piping modifications at these compressor stations to allow gas to flow southward along Index 129, and is proposing to add a new 15,900 hp gas-fired compressor unit to the Magasco Compressor Station. The improvements at these two existing station sites would be conducted within the existing property boundaries and on land owned by Gulf South.

1.5 NON-JURISDICTIONAL FACILITIES

Non-jurisdictional facilities are facilities related to the Project that are constructed, owned, and operated by others that are not subject to FERC jurisdiction. These are facilities that are related to the Project for the purpose of delivering, receiving, or using the proposed natural gas volumes, and include facilities to be owned by other companies, that are not subject to FERC jurisdiction. At this time, non-jurisdictional facilities necessary to operate the Project are anticipated to include the addition of new electric power lines at the three new compressor station sites (Wilson, Brazos, and North Houston), the former Magasco Compressor Station site, and the seven new M&R stations. Table 1.5-1 provides a summary of the non-jurisdictional facilities associated with the Project. Refer to appendix C for maps depicting the non-jurisdictional facilities.

FERC has no authority over the permitting, licensing, funding, construction, or operation of the non-jurisdictional facilities listed in table 1.5-1. The power lines would be constructed and maintained by private utility companies under state and local jurisdiction. However, the non-jurisdictional facilities above were considered by the Commission staff in the cumulative impacts section of this EA (see section 2.10).

Table 1.5-1 Non-jurisdictional Facilities Required by the Project			
Facility	Company/Owner	Type of Facility	Dimension^{a, b}
North Houston Compressor Station	CenterPoint Energy	Standard power poles (35 kV line).	4,000 feet (1.83 acres)
Brazos Compressor Station	CenterPoint Energy	Standard power poles (35 kV line).	8.3 miles (20.12 acres)
Wilson Compressor Station	CenterPoint Energy	The utility would bring in a 480 VAC from an existing power line to power both the Wilson Compressor Station and the Enterprise M&R Station.	1,100 feet (0.50 acre)
Magasco Compressor Station	Deep East Texas Electric Co-op	The utility would use an existing 7.2 kV power line.	Existing power line.
TGPL M&R Station	CenterPoint Energy	The utility would bring in a 240–120 VAC from an existing power line.	4 miles (9.40 acres)
Transco M&R Station	CenterPoint Energy	The utility would bring in a 240–120 VAC from an existing power line.	200 feet (0.09 acre)
NGPL M&R Station	CenterPoint Energy	The utility would bring in a 240–120 VAC from an existing power line.	1,100 feet (0.50 acre)
Gulf South Index 129 M&R Station	CenterPoint Energy	The utility would bring in a 240–120 VAC from an existing power line.	500 feet (0.23 acre)
HPL-Energy Transfer M&R Station	CenterPoint Energy	The utility would bring in a 240–120 VAC from an existing power line.	2,100 feet (0.96 acre)
Enterprise M&R Station	CenterPoint Energy	The utility would bring in a 480 VAC from an existing power line to power both the Wilson Compressor Station and the Enterprise M&R Station.	M&R Station would use same power source as Wilson Compressor Station.
Stratton Ridge M&R Station	CenterPoint Energy	The utility would bring in a 240–120 VAC from an existing power line.	600 feet (0.28 acre)
^a Distance measured from existing circuit. ^b Acreage based on a 20-foot-wide power line right-of-way. kV = kilovolt VAC = volt alternating current			

1.6 LAND REQUIREMENTS

Construction of the Project would affect a total of approximately 1,171.5 acres of land, including pipeline construction rights-of-way, ATWS, aboveground facility sites, access roads, and contractor pipe yards (1,054.8 acres associated with the header pipeline plus 116.7 acres for aboveground facilities). Land requirements would include both temporary and permanent impacts. Following construction, Gulf South would allow the temporary construction work areas of approximately 634.6 acres (54 percent) of the pipeline construction right-of-way and aboveground facility sites to revert to previous conditions. Gulf South would retain and maintain the remaining 536.9 acres (46 percent) as permanent pipeline right-of-way, new compressor station sites, M&R stations, associated ancillary facilities, and new permanent access roads. Table 1.6-1 identifies the land requirements for the entire Project including the new header pipeline and the associated land requirements for aboveground facilities.

Proposed Action

Construction of the new 36-inch-diameter pipeline would require a typical construction right-of-way width of 100 feet in uplands, 75 feet through waterbodies and wetlands, and 125 feet in agricultural areas. The proposed construction right-of-way configurations are depicted in appendix B for various situations along the right-of-way. For agricultural workspaces, an additional 25 feet of temporary workspace extending from the working side for topsoil storage is proposed. Post construction, a 50-foot-wide permanent easement centered on the pipeline would be retained under all pipeline right-of-way scenarios noted above. Excluding ATWS, contractor/pipe yards, and access roads, the total acreage of land affected by pipeline construction would be approximately 753.5 acres, of which approximately 395.9 acres would be new permanent easements, with the remaining 357.6 acres consisting of the temporary construction right-of-way.

As noted in table 1.6-1, Gulf South proposes to co-locate approximately 36 percent of the new header pipeline along existing easements in order to minimize the Project footprint. Where the header pipeline is proposed to be co-located, the construction right-of-way would overlap 5 feet within existing easements. Ten feet of ATWS may be obtained on the existing parallel easements for temporary topsoil storage where there is sufficient width and where permitted by the existing easement operators.

The 100-foot construction right-of-way would provide enough room for spoil storage associated with the 36-inch pipeline while still providing safe working conditions according to Occupational Safety Health Administration regulations (29 CFR 1926.650–1926.652 Subpart P). The proposed permanent right-of-way width of 50 feet would be necessary to accommodate construction right-of-way spacing requirements and future maintenance, and to protect the pipeline from ground-disturbing work that may occur in proximity to the pipeline in the future (e.g., from paralleling easements and adjacent development). The proposed header pipeline would be installed in the center of the permanent right-of-way to the extent that is practicable.

In upland areas, Gulf South would maintain a 10-foot-wide cleared permanent right-of-way centered directly over the trench on an annual basis (within the 50-foot right-of-way); and would maintain the full right-of-way by clearing vegetation every 3 years. This is in accordance with FERC's *Upland Erosion Control, Revegetation, and Maintenance Plan* (Plan). Gulf South would maintain a 10-foot-wide cleared permanent right-of-way through wetlands in accordance with FERC's *Wetland and Waterbody Construction and Mitigation Procedures* (Procedures). Unless otherwise requested and approved by FERC, right-of-way between HDD entry and exit locations would not be affected by construction or operation to minimize and avoid impacts on wetlands per the FERC Procedures. Trees within 15 feet of the pipeline with roots that could compromise the integrity of the pipeline coating would be selectively cut and removed from the permanent right-of-way to maintain pipeline integrity. Areas disturbed by construction that are not part of the permanent right-of-way would be restored to pre-construction conditions after the completion of construction activities.

Table 1.6-1 Summary of Land Requirements for the Project		
Facility	Land Affected during Construction/Short-term Impacts (Acres)^a	Land Affected during Operation/Permanent Impacts (acres)
Header Pipeline		
36-inch Header Pipeline right-of-way	753.5 ^b	395.9
ATWS	123.7	0.00
Access Roads ^c	100.4	82.4
Contractor Pipe Yards	77.2	0.00
Pipeline Facilities Subtotal	1,054.8	478.3
Above-ground Facilities		
<u>Associated with the 36-inch Header Pipeline</u>		
Wilson Compressor Station	27.9	14. 0
Meter and Regulator Stations	17.1	11.9
Mainline Valves and Other Ancillary Facilities	0.3	0.3
Access Roads	7.8	7.8
<u>Associated with the Legacy System (Index 129)</u>		
Brazos Compressor Station	29.7	10.3
North Houston Compressor Station	12.9	6.1
Goodrich Compressor Station ^d	7.2	2.5
Magasco Compressor Station ^e	11.1	3.0
Access Roads	2.7	2.7
Aboveground Facilities Subtotal	116.7	58.6
Project Total	1,171.50	536.90
<p>The numbers in this table have been rounded. As a result, the totals may not reflect the sum of the addends.</p> <p>^a Land affected during construction is inclusive of operation impacts (permanent).</p> <p>^b Approximately 57.7 miles of the Project would utilize a 100-foot-wide construction right-of-way configuration and would affect approximately 659.3 acres during construction. Approximately 3.7 miles of the Project would utilize a 75-foot-wide construction right-of-way configuration and would affect approximately 33.5 acres during construction. The remaining 60.7 acres consist of those areas in which no temporary workspace would be needed (i.e., HDD crossings and road bores).</p> <p>^c Acreage has been subtracted from the permanent right-of-way to account for permanent access road acreages within permanent easement.</p> <p>^d Gulf South's existing Goodrich Compressor Station property boundary encompasses approximately 28.5 acres.</p> <p>^e Gulf South's existing Magasco Compressor Station property boundary encompasses approximately 91.6 acres.</p>		

1.7 CONSTRUCTION PROCEDURES

The Project would be designed, constructed, tested, operated, and maintained in accordance with the U.S. Department of Transportation (DOT) regulations in Title 49 CFR Part 192, *Transportation of Natural Gas by Pipeline: Minimum Federal Safety Standards*, and other applicable federal and state regulations. Gulf South would construct the Project in accordance with the Commission's FERC Plan and FERC Procedures. The FERC Plan and FERC Procedures are found on the FERC website at <http://www.ferc.gov/industries/gas/enviro/guidelines.asp>. Gulf South has requested *Site-specific Exceptions to the FERC Procedures* (see appendix G). Our review of these alternative measures are discussed in section 2.0, where applicable. Gulf South would also implement its project-specific *Stormwater Pollution Prevention Plan* (SWPPP) (Gulf South, June 2012a), *Spill Prevention, Control, and Countermeasure (SPCC) Plan* (Gulf South, June 2012a) and *Plan for Containment of Inadvertent Release of Drilling Mud during Horizontal Directional Drilled Wetland and Waterbody Crossings* (appendix D) to protect sensitive resources from inadvertent releases during construction activities. We have reviewed these plans and have find them acceptable. Gulf South would use a combination of conventional and specialized construction procedures to construct the Project as described below.

Gulf South would utilize existing public and private roads to access the construction right-of-way and aboveground facility sites to the extent practicable. Existing roads used for access would include paved, gravel, or pasture roads and other conveyances. Some private roads would require modification or improvement to facilitate safe access for construction equipment and personnel. The Project would require construction of both permanent and temporary roads to provide access to the new facilities and for future pipeline maintenance. A total of 24 temporary and 45 permanent access roads are proposed for the Project, as depicted on the maps in appendix A.

1.7.1 General Pipeline Construction Procedures

Conventional open-cut pipeline construction techniques would be used for the majority of the Project. The pipeline would be constructed in a phased sequential manner, with each phase progressing from beginning to end of the pipeline route. Construction of the proposed pipeline would be expected to last 12 months and employ an estimated 1,000 workers during peak employment periods. The pipeline construction process would be coordinated by various work crews to minimize the total time a tract of land is disturbed and precluded from normal use, and to reduce exposure to erosion. General construction and installation phases and their sequence are described below. Construction right-of-way cross-section typicals are provided in appendix B.

Clearing and Grading

Gulf South would notify affected landowners prior to initiating pre-construction surveys. A crew would perform a standard survey and stakeout to identify right-of-way and workspace boundaries, locate existing foreign utility lines within the construction right-of-way, and identify wetland boundaries and other environmentally sensitive areas. Gulf South would also notify utility line operators through the "One Call" service to assist in locating and marking all belowground utility lines.

After the surveys, the construction right-of-way would be cleared of vegetation and debris. In wetlands areas, stumps would be cut flush with the ground and left in place, except where removal is necessary to create a safe and level workspace. Cleared vegetation and debris along the right-of-way would be disposed of in accordance with federal, state, and local regulations either by burning, chipping and spreading (chipping and spreading would be performed in accordance with the FERC Plan), or disposal at a commercial disposal facility. In order to minimize potential erosion and sedimentation of wetlands and waterbodies and to contain disturbed soils during clearing and grading in upland areas,

temporary erosion control devices (ECDs) would be installed prior to initial ground disturbance and maintained throughout construction.

Trenching

Trenching involves excavation of a ditch for pipeline placement. The trench would be excavated by a trenching machine, backhoe, or similar equipment. Soil from the trench would be deposited adjacent to each trench within the construction work areas, with topsoil segregation utilized where necessary, in accordance with the FERC Plan and Procedures. As required by 49 CFR Part 192, the trench would be excavated to a depth of approximately 7 feet to ensure a minimum of 3 feet of cover over the pipe in standard conditions. The bottom of the trench would be cut at least 12 inches wider than the width of the pipe. The width at the top of the trench would vary to allow the side slopes to be adapted to local conditions at the time of construction.

Pipe Stringing, Bending, and Welding

After trenching, the new pipe would be strung and distributed along the right-of-way parallel to the trench. Depending on the amount of available workspace, some pipe may be fabricated off site and transported to the right-of-way in various lengths or configurations. Depending on soil conditions, pipe stringing, bending, and welding may be performed prior to trenching. Once in place along the right-of-way, pipe lengths would be aligned, bends fabricated, and joints welded together. Professional welders in accordance with the American Petroleum Institute (API) Standard Number 1104, DOT pipeline safety regulations, 49 CFR Part 192, and company welding specifications would weld the pipe sections together and certified inspectors would utilize visual and non-destructive methods to test the integrity of the welds according to industry protocol. All welds would be coated for corrosion protection and visually and radiographically inspected in order to ensure that there are no defects as required by 49 CFR Part 192.

Pipe Installation and Trench Backfilling

Completed sections of pipe would be lifted off the temporary support by side boom tractors or similar equipment, and placed into the trench. Prior to the pipe being lowered in, the trench would be visually inspected to ensure that it is free of rock and other debris that could damage the pipe or the coating. Additionally, the pipe and the trench would be inspected to ensure that the configurations are compatible. Tie-in welding and pipeline coating would occur within the trench to join the newly lowered-in section with the previously installed sections of pipe. After the pipe is positioned in the trench, crews would backfill the trench with the previously excavated material and crown it to approximately 6 inches above its original elevation to compensate for subsequent settling.

Hydrostatic Testing

Following backfilling of the trench and before being placed into service, the pipeline would be hydrostatically tested to ensure that the system is free from leaks and capable of safely operating at the design pressure. Hydrostatic testing would be conducted in accordance with the requirements of DOT pipeline safety regulations, 49 CFR 192, company testing specifications, and applicable state general discharge permits (see table 1.9-1). In addition, sections that are installed by directional drilling are typically hydrostatically tested to prove the pipe's integrity prior to installation.

Proposed Action

The USFWS brought up concerns with hydrostatic testing and the effect of water withdrawals on river flows. Several measures, as outlined and required in the FERC Procedures, would be implemented to reduce environmental effects from withdrawal and discharge of test waters. Those measures include the following:

- Locating hydrostatic test manifolds outside of wetlands where practical;
- withdrawing from water sources in compliance with appropriate agency requirements;
- complying with all appropriate permit requirements;
- screening intake from surface water sources to avoid entrainment of fish and other aquatic species;
- maintaining adequate flow rates to protect aquatic life and provide for all waterbody uses and downstream withdrawals by existing users;
- anchoring the discharge pipe for safety;
- discharging test water through an energy dissipating and/or filtration device to minimize flooding and erosion, reduce velocities, spread water flow, and promote ground penetration; and
- discharging test water in compliance with all appropriate agency requirements.

During testing, the water in the pipe would be pressurized above the maximum operating pressure and held for a minimum of 8 hours. Any loss of pressure that cannot be attributed to other factors, such as temperature changes, would be investigated. In the event that a loss of pressure is detected, the pipeline would be repaired and the segment retested. The necessary permits associated with hydrostatic testing for the Project are identified in table 1.9-1.

Restoration and Clean-up

Following pipeline installation and backfilling, disturbed areas would be restored and graded to pre-construction contours, in accordance with the FERC Plan and Procedures. Construction debris and organic refuse unsuitable for distribution over the right-of-way would be disposed of at appropriate facilities in compliance with applicable regulations. Permanent erosion and sediment control measures would be installed as appropriate, and revegetation measures would be implemented as outlined in the Plan and Procedures, specific landowner requests, or in Project-specific plans.

1.7.2 Special Pipeline Construction Procedures

In addition to the standard pipeline construction methods described above, Gulf South would implement special construction procedures due to site-specific conditions as described below.

Waterbody Crossings

Construction of the Project would require crossing or otherwise affecting waterbodies at a total of 231 locations. (Refer to appendix E for a list of all waterbody crossings.) Construction methods utilized at waterbody crossings are dependent on the characteristics of the waterbody crossed. Under standard procedures, waterbodies less than 100-feet-wide would be crossed via conventional open-cut methods. The open-cut method utilizes similar general construction procedures as described above for mainline construction. Equipment is operated from the banks of the waterbody to the maximum extent possible to excavate a trench. The FERC Procedures require that flow is maintained at all times. Excavated material from the trench would be placed at or above the ordinary high water mark to be used

as backfill. As necessary, the pipe segment would be prefabricated and weighted to provide negative buoyancy and placed below scour depth. Backfill cover requirements would be met and contours would be restored within the water. Following installation, the banks would be stabilized via seeding and/or installation of erosion control matting or riprap. Excess excavated materials would be distributed in an upland area according to applicable regulations.

Gulf South would implement measures in the FERC Procedures to minimize impacts on water quality. The duration of construction within the waterbody would be limited to 24 hours for crossings less than 10 feet and 48 hours for crossings between 10 feet and 100 feet. Excavated materials would be stored 10 feet from the edge of the waterbody at a minimum, and temporary ECDs would be utilized to prevent the sediment from reentering the water.

An alternative to the open-cut method is the flume crossing method. The flume crossing method temporarily directs water flow through one or more flume pipes placed over the excavation area. Temporary dams (sandbags, bladders, or other impervious materials) are installed both upstream and downstream of the proposed crossing and used to divert water in the flumes. This technique is used to allow trenching and pipeline installation under drier conditions and does not significantly disrupt the water flow.

The dam and pump method is another alternative to the open-cut method and is similar to the flume crossing method because it allows for pipeline installation and trenching in drier conditions with minimal impacts on water flow. The dam and pump method also involves the installation of temporary dams (sandbags, bladders, or other impervious materials) both upstream and downstream of the proposed crossing. Pumps are used to dewater the excavation area and transport water flow around the construction area.

Horizontal Directional Drill (HDD)

The HDD method utilizes specialized drilling equipment and work crews to install pipeline segments well below the ground surface, typically to avoid sensitive environmental resources and challenging conventional construction areas. The design and feasibility of an HDD is determined by a variety of factors including the length, depth, and curvature (profile) of the proposed drill; surrounding topography; pipeline diameter; availability and orientation of the land on which to assemble the HDD pipeline segment; land use constraints; and geotechnical suitability of the subsurface environment. It should be noted that the HDD method is not a practicable or feasible crossing method to employ at all stream, wetland, or waterbody crossings due to the significant cost and the larger required workspaces that could cause greater disturbances to the terrestrial environment. The HDD method is initiated by drilling a small-diameter pilot hole along a predetermined underground path. A reaming tool is used to enlarge the pilot hole to a diameter slightly greater than the diameter of the pipeline, and a pre-assembled segment of the pipeline is then pulled back through the hole. After the pipeline segment is pulled into place, it is hydrostatically tested and welded to the remainder of the pipeline at the end of the HDD. The HDD process includes the use of drilling fluid to lubricate the drill bit, return cuttings to the surface, and maintain the borehole. No vegetation would be removed at HDD crossings between the entrance point and exit point.

This method would be utilized at wide (100 feet or greater) or sensitive waterbody or wetland crossings and certain road crossings. The proposed HDD locations for the Project are listed in table 1.7-1. Plan and profile drawings for each HDD crossing are included in appendix F.

In order to facilitate proposed HDD installations, Gulf South plans to hand clear one to two paths of sufficient width (not to exceed 5-foot-wide) to allow for the placement and surveying of an electric guide wire coil (closed loop system) along the ground surface between each HDD entry and exit

Proposed Action

point, where possible. The coils assist in facilitating tracking of the location of down hole drilling equipment and determines steering inputs during advancement of the pilot bore.

Table 1.7-1 Proposed Locations of Horizontal Directional Drill Operations			
Name of HDD	Milepost		Length (feet)
	Entry	Exit	
US Highway 59	10.52	10.09	2,276
Peach Creek	10.99	10.74	1,300
Linnville Bayou	27.14	27.56	2,254
San Bernard River	31.10	31.37	1,400
Brazos River	45.11	44.78	1,734
Dry Bayou	46.04	45.83	1,110
Oyster Creek	53.26	53.00	1,400
State Highway 288	55.65	55.38	1,400
Brazoria County Drainage Ditch #7	56.07	56.30	1,183
Brazoria County Drainage Ditch O	57.69	57.46	1,200
Canal New A and Coale Road/CR-220	58.27	58.64	1,907
Bastrop Bayou	60.14	59.80	1,821

After the completion of the pilot hole, reaming tools would be utilized to enlarge the hole in order to accommodate the pipeline diameter. The reaming tools would be attached to the drill string at the exit point and would then be rotated and drawn back to incrementally enlarge the pilot hole. During this process, drilling mud consisting of bentonite clay and water would be continuously pumped into the pilot hole to remove cuttings and maintain the integrity of the hole. Once the hole has become sufficiently enlarged, a prefabricated segment of pipe would be attached behind the reaming tool on the exit side of the crossing and pulled back through the drill hole toward the drill rig. If a particular drill is unsuccessful, Gulf South would implement the Contingency Plan specified in the *Plan for Containment of Inadvertent Release of Drilling Mud During Horizontal Directional Drilled Wetland and Waterbody Crossings* (appendix D).

Wetlands Crossings

Construction of the Project would cross or otherwise affect wetlands in 93 locations. In accordance with the construction methods outlined in the FERC Procedures, the construction right-of-way would be limited to 75 feet in wetlands, and buffers would be clearly marked during construction activities, unless otherwise requested in the *Site-specific Exceptions to the FERC Procedures* (appendix G). Operation of construction equipment through wetlands would be limited to necessary measures for each stage of pipe installation (e.g., clearing, trenching). Topsoil segregation techniques would be utilized in unsaturated wetlands to preserve the seedbank and allow for the successful restoration of the disturbed area after the completion of Project activities. After construction, disturbed lands would be monitored to ensure successful revegetation. Refueling would not be conducted within the construction right-of-way and fuel would not be stored within 100 feet of wetlands to minimize impacts, unless otherwise approved by the Environmental Inspector (EI).

Wetland crossing methods would be determined based on site-specific conditions at the time of construction. Wetlands with soils that could support construction equipment may be crossed using the conventional lay method.

Construction techniques for the conventional lay method are similar to the open-cut method in upland areas. This method differs in that topsoil segregation techniques would be utilized to facilitate revegetation following the completion of construction activities. In some instances, site-specific conditions may not be able to support construction equipment, but the area is still proposed for conventional lay method. Under these circumstances, construction mats would be utilized to minimize disturbance to wet hydrology and maintain soil structure. This method would be performed in accordance with all applicable permits and the FERC Procedures. Additionally, in accordance with FERC Procedures, topsoil segregation techniques in inundated wetlands is not required.

The push/float construction method may be used in inundated lowland or saturated wetland areas where conventional pipe-laying equipment cannot be supported, and in areas that have a sufficient amount of water at the time of construction that would allow for pipe to be floated through the open trench. This method requires excavation of the trench using low-ground-weight equipment limiting the need for grubbing and grading activities over the trench line or working side of the right-of-way. Topsoil segregation would not be implemented in areas where standing water is present at the time of construction.

Coated and weighted pipe would be welded at a staging area where floats are attached to the pipe. The welded pipe would be pushed along the water-filled trench until it is positioned in place. Once the trench is in place, the floats would be cut and the pipe would be allowed to sink in place. The trench would then be backfilled using previously excavated material. This method reduces wetland impacts and soil compaction by minimizing the number of construction passes required to install the pipe. To the extent possible, any required staging would be conducted within the construction right-of-way. If ATWS is needed outside of what is approved in its Certificate, Gulf South would request approval from FERC prior to use on a site-specific basis.

Road, Railroad, and Utility Crossings

Paved roads, railroads, and utility line crossings (including other pipelines and electrical lines) along the Project may be achieved using the open-cut or subsurface bore methods. In accordance with the FERC Plan, safe and accessible conditions would be maintained during construction at any road crossings. Some paved and most unpaved roads with limited traffic may be open-cut pending consultation with the affected county or landowner, in accordance with the existing regulations. Construction at road crossings typically would be conducted and completed within one day in order to reduce traffic interruptions. Typically, a minimum of 5 feet of cover over the pipe would be maintained at all road crossings (both paved and unpaved), with a minimum of 4 feet cover below side borrow/drainage ditches. Gulf South would be required to ensure that the minimum depth of cover over the pipeline is in compliance with all applicable federal, state, and local regulations for pipeline crossings. In addition, pipeline warning signs and/or markers would be used to identify the presence of a pipeline.

Prior to construction, Gulf South would request meetings with representatives of all foreign utility operators to inform them of the proposed Project, obtain their requirements for crossing their utility lines, and solicit their cooperation in facilitating safe crossings. In areas where the proposed header pipeline crosses an existing utility line, a minimum of 18 inches would be maintained between the existing utility line and the proposed header pipeline. Gulf South would have inspectors present to monitor all crossing installations. Foreign utility line operators would also have the ability to have a representative on site to help ensure that the crossings are made as safe as possible. While not anticipated, if an accident should occur and the foreign pipeline is damaged during construction, Gulf

Proposed Action

South would stop work immediately and notify all appropriate personnel and local first responders, as needed.

Residential Areas

Construction activities in residential areas would be completed as quickly and as safely as possible to minimize disturbance to residents. Gulf South would reduce construction workspace, as practicable, to minimize inconvenience to landowners, minimize the clearing of trees, limit workspace to the confines of Gulf South's pipeline easement where possible, maintain vehicle access for landowners to their property during Project construction, and make every effort to ensure that cleanup is thorough. Gulf South would be required to maintain access to residences during construction; however, if access is temporarily impeded, Gulf South would coordinate with landowners to minimize the disturbance. Gulf South would construct temporary safety fences along the construction right-of-way where construction activities would occur close to residences. Homeowners would be notified in advance of any expected utility interruption and the estimated duration of an outage.

As outlined in the FERC Plan, topsoil segregation would be used in residential areas unless specifically requested otherwise by a homeowner, or if Gulf South elects to import topsoil. After the completion of construction activities, Gulf South would remove all debris and restore residential areas to pre-construction conditions. Gulf South would coordinate with landowners in an attempt to meet any special needs regarding landscape restoration.

Agricultural Areas

The FERC Plan requires topsoil segregation be implemented in active croplands, pastures, and hayfields. A maximum of 12 inches in deep soils of topsoil would be removed and separated from the subsoil during construction. After the pipeline installation, the subsoil would be backfilled, followed by the topsoil.

For areas known to have existing drainage or irrigation systems, Gulf South proposes to develop a remediation plan before construction, and would file this plan with the Project's Implementation Plan for review and approval by the Director of the Office of Energy Projects (OEP). As part of the remediation plan, Gulf South would perform additional soil bores in areas that are currently or have historically been utilized for rice farming. The soil samples would be analyzed to further identify and classify areas that may have clay soils underlain by permeable sub-soils at a trench depth that could have long-term impacts on irrigation requirements for rice farming. The soil test results would be evaluated by a qualified soils engineer and a site-specific remediation plan would be developed with advice from the engineer. Measures would be included in the remediation plan to reduce the potential for water loss in agricultural areas, based on the results of the soil tests and discussions with landowners regarding future plans for rice cultivation. Gulf South would also return the agricultural land to its original contour to maintain pre-construction hydrology.

1.7.3 Aboveground Facility Construction Procedures

Construction of aboveground facilities would be concurrent with the construction of the header pipeline and associated facilities. Gulf South estimates the following peak construction duration and employment for each compression station, as reflected in table 1.7-2.

Sites associated with the three new compressor stations would be cleared and graded, and soils would be leveled and compacted for placement of building foundations. Any soils excavated for the placement of foundations would be compacted in place and excess soil would be used elsewhere on site or disposed of in an approved off-site location. Fencing would be constructed around the station sites.

High-strength, reinforced concrete is proposed for building foundations, as necessary, for major compressor equipment.

Compressor Station	Estimated Peak Employment	Estimated Duration of Peak Employment
Magasco Compressor Station	70–80 people	16 weeks
Goodrich Compressor Station	20–30 people	8 weeks
North Houston Compressor Station	70–80 people	16 weeks
Brazos Compressor Station	80–100 people	24 weeks
Wilson Compressor Station	150–160 people	36 weeks

Proposed buildings or enclosures would be constructed around the foundations after the compressor units are in place. Noise abatement equipment and emissions controls would be installed in buildings housing compressor units. Pipe and other equipment would be assembled and welded on site. Aboveground and belowground piping would be installed and hydrostatically tested prior to being placed in service. In addition, safety and control devices would be installed and tested prior to operation. Gravel fill, asphalt, or concrete would be used to construct roads and parking areas. Upon completion of construction activities, disturbed areas that have not been paved or covered with gravel would be finish-graded and seeded.

Construction of M&R stations, MLVs, and other ancillary facilities, as well as construction activities proposed at the Goodrich and Magasco compression stations along Index 129, would be completed using the same general procedures as described above for new compressor stations. All compressor stations, M&R stations, and MLVs would be fully automated or capable of being remotely monitored and controlled via satellite dish for the supervisory control and data acquisition system.

1.8 OPERATION, MAINTENANCE, AND SAFETY CONTROLS

Gulf South would operate and maintain all facilities associated with the Project in accordance with applicable federal and state requirements, including DOT's *Minimum Federal Safety Standards* (49 CFR 192) pursuant to the provisions of the *Natural Gas Pipeline Safety Act of 1968*, as amended.

Operation and Maintenance of Aboveground Facilities

Approximately 14 new permanent Gulf South employees would operate and maintain the proposed Wilson Compressor Station, Brazos Compressor Station, and North Houston Compressor Station. All other proposed aboveground facilities would be monitored remotely from Gulf South's gas control center. Personnel would perform routine checks of the aboveground facilities, including calibration of equipment and instrumentation, inspection of critical components, and scheduling of routine maintenance of equipment. Operational testing would be performed on safety equipment to ensure proper function. Corrective actions would be taken as necessary if issues are identified.

Maintenance of Pipeline

Maintenance of pipeline facilities would include periodic visual inspections, as well as routine pedestrian surveys, as necessary, in accordance with the applicable regulatory requirements and Gulf South's operations requirements. In accordance with DOT requirements, periodic leak inspections and

Proposed Action

cathodic protection maintenance would be conducted. In addition, all pipeline markers and signs would be routinely inspected and replaced as necessary to ensure that pipeline locations are clearly identified. Post-construction monitoring would be conducted to identify erosion or washout areas and damaged or non-functional permanent ECDs, and to evaluate restoration of affected wetlands. Any issues identified during post-construction monitoring or inspections would be addressed in accordance with applicable federal and state regulations, as well as the measures contained in the FERC Plan and Procedures.

Maintenance of the permanent pipeline right-of-way would include periodic mowing as necessary, in accordance with the provisions of the FERC Plan and Procedures, to allow for visual inspections. Actively cultivated areas would be allowed to revert to pre-construction use for the width of the right-of-way. In all other upland areas, a 50-foot-wide permanent pipeline right-of-way would be maintained in a primarily herbaceous state in accordance with the FERC Plan. In wetlands, a 10-foot corridor centered over the pipeline would be maintained. In particular, large trees within 15 feet of the pipeline with roots that could compromise the integrity of the pipeline coating may be selectively cut and removed from the permanent right-of-way in accordance with the FERC Procedures to ensure the continued integrity of the pipeline. Gulf South would also conduct routine inspections of the MLVs and M&R stations in accordance with all applicable Pipeline and Hazardous Materials Safety Administration (PHMSA) regulations.

Safety Controls

Gulf South's operating policies and procedures would be periodically reviewed by DOT. All Gulf South operating personnel are required to be trained according to these policies and procedures, which provide preventative maintenance, monitoring of facilities, and procedures to be followed in the event of an accident or catastrophe. All compressor stations, M&R stations, and MLVs would be fully automated or capable of being remotely monitored and controlled via a satellite dish for the supervisory control and data acquisition system. Gulf South also participates in periodic trainings and review of operating and emergency procedures for affected operations employees. Trainings include safe operation of pipeline valves and equipment, material handling procedures, public liaison programs, and general operating procedures.

Periodic aerial, vehicle, and pedestrian patrols of all facilities would be performed, along with scheduled preventative maintenance. Unusual conditions or situations spotted along a survey would be reported immediately. Gulf South is a member of the "One Call" and related pre-excavation notification organizations; the "One Call" system provides notification of proposed excavation to a central agency, which notifies Gulf South of excavation locations. Gulf South has a Corporate Enterprise Security Plan that incorporates the requirements of the Transportation Security Administration (TSA) guidelines, and also participates in the TSA Classified Briefings, TSA Monthly Security Call, TSA International Pipeline Security Forum, Federal Bureau of Investigation Houston Energy Cyber Task Group, and Interstate Natural Gas Association of America Security Committee.

1.9 PERMITS, APPROVALS, AND REGULATORY CONSULTATIONS

Table 1.9-1 identifies the major federal, state, and local environmental permits, approvals, and regulatory clearances for the Project.

Table 1.9-1 Federal and State Permits and Approvals			
Agency or Organization	Permit/Approval	Submittal	Received or Anticipated Receipt
Federal			
Federal Energy Regulatory Commission	Certificate of Public Convenience and Necessity	June 12, 2015	2 nd Quarter 2016
U.S. Fish and Wildlife Service, Texas Coastal Ecological Services Field Office	Endangered Species Act, Section 7; Migratory Bird Treaty Act Clearance	June 12, 2015	1 st Quarter 2016
U.S. Army Corps of Engineers, Galveston District	Section 10/404 (Nationwide Permit 12)	June 12, 2015	October 14, 2015
State			
Texas Commission of Environmental Quality	Section 401 Water Quality Certification (automatic with NWP 12)	June 12, 2015	October 14, 2015
	Air and Greenhouse Gas Permits	June 11, 2015	Permit by Rule Registration: Wilson CS – 8/11/15 Brazos CS – 8/6/15 N. Houston CS – 8/14/15 Magasco CS – 8/21/15
	Hydrostatic Test Water Appropriations Permit	2 nd Quarter 2016	3 rd Quarter 2016
Railroad Commission of Texas	Coastal Zone Management Act (automatic with NWP)	June 12, 2015	October 14, 2015
	Hydrostatic Test Water Discharge Permit	2 nd Quarter 2016	3 rd Quarter 2016
	Minor Permit: Casing/Annular Disposal of Drilling Fluid	2 nd Quarter 2016	3 rd Quarter 2016
Texas Parks and Wildlife	Threatened and Endangered Species Review	June 12, 2015	1 st Quarter 2016
Texas State Historic Preservation Office	Section 106 of the National Historic Preservation Act Clearance	June 12, 2015	July 7, 2015
Texas Department of Transportation	Utility Crossing/Temporary Driveway Permit	1 st Quarter 2016	2 nd Quarter 2016
Local			
Wharton County Precinct 1 – County Roads	Heavy Load/Pipeline Utility/ Permit to Transfer	1 st Quarter 2016	2 nd Quarter 2016
Brazoria County Precinct 1 – County Roads	Heavy Load/Pipeline Utility/ Permit to Transfer	1 st Quarter 2016	2 nd Quarter 2016
Wharton County Precinct 2 – County Roads	Heavy Load/Pipeline Utility/ Permit to Transfer	1 st Quarter 2016	2 nd Quarter 2016
Brazoria County Precinct 2 – County Roads	Heavy Load/Pipeline Utility/ Permit to Transfer	1 st Quarter 2016	2 nd Quarter 2016
Brazoria County Precinct 4 –	Heavy Load/Pipeline Utility/	1 st Quarter 2016	2 nd Quarter 2016

Proposed Action

Table 1.9-1 Federal and State Permits and Approvals			
Agency or Organization	Permit/Approval	Submittal	Received or Anticipated Receipt
County Roads	Permit to Transfer		
Wharton County Permit and Inspection Department	Development and Septic Permit	1 st Quarter 2016	2 nd Quarter 2016
	Drainage Plan Approval	1 st Quarter 2016	2 nd Quarter 2016
West Brazoria County Drainage District	Permit for Crossing Drainage	1 st Quarter 2016	2 nd Quarter 2016
No Man's Land Drainage District	Permit for Crossing Drainage	1 st Quarter 2016	2 nd Quarter 2016
Angleton Drainage District	Permit for Crossing Drainage	1 st Quarter 2016	2 nd Quarter 2016
City of Angleton	Application for Pipeline Installation	1 st Quarter 2016	2 nd Quarter 2016

2.0 ENVIRONMENTAL ANALYSIS

2.1 GEOLOGY AND SOILS

2.1.1 Geologic Setting and Impacts

The geologic setting of the Project area is characteristic of the low, gently sloping topography of the West Gulf Coastal Plain of the Coastal Plain physiographic province, which consists primarily of unconsolidated to semi-consolidated sand, silt, and clay deposits (U.S. Geological Survey [USGS], 1996). These deposits were formed in a mostly marine environment until tectonic uplift tilted the sediments seaward, causing the waters of the Gulf of Mexico to retreat (USGS, 2000).

The Project area contains six geologic units representing distinct surficial deposits or shallow/exposed bedrock features (USGS, 2005). Holocene alluvium, which underlies approximately 37.98 miles (58 percent) of the 36-inch-diameter Header Pipeline (pipeline) route, the Wilson Compressor Station, three M&R stations, and various ancillary facilities, is the most prevalent geologic unit in the Project area. Other portions of the proposed pipeline and its ancillary facilities as well as the proposed Brazos Compressor Station are underlain mostly by predominantly clay or predominantly sand areas of the late Pleistocene Beaumont Formation. Proposed Project facilities farther inland are generally associated with geologic units of increasing age, including MP 0.00 to MP 4.72 of the pipeline and North Houston Compressor Station (middle Pleistocene Lissie Formation), Goodrich Compressor Station (Miocene Fleming Formation), and Magasco Compressor Station (middle Eocene Yegua Formation).

Topography within the south and central portions of the Project area is generally flat and featureless, although shallow depressions, small mounds, and/or poorly defined ridges may be found in areas where the Lissie and Beaumont (Predominantly Sand) formations are present (USGS, 2015a, 2015b). Terrain in the vicinity of the Goodrich and Magasco compressor stations in the northern portion of the Project area is gently undulating.

The pipeline would also cross two subsurface salt dome formations: the Boling salt dome at MP 19.27 to MP 24.11 and the Stratton Ridge salt dome at MP 63.67 to MP 65.61. Salt domes, which are commonly found along the West Gulf Coastal Plain, consist of enormous underground pillars of salt, which can be a mile or more across and several miles in depth. They pierce through the surrounding sediments and are often topped by a cap rock formation of anhydrite. Salt domes are of interest to the Project due to their propensity for salt dissolution and resulting subsidence. The collapse of a large natural cavern at the Boling Salt Dome in 1983 formed a sinkhole approximately 0.17 mile from contractor/pipe yard #1 and 0.35 mile from the pipeline at MP 22.10 (Mullican III, 1988).

Mineral Resources

Table 2.1-1 lists mineral resource extraction sites identified within the Project workspace. Active sites include a storage facility for natural gas at Boling Salt Dome (MP 22.00–MP 24.69), one active oil well (MP 22.13), two injection/disposal wells (MP 22.66 and MP 24.41), a sand and gravel mine (MP 63.20), and a brining operation and underground storage cavern facility for liquid hydrocarbons, refined products, and natural gas at Stratton Ridge Salt Dome (MP 63.67–MP 65.61).

In order to avoid, minimize, or eliminate potential impacts on mineral resources, Gulf South would implement the following applicant-committed mitigation.

- Conduct civil surveys and subsurface surveys prior to construction to field-verify well locations and determine if there are any abandoned wells or other unidentified obstructions within the Project workspace.

Environmental Analysis

- Work with the well operators and landowners to make minor deviations of the line to avoid impacts on any new, planned, or abandoned wells or wellbores, as well as other related underground obstructions.
- Stop work and notify the Railroad Commission of Texas (RRC) and FERC in the unlikely event that an oil or gas well is discovered during construction. If necessary, the pipeline would be rerouted around the area.
- Gulf South would coordinate with the owner of the active sand and gravel mine, which is approximately 185 feet east of the proposed pipeline near MP 63.20, to ensure that construction and operation of the pipeline would not affect future mining operations on the property.

Gulf South does not anticipate any impacts on salt cavern storage areas or brining operations at the Boling or Stratton Ridge salt domes because these facilities are approximately 500 to 850 feet below the ground surface, well below the trenching depth for the pipeline, which is estimated to be an average depth of 7 feet (Texas State Historical Association, 2010; Lord et al., 2006). In addition, no impacts on inactive wells or mining operations listed in table 2.1-1 are anticipated, as operations at these locations have ceased.

The records of RRC do not identify any historic coal mines, or active coal mines, within 1 mile of any of the proposed Project facilities (RRC, 2015a, 2015b, 2015c). According to the Texas Commission on Environmental Quality (TCEQ), there are no Class III injection wells (used to inject fluids to dissolve and extract minerals) in Wharton or Brazoria counties where the pipeline and Wilson Compressor Station are proposed (Murray, 2015). Therefore, the Project is not anticipated to affect coal mines or Class III injection wells.

Geologic Hazards

Geologic hazards are natural physical conditions that, when they occur, can damage land or structures or cause injuries to people. Potential geologic or other natural hazards applicable to the Project are discussed below and include seismic hazards, landslides, subsidence and karst² terrain, and flash flooding.

Seismic Hazards

Seismic hazards include earthquakes, surface faulting, and soil liquefaction. There are no known faults near the Project workspace, and only four earthquakes have been recorded within one of the six counties affected by the Project since record-keeping began (University of Texas, 2013; Northern California Earthquake Data Center, 2015; USGS, 2015h). The events had a magnitude of 4.4 or less (as measured by the moment magnitude scale). Only minor superficial damage was reported from this series of earthquakes, which all occurred within Sabine County, the location of the Magasco Compressor Station improvements, in 1964 (USGS, 2015g).

United States National Seismic Hazard Maps estimate that the 500-year earthquake (an earthquake with a 10 percent probability of occurring within any 50-year interval) would result in peak ground accelerations of 1 to 2 percent gravity in the region encompassing the Project area (Petersen et al., 2014). No impacts on proposed Project facilities, including compressor stations, M&R stations, and other ancillary facilities, are anticipated because damage to buildings and other structures is unlikely to occur at ground accelerations less than 10 percent gravity (Arnold, 2006). Additionally, large permanent ground movements (e.g., deformations and displacements resulting from surface faulting, soil liquefaction, or

² Karst is a landscape formed from the dissolution of soluble rocks including limestone, dolomite, and gypsum. It is characterized by sinkholes, caves, and underground drainage systems (University of Texas, 2015).

landslides), which are the primary causes of earthquake-induced damage to pipelines (Yokel and Mathey, 1992), are unlikely to occur in the vicinity of the proposed pipeline due to the absence of known faults and low probability of damaging earthquakes in the Project area.

**Table 2.1-1
Mineral Resource Extraction Sites Located Within the Project Workspace**

Approximate Milepost/Facility	Type	API Number ¹	Status
Wharton County, TX			
5.01	Gas Well	48130541	Inactive
18.46	Dry Hole	Unknown	Inactive
19.14	Dry Hole	Unknown	Inactive
20.80 ²	Shut in Well	48182140	Inactive
22.0–24.69	Salt Dome Sulfur Mine	Not Applicable	Inactive
22.0–24.69	Salt Cavern Storage Facility for Natural Gas	Not Applicable	Active
22.12	Dry Hole	48130707	Inactive
22.13	Oil Well – Pump Jack	48133128	Active
22.35	Plugged Oil Well	Unknown	Inactive
22.65	Plugged Oil Well	48133650	Inactive
22.66	Injection/Disposal Well	48131626	Active
24.39	Dry Hole	Unknown	Inactive
24.41	Injection/Disposal Well	48133110	Active
Brazoria County, TX			
52.30	Dry Hole	Unknown	Inactive
53.40	Sand and Gravel Mine	Not Applicable	Inactive
63.20	Sand and Gravel Mine	Not Applicable	Active
63.67–65.61	Brine Mining and Salt Cavern Storage Facility for Liquid Hydrocarbons, Refined Products, and Natural Gas (inclusive of storage well at MP 64.86)	03981655	Active
Source: Well information from RRC, 2015d and field reconnaissance conducted by Gulf South. Salt dome mining and storage information from Enterprise Products Partners, L.P., 2013; Freeport LNG, 2015; and Hudgins 2010a, 2010b. Sand and gravel mines identified through review of aerial imagery, field surveys, and communication with landowners.			
¹ Oil and gas wells are identified by API numbers if provided in source data.			
² Well is located within the temporary workspace associated with the Wilson Compressor Station.			
Note: RRC data identified 420 well records associated with oil and gas activities within 0.25 mile of the Project workspace. Excluding records for historic or canceled well permits, the RRC records identify 13 wells in various stages of activity or inactivity within the Project workspace (RRC, 2015d).			

Soil liquefaction is a condition whereby soil loses strength and stiffness, causing it to flow like liquid. This condition typically occurs when loose, saturated soil is subjected to intense vibration or shockwaves, most commonly from a nearby major earthquake. The low probability of a major earthquake within the Project area makes the occurrence of soil liquefaction unlikely.

Environmental Analysis

Landslides

Landslides occur when unconsolidated soils and sediments located on steep slopes become saturated, usually from a flooding event. The region encompassing the Project area is generally flat and is characterized by low probability and low incidence of landslides, with less than 1.5 percent of the land area likely to be involved in landslides (USGS, 2014). Therefore, it is not anticipated that landslides would affect Project facilities.

Subsidence and Karst Terrain

Land subsidence is the sinking of the Earth's surface, either gradually or suddenly, due to subsurface movement of materials such as water or soil. The presence of karst terrain, aquifer system compaction, drainage of organic soils, and underground mining may increase susceptibility to subsidence (National Research Council, 1991).

The Project study area is in a region where karst terrain is not present and large subsidence events associated with this geologic hazard are unlikely to occur (Tobin and Weary, 2004); however, subsidence events have occurred at Salt Domes in the vicinity of the Project study area due to natural dissolution of the salt stock and cap rock or mining activities including sulfur production, oil and gas production, and brining operations. The Boling Salt Dome in particular has the highest incidence of human-induced subsidence of any salt dome in Texas; however, engineering practices implemented in mining operations since 1949 have decreased the risk of subsidence from mining activities (Mullican III, 1988).

All proposed facilities would be designed and constructed to meet or exceed the federal safety standards set forth in the Minimum Federal Safety Standards for the Transportation of Natural and Other Gas by Pipeline (49 CFR 192) to ensure that the integrity of the pipeline would not be compromised and the potential for failures would be minimized if subsidence occurs. Additionally, approximately 36 percent of the pipeline would be co-located with existing pipelines, none of which are known to have been adversely affected by subsidence to date. In the event that karst terrain or subsidence features are encountered during construction, the affected pipeline would be exposed, repositioned or replaced, and properly bedded or backfilled. Project activities would avoid and are not anticipated to affect the sinkhole associated with the Boling Salt Dome, located approximately 0.17 mile from contractor/pipe yard #1 and 0.35 mile from the pipeline at MP 22.10 (appendix A, Sheet 9).

Flash Flooding

Flash flooding events have the potential to upset active construction and expose, displace, or damage Project facilities that would cross or be in close proximity to streams or rivers. Approximately 11.0 acres of the 14.0-acre Wilson Compressor Station are located in a 100-year floodplain (subject to inundation by the 1 percent chance of an annual flood event) mapped by the Federal Emergency Management Agency (FEMA, 2014). Portions of the proposed pipeline would pass through streams, wetlands, and other low-lying areas subject to flood events; however, Federal Emergency Management Agency 100-year floodplain data are not currently available for Wharton or Brazoria counties. No other proposed Project facilities are located in 100-year floodplains.

The pipeline would be designed and constructed to protect against damage from high-velocity flows and erosion resulting from seasonal or flash flooding in areas within a 100-year floodplain. All facilities constructed at the Wilson Compressor Station would be designed to meet or exceed federal, state, and local standards for construction within a floodplain, and design measures including building up the site elevation, installing equipment and structures on elevated piers, and/or factoring in measures to prevent erosion and improper site drainage would be implemented as needed to reduce impacts on the floodplain. Adherence to these design measures is anticipated to adequately minimize or avoid impacts on Project facilities from flash flooding events.

Paleontology

Paleontological resources include impressions in rock and/or fossilized remains of prehistoric organisms. Although paleontological resources are relatively common in the Project area, which once supported a vast population of large mammals such as bison, mammoths, and mastodons (The Paleontology Portal, 2014), there are no known unique or important formational features or fossil collecting locations within the Project area. However, prior disturbances and a lack of shallow bedrock or rocky soils make it unlikely that the Project would adversely affect significant paleontological resources.

2.1.2 Soil Setting and Impacts

Soil map units affected by the Project were identified and assessed using the Web Soil Survey produced by the Natural Resources Conservation Service (NRCS) (NRCS, 2015a), U.S. Department of Agriculture (USDA) Official Soil Series Descriptions (NRCS, 2015b), and NRCS soil surveys for Brazoria, Fort Bend, Harris, Polk, Sabine, and Wharton counties (NRCS, 2015c, 2009, 1990, 1981, 1976, 1974).

Existing Soil Characteristics

Soils within the Project study area and workspace were evaluated to identify major soil characteristics that could affect construction or increase the potential for construction-related soil impacts. Individual soil characteristics are discussed below and listed by distance or area in table 2.1-2 and table 2.1-3.

Prime and Statewide Important Farmland

USDA identifies prime farmland as “land that is best suited to food, feed, fiber, and oilseed crops” (7 CFR 657.5). Prime farmland is generally characterized by an acceptable and reliable water supply from precipitation or irrigation, a favorable temperature and growing season, an acceptable level of acidity or alkalinity, an acceptable content of salt or sodium, and few or no rocks. Soils that do not meet the above criteria may be considered prime farmland if the limiting factor is mitigated (e.g., artificial drainage). Based on NRCS (2015a) data, 58.12 miles or 89 percent of the soils crossed by the proposed pipeline route and 72.2 acres or 53 percent of soils within the workspaces for proposed aboveground facilities are classified as prime farmland; 34.8 acres or 72 percent soils within the permanent footprints of proposed aboveground facilities are classified as prime farmland. Based on aerial photography and land use survey data collected specifically for this Project, 12.36 miles of the proposed pipeline route exhibit evidence of active cultivation.

No soils within the Project area are designated as unique farmland by NRCS. Unique farmland is land other than prime farmland that is used for production of specific high-value food and fiber crops. Furthermore, there are no areas enrolled in the NRCS Farm and Ranch Lands Protection Program (now administered under the Agricultural Conservation Easement Program) (NRCS, 2015a, 2015d; Ross, 2015).

**Table 2.1-2
Characteristics of Soils Crossed by the Proposed 36-Inch Header Pipeline (in miles)**

Facility	Pipeline Crossing Length	Prime and Statewide Important Farmland	Hydric Soils	High Compaction Potential	High Erosion Potential¹	Steep Slopes²	Low Revegetation Potential³	Shallow Bedrock⁴
Pipeline Facilities								
36-inch Header Pipeline	65.61	58.12	25.70	25.70	0.0	0.0	7.44	0.0
<p>Source: Unless otherwise specified, soil characteristics were determined through the NRCS Soil Survey Geographic Database (NRCS, 2015a).</p> <p>¹ Erosion Potential – Based on land capability class and subclass: High (subclass Ve-VIIIe), Moderate (subclass IIIe-IVe), and Low (remaining subclasses).</p> <p>² Steep Slopes – Represents soils with slopes greater than 8 percent.</p> <p>³ Revegetation Potential –Assigned based on a review of relevant soil characteristics, including prime farmland and hydric soil classifications, soil rutting hazard, and compaction potential.</p> <p>⁴ Shallow bedrock – Represents soils with unconsolidated rock 60 inches or less from the surface.</p>								

**Table 2.1-3
Characteristics of Soils Underlying Proposed Aboveground Facilities (in acres)**

Facility	Temporary Workspace Acreage/Permanent Footprint Acreage	Prime and Statewide Important Farmland	Hydric Soils	High Compaction Potential	High Erosion Potential¹	Steep Slopes²	Low Revegetation Potential³	Shallow Bedrock⁴
Aboveground Facilities – 36-inch Header Pipeline								
Wilson Compressor Station	27.9/14.0	13.9/14.0	13.9/14.0	13.9/14.0	0.0	0.0	0.0	0.0
HPL – Energy Transfer M&R Station	1.7/1.1	0.6/1.1	0.0	0.0	0.0	0.0	0.0	0.0
Gulf South Index 129 M&R Station	5.1/4.5	0.6/4.5	0.0	0.0	0.0	0.0	0.0	0.0
NGPL M&R Station	2.1/0.9	1.2/0.9	0.0	0.0	0.0	0.0	0.0	0.0
Stratton Ridge M&R Station	3.5/1.9	0.0	1.6/1.9	1.6/1.9	0.0	0.0	1.6/1.9	0.0
TGPL M&R Station	2.0/1.0	1.0/1.0	0.0	0.0	0.0	0.0	0.0	0.0
Transco M&R Station	2.8/2.5	0.3/2.5	<0.1/1.8	<0.1/1.8	0.0	0.0	0.0	0.0
MLV and Other Ancillary Facilities	0.4/0.4	0.0/0.3	0.0/0.3	0.0/0.3	0.0	0.0	0.0/<0.1	0.0
Total – 36-Inch Header Pipeline	45.5/26.3	17.6/24.3	15.6/18.0	15.6/18.0	0.0	0.0	1.6/2.0	0.0
Aboveground Facilities – Legacy System								
Brazos Compressor Station	19.4/10.3	4.5/4.4	4.5/4.4	4.5/4.4	0.0	0.0	19.4/10.3	0.0

**Table 2.1-3
Characteristics of Soils Underlying Proposed Aboveground Facilities (in acres)**

Facility	Temporary Workspace Acreage/Permanent Footprint Acreage	Prime and Statewide Important Farmland	Hydric Soils	High Compaction Potential	High Erosion Potential¹	Steep Slopes²	Low Revegetation Potential³	Shallow Bedrock⁴
North Houston Compressor Station	6.8/6.1	6.8/6.1	6.8/6.1	6.8/6.1	0.0	0.0	0.0	0.0
Goodrich Compressor Station	4.7/2.5	0.0	0.0	0.0	4.7/2.5	0.0	4.7/2.5	0.0
Magasco Compressor Station	8.0/3.0	0.0	0.0	0.0	0.1/0.0	0.1/0.0	8.0/3.0	8.0/3.0
Total – Legacy System	38.9/21.9	11.3/10.5	11.3/10.5	11.3/10.5	4.8/2.5	0.1/0.0	32.1/15.8	8.0/3.0
Contractor/Pipe Yards								
Contractor/Pipe Yard 1	13.1/0.0	13.1/0.0	0.6/0.0	0.6/0.0	0.0	0.0	0.0	0.0
Contractor/Pipe Yard 2	4.6/0.0	0.0	4.6/0.0	4.6/0.0	0.0	0.0	4.6/0.0	0.0
Contractor/Pipe Yard 3	10.7/0.0	10.7/0.0	10.7/0.0	10.7/0.0	0.0	0.0	0.0	0.0
Contractor/Pipe Yard 4	5.6/0.0	5.6/0.0	0.0	0.0	0.0	0.0	0.0	0.0
Contractor/Pipe Yard 5	22.6/0.0	13.7/0.0	22.6/0.0	22.6/0.0	0.0	0.0	5.9/0.0	0.0
Contractor/Pipe Yard 6	20.7/0.0	0.2/0.0	20.7/0.0	20.7/0.0	0.0	0.0	20.5/0.0	0.0
Total – Contractor/Pipe Yards	77.3/0.0	43.3/0.0	59.2/0.0	59.2/0.0	0.0	0.0	31.0/0.0	0.0

**Table 2.1-3
Characteristics of Soils Underlying Proposed Aboveground Facilities (in acres)**

Facility	Temporary Workspace Acreage/Permanent Footprint Acreage	Prime and Statewide Important Farmland	Hydric Soils	High Compaction Potential	High Erosion Potential¹	Steep Slopes²	Low Revegetation Potential³	Shallow Bedrock⁴
Total – All Aboveground Facilities	135.4/48.2	72.2/34.8	86.1/28.5	86.1/28.5	4.8/2.5	0.1/0.0	64.7/17.8	8.0/3.0

Source: Unless otherwise specified, soil characteristics were determined through the NRCS Soil Survey Geographic Database (NRCS, 2015a).

¹ Erosion Potential – Based on land capability class and subclass: High (subclass Ve-VIIIe), Moderate (subclass IIIe-IVe), and Low (remaining subclasses).

² Steep Slopes – Represents soils with slopes greater than 8 percent.

³ Revegetation Potential –Assigned based on a review of relevant soil characteristics, including prime farmland and hydric soil classifications, soil rutting hazard, and compaction potential.

⁴ Shallow bedrock – Represents soils with unconsolidated rock 60 inches or less from the surface.

Environmental Analysis

Hydric and Compaction Prone Soils

Hydric soils are soils that “formed under conditions of saturation, flooding or ponding long enough during the growing season to develop anaerobic conditions in the upper part,” even if they are artificially drained or protected from flooding (NRCS, 2015d). Hydric soils are generally poorly to very poorly drained and are prone to rutting and compaction due to extended periods of saturation. Based on NRCS (2015a) data, approximately 25.70 miles or 38 percent of the soils crossed by the proposed pipeline are considered hydric and as having high compaction potential. Approximately 86.1 acres or 64 percent of soils within the workspaces for proposed aboveground facilities are considered hydric and as having high compaction potential; 28.5 acres or 59 percent of soils within the permanent footprints of proposed aboveground facilities are hydric.

Highly Erodible Soils

Highly erodible soils are prone to a high degree of erosion due to characteristics such as location on a moderate or steep slope, sparse vegetative cover, soil texture and structure, and wind or rainfall intensity. Based on NRCS (2015a) data, the majority of the soils in the Project study area have low erosion potential; however, the workspaces for the proposed improvements to the Goodrich Compressor Station (4.7 acres) and part of the Magasco Compressor Station (0.1 acre) are underlain by soils characterized by high erosion potential. Approximately 2.5 acres of highly erodible soils are within the permanent footprint of the proposed improvements to the Goodrich Compressor Station.

Reduced Revegetation Potential

Soils with high compaction potential, high erosion potential, and hydric soils may have low revegetation potential. Based on NRCS (2015a) data, these soils comprise approximately 7.44 miles or 11 percent of the proposed pipeline route. Approximately 64.7 acres or 48 percent of soils within the workspaces for proposed aboveground facilities have low revegetation potential; 17.8 acres or 37 percent of soils within the permanent footprints of proposed aboveground facilities have high compaction potential. Other soils within the Project workspace have moderate to high revegetation potential.

Rocky Soils and Shallow Bedrock

Introducing stones or rocks to surface soil layers may reduce the capacity of the soil to retain moisture, resulting in a reduction of soil productivity. The workspace for proposed improvements to the Magasco Compressor Station is underlain by approximately 8.0 acres of soils characterized by shallow bedrock (bedrock less than 5 feet below the ground surface). Stony, rocky, or shallow bedrock soils are not present in the remainder of the Project area.

Soil Contamination

No contaminated sites were identified within 0.50 mile of the Project workspace through a review of the U.S. Environmental Protection Agency’s (EPA’s) online databases and TCEQ’s list of superfund sites (EPA, 2015a; TCEQ, 2015a). However, through consultations with landowners and TCEQ, Gulf South determined that there is a non-hazardous industrial waste disposal site approximately 0.19 mile north of the pipeline at MP 36.35 (Crouch-Elliot, 2015).

Impacts and Mitigation

Project construction activities that disturb soil, remove vegetation, alter existing hydrology, or transport hazardous materials have the potential to adversely affect soils and reduce revegetation potential. Based on the major soil characteristics identified above, the following sections present Gulf South's proposed mitigation for specific types of soil impacts that may result from Project activities. Through adherence to the measures contained in the Project's SWPPP; FERC's Plan and Procedures; applicable federal, state, and local requirements; and the mitigation measures listed below, no major unmitigated impacts on soils are anticipated.

Prime and Statewide Important Farmland

Adverse impacts could occur where construction activities disturb or aboveground facilities permanently occupy areas classified as prime farmland. To minimize temporary impacts from soil disturbance, Gulf South would be required to strip and segregate topsoil to a maximum depth of 12 inches from all cultivated farmland, improved pastures, residential areas, and wetland areas disturbed by the construction of Project facilities and redistribute topsoil and reseed these areas in accordance with FERC's Plan and Procedures. To mitigate permanent loss of prime farmlands, Gulf South proposes to compensate landowners for the loss of agricultural production as a result of construction and/or operation of the Project.

The operation of heavy construction equipment in saturated soils and excavation of the pipeline trench could damage agricultural drain tiles; however, no drain tiles are anticipated to be encountered during construction of the Project, as they are not a regional agricultural practice and no such structures have been identified during field surveys or landowner negotiations. If drain tiles are discovered, Gulf South proposes to (1) probe beyond the limits of the trench to determine if damage has occurred, (2) test and repair drain tiles damaged by Project activities to their original condition or better, and (3) monitor the function of drain tile systems after construction to ensure proper performance.

Comments from three landowners noted that a clay layer in some areas crossed by the pipeline was an important component of their rice farm irrigation systems. These landowners expressed concern that the ability to conduct rice farming operations on their properties could be adversely affected where the Project disturbed the water-holding clay layer under the top soil. For areas currently or historically used for rice farming, Gulf South would have additional soil bores performed to identify areas of clay soils underlain by permeable sub-soils that could be adversely affected by disturbance from project excavation. Disturbance of the clay soil layer in these locations could affect the land's ability to retain irrigation water required for successful rice farming. Gulf South has committed to including measures to reduce the potential for water loss in these agricultural areas. In Gulf South's data responses filed on August 6, and September 15, 2015, Gulf South indicates that soil test would be evaluated by a qualified soils engineer and a Remediation Plan would be developed with advice from the engineer. Gulf South indicates that its Remediation Plan would be filed with the Implementation Plan. Therefore, we recommend that:

- **Prior to construction, Gulf South should file with the Secretary of the Commission (Secretary), for the review and written approval of the Director of OEP, its Remediation Plan containing specific measures that would be implemented to reduce the potential of water loss due to disturbance of clay soils in rice farming areas.**

Hydric and Compaction Prone Soils

Construction activities, particularly the operation of heavy equipment, could rut and compact saturated soils. Impacts are most likely to occur on hydric soils during periods of increased rainfall in the

Environmental Analysis

spring and fall. Gulf South would avoid operating heavy equipment on hydric soils saturated by recent rainfall. When such operation is unavoidable, Gulf South proposes to minimize impacts through the use of timber mats, low-ground-pressure equipment, or similar methods as conditions dictate. In wetland areas, Gulf South would implement the Project wetland construction crossing techniques identified in section 2.2, *Water Resources and Wetlands*.

Highly Erodible Soils

Construction activities such as vegetation clearing and soil disturbance could cause or increase soil erosion and sedimentation of nearby waterbodies or wetlands. Gulf South proposes the following mitigation measures to minimize impacts:

- Implement erosion and sediment control measures during construction and operation of the Project as specified in the Project SWPPP, which incorporates the FERC Plan and Procedures, as well as applicable federal, state, and local requirements.
- Install ECDs (e.g., interceptor diversions and sediment filter devices) prior to or immediately after soil disturbance occurs (install temporary trench breakers immediately after ditch excavation occurs) and maintain until the Project area is successfully revegetated.
- Inspect ECDs on a regular basis and after each rainfall event of 0.5 inch or greater to ensure proper functioning.
- Remove temporary ECDs after successful revegetation. Install permanent ECDs as appropriate.
- Gulf South's EIs would monitor the effectiveness of temporary ECDs. Gulf South's operating personnel would monitor the effectiveness and revegetation potential of permanent ECDs.
- Apply mulch, blankets, or other suitable material to prevent erosion on steep slopes in accordance with TCEQ's erosion control best management practices (BMPs) (TCEQ, 2003).

Reduced Revegetation Potential

Soil disturbance and compaction resulting from construction activities could reduce soil fertility and revegetation potential. Although the Project area experiences few days below freezing, revegetation potential could be especially affected during the winter months as the success rates of replanting decreases with cooler temperatures and limited daylight. To minimize these impacts, Gulf South would apply fertilizers, soil amendments, and/or seeding nets as deemed necessary in areas with poor to moderate revegetation potential to create an environment favorable for the re-establishment of vegetation. Gulf South would follow specific recommendations provided by NRCS (NRCS, 2014a; Sanders 2015) and measures in the FERC Plan regarding seed mixtures and soil amendments to be used during restoration of the Project's construction workspaces (see the Project *Revegetation Plan* [appendix H] for additional information).

Rocky Soils and Shallow Bedrock

Excavation activities that introduce stones or rocks to surface soil layers could reduce the soil's capacity to maintain moisture. Gulf South would remove excess stone and rock from the surface of soils excavated within the Project workspace so that rock contents in the soils would be no higher than similar soils in adjacent locations.

If consolidated bedrock is encountered during construction at the site of proposed modifications to the Magasco Compressor Station, Gulf South would use rock pickers or other rock removal equipment to excavate the bedrock. Blasting would only be used if the bedrock cannot be easily removed by conventional excavation methods. In the event that blasting is required, Gulf South would adhere to all applicable federal, state, and local blasting notification requirements.

Soil Contamination

Project activities could result in soil contamination through inadvertent spills or disturbance of pre-existing contaminants. Gulf South has avoided impacts on the non-hazardous industrial waste disposal site 0.19 mile north of header pipeline MP 36.35 of the pipeline by routing the pipeline south of the site.

Gulf South would implement the Project-specific SPCC Plan (Gulf South, June 2015a) to prevent, contain, and clean up inadvertent spills of any material that may contaminate soils, such as fuels, lubricants, or coolants. If localized, pre-existing evidence of contamination is encountered during construction of the Project, Gulf South would adhere to its *Plan for the Unanticipated Discovery of Contaminated Environmental Media* (Gulf South, June 2015a), which identifies procedures to follow in the event that contaminated soils or sediments are disturbed or transported. We reviewed these plans and find them acceptable.

With implementation of mitigation measures and compliance with FERC Plan and Procedures no significant soil impacts are anticipated.

2.2 WATER RESOURCES AND WETLANDS

2.2.1 Groundwater Resources

Existing Groundwater Resources

Regional Aquifers

The Project area is underlain by two regional aquifer systems: the Coastal Lowlands aquifer system, also referred to as the Gulf Coast aquifer system, and the Sparta aquifer system. The Coastal Lowlands aquifer system underlies the entire Project area except for the Magasco Compressor Station, where the Sparta aquifer is present. Water obtained from the Coastal Lowlands aquifer system, which comprises discontinuous beds of sand, silt, clay, and gravel deposited during the Miocene to the Pleistocene periods (Chowdhury and Turco, 2006), is primarily used for municipal, industrial, and irrigation purposes (Texas Water Development Board [TWDB], 2015a). Water quality within the aquifer system generally decreases closer to the coastline, where mixing with salt water results in higher salinity and dissolved solids concentration (TWDB, 2015a). Some areas in the Project vicinity, including the northern portion of Fort Bend County (site of the proposed Brazos Compressor Station), have experienced substantial declines in groundwater pressure and elevation due to sustained pumping (USGS, 1996). Geologic formations with low permeability restrict direct infiltration of precipitation into the Coastal Lowlands aquifer throughout most of the Project area, including the proposed locations of the pipeline and the Wilson Compressor Station (USGS, 1996); however, the proposed Goodrich, North Houston, and Brazos Compressor stations are in aquifer recharge areas (Noble et al., 1996).

Water obtained from the Sparta aquifer system, which comprises sand-rich deposits with interbedded layers of silt and clay, is predominantly used for domestic and livestock purposes (TWDB, 2015b). No declines in water quality or water levels have been detected as the result of groundwater pumping; however, water quality deteriorates at depths greater than 2,000 feet due to a naturally high dissolved solids concentration (TWDB, 2015b).

*Environmental Analysis*Sole-source Aquifers and Wellhead Protection Areas

EPA defines a sole-source aquifer (SSA) as an aquifer that supplies at least 50 percent of the drinking water consumed in the area overlying the aquifer and for which there are no reasonably available alternative sources should the aquifer become contaminated (EPA, 2015c). The Project is not underlain by any EPA-designated SSAs (EPA, 2015a). In addition, no proposed Project facilities are within Priority Groundwater Management Areas designated by TCEQ (TCEQ, 2015b).

TCEQ delineates source water protection areas (SWPAs) for surface and subsurface zones surrounding public water supply wells or wellfields in an effort to prevent contaminants from entering the groundwater table and compromising the quality of public drinking water (TCEQ, 2015c). Coordination with the TCEQ Drinking Water Technical Review Team confirmed that there are 10 SWPAs within 1 mile of the Project workspace, only one of which would be crossed by the Project, at access road AR-P-27 near MP 25.54 (Ables, 2015). Table 2.2-1 below provides information about SWPAs near the Project area, including the approximate location by MP, county, and distance by direction from the SWPA to the Project.

Table 2.2-1 Source Water Protection Areas within One Mile of the Project Workspace		
Approximate Milepost	County	Distance from Project (feet)
Pipeline Facilities		
22.60	Wharton County, TX	5,174 SW
25.23	Wharton County, TX	581 SW
25.48	Wharton County, TX	317 SW
42.95	Brazoria County, TX	3,696 NE
43.10	Brazoria County, TX	2,376 SW
43.30	Brazoria County, TX	2,534 SW
51.65	Brazoria County, TX	3,062 S
64.90	Brazoria County, TX	2,746 NE
65.00	Brazoria County, TX	4,277 NE
65.20	Brazoria County, TX	3,485 NE
Aboveground Facilities		
No SWPAs identified within 1 mile of aboveground facilities.		
Access Roads		
25.54	Wharton County, TX	0 ^a
Source: Ables, 2015.		
^a AR-P-27 is an existing pasture road that crosses a SWPA near MP 25.54 for approximately 528 feet.		

Public and Private Water Supply Wells

Data were reviewed from the TCEQ Drinking Water Technical Review Team for public and private water supply wells and from field surveys conducted by Gulf South to identify public and private water supply wells within the vicinity of the Project. Table 2.2-2 provides a list of all water supply wells within 150 feet of the Project workspace, along with the approximate MP, type, status, use, and distance

from the Project. Two public water supply wells were identified within 150 feet of the existing Goodrich Compressor Station, eight private water supply wells were identified within 150 feet of the pipeline, and one private water well was identified within 150 feet of the Brazos Compressor Station (Ables, 2015; TWDB, 2015c).

Table 2.2-2 Water Wells within 150 feet of the Project Workspace				
Approximate Header Pipeline Milepost/Above-ground Facility	Well Type	Status	Use	Approximate Distance from Project (feet)^a
Wharton County				
1.04	Private	Active	Agricultural	14
13.33	Private	Active	Domestic	15
26.86	Private	Active	Irrigation Well	69
Brazoria County				
31.32	Private	Abandoned	Unknown	30
57.17	Private	Active	Unknown	0 ^b
57.17	Private	Active	Unknown	0 ^b
57.19	Private	Unknown	Unknown	48
60.06	Private	Active	Agricultural	0 ^b
Fort Bend County				
Brazos Compressor Station	Private	Active	Unknown	19.87
Polk County				
Goodrich Compressor Station	Public	Unknown	Oil Test	50
	Public	Active	Municipal	56
Sources: Ables, 2015; TWDB, 2015c.				
^a Distance from the Project to the water well is measured from the center point of the well to the edge of the nearest pipeline, temporary workspace, or aboveground facility boundary.				
^b Private water well occurs within the proposed Project workspace.				

Potential Contaminated Groundwater

There are no known sites of potential groundwater contamination or underground storage tanks within the Project workspace (EPA 2015a; TCEQ, 2015d, 2015e); however, one site of potential groundwater contamination, the former Seabreeze Environmental Landfill, is 0.28 mile from MP 62.80 of the pipeline (TCEQ, 2015d). This municipal solid waste facility has been operational since 2001 (TCEQ 2015h). There are no known reports of contamination from this facility, which is situated on low-permeability clay that limits groundwater infiltration and was constructed with multiple environmental protection and monitoring systems, including a liner system, groundwater monitoring wells, and gas probes (SeaBreeze Environmental, 2010; EPA 2015b).

Environmental Analysis

Springs

No springs were identified within 1 mile of the Project workspace based on a review of publicly available data (TPWD, 2015a).

Impacts and Mitigation

Potential impacts on groundwater resources from Project activities include changes in the filtering ability of the soil and in the volume and rate of groundwater infiltration due to vegetation removal and soil compaction; localized declines in water table elevation due to trench dewatering and reduced infiltration through compacted soil; and contamination of groundwater through trench excavation, inadvertent spills or releases of drilling fluids, or disturbance of contaminated soils.

These impacts are anticipated to occur in a localized, minor, and temporary manner due to existing geologic conditions in the Project area as well as the implementation of applicant-committed mitigation and recommended environmental conditions. The presence of geologic formations with low permeability would restrict infiltration of contaminants from groundwater near the surface to major aquifer systems that lie at greater depths throughout most of the Project area. Although freshwater may be present in shallow, unconfined aquifers and confining units that occur near the ground surface, these are unlikely to contain enough freshwater to be considered a reliable supply for public use. As such, impacts on existing or potential future sources of drinking water are not anticipated as a result of trench excavation.

Encountering contaminated groundwater potentially generated by the Seabreeze Environmental Landfill is not anticipated because groundwater monitoring systems in place at the facility are assumed to be effective in detecting groundwater contamination and there are no known reports of contamination. No impacts are anticipated on SSAs, Priority Groundwater Management Areas, underground storage tanks, or springs because they are not known to be present within the Project area. In addition, blasting is not anticipated during Project construction or operation, in which case no impacts would occur (see section 2.1, *Geology and Soils*).

The following applicant-committed mitigation measures would be applied on a Project-wide basis.

- Only clear vegetation where necessary and reclaim cleared areas in accordance with the measures in FERC's Plan once construction is complete, which would help maintain the filtering capacity of the soil in these areas.
- Limit the amount of time trenches and bore pits remain open, allowing water tables to return to their original elevations more quickly after trench dewatering.
- In the event that HDD activities result in the inadvertent release of drilling fluids, Gulf South would implement the Project's Contingency Plan specified in the *Plan for Containment of Inadvertent Release of Drilling Mud During Horizontal Directional Drilled Wetland and Waterbody Crossings* (appendix D). Inadvertent release is not anticipated to permanently affect groundwater quality because dissolved solids would be removed through natural filtration processes.
- Gulf South would utilize topsoil and subsoil segregation techniques in wetland and agricultural areas to minimize mixing and compaction, restoring the soil structure as close to its original state as feasible.
- Gulf South would adhere to proper storage, containment, and handling procedures outlined in the Project SPCC Plan (Gulf South, June 2015a) and the FERC Plan and Procedures to minimize the risk of inadvertent spills of fuels or other hazardous

chemicals. In the event of a spill, Gulf South would be required to follow the protocol outlined in the SPCC Plan to control and remediate spills.

- If contaminated groundwater, as identified by evidence of odor, sheen, or other such indicators, is encountered during construction of the Project, Gulf South would implement measures outlined in the Project-specific *Plan for the Unanticipated Discovery of Contaminated Environmental Media* (Gulf South, June 2015a), to limit exposure and spread of contaminants.

Source Water Protection Areas

AR-P-27 is an existing gravel field road that crosses a SWPA for 0.10 mile. The improvements Gulf South proposes to AR-P-27, which include grading and gravelling, would not affect the SWPA. Implementation of the measures contained in the FERC Plan and Procedures during Project construction and maintenance and the Project SPCC Plan during construction, which include prohibiting refueling or transferring hazardous materials within 100 feet of designated watershed areas and equipping all storage containers with secondary containment structures, would reduce the potential for impacts on SWPAs identified within 1 mile of the Project workspace.

Public and Private Water Supply Wells

Gulf South is proposing to follow the measures in the FERC Plan and Procedures during Project construction and maintenance and would employ measures outlined in its SPCC Plan during construction, which include equipping all storage containers with secondary containment structures and performing daily leak and integrity inspections of all equipment, vehicles, and storage areas during construction, to minimize impacts on public and private water supply wells within 150 feet of the Project workspace. Should any landowners request pre- or post-construction monitoring of their drinking water, Gulf South proposes to provide this service on an individual basis. The scope, terms, and duration of the monitoring event(s) would be negotiated with each landowner at the time of the request. Gulf South has agreed to do pre- and post-construction monitoring, however, staff is interested in additional documentation of landowner complaints to ensure resolution of potential impacts. Therefore, we recommend that:

- **Within 30 days of placing the facility in service, Gulf South should file with the Secretary a report summarizing whether any complaints were received concerning well yield or water quality and how each was resolved. Gulf South should also file in their biweekly status reports a description of any landowner/resident complaints that may relate to compliance with the requirements of the Order, and the measures taken to satisfy these concerns.**

2.2.2 Surface Water Resources

Existing Surface Waters

Waterbodies Proposed to be Crossed

Field surveys were conducted in the Project study area from December 2014 through May 2015 and identified 231 waterbody crossings for the proposed header pipeline. There would be 94 crossings in Wharton County, 134 crossings in Brazoria County, and 1 each in Harris, Polk, and Sabine Counties. Of the waterbody crossings in the Project area, 29 were identified as perennial streams, 69 as intermittent streams, 125 as ephemeral streams, and 8 as ponds or lakes (open water). The MP location, feature ID, waterbody name, state water quality classification, fisheries classification, FERC classification, flow regime, approximate crossing width, and proposed method of crossing are provided in appendix E. The

Environmental Analysis

pipeline would cross five waterbodies greater than 100 feet in width, including the Brazos River, Dry Bayou, Bastrop Bayou, an unnamed tributary to Bastrop Bayou, and a manmade pond.

Existing Surface Water Quality

The pipeline would cross three 303(d) designated impaired waters (TCEQ, 2013) and no other 303(d) impaired waters were identified within the proposed pipeline alignment (TCEQ, 2015f). There are no streams within the Project workspace identified as impaired due to the presence of contaminated sediments (EPA 2015a; TCEQ, 2015e). Table 2.2-3 provides the MP, county, name of the waterbody, and source of impairment for the three impaired waterbodies that would be crossed by the pipeline. Total maximum daily loads have not been developed for these three impaired waterbodies.

Milepost	County	Name of Waterbody	Sources of Impairment
31.23	Brazoria	San Bernard River	Bacteria
53.14	Brazoria	Oyster Creek	Bacteria; dissolved oxygen
59.98	Brazoria	Bastrop Bayou	Bacteria

Source: TCEQ, 2013.

Public Watershed Areas

No surface water intakes for public water systems or areas of primary influence for public water supplies are present within 3 miles of the proposed Project (TCEQ, 2012, 2015g). The Goodrich Compressor Station is the closest Project facility to a public water supply, approximately 4.50 miles upstream from Lake Livingston, which is used as a regional water supply.

Hydrostatic Test Water and Other Water Withdrawals

In compliance with DOT regulations, Gulf South would be required to perform hydrostatic testing of the new pipeline segments and aboveground facilities prior to placing them into service. Table 2.2-4 identifies the proposed hydrostatic test water withdrawal and discharge locations by MP for the proposed pipeline route. For the aboveground facilities, the hydrostatic test water would come from municipal sources and discharge would all occur on site. Volumes of test water for aboveground facilities would range from a low of 6,000 gallons for the Goodrich Compressor Station to a maximum of 114,000 gallons for the Wilson Compressor Station. As with the header pipeline, all withdrawal and discharge associated with the aboveground facilities would occur within the project construction zone onsite. Approximate withdrawal volumes for the HDD operations (drilling mud) are summarized in table 2.2-5. Gulf South is proposing to obtain and discharge hydrostatic test water for the proposed pipeline facilities from the Brazos River and a privately owned lake; hydrostatic test water for the proposed aboveground facilities would be obtained from municipal sources. Refer to section 2.3.1, *Fisheries Resources*, for discussion regarding fisheries and intake of hydrostatic test waters. Water used for HDD operations would be obtained from surface waterbodies and commercial sources. All activities related to hydrostatic testing would comply with required state and local permits.

**Table 2.2-4
Proposed Hydrostatic Test Water Source and Discharge Locations for Pipeline Facilities**

Test Section	Begin Milepost	End Milepost	Length (feet)	Water Source	Withdrawal Location (Milepost)	Approximate Volume (gallons)	Discharge Location (Milepost)	Discharge Rate (gpm)
1	0.00	20.70	109,296	Privately owned lake	22.55	5,540,532	20.70	3,000
2	20.75	44.75	126,720	Privately owned lake	22.55	6,322,159	22.55 or 44.75	3,000
3	44.75	55.40	56,232	Brazos River	44.75	2,805,458	44.75	3,000
4	55.40	65.61	53,908	Brazos River	44.75	2,689,552	44.75	3,000

gpm = gallons per minute

**Table 2.2-5
Proposed Volumes of Water for Horizontal Directional Drill Operations**

Name of HDD	Approximate Milepost		Length (feet)	Drilling Mud Water Volume (gallons)	Hydrostatic Testing Water Volume (gallons)	Water Source
	Entry	Exit				
US Highway 59	10.52	10.09	2,276	278,117	113,600	Commercial
Peach Creek	10.99	10.74	1,300	158,854	64,900	Peach Creek/ Commercial
Linnville Bayou	27.14	27.56	2,254	275,428	112,500	Commercial
San Bernard River	31.10	31.37	1,400	171,074	69,850	San Bernard River
Brazos River	45.11	44.78	1,734	211,887	86,550	Brazos River
Dry Bayou	46.04	45.83	1,110	135,637	55,400	Dry Bayou
Oyster Creek	53.26	53.00	1,400	171,074	69,850	Oyster Creek
Highway 288	55.65	55.38	1,400	171,074	69,850	Commercial
Brazoria County Drainage Ditch #7	56.07	56.30	1,183	144,557	59,050	Commercial
Brazoria County Drainage Ditch O	57.69	57.46	1,200	146,634	59,900	Commercial
Canal New A and Coale Road/CR-220	58.27	58.64	1,907	233,027	95,150	Canal
Bastrop Bayou	60.14	59.80	1,821	222,518	90,900	Bastrop Bayou/ Commercial

Environmental Analysis

Sensitive Surface Waters

No federally listed National Wild or Scenic Rivers or rivers listed on the Nationwide Rivers Inventory are within the Project area (National Wild and Scenic Rivers System, 2015; NPS, 2015). The pipeline would cross the San Bernard River (MP 31.23) and the Brazos River (MP 44.92), which are both designated as Ecologically Significant Rivers and Streams by the Texas Parks and Wildlife Department (TPWD, 2001). The San Bernard River (MP 31.23) and the Brazos River (MP 44.92) are also designated as navigable waters under the jurisdiction of the USACE Galveston District, which require permitting for any activity that affects the course, condition, or location of the waterbody.

Impacts and Mitigation

Impacts on surface waterbodies may occur from construction activities conducted in streams or along adjacent banks and slopes. Potential impacts include stream bank erosion, increased sedimentation and turbidity, decreased dissolved oxygen concentrations, release of existing chemical and nutrient pollutants from sediments, and introduction of chemical contaminants through inadvertent spills. Impacts are anticipated to be localized, minor, and temporary in nature due to Gulf South's commitment to the implementation of the following mitigation measures:

- Gulf South would implement the measures in the FERC Plan and Procedures, including completing water withdrawals in a manner that does not impair the flow of the waterbody.
- To minimize stream bank erosion, Gulf South would not strip vegetation along stream banks until the time of crossing and would subsequently allow the banks to regenerate in accordance with the FERC Plan once construction is complete. Where necessary and feasible, equipment bridges, mats, and pads would be utilized to provide additional protection for these areas against erosion.
- Temporary equipment bridges would be installed at stream crossings, such as timber mats, portable prefabricated bridges, or railcars. These bridges would be designed to function under high stream flows and would be maintained to prevent restricted water flow. Spoil piles near minor or intermittent waterbodies would be bordered with silt fences and/or straw bales to minimize sedimentation. When feasible, Gulf South would conduct construction at stream crossings during low-flow periods to minimize sedimentation and turbidity.
- The duration of in-stream construction activities is required to be limited to 24 to 48 hours unless otherwise approved by FERC. Gulf South would refill the excavated trench immediately after pipe installation is complete and restore stream beds to pre-construction contours to the extent feasible.
- In-stream ECDs would be installed to reduce the amount of suspended sediments flowing downstream during pipeline installation, and sandbag breakers would be installed to further restrict the transport of sediments after pipeline installation is complete.
- Discharged hydrostatic test water would be required to pass through an energy-dissipation and/or filtration device before being released. Gulf South is proposing to place the energy-dissipation and/or filtration device in a well-vegetated, upland area to minimize the potential for stream scour in accordance with the FERC Procedures. Hydrostatic test water used for the aboveground facilities would also be discharged on site through an energy-dissipation and/or filtration device.

- Gulf South is proposing to use the HDD method to cross all waterbodies with crossing lengths greater than 100 feet (except Little Slough [MP 62.44] and Big Slough [MP 63.47]). All drilling fluid would be disposed of in accordance with applicable state regulations. In the event that HDD activities result in the inadvertent release of drilling fluids, Gulf South would implement the Project-specific Contingency Plan specified in the *Plan for Containment of Inadvertent Release of Drilling Mud During Horizontal Directional Drilled Wetland and Waterbody Crossings*. Inadvertent release is not anticipated to permanently affect water quality because suspended sediment would be washed downstream (refer to section 2.3.1, *Fisheries Resources*, for discussion regarding potential impact on fisheries during construction-related activities).
- Trench dewatering may be required in some areas to remove accumulated groundwater and precipitation from open trenches. To reduce the rate of water flow and minimize the potential for sedimentation and stream scour, Gulf South would discharge water pumped from trenches and hydrostatic test water through hay bale structures or filter bags in upland areas away from nearby waterbodies.
- Gulf South would construct all proposed facilities with new steel pipe that is free of chemicals and lubricants and is not proposing to chemically treat hydrostatic test water.
- To minimize the risk of inadvertent spills that may contaminate surface water, Gulf South would adhere to proper storage, containment, and handling procedures for fuels and other chemicals, as well as any additional requirements of the FERC Plan and Procedures. Accordingly, all hazardous chemicals, lubricating oils, and fuels used during construction would be stored no less than 100 feet from surface waterbodies. Additionally, heavy equipment would be prevented from parking or being refueled less than 100 feet from surface waterbodies unless appropriate precautions, such as continual monitoring of fuel transfer, secondary containment structures, and utilization of spill kit readiness, are employed. In the event of a spill, Gulf South would follow the protocol outlined in the SPCC Plan to control and remediate spills.
- Gulf South would construct and maintain all proposed facilities in accordance with the Project-specific SWPPP (Gulf South, June 2015a), which identifies BMPs and maintenance and inspection procedures that Gulf South would implement to minimize the discharge of pollutants in stormwater runoff and protect water quality. The design and application of appropriate erosion and sediment controls and stabilization measures, in accordance with the SWPPP and with oversight by a qualified environmental inspector, would minimize the potential for sediment and other pollutants from Project-related construction activities to adversely impact surface waters. Refer to section 2.1, *Geology and Soils*, for additional information on erosion and sediment control measures.
- Gulf South would remove all surplus materials and equipment when in-stream construction and restoration is complete and would collect all trash, litter, and debris and transport it to an approved solid waste disposal facility.
- Routine maintenance activities are not anticipated to affect surface water resources. If maintenance activities involving pipe excavation and repair in or near streams is required, Gulf South would follow the measures in the FERC Plan and Procedures and environmental conditions would be applied as described for construction activities above.

Environmental Analysis

Public Watershed Areas

Construction at the Goodrich Compressor Station would temporarily affect one ephemeral waterbody approximately 4.50 miles upstream from Lake Livingston. Gulf South would implement the measures contained in the FERC Plan and Procedures to minimize impacts on the waterbody; therefore, the Project is not expected to affect the public water supply at Lake Livingston.

Hydrostatic Test Water and Other Water Withdrawals

Gulf South would obtain all necessary permits to withdraw water from the Brazos River. A Temporary Water Use Permit from TCEQ would not be required for Gulf South's proposed withdrawal of hydrostatic testing water from a privately owned lake at MP 22.55 (Subchapter B, Rights in State Water Sec. 11.021, State Water Code). Gulf South would, however, obtain permission from the landowner prior to any withdrawal from the lake. All water allocated from municipal sources would be purchased in accordance with all applicable provisions of the Texas Water Code.

Sensitive Surface Waters

Three 303(d) listed waterbodies, two Ecologically Significant Stream segments, and two Section 10 navigable waterbodies would be crossed by the pipeline using the HDD method. The HDD method would avoid potential impacts on these waterbodies. To minimize potential impacts on surface waters from HDD, Gulf South would follow the procedures outlined in its *Plan for Containment of Inadvertent Release of Drilling Mud During Horizontal Directional Drilled Wetland and Waterbody Crossings*, which would avoid or minimize adverse impacts to water quality in the event of an inadvertent release of drilling mud.

The Project is not anticipated to affect contaminated sediments, areas of primary influence/surface water intakes for public water supplies, National Wild or Scenic Rivers, or rivers listed on the Nationwide Rivers Inventory because they are not known to be present within the Project area.

Site-Specific Deviations (alternate measures) to the FERC Plan and Procedures

As listed in *Site-specific Exceptions to the FERC Procedures* (appendix G), Gulf South is seeking exemptions, proposing alternate measures from the FERC Plan and Procedures in certain instances due to limitations caused by topography, right-of-way requirements, or natural conditions. At MP 1.44, Gulf South proposes to locate an ATWS within 50 feet of an intermittent, unnamed tributary to Lone Tree Creek. Similarly, at MP 41.55, Gulf South proposes to locate an ATWS within 50 feet of an ephemeral, unnamed tributary of Varner Creek. These ATWSs are requested to provide additional trench excavation and spoil storage for the waterbody crossing. Gulf South is also seeking an exemption from the requirement to complete the crossing of a minor waterbody within 24 hours at MP 24.47 due to constructability constraints associated with multiple foreign pipelines present at the crossing location.

Gulf South proposes to minimize the potential for impacts at these locations through the following equal compliance measures: (1) install temporary erosion and sediment control devices as necessary to prevent the flow of soil or heavily silt-laden water into the adjacent waterbody; (2) design and maintain equipment bridges to prevent soil from entering the waterbody; and (3) store spoil at least 10 feet from the water's edge and limit instream construction activities to the minimum time necessary (typically 24 to 48 hours). We find these alternate measures to the FERC Plan and Procedures acceptable.

With implementation of mitigation measures and compliance with FERC Plan and Procedures, no significant impacts to water resources are anticipated.

2.2.3 Wetlands

The USACE and EPA define wetlands as “those areas that are inundated or saturated by surface or groundwater at a frequency and duration sufficient to support, and that under normal circumstances do support, a prevalence of vegetation typically adapted for life in saturated soil conditions” (33 CFR 328.3(b); 40 CFR 230.3(t)). The USACE and EPA regulate wetlands under Section 404 of the Clean Water Act (CWA), and any discharge of dredged or fill material into a wetland requires authorization from USACE.³ In addition, a CWA Section 401 water quality certification would need to be obtained from the RRC prior to USACE issuing a Section 404 authorization.

Existing Wetlands Resources

Wetlands in the Project area were identified and delineated from December 2014 through May 2015 in accordance with USACE’s *Regional Supplement to the Corps of Engineers Wetland Delineation Manual: Atlantic and Gulf Coast Region* (Version 2.0) (USACE, 2010), and were classified using the Cowardin et. al. (1979) wetland vegetation classification system. Approximately 51.66 acres of the 3,212-acre survey area (or 1.6 percent) could not be surveyed due to continuing constructability analysis, ongoing landowner negotiations, or landowner refusal. For areas that could not be field surveyed, wetlands were identified through desktop analysis. If the Project is approved by the Commission, Gulf South would be required to complete site-specific wetland delineations (and other necessary field surveys) prior to obtaining authorization from the Director of OEP to proceed with construction.

Three wetland types were classified in the Project area: Palustrine Emergent (PEM), Palustrine Scrub-Shrub (PSS), and Palustrine Forested (PFO) wetlands. Wetlands classified as PEM are characterized by erect, rooted, herbaceous vegetation; PSS wetlands are characterized by a community of emergent vegetation and woody vegetation less than 20 feet tall; and PFO wetlands are dominated by tree species at least 20 feet tall. A total of 93 wetlands—56 PEM, 4 PSS, and 33 PFO wetlands—were identified in the Project area. Table 2.2-6 summarizes the characteristic vegetation of each wetland type identified in the Project area.

Wetland Classification	Characteristic Plant Species
PEM	Switchgrass (<i>Panicum virgatum</i>), sand spikerush (<i>Eleocharis montevidensis</i>), marsh flatsedge (<i>Cyperus pseudovegetus</i>), yellow nutsedge (<i>Cyperus esculentus</i>), swamp smartweed (<i>Polygonum hydropiperoides</i>), alligator weed (<i>Alternanthera philoxeroides</i>), Pennsylvania smartweed (<i>Polygonum pennsylvanicum</i>), poisonbean (<i>Sesbania drummondii</i>), seedbox (<i>Ludwigia alternifolia</i>), marsh seedbox (<i>Ludwigia palustris</i>), maidencane (<i>Panicum hemitomon</i>), common carpetgrass (<i>Axonopus fissifolius</i>), and Bermudagrass (<i>Cynodon dactylon</i>)
PSS	Chinese tallow (<i>Triadica sebifera</i>), green ash (<i>Fraxinus pennsylvanica</i>), American elm (<i>Ulmus americana</i>), poisonbean, Cherokee sedge (<i>Carex cherokeensis</i>), marsh seedbox, common carpetgrass, and Bermudagrass
PFO	Water oak (<i>Quercus nigra</i>), sugarberry (<i>Celtis laevigata</i>), American elm, green ash, Chinese tallow, Osage-orange (<i>Maclura pomifera</i>), deciduous holly (<i>Ilex decidua</i>), green hawthorn (<i>Crataegus viridis</i>), roughleaf dogwood (<i>Cornus drummondii</i>), Cherokee sedge, Indian woodoats (<i>Chasmanthium latifolium</i>), slender woodoats (<i>Chasmanthium laxum</i>), maidencane, marsh seedbox, and common carpetgrass

³ Authorization under Section 404 is only required for surface waters and wetlands that are considered jurisdictional under CWA; these waters are defined as *Waters of the United States* (33 CFR 328.3).

Environmental Analysis

Impacts and Mitigation

Construction activities could affect wetlands through clearing, soil mixing and compaction from heavy equipment, pipeline trenching, hazardous material (e.g., fuels, lubricants) handling, and backfilling. Impacts from these activities could alter hydric soils, wetland hydrology, and wetland vegetation. There would be no permanent wetland loss because the Project would not require the placement of permanent fill in any wetland. The Project would temporarily affect wetlands during construction, and a permanent operational corridor would be maintained over the pipeline right-of-way but the wetlands would remain.

Pipeline facilities, including access roads and ATWS, would affect 88 wetlands in the Project area, resulting in 19.6 acres of temporary construction impacts, up to 2.0 acres of 10-foot corridor long-term operational impacts, and 5.3 acres of 30-foot corridor long-term operational impacts on wetland resources. The 10-foot corridor centered on the pipeline would be permanently maintained in an herbaceous state (PEM) and the 30-foot corridor (net 20 additional feet) would be maintained as PSS per the allowable maintenance guidelines in the FERC Procedures. Maintenance of the permanent right-of-way during operation of the proposed pipeline would permanently convert PFO wetland to either PEM or PSS wetland. Wetland impacts by cover type for pipeline facilities are provided in table 2.2-7.

Comments were received from the USFWS regarding impacts to wetland forested habitat (footnotes regarding MPs 29.2-34.2 and 41.5-44.9) and FERC also raised concern over impacts to wetlands along Deviations 13 and 14 that are within these same milepost segments commented on by USFWS. To address these concerns and minimize impacts to wetlands to the greatest extent possible, we have included recommended route changes along these sections of the pipeline. See section 3.4 of the EA for additional information on these recommended deviations.

Construction of aboveground facilities would temporarily affect 1.1 acres of wetland, of which 0.3 acre of two PEM wetlands would be affected by construction of the Brazos Compressor Station and 0.8 acre of three PEM wetlands would be affected by construction of the North Houston Compressor Station. Construction of the aboveground facilities would not result in permanent operational impacts on wetlands because any temporary impacts would be restored.

Additional details and maps on wetlands affected by the Project can be found in appendix I.

Gulf South would implement the measures in the FERC Plan and Procedures to the maximum extent practicable to minimize wetland impacts. However, there are places where the topography, right-of-way, and natural conditions make it impractical to implement some of the measures specified in these documents (refer to appendix G, *Site-specific Exceptions to the FERC Procedures*). We find that Gulf South provided sufficient justification for these alternate measures to the Procedures. The primary means that Gulf South is proposing to minimize wetland impacts include: (1) limiting the amount of equipment and use of ATWS in and adjacent to wetlands; (2) using equipment stabilization such as timber mats within wetlands; (3) limiting grading in wetlands; (4) segregating topsoil over the trench line in unsaturated wetlands; (5) restoring wetland contours; and (6) conducting follow-up monitoring to ensure that each wetland becomes re-established successfully. Gulf South would also adhere to all federal, state, and local regulations and permit requirements regarding wetland impacts, such as any mitigation requirements and permit conditions in its CWA Section 404 permit and 401 water quality certification.

The USACE and TPWD comments on the Project's NOI stated that the project is subject to CWA Section 404 permitting and Rivers and Harbors Act Section permitting, and recommended that Gulf South conduct wetland delineations. Gulf South has delineated wetlands as described above under the *Existing Wetland Resources* section. Gulf South submitted their Pre-Construction Notification for Nationwide Permit 12 to the USACE in June 2015. The USFWS has requested Gulf South share their wetland mitigation plan with the USFWS. As previously mentioned, there would be no permanent fill placed in any wetlands, and any mitigation plan developed as part of a Section 404 permit would be

submitted to the USACE, as they are the jurisdictional authority for authorizing mitigation plans and issuing permits under CWA Section 404.

Table 2.2-7 Wetlands Affected by the 36-inch Header Pipeline				
Wetland Type	Number of Wetlands Affected^a	Temporary Construction Impacts (acres)^b	10-foot Corridor Operational Impacts (acres)^c	30-foot Corridor Operational Impacts (acres)^d
Wharton County				
PEM	10	2.0	0.0	0.0
PSS	1	0.0	0.0	0.0
PFO	9	1.0	0.3	0.6
Wharton County Subtotal	20	3.0	0.3	0.6
Brazoria County				
PEM	41	8.6	0.0	0.0
PSS	3	0.2	<0.1	<0.1
PFO	24	7.8	1.7	4.7
Brazoria County Subtotals	68	16.6	1.7	4.7
Project Totals	88	19.6	2.0	5.3
<p>The numbers in this table have been rounded for presentation purposes.</p> <p>^a Number of wetlands affected does not include those features crossed using HDD construction methods, as impacts on these features would be avoided.</p> <p>^b Construction impact acreages were calculated using digital workspace configuration data and digital polygons, which were mapped from field-delineated wetlands using the global positioning system and from the desktop analysis. Construction acreages include temporary workspace, permanent easement, and additional temporary workspaces.</p> <p>^c There would be no operational impacts on PEM wetlands, as these wetlands would revert back to the same type following construction. Operational impacts in this column are based on a 10-foot-wide area in PFO and PSS wetlands that would be converted to other wetland types due to pipeline maintenance.</p> <p>^d There would be no operational impacts on PEM wetlands in this column, as these wetlands would revert back to the same type following construction. Operational impacts on PSS wetlands in this column are based on a 10-foot-wide operational impact that would be converted to herbaceous wetlands due to pipeline maintenance. Operational impacts on PFO wetlands in this column reflect potential for selective thinning of trees within 15 feet of the pipeline that have roots that could compromise the integrity of the pipeline coating.</p> <p>PEM = Palustrine emergent; PFO = Palustrine forested; PSS = Palustrine scrub shrub.</p>				

2.3 FISH, VEGETATION, AND WILDLIFE

2.3.1 Fisheries Resources

Fisheries resources include fish species and their habitats that could potentially be affected by the Project.

Existing Fisheries Resources

The Project would either cross or otherwise potentially affect 231 perennial, intermittent, and ephemeral streams that either support or have potential to support warmwater fisheries (appendix E). The

Environmental Analysis

majority of these surface water crossings (219) consist of streams classified as freshwater, with the remaining 12 considered brackish streams (higher salt content). The demarcation line between freshwater and brackish streams along the pipeline route is estimated to be near MP 60.29 where the pipeline route crosses Farm to Market Road 2004 (TPWD, 2014a). Streams south of this line would be expected to have higher salt content, with salinity increasing toward the coastline. Ten of the 12 brackish streams are intermittent or ephemeral, and two are perennial: Little Slough (MP 62.44) and Big Slough (MP 63.47). No coldwater fisheries would be affected, and the pipeline route would not cross any marine or estuarine waterbodies.

Fish communities in warmwater fisheries typically consist of sport fish, rough fish (not valued for sport fishing), forage minnows, or a combination of the three groups. Fish species that are common to streams in the Project area include shiners (*Notropis* spp. and *Cyprinella* spp.), fathead minnows (*Pimephales* spp.), bullhead catfish (*Ameiurus* spp.), suckers (*Catostomus* spp.), sunfish (*Lepomis* spp.), black bass (*Micropterus* spp.), catfish (*Ictalurus* spp.), temperate bass (*Morone* spp.), gar (*Lepisosteus* spp.), and crappie (*Pomoxis* spp.) (TPWD, 2014b).

The quality of a fishery and the species within that fishery are typically associated with the condition of the surface water that is inhabited. Some fish species are more tolerant of disturbed conditions and poor water quality. In the Project area, these species could include suckers, topminnows (*Fundulus* spp.), bullhead catfishes, and carp (*Cyprinus* spp.) (Klym and Garrett, 2002). Surface waters with higher water quality and less habitat disturbance often support a diverse range of fish, including sport fish populations. In the Project area, these fish species could include blue catfish (*Ictalurus furcatus*), largemouth bass (*Micropterus salmoides*), smallmouth bass (*Micropterus dolomieu*), flathead catfish (*Pylodictis olivaris*), common carp (*Cyprinus carpio*), and alligator gar (*Atractosteus spatula*). In saltwater or brackish habitats, these fish would include red drum (*Sciaenops ocellatus*), black drum (*Pogonias cromis*), and spotted seatrout (*Cynoscion nebulosus*) (TPWD, 2015b). Populations of warmwater sport fish large enough to support sport fisheries are generally restricted to large or moderately sized waterbodies, which, in the Project area, include Brazos River, Oyster Creek, San Bernard River, and Bastrop Bayou.

Fisheries of Special Concern

Fisheries of special concern include those waterbodies that support fisheries of exceptional recreational value (such as those that support trout), those that provide habitat for protected species, or those that are assigned a special state fishery management designation.

None of the waterbodies that would be crossed by the Project are classified as stocked or natural trout fisheries or commercial fisheries (TPWD, 2014c), and no designated recreational fishing areas are within the Project area or would be otherwise affected by the Project (TPWD, 2015b).

The Project would cross segments of the San Bernard River (MP 31.23) and Brazos River (MP 44.92) that have been identified by the Texas Parks and Wildlife Department (TPWD) as Ecologically Significant Stream Segments (ESSSs). ESSSs are ecologically unique stream segments that have been determined to have one or more important ecological functions related to biology, hydrology, and water quality. Two of these important functions relate to fish through the following ESSS criteria: (1) exceptional aquatic life, and (2) threatened and endangered species/unique communities. Both the San Bernard River and Brazos River ESSSs would be crossed using the HDD methodology, avoiding direct impacts on the river and the riparian area. A segment of Bastrop Bayou is also designated as ESSS, but the Project crosses Bastrop Bayou upstream of the area designated as ESSS, also using the HDD crossing methodology.

There are no federally listed fish species in the Project area, but TPWD has listed the blue sucker as threatened in Sabine and Wharton counties. Suitable habitat for this species in the Project area

is found in the Brazos River (MP 44.93), Dry Bayou (MP 45.89), and Bastrop Bayou (MP 59.98), all of which are proposed to be crossed using HDD methodology. See section 2.3.5, *Protected, Threatened, and Endangered Species*, for more information on special-status fish and other aquatic species (e.g., mollusks) in the Project area.

None of the waterbodies that would be crossed or otherwise affected by the Project contain designated Essential Fish Habitat, as defined under the Magnuson-Stevens Fisheries Conservation and Management Act.

Impacts and Mitigation

Potential Project impacts on fish and fish habitat would be primarily related to construction activities in or near surface waters, including increased turbidity, water temperature changes, entrainment of fish (i.e., loss of fish from water diversions), and introduction of pollutants. Surface water withdrawals for hydrostatic testing could also affect fish and fish habitat.

Open-cut construction at surface water crossings would temporarily increase turbidity levels through stream substrate disturbance and suspension of sediments. Vegetation clearing and exposure of bare ground in riparian areas at the crossing could further mobilize and introduce sediments to surface waters, resulting in increased turbidity. If fish are present and unable to move out of the construction area, increased sedimentation and turbidity levels in surface waters could directly affect the physical health of fish, such as damaging or clogging of gills, which could affect respiration and other physiological processes. Increased turbidity can affect fish behavior, such as the inability to feed normally due to decreased visibility and altered responses to predation risk and predator avoidance. Sediment deposition in surface waters could smother aquatic vegetation, cause changes in substrate composition, and bury or suffocate fish eggs and larvae (EPA, 2012b). Loss of stream bank and aquatic vegetation could also affect fish by reducing shade/cover and increasing water temperature, which could result in increased metabolic rates, which can lead to greater respiration rates and oxygen consumption. Altered temperatures can also affect breeding and feeding behavior in some species (Helfman et al., 2009). Potential spills of hazardous materials, such as fuels, lubricants, or solvents, could affect fish and fish habitat should the spill reach a surface water. The effect a hazardous material would have on fish may vary depending on the type and volume of the material released, ranging from no impact to sub-acute (i.e., injury) or acute (i.e., death) impacts.

Potential impacts on fish and fish habitat would be short-term and temporary, and best management practices and adherence to FERC Plan and Procedures would avoid or reduce these potential impacts. In-stream construction is anticipated to take 24 hours or less for minor waterbody crossings and no more than 48 hours for intermediate waterbody crossings. In addition, Gulf South would be required to adhere to measures outlined in its SWPPP and FERC Procedures to minimize sedimentation and turbidity in surface waters, as discussed previously in section 2.2.2. Once construction of a crossing is complete, streambeds and banks would be restored to their pre-construction conditions and contours to the maximum extent practicable, which would prevent erosion and minimize long-term impacts on fish and fish habitat. Hazardous materials spills would be avoided or minimized through implementation of measures in Gulf South's SPCC Plan (Gulf South, June 2015a) and FERC's Procedures.

Surface waters crossed using the HDD method would avoid surface waters and riparian areas and would thereby avoid impacts on fish and fish habitat. The potential does exist for HDD drilling mud to be inadvertently released into a surface water by migrating to the surface through a fracture in a surface water's underlying rock or substrate. In the unlikely event this were to occur, the impact on fish and fish habitat from the release of drilling mud into a surface water would be similar to the turbidity impacts described for the open-cut construction method. To minimize potential impacts on surface waters from HDD, Gulf South would follow the procedures outlined in its *Plan for Containment of Inadvertent Release of Drilling Mud During Horizontal Directional Drilled Wetland and Waterbody Crossings*

Environmental Analysis

(appendix D), which would avoid or minimize adverse impacts on fish and fish habitat in the event of an inadvertent release of drilling mud.

Hydrostatic test water withdrawals and discharge could potentially affect fish and fish habitat by entrainment of fish at intakes, by reducing surface water flows during withdrawal, and by increasing potential for turbidity and channel scouring of surface waters from water discharge. However, these impacts would be avoided or minimized through the use of screening intakes to avoid fish entrainment, maintenance of adequate flow rates to protect aquatic life by avoiding withdrawals during low-flow conditions, compliance with the TCEQ Temporary Water Use Permit, and discharge of water through an energy dissipation device in well-vegetated upland areas.

2.3.2 Vegetation

Vegetation resources include vegetation communities and the plant species that make up those communities that could potentially be affected by the Project.

Existing Vegetation Resources

Construction and operation of the Project would affect five major vegetation cover types: agricultural, open land, forest, developed land, and wetlands and open water (not a vegetation cover type, but includes vegetation along the edges of open water). Field surveys were conducted during December 2014 and May 2015 to verify the major vegetation cover types in the Project area. Table 2.3-1 summarizes the land use and characteristic plant species of each vegetation cover type.

Invasive plant species that occur, or have potential to occur, in the Project area include alligator weed (*Alternanthera philoxeroides*), bermudagrass (*Cynodon dactylon*), Johnsongrass (*Sorghum halepense*), Chinese tallow tree (*Sapium sebiferum*), Chinese privet (*Ligustrum sinense*), and Japanese honeysuckle (*Lonicera japonica*).

Impacts and Mitigation

Project construction and operation would result in temporary and permanent impacts on vegetation. Construction activities would result in clearing, grading, and removal of vegetation in the pipeline right-of-way and within the limits of construction footprint for aboveground facilities. However, construction of the header pipeline would not result in permanent removal and loss of vegetation for the entire right-of-way; there would be a permanently maintained right-of-way (typically 50 feet for upland and 10 feet for wetlands) where vegetation would be maintained for pipeline operations (routine mowing, cutting, or trimming of vegetation). At HDD crossings of surface waters, there would be no vegetation removal between the entry and exit points of the HDD, which would leave riparian vegetation in place. Areas disturbed by construction that are not part of the permanent right-of-way, or are outside of the permanent disturbance area of aboveground facilities and access roads, would be restored to pre-construction contours following the completion of construction activities and allowed to revert to previous conditions or revegetated per Gulf South's *Revegetation Plan* (appendix H), in accordance with the FERC Plan and Procedures. Vegetation within the fenced boundaries of the aboveground facilities would be mowed as needed.

**Table 2.3-1
Characteristic Land Use and Plant Species of the Major Vegetation Cover Types in the Project Area**

Vegetation Cover Type	Description/Land Use in Project Area	Characteristic Plant Species
Agriculture	Cultivated row crops	Corn (<i>Zea mays</i>), cotton (<i>Gossypium hirsutum</i>), grain sorghum (<i>Sorghum bicolor</i>), rice (<i>Oryza sativa</i>), and soybean (<i>Glycine max</i>)
	Cultivated turf grass	Bermudagrass (<i>Cynodon dactylon</i>), St. Augustine grass (<i>Stenotaphrum secundatum</i>), and common carpetgrass (<i>Axonopus fissifolius</i>)
	Improved pasture for livestock grazing and/or hay production	Bermudagrass, common carpetgrass, perennial ryegrass (<i>Lolium perenne</i>), Vasey’s grass (<i>Paspalum urvillei</i>), field clover (<i>Trifolium campestre</i>), smut grass (<i>Sporobolus indicus</i>), and broomsedge bluestem (<i>Andropogon virginicus</i>)
Open Land	Non-forested areas not otherwise classified as agriculture, and include existing utility rights-of-way and unimproved pastures	Bermudagrass, common carpetgrass, smut grass, switchgrass (<i>Panicum virgatum</i>), Vasey’s grass, field clover, annual ragweed (<i>Ambrosia artemisiifolia</i>), Carolina geranium (<i>Geranium carolinianum</i>), curly dock (<i>Rumex crispus</i>), Macartney rose (<i>Rosa bracteata</i>), yellow foxtail (<i>Setaria pumila</i>), poison ivy (<i>Toxicodendron radicans</i>), Canada goldenrod (<i>Solidago Canadensis</i>), Brazilian vervain (<i>Verbena brasiliensis</i>), eastern baccharis (<i>Baccharis halimifolia</i>), and southern dewberry (<i>Rubus trivialis</i>)
Forest	Upland (i.e., non-wetland) forested areas	Live oak (<i>Quercus virginiana</i>), water oak (<i>Quercus nigra</i>), sugarberry (<i>Celtis laevigata</i>), pecan (<i>Carya illinoensis</i>), American elm (<i>Ulmus Americana</i>), green ash (<i>Fraxinus pennsylvanica</i>), Chinese tallow (<i>Triadica sebifera</i>), Osage-orange (<i>Maclura pomifera</i>), trifoliolate orange (<i>Poncirus trifoliolate</i>), yaupon (<i>Ilex vomitoria</i>), deciduous holly (<i>Ilex decidua</i>), green hawthorn (<i>Crataegus viridis</i>), poison ivy, Cherokee sedge (<i>Carex cherokeensis</i>), saw greenbrier (<i>Smilax bona-nox</i>), common carpetgrass, Vasey’s grass, and sawtooth blackberry (<i>Rubus argutus</i>)
Developed	Residential – residences and associated landscapes Industrial – electric/gas utility stations, associated facilities, and transportation corridors	Bermudagrass, common carpetgrass, Vasey’s grass, field clover, annual ragweed, Carolina geranium, yellow foxtail, curly dock, and various ornamental shrubs and trees
Wetland ¹	Palustrine Emergent	Switchgrass, sand spikerush (<i>Eleocharis montevidensis</i>), marsh flatsedge (<i>Cyperus pseudovegetus</i>), yellow nutsedge (<i>Cyperus esculentus</i>), swamp smartweed (<i>Polygonum hydropiperoides</i>), alligator weed (<i>Alternanthera philoxeroides</i>), Pennsylvania smartweed (<i>Polygonum pennsylvanicum</i>), poisonbean (<i>Sesbania drummondii</i>), seedbox (<i>Ludwigia alternifolia</i>), marsh seedbox (<i>Ludwigia palustris</i>), maidencane (<i>Panicum hemitomom</i>), common carpetgrass, and Bermudagrass
	Palustrine Scrub Shrub	Chinese tallow, green ash, American elm, poisonbean, Cherokee sedge, seedbox, common carpetgrass, and Bermudagrass
	Palustrine Forested	Water oak, sugarberry, American elm, green ash, Chinese tallow, Osage-orange, deciduous holly, green hawthorn, roughleaf dogwood (<i>Cornus drummondii</i>), Cherokee sedge, Indian woodoats (<i>Chasmanthium latifolium</i>), slender woodoats (<i>Chasmanthium laxum</i>), maidencane, marsh seedbox, and common carpetgrass

**Table 2.3-1
Characteristic Land Use and Plant Species of the Major Vegetation Cover Types in the Project Area**

Vegetation Cover Type	Description/Land Use in Project Area	Characteristic Plant Species
Open Water	Manmade/natural ponds and streams greater than 100 feet wide with vegetation found along the edges of open water	Black willow, eastern cottonwood (<i>Populus deltoids</i>), poisonbean, marsh flatsedge, Chinese tallow, American elm, and American sycamore (<i>Platanus occidentalis</i>)
¹ See section 2.2.3, <i>Wetlands</i> , for complete analysis on this resource.		

Table 2.3-2 summarizes the Project's temporary (construction) and permanent (operations) vegetation impacts on each cover type. Construction and operation of the pipeline facilities account for 90 percent of all vegetation impacts from the Project. Approximately two-thirds of all Project vegetation impacts would occur within agriculture and open land cover types and approximately 10 percent would occur within forest cover types. Forest cover would be permanently converted to non-forest vegetation types in the permanent right-of-way for the life of the Project. Tree stumps would be cut flush with the ground and left in place, except where removal is necessary to facilitate the creation of a safe and level workspace. Impacts on wetlands are further discussed in section 2.2.3, *Wetlands*, and impacts on developed lands are further discussed in section 2.5.1, *Land Use*.

Additional impacts on vegetation could include the potential introduction and spread of invasive plants during construction. Construction could introduce and increase the spread of invasive plant species from: (1) construction equipment carrying invasive plant seeds and plant parts from infested areas outside the Project into the Project construction area; and (2) from construction equipment disturbing existing invasive plant infestations within the pipeline right-of-way and at the aboveground facility sites. Invasive plants can outcompete and are often more aggressive than native vegetation. The disturbed conditions of the construction site can create an environment where invasive species thrive (e.g., bare ground, compact soil), and the potential introduction and spread of invasive plants can alter vegetation structure, reduce plant species richness, and disrupt the overall plant ecosystem. However, Gulf South is proposing to implement an *Exotic and Invasive Species Control Plan* (appendix J) that includes several management strategies to minimize the spread of invasive plants, such as minimizing bare ground, minimizing movement of invasive plants into the construction site, and monitoring disturbed sites following construction to ensure that revegetation has been successful and that invasive plants have not become established.

An accidental spill or release of hazardous materials (e.g., fuels, lubricants, solvents) during construction or operations could also affect vegetation. A hazardous material's effect on vegetation would vary depending on the type and volume of the material released, and could range from no impact to complete smothering and loss of vegetation. However, potential vegetation impacts from accidental hazardous materials spills and releases would be avoided or minimized through the proposed SPCC Plan (Gulf South, June 2015a).

Table 2.3-2 Construction and Operation Impacts on Vegetation Cover Types (Acres)														
Facility	Agricultural		Open Land		Forest		Developed		Wetland ^a		Open Water		Project Total	
	Const.	Op.	Const.	Op.	Const.	Op.	Const.	Op.	Const.	Op.	Const.	Op.	Const.	Op.
Wharton County														
Pipeline Facilities														
Pipeline	265.5	134.8	33.2	17.9	14.9	8.2	4.5	2.7	4.1	2.7	0.2	0.1	322.4	166.4
ATWS	60.0	0.0	4.5	0.0	0.5	0.0	0.4	0.0	0.2	0.0	0.0	0.0	65.6	0.0
Access Roads	6.3	3.7	5.7	4.2	0.1	0.1	40.9	33.7	0.0	0.0	0.1	0.0	53.1	41.7
Contractor/ Pipe Yards	0.0	0.0	9.5	0.0	0.0	0.0	3.6	0.0	0.0	0.0	0.0	0.0	13.1	0.0
Pipeline Facilities Subtotal	331.8	138.5	52.9	22.1	15.5	8.3	49.4	36.4	4.3	2.7	0.3	0.1	454.2	208.1
Aboveground Facilities														
Wilson Compressor Station ^b	27.8	13.9	0.1	0.1	0.0	0.0	0.0	0.0	0.0	0.0	0.0	0.0	27.9	14
TGPL M&R Station	2.0	1.0	<0.1	<0.1	0.0	0.0	0.0	0.0	0.0	0.0	0.0	0.0	2.0	1.0
Transco M&R Station	2.0	1.8	0.7	0.7	0.0	0.0	0.0	0.0	0.0	0.0	0.0	0.0	2.7	2.5
NGPL M&R Station	1.8	0.9	0.2	0.0	0.0	0.0	0.1	<0.1	0.0	0.0	0.0	0.0	2.1	0.9
Gulf South Index 129 M&R Station	0.0	0.0	5.1	4.5	0.0	0.0	0.0	0.0	0.0	0.0	0.0	0.0	5.1	4.5
HPL-Energy Transfer M&R Station	1.7	1.1	0.0	0.0	0.0	0.0	0.0	0.0	0.0	0.0	0.0	0.0	1.7	1.1
Mainline Valves and other Ancillary Facilities ^c	0.0	0.0	0.1	0.1	0.0	0.0	0.0	0.0	0.0	0.0	0.0	0.0	0.1	0.1
Access Roads	0.6	0.6	3.2	3.2	0.0	0.0	4.0	4.0	0.0	0.0	0.0	0.0	7.8	7.8

**Table 2.3-2
Construction and Operation Impacts on Vegetation Cover Types (Acres)**

Facility	Agricultural		Open Land		Forest		Developed		Wetland ^a		Open Water		Project Total	
	Const.	Op.	Const.	Op.	Const.	Op.	Const.	Op.	Const.	Op.	Const.	Op.	Const.	Op.
Aboveground Facilities Subtotal	35.9	19.3	9.4	8.6	0.0	0.0	4.1	4.0	0.0	0.0	0.0	0.0	49.4	31.9
Wharton County Subtotal	367.7	157.8	62.3	30.7	15.5	8.3	53.5	40.4	4.3	2.7	0.3	0.1	503.6	240.0
Brazoria County														
Pipeline Facilities														
Pipeline	191.5	99.0	121.4	65.4	91.6	47.5	4.5	3.1	20.5	13.2	1.6	1.3	431.1	229.5
ATWS	32.1	0.0	18.7	0.0	6.5	0.0	0.6	0.0	0.2	0.0	0.0	0.0	58.1	0.0
Access Roads	4.8	3.2	21.2	18.0	0.8	0.7	20.5	18.8	<0.1	0.0	0.0	0.0	47.3	40.7
Contractor/Pipe Yards	0.0	0.0	20.6	0.0	0.0	0.0	43.5	0.0	0.0	0.0	0.0	0.0	64.1	0.0
Pipeline Facilities Subtotal	228.4	102.2	181.9	83.4	98.9	48.2	69.1	21.9	20.7	13.2	1.6	1.3	600.6	270.2
Aboveground Facilities														
Stratton Ridge M&R Station	0.0	0.0	2.9	1.9	0.6	0.0	<0.1	<0.1	0.0	0.0	0.0	0.0	3.5	1.9
Mainline Valves and other Ancillary Facilities ^c	0.1	0.1	0.1	0.1	0.0	0.0	0.0	0.0	0.0	0.0	0.0	0.0	0.2	0.2
Aboveground Facilities Subtotal	0.1	0.1	3.0	2.0	0.6	0.0	<0.1	<0.1	0.0	0.0	0.0	0.0	3.7	2.1
Brazoria County Subtotal	228.5	102.3	184.9	85.4	99.5	48.2	69.1	21.9	20.7	13.2	1.6	1.3	604.3	272.3
Fort Bend County														
Brazos Compressor Station	28.8	10.3	0.5	<0.1	0.0	0.0	0.2	0.0	0.2	0.0	0.0	0.0	29.7	10.3

**Table 2.3-2
Construction and Operation Impacts on Vegetation Cover Types (Acres)**

Facility	Agricultural		Open Land		Forest		Developed		Wetland ^a		Open Water		Project Total	
	Const.	Op.	Const.	Op.	Const.	Op.	Const.	Op.	Const.	Op.	Const.	Op.	Const.	Op.
Access Road	<0.1	<0.1	1.2	1.2	0.0	0.0	1.3	1.3	0.0	0.0	0.0	0.0	2.5	2.5
Fort Bend County Subtotal	28.8	10.3	1.7	1.2	0.0	0.0	1.5	1.3	0.2	0.0	0.0	0.0	32.2	12.8
Harris County														
North Houston Compressor Station	0.0	0.0	10.4	5.5	0.0	0.0	1.7	0.6	0.8	0.0	0.0	0.0	12.9	6.1
Access Road	0.0	0.0	0.0	0.0	0.0	0.0	0.2	0.2	0.0	0.0	0.0	0.0	0.2	0.2
Harris County Subtotal	0.0	0.0	10.4	5.5	0.0	0.0	1.9	0.8	0.8	0.0	0.0	0.0	13.1	6.3
Polk County														
Goodrich Compressor Station	0.0	0.0	4.9	0.8	0.0	0.0	2.3	1.7	0.0	0.0	0.0	0.0	7.2	2.5
Polk County Subtotal	0.0	0.0	4.9	0.8	0.0	0.0	2.3	1.7	0.0	0.0	0.0	0.0	7.2	2.5
Sabine County														
Magasco Compressor Station	0.0	0.0	9.2	2.3	<0.1	0.0	1.9	0.7	0.0	0.0	0.0	0.0	11.1	3.0
Sabine County Subtotal	0.0	0.0	9.2	2.3	<0.1	0.0	1.9	0.7	0.0	0.0	0.0	0.0	11.1	3.0
Overall Pipeline Facilities Total	560.2	240.7	234.8	105.5	114.4	56.5	118.5	58.3	25.0	15.9	1.9	1.4	1,054.8	478.3
Overall Aboveground Facilities Subtotal	64.8	29.7	38.6	20.4	0.6	0.0	11.7	8.5	1.0	0.0	0.0	0.0	116.7	58.6
Overall Project Total	625.0	270.4	273.4	125.9	115.0	56.5	130.2	66.8	26.0	15.9	1.9	1.4	1,171.5	536.9

**Table 2.3-2
Construction and Operation Impacts on Vegetation Cover Types (Acres)**

Facility	Agricultural		Open Land		Forest		Developed		Wetland ^a		Open Water		Project Total	
	Const.	Op.	Const.	Op.	Const.	Op.	Const.	Op.	Const.	Op.	Const.	Op.	Const.	Op.

The numbers in this table have been rounded for presentation purposes.

^a Operational land use impacts associated with wetlands have been calculated based on the proposed 50-foot permanent right-of-way. Per FERC Procedures, Gulf South would only maintain a 10-foot cleared easement in wetlands with an additional 20-foot tree exclusion zone (total of 30 feet centered on the pipeline) within the permanent easement. Additionally, sections of right-of-way between HDD entry and exit locations would not be affected by construction or operation to minimize and avoid wetland impacts.

^b Impacts associated with Wilson Compressor Station are inclusive of the Enterprise M&R Station.

^c Impacts associated with the pig launcher and receivers are included in the impact acreage of the facility where they are located (i.e., Wilson Compressor Station, Brazos Compressor Station, TGPL M&R station, Gulf South Index 129 M&R Station, and Stratton Ridge M&R station).

Const. = Construction

Op. = Operation

TGPL = Tennessee Gas Pipeline Company, LLC

NGPL = Natural Gas Pipeline Company, LLC

Transco = Transcontinental Gas Pipe Line Company, LLC

HPL-Energy Transfer = Houston Pipeline Company, LP – Energy Transfer Partners, LP

Enterprise = Enterprise Products Partners, LP

2.3.3 Wildlife

Wildlife resources include terrestrial animal species and their habitats that could potentially be affected by the Project.

Existing Wildlife Resources

Wildlife habitat types in the Project area are consistent with the major vegetation cover types of agriculture, open land, forest, developed, and wetlands and open water that are present in the Project area. The major vegetation cover types in the Project area are described in detail in section 2.3.2, *Vegetation*. Table 2.3-3 summarizes wildlife species that are common to the major vegetation cover types in the Project area.

Habitat/Vegetation Cover Type	Common Wildlife Species
Agriculture	American crow (<i>Corvus brachyrhynchos</i>), mourning dove (<i>Zenaida macroura</i>), common grackle (<i>Quiscalus quiscula</i>), red-winged blackbird (<i>Agelaius phoeniceus</i>), Woodhouse's toad (<i>Bufo woodhousii</i>), and crawfish (<i>Procambarus clarkia</i>)
Open Land	Coyote (<i>Canis latrans</i>), nine-banded armadillo (<i>Dasypus novemcinctus</i>), hispid cotton rat (<i>Sigmodon hispidus</i>), red-tailed hawk (<i>Buteo jamaicensis</i>), American kestrel (<i>Falco sparverius</i>), scissor-tailed flycatcher (<i>Tyrannus forficatus</i>), eastern bluebird (<i>Sialia sialis</i>), eastern racer (<i>Coluber constrictor</i>), and Gulf Coast toad (<i>Bufo nebulifer</i>)
Forest	White-tailed deer (<i>Odocoileus virginianus</i>), striped skunk (<i>Mephitis mephitis</i>), Virginia opossum (<i>Didelphis virginiana</i>), cottontail rabbit (<i>Sylvilagus floridanus</i>), eastern woodrat (<i>Neotoma floridana</i>), northern cardinal (<i>Cardinalis cardinalis</i>), tufted titmouse (<i>Baeolophus bicolor</i>), Carolina chickadee (<i>Poecile carolinensis</i>), little brown skink (<i>Scincella lateralis</i>), and eastern box turtle (<i>Terrapene carolina</i>)
Developed	Coyote, raccoon (<i>Procyon lotor</i>), northern mocking bird (<i>Mimus polyglottos</i>), house sparrow (<i>Passer domesticus</i>), mourning dove, and green anole (<i>Anolis carolinensis</i>)
Wetlands	Swamp rabbit (<i>Sylvilagus aquaticus</i>), great blue heron (<i>Ardea herodias</i>), great egret (<i>Ardea alba</i>), white ibis (<i>Eudocimus albus</i>), red-winged blackbird, green tree frog (<i>Hyla cinerea</i>), northern cricket frog (<i>Acris crepitans</i>), and diamond-back watersnake (<i>Nerodia rhombifer</i>)
Open Water	River otter (<i>Lontra Canadensis</i>), great blue heron, great egret, belted kingfisher (<i>Megaceryle alcyon</i>), mallard (<i>Anas platyrhynchos</i>), bufflehead (<i>Bucephala albeola</i>), southern leopard frog (<i>Rana sphenoccephala</i>), red-eared slider (<i>Trachemys scripta elegans</i>), and diamond-back watersnake

Protected and Sensitive Areas

Protected and sensitive areas include those areas that are managed by federal, state, local, or private entities for the purpose of protecting sensitive habitats that are important for wildlife management efforts.

No protected or sensitive areas would be affected by the Project. The pipeline route would be 0.02 mile north of the San Bernard National Wildlife Refuge (NWR) at its closest point between MP 43.75 and 44.92, and would be 0.01 mile south of a USFWS conservation easement at MP 48.62. The pipeline route would cross a road (MP 45.03) that has a USFWS easement to allow USFWS access to the San Bernard NWR. The San Bernard NWR was established to provide wintering habitat for

Environmental Analysis

migratory birds, including ducks and geese migrating south for the winter and songbirds migrating north to breeding grounds.

The Project pipeline would go through a regionally important forested habitat area known as the Columbia Bottomlands, which is important to many migratory birds for resting, feeding, and replenishment of energy stores after migration across the Gulf of Mexico; the area also provides important yearlong and wintering habitat for a number of birds. The USFWS, Sierra Club and a few landowners raised concerns about impacts on the forested area of the Columbia Bottomlands. However, the area that the pipeline would cross is privately owned and not under the management of any federal, state, local, or private entity. FERC recognizes the importance of the Columbia Bottomlands and evaluated several route options to avoid or minimize impacts on the Columbia Bottomlands. See section 3.5.

Our review of alternative routes, including potentially incorporating a southern route option, would not be able to completely avoid forested impacts. The current proposed route through the Columbia Bottomlands would impact about 25 acres of forest. Any route evaluated to avoid or minimize the resource would not substantially reduce the amount of forest impact, and would still result in impacts on other resources. Migratory bird species of concern associated with impacts on the Columbia Bottomlands would be addressed in Gulf South's *Migratory Bird Conservation Plan* (see our recommendation under section 2.3.4 *Migratory Birds, Consultations*).

The USFWS and five public commenters also raised concern about the Project pipeline crossing another section of the Columbia Bottomlands between MP 41.5-44.9. This section of the pipeline follows existing utility right-of-way, minimizing impacts on forested areas. No other protected or sensitive areas occur within 1 mile of the Project.

Impacts and Mitigation

The Project could affect wildlife through construction-related activities, primarily through habitat removal and construction noise. Direct mortality and injury could also occur from operating construction and maintenance equipment (during operations), but it is likely that most wildlife would be able to leave the immediate area of equipment use.

Wildlife habitat impacts would be consistent with the vegetation cover class impacts provided in table 2.3-2. Common wildlife species that could be affected by removal of these vegetation cover classes are listed in table 2.3-3. While most habitat impacts would be temporary and short-term and would not result in an overall change in the vegetation cover class structure, clearing of habitat along the pipeline right-of-way during construction would alter the structure of and fragment some habitats, most notably forest habitat. Clearing forest habitat could result in a long-term impact on habitat and wildlife because forest would be permanently converted to non-forested habitat for the operational life of the Project. Loss and fragmentation of forest habitat can result in the alteration of wildlife species composition by creating suitable habitat for edge species and removing habitat for interior forest dwelling species. However, based on site visits, field surveys, and review of aerial photos, it is apparent that much of the forest in the Project area has already been fragmented by agricultural land and other developments, including other maintained utility corridors. Even contiguous forested areas crossed by the proposed pipeline route, such as those between MP 29.25 and MP 34.20, are already fragmented by numerous existing utility rights-of-way. Therefore, the Project is not anticipated to significantly contribute to the effects of forest fragmentation in the Project area.

Noise generated during construction could cause potential short-term and temporary impacts on wildlife that may be in the Project area. Wildlife species exhibit different hearing ranges, and all wildlife do not respond the same way to similar sound sources or levels. Wildlife response to sounds depends on a number of factors including, but not limited to, ambient noise levels; construction noise level,

frequency, distance, and duration; weather and atmospheric conditions; and time of day. Construction noise may not affect some wildlife species, but others may be sensitive to noise, forcing individuals to move out of the construction area and expend more energy finding replacement habitat. This disruption of normal behavioral patterns could lead to reduced feeding, increased risk of predation, delayed reproduction, and increased juvenile mortality. However, these potential impacts would be short-term and temporary, lasting only the duration of construction.

Operation of construction equipment or pipeline trenches could also pose a direct impact on wildlife that may be unable to move out of the path of moving equipment or get trapped in trenches, leading to injury or mortality of individuals. Gulf South is proposing that all construction workers participate in training that addresses protective measures should wildlife be encountered during construction or found in trenches prior to commencement of construction during the work day. Training would include instruction for safely removing or relocating wildlife in the immediate Project vicinity. If the Project is authorized, FERC would further require that Gulf South certify that all company personnel, EIs, and contractor personnel be informed of the EI's authority and have been or will be trained on the implementation of the environmental mitigation measures appropriate to their jobs before becoming involved with construction and restoration activities.

An accidental spill or release of hazardous materials (e.g., fuels, lubricants, solvents) during construction or operations could potentially come into contact with wildlife, leading to injury or acute toxic effects. However, potential wildlife impacts from accidental hazardous materials spills and releases would be avoided or minimized through the implementation of measures in the SPCC Plan (Gulf South, June 2015a).

Operations-related impacts on wildlife include noise associated with new aboveground facilities, and potential noise impacts would be the same as described for construction. However, aboveground facilities would be predominantly located within or adjacent to existing industrial facilities or within agricultural areas where wildlife may not be present due to absence of habitat, or, if present, would be acclimated to the noise of industrial and agricultural areas.

2.3.4 Migratory Birds

Migratory birds are species that nest in the United States and Canada during the summer and then migrate to and from the tropical regions of Mexico, Central and South America, and the Caribbean for the non-breeding season. Migratory birds are protected under the Migratory Bird Treaty Act ([MBTA]-16 U.S. Code 703-711) and Bald and Golden Eagles are additionally protected under the Bald and Golden Eagle Act (16 U.S. Code 668-668d). The MBTA, as amended, prohibits the taking, killing, possession, transportation, and importation of migratory birds, their eggs, parts, and nests. Executive Order 13186 (66 Federal Register 3853) was enacted in 2001 to, among other things, ensure that environmental analyses of federal actions evaluate the impacts of actions on migratory birds. Executive Order 13186 directs federal agencies to identify where unintentional take is likely to have a measurable negative effect on migratory bird populations and avoid or minimize adverse impacts on migratory birds through enhanced collaboration with the USFWS. The environmental analysis should further emphasize species of concern, priority habitats, key risk factors, and that particular focus should be given to population-level impacts.

On March 30, 2011, the USFWS and the Commission entered into a Memorandum of Understanding regarding implementation of Executive Order 13186, "Responsibilities of Federal 26 Agencies to Protect Migratory Birds," that focuses on avoiding or minimizing adverse impacts on migratory birds and strengthening migratory bird conservation through enhanced collaboration between the two agencies. This voluntary Memorandum of Understanding does not waive legal requirements under the MBTA, Bald and Golden Eagle Act, Endangered Species Act, Federal Power Act, NGA, or any other statutes and does not authorize the take of migratory birds.

Environmental Analysis

USFWS maintains a list of Birds of Conservation Concern (BCC) that identifies species, subspecies, and populations of all migratory nongame birds that, without additional conservation actions, are likely to become candidates for listing under the ESA. The majority of BCC are a subset of MBTA-protected birds, but some non-MBTA-protected birds are included on the BCC list because their conservation status and efforts are of concern to USFWS. USFWS has established Bird Conservation Regions (BCR) across North America that are ecologically distinct with similar BCC bird communities, habitats, and management issues. The majority of the Project would be within BCR 37 (Gulf Coast Prairie region). The existing Magasco and Goodrich Compressor Stations are within BCR 25 (West Gulf Coast Plain/Ouachitas region). All activities associated with Magasco and Goodrich Compressor Stations would occur within the existing Gulf South property boundaries; therefore, no impacts on migratory birds of special concern are anticipated from the piping modifications and addition of a gas-fired unit at Magasco. For this reason, BCC for BCR 25 is not further discussed. For the majority of the Project in BCR 37, table 2.3-4 provides a summary of the 43 BCC listed in that region.

Bald eagle	Sprague's pipit	Solitary sandpiper
Botteri's sparrow	Swainson's warbler	Whimbrel
Dickcissel	Wallow-tailed kite	Wilson's plover
Grasshopper sparrow	Upland sandpiper	American bittern
Henslow's sparrow	American oystercatcher	Black rail
LeConte's sparrow	Buff-breasted sandpiper	Black skimmer
Loggerhead shrike	White-tailed hawk	Gull-billed tern
Mountain plover	Hudsonian godwit	Least bittern
Nelson's sharp-tailed sparrow	Marbled godwit	Least tern
Painted bunting	Lesser yellowlegs	Sandwich tern
Peregrine falcon	Long-billed curlew	Yellow rail
Prothonotary warbler	Red knot	Audubon's shearwater
Seaside sparrow	Reddish egret	Band-rumped storm-petrel
Sedge wren	Short-billed dowitcher	
Short-eared owl	Snowy plover	

Source: USFWS, 2008.

Of the 43 BCC species listed for BCR 37, five do not have ranges that extend into the Project area, 23 species only occur in the Project area as occasional migrants during winter, and the remaining 15 having breeding ranges that extend into the Project area. However, of these 15, only six have suitable breeding habitat in the Project area: bald eagle, grasshopper sparrow, loggerhead shrike, painted bunting, Swainson's warbler, and white-tailed hawk. Section 2.3.5, *Protected, Threatened, and Endangered Species*, provides additional information on bald eagle and white-tailed hawk.

Gulf South is currently preparing a *Migratory Bird Conservation Plan* to avoid, minimize, and/or compensate for impacts on migratory birds and their habitats and address USFWS's July 24, 2015 correspondence. The TPWD also recommended that vegetation removal be avoided during the primary migratory bird nesting season in their letter dated January 23, 2015.

Impacts and Mitigation

Impacts on migratory birds in the Project area would be similar to the impacts described in section 2.3.3, *Wildlife*. The *Migratory Bird Conservation Plan* may include measures such as avoiding vegetation clearing during the breeding season to avoid incidental removal of active nests, and/or conducting pre-construction surveys during the nesting season to ensure that there are no active nests in the area to be cleared. In the event an active nest is found, Gulf South would coordinate with USFWS to ensure protection of the active nest in accordance with the MBTA. Given consultation with USFWS on migratory birds of special concern is not yet complete, **we recommend that:**

- **Prior to construction, Gulf South should file with the Secretary a copy of the Migratory Bird Conservation Plan developed in consultation with the USFWS for the Project.**

In addition, implementation of vegetative measures including routine maintenance activities being conducted outside of sensitive bird seasons, and establishing habitat restoration after construction, as identified in the FERC Plan and Procedures, would further minimize impacts on migratory bird habitats.

2.3.5 Protected, Threatened, and Endangered Species

Protected, threatened, and endangered species are those species for which state or federal agencies require an additional level of protection under law, regulation, or policy. Field surveys were conducted by Gulf South from December 2014 to May 2015 to characterize and determine if protected, threatened, and endangered species habitat was present within the Project area.

Federally Protected Species

Federal agencies are required under Section 7 of the Endangered Species Act (ESA), as amended, to ensure that any actions authorized, funded, or carried out by the agency would not jeopardize the continued existence of a federally listed endangered or threatened species, or result in the destruction or adverse modification of the designated critical habitat of a federally listed species. As the lead federal agency authorizing the Project, the FERC is required to consult with the USFWS and/or the National Oceanic and Atmospheric Administration Fisheries to determine whether federally listed endangered or threatened species or designated critical habitat are found in the vicinity of the Project, and to evaluate the proposed action's potential effects on those species or critical habitats.

Fourteen species are federally listed as threatened or endangered in the counties where the Project is proposed, including one marine mammal, one fish, four birds, five turtles, and three plants (table 2.3-5). Suitable habitat was identified for only one of these species, the whooping crane. None of the remaining species would be affected by the Project because the species' ranges are outside of the Project area or there is no suitable habitat that would be affected by the Project.

Environmental Analysis

Federally Listed Species (Federal Status)	County Listed	Effect Determination	Effect Determination Justification
West Indian Manatee (E)	Brazoria, Harris	No effect	This marine mammal utilizes coastal habitats (e.g., bays and mouths of rivers). No suitable habitat is present in Project area.
Piping plover (T)	Brazoria	No effect	This bird utilizes open sandy habitats (e.g., beaches or lakeshores). No suitable habitat is present in Project area.
Red knot (T)	Brazoria	No effect	This bird utilizes estuarine habitats (e.g., coastal inlets and bays). No suitable habitat is present in Project area.
Red-cockaded woodpecker (E)	Polk, Sabine	No effect	This bird utilizes open pine forests with minimal underbrush. There are no forested impacts associated with compressor station construction in Sabine and Polk counties. No suitable habitat is present in Project area.
Sprague's pipit (C)	Brazoria, Harris	NA	Suitable winter habitat is present in the Project area and the species may be affected; however, this species is highly mobile and would likely displace to similar adjacent habitats during construction.
Whooping crane (E)	Brazoria, Fort Bend, Wharton	May affect, not likely to adversely affect	Winters along the Texas coast at Aransas NWR. The Project area may contain stopover habitat. However, this species is highly mobile and would likely avoid construction.
Atlantic hawksbill sea turtle (E)	Brazoria	No effect	This is a marine and estuarine species. No suitable habitat is present in Project area.
Green sea turtle (T)	Brazoria	No effect	This is a marine and estuarine species. No suitable habitat is present in Project area.
Kemp's ridley sea turtle (E)	Brazoria	No effect	This is a marine and estuarine species. No suitable habitat is present in Project area.
Leatherback sea turtle (E)	Brazoria	No effect	This is a marine and estuarine species. No suitable habitat is present in Project area.
Loggerhead sea turtle (T)	Brazoria	No effect	This is a marine and estuarine species. No suitable habitat is present in Project area.
Louisiana pine snake (C)	Sabine	NA	In Texas, this species inhabits the pineywoods region. Project activities associated with the compressor station in Sabine County would occur at existing or former sites. No suitable habitat is present in Project area.
Smooth pimpleback (C)	Fort Bend, Brazoria, Wharton	NA	This mollusk prefers medium to large rivers with low to medium flow and sand, mud, and gravel bottom. Potentially suitable habitat exists in the Project area (Brazos River); however, the Brazos River would be crossed via HDD, avoiding in-water work and impact on the species. Pre-construction surveys would be conducted in perennial streams crossed by open-cut pipeline method to ensure no effect on the species.
Texas fawnfoot (C)	Fort Bend, Brazoria, Wharton	NA	The only known remaining population in Texas occurs within the Brazos River, which would be crossed via HDD, avoiding in-water work and impacts on this mollusk. Pre-construction surveys would be conducted in perennial streams crossed by open-cut pipeline method to ensure no effect on the species.

Federally Listed Species (Federal Status)	County Listed	Effect Determination	Effect Determination Justification
Texas pimpleback (C)	Wharton	NA	This mollusk prefers medium to large rivers with gravel, sand, or mud bottoms. Potentially suitable habitat for the species exists within the Project area (San Bernard River); however, the San Bernard River would be crossed via HDD, avoiding in-water work and impacts on this species. Pre-construction surveys would be conducted in perennial streams crossed by open-cut pipeline method to ensure no effect on the species.
Smalltooth sawfish (E)	Harris, Brazoria	No effect	This is a marine and estuarine species. No suitable habitat is present in Project area.
Texas golden gladeceess (E)	Sabine	No effect	Project activities associated with the compressor station in Sabine County would occur at an existing site; therefore, no suitable habitat is present in Project area.
Texas prairie dawn (E)	Fort Bend, Harris	No effect	Project activities associated with the compressor station in Harris County would occur at a previously disturbed site; therefore, no suitable habitat is present. Suitable habitat was not observed within the Project area in Fort Bend County during field surveys.
Texas trailing phlox (E)	Polk	No effect	Project activities associated with the compressor station in Polk County would occur at an existing site; therefore, no suitable habitat is present in Project area.
E = endangered; T = threatened; C = candidate; NA = Candidate species are provided no statutory protection under ESA and are not given an effect determination.			

In addition, five species are listed as candidate species, including one bird, one reptile, and three mollusks (table 2.3-5). Candidate species are provided no statutory protection under the ESA; however, candidate species were included with the assessment of threatened and endangered species. One of the candidate species—Sprague’s pipit—could be affected by the Project because suitable winter habitat is in the project area. No suitable habitat for the Louisiana pine snake is present in the Project area in the county that the species is listed. It is unlikely that the three candidate mollusks would be affected by the proposed pipeline as a result of the HDD crossing method that would be used at rivers where they would most likely be present. However, habitat cannot be ruled out at smaller stream crossings where open-cut pipeline methods would be used. Comments were received from TPWD and USFWS regarding the potential for impacts to federal candidate and state listed freshwater mussel species and both agencies requested pre-construction surveys. Therefore, **we recommend that:**

- Prior to construction, Gulf South should conduct pre-construction surveys for federal candidate mollusks Smooth pimpleback, Texas fawnfoot and Texas pimpleback at perennial stream crossings where open-cut trenching methods are proposed, including Lone Tree Creek, Clarks Branch, unnamed tributaries of Linnville Bayou and the San Bernard River, Mound Creek, an unnamed tributary of Mound Creek, unnamed tributary of Varner Creek, Little Slough, and Big Slough, to ensure candidate mollusks would not be impacted by Project activities. Gulf South should coordinate with the Texas Parks and Wildlife Department on appropriate mitigation measures for mollusks listed as Threatened in the state of Texas. Gulf South should file with the Secretary, for the review and written approval by the Director of OEP, the resulting survey reports for the federal candidate mollusks.**

Environmental Analysis

The bald eagle is no longer listed under the ESA but is still protected under the MBTA and the Bald and Golden Eagle Protection Act. While no bald eagle nests were observed in the Project area during field surveys, they may be present in the area year-round and suitable breeding habitat does exist in the Project area. However, in the event a bald eagle nest is observed in the Project area during or prior to construction, Gulf South would adhere to the buffer requirements established in USFWS's *National Bald Eagle Management Guidelines* (2007).

State Protected Species

Laws and regulations pertaining to Texas state-listed threatened and endangered species are found in Chapters 67, 68, and 88 of Texas administrative code, which state that no person may capture, trap, take, or kill, or attempt to capture, trap, take, or kill endangered fish or wildlife; and that no person may take, possess, propagate, transport, export, sell or offer for sale, or ship any species of fish or wildlife listed by TPWD as endangered or threatened. These laws and regulations protect the individual species, but do not protect their habitat (unlike the federal ESA, which protects federally listed species' habitat in addition to the individual species).

Forty-eight species are state-listed as threatened or endangered in the Project counties; 44 of these species would not be affected by the Project because the species' ranges are outside of the Project area or there is no suitable habitat that would be affected by the Project (Gulf South, June 2015a). The remaining four state-listed species with suitable habitat in the Project area are the state-listed as threatened bald eagle, white-faced ibis, white-tailed hawk, and alligator snapping turtle.

Impacts and Mitigation

Federally Protected Species

The whooping crane and Sprague's pipit could be affected by the Project given suitable habitat for both species occurs in the Project area. The Project *may affect*, but is *not likely to adversely affect* the whooping crane if an individual is in the area during construction, and impacts would be similar to those described in section 2.3.3, *Wildlife*, and section 2.3.4, *Migratory Birds*. The Project would have *no effect* on the remaining federally listed species. We request USFWS concur with these determinations. Because ESA Section 7 consultation with USFWS is not yet complete, **we recommend that:**

- **Gulf South not begin construction of the Project facilities until:**
 - a. **The FERC staff completes any necessary ESA Section 7 consultation with the USFWS for the whooping crane; and**
 - b. **Gulf South has received written notification from the Director of the OEP that construction and/or use of mitigation may begin.**

Bald eagles could be impacted by Project activities if they are present during construction. Impacts on bald eagle, if present during construction, would be similar to those described in section 2.3.3, *Wildlife*, and section 2.3.4, *Migratory Birds*. Further discussion of bald eagles are described below.

State Protected Species

Impacts on the bald eagle, white-faced ibis, white-tailed hawk, and alligator snapping turtle would be similar to those described in section 2.3.3, *Wildlife*. TPWD, in their comments on the NOI, stated that Gulf South should consult the TPWD county lists and conduct on-the-ground field surveys to determine if state-protected species could be present in the Project area, and incorporate actions into the project to avoid impacts to state listed species.

Bald eagles may be present in the Project area year-round and suitable breeding habitat exists in the Project area; no bald eagle nests were observed in the Project area during field surveys. However, in the event a bald eagle nest is observed in the Project area during or prior to construction, Gulf South would be required to adhere to the buffer requirements established in USFWS's *National Bald Eagle Management Guidelines* (2007).

White-tailed hawks are year-round residents, and suitable nesting habitat is present in the Project area. If an active raptor nest is encountered prior to or during construction, Gulf South would be required to stop construction and notify the TPWD to identify recommended measures to avoid impacts, and to comply with the Migratory Bird Conservation Plan that is developed with USFWS (see section 2.3.4 *Migratory Birds*).

White-faced ibis are colonial nesting birds with large conspicuous rookeries. One known colonial nesting bird rookery has been documented within 1 mile of the Project area, and no rookeries were observed during field surveys. The USFWS expressed concerns about rookeries within 1,000 feet of the project during the nesting season from February 15 to September 1. In the event that a rookery is observed in the Project area prior to or during construction, Gulf South would minimize impacts by adjusting the Project route to avoid the rookery. Any substantive route change would require review and approval by the director of OEP. In addition, rookeries would be addressed in Gulf South's *Migratory Bird Conservation Plan* that would be developed with USFWS prior to construction (see section 2.3.4 *Migratory Birds*).

Alligator snapping turtles could occur in suitable waterbodies crossed by the Project in Brazoria County; however, once construction begins, it is anticipated that individuals in the Project area would relocate. Additionally, the majority of the waterbodies that would be crossed by the Project that contain suitable habitat would be crossed using the HDD method, avoiding direct impacts on the water and associated wildlife.

Because of potential project impacts to state listed species, **we recommend that:**

- **Prior to construction, Gulf South should consult with the TPWD on the need for surveys for the state-listed threatened species including bald eagle, white-faced ibis, white-tailed hawk, and alligator snapping turtle, and file with the Secretary the correspondence with any recommendations.**

2.4 CULTURAL RESOURCES

Section 106 of the National Historic Preservation Act (NHPA), as amended, requires FERC to take into account the effects of its undertakings on historic properties and to afford stakeholders and the Advisory Council on Historic Preservation an opportunity to comment. Historic properties are prehistoric or historic districts, cultural or historical landscapes, sites that are important to prehistory or history, buildings, structures, objects, or properties of traditional, religious, or cultural importance that are listed or eligible for listing on the National Register of Historic Places (NRHP). Gulf South is assisting FERC by providing information, analyses, and recommendations, as allowed by the Advisory Council on Historic Preservation's regulations for implementing Section 106 at 36 CFR Part 800.2(a)(3), and outlined in FERC's *Guidelines for Reporting on Cultural Resources Investigations for Pipeline Projects* (18 CFR 380.12(f)).

2.4.1 Consultation

On March 4, 2015, FERC sent copies of the NOI for the Project to a wide range of stakeholders, including the Texas Historical Commission (THC) and federally recognized Indian tribes (Tribes) that may have an interest in the Project area. The NOI contained a paragraph about Section 106 of the NHPA,

Environmental Analysis

and indicated that the notice was also used to initiate consultations with the Texas State Historic Preservation Officer (SHPO) to solicit their views and those of other government agencies, interested Tribes, and the public on the Project's potential effects on historic properties.

In addition to FERC's notification process, Gulf South separately contacted the SHPO and Tribes that might attach cultural and religious significance to cultural resources in the Project area. On December 9 and December 10, 2014, Gulf South sent letters of notification of the Project to SHPO, Alabama-Coushatta Tribe of Texas (ACT), Chitimacha Tribe of Louisiana, Comanche Nation, Coushatta Tribe of Louisiana, Jena Band of Choctaw Indians, Tonkawa Tribe of Oklahoma, and Tunica-Biloxi Indiana Tribe of Louisiana.

State Historic Preservation Officer

In a letter dated December 17, 2014, the SHPO stated that the proposed scope of work meets the state's requirements for archaeological survey for cultural resources, and looks forward to reviewing the draft survey report. FERC distributed a supplemental NOI on May 20, 2015. In a response dated May 29, 2015, the SHPO commented that the Project area has a moderate to high probability of containing significant cultural resources, that an archaeological investigation is warranted, and requested additional information when it is available. On June 15, 2015, Gulf South submitted the draft report for the *Phase I Cultural Resources Assessment* to THC for Section 106 review. In a response dated July 7, 2015, the SHPO concurred that newly recorded sites 41WH133, 41WH134, 41WH135, 41WH136, 41WH137, and 41WH138 are ineligible for inclusion in the NRHP based on the lack of buried deposits, cultural features, or temporally diagnostic materials. The SHPO further commented that the project may proceed without further consultation, provided that no significant archaeological deposits are encountered during construction and development of the property.

Federally Recognized Indian Tribes

In a letter to Gulf South dated January 6, 2015, the Comanche Nation responded to Gulf South's letter and declared that the location of the Project had been cross-referenced with its site files, and an indication of "No Properties" of cultural importance to the tribe was identified.

In an e-mail to Gulf South dated January 7, 2015, the Jena Band of Choctaw Indians requested a copy of the *Phase I Cultural Resources Survey* and all other pertinent information regarding the Project area. The draft *Phase I Cultural Resources Survey* was submitted to the Jena Band of Choctaw Indians on August 26, 2015.

In a letter to Gulf South dated January 23, 2015, the ACT requested consultation on a government-to-government basis with FERC and that consultation occur prior to the initiation of all ground-disturbing activities. ACT also stated that proposed Project "areas include areas of historical and cultural significance to the Tribe" and that proposed expansion or alteration of the existing Goodrich Compressor Station could affect current and future use of fee simple lands under the ownership of ACT. This correspondence was included in Gulf South's June 2015 Filing. Consequently, FERC staff sent a letter to ACT on July 6, 2015 and an email to ACT on July 8, 2015 to acknowledge their concerns and provide additional information regarding the NOI, Supplemental NOI, and the opportunities for consultation. Upon request by FERC to Gulf South in data request letters on August 6, 2015 and September 15, 2015, Gulf South contacted ACT to discuss their concerns. ACT provided a letter to Gulf South's cultural resources consultant on September 25, 2015 confirming that "no known impacts to cultural assets of the Alabama-Coushatta Tribe of Texas are anticipated in conjunction with this proposal, based upon all activities to occur within the existing compound."

On July 6, 2015, FERC sent letters inviting the following Tribes to review the Project and to provide assistance in identifying properties of traditional, religious, or cultural importance that may be

affected by the Project: ACT, Alabama-Quassarte Tribal Town, Chitimacha Tribe of Louisiana, Comanche Nation, Jena Band of Choctaw Indians, Tonkawa Tribe of Indians of Oklahoma, Coushatta Tribe of Louisiana, and Tunica-Biloxi Indiana Tribe of Louisiana. We did not receive any responses.

2.4.2 Overview and Inventory Results

Consistent with FERC application requirements and Section 106 of the NHPA, the Project must make a reasonable and good-faith effort to identify historic properties within the Project's area of potential effects (APE) (36 CFR 800.16(d)) and to take into account any potential effects, direct or indirect, the undertaking could have on properties listed or considered eligible for listing in the NRHP.

The Project APE is defined as the area where any direct and/or visual effects on historic properties listed or considered eligible for listing in the NRHP could occur. The APE for direct effects is limited to the area of potential ground disturbance or any portion thereof, which could be physically altered or destroyed by the Project. The cultural resources investigation includes a 300-foot-wide mainline corridor, a 100-foot-wide corridor for all access roads, and the total acreage of compressor stations and contractor/pipe yards, ATWSs, and workspace footprints. In all, the APE for the Project totals approximately 1,054.8 acres, with depths of impact affected by excavation anticipated to range from 4 to 6 feet for pipeline trenching and excavation. The APE for indirect (visual) effects is considered to be the geographic area from which any permanent infrastructure has the potential to visually diminish or alter the setting of an NRHP-listed or NRHP-eligible property.

Records Review

Gulf South conducted a background cultural resources and environmental literature search utilizing THC site files and resource databases to identify previously recorded cultural resource sites, historic structures, and properties listed in the NRHP and designated historic districts or state landmarks that could potentially be affected by the Project. Previously recorded cultural resource site forms, reports of archaeological investigations, general historical documents, and secondary sources concerning the background of the area were reviewed. The records search included a review of all site records and previous surveys on file within a 1-mile radius of the Project APE. Soil data, U.S. Geological Survey 7.5-minute topographic quadrangles, historic maps, aerial photographs, and contemporary geologic and physiographic features were also examined.

Documentation concerning the history of the area was used to model prehistoric and historic settlement patterns in relation to the landscape and terrain characteristics as well as cultural patterns and regional trends.

No historic properties are within or directly adjacent to the Project APE and no historic structures listed as eligible for the NRHP are located within the viewshed of any of the proposed above-ground facilities.

Survey Methods

The objectives of the *Phase I Cultural Resources Assessment* were to: (1) locate cultural resource sites within the APE; (2) delineate the vertical and horizontal extent of any newly identified sites; (3) provide a preliminary evaluation of each site's eligibility for listing in the NRHP; and (4) assess any potential for the Project to directly or indirectly affect historic properties or other sensitive cultural resources.

The cultural resources investigations were conducted between December 2014 and May 2015 and consisted of intensive pedestrian surveys augmented by shovel test pits and bucket auguring at select locales with the potential for deeply buried cultural resources. Surveys were conducted across all tracts

Environmental Analysis

where land access was voluntarily provided by landowners. Archaeological survey transects were placed 30 meters apart, and shovel tests were excavated at intervals ranging from 30 to 100 meters. Modifications to the survey regime were made in areas with high surface visibility, steep slopes, or widespread surface disturbance.

Survey Results

Through May 2015, approximately 64.98 miles of the pipeline route, 35.83 miles of proposed access roads, 42.11 acres of contractor/pipe yards, and 106.28 acres of aboveground facilities had been surveyed for cultural resources.

Six new archaeological sites consisting of five historic artifact scatters (41WH133, 41WH134, 41WH135, 41WH136, and 41WH137) and the remnants of a historic residential development associated with the New Gulf Sulfur Plant (41WH138) were identified. All six sites do not possess sufficient data or integrity to meet the criteria of eligibility for listing in the NRHP, and no further work is recommended. In a response dated July 7, 2015, the SHPO concurred all six sites are ineligible for inclusion in the NRHP. No historic buildings or structures listed in or eligible for the NRHP are within the viewshed of any of the proposed aboveground facilities.

Cultural Resources Studies Remaining

Due to ongoing landowner negotiations, field surveys have not been completed for 0.63 mile of the 36-inch proposed header pipeline (23 acres), the Stratton Ridge M&R Station (3.5 acres), three contractor/staging yards (approximately 20 acres), and two access roads (approximately 2.5 acres).

2.4.3 NRHP Unanticipated Discovery Plan

Gulf South would implement its *Plan for the Unanticipated Discovery of Historic Properties and Human Remains during Construction* (appendix K), which includes procedures to follow in the event that historic properties and/or human remains are encountered during construction. The plan is consistent with FERC guidelines for reporting on cultural resource investigations for pipeline projects and describes the procedures for dealing with unanticipated discoveries during the course of Project construction. The plan also provides direction and guidance to construction contractor personnel as to the proper actions to be followed in the event of an unanticipated discovery. FERC staff finds the plan to be acceptable.

2.4.4 Compliance with NHPA

Compliance with Section 106 of the NHPA has not been completed for the proposed Project **the following is recommended** to ensure that the FERC's responsibilities under the NHPA and its implementing regulations are met:

Gulf South should not begin construction of facilities and/or use of staging, storage, or temporary work areas and new or to-be-improved access roads until Gulf South files with the Secretary:

- a. the additional addendum reports or plans for any previously unreported areas and the SHPO's comments;**
- b. the ACHP is afforded an opportunity to comment if historic properties would be adversely affected; and**
- c. the FERC staff reviews and the Director of OEP approves the cultural resources reports, and notifies Gulf South in writing that construction may proceed.**

All material filed with the Commission containing location, character, and ownership information about cultural resources must have the cover and any relevant pages therein clearly labeled in bold lettering: “CONTAINS PRIVILEGED INFORMATION--DO NOT RELEASE.”

2.5 LAND USE, RECREATION, AND AESTHETICS

2.5.1 Land Use

The proposed Project would affect 1,171.5 acres of land, including 536.9 acres of permanent impacts associated with the new permanent right-of-way, access roads, and aboveground facilities. Existing land uses in the Project area consist primarily of agricultural, open land, forest, industrial, wetlands, open water, and residential. Natural gas companies like Gulf South are required to obtain easements from landowners to construct and operate natural gas facilities, or acquire the land on which the facilities would be located. To acquire a new easement, Gulf South would negotiate with landowners located along the proposed Project alignment. Landowners would be compensated for signing an easement document that gives the applicant permission to make use of their property. In addition, for the use of either new or existing easements, Gulf South may pay landowners for the loss of certain uses of their property during and after construction, the loss of other resources, and any damage that may occur.

If Gulf South and a landowner cannot reach an agreement, Gulf South could seek an easement under eminent domain. The use of eminent domain is given to companies for Commission-authorized projects under Section 7(h) of the NGA and the procedures set forth under the Federal Rules of Civil Procedure (Rule 71A), and may be used to obtain the right-of-way and ATWS areas necessary to construct and operate an authorized project. A court, either state or federal, would determine the compensation that a company must provide the landowner and specify the terms of the easement.

General Impacts from Pipeline Facilities

Construction and Permanent Right-of-Way

Construction of the proposed Project would include the acquisition of new permanent easements necessary for operation, as well as temporary construction rights-of-way necessary to facilitate pipeline installation. In total, the pipeline would require approximately 753.5 acres of construction right-of-way, consisting of 395.9 acres of permanent right-of-way and 357.6 acres of temporary workspace (construction use only). A detailed description of the proposed header pipeline alignment is found in Chapter 1.0.

Gulf South would generally use a 100-foot-wide construction right-of-way for pipeline installation, and would acquire 50 feet of new permanent right-of-way centered on the pipeline or adjacent to the existing rights-of-way in areas where the pipeline is co-located with other utilities. The pipeline would be co-located with existing utility easements (mostly other pipelines and power lines) for approximately 36 percent of the pipeline route. Where co-located, the right-of-way would typically overlap 5 feet with existing easements; in these situations, an additional 10 feet of ATWS could be obtained on the existing parallel easements for topsoil storage where there is sufficient width to do so safely and where it is allowed by agreement with the foreign line operators.

Following pipeline installation, the 50-foot right-of-way would be maintained as open land in accordance with the FERC Plan and Procedures, with the exception of wetlands, which would generally be allowed to revert to prior conditions over the majority of the right-of-way. Gulf South would maintain a 10-foot-wide cleared right-of-way through wetlands in accordance with the FERC Plan and Procedures. To ensure pipeline integrity and to maintain regular access to the pipelines, no structures would be built within the permanent right-of-way.

*Environmental Analysis*Road and Major Utility Crossings

The locations of all public and private roads and major utilities crossed by the proposed Project are shown on maps in appendix A and appendix C. Roads within the Project study area include maintained unpaved private roads, paved private roads, municipal streets, and state highways. Potential temporary impacts associated with roadway crossings include disruption of traffic flows, disturbance of existing underground utilities such as water and sewer lines or other gas pipelines, and hindrance of vehicle access. To minimize short-term effects on local access and traffic, Gulf South is proposing to complete roadway crossings within one day. There are no anticipated permanent impacts on the existing use of the roadways or utilities crossed by the proposed Project header pipeline.

Additional Temporary Workspace

The proposed Project includes 123.7 acres of ATWS for use during construction. ATWS are working areas in addition to the construction right-of-way, and are used in locations where site-specific conditions require additional space to accomplish some of the Project construction activities. Gulf South proposes to use ATWSs to facilitate construction at road, railroad, wetland, waterbody, and utility line crossings; for equipment and material storage; for equipment turnarounds; at crossover and tie-in locations; in areas with steep side slopes; for areas where full right-of-way topsoil segregation would be done; and at hydrostatic test water withdrawal locations. Gulf South is proposing to place ATWSs at least 50 feet from the edges of wetlands and waterbodies unless site-specific constraints require an alternate placement. The locations of the ATWSs are identified on the Project alignment sheets in Gulf South, June 2015a. The majority of ATWSs would be located on agricultural lands, and all ATWSs would be returned to pre-construction land uses once construction is complete.

Contractor/Pipe Yards

Gulf South proposes to use six temporary contractor/pipe yards in the vicinity of the proposed Project to support construction activities. Contractor/pipe yards would affect 77.2 acres consisting primarily of previously disturbed industrial land. Two of the parcels are naturally vegetated or partially vegetated and would require some vegetation clearing prior to use. Following completion of construction in an area, the contractor/pipe yards would be returned to pre-construction conditions. Table 2.5-1 identifies the MP, name, proposed use, and current land use of the contractor/pipe yards proposed for Project construction.

Table 2.5-1 Summary of Proposed Contractor/Pipe Yards for the Project				
Milepost	Name	Proposed Use	Current Use	Acres of Temporary Disturbance
22.05	Contractor/Pipe Yard 1	Materials and equipment storage	Open Land Industrial	13.1
Offline	Contractor/Pipe Yard 2	Materials and equipment storage	Industrial	4.5
Offline	Contractor/Pipe Yard 3	Materials and equipment storage	Industrial	10.7
Offline	Contractor/Pipe Yard 4	Materials and equipment storage	Industrial	5.6
Offline	Contractor/Pipe Yard 5	Pipe storage	Industrial	22.7
56.65	Contractor/Pipe Yard 6	Materials and equipment storage	Open Land	20.6

Source: Gulf South, June 2015a.

Access Roads

Gulf South proposes to use a mix of existing public/private roads (51 roads in total) and new access roads (18 roads in total) to support construction and operation of the proposed Project. Gulf South would construct and/or modify by improvement 69 roads requiring 110.9 acres for the proposed Project. A total of 45 roads designated as permanent access roads (92.9 acres) would be used to access aboveground facilities and to maintain access to the header pipeline right-of-way for operation and maintenance purposes. The Project would also require 24 temporary access roads, totaling approximately 18 acres of new, temporary disturbance. These 18 acres are proposed to be returned to pre-construction conditions and land uses following completion of the proposed Project. New access roads for construction would be designed to allow for the passage of a wide range of vehicles, including high-clearance vehicles and heavy trucks. All but one existing road would be improved or modified for construction equipment and vehicles. Improvements and modifications would consist of graveling or application of mats to stabilize the road surface, the placement of culverts to assist with drainage, and/or road widening to accommodate construction vehicles.

Proposed access roads and the existing land uses they cross are described in detail in table L-1 in appendix L, and summarized below. The Access Road identification references (e.g., AR-P-2) are found on the topographic maps in appendix A. Gulf South would:

- Build and permanently maintain nine new roads (four for pipeline facilities in Brazoria County and five for aboveground facilities).
- Permanently maintain 36 existing roads (10 for pipeline facilities in Wharton County and 19 in Brazoria County, with 7 for aboveground facilities).
- Build nine new roads for temporary use (three for pipeline facilities in Wharton County and six in Brazoria County).
- Modify 15 existing roads for temporary use (8 for pipeline facilities in Wharton County and 7 in Brazoria County).

Because the majority of Project roads would consist of upgraded existing roads, the current land uses in these areas is primarily industrial.

Aboveground Facilities

Compressor Stations

The proposed Project includes the construction of three new compressor stations and modification of two existing compressor stations. The five new or modified compressor stations would use 88.8 acres during construction and 35.9 acres during operation.

Gulf South would construct, own, operate, and maintain three new compressor stations as a part of the proposed Project. A new gas-fired compressor station (the Wilson Compressor Station) would be constructed along the proposed pipeline in Wharton County. Two new electric compressor stations (the Brazos Compressor Station in Fort Bend County and the North Houston Compressor Station in Harris County) would be constructed along Gulf South's existing Index 129 pipeline.

Gulf South would modify one existing compressor station (the Goodrich Compressor Station in Polk County) and one former compressor station (the former Magasco Compressor Station in Sabine County) located along the existing Index 129 pipeline. Both existing facilities would receive piping and valving modifications to allow for reversal of the traditional direction of gas flow, and the former Magasco Compressor Station would also be improved by the addition of a new gas-fired compressor unit.

Environmental Analysis

Land use within the permanent operational footprint of the compressor stations would be converted to industrial. Land use at the new proposed Wilson Compressor Station and Brazos Compressor Station is predominantly agricultural, while the current land use at the North Houston Compressor Station is predominantly open land. While the modifications at the Goodrich Compressor Station and Magasco Compressor Station would occur within the existing facility boundaries, locations currently classified as open land within those boundaries would be converted to industrial use at both sites.

Meter and Regulator Stations, Valves, and Other Ancillary Facilities

Gulf South proposes a total of seven M&R stations along the 66-mile header pipeline in Wharton and Brazoria counties. These stations would require 17.1 acres for construction, 11.9 acres of which would be used during operation. Current land use at these stations includes agricultural, open land, and forest, which would be permanently converted to industrial use in the 11.9-acre operational footprint of the M&R stations.

The proposed Project includes four MLVs along the proposed pipeline at MPs 11.61, 36.22, 51.16, and 58.95. The MLVs would be constructed within the new permanent easement of the header pipeline. Land uses at the proposed MLVs consists of agricultural and open land. Construction of the MLVs would affect 0.23 acre, all of which would be within the operational footprint of the MLVs and, therefore, permanently converted to industrial use.

Pig launchers and/or receivers are proposed for construction within the boundaries of the Wilson Compressor Station, Brazos Compressor Station, TGPL M&R Station, Gulf South M&R Station, and Stratton Ridge M&R Station; therefore, the land use impacts associated with the construction and operation of the pig launchers and/or receivers are included in the impacts associated with those facilities.

2.5.2 General Impacts on Existing Land Uses

Existing land uses in the Project area, arranged in order of acres affected by the proposed Project, are described below. In addition, table M-1 in appendix M summarizes the land uses affected by construction (temporary and permanent) and operation (permanent) of the proposed Project.

Agricultural

Agricultural land accounts for approximately 53 percent of the Project area and includes areas actively used for cultivated row crops, turf grasses, and hay production or improved pasture for livestock grazing. Field surveys of the Project area conducted by Gulf South identified the primary crops under active cultivation as corn, cotton, grain sorghum, rice, and soybeans.

Construction on 625 acres of agricultural land would result in short-term impacts from the proposed Project. The impacts on agricultural areas from Project construction activities would include the loss of any row crops within the construction work area, the disturbance of pasture or hay in areas used for livestock grazing, and the disruption of farming operations (including the temporary loss of access). To reduce adverse impacts on soil resources from construction activities, Gulf South would implement the measures in its SWPPP (Gulf South, June 2015a) and FERC's Plan and Procedures. During construction, Gulf South would remove and segregate up to 12 inches of topsoil, and would backfill subsoil and then topsoil following pipeline installation. Segregating topsoil during construction activities would help maintain soil productivity in agricultural areas that would otherwise be lost through compaction or comingling topsoil with lower-fertility subsoil. In addition, Gulf South would reimburse agricultural landowners (based on the market prices for their specific products) during easement negotiations for damages or loss of production as a result of the Project's construction activities.

Construction activities could affect existing drainage and irrigation systems, and could result in changes to hydrology that would adversely affect agricultural lands. To mitigate potential effects, Gulf South would be responsible for working with landowners to identify and locate existing drainage or irrigation systems and repairing or replacing any such systems that were damaged by construction. To limit effects on the hydrology of agricultural lands, Gulf South would be required to return these areas to their original contour post-construction and to work with landowners to identify and correct any new drainage or ponding issues caused by the proposed Project. Comments from three landowners expressed concern that the ability to conduct rice farming operations on their properties could be adversely affected where the Project disturbed the water-holding clay layer under the top soil. For areas currently or historically used for rice farming, Gulf South would have additional soil bores performed to identify areas of clay soils underlain by permeable sub-soils that could be adversely affected by disturbance from project excavation. Disturbance of the clay soil layer in these locations could affect the land's ability to retain irrigation water required for successful rice farming. Gulf South has committed to including measures to reduce the potential for water loss in these agricultural areas in its Remediation Plan, which would be filed before construction is authorized, with Gulf South's Implementation Plan. We have included a recommendation in section 2.1.2, Soil Setting and Impacts, for Gulf South to file its Remediation Plan for the review and approval by the Director of OEP.

The proposed Project would affect 270.4 acres of agricultural lands within the permanent operational area, 240.7 acres of which would be restored to their original use. Agricultural lands within the operational footprint of aboveground facilities (29.7 acres) would be permanently converted to industrial use. Areas within the operational footprint of aboveground facilities would experience permanent adverse effects on the agricultural use in the Project area. While areas within the permanent pipeline right-of-way would be allowed to return to the original use, landowners would be restricted in their ability to change crops to trees or place structures (e.g., barns or sheds) within the permanent pipeline right-of-way easement.

Open Land

Open land accounts for approximately 23 percent of the Project area and includes areas of unimproved pasture, areas of scrub-shrub vegetation, and existing utility rights-of-way.

The proposed Project would use 273.4 acres of open land during construction. The primary impacts on open land would be from the removal of vegetation and disturbance to soils. With the exception of areas within the operational footprint of aboveground facilities, impacts would be short term because areas would be allowed to return to pre-disturbance conditions. Following the completion of construction activities, Gulf South would reseed per the recommendations of NRCS (Sanders, 2015), the NRCS *Conservation Practice Standard Critical Area Planting* (NRCS, 2014a), Gulf South's *Revegetation Plan* (appendix H), and the FERC Plan. The 20.4 acres of open land within the operational footprint of aboveground facilities would be permanently converted to industrial use.

Construction of the proposed Project would affect areas of unimproved pasture that may be used for livestock grazing. Potential impacts from activities in unimproved pasture could include removal of vegetation used as forage, exclusion of livestock from the active construction area, or temporary removal of fencing. Gulf South would commit to identifying and working with landowners using open lands as pasture prior to and during construction to avoid effects on livestock grazing. When crossing pastures with existing livestock fences, Gulf would install temporary gates as needed to ensure that livestock do not escape.

Industrial

Industrial land accounts for 11 percent of the Project area and includes existing aboveground facilities, roads and railroads, and other developed non-residential lands. Industrial lands are either

Environmental Analysis

sparsely vegetated or lack vegetation due to the presence of impervious surfaces such as cement foundations, pavement, gravel pads, or bare and compacted land with a hard clay surface.

The proposed Project would temporarily affect 128.9 acres of industrial land during construction, 66.3 acres of which would be required for operation of the pipeline, aboveground facilities, and permanent access roads. Expansion at existing aboveground facilities could result in temporary impacts on the use of those facilities. Except within the operational footprint of aboveground facilities or where the industrial use included a structure inconsistent with maintenance of the permanent right-of-way, existing industrial land uses would typically resume following construction.

Where construction crosses or otherwise alters existing roadways, short-term effects could occur. Roadways are proposed to be crossed using open-cut methods or by boring. Where roadways are crossed using open-cut methods, effects would include delays and temporary loss of access, as well as construction noise, dust, and increased traffic. Because roads are often co-located with water lines and other utilities, construction in these areas could potentially affect other services but would likely be avoided by pre-construction coordination. Delays and loss of access would not occur on roadways crossed using HDD. Refer to table 1.7-1 for the list of HDD crossings, including roads and highways.

Gulf South would maintain safe and accessible conditions during construction at road crossings per the requirements of the FERC Plan, and would coordinate with affected counties and landowners (for private roads) in accordance with existing regulations. To minimize effects on local access and traffic, Gulf South would typically complete roadway crossings within one day.

Forest

Forests account for 10 percent of the Project area, and typically consist of hardwoods. Refer to section 2.3.2 for additional information on typical vegetation in forest ecosystems in the Project area.

Construction activities would require that 115.0 acres of forested land be cleared. Areas outside of the permanent pipeline right-of-way would be allowed to re-establish and regenerate, resulting in a return to pre-construction conditions. Because of the time required for trees to reach maturity, such regeneration would occur over the long term. Gulf South would commit to providing support of reestablishment of forest vegetation where indicated in guidelines established in the FERC Plan.

Within the 56.5 acres where forest lands occur in the permanent pipeline right-of-way or within the operational footprint of aboveground facilities, trees would not be allowed to regenerate due to potential impacts to interfere with pipeline and facility integrity. In permanent pipeline right-of-way, this would result in the permanent conversion of lands to open lands (i.e., scrub shrub).

Wetlands

Wetlands account for 2 percent of the Project area and are characterized as palustrine emergent, palustrine scrub shrub, and palustrine forested. Detailed descriptions and characteristics of these wetland types are included in section 2.2.3 of this document. Construction activities would disturb approximately 26.0 acres, with 15.9 acres in the new permanent right-of-way. Only wetlands in the permanent right-of-way would be maintained in an herbaceous state in accordance with the FERC Procedures. To minimize long-term potential impacts, Gulf South would be restricted to clearing a 10-foot corridor centered on the pipeline through wetland areas for operation and maintenance. In areas crossed by HDD, no right-of-way clearing would be done over the drilled section and no permanent pipeline right-of-way would be maintained through the wetland (refer to table 2.2-7 for a summary of wetland impacts and table 1.7-1 for list of HDD locations).

Open Water

Open water accounts for less than 1 percent of the Project area and includes lakes, ponds, streams, and rivers greater than 100 feet in width that would be crossed by the proposed Project (refer to section 2.2.2 of this document for additional information). Construction activities would affect 1.4 acres of open water. Following the completion of construction activities, all open water areas would be restored to pre-construction conditions. To minimize effects on major or sensitive waterways (such as the Brazos River and Bastrop Bayou), Gulf South is proposing to cross using HDD (refer to table 1.7-1 for the list of proposed HDD locations).

Residential

Residential land accounts for less than 1 percent of the Project area and includes single- and multiple-family dwellings in developed subdivisions and rural areas. Residential lands also include landscaping associated with residences. Construction activities would affect 1.3 acres of residential land, 0.5 acre of which would be permanently converted to industrial use during operations. Potential impacts on residential lands and structures, along with mitigation and other measures proposed to limit effects, are described in section 2.5.3 below. Construction methods proposed for residential areas are described in section 1.6 and further detailed in section 2.5.3.

2.5.3 Residential Areas and Planned Developments

Existing Residences and Structures near the Proposed Project

Fifty structures are within 50 feet of the edge of the construction workspace of the proposed Project. Structures within 50 feet of the construction work area are the most likely to experience effects from construction and, to a lesser extent, operation of the proposed Project. As distance to the construction work area increases, impacts on structures, particularly residences, decrease. The most common impacts on residences during construction relate to temporary disturbances, such as to access, and noise and dust. As noted in table 2.5-2, a total of 14 residential structures are located within 25-feet of the construction right-of-way. During operation, residential landowners would be restricted from constructing permanent structures in permanent pipeline right-of-way.

Construction impacts on adjacent residences and associated structures could include noise and dust generated by construction equipment and personnel; trenching of roads or driveways resulting in temporary loss of access; increases in traffic; removal of landscaping or screening vegetation; damage to utilities; or removal of fences, sheds, or trailers from the right-of-way.

Gulf South has committed to implementing the following measures to minimize construction impacts on residences and other structures.

- Construction activities would generally occur during daytime hours wherever feasible.
- Safety fencing would be placed around the edge of the construction area adjacent to any residences for a distance of 100 feet on either side of the residence.
- As many trees as possible would be retained on residential properties, and Gulf South would dispose of and clear vegetation from the property as negotiated by the landowner and Gulf South.
- Lawns and landscaping would be restored, along with walls or any other structures damaged or removed during construction, to pre-construction conditions as negotiated by the landowner and Gulf South.

Environmental Analysis

- Prior notice would be provided to landowners if construction is planned close to residences and construction requires the removal of private property features (e.g., gates or fences).
- Topsoil would be segregated where appropriate, or at the request of the landowner.
- Disruption to utilities would be avoided where possible and Gulf South would provide as much notice as possible to the landowner should the need to disrupt utilities arise.
- Residential properties would be cleaned up, and backfill would occur immediately following installation of the pipeline.
- Property would be revegetated post-construction at the first seasonal opportunity.
- Specialized construction techniques would be employed to minimize disturbances to residences (e.g., stovepipe or drag section techniques) where feasible.
- Affected landowners and adjacent landowners would be notified no later than 1 week prior to the start of construction.
- Traffic flow and emergency vehicle access would be maintained on residential roadways, and traffic detail personnel and/or detour signs would be used where appropriate.
- Any section of trench left open at the end of the workday would be fenced off or covered with a steel plate.
- Road surfaces near residences would be inspected periodically and, if necessary, cleaned of any soil and other debris.

Refer to section 1.6 for additional details on construction techniques associated with the proposed Project.

Because residences within 50 feet of construction are the most likely to be adversely affected by the proposed Project, Gulf South would implement its *Residential Construction Implementation Plan* (appendix N). As outlined in that plan, Gulf South would implement the following additional measures to minimize construction impacts on residences and other structures within 50 feet.

- All workspace limitations and construction techniques that are outlined in the *Residential Construction Implementation Plan* would be implemented.
- Gulf South would not excavate the trench until the pipe is ready to be installed, and would backfill the trench immediately after installation is complete.
- Gulf South would maintain vehicle access to residences at all times.

In addition to residences adjacent to the construction and operation areas, the proposed Project would include the removal of three structures. One residence at MP 57.15, one shop at MP 57.15, and one storage container at MP 57.18 would be acquired by Gulf South and removed prior to construction (see table 2.5-2). Also, refer to appendix O for the Site-specific Residential Crossing Drawings for each residence that would be within 25-feet of the construction right-of-way. Gulf South would acquire the property from the affected landowner, who has not filed any comments with the Commission regarding the Project.

OEP reviewed the site-specific Residential Construction Plans and finds them acceptable. However, any resident expected to be directly affected by the header pipeline construction is encouraged to provide comments to FERC on the plans as they relate specifically to an individual's property.

Following the completion of construction activities within the residential property, Gulf South would restore the property, including landscaping, in accordance with the FERC Plan, site-specific measures identified in appendix O, and any additional agreements with the landowner. Post reclamation, landowners would continue to have use of the right-of-way where such use would not interfere with Gulf South's easement rights for construction and operation of the pipeline system. However, no structures would be allowed within the permanent right-of-way, and landowners would be prohibited from constructing any permanent structure including, but not necessarily limited to, homes, barns, sheds, garages and outbuildings, decks, playgrounds, poles, guy wires, catch basins, swimming pools, trailers, leaching fields, septic tanks, and any other structures or objects not easily removed.

One commenter expressed concern that noise, emissions, light pollution, and other disturbances from operation of the Wilson Compressor Station would result in adverse effects on their nearby property. We reviewed the location of the compressor station in relation to the commenter property; residences associated with this concern are approximately 0.8-1.0-mile south from the compressor station. The Wilson Compressor Station site is buffered to the north and partially to the south by dense wooded areas and agriculture. As a result, no significant adverse impacts from the Wilson Compressor Station on residential receptors is not anticipated.

Gulf South would work to address concerns raised by stakeholders during the design and construction phase of the Project. In addition, Gulf South would supply landowner notification letters explaining procedures to follow in the event the landowner has any concerns or problems during construction. The *Environmental Complaint Resolution Plan* (Gulf South, June 2015a) outlines these procedures and provides an example of the letter that would be distributed to affected landowners prior to construction. To ensure tracking and resolution of any landowner complaints, **we recommend the following:**

- **Gulf South shall include in its biweekly status report a copy of a table that contains the following information for each problem/concern identified by landowners through the environmental complaint resolution plan:**
 - a. **the identity of the caller and date of the call;**
 - b. **the location by milepost and identification number from the authorized alignment sheet(s) of the affected property;**
 - c. **a description of the problem/concern; and**
 - d. **an explanation of how and when the problem was resolved, will be resolved, or why it has not been resolved.**

We conclude that with implementation of the proposed construction methods, *Residential Construction Implementation Plan* (appendix N), and the availability of the *Environmental Complaint Resolution Plan* (Gulf South June 2015a), impacts on residences and landowners would be minimized to the greatest extent practicable and would not be significant.

Planned Developments

The planning departments in the affected counties were contacted to identify planned residential, industrial, and commercial developments within 0.25 mile of the proposed Project. Two sites were identified in the city of Angleton near the header pipeline route: an industrial park and a gas station (Worfe, 2015). These planned developments are 0.19 mile south of MP 56.80 and 0.27 mile south of MP 57.10, respectively; the estimated timeframe for the construction of both sites is between summer 2015 and spring 2016 (Bowles, 2015). Neither identified planned development is within the construction footprint for the proposed Project, nor were there additional future planned developments within 0.25 mile of the proposed Project (Hatcher, 2015; Sloan, 2015; Palomo, 2015).

Environmental Analysis

Structure ID	Structure	Approximate Milepost	Distance from Pipeline (feet)	Distance from Edge of Construction Workspace (feet)
1	Meter Shed	4.73	48	23
2	Shed	10.64	93	53
3	Trailer House	13.32	64	15
3A	Pump Shed	13.32	64	10
4	Barn	19.87	98	5
6	Storage Building	22.08	115	38
7	Barn	24.48	130	14
8	Shed	24.52	65	32
9	Shed	25.29	28	Within
12	Warehouse	56.98	57	28
13	Storage Building	57.03	33	3
14	Storage Building	57.07	44	8
16	Shed	57.15	113	39
17**	House	57.15	0	Within
18	Shed	57.15	57	Within
19**	Shop	57.15	0	Within
20	Shop	57.15	84	4
21**	Storage Container	57.18	0	Within
22	House	57.20	37	9
23	Shed	57.20	51	Within
25	House	57.24	32	4
26	Shed	57.24	54	20
27	Shed	57.40	33	4
28	House	57.40	71	40
29	Shed	57.41	36	6
30	House	57.41	71	28
31	House	57.42	71	31
32	Shed	57.42	47	17
33	Trailer House	57.42	44	15
34	Shed	57.43	45	16
35	Trailer House	57.40	44	17
36	Shed	57.45	60	30
37	Trailer House	57.45	44	18

**Table 2.5-2
Structures Occurring within 50 feet of the Construction Right-of-Way**

Structure ID	Structure	Approximate Milepost	Distance from Pipeline (feet)	Distance from Edge of Construction Workspace (feet)
38	Trailer House	57.46	44	18
39	Trailer House	57.47	48	26
40	Trailer House	57.48	46	23
41	Trailer House	57.49	46	24
42	Trailer House	57.50	56	33
43	Trailer House	57.51	46	22
44	Trailer House	57.52	46	25
45	Shed	57.52	43	19
46	Trailer House	57.52	44	21
47	Shed	57.53	49	24
49	Trailer House	57.56	47	22
50	Shed	57.56	50	26
52	Shed	57.56	74	48
53	Shed	62.50	46	Within
54	Shed	63.36	92	25
56	Shed	63.50	41	Within
58	Building	64.80	109	23

Source: Gulf South, June 2015a.
**Indicates structures Gulf South would negotiate to acquire and remove.

Future planned development yet to be identified would be precluded from being constructed within the proposed Project right-of-way. Gulf South would continue to coordinate with county planning departments, development authorities, and development interests to identify other potential conflicts. Also, see section 2.10, Cumulative Impacts for additional information about planned or future developments.

2.5.4 Public Land, Recreation, and Other Designated Areas

Public or Conservation Land

The proposed Project would not come within 0.25 mile of any National Park System Units. National Park System Units include national parks, monuments, preserves, historic sites, historical parks, memorials, battlefields, military parks, cemeteries, recreation areas, seashores, lakeshores, rivers, parkways, trails, and other designations managed by the U.S. National Park Service (NPS, 2010a, 2014a). In addition, there are no Indian reservations, National Wilderness Areas, or registered National Landmarks within 0.25 mile of the proposed Project (NPS, 2014b, 2014c; U.S. Forest Service, 2014). Finally, the proposed Project would not come within 0.25 mile of any state parks or forests, or state wildlife management areas (TPWD, 2014d, 2014e).

Environmental Analysis

The proposed pipeline route would come within 0.02 mile (approximately 100 feet) of the USFWS San Bernard NWR (between MP 43.75 and MP 44.92) and would cross a USFWS access road easement (at MP 45.03) used by USFWS to access the San Bernard NWR (approximately 0.37 mile north of the proposed header pipeline at MP 45.03). The San Bernard NWR extends from the Gulf of Mexico into the Brazos and San Bernard river basins. The pipeline would also pass within 0.01 mile (approximately 50 feet, south of MP 48.62) of a USFWS conservation easement (Davis, 2015). Gulf South coordinated with USFWS to avoid direct impacts on the conservation easement. Additionally, Gulf South would follow the requirements of the FERC Plan and Procedures to minimize potential impacts on the San Bernard NWR properties. No other NWRs are known with 0.25 mile of the proposed Project (USFWS, 2014).

No Conservation Reserve Program lands are located within 2 miles of the proposed Project pipeline route (Sullivan, 2015). The USDA Farm Service Agency's Conservation Reserve Program is a voluntary program for agricultural landowners to assist in the prevention of topsoil erosion and conservation of natural resources. No impacts on this resource are anticipated.

No areas crossed by the proposed Project are enrolled in the NRCS Farm and Ranch Lands Protection Program and there are no known specialty crops grown on affected lands in the Project area (Ross, 2014).

The proposed Project pipeline would come within 0.01 mile south of Wetland Reserve Program (WRP) land from MP 46.02 to MP 46.14, and within 0.01 mile west of WRP land at MP 47.53 (Ross, 2014). The WRP is a voluntary conservation program managed for landowners by NRCS and is aimed at the protection, restoration, and enhancement of wetlands to achieve the greatest wetland functions and optimum wildlife habitat. Gulf South has coordinated with NRCS in the routing of the proposed Project and has committed to employing the BMPs in the FERC Plan and Procedures, which would reduce potential impacts in the identified WRP locations adjacent to the Project. No additional WRP land occurs within 0.25 mile of the proposed Project (NRCS, 2014b).

The proposed Project header pipeline would be approximately 0.04 mile west (MP 50.62) of the Texas Historic Landmark Munson Cemetery in Brazoria County. Designated as a Landmark in 1966, the cemetery was created in 1850 by Mordello Stephen Munson as a burial tract for his friends and family. The proposed Project would not cross the boundaries of the cemetery, and no impacts on the cemetery are anticipated. Gulf South would follow its *Plan for the Unanticipated Discovery of Historic Properties and Human Remains During Construction* (appendix K) should any human remains be encountered during construction.

Natural, Recreational, or Scenic Areas

Gulf South's proposed Project would cross TPWD-managed ESSs at the San Bernard River (MP 31.23) and the Brazos River (MP 44.93), as described previously in section 2.3.1 (TPWD, 2001). The ESSS designation prevents state agencies or political subdivisions from financing the construction of a reservoir within designated river or stream segments (16.051(f) of the Texas Water Code). Following recommendations provided by TPWD in its letter dated January 23, 2015, Gulf South would cross the San Bernard River and the Brazos River via HDD. The use of HDD would avoid development directly in the channel of these designated waterways, reducing the potential for adverse impacts. Refer to sections 2.2.2 and 2.3.1 for additional information on impacts on rivers from the proposed Project.

No natural, recreational, or scenic areas, outside of the aforementioned ESSs, were identified in the Project area. Natural, recreational, or scenic areas include waterways in or designated for study for inclusion in the Nationwide Rivers Inventory, National Wild and Scenic Rivers System designated waterways, National Scenic Byways, National Trails System, and Recreational River System; wilderness areas designated under the Wilderness Act; or any state or local recreational parks (NPS, 2014d, 2010a,

2010b; Federal Highway Administration, 2014; Brazoria County Parks Department, 2015; TPWD, 2015d).

2.5.5 Coastal Zone Management Areas

The Coastal Zone Management Act was passed in 1972 to achieve “effective management, beneficial use, protection, and development” of the nation’s coastal zone. The Coastal Zone Management Act requires participating states to implement management programs to achieve these goals. According to the maps of the Texas Coastal Zone from the Texas General Land Office’s Coastal Management Program (Texas General Land Office, 2014) funded by the National Oceanographic and Atmospheric Administration, a portion of the proposed header pipeline from approximately MP 61.70 to MP 65.61, the Stratton Ridge M&R Station, and a pig receiver would be within the Coastal Zone Boundary. All activities or developments that affect Texas’ coastal resources and require a federal permit or license are evaluated for compliance with the Coastal Zone Management Act through the “federal consistency” process. RRC is the responsible agency for this consistency review in Texas. In a letter dated March 22, 2015, RRC determined that activities authorized by USACE under Nationwide Permit 12 – Utility Line Activities are consistent with the goals and policies of the Texas Coastal Management Program.

Gulf South filed its request for authorization to USACE under Nationwide Permit 12 on June 12, 2015, and has indicated that it assumes authorization under this permit to confer an automatic determination of consistency with the Texas Coastal Management Program. A Consistency Determination with the Coastal Zone Management Act would be required prior to construction. Because we must ensure that the Project is consistent with the provisions of the Coastal Zone Management Act, **we recommend:**

- **Prior to construction, Gulf South shall file with the Secretary documentation of the authorization from USACE and/or RRC indicating that Gulf South’s Project is consistent with the Texas Coastal Management Program.**

2.5.6 Contaminated Sites

The proposed Project facilities do not contain and are not within 0.50 mile of any known contaminated sites (EPA, 2014). Gulf South consulted with landowners, and TCEQ determined that there is a non-hazardous industrial waste disposal site approximately 0.17 mile north of MP 36.36 (Crouch-Elliot, 2015). Gulf South has avoided this site by routing the proposed pipeline south of the site, and the Project would not cross the non-hazardous waste site. Gulf South has filed an *Unanticipated Discovery of Contamination Plan*, which addresses how any currently unknown hazardous materials would be identified, tested, and disposed of.

2.5.7 Visual Resources

The proposed Project route would not cross any federal, state, or locally designated scenic routes, trails, waterways, or other officially designated scenic areas, but would cross two Ecologically Significant Rivers and Streams. In addition, the Munson Cemetery, a Texas Historic Landmark, is located just east of the Project route at approximately MP 50.62, but a low brick wall with an iron fence and trees within and surrounding the cemetery largely prevent views of the alignment. The Project route would pass through rural residential areas (refer to table 2.5-2), and these residences would have short-range views of the proposed construction. There are no major parks or recreational features within view of the proposed header pipeline route, but there may be local, undesignated recreational areas such as fishing or swimming holes with views of the proposed Project.

As described in section 2.5.1, *Land Use*, the proposed header pipeline would pass primarily through a patchwork of agricultural, pasture, and forest lands. Small portions of the Project route would

Environmental Analysis

also pass through rural residential areas and across waterbodies and associated riparian areas. The predominance of flat agricultural and pasture lands would allow for increased foreground to middleground views of the Project route. However, mature trees and shrubs associated with hedgerows, forest lands, riparian corridors, and property landscaping would often prevent background views. Forest lands are generally limited to individual parcels that are surrounded by agricultural and pasture lands, and forest lands can also extend out from bordering riparian areas in a few locations. The majority of waterways that would be crossed by the Project route are narrow, with thinner bands of riparian vegetation flanking the banks. The proposed header pipeline would also cross mostly two-lane, paved, dirt, and gravel rural roadways, with the exception of Highway 59, Texas Route 35, Texas Route 288, and County Road 288.

Several comments were received from landowners about potential impacts from route Deviation 13 (MPs 29-34) on the aesthetic, recreational, and land use benefits of their property. To address these concerns, we have included a recommendation for a southern route variation for that section of pipeline. See section 3.5 of the EA for additional information on that recommended deviation.

The existing Magasco Compressor Station is surrounded by forest lands, with no viewers, and is accessed by a rural roadway that passes by rural residences. The existing Goodrich Compressor Station is in an area with a number of roadways and nearby industrial/commercial and light-density rural residential land uses, and is surrounded by a mixture of open space, residential lots with mature trees and shrubs, and forest lands. The proposed North Houston Compressor Station would be in a developed area with nearby commercial and medium-density residential land uses with associated mature trees and shrubs. The Union Pacific Railroad and remnant patches of agricultural open space and forest lands are also present, and construction of a new highway abuts the parcel to the south, with associated staging area and detention basin evident to the west of the proposed compressor station site. The proposed Brazos Compressor Station would be northeast of an existing Frito-Lay Factory and distribution center in an agricultural and pasture land area; there are a few rural residences within a mile of the site, but none are closer than 0.7 mile. The proposed Wilson Compressor Station along the new header pipeline route would be northwest of an existing natural gas facility that is situated within an agricultural and pasture land area, intermixed with forest lands. There are a few rural residences south of the existing natural gas facility, in proximity to the proposed compressor station, but views are blocked by mature hedgerows. The seven M&R stations and four MLVs are proposed to be located primarily within agricultural and open land use areas, with some proposed in forested areas.

Primary viewers affected by the proposed header pipeline, compressor stations, M&R stations, and MLVs would include rural residential viewers, motorists, recreational viewers, and agricultural and industrial workers. Rural residential and recreational viewers would have high sensitivity to visible changes because they have longer-term views and a higher sense of ownership over available views. Motorists and industrial workers would have moderately low to low sensitivity to visible changes because they have shorter-term, intermittent views and are focused on driving or work tasks. The visual sensitivity of agricultural workers can range from high to moderately low, depending upon if the workers are owners or long-time workers who are very familiar with and have a high sense of ownership over available views versus if the workers are seasonal and have less vested interest in views. The proposed Project facilities would be consistent with other similar oil and gas production and distribution facilities found in the region in terms of size and scale.

Impacts and Mitigation

Construction of the proposed header pipeline would occur in a transient, linear manner along the Project route and entail installation of an underground pipeline via clearing, ditching, placement, backfilling, and restoring and reseeding disturbed areas. Therefore, construction of the pipeline would be occurring and visible for only short periods of time in any one location.

The Project would also include the construction of facilities at stationary locations where compressor stations, M&R stations, and MLVs are proposed to be installed or upgraded, which would not take very long to complete. Construction would introduce heavy equipment and associated vehicles including backhoes, compactors, tractors, cranes, and trucks into the viewshed of all viewer groups. Construction activities would create temporary visual impacts on views seen of and from the Project site during the construction period by the visual presence of construction activities and equipment. Visual impacts from the construction phase would not be considered adverse due to the temporary nature of construction, transient and linear nature of construction, and some viewers' familiarity with heavy equipment used for agricultural activity within the Project vicinity. In addition, the Project would restore and reseed disturbed areas, including staging areas, after construction. HDD and horizontal boring construction methods would be used at rivers, highways, and other major roads to drill or bore under these features instead of having to trench through open-cut methods. Smaller roadway crossings would receive pavement cuts and would then be repaved once the pipeline is installed. Residential areas would be restored to pre-construction conditions and Gulf South would coordinate with landowners on any special landscape restoration needs.

There would be no change in designated land uses that would result from operation of the proposed Project. Views toward the designated Ecologically Significant Rivers would not be affected because the pipeline would travel under these resources. The Project route would not affect views from the Munson Cemetery, a Texas Historic Landmark, because existing trees and a low brick wall surrounding the cemetery would prevent ground-level views of the alignment. Limited site-specific visual changes, such as tree removal near residences or other sensitive viewers, could occur and may be perceived negatively. However, the pipeline would be underground and would not be visible in most locations because affected sites would be restored to pre-construction conditions. Therefore, the majority of the proposed header pipeline route would retain its existing visual character, and visual quality would not be affected. Where the proposed pipeline transects forest lands, however, the right-of-way would leave a linear, grassy swath of land where trees or native vegetation once stood. Because other similar corridors exist nearby to accommodate utility lines and other linear pipeline infrastructure, such features are common in this region and would not be considered an adverse impact unless a sensitive view was affected; no sensitive viewing areas were identified along the proposed pipeline route (e.g., parks, trails, picnic areas).

Visual impacts from compressor stations would be limited. Modifications at the existing Magasco Compressor Station and development of the proposed Wilson Compressor Station would not be visible due to vegetation screening. Because the station is already an existing visual feature in the landscape, modifications to the Goodrich Compressor Station would be in keeping with the existing visual context and would result in only minor visual changes that blend with existing uses. The presence of mature trees and shrubs and other intervening land uses (power lines, highway construction, industrial structures) at the North Houston Compressor Station would limit the visual impacts on sensitive viewers. The proposed Brazos Compressor Station would introduce an additional industrial-looking facility in an area where similar industrial facilities are present, and would likely not stand out as a visual focal due to its proximity to the factory.

The M&R stations and MLVs would also be located primarily within agricultural and open land uses, with some occurring in forested areas. This would introduce new aboveground, industrial-looking facilities; however, these facilities would be visible to a limited number of viewers.

*Environmental Analysis***2.6 SOCIOECONOMICS****2.6.1 Existing Socioeconomic Conditions**

The geographic area subject to potential socioeconomic and environmental justice effects of the proposed Project are the six counties where pipeline and aboveground facilities would be located. This section briefly describes socioeconomic characteristics of those counties to support the discussion of potential socioeconomic and environmental justice impacts in section 2.6.2. Table 2.6-1 shows selected social and economic characteristics of the study area.

Most of the population in the study area is in Harris County (city of Houston) (table 2.6-1). The U.S. Census Bureau (USCB) estimated a total of 791,954 rental housing units during the 2009–2013 period, with an average of 90,291 of those (11 percent) vacant (table 2.6-1). Other temporary housing locations present in the study area include recreational vehicle (RV) parks (61) and hotels and motels (630) (Gulf South, June 2015a). Public services available in the area include emergency services (medical services, police and fire protection) and are present in all counties of the study area, commensurate with the population of the counties (Gulf South 2015a). The labor force is also distributed among counties roughly in proportion to the population (table 2.6-1). In 2014 the unemployment rate averaged between 4.5 percent of the labor force in Fort Bend County and 10.5 percent in Sabine County, with an estimated 4.9 percent unemployment rate for the six-county area as a whole (BLS, 2014). Total personal income in the entire study area amounted to approximately \$283 billion in 2013 (BEA, 2013).

	Estimated Population in 2014^a	Vacant Rental Units^b	Labor Force^c	Total Personal Income (US\$ thousands)^d
Brazoria County	338,124	3,045	168,400	\$13,788,051
Fort Bend County	685,345	3,046	341,733	\$35,043,018
Harris County	4,441,370	83,550	2,251,628	\$230,462,963
Polk County	46,079	270	17,343	\$1,907,585
Sabine County	10,350	55	3,599	\$356,112
Wharton County	41,168	425	21,768	\$1,671,687
Total of Six County Area	5,562,436	90,391	2,804,471	\$283,229,416

Sources: ^a USCB, 2014; ^b USCB, 2013; ^c BLS, 2014; ^d BEA, 2013.

Because of the presence of both rural areas and the large urban area of the city of Houston, the economic base of the study area is diverse. Most land intersected by proposed facilities is agricultural, open, or forest land, with some smaller amounts being industrial and residential (Gulf South, June 2015a). Based on the share of total employment or labor earnings in the study area, non-farm industries are the main industries in the study area (BEA, 2013).

The 2012 USCB Census of Governments shows that over 40 percent of county and school district revenues in the state of Texas originate from property taxes. Counties also rely on various types of charges for services, with the remaining revenues for both counties and school districts coming mostly from intergovernmental transfers. Townships rely on similar sources but receive proportionally more revenues from utilities and sales taxes (USCB, 2012).

2.6.2 Socioeconomic Impacts

Construction of the proposed pipeline and associated facilities would be expected to last 12 months and employ an estimated 1,000 workers for pipeline construction during peak employment periods, and an additional 400 workers for construction of associated aboveground facilities, including compressor stations and M&R stations (Gulf South, June 2015a). Because specialized companies would be contracted for construction and because these companies typically utilize their own crews of specialized workers, Gulf South estimates that approximately 89 percent of these workers would be non-local staff (Gulf South, June 2015a). Because of the short construction period, construction workers would not be expected to bring their families and would be expected to reside in temporary housing. Because workers in Brazoria, Fort Bend, Wharton, and Polk counties would typically be within an hour's driving distance to the city of Houston (Harris County), workers employed in these counties (and in Harris County itself) would be expected to make use of temporary housing available within a reasonable commuting distance of any of these counties. If all workers were to be employed in Wharton, Brazoria, Fort Bend, Harris, and Polk counties, 1,246 (0.89 x 1,400) incoming workers during peak construction would constitute less than one tenth of one percent (less than 0.1 percent) of the population of those five counties as of 2014 (table 2.6-1). Using the available rental vacancy data for the period from 2009–2013 (table 2.6-1), and assuming each worker required one temporary housing unit, this increased demand for temporary housing would constitute approximately 14 percent of the housing units vacant in those counties. This does not include additional vacancy in RV parks, hotels, and motels.

Project-related construction workers in Sabine County, where the Magasco Compressor Station improvements are proposed, would be at a greater distance from the Houston metropolitan area than project-related construction workers in other counties. They would be less likely to commute from the Houston metropolitan area and would require housing closer to the Magasco Compressor Station. Gulf South estimates that approximately 70 to 80 workers would be employed for the modifications to the Magasco Compressor Station in Sabine County during a peak employment period of 16 weeks (Gulf South, 2015c). This would correspond to up to 0.8 percent of the population of the county as of 2014, and up to 145 percent of the housing units vacant in that county during the 2009–2013 period, not including RV parks, hotels, and motels (table 2.6-1). Hotels within commuting distance of the Sabine construction site include hotels catering to visitors to the Sabine National Forest as well as hotels in the communities of San Augustine, Jasper, and Many (Sabine County, Louisiana). Because of the availability of hotel accommodations within commuting distance of the Magasco Compressor Station site and the short period of construction, and because Gulf South's previous experience suggests up to 30 percent of construction workers may provide their own temporary housing (trailers and RV campers) (Gulf South, June 2015a), we anticipate that impacts on housing and public services from the influx of construction workers into Sabine County would not be significant.

Because the effects of incoming construction workers on the population and housing availability in the study area are expected to be of short duration and of small magnitude relative to current conditions, no impacts on local public services are expected.

During the construction period, the 1,246 workers estimated to come to the study area (0.89 x 1,400) would represent less than one tenth of one percent (less than 0.1 percent) of the labor force in the study area (table 2.6-1). Gulf South estimates the construction payroll to be approximately \$117 million. This would represent less than one tenth of one percent (less than 0.1 percent) of total personal income in the study area (table 2.6-1). Gulf South estimates an additional \$34 million would be spent locally for construction materials (Gulf South, June 2015a). Local expenditures for construction materials and worker payroll would contribute to local sales tax collections. The projected employment and local expenditures are considered to represent a relatively small stimulus to the local economy.

Construction of the proposed pipeline and associated facilities would require access to construction sites by workers and trucks carrying construction materials. Traffic on public roads used to

Environmental Analysis

access construction sites would likely increase during construction. However, Gulf South has indicated that the construction crews would be commuting primarily during off-peak hours. In addition, the pipeline would be constructed in a phased and sequential manner in primarily rural areas (Gulf South, June 2015a). As such, impacts on traffic on public roads from workers and trucks driving to the construction sites would be expected to be minimal. Traffic on public roads could be affected by construction of the proposed pipeline and associated facilities during upgrade of access roads and road crossings. There are an estimated 50 existing public access roads that would need upgrading. These are typically gravel or dirt roads in need of grading, gravel, culverts, and/or mats in Wharton and Brazoria counties (Gulf South, June 2015a).⁴ There are 22 proposed road crossings in Wharton County and 23 proposed road crossings in Brazoria County associated with construction of the header pipeline. Rail traffic may also be temporarily affected during construction of the header pipeline; three railroad crossings are proposed, with one in Wharton County and two in Brazoria County. However, these crossings are proposed to be bored so impacts would be minimized and temporary. Pipeline construction at minor road crossings would be accomplished primarily by using the open-cut method or subsurface bores. Major highways would be bored, with a few proposed for the HDD method (Gulf South, June 2015a). Gulf South would attempt to limit the majority of road crossings to be completed within one day. Before construction commences, Gulf South would be required to coordinate with local officials and railroad owners to minimize impacts on traffic (Gulf South, June 2015a). Because the majority of road improvements would occur on rural roads in agricultural, industrial, or open land areas, HDD crossings would be used where necessary to reduce interruption to vehicle and rail traffic flow, and because Gulf South would be required to coordinate with local officials and railroad representatives prior to the start of construction, we expect impacts on traffic from construction of the proposed pipeline and associated facilities to not be significant (Gulf South, June 2015a).

Construction would temporarily affect agricultural, industrial, and forested land. Most loss of crops and disturbance to pastures, forests, and industrial areas would be of short duration and landowners would generally be allowed to restore surfaces to their original use as construction is completed. A small share of lands at aboveground facilities would be permanently converted to industrial use (section 2.5.2, *General Impacts on Existing Land Uses*). Gulf South would commit to compensating landowners at fair market value for temporary or permanent losses. One residence at MP 57.15 would be permanently displaced and one shop and one storage container would be removed (section 2.5.2, *General Impacts on Existing Land Uses*). Mutually acceptable agreements would be sought with landowners and residents directly affected; therefore, impacts from displaced economic activity and residents would be addressed to the extent possible.

Operation of the proposed Project is expected to employ 18 full-time workers for purposes of operation and maintenance of the new and existing compressor stations. Other aboveground facilities would be monitored remotely from Gulf South's gas control center (Gulf South, June 2015a). The impact of these new jobs and overall operation and maintenance activities on the study area's employment, earnings, population, demand for housing, public services, and traffic would be negligible.

Although pipeline easements typically impose restrictions on surface use (e.g., building of structures), evidence on whether pipelines have a substantive effect on property values is inconclusive (Diskin et al., 2011; Fruits, 2008; Pan and Daniel, 2015; Wilde et al., 2012, 2013).

Operation of the proposed Project would generate fiscal revenues for local governments, mainly in the form of increased property taxes. Using the cost valuation method and assuming a total project cost of \$690 million, the property tax collection by local governments is estimated to be approximately \$3.5 million per year, with \$1.8 million per year collected in Wharton County, \$860,000 per year in

⁴ There is also one public gravel road in Fort Bend County and one in Harris County that would need upgrading for access to the Brazos and North Houston compressor stations, respectively, and there are three existing private roads that are also proposed to be upgraded (Gulf South, June 2015a).

Brazoria County, and the remaining tax collection distributed among Fort Bend, Harris, and Sabine counties (Gulf South, June 2015a).

2.6.3 Environmental Justice

Executive Order 12898, *Federal Actions to Address Environmental Justice in Minority Populations and Low-Income Populations*, was signed by the President in 1994. It requires that each federal agency address the potential for disproportionately high and adverse health or environmental effects of its programs, policies, and activities on minority populations and low income populations. An environmental justice area is defined as an area where the community's minority population is equal to or greater than 50 percent of the community population and/or a community in which the percentage of persons living below the poverty level is higher than the county average, based on poverty statistics published by the USCB. If a proposed action would result in significant adverse effects to minority or low-income populations or Native American tribes, the NEPA analysis should address those impacts as part of the alternatives analysis and identify appropriate mitigation measures to address the effects.

Based on USCB data, Harris and Fort Bend counties have a greater presence of minorities than the state of Texas as a whole, driven largely by Hispanics and African Americans in Harris County and by Asian and African Americans in Fort Bend County (table 2.6-2). The share of individuals in poverty in most counties of the study area is higher than that of the state of Texas, the exceptions being the counties of Brazoria and Fort Bend (table 2.6-2).

	Percent minority	Percent Black or African American	Percent Asian	Percent American Indian or Alaskan Native	Percent Hawaiian and Other Pacific Islander	Percent Some Other Race	Percent Two or More races	Percent Hispanic or Latino	Percent of Individuals in Poverty^a
Texas	55.2	11.8	4.0	0.5	0.1	6.9	2.3	37.9	17.6
Brazoria County	47.7	12.3	5.7	0.3	0.0	0.1	1.2	28.1	11.2
Fort Bend County	64.1	21.0	17.4	0.1	0.0	0.2	1.6	23.9	8.4
Harris County	67.4	18.5	6.3	0.2	0.1	0.2	1.1	41.1	18.5
Polk County	28.0	11.2	0.6	1.6	0.0	0.0	1.2	13.5	20.2
Sabine County	12.8	8.6	0.2	0.0	0.0	0.1	0.5	3.4	25.8
Wharton County	53.0	14.1	0.1	0.0	0.0	0.2	0.6	38.0	18.8
Total of Six-County Area	65.3	18.7	7.5	0.4	0.1	8.4	2.0	37.9	16.8

Source: USCB, 2013.

^a Percentage of individuals in poverty in six-county area estimated based on county data provided in the table.

Analysis in sections 2.1 through 2.9 of this environmental assessment concludes that there would be no significant impacts on the various resources analyzed from construction and operation of the proposed project. Because there would be no significant impacts, no disproportionately high and adverse human health or environmental effects on the minority or low-income populations listed in table 2.6-2 would be expected.

Environmental Analysis

In addition, each federal agency must also ensure that public documents, notices, and hearings are readily available and accessible to the public. As part of the preparation of this EA, the NEPA review process must provide opportunities for effective community participation and involve consultation with affected communities. As described in section 1.3, multiple opportunities to comment were provided to affected landowners in the Project Area. In addition, FERC staff attended public open house meetings. Consultation with Native American groups is described in section 2.4.1.

2.7 AIR QUALITY

2.7.1 Regulatory Status

Air quality would be affected by construction and operation of the proposed Project. The primary emissions associated with the Project would be construction-related emissions of the pipeline and aboveground facilities. Emissions from construction activities generally include fugitive dust from land clearing and vehicles travelling on unpaved roads, as well as combustion emissions from construction equipment.

The Project facilities that were evaluated for air quality effects and would have construction and operational emissions would consist of the following: 66 miles of new 36-inch diameter pipeline in Wharton and Brazoria Counties, Texas; one new gas-fired compressor station (Wilson Compressor Station) in Wharton County, Texas; two new electrically-driven compressor stations (Brazos and North Houston Compressor Stations); installation of new compression and piping modifications at Gulf South's former Magasco Compressor Station in Sabine County, Texas; piping modifications at Gulf South's existing Goodrich Compressor Station in Polk County, Texas; and seven new meter and regulator (M&R) station interconnects in Wharton and Brazoria Counties, Texas.

Regional Meteorology

Meteorological conditions, including temperature, precipitation, and wind, can affect ambient air quality. The climate of southeastern Texas, including the Project region, is generally warm during summer and cool during winter, and precipitation is generally well distributed throughout the year. The mean daily temperature measured in Houston, which is near the center of the Project region, ranges from 54 degrees Fahrenheit in January to 84 degrees Fahrenheit in August (National Weather Service, 2015). Over the course of the year, typical wind speeds vary from calm to 16 miles per hour (mph). Average wind speeds are highest (9 mph) in April and lowest (6 mph) in August. The wind is most often out of the south, southeast, north, and east, and least often out of the west (Weatherspark, 2015).

Existing Air Quality

Ambient Air Quality Standards

The Clean Air Act (CAA), as amended, is the primary federal legislation that addresses air quality. Under the CAA, EPA has established National Ambient Air Quality Standards (NAAQS) for criteria pollutants. Criteria pollutants are air contaminants that are commonly emitted from a variety of sources and include carbon monoxide (CO), lead, nitrogen dioxide (NO₂), particulate matter smaller than 10 and 2.5 microns (PM₁₀ and PM_{2.5}, respectively), ozone, and sulfur dioxide (SO₂). Ozone is not directly emitted but is formed in the atmosphere through chemical reactions of ozone precursor compounds, primarily oxides of nitrogen (NO_x) and volatile organic compounds (VOCs), in the presence of the ultraviolet component of sunlight.

Ambient air quality standards must not be exceeded in areas to which the general public has access. The CAA established two types of NAAQS. Primary standards set limits to protect public health,

including the health of sensitive populations. Secondary standards set limits to protect public welfare, including protection against decreased visibility, and damage to animals, crops, vegetation, and buildings. Table 2.7-1 lists the NAAQS.

EPA designates areas of the country based on compliance with the NAAQS. Designations fall under three main categories as follows: “attainment” (areas in compliance with the NAAQS), “nonattainment” (areas not in compliance with the NAAQS), “maintenance” (former nonattainment areas that have achieved attainment) or “unclassifiable”. Under the CAA, each state that has a nonattainment area must prepare a State Implementation Plan (SIP), which documents how the nonattainment area would reach attainment by the required date. A SIP includes inventories of emissions within the area and establishes emission budgets (targets) and emission control programs that are designed to bring the area into compliance with the NAAQS. In maintenance areas, SIPs document how the state intends to maintain compliance with the NAAQS. Maintenance areas may be subject to more stringent regulatory requirements than attainment areas to ensure continued attainment of the NAAQS. Unclassifiable areas are treated as attainment areas for the purpose of permitting a stationary source of pollution. EPA has designated the counties crossed by the proposed Project as attainment for all criteria pollutants, except that Brazoria, Fort Bend, and Harris counties are designated as nonattainment for ozone. TCEQ has prepared a SIP for the Houston-Galveston-Brazoria Nonattainment Area.

Table 2.7-1 National Ambient Air Quality Standards						
Pollutant		Standard Type	Averaging Period	Level	Form	
Carbon Monoxide		Primary	8-hour	9 ppm ^a	Not to be exceeded more than once per year	
			1-hour	35 ppm		
Lead		Primary and secondary	Rolling 3-month average	0.15 µg/m ³	Not to be exceeded	
Nitrogen Dioxide		Primary	1-hour	100 ppb	98th percentile of 1-hour daily maximum concentrations, averaged over 3 years	
		Primary and secondary	Annual	53 ppb	Annual mean	
Ozone		Primary and secondary	8-hour	0.075 ppm	Annual fourth-highest daily maximum 8-hr concentration, averaged over 3 years	
Particulate Matter		PM _{2.5}	Primary	Annual	12 µg/m ³	Annual mean, averaged over 3 years
			Secondary	Annual	15 µg/m ³	Annual mean, averaged over 3 years
			Primary and secondary	24-hour	35 µg/m ³	98th percentile, averaged over 3 years
		PM ₁₀	Primary and secondary	24-hour	150 µg/m ³	Not to be exceeded more than once per year on average over 3 years
Sulfur Dioxide		Primary	1-hour	75 ppb	99th percentile of 1-hour daily maximum concentrations, averaged over 3 years	
		Secondary	3-hour	0.5 ppm	Not to be exceeded more than once per year	

Source: 40 CFR 50.
^a µg/m³ = micrograms per cubic meter; ppb = parts per billion; ppm = parts per million.

Environmental Analysis

Greenhouse gases (GHGs) occur in the atmosphere both naturally and as a result of human activities, such as the burning of fossil fuels. These gases are the integral components of the atmosphere's greenhouse effect that warms the earth's surface and moderates day/night temperature variation. In general, the most abundant GHGs are water vapor, carbon dioxide (CO₂), methane (CH₄), nitrous oxide (N₂O), and ozone. On December 7, 2009, the EPA defined air pollution to include the mix of six long-lived and directly-emitted GHGs, finding that the presence of the following GHGs in the atmosphere may endanger public health and welfare through climate change: CO₂, CH₄, N₂O, hydrofluorocarbons, perfluorocarbons, and sulfur hexafluoride.

As with any fossil fuel-fired project or activity, the Project would contribute GHG emissions. The principal GHGs that would be produced by the Project are CO₂, CH₄, and N₂O. Emissions of GHGs are quantified and regulated in units of carbon dioxide equivalents (CO₂e). The CO₂e unit of measure takes into account the global warming potential (GWP) of each GHG. The GWP is a ratio relative to CO₂ that is based on the particular GHG's ability to absorb solar radiation as well its residence time within the atmosphere. Thus, CO₂ has a GWP of 1, CH₄ has a GWP of 25, and N₂O has a GWP of 298 (Intergovernmental Panel on Climate Change [IPCC], 2007). To obtain the CO₂e quantity, the mass of the particular compound is multiplied by the corresponding GWP, the product of which is the CO₂e for that compound. The CO₂e value for each of the GHG compounds is summed to obtain the total CO₂e GHG emissions.

Measured Ambient Air Quality in the Region

TCEQ measures ambient air quality at a number of locations throughout Texas, and the Louisiana Department of Environmental Quality does the same in Louisiana. Air quality data were obtained from the nearest available monitor for each pollutant to the Wilson and Magasco compressor Stations because these facilities have the highest potential emission rates. Table 2.7-2 provides the measured concentrations of criteria pollutants at these monitoring sites for the most recent 3 years. Table 2.7-2 indicates that no violations of the NAAQS have occurred at these monitoring sites in the last 3 years.

Regulatory Requirements for Air Quality

The Project would be potentially subject to a variety of federal and state regulations pertaining to the construction or operation of air emission sources. The TCEQ has the primary jurisdiction over air emissions produced by stationary sources associated with the Project. The TCEQ is delegated by the EPA to implement Federal air programs, with the exception of issuing permits for GHG emissions. However, on February 18, 2014, EPA issued a proposed rulemaking approving Texas' GHG permitting program. In anticipation of a final rulemaking, EPA offered applicants who are currently in the permitting process with EPA the choice of continuing the permitting process with EPA, or moving their applications to the TCEQ. On June 14, 2014, HB 788 authorizing the TCEQ permitting of GHG emissions became law in Texas.

The June 23, 2014 U.S. Supreme Court decision addressing the application of stationary source permitting requirements to GHG (*Utility Air Regulatory Group v. Environmental Protection Agency*, No. 12-1146) fundamentally changed GHG permitting requirements, regardless of whether permits are issued by EPA or the states. In summary, (1) where new sources emit GHG as the only pollutant with the potential to be emitted above the major source threshold, and (2) where existing major source modifications emit GHG as the only pollutant for which there is a significant emissions increase (and a significant net emissions increase) projects no longer require Prevention of Significant Deterioration (PSD) or Title V permits.

The following sections summarize the applicability of various state and federal regulations.

Federal Air Quality Requirements

The CAA, 42 U.S. Code 7401 et seq., as amended in 1977 and 1990, and 40 CFR Parts 50 through 99 are the basic federal statutes and regulations governing air pollution in the U.S. The following federal requirements have been reviewed for applicability to the Project.

- New Source Review (NSR) / Prevention of Significant Deterioration;
- Title V Operating Permits;
- New Source Performance Standards (NSPS);
- National Emission Standards for Hazardous Air Pollutants (NESHAP);
- Greenhouse Gas Reporting; and
- Chemical Accident Prevention Provisions.

New Source Review/Prevention of Significant Deterioration

Separate preconstruction review procedures for major new sources of air pollution (and major modifications of major sources) have been established for projects that are proposed to be built in attainment areas versus nonattainment areas. The preconstruction permit program for new or modified major sources located in attainment areas is called PSD. This review process is intended to keep new air emission sources from causing existing air quality to deteriorate beyond acceptable levels codified in the federal regulations. Construction of major new stationary sources in nonattainment areas must be reviewed in accordance with the nonattainment NSR regulations, which contain stricter thresholds and requirements.

The PSD rule defines a major stationary source as any source with a potential to emit (PTE) 100 tons per year (tpy) or more of any criteria pollutant for source categories listed in 40 CFR §52.21(b)(1)(i) or 250 tpy or more of any criteria pollutant for source categories that are not listed. In addition, with respect to GHG, the major source threshold CO_{2e} is 100,000 tpy. If a new source is determined to be a major source for any PSD pollutant, then other remaining criteria pollutants would be subject to PSD review if those pollutants are emitted at rates that exceed significant emission thresholds (100 tpy for CO; 40 tpy for NO_x, VOC, and SO₂ each; 25 tpy for total suspended particulate, 15 tpy for PM₁₀, and 10 tpy for [direct] PM_{2.5}). Sources which exceed the major source threshold are then subject to a PSD review.

The Brazos and North Houston compressor stations are located within marginal nonattainment areas for ozone and thus, were evaluated for nonattainment NSR applicability. The Wilson and Magasco compressor stations are located within attainment areas for all criteria pollutants and thus, were evaluated only for PSD applicability.

The PSD GHG Tailoring Rule intends to account for facilities that represent an estimated 70 percent of U.S. GHG emissions. This rule applies to all industrial sources that are major sources of any NSR-regulated pollutant other than GHGs and emit or have the potential to emit 75,000 tpy or more of CO_{2e}.

Major new stationary sources applying for a PSD construction permit must include a Best Available Control Technology analysis and a detailed air quality impacts analysis in its permit application. As part of the air quality impacts analysis, the applicant must demonstrate that the proposed facilities would comply with applicable NAAQS.

Environmental Analysis

Table 2.7-2 Measured Ambient Concentrations of Criteria Pollutants in the Region				
Monitor Location (EPA Site Identifier)	Pollutant (Averaging Period – Unit, Form)	Measured Concentration		
		2012	2013	2014
Nearest to Magasco Compressor Station				
Nederland, TX (48-245-1035)	CO (1 Hour – ppm, 2 nd maximum)	0.7	0.7	0.7
	CO (8 Hour – ppm, 2 nd maximum)	0.5	0.6	0.4
Deer Park, TX (48-201-1039)	Lead (Rolling 3-month average)	0.028 ^a	0.008 ^a	0.009 ^a
Westlake, LA (22-019-0008)	NO ₂ (1 Hour – ppb, 98 th percentile)	27	30	30
	NO ₂ (Annual – ppb, annual mean)	5.2	4.9	5.0
Livingston, TX (48-373-9991)	Ozone (8 Hour – ppm, 4 th maximum)	0.067	0.065	0.065
Shreveport, LA (22-015-0008)	PM ₁₀ (24 Hour – µg/m ³ , maximum)	75	85	84
Vinton, LA (22-019-0009)	PM _{2.5} (24 Hour – µg/m ³ , 98 th percentile)	18	17	19
	PM _{2.5} (Annual – µg/m ³ , annual mean)	8.0	7.4	7.2
Westlake, LA (22-019-0008)	SO ₂ (1 Hour – ppm, 99 th percentile)	41.8	30.8	33.4
	SO ₂ (3 Hour – ppm, 2 nd maximum)	37.1	30.4	26.7
Nearest to Wilson Compressor Station				
Houston, TX (48-201-0047)	CO (1 Hour – ppm, 2 nd maximum)	2.3	2.8	2.7
	CO (8 Hour – ppm, 2 nd maximum)	1.9	2.3	2.5
Deer Park, TX (48-201-1039)	Lead (Rolling 3-month average)	0.028 ^a	0.008 ^a	0.009 ^a
Lake Jackson, TX (48-039-1016)	NO ₂ (1 Hour – ppb, 98 th percentile)	51	49	46
	NO ₂ (Annual – ppb, annual mean)	12.6	11.8	10.5
Lake Jackson, TX (48-039-1016)	Ozone (8 Hour – ppm, 4 th maximum)	0.071	0.067	0.061
Houston, TX (48-201-0066)	PM ₁₀ (24 Hour – µg/m ³ , maximum)	76	89	95
Houston, TX (48-201-1035)	PM _{2.5} (24 Hour – µg/m ³ , 98 th percentile)	23.4	22.8	24.4
	PM _{2.5} (Annual – µg/m ³ , annual mean)	11.8	11.3	11.8
Houston, TX (48-201-0051)	SO ₂ (1 Hour – ppm, 99 th percentile)	12.9	17.4	28.2
	SO ₂ (3 Hour – ppm, 2 nd maximum)	14.4	16.6	16.3
Source: EPA, 2015d.				
^a 3-month average statistic is unavailable; values shown are maximum 24-hour average, which is always greater than the 3-month average.				
µg/m ³ = micrograms per cubic meter				

One additional factor considered in the PSD permit review process is the potential impacts on protected Class I areas. Class I areas were designated specifically as pristine natural areas or areas of natural significance and have the lowest increment of permissible deterioration, which precludes development near these areas. Class I areas are given special protection under the PSD program.

The nearest Class I area is the Breton NWR, which is located in Louisiana approximately 320 miles from the Project. Because of the distance to the nearest Class I area, and the quantity of emissions predicted from the Project, a Class I analysis is not required for the Project.

As previously discussed, the proposed electric motor-driven Brazos and North Houston compressor stations would be located within marginal nonattainment areas for ozone. It is anticipated that the potential operational emissions from each facility would be minimal and from ancillary equipment only. Therefore, the emissions are not anticipated to exceed the nonattainment NSR major threshold for O₃ precursors (VOC and NO_x). Therefore, the Brazos Compressor Station and the North Houston Compressor Station would not be subject to the requirements of the nonattainment NSR program permitting requirements. Additionally, the potential emissions from all Project facilities are not anticipated to exceed the PSD major threshold for any pollutants; therefore, the facilities should not be subject to the requirements of the PSD permitting program. Gulf South will continue to coordinate with TCEQ to ensure that all permitting requirements for the Project facilities are met

Title V Operating Permits

Title V of the CAA requires states to establish an air quality operating permit program. The requirements of Title V are outlined in the federal regulations in 40 CFR Part 70 and in Title 30 of the Texas Administrative Code (TAC) §122. The operating permits required by these regulations are often referred to as Title V or Part 70 permits.

Major sources (i.e., sources with a PTE greater than a major source threshold level) are required to obtain a Title V operating permit. Title V major source threshold levels are 100 tpy for CO, SO₂, PM₁₀, or PM_{2.5}, 10 tpy for an individual hazardous air pollutant (HAP), or 25 tpy for any combination of HAPs. The recent Title V GHG Tailoring Rule also requires facilities that have the potential to emit GHGs at a threshold level of 100,000 tpy CO_{2e} be subject to Title V permitting requirements.

The potential emissions associated with operation of the natural gas compressor units at the Wilson Compressor Station are anticipated to exceed the major source thresholds established under 40 CFR 70; therefore, a Title V operating permit would be required for operation of the Wilson Compressor Station. The potential emissions associated with operation of the natural gas compressor units at the Magasco Compressor Station and the electric motor-driven units at the Brazos and North Houston compressor stations are not anticipated to exceed the major source thresholds established under 40 CFR 70; therefore, the Project should not be required to obtain a Part 70 operating permit for these three compressor stations.

New Source Performance Standards

NSPS regulations (40 CFR Part 60) establish pollutant emission limits and monitoring, reporting, and recordkeeping requirements for various emission sources based on source type and size. These regulations apply to new, modified, or reconstructed sources. The following NSPS requirements were identified as potentially applicable to the specified sources at the compressor stations.

Subpart KKKK of 40 CFR Part 60, *Standards of Performance for Stationary Combustion Turbines* (the Turbine NSPS), applies to stationary combustion turbines that are modified, constructed, or reconstructed after February 18, 2005 and have maximum heat input rates greater than 10 million British Thermal Units per hour (MMBtu/hr). Turbines subject to this subpart are exempt from 40 CFR Part 60, Subpart GG emission standards for turbines. The proposed turbines associated with the Wilson and

Environmental Analysis

Magasco compressor stations would be subject to the Turbine NSPS. Pursuant to 40 CFR 60.4320(a), the turbines must meet the applicable NO_x emission limit. The proposed turbines would meet the definition of a new turbine firing natural gas with a heat input rating between 50 MMBtu/hr and 850 MMBtu/hr. As such, the NO_x emissions from the turbine would be limited to 25 ppm at 15 percent oxygen (O₂). Solar guarantees that the turbines planned for installation at the Wilson and Magasco compressor stations would meet this NO_x limit. The Turbine NSPS also limits the sulfur content of the fuel burned in each turbine. Pursuant to 40 CFR 60.4330(a)(2), the fuel burned in each unit cannot contain total potential sulfur emissions in excess of 0.060 pound (lb) SO₂ per MMBtu. According to 40 CFR 60.4365(a), turbines burning fuel with less than 20 grains of sulfur per 100 standard cubic feet would comply with the sulfur limit, and fuel sulfur monitoring is not required as long as the maximum sulfur content is contained in a current, valid tariff sheet. This is the compliance option that would be utilized by Gulf South for each of the proposed turbines. As outlined in the preceding paragraphs, the proposed turbines would comply with the emission standards contained in the Turbine NSPS (40 CFR 60, Subpart KKKK). Gulf South would also ensure that all of the monitoring, recordkeeping, and reporting requirements from this rule are met in accordance with the specified timeframes.

Subpart JJJJ of 40 CFR Part 60, *Standards of Performance for Stationary Spark Ignition Internal Combustion Engines*, applies to spark ignition engines with a maximum engine power greater than 25 hp for which construction commenced by July 12, 2006 and was manufactured after January 1, 2009. The reciprocating internal combustion engines planned for installation at the Wilson and Magasco compressor stations would be subject to Subpart JJJJ. In order to demonstrate compliance with the emission limits found in the rule, owners and operators may either operate a manufacturer-certified engine according to manufacturer's operation and maintenance procedures or conduct performance testing. Owners/operators of emergency engines are required to keep records of their hours of operation. Additionally, maintenance records must be kept for all engines. The engines installed as part of the Project would fully comply with the requirements of Subpart JJJJ.

Subpart OOOO of 40 CFR Part 60, *Standards of Performance for Crude Oil and Natural Gas Production, Transmissions and Distributions*, applies in part to compressors that are located between the wellhead and point of custody transfer. The Brazos, North Houston, Wilson, and Magasco compressor stations would fall under the "natural gas transmission and storage" segment, as outlined in Subpart OOOO. Pursuant to 40 CFR 60.5365, the only sources that are affected by Subpart OOOO at natural gas transmission facilities are new condensate storage tanks with potential VOC emissions greater than 6 tpy.

National Emission Standards for Hazardous Air Pollutants

The NESHAP codified in 40 CFR Parts 61 and 63, regulate HAP emissions. Part 61 was promulgated prior to the 1990 CAA Amendments and regulates specific HAPs, such as asbestos, benzene, beryllium, coke oven emissions, inorganic arsenic, mercury, radionuclides, and vinyl chloride.

The 1990 CAA Amendments established a list of 189 HAPs, while directing EPA to publish categories of major sources and area sources of these HAPs, for which emission standards were to be promulgated according to a schedule outlined in the CAA Amendments. These standards, also known as the Maximum Achievable Control Technology (MACT) standards, were promulgated under Part 63. The 1990 CAA Amendments defines a major source of HAPs as any source that has a PTE of 10 tpy for any single HAP or 25 tpy for all HAPs in aggregate. Area sources are stationary sources that do not exceed the thresholds for major source designation. Federal NESHAP requirements are incorporated by reference in 30 TAC §113.55 and §113.00.

The annual PTE HAP emissions from the Brazos, North Houston, Wilson, and Magasco compressor stations would be less than these thresholds; therefore, the project would not be a major source of HAPs.

Maximum Achievable Control Technology (MACT) standards are intended to reduce emissions of HAPs from source categories defined by the EPA. One such source category covers stationary combustion turbines. The Turbine MACT (40 CFR 63, Subpart YYYY) applies only to facilities that are defined as major sources of HAP, meaning that they have facility-wide potential emissions greater than 10 tpy for any single HAP or greater than 25 tpy of total HAPs. Another source category covered by a MACT standard is Reciprocating Internal Combustion Engines (RICE). The RICE MACT is promulgated as 40 CFR 63, Subpart ZZZZ and applies to units located at major sources of HAP as well as area (non-major) sources of HAP such as the Wilson and Magasco compressor stations. Pursuant to 40 CFR 63.6590(c)(1), any new stationary RICE located at an area source must meet the requirements from the Engine NSPS (40 CFR 60, Subpart JJJJ) in order to maintain compliance with the RICE MACT. As discussed in the preceding section, all engines planned for the Project would comply with Subpart JJJJ. No additional requirements from the RICE MACT apply to these units or the remainder of the Project. There is also a MACT standard that applies to Natural Gas Transmission and Storage Facilities (40 CFR 63, Subpart HHH). This standard applies only to glycol dehydration units that are located at major HAP sources. None of the planned compressor stations is a major HAP source, and the Project does not include any glycol dehydrators; therefore, Subpart HHH would not apply to the Project. On December 20, 2012, the EPA also promulgated a MACT standard applicable to industrial, commercial, and institutional boilers that are located at area HAP sources (40 CFR 63, Subpart JJJJJJ). Pursuant to 40 CFR 63.11195(e), this rule does not apply to “gas-fired boilers,” as defined within the subpart. The fuel gas heater proposed at each of the compressor stations would meet the definition of a gas-fired boiler; therefore, Subpart JJJJJJ would not apply to the Project.

Greenhouse Gas Reporting Rule

Subpart W of 40 CFR Part 98, the Mandatory Greenhouse Gas Reporting Rule, requires petroleum and natural gas systems that emit 25,000 metric tons or more of CO₂e per year to report annual emissions of GHG to the EPA.

Emissions of GHGs associated with the construction and operation of the Project, including all direct and indirect emission sources were calculated. In addition, GHG emissions were converted to total CO₂e emissions based on the GWP of each pollutant. The reporting rule does not apply to construction emissions; however, construction GHG emissions have been estimated for accounting and disclosure purposes (table 2.7-3). GHG emissions from operation of the Wilson Compressor Station and the Magasco Compressor Station are each anticipated to exceed the 25,000 metric ton (27,600 U.S. ton) threshold and therefore may be subject to the reporting rule (table 2.7-4). If actual GHG emissions from the Wilson or Magasco compressor stations are equal to or greater than the reporting threshold, Gulf South would need to comply with all applicable requirements of 40 CFR Part 98.

General Conformity

A conformity analysis must be conducted by the lead federal agency if a federal action would result in the generation of emissions that would exceed the conformity threshold levels (*de minimis*) of the pollutants(s) for which an AQCR is in nonattainment. According to Section 176(c)(1) of the CAA (40 CFR §51.853), a federal agency cannot approve or support any activity that does not conform to an approved SIP. Conforming activities or actions should not, through additional air pollutant emissions:

- Cause or contribute to new violations of the NAAQS in any area;
- Increase the frequency or severity of an existing violation of any NAAQS; or
- Delay timely attainment of any NAAQS or interim emission reductions.

Environmental Analysis

General Conformity assessments must be completed when the total direct and indirect emissions of a planned project would equal or exceed the specified pollutant conformity emission thresholds per year in each nonattainment area.

A General Conformity Determination must show that the emissions would conform to the applicable SIP and would not degrade air quality in the nonattainment area. This can be demonstrated through acquisition of emission offsets, SIP revisions, or dispersion modeling. On-site mitigation of emissions, (i.e., controls above and beyond what is required by regulation), can also be used to demonstrate conformity. According to 40 CFR §51.853, emissions from sources subject to NSR or PSD requirements are exempt and are deemed to have conformed.

The Project areas are in attainment/unclassifiable (considered attainment) for all criteria pollutants, with the exception of Brazoria, Fort Bend, and Harris counties, which are classified as nonattainment for the 1- and 8-hour ozone NAAQS. Therefore, emissions associated with construction of approximately 38 miles of the new header pipeline, Stratton Ridge M&R station, one pig receiver, and three MLVs in Brazoria County as well as construction and operation of the Brazos and North Houston compressor stations in Fort Bend and Harris counties, respectively, are potentially subject to General Conformity. The Project is not anticipated to result in emissions (subject to General Conformity determination) during construction or operation that exceed General Conformity applicability thresholds and would not cause a new NAAQS violation or significantly contribute to a NAAQS violation.

In accordance with the EPA General Conformity Rule, table 2.7-3 compares Project-related emissions in the nonattainment area to the conformity thresholds. Table 2.7-3 shows that the emissions due to the Project would be less than the thresholds. Accordingly, the Project would conform to the Houston-Galveston-Brazoria Ozone Nonattainment Area SIP, and no further conformity evaluation is required.

Applicable State Air Quality Requirements

In addition to the federal regulations identified above, the TCEQ has its own air quality regulations, codified in 30 TAC. The state requirements potentially applicable to the Project are discussed below.

- 30 TAC Chapter 101, Subchapter A – *General Rules*. This chapter includes provisions related to circumvention, nuisance, traffic hazards, sampling and sampling ports, emissions inventory requirements, sampling procedures and terminology, compliance with EPA standards, inspection and emission fees, and emission events and scheduled maintenance, startup, and shutdown activities.
- 30 TAC 106 – *Permit by Rule – Oil and Natural Gas Production Facility*. This permit is appropriate for facilities with VOC emissions less than 25 tpy and subject to federal regulations.
- 30 TAC Chapter 111 – *Control of Air Pollution from Visible Emissions and Particulate Matter*. This chapter outlines the allowable visible emission (i.e., opacity) requirements and total suspended particulate emission limits based on calculated emission rates.
- 30 TAC Chapter 112 – *Control of Air Pollution from Sulfur Compounds*. This chapter outlines emission limits and monitoring, reporting, and recordkeeping requirements. This chapter also lists net ground-level concentration standards at the property line for certain sulfur compounds.
- 30 TAC Chapter 113 – *Control of Air Pollution from Toxic Materials*. Chapter 113 incorporates by reference the NESHAP source categories (40 CFR Part 63).

Table 2.7-3 Comparison of Emissions for the Project to General Conformity Thresholds		
Houston-Galveston-Brazoria, TX Ozone Nonattainment Area	NO_x	VOC
Brazoria County – 37.88 miles of new pipeline^a		
Construction Emissions ^b (tons)	26.23	9.01
Operation Emissions (tons per year)	0.04	0.96
Brazoria County Subtotal ^c	26.27	9.97
Fort Bend County – Brazos Compressor Station		
Construction Emissions ^b (tons)	0.55	0.07
Operation Emissions (tons per year)	0.88	7.11
Fort Bend County Subtotal ^c	1.43	7.18
Harris County – North Houston Compressor Station		
Construction Emissions ^b (tons)	0.55	0.07
Operation Emissions (tons per year)	0.88	7.11
Harris County Subtotal ^c	1.43	7.18
Total Project Emissions^c for Nonattainment Area	29.13	24.33
General Conformity Threshold (tons per year)	100	100
Emissions less than threshold?	Yes	Yes
Source: Gulf South, 2015c, table 9.2-12		
^a The potential construction emissions from the proposed Project were calculated based on the entire length of the new header pipeline which is approximately 66 miles. Approximately 38 miles of the new header pipeline would be located in nonattainment areas and potentially subject to General Conformity. Construction of the remaining portion of the new header pipeline which is approximately 28 miles would occur within areas that are in attainment/unclassifiable for all criteria pollutants, and thus not subject to General Conformity.		
^b Assumes all construction would occur in the same year.		
^c Sum of construction emissions plus 1 year of operational emissions, which provides a conservative (high) emissions estimate.		

- 30 TAC Chapter 114 – *Control of Air Pollution from Motor Vehicles*. This chapter addresses inspection requirements and maintenance and operation of air pollution control systems/devices for motor vehicles owned and/or operated at the Project facilities. This chapter applies to use of construction- and operations-related vehicles.
- 30 TAC Chapter 115 – *Control of Air Pollution from Volatile Organic Compounds*. This chapter outlines applicable requirements for storage tanks, process vents, and loading operations, including the standards and recordkeeping and reporting requirements.
- 30 TAC Chapter 116, Subchapter B – *Control of Air Pollution by Permits for New Construction or Modification*. This chapter outlines the permitting requirements for the construction of new sources.
- 30 TAC Chapter 118 – *Control of Air Pollution Episodes*. This chapter outlines the requirements relating to generalized and localized air pollution episodes.
- 30 TAC Chapter 122 – *Federal Operating Permits*. This chapter outlines the requirements for complying with the Federal operating permits (Title V) program.

Environmental Analysis

Operation of the electric motor-driven Brazos and North Houston compressor stations and M&R stations, which would contain only minor ancillary emission sources, as well as operation of the Wilson and Magasco compressor stations would be authorized under Permits-by-Rule (PBRs), per 30 TAC Chapter 106. Applications to register each compressor station under the PBR program, including completed PI-7-Cert Forms, have been filed with the TCEQ. PI-7 Forms requesting coverage under the PBR would not be required for the M&R stations due to the minimal emissions associated with the emergency generators.

2.7.2 Impacts and Mitigation

Construction

Sources of emissions associated with construction of the Project would include engine exhaust and fugitive particulate matter (dust). Fugitive emissions are those that are not associated with a stack, exhaust vent, or opening that controls the discharge. Exhaust emissions would result from construction equipment, trucks, and workers' personal vehicles. Fugitive particulate matter would result from trenching, backfilling, excavation, and other earthmoving activities, vehicle and equipment travel over unpaved roads and surfaces, and erosion of exposed earth or material surfaces by the wind. Gulf South filed a Fugitive Dust Control Plan (FDCP). FERC staff reviewed the FDCP and found it acceptable. To minimize construction emissions, the FDCP would include the following measures:

- proper operation and maintenance of equipment and vehicle engines;
- implementation of the FDCP (appendix P);
- use of water for control of dust during construction operations, road grading, or land clearing;
- maintenance of roadways;
- street cleaning to remove soil or other material from paved streets onto which it has been transported by trucking or earth-moving equipment, erosion by water, or other means;
- covering of open-bodied trucks while transporting materials;
- minimization of soil disturbance; and
- use of off-site parking and shuttle buses to minimize traffic (if necessary).

Construction of the header pipeline would take 8 months. Construction of the meter stations would take 6 months. Construction of each compressor station would take 12 months.

The construction emission calculations used emission factors and brake-specific fuel consumption values (BSFC) from the EPA MOVES2014 model, which incorporates data from the EPA NONROAD 2008a model. The emission factors and BSFC are for Wharton County, Texas with calendar year 2017 as the construction timeframe. The NONROAD2008a emission factors and BSFC do not vary appreciably across the project area. Therefore, the data for the Wharton County were used for the entire pipeline construction area. The factors for calendar year 2017 and 2018 are similar with the 2018 factors being lower. Therefore, the use of 2017 factors for the entire Project duration is conservative (tending to overestimate emissions). For each piece of planned construction equipment, the nearest fit from the equipment types available in the MOVES2014 model was selected.

The model years for the various pieces of construction equipment to be used for the Project are not currently known. Construction equipment must meet EPA emission standards which set required levels ("Tiers") based on model year. The most stringent standard, Tier 4, typically applies to model

years after 2011. However, to be conservative it was assumed that no Tier 4 equipment would be used for the Project due to the relatively recent implementation of those standards and the typical age of most construction equipment. Emission factors from the EPA AP-42 emission factor compilation were used to estimate HAP emissions for all engines regardless of their Tier status.

Gulf South estimated the emissions associated with Project construction activities as shown in table 2.7-4. Details of the construction equipment and vehicles used for the analysis are reported in appendix 9C of the Gulf South application (Gulf South, 2015c).

It is not known at this time whether open burning of cleared vegetation would occur. Therefore, Gulf South has provided emission estimates, included in table 2.7-4 above, for open burning in attainment and nonattainment areas. Should open burning be utilized, Gulf South would review state and county websites to confirm that no county-level burn bans are in place prior to conducting burning activities, and would adhere to any other applicable state/local requirements.

Construction Activity	NO_x	CO	SO₂	PM₁₀	PM_{2.5}	VOC	Form- aldehyde	Total HAPs	GHGs (CO_{2e})
Wilson Compressor Station	0.83	0.46	0.001	0.99	0.18	0.10	0.002	0.005	213
Magasco Compressor Station	0.56	0.38	0.001	0.88	0.15	0.08	0.001	0.003	149
Brazos Compressor Station	0.55	0.32	0.001	0.87	0.15	0.07	0.001	0.003	147
North Houston Compressor Station	0.55	0.32	0.001	0.87	0.15	0.07	0.001	0.003	147
Pipeline construction (102pprox.. 66 miles)	45.43	98.00	0.064	47.27	16.72	15.93	0.08	0.27	13,719
Totals	47.92	99.48	0.07	47.27	16.72	15.93	0.09	0.28	14,375

Source: Gulf South, 2015c, table 9.2-11.

Construction emissions would be temporary and at any given time would occur only where construction is occurring or along roads traveled by construction vehicles. The effects of construction emissions on ambient air quality would vary with time due to the construction schedule, the mobility of the emission sources, the types of equipment in use, and local meteorology. Air pollutant impacts from construction equipment would generally be limited to the immediate vicinity of the construction area. Once construction activities are completed, the construction emissions would cease. With the implementation of the mitigation measures outlined in the FDCP, and the temporary nature of construction emissions, construction activities are not anticipated to cause significant impact on air quality.

Operation

Operational emissions would result primarily from operation of the combustion turbines and ancillary equipment at the proposed Wilson and Magasco compressor stations, the seven meter stations, and from ancillary equipment at the proposed Brazos and North Houston compressor stations. (The compressors at the Brazos and North Houston compressor stations would be electrically powered and

Environmental Analysis

would not produce emissions on site.) The turbines and ancillary equipment would emit criteria pollutants, HAPs, and GHGs. Other Project facilities would contribute much lower levels of emissions.

Gulf South would conduct some modifications at the Goodrich Compressor Station. Some of those changes may include installation of four new valves, and six new flanges at the facility. As shown in table 2.7-5 below, the emissions associated with the modifications at Goodrich Compressor Station would be negligible.

Table 2.7-5 displays the potential-to-emit emissions estimated by Gulf South for the proposed compressor stations and other Project facilities. The potential-to-emit emissions represent the maximum capacity of a stationary source to emit criteria pollutants, although actual operational emissions may be less.

Facility	NO_x	CO	SO₂	PM₁₀	PM_{2.5}	VOC	Form- aldehyde	Total HAPs	GHGs (CO₂e)
Wilson Compressor Station	157.47	159.14	1.23	9.73	9.73	23.55	6.32	6.85	314,091
Magasco Compressor Station	32.05	32.12	0.25	1.95	1.95	10.57	1.32	1.49	67,525
Brazos Compressor Station	0.88	0.57	0.001	0.01	0.01	7.11	0.08	0.16	6,097
North Houston Compressor Station	0.88	0.57	0.001	0.01	0.01	7.11	0.08	0.16	6,097
Goodrich Compressor Station Modifications	0.00	0.00	0.00	0.00	0.00	0.005	Negligible	Negligible	5
Pipeline and Other Facilities	0.23	14.06	0.0002	0.008	0.008	3.88	No data	0.213	294
Totals	191.51	206.46	1.482	11.71	11.71	52.22	7.80	8.87	394,109

Source: Gulf South, 2015a and 2015b.

The Wilson Compressor station would be a new facility and would contribute the largest proportion of the total Project operational emissions. Table 2.7-6 provides a breakdown of all the operational emissions of the Wilson Compressor Station.

The Wilson Compressor Station would be in an attainment area, is anticipated to have emissions below the threshold requirements for PSD permitting, and would be a Title V major source. The former Magasco Compressor Station is also in an attainment area, is anticipated to have emissions below the threshold requirements for PSD permitting, and would not be a Title V major source. Both facilities would be permitted through the TCEQ PBR program under 30 TAC Chapter 106.

The Brazos Compressor Station and North Houston Compressor Station would be in an ozone nonattainment area. Emissions associated with the operation of these facilities are anticipated to be below the threshold requirements for Nonattainment New Source Review and PSD permitting, and they would not be Title V major sources. Therefore, both facilities would be permitted under the TCEQ PBR program.

**Table 2.7-6
Potential Emission Rates Associated with the Wilson Compressor Station**

Emission Source	Nox	CO	VOC	SO₂	PM_{2.5} / PM₁₀	Formaldehyde	Total HAP	GHG (CO₂e)
Annual Potential Emissions (tpy)								
Turbine #1 Solar Taurus 70	20.96	21.26	1.84	0.16	1.30	0.84	0.90	41,024
Turbine #2 Solar Taurus 70	20.96	21.26	1.84	0.16	1.30	0.84	0.90	41,024
Turbine #3 Solar Titan 130	37.65	38.20	3.28	0.30	2.33	1.52	1.63	73,738
Turbine #4 Solar Titan 130	37.65	38.20	3.28	0.30	2.33	1.52	1.63	73,738
Turbine #5 Solar Titan 130	37.65	38.20	3.28	0.30	2.33	1.52	1.63	73,738
Emergency Generator	0.88	0.57	0.12	.00084	0.014	0.075	0.102	167
Fuel Gas Heater	1.72	1.44	0.094	0.010	0.131	.0013	.0014	2050
Storage Tanks	N/A	N/A	0.68	N/A	N/A	N/A	0.059	45
Condensate Loading	N/A	N/A	0.11	N/A	N/A	N/A	N/A	N/A
Equipment Leaks	N/A	N/A	0.42	N/A	N/A	N/A	N/A	397
Natural Gas Venting	N/A	N/A	8.60	N/A	N/A	N/A	N/A	8,168
Facility-Wide Totals	157.47	159.14	23.55	1.23	9.73	6.32	6.85	314,091
Permitting Requirement Thresholds								
PSD Major Source Thresholds ^a	250	250	250	250	250	N/A	N/A	100,000 ^c
Title V Major Source Thresholds ^b	100	100	100	100	100	10	25	100,000 ^c
Texas Permit Thresholds ^d	<250	<250	<25	<25	<15 (PM ₁₀) <10 (PM _{2.5})	<25	<25	N/A
^a The PSD major source thresholds were obtained from 40 CFR 52.21(b)(1)(b) for areas in attainment of the NAAQS. HAP emissions are not covered by the PSD permitting program. ^b The Title V major source thresholds were obtained from 40 CFR 70.2 for areas in attainment of the NAAQS. ^c Projects that are not subject to NSR/PSD review for a non-GHG pollutant are not subject to PSD review for GHG. This facility will therefore not be required to undergo PSD review for GHG. ^d The facility-wide Texas Permit-by-Rule thresholds are taken from 30 TAC § 106.4(a)(4). Facilities with emissions greater than the Permit-by-Rule thresholds are required to obtain a Pre-Construction Permit pursuant to 30 TAC Chapter 116. Source: Gulf South, 2015a, table 9.2-7								

The final design of the seven meter stations has not yet been completed. However, table 2.7-7 presents preliminary emission estimates for the equipment to be installed. Although the final equipment selected may vary from the preliminary estimates, these emissions would be representative of the meter stations upon being placed into service.

Meter Station Name (County)	Annual Emissions (tons/year)							Total All Stations
	TGPL (Wharton)	Transco (Wharton)	NGPL (Wharton)	Gulf South – Index 129 (Wharton)	HPL (Wharton)	Enterprise (Wharton)	Stratton Ridge (Brazoria)	
Nox	0.04	0.04	0.04	0.04	0.04	-	0.04	0.23
CO	1.79	1.79	1.79	3.46	1.79	-	3.46	14.06
VOC	0.28	0.28	0.28	0.90	0.28	0.24	0.90	3.17
SO ₂	0.00004	0.00004	0.00004	0.0001	0.00004	-	0.0001	0.0002
PM _{2.5} / PM ₁₀	0.001	0.001	0.001	0.002	0.001	-	0.002	0.008
Total HAP	0.018	0.018	0.018	0.062	0.018	0.016	0.062	0.213
GHG (in CO ₂ e)	17.9	17.9	17.9	55.7	17.9	10.9	55.7	194.0

Source: Gulf South, 2015c.

Emissions from pipeline operation and maintenance activities would primarily consist of natural gas blowdowns associated with line pigging activities. Gulf South estimates that 73,740 standard cubic feet of natural gas per year would be vented from the blowdown and purging of pig traps associated with the line pigging activities. Emissions from pipeline operation and maintenance activities would also result from the operation of actuated valves. Gulf South estimates that 3,040 standard cubic feet per year would be released from planned valve actuation. The estimated total amount of natural gas released from the activities outlined above would be about 76,800 standard cubic feet per year. The estimated VOC and GHGs emissions based on this volume would be 0.042 tpy and 40.22 tpy respectively.

Pipeline operation would have fugitive emissions associated with it due to equipment leaks. Emissions of HAPs from the components would be negligible due to the extremely small quantities of HAPs present in natural gas. Table 2.7-8 summarizes the emissions from pipeline operations and maintenance activities including pipeline pigging, valve actuation, and equipment leaks.

Emission Source	Annual Potential VOC Emissions (tons/year)	Annual Potential CO₂e Emissions (tons/year)
Pipeline Pigging and Valve Actuation	0.042	40.22
Equipment Leaks	0.063	59.80
Total Emissions from Pipeline Operation and Maintenance Activities	0.105	100.02

Source: Gulf South, 2015c.

Air Quality Modeling

Gulf South conducted an air quality dispersion modeling analysis to estimate ambient pollutant concentrations in the vicinity of the proposed Wilson Compressor Station and the former Magasco Compressor Station. Modeling was not conducted for the proposed Brazos Compressor Station and North Houston Compressor Station because operational emissions from these two stations would be minimal (see table 2.7-5). The modeling for the Wilson and Magasco compressor stations was conducted according to EPA and TCEQ approved modeling methods, using the latest version of the AERMOD model (version 14134) along with the suite of supporting programs (AERMET and AERMAP). Five years of representative meteorological data were obtained from TCEQ for Wharton County (for the Wilson Compressor Station) including surface meteorological data from the Houston Sugarland Memorial Airport (KSGR and station ID 12977) and upper air data as obtained at the Corpus Christi, Texas (KCRP and station ID 12924). For the Magasco Compressor Station, five years of representative meteorological data for Sabine County were obtained from TCEQ including surface meteorological data from the Lufkin Angelina County Airport (KLFK and station ID 93987) and upper air data as obtained at Shreveport, Louisiana (KSHV and station ID 13957).

The receptor grid included receptors spaced at 20 meter spacing around each facility fence line and then extending outward into ambient air. Beyond the fence line the receptors were spaced at 50 meters to a distance of 300 meters and at 100-meter spacing to 1.5 kilometers from each site. A good engineering practice (GEP) evaluation of the planned stack heights showed that none exceeded GEP and therefore the dispersion of emissions could be affected by upwind buildings or structures. The EPA Building Profile Input Program (BPIP) was used to determine direction-specific building dimension data based on the planned building footprints and heights. The direction-specific building dimensions were determined using the BPIP-PRIME processor and input into the AERMOD to simulate the effects of downwash on plume characteristics.

The results of the modeling indicated that the locations of maximum concentrations at each facility occurred at receptors located along the facility fence line and therefore are in close proximity to the emission units. Modeled concentrations were compared to the EPA significant impact levels (SILs). EPA established the SILs as thresholds for use in modeling assessments. EPA considers modeled concentrations less than the SIL to show that the impact cannot cause or contribute to an exceedance of an air quality standard. The modeled concentrations of CO, SO₂, and PM₁₀/PM_{2.5} were all less than their respective SILs and therefore no further assessment of impacts for these pollutants was required. Only the modeled concentrations of NO₂ potentially exceeded the respective SILs, and therefore further analysis to compare the NO₂ concentrations to the NAAQS was required. For this comparison ambient NO₂ concentrations representative of the background NO₂ levels in the vicinity of each compressor station were obtained from TCEQ monitoring data. The modeled NO₂ concentrations were added to the background concentrations and the sums were compared to the NAAQS. The summed concentrations were less than the NAAQS for each facility, as shown in table 2.7-9. These results demonstrate that ambient concentrations of regulated pollutants associated with operation of the Wilson and Magasco Compressor Stations would not adversely affect local air quality. For further details on the dispersion modeling see appendix 9B of the Application (Gulf South, 2015a).

**Table 2.7-9
Modeled and Background 1-Hour NO₂ Concentration Comparison to NAAQS**

Compressor Station	Modeled Concentration (µg/m ³)	Background Concentration		Total Concentration (µg/m ³)	NAAQS (µg/m ³)	Percent of NAAQS
		Value (µg/m ³)	Monitor Location (EPA Site Identifier)			
Wilson	15.3	60	Brazoria County (480-39-1004)	75.3	188	40.0%
Magasco	16.2	36	Harrison County (482-03-0002)	52.2	188	27.8%

2.8 NOISE

2.8.1 Applicable Noise Regulations

Noise would affect the local environment during both construction of the Project facilities and operation of each of the compressor stations associated with the Project.

The ambient sound level of a region is defined by the total noise generated within the specific environment, and usually comprises sounds emanating from natural and artificial sources. At any location, both the magnitude and frequency of environmental noise may vary considerably over the course of a day and through the week. This variation is caused in part by changing weather conditions and the effect of seasonal vegetative cover.

Two measures used by federal agencies to relate the time-varying quality of environmental noise to its known effect on people are the equivalent sound level (L_{eq}) and the day-night average sound level (L_{dn}). The L_{eq} is the level of steady sound with the same total (equivalent) energy as the time-varying sound of interest. L_{eq} can be determined for any duration but typically one-hour and 24-hour periods are used. The L_{dn} is the L_{eq} with 10 decibels on the A-weighted scale (dBA) added to nighttime sound levels between the hours of 10:00 PM and 7:00 AM to account for people's greater sensitivity to sound during nighttime hours. The A-weighted scale is used because human hearing is less sensitive to low and high frequencies than mid-range frequencies. A person's threshold of perception for a perceivable change in loudness on the A-weighted sound level is on average 3 dBA, whereas a 5 dBA change is clearly noticeable and a 10 dBA change is perceived as twice or half as loud.

In 1974, the EPA published *Information on Levels of Environmental Noise Requisite to Protect Public Health and Welfare with an Adequate Margin of Safety* (EPA, 1974). This document provides information for state and local governments to use in developing their own ambient noise standards. The EPA has determined that, to protect the public from activity interference and annoyance outdoors in residential areas, noise levels should not exceed an L_{dn} of 55 dBA. For a source that operates at a continuous sound level over a 24-hour period, such as a natural gas compressor station, the L_{dn} is approximately 6.4 decibels (dB) above the measured L_{eq} . Consequently, an L_{dn} of 55 dBA corresponds to a L_{eq} of 48.6 dBA. FERC has adopted this L_{dn} 55 criterion and uses it to evaluate the potential noise impacts from the Project at noise-sensitive areas (NSAs), such as residences, schools, or hospitals. Due to the 10 dBA nighttime penalty added prior to calculation of the L_{dn} , for a facility to meet the L_{dn} 55 dBA limit, it must be designed such that actual constant noise levels on a 24-hour basis do not exceed 48.6 dBA L_{eq} at any NSA. FERC guidelines also require that station modifications not result in a perceptible increase in vibration at any NSAs. No other applicable state or local noise regulations have been identified for the proposed new facilities.

2.8.2 Noise Sensitive Areas and Ambient Sound Levels

Pre-construction sound surveys were conducted at four of the five compressor stations (Wilson Compressor Station, Brazos Compressor Station, North Houston Compressor Station, and the former Magasco Compressor Station), seven M&R stations, and all HDD locations to document the existing acoustic environment and locate/verify nearby NSAs, such as residences, hospitals, and schools, around each site. Pre-construction sound survey was not conducted at the Goodrich Compressor Station because the piping modifications to be conducted at the site would not result in long-term noise impacts.

The following is a discussion of NSAs and ambient sound levels near the compressor stations, M&R stations, and HDD sites.

Compressor Stations

A description of the proposed (Wilson, Brazos, and North Houston) and former (Magasco) compressor stations associated with the Project, including a summary of the anticipated equipment and operations that could influence noise contributions, is presented below. The significant sources of noise associated with a compressor station are typically generated by noise of the turbine/compressor casing that radiates through the compressor building; noise radiated from outdoor aboveground piping and associated components; noise generated by the gas aftercooler; noise generated by the lube oil cooler; noise associated with the air intake for the turbine; and noise associated with the air exhaust for the turbine.

In addition, a compressor unit may also employ a unit blowdown/vent system that may include a blowdown silencer. During the period of commissioning and testing, a unit blowdown could occur three to four times daily, typically only during the daytime hours. During normal operation of a compressor station (after the commissioning period), unit blowdown events generally occur infrequently (one to three times monthly). Furthermore, the duration of a gas blowdown event is generally short (approximately 1 to 5 minutes).

Wilson Compressor Station

The new Wilson Compressor Station would be in Wharton County along the proposed header pipeline. The area surrounding the Wilson Compressor Station is primarily agricultural and open land, with an existing industrial facility adjacent to the proposed site along the east side of Friel Barker Road.

Brazos Compressor Station

The proposed Brazos Compressor Station would be along Gulf South's existing Index 129 pipeline in Fort Bend and Harris counties. The area surrounding the Brazos Compressor Station is primarily open and agricultural land, with an existing industrial facility southwest of the proposed site along Highway 36.

North Houston Compressor Station

The proposed North Houston Compressor Station would be along Gulf South's existing Index 129 pipeline in Fort Bend and Harris counties. The area surrounding the North Houston Compressor Station is characterized as industrial and open land, with nearby residences along both Root Road and Gosling Road to the north, a new highway and overpass to the south (Grand Parkway Segment F-2 construction project), and Klein Oak High School approximately 0.25 mile to the west. A stormwater detention basin and a pump station associated with the highway project would be constructed on the tract

of land between Klein Oak High School and the station site. The school is approximately 2,776 feet west of where the proposed facilities would be constructed.

Magasco Compressor Station

The Magasco Compressor Station site is located along the Index 129 pipeline in Sabine County and is a facility owned by Gulf South. The area surrounding the site includes open and forested land, with nearby residences along Highway 1 and Magasco Road.

Ambient Sound Levels

Table 2.8-1 summarizes existing ambient sound levels near each compressor site.

Table 2.8-1 Ambient Sound Levels Near Compressor Sites		
NSA	Distance and Direction of NSA to Compressor Site (feet)	Ambient Sound Level (Ldn)
Wilson Compressor Station		
NSA #1 (Residences)	2,254 SSE	39.4 dBA
NSA #2 (Residences)	2,730 NNE	39.3 dBA
Magasco Compressor Station		
NSA #1 (Residences)	934 SE	44.2 dBA
NSA #2 (Residences)	1,126 SSE	44.2 dBA
Brazos Compressor Station		
NSA #1 (Residence)	2,714 N	42.3 dBA
NSA #2 (Residence)	3,307 S	47.9 dBA
North Houston Compressor Station		
NSA #1 (Residence)	600 N	50.6 dBA
NSA #2 (Residence)	1,245 SE	61.2 dBA
NSA #3 (Residence)	2,776 W	50.2 dBA
NSA #4 (Residence)	1,034 S	60.3 dBA

Meter and Regulator Stations

The seven M&R stations would be at interconnects between various interstate and intrastate pipelines and the proposed header pipeline in Wharton and Brazoria counties, one of which (Enterprise M&R station) would be constructed within the Wilson Compressor Station.

The greatest source of noise associated with an M&R station is operation of regulator valves and the resulting noise that is radiated through the aboveground gas piping. The level of regulator piping noise is directly related to the pressure drop and gas flow across the flow-control valves associated with the regulator runs.

*Environmental Analysis*Ambient Sound Levels

Table 2.8-2 summarizes existing ambient sound levels near each compressor site.

Table 2.8-2 Ambient Sound Levels Near Meter and Regulator Stations		
NSA	Distance and Direction of NSA to Compressor Site (feet)	Ambient Sound Level (Ldn)
NGPL M&R Station		
NSA #1 (Residences)	1,250 SW	50.7 dBA
Gulf South Index 129 M&R Station		
NSA #1 (Residences)	1,600 W	46.8 dBA
HPL-Energy Transfer M&R Station		
NSA #1 (Residence)	1,900 W	44.3 dBA

Horizontal Directional Drilling Sites

While typical pipeline installation techniques lead to variable noise levels from the constant progression along the construction corridor, pipeline installation via HDD produces a stationary noise source that, while temporary, can be of moderate duration and may potentially affect nearby NSAs. As noted in table 1.7-1 in Chapter 1, the HDD procedure is proposed at 12 locations for the Project, with the length of drilling varying between 1,110 and 2,276 feet in length. Typically, HDDs are conducted within 7 to 10 days but can run significantly longer based on the specifics of each drill. Additionally, some activities associated with the HDDs, especially the pipe pulling, may be conducted during nighttime hours, making further evaluation of impacts necessary.

Ambient Sound Levels

Table 2.8-3 summarizes existing ambient sound levels near HDD entry and exit points.

HDD Name	Entry or Exit Point	Approximate Milepost	Closest NSA and Type	Distance and Direction of NSA to Drill Site (feet)	Ambient Sound Level (Ldn)
US Highway 50	Entry	10.52	Residence	1,820 NW	59.0 dBA
	Exit	10.09	Residence	900 NE	59.0 dBA
Peach Creek	Entry	10.99	Residence	580 E	48.4 dBA
	Exit	10.74	Residence	1,700 ESE	48.4 dBA
Linnville Bayou	Entry	27.14	Residence	2,500 NE+	43.1 dBA
	Exit	27.56	Residence	1,580 N	43.1 dBA
San Bernard River	Entry	31.1	No NSAs identified within 0.50 mile		
	Exit	31.37			
Brazos River	Entry	45.11	Residence	2,000 W	37.0 dBA
	Exit	44.78	No NSAs identified within 0.50 mile		
Dry Bayou	Entry	46.04	No NSAs identified within 0.50 mile		
	Exit	45.83	Residence	2,050 NW	37.0 dBA
Oyster Creek	Entry	53.26	Residence	600 W	43.1 dBA
	Exit	53.00	Residence	750 S	43.1 dBA
State Highway 288	Entry	55.65	Hospital	1,350 S	50.4 dBA
	Exit	55.38	Hospital	2,280 SE	50.4 dBA
Brazoria County Drainage Ditch #7	Entry	56.07	Residence	1,050 N	54.4 dBA
	Exit	56.30	Residence	1,850 NW	54.4 dBA
Brazoria County Drainage Ditch O	Entry	57.69	Residences	700 W	53.5 dBA
	Exit	57.46	Residences	100 S	53.5 dBA
Canal New A and Coale Road/CR-220	Entry	58.27	Residences	2,500 S	48.5 dBA
	Exit	58.64	Residences	2,050 SW	48.5 dBA
Bastrop Bayou	Entry	60.14	Residence	650 N	48.3 dBA
	Exit	59.80	Residence	1,320 SE	48.3 dBA

2.8.3 Noise Impacts

Construction Noise Impacts

Pipeline Facilities

The acoustical analysis of pipeline facility construction activities considers the noise produced by construction equipment that could affect nearby NSAs. Typical construction equipment likely to be used during construction of the pipelines, along with the estimated sound level of each piece of equipment at 50 feet, is presented in table 2.8-4 below.

Environmental Analysis

Equipment Type	Sound Level at 50 Feet (dBA)
Trucks	85
Crane	80
Roller	80
Bulldozer	85
Pickup Trucks	55
Backhoes	80
Haul Trucks	85

In general, these construction activities would be temporary, of short duration, and would vary considerably from day to day as construction progresses along the pipeline construction corridor. It is anticipated that the highest level of construction-related noise would occur during site earth work activities, such as site grading and clearing, when the largest amount of construction equipment would be operating.

The acoustical analysis for pipeline construction noise impacts indicates that the A-weighted sound level of temporary construction activities would be equal to or less than 85 dBA at 50 feet when construction equipment is operating at full load. There would be locations where pipeline construction would occur within 50 feet of residences. Construction noise therefore may be periodically audible at nearby NSAs. Typical construction of the pipelines would be predominantly scheduled during daylight hours, although various discrete activities (e.g., hydrostatic testing, tie-ins) may require 24 hours of activity for limited periods of time (e.g., 1 to 3 days), thereby making impacts negligible.

Noise and any vibration generated during construction at this distance would not be unusual in nature and would be similar to that which occurs during public works-type projects (e.g., paving, trenching). Because this work would only occur for a few days or less at any location and because any impacts would be temporary, no adverse effects from pipeline construction are expected.

Gulf South does not anticipate conducting blasting. However, if blasting becomes required to complete construction, then Gulf South would conduct all blasting activities in accordance with federal, state, and local regulations.

Aboveground Facilities

Noise associated with construction of the M&R stations should have a negligible noise impact on nearby NSAs, as construction activities would be primarily limited to daytime hours, and the nearby NSAs to each M&R station would be relatively distant. The most prevalent sound source during construction of aboveground facilities would be internal combustion engines used to power construction equipment. Construction related to new equipment would consist of some earth work (e.g., site grading, clearing, and grubbing related to construction of any new building and installation of new equipment). Construction activities would be performed with standard heavy equipment such as a track-excavator and backhoe, as well as a bulldozer, dump truck(s), and concrete trucks. Many construction machines operate intermittently and the types of machines in use at a construction site change with the construction phase. The acoustical assessments indicate that the noise from construction activities at the new compressor stations and new M&R stations would not exceed 55 Ldn at the nearest NSAs. Accordingly, no adverse effects from construction of aboveground facilities are expected.

Horizontal Directional Drilling

Table 2.8-5 below summarizes the NSAs identified within 0.50 mile of exit and entry points of all HDD crossings and provides the estimated sound level of drilling operations during peak conditions. The effect of the anticipated control measures at the closest NSA to each HDD crossing entry or exit point is included in this analysis.

Footnote “b” in table 2.8-5 indicates those locations where the effects of applicant-committed mitigation measures for noise control have been incorporated into the noise analysis. These additional measures are included for these specific HDD sites because the analysis indicates that noise from drilling operations at these sites could exceed the 55 dBA sound criterion at the closest NSA(s) if these additional noise mitigation measures are not included. The noise analysis for the remaining HDD sites assumes that no additional measures would be employed and that a “standard” drilling rig would be used.

Where additional noise mitigation measures are employed at an HDD site (i.e., either entry or exit pit/site) to bring HDD noise levels at the closest NSA(s) in compliance with 55 dBA (L_{dn}), HDD noise levels at receptors more distant than the closest NSA(s) would also be in compliance. In other words, the benefits of additional noise mitigation measures at an HDD site effect all receptors, not just the closest NSA(s).

The results in table 2.8-5 indicate that the sound level contribution of the HDD operations (i.e., with or without additional noise control measures) should not exceed the sound level guideline (i.e., compliance level) of 55 dBA (L_{dn}). There are specific HDD sites in which the estimated “total” sound level (i.e., HDD noise plus existing ambient noise) could be higher than 55 dBA (L_{dn}) due to relatively high ambient noise levels, but the “compliance level” applies only to the noise generated by the HDD operations.

For those HDD sites listed with footnote “b” in table 2.8-5 in which additional measures could be necessary to bring HDD operating noise levels in compliance with 55 dBA (L_{dn}), the noise mitigation measures are discussed in the Gulf South noise analysis report presented in the application. For example, for an HDD entry site in which the analysis indicates that the HDD noise could be higher than 55 dBA (L_{dn}) at the closest NSA(s), additional noise mitigation measures included a temporary noise barrier around the drill rig hydraulic power unit and other engine-driven equipment (e.g., pumps and generators). For an HDD exit site in which the analysis indicates that the HDD noise could be higher than 55 dBA (L_{dn}) at the closest NSA(s), additional noise mitigation measures included temporary noise barrier located between the exit site workspace and nearby NSAs.

The results in table 2.8-5 indicate that HDD would typically result in noise that is less than 55 Ldn. However, there are four NSAs where the total noise may exceed 55 Ldn (**bold** text in table). Some of the mitigation measures Gulf South would commit to are the following:

- installation of a temporary noise barrier and/or a temporary noise-reducing tent over the HDD entry side workspace prior to commencement of drilling operations;
- use of residential-grade exhaust silencers on any engines associated with the operation of HDD equipment;
- relocating equipment (e.g., relocate mud rig remotely);
- installation of a partial barrier or enclosure around the hydraulic power unit;
- installation of a partial barrier around other engine-driven equipment (e.g., pumps and generators); and
- limiting HDD operation to daytime hours.

Environmental Analysis

**Table 2.8-5
Ambient Sound Levels Near HDD Entry and Exit Points**

HDD Name	Entry or Exit Point	Approximate Milepost	Closest NSA and Type	Distance and Direction of NSA to Drill Site (feet)	Ambient Sound Level (Ldn)	Estimated Sound Level of HDD (Ldn)	Estimated Total Sound Level (HDD Ldn + Ambient Ldn)^a	Potential Increase of Ambient
US Highway 50	Entry	10.52	Residence	1,820 NW	59.0 dBA	49.8 dBA	59.5 dBA	0.5 dB
	Exit	10.09	Residence	900 NE	59.0 dBA	48.6 dBA	59.5 dBA	0.4 dB
Peach Creek	Entry	10.99	Residence	580 E	48.4 dBA	53.6 dBA ^b	54.7 dBA ^b	6.3 dB ^b
	Exit	10.74	Residence	1,700 ESE	48.4 dBA	42.1 dBA	49.3 dBA	0.9 dB
Linnville Bayou	Entry	27.14	Residence	2,500 NE	43.1 dBA	47.3 dBA	48.7 dBA	5.6 dB
	Exit	27.56	Residence	1,580 N	43.1 dBA	41.9 dBA	45.6 dBA	2.5 dB
San Bernard River	Entry	31.1	No NSAs identified within 0.50 mile					
	Exit	31.37						
Brazos River	Entry	45.11	Residence	2,000 W	37.0 dBA	48.8 dBA	49.1 dBA	12.1 dB
	Exit	44.78	No NSAs identified within 0.50 mile					
Dry Bayou	Entry	46.04	No NSAs identified within 0.50 mile					
	Exit	45.83	Residence	2,050 NW	37.0 dBA	40.1 dBA	41.8 dBA	4.8 dB
Oyster Creek	Entry	53.26	Residence	600 W	43.1 dBA	53.2 dBA ^b	53.6 dBA ^b	10.5 dB ^b
	Exit	53.00	Residence	750 S	43.1 dBA	50.4 dBA	51.2 dBA	8.1 dB
State Highway 288	Entry	55.65	Hospital	1,350 S	50.4 dBA	53.0 dBA	54.9 dBA	4.5 dB
	Exit	55.38	Hospital	2,280 SE	50.4 dBA	37.2 dBA	50.6 dBA	0.2 dB
Brazoria County Drainage Ditch #7	Entry	56.07	Residence	1,050 N	54.4 dBA	47.9 dBA ^b	55.3 dBA ^b	0.9 dB ^b
	Exit	56.30	Residence	1,850 NW	54.4 dBA	41.2 dBA	54.6 dBA	0.2 dB
Brazoria County Drainage Ditch O	Entry	57.69	Residences	700 W	53.5 dBA	51.8 dBA ^b	55.7 dBA^b	2.2 dB ^b
	Exit	57.46	Residences	100 S	53.5 dBA	54.3 dBA ^b	56.9 dBA^b	3.4 dB ^b
Canal New A and Coale Road/ CR-220	Entry	58.27	Residences	2,500 S	48.5 dBA	46.3 dBA	50.6 dBA	2.1 dB
	Exit	58.64	Residences	2,050 SW	48.5 dBA	40.1 dBA	49.1 dBA	0.8 dB
Bastrop Bayou	Entry	60.14	Residence	650 N	48.3 dBA	52.5 dBA ^b	53.9 dBA ^b	5.6 dB ^b
	Exit	59.80	Residence	1,320 SE	48.3 dBA	44.7 dBA	49.9 dBA	1.6 dB

Note: Sound levels that exceed 55 Ldn are highlighted in bold.

^a Includes the noise generated by the HDD plus ambient sound levels measured at the NSA.

^b Includes the effect of applicant-committed mitigation measures for noise control for the drill (Gulf South June 2015a).

Operational Noise Impacts

Compressor Stations

Table 2.8-6 summarizes the estimated sound levels from each station evaluated, the estimated total sound level (ambient plus station sound), and the potential increase in noise above the ambient sound level.

Table 2.8-6 Operational Noise Levels Near Compressor Sites					
NSA	Distance and Direction of NSA to Compressor Site (feet)	Ambient Sound Level (Ldn)	Estimated Sound Level of the Station (Ldn) ^a	Estimated Total Sound Level (Station Ldn + Ambient Ldn)	Potential Increase Above Ambient
Wilson Compressor Station					
NSA #1 (Residences)	2,254 SSE	39.4 dBA	45.0 dBA	46.0 dBA	6.6 dB
NSA #2 (Residences)	2,730 NNE	39.3 dBA	42.8 dBA	44.4 dBA	5.1 dB
Magasco Compressor Station					
NSA #1 (Residences)	934 SE	44.2 dBA	50.0 dBA	51.0 dBA	6.8 dB
NSA #2 (Residences)	1,126 SSE	44.2 dBA	48.1 dBA	49.6 dBA	5.4 dB
Brazos Compressor Station					
NSA #1 (Residence)	2,714 N	42.3 dBA	44.8 dBA	46.8 dBA	4.5 dB
NSA #2 (Residence)	3,307 S	47.9 dBA	41.7 dBA	48.8 dBA	0.9 dB
North Houston Compressor Station					
NSA #1 (Residence)	600 N	50.6 dBA	51.0 dBA	53.8 dBA	3.2 dB
NSA #2 (Residence)	1,245 SE	61.2 dBA	43.7 dBA	61.3 dBA	0.1 dB
NSA #3 (Residence)	2,776 W	50.2 dBA	35.0 dBA	50.3 dBA	0.1 dB
NSA #4 (Residence)	1,034 S	60.3 dBA	45.6 dBA	60.4 dBA	0.1 dB

^a Includes the effect of the anticipated noise control measures at each compressor station.

The results of the acoustical analysis indicate that the noise attributable to the Wilson, Magasco, Brazos, and North Houston Compressor Stations would be lower than 55 dBA (Ldn) at the closest NSAs. The sound level from operation of the blowdown unit at each compressor station is expected to be lower than 55 Ldn, as well. Accordingly, no adverse effects from operation of the compressor station are expected.

To ensure that the actual noise levels resulting from operation of the compressor stations do not exceed an Ldn of 55 dBA, **we recommend the following:**

- **Gulf South should file a noise survey with the Secretary no later than 60 days after placing the Wilson, Brazos, North Houston, and Magasco Compressor Stations into service. If full load condition noise surveys are not possible, Gulf South should provide interim surveys at the maximum possible horsepower load and provide the full load survey within 6 months. If the noise attributable to the operation of all of the equipment at the compressor stations under interim or full horsepower load exceeds an Ldn of 55 dBA at the nearest NSA, Gulf South should**

Environmental Analysis

file a report on what changes are needed and will install the additional noise controls to meet the level within 1 year of the in-service date. Gulf South should confirm compliance with the above requirement by filing a second noise survey for each station with the Secretary no later than 60 days after it installs the additional noise controls.

We received a comment letter regarding vibration concerns at the proposed compressor station in Wharton County, Texas. Potential ground-borne vibration due to the operation of the compressor units is not anticipated to be perceptible; ground vibration due to the operation of turbine-driven centrifugal compressor units would only be perceptible at distances of less than 200 feet from the compressor units. The closest NSA is approximately 2,254 feet from the compressor station site center which is clearly beyond the distance where vibration would be perceptible. Furthermore, operation of the Wilson Compressor Station would not result in any increase in noise-induced vibration at any NSA. The compressor station's noise sources that could generate perceptible vibration, such as noise from the exhaust for the station turbines, would be adequately mitigated, as necessitated by the installation of exhaust systems for the turbines which would include a 2-stage silencer system.

Meter and Regulator Stations

Table 2.8-7 summarizes the estimated sound levels from each station evaluated, the estimated total sound level (ambient plus station sound), and the potential increase in noise above the ambient sound level.

Table 2.8-7 Ambient Sound Levels and Operational Sound Levels Near Meter and Regulator Stations					
NSA	Distance and Direction of NSA to Compressor Site (feet)	Ambient Sound Level (Ldn)	Sound Level (Ldn) of the Station^a	Estimated Total Sound Level (Station Ldn + Ambient Ldn)^b	Potential Increase Above Ambient
NGPL M&R Station					
NSA #1 (Residences)	1,250 SW	50.7 dBA	40.6 dBA	51.1 dBA	0.4 dB
Gulf South Index 129 M&R Station					
NSA #1 (Residences)	1,600 W	46.8 dBA	41.3 dBA	47.9 dBA	1.1 dB
HPL-Energy Transfer M&R Station					
NSA #1 (Residence)	1,900 W	44.3 dBA	39.0 dBA	45.4 dBA	1.1 dB
^a Includes the effect of the anticipated noise control measures at each M&R station.					
^b Includes the noise generated by the M&R station plus ambient sound levels measured at the NSA.					

The results of the acoustical analysis indicate that the noise attributable to the proposed meter and regulator stations would be lower than 55 Ldn at the closest NSAs. Accordingly, no adverse effects from operation of the M&R stations are expected and no additional mitigation is necessary.

2.9 RELIABILITY AND SAFETY

The transportation of natural gas by pipeline involves some incremental risk to the public due to the potential for an accidental release of natural gas. The greatest hazard is a fire or explosion following a major pipeline rupture.

CH₄, the primary component of natural gas, is colorless, odorless, and tasteless. It is not toxic, but it is classified as a simple asphyxiant, possessing a slight inhalation hazard. If breathed in high concentration, it can cause oxygen deficiency, resulting in serious injury or death.

CH₄ has an auto-ignition temperature of 1,000° Fahrenheit and is flammable at concentrations between 5.0 percent and 15.0 percent in air. An unconfined mixture of CH₄ and air is not explosive; however, it may ignite if there is an ignition source. A flammable concentration within an enclosed space in the presence of an ignition can explode. It is buoyant at atmospheric temperatures and disperses rapidly in air.

2.9.1 Safety Standards

The DOT is mandated to prescribe minimum safety standards to protect against risks posed by pipeline facilities under Title 49, U.S.C. Chapter 601. The DOT's PHMSA administers the national regulatory program to ensure the safe transportation of natural gas and other hazardous materials by pipeline. It develops safety regulations and other approaches to risk management that ensure safety in the design, construction, testing, operation, maintenance, and emergency response of pipeline facilities. Many of the regulations are written as performance standards which set the level of safety to be attained and allow the pipeline operator to use various technologies to achieve safety. PHMSA's safety mission is to ensure that people and the environment are protected from the risk of pipeline incidents. This work is shared with state agency partners and others at the federal, state, and local level.

Title 49, U.S.C. Chapter 601 provides for a state agency to assume all aspects of the safety program for intrastate facilities by adopting and enforcing the federal standards. A state may also act as DOT's agent to inspect interstate facilities within its boundaries; however, the DOT is responsible for enforcement actions.

The DOT pipeline standards are published in 49 CFR Part 190–199. Part 192 specifically addresses the minimum federal safety standards for transportation of natural gas by pipeline.

Under a *Memorandum of Understanding on Natural Gas Transportation Facilities* between DOT and FERC dated January 15, 1993, DOT has the exclusive authority to promulgate federal safety standards used in the transportation of natural gas. Section 157.14(a)(9)(vi) of FERC's regulations require that an applicant certify that it would design, install, inspect, test, construct, operate, replace, and maintain the facility for which a Certificate is requested in accordance with DOT federal safety standards and plans for maintenance and inspection. Alternatively, an applicant may certify that it has been granted a waiver of the requirements of the safety standards by DOT in accordance with Section 3(e) of the Natural Gas Pipeline Safety Act. FERC accepts this certification and does not impose additional safety standards. If the Commission becomes aware of an existing or potential safety problem, there is a provision in the memorandum to promptly alert DOT. The memorandum also provides for referring complaints and inquiries made by state and local governments and the general public involving safety matters related to pipelines under the Commission's jurisdiction.

FERC also participates as a member of DOT's Technical Pipeline Safety Standards Committee, which determines if proposed safety regulations are reasonable, feasible, and practicable.

The pipeline facilities would be designed, constructed, operated, and maintained in accordance with DOT Minimum Federal Safety Standards presented in 49 CFR Part 192. These regulations are intended to ensure adequate protection of the public from natural gas pipeline failures. Part 192 specifies material selection and qualification, minimum design requirements, and protection from internal, external, and atmospheric corrosion.

Gulf South maintains a program of coordination with public authorities and local utilities for all facility locations. Gulf South's plan requires that contact is made with the police and fire departments

Environmental Analysis

and/or public officials of all communities that contain Gulf South facilities in order to accomplish the following.

- Ascertain how the officials may be able to assist during an emergency, including the determination of the jurisdiction and/or responsibility with resources that may be involved in a response to an emergency.
- Acquaint the officials with how Gulf South responds to an emergency.
- Notify the officials of the types of pipeline emergencies for which they may be contacted.
- Inform them how Gulf South, in working with their departments, would cooperate in mutually assisting in protecting life or property during an emergency.

Gulf South maintains a list of all local contact information with police, fire departments, and other public officials in the event of an emergency. This listing is reviewed on a periodic basis and is revised as necessary. In addition, Gulf South invites fire departments to participate in periodic fire response demonstrations and emergency simulation exercises that focus on when and how to extinguish a natural gas fire during an emergency. Gulf South also holds informational meetings and trainings in municipalities and communities where facilities are located at the request of the municipality. These meetings cover Gulf South's role in emergencies on its pipeline system, the properties of natural gas and precautionary measures to be taken before and during an emergency, and the role local fire departments play during an emergency.

Part 192 defines area classifications, based on population density in the vicinity of the pipeline, and specifies rigorous safety requirements for populated areas. The class location unit is an area that extends 220 yards on either side of the centerline of any continuous 1-mile length of pipeline (49 CFR 192.5). The four classifications are defined as follows.

- Class 1: Location with 10 or fewer buildings intended for human occupancy
- Class 2: Location with more than 10 but less than 46 buildings intended for human occupancy
- Class 3: Location with 46 or more buildings intended for human occupancy or where pipeline lies within 100 yards of any building or small, well-defined outside area occupied by 20 or more people during normal use
- Class 4: Location where buildings with four or more stories aboveground are prevalent

Class locations representing more populated areas require higher safety factors in pipeline design, testing, and operation. For instance, pipelines constructed on land in Class 1 locations must be installed with a minimum depth of cover of 30 inches in normal soil and 18 inches in consolidated rock. Class 2, 3, and 4 locations, as well as drainage ditches of public roads and railroad crossings, require a minimum cover of 36 inches in normal soil and 24 inches in consolidated rock.

Class locations also specify the maximum distance to a sectionalizing block valve (e.g., 10.0 miles in Class 1, 7.5 miles in Class 2, 4.0 miles in Class 3, and 2.5 miles in Class 4). Pipe wall thickness and pipeline design pressures; hydrostatic test pressures; maximum allowable operating pressure (MAOP); inspection and testing of welds; and frequency of pipeline patrols and leak surveys must also conform to higher standards in more populated areas.

The minimum depth of cover for pipelines within each class location, as defined by DOT, are summarized below in table 2.9-1.

Location	Depth of Cover (inches)	
	Normal Soils	Consolidated Rock
Class 1	30	18
Class 2, 3, and 4	36	24
Drainage ditches of public roads and railroad crossings	36	24
Source: 49 CFR 192.327.		

If a subsequent increase in population density adjacent to the right-of-way results in a change in class location for the pipeline, Gulf South would reduce the MAOP or replace the segment with pipe of sufficient grade and wall thickness, if required to comply with the DOT requirements for the new class location.

Pipeline design pressures, hydrostatic test pressures and maximum allowable operating pressure, inspection and testing of welds, and frequency of pipeline patrols and leak surveys must also conform to higher standards in more populated areas, also referred to as high consequence areas (HCAs). DOT Pipeline Safety Regulations require operators to develop and follow a written Integrity Management Program that contains all the elements described in 49 CFR Part 192.911 and address the risk on each transmission pipeline segment. This rule establishes an Integrity Management Program that applies to all HCAs.

DOT has published rules that define HCAs where a gas pipeline accident could do considerable harm to people and their property and requires an Integrity Management Program to minimize the potential for an accident. This definition satisfies the Congressional mandate for DOT to prescribe standards that establish criteria for identifying each gas pipeline facility in a high-density population area. The HCAs may be defined in one of two ways. The first definition of an HCA includes:

- Current Class 3 and Class 4 locations
- Any area in Class 1 or Class 2 where the potential impact radius⁵ is greater than 660 feet and there are 20 or more buildings intended for human capacity within the potential impact circle⁶
- Any area in Class 1 or Class 2 where the potential impact circle includes an identified site

An identified site is an outside area or open structure that is occupied by 20 or more persons on at least 50 days in any 12-month period; a building that is occupied by 20 or more persons on at least 5 days a week for any 10 weeks in any 12-month period; or a facility that is occupied by persons who are confined, have impaired mobility, or would be difficult to evacuate.

The second definition of an HCA includes any area within a potential impact circle that contains:

- 20 or more buildings intended for human occupancy

⁵ The potential impact radius is calculated as the product of 0.69 and the square root of maximum allowable operating pressure of the pipeline in pounds per square inch gauge multiplied by the square of the pipeline diameter in inches.

⁶ The potential impact circle is a circle of radius equal to the potential impact radius.

Environmental Analysis

- An identified site

Once a pipeline operator has determined there are HCAs along its pipeline, it must apply the elements of its Integrity Management Program to those segments of the pipeline within the HCAs. DOT regulations specify the requirements for the Integrity Management Program in Section 192.91. The pipeline integrity management rule for HCAs requires inspection of pipeline HCAs every 7 years.

Gulf South has identified six HCAs crossed by the proposed Project area. Additional information regarding the location, distance from the pipeline, and description of each HCA is provided in table 2.9-2.

Milepost	Distance from Pipeline (feet)	Description
10.29	405	Gas Station/RV Park
21.26	470	Compressor Station
24.51	590	Power Plant
56.50–57.70	N/A	Class 3
64.59	605	Office Building
64.73	600	Office Building

Note: HCA location determinations are preliminary and have not been verified by structure use/occupancy data.

The majority of the proposed header pipeline would be Class 1 (64.41 miles), while 1.20 miles would be Class 3. The entire header pipeline would be designed according to the designated population density specifications. Gulf South would monitor for changes in population density around the pipeline with a yearly aerial survey that would facilitate a comparison between the previous and current residence count. Table 2.9-3 provides the class locations by MP along the header pipeline route.

Class	Begin Milepost	End Milepost	Length
1	0.00	56.50	56.50
3	56.50	57.70	1.20
1	57.70	65.61	7.91

Note: Class location determinations are preliminary and have not been verified by structure use/occupancy data.

PHMSA also requires operators to place pipeline markers at frequent intervals along the right-of-way, particularly at prominent points along the route such as where a pipeline intersects a street, highway, railway, waterway, or other significant feature. Pipeline right-of-way markers can help prevent encroachment and excavation-related damage to pipelines. Because the pipeline right-of-way would be much wider than the pipeline itself, and a pipeline can be located anywhere within the right-of-way, state laws require excavators to call their state “One Call” center well in advance of digging to locate utilities in order to ensure that it is safe for the contractor to dig in that location.

Gulf South is a member of the “One Call” and related pre-excavation notification organizations in the states in which it operates. Through “One Call,” contractors provide notification of proposed

excavation to a central agency that, in turn, notifies Gulf South of the excavation locations. If Gulf South facilities are located in the area of proposed contractor activity, they would be marked in the field, and a representative of Gulf South would be present during excavation to ensure that the facility is not compromised.

Part 192 prescribes the minimum standards for operating and maintaining pipeline facilities, including the requirement to establish a written plan governing these activities. Under Section 192.615, each pipeline operator must also establish an emergency plan that provides written procedures to minimize the hazards from a gas pipeline emergency. Gulf South would implement the following key elements of the plan including, but not limited to, the following tasks:

- Receiving, identifying, and classifying emergency event: gas leakage, fires, explosions, and natural disasters
- Establishing and maintaining communication with local fire, police, and public officials and coordinating emergency responses
- Making personnel, equipment, tools, and materials available at the scene of an emergency
- Protecting people first and then property, and making them safe from actual or potential hazards
- Performing emergency shutdown of system and safely restoring service

DOT also requires that each operator establish and maintain liaison with appropriate fire, police, and public officials to learn the resources and responsibilities of each organization that may respond to a natural gas pipeline emergency, and to coordinate mutual assistance. The operator must also establish a continuing education program to enable customers, the public, government officials, and those engaged in excavation activities to recognize a gas pipeline emergency and report it to appropriate officials.

2.9.2 Pipeline Accident Data

The DOT requires all operators of natural gas transmission pipelines to notify the DOT of any significant incident and to submit a report within 30 days. Significant incidents are defined as any leaks that:

- caused a death or personal injury requiring hospitalization; or
- involve property damage of more than \$50,000 (1984 dollars).
- During the 20 year period from 1994 through 2013, a total of 1,237 significant incidents were reported on the more than 300,000 total miles of natural gas transmission pipelines nationwide.

Additional insight into the nature of service incidents may be found by examining the primary factors that caused the failures. Table 2.9-4 provides a distribution of the causal factors as well as the number of each incident by cause.

The dominant causes of pipeline incidents are corrosion and pipeline material, weld or equipment failure constituting 48.2 percent of all significant incidents. The pipelines included in the data set in table 2.9-4 vary widely in terms of age, diameter, and level of corrosion control. Each variable influences the incident frequency that may be expected for a specific segment of pipeline.

The frequency of significant incidents is strongly dependent on pipeline age. Older pipelines have a higher frequency of corrosion incidents and material failure, since corrosion and pipeline stress/strain is a time-dependent process.

Environmental Analysis

Cause	No. of Incidents	Percentage
Corrosion	292	23.6
Excavation ²	211	17.0
Pipeline material, weld or equipment failure	304	24.6
Natural force damage	142	11.5
Outside force ³	74	6.0
Incorrect operation	33	2.7
All other causes ⁴	181	14.6
TOTAL	1,237	-

1. All data gathered from PHMSA Significant incident files, March 25, 2014.
<http://primis.phmsa.dot.gov/comm/reports/safety/>

2. Includes third party damage

3. Fire, explosion, vehicle damage, previous damage, intentional damage

4. Miscellaneous causes or unknown causes

The reportable incident data summarized in table 2.9-4 include pipeline failures of significant magnitudes with widely varying causes and consequences. Table 2.9-5 further evaluates the reportable incident data by specific causes of “damage by external forces.”

The use of both an external protective coating and a cathodic protection system⁷, required on all pipelines installed after July 1971, significantly reduces the corrosion rate compared to unprotected or partially protected pipe.

Outside force, excavation, and natural forces are the cause in 34.5 percent of significant pipeline incidents. These result from the encroachment of mechanical equipment such as bulldozers and backhoes; earth movements due to soil settlement, washouts, or geologic hazards; weather effects such as winds, storms, and thermal strains; and willful damage. Table 2.9-5 provides a breakdown of outside force incidents by cause.

Older pipelines have a higher frequency of outside forces incidents partly because their location may be less well known and less well marked than newer lines. In addition, the older pipelines contain a disproportionate number of smaller-diameter pipelines; which have a greater rate of outside forces incidents. Small diameter pipelines are more easily crushed or broken by mechanical equipment or earth movement.

Since 1982, operators have been required to participate in “One Call” public utility programs in populated areas to minimize unauthorized excavation activities in the vicinity of pipelines. The "One Call" program is a service used by public utilities and some private sector companies (e.g., oil pipelines and cable television) to provide preconstruction information to contractors or other maintenance workers on the underground location of pipes, cables, and culverts.

⁷ Cathodic protection is a technique to reduce corrosion (rust) of the natural gas pipeline through the use of an induced current or a sacrificial anode (like zinc) that corrodes at faster rate to reduce corrosion.

**Table 2.9-5
Outside Forces Incidents by Cause, 1994-2013¹**

Cause	No. of Incidents	Percent of all Incidents
Third party excavation damage	176	14.2
Operator excavation damage	25	2.0
Unspecified excavation damage/previous damage	10	0.8
Heavy rain/floods	72	5.8
Earth movement	35	2.8
Lightning/temperature/high winds	21	1.7
Natural force (other)	14	1.1
Vehicle (not engaged with excavation)	45	3.6
Fire/explosion	8	0.6
Previous mechanical damage	5	0.4
Fishing or maritime activity	7	0.6
Intentional damage	1	0.1
Electrical arcing from other equipment/facility	1	0.1
Unspecified/other outside force	7	0.6
TOTAL	427	-

1. Excavation, Outside Force, and Natural Force from table 2.9-4.

2.9.3 Impacts on Public Safety

The transportation of natural gas by pipeline may involve some risk to the public in the event of an incident and subsequent release of natural gas. Previous impacts on public safety from pipeline transport of natural gas have been directly related to leaks or line breaks due to corrosion or equipment malfunctions. Impacts on public safety have also been indirectly related to leaks or line breaks resulting from external forces not associated with pipeline operations, such as damage from third-party digging near buried pipeline sections or damage from natural forces.

FERC has received comments regarding potential damage to existing pipelines. In general, the natural gas transmission industry has an excellent record of public safety. Pipelines and related facilities are designed and maintained with strict adherence to DOT standards to ensure public safety and reliability and to minimize the risk of system failure. Gulf South would continue to employ similar system design, construction, operation, and maintenance practices to ensure this excellent record is maintained.

Gulf South's operating policies and procedures are periodically reviewed by DOT. All operating personnel are thoroughly trained to perform their activities in accordance with these policies and procedures. These policies provide specific direction in preventative maintenance and monitoring of facilities as well as procedures to be followed in the event of an accident or natural catastrophe.

Table 2.9-6 presents the average annual injuries and fatalities that occurred on natural gas transmission lines for the 5 year period between 2009 and 2013. The majority of fatalities from pipelines are due to local distribution pipelines not regulated by FERC. These are natural gas pipelines that distribute natural gas to homes and businesses after transportation through interstate natural gas transmission pipelines. In general, these distribution lines are smaller diameter pipes and/or plastic pipes

Environmental Analysis

which are more susceptible to damage. Local distribution systems do not have large right-of-ways and pipeline markers common to the FERC regulated natural gas transmission pipelines.

Year	Injuries	Fatalities
2009	11	0
2010 ¹	61	10
2011	1	0
2012	7	0
2013	2	0

1. All of the fatalities in 2010 were due to the Pacific Gas and Electric pipeline rupture and fire in San Bruno, California on September 9, 2010.

The nationwide totals of accidental fatalities from various anthropogenic and natural hazards are listed in table 2.9-7 in order to provide a relative measure of the industry-wide safety of natural gas transmission pipelines. Direct comparisons between accident categories should be made cautiously, however, because individual exposures to hazards are not uniform among all categories. The data nonetheless indicate a low risk of death due to incidents involving natural gas transmission pipelines compared to the other categories. Furthermore, the fatality rate is much lower than the fatalities from natural hazards such as lightning, tornados, or floods.

The available data show that natural gas transmission pipelines continue to be a safe, reliable means of energy transportation. From 1994 to 2013, there were an average of 62 significant incidents, 10 injuries and 2 fatalities per year. The number of significant incidents over the more than 303,000 miles of natural gas transmission lines indicates the risk is low for an incident at any given location. The operation of the Gulf South Project would represent a slight increase in risk to the nearby public.

Gulf South currently has substantial operations in Texas and has begun to notify all state and local government agencies about the Project. To date, the contacted officials have indicated adequate facilities and resources are available to respond to potential needs associated with the Project in case of injury or accident during construction or operations. Because there is an abundance of other natural gas and liquid pipelines in this region, many of the responders are also regularly involved in emergency response drills and participate with industry and DOT training programs and local command centers to meet the needs for improving public and worker safety.

**Table 2.9-7
Nationwide Accidental Deaths¹**

Type of Accident	Annual No. of Deaths
All accidents	117,809
Motor Vehicle	45,343
Poisoning	23,618
Falls	19,656
Injury at work	5,113
Drowning	3,582
Fire, smoke inhalation, burns	3,197
Floods ²	89
Tractor Turnover ³	62
Lightning ²	54
Natural gas distribution lines ⁴	14
Natural gas transmission pipelines ⁴	2
<p>1. All data, unless otherwise noted, reflects 2005 statistics from USCB, Statistical Abstract of the United States: 2010 (129th Edition) Washington, DC, 2009; http://www.census.gov/statab.</p> <p>2. NOAA National Weather Service, Office of Climate, Water and Weather Services, 30 year average (1983-2012) http://www.weather.gov/om/hazstats.shtml</p> <p>3. Bureau of Labor Statistics, 2007 Census of Occupational Injuries</p> <p>4. PHMSA significant incident files, March 25, 2014. http://primis.phmsa.dot.gov/comm/reports/safety/, 20 year average.</p>	

2.10 CUMULATIVE IMPACTS

In accordance with NEPA and FERC policy, the impacts of the proposed Project in conjunction with the impacts from other projects or actions in the area are considered. According to federal regulations (40 CFR 1500–1508), the cumulative impacts analysis must consider the impact on the environment as a result of the incremental effects from the Project, when added to other past, present, and reasonably foreseeable future actions, regardless of which agency (federal or non-federal) or person (e.g., private citizen, corporation) undertakes the other actions. The analysis must consider relevant other projects in addition to similar natural gas projects, because other types of projects could generate related or similar human or environmental effects. Cumulative impacts can result from individually minor, but collectively significant, actions taking place in the same general area over a given period of time. In general, small-scale projects that have minimal impacts that are of short duration do not contribute significantly to cumulative impacts.

The purpose of this cumulative impact analysis is to identify and describe cumulative impacts that would potentially result from implementation of multiple projects located in the same resource impact analysis area as the proposed Project and over the same or overlapping timeframes. This cumulative impact analysis generally follows CFR Part 1500, Section 1508. Under these guidelines, inclusion of other actions within the analysis area is based on identifying commonalities of impacts from other actions to potential impacts that would result from the Project. An action must meet the following criteria to be included in the cumulative impact analysis.

Environmental Analysis

- Affect a resource area potentially affected by the Project.
- Cause this impact within all, or part, of the Project area.
- Cause this impact within all, or part, of the time span for the potential impact of the Project.

2.10.1 Cumulative Impact Analysis Area

The projects considered in this cumulative impact analysis may vary from the proposed Project in nature, magnitude, and duration but were included in this analysis if they were in the region of influence in which impacts may have the potential to be cumulative. For purposes of this analysis, the broader region of influence considered for identifying other projects includes the following six counties: Wharton, Brazoria, Fort Bend, Harris, Polk, and Sabine. From the broader region of influence, projects considered for cumulative effects were based on the cumulative impact analysis area unique to a specific resource. The study area for each resource is summarized in table 2.10-1. For purposes of defining the impact analysis area in table 2.10-1, the term “Project workspace” refers to the extent of surface disturbance, including temporary workspaces, long-term disturbance, and short-term use areas such as construction roads.

Table 2.10-1 Cumulative Impact Analysis Areas and Rationale	
Resource	Cumulative Impact Analysis Area
Geology and Soils	The Project workspace.
Water Resources and Wetlands	The 10-digit hydrological code watersheds crossed by the Project workspace.
Fish, Wildlife and Vegetation	Fish: The 10-digit hydrological code watersheds crossed by the Project workspace.
	Wildlife: The area adjacent to and in proximity of the proposed Project workspace.
	Vegetation: The 10-digit hydrological code watersheds within the Project workspace.
Cultural Resources	The APE, as defined for the Project, plus an additional 0.25-mile region of influence.
Land Use, Recreation, and Aesthetics	The area adjacent to and in proximity of the proposed Project workspace, and up to 0.5 mile for visual effects.
Socioeconomics	The counties within which the proposed Project would be constructed, counties where non-local workers are expected to reside during construction, and counties where operations personnel are expected to reside permanently.
Air Quality	The region of influence for long-term cumulative air quality effects includes projects within the same Air Quality Control Region(s) as the proposed Project’s sources of operational emissions (gas-fired compressor stations) and extends up to 50 kilometers from the gas-fired stations.
Climate Change	Global, based on GHG contributions; however, the six counties in which the Project would be located are considered the immediate focus for cumulative effects.
Noise	One mile from the primary sources of operational noise associated with the proposed Project (with focus specifically on compressor stations).

2.10.2 Past, Present, and Reasonably Foreseeable Projects

Major projects were identified within the cumulative impact analysis areas by contacting county planning and development departments, RRC, and EPA; reviewing the FERC Docket for other

jurisdictional projects; and reviewing publicly available online resources, including websites for the Texas Department of Transportation and TCEQ. Projects expected to be completed within 1 year prior to the proposed Project, currently under construction, or considered to be a reasonably foreseeable project were included in this analysis. Fourteen major projects were identified within the region of influence for the Project. Table 2.10-2 summarizes the name, description, location, and estimated timeline of each project and figure 2.10-1 provides a map showing the general location relative to the Project. Two of the projects involve two separate but related facilities. Detailed descriptions follow the table.

Freeport Liquefaction Project

Freeport LNG is constructing liquefaction infrastructure at the existing terminal to provide nominal export capacity of approximately 13.9 million metric tonnes per annum of liquid natural gas, which equates to processing approximately 2.0 billion cubic feet per day of pipeline-quality natural gas (feed gas). The feed gas will be derived from the interconnecting intrastate pipeline systems through Freeport LNG's existing Stratton Ridge meter station. In August 2012, Freeport LNG filed a formal FERC application pursuant to Section 3 of the NGA. In July 2014, Freeport LNG received FERC authorization to site, construct, and operate the liquefaction project. Freeport LNG received its final approvals from FERC in November 2014. Construction began in November 2014 and commercial operation is expected to begin in 2019. In addition to the terminal expansion, a pretreatment plant will be constructed consisting of three natural gas pretreatment units at the Quintana Island Terminal. The pretreatment plant will be operational by 2018.

Light Hydrocarbon 9 Unit Project

DOW Chemical Company (DOW) is expanding its production facilities in Freeport with construction of a new ethylene production unit (Light Hydrocarbon 9 [LHC-9]) within Oyster Creek. The LHC-9 Unit Project will use ethane and propane as feedstock. A new 78-mile, 12-inch pipeline will be constructed between Mont Belvieu and Freeport to supply ethane to the proposed LHC-9 unit. The primary products produced at the LHC-9 facility (ethylene and propylene) will be used as feedstock for other existing units at the DOW Freeport Site or transported via pipeline to existing underground storage caverns at Stratton Ridge. Mechanical completion is expected in 2015 for the propane dehydrogenation facility and 2016 for the LHC-9 facility.

U.S. Gulf Coast Petrochemicals Project

The U.S. Gulf Coast Petrochemicals Project, being developed by Chevron Phillips Chemicals in Texas, includes an ethane cracker and two polyethylene units. The ethane cracker is estimated to have an annual capacity of 1.5 million tonnes a year (3.3 billion pounds/year), while each of the polyethylene units will have an annual capacity of 500,000 tonnes (1.1 billion pounds). The project began in March 2011 and received EPA and TCEQ air permits in August 2013. Construction began in April 2014 and commissioning is expected in 2017.

Springwoods Village Project

Springwoods Village is a 2,000-acre master-planned, mixed-use community situated 20 miles north of downtown Houston. The project will ultimately include 3,500–5,000 housing units, an ExxonMobil campus, a hospital, a hotel, office buildings, parks, a school, a nature preserve, a shopping district, restaurants, and other civic and transportation services. Development of this community began in 2014 and is expected to continue through 2024.

Environmental Analysis

Table 2.10-2 Projects Potentially Contributing to Cumulative Impacts					
Project	Description	Estimated Construction and/or In-Service Dates	Location^a	Figure 2.10-1 (ID #)	
FERC Jurisdictional					
1	Freeport Liquefaction Project (FERC Docket No. CP12-509-000)	Expansion of the existing Freeport LNG import terminal, to include natural gas liquefaction and export capabilities.	August 2014–December 2019	Approximately 8.2 miles southeast of MP 65.61 of the header pipeline on Quintana Island in Brazoria County.	1
		Construction of a pretreatment plant consisting of three natural gas pretreatment units that will be connected to Freeport LNG’s existing natural gas send-out pipeline.	August 2014–December 2018	Approximately 2.6 miles southeast of MP 65.61 of the header pipeline, which connects to the Quintana Island terminal approximately 3.5 miles north of Quintana Island.	2
Other Projects					
2	Light Hydrocarbon 9 (LHC-9) Unit Project	Approximately 78 miles of new 12-inch-diameter ethane pipeline.	June 2014–January 2017	Ethane pipeline intersects with the header pipeline at MP 64.66 between Mont Belvieu and Freeport.	3
		DOW Chemical Company’s ethylene LHC-9 production unit will use ethane supplied by the new ethane pipeline to produce ethylene and propylene for use at the existing DOW Freeport Site or for transport via pipeline to existing underground storage caverns.		Approximately 5.0 miles south from MP 65.61 of the header pipeline located on the existing DOW Chemical property in Brazoria County.	4
3	Springwoods Village Project	Springwoods Village is a 2,000-acre master-planned, mixed-use community. The community will include single-family housing, multi-family housing, retail, dining, offices, and public amenities.	2014–2024	Approximately 3.0 miles east of the North Houston Compressor Station in Spring.	5
4	U.S. Gulf Coast Petrochemicals Project	Chevron Philips Chemicals is constructing two polyethylene facilities. Each facility will have the capacity to produce 500,000 tons of plastic resin per year.	2014–2017	Approximately 10 miles southwest of MP 43.75 of the header pipeline at the existing Sweeny Plant in Old Ocean.	6
5	Channel Widening Project	The Port of Freeport has proposed to widen the Freeport Harbor Channel from 400 feet to 600 feet for 6.1 miles.	2013–2018	Approximately 6.8 miles south from MP 65.61 of the header pipeline at the Port of Freeport.	7

Table 2.10-2 Projects Potentially Contributing to Cumulative Impacts					
Project		Description	Estimated Construction and/or In-Service Dates	Location^a	Figure 2.10-1 (ID #)
6	Channel Deepening Project	The Port of Freeport and USACE are proposing to deepen the Freeport Harbor Entrance Channel from 45 feet to 50–57 feet, requiring approximately 12 miles of dredging.	2015–2021	Approximately 8.3 miles southeast from MP 65.61 of the header pipeline at the Port of Freeport.	8
7	CenterPoint Energy Substation	CenterPoint Energy is proposing to construct a substation in Wharton County.	b	Approximately 6 miles from the Wilson Compressor Station.	9
8	State Highway 36 Improvements	Texas Department of Transportation and Brazoria County are proposing to widen and rehabilitate State Highway 36.	2017	Approximately within a 3-mile buffer of the pipeline in Brazoria County.	10
9	Sweeny Refinery, Phillips 66 Company	Phillips 66 Company plans to build a condensate splitter at its 247,000-barrel per day Sweeny refinery in Brazoria County.	2016–2017	Approximately 34.3 kilometers from the Wilson Compressor Station.	11
10	Halyard Wharton Energy Company	Halyard Wharton Energy Center is proposing to build a 650-megawatt natural gas-fired power plant with three F-class combustion turbine generators and 20 megawatts of battery storage in Wharton County.	2014–2016	Approximately 44.5 kilometers from the Wilson Compressor Station.	12
11	OXEA Corporation	OXEA Corporation is proposing to build a 2-Ethylhexanol and a Propanol unit at its production plant in Bay City in Matagorda County.	2014–2016	Approximately 48.9 kilometers from the Wilson Compressor Station.	13
12	Petra Nova Carbon Capture System, Hilcorp Energy Company	Hilcorp Energy Company, JX Nippon Oil & Gas Exploration Company, and NRG Energy, Inc. are building the Petra Nova Carbon Capture System, a commercial-scale carbon capture system in Fort Bend County.	2014–2016	Approximately 34.3 kilometers from the Wilson Compressor Station.	14
13	Oakbend Medical Center	Oakbend Medical Center plans to renovate its Jackson Street Campus in Fort Bend County.	2015–2020	Approximately 35.3 kilometers from Wilson Compressor Station.	15
14	Phillips 66 Reservoir	Proposed Detention Facility.	2017	South of Deviation 13	16
<p>^a Distance is in miles and kilometers; kilometers used for cumulative air quality projects.</p> <p>^b Limited information available.</p>					

Environmental Analysis

**Figure 2.10-1
Cumulative Projects**

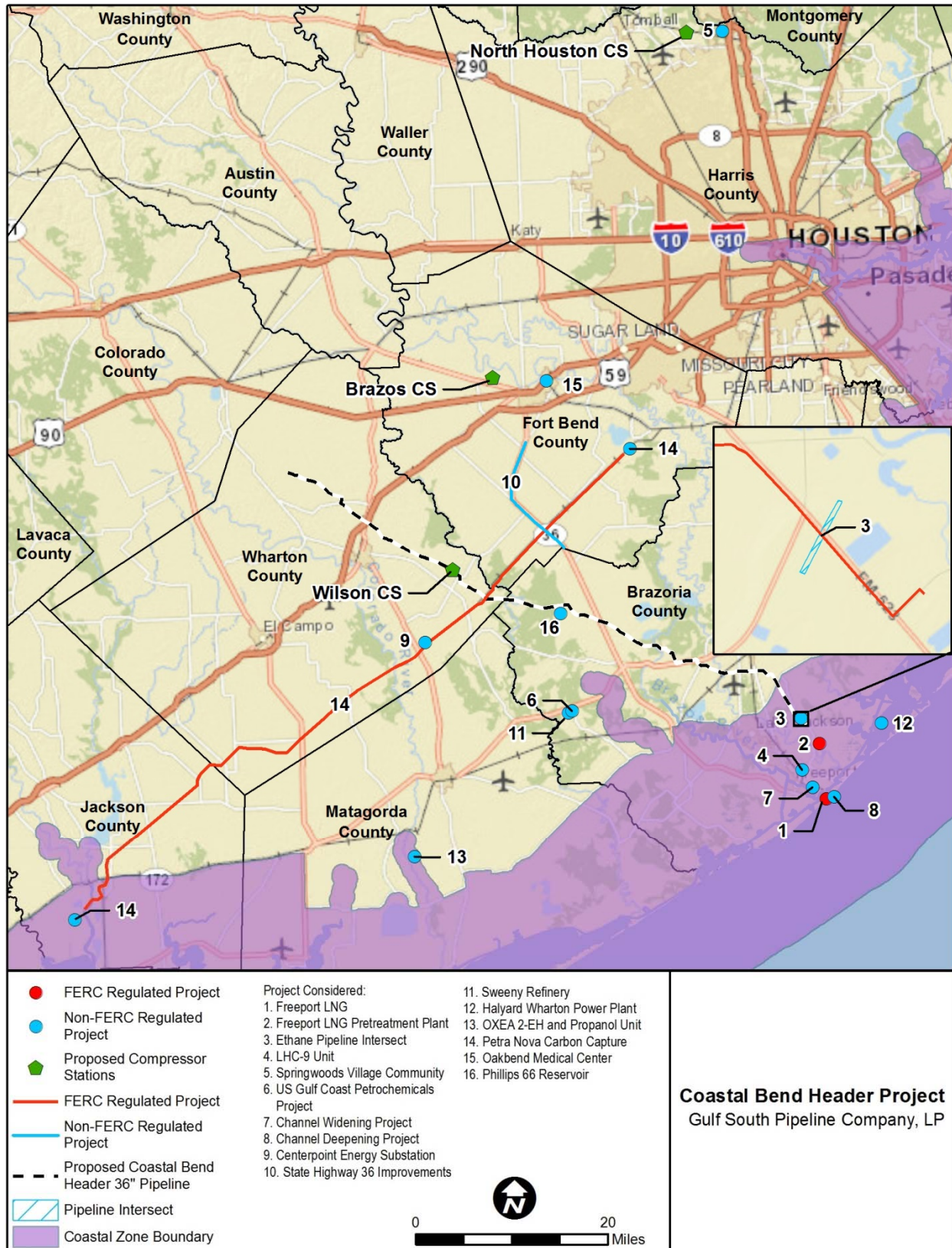

Port of Freeport Channel Widening

The Port of Freeport is undergoing a \$30 million dredging project to widen the bend at the entrance of the channel so that larger ships can pass through. Approximately 4.5 miles of the channel will be widened by 200 feet to enable larger ships to safely navigate the 600-foot-wide channel. Widening the channel entails removing approximately 3.2 million cubic yards of material and approximately 300,000 cubic yards of beach-quality sand, which will be used for beach nourishment and placed on sections of the beach on Quintana Island. USACE granted the Port of Freeport this permit in March 2009. Construction began in October 2014 and is expected to be completed in 2021.

Port of Freeport Channel Deepening

The Port of Freeport and USACE are proposing to deepen the Freeport Harbor Entrance Channel from 45 feet to 50–57 feet, which would require approximately 12 miles of dredging. The Port of Freeport received Congressional approval and funding for this project as part of the Water Resources Reform Development Act of 2014. The Port proposes to deepen the main channel to 55 feet and deepen the port container berths to 50 feet.

CenterPoint Energy Substation

CenterPoint Energy is proposing to build a substation near County Road 112 in Wharton County. Limited information was available from County officials.

State Highway 36 Improvements

The Texas Department of Transportation and the County of Brazoria are proposing to improve State Highway 36. The proposal includes plans to widen the highway from two lanes to four lanes and rehabilitate the highway. Construction could start as early as 2017.

Sweeny Refinery, Phillips 66 Company

Phillips 66 Company filed a permit with TCEQ on December 5, 2014 to build a simplified condensate splitter unit at its 247,000-barrel per day Sweeny Refinery. The proposed 110,000-barrel per day Sweeny Fractionator 2 may be built near the Sweeny refinery and Sweeny Fractionator 1, while the crude and condensate pipeline will connect Eagle Ford production to the Sweeny refinery and Phillips 66's terminal in Freeport. Final approval for the second fractionator and crude and condensate pipeline is expected by mid-2015, with start-up of the pipeline planned for late 2016 and the second fractionator at Sweeny slated for start-up in 2017.

Halyard Wharton Energy Center

Halyard Wharton Energy Center proposes to construct and operate a nominal net 650-megawatt simple generating facility at a new site in Wharton County. The facility will have three F-class combustion turbines in a simple cycle mode. The facility will be constructed on approximately 20 acres within the quarter-section property situated at the northwestern corner of State Route 71 and Farm-to-Market Road 441. It will be configured as three operating units; each unit will be able to operate independently to respond to varying electric load dispatch requirements. Construction began in mid-2014 and will continue for a period of approximately 24 months. The facility is expected to commence commercial operations in mid-2016.

Environmental Analysis

OXEA Corporation

OXEA Corporation is proposing to build a 2-Ethylhexanol (2-EH) and a Propanol unit at its chemical production plant in Bay City (Matagorda County). 2-EH is used in the production of acrylates, nitrates, acids, and plasticizers and serves, among others, as a solvent in the paint and coatings industries. Propanol is used to manufacture products such as cosmetics and pharmaceuticals, printing inks, coatings, and adhesives. In March 2014, OXEA began basic engineering on both proposed units. These units are expected to come online in late 2016. The units are expected to add to OXEA's most recent capacity expansion of its Bay City plant, which will increase current output of Butanol and Propanol by 25 percent.

Hilcorp Energy Company

Hilcorp Energy Company, JX Nippon Oil & Gas Exploration Company, and NRG Energy, Inc. are building the Petra Nova Carbon Capture System, a commercial-scale carbon capture system in Fort Bend County. This project is expected to capture 90 percent of CO₂ in the processed flue gas from an existing unit at the WA Parish power plant in Fort Bend County. Construction began in September 2014 and the project is expected to be completed in 2016. When completed, the project is expected to be the world's largest post-combustion carbon capture facility installed on an existing coal plant. The CO₂ captured from the plant will be compressed and piped approximately 80 miles to the West Ranch oil field, jointly owned by NRG, JX, and Hilcorp. Through Enhanced Oil Recovery, the captured CO₂ is expected to create a revenue stream for the project by increasing domestic oil production from around 500 barrels per day to approximately 15,000 barrels per day.

Oakbend Medical Center

Oakbend Medical Center is proposing Vision 2020, a 5-year campaign that will provide for a comprehensive renovation of its Jackson Street Campus in Fort Bend County. This project will include improvements to the hospital's medical-surgical floors, skilled nursing facility, and emergency center. In addition, Oakbend Medical Center will expand its Acute Care for the Elderly Unit and renovate the facility's exterior and landscaping.

Phillips 66 Reservoir No. 4

Phillips 66 is planning a reservoir south of Deviation 13, between MPs 34 and 35. The reservoir is approximately 560 acres in size and includes an outfall pipeline to the San Bernard River. Our search for information shows that limited information is publicly available about the planned reservoir.

Other Cumulative Projects Considered but not Carried Forward for AnalysisGrand Parkway Project

The Grand Parkway, State Highway 99, is a 180-mile scenic parkway encircling the Houston region. The State Highway 99 project is the result of a partnership between the state, local governments, agencies, and landowners. The project is considered a controlled access parkway with four lanes (two lanes in each direction) and intermittent access roads crossing seven counties: Harris, Montgomery, Liberty, Chambers, Galveston, Brazoria, and Fort Bend. Construction of a 38-mile segment through Harris and Montgomery counties began in 2013 and is expected to be completed in late 2015. A portion of this segment is approximately 0.10 mile north of the proposed North Houston Compressor Station.

The Grand Parkway Project it is not being carried forward in the cumulative impact analysis because the construction of the parkway will be completed prior to the start of the proposed Project.

Small Projects

As a result of consultation with county planning and development departments, a few small projects were identified. Two small projects were identified by the City of Angleton: an industrial park and a new gas station. These two projects are in the early stages of planning and have anticipated construction start dates between summer 2015 and spring 2016. These projects would be fully constructed before Project construction would start in the first quarter of 2017.

Fort Bend County identified two residential subdivisions within 5 miles of the proposed Brazos Compressor Station: the Kingdom Heights Subdivision on Farm-to-Market Road 723 and the Highland Bend Subdivision on Montgomery Road. The Kingdom Heights Subdivision includes 415 recently constructed single-family residential lots, with an additional 73 homes scheduled for 2015. The Highland Bend Subdivision is a large-lot subdivision on approximately 500 acres, with approximately 6–10 lots planned for homes. These projects are in the early stages of planning and are considered too small to be included in the cumulative impact analysis.

2.10.3 Resource-Specific Cumulative Impacts

As noted previously, the cumulative impact analysis area varies by resource. Considering the cumulative impact analysis areas summarized in table 2.10-1 and the list of cumulative projects listed in table 2.10-2, table 2.10-3 provides a summary of the projects that may result in cumulative resource impacts when combined with the proposed project impacts, by resource.

Geology and Soils

The cumulative impact area for geology and soils was the Project workspace because impacts on geology and soils from direct disturbances and vegetation removal associated with the proposed Project would occur within this area. The ethane pipeline associated with the LHC-9 Unit Project, which intersects the route of Gulf South's pipeline between MP 64 and MP 65, was the only project identified within the cumulative impact area. Although construction of the LHC-9 Unit Project is anticipated to be complete in 2016, disturbed areas along the pipeline corridor are unlikely to be fully revegetated prior to construction of the proposed Project. As a result, additional areas of exposed or sparsely vegetated soils associated with the LHC-9 Unit Project may be present within the cumulative impact area. Because exposed or sparsely vegetated soils are more susceptible to erosion, the LHC-9 Unit Project may contribute incrementally to adverse cumulative impacts on soils within this localized area. Incremental impacts from the proposed Project would be minimized through the application of appropriate erosion and sediment control measures during construction and operation activities, and the installation and maintenance of appropriate ECDs until these areas are successfully revegetated, as specified in FERC's Plan and in accordance with the Project-specific SWPPP. Specific types of mitigation that may be applied for the LHC-9 Unit Project are unknown; however, adherence to any applicable federal, state, and local permitting procedures, such as the development of a SWPPP, are likely to result in a similar level of erosion control as the proposed Project.

Re-disturbance and compaction of recently filled areas could result in combined compaction impacts in areas where the Project workspaces for the LHC-9 Unit Project and the proposed Project overlap. Recent or repeated disturbance and mixing could weaken soil structure and decrease particle size, increasing its susceptibility to compaction. Incremental impacts from the proposed Project would be minimized through the avoidance of hydric soils saturated by recent rainfall or through the application of appropriate mitigation practices for heavy vehicle use. Because the area where these cumulative impacts could occur is not used for agricultural or residential purposes, no additional soil compaction mitigation measures are prescribed.

Environmental Analysis

Table 2.10-3 Cumulative Projects Evaluated by Resource	
Resource	Applicable Cumulative Projects
Geology and Soils	Light Hydrocarbon 9 Unit Project
Water Resources and Wetlands	Freeport Liquefaction Project Light Hydrocarbon 9 Unit Project U.S. Gulf Coast Petrochemicals Project Springwoods Village Project Channel Widening Project Channel Deepening Project Phillips 66 Reservoir
Fish, Wildlife, and Vegetation	Fish: Light Hydrocarbon 9 Unit Project
	Wildlife: Light Hydrocarbon 9 Unit Project
	Vegetation: Freeport Liquefaction Project Light Hydrocarbon 9 Unit Project Springwoods Village Project
Cultural Resources	Light Hydrocarbon 9 Unit Project
Land Use, Recreation, and Aesthetics	Light Hydrocarbon 9 Unit Project
Socioeconomics	Freeport Liquefaction Project U.S. Gulf Coast Petrochemicals Project Springwoods Village Project Channel Widening Project Channel Deepening Project
Air Quality	Light Hydrocarbon 9 Unit Project U.S. Gulf Coast Petrochemicals Project Sweeny Refinery, Phillips 66 Company Halyard Wharton Energy Center OXEA Corporation Hilcorp Energy Company Oakbend Medical Center
Climate Change	Freeport Liquefaction Project Light Hydrocarbon Unit 9 Project U.S. Gulf Coast Petrochemicals Project Springwoods Village Project Channel Widening Project Channel Deepening Project
Noise	None

Incremental impacts on geological resources from both the LHC-9 Unit Project and the proposed Project would be temporary and are likely to have minimal effects, especially due to the low topographical relief in the area of overlap, which would require little to no recontouring to restore to its original form. Construction activities should be coordinated with ongoing brine mining and salt cavern storage operations that occur in this area in association with the Stratton Ridge Salt Dome to minimize the

potential for construction or operational conflicts and to identify any known subsidence hazards associated with natural salt dissolution or mining activities.

Water Resources and Wetlands

Cumulative impacts on groundwater resources were not evaluated because the proposed Project would not withdraw groundwater for construction or operation, would not consumptively use water, and, through implementation of BMPs discussed in section 2.2.1, any impacts on groundwater would be localized, minor, and temporary. The potential for cumulative impacts would also be limited by the presence of confining units or confining conditions that restrict the infiltration of contaminants from groundwater near the surface to major aquifer systems that lie at greater depths throughout most of the Project area.

The cumulative impact area for surface water resources (waterbodies and wetlands) was the 10-digit hydrologic unit code watersheds within the Project area, which includes all watersheds in which discernable impacts from Project construction and operations could occur. Based on review of publicly available information, all of the Projects identified in table 2.10-2, except the Grand Parkway Project, are within the cumulative impact area.

Although the precise timing of construction activities for the various projects is unknown, construction activities from multiple projects may occur simultaneously, thereby increasing the total area of exposed or sparsely vegetated soils, as well as in-stream disturbances, in the cumulative analysis area. Soil erosion and, where applicable, in-stream construction activities from the various projects could contribute incrementally to the potential for a cumulative increase in sedimentation to surface waterbodies, which would adversely affect water quality. Excavation and dredging activities associated with the Channel Widening Project and the Channel Deepening Project would release a particularly large volume of sediment into the Freeport Ship Channel. Any sediment contributions from the Project would originate in streams miles upstream of the Freeport Ship Channel, minimizing the potential for cumulative impacts due to the increasing dilution of sediment concentrations with downstream flow, the temporary nature of impacts from the proposed Project, and adherence to measures contained in FERC's Plan and Procedures to minimize sedimentation. Municipal and surface water resources used for hydrostatic testing and dust control would be discharged or used on site in accordance with all applicable permits and in accordance with FERC Procedures.

While information is not yet available for the Phillips 66 Reservoir No. 4 project, its proximity to a route variation identified in section 3.5 (southern route option to Deviation 13) may result in short-term cumulative impacts on surface waters of the San Bernard River, if construction activities for the header pipeline and the reservoir outfall coincide. However, with implementation of BMPs in FERC Plan and Procedures during pipeline construction which would further minimize erosion and sedimentation, the Project's contribution to cumulative surface water impacts would be minor.

All identified projects are subject to regulation by USACE under the CWA if the project impacts waters or wetlands of the U.S. The proposed Project and the Freeport Liquefaction Project are also regulated by FERC. Furthermore, all projects identified in table 2.10-2, except for the Grand Parkway Project, U.S. Gulf Coast Petrochemicals Project, and the Springwoods Village Project, are within the coastal zone and therefore would be subject to regulations under the Coastal Zone Management Act. Implementation of BMPs required by the various regulating agencies that have jurisdiction over the identified projects would ensure avoidance, minimization, and/or mitigation of potential impacts on surface water resources. Therefore, cumulative impacts on surface water resources would be minor.

Construction of the Project would affect wetlands through clearing, soil mixing and compaction from heavy equipment, pipeline trenching, hazardous materials (e.g., fuels, lubricants) handling, and backfilling. Impacts from these activities could alter hydric soils, wetland hydrology, and wetland

Environmental Analysis

vegetation. There would be no permanent wetland loss because the Project would not require the placement of permanent fill in any wetland. The Project would temporarily affect wetlands during construction, and operations would maintain a permanent operational corridor over the pipeline.

The Project would contribute to cumulative impacts on wetlands by adding to impacts from the Freeport Liquefaction Project, LHC-9 Unit Project, and Springwoods Village Project. Clearing of wetlands as a result of construction of the identified projects could result in similar wetland impacts described for the Project. However, the Freeport Liquefaction Project would permanently fill some wetlands, whereas the Project would not permanently fill any wetlands. Construction of the LHC-9 pipeline may also affect wetlands, but likely in a short-term and temporary manner lasting only the duration of construction. The Springwoods Village Project would be near one component of the Project—the North Houston Compressor Station—which would be approximately 3 miles west of the Springwoods Village Project. Based on the National Wetlands Inventory (NWI) map, the Springwoods Village Project may affect wetlands in the future because the site contains wetlands mapped by the NWI. The North Houston Compressor Station would also affect wetlands, although only temporarily.

All identified projects are subject to regulation by USACE under the CWA if they affect waters or wetlands of the U.S., and any placement of fill material into a jurisdictional wetland would require compensatory mitigation to replace the wetland functions and to ensure no net loss of wetlands. The proposed Project and the Freeport Liquefaction Project are both subject to implementation of the provisions of the FERC Procedures, which are designed to avoid and minimize wetland impacts. Implementation of BMPs required by the various regulating agencies that have jurisdiction over the identified projects would also ensure avoidance, minimization, and/or mitigation of potential impacts on wetlands. Therefore, significant cumulative impacts on wetlands are not anticipated and are minimized to the extent practicable.

Fish, Wildlife, and Vegetation

Fish

Potential Project impacts on fish and fish habitat are primarily related to construction activities in or near fish-bearing surface waters and include increased turbidity, water temperature changes, entrainment of fish, and introduction of pollutants. Surface water withdrawals for hydrostatic testing could also affect fish and fish habitat. These impacts could all affect the physical health of fish that may be present during construction.

The Project would contribute to cumulative impacts on fish by adding to impacts from the LHC-9 pipeline. The proposed Project pipeline and LHC-9 pipeline would both cross the same intermittent unnamed tributary to Salt Bayou. This stream may support fish, and any in-water work could affect fish habitat or fish that could be present during construction. Areas disturbed by construction would have an increased duration of soil exposure, which may increase the potential for sedimentation in the stream as a result of soil erosion. This could adversely affect water quality and fish. Any spills of hazardous materials in the vicinity of the stream may also affect water quality. However, Gulf South would follow the measures in FERC's Plan and Procedures, which include completing instream construction activities within 48 hours, limiting the use of equipment in the waterbody, utilizing an equipment bridge for crossing the water, and restoring the vegetation and stream banks. In addition, BMPs and an SPCC Plan would minimize and reduce potential water quality impacts. If construction of the LHC-9 pipeline crossing of the tributary were to occur at the same time as the Project, there could be a combined cumulative impact on water quality. However, these potential impacts would be short term and temporary, and BMPs required by permitting agencies and other requirements would reduce and minimize impacts on fish from both projects. Therefore, significant cumulative impacts on fish are not anticipated.

Vegetation

Construction and operation of the pipeline and aboveground facilities would result in temporary and permanent impacts on vegetation through clearing, grading, and maintenance. However, construction of the pipeline would not result in permanent removal and loss of vegetation, but there would be a permanent right-of-way where vegetation would be maintained for operations. Construction of aboveground facilities and new access roads would result in permanent removal and loss of vegetation; however, this permanent vegetation loss comprises approximately 3 percent of all vegetation affected by the Project, and nearly 100 percent of this permanent vegetation loss would occur on previously disturbed lands—agriculture, open land, and developed vegetation cover types.

The Project would contribute to cumulative impacts on vegetation by adding to impacts from the Freeport Liquefaction Project, LHC-9 Unit Project, and Springwoods Village Project. Clearing of vegetation as a result of construction of the identified projects could result in similar vegetation impacts described for the Project. However, the Freeport Liquefaction Project site includes an existing and previously disturbed liquid natural gas terminal on Quintana Island and a pretreatment plant that would be situated primarily on grazing lands. Similarly, the LHC-9 production unit is located on an existing and previously disturbed DOW facility site, and the LCH-9 pipeline would cross the Project's proposed pipeline right-of-way in an area that consists of disturbed vegetation cover types—open land and developed vegetation—and is adjacent to existing industrial facilities. No significant cumulative vegetation impacts would be anticipated from these projects because of the already disturbed nature of the areas that would be affected. The Springwoods Village Project would be near one component of the Project—the North Houston Compressor Station—which would be approximately 3 miles west of the Springwoods Village Project. While the vegetation cover type at the Springwoods Village Project is predominantly undisturbed forested/shrub vegetation cover classes, the North Houston Compressor Station site consists of disturbed areas consisting primarily of open land and developed vegetation cover classes. Therefore, no significant cumulative vegetation impacts are anticipated when combined with the Springwoods Village Project.

Construction of the Project could also result in establishment of invasive plant species, which can have adverse effects on native vegetation and communities, and an accidental spill or release of hazardous materials (e.g., fuels, lubricants, solvents) during construction or operations could also adversely affect vegetation. However, Gulf South would implement an invasive species control plan and an SPCC Plan to avoid and minimize impacts on vegetation. In addition, similar measures would likely be required for the cumulative projects under federal, state, or local requirements. Therefore, no significant cumulative impacts on vegetation are anticipated from invasive plants or hazardous material spills.

Wildlife

The Project could affect wildlife through construction-related activities, primarily habitat removal/alteration and construction noise. Wildlife habitat impacts are consistent with vegetation cover class impacts. These impacts could result in wildlife displacement and related secondary effects such as increased stress and predation. However, these potential impacts would be short term and temporary, lasting only the duration of construction. Direct mortality and injury could also occur from operating construction and maintenance equipment (during operations), but it is likely that most wildlife would be able to leave the immediate area of equipment use.

The Project would contribute to cumulative impacts on wildlife and habitat by adding to impacts from the LHC-9 pipeline. Clearing of vegetation as a result of construction of the LHC-9 pipeline could result in similar habitat and wildlife impacts described for the Project. However, the LCH-9 pipeline would cross the Project's proposed pipeline right-of-way in an area that consists of disturbed

Environmental Analysis

vegetation cover types—open land and developed vegetation—and is adjacent to existing industrial facilities. This area does not provide high-quality habitat for wildlife due to the disturbed habitat conditions and surrounding industrial development. While this would not preclude wildlife from being present, the LHC-9 pipeline crossing would not contribute significantly to cumulative impacts on wildlife and habitat in the region.

The development of the Project and the LHC-9 pipeline could result in habitat fragmentation; however, it is not anticipated that this would significantly contribute to cumulative wildlife impacts. There is no forested habitat in the area where the LHC-9 pipeline crosses the Project's proposed pipeline right-of-way; fragmentation impacts are most pronounced in forested habitats, and this area of the Project would consist of disturbed developed and open land cover classes. In addition, the LHC-9 pipeline would be constructed within an existing and already cleared pipeline right-of-way at the crossing of the Project's proposed pipeline right-of-way. And any disturbance during construction would be allowed to revert back to pre-construction conditions within the permanent right-of-way of the Project and the LHC-9 Unit Project. Therefore, there would be no significant cumulative impacts related to habitat fragmentation.

The Project and LHC-9 pipeline are both subject to the federal ESA and MBTA. Consultation between Gulf South and the USFWS is ongoing for the Project for the whooping crane; although we find that the Project may affect, but is not likely to adversely affect the crane, concurrence from the USFWS has not been received and consultation is not yet completed. If there is no federal nexus for the LHC-9 pipeline, the project is still subject to Section 10 of the ESA to ensure that the project would not jeopardize the continued existence of any federally listed threatened or endangered species. In addition, Gulf South is consulting with the USFWS regarding migratory birds and will be developing a *Migratory Bird Conservation Plan* to avoid, minimize, and/or compensate for impacts on migratory birds of special concern and their habitats. The LHC-9 Unit Project would also be subject to the MBTA to ensure that migratory birds are protected during construction of the project. These statutes and associated regulations and requirements would ensure that threatened and endangered species and migratory birds are protected for both projects. Therefore, significant cumulative impacts on these species are not anticipated.

Cultural Resources

Gulf South consulted with the Texas SHPO regarding the potential effects on cultural resources from the Project. The Texas SHPO concurred that the six newly recorded sites in the Project APE are ineligible for inclusion in the NRHP. As a result, there would be no effect on historic properties from the Project. The cumulative impact region of influence for cultural resources is 0.25 mile from the Project. A small region of influence is used because cumulative impacts on cultural resources would only occur if other projects were to affect the same historic properties as the Project and cultural resources are stationary. During the surveys no historic properties were identified in the direct or indirect APE. Additional surveys are pending.

Based on available information for the cumulative projects listed in table 2.10-2, the LHC-9 Unit Project is the only project that could occur within the same area as the cultural resources affected by the Project. However, this project would be required by federal and/or state regulation to avoid, minimize and mitigate impacts on cultural resources in a similar manner to the Project. The Project may incrementally add to the cumulative effects of the LHC-9 Unit Project that may occur at the same time; however, this incremental increase would not be significant.

Land Use, Recreation, and Aesthetics

Construction and operation of the proposed Project would affect existing land uses through the temporary and permanent conversion of areas to accommodate the right-of-way, access roads, and aboveground facilities. The majority of acres would be temporarily affected during construction of the proposed Project; however, areas within the new permanent right-of-way, access roads, and aboveground

facilities (536.9 acres of the 1,171.5 total acres affected during construction and operation of the proposed Project) would be permanently affected. Long-term and permanent impacts would occur on 56.5 acres of forest lands in the permanent pipeline right-of-way or within the operational footprint of aboveground facilities, where regeneration would not be allowed to occur. Similar long-term impacts would occur on 15.9 acres of wetlands, where the area would be maintained in a permanent herbaceous state. Agricultural areas and open land areas would generally be allowed to return to pre-construction use during operations, except where they are converted to permanent industrial use as a result of new facility placement. Because of the small area of permanent conversion to support proposed Project operations, effects on land uses would be minor.

The LHC-9 Unit Project would cross similar land uses to the proposed Project, and would result in similar construction and operations impacts. It is anticipated that the LHC-9 Unit Project would coordinate with affected landowners and applicable land management and regulatory agencies, and develop mitigation through coordination with landowners for any impacts. Construction of the LHC-9 Unit Project pipeline would likely result in a mix of temporary and limited, permanent conversion of land uses similar in type and magnitude to the proposed Project. These additional minor land use conversions are not anticipated to result in significant cumulative impacts on land use.

The proposed Project would not cross any public or conservation lands or any recreational or scenic areas. The proposed Project would cross state-designated ESSs at the San Bernard River and the Brazos River. However, use of HDD at these ESS crossings would limit the potential for impacts on the values of these waterways. The proposed Project would occur near the USFWS San Bernard NWR and would cross an access road to the refuge. Gulf South has coordinated with USFWS on ways to avoid affecting the refuge, and would continue to coordinate and commit to using BMPs to avoid or minimize potential impacts. Because the proposed Project would result in minimal, if any, impacts on state or federally designated areas, no potential for cumulative impacts from construction or operation of the LHC-9 Unit Project are anticipated.

Cumulative visual effects consider the area up to 0.5 mile adjacent to and in proximity of the proposed Project workspace (refer to table 2.10-1). As identified in table 2.10-2, the only project falling within this area includes approximately 78 miles of new 12-inch-diameter underground pipeline associated with the LHC-9 Unit Project. Like the proposed Project, the LHC-9 Unit Project would result mostly in temporary construction impacts because construction would occur in a transient, linear manner along the route to install the underground pipeline via clearing, ditching, placement, and backfilling. It is assumed that the LHC-9 Unit Project would be constructed in a similar manner to the Project so that it would bore under rivers and highways; use pavement cuts on smaller roadway crossings that would then be repaved; and restore and reseed disturbed areas after construction, including staging areas. It is further assumed that the LHC-9 Unit Project applicant would restore residential areas to pre-construction conditions. Therefore, like the Project, the pipeline would be underground and would not be visible in most locations after restoration, and the primary visual changes that would be associated with the LHC-9 Unit Project would be limited to site-specific visual changes, such as tree removal near residences or other sensitive viewers. Similar to the proposed Project, the majority of the LHC-9 Unit Project route would retain its existing visual character, and visual quality would not be affected. Where the LHC-9 Unit pipeline transects forest lands, it would leave a linear, grassy swath of land along the right-of-way where trees once stood, like the proposed Project; however, the long-term visual impacts associated with these impacts would be minimized due to the presence of other linear infrastructure and disturbance in the area from permanent structures such as transmission lines, M&R stations, and MLVs. These are all common visual elements in the landscape. Therefore, this visual impact is not considered cumulatively considerable.

Environmental Analysis

Socioeconomics

Construction projects in the six-county study area that overlap with the proposed Project construction in time would be expected to generate an influx of construction workers to the study area that would be cumulative with the influx generated by the proposed Project pipeline and associated facilities. Because of the large population, labor force, and housing availability of the study area, cumulative impacts on population, employment, earnings, housing, and public services from the projects listed above with the proposed Project pipeline and associated facilities would not be expected to be significant.

The Springwoods Village development is a few miles east of the proposed North Houston Compression Station. During construction, short-term cumulative effects on traffic on local roads are possible. Over time, the Springwood Village development is expected to increase available housing in the area.

Plans to widen State Highway 36 would include the segment crossed by the proposed Project pipeline. To the extent that widening the state highway would include temporary impacts on traffic, coordination of construction of the Project pipeline crossing would be desirable to minimize impacts.

Analysis of the cumulative impacts of the various resources considered in this section concludes that there would be no significant cumulative impacts from construction and operation of the proposed Project. Because there would be no significant cumulative impacts, no disproportionately high and adverse human health or environmental effects on minority or low-income populations would be expected.

Air Quality

Construction of the proposed Project and other projects in the area would involve the use of heavy equipment that would generate emissions of air pollutants. Because pipeline construction moves through an area quickly, emissions associated with pipeline construction would be intermittent and short term at any one location. Emissions associated with construction of compressor stations and other facilities would occur for the duration of construction at each site but would be intermittent and variable on any given day depending on the construction equipment in use. Short-term construction emissions are not likely to have a substantial impact on long-term air quality in the region.

Construction is primarily a localized activity and, as noted in table 2.10-1, the region of influence for cumulative construction impacts extends 0.25 mile from the Project construction sites. None of the applicable cumulative projects identified (see table 2.10-3) would be within 0.25 mile of any proposed Project facility, with the exception of the proposed ethane pipeline associated with the DOW LHC-9 Unit Project. This pipeline would intersect the header pipeline at MP 64.66. According to publicly available sources on the internet, the construction of the LHC-9 pipeline would be completed just prior to construction of the proposed Project. Because the two projects would not overlap in time at this location, there would be no cumulative air quality impact from construction of the LHC-9 ethane pipeline.

Emissions from all sources in a region become mixed as they disperse and are transported by the wind, and the resulting ambient pollutant concentrations are measured by the monitoring stations in the region. For purposes of assessing cumulative impacts, these measured pollutant levels indicate the impacts of past and present projects (i.e., existing sources of emissions). Gulf South conducted an air quality modeling analysis (Gulf South June 2015a) that estimated background concentrations based on these measured levels and estimated the concentration impacts of the proposed Project. The background concentrations were added to the impacts of the proposed Project to estimate the total ambient concentrations that could occur from existing sources plus proposed Project operation. The modeling results show that total ambient concentrations for existing sources plus the proposed Project would be less than the NAAQS. Emissions from operation of the applicable cumulative projects (see table 2.10-2)

could add incrementally to ambient concentrations when the projects begin operations, and could contribute cumulatively to air quality in the region.

Impacts from the applicable projects within the area of influence are likely to be small because of the distances between the projects and the proposed Project facilities (see figure 2.10-1). Ambient impacts on air quality decrease with distance from the emission source. In addition, the applicable projects would be subject to federal and Texas air quality regulations and would be required to minimize their impacts on air quality in accordance with the conditions of their air quality permits and other applicable air quality requirements. As a result of the applicable projects' distances from the proposed Project and the emission control requirements applicable to these projects, the cumulative air quality impacts from all sources would be unlikely to lead to a violation of the NAAQS.

The Sierra Club submitted comments in response to the NOI for the Project, April 3, 2015. In its letter, the Sierra Club raised concern over the contribution the Project would have on greenhouse gases related to the eventual export of gas from the Freeport LNG facility, and from project construction and operations emissions. The Sierra Club Houston Regional Group submitted comments on November 30, 2015 also requesting analysis of climate change impacts, mitigation for GHGs and potential impacts from GHG on ecological resources. Emission of GHGs from the Project would not have any direct impacts on the environment in the Project area. Currently, there is no standard methodology to determine how the Project's relatively small incremental contribution to GHGs would translate into physical effects on the global environment. Any projection for climate change in the local region is speculative at this time; the Applicant's commitment to mitigation measures and compliance with FERC Plan and Procedures would minimize air quality impacts and would ensure that the project area is returned to its original condition to the extent practicable.

Climate Change

Climate change is the change in climate over an extended period of time, whether due to natural variability, human activities, or a combination of both, and cannot be characterized by an individual event or anomalous weather pattern. For example, a severe drought or abnormally hot summer in a particular region is not an indication of climate change, while a series of severe droughts or hot summers that statistically alter the trend in average precipitation or temperature over decades may indicate climate change.

The IPCC is the leading international, multi-governmental scientific body for the assessment of climate change. The U.S. is a member of the IPCC and participates in the IPCC working groups studying various aspects of climate change. The leading U.S. scientific body on climate change is the U.S. Global Change Research Program (USGCRP). Thirteen federal departments and agencies⁸ participate in the USGCRP, which began as a presidential initiative in 1989 and was mandated by Congress in the Global Change Research Act of 1990 (GCRA). The USGCRP coordinates and supports U.S. participation in the IPCC assessments.

The IPCC and USGCRP have recognized that:

- Globally, GHGs have been accumulating in the atmosphere since the beginning of the industrial era (circa 1750);
- Combustion of fossil fuels (coal, petroleum, and natural gas), combined with agriculture and clearing of forests, is primarily responsible for the accumulation of GHG;

⁸ The USGCRP member agencies are: Department of Agriculture, Department of Commerce, Department of Defense, Department of Energy, Department of Health and Human Services, Department of the Interior, Department of State, Department of Transportation, Environmental Protection Agency, National Aeronautics and Space Administration, National Science Foundation, Smithsonian Institution, and U.S. Agency for International Development.

Environmental Analysis

- Anthropogenic GHG emissions are the primary contributing factor to climate change; and
- Impacts extend beyond atmospheric climate change alone, and include changes to water resources, transportation, agriculture, ecosystems, and human health.

The USGCRP issued the report, *Global Climate Change Impacts in the United States*, in June 2009 (updated in 2014) summarizing the impacts climate change has already had on the U.S. and the projected future impacts due to continued climate change (USGCRP, 2009, 2014). The report describes the effects of global change on different regions of the U.S. (e.g., Southeast) and on various societal and environmental sectors, such as water resources, agriculture, energy use, and human health. Building on the findings presented in this report as well as other recent research, the USGCRP issued the report, *The National Global Change Research Plan 2012-2021: A Strategic Plan for the USGCRP*, which outlines specific goals and objectives for the Program to generate and disseminate scientific knowledge that is readily available and directly useful to decision-makers and the general public (USGCRP, 2012). These efforts are intended to fulfill the Congressional mandate of the GCRA. Although climate change is a global concern, for this analysis, the focus is on the cumulative impacts of climate change in the Project area.

The USGCRP's report notes the following observations of environmental impacts that may be attributed to climate change in the Southeast region:

- Average temperatures have risen about 2°F since 1970 and are projected to increase another 4.5 to 9°F during this century;
- Increases in illness and death due to greater summer heat stress;
- The destructive potential of Atlantic hurricanes increased since 1970 and the intensity (with higher peak wind speeds, rainfall intensity, and storm surge height and strength) is likely to increase during this century;
- Within the past century in the U.S., relative sea level changes ranged from falling several inches to rising about 2 feet and are projected to increase another 3 to 4 feet this century;
- Sea level rise and human alterations have caused coastal wetland loss during the past century, reducing the capacity of those wetlands to protect against storm surge, and projected sea level rise is anticipated to result in the loss of a large portion of the nation's remaining coastal wetlands;
- Declines in dissolved oxygen in streams and lakes have caused fish kills and loss of aquatic species diversity;
- Moderate to severe spring and summer drought areas have increased 12 to 14 percent (with frequency, duration and intensity also increasing and projected to increase);
- Longer periods of time between rainfall events may lead to declines in recharge of groundwater and decreased water availability;
- Responses to decreased water availability, such as increased groundwater pumping, may lead to stress or depletion of aquifers and a strain on surface water sources;
- Increases in evaporation and plant water loss rates may alter the balance of runoff and groundwater recharge, which would likely to lead to saltwater intrusion into shallow aquifers;

- Coastal water temperatures rose about 2°F in several regions and are likely to continue to warm as much as 4 to 8°F this century; and
- Coastal water warming may lead to the transport of invasive species through ballast water exchange during ship transit.

Climate Change in the Project region would have two effects which may cause increased storm surges; increase temperatures of Gulf Waters which would increase storm intensity, and a rising sea level. Even with the increased sea levels due to climate change, and increased storm surge, the critical structure elevations of 25-feet above mean sea level at the Liquefaction Plant would provide a significant barrier to a 100-year climate change-enhanced storm surge.

The GHG emissions associated with construction and operation of the Project were identified and quantified in section 2.7.2. Based on the total annual potential emissions for the Project, operation of the Project would increase energy-related CO₂ emissions in Texas by approximately 0.06 percent, based on 2013 emissions of 641.0 million MT for the State (DOE, 2015).

Currently, there is no standard methodology to determine how the Project's incremental contribution to GHGs would result in physical effects on the environment, either locally or globally. However, estimated emissions associated with the Project would incrementally increase the atmospheric concentrations of GHGs, in combination with GHG emissions from other sources identified in the cumulative impacts analysis. Because we cannot determine the Project's incremental physical impacts due to climate change on the environment, we cannot determine whether or not the Project's contribution to cumulative impacts on climate change would be significant.

Noise

With the exception of the LHC-9 Unit Project, all of the projects listed in table 2.10-2 are at least 2.5 miles from the proposed Project pipeline alignment. The effects of noise generated by construction and operational activities are highly localized. Because of the large distances between Project components and these other projects, no cumulative noise effects between concurrent projects are anticipated.

The ethane pipeline for the LHC-9 Unit Project is planned to intersect with the header pipeline at MP 64.66 between Mont Belvieu and Freeport. Construction of the LHC-9 pipeline is expected to occur between June 2014 and January 2017. Gulf South proposes to begin construction on the Project during the second quarter of 2017, after work on the LHC-9 Unit Project is completed. Although these projects would intersect, work is not expected to be concurrent. Accordingly, these two projects are not expected to result in any cumulative noise effects.

For these reasons, the Project would not result in a significant cumulative noise impact.

2.10.4 Conclusions on Cumulative Impacts

We identified recently completed, ongoing, and planned projects in the Project area that met the criteria for inclusion in the cumulative impacts analysis. With implementation of standard engineering controls and BMPs, permitting for resource protection, FERC's Plan and Procedures, and Gulf South's proposed measures, impacts from the Project, when added to the impacts from other identified projects in the area, would be considered minimal with regard to cumulative impacts.

Environmental Analysis

This page intentionally left blank.

3.0 ALTERNATIVES

In accordance with NEPA and Commission policy, we evaluated alternatives to the Project to determine whether they would be reasonable and environmentally preferable to the proposed action. These alternatives include the No-Action Alternative, system alternatives, route alternatives, route variations, and aboveground facility alternatives. Information used to evaluate alternatives to the proposed Project includes data provided by Gulf South, publicly available data, comments and suggestions from regulatory agencies, and public comments. The evaluation criteria used for developing and reviewing alternatives were as follows.

- Technical and economic feasibility and practicality;
- significant environmental benefits over the proposed action; and
- ability to meet the Project's purpose.

3.1 NO-ACTION ALTERNATIVE

Under the no-action alternative, the Commission would deny Gulf South's application and Gulf South would not construct the proposed Project. Environmental impacts associated with the Project would not occur under the no-action alternative; however, this alternative would not meet the purpose and need of the Project which is to expand the capacity of its pipeline system to 1.42 billion cubic feet per day to provide firm transportation service to the Freeport LNG terminal.

If the Project is not constructed under the no-action alternative, Freeport LNG terminal shippers may be forced to seek other natural gas supplies. Although it is speculative and beyond the scope of this analysis to predict what action might be taken by policy makers or end users in response to the no-action alternative, it is possible that without the proposed Project, the natural gas needs at the Freeport LNG terminal may be met by alternative natural gas sources, likely resulting in similar or greater environmental impacts. Therefore, due to environmental, safety, regulatory, and technologic limitations, conservation programs and other energy sources would either be unable to provide the natural gas supplies provided by the proposed Project, would not offer an environmental advantage over the proposed Project, or would not be available within the timeframe of the proposed Project. Further, we have concluded that the impacts associated with the Project would not be significant; therefore, we do not recommend the no-action alternative.

3.2 SYSTEM ALTERNATIVES

System alternatives are alternatives that would use existing or modified pipeline systems to meet the purpose and need of the Project. Although some modifications or additions to an existing or proposed pipeline system may be required, implementation of a system modification would make it unnecessary to construct all or part of the proposed Project. Such modifications or additions would result in environmental impacts that could be less than, similar to, or potentially greater than those associated with the proposed Project. The purpose of identifying and evaluating system alternatives is to determine whether the environmental impacts associated with construction and operation of the proposed Project could be avoided or substantially reduced by using another pipeline system, while still meeting the objectives of the proposed Project.

To be a viable system alternative to the proposed Project, any potential system alternative must meet the following criteria,

- Capable of transporting up to 1.42 billion cubic feet per day of natural gas to Freeport LNG's Stratton Ridge M&R Station for delivery to the Freeport LNG terminal;

Alternatives

- capable of being constructed within the same schedule as the Project; and
- able to meet the criteria above with reduced environmental impacts when compared to the Project.

Our review of the existing interstate natural gas facilities in the project area show that other systems in the region have no means of connecting to Freeport LNG's Stratton Ridge M&R Station without constructing a new lateral similar to the proposed Project. In addition, our review shows that the existing interstate natural gas facilities are not capable of providing the southbound capacity necessary to meet the purpose of the proposed Project unless additional compression is added and piping modifications are developed to allow the reversal of gas flow.

We also note that Gulf South was the successful bidder in a competitive bidding process sponsored by the Foundation Shippers of the Freeport LNG Project. Gulf South's binding precedent agreements with contract terms of 20 years were executed with the Foundation Shippers in September 2014. For these reasons, including that we find the impacts associated with the Project are not significant, expansion of other systems as alternatives were not considered.

3.3 ROUTE ALTERNATIVES

Route alternatives are assessed to determine whether environmental impacts could be reduced or avoided by moving the location of the proposed pipeline. Three route alternatives with the same terminus as the proposed route have been assessed and compared to the proposed route (figure 3.3-1). Table 3.3-1 compares the category factors of the proposed route with the corresponding Alternatives 1 through 3.

Alternative 1 would begin approximately 7.50 miles northeast of MP 0.00 of the proposed route and would travel southeast approximately 11.46 miles until joining with the proposed route at MP 10.12. This alternative was considered to evaluate an alternate interconnect location with an existing Tennessee Gas Pipeline Company (TGPL) pipeline. Although Alternative 1 would affect a similar number of NWI-mapped wetlands and fewer waterbodies than the proposed route, it would affect more forested wetland than emergent wetland, proportionately. Alternative 1 would also add over 1.3 miles to the length of the pipeline and would reduce the amount of co-location with other utilities, which would increase the amount of anticipated land disturbance and would result in higher construction costs. Overall, Alternative 1 shows no significant environmental advantage over the proposed route.

Alternative 2 would generally follow the proposed route until MP 60.96, where it would deviate east then south for approximately 5.68 miles until reaching the Freeport LNG Stratton Ridge M&R Station. This alternative was evaluated to avoid the area crossed by the proposed route west of the Stratton Ridge M&R station, which is congested by existing facilities, utility lines, and roads. Alternative 2 would be over 1 mile longer and would affect more NWI-mapped wetland than the proposed route. Overall, Alternative 2 shows no significant environmental advantage, and we do not prefer it over the proposed route.

Figure 3.3-1
Alternatives and Variations

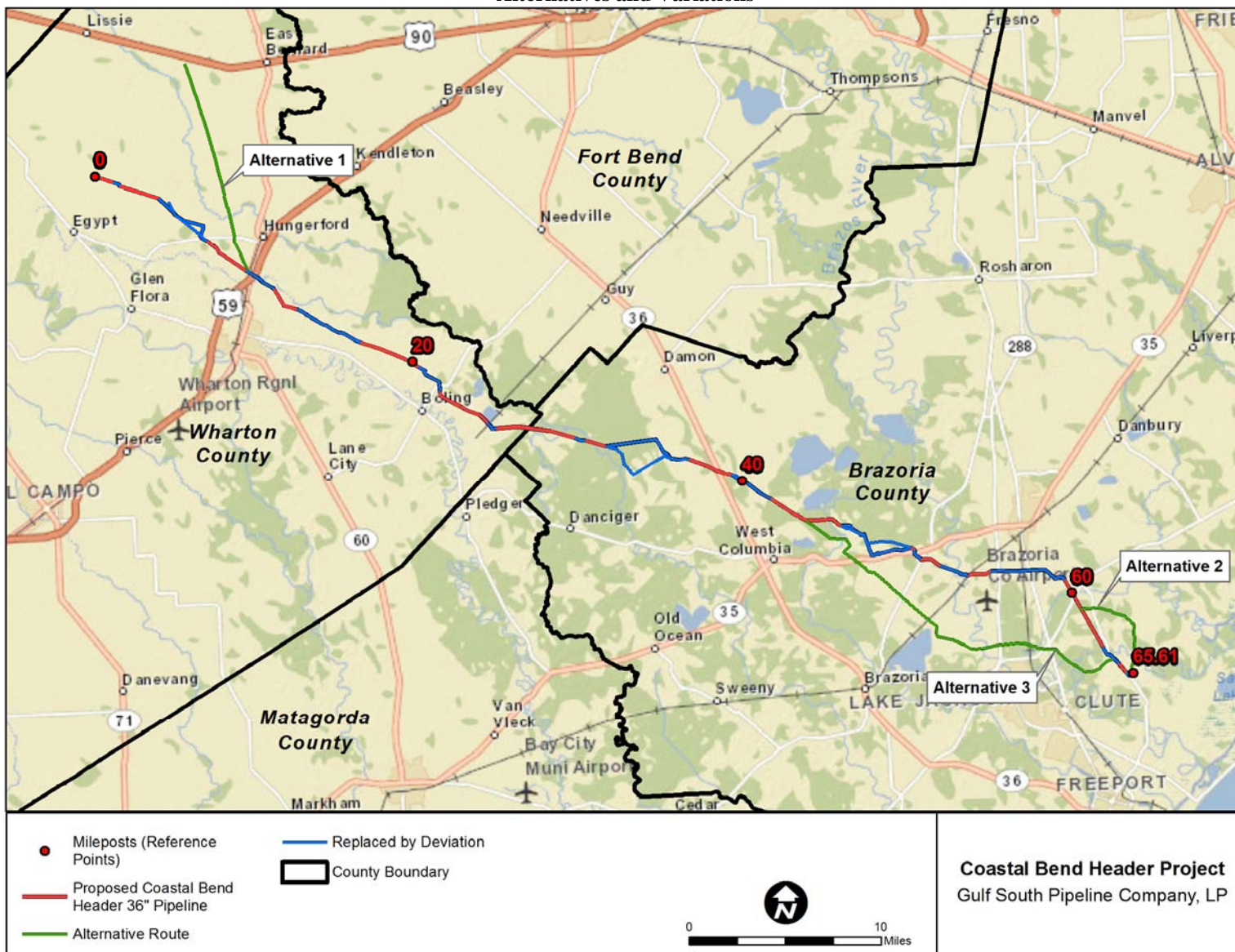

Alternatives

Table 3.3-1 Pipeline Route Alternative Comparison for the Coastal Bend Header Project				
Category	Proposed Route	Alternative 1	Alternative 2	Alternative 3
Route Length (miles)	65.61	66.94	66.64	65.45
Total Land Disturbance (acres)	753.24	772.56 ^a	768.94 ^a	773.45 ^a
Percentage Adjacent to Existing Right-of-Way	36	30	37	41
Roads Crossed				
Minor Roads Crossed	71	68	68	77
Major Roads Crossed	7	7	7	8
Total Road Crossings	78	75	75	85
Residences within 100 feet	25	25	25	20
Federal Lands within 0.25 mile	4	4	4	3
Federal Lands Crossed	0	0	0	2
State Lands within 0.25 mile	0	0	0	0
State Lands Crossed	0	0	0	0
Number of Federally or State Listed Threatened and Endangered Species	33	33	33	33
Designated Critical Habitat Crossed	No	No	No	No
NRHP-listed sites within Project Area	No	No	No	No
Number of Compressor Stations Required	4	4	4	4
Land Use (percentage)^b				
Agriculture	61	62	59	61
Forest	14	14	14	17
Wetland	3	3	10	8
Open Land	21	20	16	12
Open Water	<1	<1	<1	<1
Developed ^c	1	1	1	2
Waterbodies Crossed				
Minor Waterbodies Crossed ^d	99	83	99	96
Intermediate Waterbodies Crossed ^e	59	56	58	40
Major Waterbodies Crossed ^f	5	5	4	3
Total Waterbody Crossings	163	144	161	139

Category	Proposed Route	Alternative 1	Alternative 2	Alternative 3
Wetland Impact (Percentage)				
Non-forested (PEM/PSS) Wetland	2	1	4	5
Forested (PFO) Wetland	1	2	6	3
Total Wetland Impacts	3	3	10	8
<p>^a Acreage is based on 100-foot workspace where the alternative route deviates from the proposed route.</p> <p>^b Land use impacts for the proposed route and Alternatives 1, 2, and 3 are based on aerial imagery, NWI data, and the U.S. Geological Survey National Land Cover Database (2006).</p> <p>^c Developed land use category includes roads, urban, industrial, and residential areas.</p> <p>^d Minor waterbodies are those with a crossing width of 10 feet or less.</p> <p>^e Intermediate waterbodies are those with a crossing width of greater than 10 feet and less than 100 feet.</p> <p>^f Major waterbodies are those with a crossing width of 100 feet or greater.</p>				

In conclusion, none of the three route alternatives demonstrated clear environmental advantages when compared to the proposed route.

3.4 ROUTE VARIATIONS

Route deviations or variations, are small shifts designed to address localized concerns, including avoiding or minimizing impacts on sensitive resources, addressing landowner concerns, or resolving engineering or constructability constraints. Based on input received from stakeholders during the pre-filing process, a total of 22 minor route deviations were incorporated by Gulf South in its original route alignment maps on December 12, 2014. These were all evaluated as the proposed route in section 2 of this EA.

Based on landowner and agency input during the NOI process, as well as further review of each of the route segments, two of the route variations were determined to require further study and refinement to minimize impacts to resources and reduce impacts related to landowner concerns. Deviations 13 and 14 were analyzed further, resulting in recommendations for additional route variations as summarized below.

Southern Alternative B Route

Several comments were received from concerned landowners about Gulf South's proposed route (Deviation 13) between MP 31.5 and 34.87 that was developed to avoid Phillip 66's planned water reservoir and the potential impacts on the recreational, aesthetic, and land uses, including impacts on old growth trees, habitat and wildlife of the Columbia Bottomlands. The USFWS also raised concerns about impacts on the forested area of the Columbia Bottomlands. After our careful review of the project alignment sheets, aerial photography, and Gulf South filings, we conclude that impacts on forested areas can further be reduced by following existing rights-of-way, which would also minimize impacts on landowners' properties. At the request of FERC staff, a few different options were considered by Gulf South to avoid the reservoir while addressing concerns raised by landowners and agency officials.

Alternatives

Southern Alternative B Route, would begin at MP 31.50 and head south around the reservoir before heading northeast and connecting with the proposed route at approximately MP 36.07. Southern Alternative B Route would address concerns raised by Gulf South regarding potential constructability issues related to the planned reservoir outfall pipe. This route deviation would replace the corresponding segment of the proposed route (Deviation 13), as well as Deviation 4 on the eastern end of the route. Refer to figure 3.4-1 for a map of the Southern Alternative B Route in relation to the proposed route. As noted in table 3.4-1, the Southern Alternative B Route would substantially reduce impacts on wetlands and forested areas when compared to the corresponding segments of the proposed route. Southern Alternative B Route would reduce impacts on wetlands by over 4 acres when compared to the corresponding segment of the proposed route and would increase co-location of the pipeline by 2.3 miles. For purposes of the quantitative comparative analysis, the mileposts used in table 3.4-1 are based on the original route mileposts and are identified also in figure 3.4-1.

Based on the quantitative comparison of Southern Alternative B Route to the corresponding segment of the proposed route, the southern route would circumvent the proposed Phillips 66 reservoir, increase co-location within existing rights-of-way, substantially reduce impacts on forested Columbia Bottomlands, and minimize impacts raised by affected landowners regarding Deviation 13. Therefore, **we recommend that:**

- **Prior to construction, Gulf South should incorporate into its final route alignment the Southern Alternative B Route between MPs 31 and 36. Gulf South should file with the Secretary detailed alignment sheets and all appropriate resource information based on updated field surveys of the new alignment for review and approval by the Director of OEP.**

Deviation 14A

Deviation 14 was incorporated into the proposed route by Gulf South in response to a landowner's request to minimize impacts on their property. Deviation 14 is located to the south of the original route between MP 38.38 and MP 40.86. The proposed route (Deviation 14) is 0.05 mile shorter than the original route and would cross nine fewer waterbodies, but would affect an additional 3.21 acres of wetlands.

Due to the impacts on wetlands, we evaluated other alternatives to reduce those impacts. Deviation 14A would reduce affects to wetlands by 2.5 acres (compared to the corresponding segment of the proposed route, Deviation 14) and would co-locate an additional 0.2 mile of pipeline within an existing right-of-way. Refer to figure 3.4-2 for a map depicting Deviations 14 and 14A.

While Deviation 14A would increase the overall land disturbed by 1.3 acres, it would reduce the overall environmental impacts compared to Deviation 14 while still adhering to the landowner's request to minimize impacts on their property. Therefore, **we recommend that:**

- **Prior to construction, Gulf South should incorporate into its final route alignment Deviation 14A between MPs 39 and 40. Gulf South should file with the Secretary detailed alignment sheets and all appropriate resource information based on updated field surveys of the new alignment for review and approval by the Director of OEP.**

**Figure 3.4-1
Southern Alternative B Route**

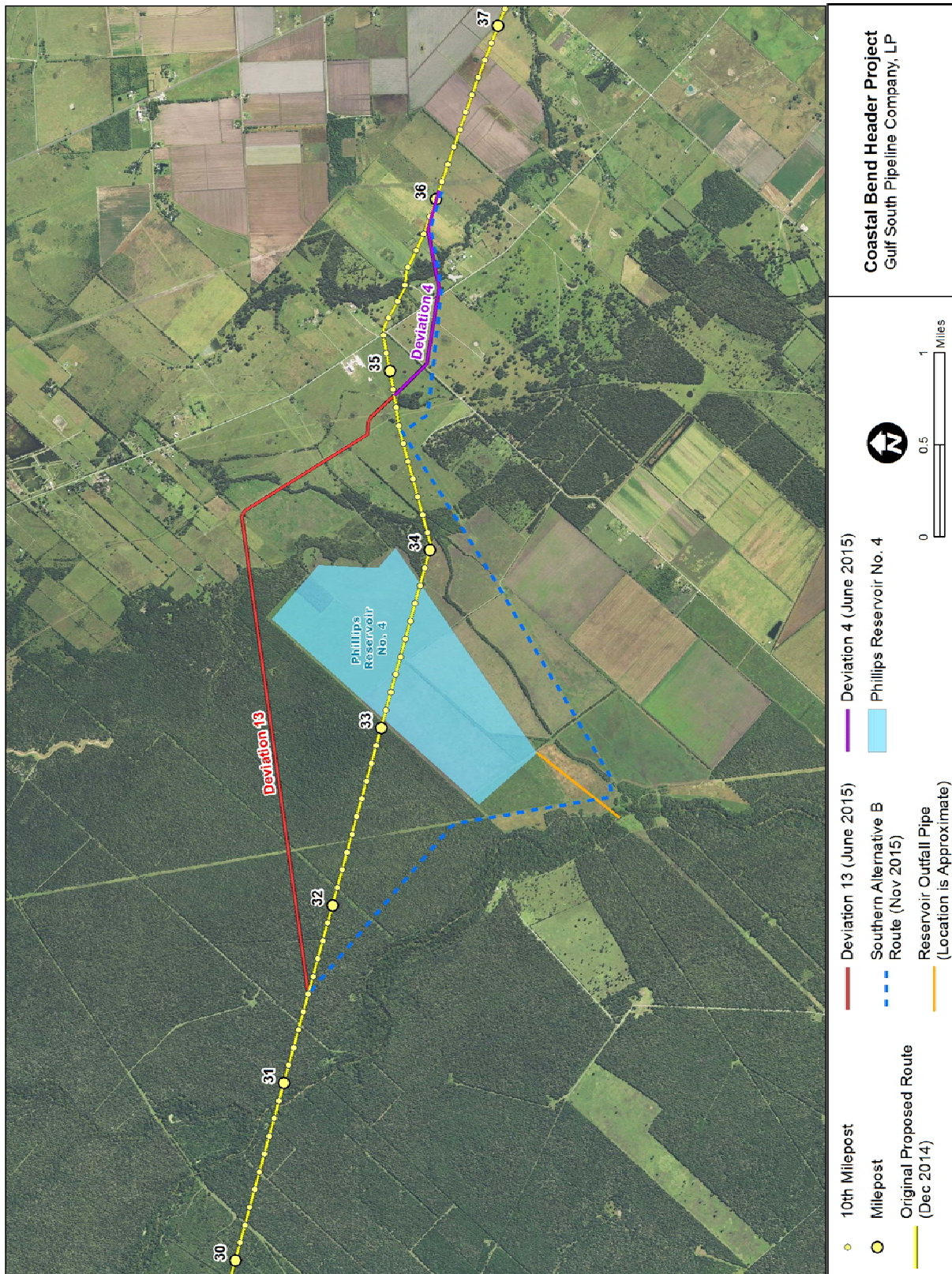

Figure 3.4-2
Deviation 14A

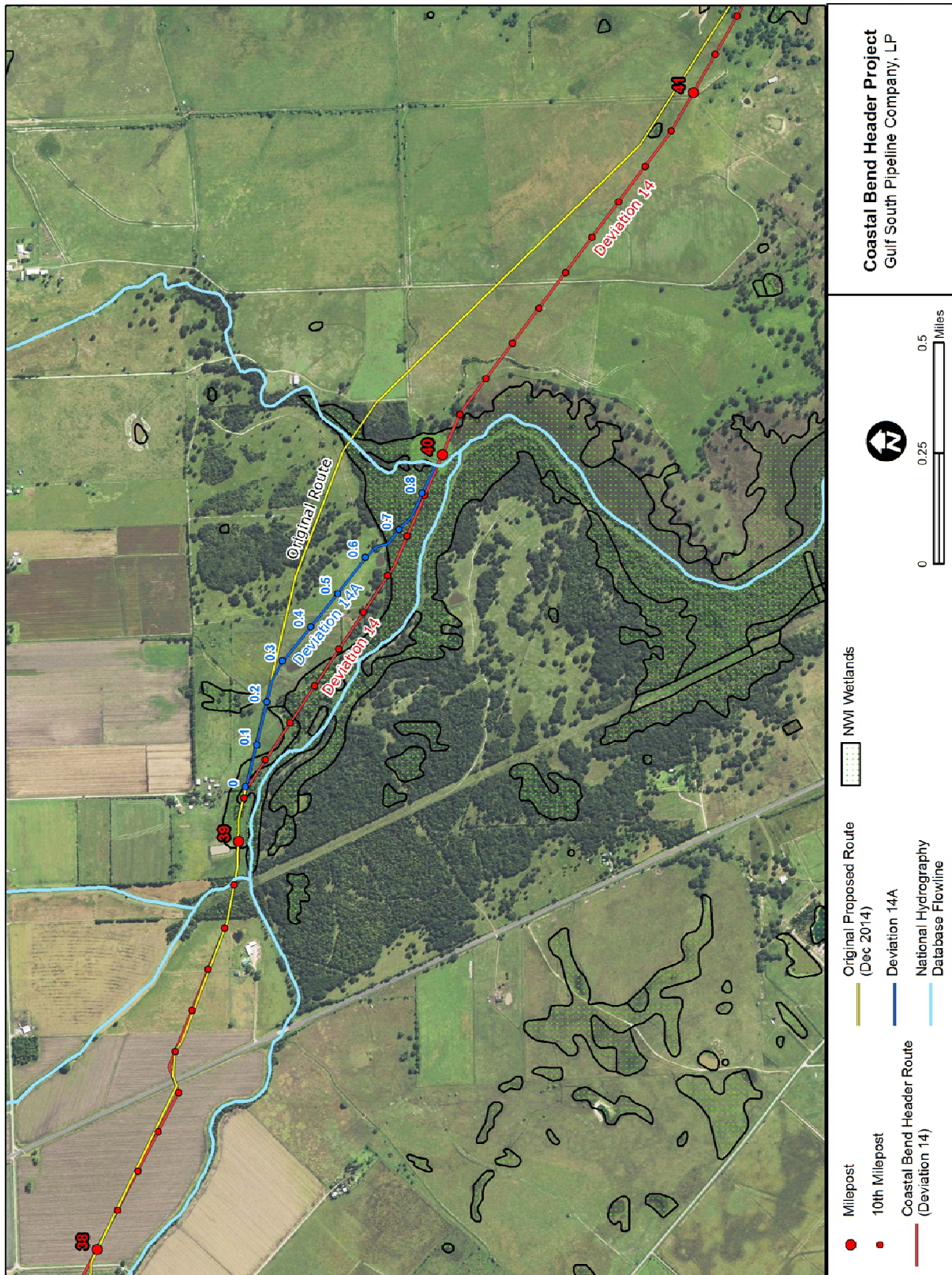

Table 3.4-1 Quantitative Comparison of Proposed Route and Southern Alternative B Route		
	Proposed Route (Deviation 13^a)	Southern Alternative B Route^b
Pipeline Length (miles)	4.9	5.8
Construction Impacts		
Temporary (acres)	33.0	35.2
Permanent (acres)	30.0	35.8
Total (acres)	63.0	71.0
Waterbody Impacts		
Total Number Crossed	13	10
Total Crossing Length (feet)	141	149
Wetlands Impacts		
Total Number Crossed	16	2
Total Impacts (acres)	4.3	0.2
Land Use Impacts		
Total Agricultural Land Impacts	32.8	50.0
Total Forested Land Impacts	25.0	18.1
Length of Co-location (miles)	0.8	3.1
Residences within 100 feet	0	0
<p>^a The information provided for Deviation 13 which was incorporated into the proposed route is based on analysis of data collected along that route, as filed on June 12, 2015. Impacts are calculated using workspace design as filed on June 12, 2015.</p> <p>^b The information provided for the Southern Alternative B Route is based off of a desktop analysis utilizing a 100-foot construction corridor.</p>		

Alternatives

Table 3.4-2 Quantitative Comparison of Proposed Route and Deviation 14A		
	Proposed Route (Deviation 14^a)	Deviation 14A
Pipeline Length (miles)	0.9	0.9
Construction Impacts		
Temporary (acres)	4.3	5.5
Permanent (acres)	5.2	5.3
Total (acres)	9.5	10.8
Waterbody Impacts		
Total Number Crossed	1	1
Total Crossing Length (feet)	3	3
Wetlands Impacts		
Total Number Crossed	2	2
Total Impacts (acres)	3.4	0.9
Land Use Impacts		
Total Agricultural Land Impacts (acres)	3.5	8.5
Total Forested Land Impacts (acres)	1.0	1.4
Length of Co-location (miles)	0	0.2 ¹
Residences within 50 feet	0	0
Note: The information provided in this table was generated based on a comparison of where Deviation 14 and Deviation 14A diverge (MP 39.1) and converge (MP 40.0) using a combination of field data and desktop analysis.		
¹ A portion of Deviation 14A would be installed along an existing field road, and this length is provided in the table as an area of co-location.		

3.5 ABOVEGROUND FACILITY ALTERNATIVES

We evaluated the locations of the aboveground facilities to determine whether alternative sites could reduce or avoid environmental impacts from aboveground facility construction and operation. Aboveground facilities associated with the Project include the following.

- the Wilson Compressor Station near MP 20.66 of the new pipeline to provide 83,597 nominal hp of compression to pump gas to meet contract delivery flow and pressure to the Freeport LNG Stratton Ridge M&R Station;
- the 26,400-hp Brazos Compressor Station located along the Legacy System facilities approximately 3.72 miles northwest of Rosenberg to increase southbound capacity to meet contract delivery flow and pressure to the Freeport LNG Stratton Ridge M&R Station; and
- the 10,700-hp North Houston Compressor station located along the Legacy System facilities approximately 5.65 miles west of Spring to pump gas south through the Legacy System facilities to meet contract delivery flow and pressure to the Freeport LNG Stratton Ridge M&R Station.

Feasible alternative sites must be on or adjacent to the existing pipeline or the new pipeline route, and within a specific range of mileposts for optimal operational and horsepower requirements. One alternative site was assessed for the Wilson Compressor Station, one alternative site was assessed for the Brazos Compressor Station, and two alternative sites were assessed for the North Houston Compressor Station. Refer to appendix Q for the Aboveground Alternatives maps.

Wilson Compressor Station Alternative Site 1 would be south of the proposed site, near MP 20.90 in Wharton County. The physical footprint of Alternative Site 1 for the Wilson Compressor Station would include more prime farmland (28.53 acres) when compared to the proposed site for the Wilson Compressor Station (27.81 acres), and would affect a minor waterbody that crosses the alternative site.

Brazos Compressor Station Alternative Site 1 would be approximately 3.84 miles northwest of Rosenberg. Alternative Site 1 for the Brazos Compressor Station would be in a mapped Federal Emergency Management Agency floodway, which would be prohibited by Fort Bend County for the placement of permanent structures resulting in the rise of the base flood water surface elevation.

North Houston Compressor Station Alternative Site 1 would be approximately 4.45 miles southeast of Cypress. Because the location of this alternative compressor site would be approximately 0.25 mile west of an existing Legacy Systems facility, it would require the construction of additional suction/discharge piping. There are also more NSAs within a 0.5-mile distance from Alternative Site 1 than the proposed site for the North Houston Compressor Station. North Houston Compressor Station Alternative Site 2 would be approximately 4.86 miles southeast of Cypress. It would be in a primarily residential area and the total number of NSAs within 0.5 mile of Alternative Site 2 would be greater than the number of NSAs within 0.5 mile of the proposed site for the North Houston Compressor Station.

In the case of all three compressor stations, the alternative sites do not offer any significant environmental advantages over the current proposed locations.

In addition to alternative sites, we requested from Gulf South to assess the feasibility of installing electric compressor unit at the former Magasco Compressor Station instead of the natural gas currently proposed. Gulf South stated that installing an electric compressor unit at the Magasco Compressor Station would not be feasible as the electric power infrastructure capable of delivering enough electricity to run the large load compressor unit has not been installed near the former Magasco Compressor Station site. In addition, Gulf South stated that electric power would not be as reliable as natural gas, and therefore, to ensure that Magasco Compressor Station never loses power, infrastructure for a second independent power source would have to be constructed.

Alternatives

This page intentionally left blank

4.0 CONCLUSIONS AND RECOMMENDATIONS

We conclude that approval of the Coastal Bend Header Project would not constitute a major federal action significantly affecting the quality of the human environment based on the environmental analysis presented herein, Gulf South's application and supplements (including responses to staff data requests), and implementation of Gulf South's proposed and our recommended mitigation measures. We recommend that the Commission Order contain a finding of no significant impact and that the following mitigation measures be included as conditions of any Certificate the Commission may issue:

1. Gulf South shall follow the construction procedures and mitigation measures described in its application and supplements (including responses to staff data requests) and as identified in the EA, unless modified by the Order. Gulf South must:
 - a. request any modification to these procedures, measures, or conditions in a filing with the Secretary;
 - b. justify each modification relative to site-specific conditions;
 - c. explain how that modification provides an equal or greater level of environmental protection than the original measure; and
 - d. receive approval in writing from the Director of OEP **before using that modification**.
2. The Director of OEP has delegated authority to take whatever steps are necessary to ensure the protection of all environmental resources during construction and operation of the Project. This authority shall allow:
 - a. the modification of conditions of the Order; and
 - b. the design and implementation of any additional measures deemed necessary (including stop-work authority) to assure continued compliance with the intent of the environmental conditions, as well as the avoidance or mitigation of adverse environmental impacts resulting from Project construction, operation, and activities associated with abandonment.
3. **Prior to any construction activities**, Gulf South shall file an affirmative statement with the Secretary, certified by a senior company official, that all company personnel, Environmental Inspectors (EIs), and contractor personnel would be informed of the EIs' authority and have been or will be trained on the implementation of the environmental mitigation measures appropriate to their jobs **before** becoming involved with construction and restoration activities.
4. The authorized facility locations shall be as shown in the EA, as supplemented by filed alignment sheets. **As soon as they are available, and before the start of construction**, Gulf South shall file with the Secretary any revised detailed survey alignment maps/sheets at a scale not smaller than 1:6,000 with station positions for all facilities approved by the Order. All requests for modifications of environmental conditions of the Order or site-specific clearances must be written and must reference locations designated on these alignment maps or sheets.

Gulf South's exercise of eminent domain authority granted under the NGA Section 7(h) in any condemnation proceedings related to the Order must be consistent with these authorized facilities and locations. Gulf South's right of eminent domain granted under the NGA Section 7(h) does not authorize it to increase the size of its natural gas pipelines or aboveground facilities to accommodate future needs or to acquire a right-of-way for a pipeline to transport a commodity other than natural gas.
5. Gulf South shall file with the Secretary detailed alignment maps/sheets and aerial photographs at a scale not smaller than 1:6,000 identifying all route realignments or facility relocations, and

Conclusions and Recommendations

staging areas, pipe storage yards, new access roads, and other areas that would be used or disturbed and have not been previously identified in filings with the Secretary. Approval for each of these areas must be explicitly requested in writing. For each area, the request must include a description of the existing land use/cover type, documentation of landowner approval, whether any cultural resources or federally listed threatened or endangered species would be affected, and whether any other environmentally sensitive areas are within or abutting the area. All areas shall be clearly identified on the maps/sheets/aerial photographs. Each area must be approved in writing by the Director of OEP **before construction in or near that area.**

This requirement does not apply to extra workspace allowed by the *Commission's Upland Erosion Control, Revegetation and Maintenance Plan*, and/or minor field realignments per landowner needs and requirements that do not affect other landowners or sensitive environmental areas such as wetlands.

Examples of alterations requiring approval include all route realignments and facility location changes resulting from:

- a. implementation of cultural resources mitigation measures;
 - b. implementation of endangered, threatened, or special concern species mitigation measures;
 - c. recommendations by state regulatory authorities; and
 - d. agreements with individual landowners that affect other landowners or could affect sensitive environmental areas.
6. **Within 60 days of the acceptance of the Certificate and before construction begins,** Gulf South shall file an Implementation Plan with the Secretary for review and written approval by the Director of OEP. Gulf South must file revisions to the plan as schedules change. The plan shall identify:
- a. how Gulf South will implement the construction procedures and mitigation measures described in its application and supplements (including responses to staff data requests), identified in the EA, and required by the Order;
 - b. how Gulf South will incorporate these requirements into the contract bid documents, construction contracts (especially penalty clauses and specifications), and construction drawings so that the mitigation required at each site is clear to onsite construction and inspection personnel;
 - c. the number of EIs assigned per spread, and how the company will ensure that sufficient personnel are available to implement the environmental mitigation;
 - d. company personnel, including EIs and contractors, who will receive copies of the appropriate material;
 - e. the location and dates of the environmental compliance training and instructions Gulf South will give to all personnel involved with construction and restoration (initial and refresher training as the Project progresses and personnel change);
 - f. the company personnel (if known) and specific portion of Gulf South's organization having responsibility for compliance;
 - g. the procedures (including use of contract penalties) Gulf South will follow if noncompliance occurs; and

-
- h. for each discrete facility, a Gantt or PERT chart (or similar project scheduling diagram), and dates for:
 - (1) the completion of all required surveys and reports;
 - (2) the environmental compliance training of onsite personnel;
 - (3) the start of construction and/or abandonment; and
 - (4) the start and completion of restoration.
7. Gulf South shall employ at least one EI per construction spread. The EI(s) shall be:
- a. responsible for monitoring and ensuring compliance with all mitigation measures required by the Order and other grants, permits, certificates, or other authorizing documents;
 - b. responsible for evaluating the construction contractor's implementation of the environmental mitigation measures required in the contract (see condition 6 above) and any other authorizing document;
 - c. empowered to order correction of acts that violate the environmental conditions of the Order, and any other authorizing document;
 - d. a full-time position, separate from all other activity inspectors;
 - e. responsible for documenting compliance with the environmental conditions of the Order, as well as any environmental conditions/permit requirements imposed by other federal, state, or local agencies; and
 - f. responsible for maintaining status reports.
8. Beginning with the filing of its Implementation Plan, Gulf South shall file updated status reports with the Secretary on a **biweekly basis until all construction, and restoration activities are complete**. On request, these status reports will also be provided to other federal and state agencies with permitting responsibilities. Status reports shall include:
- a. an update on Gulf South's efforts to obtain the necessary federal authorizations;
 - b. the construction status of the Project, work planned for the following reporting period, and any schedule changes for stream crossings or work in other environmentally sensitive areas;
 - c. a listing of all problems encountered and each instance of noncompliance observed by the EIs during the reporting period (both for the conditions imposed by the Commission and any environmental conditions or permit requirements imposed by other federal, state, or local agencies);
 - d. a description of corrective actions implemented in response to all instances of noncompliance, and their cost;
 - e. the effectiveness of all corrective actions implemented;
 - f. a description of any landowner/resident complaints that may relate to compliance with the requirements of the Order, and the measures taken to satisfy their concerns; and
 - g. copies of any correspondence received by Gulf South from other federal, state, or local permitting agencies concerning instances of noncompliance, and Gulf South's response.
9. **Prior to receiving written authorization from the Director of OEP to commence construction of any Project facilities**, Gulf South shall file with the Secretary documentation

Conclusions and Recommendations

- that it has received all applicable authorizations required under federal law (or evidence of waiver thereof).
10. Gulf South must receive written authorization from the Director of OEP **before placing the Project into service**. Such authorization will only be granted following a determination that rehabilitation and restoration of the right-of-way and other areas affected by the Project are proceeding satisfactorily.
 11. **Within 30 days of placing the authorized facilities in service**, Gulf South shall file an affirmative statement with the Secretary, certified by a senior company official:
 - a. that the facilities have been constructed, and/or installed in compliance with all applicable conditions, and that continuing activities will be consistent with all applicable conditions; or
 - b. identifying which of the certificate conditions Gulf South has complied with or will comply with. This statement shall also identify any areas affected by the Project where compliance measures were not properly implemented, if not previously identified in filed status reports, and the reason for noncompliance.
 12. **Prior to construction**, Gulf South shall file with the Secretary of the Commission (Secretary), for the review and written approval of the Director of OEP, its Remediation Plan containing specific measures that would be implemented to reduce the potential of water loss due to disturbance of clay soils in rice farming areas. (*EA section 2.1.2*)
 13. **Within 30 days of placing the facilities in service**, Gulf South shall file with the Secretary a report summarizing whether any complaints were received concerning well yield or water quality and how each was resolved. Gulf South shall also file in their biweekly status reports a description of any landowner/resident complaints that may relate to compliance with the requirements of the Order, and the measures taken to satisfy these concerns. (*EA section 2.2.1*)
 14. **Prior to construction** Gulf South shall file with the Secretary a copy of the Migratory Bird Conservation Plan developed in consultation with the USFWS for the Project. (*EA section 2.3.4*)
 15. **Prior to construction**, Gulf South shall conduct pre-construction surveys for federal candidate mollusks Smooth pimpleback, Texas fawnfoot, and Texas pimpleback at perennial stream crossings where open-cut trenching methods are proposed, including Lone Tree Creek, Clarks Branch, unnamed tributaries of Linnville Bayou and the San Bernard River, Mound Creek, an unnamed tributary of Mound Creek, unnamed tributary of Varner Creek, Little Slough, and Big Slough, to ensure candidate mollusks would not be impacted by Project activities. Gulf South shall coordinate with the Texas Parks and Wildlife Department on appropriate mitigation measures for mollusks listed at Threatened in the state of Texas. Gulf South shall file with the Secretary, for the review and written approval by the Director of OEP, the resulting survey reports for the federal candidate mollusks. (*EA section 2.3.5*)
 16. Gulf South shall not begin construction of the Project facilities **until**:
 - a. The FERC staff complete any necessary ESA Section 7 consultation with the USFWS for the whooping crane; and
 - b. Gulf South has received written notification from the Director of the OEP that construction and/or use of mitigation may begin. (*EA section 2.3.5*)
 17. **Prior to construction**, Gulf South shall consult with the TPWD on the need for surveys for the state-listed threatened species including bald eagle, white-faced ibis, white-tailed hawk, and alligator snapping turtle, and file with the Secretary the correspondence with any recommendations. (*section 2.3.5*)

Gulf South shall not begin construction of facilities and/or use of staging, storage, or temporary work areas and new or to-be-improved access roads **until** Gulf South files with the Secretary:

- a. the additional addendum reports or plans for any previously unreported areas and the SHPO's comments;
- b. the ACHP is afforded an opportunity to comment if historic properties would be adversely affected; and
- c. the FERC staff reviews and the Director of OEP approves the cultural resources reports, and notifies Gulf South in writing that construction may proceed.

All material filed with the Commission containing location, character, and ownership information about cultural resources must have the cover and any relevant pages therein clearly labeled in bold lettering: "CONTAINS PRIVILEGED INFORMATION--DO NOT RELEASE." (EA section 2.4.4)

18. **Gulf South shall include in its biweekly status report** a copy of a table that contains the following information for each problem/concern identified by landowners through the environmental complaint resolution plan:
 - a. the identity of the caller and date of the call;
 - b. the location by milepost and identification number from the authorized alignment sheet(s) of the affected property;
 - c. a description of the problem/concern; and
 - d. an explanation of how and when the problem was resolved, will be resolved, or why it has not been resolved. (EA section 2.5.3)
19. **Prior to construction**, Gulf South shall file with the Secretary documentation of the authorization from USACE and/or RRC indicating that Gulf South's Project is consistent with the Texas Coastal Management Program. (EA section 2.5.5)
20. Gulf South shall file a noise survey with the Secretary **no later than 60 days** after placing the Wilson, Brazos, North Houston, and Magasco Compressor Stations into service. If full load condition noise surveys are not possible, Gulf South shall provide interim surveys at the maximum possible horsepower load and provide the full load survey **within 6 months**. If the noise attributable to the operation of all of the equipment at the compressor stations under interim or full horsepower load exceeds an Ldn of 55 dBA at the nearest NSA, Gulf South shall file a report on what changes are needed and will install the additional noise controls to meet the level **within 1 year** of the in-service date. Gulf South shall confirm compliance with the above requirement by filing a second noise survey for each station with the Secretary **no later than 60 days** after it installs the additional noise controls. (EA section 2.8.3)
21. **Prior to construction**, Gulf South shall incorporate into its final route alignment the Southern Alternative B Route between MPs 31 and 36. Gulf South shall file with the Secretary detailed alignment sheets and all appropriate resource information based on updated field surveys of the new alignment for review and approval by the Director of OEP. (EA section 3.4)
22. **Prior to construction**, Gulf South shall incorporate into its final route alignment Deviation 14A between MPs 39 and 40. Gulf South shall file with the Secretary detailed alignment sheets and all appropriate resource information based on updated field surveys of the new alignment for review and approval by the Director of OEP. (EA section 3.4).

Conclusions and Recommendations

This page intentionally left blank.

5.0 REFERENCES

- Ables, Sean. January 13, 2015. Texas Commission on Environmental Quality drinking Water Technical Review Team. Personal communication with Megan Rathwell (Environmental Specialist, Perennial Environmental Services, LLC).
- Arnold, C. 2006. Earthquake Effects on Buildings. In Federal Emergency Management Agency (Ed.), *Designing for Earthquakes: A Manual for Architects*. (pp. 4-1 – 4-27). Available online at: <https://www.fema.gov/media-library/assets/documents/8669>. Accessed April 27, 2015.
- Bowles, Brent. April 20, 2015. Architect, IAD Architects. Personal communication with Kaylyn Marsano (Staff Biologist, Perennial Environmental Services, LLC).
- Brazoria County Parks Department. 2015. Location of County Parks and Boat Ramps. Available online at: http://www.brazoria-county.com/parks/park_location_map.html. Accessed April 2015.
- Bureau of Economic Analysis (BEA). 2013. Regional Data. Local Area Personal Income and Employment. Available online at: <http://www.bea.gov/regional/index.htm>. Accessed May 1, 2015.
- Bureau of Labor Statistics (BLS). 2014. Local Area Unemployment Statistics. Labor Force by County. 2014 Annual Averages. Available online at: <http://www.bls.gov/lau/>. Accessed May 1, 2015.
- Center for Disease Control and Prevention. 2015. Deaths: Final Data for 2012. Available online at: http://www.cdc.gov/nchs/data/nvsr/nvsr63/nvsr63_09.pdf. Accessed September 2015.
- Chowdhury, A.H., and M.J. Turco. 2006. Geology of the Gulf Coast Aquifer, Texas. In Mace, R.E., S.C. Davidson, E.S. Angle, and W.F. Mullican III (Eds.). *Texas Water Development Board Report 365: Aquifers of the Gulf Coast of Texas*. Available online at: https://www.twdb.texas.gov/publications/reports/numbered_reports/doc/R365/R365_Composite.pdf. Accessed May 1, 2014.
- Council on Environmental Quality (CEQ). 2014. Revised Draft Guidance for Federal Departments and Agencies on Consideration of Greenhouse Gas Emissions and the Effects of Climate Change in NEPA Reviews. Available online at: <https://federalregister.gov/a/2014-30035>. Accessed January 17, 2015.
- Cowardin, L.M., V. Carter, F.C. Golet, and E.T. LaRoe. 1979. *Classification of Wetlands and Deepwater Habitats of the United States*. U.S. Fish and Wildlife Service FWS/OBS 76/09.
- Crouch-Elliott, Kelly. January 23, 2015. Personnel communication with Kaylyn Marsano (Staff Biologist, Perennial Environmental Services, LLC).
- Davis, Roland. February 17, 2015. USFWS. Personal communication with Marshall Olson (Environmental Specialist, Perennial Environmental Services, LLC).
- Diskin, B.A, J.P. Friedman, S.C. Peppas, and S.R. Peppas. 2011. The Effect of Natural Gas Pipelines on Residential Value. Right of Way, Jan-Feb. Available online at: http://pstrust.org/docs/web_jan_NaturalGas-1.pdf. Accessed September 22, 2015.
- Enterprise Products Partners, L.P. 2013. Natural Gas Storage. Available online at: <http://www.enterpriseproducts.com/operations/onshoreNatGasStorage.shtm>. Accessed June 18, 2015.
- Federal Emergency Management Agency (FEMA). 2014. Map Viewer. Available online at: <http://hazards.fema.gov>. Accessed January 2015.

References

- Federal Energy Regulatory Commission (FERC). 2013a. *Upland Erosion Control, Revegetation, and Mitigation Plan*. May 2013 Version. Office of Energy Projects, Washington, DC. Available online at: <http://www.ferc.gov/industries/gas/enviro/plan.pdf>.
- Federal Energy Regulatory Commission (FERC). 2013b. *Wetland and Waterbody Construction and Mitigation Procedures*. May 2013 Version. Office of Energy Projects, Washington, DC. Available online at: <http://www.ferc.gov/industries/gas/enviro/procedures.pdf>.
- Federal Highway Administration. 2014. America's Byways. Available online at: <http://www.fhwa.dot.gov/byways/>. Accessed November 2014.
- Freeport LNG Development, L.P. 2015. Underground Cavern Gas Storage. Available online at: http://www.freeportlng.com/Underground_Cavern.asp. Accessed June 18, 2015.
- Fruits, E. 2008. The Impact of the Presence of a Natural Gas Pipeline on Residential Property Values. Portland State University. November 2008. Available online at: http://papers.ssrn.com/sol3/papers.cfm?abstract_id=1518065. Accessed September 22, 2015.
- Gulf South. 2015a. Coastal Bend Header Project. Environmental Report; Docket No. CP15-517-000. June 2015.
- Gulf South. 2015b. Coastal Bend Header Project. Response to the Federal Energy Regulatory Commission's Environmental Data Request dated April 16, 2015. May 2015.
- Gulf South. 2015c. Coastal Bend Header Project. Response and Supplemental Response to the Federal Energy Regulatory Commission's Environmental Data Request dated July 17, 2015. August 6 and 27, 2015.
- Gulf South. 2015d. Coastal Bend Header Project. Response to the Federal Energy Regulatory Commission's Environmental Data Request dated August 26, 2015. September 2015.
- Gulf South. 2015e. Coastal Bend Header Project. Response to the Commission Staff's Informal Data Request. October 9, 2015.
- Gulf South. 2015f. Coastal Bend Header Project. Response to the Federal Energy Regulatory Commission's Environmental Data Request dated October 20, 2015. October 2015.
- Hamlin, H.S. 2006. Salt Domes in the Gulf Coast Aquifer. In Mace, R.E., S.C. Davidson, E.S. Angle, and W.F. Mullican III (Eds.). Texas Water Development Board Report 365: Aquifers of the Gulf Coast of Texas. Available online at: https://www.twdb.texas.gov/publications/reports/numbered_reports/doc/R365/R365_Composite.pdf. Accessed June 18, 2014.
- Hatcher, Nathan. January 14, 2015. Fort Bend County Engineering Development Coordinator. Personal Communication with Kaylyn Marsano (Staff Biologist, Perennial Environmental Services).
- Helfman, Gene S., Bruce B. Collette, Douglas E. Facey, and Brian W. Bowen. 2009. *The Diversity of Fishes: Biology, Evolution, and Ecology*. Second Edition. Wiley-Blackwell. 736 p.
- Hudgins, M.R. 2010a. "Boling Dome," Handbook of Texas Online. Published by the Texas State Historical Association. Available online at: <http://www.tshaonline.org/handbook/online/articles/gzb01>. Accessed June 18, 2015.
- Hudgins, M.R. 2010b. "Texasgulf," Handbook of Texas Online. Published by the Texas State Historical Association. Available online at: <https://tshaonline.org/handbook/online/articles/dktgq>. Accessed June 18, 2015.
- International Dark-Sky Association. 2010a. Seeing Blue. April 2010. Nightscape 80: 8-12. Available online at: <http://www.darksky.org/assets/documents/SeeingBlue.pdf>. Accessed June 14, 2015.

- International Dark-Sky Association. 2010b. Visibility, Environmental, and Astronomical Issues Associated with Blue-Rich White Outdoor Lighting. Available online at: <http://www.darksky.org/assets/documents/Reports/IDA-Blue-Rich-Light-White-Paper.pdf>. Document date: May 4, 2010. Accessed June 14, 2015.
- International Dark-Sky Association. 2015. IDA Issues New Standards on Blue Light at Night. April 2015. *Nightscape* 94: 10. Available online at: http://www.darksky.org/assets/documents/Nightscape/IDA_April2015_LowRes.pdf. Accessed June 14, 2015.
- Kasmarek, M.C., and J.L. Robinson. 2004. Hydrogeology and simulation of groundwater flow and land-surface subsidence in the northern part of the Gulf Coast aquifer system: U.S. Geological Survey, Scientific Investigations Report 2004-5102, 111 p. Available online at: <http://pubs.usgs.gov/sir/2012/5154/>. Accessed June 30, 2015.
- Klym, Mark, and Gary P. Garrett. 2002. Texas Non-Game Freshwater Fishes. Published by Texas Parks and Wildlife Department. Available online at: http://tpwd.texas.gov/publications/pwdpubs/media/pwd_bk_w7000_0798.pdf. Accessed April 30, 2015.
- Lord, A.S., K.M. Loeff, and C.A. Rautman. 2006. Geologic technical assessment of the Stratton Ridge salt dome, Texas, for potential expansion of the U.S. strategic petroleum reserve. Available online at: <http://prod.sandia.gov/techlib/access-control.cgi/2006/067159.pdf>. Accessed July 13, 2015.
- Magee, Melanie. May, 15, 2015. Environmental Protection Agency. Personal Communication with Kaylyn Marsano (Staff Biologist, Perennial Environmental Services).
- Mosby, Brent. January 14, 2015. Railroad Commission of Texas. Personal Communication with Kaylyn Marsano (Staff Biologist, Perennial Environmental Services, LLC).
- Mullican III, William F. 1988. Subsidence and Collapse at Texas Salt Domes. Bureau of Economic Geology, Geologic Circular 88-2. Accessed May 2015.
- Murray, David. April 30, 2015. Radioactive Materials Division, Texas Commission on Environmental Quality. Personal communication with Amanda Solitro (Staff Biologist, Perennial Environmental Services, LLC).
- National Oceanic and Atmospheric Administration (NOAA). 2014. Office of Climate, Water, and Weather Services. Natural Hazard Statistics. Available online at: <http://www.nws.noaa.gov/om/hazstats.shtml>. Accessed September 2015.
- National Park Service. 2010a. National Trails Map. Available online at: <http://www.nps.gov/nts/maps/National%20Trails%20map.pdf>. Accessed November 2014.
- National Park Service. 2010b. Nationwide Rivers Inventory for Texas. Available online at: <http://www.nps.gov/ncrc/programs/rtca/nri/states/in.html>. Accessed November 2014.
- National Park Service. 2014a. Nationwide Rivers Inventory – Texas Segments. Available online at: <http://www.nps.gov/ncrc/programs/rtca/nri/states/tx.html>. Accessed May 1, 2015.
- National Park Service. 2014b. Indian Reservations in the Continental U.S. Available online at: <http://www.nps.gov/nagpra/documents/RESERV.PDF>. Accessed December, 2014.
- National Park Service. 2014c. Listing of Historic National Landmarks by State. Available online at: <http://www.nps.gov/nhl/find/statelists/tx/TX.pdf>. Accessed December, 2014.
- National Park Service. 2014d. Explore Designated Rivers by State. Available online at: <http://www.rivers.gov/map.php>. Accessed November 2014.

References

- National Research Council. 1991. Mitigating losses from land subsidence in the United States: Washington, D.C., National Academy Press, 58 p. Available online at: http://www.nap.edu/openbook.php?record_id=1796. Accessed April 28, 2015.
- National Weather Service. 2015. Weather Forecast Office. Houston/Galveston, TX. Hobby Extremes, Normals and Annual Summaries. Available online at: http://www.srh.noaa.gov/hgx/?n=climate_hobby_normals_summary. Accessed April 29, 2015.
- National Wild and Scenic Rivers System. 2015. Available online at: <http://www.rivers.gov/texas.php>. Accessed May 1, 2015.
- Natural Resources Conservation Service (NRCS). 1974. Soil Survey of Wharton County, Texas. Available online at: http://www.nrcs.usda.gov/Internet/FSE_MANUSCRIPTS/texas/whartonTX1974/whartonTX1974.pdf. Accessed December 2014.
- Natural Resources Conservation Service (NRCS). 1976. Soil Survey of Harris County, Texas. Available online at: http://www.nrcs.usda.gov/Internet/FSE_MANUSCRIPTS/texas/harrisTX1976/harris.pdf. Accessed December 2014.
- Natural Resources Conservation Service (NRCS). 1981. Soil Survey of Brazoria County, Texas. Available online at: http://www.nrcs.usda.gov/Internet/FSE_MANUSCRIPTS/texas/TX039/0/brazoria.pdf. Accessed January 2015.
- Natural Resources Conservation Service (NRCS). 1990. Soil Survey of Fort Bend County, Texas. Available online at: http://www.nrcs.usda.gov/Internet/FSE_MANUSCRIPTS/texas/fortbendTX1960/Fort%20Bend.pdf. Accessed December 2014.
- Natural Resources Conservation Service (NRCS). 2009. Soil Survey of San Augustine and Sabine Counties, Texas. Available online at: http://www.nrcs.usda.gov/Internet/FSE_MANUSCRIPTS/texas/sanaugustine_sabineTX2010/San%20Augustine%20and%20Sabine.pdf. Accessed December 2014.
- Natural Resources Conservation Service (NRCS). 2014a. Conservation Practice Standard Critical Area Planting. Available online at: http://efotg.sc.egov.usda.gov/references/public/TX/TX_342_Final_DEC_2014.pdf. Accessed June 29, 2015.
- Natural Resources Conservation Service (NRCS). 2014b. WRP Easement Shapefiles. Available online at: <http://www.nrcs.usda.gov/wps/portal/nrcs/main/tx/programs/easements/>. Accessed December 2014.
- Natural Resources Conservation Service (NRCS). 2015a. Soil Survey Geographic Database. Available online at: <http://soils.usda.gov/survey/>. Accessed January 2015.
- Natural Resources Conservation Service (NRCS). 2015b. Official Soil Series Descriptions. Available online at: <https://soilseries.sc.egov.usda.gov/osdname.asp>. Accessed January 2015.
- Natural Resources Conservation Service (NRCS). 2015c. Soil Survey of Polk and San Jacinto Counties, Texas. Available online at: http://www.nrcs.usda.gov/Internet/FSE_MANUSCRIPTS/texas/TX617/0/Polk.pdf. Accessed December 2014.

- Natural Resources Conservation Service (NRCS). 2015d. Hydric Soils – Introduction. Available online at: http://www.nrcs.usda.gov/wps/portal/nrcs/detail/soils/use/hydric/?cid=nrcs142p2_053961. Accessed April 29, 2015.
- Natural Resources Conservation Service (NRCS). 2015e. NRCS Texas Conservation Easements. <http://www.nrcs.usda.gov/wps/portal/nrcs/main/tx/programs/easements/>. Accessed May 2015.
- Noble J.E., P.W. Bush, M.C. Kasmarek, and D.L. Barbie. 1996. Estimated Depth to the Water Table and Estimated Rate of Recharge in Outcrops of the Chicot and Evangeline Aquifers Near Houston, Texas. Water Resources Investigations Report 96-4018, U.S. Geological Survey. Available online at: <http://pubs.usgs.gov/wri/wri96-4018/pdf/wri96-4018.pdf>. Accessed July 2, 2015.
- Northern California Earthquake Data Center. 2015. ANSS Catalog Search. Available online at: <http://www.quake.geo.berkeley.edu/anss/catalog-search.html>. Accessed April 27, 2015.
- Palomo, Rudy. January 21, 2015. Harris County Public Infrastructure Department, Agriculture and Engineering Department. Personal Communication with Kaylyn Marsano (Staff Biologist, Perennial Environmental Services, LLC).
- Pan, Q., and R. Daniel. 2015. The Impacts of Oil and Gas Pipelines on Urban Residential Property Values: A Case Study in Houston. The 2015 ESRI User Conference. July 2015. Available online at: http://proceedings.esri.com/library/userconf/proc15/papers/109_217.pdf. Accessed September 22, 2015.
- Petersen, M.D., M.P. Moschetti, P.M. Powers, C.S. Mueller, K.M. Haller, A.D. Frankel, Y. Zeng, S. Rezaeian, S.C. Harmsen, O.S. Boyd, N. Field, R. Chen, K.S. Rukstales, N. Luco, R.L. Wheeler, R.A. Williams, and A.H. Olsen. 2014. Documentation for the 2014 update of the United States national seismic hazard maps: U.S. Geological Survey Open-File Report 2014-1091, 243 p. Available online at: <http://dx.doi.org/10.3133/ofr20141091>. Accessed April 27, 2015.
- Pipeline and Hazardous Materials Safety Administration. 2015. Significant Pipeline Incidents. Available online at: <http://primis.phmsa.dot.gov/comm/reports/safety/sigpsi.html?nocache=8124>. Accessed September 2015.
- Railroad Commission of Texas (RRC). 2015a. Historic Coal Mining Zones in Texas. Available online at: http://www.rrc.state.tx.us/media/27810/historicalcoalminingzonestexas_feb2015.pdf. Accessed April 27, 2015.
- Railroad Commission of Texas (RRC). 2015b. Lignite Surface Mine Permit Locations. Available online at: <http://www.rrc.state.tx.us/media/28229/coal-mine-map-04-15.pdf>. Accessed April 27, 2015.
- Railroad Commission of Texas (RRC). 2015c. Surface Coal Mine County Information. Available online at: <http://www.rrc.state.tx.us/mining-exploration/permits/surface-coal-mine-county-information/>. Accessed April 27, 2015.
- Railroad Commission of Texas (RRC). 2015d. Oil and Gas Well Data. Available online at: <http://www.rrc.state.tx.us/oil-gas/research-and-statistics/obtaining-commission-records/oil-and-gas-well-records/>. Accessed January 2015.
- Ross, Claude. December 12, 2014. NRCS. Personal communication with Marshall Olson (Environmental Specialist, Perennial Environmental Services, LLC). The Paleontology Portal. 2014. Exploring Time and Space. Available online at: http://www.paleoportal.org/index.php?globalnav=time_space. Accessed January 2015.
- Ross, Claude. May 4, 2015. NRCS. Personal communication with Erin Broussard (Staff Environmental Specialist, Perennial Environmental Services, LLC).

References

- Sanders, Cristela. May 1, 2015. NRCS. Personal communication with Marshall Olson (Environmental Specialist, Perennial Environmental Services, LLC).
- SeaBreeze Environmental. 2010. Environmental Protection. Available online at: <http://www.seabreezelandfill.com/environment.aspx>. Accessed June 30, 2015.
- Sloan, Lisa. January 13, 2015. Director of the Polk County Department of Emergency Management. Personal Communication with Kaylyn Marsano (Staff Biologist, Perennial Environmental Services).
- Sullivan, David. January 14, 2015. Texas Farm Service Agency, Program Analysis Chief. Personal communication with Kaylyn Marsano (Staff Biologist, Perennial Environmental Services, LLC).
- Texas Commission on Environmental Quality (TCEQ). 2003. Description of BMPs - Erosion Control BMPs. Available online at: <https://www.tceq.texas.gov/assets/public/permitting/waterquality/attachments/401certification/erosion.pdf>. Accessed June 29, 2015.
- Texas Commission on Environmental Quality (TCEQ). 2012. Public Water System Wells and Surface Water Intakes. Available online at: <https://www.tceq.texas.gov/gis/download-tceq-gis-data/#water>. Accessed January 2015.
- Texas Commission on Environmental Quality (TCEQ). 2013. 2012 Texas Integrated Report – Texas 303(d) List (Category 5). Available online at: https://www.tceq.texas.gov/assets/public/waterquality/swqm/assess/12twqi/2012_303d.pdf. Accessed May 1, 2015.
- Texas Commission on Environmental Quality (TCEQ). 2015a. Alphabetical Index of Superfund Sites in Texas. Available online at: <https://www.tceq.texas.gov/remediation/superfund/sites/byname.html>. Accessed April 2015.
- Texas Commission on Environmental Quality (TCEQ). 2015b. Priority Groundwater Management Areas. Available online at: <http://www.tceq.state.tx.us/groundwater/pgma.html>. Accessed May 7, 2015.
- Texas Commission on Environmental Quality (TCEQ). 2015c. Consumer Confidence Report (CCR): Definitions. Texas Commission on Environmental Quality. Available online at: https://www.tceq.texas.gov/drinkingwater/ccr/ccr_definitions.html. Accessed May 1, 2015.
- Texas Commission on Environmental Quality (TCEQ). 2015d. TCEQ GIS Data. Available online at: <https://www.tceq.texas.gov/gis/download-tceq-gis-data>. Accessed March 2015.
- Texas Commission on Environmental Quality (TCEQ). 2015e. Alphabetical Index of Superfund Sites in Texas. Available online at: <https://www.tceq.texas.gov/remediation/superfund/sites/byname.html>. Accessed April 2015.
- Texas Commission on Environmental Quality (TCEQ). 2015f. DRAFT 2014 Texas Integrated Report – Texas 303(d) List (Category 5). Available online at: https://www.tceq.texas.gov/assets/public/waterquality/swqm/assess/14txir/2014_303d.pdf. Accessed July 2015.
- Texas Commission on Environmental Quality (TCEQ). 2015g. Source Water Protection. Available online at: <http://gisweb.tceq.texas.gov/swav/moreInfo.jsp>. Accessed April 2015.

- Texas Commission on Environmental Quality (TCEQ). 2015h. Central Registry Query – Regulated Entity Information, Seabreeze Environmental Landfill. Available online at: <http://www15.tceq.texas.gov/crpub/index.cfm?fuseaction=regent.RNSearch>. Accessed July 20, 2015.
- Texas Department of Transportation. 2015. Project Tracker. Available online at: <http://www.txdot.gov/inside-txdot/projects/project-tracker.html>. Accessed January 2015.
- Texas General Land Office. 2014. Coastal Zone Map. Available online at: http://www.glo.texas.gov/what-we-do/caring-for-the-coast/_documents/landing-page-folder/CoastalBoundaryMap.pdf. Accessed December 2014.
- Texas Parks and Wildlife Department (TPWD). 2001. Ecologically Significant River and Stream Segments. Available online at: https://tpwd.texas.gov/landwater/water/conservation/water_resources/water_quantity/sigsegs/media/sigseg_map_allregions.pdf. Accessed May 1, 2015.
- Texas Parks and Wildlife Department (TPWD). 2014a. Outdoor Annual Freshwater/Saltwater Boundary. Available online at: <http://tpwd.texas.gov/regulations/outdoor-annual/fishing/general-rules-regulations/freshwater-saltwater-boundaries>. Accessed April 30, 2015.
- Texas Parks and Wildlife Department (TPWD). 2014b. Freshwater Fishes Found in Texas. Available online at: <https://tpwd.texas.gov/landwater/water/aquaticspecies/inland.phtml>. Accessed April 30, 2015.
- Texas Parks and Wildlife Department (TPWD). 2014c. Trout Stocking Schedule by County. Available online at: http://tpwd.texas.gov/fishboat/fish/management/stocking/trout_stocking.phtml?s=o. Accessed December 2014.
- Texas Parks and Wildlife Department (TPWD). 2014d. Texas State Parks Map. Available online at: <http://www.tpwd.state.tx.us/state-parks/state-parks-map.phtml>. Accessed November 2014.
- Texas Parks and Wildlife Department (TPWD). 2014e. Find a Wildlife Management Area. Available online at: http://www.tpwd.state.tx.us/huntwild/hunt/wma/find_a_wma/. Accessed November, 2014.
- Texas Parks and Wildlife Department (TPWD). 2015a. GIS Data Downloads: Springs. Available online at: <http://tpwd.texas.gov/gis/data>. Accessed April 2015.
- Texas Parks and Wildlife Department (TPWD). 2015b. Marine Fishes and Shellfishes of the Gulf. Available online at: <https://tpwd.texas.gov/landwater/water/aquaticspecies/marine.phtml>. Accessed February 2015.
- Texas Parks and Wildlife Department (TPWD). 2015c. Where to Fish in Texas State Waters. Available online at: <https://tpwd.texas.gov/fishboat/fish/recreational/wheretofish/>. Accessed May 2015.
- Texas Parks and Wildlife Department (TPWD). 2015d. All Parks. Available online at: <http://tpwd.texas.gov/state-parks/nearby/all-parks/>. Accessed April 2015.
- Texas State Historical Association. 2010. Boling Dome. Available online at: <https://tshaonline.org/handbook/online/articles/gzb01>. Accessed July 13, 2015.
- Texas Water Development Board. 2015a. Gulf Coast Aquifer. Available online at: <http://www.twdb.texas.gov/groundwater/aquifer/majors/gulf-coast.asp>. Accessed May 1, 2015.
- Texas Water Development Board. 2015b. Sparta Aquifer. Available online at: <http://www.twdb.texas.gov/groundwater/aquifer/minors/sparta.asp>. Accessed May 1, 2015.

References

- Texas Water Development Board. 2015c. Groundwater Well Database. Available online at: <http://www.twdb.texas.gov/groundwater/data/gwdbbrpt.asp>. Accessed May 2015.
- Tobin, B.D., and D.J. Weary. 2004. U.S. Geological Survey Open File Report 2004-1352. Digital Engineering Aspects of Karst Map: A GIS version of Davies, W.E., J.H. Simpson, G.C. Ohlmacher, W.S. Kirk, and E.G. Newton, 1984, Engineering aspects of karst: U.S. Geological Survey, National Atlas of the United States of America, scale 1:7,500,000. Available online at: http://pubs.usgs.gov/of/2004/1352/data/USA_karst.pdf. Accessed April 29, 2015.
- U.S. Army Corps of Engineers (USACE). 2010. Regional Supplement to the Corps of Engineers Wetlands Delineation Manual: Atlantic and Gulf Coastal Plain Region. Version 2.0. U.S. Army Engineers Research and Development Center, Vicksburg, MS.
- U.S. Bureau of Land Management. 2008. Visual Resource Management Program (Course 8400-05).
- U.S. Census Bureau. 2012. Census of Governments. Local Government Finances by Type of Government and State. Accessed online at: <http://factfinder.census.gov>. Accessed May 1, 2015.
- U.S. Census Bureau. 2013. 2009–2013 Five-Year American Community Survey. Available online at: <http://factfinder.census.gov>. Accessed April 30, 2015.
- U.S. Census Bureau. 2014. Annual Estimates of the Resident Population, July 1. Available online at: <http://factfinder.census.gov>. Accessed April 30, 2015.
- U.S. Environmental Protection Agency (EPA). 2012a. Designated Sole Source Aquifers in EPA Region VI. Available online at: <http://www.epa.gov/region6/water/swp/ssa/maps.htm>. Accessed May 1, 2015.
- U.S. Environmental Protection Agency (EPA). 2012b. What are Suspended and Bedded Sediments (SABS)? Available online at: <http://water.epa.gov/scitech/datait/tools/warsss/sabs.cfm>. Accessed May 2015.
- U.S. Environmental Protection Agency (EPA). 2015a. NEPAssist. Available online at: <http://nepassisttool.epa.gov/nepassist/entry.aspx>. Accessed April 2015.
- U.S. Environmental Protection Agency (EPA). 2015b. Envirofacts, Seabreeze Environmental Landfill. Available online at: http://ofmpub.epa.gov/enviro/afs_reports.detail_plt_view?p_state_county_compliance_src=4803900667. Accessed June 30, 2015.
- U.S. Environmental Protection Agency (EPA). 2015c. Designation of Sole Source Aquifers: Fact Sheet. Available online at: <http://www.epa.gov/region6/water/swp/ssa/factshee.htm>. Accessed May 1, 2015.
- U.S. Environmental Protection Agency (EPA). 2015d. AirData. Data files available for download. Available online at: http://aqsdrl.epa.gov/aqsweb/aqstmp/airdata/download_files.html. Accessed February 18, 2015.
- U.S. Fish and Wildlife Service (USFWS). 2007. National Bald Eagle Management Guidelines. Available online at: <http://www.fws.gov/southdakotafieldoffice/NationalBaldEagleManagementGuidelines.pdf>. Accessed May 2015.

- U.S. Fish and Wildlife Service (USFWS). 2008. Birds of Conservation Concern 2008. Available online at:
<http://www.fws.gov/migratorybirds/NewReportsPublications/SpecialTopics/BCC2008/BCC2008.pdf>. Accessed on April 30, 2015.
- U.S. Fish and Wildlife Service (USFWS). 2014. National Wildlife Refuge System Map.
http://www.fws.gov/refuges/maps/NWRS_National_Map.pdf. Accessed November 2014.
- U.S. Forest Service. 2014. National Forest Locator Map. Available online at:
<http://www.fs.fed.us/locatormap/>. Accessed November 2014.
- U.S. Geological Survey (USGS). 1996. Groundwater Atlas of the United States, Oklahoma and Texas. Available online at: http://pubs.usgs.gov/ha/ha730/ch_e/index.html. Accessed April 27, 2015.
- U.S. Geological Survey (USGS). 2000. A Tapestry of Time and Terrain: The Union of Two Maps - Geology and Topography. Available online at: <http://pubs.usgs.gov/imap/i2720/>. Accessed April 23, 2015.
- U.S. Geological Survey (USGS). 2005. Preliminary Integrated Geologic Map Databases for the United States Central States: Montana, Wyoming, Colorado, New Mexico, Kansas, Oklahoma, Texas, Missouri, Arkansas, and Louisiana - The State of Texas. Version 1.0. Available online at:
<http://mrdata.usgs.gov/geology/state/state.php?state=TX>. Accessed June 18, 2015.
- U.S. Geological Survey (USGS). 2014. Landslide Overview Map of the Conterminous United States. Available online at: <http://landslides.usgs.gov/hazards/nationalmap/>. Accessed January 2015.
- U.S. Geological Survey (USGS). 2015a. Lissie Formation. Available online at:
<http://mrdata.usgs.gov/geology/state/sgmc-unit.php?unit=TXQl;0>. Accessed April 27, 2015.
- U.S. Geological Survey (USGS). 2015b. Beaumont Formation, Predominantly Clay. Available online at: <http://mrdata.usgs.gov/geology/state/sgmc-unit.php?unit=TXQbc;0>. Accessed April 27, 2015.
- U.S. Geological Survey (USGS). 2015c. Beaumont Formation, Predominantly Sand. Available online at: <http://mrdata.usgs.gov/geology/state/sgmc-unit.php?unit=TXQbs;0>. Accessed April 27, 2015.
- U.S. Geological Survey (USGS). 2015d. Alluvium. Available online at:
<http://mrdata.usgs.gov/geology/state/sgmc-unit.php?unit=TXQal;0>. Accessed April 27, 2015.
- U.S. Geological Survey (USGS). 2015e. Fleming Formation. Available online at:
<http://mrdata.usgs.gov/geology/state/sgmc-unit.php?unit=TXMlf;0>. Accessed April 27, 2015.
- U.S. Geological Survey (USGS). 2015f. Yegua Formation. Available online at:
<http://mrdata.usgs.gov/geology/state/sgmc-unit.php?unit=TXEOy;0>. Accessed April 27, 2015.
- U.S. Geological Survey (USGS). 2015g. Texas Earthquake History. Available online at:
<http://earthquake.usgs.gov/earthquakes/states/texas/history.php>. Accessed April 27, 2015.
- U.S. Geological Survey (USGS). 2015h. Search Earthquake Archives. Available online at:
<http://earthquake.usgs.gov/earthquakes/search/>. Accessed April 27, 2015.
- U.S. Global Change Research Program (USGCRP). 2014. Climate Change Impacts in the United States. Available online at: <http://www.globalchange.gov/nca3-downloads-materials>. Accessed April 24, 2015.
- University of Texas. 2013. Texas Earthquakes. Available online at:
<http://www.ig.utexas.edu/research/seismology/TXEQ/index.html>. Accessed January 2015.

References

- University of Texas. 2015. What is Karst? Available online at: <http://www.esi.utexas.edu/outreach/caves/karst.php>. Accessed September 15, 2015.
- Weatherspark. 2015. Average Weather For Houston, Texas, USA. Available online at: <https://weatherspark.com/averages/30560/Houston-Texas-United-States>. Accessed April 29, 2015.
- Wilde, L., C. Loos, and J. Williamson. 2012. Pipelines and Property Values: An Eclectic Review of the Literature. February 2015. Gnarus Advisors. Available online at: http://www.co.medina.oh.us/property_values.pdf. Accessed September 22, 2015.
- Wilde, L., C. Loos, and J. Williamson. 2013. A Long-term Study of the Effect of a Natural Gas Pipeline on Residential Property Values. June 2013. Gnarus Advisors. Available online at: http://www.gnarusllc.com/wp-content/uploads/2013/07/Kern_Emp_Paper_JRER_Forthcoming.pdf. Accessed September 22, 2015.
- Worfe, Patti. February 24, 2015. Assistant City Manager / Economic Development Director, City of Angleton. Personal Communication with Kaylyn Marsano (Staff Biologist, Perennial Environmental Services LLC).
- Yokel, F.Y., and R.G. Mathey. 1992. Earthquake Resistant Construction of Gas and Liquid Fuel Pipeline Systems Serving, or Regulated by, the Federal Government. Prepared for Federal Emergency Management Agency. Available online at: <https://www.fema.gov/media-library/assets/documents/2978>. Accessed April 27, 2015.

6.0 LIST OF PREPARERSFederal Energy Regulatory Commission**John Wisniewski – Environmental Project Manager**

B.S., Mineral Economics, 1975, The Pennsylvania State University

Joanne Wachholder – Wildlife, Threatened & Endangered Species, Water

M.S., Crop and Soil Sciences/Environmental Toxicology, 1997, Michigan State University
B.S., Biology, 1994, University of Wisconsin – Stevens Point

Nancy Fox-Fernandez – Wildlife, Threatened & Endangered Species, Water

M.S., Natural Resources: Wildlife, 2006, Humboldt State University
B.A., Psychology, 1993, Skidmore College

Kandilarya Barakat – Air Quality, Noise

M.E., Environmental Engineering, 2006, University of Maryland, College Park
B.S., Chemical Engineering, 2003, University of Maryland, College Park

Eric Howard – Cultural Resources

M.A., Anthropology, 1997, University of Tennessee
B.A., Anthropology, 1992, University of Tennessee

ICF International**Steve Wyngarden – Project Director**

M.E.M., Environmental Management, School of Forestry and Environmental Studies, Duke University 1982
B.S., Applied Biology, Georgia Institute of Technology, 1980

Ellen Miille – Project Manager

B.A., Social Ecology/Environmental Planning, University of California, Irvine, 1984

Lonnie Lister – Senior Advisor

B.S., Geology, Brooklyn College, City University of New York, 1976

David Buehler – Noise

B.S., Civil Engineering, California State University, 1980

David Ernst – Air Quality

M.C.R.P., Environmental Policy, Harvard University Graduate School of Design, 1979
B.S., Urban Systems Engineering, Brown University, 1975
B.A., Ethics and Prose, Brown University, 1975

Jessica Feldman – Cultural Resources

M.A., Historic Preservation Planning, City and Regional Planning, Cornell University, 2001
B.A., History, William Smith College, 1993

David Johnson – Fish, Wildlife, Vegetation

B.S., Biology, University of Minnesota, 1997

List of Preparers

Chris Moelter – Alternatives

M.E.M., Environmental Tourism, University of Queensland, Australia, 2013
B.S., Zoology, University of Wisconsin-Madison, 2001

Dan Nally – Geology, Soils, Water

M.A., Urban and Environmental Policy and Planning, Tufts University, 2011
B.S., Biology, The College of William and Mary, 2007

James Rice – Geology, Soils, Water

M.S., Geology, New Mexico Institute of Mining and Technology, 1985
B.S., Geology, New Mexico Institute of Mining and Technology, 1981

Richard Starzak – Cultural Resources

M.A., Architecture: History, Criticism & Analysis, University of California Los Angeles, 1994
B.A., Biology, Brown University, 1976

Alex Uriarte – Socioeconomics

Ph.D., Development Studies, University of Wisconsin-Madison, 2000
M.S., Economics, University of Wisconsin-Madison, 1996
Masters, Business Economics, Getúlio Vargas Foundation, São Paulo, Brazil, 1994
B.A., Economics, University of São Paulo, Brazil, 1989

Nathan Wagoner – Land Use

M.S., Human Dimensions of Ecosystem Science and Management, Utah State University, 2006
B.S., Natural Resources Integrated Policy and Planning, The Ohio State University, 2003

Jennifer Wynn – Research Assistant

M.P.P., Environmental Policy, George Washington University, 2014
B.A., Political Science, University of Michigan, 2011

APPENDICES

APPENDIX A

TOPOGRAPHIC MAPS OF PIPELINE ROUTE AND ABOVEGROUND FACILITIES

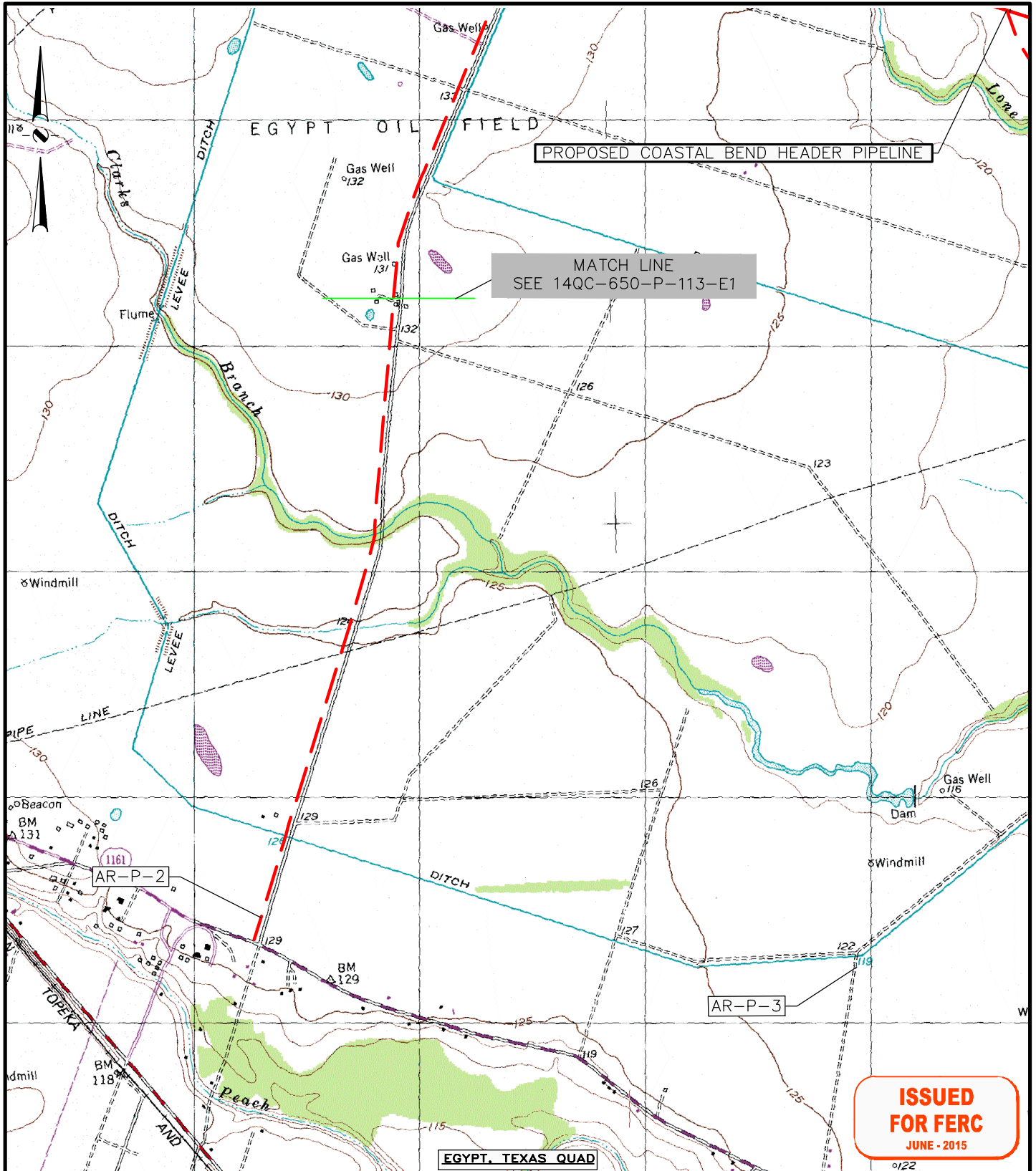

ISSUED FOR FERC
JUNE - 2015

LEGEND

- - - - - Proposed Pipeline
- - - - - Access Road
- Mile Post
- Facility



WILBROS ENGINEERS (U.S.) LLC
FIRM REGISTRATION NUMBER: TX F-82



PROPOSED COASTAL BEND HEADER PIPELINE
WHARTON COUNTY, TEXAS

A	ISSUED FOR FERC	JMW	RSC			
NO.	REVISION	DRAWN	DATE	APPR.	DATE	
SCALE	DRAWN	DATE	CHECKED	DATE	APPROVED	DATE
1"=2000'	CB	5/16/15	RSC	5/18/15		

WEI PROJ. NO.	DRAWING NUMBER	REV. NO.
52715	14CQ-650-P-113-E2	A

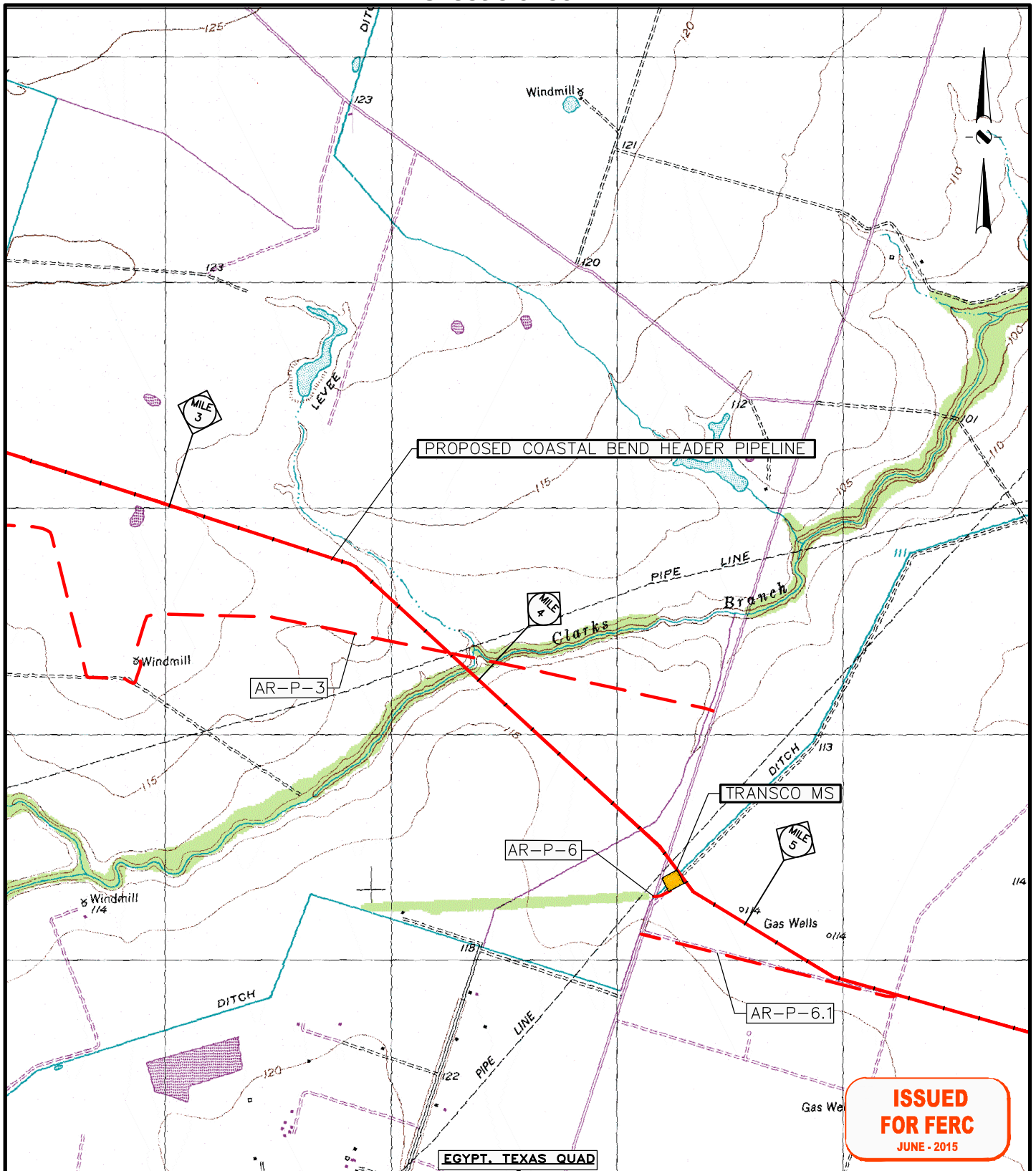

ISSUED FOR FERC
JUNE - 2015

LEGEND

- Proposed Pipeline
- - - - Access Road
- Mile Post
- Facility



WILLBROS ENGINEERS (U.S.) LLC
FIRM REGISTRATION NUMBER: TX F-82



**PROPOSED COASTAL BEND HEADER PIPELINE
WHARTON COUNTY, TEXAS**

NO.	REVISION	DRAWN	DATE	APPR.	DATE	
A	ISSUED FOR FERC	JMW		RSC		
SCALE	DRAWN	DATE	CHECKED	DATE	APPROVED	DATE
1"=2000'	CB	5/16/15	RSC	5/18/15		

WEI PROJ. NO.	DRAWING NUMBER	REV NO.
52715	14CQ-650-P-113-E3	A

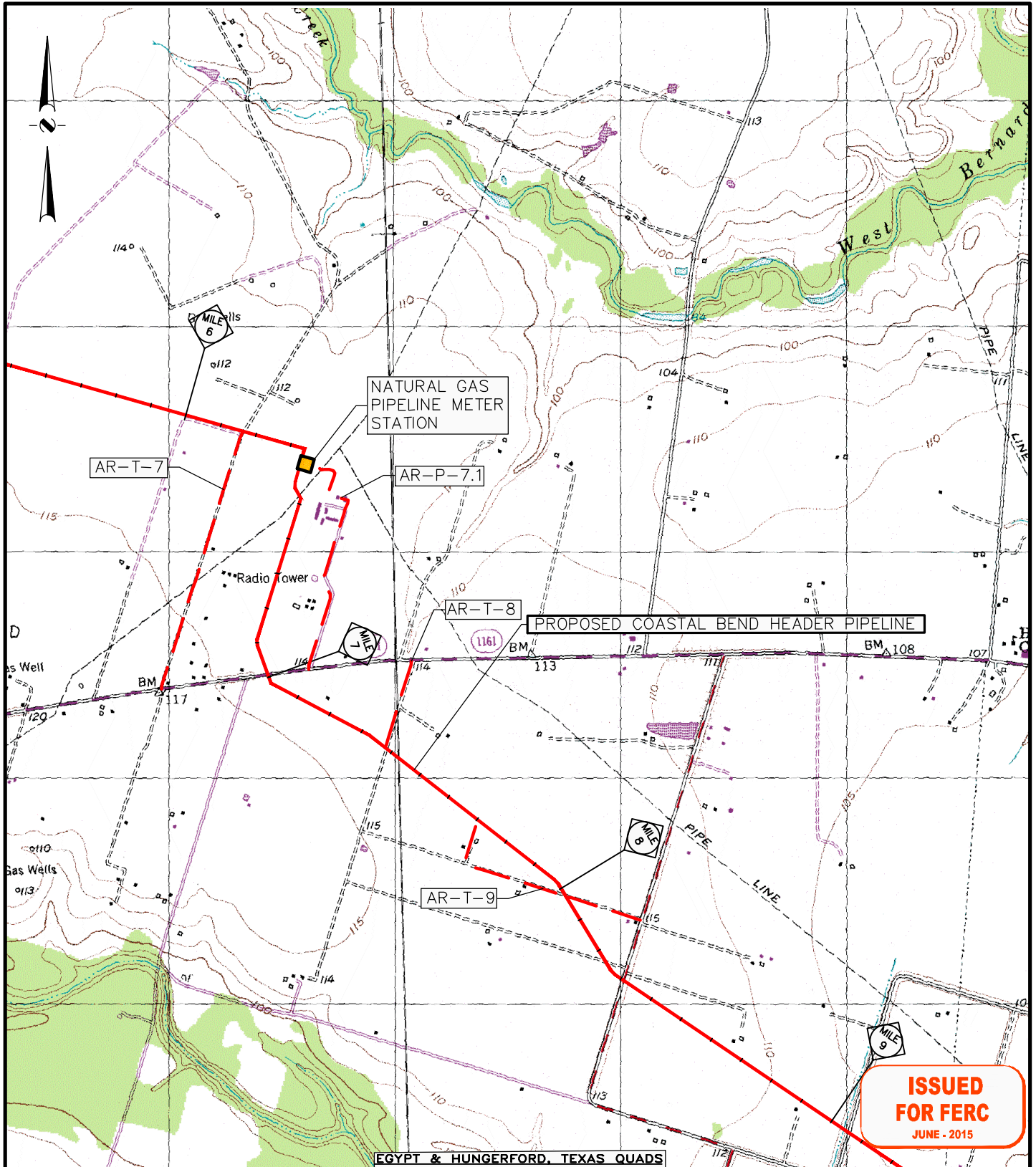

ISSUED FOR FERC
JUNE - 2015

LEGEND

- Proposed Pipeline
- - - Access Road
- Mile Post
- Facility

WILLBROS ENGINEERS (U.S.) LLC
FIRM REGISTRATION NUMBER: TX F-82



**PROPOSED
COASTAL BEND HEADER PIPELINE
WHARTON COUNTY, TEXAS**

A	ISSUED FOR FERC	JMW	RSC						
NO.	REVISION	DRAWN	DATE	APPR.	DATE				
SCALE	DRAWN	DATE	CHECKED	DATE	APPROVED	DATE	WEI PROJ. NO.	DRAWING NUMBER	REV. NO.
1"=2000'	CB	5/16/15	RSC	5/18/15			52715	14CQ-650-P-113-E4	A

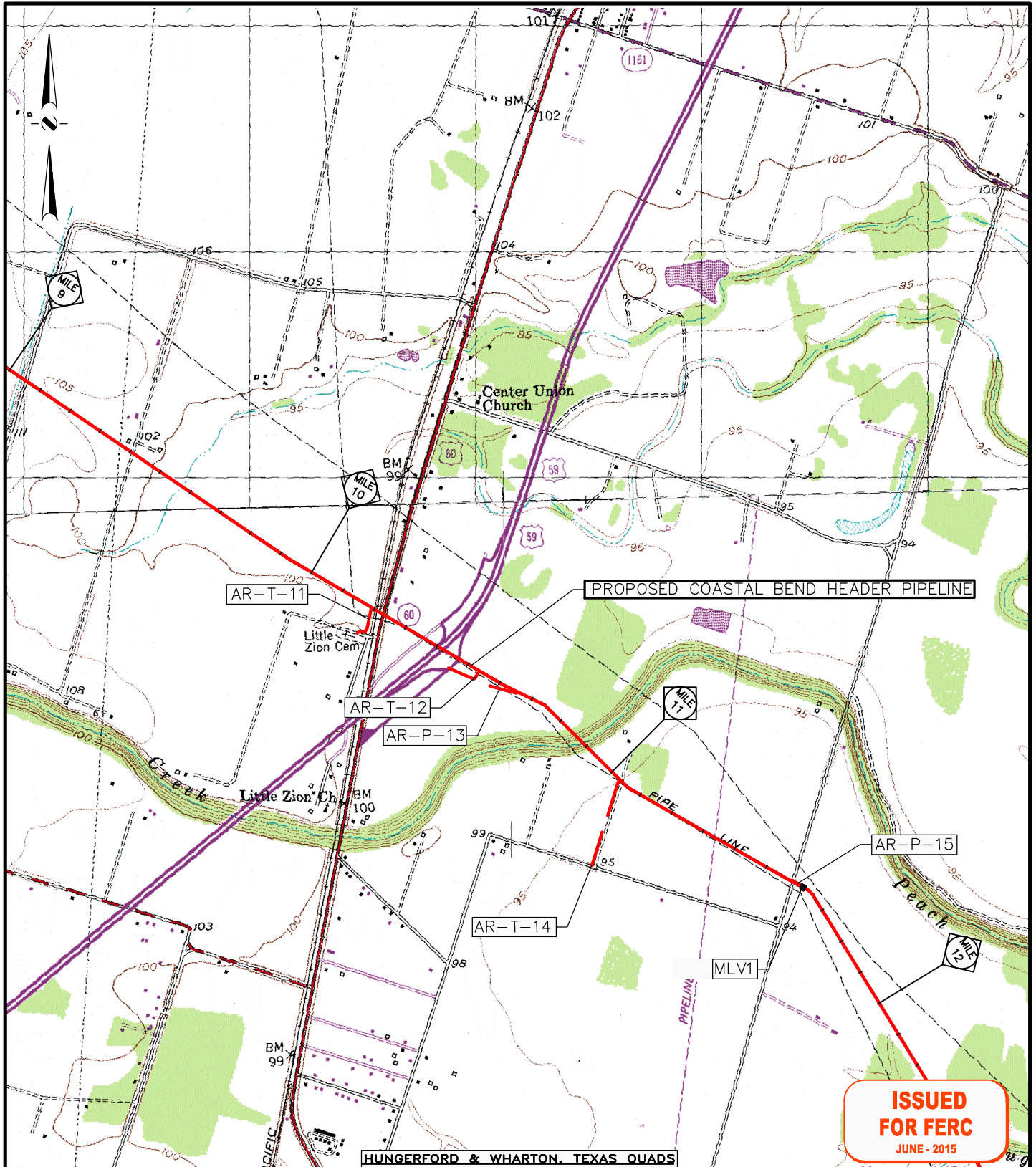

ISSUED FOR FERC
JUNE - 2015

HUNGERFORD & WHARTON, TEXAS QUADS

LEGEND
 Proposed Pipeline
 Access Road
 Mile Post
 Facility

WILBROS **WILBROS ENGINEERS (U.S.) LLC**
FIRM REGISTRATION NUMBER: TX F-82



PROPOSED COASTAL BEND HEADER PIPELINE
WHARTON COUNTY, TEXAS

NO.	REVISION	DATE	CHECKED	DATE	APPROVED	DATE	WEI PROJ. NO.	DRAWING NUMBER	REV. NO.	
A	ISSUED FOR FERC		JMW		RSC		52715	14CQ-650-P-113-E5	A	
	SCALE	DRAWN	DATE	CHECKED	DATE	APPROVED	DATE	WEI PROJ. NO.	DRAWING NUMBER	REV. NO.
	1"=2000'	CB	5/16/15	RSC	5/18/15			52715	14CQ-650-P-113-E5	A

Sheet 6 of 30

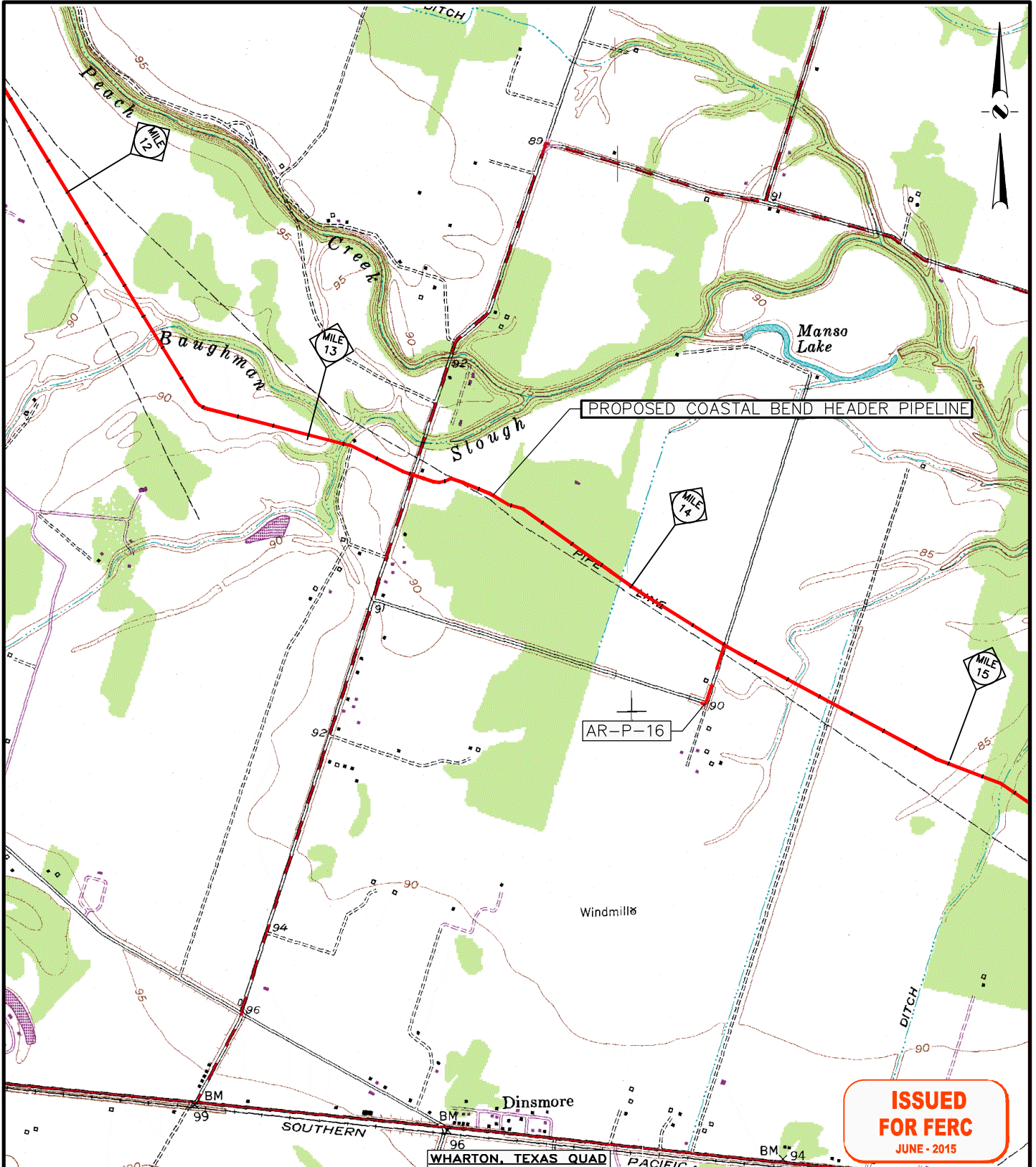

ISSUED FOR FERC
JUNE - 2015

LEGEND

- Proposed Pipeline
- - - Access Road
- Mile Post
- Facility



WILLBROS ENGINEERS (U.S.) LLC
FIRM REGISTRATION NUMBER: TX F-82



**PROPOSED COASTAL BEND HEADER PIPELINE
WHARTON COUNTY, TEXAS**

NO.	REVISION	DATE	CHECKED	DATE	APPROVED	DATE
A	ISSUED FOR FERC		JMW		RSC	
SCALE	DRAWN	DATE	CHECKED	DATE	APPROVED	DATE
1"=2000'	CB	5/16/15	RSC	5/18/15		

WEI PROJ. NO.	DRAWING NUMBER	REV. NO.
52715	14CQ-650-P-113-E6	A

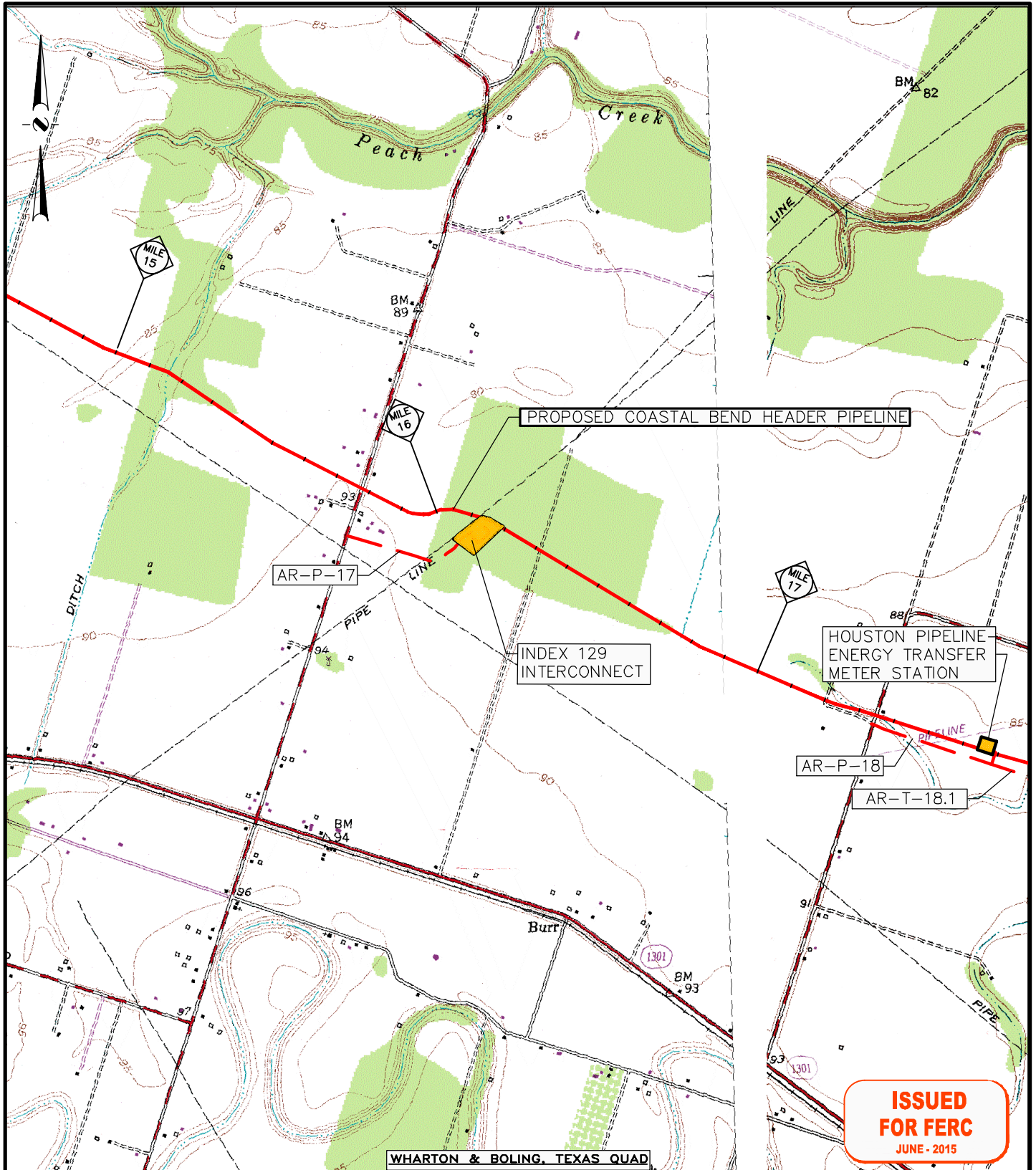

ISSUED FOR FERC
JUNE - 2015

WHARTON & BOLING, TEXAS QUAD

LEGEND

- Proposed Pipeline
- - - Access Road
- Mile Post
- Facility



WILLBROS ENGINEERS (U.S.) LLC
FIRM REGISTRATION NUMBER: TX F-82



**PROPOSED COASTAL BEND HEADER PIPELINE
WHARTON COUNTY, TEXAS**

NO.	REVISION	DRAWN	DATE	APPR.	DATE	
A	ISSUED FOR FERC	JMW		RSC		
SCALE	DRAWN	DATE	CHECKED	DATE	APPROVED	DATE
1"=2000'	CB	5/16/15	RSC	5/18/15		

WEI PROJ. NO.	DRAWING NUMBER	REV NO.
52715	14CQ-650-P-113-E7	A

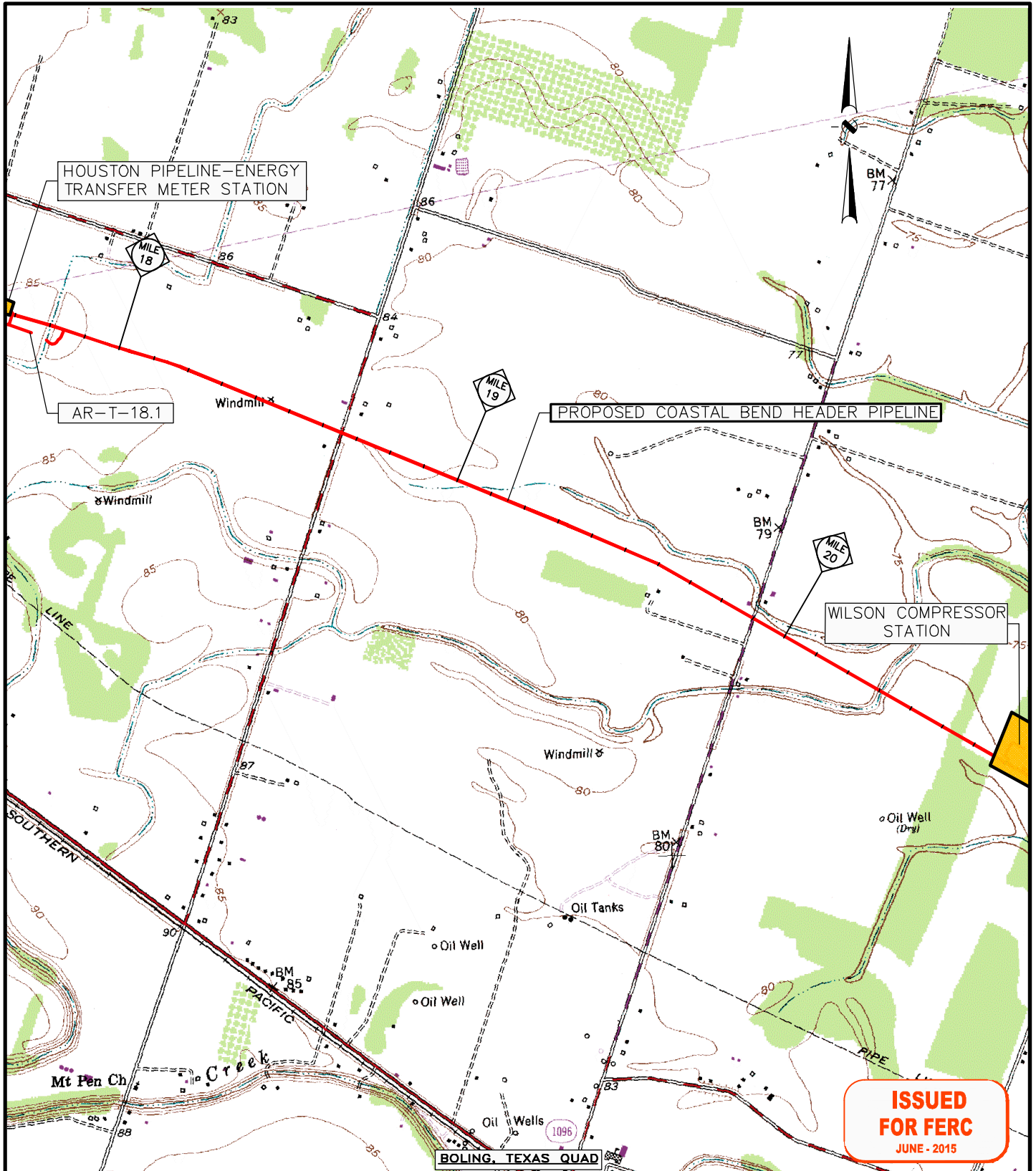

ISSUED FOR FERC
JUNE - 2015

LEGEND

- Proposed Pipeline
- - - Access Road
- Mile Post
- Facility



WILLBROS ENGINEERS (U.S.) LLC
FIRM REGISTRATION NUMBER: TX F-82



**PROPOSED
COASTAL BEND HEADER PIPELINE
WHARTON COUNTY, TEXAS**

NO.	REVISION	DRAWN	DATE	APPR.	DATE	
A	ISSUED FOR FERC	JMW		RSC		
SCALE	DRAWN	DATE	CHECKED	DATE	APPROVED	DATE
1"=2000'	CB	5/16/15	RSC	5/18/15		

WEI PROJ. NO.	DRAWING NUMBER	REV NO.
52715	14CQ-650-P-113-E8	A

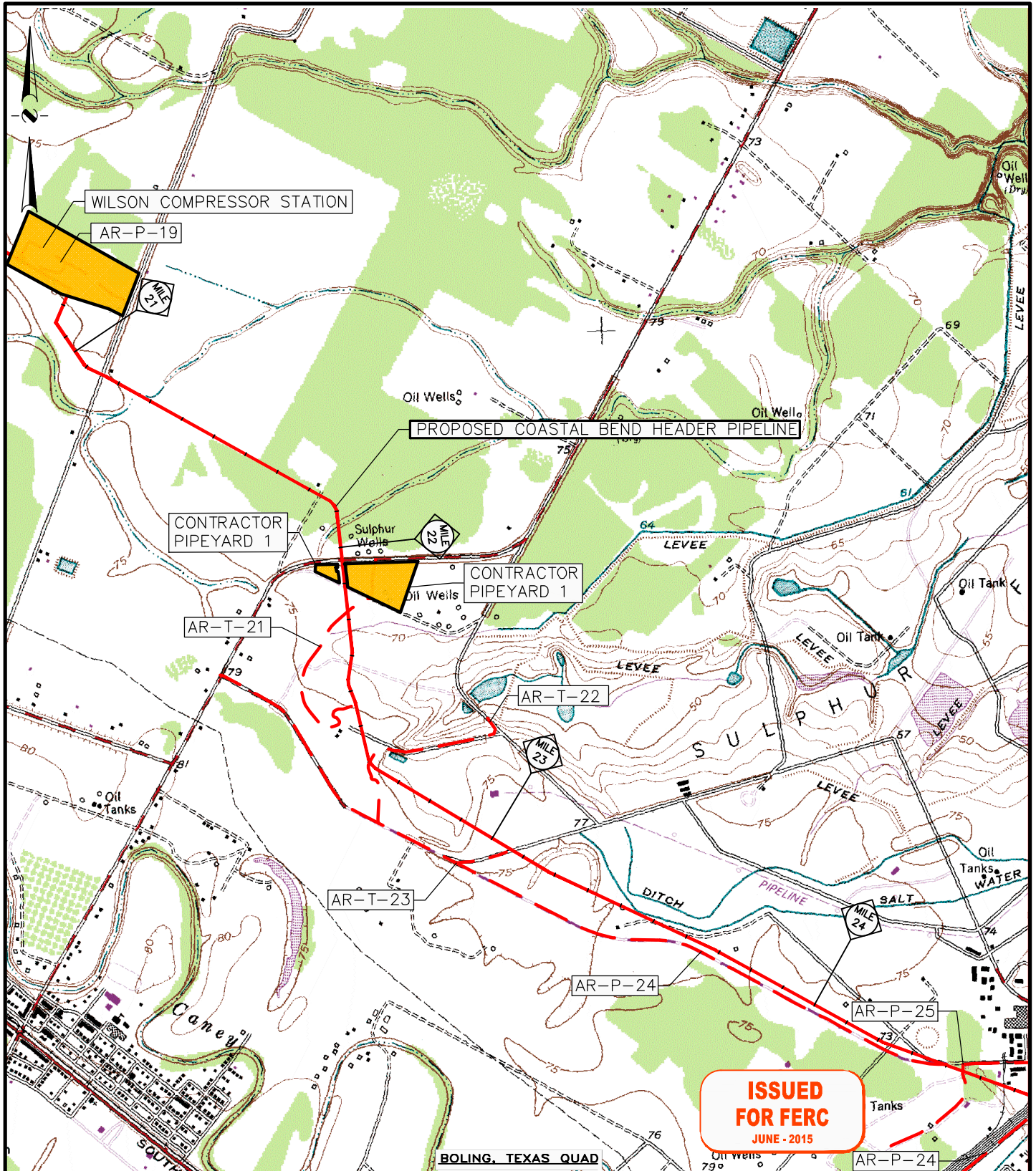

ISSUED FOR FERC
JUNE - 2015

LEGEND

- Proposed Pipeline
- - - Access Road
- Mile Post
- Facility



WILLBROS ENGINEERS (U.S.) LLC
FIRM REGISTRATION NUMBER: TX F-82



**PROPOSED COASTAL BEND HEADER PIPELINE
WHARTON COUNTY, TEXAS**

A		ISSUED FOR FERC		JMW	RSC				
NO.	REVISION			DRAWN	DATE	APPR.	DATE		
SCALE	DRAWN	DATE	CHECKED	DATE	APPROVED	DATE	WEI PROJ. NO.	DRAWING NUMBER	REV. NO.
1"=2000'	CB	5/16/15	RSC	5/18/15			52715	14CQ-650-P-113-E9	A

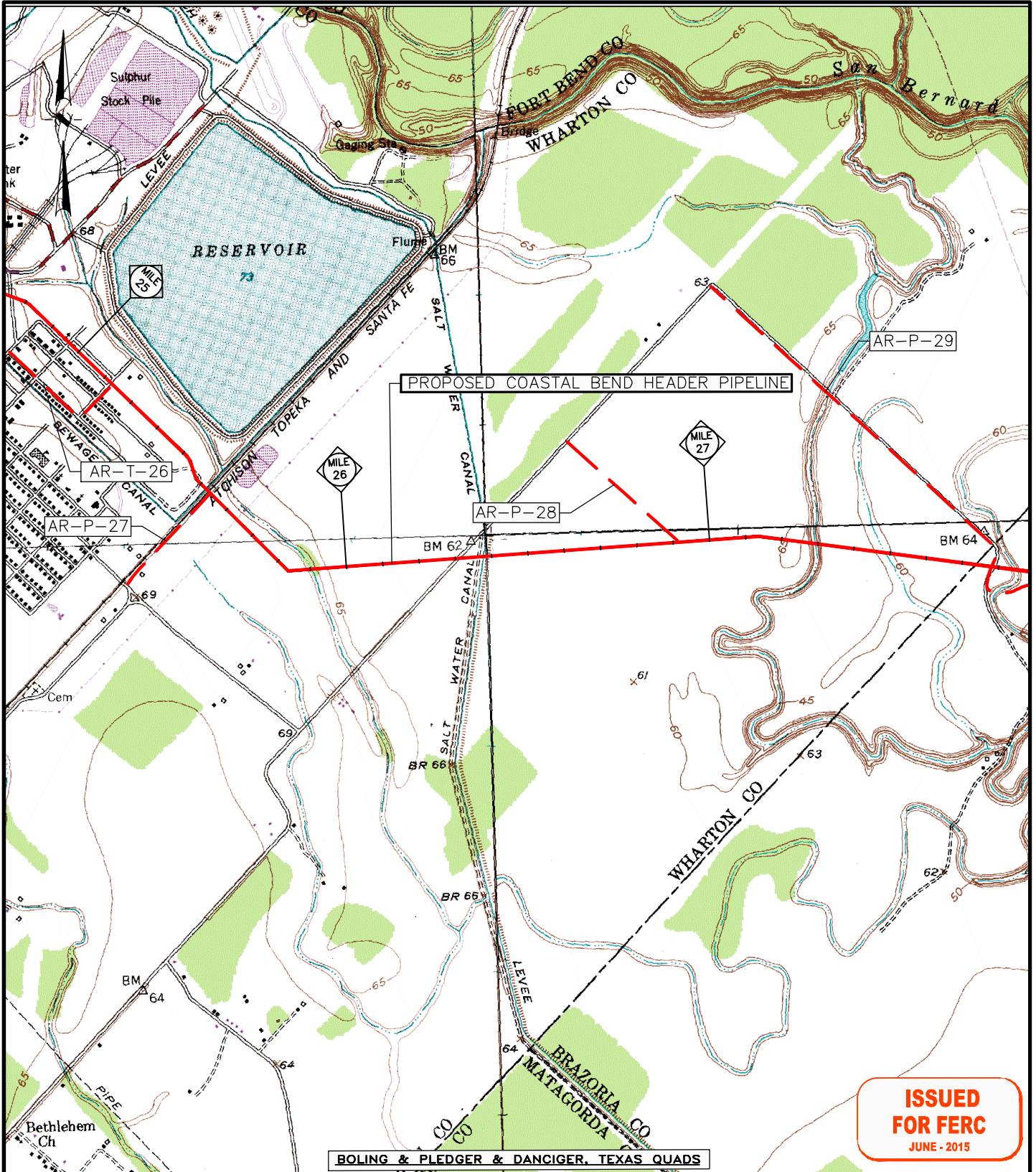

ISSUED FOR FERC
JUNE - 2015

LEGEND	
	Proposed Pipeline
	Access Road
	Mile Post
	Facility

WILBROS ENGINEERS (U.S.) LLC
FIRM REGISTRATION NUMBER: TX F-82



PROPOSED COASTAL BEND HEADER PIPELINE
WHARTON & BRAZORIA COUNTIES, TEXAS

NO.	REVISION	DRAWN	DATE	APPR.	DATE																				
A	ISSUED FOR FERC	JMW		RSC																					
<table border="1" style="width: 100%; border-collapse: collapse;"> <thead> <tr> <th>SCALE</th> <th>DRAWN</th> <th>DATE</th> <th>CHECKED</th> <th>DATE</th> <th>APPROVED</th> <th>DATE</th> <th>WEI PROJ. NO.</th> <th>DRAWING NUMBER</th> <th>REV NO.</th> </tr> </thead> <tbody> <tr> <td>1"=2000'</td> <td>CB</td> <td>5/16/15</td> <td>RSC</td> <td>5/18/15</td> <td></td> <td></td> <td>52715</td> <td>14CQ-650-P-113-E10</td> <td>A</td> </tr> </tbody> </table>						SCALE	DRAWN	DATE	CHECKED	DATE	APPROVED	DATE	WEI PROJ. NO.	DRAWING NUMBER	REV NO.	1"=2000'	CB	5/16/15	RSC	5/18/15			52715	14CQ-650-P-113-E10	A
SCALE	DRAWN	DATE	CHECKED	DATE	APPROVED	DATE	WEI PROJ. NO.	DRAWING NUMBER	REV NO.																
1"=2000'	CB	5/16/15	RSC	5/18/15			52715	14CQ-650-P-113-E10	A																

Sheet 11 of 30

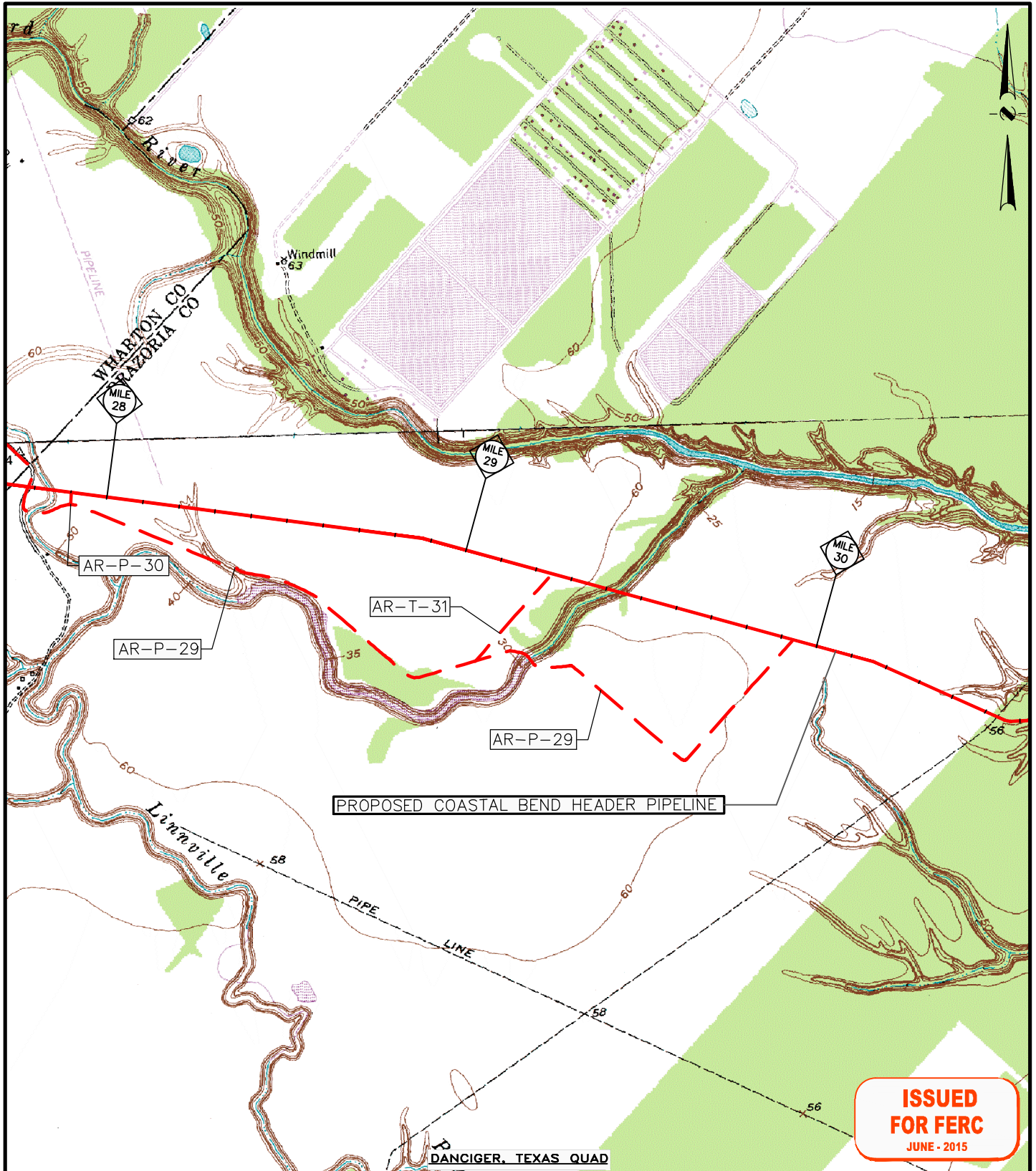

ISSUED FOR FERC
JUNE - 2015

LEGEND

- Proposed Pipeline
- - - Access Road
- Mile Post
- Facility



WILLBROS ENGINEERS (U.S.) LLC
FIRM REGISTRATION NUMBER: TX F-82



**PROPOSED COASTAL BEND HEADER PIPELINE
BRAZORIA COUNTIES, TEXAS**

NO.	REVISION	DRAWN	DATE	APPR.	DATE	
A	ISSUED FOR FERC	JMW		RSC		
SCALE	DRAWN	DATE	CHECKED	DATE	APPROVED	DATE
1"=2000'	CB	5/16/15	RSC	5/18/15		

WEI PROJ. NO.	DRAWING NUMBER	REV. NO.
52715	14CQ-650-P-113-E11	A

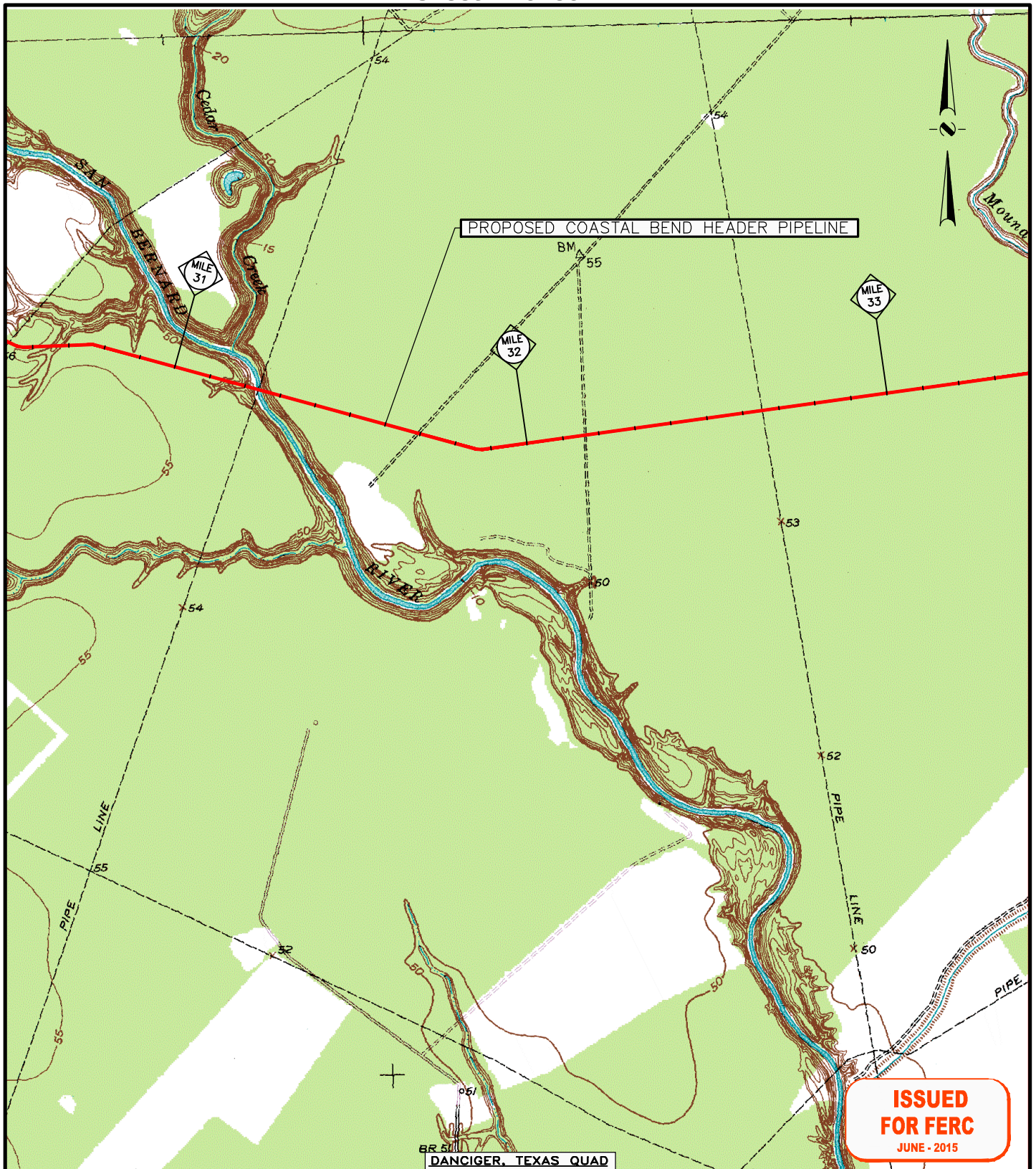

ISSUED FOR FERC
JUNE - 2015

DANCIGER, TEXAS QUAD

LEGEND

- Proposed Pipeline
- - - - - Access Road
- Mile Post
- Facility



WILLBROS ENGINEERS (U.S.) LLC
FIRM REGISTRATION NUMBER: TX F-82



PROPOSED COASTAL BEND HEADER PIPELINE
BRAZORIA COUNTY, TEXAS

NO.	REVISION	DRAWN	DATE	APPR.	DATE
A	ISSUED FOR FERC	JMW		RSC	

SCALE	DRAWN	DATE	CHECKED	DATE	APPROVED	DATE
1"=2000'	CB	5/16/15	RSC	5/18/15		

WEI PROJ. NO.	DRAWING NUMBER	REV NO.
52715	14CQ-650-P-113-E12	A

Sheet 13 of 30

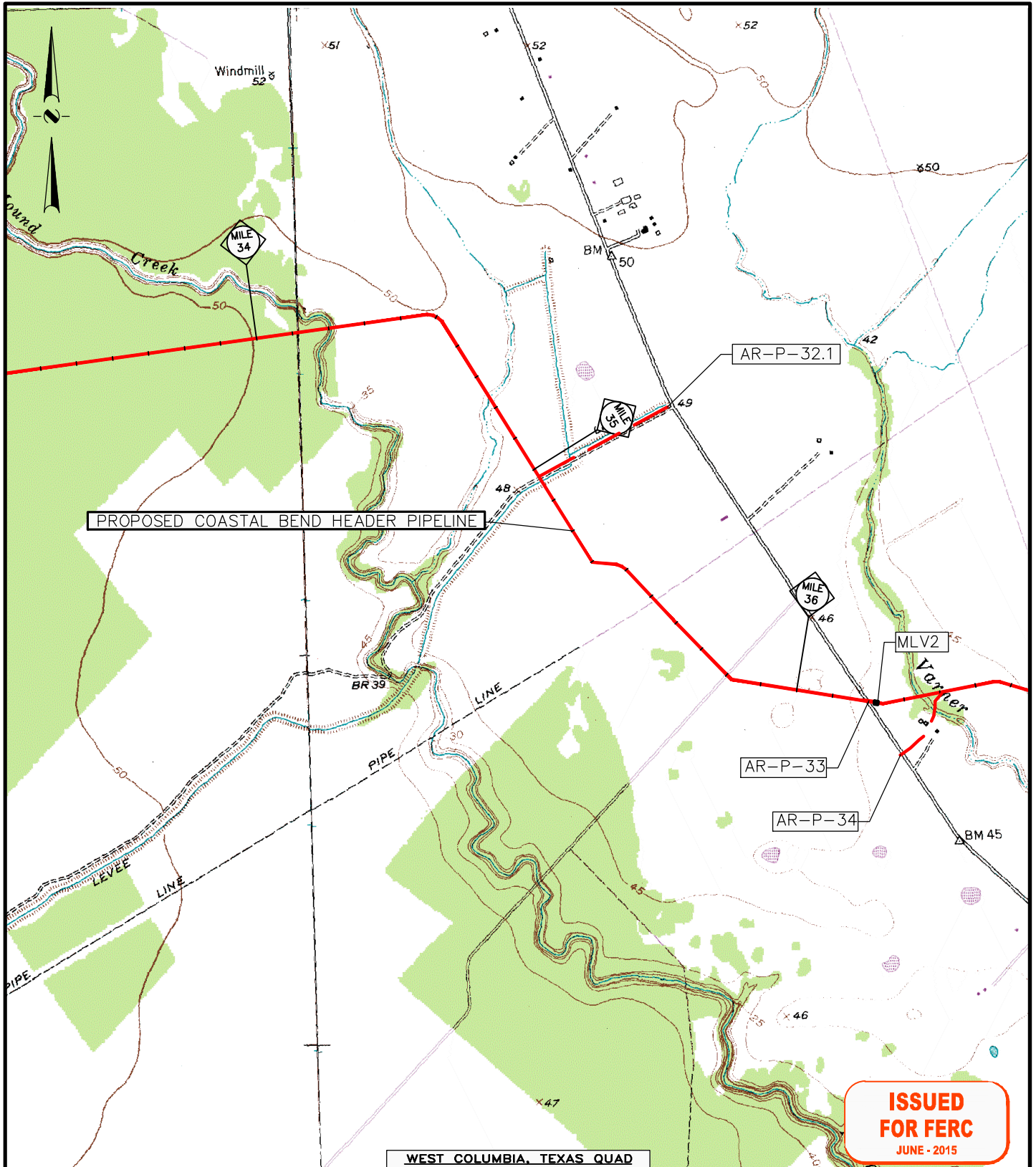

LEGEND

- Proposed Pipeline
- - - Access Road
- Mile Post
- Facility



WILBROS ENGINEERS (U.S.) LLC
FIRM REGISTRATION NUMBER: TX F-82



**PROPOSED
COASTAL BEND HEADER PIPELINE
BRAZORIA COUNTY, TEXAS**

NO.	REVISION	DRAWN	DATE	APPR.	DATE	
A	ISSUED FOR FERC	JMW		RSC		
SCALE	DRAWN	DATE	CHECKED	DATE	APPROVED	DATE
1"=2000'	CB	5/16/15	RSC	5/18/15		

WEI PROJ. NO.	DRAWING NUMBER	REV NO.
52715	14CQ-650-P-113-E13	A

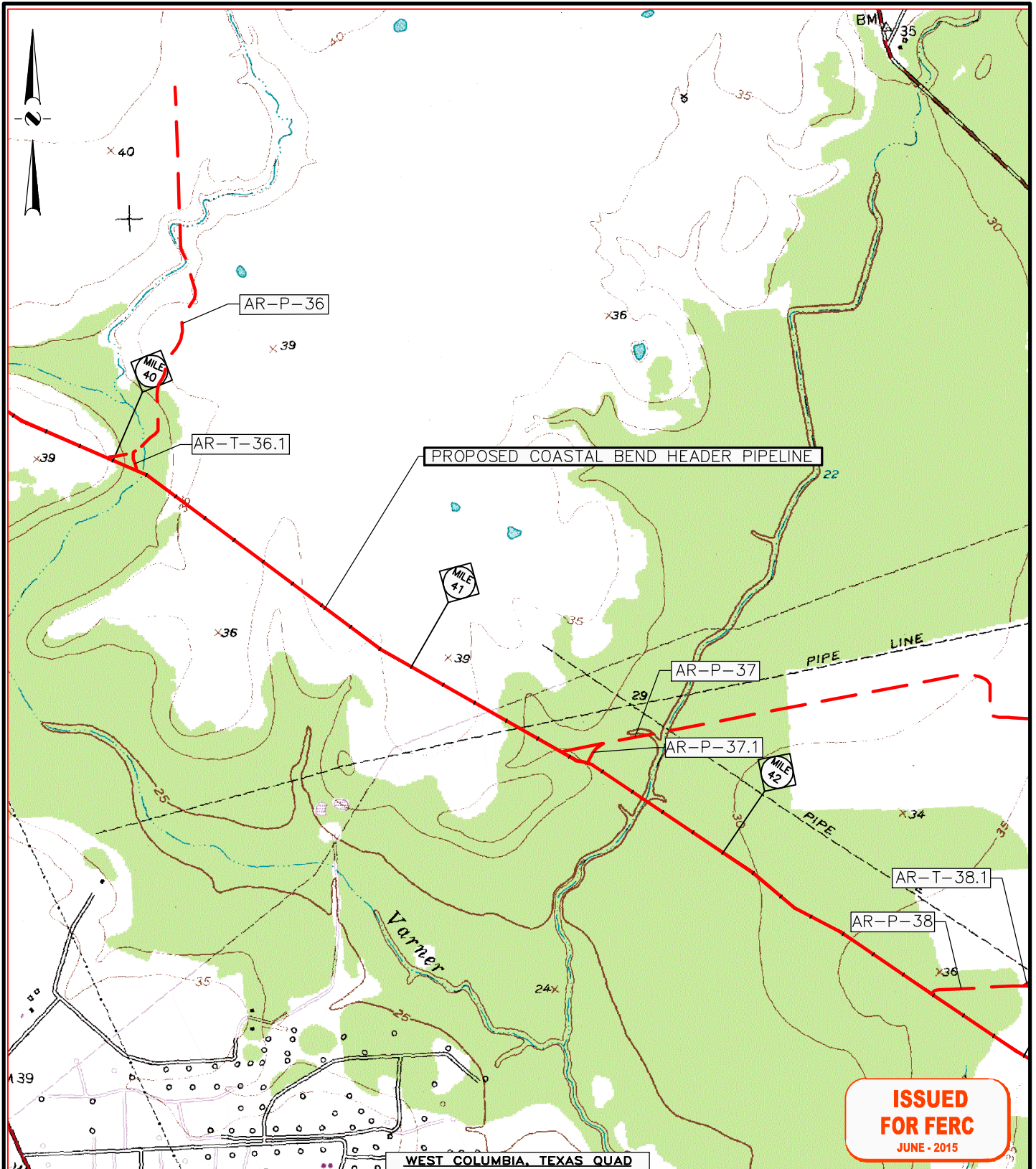

ISSUED FOR FERC
JUNE - 2015

WEST COLUMBIA, TEXAS QUAD

LEGEND

- Proposed Pipeline
- - - - - Access Road
- Mile Post
- Facility



WILBROS ENGINEERS (U.S.) LLC
FIRM REGISTRATION NUMBER: TX F-82



PROPOSED COASTAL BEND HEADER PIPELINE
BRAZORIA COUNTY, TEXAS

NO.	REVISION	DRAWN	DATE	APPR.	DATE				
A	ISSUED FOR FERC	JMW		RSC					
SCALE	DRAWN	DATE	CHECKED	DATE	APPROVED	DATE	WEI PROJ. NO.	DRAWING NUMBER	REV NO.
1"=2000'	CB	5/16/15	RSC	5/18/15			52715	14CQ-650-P-113-E15	A

Sheet 16 of 30

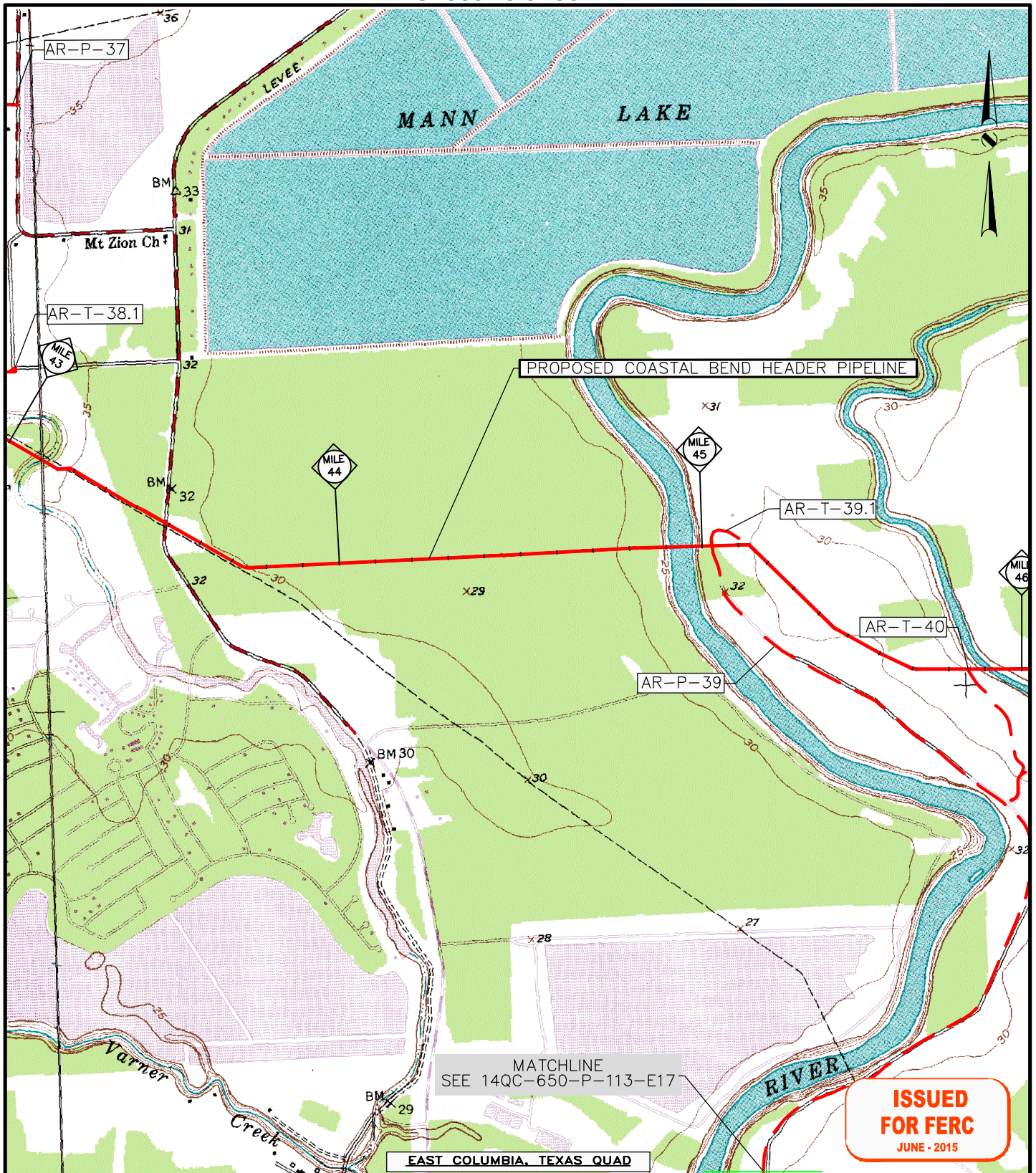

ISSUED FOR FERC
JUNE - 2015

LEGEND

- Proposed Pipeline
- - - - - Access Road
- Mile Post
- Facility



WILLBROS ENGINEERS (U.S.) LLC
FIRM REGISTRATION NUMBER: TX F-82



**PROPOSED COASTAL BEND HEADER PIPELINE
BRAZORIA COUNTY, TEXAS**

A	ISSUED FOR FERC	JMW	RSC			
NO.	REVISION	DRAWN	DATE	APPR.	DATE	
SCALE	DRAWN	DATE	CHECKED	DATE	APPROVED	DATE
1"=2000'	CB	5/16/15	RSC	5/18/15		

WEI PROJ. NO.	DRAWING NUMBER	REV NO.
52715	14QC-650-P-113-E16	A

Sheet 17 of 30

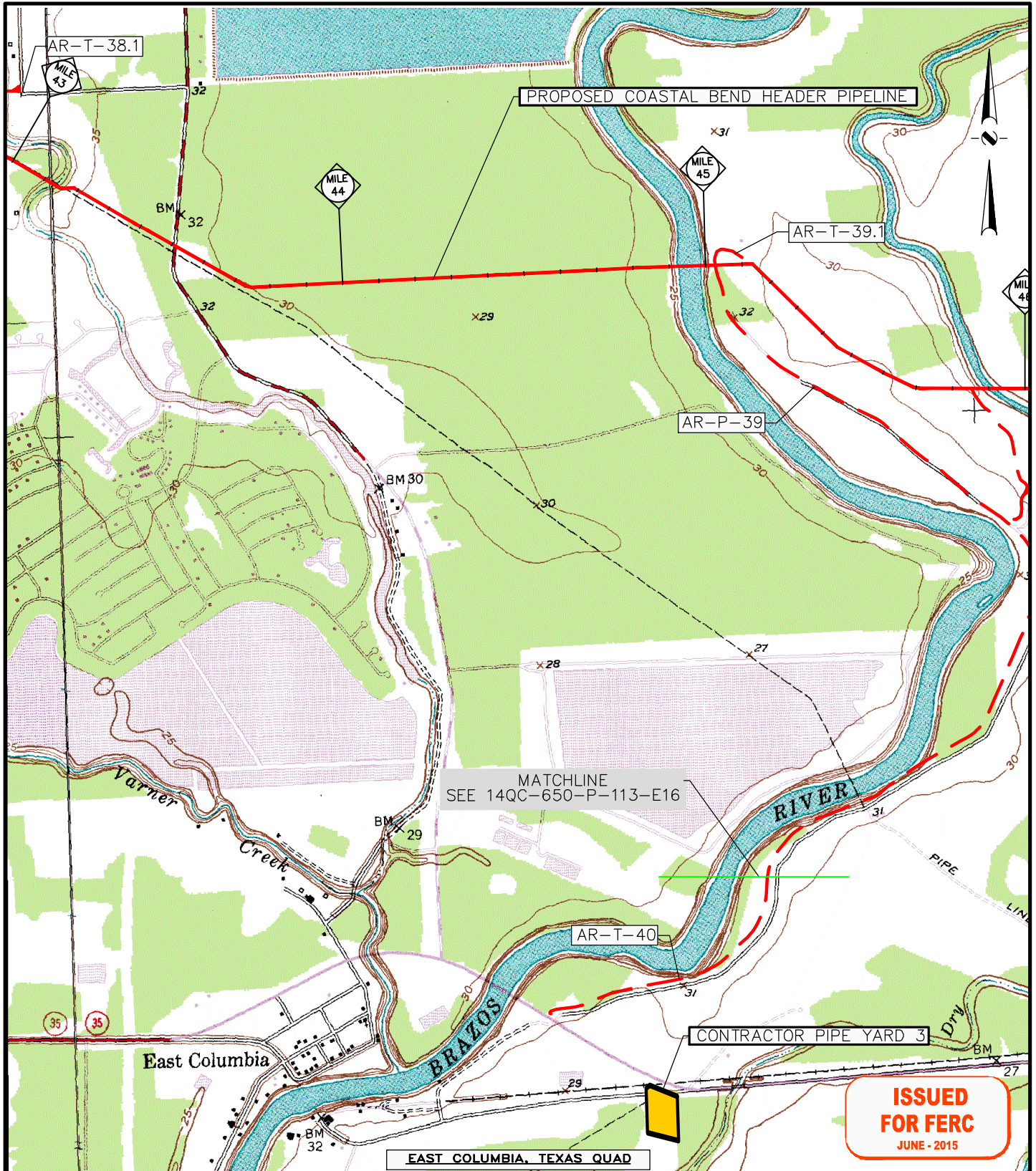

ISSUED FOR FERC
JUNE - 2015

LEGEND

- Proposed Pipeline
- - - Access Road
- Mile Post
- Facility



WILLBROS ENGINEERS (U.S.) LLC
FIRM REGISTRATION NUMBER: TX F-82



PROPOSED COASTAL BEND HEADER PIPELINE
BRAZORIA COUNTY, TEXAS

A		ISSUED FOR FERC		JMW	RSC						
NO.	REVISION			DRAWN	DATE	APPR.	DATE				
SCALE	DRAWN	DATE	CHECKED	DATE	APPROVED	DATE	WEI PROJ. NO.	DRAWING NUMBER	REV NO.		
1"=2000'	CB	5/16/15	RSC	5/18/15			52715	14CQ-650-P-113-E17	A		

Sheet 18 of 30

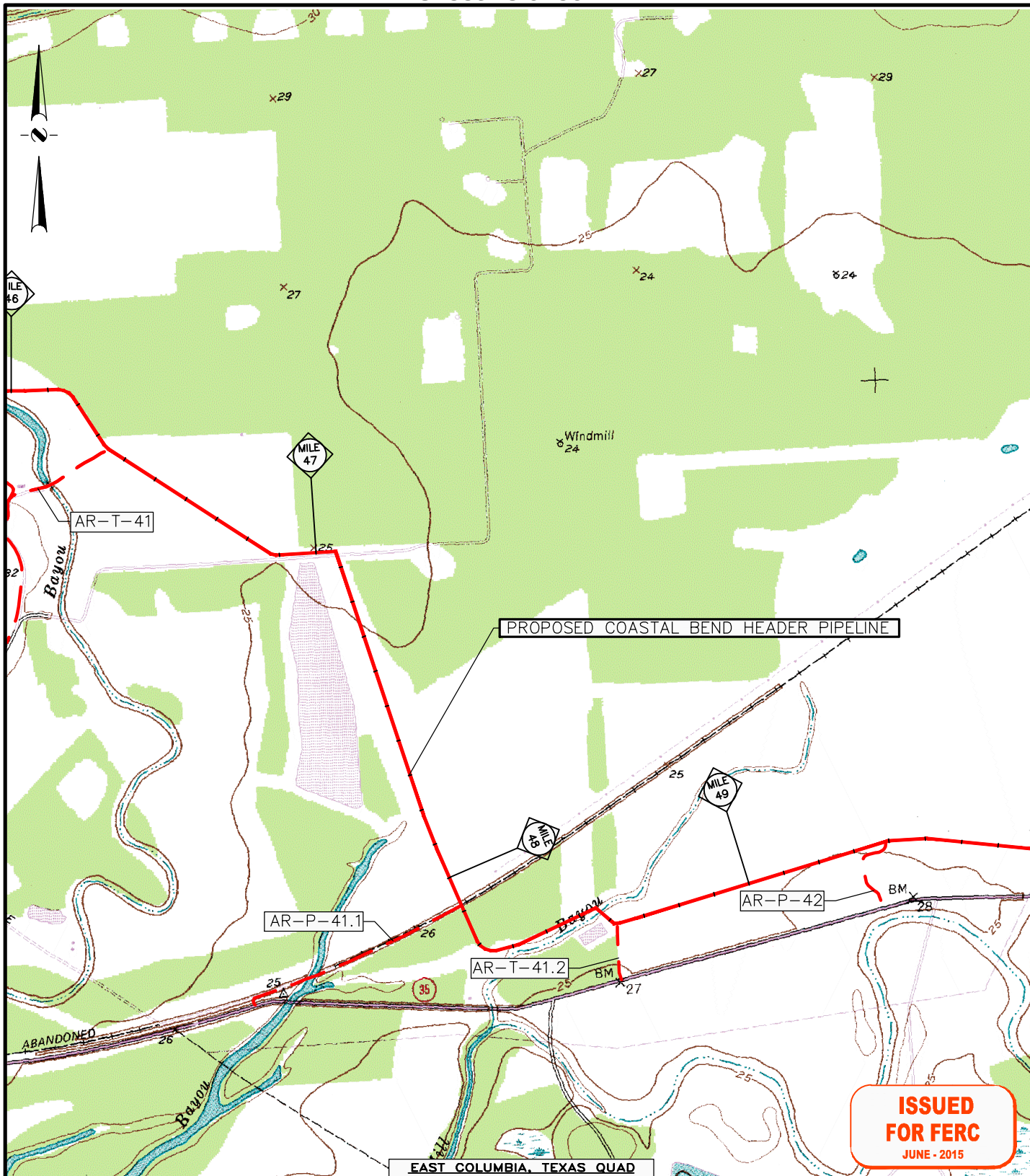

ISSUED FOR FERC
JUNE - 2015

LEGEND

- Proposed Pipeline
- - - Access Road
- Mile Post
- Facility



WILBROS ENGINEERS (U.S.) LLC
FIRM REGISTRATION NUMBER: TX F-82



**PROPOSED COASTAL BEND HEADER PIPELINE
BRAZORIA COUNTY, TEXAS**

NO.	REVISION	DATE	CHECKED	DATE	APPROVED	DATE
A	ISSUED FOR FERC		JMW		RSC	
SCALE	DRAWN	DATE	CHECKED	DATE	APPROVED	DATE
1"=2000'	CB	5/16/15	RSC	5/18/15		

WEI PROJ. NO.	DRAWING NUMBER	REV. NO.
52715	14CQ-650-P-113-E18	A

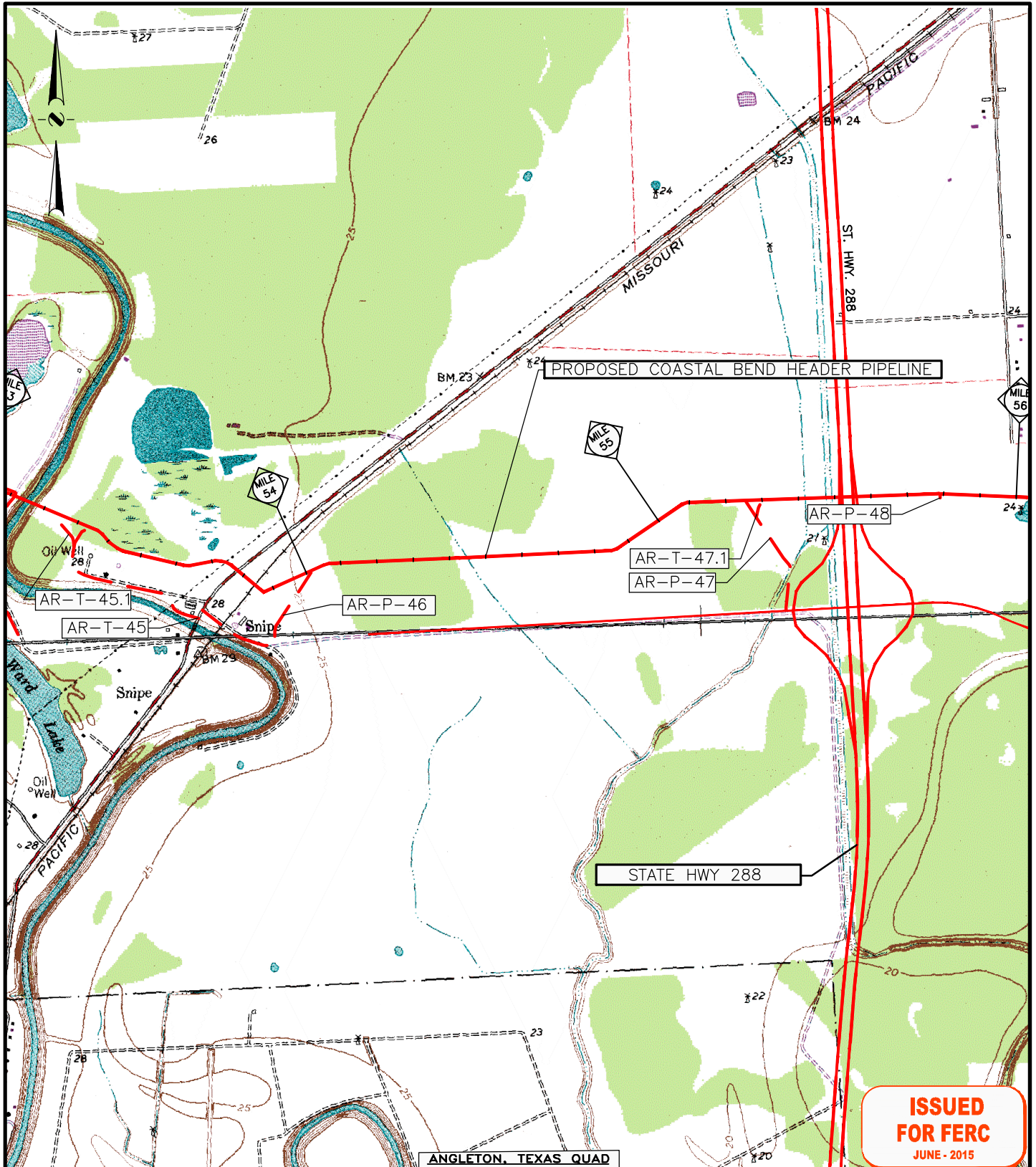

ISSUED FOR FERC
JUNE - 2015

LEGEND

- Proposed Pipeline
- ⊕ Access Road
- Mile Post
- Facility



WILLBROS ENGINEERS (U.S.) LLC
FIRM REGISTRATION NUMBER: TX F-82



**PROPOSED COASTAL BEND HEADER PIPELINE
BRAZORIA COUNTY, TEXAS**

NO.	REVISION	DRAWN	DATE	APPR.	DATE	
A	ISSUED FOR FERC	JMW		RSC		
SCALE	DRAWN	DATE	CHECKED	DATE	APPROVED	DATE
1"=2000'	CB	5/16/15	RSC	5/18/15		

WEI PROJ. NO.	DRAWING NUMBER	REV NO.
52715	14CQ-650-P-113-E20	A

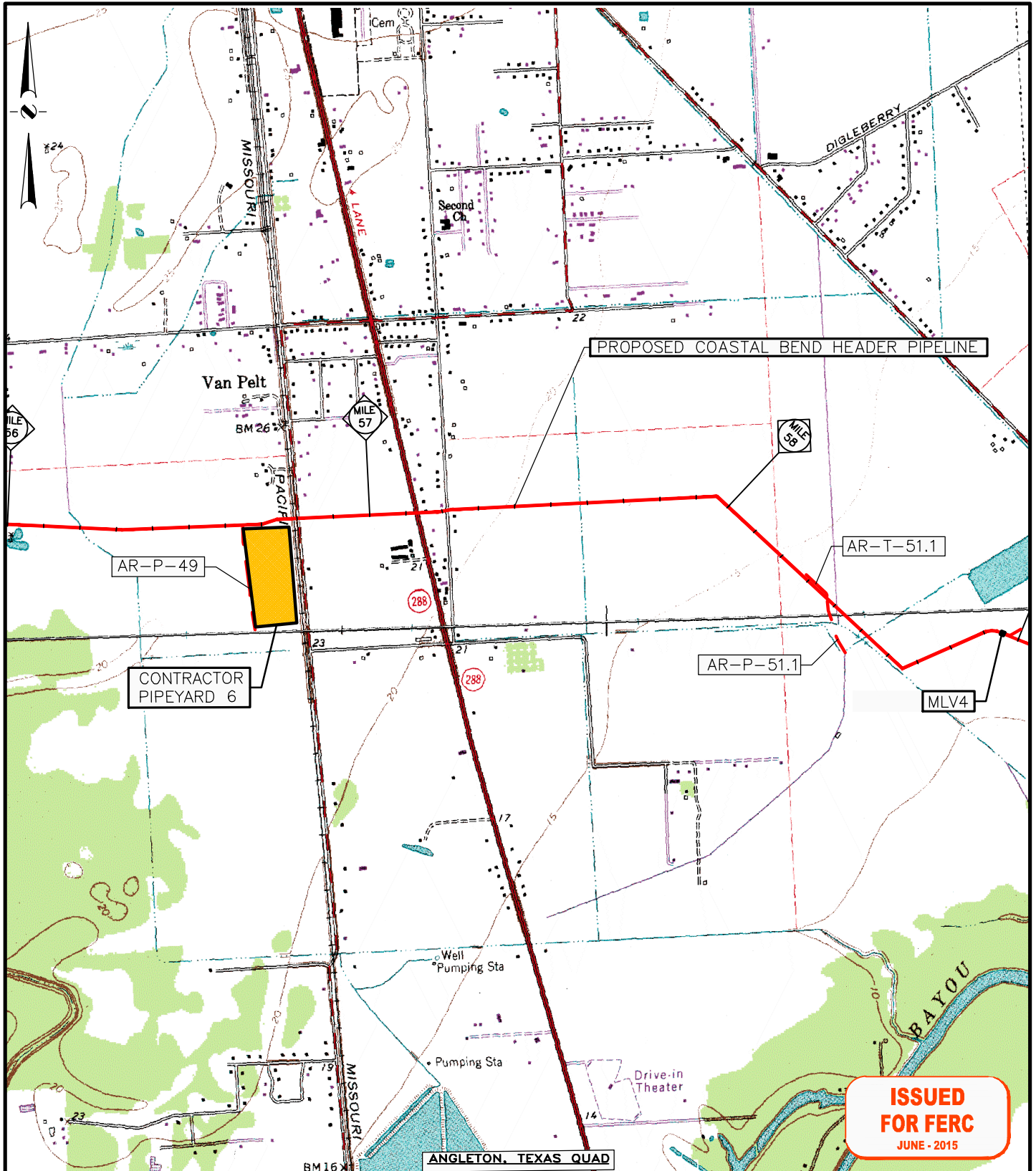

ISSUED FOR FERC
JUNE - 2015

LEGEND

- Proposed Pipeline
- - - Access Road
- Mile Post
- Facility



WILBROS ENGINEERS (U.S.) LLC
FIRM REGISTRATION NUMBER: TX F-82



PROPOSED COASTAL BEND HEADER PIPELINE
BRAZORIA COUNTY, TEXAS

NO.	REVISION	DRAWN	DATE	APPR.	DATE				
A	ISSUED FOR FERC	JMW	5/16/15	RSC	5/18/15				
SCALE	DRAWN	DATE	CHECKED	DATE	APPROVED	DATE	WEI PROJ. NO.	DRAWING NUMBER	REV NO.
1"=2000'	CB	5/16/15	RSC	5/18/15			52715	14CQ-650-P-113-E21	A

Sheet 22 of 30

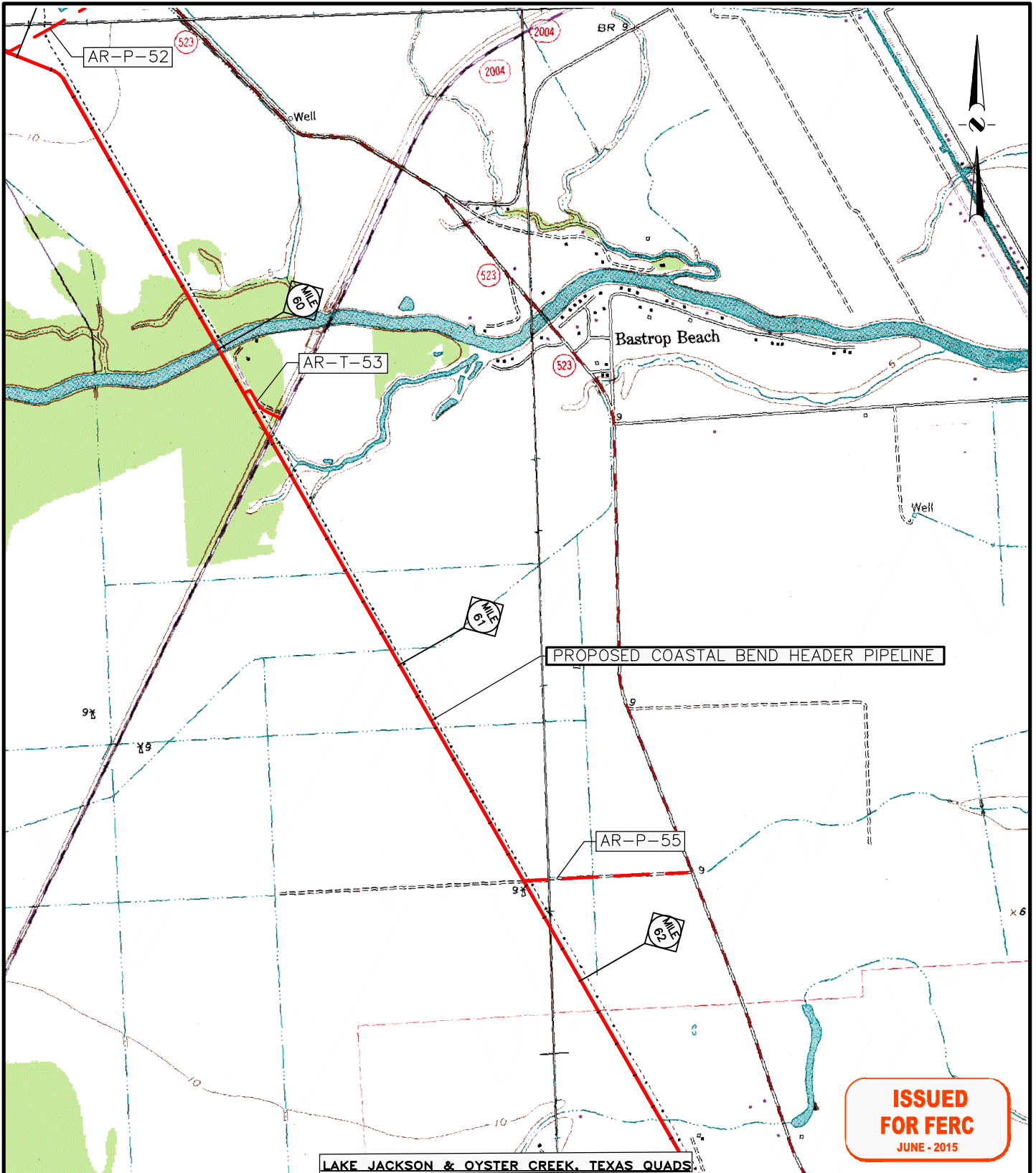

ISSUED FOR FERC
JUNE - 2015

LAKE JACKSON & OYSTER CREEK, TEXAS QUADS

LEGEND

- Proposed Pipeline
- - - - - Access Road
- Mile Post
- Facility



WILLBROS ENGINEERS (U.S.) LLC
FIRM REGISTRATION NUMBER: TX F-82



NO.	REVISION	DATE	CHECKED	DATE	APPROVED	DATE
A	ISSUED FOR FERC		JMW		RSC	

PROPOSED COASTAL BEND HEADER PIPELINE
BRAZORIA COUNTY, TEXAS

SCALE	DRAWN	DATE	CHECKED	DATE	APPROVED	DATE	WEI PROJ. NO.	DRAWING NUMBER	REV NO.
1"=2000'	CB	5/16/15	RSC	5/18/15			52715	14CQ-650-P-113-E22	A

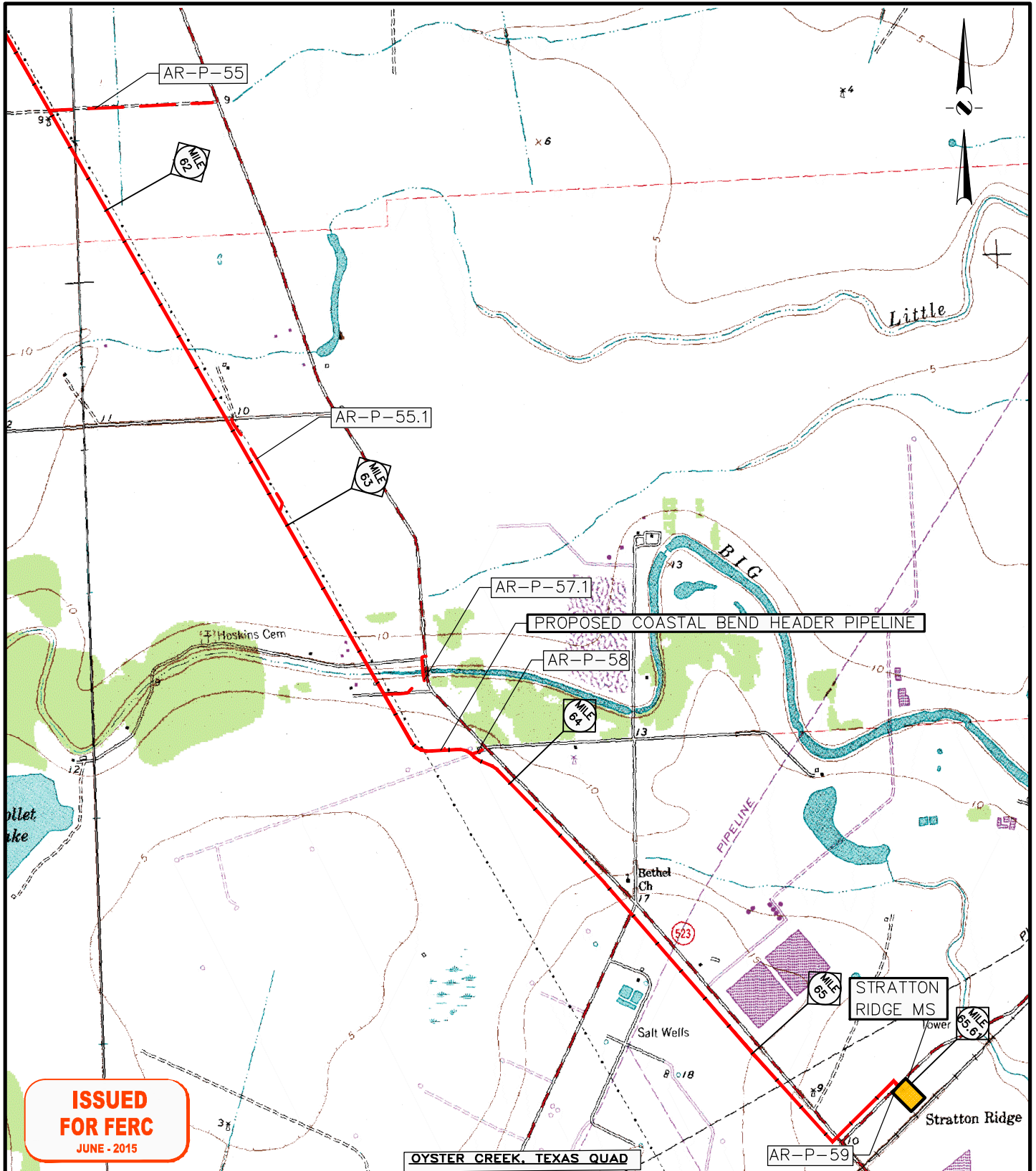

ISSUED FOR FERC
JUNE - 2015

LEGEND

- Proposed Pipeline
- Access Road
- Mile Post
- Facility

WILLBROS ENGINEERS (U.S.) LLC
FIRM REGISTRATION NUMBER: TX F-82



NO.	REVISION	DRAWN	DATE	CHECKED	DATE	APPROVED	DATE
A	ISSUED FOR FERC	JMW		RSC			
SCALE	DRAWN	DATE	CHECKED	DATE	APPROVED	DATE	
1"=2000'	CB	5/16/15	RSC	5/18/15			

PROPOSED COASTAL BEND HEADER PIPELINE
BRAZORIA COUNTY, TEXAS

WEI PROJ. NO.	DRAWING NUMBER	REV NO.
52715	14CQ-650-P-113-E23	A

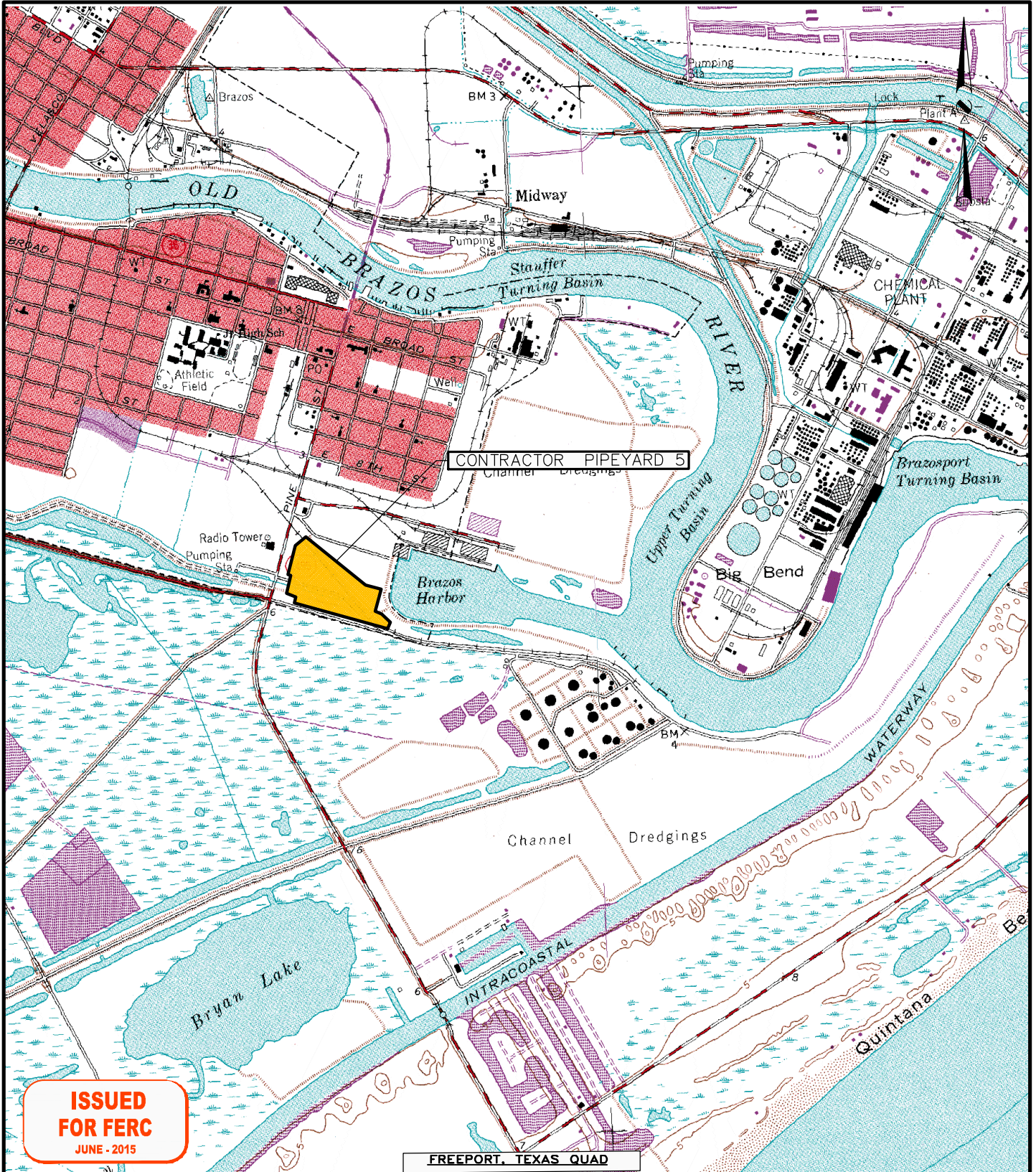

ISSUED FOR FERC
JUNE - 2015

FREEPORT, TEXAS QUAD

LEGEND

- Proposed Pipeline
- Access Road
- Mile Post
- Facility



WILLBROS ENGINEERS (U.S.) LLC
FIRM REGISTRATION NUMBER: TX F-82



A	ISSUED FOR FERC		JMW		RSC		
NO.	REVISION		DRAWN	DATE	APPR.	DATE	
SCALE	DRAWN	DATE	CHECKED	DATE	APPROVED	DATE	
1"=2000'	CB	5/16/15	RSC	5/18/15			

PROPOSED CONTRACTOR PIPEYARD 5
BRAZORIA COUNTY, TEXAS

WEI PROJ. NO.	DRAWING NUMBER	REV NO.
52715	14CQ-650-P-113-E24	A

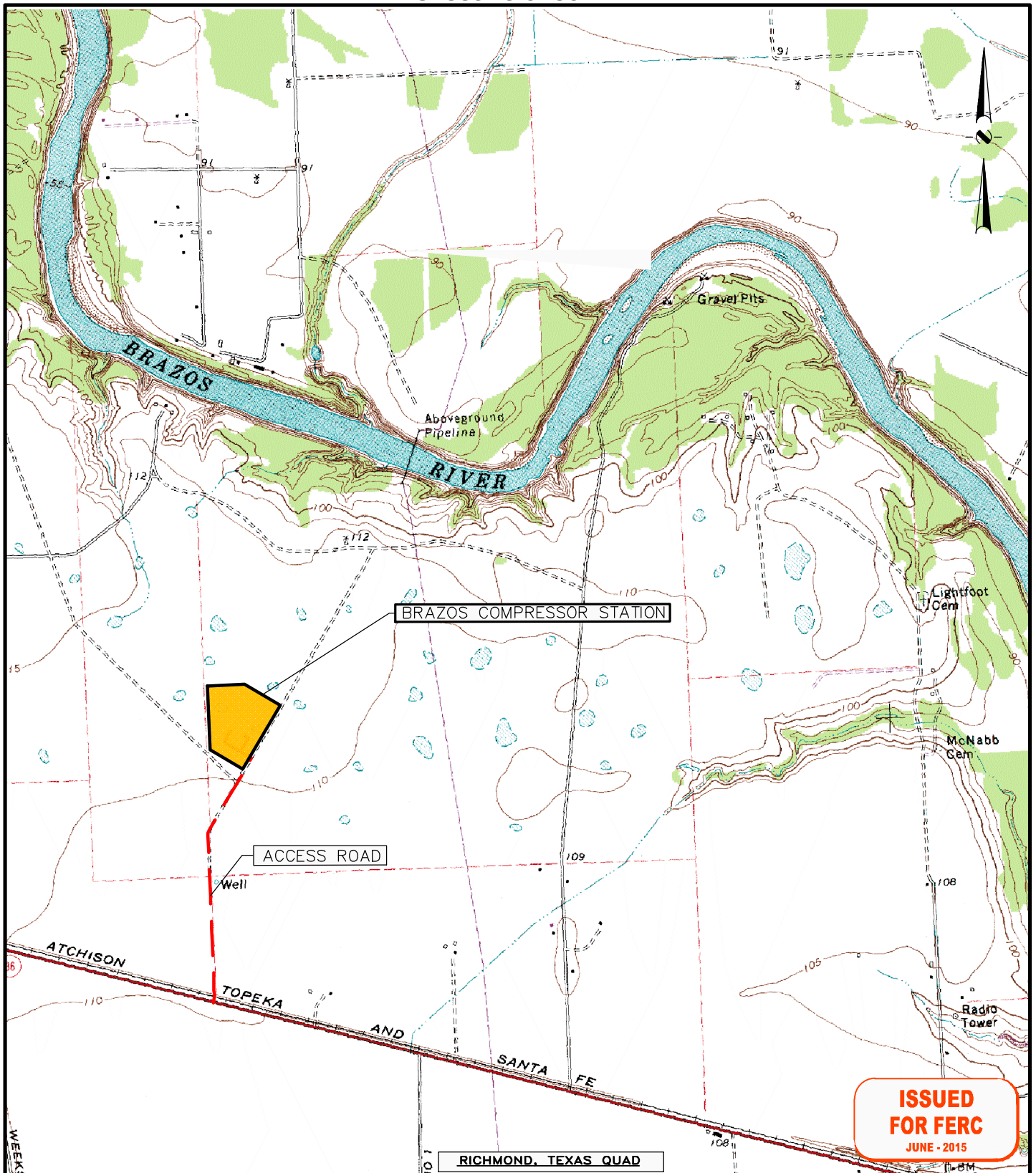

ISSUED FOR FERC
JUNE - 2015

RICHMOND, TEXAS QUAD

LEGEND	
	Proposed Pipeline
	Access Road
	Mile Post
	Facility

WILBROS ENGINEERS (U.S.) LLC
FIRM REGISTRATION NUMBER: TX F-82



PROPOSED BRAZOS COMPRESSOR STATION
WHARTON COUNTY, TEXAS

NO.	REVISION	DATE	CHECKED	DATE	APPROVED	DATE	WEI PROJ. NO.	DRAWING NUMBER	REV. NO.	
A	ISSUED FOR FERC		JMW		RSC		52715	14CQ-650-P-113-E25	A	
	SCALE	DRAWN	DATE	CHECKED	DATE	APPROVED	DATE	WEI PROJ. NO.	DRAWING NUMBER	REV. NO.
	1"=2000'	CB	5/16/15	RSC	5/18/15			52715	14CQ-650-P-113-E25	A

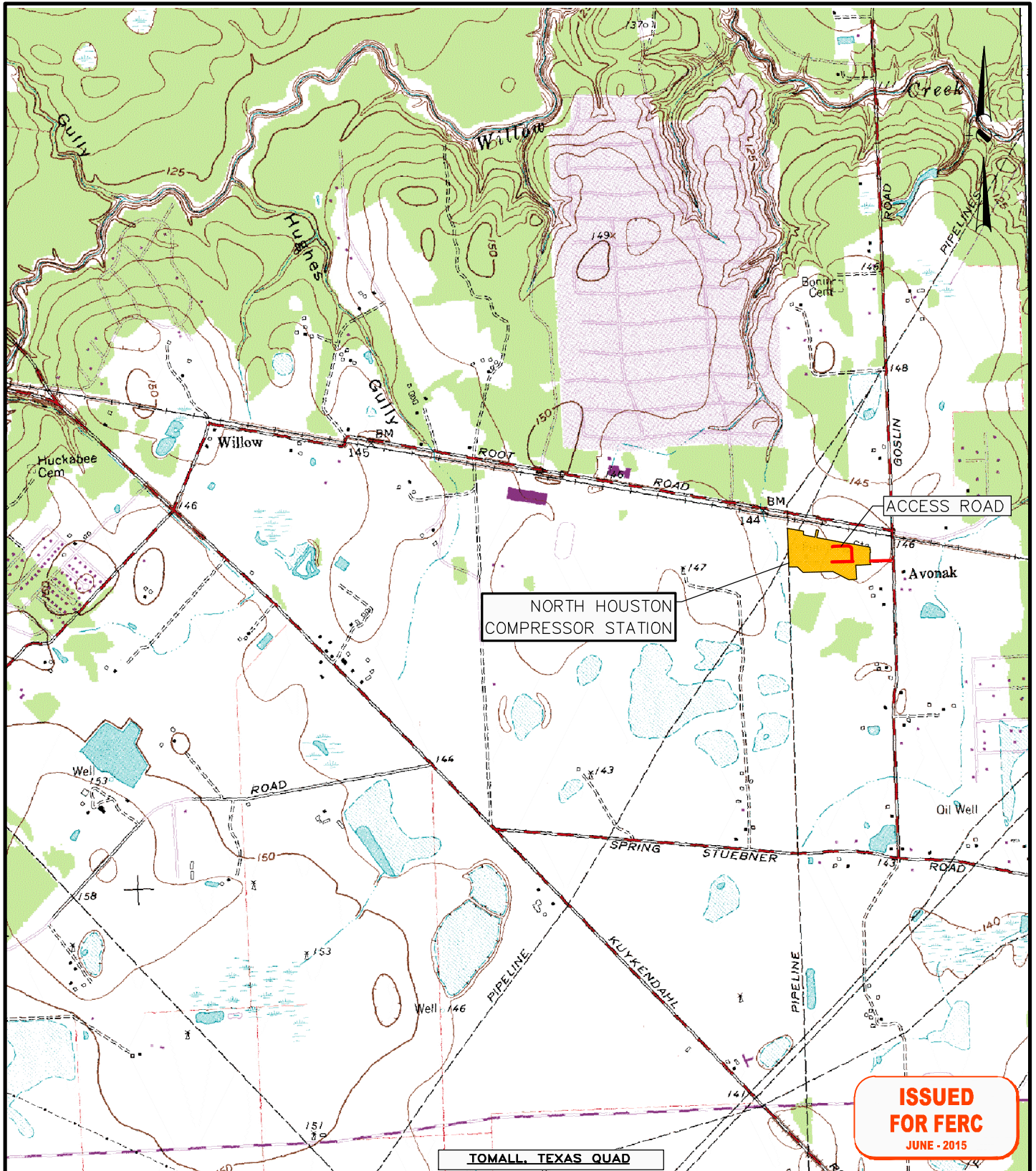

LEGEND

- — — Proposed Pipeline
- — — Access Road
- Mile Post
- Facility



WILBROS ENGINEERS (U.S.) LLC
 FIRM REGISTRATION NUMBER: TX F-82



**PROPOSED NORTH HOUSTON
 COMPRESSOR STATION
 WHARTON COUNTY, TEXAS**

A							ISSUED FOR FERC			JMW		RSC							
NO.							REVISION		DRAWN		DATE		APPR.		DATE				
SCALE		DRAWN		DATE		CHECKED		DATE		APPROVED		DATE		WEI PROJ. NO.		DRAWING NUMBER		REV. NO.	
1"=2000'		CB		5/16/15		RSC		5/18/15						52715		14CQ-650-P-113-E26		A	

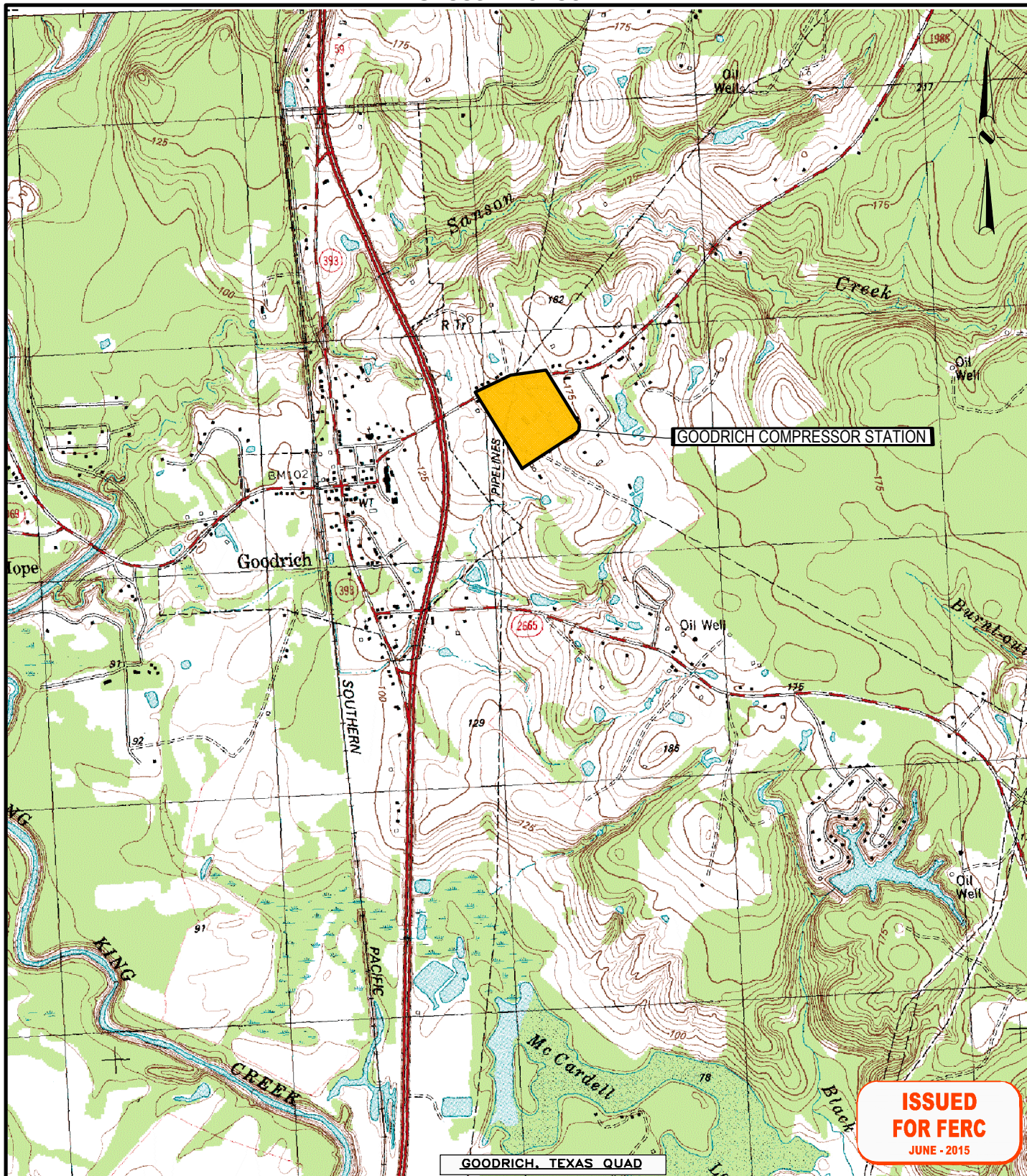

ISSUED FOR FERC
JUNE - 2015

GOODRICH, TEXAS QUAD

LEGEND

- Proposed Pipeline
- - - - - Access Road
- Mile Post
- Facility



WILLBROS ENGINEERS (U.S.) LLC
FIRM REGISTRATION NUMBER: TX F-82



A	ISSUED FOR FERC	JMW	RSC		
NO.	REVISION	DRAWN	DATE	APPR.	DATE

PROPOSED GOODRICH SITE
WHARTON COUNTY, TEXAS

SCALE	DRAWN	DATE	CHECKED	DATE	APPROVED	DATE	WEI PROJ. NO.	DRAWING NUMBER	REV NO.
1"=2000'	CB	5/16/15	RSC	5/18/15			52715	14CQ-650-P-113-E27	A

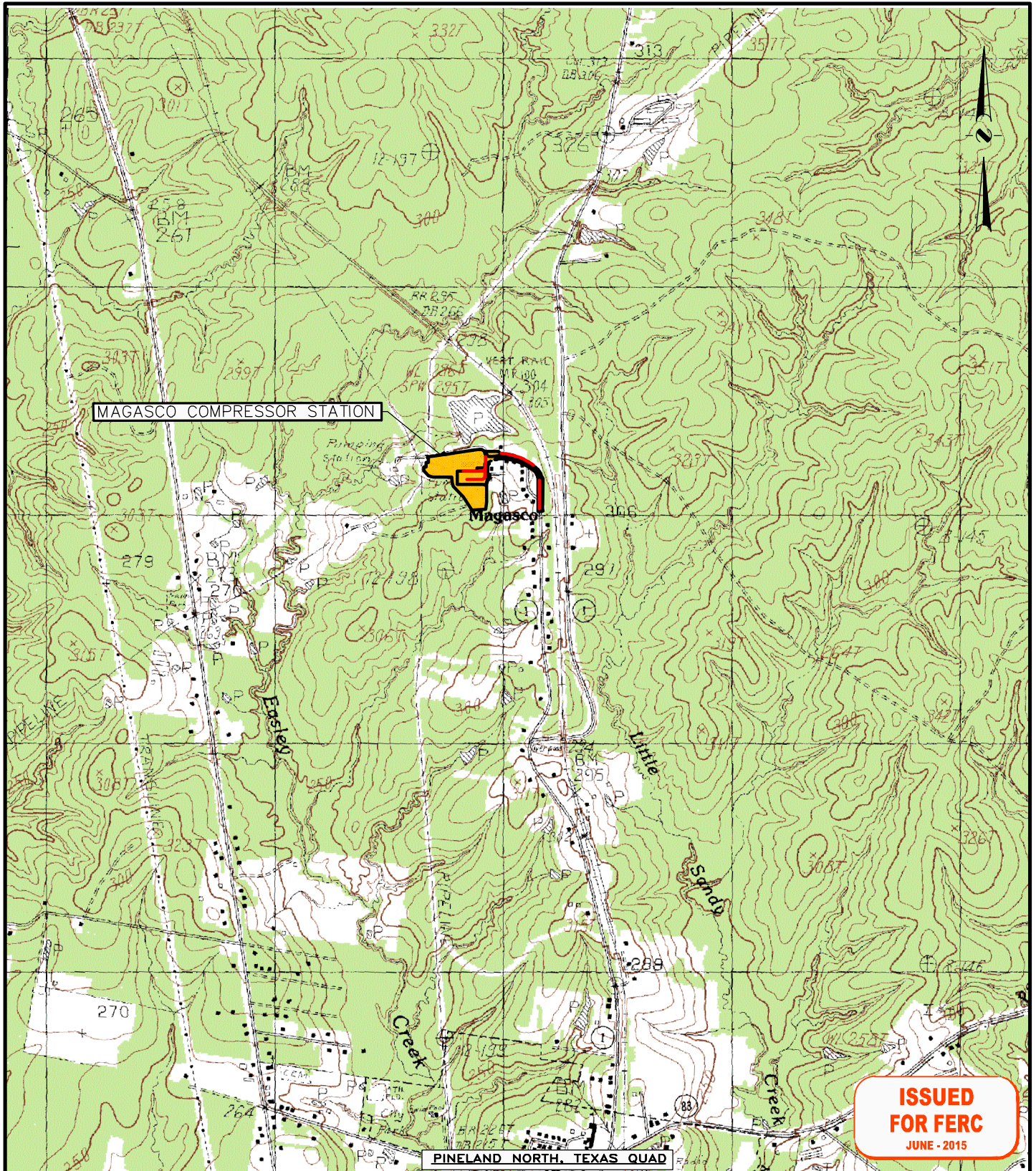

ISSUED FOR FERC
JUNE - 2015

PINELAND NORTH, TEXAS QUAD

LEGEND

- Proposed Pipeline
- Access Road
- Mile Post
- Facility



WILLBROS ENGINEERS (U.S.) LLC
FIRM REGISTRATION NUMBER: TX F-82



**PROPOSED
MAGASCO COMPRESSOR STATION
WHARTON COUNTY, TEXAS**

NO.	REVISION	DATE	CHECKED	DATE	APPROVED	DATE
A	ISSUED FOR FERC		JMW		RSC	
	SCALE	DRAWN	DATE	CHECKED	DATE	APPROVED
	1"=2000'	CB	5/16/15	RSC	5/18/15	

WEI PROJ. NO.	DRAWING NUMBER	REV. NO.
52715	14CQ-650-P-113-E28	A

Sheet 29 of 30

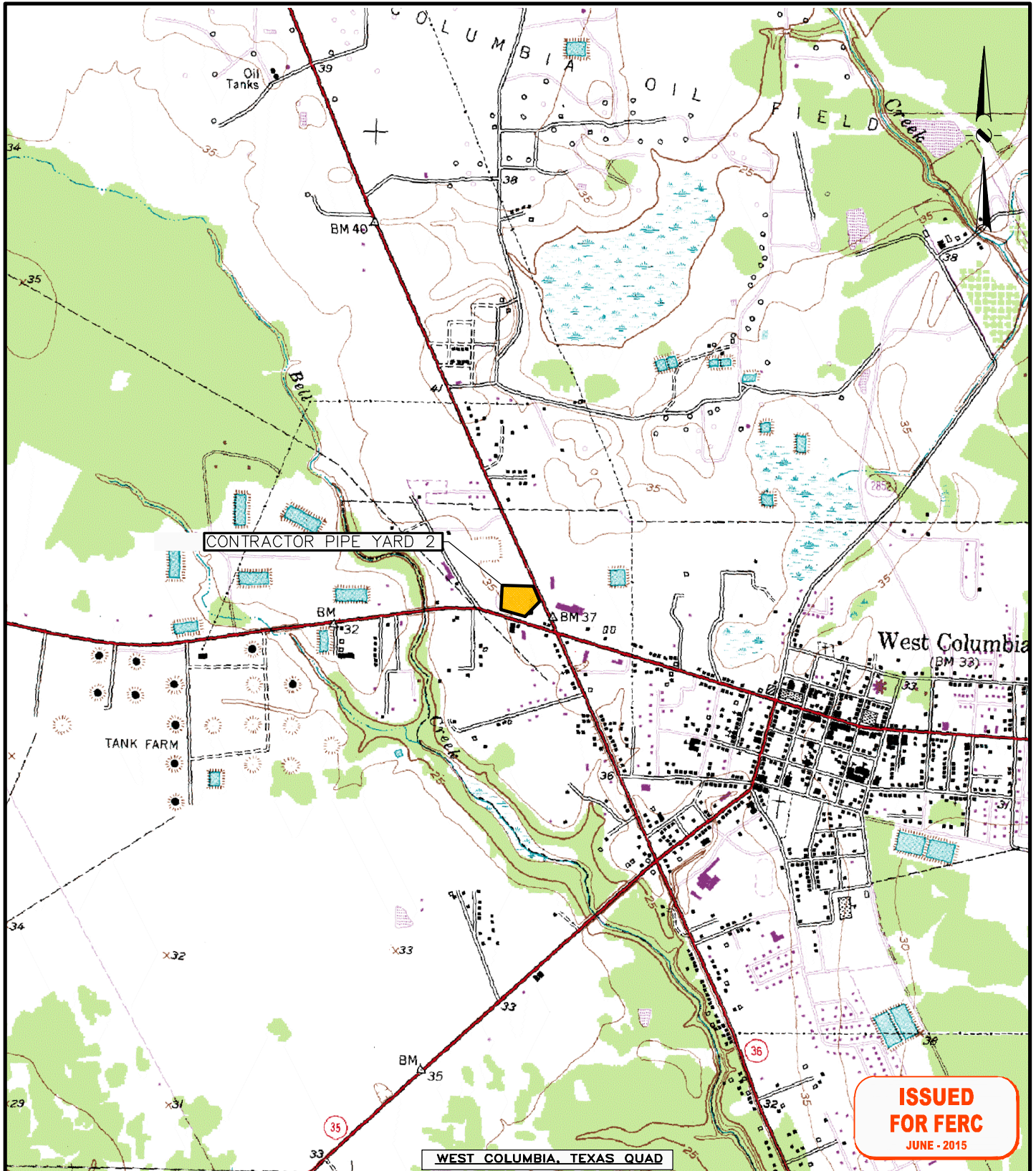

ISSUED FOR FERC
JUNE - 2015

LEGEND

- Proposed Pipeline
- - - Access Road
- Mile Post
- Facility



WILBROS ENGINEERS (U.S) LLC
FIRM REGISTRATION NUMBER: TX F-82



**PROPOSED
CONTRACTOR PIPE YARD 2
BRAZORIA COUNTY, TEXAS**

NO.	REVISION	DRAWN	DATE	APPR.	DATE	
A	ISSUED FOR FERC	JMW	6/11/15	RSC	6/11/15	
SCALE	DRAWN	DATE	CHECKED	DATE	APPROVED	DATE
1"=2000'	JMW	6/11/15	RSC	6/11/15		

WEI PROJ. NO.	DRAWING NUMBER	REV. NO.
52715	14CQ-650-P-113-E29	A

Sheet 30 of 30

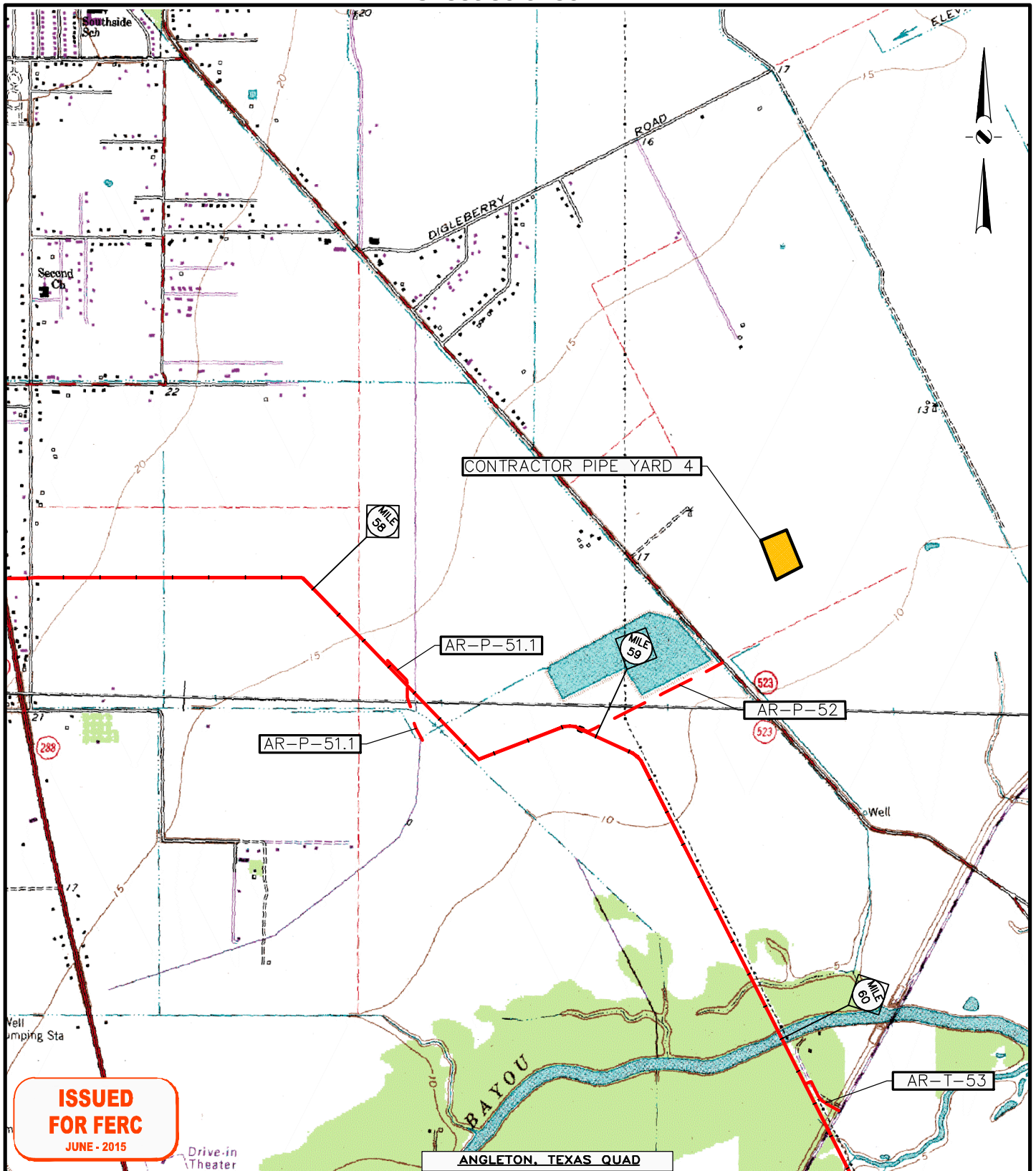

ISSUED FOR FERC
JUNE - 2015

ANGLETON, TEXAS QUAD

LEGEND

- Proposed Pipeline
- - - - - Access Road
- Mile Post
- Facility



WILLBROS ENGINEERS (U.S.) LLC
FIRM REGISTRATION NUMBER: TX F-82



**PROPOSED
CONTRACTOR PIPE YARD 4
BRAZORIA COUNTY, TEXAS**

NO.	REVISION	DRAWN	DATE	APPR.	DATE
A	ISSUED FOR FERC	JMW		RSC	

SCALE	DRAWN	DATE	CHECKED	DATE	APPROVED	DATE
1"=2000'	JMW	6/11/15	RSC	6/11/15		

WEI PROJ. NO.	DRAWING NUMBER	REV NO.
52715	14CQ-650-P-113-E29	A

APPENDIX B
CONSTRUCTION TYPICALS

June 2015

**Gulf South Pipeline Company, LP
Coastal Bend Header Project**

Page 1 of 8

Coastal Bend Header Project Pipeline Construction ROW Configurations and Corresponding Typical Drawings by Milepost				
Milepost Begin	Milepost End	Distance (miles)	Typical Drawing	Construction ROW Width (feet) ^a
0.00	1.32	1.32	52715-TYP-013	100
1.32	1.43	0.11	52715-TYP-005	75
1.43	1.51	0.08	52715-TYP-024	100
1.51	1.63	0.12	52715-TYP-015	100
1.63	1.72	0.09	52715-TYP-013	100
1.72	1.74	0.02	52715-TYP-015	100
1.74	1.94	0.2	52715-TYP-013	100
1.94	1.97	0.03	52715-TYP-015	100
1.97	2.01	0.04	52715-TYP-005	75
2.01	2.02	0.01	52715-TYP-015	100
2.02	2.33	0.31	52715-TYP-013	125
2.33	2.35	0.02	52715-TYP-015	100
2.35	2.61	0.26	52715-TYP-013	100
2.61	2.65	0.04	52715-TYP-015	100
2.65	2.73	0.08	52715-TYP-005	75
2.73	2.74	0.01	52715-TYP-015	100
2.74	3.03	0.29	52715-TYP-013	100
3.03	3.04	0.01	52715-TYP-015	100
3.04	3.93	0.89	52715-TYP-013	100
3.93	3.94	0.01	52715-TYP-015	100
3.94	3.98	0.04	52715-TYP-005	75
3.98	3.99	0.01	52715-TYP-015	100
3.99	4.70	0.71	52715-TYP-013	100
4.70	4.72	0.02	52715-TYP-015	100
4.72	4.80	0.08	Transco M&R Station	N/A
4.80	6.35	1.55	52715-TYP-013	125
6.35	6.49	0.14	NGPL M&R Station	N/A
6.49	10.06	3.57	52715-TYP-013	100
10.06	10.55	0.49	HDD	50
10.55	10.65	0.1	52715-TYP-018	100
10.65	10.71	0.06	52715-TYP-015	100
10.71	11.02	0.31	HDD	50
11.02	11.37	0.35	52715-TYP-018	100
11.37	11.42	0.05	Pond	75

June 2015

**Gulf South Pipeline Company, LP
Coastal Bend Header Project**

Page 2 of 8

Coastal Bend Header Project Pipeline Construction ROW Configurations and Corresponding Typical Drawings by Milepost				
Milepost Begin	Milepost End	Distance (miles)	Typical Drawing	Construction ROW Width (feet) ^a
11.42	12.00	0.58	52715-TYP-018	100
12.00	12.04	0.04	52715-TYP-015	100
12.04	12.36	0.32	52715-TYP-018	100
12.36	12.47	0.11	52715-TYP-015	100
12.47	13.09	0.62	52715-TYP-018	100
13.09	13.11	0.02	52715-TYP-015	100
13.11	13.31	0.2	52715-TYP-018	100
13.31	13.33	0.02	Residence (refer to Dwg No. 52715-RES-01)	80
13.33	13.52	0.19	52715-TYP-018	100
13.52	13.60	0.08	52715-TYP-005	75
13.60	13.97	0.37	52715-TYP-015	100
13.97	14.64	0.67	52715-TYP-018	100
14.64	14.65	0.01	52715-TYP-015	100
14.65	14.95	0.3	52715-TYP-013	100
14.95	15.16	0.21	52715-TYP-018	100
15.16	15.17	0.01	52715-TYP-015	100
15.17	15.38	0.21	52715-TYP-018	100
15.38	15.77	0.39	52715-TYP-013	100
15.77	16.03	0.26	52715-TYP-018	100
16.03	16.62	0.59	52715-TYP-015	100
16.62	16.74	0.12	52715-TYP-018	100
16.74	16.77	0.03	52715-TYP-015	100
16.77	17.64	0.87	52715-TYP-013	100
17.64	17.69	0.05	HPL-Energy Transfer M&R Station	N/A
17.69	19.30	1.61	52715-TYP-013	100
19.30	19.54	0.24	52715-TYP-018	100
19.54	19.59	0.05	52715-TYP-015	100
19.59	20.66	1.07	52715-TYP-018	100
20.66	20.87	0.21	Wilson Compressor Station	N/A
20.87	21.27	0.40	52715-TYP-013	100
21.27	21.30	0.03	52715-TYP-005	75
21.30	21.44	0.14	52715-TYP-013	100
21.44	21.45	0.01	52715-TYP-015	100
21.45	21.53	0.08	52715-TYP-005	75

June 2015

**Gulf South Pipeline Company, LP
Coastal Bend Header Project**

Page 3 of 8

Coastal Bend Header Project Pipeline Construction ROW Configurations and Corresponding Typical Drawings by Milepost				
Milepost Begin	Milepost End	Distance (miles)	Typical Drawing	Construction ROW Width (feet) ^a
21.53	21.70	0.17	52715-TYP-015	100
21.70	21.78	0.08	52715-TYP-005	75
21.78	21.89	0.11	52715-TYP-015	100
21.89	21.91	0.02	52715-TYP-005	75
21.91	21.93	0.02	52715-TYP-015	100
21.93	21.94	0.01	52715-TYP-005	75
21.94	21.95	0.01	52715-TYP-015	100
21.95	22.01	0.06	52715-TYP-018	100
22.01	22.05	0.04	52715-TYP-015	100
22.05	22.43	0.38	52715-TYP-018	100
22.43	22.46	0.03	52715-TYP-015	100
22.46	23.43	0.97	52715-TYP-018	100
23.43	23.45	0.02	52715-TYP-015	100
23.45	23.68	0.23	52715-TYP-018	100
23.68	23.72	0.04	52715-TYP-015	100
23.72	24.08	0.36	52715-TYP-018	100
24.08	25.54	1.46	52715-TYP-015	100
25.54	25.89	0.35	52715-TYP-018	100
25.89	25.93	0.04	52715-TYP-015	100
25.93	26.30	0.37	52715-TYP-018	100
26.30	26.93	0.63	52715-TYP-013	100
26.93	27.12	0.19	52715-TYP-015	100
27.12	27.58	0.46	HDD	50
27.58	27.62	0.04	52715-TYP-015	100
27.62	27.63	0.01	52715-TYP-005	75
27.63	27.73	0.1	52715-TYP-015	100
27.73	27.74	0.01	52715-TYP-005	75
27.74	28.23	0.49	52715-TYP-015	100
28.23	28.25	0.02	52715-TYP-005	75
28.25	29.13	0.88	52715-TYP-018	100
29.13	29.16	0.03	52715-TYP-005	75
29.16	29.22	0.06	52715-TYP-018	100
29.22	31.07	1.85	52715-TYP-015	100
31.07	31.40	0.33	HDD	50

June 2015

**Gulf South Pipeline Company, LP
Coastal Bend Header Project**

Page 4 of 8

Coastal Bend Header Project Pipeline Construction ROW Configurations and Corresponding Typical Drawings by Milepost				
Milepost Begin	Milepost End	Distance (miles)	Typical Drawing	Construction ROW Width (feet) ^a
31.40	32.54	1.14	52715-TYP-015	100
32.54	32.65	0.11	52715-TYP-005	75
32.65	33.46	0.81	52715-TYP-015	100
33.46	33.64	0.18	52715-TYP-005	75
33.64	33.78	0.14	52715-TYP-015	100
33.78	33.82	0.04	52715-TYP-005	75
33.82	33.95	0.13	52715-TYP-015	100
33.95	34.09	0.14	52715-TYP-005	75
34.09	34.20	0.11	52715-TYP-015	100
34.20	34.95	0.75	52715-TYP-018	100
34.95	35.00	0.05	52715-TYP-015	100
35.00	35.04	0.04	52715-TYP-005	75
35.04	35.10	0.06	52715-TYP-015	100
35.10	35.17	0.07	52715-TYP-005	75
35.17	35.23	0.06	52715-TYP-015	100
35.23	35.40	0.17	52715-TYP-018	100
35.40	35.43	0.03	52715-TYP-015	100
35.43	35.48	0.05	52715-TYP-005	75
35.48	35.54	0.06	52715-TYP-015	100
35.54	36.04	0.5	52715-TYP-018	100
36.04	36.08	0.04	52715-TYP-015	100
36.08	36.57	0.49	52715-TYP-018	100
36.57	36.60	0.03	52715-TYP-015	100
36.60	37.07	0.47	52715-TYP-018	100
37.07	37.08	0.01	52715-TYP-015	100
37.08	37.78	0.7	52715-TYP-013	100
37.78	37.84	0.06	52715-TYP-015	100
37.84	38.78	0.94	52715-TYP-013	100
38.78	38.81	0.03	52715-TYP-015	100
38.81	38.83	0.02	52715-TYP-013	100
38.83	38.93	0.1	52715-TYP-015	100
38.93	39.29	0.36	52715-TYP-018	100
39.29	39.31	0.02	52715-TYP-015	100
39.31	39.48	0.17	52715-TYP-005	75

June 2015

Gulf South Pipeline Company, LP
Coastal Bend Header Project

Page 5 of 8

Coastal Bend Header Project Pipeline Construction ROW Configurations and Corresponding Typical Drawings by Milepost				
Milepost Begin	Milepost End	Distance (miles)	Typical Drawing	Construction ROW Width (feet) ^a
39.48	39.68	0.2	52715-TYP-015	100
39.68	39.96	0.28	52715-TYP-005	75
39.96	40.00	0.04	52715-TYP-015	100
40.00	40.23	0.23	52715-TYP-018	100
40.23	40.26	0.03	52715-TYP-015	100
40.26	40.86	0.6	52715-TYP-018	100
40.86	40.90	0.04	52715-TYP-015	100
40.90	40.97	0.07	52715-TYP-018	100
40.97	41.00	0.03	52715-TYP-015	100
41.00	41.12	0.12	52715-TYP-018	100
41.12	41.13	0.01	52715-TYP-015	100
41.13	41.29	0.16	52715-TYP-018	100
41.29	41.93	0.64	52715-TYP-015	100
41.93	42.24	0.31	52715-TYP-024	100
42.24	43.12	0.88	52715-TYP-015	100
43.12	43.20	0.08	52715-TYP-024	100
43.20	43.80	0.6	52715-TYP-015	100
43.80	43.98	0.18	52715-TYP-013	100
43.98	44.16	0.18	52715-TYP-015	100
44.16	44.28	0.12	52715-TYP-005	75
44.28	44.32	0.04	52715-TYP-015	100
44.32	44.63	0.31	52715-TYP-005	75
44.63	44.76	0.13	52715-TYP-013	100
44.76	45.10	0.34	HDD	50
45.10	45.27	0.17	52715-TYP-018	100
45.27	45.28	0.01	52715-TYP-005	75
45.28	45.32	0.04	52715-TYP-015	100
45.32	45.68	0.36	52715-TYP-018	100
45.68	45.85	0.17	52715-TYP-024	100
45.85	46.03	0.18	HDD	50
46.03	46.13	0.1	52715-TYP-024	100
46.13	46.38	0.25	52715-TYP-018	100
46.38	46.49	0.11	52715-TYP-015	100
46.49	46.58	0.09	52715-TYP-018	100

June 2015

**Gulf South Pipeline Company, LP
Coastal Bend Header Project**

Page 6 of 8

Coastal Bend Header Project Pipeline Construction ROW Configurations and Corresponding Typical Drawings by Milepost				
Milepost Begin	Milepost End	Distance (miles)	Typical Drawing	Construction ROW Width (feet) ^a
46.58	46.62	0.04	52715-TYP-015	100
46.62	46.63	0.01	52715-TYP-005	75
46.63	46.85	0.22	52715-TYP-018	100
46.85	46.87	0.02	52715-TYP-015	100
46.87	47.00	0.13	52715-TYP-024	100
47.00	47.04	0.04	52715-TYP-015	100
47.04	47.81	0.77	52715-TYP-018	100
47.81	47.91	0.1	52715-TYP-015	100
47.91	48.07	0.16	52715-TYP-018	100
48.07	48.55	0.48	52715-TYP-015	100
48.55	48.62	0.07	52715-TYP-005	75
48.62	49.28	0.66	52715-TYP-018	100
49.28	49.38	0.1	52715-TYP-015	100
49.38	49.39	0.01	52715-TYP-005	75
49.39	49.53	0.14	52715-TYP-015	100
49.53	49.56	0.03	52715-TYP-018	100
49.56	49.58	0.02	52715-TYP-015	100
49.58	49.61	0.03	52715-TYP-005	75
49.61	49.62	0.01	52715-TYP-015	100
49.62	49.86	0.24	52715-TYP-018	100
49.86	50.48	0.62	52715-TYP-015	100
50.48	50.49	0.01	52715-TYP-005	75
50.49	50.76	0.27	52715-TYP-015	100
50.76	50.78	0.02	52715-TYP-005	75
50.78	50.79	0.01	52715-TYP-015	100
50.79	51.71	0.92	52715-TYP-024	100
51.71	51.90	0.19	52715-TYP-018	100
51.90	51.93	0.03	52715-TYP-015	100
51.93	52.29	0.36	52715-TYP-018	100
52.29	52.35	0.06	52715-TYP-015	100
52.35	52.77	0.42	52715-TYP-024	100
52.77	52.85	0.08	52715-TYP-015	100
52.85	53.00	0.15	52715-TYP-024	100
53.00	53.28	0.28	HDD	50

June 2015

**Gulf South Pipeline Company, LP
Coastal Bend Header Project**

Page 7 of 8

Coastal Bend Header Project Pipeline Construction ROW Configurations and Corresponding Typical Drawings by Milepost				
Milepost Begin	Milepost End	Distance (miles)	Typical Drawing	Construction ROW Width (feet) ^a
53.28	53.32	0.04	52715-TYP-005	75
53.32	53.33	0.01	52715-TYP-015	100
53.33	53.43	0.10	52715-TYP-005	75
53.43	54.07	0.64	52715-TYP-018	100
54.07	54.45	0.38	52715-TYP-015	100
54.45	54.82	0.37	52715-TYP-018	100
54.82	54.83	0.01	52715-TYP-015	100
54.83	55.11	0.28	52715-TYP-018	100
55.11	55.13	0.02	52715-TYP-005	75
55.13	55.15	0.02	52715-TYP-015	100
55.15	55.38	0.23	52715-TYP-018	100
55.38	55.68	0.3	HDD	50
55.68	56.04	0.36	52715-TYP-018	100
56.04	56.33	0.29	HDD	50
56.33	56.49	0.16	52715-TYP-024	100
56.49	56.50	0.01	52715-TYP-015	100
56.50	56.51	0.01	52715-TYP-005	75
56.51	56.53	0.02	52715-TYP-015	100
56.53	56.8	0.27	52715-TYP-024	100
56.80	56.81	0.01	52715-TYP-015	100
56.81	57.09	0.28	52715-TYP-024	100
57.09	57.17	0.08	52715-TYP-015	100
57.17	57.22	0.05	Residence (refer to Dwg No. 52715-RES-03)	100
57.22	57.43	0.21	52715-TYP-024	100
57.43	57.72	0.29	HDD	50
57.72	58.25	0.53	52715-TYP-024	100
58.25	58.69	0.44	HDD	50
58.69	59.68	0.99	52715-TYP-018	100
59.68	59.72	0.04	52715-TYP-005	75
59.72	59.76	0.04	52715-TYP-018	100
59.76	60.17	0.41	HDD	50
60.17	60.88	0.71	52715-TYP-015	100
60.88	60.92	0.04	52715-TYP-005	75
60.92	61.33	0.41	52715-TYP-015	100

June 2015

**Gulf South Pipeline Company, LP
Coastal Bend Header Project**

Page 8 of 8

Coastal Bend Header Project Pipeline Construction ROW Configurations and Corresponding Typical Drawings by Milepost				
Milepost Begin	Milepost End	Distance (miles)	Typical Drawing	Construction ROW Width (feet) ^a
61.33	61.34	0.01	52715-TYP-005	75
61.34	61.62	0.28	52715-TYP-015	100
61.62	61.68	0.06	52715-TYP-005	75
61.68	61.72	0.04	52715-TYP-015	100
61.72	62.05	0.33	52715-TYP-005	75
62.05	62.53	0.48	52715-TYP-015	100
62.53	62.66	0.13	52715-TYP-005	75
62.66	62.70	0.04	52715-TYP-015	100
62.70	62.95	0.25	52715-TYP-005	75
62.95	63.05	0.1	52715-TYP-015	100
63.05	63.21	0.16	52715-TYP-005	75
63.21	63.58	0.37	52715-TYP-015	100
63.58	63.70	0.12	52715-TYP-024	100
63.70	63.79	0.09	52715-TYP-015	100
63.79	63.93	0.14	52715-TYP-018	100
63.93	64.02	0.09	52715-TYP-024	100
64.02	64.04	0.02	52715-TYP-015	100
64.04	64.25	0.21	52715-TYP-024	100
64.25	64.29	0.04	52715-TYP-005	75
64.29	65.57	1.28	52715-TYP-024	100
63.93	64.02	0.09	52715-TYP-024	100
64.02	64.04	0.02	52715-TYP-015	75
64.04	64.25	0.21	52715-TYP-024	100
64.25	64.29	0.04	52715-TYP-005	100
64.29	65.61	1.28	52715-TYP-024	100

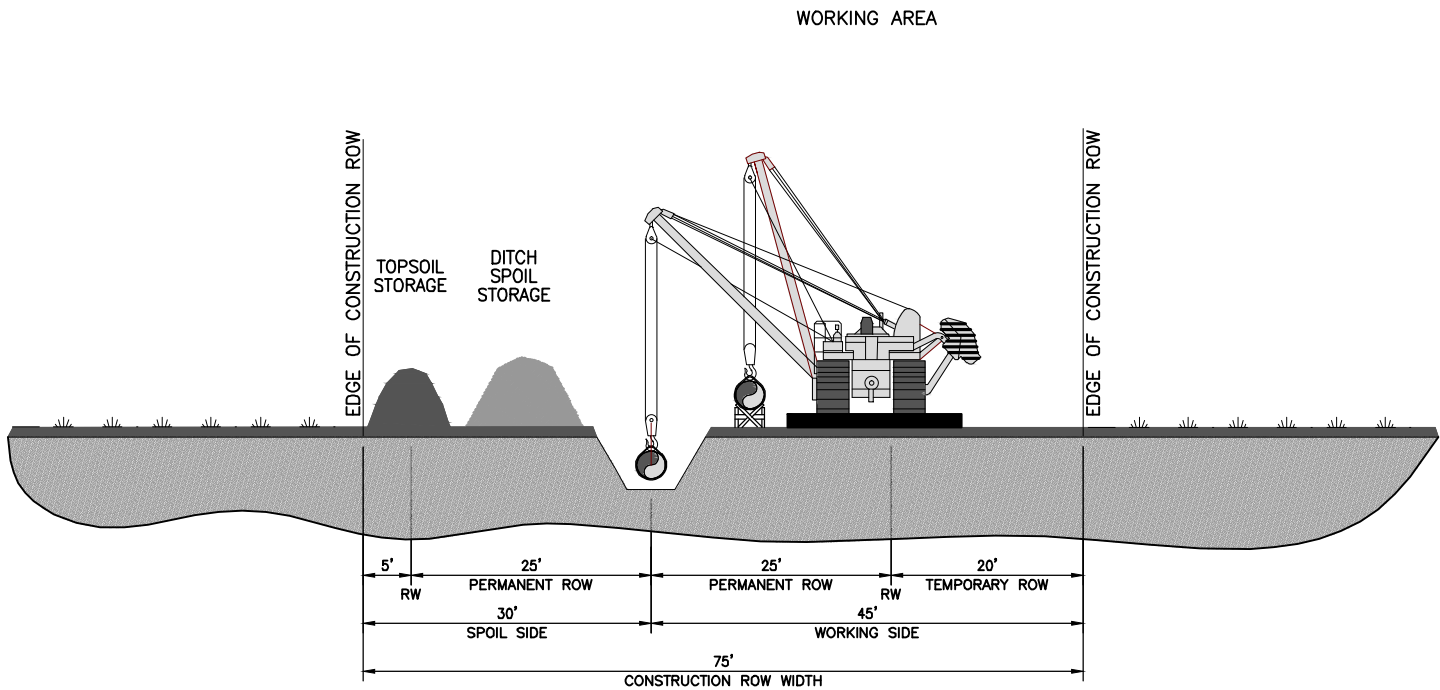

NOTES:

1. CONSTRUCTION RIGHT-OF-WAY WILL TYPICALLY BE 75 FEET WIDE IN WETLANDS CONSISTING OF 50 FEET OF PERMANENT EASEMENT AND 25 FEET OF TEMPORARY WORKSPACE.
2. EQUIPMENT MATS OR LOW GROUND WEIGHT EQUIPMENT SHALL BE USED IN SATURATED CONDITIONS.
3. UTILIZE THE "TRENCH ONLY" WETLAND TOPSOIL SEGREGATION METHOD, EXCEPT IN SATURATED CONDITIONS.
4. FOR TRENCH ONLY STRIPPING, THE STRIPPED AREA SHALL BE WIDE ENOUGH TO ACCOMMODATE TRENCHING EQUIPMENT.
5. DEPTH OF TOPSOIL TRENCHING NOT TO EXCEED 12 INCHES EXCEPT WHERE DEEPER STRIPPING IS STIPULATED BY THE CONSTRUCTION LINE LISTS OR CONSTRUCTION ALIGNMENT SHEETS.
6. KEEP TOPSOIL CLEAN OF ALL CONSTRUCTION DEBRIS. MAINTAIN ADEQUATE SEPARATION BETWEEN TOPSOIL AND TRENCH SPOIL PILES.
7. LEAVE GAPS IN SPOIL PILES AT OBVIOUS DRAINAGES. DO NOT PUSH UPLAND SOILS INTO WATERBODIES OR WETLANDS. DO NOT USE TOPSOIL FOR PADDING.
8. TOPSOIL MAY BE REMOVED AND STORED ON TEMPORARY EXTRA WORKSPACE OUTSIDE OF THE WETLAND WHERE CONDITIONS DO NOT ALLOW FOR PROPER SEPARATION OF THE SPOIL.

				MAINLINE CONSTRUCTION WETLAND CROSSING	
B	ISSUED FOR FERC	06/2015	JSC		
A	DRAFT ISSUED FOR FERC	03/2015	JSC		
NO.	REVISION	DATE	APPR.		
WILLBROS ENGINEERS (U.S.) LLC <small>FIRM REGISTRATION NUMBER: TX F-82</small>				DRAWING NUMBER	
				52715-TYP-005	
				SHEET	
				1 OF 1	

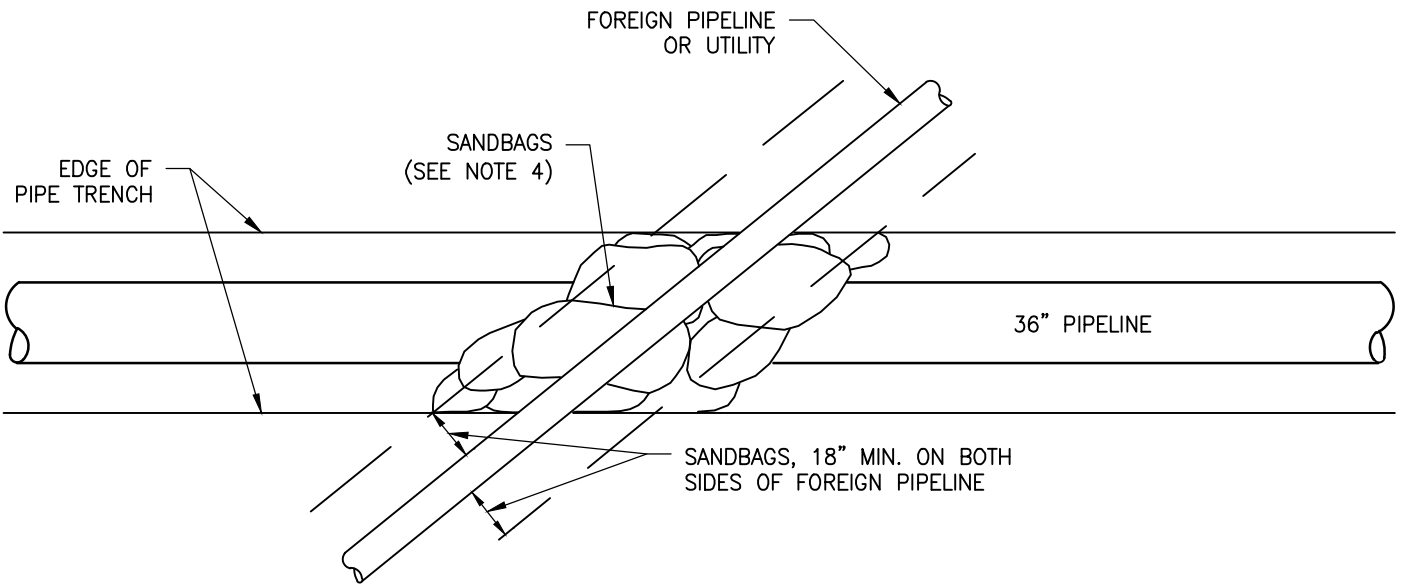

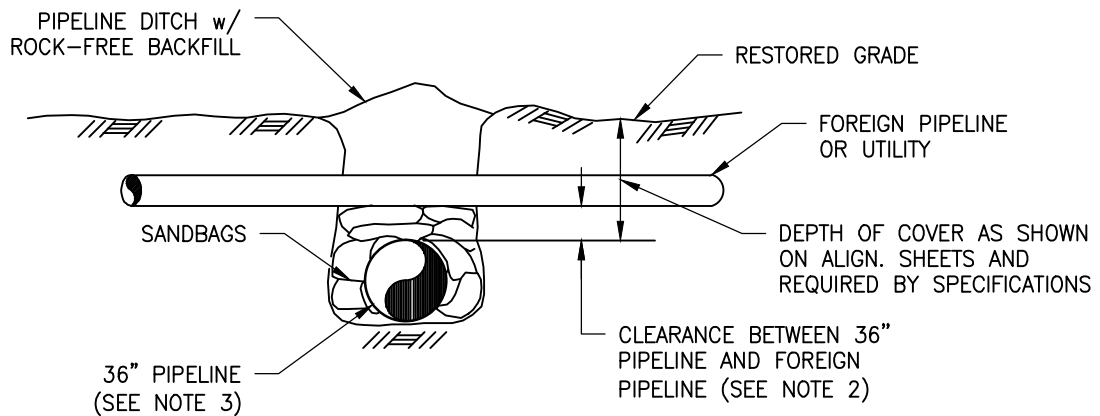

PLAN



END VIEW
CROSS SECTION

NOTES:

1. CATHODIC PROTECTION TEST STATION SHALL BE INSTALLED AT FOREIGN PIPELINE CROSSINGS, WHEN INDICATED ON THE ALIGNMENT SHEETS.
2. MAINTAIN 18" MINIMUM CLEARANCE WHEN CROSSING OVER OR UNDER FOREIGN PIPELINES.
3. 36" PIPELINE IS TO BE PLACED ABOVE, IF FOREIGN PIPELINE OR UTILITY IS BURIED AT A DEPTH SUCH THAT 18" SEPARATION AND MINIMUM 36" COVER IS MAINTAINED OVER 16" LINE, OTHERWISE 36" PIPELINE IS TO BE PLACED UNDER FOREIGN PIPELINE OR UTILITY.
4. SANDBAGS CONSIST OF BURLAP BAGS FILLED WITH EARTH THAT IS FREE OF SHARP ROCKS, TWIGS, AND OTHER OBJECTIONABLE MATERIALS (TOP SOIL SHALL NOT BE USED). USE OF SYNTHETIC MATERIALS FOR BAGS IS NOT ACCEPTABLE.

					
				FOREIGN PIPELINE UTILITY CROSSING	
B ISSUED FOR FERC		06/12/15			
A DRAFT ISSUED FOR FERC		03/02/15			
NO.	REVISION	DATE	APPR.		
 WILBROS ENGINEERS (U.S.) LLC <small>FIRM REGISTRATION NUMBER: TX F-82</small>				DRAWING NUMBER 52715-TYP-006	
				SHEET 1 OF 1	

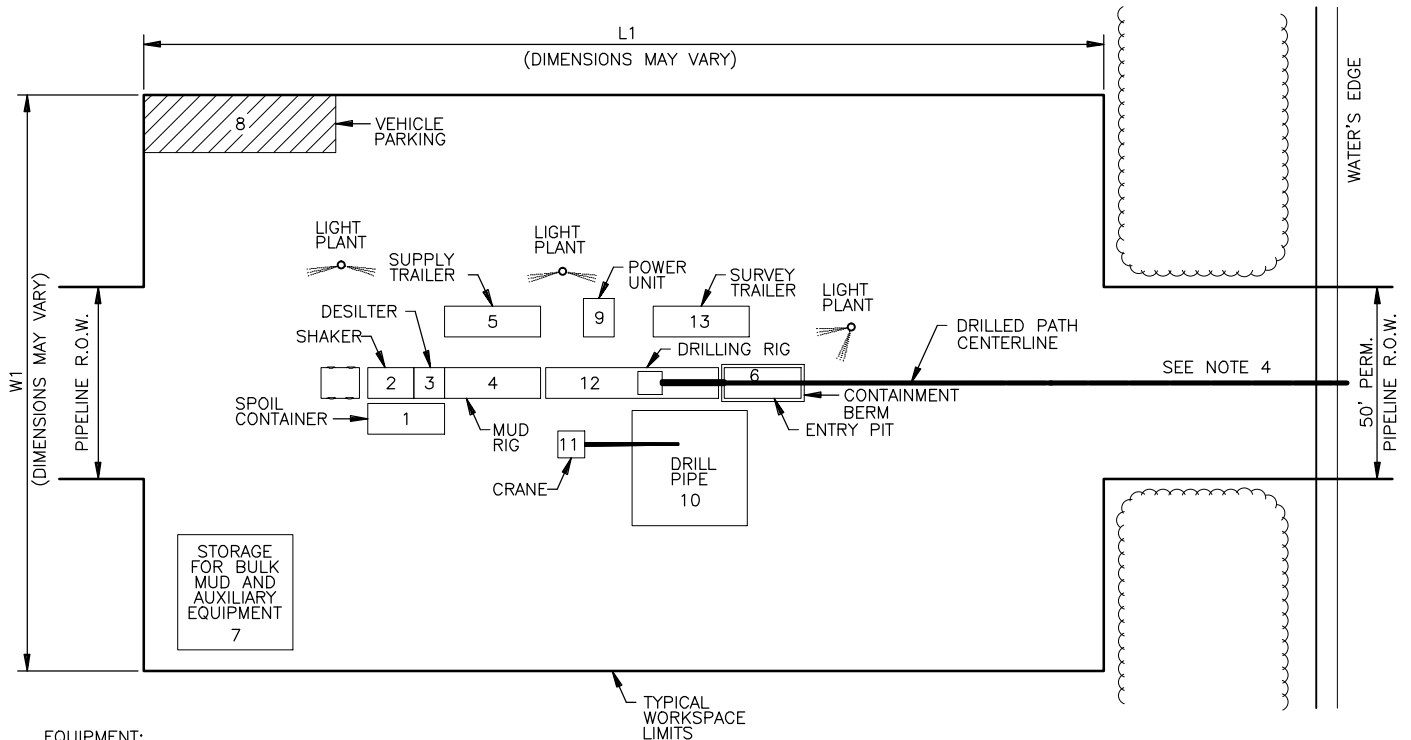

EQUIPMENT:

1. SPOIL CONTAINER: 8' x 20'
2. SHAKER: 8' x 12'
3. DESILTER: 8' x 8'
4. MUD RIG: 8' x 25'
5. SUPPLY TRAILER: 8' x 25'
6. ENTRY PIT: 8' x 20'
7. STORAGE: 30' x 30'
8. VEHICLE PARKING: 15' x 50'
9. POWER UNIT: 8' x 10'
10. DRILL PIPE: 30' x 30'
11. CRANE: 8' x 8'
12. DRILLING RIG: 8' x 45'
13. SURVEY TRAILER: 8' x 25'

NOTES:

1. EQUIPMENT ORIENTATION MAY VARY DEPENDING ON CONTRACTOR OR SITE CONDITIONS.
2. EQUIPMENT TO BE SUPPORTED ON THE GROUND SURFACE OR TIMBER MATS AS CONDITIONS DICTATE.
3. SILT FENCE, BERMS AND/OR STRAW BALE BARRIER TO BE USED AS REQUIRED TO PREVENT IMPACTS FROM OCCURRING OUTSIDE OF PROJECT LIMITS.
4. HAND CLEARED ACCESS PATH WILL BE USED TO OBTAIN WATER FROM SOURCE WHERE PERMITTED.

ENTRY SITE PLAN

SCALE: N.T.S.

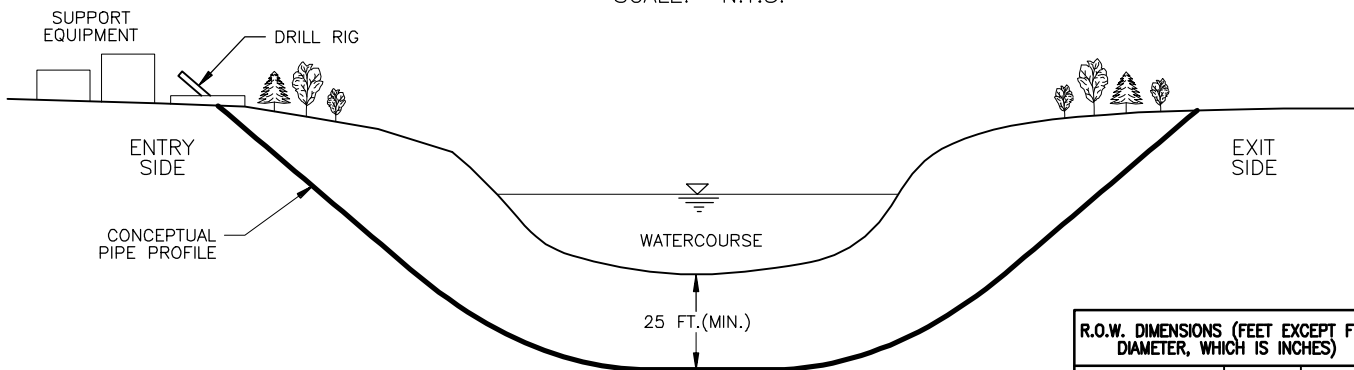

R.O.W. DIMENSIONS (FEET EXCEPT FOR DIAMETER, WHICH IS INCHES)		
DIAMETER PIPE	L1	W1
36"	300	200

GENERAL NOTES:

- 1.) PIPE DEPTHS MAY VARY.

PROFILE

SCALE: N.T.S.



**MAINLINE CONSTRUCTION
TYPICAL DIRECTIONAL DRILL
ENTRY SITE PLAN & PROFILE**

NO.	REVISION	DATE	APPR.
B	ISSUED FOR FERC	06/12/15	
A	DRAFT ISSUED FOR FERC	03/02/15	



WILLBROS ENGINEERS (U.S.) LLC
FIRM REGISTRATION NUMBER: TX F-82

DRAWING NUMBER

SHEET

52715-TYP-011

1 OF 1

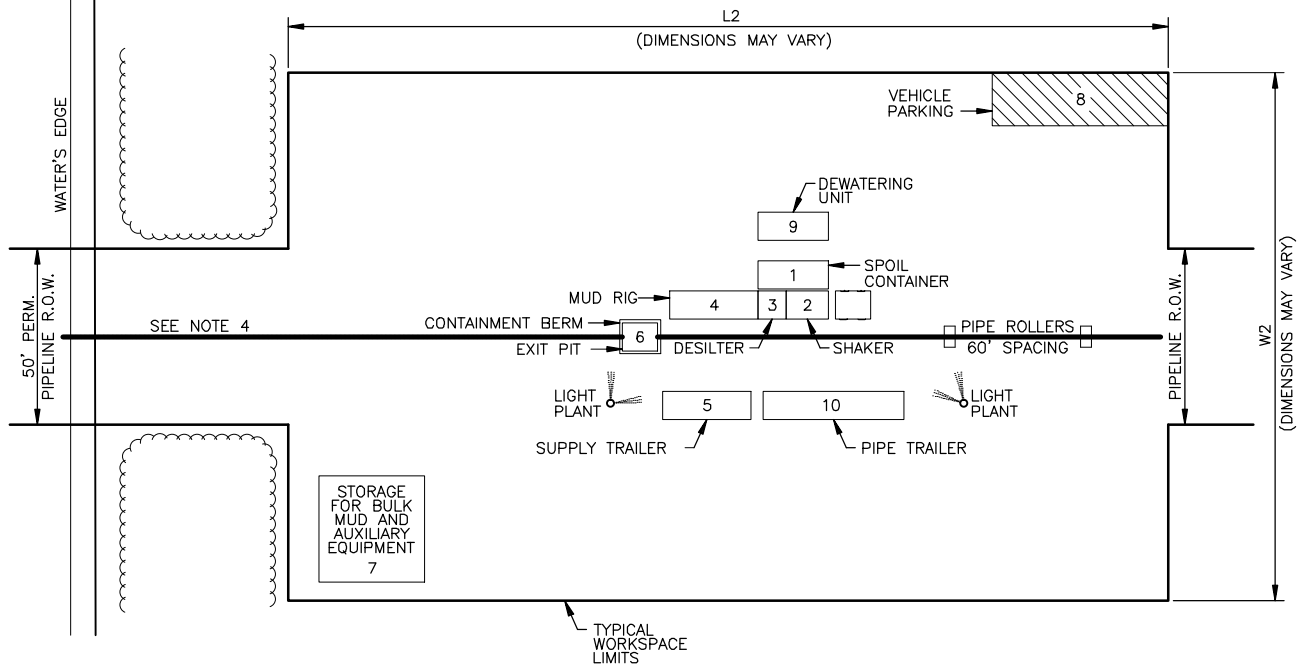

EQUIPMENT:

- 1. SPOIL CONTAINER: 8' x 20'
- 2. SHAKER: 8' x 12'
- 3. DESILTER: 8' x 8'
- 4. MUD RIG: 8' x 25'
- 5. SUPPLY TRAILER: 8' x 25'
- 6. EXIT PIT: 8' x 10'
- 7. STORAGE: 30' x 30'
- 8. VEHICLE PARKING: 15' x 50'
- 9. DEWATERING UNIT: 8' x 20'
- 10. PIPE TRAILER: 8' x 40'

NOTES:

- 1. EQUIPMENT ORIENTATION MAY VARY DEPENDING ON CONTRACTOR OR SITE CONDITIONS.
- 2. EQUIPMENT TO BE SUPPORTED ON THE GROUND SURFACE OR TIMBER MATS AS CONDITIONS DICTATE.
- 3. SILT FENCE, BERMS AND/OR STRAW BALE BARRIER TO BE USED AS REQUIRED TO PREVENT IMPACTS FROM OCCURRING OUTSIDE OF PROJECT LIMITS.
- 4. HAND CLEARED ACCESS PATH WILL BE USED TO OBTAIN WATER FROM SOURCE WHERE PERMITTED.

EXIT SITE PLAN

SCALE: N.T.S.

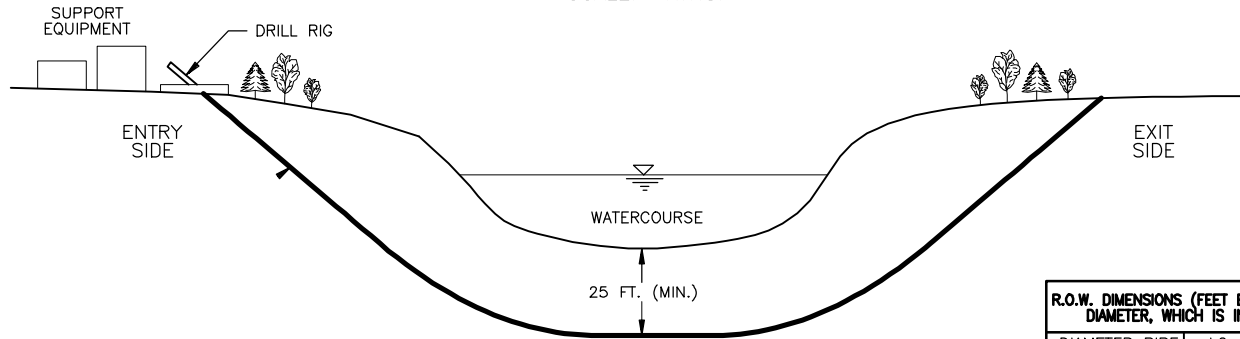

R.O.W. DIMENSIONS (FEET EXCEPT FOR DIAMETER, WHICH IS INCHES)		
DIAMETER PIPE	L2	W2
36"	300	200

GENERAL NOTES

- 1.) PIPE DEPTHS MAY VARY.

PROFILE

SCALE: N.T.S.



**MAINLINE CONSTRUCTION
TYPICAL DIRECTIONAL DRILL
EXIT SITE PLAN & PROFILE**

B	ISSUED FOR FERC	06/12/15	
A	DRAFT ISSUED FOR FERC	03/02/15	
NO.	REVISION	DATE	APPR.



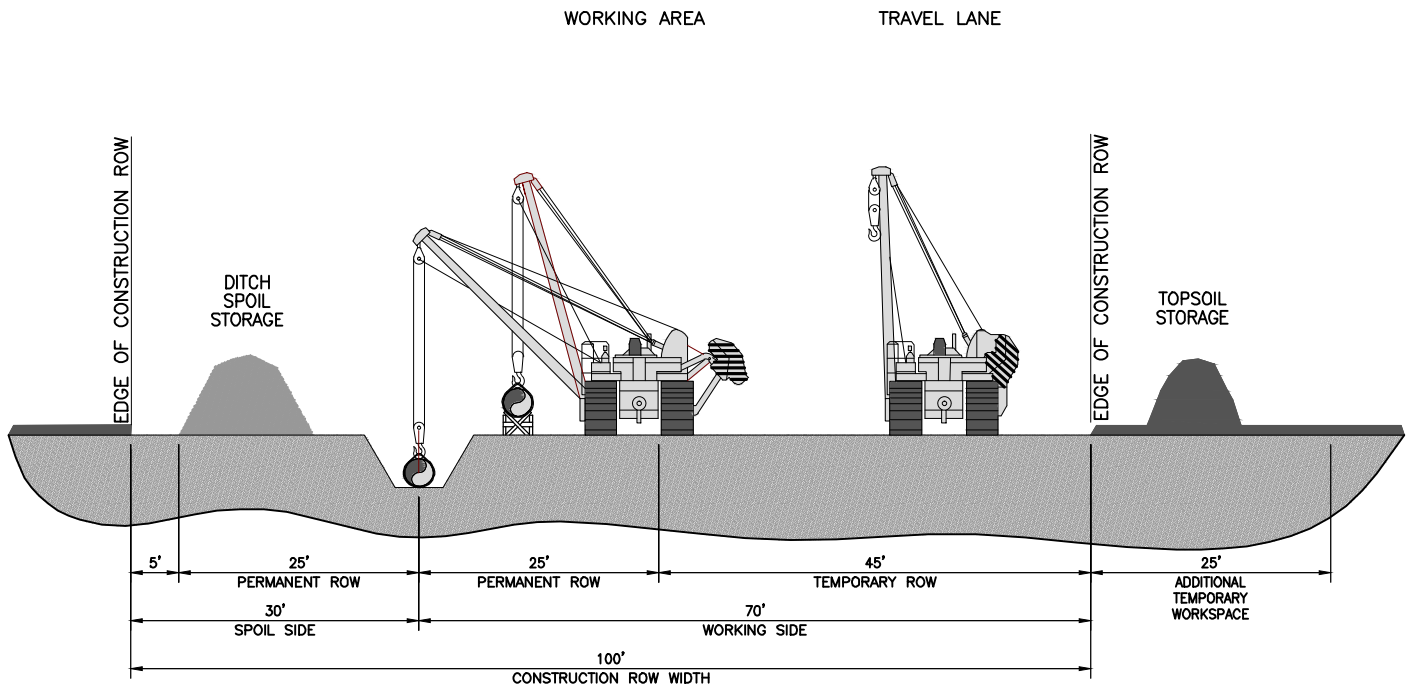

DRAWING NUMBER	SHEET
52715-TYP-012	1 OF 1



NOTES:

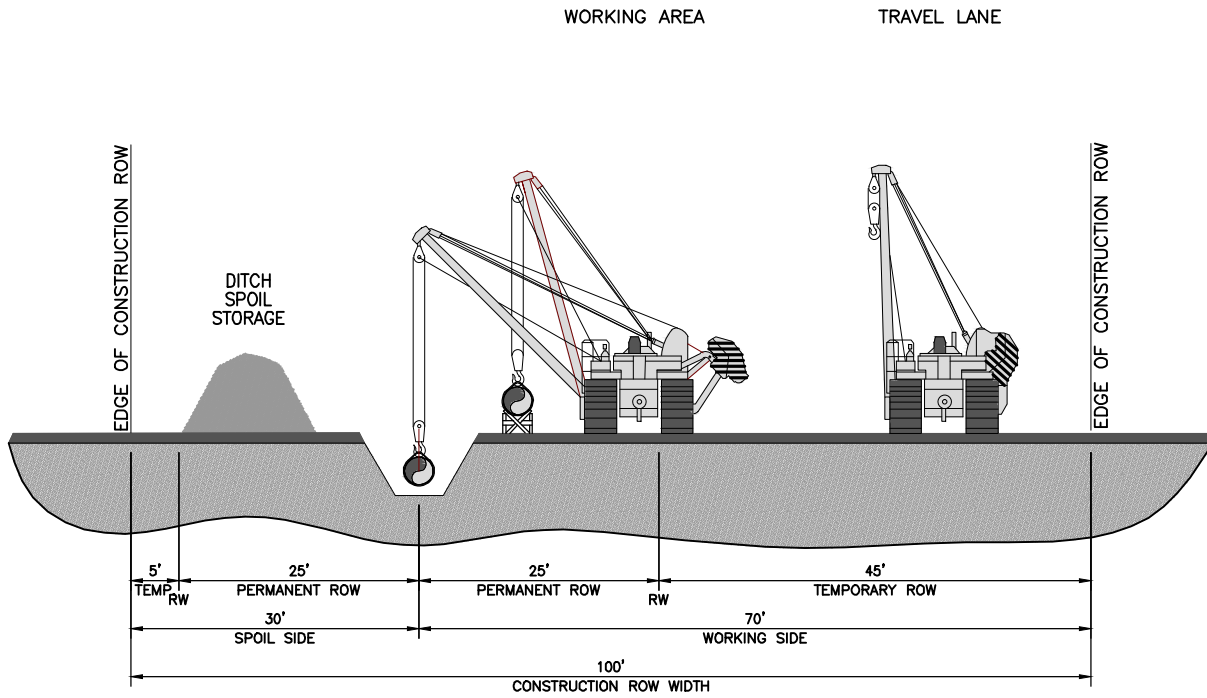

1. AGRICULTURAL CONSTRUCTION WORKSPACE WILL TYPICALLY REQUIRE 125 FEET WIDTH CONSISTING OF 50 FEET OF PERMANENT EASEMENT, 50 FEET OF TEMPORARY WORKSPACE AND 25 FEET OF ADDITIONAL TEMPORARY WORKSPACE, FURTHER ADDITIONAL TEMPORARY WORKSPACE WILL BE NECESSARY AT ROAD, RAIL AND RIVER CROSSINGS AND OTHER SPECIAL CIRCUMSTANCES, AS REQUIRED. CERTAIN SITUATIONS MAY REQUIRE A NARROWER WIDTH.
2. LEAVE GAPS IN SPOIL PILES AT OBVIOUS DRAINAGES. DO NOT PUSH UPLAND SOILS INTO WATERBODIES OR WETLANDS.

					
				TYPICAL AGRICULTURAL WORKSPACE WITH FULL ROW TOP SOIL	
B	ISSUED FOR FERC	06/2015	JSC		
A	DRAFT ISSUED FOR FERC	03/2015	JSC		
NO.	REVISION	DATE	APPR.		
 WILLBROS ENGINEERS (U.S.) LLC <small>FIRM REGISTRATION NUMBER: TX F-82</small>				DRAWING NUMBER 52715-TYP-013	
				SHEET 1 OF 1	



NOTES:

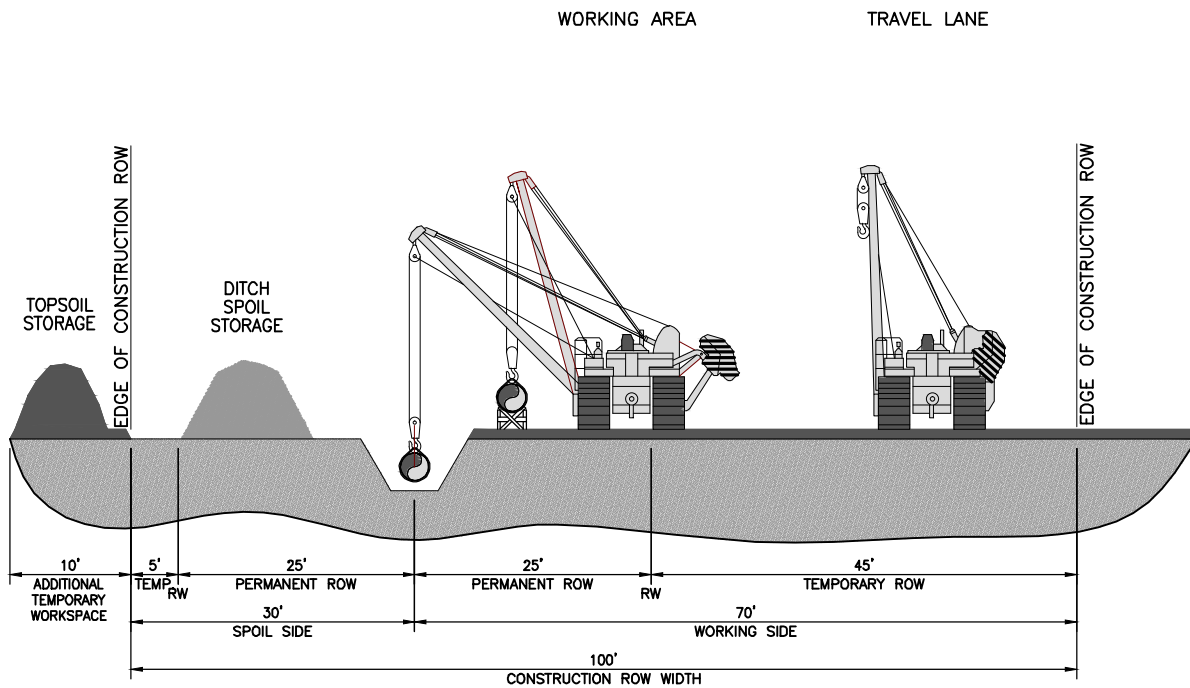

1. UPLAND CONSTRUCTION WILL TYPICALLY REQUIRE 100 FEET WIDE CONSISTING OF 50 FEET OF PERMANENT EASEMENT, 50 FEET OF TEMPORARY WORKSPACE, FURTHER ADDITIONAL TEMPORARY WORKSPACE WILL BE NECESSARY AT ROAD, RAIL AND RIVER CROSSINGS AND OTHER SPECIAL CIRCUMSTANCES, AS REQUIRED. CERTAIN SITUATIONS MAY REQUIRE A NARROWER WIDTH.
2. LEAVE GAPS IN SPOIL PILES AT OBVIOUS DRAINAGES. DO NOT PUSH UPLAND SOILS INTO WATERBODIES OR WETLANDS.

					
				TYPICAL CONSTRUCTION WORKSPACE	
B	ISSUED FOR FERC	06/2015	JSC		
A	DRAFT ISSUED FOR FERC	03/2015	JSC		
NO.	REVISION	DATE	APPR.		
 WILLBROS ENGINEERS (U.S.) LLC <small>FIRM REGISTRATION NUMBER: TX F-82</small>				DRAWING NUMBER 52715-TYP-015	
				SHEET 1 OF 1	



NOTES:

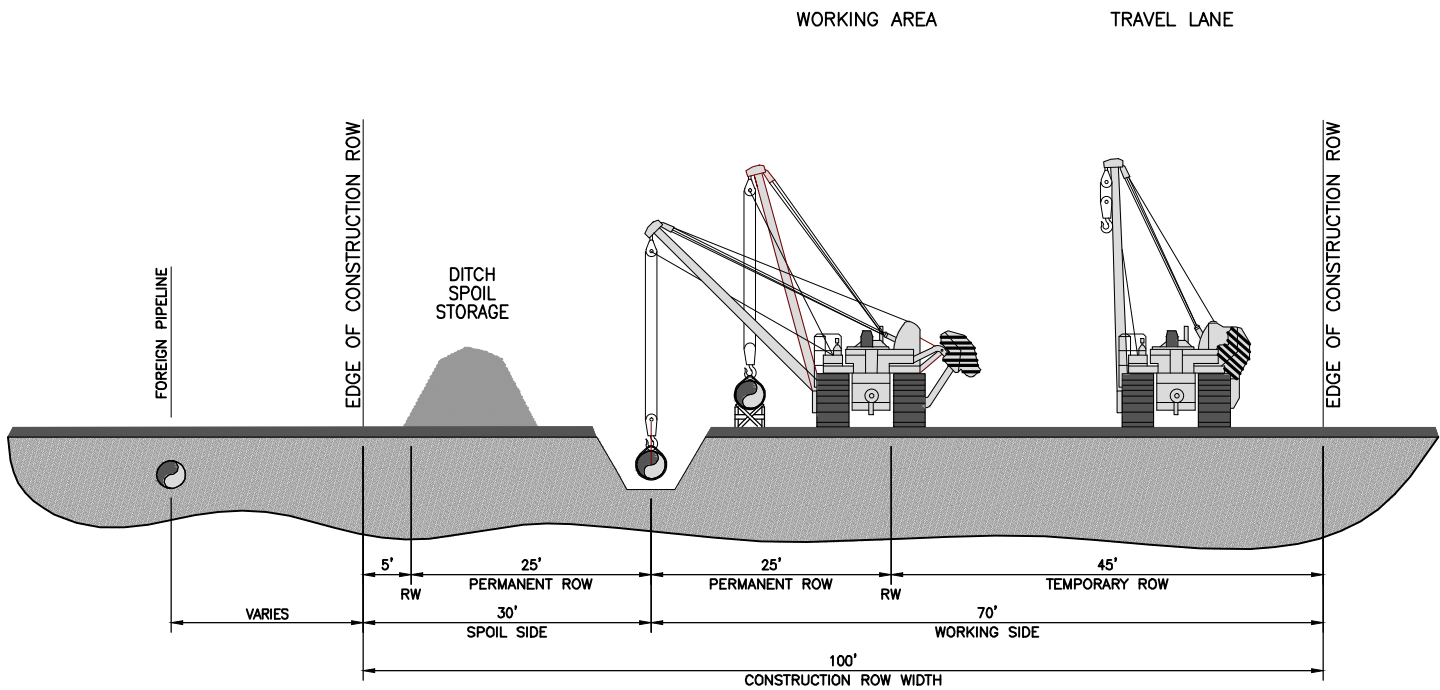

1. CONSTRUCTION WORKSPACE WILL TYPICALLY REQUIRE 110 FEET WIDTH CONSISTING OF 50 FEET OF PERMANENT EASEMENT, 50 FEET OF TEMPORARY WORKSPACE AND 10 FEET OF ADDITIONAL TEMPORARY WORKSPACE, FURTHER ADDITIONAL TEMPORARY WORKSPACE WILL BE NECESSARY AT ROAD, RAIL AND RIVER CROSSINGS AND OTHER SPECIAL CIRCUMSTANCES, AS REQUIRED. CERTAIN SITUATIONS MAY REQUIRE A NARROWER WIDTH.
2. LEAVE GAPS IN SPOIL PILES AT OBVIOUS DRAINAGES. DO NOT PUSH UPLAND SOILS INTO WATERBODIES OR WETLANDS.

					
				TYPICAL CONSTRUCTION WORKSPACE WITH DITCH & SPOIL TOPSOIL ONLY ATWS SPOIL SIDE	
B	ISSUED FOR FERC	06/2015	JSC		
A	DRAFT ISSUED FOR FERC	03/2015	JSC		
NO.	REVISION	DATE	APPR.		
 WILLBROS ENGINEERS (U.S.) LLC <small>FIRM REGISTRATION NUMBER: TX F-82</small>				DRAWING NUMBER	SHEET
				52715-TYP-018	1 OF 1



NOTES:

1. UPLAND CONSTRUCTION WILL TYPICALLY REQUIRE 100 FEET WIDE CONSISTING OF 50 FEET OF PERMANENT EASEMENT, 50 FEET OF TEMPORARY WORKSPACE, FURTHER ADDITIONAL TEMPORARY WORKSPACE WILL BE NECESSARY AT ROAD, RAIL AND RIVER CROSSINGS AND OTHER SPECIAL CIRCUMSTANCES, AS REQUIRED. CERTAIN SITUATIONS MAY REQUIRE A NARROWER WIDTH.
2. LEAVE GAPS IN SPOIL PILES AT OBVIOUS DRAINAGES. DO NOT PUSH UPLAND SOILS INTO WATERBODIES OR WETLANDS.

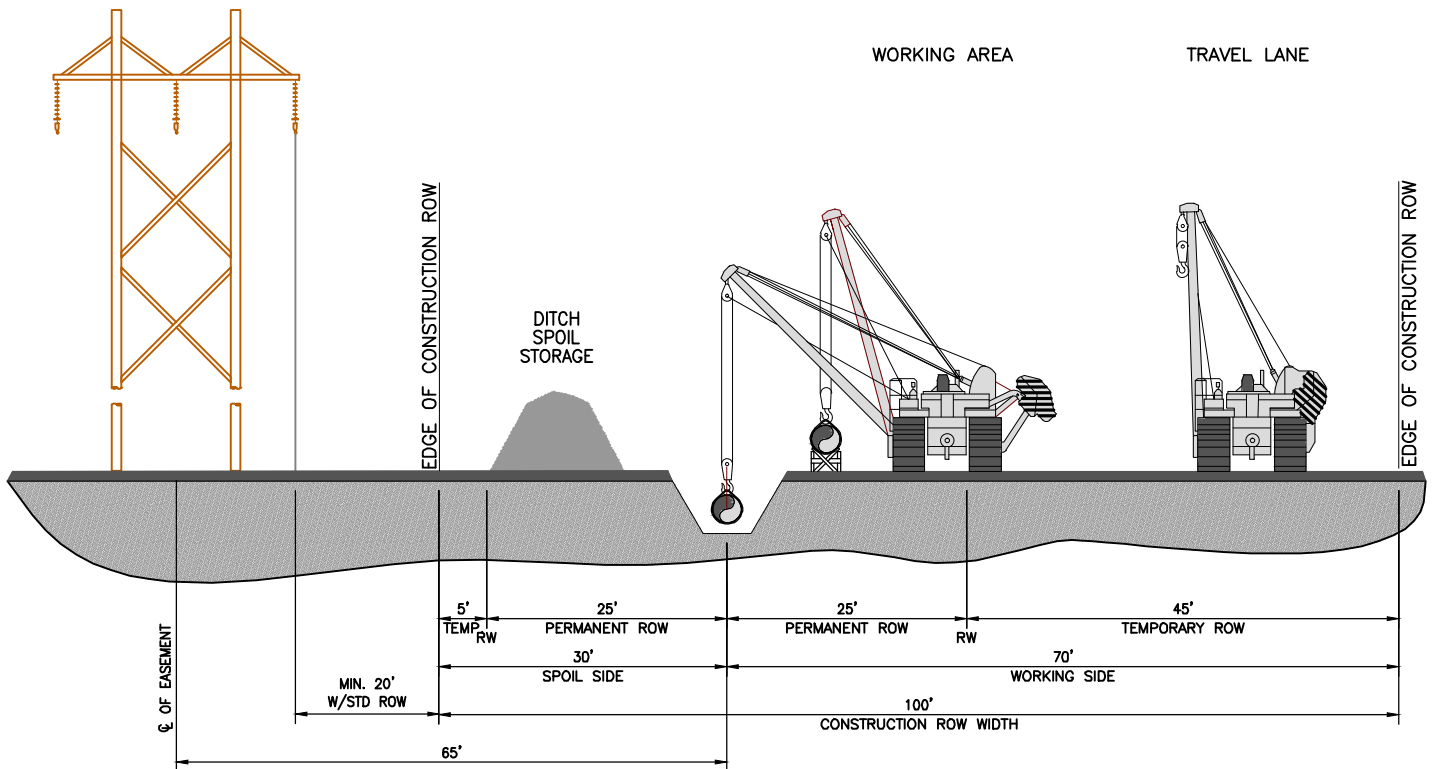

					
				TYPICAL COLOCATION WITH FOREIGN PIPELINES	
B	ISSUED FOR FERC	06/2015	JSC		
A	DRAFT ISSUED FOR FERC	03/2015	JSC		
NO.	REVISION	DATE	APPR.		
 WILLBROS ENGINEERS (U.S.) LLC <small>FIRM REGISTRATION NUMBER: TX F-82</small>				DRAWING NUMBER 52715-TYP-021	
				SHEET 1 OF 1	



POWER LINE VOLTAGE	OSHA MINIMUM APPROACH DISTANCE
0-69,000 VOLTS	10 FEET
115,000 - 138,000 VOLTS	11 FEET
230,000 VOLTS	13 FEET
500,000 VOLTS	18 FEET

NOTES:

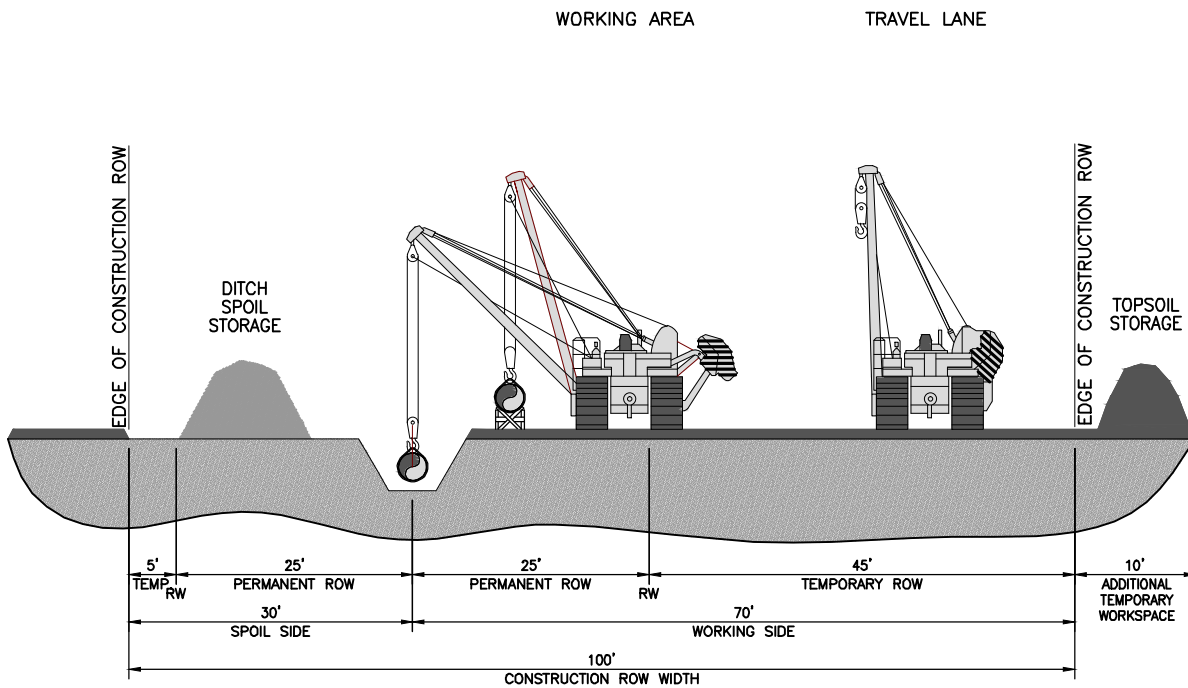

1. DEPICTED WITH STANDARD UPLAND ROW CONFIGURATION PER TYPICAL DWG 52715-TYP-015.
2. WHERE TOPSOIL STRIPPING IS REQUIRED, AN ADDITIONAL 10' WILL BE USED FOR SPOIL STORAGE PER TYPICAL DWG 52715-TYP-024.

					
				TYPICAL COLOCATION WITH POWERLINES	
B	ISSUED FOR FERC	06/2015	JSC		
A	DRAFT ISSUED FOR FERC	03/2015	JSC		
NO.	REVISION	DATE	APPR.		
 WILLBROS ENGINEERS (U.S.) LLC <small>FIRM REGISTRATION NUMBER: TX F-82</small>				DRAWING NUMBER 52715-TYP-022	
				SHEET 1 OF 1	



NOTES:

1. CONSTRUCTION WORKSPACE WILL TYPICALLY REQUIRE 110 FEET WIDTH CONSISTING OF 50 FEET OF PERMANENT EASEMENT, 50 FEET OF TEMPORARY WORKSPACE AND 10 FEET OF ADDITIONAL TEMPORARY WORKSPACE, FURTHER ADDITIONAL TEMPORARY WORKSPACE WILL BE NECESSARY AT ROAD, RAIL AND RIVER CROSSINGS AND OTHER SPECIAL CIRCUMSTANCES, AS REQUIRED. CERTAIN SITUATIONS MAY REQUIRE A NARROWER WIDTH.
2. LEAVE GAPS IN SPOIL PILES AT OBVIOUS DRAINAGES. DO NOT PUSH UPLAND SOILS INTO WATERBODIES OR WETLANDS.

					
				TYPICAL CONSTRUCTION WORKSPACE WITH DITCH & SPOIL TOPSOIL ONLY ATWS WORKING SIDE	
A	ISSUED FOR FERC	06/2015	JSC		
NO.	REVISION	DATE	APPR.		
 WILLBROS ENGINEERS (U.S.) LLC <small>FIRM REGISTRATION NUMBER: TX F-82</small>				DRAWING NUMBER 52715-TYP-024	
				SHEET 1 OF 1	

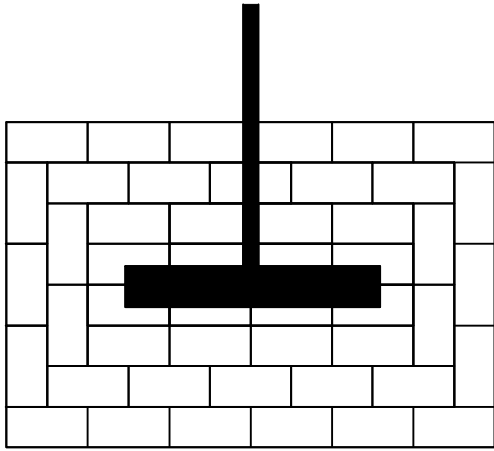

PLAN VIEW
(NOT TO SCALE)

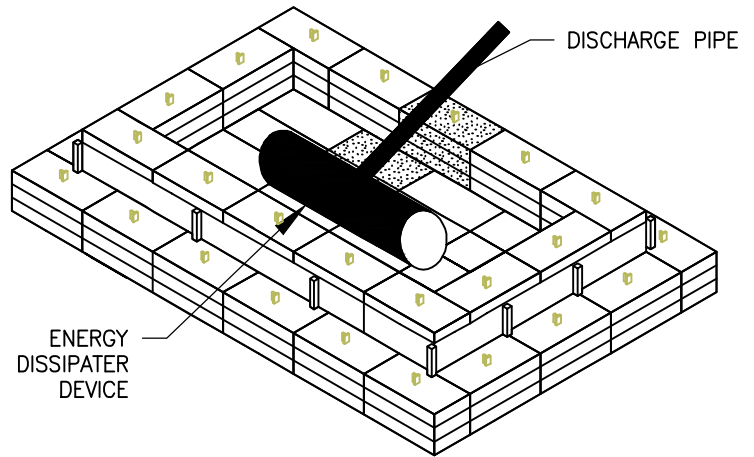

ISOMETRIC VIEW
(NOT TO SCALE)

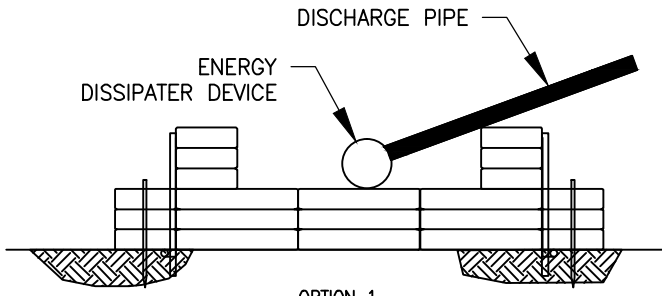

OPTION 1

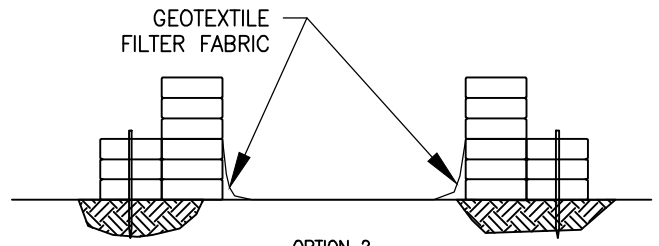

OPTION 2

NOTES:

1. INSTALL A STRAW BALE DEWATERING STRUCTURE WHEREVER IT IS NECESSARY AND AS DIRECTED BY THE ENGINEER TO PREVENT THE FLOW OF HEAVILY SILT LADEN WATER INTO WATER BODIES OR WETLANDS. ALL DEWATERING ACTIVITIES SHALL BE CONDUCTED IN ACCORDANCE WITH PERMIT CONDITIONS.
2. DISCHARGE SITE SHOULD BE WELL VEGETATED AND LOCATED AT LEAST 100 FEET FROM ANY WATERCOURSE. THE TOPOGRAPHY OF THE SITE SHOULD BE SUCH THAT WATER WILL FLOW INTO THE DEWATERING STRUCTURE AND AWAY FROM ANY WORK AREAS. THE AREA DOWNSLOPE FROM THE SITE MUST BE REASONABLY LEVEL OR STABILIZED BY VEGETATION OR OTHER MEANS TO ALLOW THE FILTERED WATER TO CONTINUE AS SHEET FLOW.
3. DIRECT THE PUMPED WATER ONTO A STABLE SPILL PAD CONSTRUCTED OF STRAW BALES, ROCK FILL, WEIGHTED TIMBERS, OR A WOVEN GEOTEXTILE STAKED TO THE GROUND SURFACE.
4. DISCHARGE RATES SHOULD BE SUCH THAT THE STRUCTURE WILL NOT OVERFLOW.
5. DISCHARGE WATER TO BE FORCED INTO SHEET FLOW IMMEDIATELY BEYOND THE SPILL PAD USING A COMBINATION OF STRAW BALES AND THE NATURAL TOPOGRAPHY. RECESS STRAW BALES A MINIMUM OF FOUR (4) INCHES, DRIVE TWO (2) STAKES OR REBAR INTO EACH BALE TO ANCHOR THEM IN PLACE.
6. MANUFACTURED FILTER BAGS ARE A SUITABLE ALTERNATIVE TO STRAW BALE STRUCTURES FOR TRENCH DEWATERING.
7. ENERGY DISSIPATER DEVICE SHALL BE ANCHORED BY CONTRACTOR.

B	ISSUED FOR FERC	06/12/15	
A	DRAFT ISSUED FOR FERC	03/02/15	
NO.	REVISION	DATE	APPR.
 WILLBROS ENGINEERS (U.S.) LLC <small>FIRM REGISTRATION NUMBER: TX F-82</small>			



HYDROSTATIC TEST
DEWATERING STRUCTURE

DRAWING NUMBER	SHEET
52715-TYP-110	1 OF 1

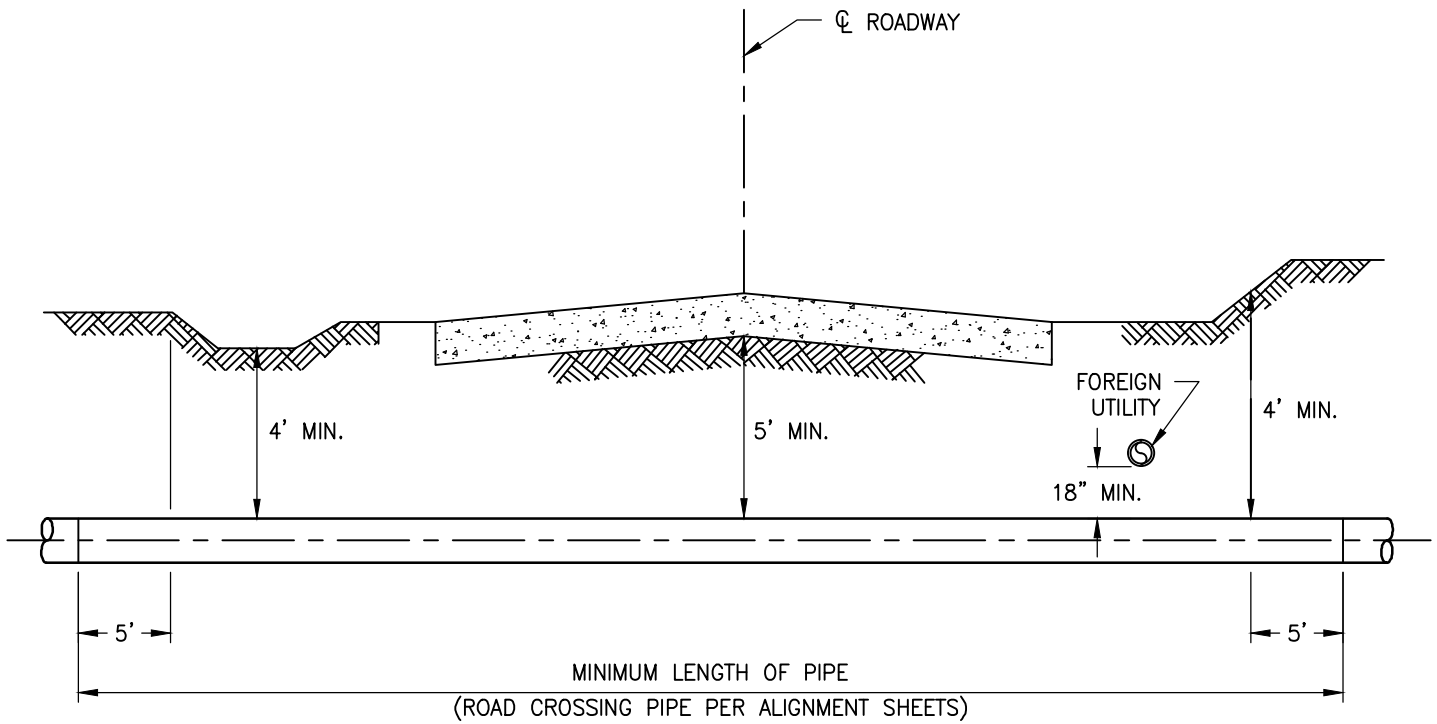

TYPICAL CROSS SECTION

NOTES:

1. CONTRACTOR SHALL INSTALL THE STEEL PIPE, BACKFILL AND REPLACE ROAD SURFACE IN ACCORDANCE WITH THE LINE LIST, ALIGNMENT SHEETS, OR AS SPECIFIED BY JURISDICTIONAL AUTHORITY, WHICHEVER IS THE MOST STRINGENT.
2. THE PIPELINE SHALL CROSS AS NEAR TO A RIGHT ANGLE AS POSSIBLE AND ECONOMICALLY PRACTICAL.
3. THE STEEL PIPE SHALL BE INSTALLED FROM THE PRIVATE ROAD LIMITS AND EXTEND A MINIMUM OF FIVE (5) FEET BEYOND PRIVATE ROAD LIMITS.
4. ANY OPEN CUT TRENCH SHALL BE IN ACCORDANCE WITH AND AS DEFINED IN THE SPECIFICATION AND STANDARD. THE TRENCH SHALL BE BACKFILLED IN EIGHT (8) INCH LIFTS AND COMPACTED TO 95% OF THE MAXIMUM DRY DENSITY AS DETERMINED BY THE PROCTOR COMPACTION TEST (ASTM D698).
5. AS AN ALTERNATE, AND WHEN APPROVED BY ENGINEER, CONCRETE SLURRY (2000 PSI CONCRETE) MAY BE USED AS BACKFILL MATERIAL ABOVE THE PIPE.
6. REPLACE SUB-GRADE AND ROAD SURFACE MATERIAL WITH EQUAL OR GREATER THICKNESS AND WITH EQUAL OR GREATER MATERIAL AND SPECIFICATIONS TO PROVIDE A SMOOTH AND CONTINUOUS ROAD SURFACE.

B	ISSUED FOR FERC	06/12/15	
A	DRAFT ISSUED FOR FERC	03/02/15	
NO.	REVISION	DATE	APPR.
 WILLBROS ENGINEERS (U.S.) LLC <small>FIRM REGISTRATION NUMBER: TX F-82</small>			



TYPICAL OPEN CUT
PRIVATE ROAD CROSSING

DRAWING NUMBER	SHEET
52715-TYP-111	1 OF 1

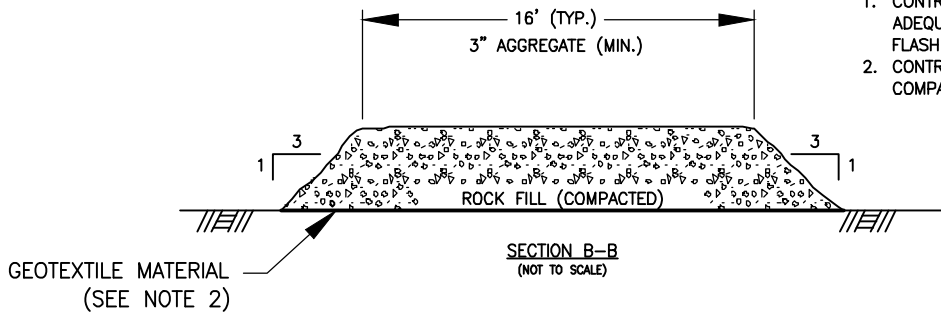
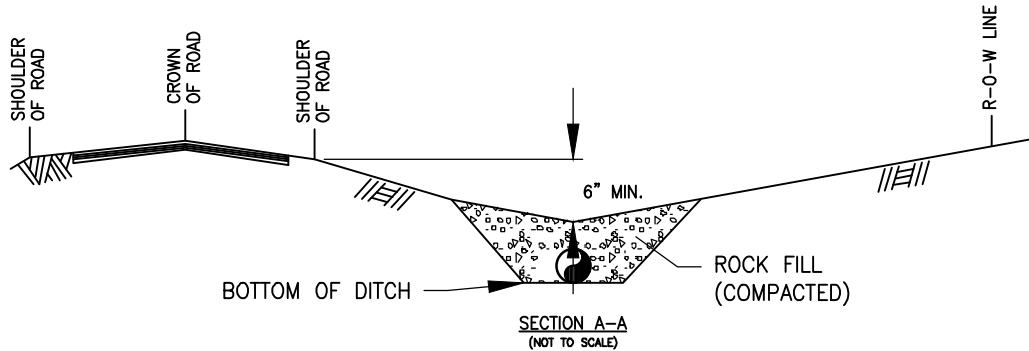
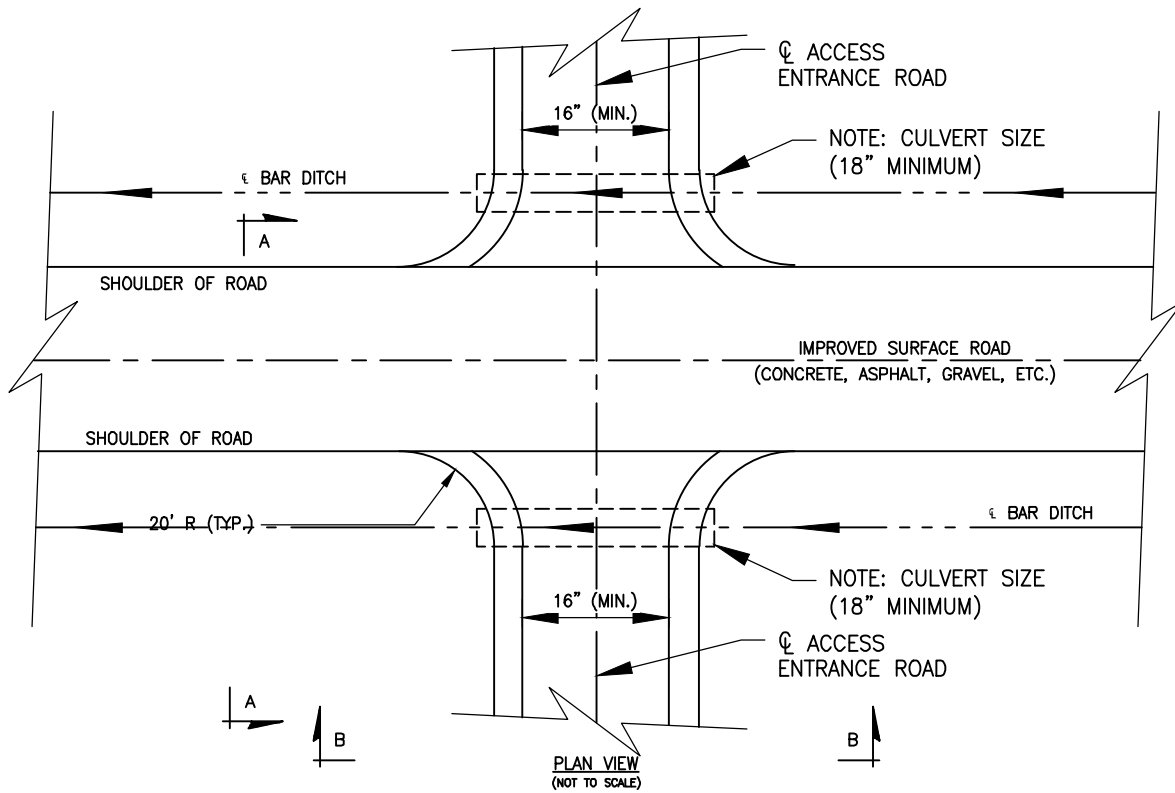

NOTES:

1. CONTRACTOR SHALL FURNISH AND INSTALL ADEQUATE TRAFFIC CONTROL SIGNS, MARKERS, FLASHERS, ETC.
2. CONTRACTOR SHALL FURNISH AND INSTALL COMPANY APPROVED GEOTEXTILE MATERIAL.

B	ISSUED FOR FERC	06/12/15		
A	DRAFT ISSUED FOR FERC	03/02/15		
NO.	REVISION	DATE	APPR.	
 WILLBROS ENGINEERS (U.S.) LLC <small>FIRM REGISTRATION NUMBER: TX F-62</small>				



**TYPICAL PUBLIC ACCESS ROAD
ACCESS RAMP**

DRAWING NUMBER	SHEET
52715-TYP-112	1 OF 1

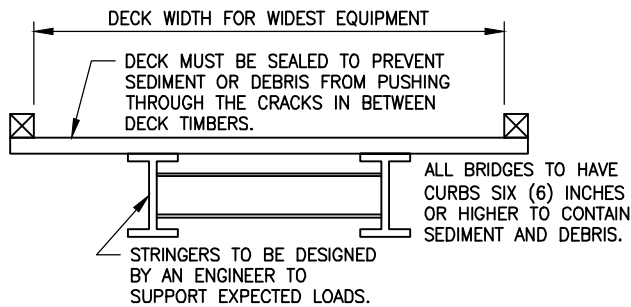

SECTION A-A

THE FOLLOWING IS A SEQUENCE OF CONSTRUCTION AND MITIGATION MEASURES TO BE FOLLOWED AT ALL TEMPORARY BRIDGE CROSSINGS.

1. A PRE-FABRICATED BRIDGE OR FLATBED RAILCAR, FLEXI-FLOAT OR FLUMED VEHICLE CROSSING MAY BE SUBSTITUTED FOR THE TEMPORARY BRIDGE.
2. INSTALL THE BRIDGE IN A MANNER THAT WILL MINIMIZE SEDIMENT ENTERING THE WATER. STRINGERS MUST BE DESIGNED TO SUPPORT THE LOADS EXPECTED ON THE BRIDGE. CURBS AT LEAST SIX (6) INCHES HIGH MUST BE INSTALLED ALONG THE EDGE OF THE DECK TO CONTAIN SEDIMENT AND DEBRIS ON THE BRIDGE. FASTENERS CONNECTING COMPONENTS MUST BE STRONG ENOUGH TO HOLD THEM IN POSITION DURING THE LIFE OF THE BRIDGE. CRIBS MAY BE FILLED WITH ROCK OR COBBLE, OR MAY BE SOLID TIMBER ROTATED 90° IN ALTERNATIVE LAYERS. RIP-RAP EROSION PROTECTION IS TO BE PLACED AROUND THE CRIBS AND ON ANY FILL SLOPES PROJECTING INTO THE WATER.
3. ROAD APPROACHES LEADING TO THE BRIDGE MUST BE RAISED AND STABLE SO EQUIPMENT LOADS ARE SUPPORTED A SUFFICIENT DISTANCE BACK FROM THE WATER TO REDUCE SEDIMENT AND DEBRIS ENTERING THE STREAM FROM EQUIPMENT TRACKS. DO NOT USE SOIL TO CONSTRUCT OR STABILIZE EQUIPMENT BRIDGES. IF CUTS ARE NEEDED TO OBTAIN A SATISFACTORY GRADE, THEY ARE TO BE DUG WITH SIDE DITCHES AND STABLE SLOPES. EROSION AND SEDIMENT CONTROL MEASURES ARE TO BE INSTALLED TO KEEP SEDIMENT ON LAND (E.G., SILT FENCING, FILTER CLOTH, RIP-RAP, SEED AND MULCH, ETC.).
4. PERIODICALLY CHECK BRIDGE INSTALLATION AND REMOVE ANY BUILD-UP OF SEDIMENT OR DEBRIS ON THE BRIDGE.

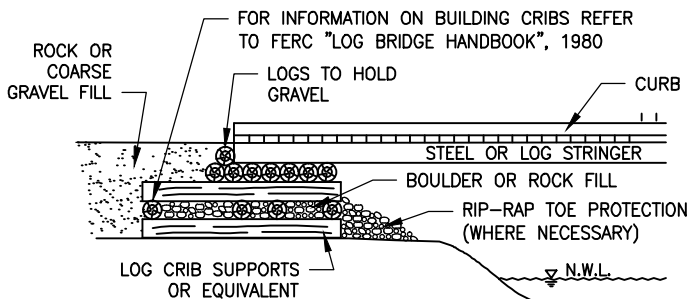

POSSIBLE CONFIGURATION FOR TEMPORARY CRIB ABUTMENT

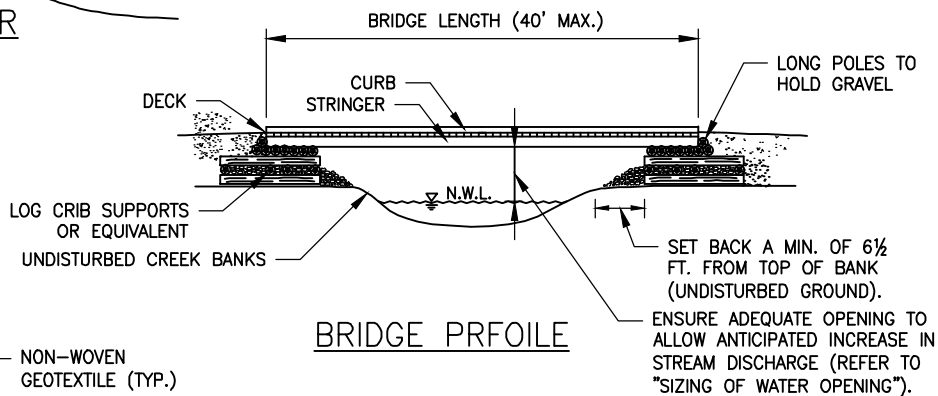

BRIDGE PROFILE

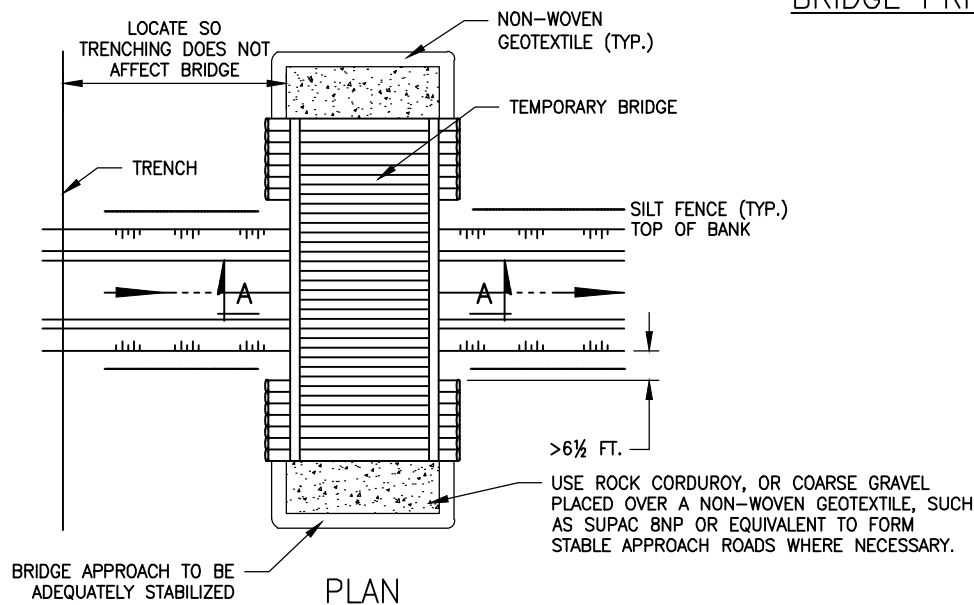

TEMPORARY BRIDGE

B	ISSUED FOR FERC	06/12/15	
A	DRAFT ISSUED FOR FERC	03/02/15	
NO.	REVISION	DATE	APPR.



WILLBROS ENGINEERS (U.S.) LLC
FIRM REGISTRATION NUMBER: TX F-82

DRAWING NUMBER

SHEET

52715-TYP-115

1 OF 1

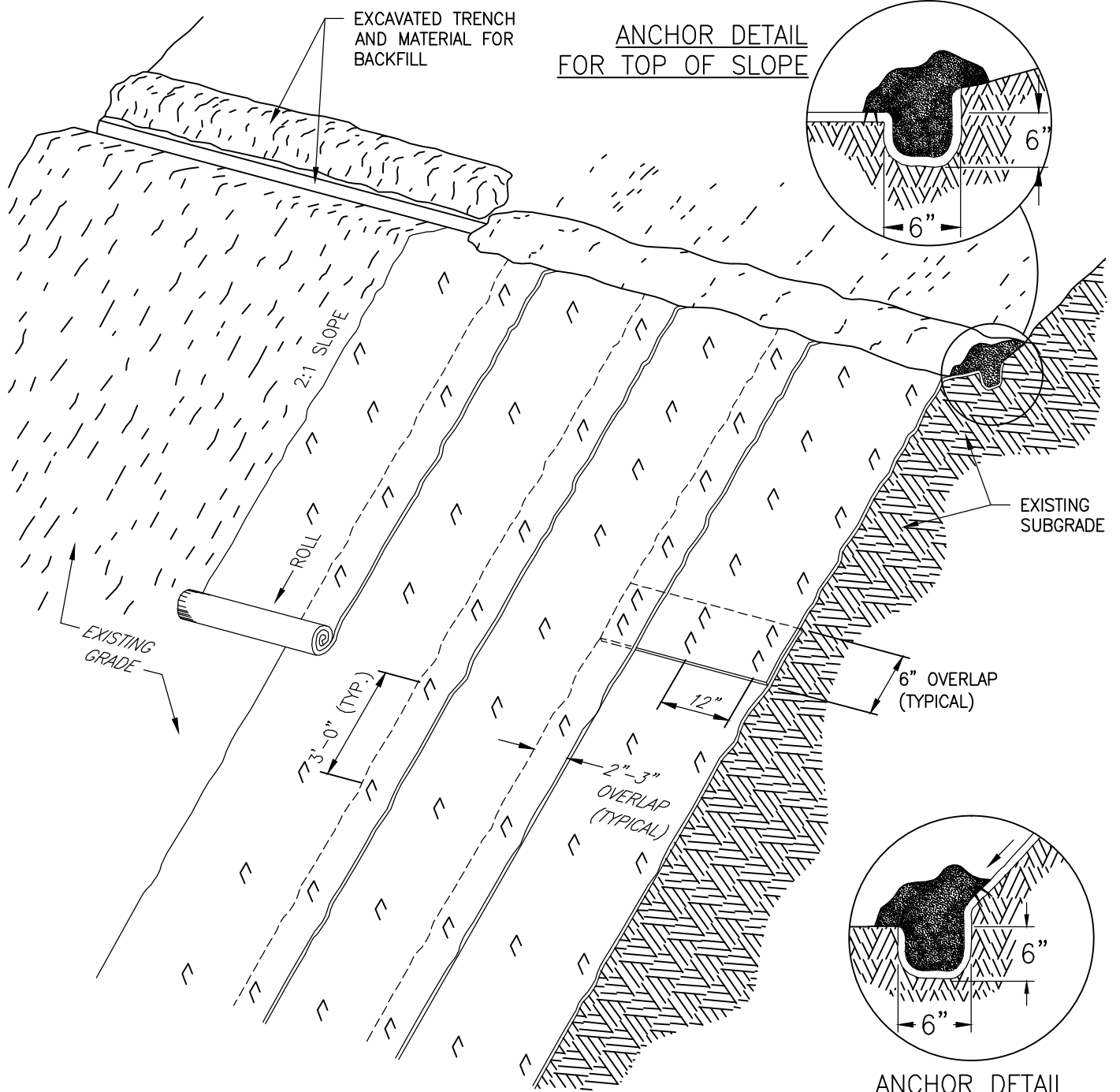

NOTES:

1. SLOPE SURFACE SHALL BE FREE OF ROCKS, CLODS, STICKS AND GRASS; MAT/BLANKETS SHALL HAVE GOOD SOIL CONTACT.
2. LAY BLANKET LOOSELY AND STAKE OR STAPLE TO MAINTAIN DIRECT CONTACT WITH THE SOIL; DO NOT STRETCH MATERIAL.
3. STAPLES SHALL BE INSTALLED PER THE STAPLE LAYOUT DETAIL AND WITH STANDARD MAT STAPLES.
4. ON SLOPED AREAS MATTING SHOULD BE INSTALLED VERTICALLY DOWNSLOPE.

ANCHOR DETAIL FOR BASE OF SLOPE

B	ISSUED FOR FERC	06/12/15	
A	DRAFT ISSUED FOR FERC	03/02/15	
NO.	REVISION	DATE	APPR.



SHORELINE /
BANK STABILIZATION



WILLBROS ENGINEERS (U.S.) LLC
FIRM REGISTRATION NUMBER: TX F-82

DRAWING NUMBER	SHEET
52715-TYP-116	1 OF 1

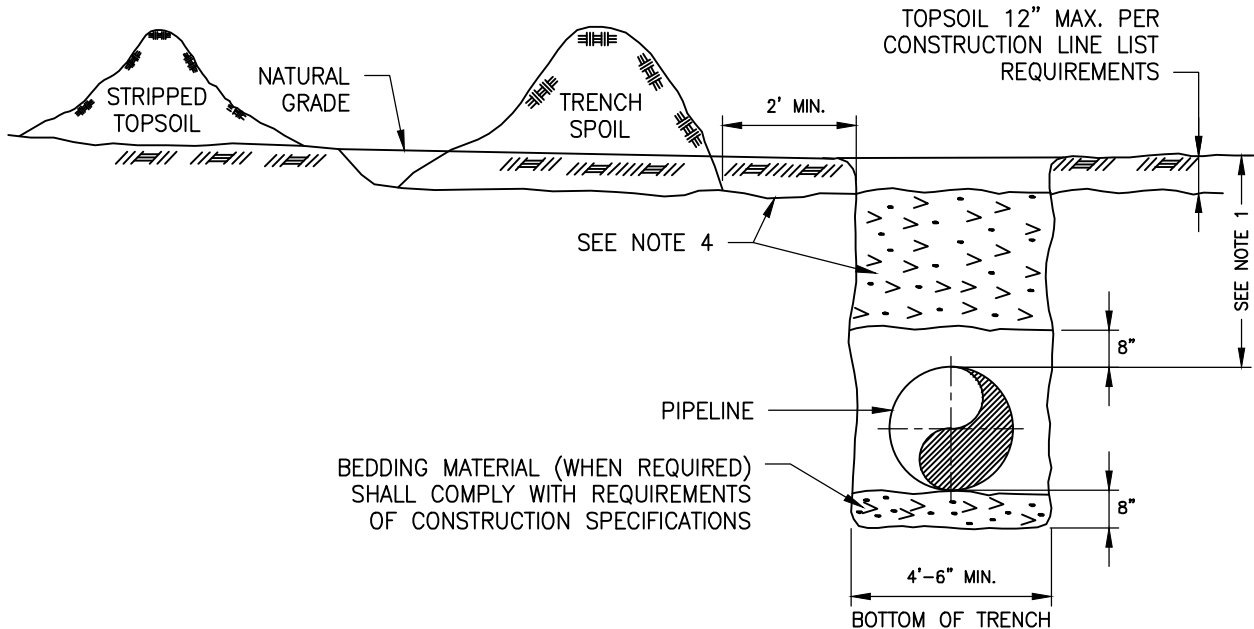

NOTES:

- INSTALL WITH A MINIMUM COVER AS FOLLOWS: (OR PER RIGHT-OF-WAY, OR PERMIT STIPULATIONS, OR PER SITE SPECIFIC DRAWINGS)

LOCATION	NORMAL SOIL	CONSOLIDATED ROCK*
NON-CULTIVATED LAND	36 INCHES	24 INCHES
CULTIVATED DEEP PLOW	48 INCHES	N/A
CULTIVATED LAND	48 INCHES	N/A
PUBLIC ROAD SURFACES	60 INCHES	SITE SPECIFIC
RAILROADS, BOTTOM OF TRACKS	SITE SPECIFIC	SITE SPECIFIC
DRAINAGE DITCHES OF PUBLIC ROAD CROSSINGS	48 INCHES	SITE SPECIFIC
DRAINAGE DITCHES OF RAILROAD CROSSINGS	72 INCHES	SITE SPECIFIC
RIVER AND STREAM CROSSINGS	60 INCHES	SITE SPECIFIC
INDUSTRIAL, COMMERCIAL, & RESIDENTIAL	48 INCHES	N/A

* CONSOLIDATED ROCK IS DEFINED AS ROCK LAYERS WHOSE UPPERMOST SURFACE EXISTS AT A HIGHER ELEVATION THAN THE ELEVATION OF THE TOP OF THE PIPE.

- BOTTOM OF TRENCH WIDTH TO BE PIPE O.D. PLUS 18 TO 24 INCHES.
- PADDING MATERIAL SHALL CONSIST OF SOIL, SAND, OR CRUSHED ROCK THAT PASSES THROUGH A 1½ INCH SCREENING MECHANISM.
- BACKFILL SHALL NOT CONTAIN ROCK EXCEEDING TWELVE (12) INCHES IN SIZE.
- THESE ARE MINIMUM SPECIFICATIONS AND MAY BE INCREASED BY SPECIAL REQUIREMENTS AS DEFINED ELSEWHERE IN CONSTRUCTION SPECIFICATIONS OR ON DRAWINGS, DEPTH OF COVER IS MEASURED FROM NATURAL GRADE ELEVATION TO TOP OF PIPE COATING.

B	ISSUED FOR FERC	06/12/15	
A	DRAFT ISSUED FOR FERC	03/02/15	
NO.	REVISION	DATE	APPR.



STANDARD TRENCH AND BACKFILL REQUIREMENTS (WITH BEDDING AND PADDING)



WILLBROS ENGINEERS (U.S.) LLC
FIRM REGISTRATION NUMBER: TX F-82

DRAWING NUMBER

SHEET

52715-TYP-119

1 OF 1

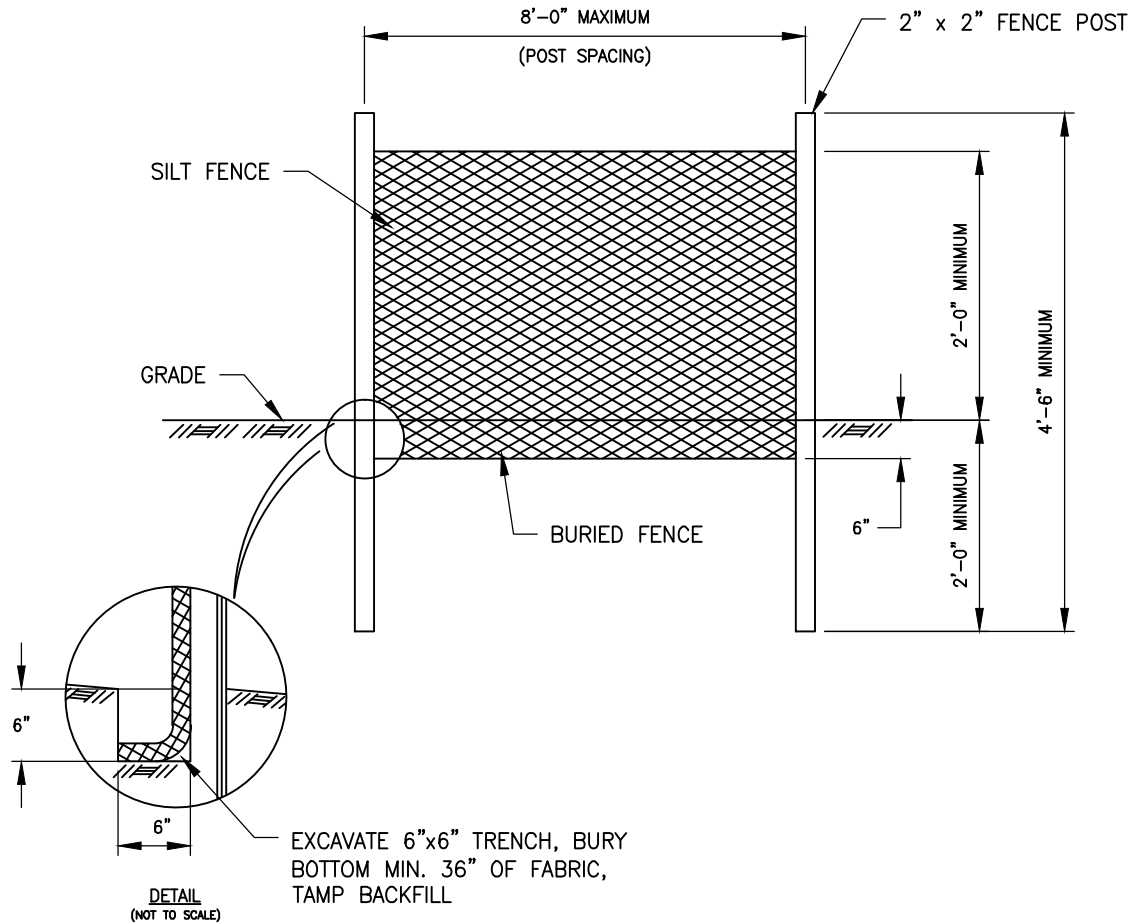

NOTES:

1. SILT FENCES ARE CONSTRUCTED FROM SYNTHETIC MESH MATERIAL DESIGNED TO RETAIN SILT WHILE ALLOWING WATER TO PASS THROUGH (EXXON GTF 180, MIRAFLI 600X OR APPROVED EQUAL).
2. SILT FENCES WILL BE CONSTRUCTED AT THE EDGE OF THE RIGHT-OF-WAY:
 - AT THE OUTFALL OF AN INTERCEPTOR DIKE IF NATURAL VEGETATION IS INSUFFICIENT TO FILTER THE SILT FROM THE RUN-OFF WATER.
 - AT THE BASE OF SLOPES ADJACENT TO ROADWAYS AND STREAMS WHEN THE NATIVE VEGETATION COVER HAS BEEN DISTURBED.
 - WHEN THE DISTANCE (IN AREAS OF GOOD VEGETATION COVER) OF THE RIGHT-OF-WAY TO A BODY OF WATER IS EQUAL TO OR LESS THAN THE FOLLOWING SCHEDULE.

PERCENT	SLOPE DISTANCE
0 - 5%	25 FEET
5 - 15%	50 FEET
15 - 30%	75 FEET
OVER 30%	100 FEET

 - WHEN THE DISTANCE (IN AREAS OF POOR VEGETATION COVER) OF THE RIGHT-OF-WAY TO A BODY OF WATER IS WITHIN 150 FEET AND THE AREA SLOPES TOWARD THE WATER.



EROSION CONTROL
SILT FENCE

B	ISSUED FOR FERC	06/12/15		
A	DRAFT ISSUED FOR FERC	03/02/15		
NO.	REVISION	DATE	APPR.	
WILLBROS ENGINEERS (U.S.) LLC <small>FIRM REGISTRATION NUMBER: TX F-82</small>				

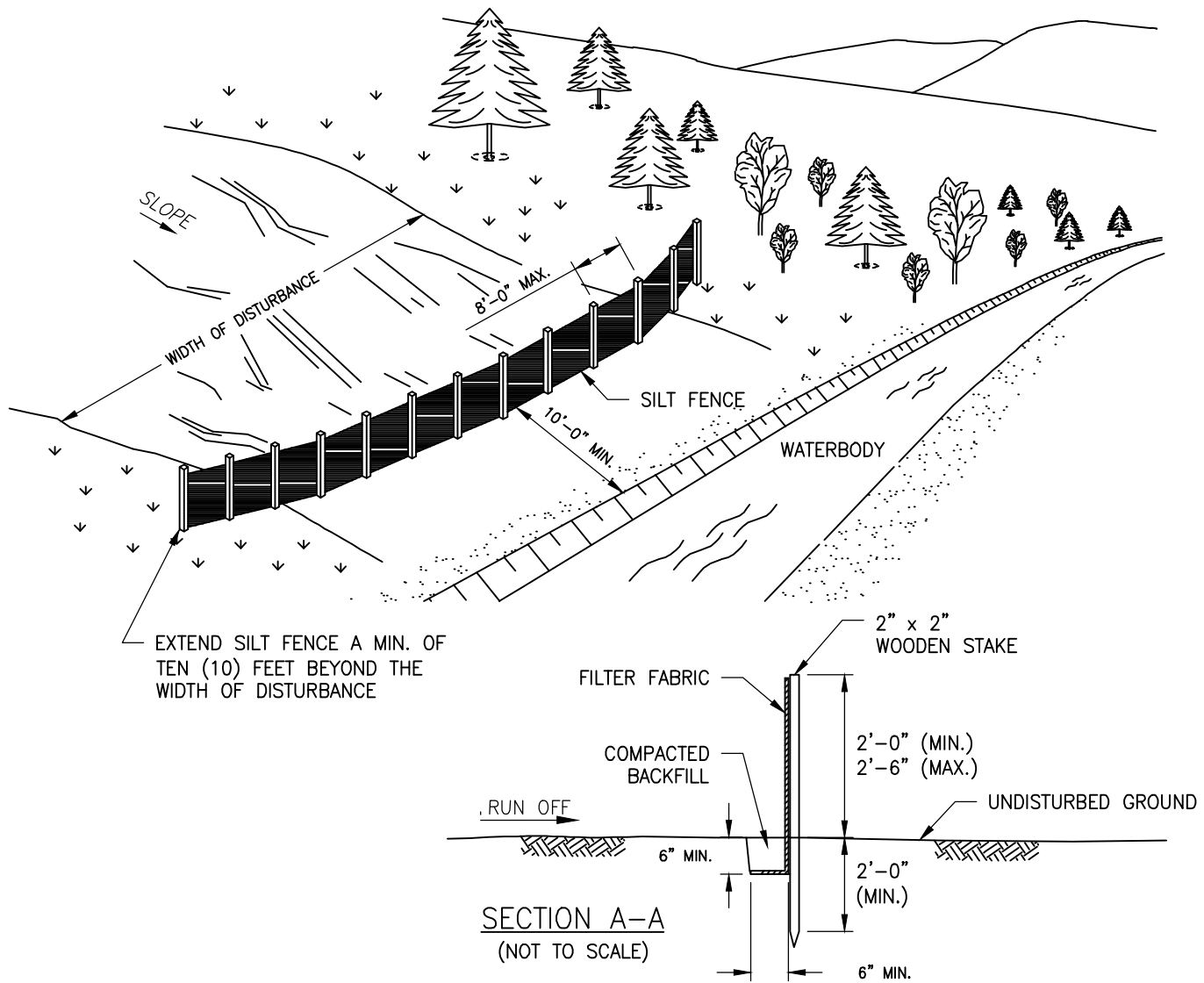

NOTES:

1. SILT FENCES ARE TO BE USED IN AREAS WHERE SHEET FLOW OR RELATIVELY SMALL VOLUMES OF WATER CAN BE EXPECTED TO OCCUR. FOR LARGER VOLUMES SUCH AS WITHIN A DEFINED CHANNEL, A CHECK DAM WILL BE REQUIRED.
2. STAKES ARE TO BE PLACED EVERY TEN (8) FEET OR CLOSER AS CONDITIONS REQUIRE.
3. ATTACH FILTER FABRIC AT EACH POST AT A MINIMUM OF THREE (3) LOCATIONS.
4. THE FILTER FABRIC (MIN. OF 36") IS TO BE ANCHORED IN A SIX (6) INCH x SIX (6) INCH TRENCH WITH WELL COMPACTED BACKFILL OVER THE FABRIC TO PREVENT UNDERMINING.
5. TO ELIMINATE POSSIBLE END FLOW, BOTH ENDS OF THE SILT FENCE SHALL BE TURNED AND EXTENDED UPSLOPE.
6. SILT FENCES ARE TO BE CHECKED AND MAINTAINED ON A REGULAR BASIS. REMOVE ANY BUILD-UP OF SEDIMENT WHEN THE HEIGHT OF SEDIMENT EXCEEDS APPROXIMATELY 20% OF THE HEIGHT OF THE BARRIER.
7. MATERIAL SHOULD BE WOVEN GEOTEXTILE FABRIC SUCH AS EXXON GTF 180 OR MIRAFI 600X, OR AN APPROVED EQUIVALENT. SECONDARY REINFORCEMENT, SUCH AS A CONSTRUCTION BARRIER FENCE OR WIRE MESH CAN ALSO BE USED BEHIND THE FILTER FABRIC.
8. WHERE ANCHORING CONDITIONS FOR THE SILT FENCE ARE POOR, PLACE ANCHORED STRAW BALES ON DOWNSTREAM SIDE OF THE SILT FENCE.

B	ISSUED FOR FERC	06/12/15	
A	DRAFT ISSUED FOR FERC	03/02/15	
NO.	REVISION	DATE	APPR.
 WILLBROS ENGINEERS (U.S.) LLC <small>FIRM REGISTRATION NUMBER: TX F-82</small>			



**EROSION CONTROL
SILT FENCE BARRIER**

DRAWING NUMBER	SHEET
52715-TYP-124	1 OF 1

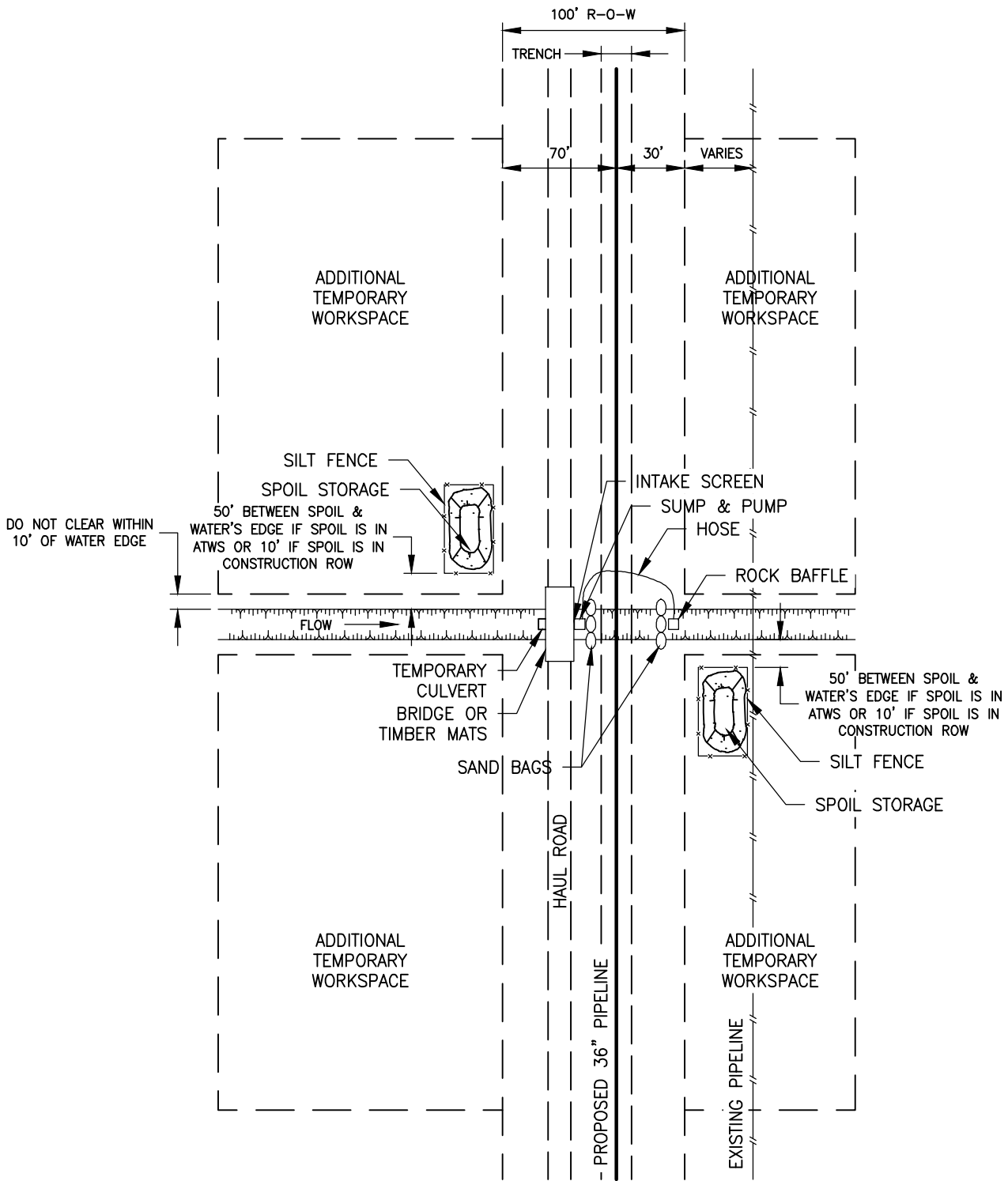

REFER TO SHEET 2 OF 2

SHEET 1 OF 2

B	ISSUED FOR FERC	06/12/15	
A	DRAFT ISSUED FOR FERC	03/02/15	
NO.	REVISION	DATE	APPR.



EROSION CONTROL
DAM AND PUMP



DRAWING NUMBER	SHEET
52715-TYP-127A	1 OF 2

DAM AND PUMP CROSSING

THE FOLLOWING IS A SEQUENCE OF CONSTRUCTION AND MITIGATION MEASURES TO BE FOLLOWED AT ALL "DAM AND PUMP" TYPE CROSSINGS.

SEQUENCE OF ACTIVITIES

- STEP 1. CLEAR AND GRADE RIGHT-OF-WAY AS NECESSARY.
- STEP 2. IMPLEMENT THE TEMPORARY EROSION AND SEDIMENT CONTROLS.
- STEP 3. FABRICATE PIPE.
- STEP 4. INSTALL DRY STREAM CROSSING MATERIALS.
- STEP 5. EXCAVATE TRENCH AND INSTALL PIPE.
- STEP 6. BACKFILL AND RESTORE STREAM BANKS.
- STEP 7. REMOVE DAMS.
- STEP 8. IMPLEMENT THE PERMANENT EROSION & SEDIMENTATION CONTROLS.

MAINTENANCE OF STREAMFLOW



IF THERE IS ANY FLOW IN THE WATERCOURSE, INSTALL PUMPS TO MAINTAIN STREAM FLOW AROUND THE BLOCKED OFF SECTIONS OF CHANNEL. THE PUMP IS TO HAVE 1.5 TO 2 TIMES THE PUMPING CAPACITY OF ANTICIPATED FLOW. A SECOND STANDBY PUMP OF EQUAL CAPACITY IS TO BE READILY AVAILABLE AT ALL TIMES. AN ENERGY DISSIPATER IS TO BE BUILT TO ACCEPT PUMP DISCHARGE WITHOUT STREAM BED OR STREAM BANK EROSION. IF THE CROSSING IS PROLONGED BEYOND ONE (1) DAY THE OPERATION NEEDS TO BE MONITORED OVERNIGHT.

NOTES:

1. WHERE NECESSARY, OBTAIN PRIOR APPROVAL BEFORE USING THE DAM AND PUMP METHOD.
2. SCHEDULE INSTREAM ACTIVITY FOR LOW FLOW PERIODS AND FOR THE APPROPRIATE TIMING WINDOW.
3. MARK OUT AND MAINTAIN LIMITS OF AUTHORIZED WORK AREAS WITH FENCING OR FLAGGING TAPE TO AVOID UNNECESSARY DISTURBANCE OF VEGETATION. ENSURE EQUIPMENT OPERATORS WORKING ON THE CROSSING HAVE BEEN BRIEFED ABOUT THIS PLAN AND THE MEASURES NEEDED TO PROTECT WATER QUALITY. INSTALL PRE-WORK SEDIMENT CONTROL MEASURES AS SPECIFIED IN THE PLAN. ALL NECESSARY EQUIPMENT AND MATERIALS TO BUILD THE DAMS AND TO PUMP WATER MUST BE ON SITE OR READILY AVAILABLE PRIOR TO COMMENCING IN-WATER CONSTRUCTION. PIPE SHOULD BE STRUNG, WELDED AND COATED AND READY FOR INSTALLATION PRIOR TO WATERCOURSE TRENCHING.
4. CONTRACTOR SHALL SUPPLY, INSTALL AND MAINTAIN SEDIMENT CONTROL STRUCTURES, AS DEPICTED OR ALONG DOWN GRADIENT SIDES OF WORK AREAS AND STAGING AREAS SUCH THAT NO HEAVILY SILT LADEN WATER ENTERS STREAM.
 - a. NO HEAVILY SILT LADEN WATER SHALL BE DISCHARGED DIRECTLY OR INDIRECTLY INTO THE STREAM.
 - b. EROSION AND SEDIMENT CONTROL STRUCTURE LOCATIONS AS DEPICTED ARE APPROXIMATE AND MAY BE ADJUSTED AS DIRECTED BY THE COMPANY INSPECTOR TO ACTUAL SITE CONDITIONS.
 - c. SILT FENCE OR STRAW BALE INSTALLATIONS SHALL INCLUDE REMOVABLE SECTIONS TO FACILITATE ACCESS DURING CONSTRUCTION. UTILIZE STRAW BALE BARRIERS ONLY IN LIEU OF A SILT FENCE WHERE FREQUENT ACCESS IS REQUIRED.
 - d. SEDIMENT LADEN WATER FROM TRENCH DEWATERING SHALL BE DISCHARGED TO A WELL VEGETATED UPLAND AREA, INTO A STRAW BALE DEWATERING STRUCTURE OR GEOTEXTILE FILTER BAG.
 - e. SEDIMENT CONTROL STRUCTURES MUST BE IN PLACE AT ALL TIMES ACROSS THE DISTURBED PORTIONS OF THE RIGHT-OF-WAY EXCEPT DURING EXCAVATION/INSTALLATION OF THE CROSSING PIPE.
 - f. SOFT DITCH PLUGS MUST REMAIN IN PLACE AT CONVENIENT LOCATIONS TO SEPARATE MAINLINE DITCH FROM THE RIVER CROSSING UNTIL THE RIVER CROSSING IS INSTALLED AND BACKFILLED.
5. TO THE EXTENT POSSIBLE, MAINTAIN A MINIMUM 50 FEET ON FEDERAL LAND AND 10 FEET ON PRIVATE LAND. VEGETATIVE BUFFER STRIP BETWEEN DISTURBED AREAS AND THE WATERCOURSE. INSTALL AND MAINTAIN A SILT FENCE UPSLOPE OF THE BUFFER STRIP ON EACH SIDE OF THE WATERCOURSE. THE SILT FENCE SHOULD INCORPORATE REMOVABLE "GATES" AS REQUIRED TO ALLOW ACCESS WHILE MAINTAINING EASE OF REPLACEMENT FOR OVERNIGHT OR DURING PERIODS OF RAINFALL.
6. CONSTRUCT A TEMPORARY SUMP UPSTREAM OF THE DAM AND LINE WITH ROCKFILL IF A NATURAL POOL DOES NOT EXIST. INSTALL THE PUMP OR PUMP INTAKE IN THE POOL OR SUMP. DISCHARGE WATER ONTO AN ENERGY DISSIPATER DOWNSTREAM OF THE WORK AREA.
7. EXCAVATED MATERIAL MUST NOT BE STOCKPILED WITHIN 50 FEET ON FEDERAL LAND AND 10 FEET ON PRIVATE LAND OF THE WATERCOURSE.
8. CHEMICALS, FUELS, LUBRICATING OILS SHALL NOT BE STORED AND EQUIPMENT REFUELED WITHIN 500 FEET OF THE WATERBODY. PUMPS ARE TO BE REFUELED AS PER THE SPOC PLANS.
9. STAGING AREAS ARE TO BE LOCATED AT LEAST 50 FEET FROM THE WATER'S EDGE ON FEDERAL LAND AND 10 FEET ON PRIVATE LAND (WHERE TOPOGRAPHIC CONDITIONS PERMIT) AND SHALL BE THE MINIMUM SIZE NEEDED.
10. DAMS ARE TO BE MADE OF STEEL PLATE, INFLATABLE PLASTIC DAM, SAND BAGS, COBBLES, WELL GRADED COARSE GRAVEL FILL, OR ROCK FILL. DAMS MAY NEED KEYING INTO THE BANKS AND STREAM BED. ENSURE THAT THE DAM AND VEHICLE CROSSING ARE LOCATED FAR ENOUGH APART TO ALLOW FOR A WIDE EXCAVATION. CAP FLUMES USED UNDER VEHICLE CROSSING DURING DRY CROSSING.
11. DEWATER AREA BETWEEN DAMS IF POSSIBLE. DEWATERING SHOULD OCCUR IN A STABLE VEGETATIVE AREA A MINIMUM OF 50 FT. FROM ANY WATERBODY. THE PUMP DISCHARGE SHOULD BE DISCHARGED ONTO A STABLE SPILL PAD CONSTRUCTED OF ROCKFILL SANDBAGS, OR TIMBERS TO PREVENT LOCALIZED EROSION. THE DISCHARGE WATER SHOULD ALSO BE FORCED INTO SHEET FLOW IMMEDIATELY BEYOND THE SPILL PAD BY USING STRAW BALES AND THE NATURAL TOPOGRAPHY. IF IT IS NOT POSSIBLE TO DEWATER THE EXCAVATION DUE TO SOILS WITH A HIGH HYDRAULIC CONDUCTIVITY, THE EXCAVATION AND PIPE PLACEMENT IS TO BE CARRIED OUT IN THE STANDING WATER. PUMP ANY DISPLACED WATER AS DESCRIBED ABOVE TO PREVENT OVERTOPPING OF DAMS.
12. EXCAVATE TRENCH THROUGH PLUGS AND STREAM BED FROM BOTH SIDES, RE-POSITIONING DISCHARGE HOSE AS NECESSARY. LOWER THE PIPE IN THE TRENCH AND BACKFILL IMMEDIATELY. DURING THIS OPERATION WORK IS TO BE COMPLETED AS QUICKLY AS POSSIBLE.
13. CONTRACTOR SHALL RESTORE THE STREAM BED AND BANKS TO PRE-CONSTRUCTION CONTOURS, BUT NOT TO EXCEED TWO (2) HORIZONTAL TO ONE (1) VERTICAL.
 - a. CONTRACTOR SHALL INSTALL PERMANENT EROSION AND SEDIMENT CONTROL STRUCTURES AS INDICATED ON A SITE SPECIFIC BASIS.
 - b. ANY MATERIALS PLACED IN THE STREAM TO FACILITATE CONSTRUCTION SHALL BE REMOVED DURING RESTORATION. BANKS SHALL BE STABILIZED AND TEMPORARY SEDIMENT BARRIERS INSTALLED AS SOON AS POSSIBLE AFTER CROSSING, BUT WITHIN 24 HOURS OF COMPLETING THE CROSSING.
 - c. MAINTAIN A SILT FENCE OR STRAW BALE BARRIER ALONG THE WATER COURSE UNTIL VEGETATION IS ESTABLISHED IN ADJACENT DISTURBED AREAS.
14. WHEN THE STREAM BED HAS BEEN RESTORED, THE CREEK BANKS ARE TO BE CONTOURED TO A STABLE ANGLE AND PROTECTED WITH EROSION RESISTANT MATERIAL COMPATIBLE WITH FLOW VELOCITY BETWEEN DAMS (E.G., EROSION CONTROL BLANKETS, CRIBBING, ROCK RIP-RAP, ETC.). THE DAMS ARE TO BE REMOVED DOWNSTREAM FIRST. KEEP PUMP RUNNING UNTIL NORMAL FLOW IS RESUMED. COMPLETE BANK TRIMMING AND EROSION PROTECTION. IF SANDBAGS ARE USED FOR THE DAMS, PLACE AND REMOVE BY HAND TO AVOID EQUIPMENT BREAKING BAGS.

REFER TO SHEET 1 OF 2

SHEET 2 OF 2

					
				EROSION CONTROL DAM AND PUMP (NOTES)	
B ISSUED FOR FERC		06/12/15			
A DRAFT ISSUED FOR FERC		03/02/15			
NO.	REVISION	DATE	APPR.		
 WILLBROS ENGINEERS (U.S.) LLC <small>FIRM REGISTRATION NUMBER: TX F-82</small>				DRAWING NUMBER 52715-TYP-127B	
				SHEET 2 OF 2	

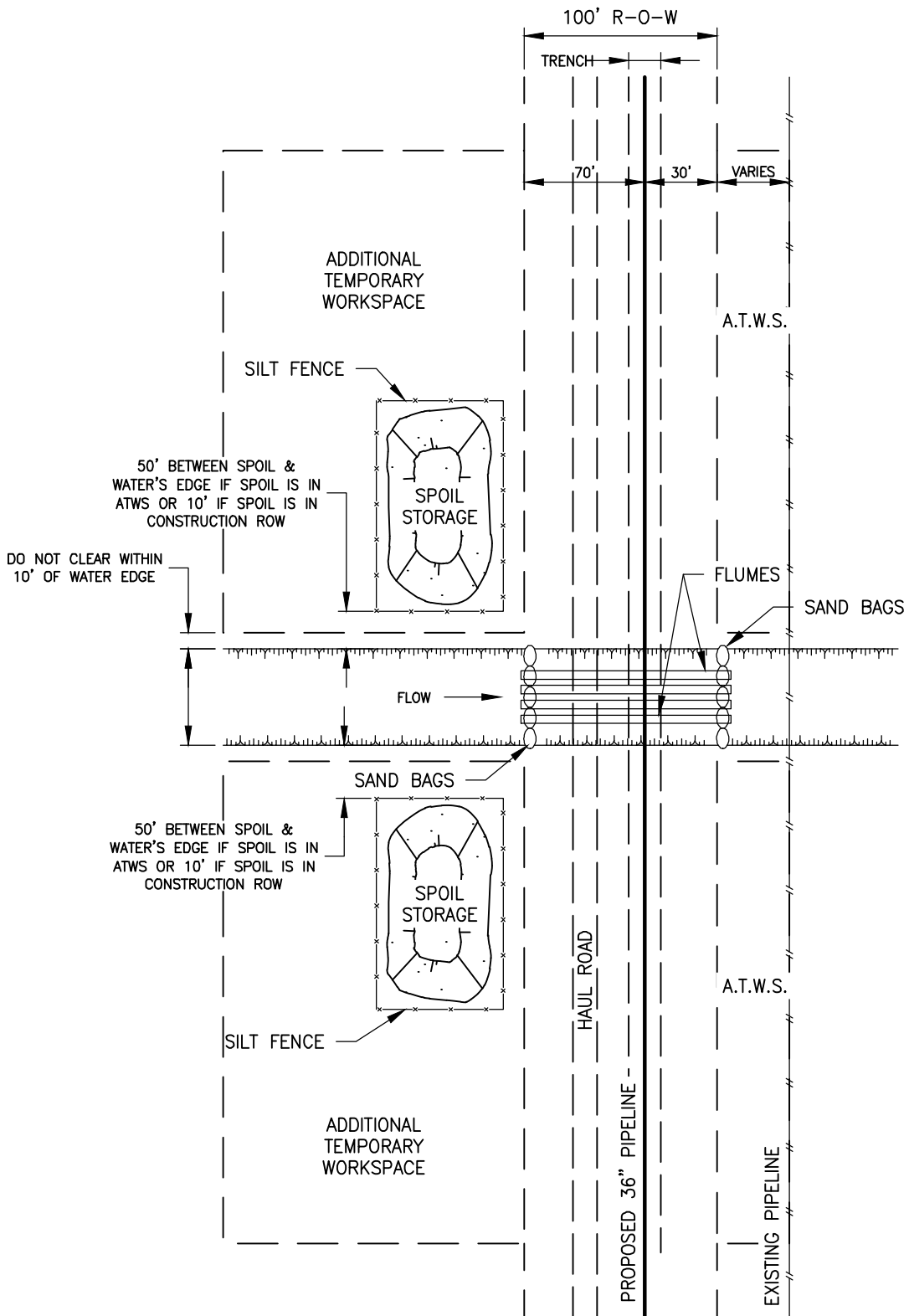

REFER TO SHEET 2 OF 2

SHEET 1 OF 2

B	ISSUED FOR FERC	06/12/15	
A	DRAFT ISSUED FOR FERC	03/02/15	
NO.	REVISION	DATE	APPR.



EROSION CONTROL
DRY FLUMED



WILLBROS ENGINEERS (U.S.) LLC
FIRM REGISTRATION NUMBER: TX F-82

DRAWING NUMBER	SHEET
52715-TYP-129A	1 OF 2

DRY FLUMED CROSSING

THE FOLLOWING IS A SEQUENCE OF CONSTRUCTION AND MITIGATION MEASURES TO BE FOLLOWED AT ALL "DRY FLUME" TYPE CROSSINGS.

SEQUENCE OF ACTIVITIES



- STEP 1. CLEAR AND GRADE RIGHT-OF-WAY AS NECESSARY.
- STEP 2. IMPLEMENT THE TEMPORARY EROSION AND SEDIMENT CONTROLS.
- STEP 3. FABRICATE PIPE.
- STEP 4. INSTALL DRY STREAM CROSSING MATERIALS.
- STEP 5. EXCAVATE TRENCH AND INSTALL PIPE.
- STEP 6. BACKFILL AND RESTORE STREAM BANKS.
- STEP 7. REMOVE FLUME CROSSING.
- STEP 8. IMPLEMENT THE PERMANENT EROSION & SEDIMENTATION CONTROLS.

NOTES:

1. MARK OUT AND MAINTAIN LIMITS OF AUTHORIZED WORK AREAS WITH FENCING OR FLAGGING TAPE TO AVOID UNNECESSARY DISTURBANCE OF VEGETATION. ENSURE EQUIPMENT OPERATORS WORKING ON THE CROSSING HAVE BEEN BRIEFED ABOUT THIS PLAN AND THE MEASURES NEEDED TO PROTECT WATER QUALITY.
2. ALL NECESSARY EQUIPMENT AND MATERIALS TO BUILD THE FLUME MUST BE ON SITE OR READILY AVAILABLE PRIOR TO COMMENCING.
3. TO THE EXTENT POSSIBLE, MAINTAIN A MINIMUM FIFTY (50) FEET ON FEDERAL LAND AND TEN (10) FEET ON PRIVATE LAND ON VEGETATIVE BUFFER STRIP BETWEEN DISTURBED AREAS AND THE WATERCOURSE. INSTALL AND MAINTAIN A SILT FENCE OR STRAW BALE BARRIER UPSLOPE OF THE BUFFER STRIP ON EACH SIDE OF THE WATERCOURSE.
4. CONTRACTOR SHALL SUPPLY, INSTALL AND MAINTAIN SEDIMENT CONTROL STRUCTURES, AS DEPICTED OR ALONG DOWN GRADIENT SIDES OF WORK AREAS AND STAGING AREAS SUCH THAT NO HEAVILY SILT LADEN WATER ENTERS STREAM.
 - a. NO HEAVILY SILT LADEN WATER SHALL BE DISCHARGED DIRECTLY OR INDIRECTLY INTO THE STREAM.
 - b. EROSION AND SEDIMENT CONTROL STRUCTURE LOCATIONS AS DEPICTED ARE APPROXIMATE AND MAY BE ADJUSTED AS DIRECTED BY THE COMPANY INSPECTOR TO ACTUAL SITE CONDITIONS.
 - c. SILT FENCE OR STRAW BALE INSTALLATIONS SHALL INCLUDE REMOVABLE SECTIONS TO FACILITATE ACCESS DURING CONSTRUCTION. UTILIZE STRAW BALE BARRIERS ONLY IN LIEU OF A SILT FENCE WHERE FREQUENT ACCESS IS REQUIRED.
 - d. SEDIMENT CONTROL STRUCTURES MUST BE IN PLACE AT ALL TIMES ACROSS THE DISTURBED PORTIONS OF THE RIGHT-OF-WAY EXCEPT DURING EXCAVATION/INSTALLATION OF THE CROSSING PIPE.
5. PIPE SHALL BE STRUNG AND WELDED FOR READY INSTALLATION PRIOR TO WATERCOURSE TRENCHING.
6. EXCAVATE TRENCH THROUGH PLUGS AND UNDER FLUME FROM BOTH SIDES. WORK IS TO BE COMPLETED AS QUICKLY AS POSSIBLE.
 - a. LOWER IN PIPE BY PASSING UNDER FLUME AND BACKFILL IMMEDIATELY WITH SPOIL MATERIAL.
 - b. IF THE SPOIL MATERIAL IS NOT SUITABLE, USE IMPORTED CLEAN GRAVEL MATERIAL FOR BACKFILL.
 - c. IF BLASTING IS REQUIRED, USE CONTROLLED BLASTING TECHNIQUES TO PREVENT DAMAGE TO THE FLOW CONVEYANCE SYSTEM. ALTERNATIVELY, BLASTING MAY BE ACCOMPLISHED PRIOR TO FLUME INSTALLATION BY DRILLING THROUGH THE OVERBURDEN.
7. EXCAVATED MATERIAL MUST NOT BE STOCKPILED WITHIN FIFTY (50) FEET ON FEDERAL LAND AND TEN (10) FEET ON PRIVATE LAND FOR THE WATERCOURSE. THIS MATERIAL MUST BE CONTAINED WITHIN BERM CONTAINMENT, WITH SECONDARY SILT FENCE PROTECTION TO PREVENT SATURATED SOIL FROM FLOWING BACK INTO THE WATERCOURSE.
8. FLUMES SHOULD BE REMOVED AS SOON AS POSSIBLE, WHEN NO LONGER REQUIRED FOR PIPE LAYING OR FOR ROAD ACCESS, IN THE FOLLOWING MANNER:
 - a. REMOVE THE VEHICLE CROSSING RAMP. BANKS ARE TO BE RESTORED TO A STABLE ANGLE AND PROTECTED WITH EROSION RESISTANT MATERIAL COMPATIBLE WITH THE FLOW CONDITIONS (E.G., EROSION CONTROL BLANKETS, CRIBBING, ROCK RIP-RAP, ETC.) TO THE MAXIMUM EXTENT POSSIBLE BEFORE REMOVING THE DAMS.
 - b. REMOVE DOWNSTREAM DAM.
 - c. REMOVE UPSTREAM DAM.
 - d. REMOVE FLUME.
 - e. COMPLETE BANK TRIMMING AND EROSION PROTECTION. IF SANDBAGS ARE USED FOR THE DAMS, PLACE AND REMOVE BY HAND TO AVOID EQUIPMENT BREAKING BAGS.
9. CONTRACTOR SHALL RESTORE THE STREAM BED AND BANKS TO PRE-CONSTRUCTION CONTOURS, BUT NOT TO EXCEED TWO (2) HORIZONTAL TO ONE (1) VERTICAL.
 - a. CONTRACTOR SHALL INSTALL PERMANENT EROSION AND SEDIMENT CONTROL STRUCTURES AS INDICATED ON A SITE SPECIFIC BASIS.
 - b. ANY MATERIALS PLACED IN THE STREAM TO FACILITATE CONSTRUCTION SHALL BE REMOVED DURING RESTORATION. BANKS SHALL BE STABILIZED AND TEMPORARY SEDIMENT BARRIERS INSTALLED AS SOON AS POSSIBLE AFTER CROSSING, BUT WITHIN 24 HOURS OF COMPLETING THE CROSSING.
 - c. MAINTAIN A SILT FENCE OR STRAW BALE BARRIER ALONG THE WATER COURSE UNTIL VEGETATION IS ESTABLISHED IN ADJACENT DISTURBED AREAS.

REFER TO SHEET 1 OF 2

SHEET 2 OF 2

				
			EROSION CONTROL DRY FLUMES (NOTES)	
B ISSUED FOR FERC		06/12/15		
A DRAFT ISSUED FOR FERC		03/02/15		
NO.	REVISION	DATE	APPR.	
 WILLBROS ENGINEERS (U.S.) LLC <small>FIRM REGISTRATION NUMBER: TX F-82</small>			DRAWING NUMBER	SHEET
			52715-TYP-129B	2 OF 2

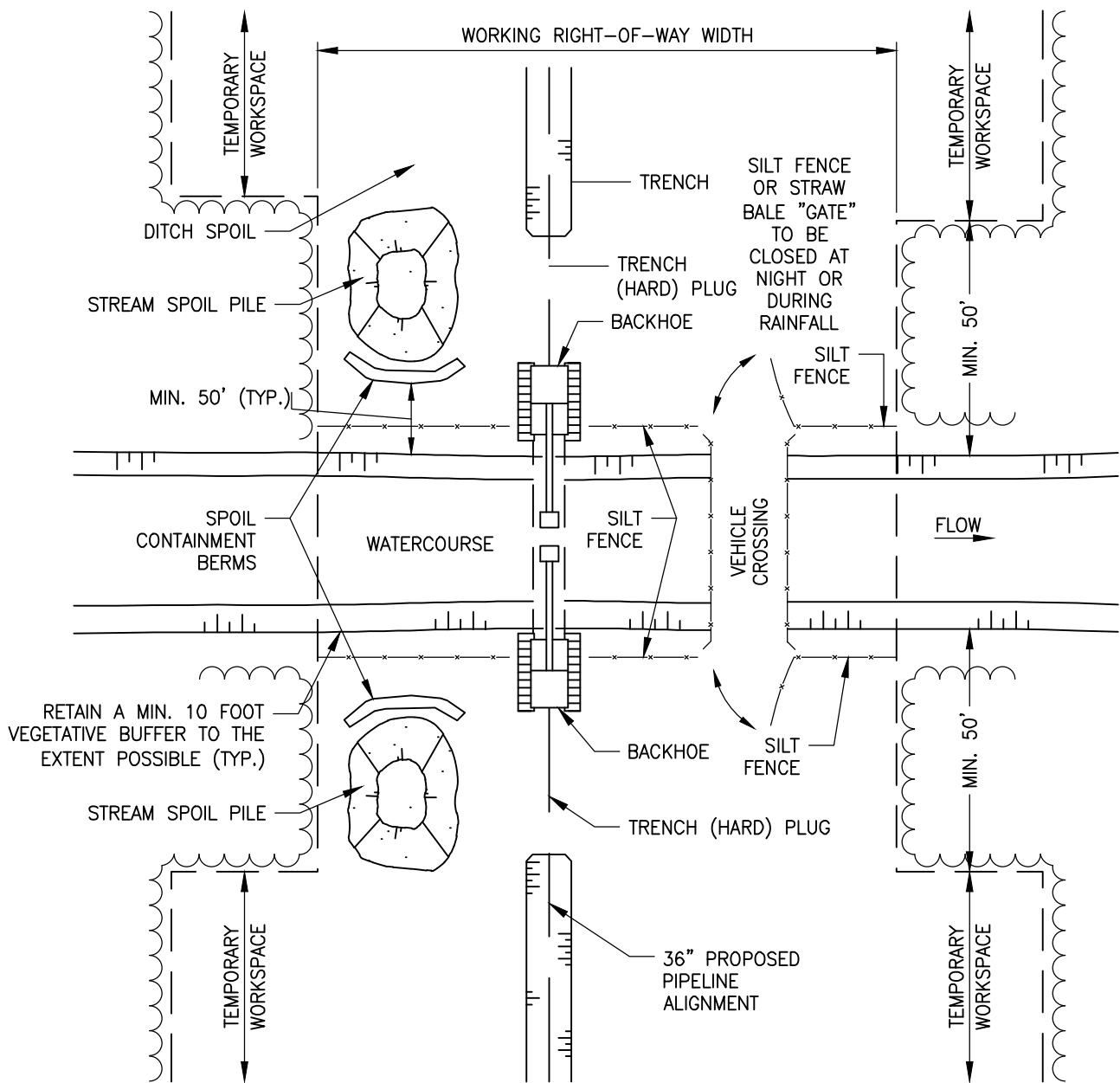

PLAN VIEW
(NOT TO SCALE)

SEQUENCE OF ACTIVITIES:

- STEP 1. CLEAR AND GRADE.
- STEP 2. IMPLEMENT THE TEMPORARY EROSION AND SEDIMENT CONTROLS.
- STEP 3. FABRICATE PIPE.
- STEP 4. EXCAVATE TRENCH AND INSTALL PIPE.
- STEP 5. BACKFILL AND RESTORE STREAM BANKS.
- STEP 6. IMPLEMENT THE PERMANENT EROSION AND SEDIMENT CONTROLS.

REFER TO SHEET 2 OF 2

SHEET 1 OF 2

B	ISSUED FOR FERC	06/12/15	
A	DRAFT ISSUED FOR FERC	03/02/15	
NO.	REVISION	DATE	APPR.
 WILLBROS ENGINEERS (U.S.) LLC <small>FIRM REGISTRATION NUMBER: TX F-82</small>			



OPEN CUT WATERBODY
CROSSING WITH FLOW



DRAWING NUMBER	SHEET
52715-TYP-131A	1 OF 2

NOTES:

1. WORK SPACE – LIMITS ARE DEPICTED. STAGING FOR MAKEUP LOCATED A MINIMUM OF FIFTY (50) FEET ON FEDERAL LAND AND TEN (10) FEET ON PRIVATE LAND FROM WATERBODY.
2. CLEARING – MARK CLEARING LIMITS AND MINIMIZE CLEARING OF RIPARIAN VEGETATION. WOODY VEGETATION SHALL BE CUT AT GROUND LEVEL AND THE STUMPS/ROOTS LEFT IN PLACE TO THE EXTENT POSSIBLE.
3. SPILL PREVENTION – CONTRACTOR SHALL INSTALL SIGNS 100 FEET MINIMUM FROM EACH STREAM BANK AND WETLAND TO IDENTIFY THE HAZARDOUS MATERIALS EXCLUSION AREA.
4. EROSION AND SEDIMENT CONTROL
 - A. CONTRACTOR SHALL SUPPLY, INSTALL AND MAINTAIN SEDIMENT CONTROL STRUCTURES, AS DEPICTED OR ALONG DOWN GRADIENT SIDES OF WORK AREAS AND STAGING AREAS SUCH THAT NO HEAVILY SILT LADEN WATER ENTERS STREAM OR WETLAND.
 - B. NO HEAVILY SILT LADEN WATER SHALL BE DISCHARGED DIRECTLY OR INDIRECTLY INTO THE STREAM. ALL EROSION AND SEDIMENT CONTROL STRUCTURE LOCATIONS AS DEPICTED ARE APPROXIMATE AND MAY BE ADJUSTED AS DIRECTED BY THE COMPANY INSPECTOR TO SUIT ACTUAL SITE CONDITIONS. SILT FENCE OR STRAW BALE INSTALLATIONS SHALL INCLUDE REMOVABLE SECTIONS TO FACILITATE ACCESS DURING CONSTRUCTION.
 - C. SEDIMENT LADEN WATER FROM TRENCH DEWATERING SHALL BE DISCHARGED TO A WELL VEGETATED UPLAND AREA, INTO A STRAW BALE DEWATERING STRUCTURE OR GEOTEXTILE FILTER BAG. SEDIMENT CONTROL STRUCTURES MUST BE IN PLACE AT ALL TIMES ACROSS THE DISTURBED CONSTRUCTION RIGHT OF WAY EXCEPT DURING EXCAVATION/INSTALLATION OF THE CROSSING PIPE.
 - D. SOFT DITCH PLUGS MUST REMAIN IN PLACE AT CONVENIENT LOCATIONS TO SEPARATE MAINLINE DITCH FROM THE RIVER CROSSING UNTIL THE RIVER CROSSING IS INSTALLED AND BACKFILLED.
 - E. TRENCH BREAKERS ARE TO BE INSTALLED AT THE SAME SPACING AND IMMEDIATELY UPSLOPE OF PERMANENT SLOPE BREAKERS, OR AS DIRECTED BY THE COMPANY.
5. INSTALLATION – CONTRACTOR SHALL MAINTAIN HARD PLUGS IN THE DITCH AT THE RIVER EDGE UNTIL JUST PRIOR TO PIPE INSTALLATION. CONTRACTOR SHALL EXCAVATE TRENCH AND INSTALL PIPE AS EXPEDIENTLY AS PRACTICAL TO REDUCE THE DURATION OF WORK ACTIVITIES IN THE STREAM BED.
6. SPOIL PLACEMENT – CONTRACTOR SHALL PLACE TRENCH SPOIL ONLY IN APPROVED WORK SPACES AND A MINIMUM OF TEN (10) FEET FROM THE STREAM BANKS TO PREVENT ENTRY OF SPOIL INTO THE STREAM FLOW. SPOIL SHALL BE CONTAINED AS NECESSARY USING EITHER A STRAW BALE BARRIER OR AN EARTH/ROCK BERM.
7. CLEANUP BANK STABILIZATION RESTORATION – CONTRACTOR SHALL RESTORE THE STREAM BED AND BANKS TO APPROXIMATE PRECONSTRUCTION CONTOURS, UNLESS OTHERWISE APPROVED BY THE COMPANY. CONTRACTOR SHALL INSTALL PERMANENT EROSION AND SEDIMENT CONTROL STRUCTURES AS INDICATED. ANY MATERIALS PLACED IN THE STREAM TO FACILITATE CONSTRUCTION SHALL BE REMOVED DURING RESTORATION. BANKS SHALL BE STABILIZED AND TEMPORARY SEDIMENT BARRIERS INSTALLED AS SOON AS POSSIBLE AFTER CROSSING, BUT WITHIN 24 HOURS OF COMPLETING THE CROSSING. MAINTAIN A SILT FENCE OR STRAW BALE BARRIER ALONG THE WATER COURSE AND WETLAND BOUNDARIES UNTIL VEGETATION IS ESTABLISHED IN ADJACENT DISTURBED AREAS.
8. TEMPORARY VEHICLE CROSSING – VEHICLE CROSSING CAN BE CONSTRUCTED USING EITHER A FLUME CROSSING OR A TEMPORARY BRIDGE.
9. REFERENCE – REFER TO WATER BODY AND WETLAND CROSSING PROCEDURES FOR REQUIREMENTS.

REFER TO SHEET 1 OF 2

SHEET 2 OF 2

					
				EROSION CONTROL OPEN CUT WET CROSSING (NOTES)	
B ISSUED FOR FERC		06/12/15			
A DRAFT ISSUED FOR FERC		03/02/15			
NO.	REVISION	DATE	APPR.		
 WILLBROS ENGINEERS (U.S.) LLC <small>FIRM REGISTRATION NUMBER: TX F-82</small>				DRAWING NUMBER	
				52715-TYP-131B	
				SHEET	
				2 OF 2	

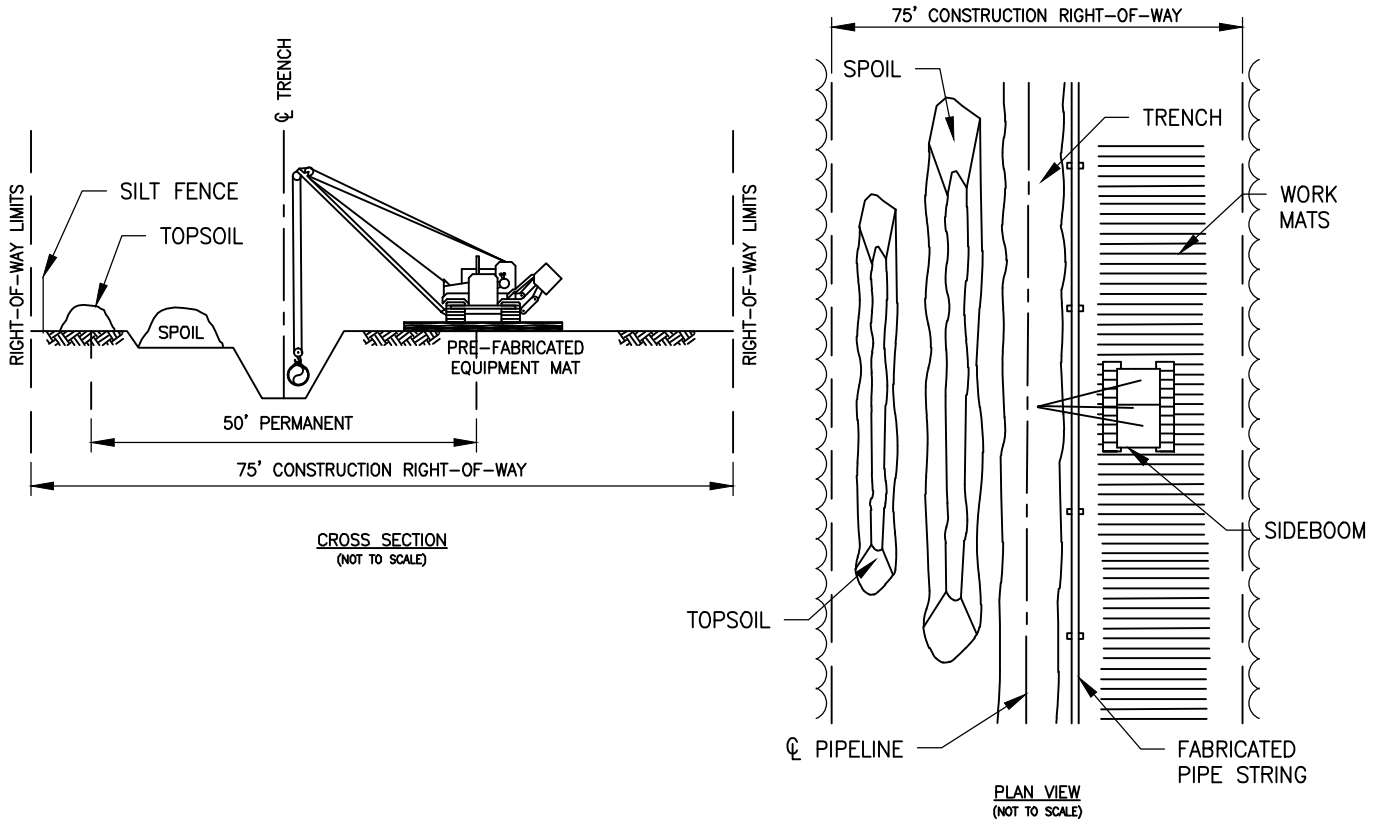

CONSTRUCTION PROCEDURE NOTES:

1. FLAG WETLAND BOUNDARIES PRIOR TO CLEARING. VEGETATION CANNOT BE CLEARED WITHIN A 10' BUFFER BETWEEN WETLAND BOUNDARIES AND CONSTRUCTION ROW, EXCEPT OVER THE TRENCH.
2. NO REFUELING OF MOBILE EQUIPMENT IS ALLOWED WITHIN 500 FEET OF WETLAND. PLACE "NO FUELING" SIGN POSTS 500 FEET BACK FROM WETLAND BOUNDARY. REFUEL STATIONARY EQUIPMENT AS PER SPCC PLAN.
3. INSTALL TEMPORARY SLOPE BREAKER UPSLOPE WITHIN 100 FEET OF WETLAND BOUNDARY IF DIRECTED BY THE ENVIRONMENTAL INSPECTOR.
4. CONSTRUCT WHEN DRY, IF POSSIBLE. IF SITE BECOMES WET AT TIME OF TRENCHING, AVOID SOIL COMPACTION BY UTILIZING TIMBER RIP-RAP OR PREFABRICATED EQUIPMENT MATS.
5. AVOID ADJACENT WETLANDS. INSTALL SEDIMENT BARRIERS (STRAW BALES AND/OR SILT FENCE) AT DOWN SLOPE EDGE OF RIGHT-OF-WAY ALONG WETLAND EDGE IF EVIDENT, OTHERWISE INSTALL BARRIER ON BOTH EDGES.
6. RESTRICT ROOT GRUBBING TO ONLY THAT AREA OVER THE DITCHLINE AND DITCH SPOIL AREAS. GRIND STUMPS IF NECESSARY IN OTHER AREAS TO FACILITATE CONSTRUCTION.
7. CONDUCT TRENCH LINE TOPSOIL STRIPPING (IF TOPSOIL IS NOT SATURATED). SALVAGE TOPSOIL TO ACTUAL DEPTH OR A MAXIMUM DEPTH OF TWELVE (12) INCHES, AS DETERMINED BY THE ENVIRONMENTAL INSPECTOR. SEGREGATED TOPSOIL PILE MAY BE LOCATED ON SPOIL SIDE, AS REQUIRED.
8. TRENCH THROUGH WETLANDS.
9. PIPE SECTION MAY BE FABRICATED WITHIN THE WETLAND AND ADJACENT TO ALIGNMENT, OR IN STAGING AREA OUTSIDE THE WETLAND AND WALKED IN.
10. LOWER IN PIPE. PRIOR TO BACKFILLING TRENCH, TRENCH PLUG REQUIREMENTS SHALL BE DETERMINED BY THE ENVIRONMENTAL INSPECTOR. BACKFILL TRENCH.
11. RESTORE GRADE TO NEAR PRE-CONSTRUCTION TOPOGRAPHY, REPLACE TOPSOIL AND INSTALL PERMANENT EROSION CONTROL.
12. REMOVE ANY TIMBER MATS OR PREFABRICATED MATS FROM WETLANDS UPON COMPLETION.

B	ISSUED FOR FERC	06/12/15	
A	DRAFT ISSUED FOR FERC	03/02/15	
NO.	REVISION	DATE	APPR.
 WILLBROS ENGINEERS (U.S.) LLC <small>FIRM REGISTRATION NUMBER: TX F-82</small>			



**TYPE 1
UNSATURATED WETLAND CROSSING**

DRAWING NUMBER	SHEET
52715-TYP-133	1 OF 1

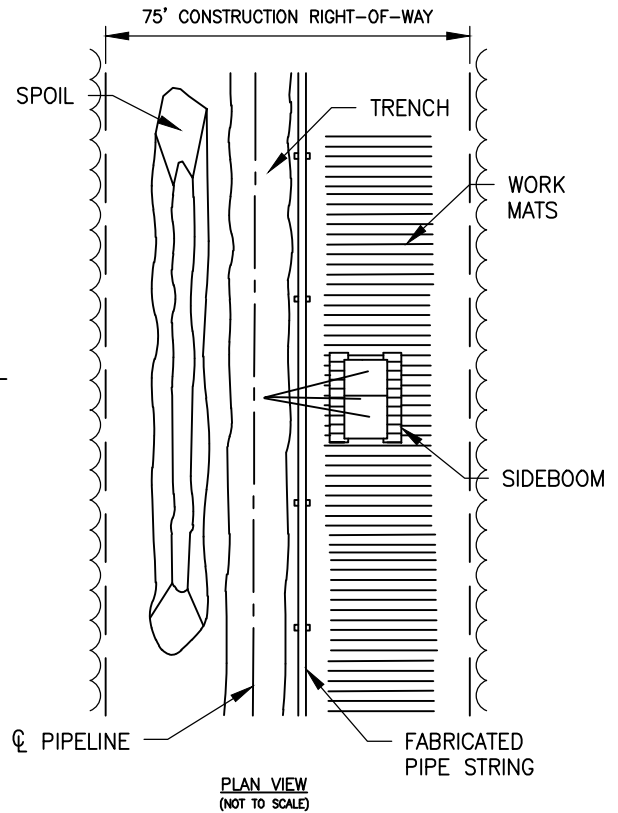
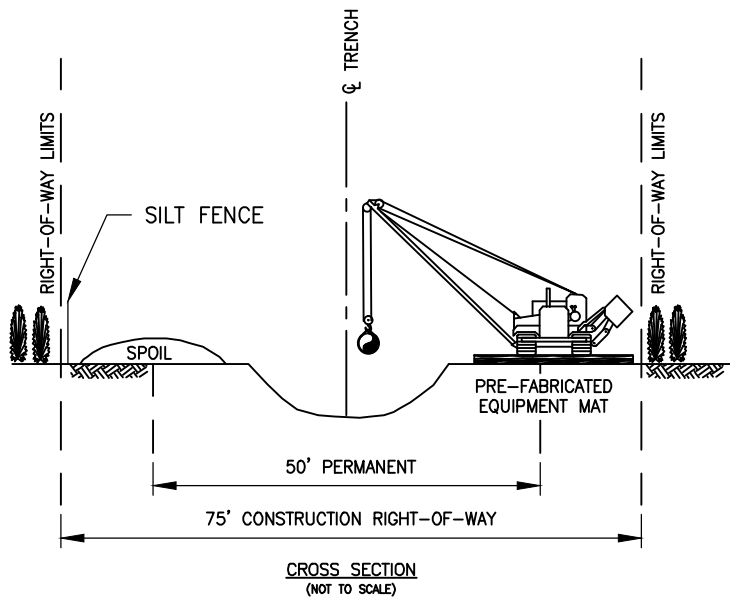

CONSTRUCTION PROCEDURE NOTES:

1. FLAG WETLAND BOUNDARIES PRIOR TO CLEARING. VEGETATION CANNOT BE CLEARED WITHIN A 10' BUFFER BETWEEN WETLAND BOUNDARIES AND CONSTRUCTION ROW EXCEPT OVER THE TRENCH.
2. NO REFUELING OF MOBILE EQUIPMENT IS ALLOWED WITHIN 500 FEET OF WETLAND. PLACE "NO FUELING" SIGN POSTS 500 FEET BACK FROM WETLAND BOUNDARY. REFUEL STATIONARY EQUIPMENT AS PER SPCC PLAN
3. INSTALL TEMPORARY SLOPE BREAKER UPSLOPE WITHIN 100 FEET OF WETLAND BOUNDARY IF DIRECTED BY THE ENVIRONMENTAL INSPECTOR.
4. MINIMIZE SOIL COMPACTION BY UTILIZING PREFABRICATED EQUIPMENT MATS.
5. AVOID ADJACENT WETLANDS. INSTALL SEDIMENT BARRIERS (STRAW BALES AND/OR SILT FENCE) AT DOWN SLOPE EDGE OF RIGHT-OF-WAY AND ALONG WETLAND EDGE AS REQUIRED.
6. RESTRICT ROOT GRUBBING TO ONLY THAT AREA OVER THE DITCHLINE AND DITCH SPOIL AREAS. GRIND STUMPS IF NECESSARY IN OTHER AREAS TO FACILITATE CONSTRUCTION.
7. TOPSOIL STRIPPING SHALL NOT BE REQUIRED IN SATURATED SOIL CONDITIONS.
8. LEAVE HARD PLUGS AT THE EDGE OF WETLAND UNTIL JUST PRIOR TO TRENCHING.
9. INSTALL TIMBER MATS THROUGH WETLAND AREA AS NEEDED OR DIRECTED BY ENVIRONMENTAL INSPECTOR. EQUIPMENT NECESSARY FOR RIGHT-OF-WAY CLEARING MAY MAKE ONE (1) PASS THROUGH THE WETLAND BEFORE MATS ARE INSTALLED.
10. TRENCH THROUGH WETLANDS.
11. PIPE SECTION MAY BE FABRICATED WITHIN THE WETLAND AND ADJACENT TO ALIGNMENT, OR IN STAGING AREA OUTSIDE THE WETLAND AND WALKED IN.
12. LOWER IN PIPE, INSTALL TRENCH PLUGS AT WETLAND EDGES IF DIRECTED BY THE ENVIRONMENTAL INSPECTOR AND BACKFILL IMMEDIATELY.
13. REMOVE ANY TIMBER MATS OR PREFABRICATED MATS FROM WETLANDS UPON COMPLETION.
14. RESTORE GRADE TO NEAR PRE-CONSTRUCTION TOPOGRAPHY, REPLACE TOPSOIL AND INSTALL PERMANENT EROSION CONTROL.
15. GENERALLY, SEEDING IN WETLANDS WILL NOT BE NECESSARY SINCE WETLANDS REVEGETATE QUICKLY AND SOD WILL REMAIN INTACT EXCEPT OVER TRENCH. THE CONTRACTOR SHALL SEED ANY WETLANDS THAT MAY REQUIRE SEEDING AS DETERMINED BY THE ENVIRONMENTAL INSPECTOR.

B	ISSUED FOR FERC	06/12/15	
A	DRAFT ISSUED FOR FERC	03/02/15	
NO.	REVISION	DATE	APPR.



WILLBROS ENGINEERS (U.S.) LLC
FIRM REGISTRATION NUMBER: TX F-82



TYPE II
SATURATED WETLAND CROSSING

DRAWING NUMBER

52715-TYP-134

SHEET

1 OF 1

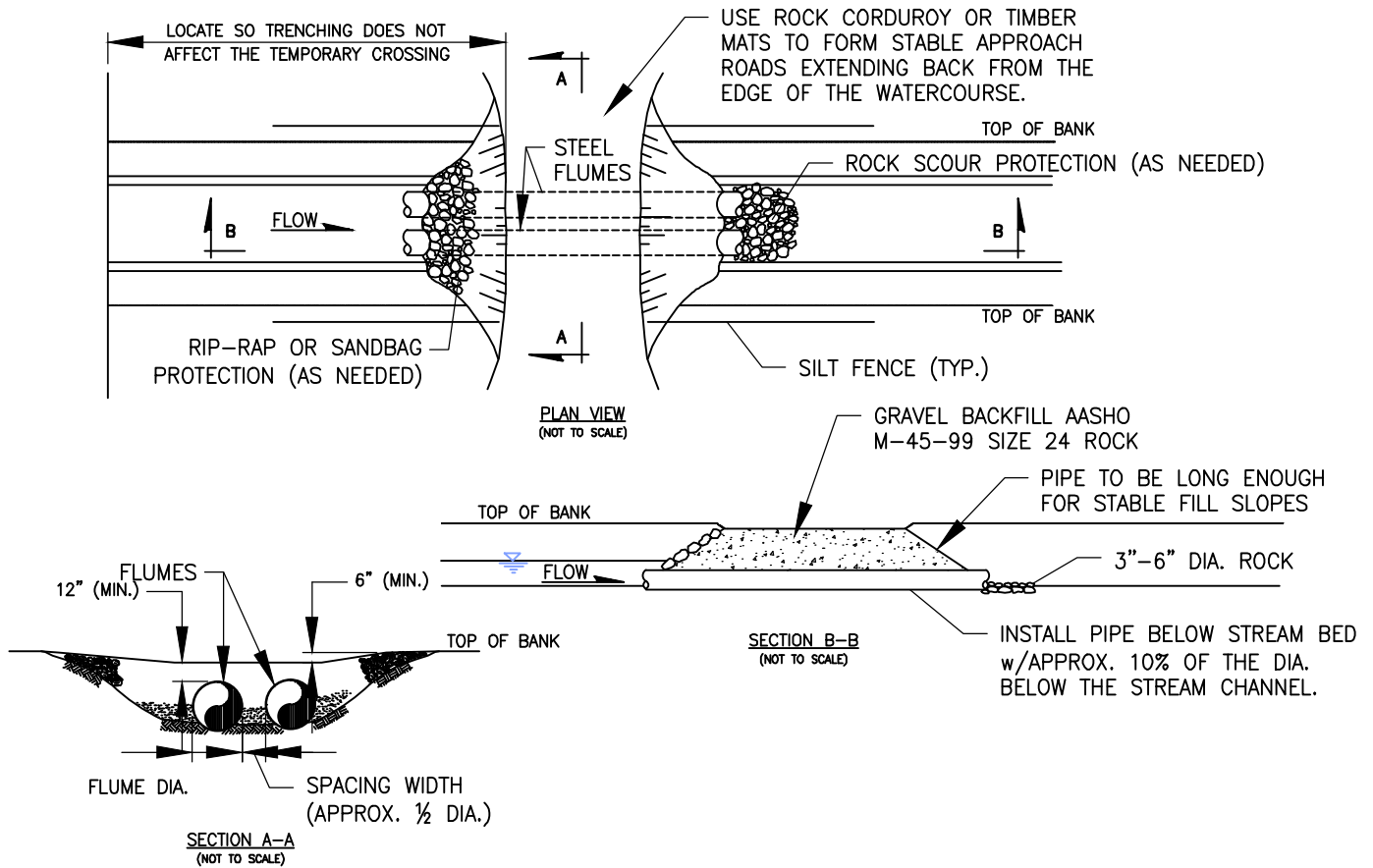

THE FOLLOWING IS A SEQUENCE OF CONSTRUCTION AND MITIGATION MEASURES TO BE FOLLOWED AT ALL TEMPORARY FLUME VEHICLE CROSSINGS.

1. A PORTABLE FLEXI-FLOAT, OR TEMPORARY BRIDGE MAY BE SUBSTITUTED FOR THE TEMPORARY FLUME CROSSING.
2. THE LENGTH OF THE FLUME SHALL BE SUFFICIENT TO SPAN THE ENTIRE AREA REQUIRED FOR VEHICULAR ACCESS, EXTENDING FOUR (4) FEET BEYOND TOE OF FILL MATERIAL, SO TRENCHING WILL NOT AFFECT THE ROAD CROSSING. A LONGER PIPE IS TO BE USED, IF NEEDED, TO MAINTAIN STABLE SIDE SLOPES. FLUME CAPACITY TO BE BASED ON THE TWO (2) YEAR DESIGN FLOW OR MAXIMUM FLOW ANTICIPATED TO OCCUR DURING INSTALLATION, AS SPECIFIED IN CONSTRUCTION DOCUMENTS.
3. BACKFILL AROUND THE PIPES WITH CLEAN COARSE ROCK FILL MATERIAL. AASHO SPECIFICATION NO. M45-99 SIZE 24. TIMBER EQUIPMENT MATS OR TIMBER CORDUROY MAY BE PLACED ON THE ROCK FILL FOR A DRIVING SURFACE.
4. ROCK WITH DIAMETERS OF 3 TO 6 INCHES SHALL BE PLACED ON THE STREAMBED DOWNSTREAM OF THE FLUME OUTLET. THE ROCK SHALL EXTEND DOWNSTREAM TWO (2) FLUME DIAMETERS.
5. TO REDUCE MUD ENTERING THE WATER FROM EQUIPMENT TRACKS, THE APPROACH ROAD LEADING TO THE FLUME CROSSING MUST BE RAISED AND STABLE SO EQUIPMENT LOADS ARE SUPPORTED A SUFFICIENT DISTANCE BACK FROM THE WATER. IF CUTS ARE NEEDED TO OBTAIN A SATISFACTORY GRADE, THEY ARE TO BE DUG WITH SIDE DITCHES AND STABLE SLOPES. EROSION AND SEDIMENT CONTROL MEASURES ARE TO BE INSTALLED TO LIMIT THE POTENTIAL FOR SEDIMENT TO ENTER THE WATERWAY (E.G., CHECK DAMS, SILT FENCE, RIP-RAP, SEED AND MULCH, SEDIMENT TRAPS, ETC.).
6. PERIODICALLY CHECK THE TEMPORARY CROSSING INSTALLATION AND REMOVE ANY BUILD-UP OF SEDIMENT OR DEBRIS ON THE BRIDGE. STORE THIS MATERIAL AT LEAST 100 FEET FROM THE WATERCOURSE AND ABOVE THE HIGH WATER LEVEL, IN AN APPROVED AREA.

B	ISSUED FOR FERC	06/12/15	
A	DRAFT ISSUED FOR FERC	03/02/15	
NO.	REVISION	DATE	APPR.



WILLBROS ENGINEERS (U.S.) LLC
FIRM REGISTRATION NUMBER: TX F-82



**EROSION CONTROL
FLUMED EQUIPMENT CROSSING**

DRAWING NUMBER

52715-TYP-136

SHEET

1 OF 1

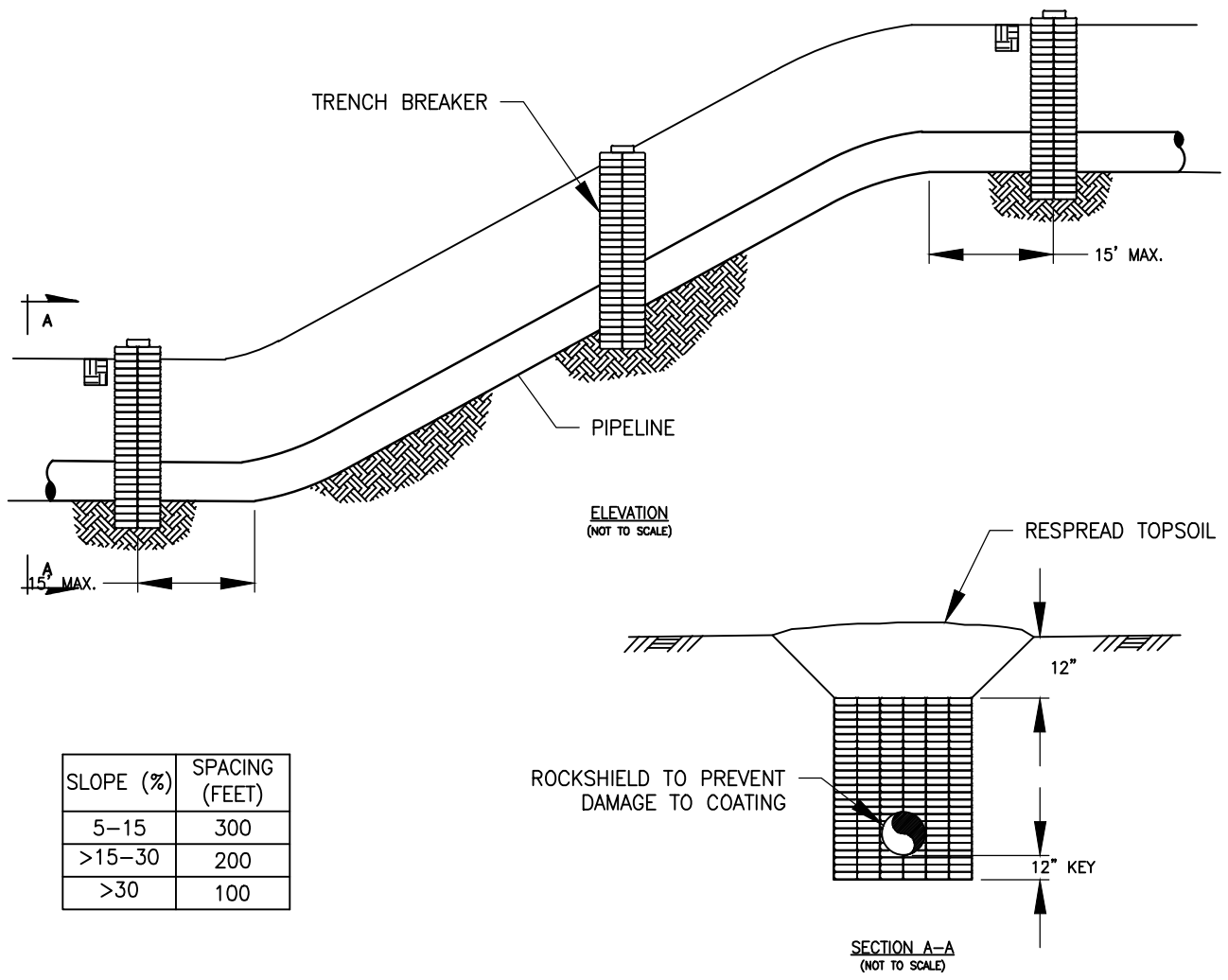

SLOPE (%)	SPACING (FEET)
5-15	300
>15-30	200
>30	100

NOTES:

- INSTALL TRENCH BREAKERS PER ENVIRONMENTAL INSPECTOR WHERE PIPELINE TRENCH MAY DRAIN A WETLAND OR DIVERT A STREAM. BREAKERS SHALL ALSO BE INSTALLED WHERE NATURAL DRAINAGE PATTERN, PROFILE AND TYPE OF BACKFILL MATERIAL MAY RESULT IN LOSS OF BACKFILL MATERIAL OR ALTERATION OF NATURAL DRAINAGE PATTERN.
- INSTALL TRENCH BREAKERS IMMEDIATELY UPSLOPE OF ALL DIVERSION BERMS UNLESS OTHERWISE AUTHORIZED BY THE ENVIRONMENTAL INSPECTOR.
- SLOPE BREAKER LOCATIONS AND SPACING SHALL BE DETERMINED IN ACCORDANCE WITH "THE UPLAND EROSION CONTROL, REVEGETATION AND MAINTENANCE PLAN" AND ENVIRONMENTAL SPECIFICATIONS.
- KEY EACH TRENCH BREAKER A MINIMUM OF ONE (1) FOOT INTO BOTTOMS AND SIDES OF TRENCH.
- OPEN WEAVE HEMP OR JUTE SACKS SHALL BE FILLED WITH AN AVERAGE 55 LBS. MIXTURE OF:
 - ONE (1) PART CEMENT AND SIX (6) PARTS SAND OR SUBSOIL, OR
 - ONE (1) PART CEMENT, THREE (3) PARTS FLYASH, AND FIVE (5) PARTS SAND OR SUBSOIL WITH JUST SUFFICIENT WATER TO PERMIT MIXTURE TO EXUDE AND BOND SACKS TOGETHER. TOPSOIL IS NOT TO BE USED IN SACKS. ALTERNATIVELY, FOAM TRENCH BREAKERS MAY BE USED AS SPECIFIED BY THE ENVIRONMENTAL INSPECTOR.

B	ISSUED FOR FERC	06/12/15	
A	DRAFT ISSUED FOR FERC	03/02/15	
NO.	REVISION	DATE	APPR.



PERMANENT TRENCH BREAKERS



DRAWING NUMBER	SHEET
52715-TYP-154	1 OF 1

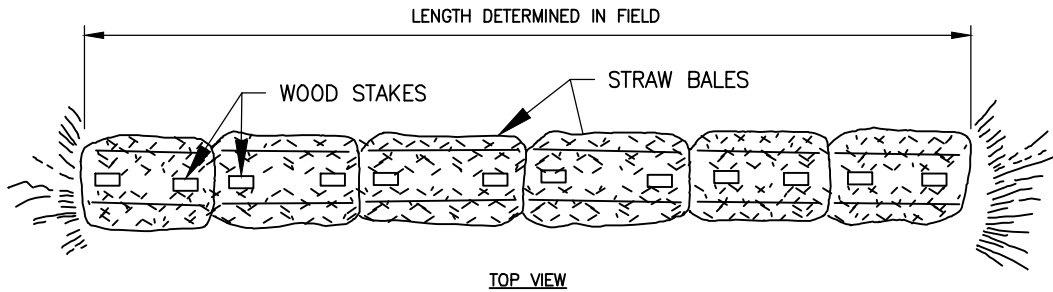
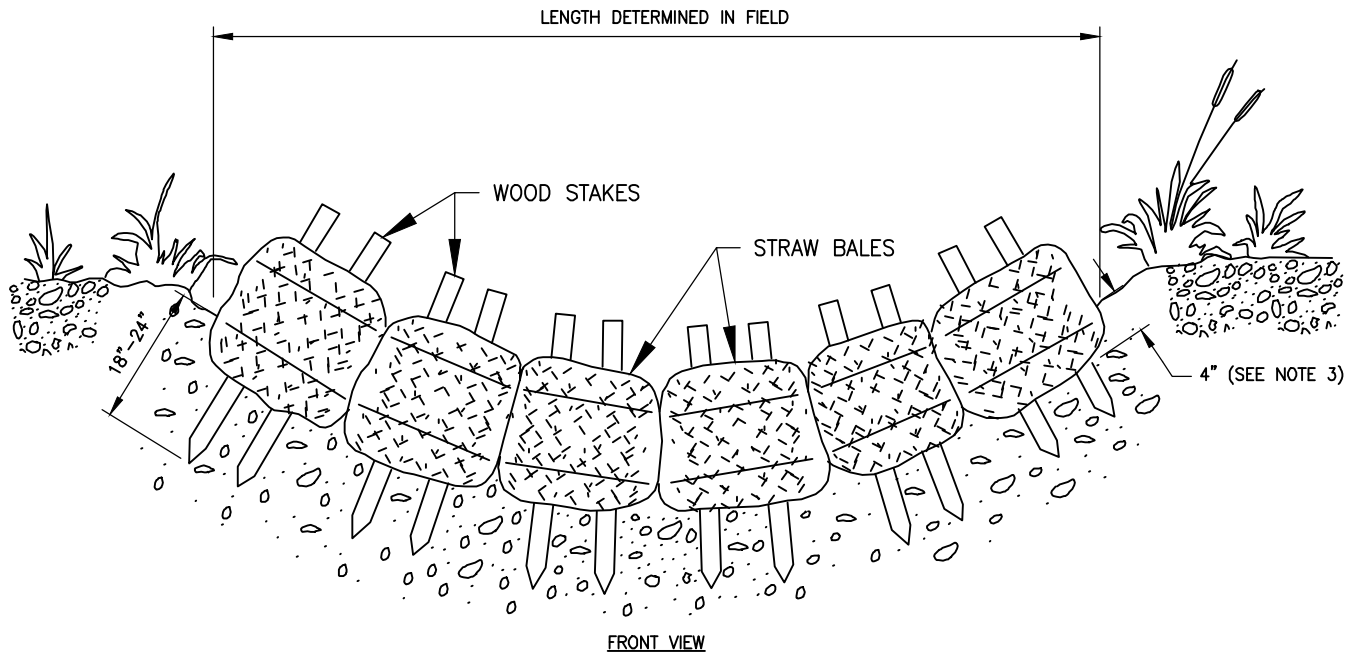

NOTES:

1. INSTALL PRIOR TO GRADING.
2. ANGLE FIRST STAKE TOWARD PREVIOUSLY LAID BALE.
3. IMBED BALES IN EARTH APPROXIMATELY FOUR (4) INCHES.
4. WHEN REMOVING BALES, SCATTER SILT AND STRAW OVER RIGHT-OF-WAY.
5. ALL MATERIALS TO BE SUPPLIED BY CONTRACTOR.

B	ISSUED FOR FERC	06/12/15	
A	DRAFT ISSUED FOR FERC	03/02/15	
NO.	REVISION	DATE	APPR.



WILLBROS ENGINEERS (U.S.) LLC
FIRM REGISTRATION NUMBER: TX F-82



**EROSION CONTROL
STAKED STRAW BALES**

DRAWING NUMBER
52715-TYP-123

SHEET
1 OF 1

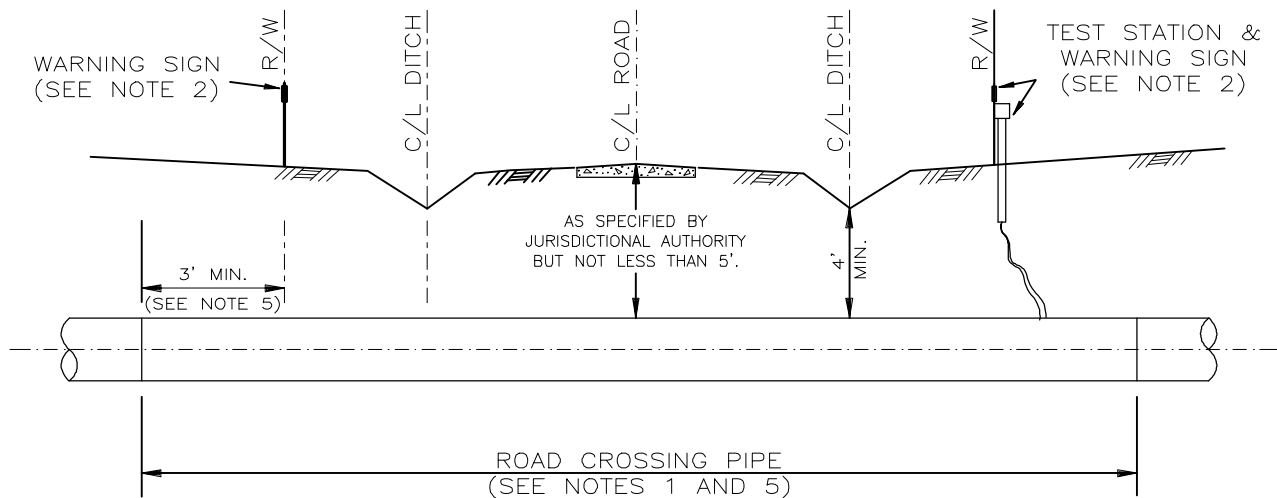

NOTES

1. THE TYPE AND LENGTH OF PIPE FOR CROSSING OF PUBLIC ROADS SHALL BE AS SPECIFIED ON THE ALIGNMENT SHEETS. FOR CROSSING OF PRIVATE ROADS IT SHALL BE THE SAME AS ADJACENT PIPELINE. NO VERTICAL BENDS SHALL BE MADE WITHIN THESE LIMITS.
2. INSTALL PIPELINE WARNING SIGN ON EACH SIDE OF CROSSING, AND CATHODIC PROTECTION TEST STATION ON ONE SIDE AS SPECIFIED ON THE ALIGNMENT SHEETS.
3. THIS CROSSING SHALL BE MADE AT ALL ROADS WHERE CASING IS NOT SPECIFIED.
4. INSTALLATIONS SHALL BE MADE BY DRY BORING OR OPEN CUTTING AS STIPULATED IN THE APPLICABLE PERMIT.
5. ROAD CROSSING PIPE (HEAVY WALL) SHALL EXTEND TO A MINIMUM OF 3 FEET BEYOND TOE OF SLOPE OR R.O.W. LINE, WHICHEVER IS GREATER (TYPICAL EACH SIDE).
6. WHEN CROSSING PUBLIC ROADS WITH EQUIPMENT, THE ROAD SURFACE SHALL BE ADEQUATELY PROTECTED WITH PADDING SUCH AS TIMBER MATS OR RUBBER TIRES.
7. WHEN OPEN CUTTING IS PERMITTED, THE TRENCH BACKFILL UNDER THE ROAD BASE AND SHOULDERS SHALL BE MECHANICALLY COMPACTED IN 8" (MAX.) LIFTS TO A MINIMUM 95 PERCENT STANDARD PROCTOR DENSITY. THE ROAD SURFACE SHALL BE RESTORED TO ITS ORIGINAL OR BETTER CONDITION.

B	ISSUED FOR FERC	06/12/15	
A	DRAFT ISSUED FOR FERC	03/02/15	
NO.	REVISION	DATE	APPR.
 WILLBROS ENGINEERS (U.S.) LLC <small>FIRM REGISTRATION NUMBER: TX F-82</small>			



TYPICAL BORED UNCASSED ROAD CROSSING

DRAWING NUMBER	SHEET
STD-A-024	1 OF 1

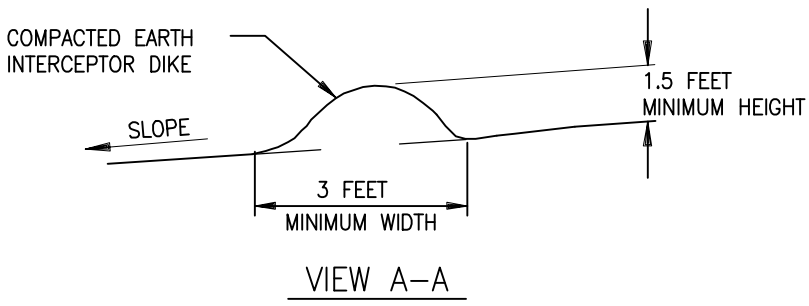
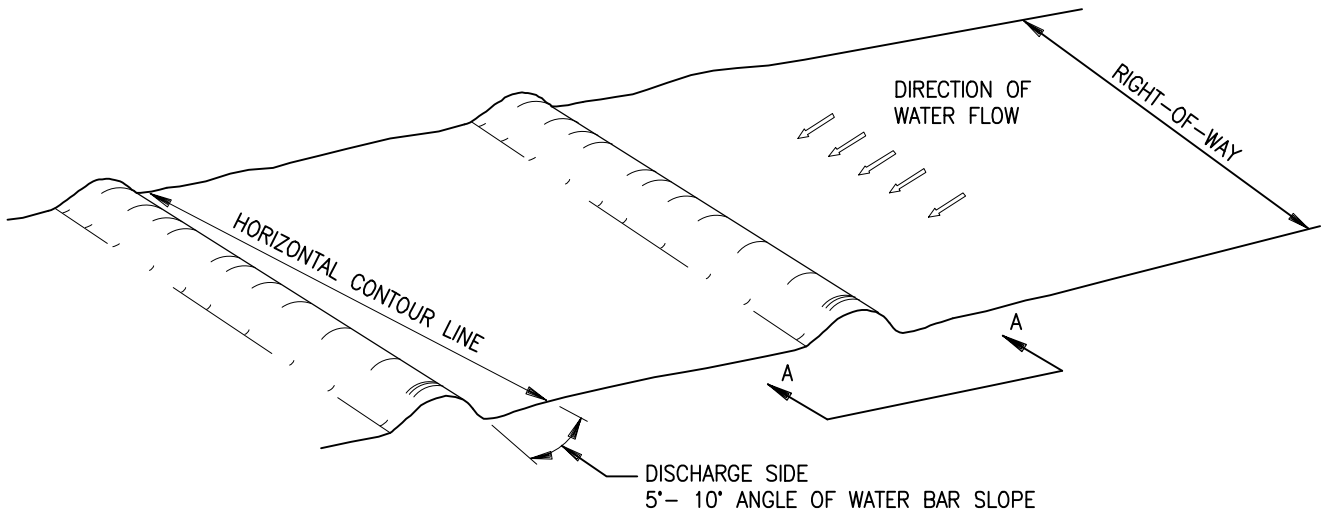

SLOPE BREAKER SPACING	
GRADE, %	SPACING
0 - 5	NONE REQ'D
5 - 15	300
15 - 30	200
> 30	100

NOTES:

1. WATER SHALL BE DIVERTED OFF THE GRADED RIGHT-OF-WAY BY CONSTRUCTING SLOPE BREAKERS ACCORDING TO THE FOLLOWING PROCEDURE.
 - A. THE HORIZONTAL CONTOUR LINE ACROSS THE ENTIRE RIGHT-OF-WAY WIDTH WILL BE ESTABLISHED AT EACH INTERCEPT OR SLOPE BREAKERS. THE HORIZONTAL CONTOUR LINE WILL BE PERPENDICULAR TO THE DIRECTION OF FLOW. A SURVEYOR'S LEVEL OR HAND LEVEL WILL BE USED TO LOCATE THE CONTOUR LINE.
 - B. THE SLOPE BREAKER SHALL SLOPE DOWNHILL 5' - 10' FROM HORIZONTAL CONTOUR LINE AND TOWARD DISCHARGE SIDE. CHANNEL THE FLOW TO THE SIDE OF THE GRADED RIGHT-OF-WAY WITH THE BEST VEGETATIVE COVER AND TOPOGRAPHY. IF VEGETATION IS SPARSE SECURE OUTLET WITH STRAW BALES.
2. SLOPE BREAKER SPACING SHALL BE IN ACCORDANCE WITH LOCAL SOIL CONSERVATION SERVICE RECOMMENDATIONS. IN ABSENCE OF THESE RECOMMENDATIONS THE ABOVE TABLE SHALL BE USED.
3. REFER TO "ENVIRONMENTAL AND RIGHT-OF-WAY STIPULATIONS" FOR INSTALLATION.

B	ISSUED FOR FERC	06/12/15	
A	DRAFT ISSUED FOR FERC	03/02/15	
NO.	REVISION	DATE	APPR.



EROSION CONTROL
SLOPE BREAKERS



DRAWING NUMBER	SHEET
STD-A-038	1 OF 1

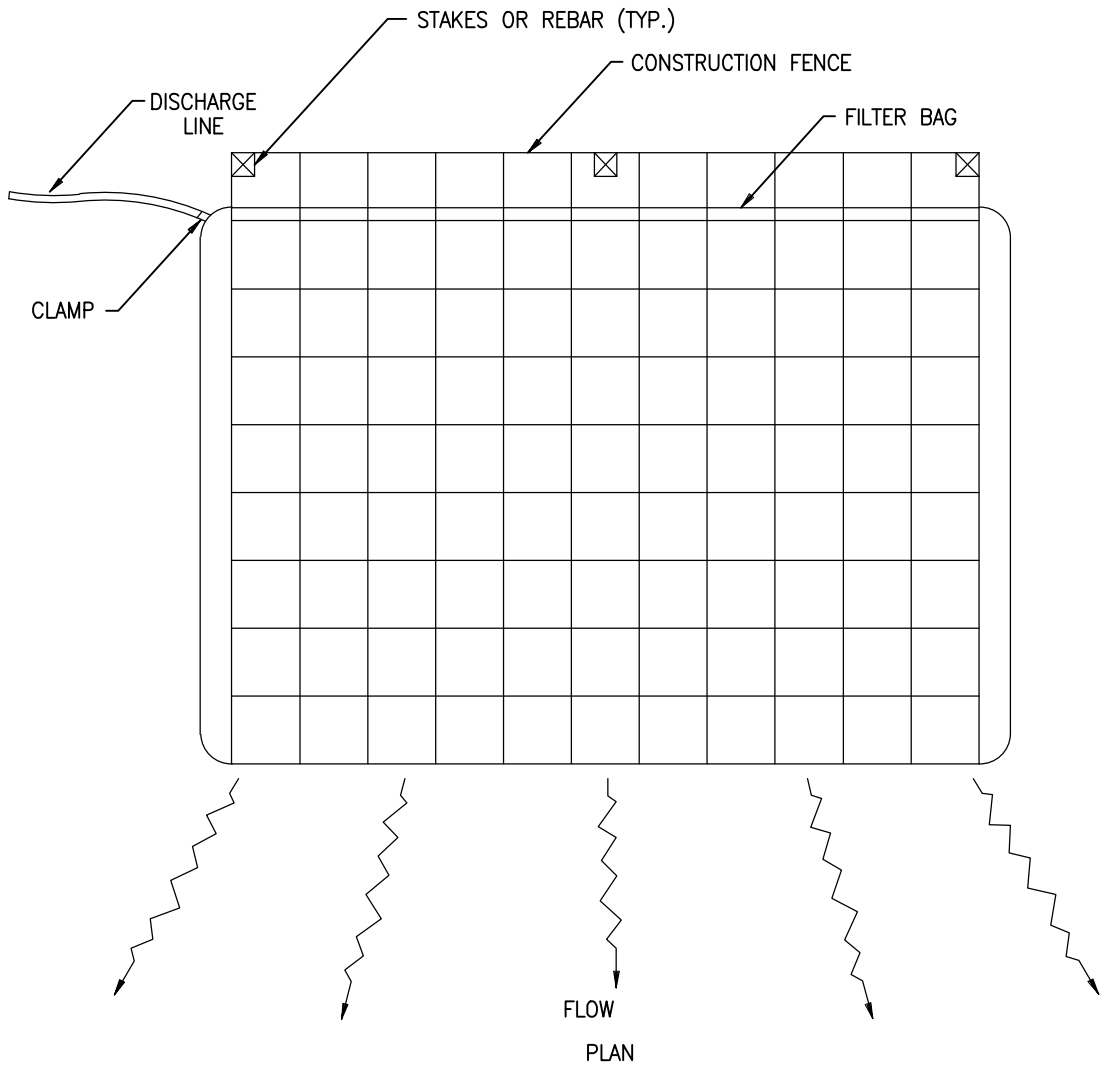
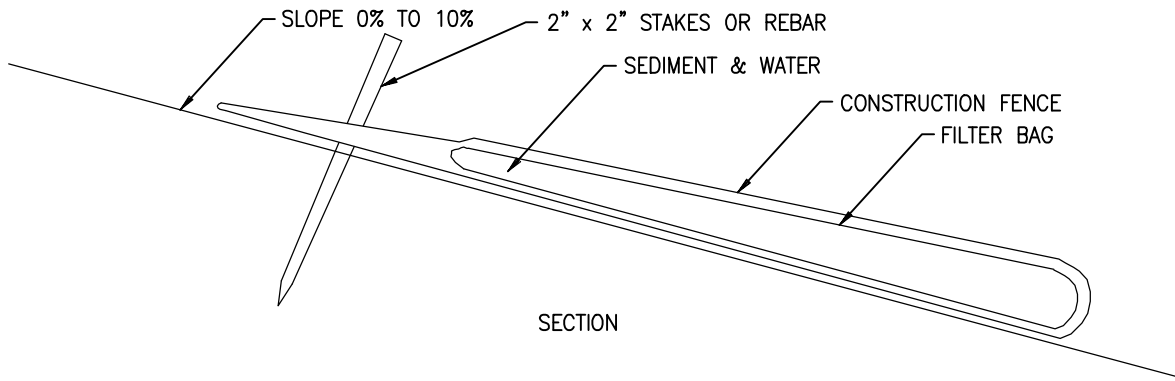

B	ISSUED FOR FERC	06/12/15	
A	DRAFT ISSUED FOR FERC	03/02/15	
NO.	REVISION	DATE	APPR.



TRENCH DEWATERING
FILTER BAG



WILLBROS ENGINEERS (U.S.) LLC
FIRM REGISTRATION NUMBER: TX F-82

DRAWING NUMBER
STD-A-114

SHEET
1 OF 1

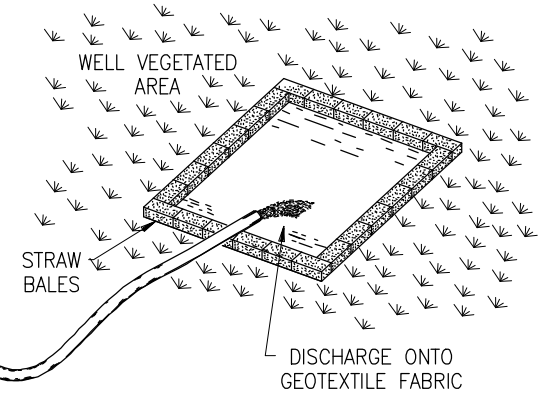
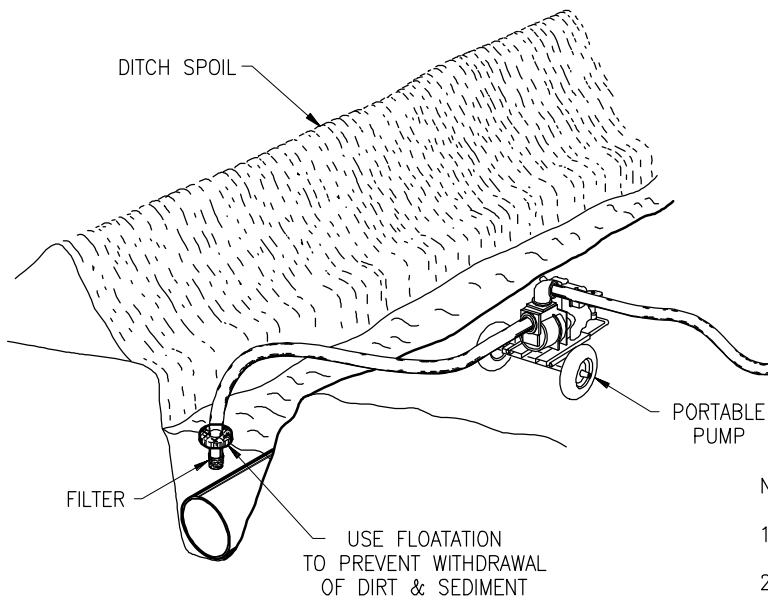

- NOTE:
1. ENSURE DISCHARGE AREA IS COVERED BY STABLE VEGETATION.
 2. USE DIFFUSER NOZZLE OR LOW DISCHARGE RATE TO PREVENT SCOURING.
 3. USE A FLOATATION DEVICE ON INTAKE; & MAINTAIN DISTANCE FROM SIDES & BOTTOM OF DITCH.

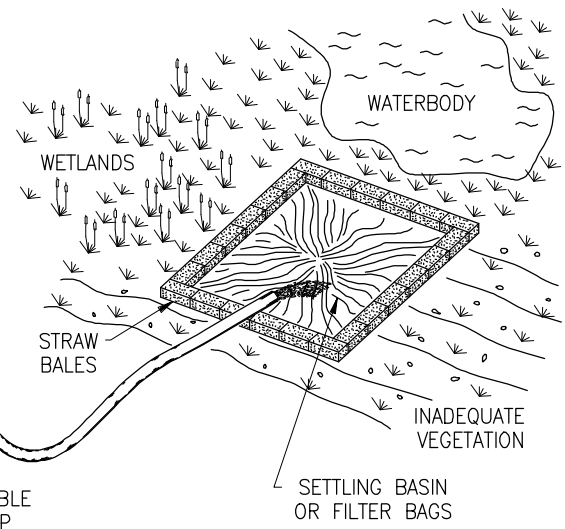
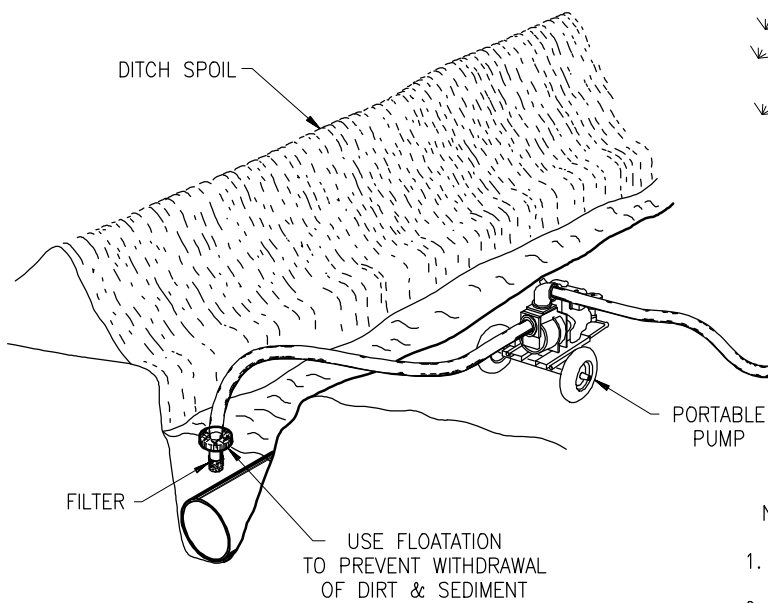

- NOTE:
1. USE ON SLOPING TERRAIN OR IN AREA WITH EROSION PRONE SOILS.
 2. USE DIFFUSER NOZZLE OR LOW DISCHARGE RATE TO PREVENT SCOURING.
 3. ADDITIONAL STRAW BALES MAY BE USED TO INCREASE RETENTION & FILTERING.
 4. USE A FLOATATION DEVICE ON INTAKE; & MAINTAIN DISTANCE FROM SIDES & BOTTOM OF DITCH.

B	ISSUED FOR FERC	06/12/15	
A	DRAFT ISSUED FOR FERC	03/02/15	
NO.	REVISION	DATE	APPR.



TRENCH DEWATERING



DRAWING NUMBER	SHEET
STD-A-116	1 OF 1

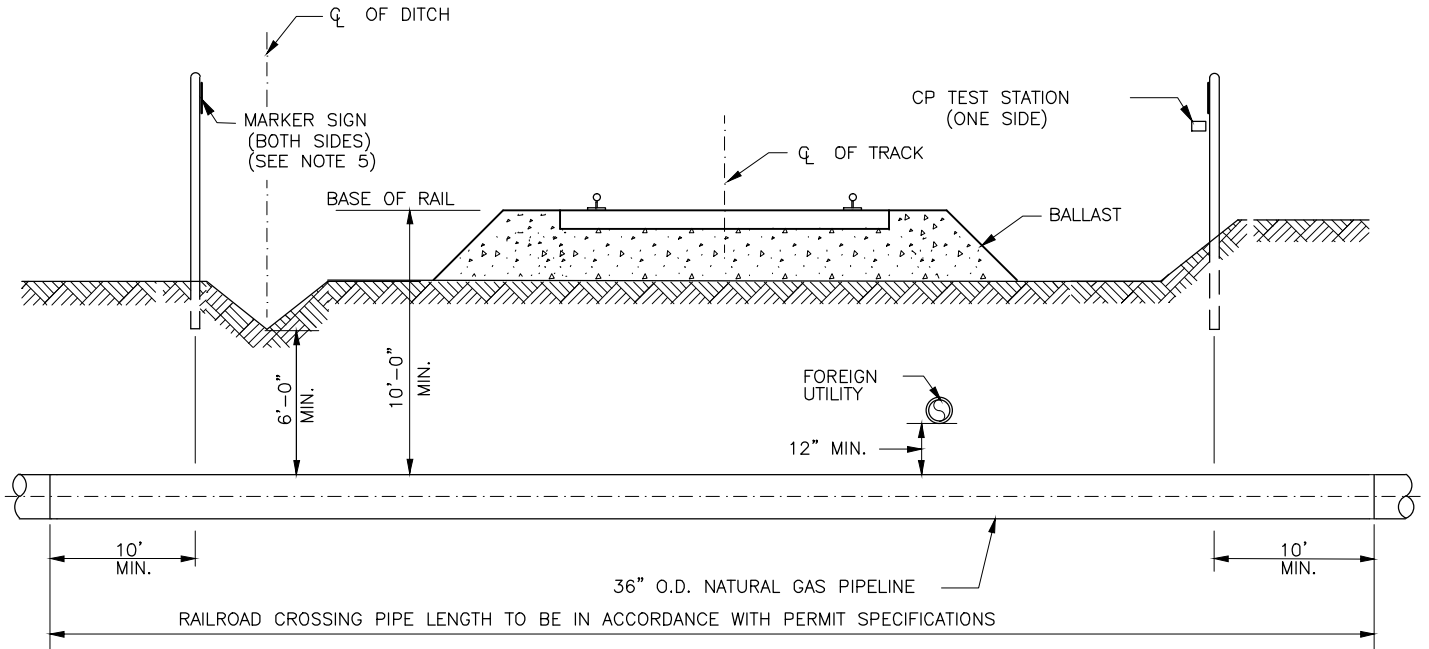

TYPICAL CROSS SECTION

NTS

NOTES:

1. WHERE CONFLICTS MAY EXIST, PERMIT SPECIFICATIONS SHALL ALWAYS GOVERN THIS DRAWING.
2. THE MINIMUM BORE LENGTH SHOULD BE IN ACCORDANCE WITH THE PERMIT SPECIFICATIONS.
3. PIPE SHALL BE DESIGNED IN ACCORDANCE WITH THE SPECIFIC PERMIT REQUIREMENTS AND DOT TITLE 49, PART 192, TRANSPORTATION OF NATURAL AND OTHER GAS BY PIPELINE. RAILROAD CROSSING PIPE SHALL EXTEND A MINIMUM OF 10 FEET OUTSIDE THE R-O-W LIMITS ON EITHER SIDE OF THE RAILROAD.
4. ANY EXCAVATION WITHIN THE LIMITS OF THE RAILROAD R-O-W SHALL BE REPLACED WITH BACKFILL SPECIFIED BY THE ENGINEER AND COMPACTED IN 8" LAYERS AT 95% OF DENSITY OF UNDISTURBED SOIL ADJACENT TO THE LOCATION OR IN ACCORDANCE WITH THE SPECIFIC PERMIT REQUIREMENTS.
5. MARKERS SHALL BE PLACED AT RAILROAD R-O-W LINES.
6. NO VERTICAL OR HORIZONTAL PIPE BENDS SHALL BE PLACED WITHIN THE RAILROAD R-O-W.
7. PIPE DIAMETER, WALL THICKNESS AND GRADE SHALL BE SPECIFIED ON THE ALIGNMENT SHEET DRAWINGS.



TYPICAL UNCASD
RAILROAD CROSSING

NO.	REVISION	DATE	APPR.
B	ISSUED FOR FERC	06/12/15	
A	DRAFT ISSUED FOR FERC	03/02/15	



WILLBROS ENGINEERS (U.S.) LLC
FIRM REGISTRATION NUMBER: TX F-82

DRAWING NUMBER

STD-A-404

SHEET



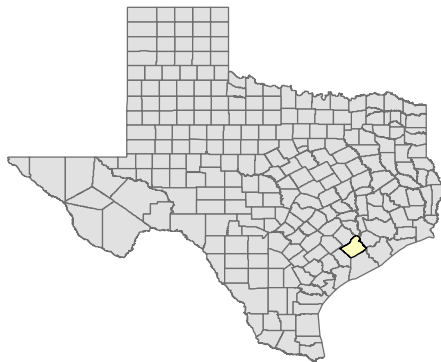

1 OF 1

APPENDIX C

NON-JURISDICTIONAL FACILITY MAPS



Legend

-  Wilson Compressor Station
-  Enterprise M&R Station
-  Proposed 36-inch Header Pipeline
-  Proposed Non-Jurisdictional Facility



**Gulf South Pipeline Company, LP
Coastal Bend Header Project -
Wilson Compressor Station and
Enterprise M&R Station
Wharton County, Texas**

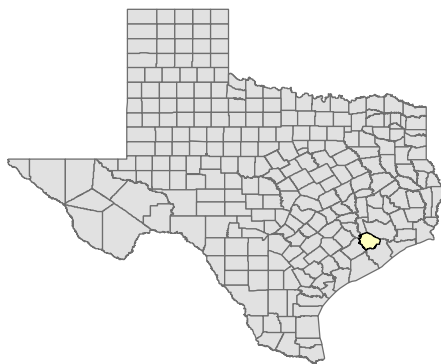
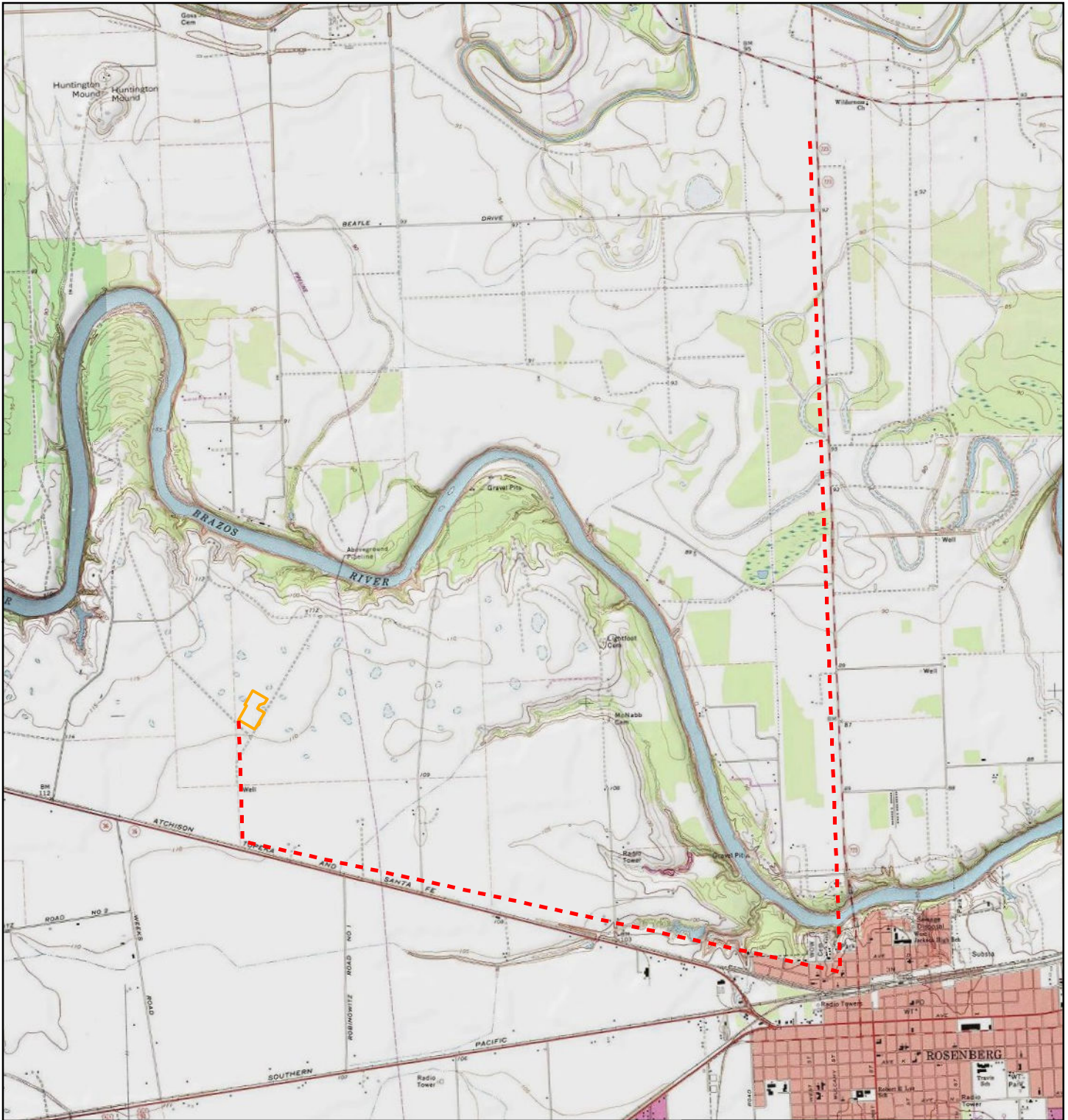

Legend

- Brazos Compressor Station
- Proposed Non-Jurisdictional Facility

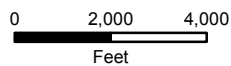

**Gulf South Pipeline Company, LP
Coastal Bend Header Project -
Brazos Compressor Station
Fort Bend County, Texas**

Page 1 of 1

Scale: 1:48,000

NAD83 TX SC 4204

Date: September 2015

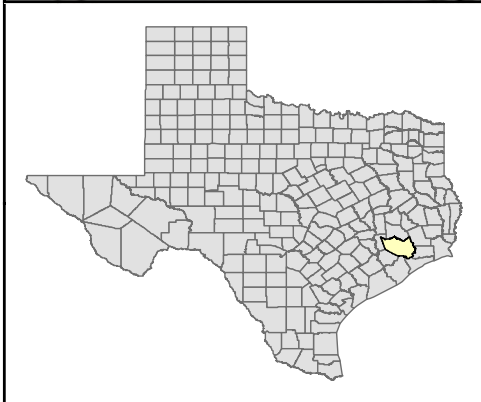
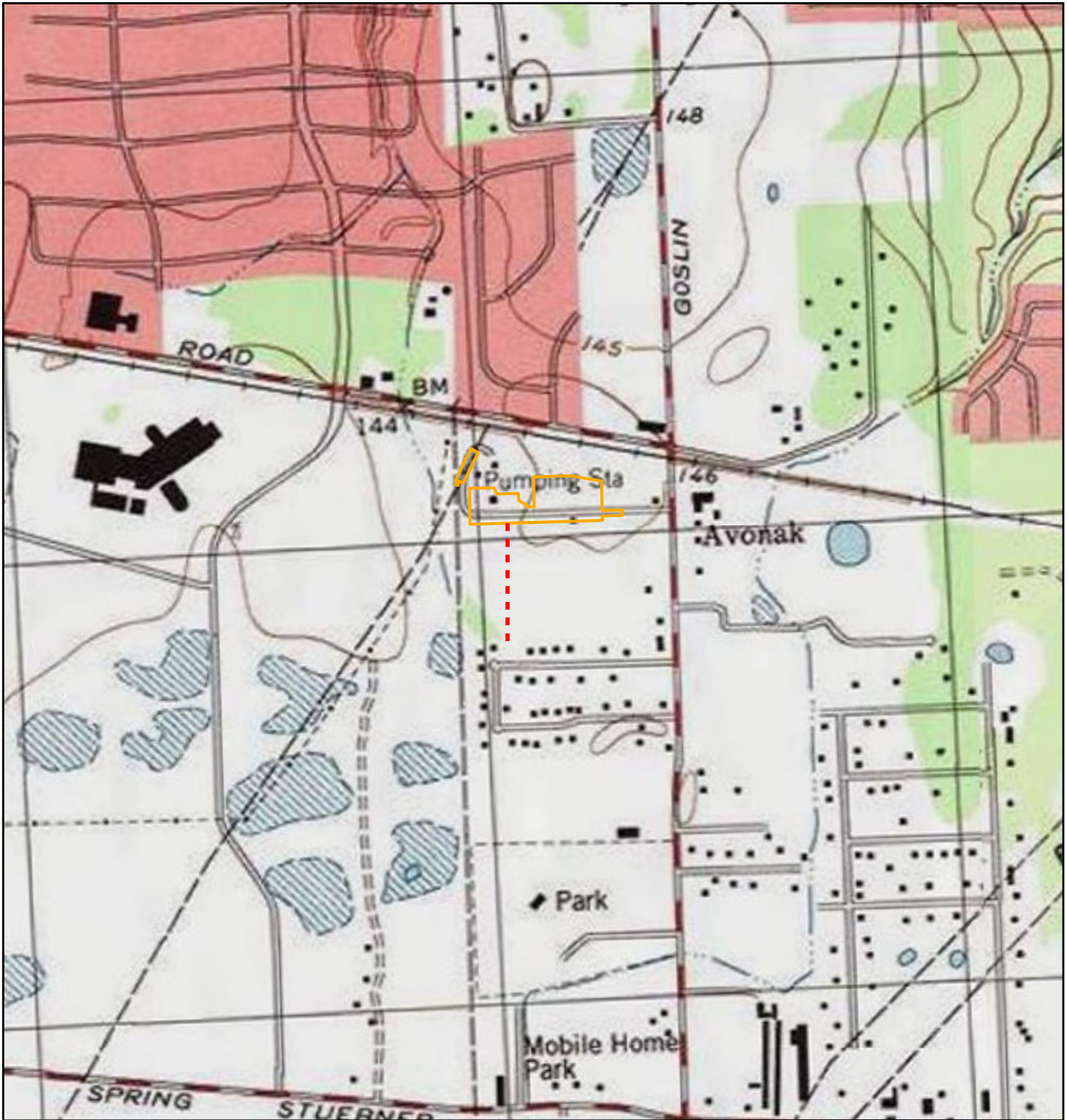

Legend

- North Houston Compressor Station
- Proposed Non-Jurisdictional Facility

0 500 1,000
Feet





Gulf South Pipeline Company, LP
Coastal Bend Header Project -
North Houston Compressor Station
Harris County, Texas

Page 1 of 1	Scale: 1:12,000
NAD83 TX SC 4204	Date: September 2015

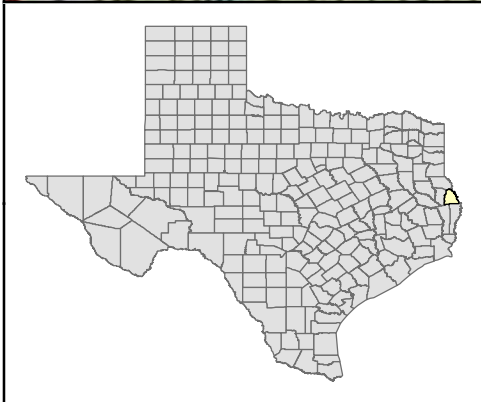
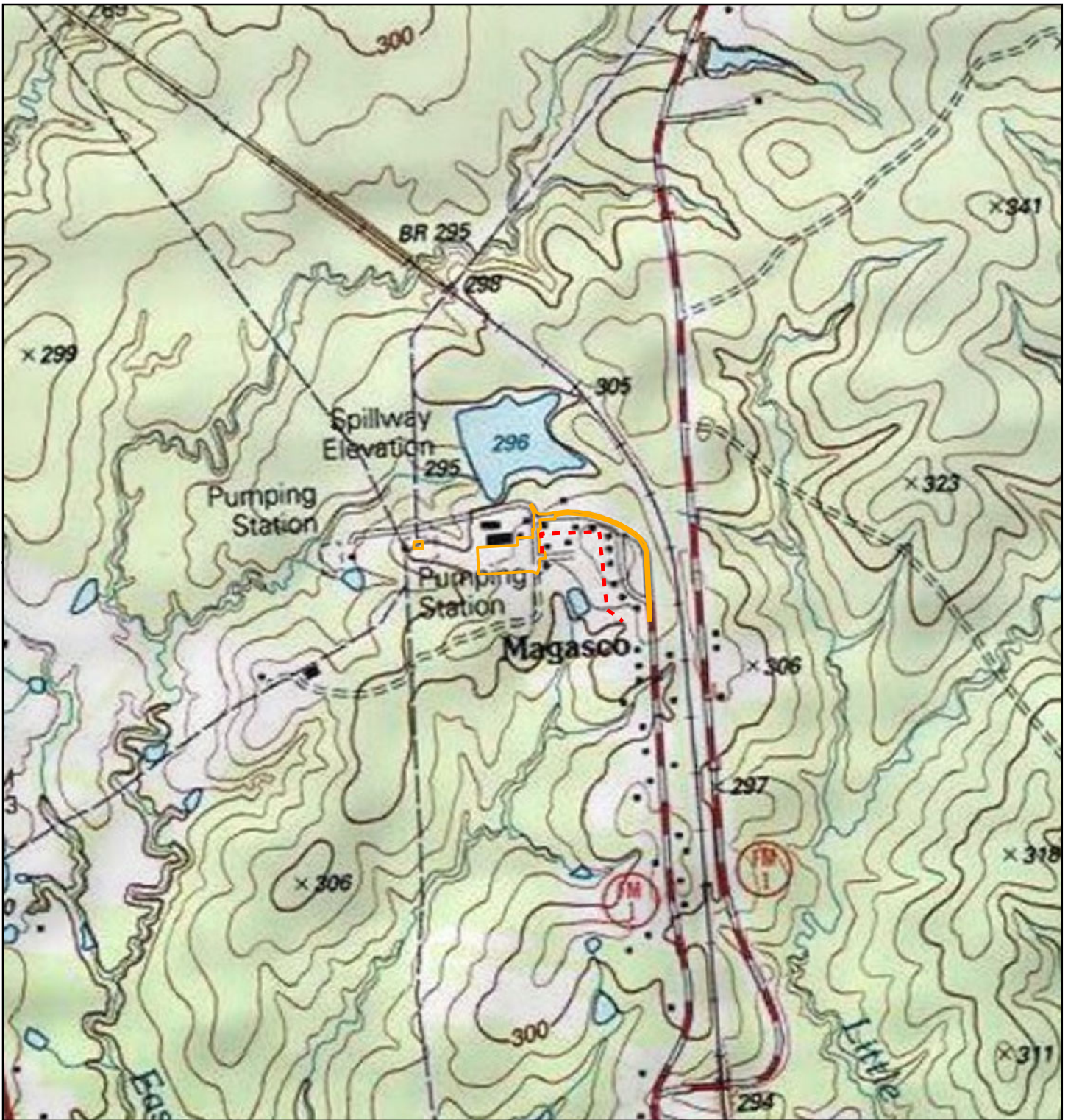

Legend

- Magasco Compressor Station
- Existing Non-Jurisdictional Facility

0 500 1,000
Feet





Gulf South Pipeline Company, LP
Coastal Bend Header Project -
Magasco Compressor Station
Sabine County, Texas

Page 1 of 1	Scale: 1:12,000
NAD83 TX SC 4204	Date: September 2015

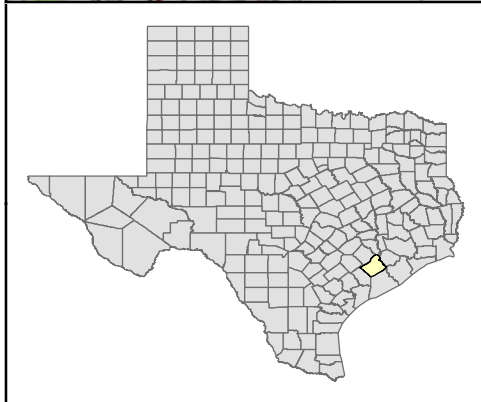
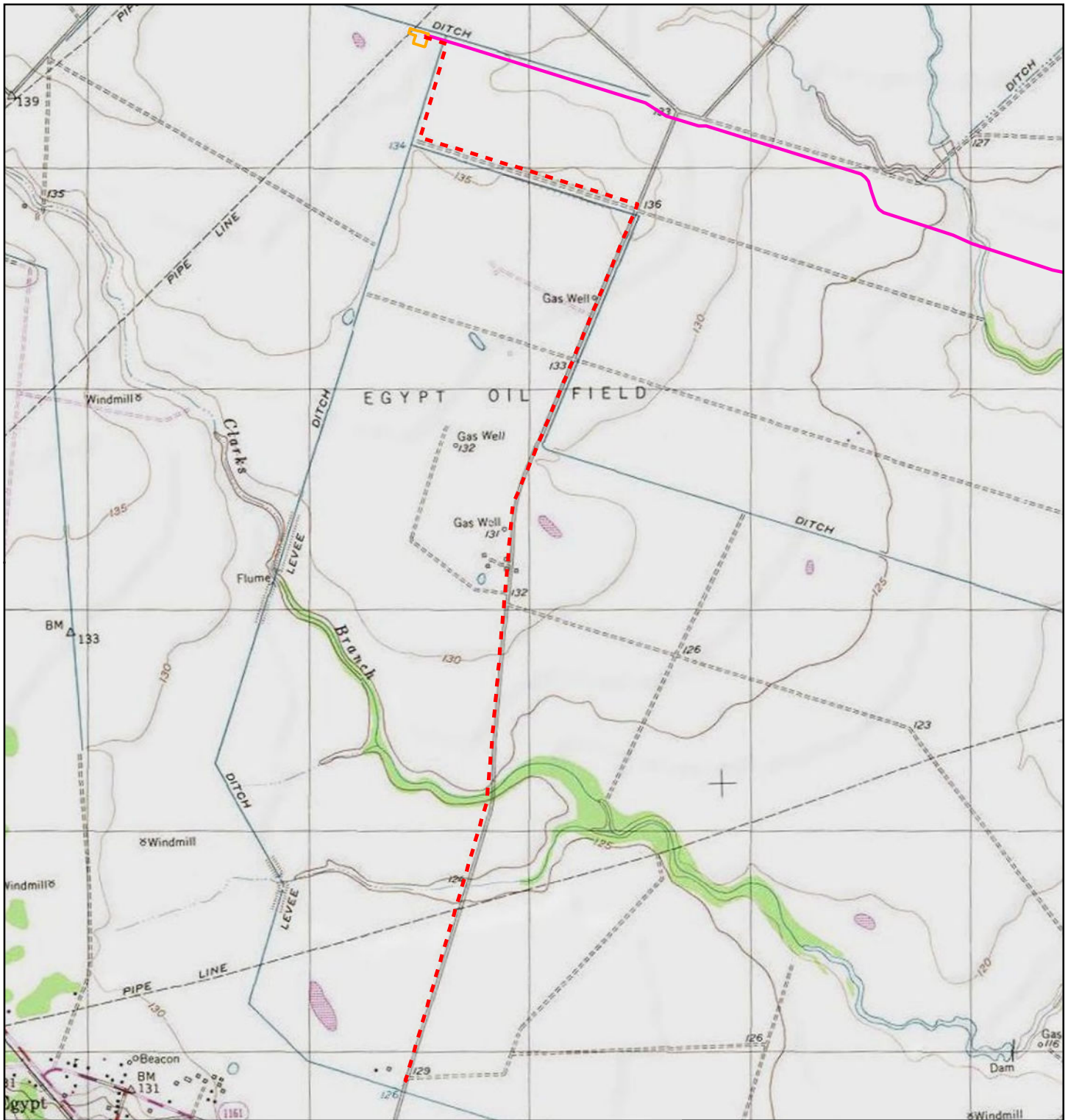

Legend

- TGPL M&R Station
- Proposed Non-Jurisdictional Facility
- Proposed 36-inch Header Pipeline



0 1,050 2,100
Feet

Gulf South Pipeline Company, LP
Coastal Bend Header Project -
TGPL M&R Station
Wharton County, Texas

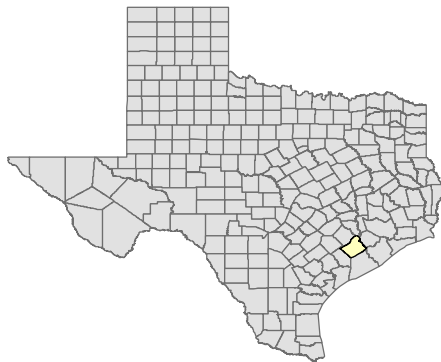
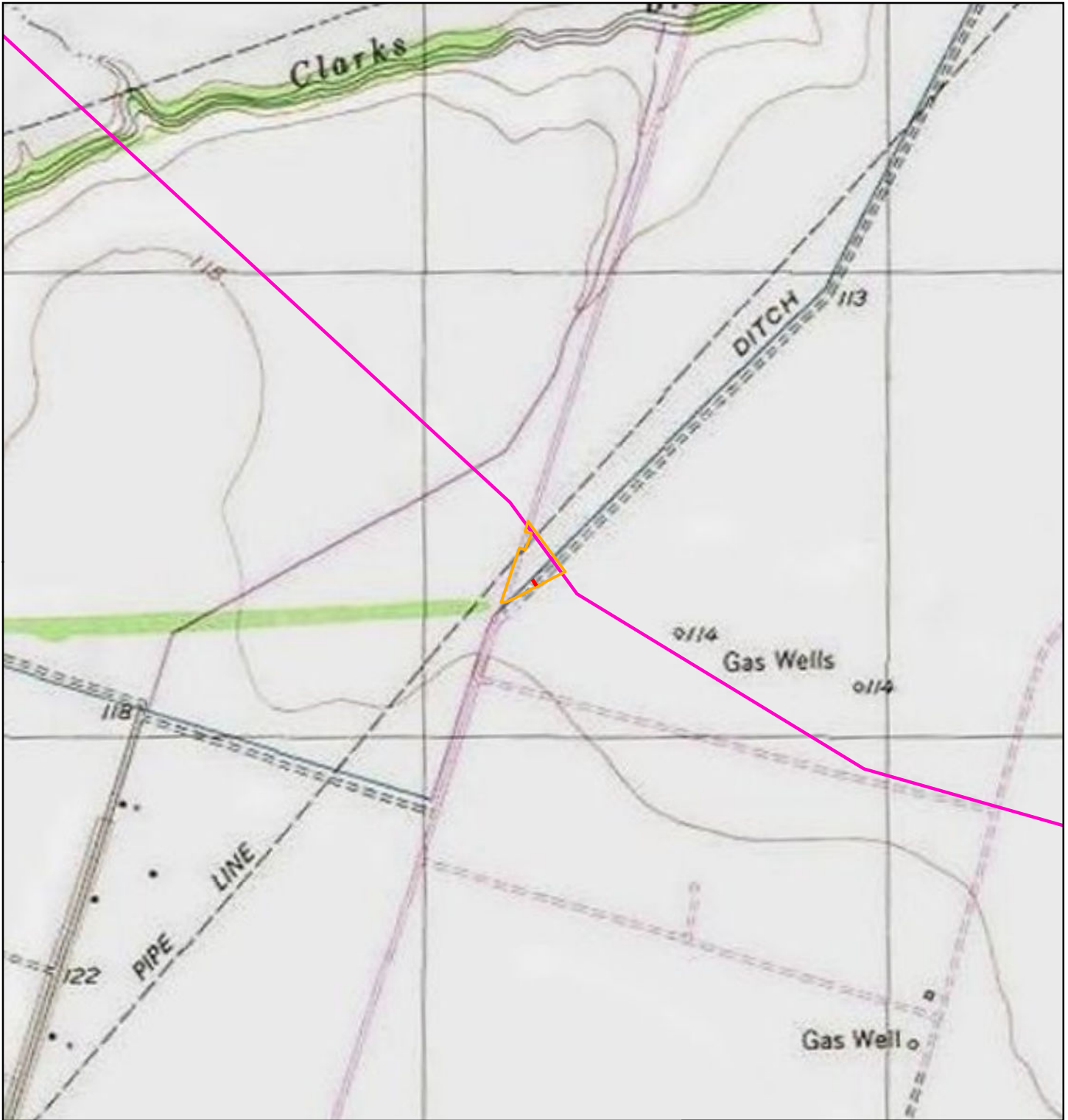
Page 1 of 1	Scale: 1:25,200
NAD83 TX SC 4204	Date: September 2015



Legend

-  Transco M&R Station
-  Proposed Non-Jurisdictional Facility
-  Proposed 36-inch Header Pipeline

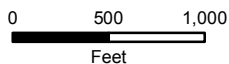

**Gulf South Pipeline Company, LP
Coastal Bend Header Project -
Transco M&R Station
Wharton County, Texas**

Page 1 of 1



Scale: 1:12,000

NAD83 TX SC 4204

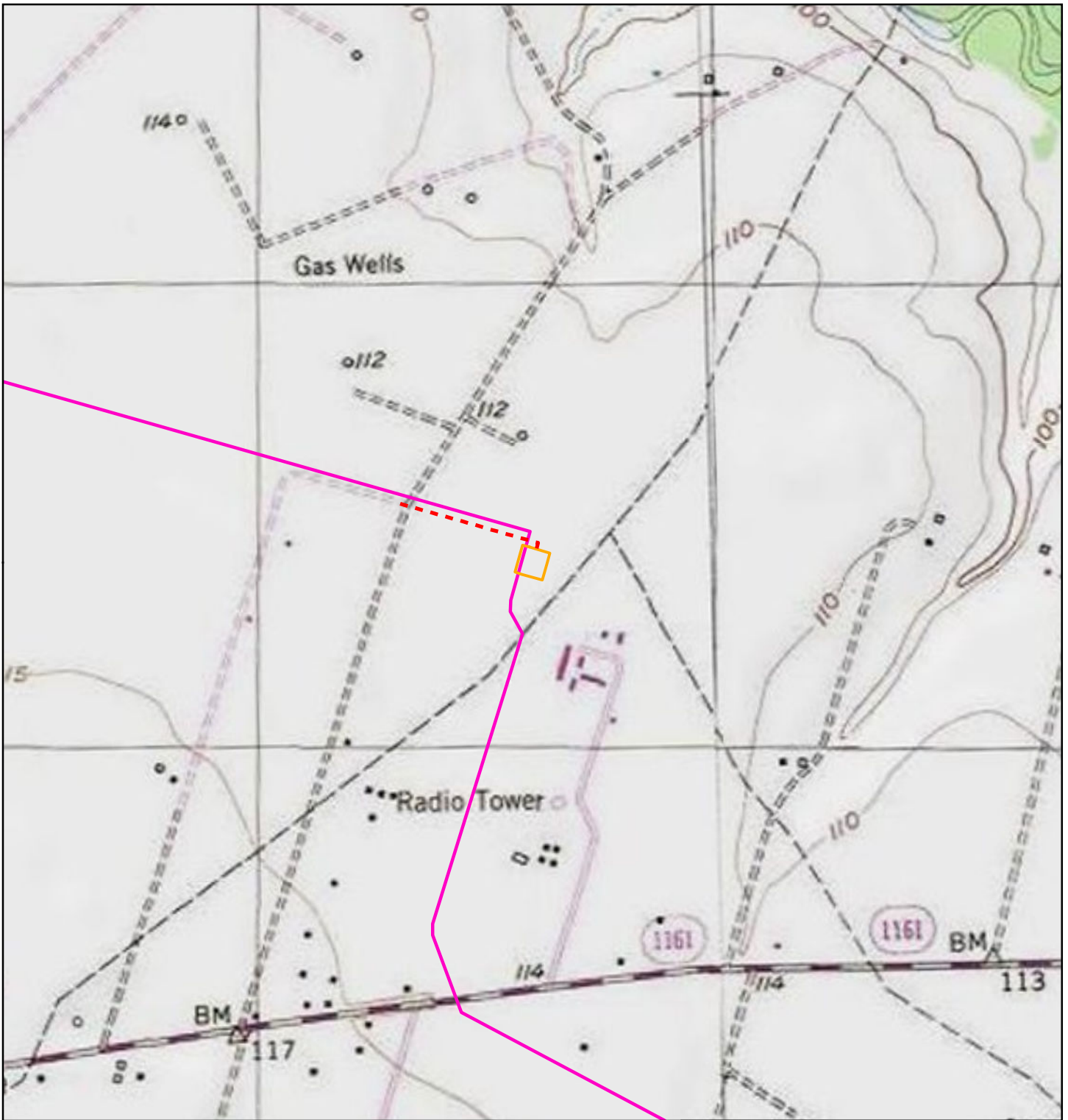
Date: September 2015



Legend

-  NGPL M&R Station
-  Proposed Non-Jurisdictional Facility
-  Proposed 36-inch Header Pipeline

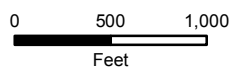

Gulf South Pipeline Company, LP
Coastal Bend Header Project -
NGPL M&R Station
Wharton County, Texas

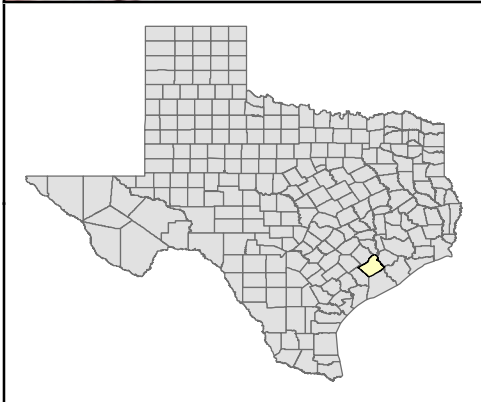
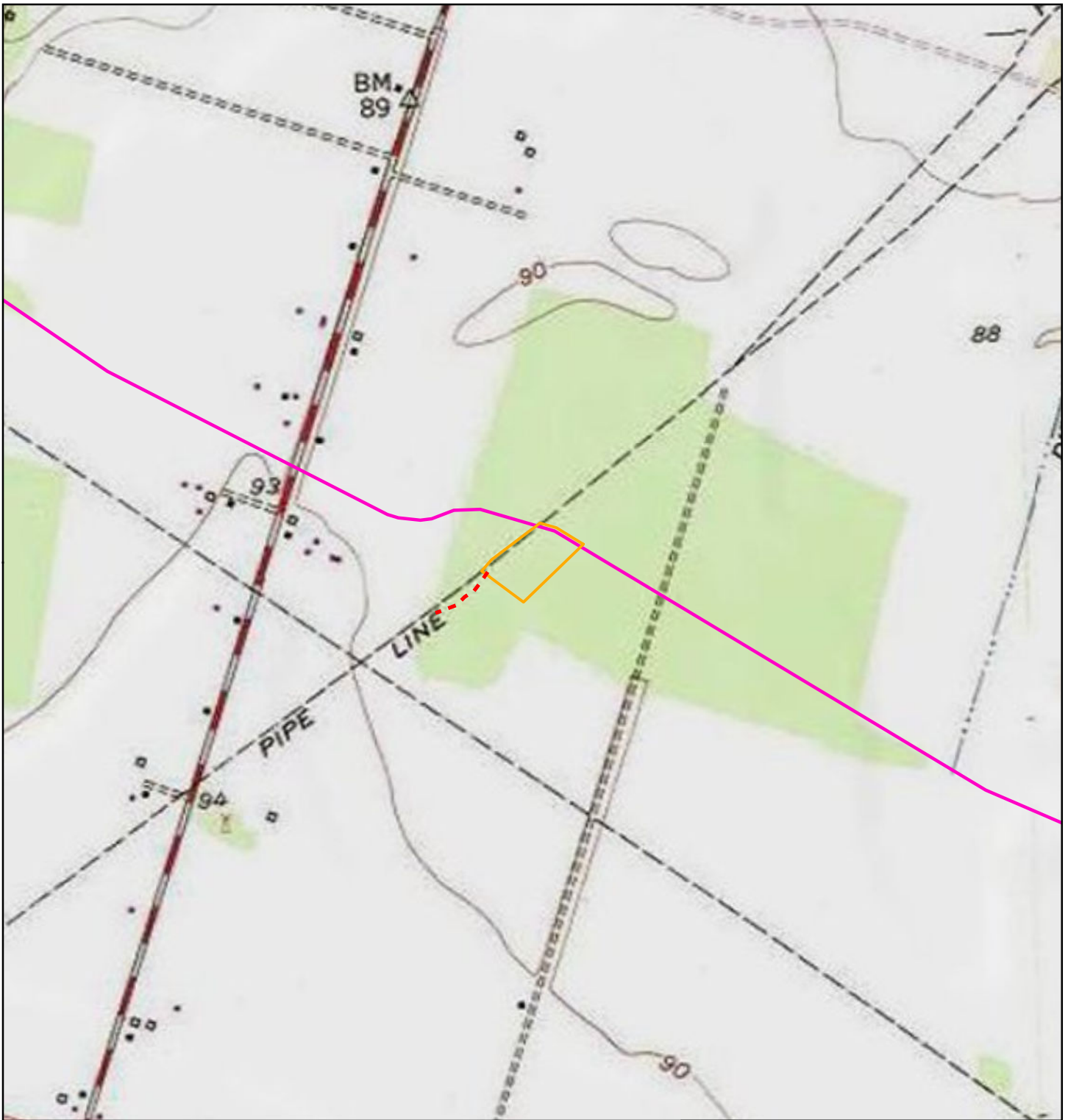

Legend

- Gulf South Index 129 M&R Station
- Proposed Non-Jurisdictional Facility
- Proposed 36-inch Header Pipeline

0 500 1,000
 ───────────
 Feet





**Gulf South Pipeline Company, LP
 Coastal Bend Header Project -
 Gulf South Index 129 M&R Station
 Wharton County, Texas**

Page 1 of 1	Scale: 1:12,000
NAD83 TX SC 4204	Date: September 2015

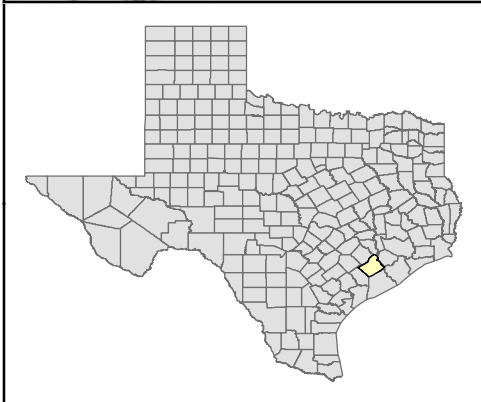
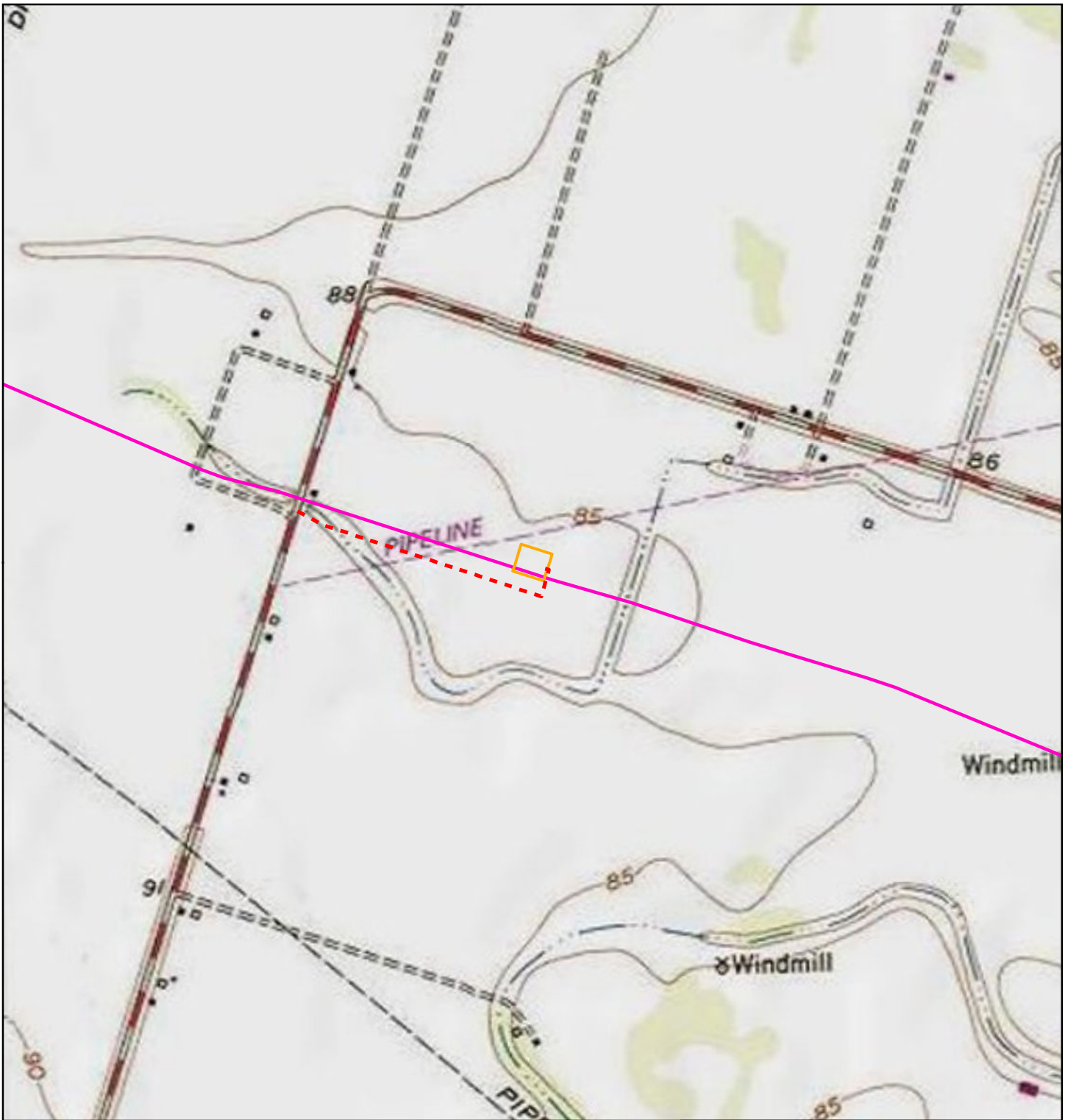

Legend

- HPL-Energy Transfer M&R Station
- Proposed Non-Jurisdictional Facility
- Proposed 36-inch Header Pipeline

0 500 1,000
 Feet





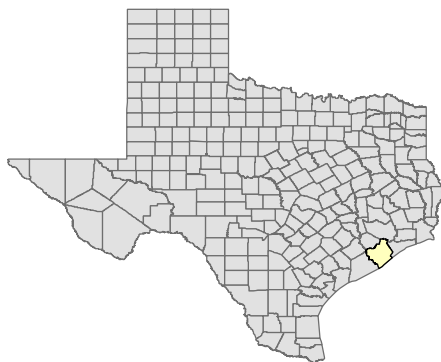
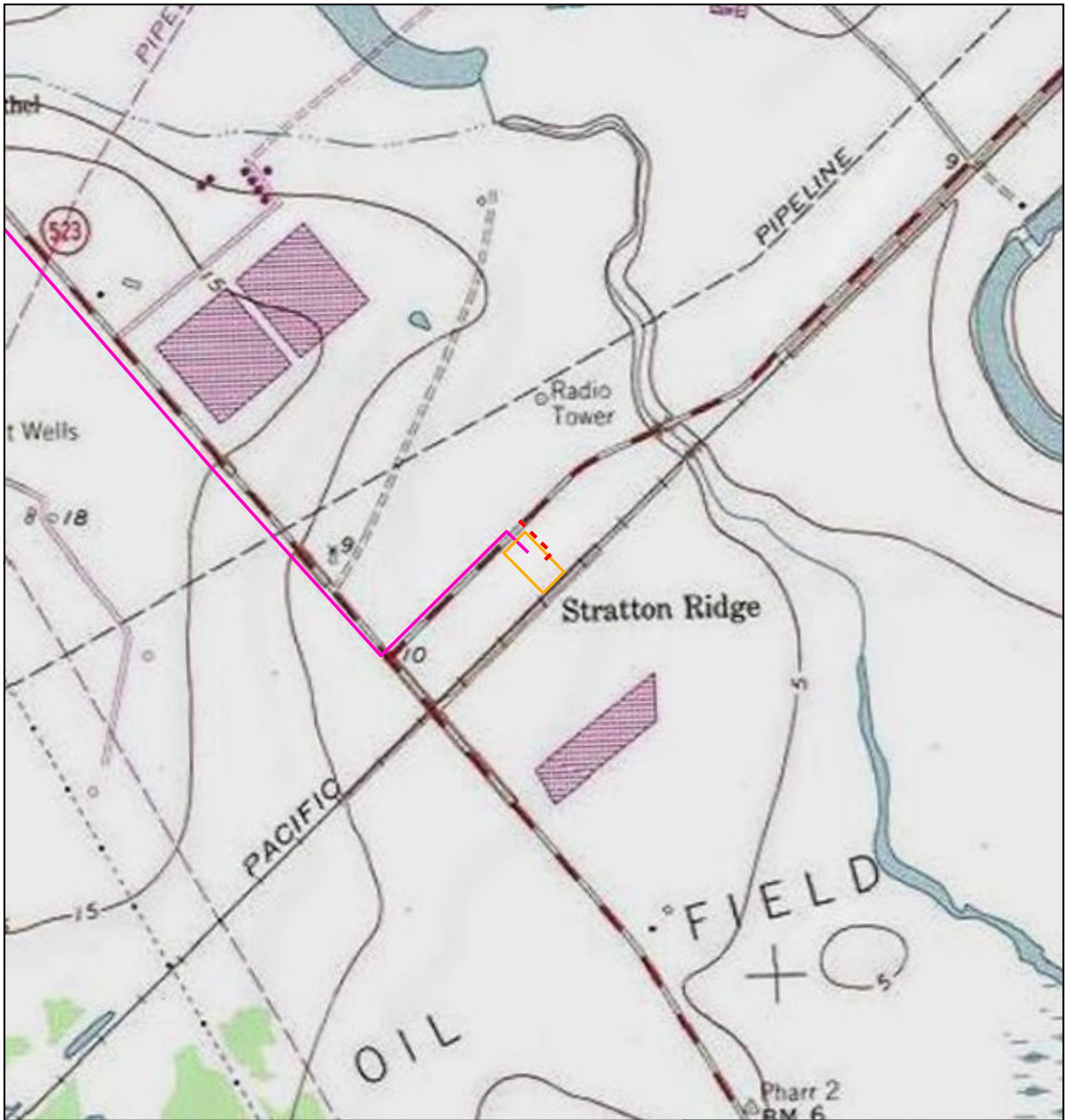

**Gulf South Pipeline Company, LP
 Coastal Bend Header Project -
 HPL-Energy Transfer M&R Station
 Wharton County, Texas**

Page 1 of 1	Scale: 1:12,000
NAD83 TX SC 4204	Date: September 2015



Legend

-  Stratton Ridge M&R Station
-  Proposed Non-Jurisdictional Facility
-  Proposed 36-inch Header Pipeline

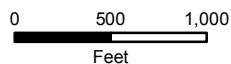

**Gulf South Pipeline Company, LP
Coastal Bend Header Project -
Stratton Ridge M&R Station
Brazoria County, Texas**

APPENDIX D

**PLAN FOR CONTAINMENT OF INADVERTENT RELEASE OF DRILLING MUD
DURING HORIZONTAL DIRECTION DRILLED WETLAND AND
WATERBODY CROSSINGS**



Gulf South Pipeline Company, LP

**Plan for Containment of Inadvertent Release of Drilling Mud during Horizontal Directional
Drilled Wetland and Waterbody Crossings**

Coastal Bend Header Project

June 2015

TABLE OF CONTENTS

1.0 Introduction 1

2.0 Monitoring and Sampling Procedures 1

3.0 Notification Procedures 2

4.0 Corrective Action..... 2

4.1 Wetland or Waterbody Release 2

4.2 Upland Release 3

5.0 Contingency Plan 3

5.1 Abandonment 3

5.2 Alternative Crossings..... 4

PLAN FOR CONTAINMENT OF INADVERTENT RELEASE OF DRILLING MUD DURING HORIZONTAL DIRECTIONAL DRILLED WETLAND AND WATERBODY CROSSINGS

1.0 INTRODUCTION

This plan provides specific procedures and steps to address inadvertent releases of drilling mud during horizontal directional drilling (HDD) beneath wetlands and waterbodies. Drilling mud to be used for the Coastal Bend Header Project (Project) will generally consist primarily of fresh water, with a high yield bentonite added to achieve the necessary properties, such as viscosity. Bentonite is composed of clay minerals and is not considered a hazardous material by U.S. Environmental Protection Agency. Therefore, in the event of a release into a wetland or waterbody, there will be no adverse environmental impact other than a temporary increase in turbidity from the bentonite and the efforts to contain and collect the release. While drilling parameters will be established to maximize circulation and minimize risk of inadvertent releases, the possibility of lost circulation and releases cannot be eliminated. Therefore, the following plan has been prepared to address containment procedures in the event of an inadvertent release. Unless otherwise specified, Gulf South Pipeline Company, LP (Gulf South) will implement the following plan in consultation with the Contractor, Construction Inspector, and environmental inspector(s) (EI).

Elements of this plan include:

- Monitoring and Sampling Procedures;
- Notification Procedures;
- Corrective Action; and
- Abandonment.

2.0 MONITORING AND SAMPLING PROCEDURES

HDD activities will be closely and continually monitored by the Contractor, the Construction Inspector, the EI(s), or any combination of the three. Monitoring and sampling procedures will include:

- Visual inspection along the drill path, including monitoring the wetlands and waterbodies for evidence of a release.
- Continuous monitoring of drilling mud, drilling mud pressures, and return flows by the Contractor.
- Periodic recordation of drill status information regarding drill conditions, pressures, returns, and progress during the course of drilling activities.

3.0 NOTIFICATION PROCEDURES

If an inadvertent release is discovered, Gulf South will contain the release as described below in the Corrective Action section (Section 4.0).

If a release occurs in a wetland or waterbody, the Contractor, Construction Inspector, or EI(s) will immediately notify Gulf South's construction management personnel.

Gulf South will notify the Texas Commission on Environmental Quality and the U.S. Army Corps of Engineers immediately upon discovery by telephone and/or facsimile of an inadvertent release in a wetland or waterbody, detailing the location and nature of the release, corrective actions being taken, and whether the release poses any threat to public health and safety.

4.0 CORRECTIVE ACTION

Gulf South will address an inadvertent release immediately upon discovery. Containment equipment including portable pumps, hand tools, sand, hay bales, silt fencing, and lumber will be readily available and stored at the drilling site. The following measures will be implemented to minimize or prevent further release, contain the release, and clean up the affected area:

4.1 WETLAND OR WATERBODY RELEASE

- Inspection will be initiated to determine the potential movement of released drilling mud within the wetland or waterbody.
- Drilling mud returns will be collected at the drill entry location for future analysis, as required.
- Monitoring of the release will be documented by the EI(s). Gulf South will keep photographs of release events on record.
- The Contractor will determine and implement modifications to the drilling technique or composition of drilling fluid (e.g., thickening of mud by increasing bentonite content) as appropriate to minimize or prevent further releases of drilling mud.
- Reasonable measures, within the limitation of directional drilling technology and Contractor's capability, will be taken to re-establish drilling mud circulation.
- Gulf South will evaluate the release to determine if containment structures are warranted and can effectively contain the release. When making this determination, Gulf South will also consider if placement of containment structures will cause additional adverse environmental impact.

- Upon completion of the drilling operations, Gulf South will consult with applicable regulatory agencies to determine any final clean-up requirements for the inadvertent release.
- If public health and safety are threatened by the inadvertent release, drilling operations will be shut down until the threat is eliminated.

4.2 UPLAND RELEASE

- The Contractor will determine and implement modifications to the drilling technique or composition of drilling fluid (e.g., thickening of mud by increasing bentonite content) as appropriate to minimize or prevent further releases of drilling mud.
- Gulf South will place containment structures at the affected area to prevent migration of the release.
- If the amount of the release is large enough to allow collection, the drilling mud released into containment structures will be collected and returned to either the drilling operations or a disposal site by hose or tanker.
- If the amount of the release is not large enough to allow collection, the affected area will be diluted with fresh water and allowed to dry. Steps will be taken to prevent silt-laden water from flowing into a wetland or waterbody.
- If public health and safety are threatened by an inadvertent release, drilling operations will be shut down until the threat is eliminated.

5.0 CONTINGENCY PLAN

If the corrective actions described above do not correct the problem, Gulf South may opt to abandon the drill hole and consider alternate measures. Abandonment procedures and alternative measures both will be discussed with appropriate permitting and regulatory agencies and approvals will be secured. Abandonment procedures and alternative crossings are described in the subsequent sub-sections.

5.1 ABANDONMENT

- In the event the drill hole is to be abandoned the following procedures will be implemented:
- To seal the abandoned drill hole, drilling mud will be pumped into the hole as the drill assembly is extracted.
- At the surface (within approximately 5 feet of the surface), Gulf South will fill the drill end points with soil and grade the location to the original contour.

5.2 ALTERNATIVE CROSSINGS

Before any determination of alternative crossings an attempt will be made to identify and assess the reason for the drill failure as this may be critical for selection of the alternate. Consideration of alternatives will include but not be limited to:

- horizontal relocation of the drill hole;
- changing of the drill profile (depth of hole);
- changing drill procedures (mud viscosity/pressure/flow velocity, bit rotation/velocity, etc);
- open cut from banks with pipe pulled across;
- open cut from banks with pipe lay from barge; and
- partial stream diversion using cofferdams with pipe tie-in in pit during second diversion.

In developing the appropriate alternate, consideration will be given to:

- stream bank type, flow width, depth, velocity, and flow volume;
- surrounding topography;
- condition of riparian areas;
- condition and extent of wetlands, if any, on each side;
- aquatic biota; and
- downstream water uses, needs.

These and other factors will be considered and discussed with appropriate regulatory agencies so as to minimize environmental and public convenience aspects and secure appropriate approvals. Final selection will be submitted to the Federal Energy Regulatory Commission with supporting data.

APPENDIX E
WATERBODY CROSSINGS

Surface Waterbodies Crossed or Otherwise Impacted by the Coastal Bend Header Project									
Milepost	Feature ID	Waterbody Name	State Water Quality Classification ^{a b}	Fishery Classification ^a	Flow Regime	FERC Classification	Waterbody Width (feet)	Pipeline Crossing Length (feet)	Proposed Crossing Method
Pipeline Facilities									
Wharton County									
0.06	SP1WH076	Unnamed Tributary of Clarks Branch	PCR, M	Warmwater	Ephemeral	Minor	4	4	Open-cut
0.06	SP1WH075	Unnamed Tributary of Clarks Branch	PCR, M	Warmwater	Intermittent	Minor	8	8	Open-cut
0.07	SP1WH057	Unnamed Tributary of Clarks Branch	PCR, M	Warmwater	Ephemeral	Minor	3	3	Open-cut
0.74	SP1WH151	Unnamed Tributary of Lone Tree Creek	PCR, M	Warmwater	Ephemeral	Minor	2	2	Road Bore
0.75	SP1WH078	Unnamed Tributary of Lone Tree Creek	PCR, M	Warmwater	Intermittent	Minor	8	8	Road Bore
1.43	SP1WH077	Unnamed Tributary of Lone Tree Creek	PCR, M	Warmwater	Intermittent	Intermediate	15	16	Open-cut
1.73	SP1WH060	Lone Tree Creek	PCR, H	Warmwater	Perennial	Intermediate	10	11	Open-cut
1.94	SP1WH061	Unnamed Tributary of Lone Tree Creek	PCR, M	Warmwater	Ephemeral	Minor	2	2	Open-cut
2.13	SP1WH062	Unnamed Tributary of Lone Tree Creek	PCR, M	Warmwater	Ephemeral	Minor	3	0 ^c	Workspace only

Surface Waterbodies Crossed or Otherwise Impacted by the Coastal Bend Header Project									
Milepost	Feature ID	Waterbody Name	State Water Quality Classification ^{a b}	Fishery Classification ^a	Flow Regime	FERC Classification	Waterbody Width (feet)	Pipeline Crossing Length (feet)	Proposed Crossing Method
2.31	SP1WH063	Unnamed Tributary of Lone Tree Creek	PCR, M	Warmwater	Intermittent	Intermediate	6	11	Open-cut
2.61	SP1WH065	Unnamed Tributary of Lone Tree Creek	PCR, M	Warmwater	Ephemeral	Minor	7	8	Open-cut
3.03	SP1WH066	Unnamed Tributary of Clarks Branch	PCR, M	Warmwater	Ephemeral	Minor	4	4	Open-cut
3.97	SP1WH148	Clarks Branch	PCR, H	Warmwater	Perennial	Intermediate	20	49	Open-cut
4.60	SP1WH039	Unnamed Tributary of Clarks Branch	PCR, M	Warmwater	Intermittent	Minor	5	6	Open-cut
4.70	SP1WH209	Unnamed Tributary of Clarks Branch	PCR, M	Warmwater	Ephemeral	Minor	6	7	Road Bore
4.71	SP1WH170	Unnamed Tributary of Clarks Branch	PCR, M	Warmwater	Ephemeral	Minor	3	4	Road Bore
5.32	SP1WH122	Unnamed Tributary of West Bernard Creek	PCR, M	Warmwater	Ephemeral	Minor	5	6	Open-cut
5.48	SP1WH123	Unnamed Tributary of West Bernard Creek	PCR, M	Warmwater	Ephemeral	Minor	3	5	Open-cut
5.60	SP1WH124	Unnamed Tributary of Peach Creek	PCR, M	Warmwater	Ephemeral	Minor	8	8	Open-cut

Surface Waterbodies Crossed or Otherwise Impacted by the Coastal Bend Header Project									
Milepost	Feature ID	Waterbody Name	State Water Quality Classification ^{a b}	Fishery Classification ^a	Flow Regime	FERC Classification	Waterbody Width (feet)	Pipeline Crossing Length (feet)	Proposed Crossing Method
6.16	SP1WH125	Unnamed Tributary of West Bernard Creek	PCR, M	Warmwater	Ephemeral	Minor	6	6	Open-cut
8.30	SP1WH006	Unnamed Tributary of Peach Creek	PCR, M	Warmwater	Ephemeral	Minor	6	6	Road Bore
9.05	SP1WH126	Unnamed Tributary of Peach Creek	PCR, M	Warmwater	Ephemeral	Minor	6	6	Road Bore
9.40	SP1WH127	Unnamed Tributary of Peach Creek	PCR, M	Warmwater	Ephemeral	Minor	8	8	Road Bore
9.57	SP1WH128	Unnamed Tributary of Peach Creek	PCR, M	Warmwater	Ephemeral	Minor	8	8	Open-cut
10.20	SP1WH217	Unnamed Tributary of Peach Creek	PCR, M	Warmwater	Ephemeral	Minor	5	N/A	HDD
10.85	SP1WH070	Peach Creek	PCR, H, PS	Warmwater	Perennial	Intermediate	40	N/A	HDD
10.87	SP1WH069	Peach Creek	PCR, H, PS	Warmwater	Perennial	Intermediate	30	N/A	HDD
12.04	SP1WH071	Unnamed Tributary of Baughman Slough	PCR, M	Warmwater	Ephemeral	Minor	5	9	Open-cut
12.37	SP1WH200	Unnamed Tributary of Baughman Slough	PCR, M	Warmwater	Intermittent	Minor	6	9	Open-cut
12.45	SP1WH201	Baughman Slough	PCR, M	Warmwater	Intermittent	Intermediate	20	31	Open-cut
13.07	SP1WH021	Unnamed Tributary of Baughman Slough	PCR, M	Warmwater	Ephemeral	Minor	4	0 ^c	Workspace only

Surface Waterbodies Crossed or Otherwise Impacted by the Coastal Bend Header Project									
Milepost	Feature ID	Waterbody Name	State Water Quality Classification ^{a b}	Fishery Classification ^a	Flow Regime	FERC Classification	Waterbody Width (feet)	Pipeline Crossing Length (feet)	Proposed Crossing Method
13.10	SP1WH019	Unnamed Tributary of Baughman Slough	PCR, M	Warmwater	Intermittent	Minor	5	5	Open-cut
13.97	SP1WH007	Unnamed Tributary of Peach Creek	PCR, M	Warmwater	Ephemeral	Minor	4	4	Open-cut
14.64	SP1WH008	Unnamed Tributary of Peach Creek	PCR, M	Warmwater	Ephemeral	Minor	3	3	Open-cut
15.16	SP1WH219	Unnamed Tributary of Peach Creek	PCR, M	Warmwater	Intermittent	Intermediate	20	17	Open-cut
15.77	SP1WH010	Unnamed Tributary of Peach Creek	PCR, M	Warmwater	Ephemeral	Minor	3	3	Road Bore
16.75	SP1WH131	Unnamed Tributary of Peach Creek	PCR, M	Warmwater	Ephemeral	Minor	5	5	Open-cut
16.77	SP1WH130	Unnamed Tributary of Peach Creek	PCR, M	Warmwater	Intermittent	Intermediate	12	13	Open-cut
17.35	SP1WH022	Unnamed Tributary of Peach Creek	PCR, M	Warmwater	Ephemeral	Minor	6	6	Road Bore
19.54	SP1WH011	Unnamed Tributary of San Bernard River	PCR, M	Warmwater	Ephemeral	Minor	4	8	Open-cut
20.29	SP1WH266	Unnamed Tributary of San Bernard River	PCR, M	Warmwater	Intermittent	Minor	5	5	Open-cut
20.54	SP1WH072	Unnamed Tributary of San Bernard River	PCR, M	Warmwater	Ephemeral	Minor	8	8	Open-cut

Surface Waterbodies Crossed or Otherwise Impacted by the Coastal Bend Header Project									
Milepost	Feature ID	Waterbody Name	State Water Quality Classification ^{a b}	Fishery Classification ^a	Flow Regime	FERC Classification	Waterbody Width (feet)	Pipeline Crossing Length (feet)	Proposed Crossing Method
21.14	SP1WH023	Unnamed Tributary of San Bernard River	PCR, M	Warmwater	Ephemeral	Minor	4	4	Road Bore
21.94	SP1WH079	Unnamed Tributary of San Bernard River	PCR, M	Warmwater	Intermittent	Intermediate	10	11	Open-cut
22.02	SP1WH081	Unnamed Tributary of San Bernard River	PCR, M	Warmwater	Ephemeral	Minor	6	6	Road Bore
22.04	SP1WH132	Unnamed Tributary of San Bernard River	PCR, M	Warmwater	Ephemeral	Minor	8	8	Road Bore
22.12	SP1WH133_A	Unnamed Tributary of San Bernard River	PCR, M	Warmwater	Ephemeral	Minor	6	7	Open-cut
22.45	OWP1WH002	Manmade Pond	N/A	N/A	Open Water	Intermediate	47	0 ^c	Workspace only
23.44	SP1WH013	Unnamed Tributary of San Bernard River	PCR, M	Warmwater	Ephemeral	Minor	8	8	Open-cut
23.71	SP1WH014	Unnamed Tributary of San Bernard River	PCR, M	Warmwater	Ephemeral	Minor	3	5	Open-cut
24.14	SP1WH015	Unnamed Tributary of San Bernard River	PCR, M	Warmwater	Ephemeral	Minor	3	4	Open-cut
24.20	SP1WH016	Unnamed Tributary of San Bernard River	PCR, M	Warmwater	Ephemeral	Minor	4	5	Open-cut

Surface Waterbodies Crossed or Otherwise Impacted by the Coastal Bend Header Project									
Milepost	Feature ID	Waterbody Name	State Water Quality Classification ^{b c}	Fishery Classification ^a	Flow Regime	FERC Classification	Waterbody Width (feet)	Pipeline Crossing Length (feet)	Proposed Crossing Method
24.50	SP1WH133	Unnamed Tributary of Linnville Bayou	PCR, M	Warmwater	Ephemeral	Minor	6	10	Open-cut
24.71	SP1WH018	Unnamed Tributary of Caney Creek	PCR, M	Warmwater	Ephemeral	Minor	4	4	Open-cut
25.52	SP1WH017	Unnamed Tributary of Linnville Bayou	PCR, M	Warmwater	Intermittent	Minor	10	10	Open-cut
25.91	OWP1WH010	Manmade Pond	N/A	N/A	Open Water	Intermediate	47	46	Open-cut
26.36	SP1WH073	Unnamed Tributary of Linnville Bayou	PCR, M	Warmwater	Ephemeral	Intermediate	12	13	Open-cut
26.43	SP1WH024	Unnamed Tributary of Linnville Bayou	PCR, H	Warmwater	Perennial	Intermediate	20	18	Open-cut
26.58	SP1WH031	Unnamed Tributary of Linnville Bayou	PCR, H	Warmwater	Perennial	Intermediate	30	44	Open-cut
26.83	SP1WH032	Unnamed Tributary of Linnville Bayou	PCR, M	Warmwater	Intermittent	Minor	4	6	Open-cut
26.85	SP1WH033	Unnamed Tributary of Linnville Bayou	PCR, M	Warmwater	Intermittent	Minor	4	6	Open-cut
26.92	SP1WH034	Unnamed Tributary of Linnville Bayou	PCR, M	Warmwater	Intermittent	Minor	4	6	Open-cut

Surface Waterbodies Crossed or Otherwise Impacted by the Coastal Bend Header Project									
Milepost	Feature ID	Waterbody Name	State Water Quality Classification ^{a b}	Fishery Classification ^a	Flow Regime	FERC Classification	Waterbody Width (feet)	Pipeline Crossing Length (feet)	Proposed Crossing Method
27.26	SP1WH246	Linnville Bayou	PCR, H	Warmwater	Perennial	Intermediate	50	N/A	HDD
Brazoria County									
27.84	SP1BR247	Unnamed Tributary of Linnville Bayou	PCR, M	Warmwater	Perennial	Intermediate	50	60	Open-cut
29.42	SP1BR249	Unnamed Tributary of San Bernard River	PCR, M	Warmwater	Perennial	Intermediate	15	21	Open-cut
29.44	SP1BR251	Unnamed Tributary of San Bernard River	PCR, M	Warmwater	Ephemeral	Minor	3	3	Open-cut
29.45	SP1BR252	Unnamed Tributary of San Bernard River	PCR, M	Warmwater	Ephemeral	Minor	3	0 ^d	Workspace only
30.39	SP1BR254	Unnamed Tributary of San Bernard River	PCR, M	Warmwater	Ephemeral	Minor	4	9	Open-cut
30.48	SP1BR265	Unnamed Tributary of San Bernard River	PCR, M	Warmwater	Ephemeral	Minor	2	0 ^c	Workspace only
30.50	SP1BR255	Unnamed Tributary of San Bernard River	PCR, M	Warmwater	Ephemeral	Minor	2	2	Open-cut
30.67	SP1BR158	Unnamed Tributary of San Bernard River	PCR, M	Warmwater	Ephemeral	Minor	4	5	Open-cut

Surface Waterbodies Crossed or Otherwise Impacted by the Coastal Bend Header Project									
Milepost	Feature ID	Waterbody Name	State Water Quality Classification ^{a b}	Fishery Classification ^a	Flow Regime	FERC Classification	Waterbody Width (feet)	Pipeline Crossing Length (feet)	Proposed Crossing Method
30.86	SP1BR159	Unnamed Tributary of San Bernard River	PCR, M	Warmwater	Ephemeral	Minor	3	3	Open-cut
30.87	SP1BR160	Unnamed Tributary of San Bernard River	PCR, M	Warmwater	Ephemeral	Minor	3	4	Open-cut
31.22	SP1BR163	Unnamed Tributary of San Bernard River	PCR, M	Warmwater	Ephemeral	Intermediate	2	N/A	HDD
31.23	SP1BR164	San Bernard River	PCR, H, PS	Warmwater	Perennial	Intermediate	50	N/A	HDD
31.25	SP1BR165	Unnamed Tributary of San Bernard River	PCR, M	Warmwater	Ephemeral	Minor	3	N/A	HDD
31.34	SP1BR166	Unnamed Tributary of San Bernard River	PCR, M	Warmwater	Ephemeral	Minor	4	N/A	HDD
31.69	SP1BR225	Unnamed Tributary of San Bernard River	PCR, M	Warmwater	Ephemeral	Minor	3	3	Open-cut
31.70	SP1BR226	Unnamed Tributary of San Bernard River	PCR, M	Warmwater	Ephemeral	Minor	3	3	Open-cut
34.19	SP1BR236	Mound Creek	PCR, H	Warmwater	Perennial	Intermediate	25	19	Open-cut
34.51	SP1BR216	Unnamed Tributary of Mound Creek	PCR, M	Warmwater	Ephemeral	Minor	6	6	Open-cut
34.76	SP1BR215	Unnamed Tributary of Mound Creek	PCR, H	Warmwater	Perennial	Minor	15	10	Open-cut

Surface Waterbodies Crossed or Otherwise Impacted by the Coastal Bend Header Project									
Milepost	Feature ID	Waterbody Name	State Water Quality Classification ^{a b}	Fishery Classification ^a	Flow Regime	FERC Classification	Waterbody Width (feet)	Pipeline Crossing Length (feet)	Proposed Crossing Method
35.02	SP1BR214	Unnamed Tributary of Mound Creek	PCR, M	Warmwater	Ephemeral	Minor	8	8	Open-cut
35.03	SP1BR213	Unnamed Tributary of Mound Creek	PCR, M	Warmwater	Ephemeral	Minor	8	8	Open-cut
35.53	SP1BR212	Unnamed Tributary of Mound Creek	PCR, M	Warmwater	Ephemeral	Minor	6	7	Open-cut
35.80	SP1BR210	Unnamed Tributary of Mound Creek	PCR, M	Warmwater	Ephemeral	Minor	8	8	Road Bore
35.81	SP1BR211	Unnamed Tributary of Mound Creek	PCR, M	Warmwater	Ephemeral	Minor	3	3	Road Bore
36.06	SP1BR084	Unnamed Tributary of Mound Creek	PCR, M	Warmwater	Ephemeral	Intermediate	12	22	Open-cut
36.07	SP1BR085	Unnamed Tributary of Mound Creek	PCR, M	Warmwater	Ephemeral	Intermediate	12	16	Open-cut
36.34	SP1BR146	Varner Creek	PCR, M	Warmwater	Intermittent	Intermediate	20	28	Open-cut
36.58	SP1BR199	Unnamed Tributary of Varner Creek	PCR, M	Warmwater	Ephemeral	Minor	3	3	Open-cut
36.59	SP1BR198	Unnamed Tributary of Varner Creek	PCR, M	Warmwater	Ephemeral	Minor	3	3	Open-cut
37.07	SP1BR040	Unnamed Tributary of Varner Creek	PCR, M	Warmwater	Intermittent	Minor	8	9	Open-cut
37.77	SP1BR035	Unnamed Tributary of Varner Creek	PCR, M	Warmwater	Ephemeral	Minor	2	4	Open-cut
38.90	SP4BR022_DT ^d	Unnamed Tributary of Varner Creek	PCR, M	Warmwater	Intermittent	Intermediate	21	21	Open-cut

Surface Waterbodies Crossed or Otherwise Impacted by the Coastal Bend Header Project									
Milepost	Feature ID	Waterbody Name	State Water Quality Classification ^{a b}	Fishery Classification ^a	Flow Regime	FERC Classification	Waterbody Width (feet)	Pipeline Crossing Length (feet)	Proposed Crossing Method
39.30	SP1BR037	Unnamed Tributary of Varner Creek	PCR, M	Warmwater	Ephemeral	Minor	3	3	Open-cut
39.99	SP1BR176	Unnamed Tributary of Varner Creek	PCR, M	Warmwater	Intermittent	Intermediate	12	16	Open-cut
40.26	SP1BR177	Unnamed Tributary of Varner Creek	PCR, H	Warmwater	Perennial	Intermediate	20	16	Open-cut
40.99	SP1BR178	Unnamed Tributary of Varner Creek	PCR, M	Warmwater	Ephemeral	Minor	4	4	Open-cut
41.55	SP3BR002	Unnamed Tributary of Varner Creek	PCR, M	Warmwater	Ephemeral	Minor	4	0 ^c	Workspace only
41.59	SP3BR003	Unnamed Tributary of Varner Creek	PCR, M	Warmwater	Intermittent	Minor	2	2	Open-cut
41.61	SP3BR004	Unnamed Tributary of Brazos Rivers	PCR, M	Warmwater	Intermittent	Intermediate	10	44	Open-cut
41.67	SP3BR005	Unnamed Tributary of Brazos Rivers	PCR, M	Warmwater	Ephemeral	Minor	2	0 ^c	Workspace only
42.41	SP3BR006	Unnamed Tributary of Varner Creek	PCR, M	Warmwater	Ephemeral	Minor	4	7	Open-cut
43.10	SP1BR090	Unnamed Tributary of Varner Creek	PCR, M	Warmwater	Intermittent	Intermediate	15	15	Open-cut
43.48	SP1BR091	Unnamed Tributary of Varner Creek	PCR, M	Warmwater	Ephemeral	Minor	6	7	Open-cut
43.95	SP1BR005	Unnamed Tributary of Brazos River	PCR, M	Warmwater	Intermittent	Intermediate	8	20	Open-cut

Surface Waterbodies Crossed or Otherwise Impacted by the Coastal Bend Header Project									
Milepost	Feature ID	Waterbody Name	State Water Quality Classification ^{a b}	Fishery Classification ^a	Flow Regime	FERC Classification	Waterbody Width (feet)	Pipeline Crossing Length (feet)	Proposed Crossing Method
43.96	SP1BR005	Unnamed Tributary of Brazos River	PCR, M	Warmwater	Intermittent	Intermediate	8	27	Open-cut
43.98	SP1BR005	Unnamed Tributary of Brazos River	PCR, M	Warmwater	Intermittent	Intermediate	8	21	Open-cut
44.10	SP1BR005	Unnamed Tributary of Brazos River	PCR, M	Warmwater	Intermittent	Intermediate	8	0 ^c	Workspace only
44.24	SP1BR004	Unnamed Tributary of Brazos River	PCR, M	Warmwater	Intermittent	Minor	6	0 ^c	Workspace only
44.92	SP2BR001	Brazos River	PCR, H, PS	Warmwater	Perennial	Major	200	N/A	HDD
45.86	SP1BR179	Unnamed Tributary of Dry Bayou	PCR, M	Warmwater	Ephemeral	Intermediate	6	N/A	HDD
45.89	SP1BR100_C	Dry Bayou	PCR, H	Warmwater	Perennial	Major	110	N/A	HDD
46.40	SP1BR101	Unnamed Tributary of Dry Bayou	PCR, M	Warmwater	Ephemeral	Minor	8	10	Open-cut
46.41	SP1BR102	Unnamed Tributary of Dry Bayou	PCR, M	Warmwater	Ephemeral	Minor	8	10	Open-cut
46.47	SP1BR103	Unnamed Tributary of Middle Bayou	PCR, M	Warmwater	Intermittent	Intermediate	12	24	Open-cut
46.86	SP1BR104	Unnamed Tributary of Middle Bayou	PCR, M	Warmwater	Intermittent	Intermediate	12	11	Open-cut
47.01	SP1BR104	Unnamed Tributary of Middle Bayou	PCR, M	Warmwater	Intermittent	Intermediate	12	17	Open-cut
47.91	SP1BR104	Unnamed Tributary of Middle Bayou	PCR, M	Warmwater	Intermittent	Intermediate	12	22	Open-cut

Surface Waterbodies Crossed or Otherwise Impacted by the Coastal Bend Header Project									
Milepost	Feature ID	Waterbody Name	State Water Quality Classification ^{a b}	Fishery Classification ^a	Flow Regime	FERC Classification	Waterbody Width (feet)	Pipeline Crossing Length (feet)	Proposed Crossing Method
48.07	SP1BR180	Unnamed Tributary of Middle Bayou	PCR, M	Warmwater	Intermittent	Intermediate	12	12	Open-cut
48.56	SP1BR183	Mill Bayou	PCR, M	Warmwater	Intermittent	Minor	8	8	Open-cut
48.62	SP1BR184	Unnamed Tributary of Mill Bayou	PCR, M	Waterwater	Ephemeral	Minor	1	1	Open-cut
49.45	OWP1BR019	Manmade Pond	N/A	N/A	Open water	Intermediate	44	0 ^c	Workspace only
49.57	SP1BR195	Unnamed Tributary of Mill Bayou	PCR, M	Waterwater	Intermittent	Intermediate	20	19	Open-cut
50.63	OWP1BR029	Manmade Pond	N/A	N/A	Open Water	Intermediate	53	0 ^c	Workspace only
50.68	SP1BR086	Unnamed Tributary of Mill Bayou	PCR, M	Waterwater	Ephemeral	Minor	4	4	Road Bore
51.21	SP1BR041	Unnamed Tributary of Brazos River	PCR, M	Warmwater	Ephemeral	Minor	6	6	Road Bore
51.23	SP1BR042	Unnamed Tributary of Brazos River	PCR, M	Warmwater	Ephemeral	Minor	6	6	Road Bore
51.72	SP1BR044	Unnamed Tributary of Oyster Creek	PCR, M	Warmwater	Intermittent	Minor	8	8	Open-cut
51.91	SP1BR045	Unnamed Tributary of Oyster Creek	PCR, M	Warmwater	Intermittent	Intermediate	20	35	Open-cut
52.34	SP1BR046	Unnamed Tributary of Oyster Creek	PCR, M	Warmwater	Intermittent	Intermediate	20	30	Open-cut
52.35	SP1BR047	Unnamed Tributary of Oyster Creek	PCR, M	Warmwater	Ephemeral	Intermediate	8	11	Open-cut
53.14	SP1BR048	Oyster Creek	PCR, H, PS	Warmwater	Perennial	Intermediate	40	N/A	HDD

Surface Waterbodies Crossed or Otherwise Impacted by the Coastal Bend Header Project									
Milepost	Feature ID	Waterbody Name	State Water Quality Classification ^{a b}	Fishery Classification ^a	Flow Regime	FERC Classification	Waterbody Width (feet)	Pipeline Crossing Length (feet)	Proposed Crossing Method
53.16	SP1BR196	Unnamed Tributary of Oyster Creek	PCR, M	Warmwater	Intermittent	Intermediate	10	N/A	HDD
53.43	SP1BR049	Unnamed Tributary of Oyster Creek	PCR, M	Warmwater	Ephemeral	Minor	4	4	Open-cut
54.44	SP1BR050	Unnamed Tributary of Bastrop Bayou	PCR, M	Warmwater	Ephemeral	Intermediate	10	26	Open-cut
54.82	SP1BR051	Unnamed Tributary of Bastrop Bayou	PCR, M	Warmwater	Intermittent	Intermediate	20	33	Open-cut
55.41	SP1BR053	Unnamed Tributary of Bastrop Bayou	PCR, M	Warmwater	Ephemeral	Minor	6	N/A	HDD
55.46	SP1BR052	Unnamed Tributary of Bastrop Bayou	PCR, M	Warmwater	Intermittent	Intermediate	15	N/A	HDD
55.49	SP1BR259	Unnamed Tributary of Bastrop Bayou	PCR, H	Warmwater	Perennial	Intermediate	40	N/A	HDD
55.57	SP1BR258	Unnamed Tributary of Bastrop Bayou	PCR, M	Warmwater	Ephemeral	Minor	4	N/A	HDD
56.19	SP1BR074	Unnamed Tributary of Bastrop Bayou	PCR, H	Warmwater	Perennial	Intermediate	30	N/A	HDD
56.80	SP1BR273	Unnamed Tributary of Bastrop Bayou	PCR, M	Warmwater	Ephemeral	Minor	2	2	Road Bore

Surface Waterbodies Crossed or Otherwise Impacted by the Coastal Bend Header Project									
Milepost	Feature ID	Waterbody Name	State Water Quality Classification ^{a b}	Fishery Classification ^a	Flow Regime	FERC Classification	Waterbody Width (feet)	Pipeline Crossing Length (feet)	Proposed Crossing Method
57.11	SP1BR274	Unnamed Tributary of Bastrop Bayou	PCR, M	Warmwater	Ephemeral	Minor	3	3	Road Bore
57.13	SP1BR275	Unnamed Tributary of Bastrop Bayou	PCR, M	Warmwater	Ephemeral	Minor	4	4	Road Bore
57.21	SP1BR276	Unnamed Tributary of Bastrop Bayou	PCR, M	Warmwater	Ephemeral	Minor	3	3	Road Bore
57.21	SP1BR277	Unnamed Tributary of Bastrop Bayou	PCR, M	Warmwater	Ephemeral	Minor	3	3	Road Bore
57.57	SP1BR278	Unnamed Tributary of Bastrop Bayou	PCR, M	Warmwater	Ephemeral	Minor	3	N/A	HDD
57.58	SP1BR279	Unnamed Tributary of Bastrop Bayou	PCR, M	Warmwater	Intermittent	Intermediate	15	N/A	HDD
58.35	OWP1BR023	Manmade pond	N/A	N/A	Open Water	Minor	154	N/A	HDD
58.40	SP1BR232	Unnamed Tributary of Bastrop Bayou	PCR, H	Warmwater	Perennial	Intermediate	30	N/A	HDD
58.51	SP1BR233	Unnamed Tributary of Bastrop Bayou	PCR, M	Warmwater	Ephemeral	Minor	4	N/A	HDD
58.54	SP1BR234	Unnamed Tributary of Bastrop Bayou	PCR, M	Warmwater	Ephemeral	Minor	3	N/A	HDD

Surface Waterbodies Crossed or Otherwise Impacted by the Coastal Bend Header Project									
Milepost	Feature ID	Waterbody Name	State Water Quality Classification ^{a b}	Fishery Classification ^a	Flow Regime	FERC Classification	Waterbody Width (feet)	Pipeline Crossing Length (feet)	Proposed Crossing Method
59.83	SP1BR055	Unnamed Tributary of Bastrop Bayou	PCR, H	Warmwater	Perennial	Intermediate	15	N/A	HDD
59.98	SP1BR056	Bastrop Bayou	PCR, H	Warmwater	Perennial	Major	200	N/A	HDD
60.11	OWP1BR028	Manmade Pond	N/A	N/A	Open Water	Intermediate	81	N/A	HDD
60.30	SP1BR261	Unnamed Tributary of Bastrop Bayou	PCR, M	Warmwater	Intermittent	Intermediate	20	22	Road Bore
60.71	SP1BR093	Unnamed Tributary of Bastrop Bayou	PCR, M	Warmwater	Intermittent	Intermediate	25	18	Open-cut
60.95	SP1BR094	Unnamed Tributary of Bastrop Bayou	PCR, M	Warmwater	Intermittent	Intermediate	10	23	Open-cut
61.20	SP1BR095	Unnamed Tributary of Bastrop Bayou	PCR, M	Warmwater	Ephemeral	Minor	8	9	Open-cut
61.68	SP1BR096	Unnamed Tributary of Bastrop Bayou	PCR, M	Warmwater	Intermittent	Intermediate	20	29	Open-cut
61.69	SP1BR097	Unnamed Tributary of Bastrop Bayou	PCR, M	Warmwater	Intermittent	Intermediate	300	29	Open-cut
62.44	SP1BR092_ DT ^d	Little Slough	PCR, H	Warmwater	Perennial	Major	99	115	Open-cut
62.70	SP1BR112	Unnamed Tributary of Big Slough	PCR, M	Warmwater	Ephemeral	Minor	8	9	Road Bore

Surface Waterbodies Crossed or Otherwise Impacted by the Coastal Bend Header Project									
Milepost	Feature ID	Waterbody Name	State Water Quality Classification ^{b c}	Fishery Classification	Flow Regime	FERC Classification	Waterbody Width (feet)	Pipeline Crossing Length (feet)	Proposed Crossing Method
62.71	SP1BR113	Unnamed Tributary of Big Slough	PCR, M	Warmwater	Intermittent	Intermediate	8	31	Road Bore
63.32	SP1BR114	Unnamed Tributary of Bastrop Bayou	PCR, M	Warmwater	Intermittent	Intermediate	15	17	Open-cut
63.47	SP1BR059_DT ^d	Big Slough	PCR, H	Warmwater	Perennial	Major	96	111	Open-cut
64.03	SP2BR002	Unnamed Tributary of Salt Bayou	PCR, M	Warmwater	Intermittent	Intermediate	10	23	Open-cut
Aboveground Facilities									
36-inch Header Pipeline									
No waterbodies will be impacted by construction and operation of the proposed aboveground facilities located on the header pipeline.									
Legacy System Facilities									
Harris County									
North Houston Compressor Station	SP3HA001	Unnamed Tributary of Willow Creek	PCR, M	Warmwater	Intermittent	Minor	6	N/A	Workspace Only
Polk County									
Goodrich Compressor Station	SP1PO280	Unnamed Tributary of Long King Creek	PCR, M	Warmwater	Ephemeral	Minor	4	N/A	Workspace Only
Sabine County									
Magasco Compressor Station	SP5SA002	Unnamed Tributary of Easley Creek	PCR, M	Warmwater	Ephemeral	Minor	2	N/A	Existing Culvert

Surface Waterbodies Crossed or Otherwise Impacted by the Coastal Bend Header Project									
Milepost	Feature ID	Waterbody Name	State Water Quality Classification ^{a b}	Fishery Classification ^a	Flow Regime	FERC Classification	Waterbody Width (feet)	Pipeline Crossing Length (feet)	Proposed Crossing Method
Access Roads									
Wharton County									
AR-P-2	SP1WH078	Unnamed Tributary of Lone	PCR, M	Warmwater	Intermittent	Minor	8	N/A	Existing Culvert
AR-P-2	SP1WH152	Unnamed Tributary of Lone Tree	PCR, M	Warmwater	Ephemeral	Intermediate	15	N/A	Existing Culvert
AR-P-2	SP1WH153	Unnamed Tributary of Lone Tree	PCR, M	Warmwater	Ephemeral	Minor	4	N/A	Existing Culvert
AR-P-2	SP1WH154	Unnamed Tributary of Clarks Branc	PCR, M	Warmwater	Intermittent	Minor	8	N/A	Existing Culvert
AR-P-2	SP1WH155	Clarks Branch	PCR, M	Warmwater	Intermittent	Minor	8	N/A	Existing Culvert
AR-P-2	SP1WH156	Unnamed Tributary of Clark	PCR, M	Warmwater	Intermittent	Minor	8	N/A	Existing Culvert
AR-P-2	SP1WH157	Unnamed Tributary of West Bernard	PCR, M	Warmwater	Intermittent	Minor	8	N/A	Existing Culvert
AR-P-3	SP1WH067	Unnamed Tributary of Clarks Branc	PCR, M	Warmwater	Intermittent	Minor	4	N/A	Existing Culvert
AR-P-3	SP1WH147	Unnamed Tributary of Clark	PCR, M	Warmwater	Intermittent	Minor	5	N/A	Existing Culvert
AR-P-3	SP1WH148	Clarks Branch	PCR, H	Warmwater	Perennial	Intermediate	20	N/A	Existing Culvert

Surface Waterbodies Crossed or Otherwise Impacted by the Coastal Bend Header Project									
Milepost	Feature ID	Waterbody Name	State Water Quality Classification ^{a b}	Fishery Classification ^a	Flow Regime	FERC Classification	Waterbody Width (feet)	Pipeline Crossing Length (feet)	Proposed Crossing Method
AR-P-3	SP1WH150	Unnamed Tributary of Lone	PCR, M	Warmwater	Intermittent	Minor	5	N/A	Existing Culvert
AR-P-6	SP1WH170	Unnamed Tributary of Clarks Branch	PCR, M	Warmwater	Ephemeral	Minor	3	N/A	Existing Culvert
AR-P-6.1	SP1WH227	Unnamed Tributary of Clarks Branch	PCR, M	Warmwater	Ephemeral	Minor	6	N/A	Existing Culvert
AR-P-6.1	SP1WH122	Unnamed Tributary of West Bernard	PCR, M	Warmwater	Ephemeral	Minor	5	N/A	Existing Culvert
AR-T-8	SP1WH139	Unnamed Tributary of Dry Branch	PCR, M	Warmwater	Ephemeral	Minor	5	N/A	Existing Culvert
AR-P-17	SP1WH137	Unnamed Tributary of Peach	PCR, M	Warmwater	Ephemeral	Minor	3	N/A	Existing Culvert
AR-P-18	SP1WH136	Unnamed Tributary of Peach	PCR, M	Warmwater	Ephemeral	Minor	2	N/A	Existing Culvert
AR-T-11	SP1WH218	Unnamed Tributary of Peach	PCR, M	Warmwater	Ephemeral	Minor	5	N/A	Existing Culvert
AR-T-14	SP1WH138	Unnamed Tributary of Baughma	PCR, M	Warmwater	Ephemeral	Minor	5	N/A	Existing Culvert
AR-T-21	SP1WH133_A	Unnamed Tributary of Linnville Bayou	PCR, M	Warmwater	Ephemeral	Minor	6	N/A	Existing Culvert
AR-T-22	OWP1WH053	Manmade Pond	N/A	N/A	Open Water	Major	869	0 ^c	Workspace Only

Surface Waterbodies Crossed or Otherwise Impacted by the Coastal Bend Header Project									
Milepost	Feature ID	Waterbody Name	State Water Quality Classification ^{b c}	Fishery Classification	Flow Regime	FERC Classification	Waterbody Width (feet)	Pipeline Crossing Length (feet)	Proposed Crossing Method
AR-P-24	SP1WH016	Unnamed Tributary of San Bernard River	PCR, M	Warmwater	Ephemeral	Minor	4	N/A	Existing Culvert
AR-P-24	SP1WH015	Unnamed Tributary of San Bernard River	PCR, M	Warmwater	Ephemeral	Minor	3	N/A	Existing Culvert
AR-P-24	SP1WH133	Unnamed Tributary of Linnville Bayou	PCR, M	Warmwater	Ephemeral	Minor	6	N/A	Existing Culvert
AR-P-25	SP1WH134	Unnamed Tributary of Linnville Bayou	PCR, H	Warmwater	Perennial	Intermediate	30	N/A	Existing Culvert
AR-P-28	SP1WH033	Unnamed Tributary of Linnville Bayou	PCR, M	Warmwater	Intermittent	Minor	4	N/A	Existing Culvert
AR-P-29	SP1WH240	Unnamed Tributary of Linnville Bayou	PCR, M	Warmwater	Ephemeral	Minor	5	N/A	Existing Culvert
AR-P-29	SP1WH241	Unnamed Tributary of Linnville Bayou	PCR, M	Warmwater	Ephemeral	Minor	3	N/A	Existing Culvert
AR-P-29	SP1WH242	Unnamed Tributary of Linnville Bayou	PCR, H	Warmwater	Perennial	Intermediate	40	N/A	Existing Culvert
AR-P-29	SP1WH243	Unnamed Tributary of Linnville Bayou	PCR, M	Warmwater	Ephemeral	Minor	5	N/A	Existing Culvert

Surface Waterbodies Crossed or Otherwise Impacted by the Coastal Bend Header Project									
Milepost	Feature ID	Waterbody Name	State Water Quality Classification ^{a b}	Fishery Classification ^a	Flow Regime	FERC Classification	Waterbody Width (feet)	Pipeline Crossing Length (feet)	Proposed Crossing Method
Brazoria County									
AR-P-29	SP1BR244	Unnamed Tributary of Linnville Bayou	PCR, M	Warmwater	Intermittent	Intermediate	25	N/A	Existing Culvert
AR-P-29	SP1BR245	Unnamed Tributary of Linnville Bayou	PCR, M	Warmwater	Intermittent	Minor	4	N/A	Existing Culvert
AR-P-29	SP4BR059_DT ^d	Unnamed Tributary of Linnville Bayou	PCR, M	Warmwater	Ephemeral	Minor	9	N/A	Matting
AR-P-32.1	SP1BR223	Unnamed Tributary of Mound Creek	PCR, M	Warmwater	Ephemeral	Minor	8	N/A	Existing Culvert
AR-P-32.1	SP1BR221	Unnamed Tributary of Mound Creek	PCR, M	Warmwater	Intermittent	Intermediate	12	N/A	Existing Culvert
AR-P-34	OWP1BR011	Manmade Pond	N/A	N/A	Open Water	Intermediate	49	N/A	Workspace Only
AR-P-34	SP1BR146	Varner Creek	PCR, M	Warmwater	Intermittent	Intermediate	20	N/A	Existing Culvert
AR-P-34	SP1BR145	Unnamed Tributary of Varner Creek	PCR, M	Warmwater	Ephemeral	Minor	6	N/A	Existing Culvert
AR-P-36	SP1BR176	Unnamed Tributary of Varner Creek	PCR, M	Warmwater	Intermittent	Intermediate	12	N/A	Existing Culvert
AR-P-36	SP1BR174	Unnamed Tributary of Varner Creek	PCR, M	Warmwater	Intermittent	Intermediate	15	N/A	Existing Culvert
AR-P-36	SP1BR173	Unnamed Tributary of Varner Creek	PCR, H	Warmwater	Perennial	Intermediate	30	N/A	Existing Culvert
AR-P-36	SP1BR172	Unnamed Tributary of Manmade Pond	PCR, M	Warmwater	Ephemeral	Minor	1	N/A	Existing Culvert

Surface Waterbodies Crossed or Otherwise Impacted by the Coastal Bend Header Project									
Milepost	Feature ID	Waterbody Name	State Water Quality Classification ^{a b}	Fishery Classification ^a	Flow Regime	FERC Classification	Waterbody Width (feet)	Pipeline Crossing Length (feet)	Proposed Crossing Method
AR-P-37	SP1BR144	Unnamed Tributary of Varner Creek	PCR, M	Warmwater	Intermittent	Intermediate	20	N/A	Existing Culvert
AR-P-37	SP1BR140	Unnamed Tributary of Varner Creek	PCR, M	Warmwater	Ephemeral	Minor	4	N/A	Existing Culvert
AR-P-37	SP1BR141	Unnamed Tributary of Brazos Rivers	PCR, H	Warmwater	Perennial	Intermediate	50	N/A	Existing Culvert
AR-P-37	SP1BR143	Unnamed Tributary of Varner Creek	PCR, M	Warmwater	Ephemeral	Minor	5	N/A	Existing Culvert
AR-P-38	SP1BR239	Unnamed Tributary of Varner Creek	PCR, M	Warmwater	Intermittent	Intermediate	30	N/A	Existing Culvert
AR-P-39	SP1BR111	Unnamed Tributary of Brazos River	PCR, M	Warmwater	Ephemeral	Minor	6	N/A	Existing Culvert
AR-P-41.1	SP1BR185	Unnamed Tributary of Dry Bayou	PCR, M	Warmwater	Ephemeral	Minor	6	N/A	Existing Culvert
AR-P-41.1	SP1BR187	Unnamed Tributary of Middle Bayou	PCR, H	Warmwater	Perennial	Intermediate	40	N/A	Existing Culvert
AR-T-41.2	SP1BR188	Unnamed Tributary of Mill Bayou	PCR, M	Waterwater	Ephemeral	Minor	4	N/A	Existing Culvert
AR-P-42.1	SP1BR086	Unnamed Tributary of Mill Bayou	PCR, M	Waterwater	Ephemeral	Minor	4	N/A	Existing Culvert
AR-T-45	SP1BR049_B	Unnamed Tributary of Oyster Creek	PCR, M	Warmwater	Ephemeral	Minor	4	N/A	Existing Culvert
AR-P-47	SP1BR168	Unnamed Tributary of Bastrop Bayou	PCR, M	Warmwater	Ephemeral	Minor	4	N/A	Existing Culvert

Surface Waterbodies Crossed or Otherwise Impacted by the Coastal Bend Header Project									
Milepost	Feature ID	Waterbody Name	State Water Quality Classification ^{a b}	Fishery Classification ^a	Flow Regime	FERC Classification	Waterbody Width (feet)	Pipeline Crossing Length (feet)	Proposed Crossing Method
AR-P-47	SP1BR169	Unnamed Tributary of Bastrop Bayou	PCR, M	Warmwater	Ephemeral	Minor	8	N/A	Matting
AR-P-51.1	SP1BR272	Unnamed Tributary of Bastrop Bayou	PCR, M	Warmwater	Ephemeral	Minor	6	N/A	Matting
AR-P-51.1	SP1BR271	Unnamed Tributary of Bastrop Bayou	PCR, M	Warmwater	Intermittent	Minor	8	N/A	Matting
AR-P-55.1	SP1BR112	Unnamed Tributary of Big Slough	PCR, M	Warmwater	Ephemeral	Minor	8	N/A	Existing Culvert
Contractor/Pipe Yards									
Wharton County									
Contractor/Pipe Yard 1	SP1WH207	Unnamed Tributary of San Bernard River	PCR, M	Warmwater	Ephemeral	Minor	10	N/A	Existing Culvert
Notes: ^a State Water Quality Classifications and Fisheries Classifications were obtained from the Texas Surface Water Quality Standards (Chapter 307) ^b PCR-primary contact recreation; H-High Aquatic Life Use; M-Minimal Aquatic Life Use; PS-Public Water Supply ^c Waterbody will not be crossed by the pipeline centerline, but is located within the Project footprint. ^d Features documented during desktop (DT) analysis are notated with a DT at the end of the feature name.									

APPENDIX F

PLAN AND PROFILE FOR HORIZONTAL DIRECTIONAL DRILL CROSSINGS

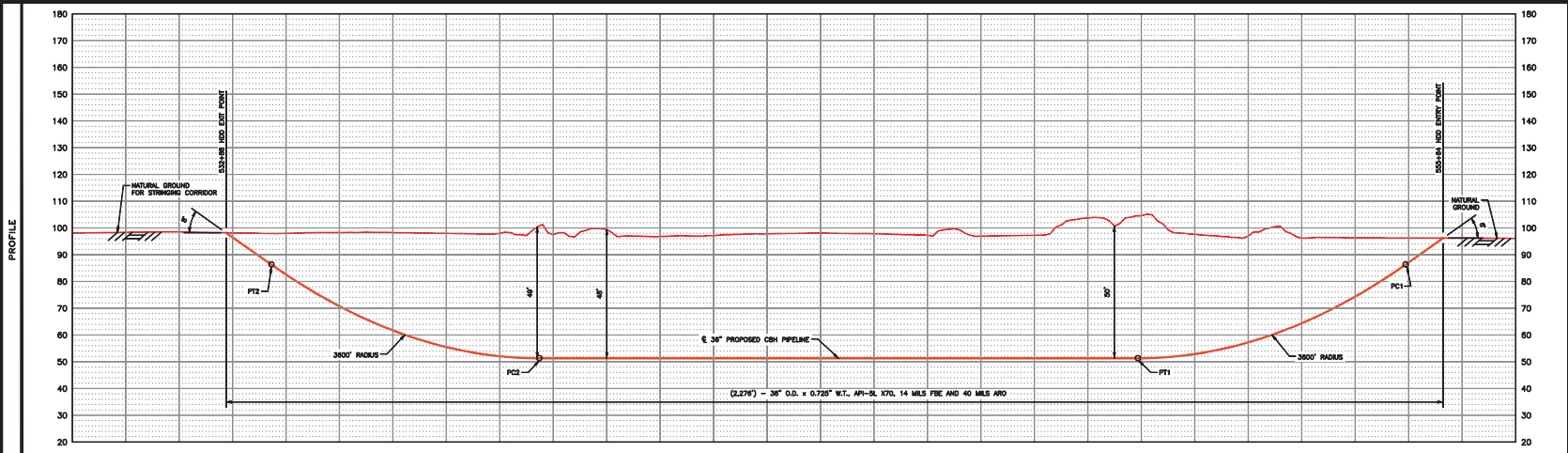
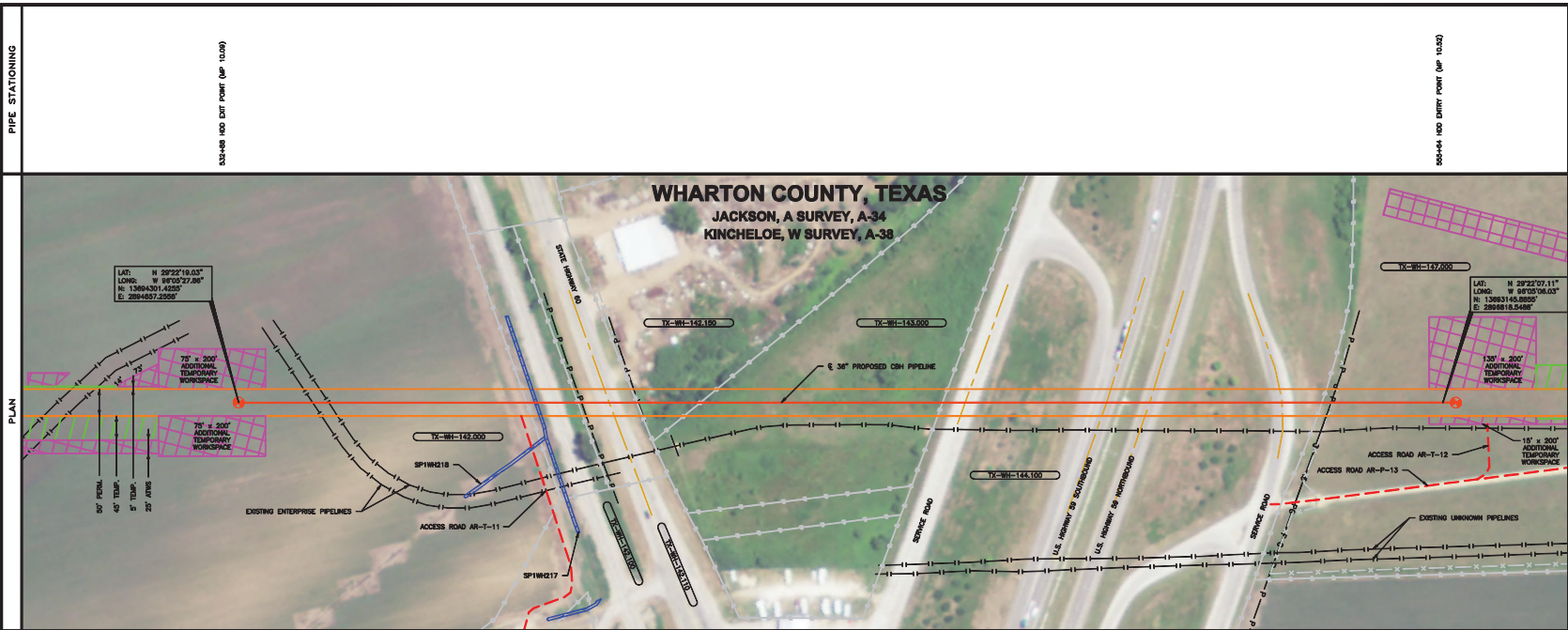

LEGEND

- ⊕ HDD ENTRY / EXIT POINTS
- ⊕ GEOTECH BORE HOLE LOCATIONS

- GENERAL NOTES**
- IT IS THE CONTRACTOR'S RESPONSIBILITY TO MAKE NECESSARY ARRANGEMENTS IF TRAFFIC CONTROL PLANS AND/OR ROAD RECONSTRUCTION ARE REQUIRED.
 - CONTRACTOR TO LOCATE, MARK AND POT-HOLE FOREIGN LINES PRIOR TO EXCAVATION (AND MONITOR DURING DRILLING).
 - CONTRACTOR TO MAT OVER ANY FOREIGN PIPELINES CROSSED WITH DRILLING EQUIPMENT.
 - LOCATIONS OF EXISTING FACILITIES SHOWN ARE APPROXIMATE. CONTRACTOR TO LOCATE AND/OR CONFIRM THE LOCATIONS AND DEPTH OF ALL UTILITIES, PIPELINES OR OTHER OBSTACLES PRIOR TO EXCAVATION.
 - CONTRACTOR TO SUPPORT EXISTING UTILITIES, PIPELINES AND/OR OTHER FEATURES.
 - CONTRACTOR TO GRADE EXCAVATION AREA AND RESTORE TO ORIGINAL CONDITIONS.
 - NATURAL GROUND ELEVATION DATA IS PRELIMINARY BASED UPON DE DATA, NOT GROUND SURVEY.

PROJECTION SYSTEM:
NAD83 STATE PLANE, TEXAS SOUTH CENTRAL (U.S. SURVEY FEET)

ISSUED FOR FERC
JUNE - 2015

HORIZONTAL DIRECTIONAL DRILL DATA

DESCRIPTION	STA.	ELEV.
ENTRY ANGLE @ 0'	505+64	96.2'
POINT OF CURVATURE (PC1) (L&S ON L&S)	504+60	86.3'
POINT OF TANGENCY (PT1)	549+84	51.3'
POINT OF CURVATURE (PC2) (L&S ON L&S)	538+74	51.3'
POINT OF TANGENCY (PT2)	533+73	86.3'
EXIT ANGLE @ 0'	532+88	86.2'

HORIZONTAL DIRECTIONAL DRILL PARAMETERS

1.) MAX. OPER. PRESS:	250.2588
2.) PIPE O.D. x 0.725" W.T. GRADE:	36" x 0.30"
3.) PIPE COATING:	16 MILS FBE
EXTRINSIC COATING:	16 MILS FBE
LENGTH OF CROSSING:	2,578 L.F.
4.) TYPE OF PIPE JOINT:	WELDED X 40' LG.
LENGTH OF PIPE:	2,281'

LEGEND

- Road
- - - Canal
- x Fence
- D.H. Par. Ln.
- U.S. Cable
- E. Borehole
- Waterline
- Tract Number
- Prop. Easement
- Temporary Right-of-Way
- Admitted Temp. Way
- Property Line
- Access Road
- Stream
- Wetlands
- Open Water

REFERENCE DRAWINGS

DWG. NO.	DRAWING TITLE
14CQ-650-P-107-07	ALIGNMENT SHEET

NO. DATE REVISION BY APPD.

NO.	DATE	REVISION	BY	APPD.
A	12/20/15	DRAFT ISSUED FOR FERC	AMF	DL
B	6/15	ISSUED FOR FERC	AMF	

GULF SOUTH
SPECIALTY SERVICES

SCALE: PLAN SCALE: 1"=100'
PROFILE (D) SCALE: 1"=100'
PROFILE (V) SCALE: 1"=20'

DRAWN BY: AMF DATE: 12/16/14
CHECKED BY: MCL DATE: 05/06/15
APPROVED BY: EPO APPROVAL:

WILLBROS ENGINEERING
Willbros Engineers (2013) Ltd. 1001 Fox Hill

COASTAL BEND HEADER PIPELINE
U.S. HIGHWAY 59 MP 10.4
WHARTON COUNTY, TEXAS

SCALE: 1" = 100' DRAWING NO: 14CQ-650-P-107-002 REV. B

June 08, 2015 - 1:50pm

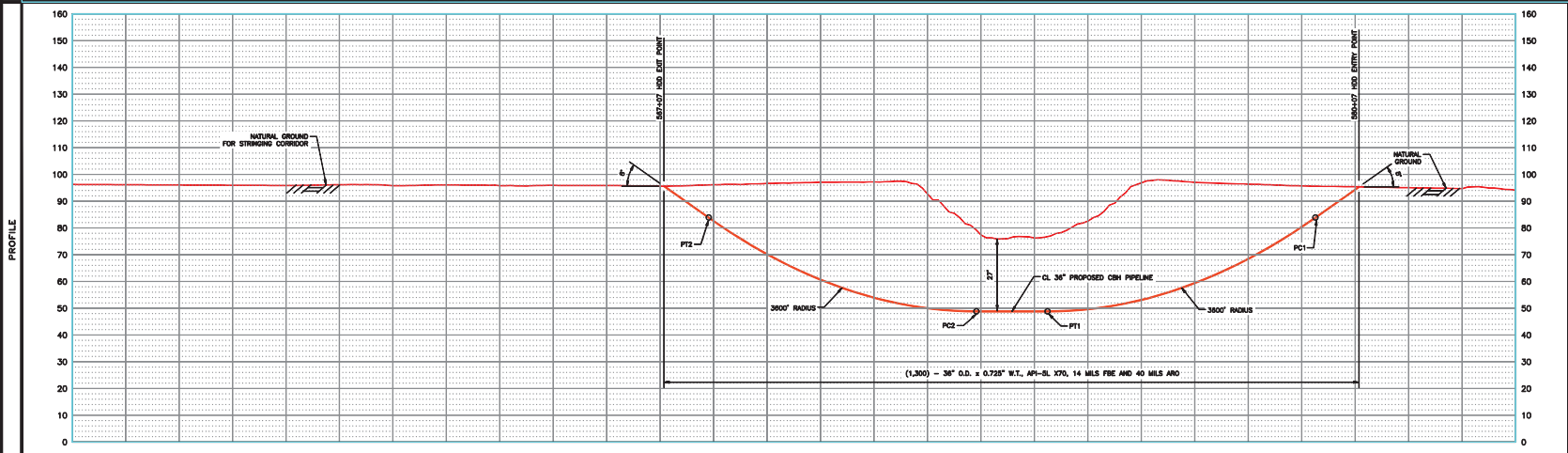
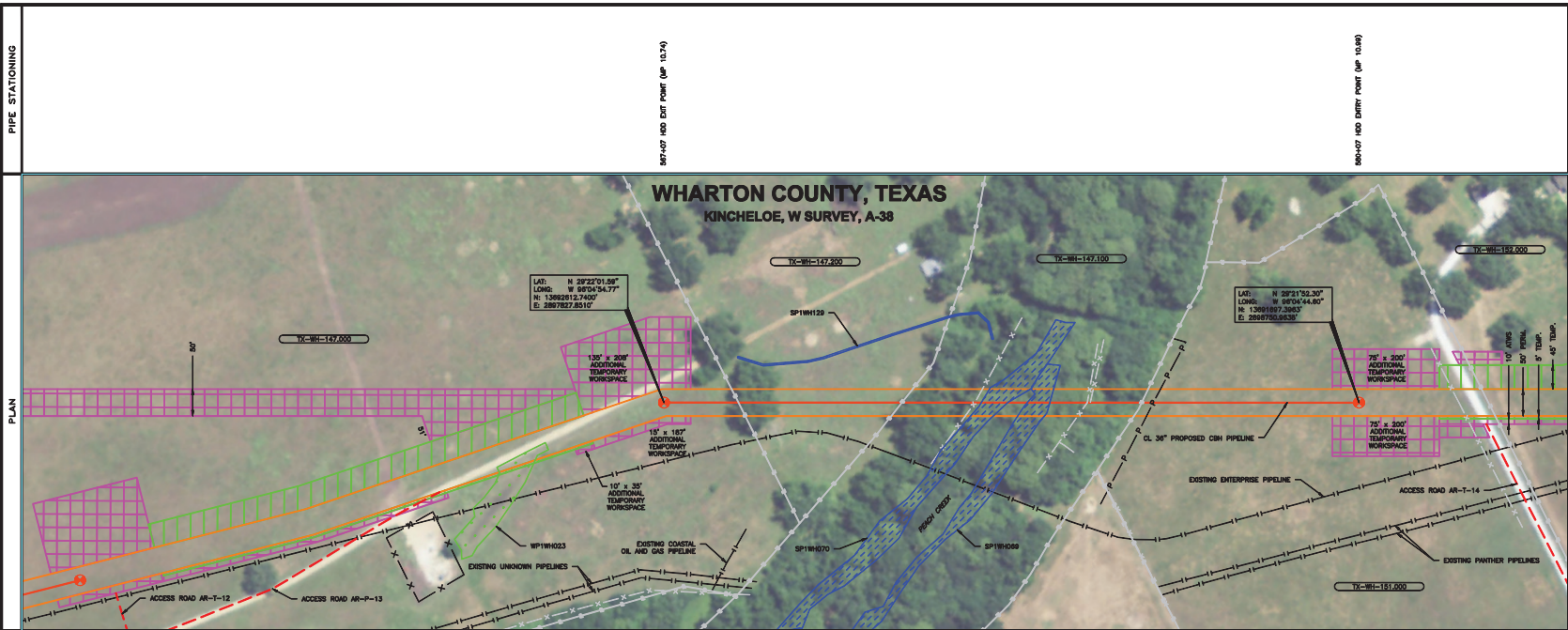

LEGEND

- ⊕ HDD ENTRY / EXIT POINTS
- ⊕ GEOTECH BORE HOLE LOCATIONS

- GENERAL NOTES**
- IT IS THE CONTRACTOR'S RESPONSIBILITY TO MAKE NECESSARY ARRANGEMENTS IF TRAFFIC CONTROL PLANS AND/OR RAILROAD REPRESENTATION ARE REQUIRED.
 - CONTRACTOR TO LOCATE, MARK AND POT-HOLE FOREIGN LINES PRIOR TO EXCAVATION (AND MONITOR DURING DRILLING).
 - CONTRACTOR TO MAT OVER ANY FOREIGN PIPELINES CROSSED WITH DRILLING EQUIPMENT.
 - LOCATIONS OF EXISTING FACILITIES SHOWN ARE APPROXIMATE. CONTRACTOR TO LOCATE AND/OR CONFIRM THE LOCATIONS AND DEPTH OF ALL UTILITIES, PIPELINES OR OTHER OBSTACLES PRIOR TO EXCAVATION.
 - CONTRACTOR TO SUPPORT EXISTING UTILITIES, PIPELINES AND/OR OTHER FEATURES.
 - CONTRACTOR TO GRADE EXCAVATION AREA AND RESTORE TO ORIGINAL CONDITIONS.
 - NATURAL GROUND ELEVATION DATA IS PRELIMINARY BASED UPON DE DATA, NOT GROUND SURVEY.

PROJECTION SYSTEM:
NAD83 STATE PLANE, TEXAS SOUTH CENTRAL (U.S. SURVEY FEET)

ISSUED FOR FERC
JUNE - 2015

HORIZONTAL DIRECTIONAL DRILL DATA

DESCRIPTION	STA.	ELEV.
ENTRY ANGLE @ 8'	580+07	95.3'
POINT OF CURVATURE (PC1)	579+25	83.8'
POINT OF TANGENCY (PT1)	574+24	48.8'
POINT OF CURVATURE (PC2)	572+01	48.8'
POINT OF TANGENCY (PT2)	567+00	83.8'
EXIT ANGLE @ 8'	567+07	85.5'

HORIZONTAL DIRECTIONAL DRILL PARAMETERS

1.) MAX. OPER. PRESS.: 2500 PSIG
2.) PIPE: 36" O.D. x 0.725" W.T. GRADE: 80%AL X20 DESIGN FACTOR: 0.90
3.) PIPE COATING: 14 MILS FBE
EXTERNAL COATING: 60 MILS ZPP
LENGTH OF CROSSING: 1,300 L.F.
4.) TYPE OF PIPE JOINT: WELDED X 40' LG.
LENGTH OF PIPE: 1,264'
5.) THIS PRELIMINARY PROFILE WAS PREPARED PRIOR TO GEOTECHNICAL INVESTIGATIONS BEING CONDUCTED, AND MAY REQUIRE REVISION AFTER REVIEW OF GEOTECHNICAL FINDINGS.

LEGEND

- Road
- - - Canal
- x Fence
- D.H. Par. Ln.
- U.S. Cable
- E. Right-of-Way
- Foreign Pipeline
- Waterline
- Trestle
- Farm Easement
- Temporary Right-of-Way
- Adjoining Prop. W/prop
- Property Line
- Access Road
- Stream
- Wetlands
- Wetlands
- Open Water

REFERENCE DRAWINGS

DWG. NO.	DRAWING TITLE
14CQ-650-P-102-07	ALIGNMENT SHEET
14CQ-650-P-102-08	ALIGNMENT SHEET

NO. DATE REVISION BY APPD.

NO.	DATE	REVISION	BY	APPD.
1	6/15	ISSUED FOR FERC	AMF	

GULF SOUTH
SPECIALTY SERVICES

SCALE: 1"=100'
PROFILE (D) SCALE: 1"=100'
PROFILE (V) SCALE: 1"=20'

DRAWN BY: AMF DATE: 12/16/14
CHECKED BY: MCT DATE: 05/14/15
APPROVED BY: EPO APPROVAL:

WILLBROS ENGINEERING
Coastal Bend Header Pipeline
PEACH CREEK MP 10.9
WHARTON COUNTY, TEXAS

SCALE: 1"=100' DRAWING NO: 14CQ-650-P-107-003 REV: A

June 08, 2015 - 2:01pm



- LEGEND**
- ⊕ HDD ENTRY / EXIT POINTS
 - ⊕ GEOTECH BORE HOLE LOCATIONS

GENERAL NOTES

- 1.) IT IS THE CONTRACTOR'S RESPONSIBILITY TO MAKE NECESSARY ARRANGEMENTS IF TRAFFIC CONTROL PLANS AND/OR RAILROAD REPRESENTATION ARE REQUIRED.
- 2.) CONTRACTOR TO LOCATE, MARK AND POTHOLE FOREIGN LINES PRIOR TO EXCAVATION (AND MONITOR DURING DRILLING).
- 3.) CONTRACTOR TO MAT OVER ANY FOREIGN PIPELINES CROSSED WITH DRILLING EQUIPMENT.
- 4.) LOCATIONS OF EXISTING FACILITIES SHOWN ARE APPROXIMATE. CONTRACTOR TO LOCATE AND/OR CONFIRM THE LOCATIONS AND DEPTH OF ALL UTILITIES, PIPELINES OR OTHER OBSTACLES PRIOR TO EXCAVATION.
- 5.) CONTRACTOR TO SUPPORT EXISTING UTILITIES, PIPELINES AND/OR OTHER FEATURES.
- 6.) CONTRACTOR TO GRADE EXCAVATION AREA AND RESTORE TO ORIGINAL CONDITIONS.
- 7.) NATURAL GROUND ELEVATION DATA IS PRELIMINARY BASED UPON DE DATA, NOT GROUND SURVEY.

PROJECTION SYSTEM:

NAD83 STATE PLANE, TEXAS SOUTH CENTRAL (U.S. SURVEY FEET)

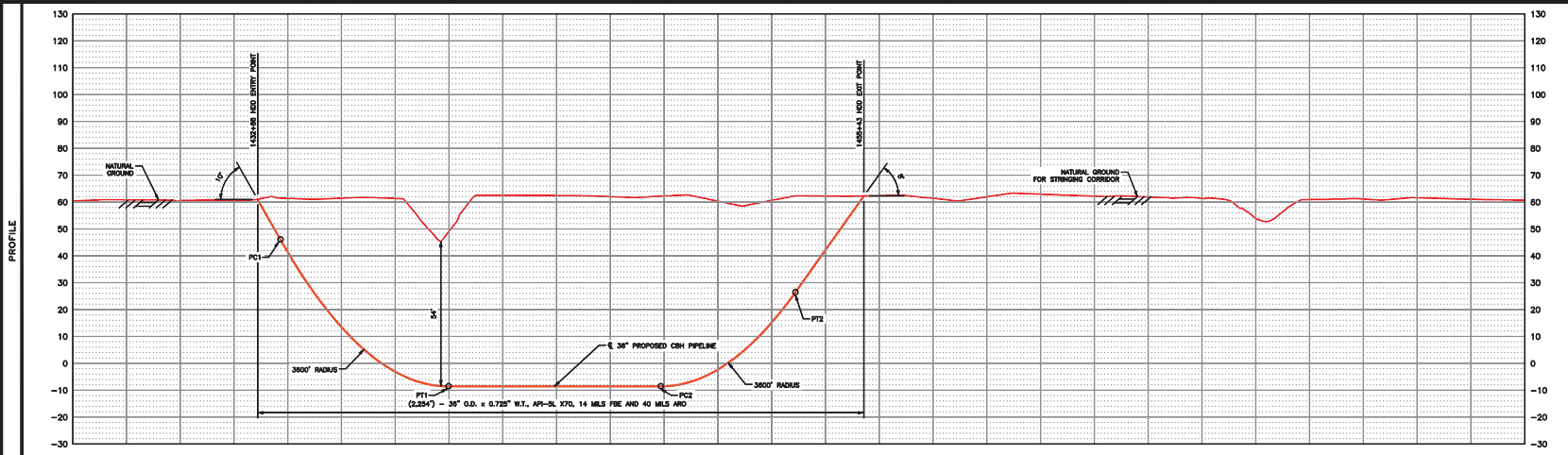
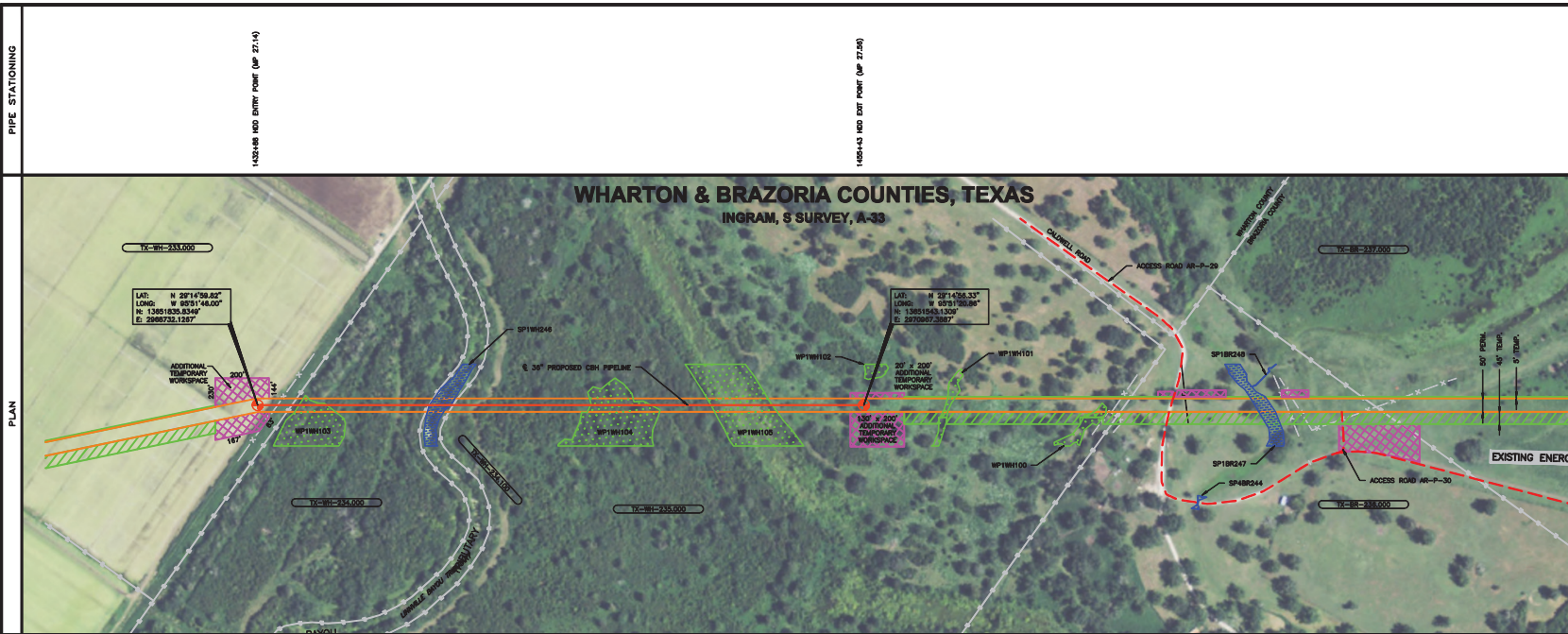

ISSUED FOR FERC
JUNE - 2015

HORIZONTAL DIRECTIONAL DRILL DATA			HORIZONTAL DIRECTIONAL DRILL PARAMETERS		
DESCRIPTION	STA.	ELEV.			
ENTRY ANGLE @ 10'	1432+48	61.0'	1.) MAX. OPER. PRESS:	1,250 PSIG	
POINT OF CURVATURE (PC)	1433+73	46.1'	2.) PIPE: 36" O.D. x 0.725" W.T. GRADE:	405-SL_X20	
END OF 1 ST CROSSING	1439+87	-6.0'	DESIGN FACTOR:	2.00	
POINT OF TANGENCY (PT1)	1447+87	-6.0'	3.) PIPE COATING:	14 MILS FBE	
POINT OF CURVATURE (PC2)	1447+87	-6.0'	EXTERNAL COATING:	60 MILS FBE	
END OF 2 ND CROSSING	1452+43	62.2'	LENGTH OF CROSSING:	2,262' L.F.	
POINT OF TANGENCY (PT2)	1452+43	28.5'	4.) TYPE OF PIPE JOINT:	WELDED X 40' LG.	
EXIT ANGLE @ 6'	1455+43	62.2'	LENGTH OF PIPE:	2,262'	

- 5.) THIS PRELIMINARY PROFILE WAS PREPARED PRIOR TO GEOTECHNICAL INVESTIGATIONS BEING CONDUCTED, AND MAY REQUIRE REVISION AFTER REVIEW OF GEOTECHNICAL FINDINGS.

LEGEND		REFERENCE DRAWINGS		NO. DATE		REVISION		BY APPD.	
---	⊕ Road	---	Form. Element	1400-650-P-107-18	A	12/2014	DRAFT ISSUED FOR FERC	AMF	AMF
---	⊕ Canal	---	Temporary Retention		B	6/15	ISSUED FOR FERC	AMF	AMF
---	⊕ Fence	---	Addressed Temp. Work						
---	⊕ D.H. Par. Ln.	---	Property Line						
---	⊕ U.S. Cable	---	⊕ Access Road						
---	⊕ Railroad	---	Stream						
---	⊕ Foreign Pipeline	---	Wetlands						
---	⊕ Waterline	---	Open Water						
---	⊕ Trench Marker								

DRIVEN BY: AMF DATE: 12/16/14
CHECKED BY: MCT DATE: 05/06/15
APPROVED BY: EPO APPROVAL:

COASTAL BEND HEADER PIPELINE
LINNVILLE BAYOU TRIBUTARY MP 27.3
WHARTON & BRAZORIA COUNTIES, TEXAS

SCALE: 1" = 200' DRAWING NO: 14CQ-650-P-107-004 REV. B

P:\Projects\15710 - Coastal Bend Header Pipeline\CA - CAD\Projects\Drawings\Plan\14CQ-650-P-107.dwg

31/01/00

June 08, 2015 - 2:03pm

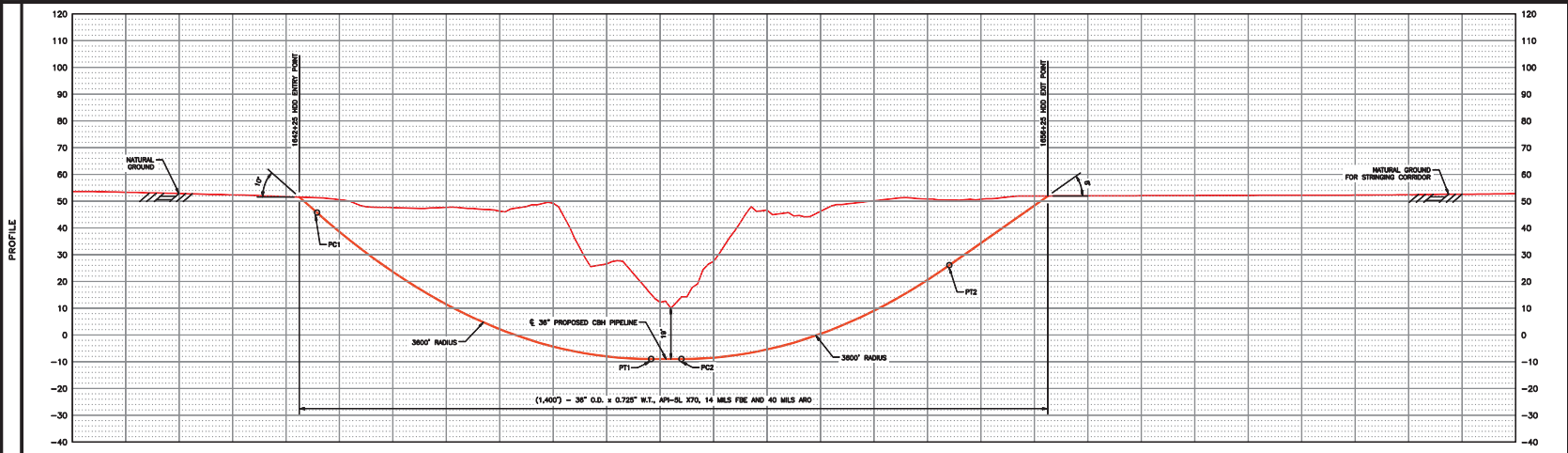
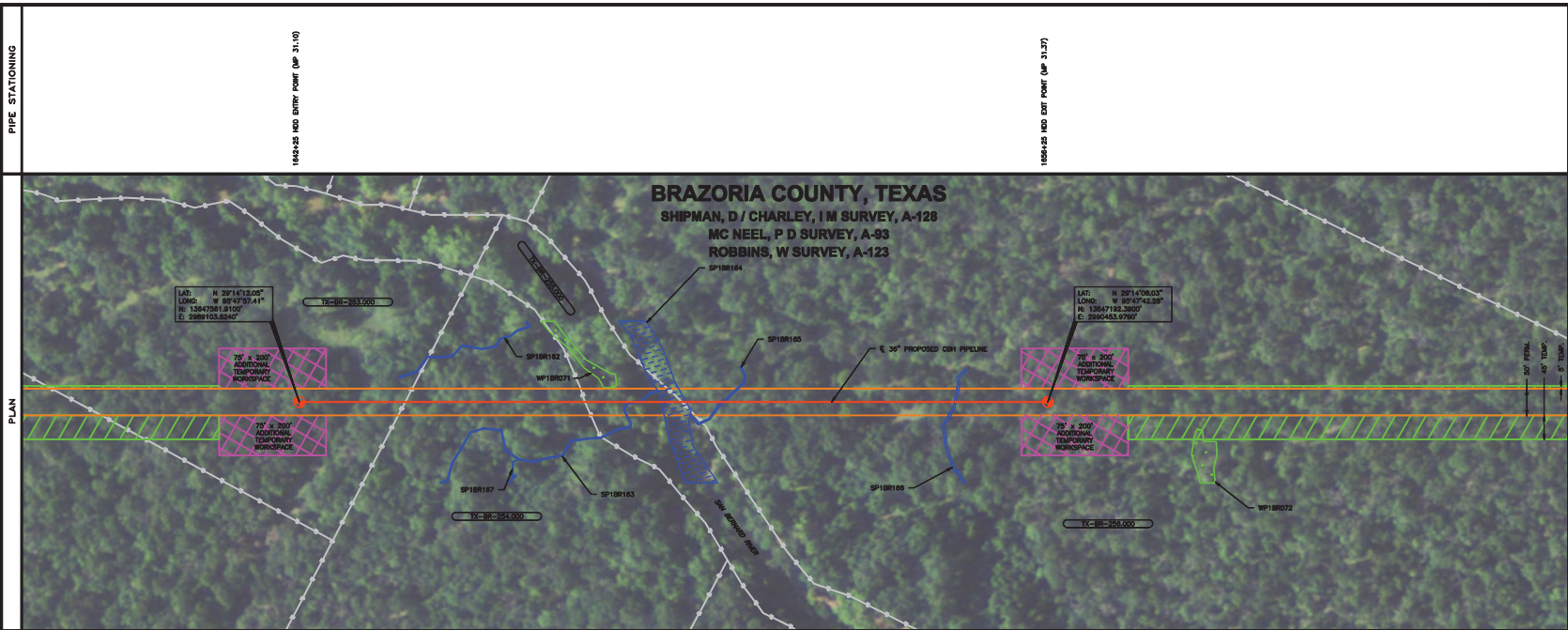

LEGEND

- ⊕ HDD ENTRY / EXIT POINTS
- ⊕ GEOTECH BORE HOLE LOCATIONS

- GENERAL NOTES**
- IT IS THE CONTRACTOR'S RESPONSIBILITY TO MAKE NECESSARY ARRANGEMENTS IF TRAFFIC CONTROL PLANS AND/OR RAILROAD REPRESENTATION ARE REQUIRED.
 - CONTRACTOR TO LOCATE, MARK AND POTHOLE FOREIGN LINES PRIOR TO EXCAVATION (AND MONITOR DURING DRILLING).
 - CONTRACTOR TO MAT OVER ANY FOREIGN PIPELINES CROSSED WITH DRILLING EQUIPMENT.
 - LOCATIONS OF EXISTING FACILITIES SHOWN ARE APPROXIMATE. CONTRACTOR TO LOCATE AND/OR CONFIRM THE LOCATIONS AND DEPTH OF ALL UTILITIES, PIPELINES OR OTHER OBSTACLES PRIOR TO EXCAVATION.
 - CONTRACTOR TO SUPPORT EXISTING UTILITIES, PIPELINES AND/OR OTHER FEATURES.
 - CONTRACTOR TO GRADE EXCAVATION AREA AND RESTORE TO ORIGINAL CONDITIONS.
 - NATURAL GROUND ELEVATION DATA IS PRELIMINARY BASED UPON DE DATA, NOT GROUND SURVEY.

PROJECTION SYSTEM:
NAD83 STATE PLANE, TEXAS SOUTH CENTRAL (U.S. SURVEY FEET)

ISSUED FOR FERC
JUNE - 2015

HORIZONTAL DIRECTIONAL DRILL DATA			HORIZONTAL DIRECTIONAL DRILL PARAMETERS		
DESCRIPTION	STA.	ELEV.	NO.	TYPE	PARAMETER
ENTRY ANGLE @ 10'	1542+25	51.5'	1.)	MAX. OPER. PRESS.	1,250 PSIG
POINT OF CURVATURE (PC1)	1542+59	45.7'	2.)	PIPING O.D. x 0.725" W.T. GRADE:	40"-SL X20 0.30"
POINT OF TANGENCY (PT1)	1548+83	-9.0'	3.)	PIPE COATING:	14 MILS FBE
POINT OF CURVATURE (PC2)	1549+40	-9.0'		EXTERNAL COATING:	50 MILS FBE
POINT OF TANGENCY (PT2)	1554+41	26.1'		LENGTH OF CROSSING:	1,600 L.F.
EXIT ANGLE @ 6'	1556+25	52.0'	4.)	TYPE OF PIPE JOINT:	WELDED x 40' LG.
				LENGTH OF PIPE:	1,602'

LEGEND

- Road
- - - Canal
- x Fence
- - - D.H. Par. Ln.
- - - U.S. Cable
- - - E. Right-of-Way
- - - Foreign Pipeline
- - - Waterline
- ⊕ Tract Marker
- Perm. Easement
- Temporary Reliance
- Admitted Temp. Way
- Property Line
- Access Road
- Stream
- Wetlands
- Wetlands
- Open Water

REFERENCE DRAWINGS

DWG. NO.	DRAWING TITLE
14CQ-650-P-107-21	ALIGNMENT SHEET

NO. DATE REVISION BY APPD.

NO.	DATE	REVISION	BY	APPD.
1	02/20/15	DRAFT ISSUED FOR FERC	AMF	DL
2	6/15	ISSUED FOR FERC	AMF	

GULF SOUTH
SPECIALTY SERVICES

SCALE: PLAN SCALE: 1"=100'
PROFILE (D) SCALE: 1"=100'
PROFILE (V) SCALE: 1"=20'

DRAWN BY: AMF DATE: 12/16/14
CHECKED BY: MCT DATE: 05/06/15
APPROVED BY: EPO APPROVAL:

WILLBROS ENGINEERING
Coastal Bend Header Pipeline
San Bernard River MP 31.2
Brazoria County, Texas

SCALE: 1" = 100' DRAWING NO: 14CQ-650-P-107-005 REV. B

June 08, 2015 - 2:00pm

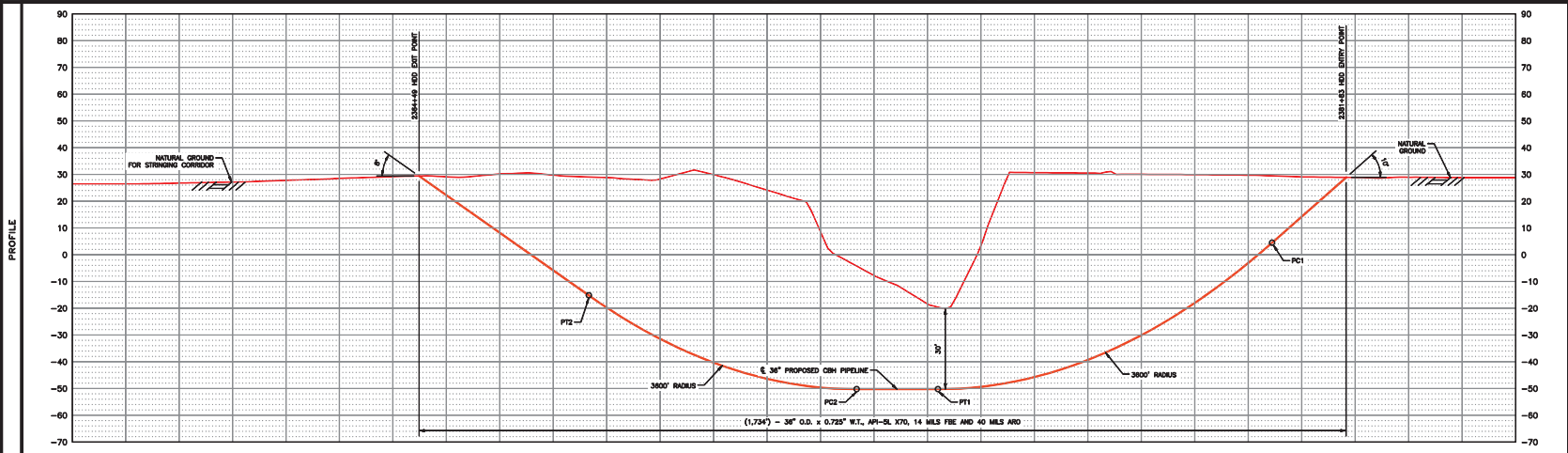
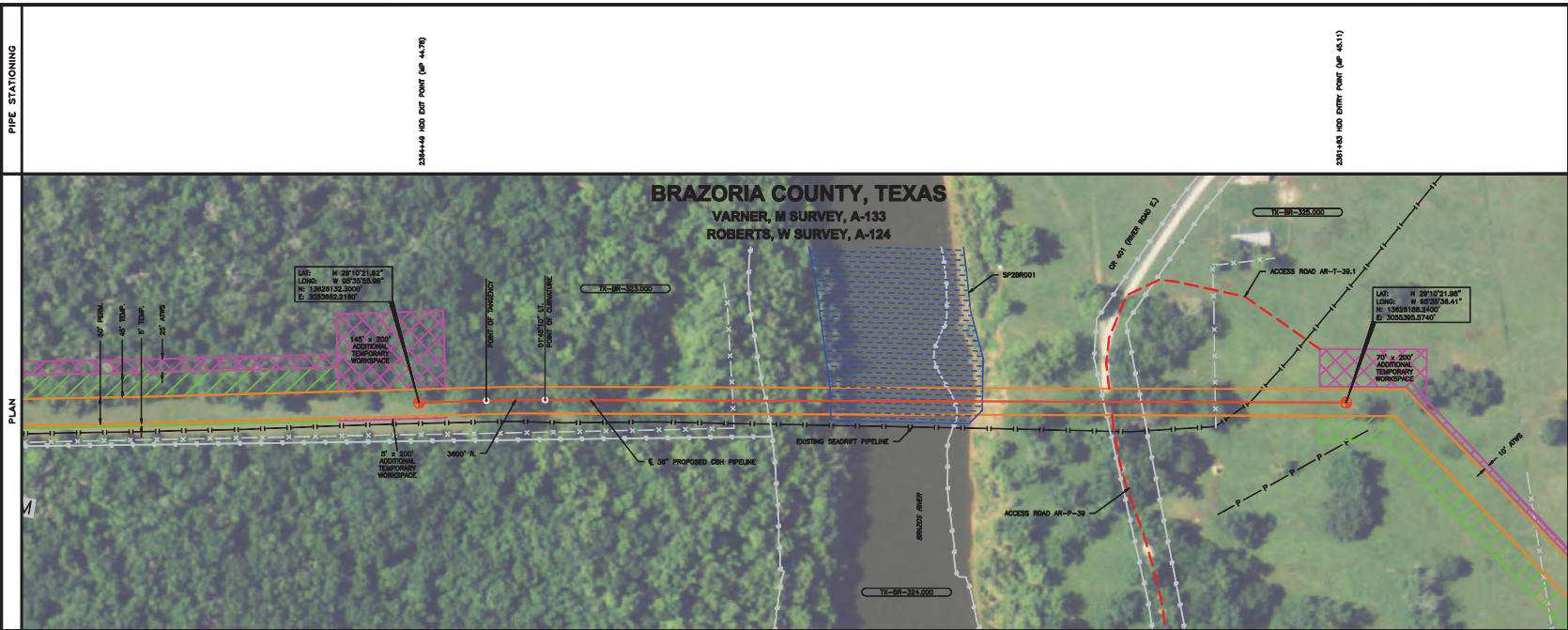

LEGEND

- ⊕ HDD ENTRY / EXIT POINTS
- ⊕ GEOTECH BORE HOLE LOCATIONS

GENERAL NOTES

- IT IS THE CONTRACTOR'S RESPONSIBILITY TO MAKE NECESSARY ARRANGEMENTS IF TRAFFIC CONTROL PLANS AND/OR RAILROAD REPRESENTATION ARE REQUIRED.
- CONTRACTOR TO LOCATE, MARK AND POT-HOLE FOREIGN LINES PRIOR TO EXCAVATION (AND MONITOR DURING DRILLING).
- CONTRACTOR TO MAT OVER ANY FOREIGN PIPELINES CROSSED WITH DRILLING EQUIPMENT.
- LOCATIONS OF EXISTING FACILITIES SHOWN ARE APPROXIMATE. CONTRACTOR TO LOCATE AND/OR CONFIRM THE LOCATIONS AND DEPTH OF ALL UTILITIES, PIPELINES OR OTHER OBSTACLES PRIOR TO EXCAVATION.
- CONTRACTOR TO SUPPORT EXISTING UTILITIES, PIPELINES AND/OR OTHER FEATURES.
- CONTRACTOR TO GRADE EXCAVATION AREA AND RESTORE TO ORIGINAL CONDITIONS.
- NATURAL GROUND ELEVATION DATA IS PRELIMINARY BASED UPON DE DATA, NOT GROUND SURVEY.

PROJECTION SYSTEM:
 NAD83 STATE PLANE, TEXAS SOUTH CENTRAL (U.S. SURVEY FEET)

DRILL HAS HORIZONTAL CURVE

ISSUED FOR FERC
 JUNE - 2015

HORIZONTAL DIRECTIONAL DRILL DATA	
DESCRIPTION	STA. ELEV.
ENTRY ANGLE @ 10'	2381+63 28.0'
POINT OF CURVATURE (PC1)	2380+44 4.4'
POINT OF TANGENCY (PT1)	2374+19 -50.3'
POINT OF CURVATURE (PC2)	2372+47 -50.3'
POINT OF TANGENCY (PT2)	2367+88 -15.2'
EXIT ANGLE @ 6'	2364+49 28.4'

HORIZONTAL DIRECTIONAL DRILL PARAMETERS	
1.) MAX. OPER. PRESS:	1,250 PSIG
2.) PITCH 36" G.D. x 0.725" W.T. GRADE:	APPROX. 0.30%
DESIGN FACTOR:	1.6
3.) PIPE COATING:	14 MILS FIB AND 40 MILS AND
EXTERNAL COATING:	17.5 MILS AND
LENGTH OF CROSSING:	1,734 L.F.
4.) TYPE OF PIPE JOINT:	WELDED X 40' LG.
LENGTH OF PIPE:	1,734'
5.) THIS PRELIMINARY PROFILE WAS PREPARED PRIOR TO GEOTECHNICAL INVESTIGATIONS BEING CONDUCTED, AND MAY REQUIRE REVISION AFTER REVIEW OF GEOTECHNICAL FINDINGS.	

LEGEND

- Road
- - - Canal
- x - Fence
- - - D.H. Par. Ln.
- - - U.S. Cable
- - - E. Right-of-Way
- - - Foreign Pipeline
- - - Well/Line
- ⊕ Tract Marker
- Perm. Easement
- Temporary Reliance
- Admitted Temp. Way
- Property Line
- Access Road
- Stream
- Wetlands
- Open Water

DWG. NO.	REFERENCE DRAWINGS	NO.	DATE	REVISION	BY	APPD.
14CQ-650-P-107-30	ALIGNMENT SHEET	A	12/20/15	DRAFT ISSUED FOR FERC	AMF	AKL
		B	6/15	ISSUED FOR FERC	AMF	

SCALE	
PLAN SCALE: 1"=100'	
PROFILE (V) SCALE: 1"=100'	
PROFILE (H) SCALE: 1"=200'	

GULF SOUTH
 SPECIALTY SERVICES

DRAWN BY: AMF DATE: 12/16/14
 CHECKED BY: MCT DATE: 05/06/15
 APPROVED BY: EPO APPROVAL:

WILLBROS ENGINEERING
 Coastal Bend Header Pipeline
 BRAZOS RIVER CROSSING MP 45.0
 BRAZORIA COUNTY, TEXAS

SCALE: 1" = 100' DRAWING NO: 14CQ-650-P-107-007 REV. B

June 08, 2015 - 2:07pm

P:\Projects\15713 - Coastal Bend Header Pipeline\CA - GAD\Projects\Drawings\Plan\14CQ-650-007.dwg

BRAZORIA COUNTY, TEXAS
M.P. 44.79 TO 44.93



TX-BR-323.000

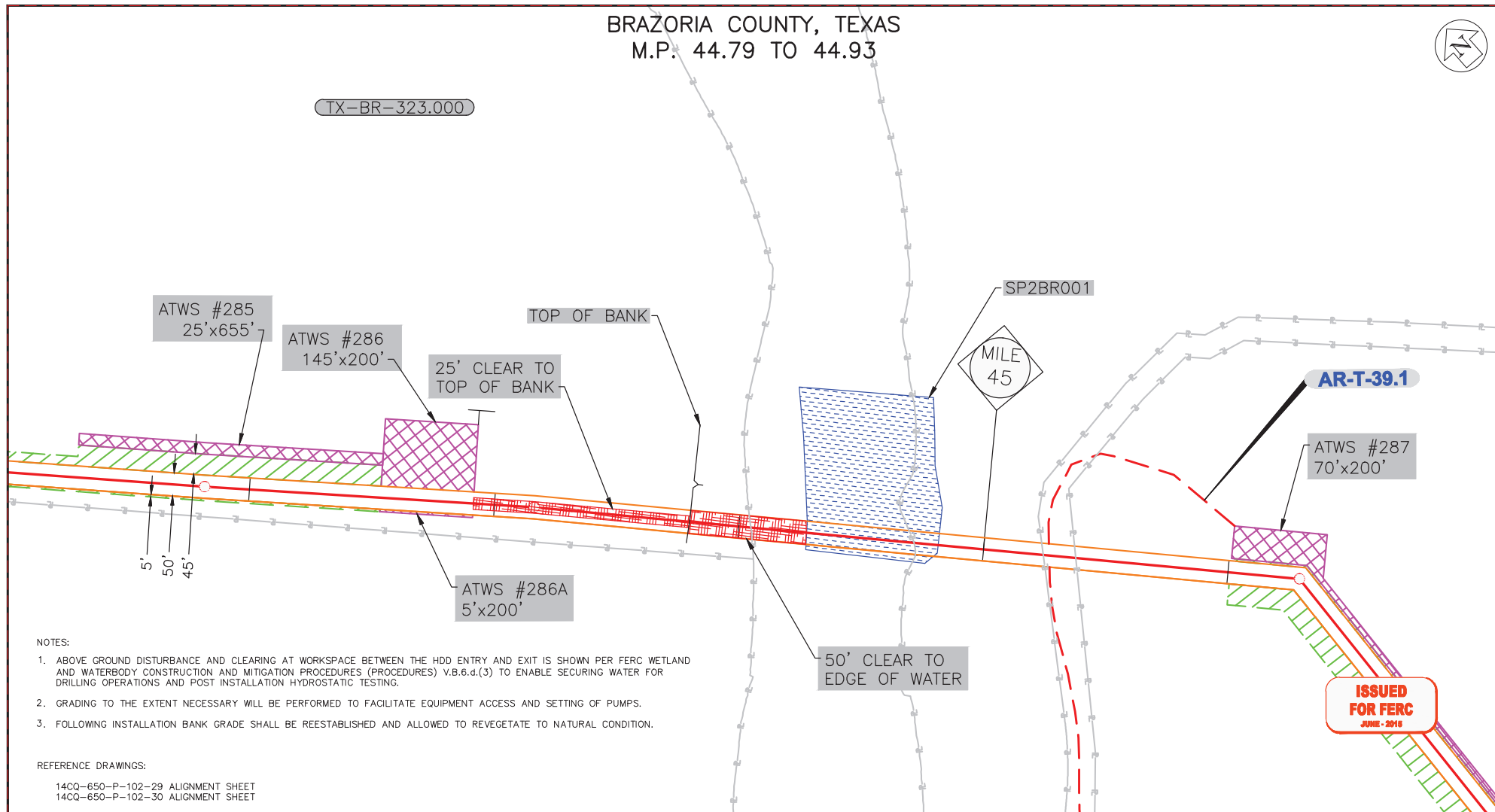

- NOTES:
1. ABOVE GROUND DISTURBANCE AND CLEARING AT WORKSPACE BETWEEN THE HDD ENTRY AND EXIT IS SHOWN PER FERC WETLAND AND WATERBODY CONSTRUCTION AND MITIGATION PROCEDURES (PROCEDURES) V.B.6.d.(3) TO ENABLE SECURING WATER FOR DRILLING OPERATIONS AND POST INSTALLATION HYDROSTATIC TESTING.
 2. GRADING TO THE EXTENT NECESSARY WILL BE PERFORMED TO FACILITATE EQUIPMENT ACCESS AND SETTING OF PUMPS.
 3. FOLLOWING INSTALLATION BANK GRADE SHALL BE REESTABLISHED AND ALLOWED TO REVEGETATE TO NATURAL CONDITION.

REFERENCE DRAWINGS:
14CQ-650-P-102-29 ALIGNMENT SHEET
14CQ-650-P-102-30 ALIGNMENT SHEET

ISSUED FOR FERC
JUNE - 2016

PROPOSED PIPELINE	ABOVE GROUND FACILITY SITE
ACCESS ROAD	WETLAND AREA
PERMANENT EASEMENT	STREAM
TEMPORARY WORKSPACE	OPEN WATER
ADDITIONAL TEMPORARY WORKSPACE	MILE POST

GULF SOUTH PIPELINE COMPANY, LP
COASTAL BEND HEADER PIPELINE

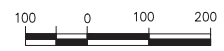

DRAWN BY:	DCG	5-15-15
CHECKED BY:	JOE	5-15-15
APPROVED BY:		
PROJECT:		52715
DATE:		
REV:		
ABSOLUTE SCALE:	1:2,400	
REFERENCE SCALE:	1 IN = 200 FT.	
PAGE:	4 of 7	

GULF SOUTH
WILBROS ENGINEERING
Wilbros Engineers (U.S.) LLC, TBPE Firm #82

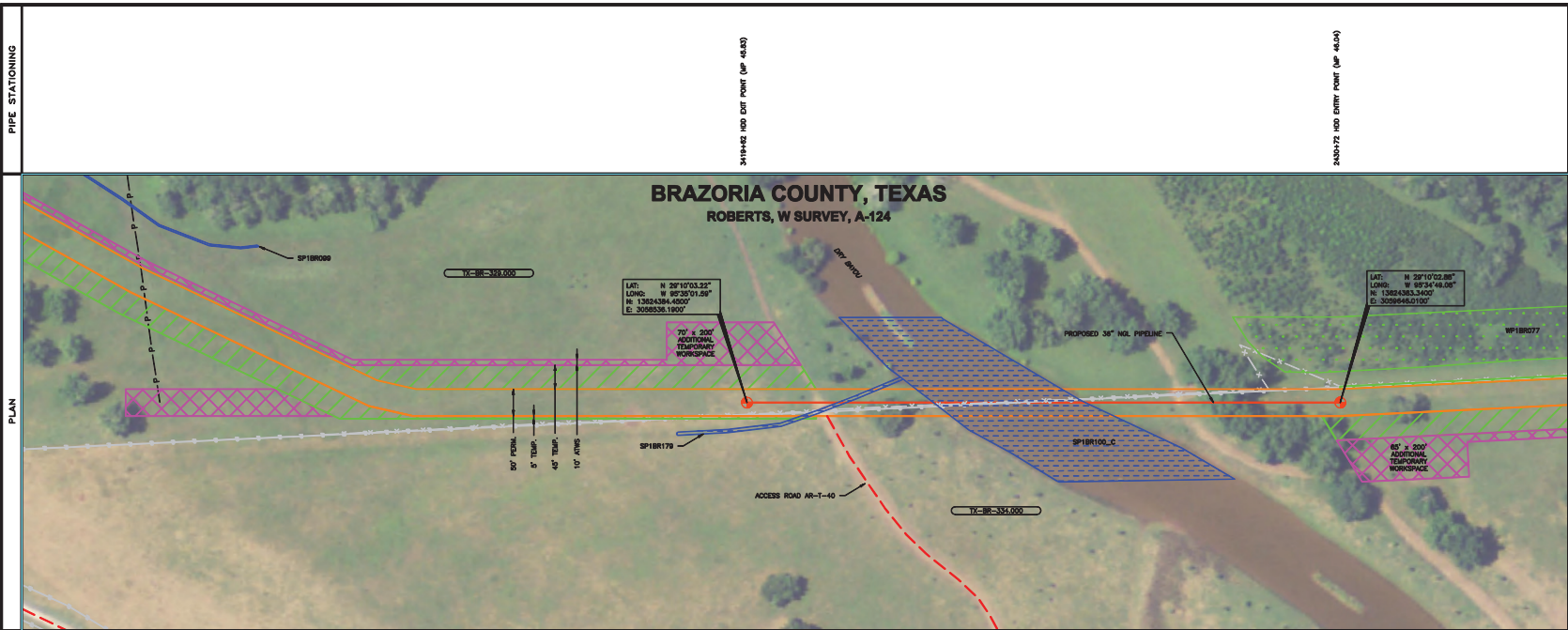

LEGEND

- HD ENTRY / EXIT POINTS
- GEOTECH BORE HOLE LOCATIONS

- GENERAL NOTES**
- IT IS THE CONTRACTOR'S RESPONSIBILITY TO MAKE NECESSARY ARRANGEMENTS IF TRAFFIC CONTROL PLANS AND/OR RAILROAD REPRESENTATION ARE REQUIRED.
 - CONTRACTOR TO LOCATE, MARK AND POT-HOLE FOREIGN LINES PRIOR TO EXCAVATION (AND MONITOR DURING DRILLING).
 - CONTRACTOR TO MAT OVER ANY FOREIGN PIPELINES CROSSED WITH DRILLING EQUIPMENT.
 - LOCATIONS OF EXISTING FACILITIES SHOWN ARE APPROXIMATE. CONTRACTOR TO LOCATE AND/OR CONFIRM THE LOCATIONS AND DEPTH OF ALL UTILITIES, PIPELINES OR OTHER OBSTACLES PRIOR TO EXCAVATION.
 - CONTRACTOR TO SUPPORT EXISTING UTILITIES, PIPELINES AND/OR OTHER FEATURES.
 - CONTRACTOR TO GRADE EXCAVATION AREA AND RESTORE TO ORIGINAL CONDITIONS.
 - NATURAL GROUND ELEVATION DATA IS PRELIMINARY BASED UPON DE DATA, NOT GROUND SURVEY.

PROJECTION SYSTEM:
NAD83 STATE PLANE, TEXAS SOUTH CENTRAL (U.S. SURVEY FEET)

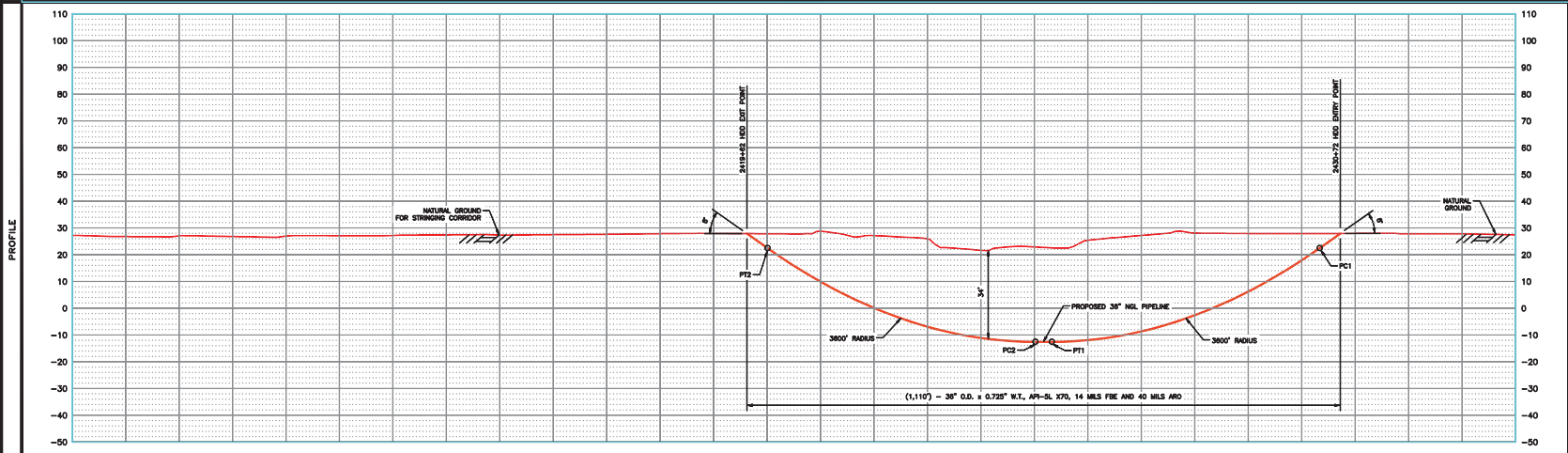

ISSUED FOR FERC
JUNE - 2015

HORIZONTAL DIRECTIONAL DRILL DATA		HORIZONTAL DIRECTIONAL DRILL PARAMETERS	
DESCRIPTION	STA.	ELEV.	
ENTRY ANGLE @ 8"	2430+72	27.8'	1.250_P280
POINT OF CURVATURE (PC1)	2430+33	22.8'	16.000_X20
POINT OF TANGENCY (PT1)	2424+32	-12.8'	1.110_L16
POINT OF CURVATURE (PC2)	2428+01	-12.8'	1.110_L16
POINT OF TANGENCY (PT2)	2420+00	22.8'	1.110_L16
EXIT ANGLE @ 8"	2419+82	27.8'	1.110_L16

LEGEND

- Prop. Element
- Temporary Retention
- Addressed Temp. Work
- Property Line
- Access Road
- Stream
- Waterline
- Open Water
- Tract Number

REFERENCE DRAWINGS

DWG. NO.	DRAWING TITLE
1400-650-P-107-30	ALIGNMENT SHEET

NO. DATE REVISION BY APPD.

NO.	DATE	REVISION	BY	APPD.
1	05/19	ISSUED FOR FERC	AMF	

GULF SOUTH
SPECIALTY ENGINEERS

SCALE: PLAN SCALE: 1"=100'
PROFILE (D) SCALE: 1"=100'
PROFILE (V) SCALE: 1"=20'

DRAWN BY: AMF DATE: 12/16/14
CHECKED BY: MCI DATE: 05/06/15
APPROVED BY: EPO APPROVAL:

WILLBROS ENGINEERING
WILLBROS ENGINEERING
10000 Highway 100, Suite 1000, Houston, TX 77036

**COASTAL BEND HEADER PIPELINE
DRY BAYOU MP 45.9
BRAZORIA COUNTY, TEXAS**

SCALE: 1" = 100' DRAWING NO: 1400-650-P-107-008 REV. A

June 08, 2015 - 2:00pm

P:\Projects\140000 - Coastal Bend Header Pipeline\1400-650-P-107-008.dwg

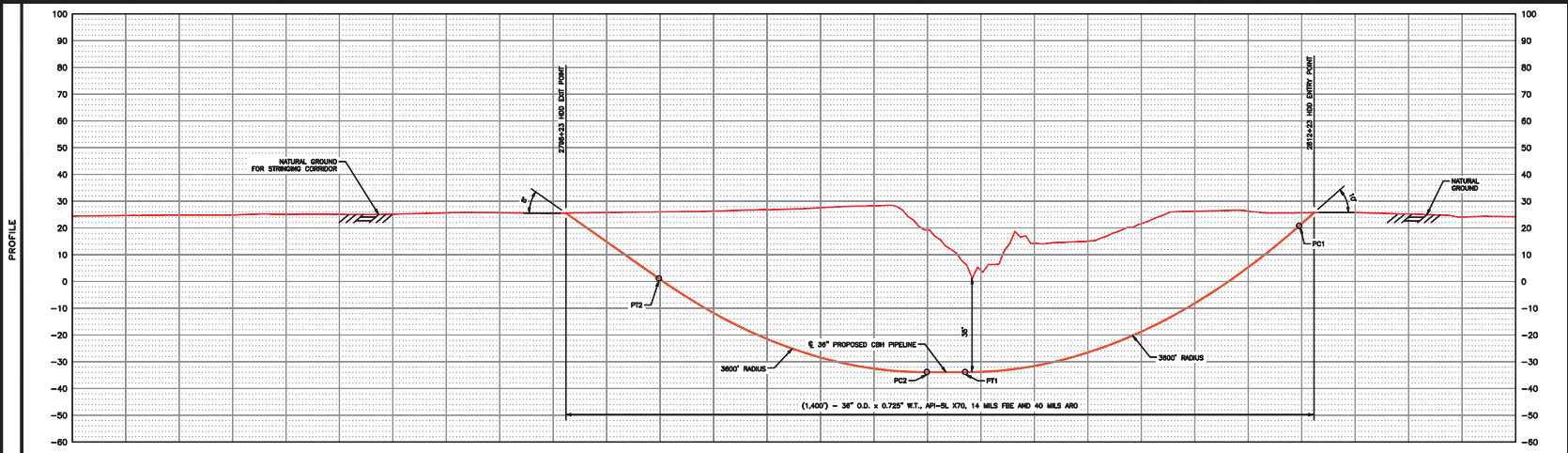
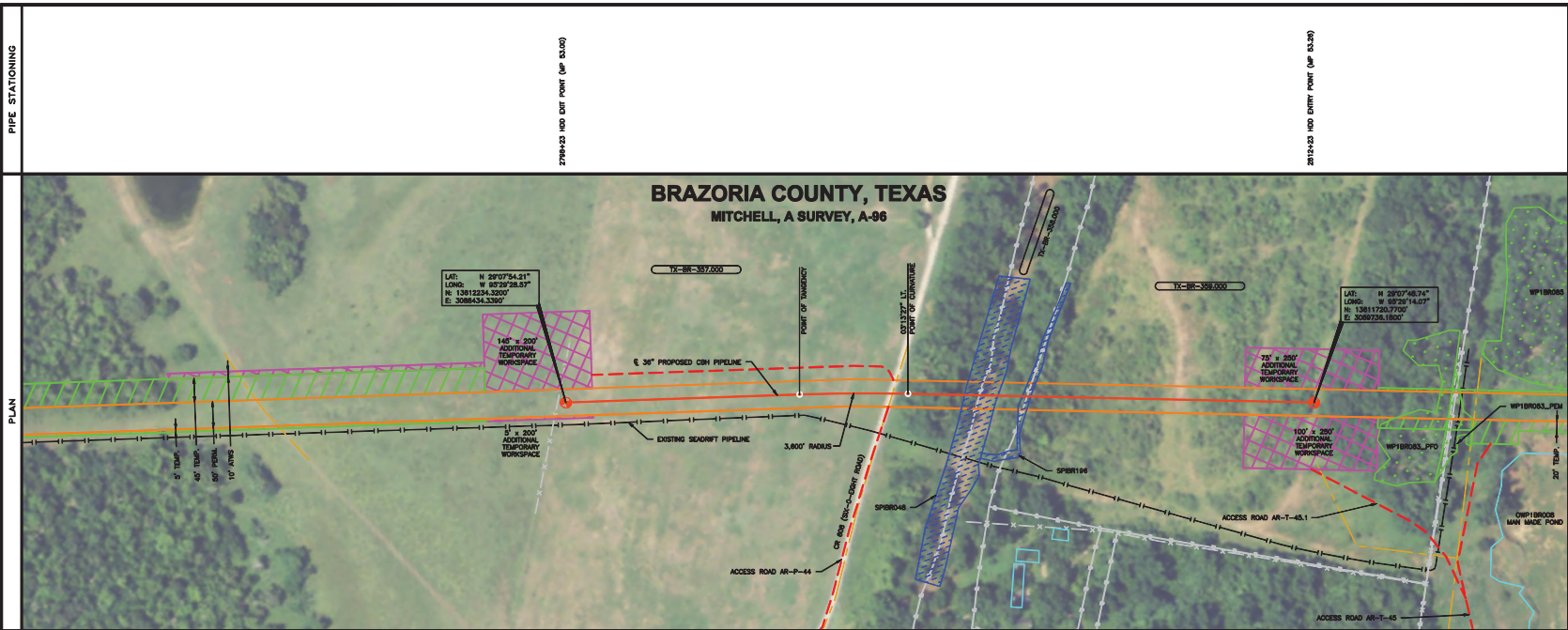

LEGEND

- ⊕ HDD ENTRY / EXIT POINTS
- ⊕ GEOTECH BORE HOLE LOCATIONS

- GENERAL NOTES**
- IT IS THE CONTRACTOR'S RESPONSIBILITY TO MAKE NECESSARY ARRANGEMENTS IF TRAFFIC CONTROL PLANS AND/OR RAILROAD REPRESENTATION ARE REQUIRED.
 - CONTRACTOR TO LOCATE, MARK AND POT-HOLE FOREIGN LINES PRIOR TO EXCAVATION (AND MONITOR DURING DRILLING).
 - CONTRACTOR TO MAT OVER ANY FOREIGN PIPELINES CROSSED WITH DRILLING EQUIPMENT.
 - LOCATIONS OF EXISTING FACILITIES SHOWN ARE APPROXIMATE. CONTRACTOR TO LOCATE AND/OR CONFIRM THE LOCATIONS AND DEPTH OF ALL UTILITIES, PIPELINES OR OTHER OBSTACLES PRIOR TO EXCAVATION.
 - CONTRACTOR TO SUPPORT EXISTING UTILITIES, PIPELINES AND/OR OTHER FEATURES.
 - CONTRACTOR TO GRADE EXCAVATION AREA AND RESTORE TO ORIGINAL CONDITIONS.
 - NATURAL GROUND ELEVATION DATA IS PRELIMINARY BASED UPON DE DATA, NOT GROUND SURVEY.

PROJECTION SYSTEM:
NAD83 STATE PLANE, TEXAS SOUTH CENTRAL (U.S. SURVEY FEET)

DRILL HAS COMPOUND CURVE

ISSUED FOR FERC
JUNE - 2015

HORIZONTAL DIRECTIONAL DRILL DATA		HORIZONTAL DIRECTIONAL DRILL PARAMETERS	
DESCRIPTION	STA. ELEV.		
ENTRY ANGLE @ 10'	2812+23 25.7'	1.) MAX. OPER. PRESS.: 1,500 PSIG	
POINT OF CURVATURE (PC1)	2811+88 20.8'	2.) PIPE 36" O.D. x 0.725" W.T. GRADE: 1400-AL-X20	
POINT OF TANGENCY (PT1)	2805+70 -33.9'	DESIGN FACTOR: 2.00	
POINT OF CURVATURE (PC2)	2804+99 -33.9'	3.) PIPE COATING: 1.6 MILS FIBRE	
POINT OF TANGENCY (PT2)	2789+23 1.1'	EXTERNAL COATING: 60 MILS FIBRE	
EXIT ANGLE @ 6'	2789+23 25.5'	LENGTH OF CROSSING: 1,400' L.P.	
		4.) TYPE OF PIPE JOINT: WELDED X 40' LG.	
		LENGTH OF PIPE: 1,462'	
		5.) THIS PRELIMINARY PROFILE WAS PREPARED PRIOR TO GEOTECHNICAL INVESTIGATIONS BEING CONDUCTED, AND MAY REQUIRE REVISION AFTER REVIEW OF GEOTECHNICAL FINDINGS.	

LEGEND

- Road
- - - Canal
- - - Fence
- - - D.H. Par. Ln.
- - - U.S. Cable
- - - E. Right-of-Way
- - - Foreign Pipeline
- - - Waterline
- ⊕ Trestle
- Farm Easement
- Temporary Right-of-Way
- Admitted Temp. Way
- Property Line
- Access Road
- Stream
- Wetlands
- Open Water

REFERENCE DRAWINGS

DWG. NO.	DRAWING TITLE
1400-650-P-107-38	ALIGNMENT SHEET

NO. DATE REVISION BY APPD.

NO.	DATE	REVISION	BY	APPD.
1	02/20/15	DRAFT ISSUED FOR FERC	AMF	AKL
2	05/15	ISSUED FOR FERC	AMF	

GULF SOUTH
SPECIALTY SERVICES

SCALE: PLAN SCALE: 1"=100'
PROFILE (D) SCALE: 1"=100'
PROFILE (E) SCALE: 1"=20'

DRAWN BY: AMF DATE: 12/16/14
CHECKED BY: MCL DATE: 05/21/15
APPROVED BY: EPO APPROVAL:

WILLBROS ENGINEERING
Coastal Bend Header Pipeline
Oyster Creek MP 53.1
Brazoria County, Texas

SCALE: 1"=100' DRAWING NO: 1400-650-P-107-010 REV: B

June 08, 2015 - 2:13pm



- LEGEND**
- ⊕ HDD ENTRY / EXIT POINTS
 - ⊕ GEOTECH BORE HOLE LOCATIONS

GENERAL NOTES

- 1.) IT IS THE CONTRACTOR'S RESPONSIBILITY TO MAKE NECESSARY ARRANGEMENTS IF TRAFFIC CONTROL PLANS AND/OR RAILROAD REPRESENTATION ARE REQUIRED.
- 2.) CONTRACTOR TO LOCATE, MARK AND POTHOLE FOREIGN LINES PRIOR TO EXCAVATION (AND MONITOR DURING DRILLING).
- 3.) CONTRACTOR TO MAT OVER ANY FOREIGN PIPELINES CROSSED WITH DRILLING EQUIPMENT.
- 4.) LOCATIONS OF EXISTING FACILITIES SHOWN ARE APPROXIMATE. CONTRACTOR TO LOCATE AND/OR CONFIRM THE LOCATIONS AND DEPTH OF ALL UTILITIES, PIPELINES OR OTHER OBSTACLES PRIOR TO EXCAVATION.
- 5.) CONTRACTOR TO SUPPORT EXISTING UTILITIES, PIPELINES AND/OR OTHER FEATURES.
- 6.) CONTRACTOR TO GRADE EXCAVATION AREA AND RESTORE TO ORIGINAL CONDITIONS.
- 7.) NATURAL GROUND ELEVATION DATA IS PRELIMINARY BASED UPON DE DATA, NOT GROUND SURVEY.

PROJECTION SYSTEM:

NAD83 STATE PLANE, TEXAS SOUTH CENTRAL (U.S. SURVEY FEET)

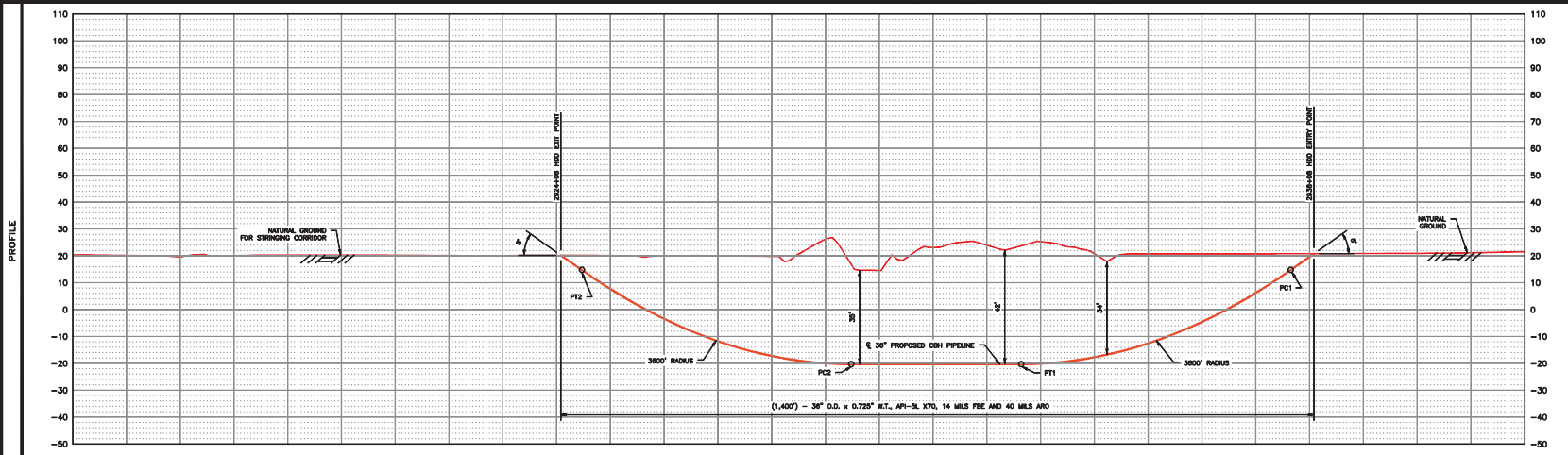
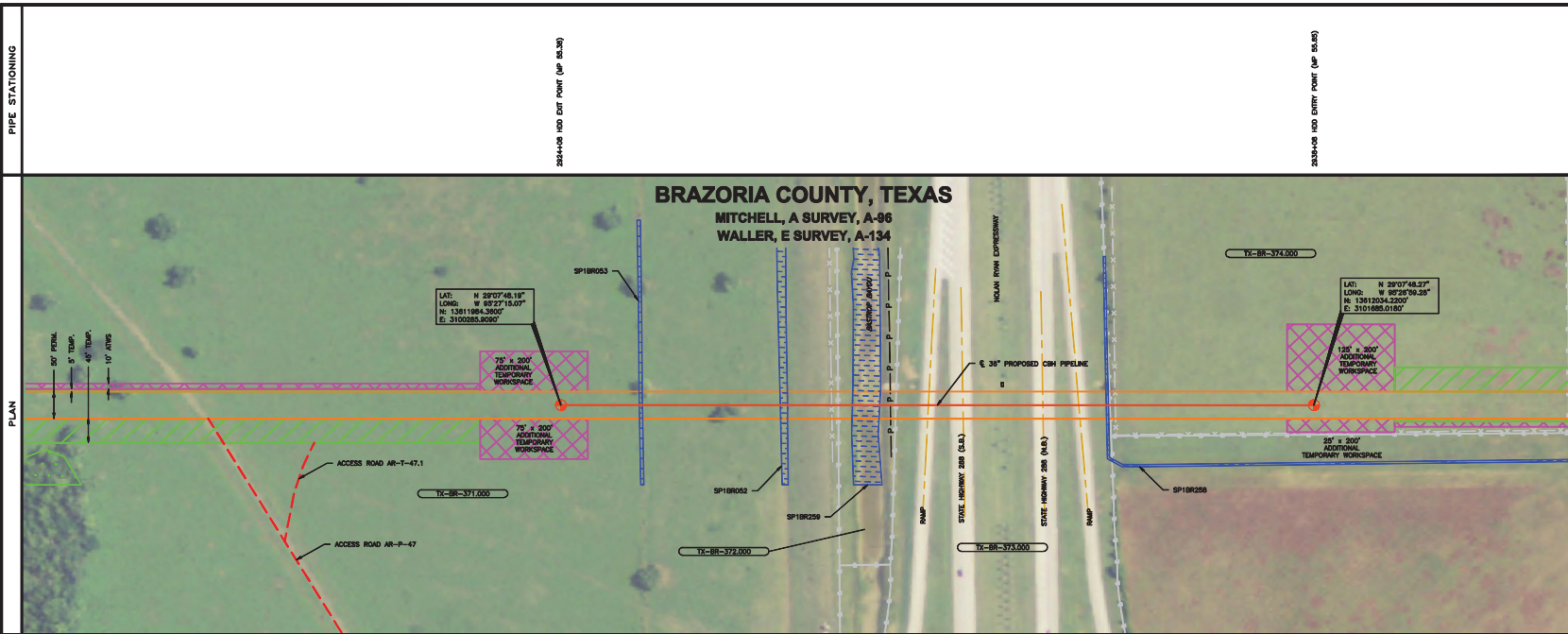

ISSUED FOR FERC
JUNE - 2015

HORIZONTAL DIRECTIONAL DRILL DATA		HORIZONTAL DIRECTIONAL DRILL PARAMETERS	
DESCRIPTION	STA. ELEV.		
ENTRY ANGLE @ 8'	2338+08 20.8'	1.) MAX. OPER. PRESS:	1,500 PSIG
POINT OF CURVATURE (PC1)	2337+83 14.7'	2.) PIPE O.D. x 0.725" W.T. GRADE:	36\"/>

LEGEND	
—	Prop. Element
---	Temporary Reliance
---	Addressed Temp. Work
---	Property Line
---	Access Road
---	Stream
---	Waterway
---	Open Water
---	Treat Number

REFERENCE DRAWINGS	
DWG. NO.	DRAWING TITLE
14CQ-650-P-107-37	ALIGNMENT SHEET

NO.	DATE	REVISION	BY	APPD.
1	02/20/15	DRAFT ISSUED FOR FERC	AMF	DL
2	05/15	ISSUED FOR FERC	AMF	

GULF SOUTH
SPECIALTY SERVICES

SCALE: 1" = 100'
PROFILE (V) SCALE: 1" = 20'

DRAWN BY: AMF DATE: 12/16/14
CHECKED BY: MCL DATE: 5/27/15
APPROVED BY: EPO APPROVAL:

WILLBROS ENGINEERING
WILLBROS ENGINEERING (USA) LLC, 1001 FOM DR

COASTAL BEND HEADER PIPELINE
HIGHWAY 288 MP 55.5
BRAZORIA COUNTY, TEXAS

SCALE: 1" = 100' DRAWING NO: 14CQ-650-P-107-011 REV. B

June 08, 2015 - 2:14pm

P:\Projects\15713 - Coastal Bend Header Pipeline\CA - 650\Drawings\Drawings\15713\15713-0102-01.dwg

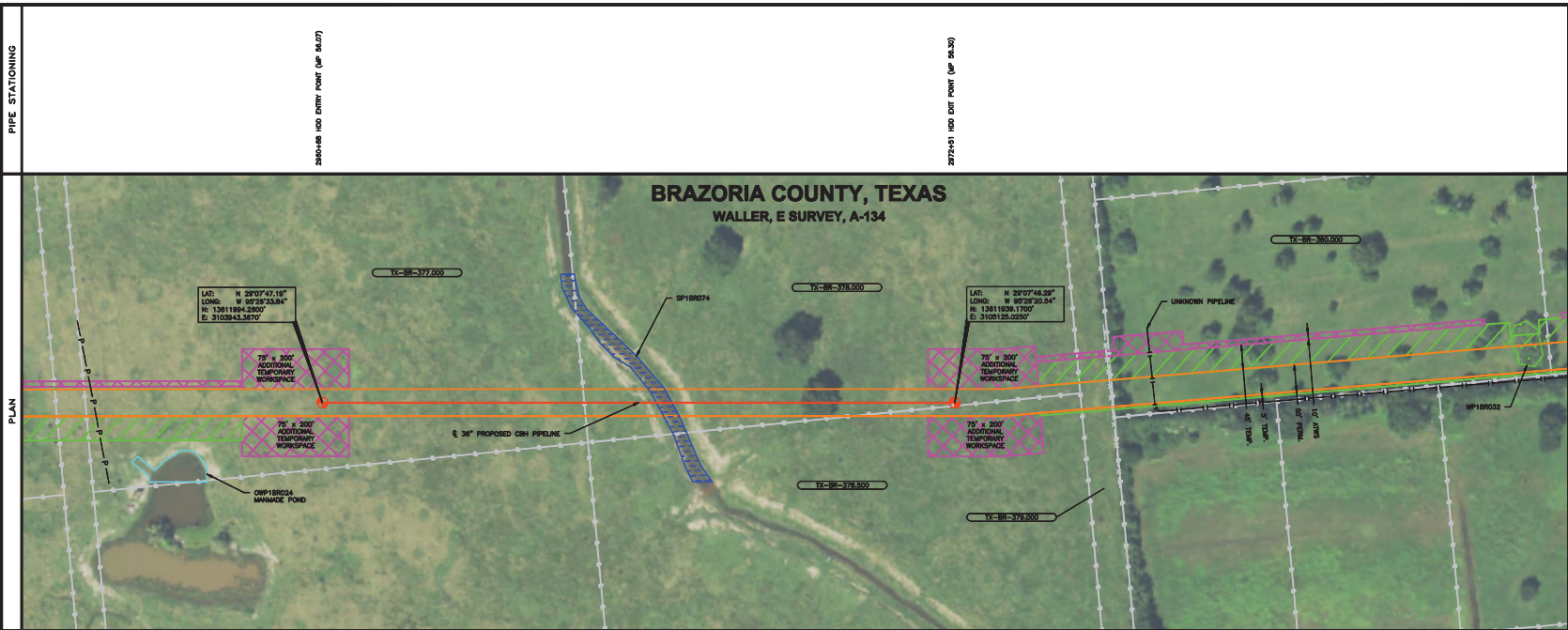

- LEGEND**
- HDD ENTRY / EXIT POINTS
 - GEOTECH BORE HOLE LOCATIONS
- GENERAL NOTES**
- IT IS THE CONTRACTOR'S RESPONSIBILITY TO MAKE NECESSARY ARRANGEMENTS IF TRAFFIC CONTROL PLANS AND/OR RAILROAD REPRESENTATION ARE REQUIRED.
 - CONTRACTOR TO LOCATE, MARK AND POT-HOLE FOREIGN LINES PRIOR TO EXCAVATION (AND MONITOR DURING DRILLING).
 - CONTRACTOR TO MAT OVER ANY FOREIGN PIPELINES CROSSED WITH DRILLING EQUIPMENT.
 - LOCATIONS OF EXISTING FACILITIES SHOWN ARE APPROXIMATE. CONTRACTOR TO LOCATE AND/OR CONFIRM THE LOCATIONS AND DEPTH OF ALL UTILITIES, PIPELINES OR OTHER OBSTACLES PRIOR TO EXCAVATION.
 - CONTRACTOR TO SUPPORT EXISTING UTILITIES, PIPELINES AND/OR OTHER FEATURES.
 - CONTRACTOR TO GRADE EXCAVATION AREA AND RESTORE TO ORIGINAL CONDITIONS.
 - NATURAL GROUND ELEVATION DATA IS PRELIMINARY BASED UPON DE DATA, NOT GROUND SURVEY.
- PROJECTION SYSTEM:**
NAD83 STATE PLANE, TEXAS SOUTH CENTRAL (U.S. SURVEY FEET)

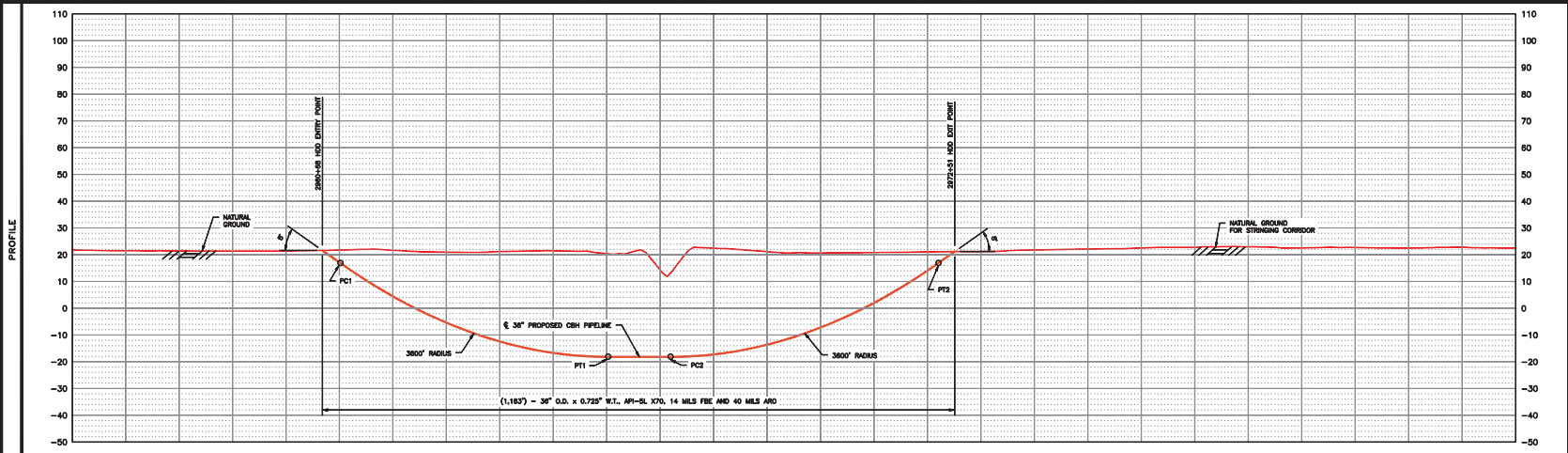

ISSUED FOR FERC
JUNE - 2015

HORIZONTAL DIRECTIONAL DRILL DATA	
DESCRIPTION	STA. ELEV.
ENTRY ANGLE @ 0'	2880+88 21.6'
POINT OF CURVATURE (PC1)	2881+02 18.9'
POINT OF TANGENCY (PT1)	2886+03 -18.2'
POINT OF CURVATURE (PC2)	2887+19 -18.2'
POINT OF TANGENCY (PT2)	2872+20 18.9'
EXIT ANGLE @ 0'	2872+51 21.2'

HORIZONTAL DIRECTIONAL DRILL PARAMETERS	
1.) MAX. OPER. PRESS.	1,500 PSIG
2.) PIPE O.D. x 0.725" W.T. GRADE:	36" x 0.725"
3.) PIPE COATING:	14 MILS FBE AND 40 MILS APO
4.) TYPE OF PIPE JOINT:	WELDED X 40' LG. 1.183%

LEGEND

- Prop. Element
- Temporary Reliance
- Addressed Item, Wep
- Property Line
- Access Road
- Stream
- Waterline
- Open Water

REFERENCE DRAWINGS	
DWG. NO.	DRAWING TITLE
14CQ-650-P-107-38	ALIGNMENT SHEET

NO.	DATE	REVISION	BY	APPD.
1	6/15	ISSUED FOR FERC	AMF	

GULF SOUTH
SPECIALTY SERVICES

SCALE: 1" = 100'

PROFILE (D) SCALE: 1" = 100'

PROFILE (E) SCALE: 1" = 20'

WILLBROS ENGINEERING
Coastal Bend Header Pipeline
BRAZORIA COUNTY DRAINAGE DITCH #7 MP 56.2
BRAZORIA COUNTY, TEXAS

SCALE: 1" = 100' DRAWING NO: 14CQ-650-P-107-011A REV. A

DATE: 04/30/15
DATE: 05/06/15

P:\Projects\15713 - Coastal Bend Header Pipeline\CA - CAD\Drawings\DWG\14CQ-011A.dwg

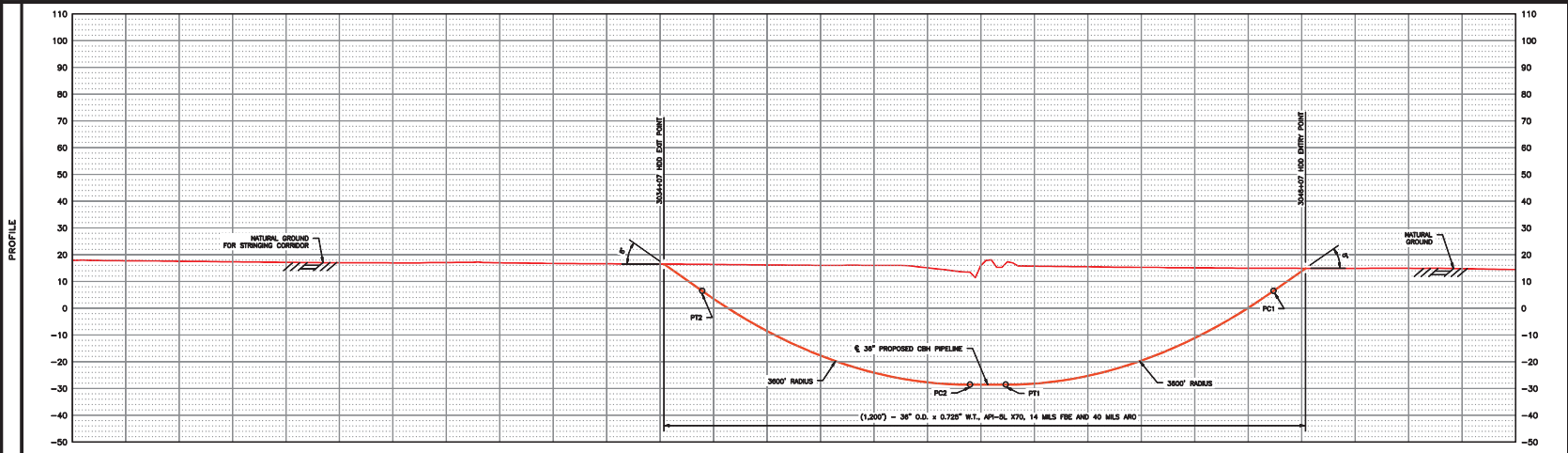
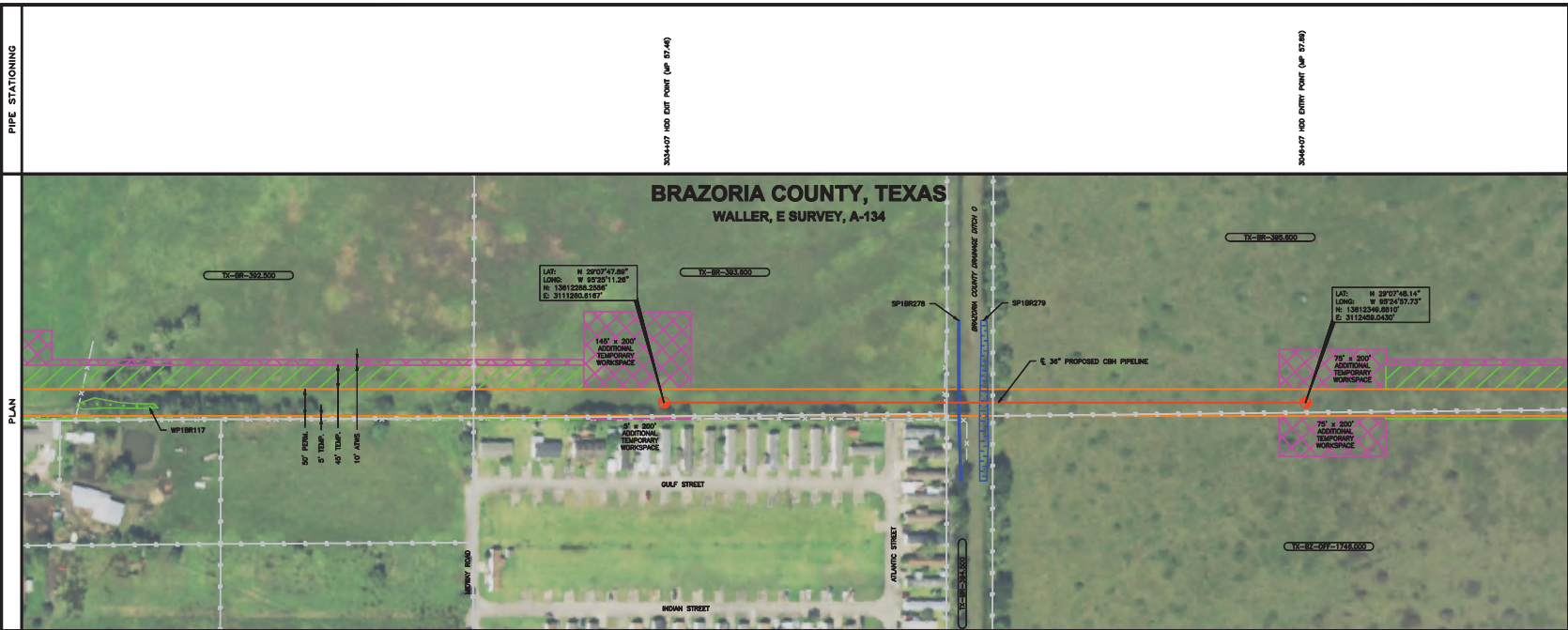

LEGEND

- HDD ENTRY / EXIT POINTS
- GEOTECH BORE HOLE LOCATIONS

- GENERAL NOTES**
- IT IS THE CONTRACTOR'S RESPONSIBILITY TO MAKE NECESSARY ARRANGEMENTS IF TRAFFIC CONTROL PLANS AND/OR RAILROAD REPRESENTATION ARE REQUIRED.
 - CONTRACTOR TO LOCATE, MARK AND POTHOLE FOREIGN LINES PRIOR TO EXCAVATION (AND MONITOR DURING DRILLING).
 - CONTRACTOR TO MAT OVER ANY FOREIGN PIPELINES CROSSED WITH DRILLING EQUIPMENT.
 - LOCATIONS OF EXISTING FACILITIES SHOWN ARE APPROXIMATE. CONTRACTOR TO LOCATE AND/OR CONFIRM THE LOCATIONS AND DEPTH OF ALL UTILITIES, PIPELINES OR OTHER OBSTACLES PRIOR TO EXCAVATION.
 - CONTRACTOR TO SUPPORT EXISTING UTILITIES, PIPELINES AND/OR OTHER FEATURES.
 - CONTRACTOR TO GRADE EXCAVATION AREA AND RESTORE TO ORIGINAL CONDITIONS.
 - NATURAL GROUND ELEVATION DATA IS PRELIMINARY BASED UPON DE DATA, NOT GROUND SURVEY.

PROJECTION SYSTEM:
NAD83 STATE PLANE, TEXAS SOUTH CENTRAL (U.S. SURVEY FEET)

ISSUED FOR FERC
JUNE - 2015

HORIZONTAL DIRECTIONAL DRILL DATA		HORIZONTAL DIRECTIONAL DRILL PARAMETERS	
DESCRIPTION	STA. ELEV.		
ENTRY ANGLE @ 0'	3048+07 15.0'	1) MAX. OPER. PRESS:	1,000 PSIG
POINT OF CURVATURE (PC1)	3048+47 6.8'	2) PIPE: 36" O.D. x 0.728" W.T. GRADE:	605-AL X20
POINT OF TANGENCY (PT1)	3049+48 -28.0'	3) PIPE COATING:	1.6 MILS FBE
POINT OF CURVATURE (PC2)	3038+79 -28.0'	EXTERNAL COATING:	16 MILS FBE
POINT OF TANGENCY (PT2)	3034+78 6.8'	LENGTH OF CROSSING:	1,200 L.F.
EXIT ANGLE @ 0'	3034+07 15.5'	4) TYPE OF PIPE JOINT:	WELDED X 40' LG.
		LENGTH OF PIPE:	1,200'

LEGEND

- Prop. Element
- Temporary Reliance
- Addressed Temp. Work
- Property Line
- Access Road
- Stream
- Waterway
- Open Water
- Trestle
- Tract Number

REFERENCE DRAWINGS

DWG. NO.	DRAWING TITLE
1400-650-P-107-30	ALIGNMENT SHEET

NO. DATE REVISION BY APPD.

NO.	DATE	REVISION	BY	APPD.
1	05/15	ISSUED FOR FERC	AMF	

GULF SOUTH
SPECIALTY SERVICES

SCALE: 1" = 100'
PROFILE (P) SCALE: 1" = 20'

DRAWN BY: AMF DATE: 04/30/15
CHECKED BY: MCT DATE: 05/06/15
APPROVED BY: EPO APPROVAL:

WILLBROS ENGINEERING
Coastal Bend Header Pipeline
Brazoria County Drainage Ditch 0 MP 57.6
Brazoria County, Texas

SCALE: 1" = 100' DRAWING NO: 1400-650-P-107-011B REV. A

June 08, 2015 - 2:18pm

P:\Projects\15710 - Coastal Bend Header Pipeline\15710 - Coastal Bend Header Pipeline\15710\15710-011B.dwg

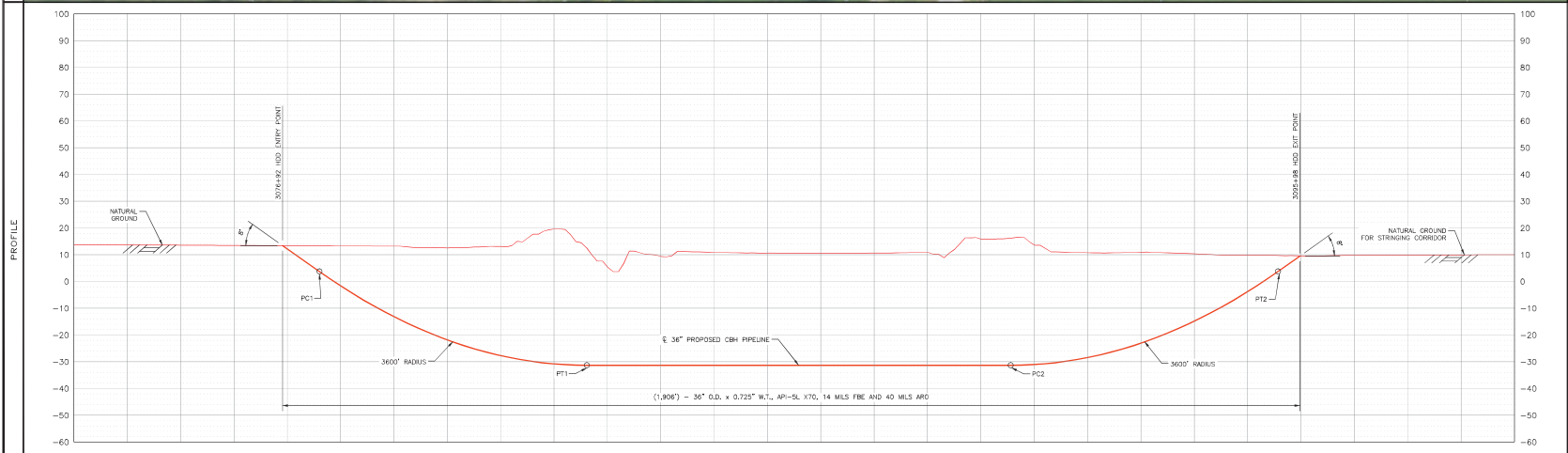
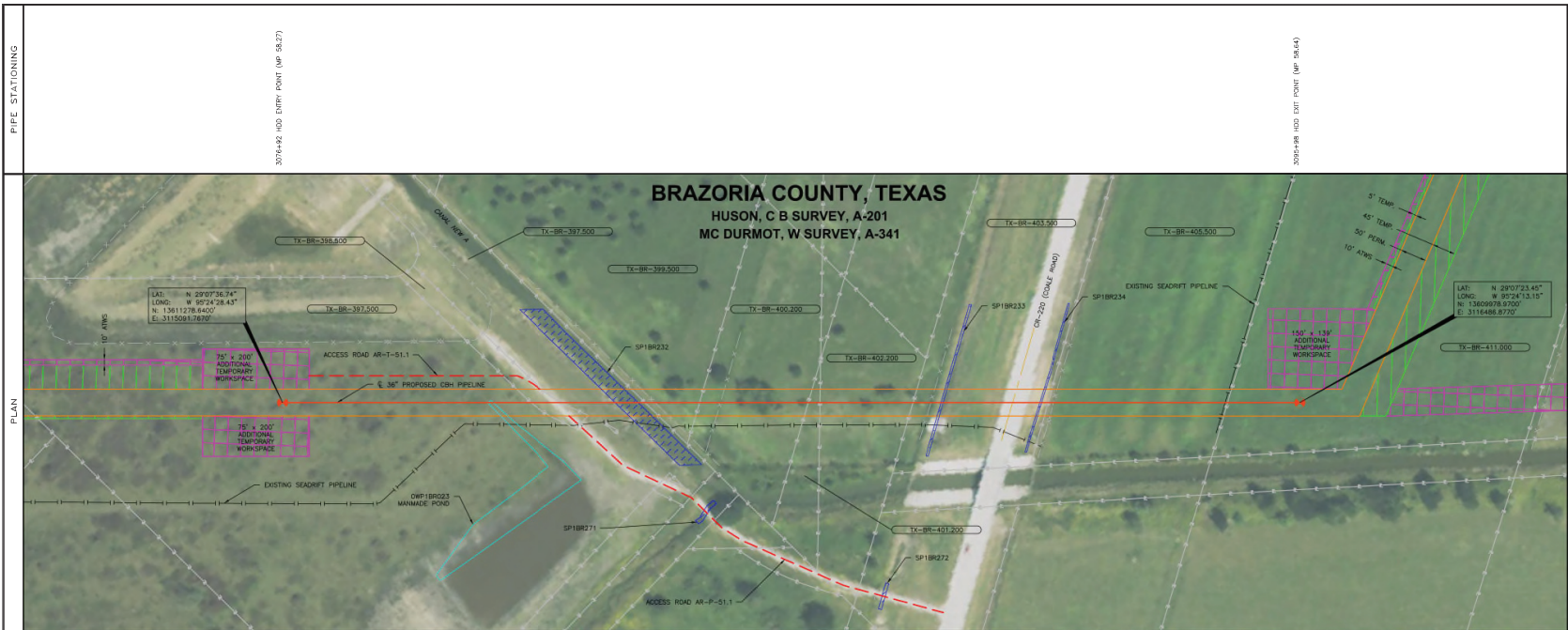

LEGEND:

- HDD ENTRY / EXIT POINTS
- GEOTECH BORE HOLE LOCATIONS

GENERAL NOTES:

- IT IS THE CONTRACTOR'S RESPONSIBILITY TO MAKE NECESSARY ARRANGEMENTS IF TRAFFIC CONTROL PLANS AND/OR RAILROAD REPRESENTATION ARE REQUIRED.
- CONTRACTOR TO LOCATE, MARK AND POHOLE FOREIGN LINES PRIOR TO EXCAVATION (AND MONITOR DURING DRILLING).
- CONTRACTOR TO MAT OVER ANY FOREIGN PIPELINES CROSSED WITH DRILLING EQUIPMENT.
- LOCATIONS OF EXISTING FACILITIES SHOWN ARE APPROXIMATE. CONTRACTOR TO LOCATE AND/OR CONFIRM THE LOCATIONS AND DEPTH OF ALL UTILITIES, PIPELINES OR OTHER OBSTACLES PRIOR TO EXCAVATION.
- CONTRACTOR TO SUPPORT EXISTING UTILITIES, PIPELINES AND/OR OTHER FEATURES.
- CONTRACTOR TO GRADE EXCAVATION AREA AND RESTORE TO ORIGINAL CONDITIONS.
- NATURAL GROUND ELEVATION DATA IS PRELIMINARY BASED UPON GDS DATA, NOT GROUND SURVEY.

PROJECTION SYSTEM:
NAD83 STATE PLANE, TEXAS SOUTH CENTRAL (U.S. SURVEY FEET)

ISSUED FOR FERC
JUNE-2015

HORIZONTAL DIRECTIONAL DRILL DATA			HORIZONTAL DIRECTIONAL DRILL PARAMETERS		
DESCRIPTION	STA.	P.T.C.	DESCRIPTION	VALUE	UNIT
ENTRY ANGLE @ B"	3076-92	13.4°	1) MAX. OPER. PRESS.	3,250	PSIG
POINT OF CURVATURE (PC1)	3077-61	3.7'	2) PIPE: 36" O.D. x 0.725" W.T. GRADE:	API-5L X70	
LEASD O.T. RADIUS			DESIGN FACTOR:	0.50	
POINT OF TANGENCY (PT1)	3082-42	-31.3'	3) PIPE COATING:	14 MILS FBE	
POINT OF CURVATURE (PC2)	3090+56	-31.3'	EXTERNAL COATING:	50 MILS FBE	
LEASD O.T. RADIUS			LENGTH OF CROSSING:	1,908 LF	
POINT OF TANGENCY (PT2)	3095+57	3.7'	4) TYPE OF PIPE JOINT:	WELDED X 40" LG.	
EXIT ANGLE @ B"	3095+98	9.5°	LENSH OF PIPE:	3.21LC	
			5) THIS PRELIMINARY PROFILE WAS PREPARED PRIOR TO GEOTECHNICAL INVESTIGATIONS BEING CONDUCTED, AND MAY REQUIRE REVISION AFTER REVIEW OF GEOTECHNICAL FINDINGS.		

LEGEND:

- Road
- Drain
- Fence
- Dist. Par. Lt.
- UG. Cable
- Retroad
- Foreign Pipeline
- Waterline
- Tract Number
- Perm. Easement
- Temporary Workarea
- Additional Temp. Wsg
- Property Line
- Access Road
- Stream
- Methods
- Open Water

REFERENCE DRAWINGS

DWG. NO.	DRAWING TITLE
14CQ-650-P-107-39	ALIGNMENT SHEET

NO. DATE REVISION BY APPR.

NO.	DATE	REVISION	BY	APPR.
A	03/2015	DRAWN ISSUED FOR FERC	AWF	DL
B	06/15	ISSUED FOR FERC	AWF	

GULF SOUTH PIPELINES

SCALE: PLAN SCALE: 1"=100'
PROFILE (V) SCALE: 1"=20'

DRAWN BY: AWF DATE: 12/9/14
CHECKED BY: WLT DATE: 05/11/15
APPROVED BY: [Signature] EPC APPROVAL:

WILLBROS ENGINEERING

COASTAL BEND HEADER PIPELINE
CANAL NEW A & COALE ROAD/CR-220 MP 58.4
BRAZORIA COUNTY, TEXAS

SCALE: 1" = 100' DRAWING NO.: 14CQ-650-P-107-012 REV. B

June 06, 2015 - 4:28pm

P:\Projects\142715 - Coastal Bend Header Pipeline\A-400\Drawings\Drawings\14CQ-650-P-107-012.dwg

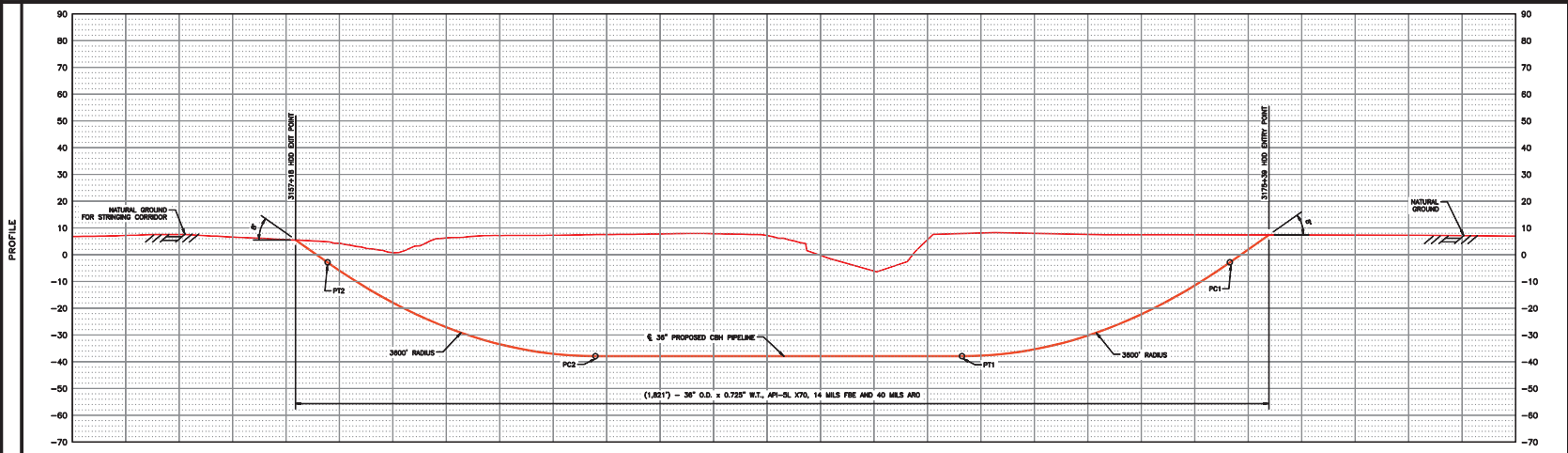
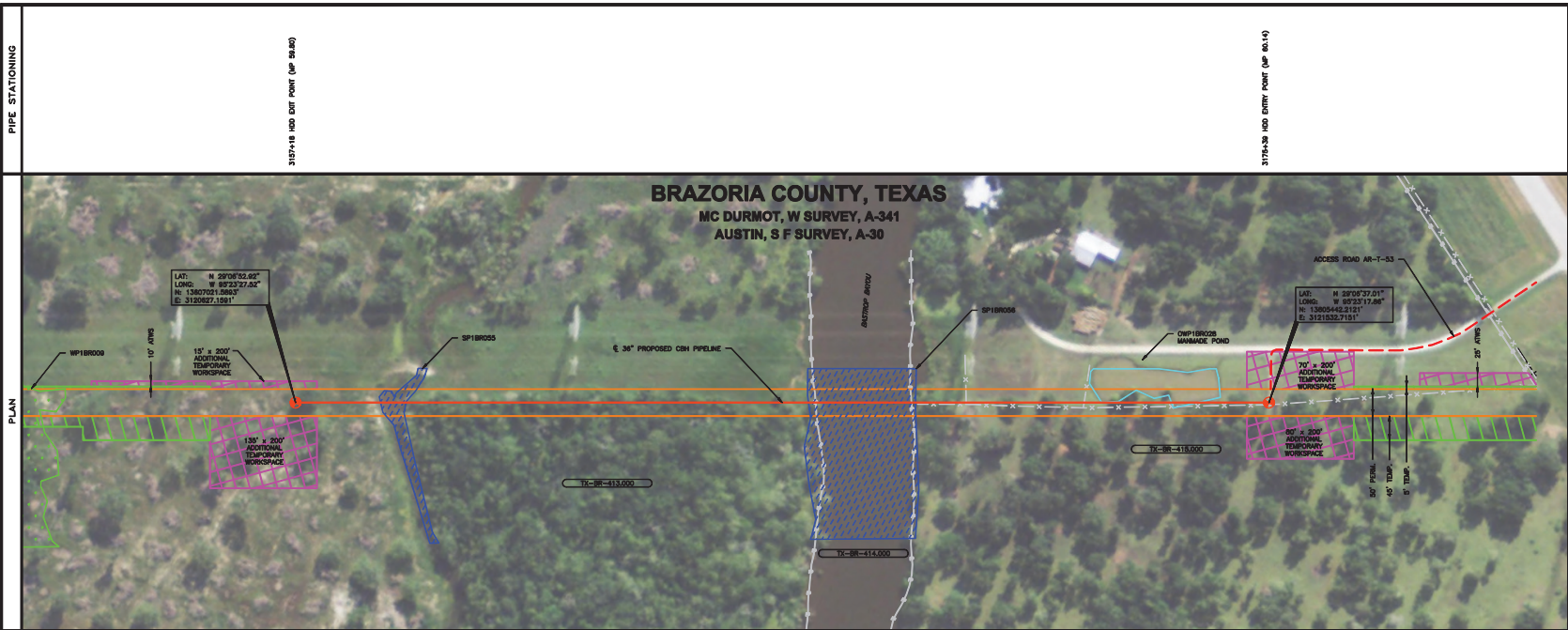

LEGEND

- ⊕ HDD ENTRY / EXIT POINTS
- ⊕ GEOTECH BORE HOLE LOCATIONS

- GENERAL NOTES**
- IT IS THE CONTRACTOR'S RESPONSIBILITY TO MAKE NECESSARY ARRANGEMENTS IF TRAFFIC CONTROL PLANS AND/OR RAILROAD REPRESENTATION ARE REQUIRED.
 - CONTRACTOR TO LOCATE, MARK AND POT-HOLE FOREIGN LINES PRIOR TO EXCAVATION (AND MONITOR DURING DRILLING).
 - CONTRACTOR TO MAT OVER ANY FOREIGN PIPELINES CROSSED WITH DRILLING EQUIPMENT.
 - LOCATIONS OF EXISTING FACILITIES SHOWN ARE APPROXIMATE. CONTRACTOR TO LOCATE AND/OR CONFIRM THE LOCATIONS AND DEPTH OF ALL UTILITIES, PIPELINES OR OTHER OBSTACLES PRIOR TO EXCAVATION.
 - CONTRACTOR TO SUPPORT EXISTING UTILITIES, PIPELINES AND/OR OTHER FEATURES.
 - CONTRACTOR TO GRADE EXCAVATION AREA AND RESTORE TO ORIGINAL CONDITIONS.
 - NATURAL GROUND ELEVATION DATA IS PRELIMINARY BASED UPON DE DATA, NOT GROUND SURVEY.

PROJECTION SYSTEM:
 NAD83 STATE PLANE, TEXAS SOUTH CENTRAL (U.S. SURVEY FEET)

ISSUED FOR FERC
 JUNE - 2015

HORIZONTAL DIRECTIONAL DRILL DATA

DESCRIPTION	STA.	ELEV.
ENTRY ANGLE @ 0'	3175+30	7.4'
POINT OF CURVATURE (PC1)	3174+63	-2.0'
POINT OF TANGENCY (PT1)	3180+84	-37.0'
POINT OF CURVATURE (PC2)	3182+79	-37.0'
POINT OF TANGENCY (PT2)	3157+70	-2.0'
EXIT ANGLE @ 0'	3157+18	5.5'

HORIZONTAL DIRECTIONAL DRILL PARAMETERS

1.) MAX. OPER. PRESS:	1,050 PSIG
2.) PIPE: 36" O.D. ± 0.725" W.T. GRADE:	API-5L X70
COSSON FACTOR:	0.90
3.) PIPE COATING:	14 MILS FBE
EXTERNAL COATING:	60 MILS APO
LENGTH OF CROSSING:	3,181 L.F.
4.) TYPE OF PIPE JOINT:	WELDED X 40' LG.
LENGTH OF PIPE:	1,850'
5.) THIS PRELIMINARY PROFILE WAS PREPARED PRIOR TO GEOTECHNICAL INVESTIGATIONS BEING CONDUCTED, AND MAY REQUIRE REVISION AFTER REVIEW OF GEOTECHNICAL FINDINGS.	

LEGEND

- Road
- - - Canal
- x Fence
- - - D.H. Par. Ln.
- - - U.S. Cable
- - - E. Right-of-Way
- - - Foreign Pipeline
- - - Waterline
- ⊕ Tract Marker
- Park Easement
- Temporary Right-of-Way
- Addressed Temp. Way
- Property Line
- Access Road
- Stream
- Wetlands
- Open Water

REFERENCE DRAWINGS

DWG. NO.	DRAWING TITLE
140Q-650-P-102-00	ALIGNMENT SHEET
140Q-650-P-102-01	ALIGNMENT SHEET

NO. DATE REVISION BY APPD.

1	02/20/15	DRAFT ISSUED FOR FERC	AMF	DL
2	05/15	ISSUED FOR FERC	AMF	

GULF SOUTH
 PIPELINE SERVICES

SCALE: 1" = 100'
 PROFILE (V) SCALE: 1" = 20'

DRAWN BY: AMF DATE: 12/16/14
 CHECKED BY: MCT DATE: 05/11/15
 APPROVED BY: EPO APPROVAL:

WILLBROS ENGINEERING
Member Superior 0243 Lic. 0017, Firm 001

COASTAL BEND HEADER PIPELINE
BASTROP BAYOU MP 60.0
BRAZORIA COUNTY, TEXAS

SCALE: 1" = 100' DRAWING NO: 140Q-650-P-107-013 REV. B

June 08, 2015 - 2:30pm

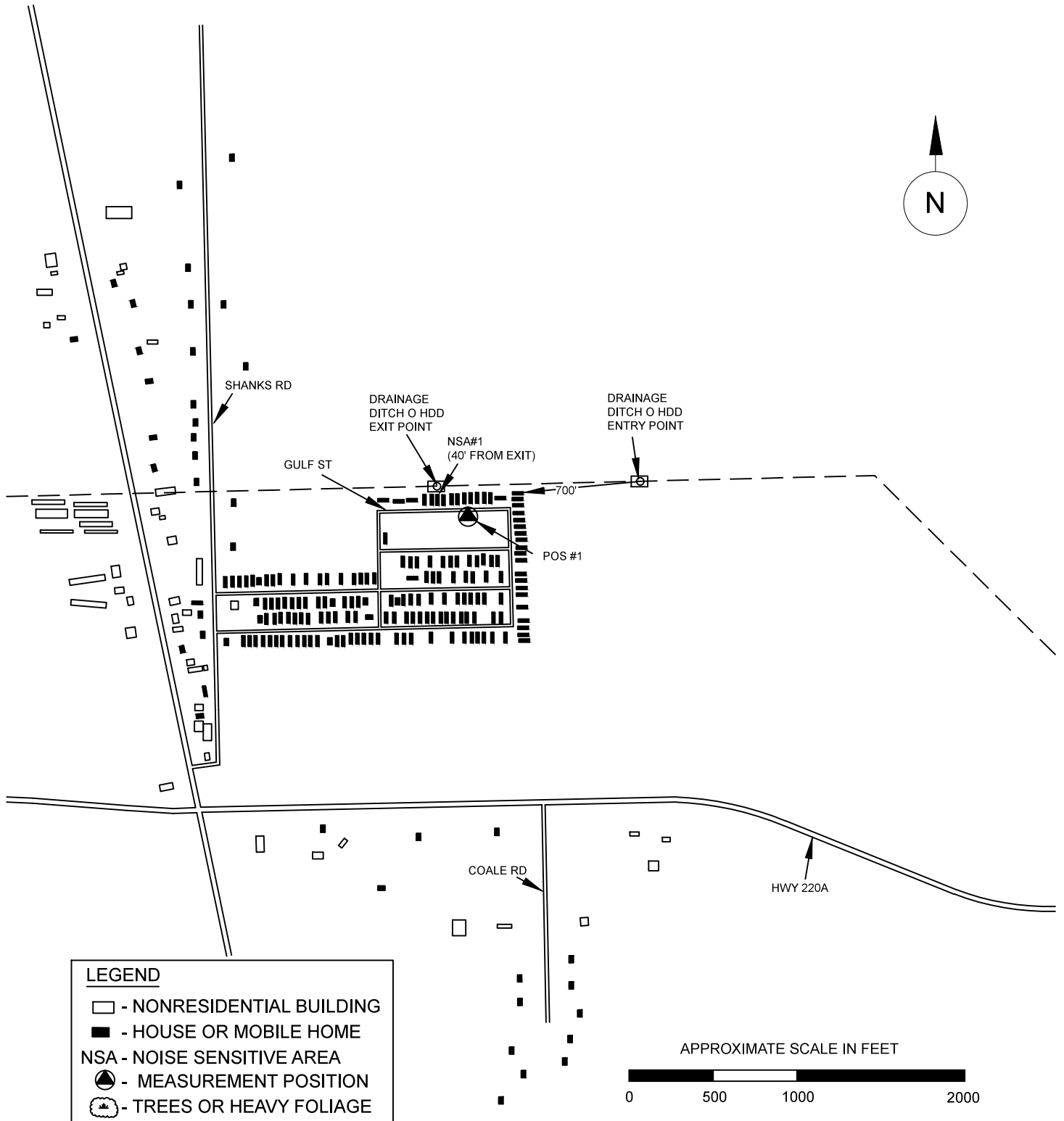

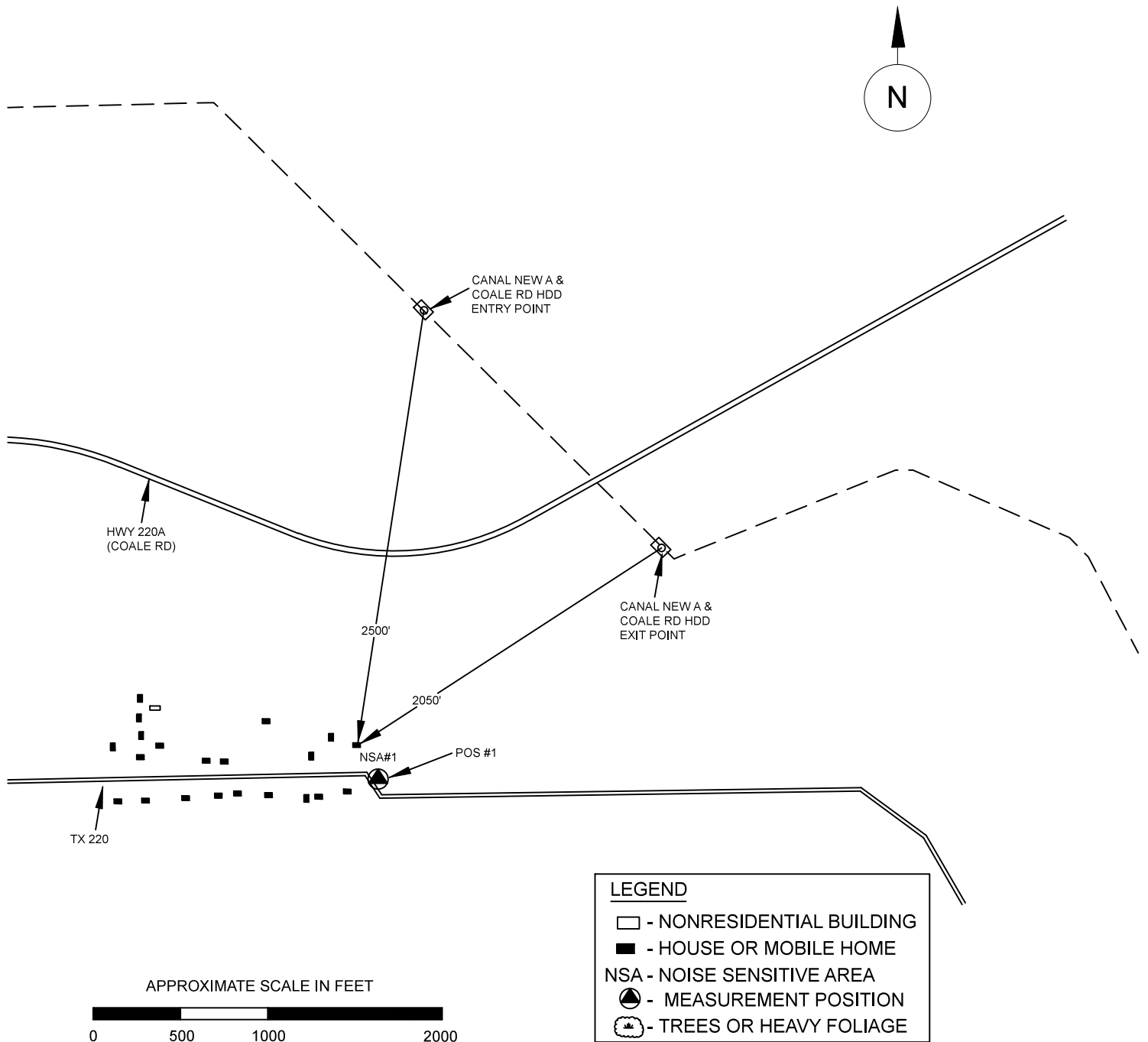

APPENDIX G

SITE-SPECIFIC EXCEPTIONS TO THE FERC PROCEDURES

Site-Specific Deviations to the FERC Procedures						
Workspace ID	Milepost	Waterbody or Wetland	Section of Plan and Procedures	Deviations to FERC Plan and Procedures	Justification	Equal Compliance Measures
Construction Corridor	0.00 – 65.61	N/A	Plan Section IV.A.2	Construction corridor of 100'	Necessary to provide for safe and efficient construction of the 36" pipeline	Not a Deviation
11	1.39	WP1WH022	Procedures Section VI.B.1.a.	ATWS located within 50' of wetland	ATWS required for wetland top soil storage and for additional trench excavation and spoil storage for crossing both a waterbody and foreign pipeline	Topsoil to be segregated in unsaturated wetlands; temporary timber mats or riprap to be installed where necessary to create a stable surface for equipment; trench plugs to be installed at the edges of wetlands to prevent subsurface drainage; and erosion controls to be implemented as needed to control sedimentation until disturbed soils are adequately stabilized and adjacent upland areas are restored.
12	1.44	SP1WH077 and SP1WH059	Procedures Section V.B.2.a.	ATWS located within 50' of waterbody	ATWS required for waterbody crossing	Temporary erosion and sediment control devices to be installed across the construction corridor as necessary to prevent the flow of spoil or heavily silt-laden water into any waterbody; equipment bridges to be designed and maintained to prevent spoil from entering the waterbody; spoil placement to occur at least 10 feet from the water's edge; and instream construction activities to be limited to the minimum time necessary (typically 24 to 48 hours).
180	24.47	SP1WH133	Procedures Section V.B.7.a.	Minor waterbody crossing will not be completed within 24 hours	Constructability constraints associated with multiple foreign pipeline crossings at the waterbody crossing require additional time to successfully construct the crossing	Temporary erosion and sediment control devices to be installed across the construction corridor as necessary to prevent the flow of spoil or heavily silt-laden water into any waterbody; equipment bridges to be designed and maintained to prevent spoil from entering the waterbody; spoil placement to occur at least 10 feet from the water's edge; and instream construction activities to be limited to 48 hours.
273	41.55	SP3BR002 and SP3BR003	Procedures Section V.B.2.a.	ATWS located within 50' of waterbody	ATWS required for additional trench excavation and spoil storage for waterbody crossing	Temporary erosion and sediment control devices to be installed across the construction corridor as necessary to prevent the flow of spoil or heavily silt-laden water into any waterbody; equipment bridges to be designed and maintained to prevent spoil from entering the waterbody; spoil placement to occur at least 10 feet from the water's edge; and instream construction activities to be limited to the minimum time necessary (typically 24 to 48 hours).
330 / 330A	53.24	WP1BR083_PFO	Procedures Section VI.B.1.a.	ATWS located within 50' of wetland	ATWS required for drilling operations, HDD crossing of Oyster Creek	Erosion controls to be implemented as needed to control sedimentation until disturbed soils are adequately stabilized and adjacent upland areas are restored.
377	62.62	WP1BR059	Procedures Section VI.B.1.a.	ATWS located within 50' of wetland	ATWS required for road crossing of Dixie Brown Road / County Road 223	Topsoil to be segregated in unsaturated wetlands; temporary timber mats or riprap to be installed where necessary to create a stable surface for equipment; trench plugs to be installed at the edges of wetlands to prevent subsurface drainage; and erosion controls to be implemented as needed to control sedimentation until disturbed soils are adequately stabilized and adjacent upland areas are restored.
390B	65.56	WP4BR035_DT	Procedures Section VI.B.1.a.	ATWS located within 50' of wetland	ATWS required for road crossings	Topsoil to be segregated in unsaturated wetlands; temporary timber mats or riprap to be installed where necessary to create a stable surface for equipment; trench plugs to be installed at the edges of wetlands to prevent subsurface drainage; and erosion controls to be implemented as needed to control sedimentation until disturbed soils are adequately stabilized and adjacent upland areas are restored. ^a

^a Deviation associated with environmental feature identified through desktop evaluations. Gulf South could make adjustments to Project workspaces once field surveys have been completed.

APPENDIX H
REVEGETATION PLAN



Gulf South Pipeline Company, LP

Revegetation Plan

Coastal Bend Header Project

June 2015

REVEGETATION PLAN
Coastal Bend Header Project
Gulf South Pipeline Company, LP

The following *Revegetation Plan* was developed by Gulf South Pipeline Company, LP (Gulf South) to incorporate all information from consultations with the National Resources Conservation Service (NRCS) Field Service Center in Texas and consultations with state resource agencies. Additionally, Gulf South's standard construction methods and procedures, and techniques defined in the Federal Energy Regulatory Commission (FERC) *Upland Erosion Control, Revegetation, and Maintenance Plan* (Plan) and *Wetland and Waterbody Construction and Mitigation Procedures* (Procedures) will be followed.

Unless specified by individual landowner agreements (e.g., agricultural fields) or Gulf South, upland disturbed areas will be planted using the seed mix below. Based on the construction schedule, all areas should be seeded at the rates given in the table below unless approved by Gulf South.

Species	PLS lbs/acre
Little Bluestem	3.4
Big Bluestem	6.0
Switchgrass	4.5
Sideoats grama	2.5
Green sprangletop	1.7
Total	18.1
Winter triticale ^a	5.0
Total (if triticale required)	23.1
Browntop millet ^b	7.5
Total (if millet required)	30.6
PLS = Pure Live Seed ^a Winter triticale will be added to the seeding/revegetation seed mix at a rate of 5.0 lbs per acre if late-season planting occurs from September through November. ^b Browntop millet will be added to the seeding/revegetation seed mix at a rate of 7.5 lbs per acre if summer planting occurs from June through September.	

Soil amendments will be applied with the recommendations provided by the local soil conservation authority after soil testing has been completed. Prior to seeding, the seedbed will be prepared by ripping the compacted layers and re-firming the soil. In areas of erosion concern, mulching will be conducted. Revegetated areas will be monitored following construction in accord with FERC's Plan and Procedures to assure success.

References

Natural Resources Conservation Service. 2014. Conservation Practice Standard Critical Area Planting.

http://efotg.sc.egov.usda.gov/references/public/TX/TX_342_Final_DEC_2014.pdf.

Accessed February 2015.

Natural Resources Conservation Service. 2012. Nutrient Management.

http://efotg.sc.egov.usda.gov/references/public/TX/2012_Texas_590_NM_Standard_Final.pdf. Accessed February 2015.

Sanders, Cristela. May 1, 2015. Natural Resources Conservation Services. Bay City Field Office. Personal communication with Marshall Olson (Staff Biologist, Perennial Environmental Services, LLC).

APPENDIX I

WETLANDS AFFECTED BY THE COASTAL BEND HEADER PROJECT

Wetland Resources Crossed or Otherwise Impacted by the Coastal Bend Header Project									
Feature ID	Approximate Milepost	Wetland Type ^a	Proposed Crossing Method	Jurisdictional Status	Approximate Crossing Length (feet)	Temporary Impacts (acres)	10-foot Corridor Operational Impacts (acres) ^b	30 foot Corridor Operational Impacts (acres) ^c	
Pipeline Facilities									
Wharton County									
WP1WH022	1.34	PEM	Open-cut	\$ 404	495	1.1	0.0	0.0	
WP1WH010	1.52	PEM	Workspace Only	\$ 404	0 ^d	0.1	0.0	0.0	
WP1WH011	1.72	PEM	Open-cut	\$ 404	5	<0.1	0.0	0.0	
WP1WH012	1.97	PEM	Workspace Only	\$ 404	0 ^d	0.1	0.0	0.0	
WP1WH013	2.65	PEM	Open-cut	\$ 404	242	0.5	0.0	0.0	
WP1WH015	3.02	PEM	Open-cut	\$ 404	38	<0.1	0.0	0.0	
WP1WH089	3.94	PFO	Workspace Only	\$ 404	0 ^d	<0.1	0.0	0.0	
WP1WH089	3.94	PFO	Open-cut	\$ 404	228	0.2	0.1	0.2	
WP1WH023	10.68	PEM	Workspace Only	\$ 404	0 ^d	<0.1	0.0	0.0	
WP1WH021	13.52	PFO	Open-cut	\$ 404	69	0.1	<0.1	<0.1	
WP1WH024	21.29	PEM	Open-cut	\$ 404	21	0.1	0.0	0.0	
WP1WH025	21.47	PFO	Open-cut	\$ 404	370	0.3	0.1	0.2	
WP1WH027	21.70	PFO	Open-cut	\$ 404	207	0.2	0.1	0.1	
WP1WH027	21.70	PFO	Workspace Only	\$ 404	0 ^d	0.1	<0.1	<0.1	
WP1WH028	21.90	PFO	Open-cut	\$ 404	75	0.1	<0.1	0.1	
WP1WH103	27.17	PFO	HDD	\$ 404	104	0.0	0.0	0.0	
WP1WH104	27.37	PFO	HDD	\$ 404	226	0.0	0.0	0.0	

Wetland Resources Crossed or Otherwise Impacted by the Coastal Bend Header Project									
Feature ID	Approximate Milepost	Wetland Type ^a	Proposed Crossing Method	Jurisdictional Status	Approximate Crossing Length (feet)	Temporary Impacts (acres)	10-foot Corridor Operational Impacts (acres) ^b	30 foot Corridor Operational Impacts (acres) ^c	
WP1WH105	27.46	PSS	HDD	\$ 404	228	0.0	0.0	0.0	
WP1WH101	27.62	PEM	Open-cut	\$ 404	19	<0.1	0.0	0.0	
WP1WH100	27.73	PEM	Open-cut	\$ 404	13	0.1	0.0	0.0	
Wharton County Totals					2,340	3.0	0.3	0.6	
Brazoria County									
WP1BR106	28.23	PEM	Open-cut	\$ 404	26	0.1	0.0	0.0	
WP1BR107	29.14	PEM	Open-cut	\$ 404	157	0.3	0.0	0.0	
WP1BR108	30.21	PFO	Workspace Only	\$ 404	0 ^d	<0.1	0.0	<0.1	
WP1BR072	31.42	PEM	Workspace Only	\$ 404	0 ^d	<0.1	0.0	0.0	
WP1BR094_PFO	32.53	PFO	Open-cut	\$ 404	592	0.6	0.1	0.4	
WP1BR094_PEM	32.64	PEM	Open-cut	\$ 404	21	0.1	0.0	0.0	
WP1BR109_PFO	33.47	PFO	Open-cut	\$ 404	316	0.4	0.1	0.2	
WP1BR109_PEM	33.53	PEM	Open-cut	\$ 404	60	0.1	0.0	0.0	
WP1BR109_PFO_B	33.54	PFO	Open-cut	\$ 404	177	0.2	<0.1	0.1	
WP1BR109_PEM	33.58	PEM	Open-cut	\$ 404	45	0.1	0.0	0.0	
WP1BR109_PFO_C	33.58	PFO	Open-cut	\$ 404	317	0.3	0.1	0.2	
WP1BR110_PEM	33.80	PEM	Workspace Only	\$ 404	0 ^d	<0.1	0.0	0.0	
WP1BR111	33.97	PFO	Open-cut	\$ 404	237	0.3	0.1	0.2	
WP1BR111	34.03	PFO	Workspace Only	\$ 404	0 ^d	<0.1	0.0	0.0	
WP1BR112	34.17	PFO	Workspace Only	\$ 404	0 ^d	<0.1	0.0	0.0	

Wetland Resources Crossed or Otherwise Impacted by the Coastal Bend Header Project									
Feature ID	Approximate Milepost	Wetland Type ^a	Proposed Crossing Method	Jurisdictional Status	Approximate Crossing Length (feet)	Temporary Impacts (acres)	10-foot Corridor Operational Impacts (acres) ^b	30 foot Corridor Operational Impacts (acres) ^c	
WP1BR092	34.96	PEM	Workspace Only	\$ 404	0 ^d	<0.1	0.0	0.0	
WP1BR092	35.01	PEM	Open-cut	\$ 404	26	0.1	0.0	0.0	
WP1BR091	35.04	PEM	Open-cut	\$ 404	41	0.1	0.0	0.0	
WP1BR091	35.10	PEM	Open-cut	\$ 404	389	0.6	0.0	0.0	
WP1BR090	35.42	PEM	Open-cut	\$ 404	176	0.3	0.0	0.0	
WP1BR073	39.31	PFO	Open-cut	\$ 404	690	0.7	0.2	0.5	
WP1BR075	39.70	PFO	Open-cut	\$ 404	1,393	1.3	0.3	0.9	
WP1BR002_PFO	44.11	PFO	Workspace Only	\$ 404	0 ^d	<0.1	0.0	0.0	
WP1BR002_PSS	44.16	PSS	Workspace Only	\$ 404	0 ^d	<0.1	0.0	0.0	
WP2BR002_PEM_B	44.25	PEM	Open-cut	\$ 404	179	0.3	0.0	0.0	
WP2BR002_PFO	44.40	PFO	Workspace Only	\$ 404	0 ^d	0.1	0.0	0.0	
WP2BR002_PEM	44.41	PEM	Open-cut	\$ 404	291	0.4	0.0	0.0	
WP2BR001_PEM	44.47	PEM	Open-cut	\$ 404	706	0.9	0.0	0.0	
WP2BR001_PFO_B	44.47	PFO	Open-cut	\$ 404	33	0.2	<0.1	<0.1	
WP2BR001_PFO	44.56	PFO	Workspace Only	\$ 404	0 ^d	0.1	0.0	0.0	
WP1BR039	45.28	PEM	Open-cut	\$ 404	33	0.1	0.0	0.0	
WP1BR039	45.31	PEM	Open-cut	\$ 404	30	0.1	0.0	0.0	
WP1BR041	46.63	PEM	Open-cut	\$ 404	17	0.1	0.0	0.0	
WP1BR043	47.21	PEM	Workspace Only	\$ 404	0 ^d	0.2	0.0	0.0	

Wetland Resources Crossed or Otherwise Impacted by the Coastal Bend Header Project									
Feature ID	Approximate Milepost	Wetland Type ^a	Proposed Crossing Method	Jurisdictional Status	Approximate Crossing Length (feet)	Temporary Impacts (acres)	10-foot Corridor Operational Impacts (acres) ^b	30 foot Corridor Operational Impacts (acres) ^c	
WP1BR078	47.91	PFO	Workspace Only	\$ 404	0 ^d	<0.1	0.0	0.0	
WP1BR079	48.28	PFO	Workspace Only	\$ 404	0 ^d	0.1	0.0	0.0	
WP1BR079	48.56	PFO	Open-cut	\$ 404	291	0.3	0.1	0.2	
WP1BR080	49.29	PEM	Open-cut	\$ 404	74	0.1	0.0	0.0	
WP1BR066_PEM	49.38	PEM	Open-cut	\$ 404	41	0.1	0.0	0.0	
WP1BR065_PEM	49.39	PEM	Open-cut	\$ 404	34	<0.1	0.0	0.0	
WP1BR081	49.46	PEM	Workspace Only	\$ 404	0 ^d	<0.1	0.0	0.0	
WP1BR081	49.49	PEM	Open-cut	\$ 404	82	0.1	0.0	0.0	
WP1BR082	49.58	PEM	Open-cut	\$ 404	170	0.3	0.0	0.0	
WP1BR004_PSS	50.49	PSS	Open-cut	\$ 404	52	0.1	<0.1	<0.1	
WP1BR031	50.76	PEM	Workspace Only	\$ 404	0 ^d	<0.1	0.0	0.0	
WP1BR083_PFO	53.31	PFO	Open-cut	\$ 404	23	0.1	<0.1	<0.1	
WP1BR083_PEM	53.31	PEM	Open-cut	\$ 404	24	0.1	0.0	0.0	
WP1BR008	55.10	PFO	Workspace Only	\$ 404	0 ^d	0.3	0.0	<0.1	
WP1BR032	56.50	PSS	Open-cut	\$ 404	43	0.1	<0.1	<0.1	
WP1BR117	57.26	PEM	Open-cut	\$ 404	75	<0.1	0.0	0.0	
WP1BR009	59.69	PEM	Open-cut	\$ 404	139	0.2	0.0	0.0	
WP1BR113	60.39	PEM	Open-cut	\$ 404	46	0.1	0.0	0.0	
WP1BR035	60.89	PFO	Workspace Only	\$ 404	0 ^d	0.1	0.0	<0.1	
WP1BR036	61.33	PEM	Open-cut	\$ 404	34	<0.1	0.0	0.00	

Wetland Resources Crossed or Otherwise Impacted by the Coastal Bend Header Project									
Feature ID	Approximate Milepost	Wetland Type ^a	Proposed Crossing Method	Jurisdictional Status	Approximate Crossing Length (feet)	Temporary Impacts (acres)	10-foot Corridor Operational Impacts (acres) ^b	30 foot Corridor Operational Impacts (acres) ^c	
WP1BR037_PEM	61.62	PEM	Open-cut	\$ 404	156	0.2	0.0	0.0	
WP1BR037_PFO	61.64	PFO	Open-cut	\$ 404	39	0.1	<0.1	<0.1	
WP1BR038_PEM_B	61.74	PEM	Open-cut	\$ 404	618	1.2	0.0	0.0	
WP1BR038_PFO_B	61.78	PFO	Open-cut	\$ 404	836	0.8	0.2	0.6	
WP1BR059	62.56	PEM	Open-cut	\$ 404	504	1.1	0.0	0.0	
WP1BR057_PEM	62.72	PEM	Open-cut	\$ 404	52	0.3	0.0	0.0	
WP1BR057_PFO	62.72	PFO	Open-cut	\$ 404	1,183	1.1	0.3	0.8	
WP1BR058	63.06	PFO	Open-cut	\$ 404	820	0.7	0.2	0.6	
WP2BR008	63.75	PEM	Open-cut	\$ 404	151	0.1	0.0	0.0	
WP2BR005	64.25	PEM	Open-cut	\$ 404	231	0.4	0.0	0.0	
WP2BR006	64.80	PEM	Open-cut	\$ 404	24	<0.1	0.0	0.0	
WP4BR035_DT	65.53	PEM	Workspace Only	\$ 404	0 ^d	0.4	0.0	0.0	
				Brazoria County Totals	11,694	16.6	1.7	4.7	
				Pipeline Facilities Totals	14,034	19.6	2.0	5.3	
Aboveground Facilities									
36-inch Header Pipeline									
There are no wetlands located within the Project footprint of the aboveground facilities located along the 36-inch header pipeline.									
Legacy System Facilities									
Brazos Compressor Station									
WP1FB086	N/A	PEM	Workspace Only	\$ 404	N/A	0.1	0.0	0.0	

Wetland Resources Crossed or Otherwise Impacted by the Coastal Bend Header Project									
Feature ID	Approximate Milepost	Wetland Type ^a	Proposed Crossing Method	Jurisdictional Status	Approximate Crossing Length (feet)	Temporary Impacts (acres)	10-foot Corridor Operational Impacts (acres) ^b	30 foot Corridor Operational Impacts (acres) ^c	
WP2FB003	N/A	PEM	Workspace Only	\$ 404	N/A	0.2	0.0	0.0	
Brazos Compressor Station Totals									
North Houston Compressor Station									
WP3HA006	N/A	PEM	Workspace Only	\$ 404	N/A	0.2	0.0	0.0	
WP3HA008	N/A	PEM	Workspace Only	\$ 404	N/A	0.4	0.0	0.0	
WP3HA009	N/A	PEM	Workspace Only	\$ 404	N/A	0.2	0.0	0.0	
North Houston Compressor Station Totals									
Aboveground Facilities Totals									
Access Roads									
Brazoria County									
WP1BR099	AR-T-31	PEM	N/A	\$ 404	N/A	<0.1	0.0	0.0	
WP1BR066_PEM	AR-P-42	PEM	N/A	\$ 404	N/A	<0.1	0.0	0.0	
Brazoria County Totals									
Access Roads Totals									
					14,034	20.7	2.0	5.3	
					Project Totals				

Wetland Resources Crossed or Otherwise Impacted by the Coastal Bend Header Project								
Feature ID	Approximate Milepost	Wetland Type ^a	Proposed Crossing Method	Jurisdictional Status	Approximate Crossing Length (feet)	Temporary Impacts (acres)	10-foot Corridor Operational Impacts (acres) ^b	30 foot Corridor Operational Impacts (acres) ^c
<p><i>The numbers in this table have been rounded for presentation purposes. As a result, the totals may not reflect the sum of the addends.</i></p> <p>Note: Wetland data is based on field delineations conducted to date. For a summary of areas not surveyed, see Table 2.0-1. Features documented during desktop (DT) analysis are notated with a DT at the end of the feature name. The values in this table have been rounded for presentation purposes.</p> <p>HDD = Horizontal Directional Drill N/A = Not Applicable</p> <p>^a Cowardin Wetland Types: PEM - palustrine emergent; PSS - palustrine scrub-shrub; PFO - palustrine forested</p> <p>^b There will be no operation impacts on PEM wetlands as these wetlands will revert back to the same type following construction. Operation impacts in this column are based on a 10-foot-wide area in PFO and PSS wetlands that will be converted to other wetland types due to pipeline maintenance.</p> <p>^c There will be no operation impacts on PEM wetlands as these wetlands will revert back to the same type following construction. Operation impacts in this column are based on a 10-foot-wide operation impact on PSS wetlands that will be converted to herbaceous wetlands due to pipeline maintenance. Operation impacts on forested wetlands in this column reflect potential for selective thinning of trees within 15 feet of the pipeline that have roots that could compromise the integrity of the pipeline coating.</p> <p>^d Wetland is not crossed by proposed centerline, but is located within the Project workspace.</p>								

National Wetland Inventory Maps

COASTAL BEND HEADER PROJECT



COUNTY: Wharton
 STATE: TEXAS
 PROJECTION: TX SCORPLUSFT
 REGION: S, NW
 CHECKED BY:

GULF SOUTH PIPELINE COMPANY, LP
 COASTAL BEND HEADER PROJECT

WHARTON AND BRAZORIA COUNTIES, TEXAS



Legend

- 10th Milepost
- Milepost
- Coastal Bend Header Route
- ▨ NWI Wetlands

COASTAL BEND HEADER PROJECT

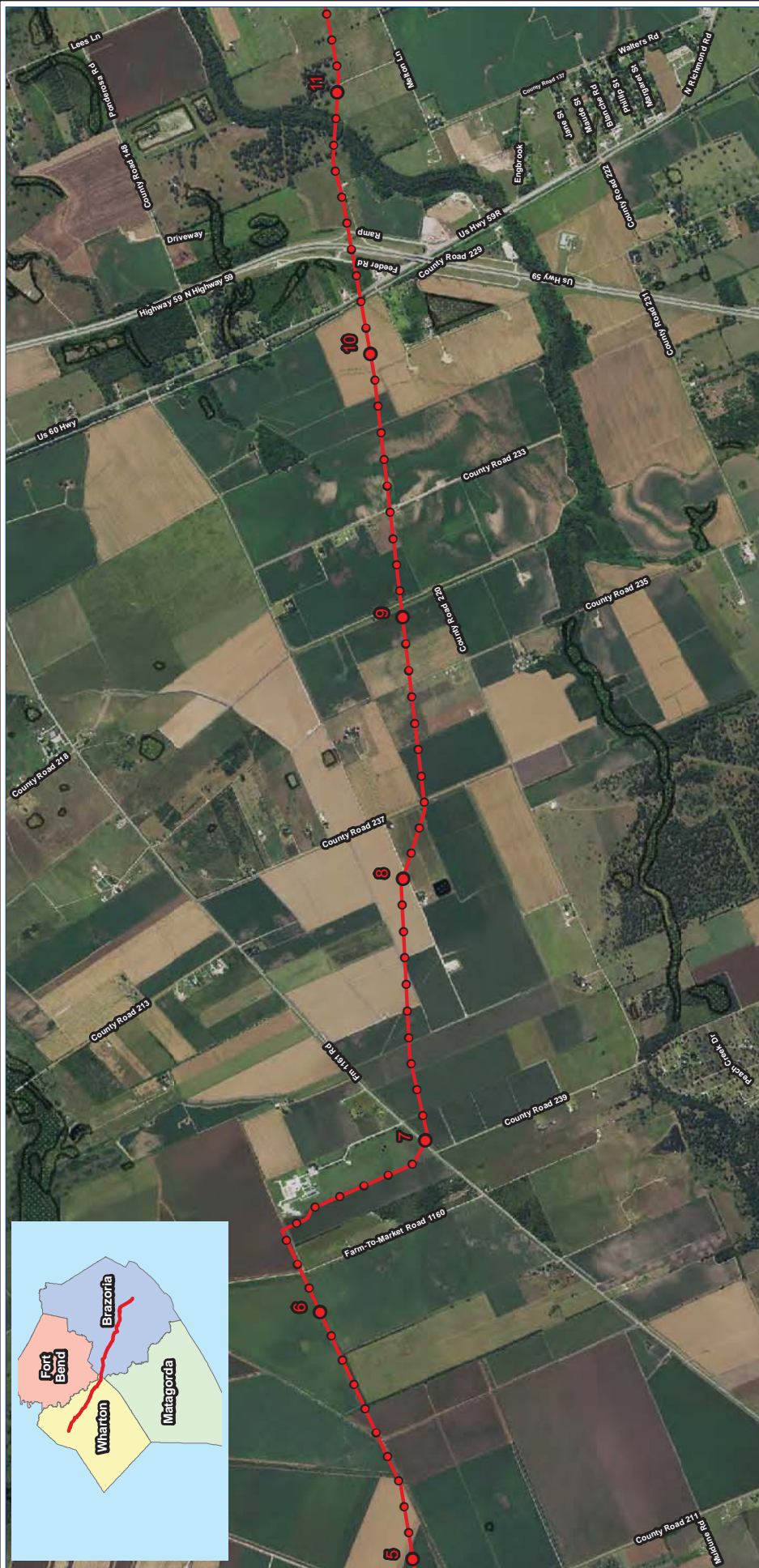

DATE: 01/09/15 SHEET: 2



COUNTY: Wharton
 STATE: TEXAS
 PROJECTION: TX SCWRL/USFT
 REGION: MW
 CHECKED BY:

GULF SOUTH PIPELINE COMPANY, LP
 COASTAL BEND HEADER PROJECT

WHARTON AND BRAZORIA COUNTIES, TEXAS

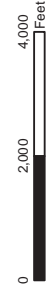

Legend

- 10th Milepost
- Milepost
- Coastal Bend Header Route
- ▨ NWI Wetlands

COASTAL BEND HEADER PROJECT



GULF SOUTH PIPELINE
A DIVISION OF BRIDGE & BURNETT PARTNERS, LP

WILLBROS
A DIVISION OF BRIDGE & BURNETT PARTNERS, LP

Legend

- 10th Milepost
- Milepost
- Coastal Bend Header Route
- ▨ NWI Wetlands

COUNTY: Wharton
STATE: TEXAS
PROJECTION: TX SCWTR-LUSFT
REVISION: 01/29/16
CHECKED BY:

**GULF SOUTH PIPELINE COMPANY, LP
COASTAL BEND HEADER PROJECT**

WHARTON AND BRAZORIA COUNTIES, TEXAS

DATE: 01/29/15 SHEET: 3

COASTAL BEND HEADER PROJECT



DATE: 6/10/2015 SHEET: 4



COUNTY: Wharton
 STATE: TEXAS
 PROJECTION: TX SCNTRLSUFT
 REGION: MW
 CHECKED BY:

GULF SOUTH PIPELINE COMPANY, LP
 COASTAL BEND HEADER PROJECT

WHARTON AND BRAZORIA COUNTIES, TEXAS



Legend

- 10th Milepost
- Milepost
- Coastal Bend Header Route
- ▨ NWI Wetlands

COASTAL BEND HEADER PROJECT



DATE: 6/10/2015 SHEET: 5



COUNTY: Wharton
 STATE: TEXAS
 PROJECTION: TX SNTWRLUSFT
 REGION: MW
 CHECKED BY:

GULF SOUTH PIPELINE COMPANY, LP
 COASTAL BEND HEADER PROJECT

WHARTON AND BRAZORIA COUNTIES, TEXAS



Legend

- 10th Milepost
- Milepost
- Coastal Bend Header Route
- ▨ NWI Wetlands

COASTAL BEND HEADER PROJECT

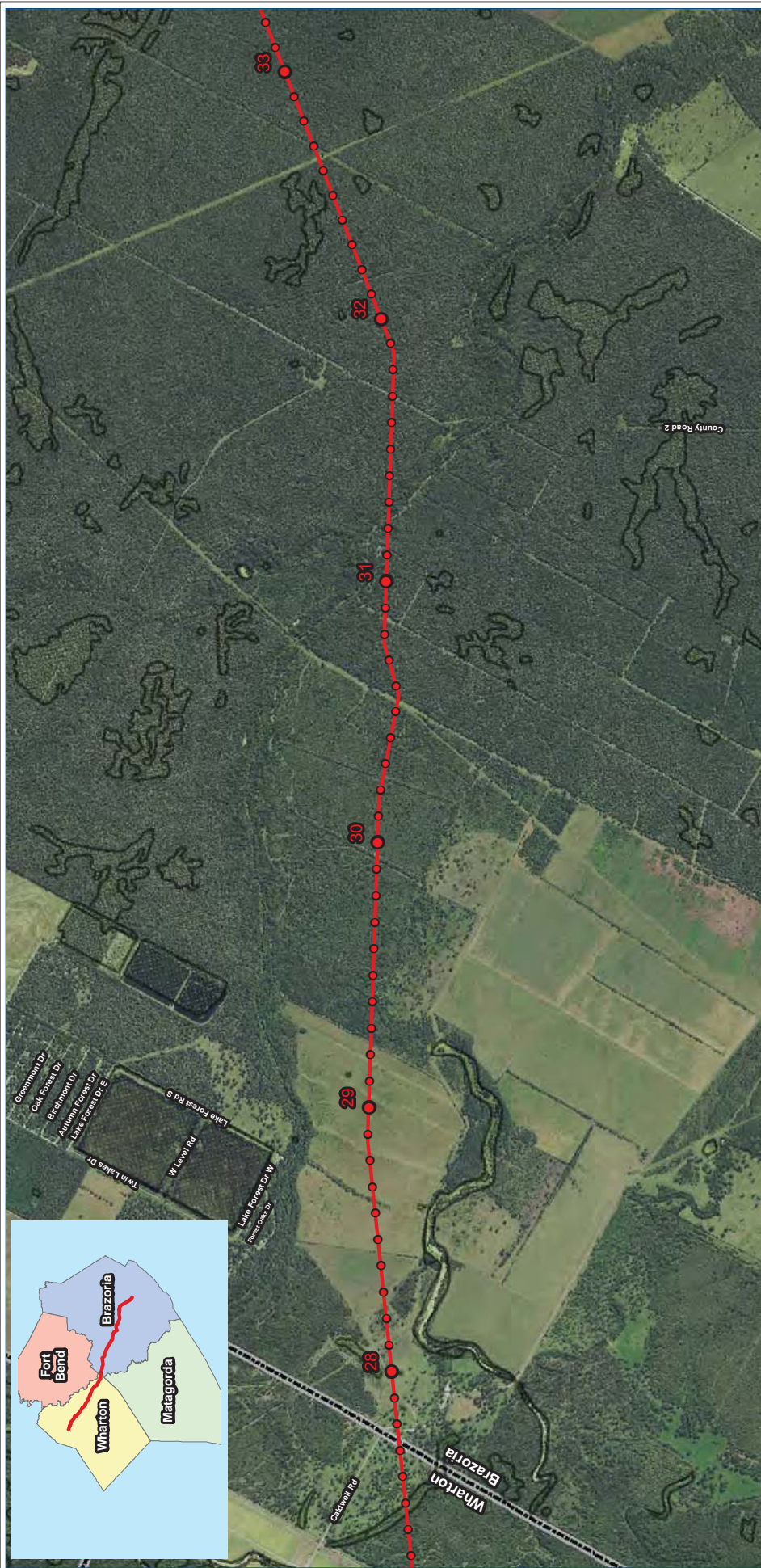

GULF SOUTH PIPELINE
A DIVISION OF PUBLIC SERVICE COMPANY OF TEXAS

WILLEROS
AN ENERGY SERVICES COMPANY

DATE: 01/09/15 SHEET: 6

Legend

- 10th Milepost
- Milepost
- Coastal Bend Header Route
- ▨ NWI Wetlands

**GULF SOUTH PIPELINE COMPANY, LP
 COASTAL BEND HEADER PROJECT**

WHARTON AND BRAZORIA COUNTIES, TEXAS

0 2,000 4,000 Feet

COUNTY: Wharton
 STATE: TEXAS
 PROJECTION: TX SCNTRALUST
 REGION: 8, NW
 CHECKED BY:

Legend

- 10th Milepost
- Milepost
- Coastal Bend Header Route
- ▨ NWI Wetlands

COASTAL BEND HEADER PROJECT







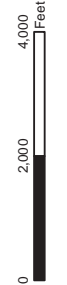

 COUNTY: Brazoria
 STATE: TEXAS
 PROJECTION: TX SNTWRL-USTF
 REGION: MW
 CHECKED BY:

GULF SOUTH PIPELINE COMPANY, LP
COASTAL BEND HEADER PROJECT
WHARTON AND BRAZORIA COUNTIES, TEXAS



Legend

-  10th Milepost
-  Milepost
-  Coastal Bend Header Route
-  NWI Wetlands

COASTAL BEND HEADER PROJECT



GULF SOUTH
PIPELINE
A Division of Baker Hughes Services

WILLBROS
A Division of Baker Hughes Services

COUNTY: Brazoria
STATE: TEXAS
PROJECTION: TX SCVTRLSJST
REVISION: MW
CHECKED BY:

DATE: 6/10/2015 SHEET: 8

**GULF SOUTH PIPELINE COMPANY, LP
COASTAL BEND HEADER PROJECT**

WHARTON AND BRAZORIA COUNTIES, TEXAS

0 2,000 4,000 Feet

Legend

- 10th Milepost
- Milepost
- Coastal Bend Header Route
- ▨ NWI Wetlands

COASTAL BEND HEADER PROJECT



GULF SOUTH PIPELINE
A DIVISION OF BAKER Hughes Services

WILLEROS
AN IRVING-CLOUD COMPANY

DATE: 6/10/2015 SHEET: 9

Country: Brazoria
 State: Texas
 Projection: TX SCVTRJUSFT
 Revision: 01 MW
 Checked By:

**GULF SOUTH PIPELINE COMPANY, LP
 COASTAL BEND HEADER PROJECT**

WHARTON AND BRAZORIA COUNTIES, TEXAS

0 2,000 4,000 Feet

Legend

- 10th Milepost
- Milepost
- Coastal Bend Header Route
- ▨ NWI Wetlands

COASTAL BEND HEADER PROJECT



GULF SOUTH PIPELINE COMPANY, LP
 COASTAL BEND HEADER PROJECT
 WHARTON AND BRAZORIA COUNTIES, TEXAS

Legend

- 10th Milepost
- Milepost
- Coastal Bend Header Route
- ▨ NWI Wetlands

COASTAL BEND HEADER PROJECT



COUNTY: Brazoria
 STATE: TEXAS
 PROJECTION: TX SCWRL-USTF
 REGION: 10, MW
 CHECKED BY:



WHARTON AND BRAZORIA COUNTIES, TEXAS
GULF SOUTH PIPELINE COMPANY, LP
COASTAL BEND HEADER PROJECT

DATE: 01/09/15 SHEET: 11

Legend

- 10th Milepost
- Milepost
- Coastal Bend Header Route
- NWI Wetlands

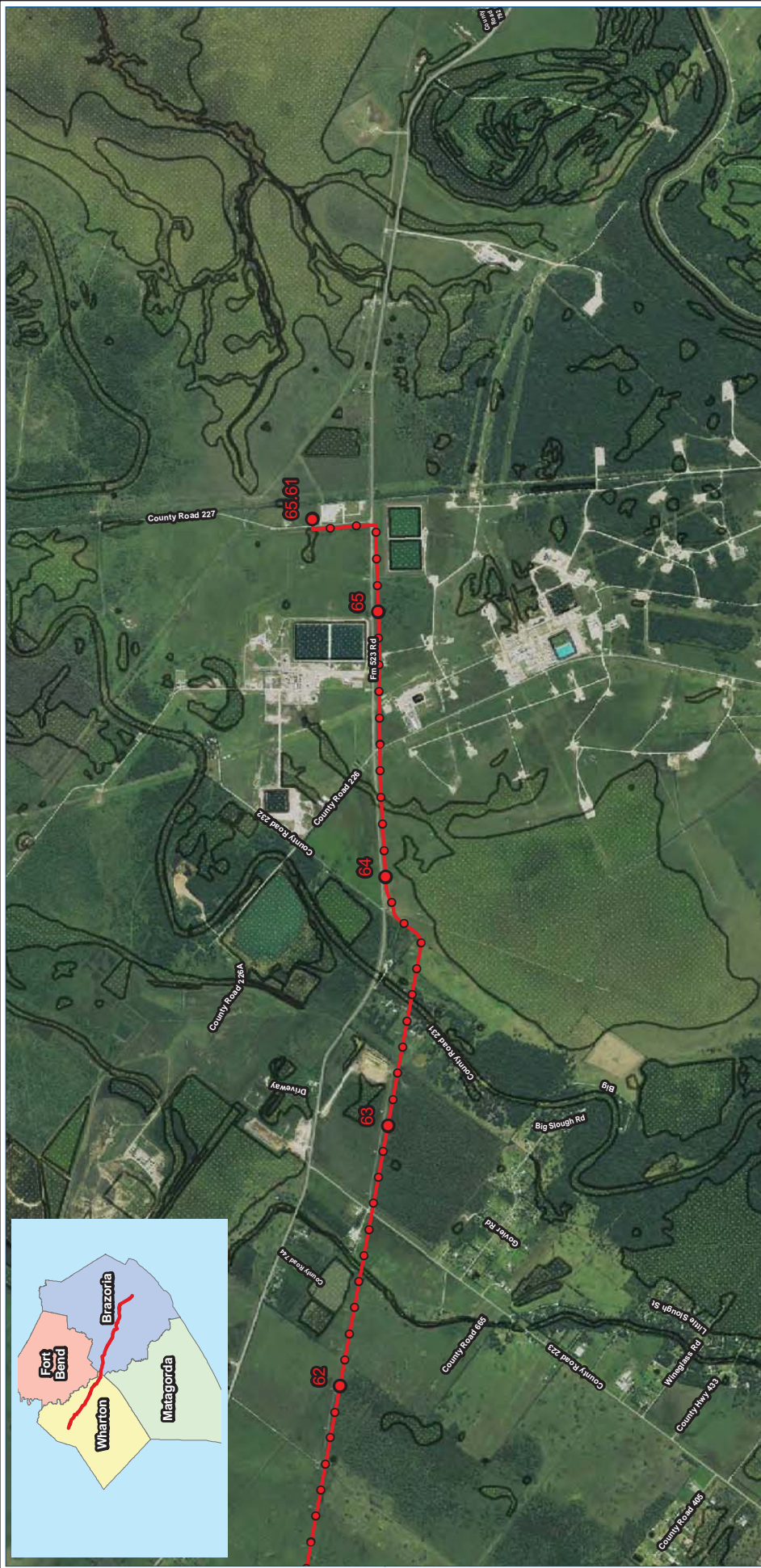
COASTAL BEND HEADER PROJECT

DATE: 6/10/2015 SHEET: 12





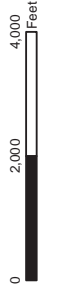

COUNTY: Brazoria
STATE: TEXAS
PROJECTION: TX STATEPLSUST
REGION: NAD 83
CHECKED BY:

**GULF SOUTH PIPELINE COMPANY, LP
COASTAL BEND HEADER PROJECT**

WHARTON AND BRAZORIA COUNTIES, TEXAS



Legend

-  10th Milepost
-  Milepost
-  Coastal Bend Header Route
-  NWI Wetlands

COASTAL BEND HEADER PROJECT - WILSON COMPRESSOR STATION

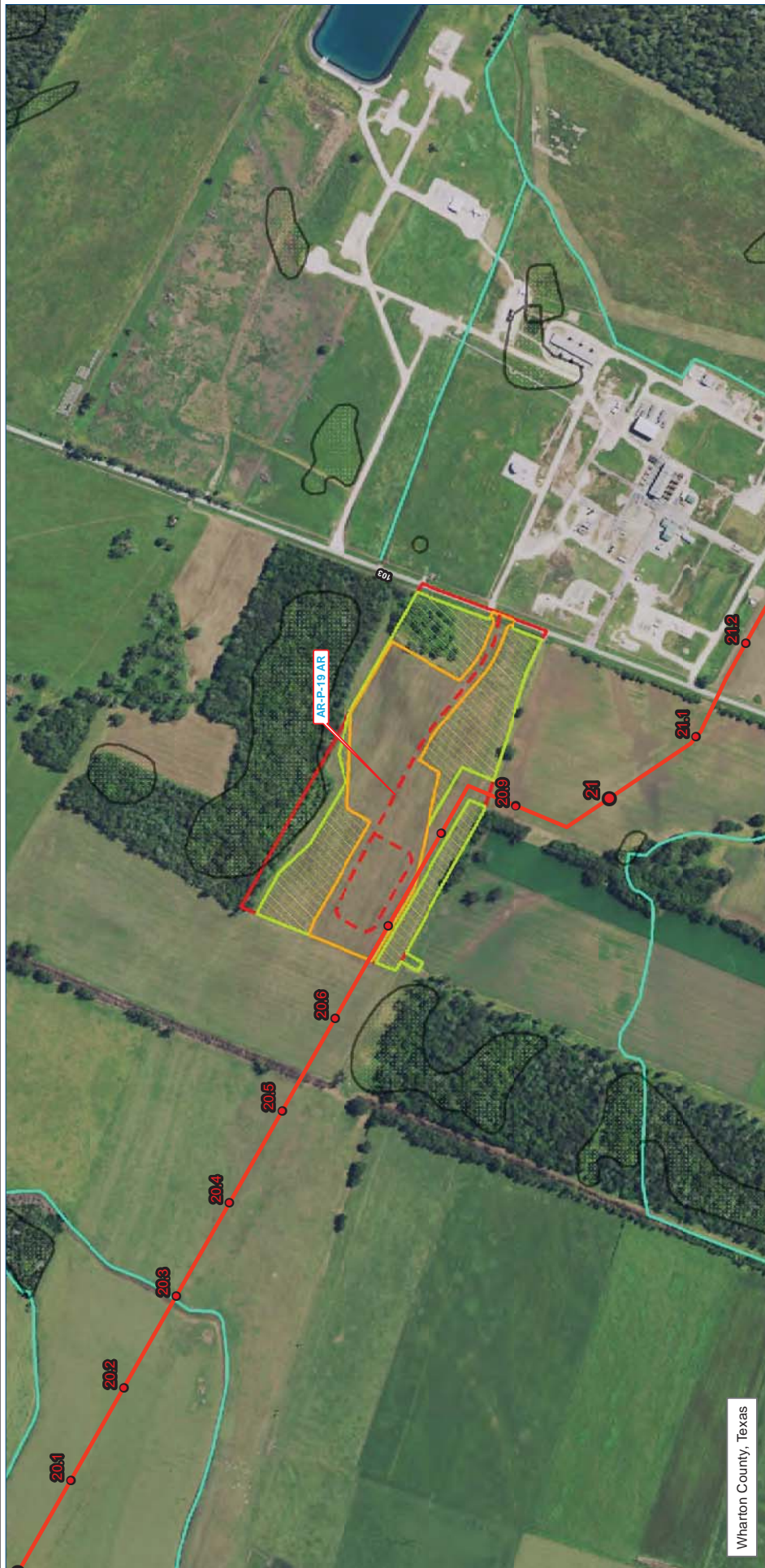

Wharton County, Texas



LEGEND

- 10th Milepost
- Milepost
- Coastal Bend Header Project Proposed Pipeline
- Permanent Workspace
- Temporary Workspace
- Proposed Site Property Boundary
- Access Roads
- NWI Wetlands
- NHD Flowline



Scale: 1" = 1000'	DATE: 07/2015	SHEET: 1
-------------------	---------------	----------

COASTAL BEND HEADER PROJECT - BRAZOS COMPRESSOR STATION



GULF SOUTH PIPELINE
A subsidiary of Bechtel Pipeline Services LP

Date: 6/7/2016
 SHEET: 1

LEGEND

- Milepost
- Existing Index 129 Pipeline
- Permanent Workspace
- Temporary Workspace
- Proposed Site Property Boundary
- - - Access Roads
- NHD Flowline
- ▨ NWI Wetlands



Fort Bend County, Texas

COASTAL BEND HEADER PROJECT - NORTH HOUSTON COMPRESSOR STATION

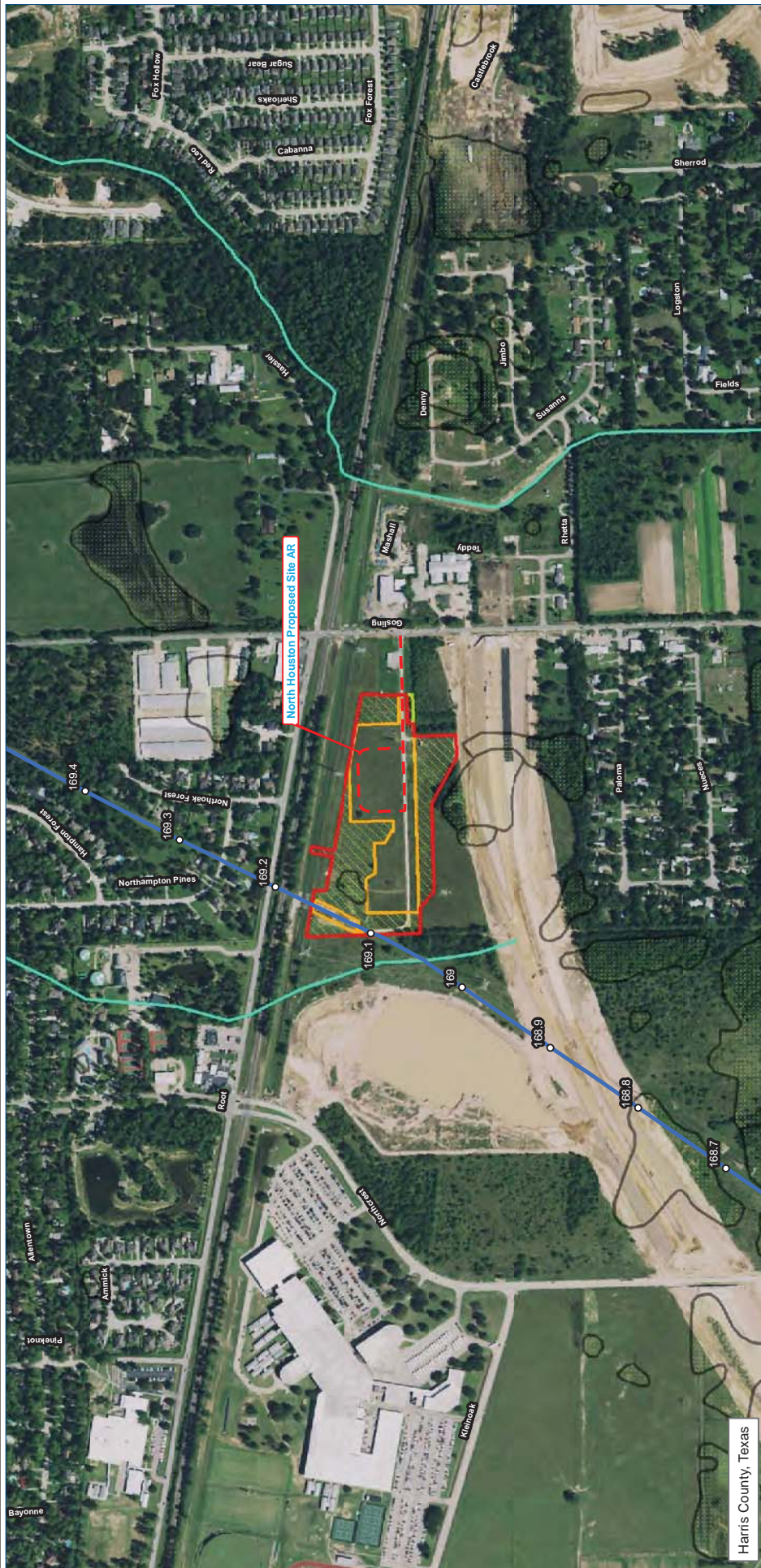

LEGEND

- Milepost
- Existing Index 129 Pipeline
- Permanent Workspace
- Temporary Workspace
- Reduced Proposed Site Property Boundary
- Access Roads
- NWI Wetlands
- NHD Flowline



Date: 08/20/15
SHEET: 1

COASTAL BEND HEADER PROJECT - GOODRICH COMPRESSOR STATION

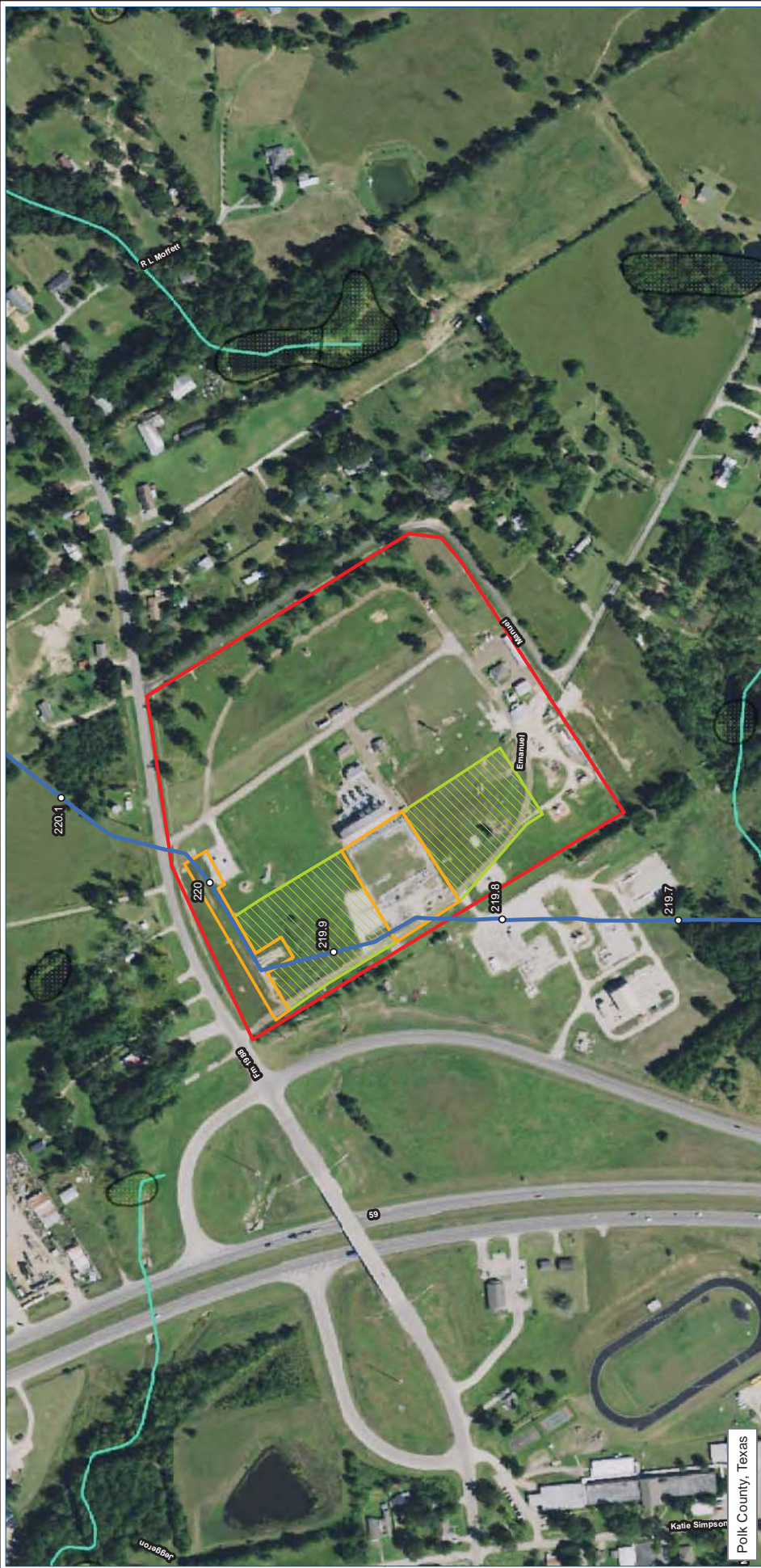

LEGEND

- Milepost
- Existing 129 Pipeline
- Permanent Workspace
- ▨ Temporary Workspace
- Existing Site Property Boundary
- - - Access Roads
- ▨ NWI Wetlands
- NHD Flowline



GULF SOUTH PIPELINE
A subsidiary of Flowback Pipeline Services, LP

Date: 07/20/15 SHEET: 1

COASTAL BEND HEADER PROJECT - MAGASCO COMPRESSOR STATION

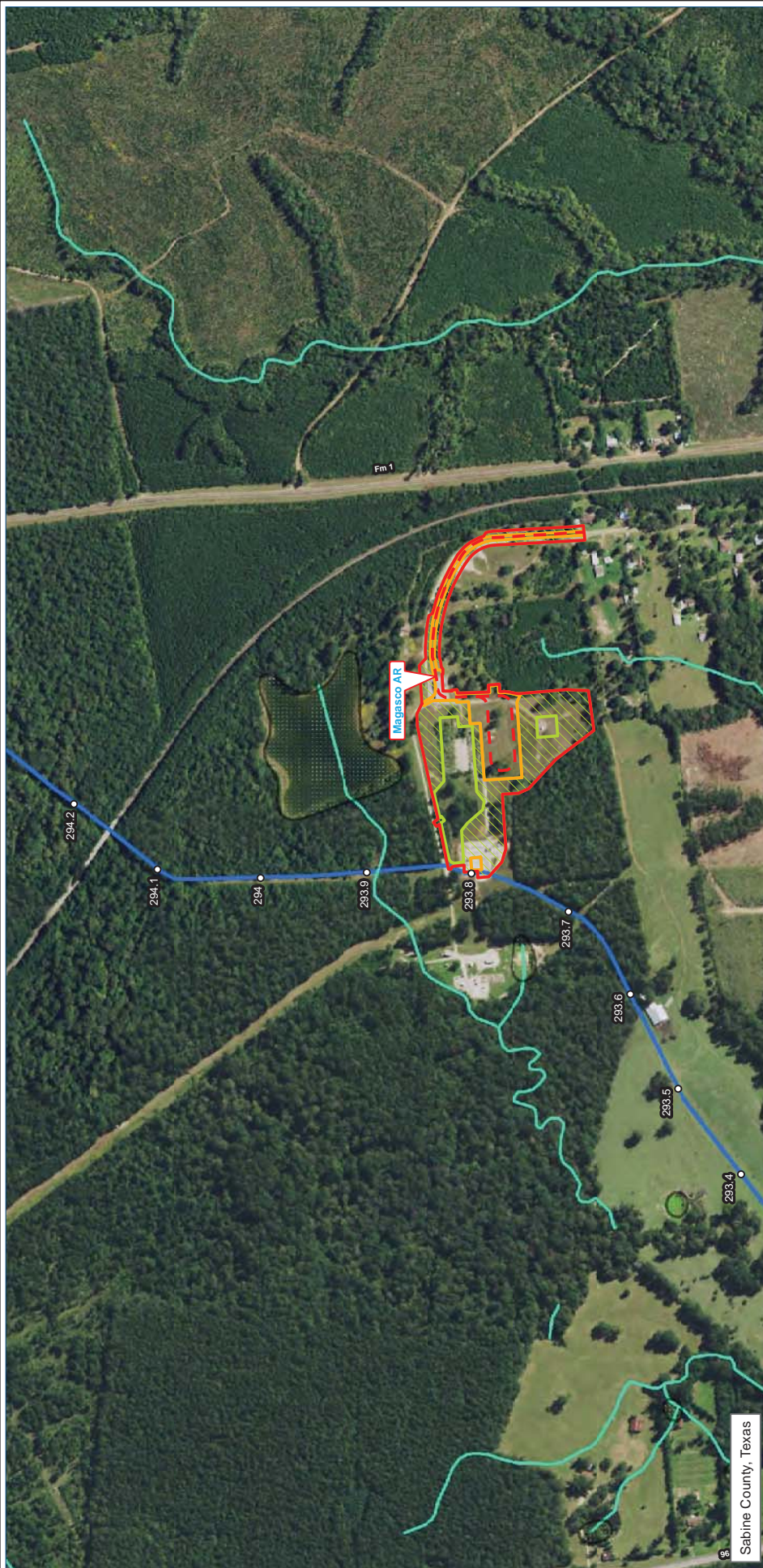

LEGEND

- MP
- Permanent Workspace
- ▨ Temporary Workspace
- Reduced Site Property Boundary
- Existing 129 Pipeline
- - - Access Roads
- ▨ NWI Wetlands
- NHD Flowline

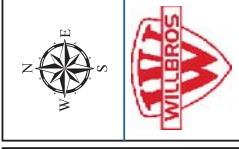

GULF SOUTH PIPELINE
A subsidiary of Fluor Daniel Pipeline Services LP

Date: 07/20/15

SHEET: 1

COASTAL BEND HEADER PROJECT - CONTRACTOR/PIPE YARD

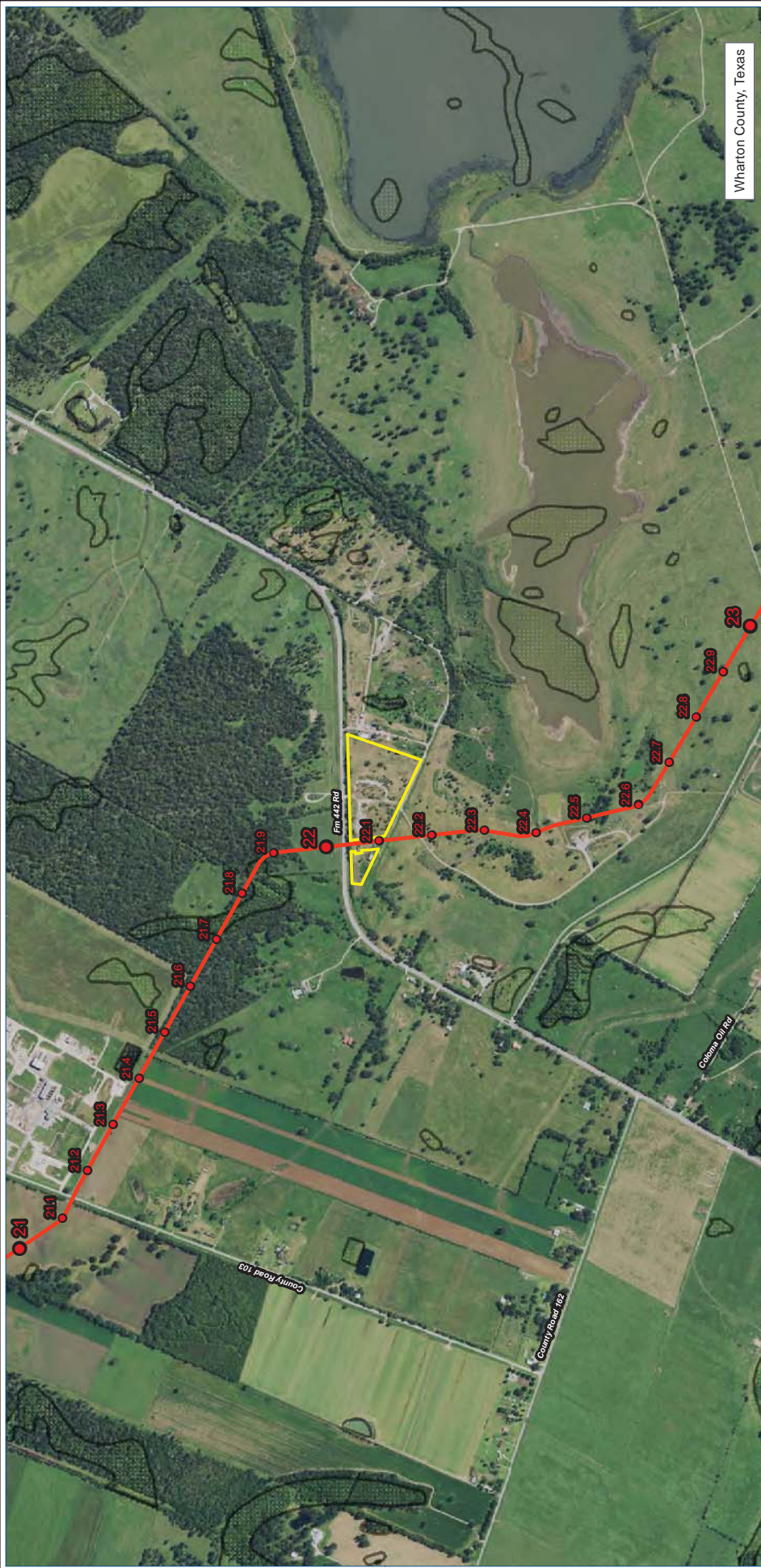

LEGEND

- 10th Milepost
- Milepost
- Proposed Coastal Bend Header Route
- ▭ Contractor/Pipe Yard 1
- ▨ NWI Wetlands

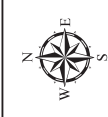

GULF SOUTH
PIPELINE
A subsidiary of Flowback Pipeline, Inc. LP

Date: 02/22/16
SHEET: 1

Wharton County, Texas

COASTAL BEND HEADER PROJECT - CONTRACTOR/PIPE YARD

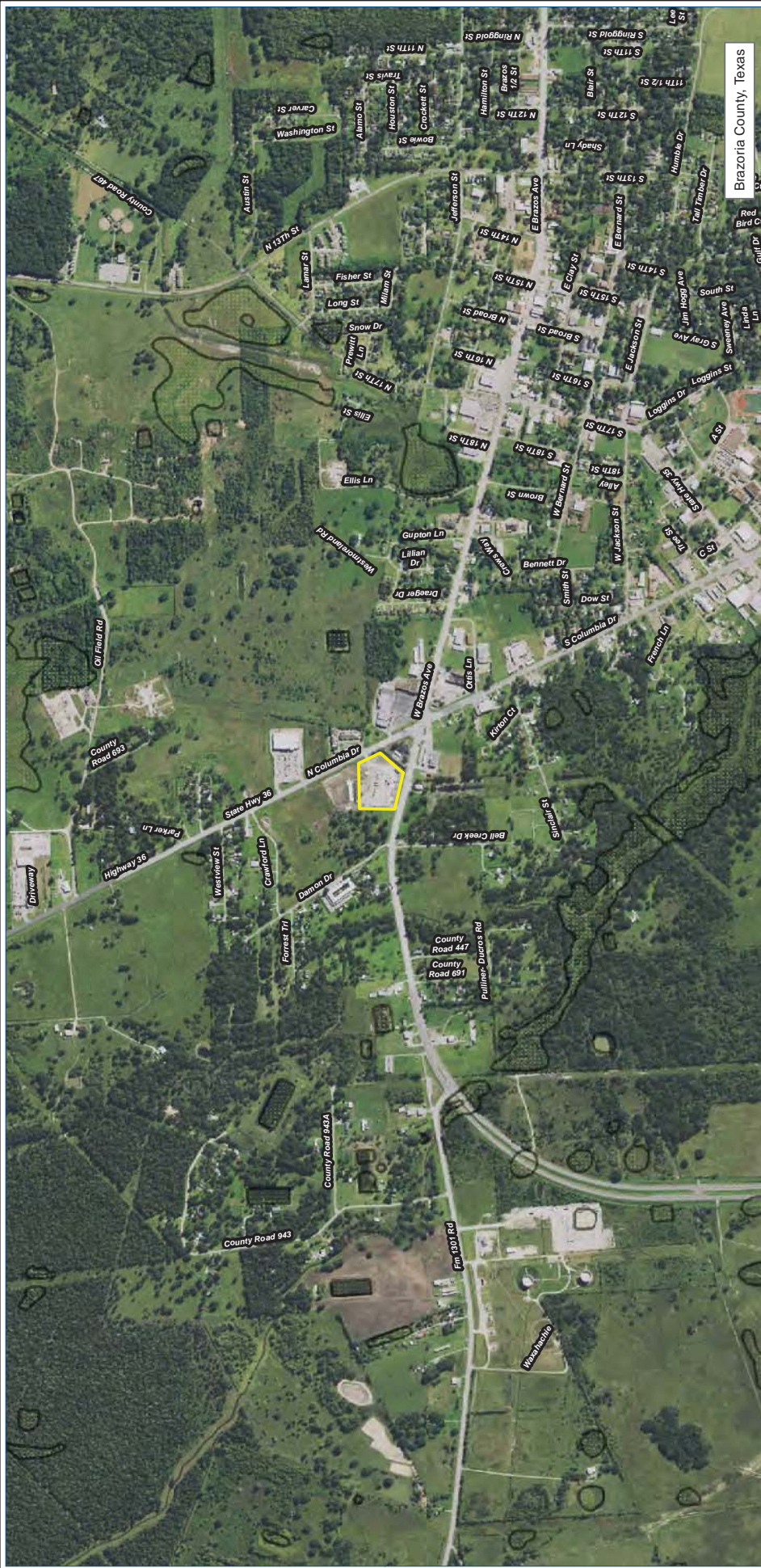

- LEGEND
- 10th Milepost
 - Milepost
 - Proposed Coastal Bend Header Route
 - Contractor/Pipe Yard 2
 - ▨ NWI Wetlands

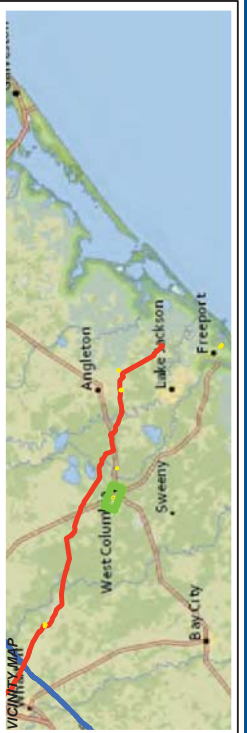

Date: 8/27/2015
SHEET: 1

COASTAL BEND HEADER PROJECT - CONTRACTOR/PIPE YARD



Brazoria County, Texas

GULF SOUTH®
PIPELINE
A Subsidiary of Blackhawk Pipeline Partners, LP

Date: 8/1/2015

SHEET: 1

WILLBROS

LEGEND

- 10th Milepost
- Milepost
- Proposed Coastal Bend Header Route
- Contractor/Pipe Yard 3
- NWI Wetlands



COASTAL BEND HEADER PROJECT - CONTRACTOR/PIPE YARD



GULF SOUTH
PIPELINE
An Authority of Freshwater Aquifers, L.P.

Date: 02/27/2016
SHEET: 1

LEGEND

- 10th Milepost
- Milepost
- Proposed Coastal Bend Header Route
- ▭ Contractor/Pipe Yard 4
- ▨ NWI Wetlands



COASTAL BEND HEADER PROJECT - CONTRACTOR/PIPE YARD



Brazoria County, Texas

Date: 02/27/2016

SHEET: 1

LEGEND

- 10th Milepost
- Milepost
- Proposed Coastal Bend Header Route
- Contractor/Pipe Yard 5
- NWI Wetlands



COASTAL BEND HEADER PROJECT - CONTRACTOR/PIPE YARD

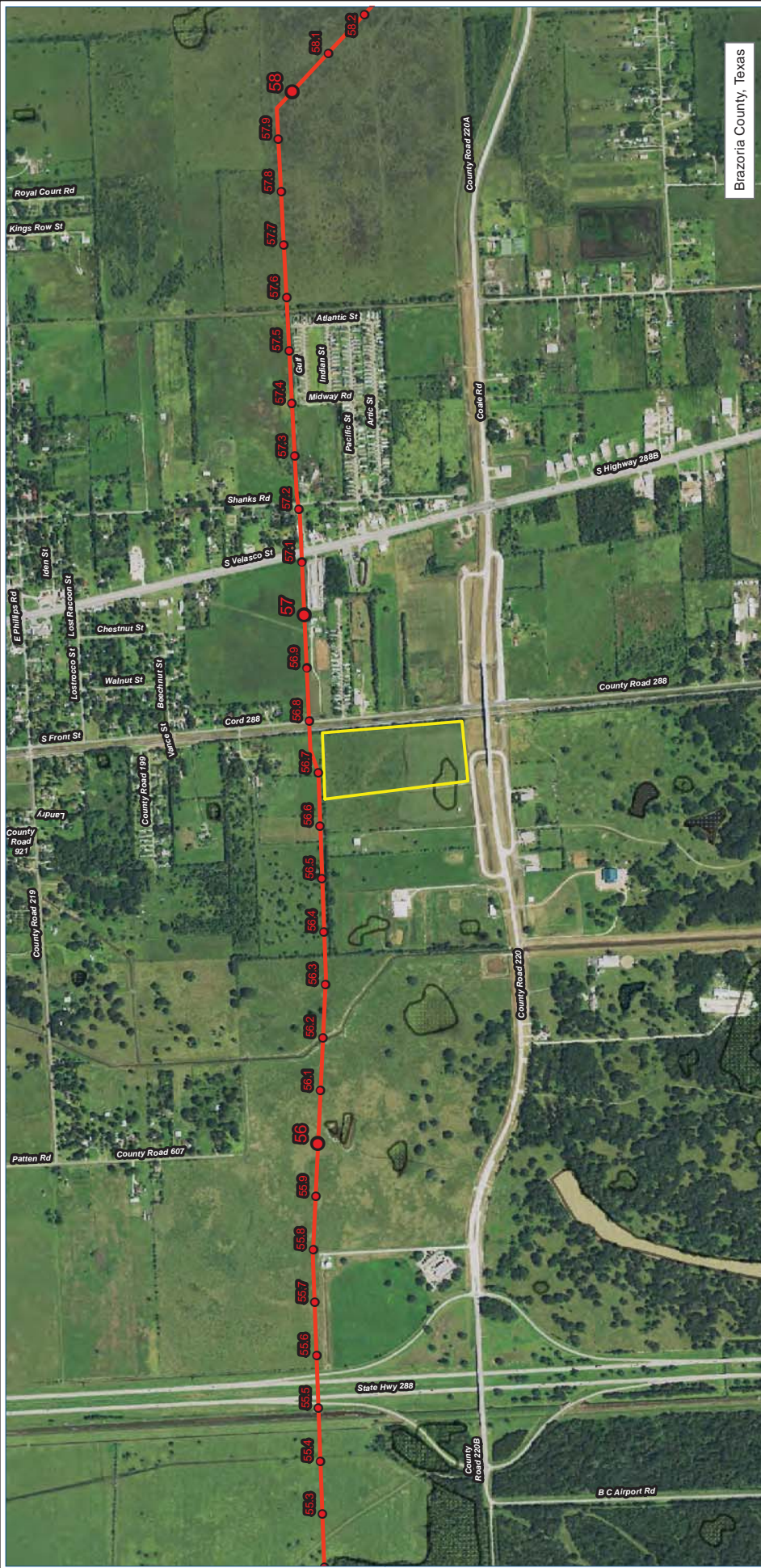

LEGEND

- 10th Milepost
- Milepost
- Proposed Coastal Bend Header Route
- ▭ Contractor/Pipe Yard 6
- ▨ NWI Wetlands



Brazoria County, Texas

APPENDIX J

EXOTIC AND INVASIVE SPECIES CONTROL PLAN



Gulf South Pipeline Company, LP

Exotic and Invasive Species Control Plan

Coastal Bend Header Project

June 2015

EXOTIC AND INVASIVE SPECIES CONTROL PLAN

Table 1 below lists the exotic and invasive species that have the potential to occur in the Coastal Bend Header Project (Project) area.

Common Name	Scientific Name	Growth Form	Typical Habitat
Alligatorweed	<i>Alternanthera philoxeroides</i>	Floating aquatic	Aquatic
Bermudagrass	<i>Cynodon dactylon</i>	Grass	Upland
Johnsongrass	<i>Sorghum halepense</i>	Grass	Upland
Chinese tallow tree	<i>Sapium sebiferum</i>	Tree	Upland to wet
Chinese privet	<i>Ligustrum sinense</i>	Shrub	Upland to mesic
Japanese honeysuckle	<i>Lonicera japonica</i>	Vine	Upland to mesic

The linear nature of the Project may provide exposed topsoil for potential recruitment of exotic and invasive species, and the potential exists for equipment to bring in hitchhikers to areas without infestations. In order to counteract this potential introduction, Gulf South Pipeline Company, LP (Gulf South) will implement control measures that will be used to minimize introduction and spread of exotic and invasive species including:

- Follow the Federal Energy Regulatory Commission *Upland Erosion Control, Revegetation, and Maintenance Plan* and *Wetland and Waterbody Construction and Mitigation Procedures* to assure that sediment movement and the associated movement of non-native seeds into newly disturbed soils are minimized.
- Use construction techniques along the pipeline route that minimize the time that bare soil is exposed and, therefore, minimize the opportunity for exotic species to become established.
- In wetland construction areas where practicable, remove topsoil from the excavation areas and store it to the side for replacement once the construction is complete. This will minimize the introduction of non-native species and maintain the native plant seed bank.
- Sow a cover crop along all exposed soil surfaces within a short time to assure that a suitable growing substrate for exotic or invasive species is not available for long periods of time.

Gulf South's plan for controlling nuisance and exotic vegetation will also involve monitoring and selective spot treatment/eradication of any exotic and invasive species encountered in construction. Gulf South proposes to monitor the right-of-way (ROW) during normal pipeline

monitoring to allow for early detection of exotic and invasive species infestation. If species or colonies of species are found in numbers which are significantly different from existing nearby off ROW locations, Gulf South will conduct spot eradication of those species. This control could be herbicide application or hand cutting/removal of the species.

APPENDIX K

**PLAN FOR THE UNANTICIPATED DISCOVERY OF HISTORIC PROPERTIES AND
HUMAN REMAINS DURING CONSTRUCTION**

UNANTICIPATED DISCOVERIES PLAN CULTURAL RESOURCES, HUMAN REMAINS

Coastal Bend Header Project

A. INTRODUCTION

Gulf South Pipeline Company, LP (Gulf South) proposes to construct approximately 67 miles of new 36-inch diameter natural gas pipeline, one new gas fired compressor station (Wilson Storage Compressor Station), seven meter and regulator (M&R) station interconnects, and appurtenant facilities in Wharton and Brazoria counties, Texas. The Project will also require the construction and operation of two new electric motor driven compressor stations (Brazos Compressor Station and Cypress Compressor Station), piping modifications and installation of new compression at Gulf South's former Magasco Compressor Station, and piping modifications at Gulf South's existing Goodrich Compressor Station to increase capacity on Gulf South's existing Index 129 pipeline. The new compressor stations constructed on Gulf South's Index 129 pipeline will be located in Fort Bend and Harris counties, Texas, while modifications at the existing Goodrich Compressor Stations and the former Magasco Compressor Station on Gulf South's Index 129 pipeline will occur in Polk and Sabine counties, Texas, respectively. This document describes the procedures for dealing with unanticipated discoveries during the course of project construction. It is intended to:

- Maintain compliance with applicable Federal and State laws and regulations during construction of the Project;
- Describe to regulatory and review agencies the procedure the Project or its representative will follow to prepare for and deal with unanticipated discoveries; and,
- Provide direction and guidance to project personnel as to the proper procedure to be followed should an unanticipated discovery occur.

B. PROCEDURES FOR THE DISCOVERY OF CULTURAL RESOURCES

In the event that any member of the construction work force believes that a cultural resource discovery is encountered the following plan will be implemented:

1. All work within 100 feet both sides of the discovery will immediately stop and the Environmental Inspector will be notified. The area of work stoppage will be adequate to provide for the security, protection, and integrity of the materials. A cultural resource can be prehistoric or historic and could consist of, but not be limited to, for example:
 - An accumulation of shell, burned rocks, ceramics or other subsistence related materials
 - An area of charcoal or very dark soil with artifacts
 - Stone tools, arrowheads, or dense concentrations of stone artifacts
 - A cluster of bones in association with shell, charcoal, burned rocks, stone artifacts, ceramics, or other culturally-modified items. A historic structure or assemblage of historic materials older than 50 years

2. If the Environmental Inspector believes that the discovery is a cultural resource, the Environmental Inspector will take appropriate steps to protect the discovery site. This will include flagging the immediate area of discovery and stop work or exclusion zone, as well as notifying the Environmental Project Manager and/or Company Representative. Work in the immediate area will not resume until treatment of the discovery has been completed.
3. Gulf South or its representative will arrange for the discovery to be evaluated by a qualified archaeologist. The archaeologist will evaluate the remains and provide recommendations for how to manage the resource under the appropriate State's Historic Preservation Plan.
4. The archaeologist will seek consultation with the SHPO and Federal Agency Officials regarding the National Register eligibility status of the discovery. If the discovery is determined to have the potential for eligibility, the archaeologist will consult with the SHPO on how best to avoid, minimize, or otherwise mitigate further impacts. Treatment measures may include mapping, photography, sample collection, or excavation activity.
5. The archaeologist will implement the appropriate treatment measure(s) and provide a report on its methods and results. The investigation and technical report will be performed in compliance with the Secretary of the Interior's Standards and Guidelines for Archaeological Documentation (48 CFR 44734--44737); the Advisory Council on Historic Preservation (ACHP) publication "Treatment of Archaeological Properties" (ACHP 1980); and follow the guidelines set forth by the applicable State(s) Historic Preservation Office.

C. PROCEDURES FOR THE DISCOVERY OF HUMAN REMAINS

In the event that human remains are encountered during either construction or maintenance activities, the following plan outlines the specific procedures to be followed. These procedures meet or exceed the Policy Statement Regarding Treatment of Burial Sites, Human Remains, and Funerary Objects adopted by the ACHP, "Protection of Historic and Cultural Properties" (36 CFR Part 800); the Native American Graves Protection and Repatriation Act (43 CFR Part 10); Procedures for the Protection of Historic Properties (33 CFR 325 Appendix C); the Archaeological and Historic Preservation Act; Consultation and Coordination with Indian Tribal Governments (EO 13175), and Texas Health and Safety Code (Title 8, Chapters 711-714).

All activity that might disturb the remains shall cease and may not resume until authorized by appropriate law enforcement officials or the State Archaeologist. Any human remains, burial sites, or burial related materials that are discovered during construction will at all times be treated with dignity and respect.

1. The Site Manager- or archaeologist, if present, will notify Gulf South's Project Manager, the law enforcement agency and the coroner of the jurisdiction where the site or remains are located within two days of the discovery. The State Archaeologist will also be contacted to assist with identifying the remains.
2. Any activity that may disturb the unmarked burial site, human skeletal remains, or burial artifacts associated with the site will immediately cease on discovery. The site will be

carefully covered and secured for protection from degradation by weather or unauthorized individuals.

3. The Environmental Inspector will be responsible for taking appropriate steps to protect the discovery. This will include fencing off the immediate area of discovery and flagging the area as an exclusion zone. No activity may resume until authorized by the agency authority governing the disposition of the human remains.
4. If the unmarked burial site, human skeletal remains, or funerary objects can be shown to have ethnic affinity with a living Native American tribe, a Company Representative will notify the FERC and SHPO to assist in determining the tribe(s), if any, who may have historic ties to the region and represent descendants of any Native American remains. If direct relations to a Native American tribe are verified, the tribe will have control of the disposition of the human skeletal remains
5. If the District Coroner finds that the unmarked burial site is over 50 years old and that there is no need for a legal inquiry by their office or for a criminal investigation, and if no direct relations to any Native American tribe are found, then the SHPO will have jurisdiction of the site, human skeletal remains, and the burial artifacts.

E. PROJECT CONTACTS

Environmental Inspector

Attn: To Be Determined

Phone:

Chief Inspector

Attn: To Be Determined

Phone:

Gulf South Environmental Project Manager

Attn: Cale LeBlanc

9 Greenway Plaza, Suite 2800

Houston, TX 77046

Phone: (o) 225-292-6944 (c) 985-791-8395

FERC Project Manager

Attn: To Be Determined

Phone:

FERC Archaeologist

Attn: To Be Determined

Phone:

Texas Historical Commission

1511 Colorado, Austin, TX 78701

Phone: 512-463-6100

Texas Health and Safety Code (Title 8, Chapters 711-714)

APPENDIX L

**TEMPORARY AND PERMANENT ACCESS ROADS FOR THE
COASTAL BEND HEADER PROJECT**

Table L-1. Temporary and Permanent Access Roads for the Coastal Bend Header Project							
Access Road ID	Milepost/ Facility	Proposed Use	Existing Use	Upgrade Requirements	Approx. Length (feet)	Approx. Width (feet)	Surrounding Land Use
Pipeline Facilities							
Wharton County							
AR-P-2	0.74	Permanent	Gravel Road	Grading and Gravel	18,150	30	Developed
AR-P-3	2.10	Permanent	Field Road	Grading, Gravel, and Mats	16,055	25	Industrial
AR-P-6	4.80	Permanent	Gravel Road	Grading and Gravel	585	25	Open Land
AR-P-6.1	5.46	Permanent	Field Road	Grading and Gravel	3,804	25	Agricultural
AR-T-7	6.17	Temporary	Field Road	Grading and Gravel	3,904	25	Industrial
AR-T-8	7.38	Temporary	Field Road	Grading	1,282	25	Agricultural
AR-T-9	7.70	Temporary	Gravel Road	Grading and Gravel	3,041	25	Industrial
AR-T-11	10.19	Temporary	N/A	Mats	471	25	Agricultural
AR-T-12	10.54	Temporary	N/A	Mats	114	25	Agricultural
AR-P-13	10.65	Permanent	Field Road	Grading and Gravel	1,058	25	Agricultural
AR-T-14	11.03	Temporary	Gravel Road	None	1,277	25	Agricultural
AR-P-16	14.30	Permanent	Gravel Road	Grading and Gravel	932	25	Industrial
AR-T-18.1	17.84	Temporary	Field Road	Grading and Gravel	977	25	Agricultural
AR-T-21	22.17	Temporary	Gravel Road	Grading and Gravel	3,782	25	Industrial
AR-T-22	22.60	Temporary	N/A	Grading, Gravel, and Mats	3,169	25	Open Land
AR-T-23	23.07	Temporary	Gravel Road	Grading and Gravel	744	25	Industrial
AR-P-24	24.40	Permanent	Gravel Road	Gravel	16,648	25	Industrial
AR-P-25	24.45	Permanent	Private Road	Grading and Gravel	3,045	25	Industrial
AR-T-26	25.13	Temporary	Field Road	Grading and Gravel	2,006	25	Industrial
AR-P-27	25.54	Permanent	Gravel Road	Grading and Gravel	1,757	25	Industrial

Table L-1. Temporary and Permanent Access Roads for the Coastal Bend Header Project							
Access Road ID	Milepost/ Facility	Proposed Use	Existing Use	Upgrade Requirements	Approx. Length (feet)	Approx. Width (feet)	Surrounding Land Use
AR-P-28	26.92	Permanent	Field Road	Grading and Gravel	2,146	25	Industrial
Brazoria County							
AR-P-29	27.78	Permanent	Gravel Road/Field Road	Grading, Gravel, and Mats	19,485	25	Open Land
AR-P-30	27.90	Permanent	Field Road	Mats	168	25	Agricultural
AR-T-31	29.24	Temporary	Field Road	Mats	1,663	25	Open Land
AR-P-32.1	35.03	Permanent	Field Road	Grading and Gravel	2,100	25	Open Land
AR-P-34	36.40	Permanent	Private Road	Grading and Gravel	1,130	25	Agricultural
AR-P-36	39.99	Permanent	Field Road	Grading and Gravel	6,000	25	Industrial
AR-T-36.1	40.07	Temporary	Field Road	Grading and Gravel	263	25	Agricultural
AR-P-37	41.48	Permanent	Field Road	Grading and Gravel	7,396	25	Industrial
AR-P-37.1	41.55	Temporary	N/A	Grading and Gravel	338	25	Agricultural
AR-P-38	42.69	Permanent	Field Road	Grading and Gravel	1,483	25	Forest
AR-P-38.1	42.89	Permanent	N/A	Grading and Gravel	115	25	Open Land
AR-P-39	45.03	Permanent	Field Road	Grading and Gravel	17,115	25	Agricultural
AR-T-39.1	45.03	Temporary	Field Road	Mats	585	25	Agricultural
AR-T-40	45.85	Temporary	Field Road	Grading, Gravel, and Mats	1,790	25	Open Land
AR-T-41	46.34	Temporary	Field Road	Grading, Gravel, and Mats	2,062	25	Industrial
AR-P-41.1	48.09	Permanent	Gravel/Field Road	Grading and Gravel	3,362	25	Industrial
AR-T-41.2	48.62	Temporary	Field Road	Grading and Gravel	775	25	Open Land
AR-P-42	49.39	Permanent	Gravel/Field Road	Grading and Gravel	1,126	25	Industrial
AR-P-42.1	50.76	Permanent	Gravel Road	Grading and Gravel	431	25	Open Land

Table L-1. Temporary and Permanent Access Roads for the Coastal Bend Header Project							
Access Road ID	Milepost/ Facility	Proposed Use	Existing Use	Upgrade Requirements	Approx. Length (feet)	Approx. Width (feet)	Surrounding Land Use
AR-P-44	53.11	Permanent	Field Road	Grading and Gravel	2,470	25	Open Land
AR-T-44.1	53.11	Temporary	N/A	Mats	578	25	Agricultural
AR-T-45.1	53.27	Temporary	N/A	Grading and Gravel	390	25	Open Land
AR-T-45	53.33	Temporary	N/A	Grading, Gravel, and Mats	2,625	25	Open Land
AR-P-46	54.01	Permanent	N/A	Grading, Gravel, and Mats	2,326	25	Open Land
AR-P-47	55.25	Permanent	N/A	Grading, Gravel, and Mats	1,774	25	Agricultural
AR-T-47.1	55.30	Temporary	N/A	Mats	192	25	Agricultural
AR-P-48	55.79	Permanent	N/A	Grading and Gravel	37	25	Developed
AR-P-49	56.65	Permanent	Field Road	Grading and Gravel	1,508	25	Open Land
AR-P-51.1	58.38	Permanent	Gravel Road	Grading and Gravel	804	25	Open Land
AR-T-51.1	58.38	Temporary	N/A	Mats	439	25	Open Land
AR-P-52	58.96	Permanent	Field Road	Grading, Gravel, and Mats	2,278	25	Open Land
AR-T-53	60.14	Temporary	Field Road	Grading, Gravel, and Mats	681	25	Industrial
AR-P-55	61.68	Permanent	Field Road	Grading and Gravel	2,346	25	Open Land
AR-P-55.1	62.96	Permanent	Gravel Road	Grading and Gravel	1,530	25	Open Land
AR-P-57.1	63.54	Permanent	Gravel Road/Field Road	Grading and Gravel	1,055	25	Open Land
AR-P-58	63.87	Permanent	Field Road	Grading and Gravel	147	25	Agricultural
Aboveground Facilities							
36-inch Header Pipeline							
AR-P-1	TGPL M&R Station	Permanent	Field Road	Grading, Gravel, and Culvert	5,264	30	Open Land
AR-P-7.1	NGPL M&R Station	Permanent	Gravel Road	Grading and Gravel	3,789	25	Industrial

**Table L-1.
Temporary and Permanent Access Roads for the Coastal Bend Header Project**

Access Road ID	Milepost/ Facility	Proposed Use	Existing Use	Upgrade Requirements	Approx. Length (feet)	Approx. Width (feet)	Surrounding Land Use
AR-P-15	MLV	Permanent	N/A	Grading and Gravel	164	25	Open Land
AR-P-17	Index 129 M&R Station	Permanent	Private Road	Grading and Gravel	1,744	25	Industrial
AR-P-18	HPL-Energy Transfer M&R Station	Permanent	Field Road	Grading and Gravel	2,014	25	Open Land
AR-P-19	Wilson Compressor Station	Permanent	N/A	Grading, Gravel, and Culvert	2,513	30	Agricultural
AR-P-33	MLV	Permanent	N/A	Culvert and Gravel	161	25	Agricultural
AR-P-43	MLV	Permanent	N/A	Grading, Gravel, and Culvert	246	25	Open Land
AR-P-59	Stratton Ridge M&R Station	Permanent	N/A	Grading, Gravel, and Culvert	45	25	Industrial
Legacy System Facilities							
Brazos Compressor Station AR	Brazos Compressor Station	Permanent	Gravel Road	Grading and Gravel	3,677	25	Industrial
North Houston Compressor Station AR	North Houston Compressor Station	Permanent	Gravel Road	Paving	296	25	Industrial
Magasco Compressor Station AR	Magasco Compressor Station	Permanent	Private Road	Re-paving	1,500	25	Industrial
Source: Gulf South, June 2015a							

APPENDIX M

SUMMARY OF LAND USE IMPACTS (ACRES)

Table M-1																
Summary of Land Use Impacts (acres)																
Facility	Agricultural		Open Land		Forest		Industrial		Wetland ^a		Open Water		Residential		Project Total	
	C	O	C	O	C	O	C	O	C	O	C	O	C	O	C	O
Wharton County																
Pipeline Facilities																
Pipeline	265.5	134.8	33.2	17.9	14.9	8.2	4.5	2.7	4.1	2.7	0.2	0.1	0.0	0.0	322.4	166.4
ATWS	60.0	0.0	4.5	0.0	0.5	0.0	0.4	0.0	0.2	0.0	0.0	0.0	0.0	0.0	65.6	0.0
Access Roads	6.3	3.7	5.7	4.2	0.1	0.1	40.9	33.7	0.0	0.0	0.1	0.0	0.0	0.0	53.1	41.7
Contractor/Pipe Yards	0.0	0.0	9.5	0.0	0.0	0.0	3.6	0.0	0.0	0.0	0.0	0.0	0.0	0.0	13.1	0.0
Pipeline Facilities Subtotal	331.8	138.5	52.9	22.1	15.5	8.3	49.4	36.4	4.3	2.7	0.3	0.1	0.0	0.0	454.2	208.1
Aboveground Facilities																
Wilson Compressor Station ^b	27.8	13.9	0.1	0.1	0.0	0.0	0.0	0.0	0.0	0.0	0.0	0.0	0.0	0.0	27.9	14.0
TGPL M&R Station	2.0	1.0	<0.1	<0.1	0.0	0.0	0.0	0.0	0.0	0.0	0.0	0.0	0.0	0.0	2.0	1.0
Transco M&R Station	2.0	1.8	0.7	0.7	0.0	0.0	0.0	0.0	0.0	0.0	0.0	0.0	0.0	0.0	2.7	2.5
NGPL M&R Station	1.8	0.9	0.2	0.0	0.0	0.0	0.1	<0.1	0.0	0.0	0.0	0.0	0.0	0.0	2.1	0.9
Gulf South Index 129 M&R Station	0.0	0.0	5.1	4.5	0.0	0.0	0.0	0.0	0.0	0.0	0.0	0.0	0.0	0.0	5.1	4.5
HPL-Energy Transfer M&R Station	1.7	1.1	0.0	0.0	0.0	0.0	0.0	0.0	0.0	0.0	0.0	0.0	0.0	0.0	1.7	1.1
Mainline Valves and other Ancillary Facilities ^c	0.0	0.0	0.1	0.1	0.0	0.0	0.0	.0	0.0	0.0	0.0	0.0	0.0	0.0	0.1	0.1
Access Roads	0.6	0.6	3.2	3.2	0.0	0.0	4.0	4.0	0.0	0.0	0.0	0.0	0.0	0.0	7.8	7.8
Aboveground Facilities Subtotal	35.9	19.3	9.4	8.6	0.0	0.0	4.1	4.0	0.0	0.0	0.0	0.0	0.0	0.0	49.4	31.9
Wharton County Subtotal	367.7	157.8	62.3	30.7	15.5	8.3	53.5	40.4	4.3	2.7	0.3	0.1	0.0	0.0	503.6	240.0
Brazoria County																
Pipeline Facilities																
Pipeline	191.5	99.0	121.4	65.4	91.6	47.5	3.6	2.6	20.5	13.2	1.6	1.3	0.9	0.5	431.1	229.5
ATWS	32.1	0.0	18.7	0.0	6.5	0.0	0.2	0.0	0.2	0.0	0.0	0.0	0.4	0.0	58.1	0.0
Access Roads	4.8	3.2	21.2	18.0	0.8	0.7	20.5	18.8	<0.1	0.0	0.0	0.0	0.0	0.0	47.3	40.7
Contractor/ Pipe Yards	0.0	0.0	20.6	0.0	0.0	0.0	43.5	0.0	0.0	0.0	0.0	0.0	0.0	0.0	64.1	0.0
Pipeline Facilities Subtotal	228.4	102.2	181.9	83.4	98.9	48.2	67.8	21.4	20.7	13.2	1.6	1.3	1.3	0.5	600.6	270.2
Aboveground Facilities																
Stratton Ridge M&R Station	0.0	0.0	2.9	1.9	0.6	0.0	<0.1	<0.1	0.0	0.0	0.0	0.0	0.0	0.0	3.5	1.9
Mainline Valves and Other Ancillary Facilities ^c	0.1	0.1	0.1	0.1	0.0	0.0	0.0	0.0	0.0	0.0	0.0	0.0	0.0	0.0	0.2	0.2
Aboveground Facilities Subtotal	0.1	0.1	3.0	2.0	0.6	0.0	<0.1	<0.1	0.0	0.0	0.0	0.0	0.0	0.0	3.7	2.1
Brazoria County Subtotal	228.5	102.3	184.9	85.4	99.5	48.2	67.8	21.4	20.7	13.2	1.6	1.3	1.3	0.5	604.3	272.3

**Table M-1
Summary of Land Use Impacts (acres)**

Facility	Agricultural		Open Land		Forest		Industrial		Wetland ^a		Open Water		Residential		Project Total		
	C	O	C	O	C	O	C	O	C	O	C	O	C	O	C	O	
Fort Bend County																	
Brazos Compressor Station	28.8	10.3	0.5	<0.1	0.0	0.0	0.2	0.0	0.2	0.0	0.0	0.0	0.0	0.0	0.0	29.7	10.3
Access Road	<0.1	<0.1	1.2	1.2	0.0	0.0	1.3	1.3	0.0	0.0	0.0	0.0	0.0	0.0	0.0	2.5	2.5
Fort Bend County Subtotal	28.8	10.3	1.7	1.2	0.0	0.0	1.5	1.3	0.2	0.0	0.0	0.0	0.0	0.0	0.0	32.2	12.8
Harris County																	
North Houston Compressor Station	0.0	0.0	10.4	5.5	0.0	0.0	1.7	0.6	0.8	0.0	0.0	0.0	0.0	0.0	0.0	12.9	6.1
Access Road	0.0	0.0	0.0	0.0	0.0	0.0	0.2	0.2	0.0	0.0	0.0	0.0	0.0	0.0	0.0	0.2	0.2
Harris County Subtotal	0.0	0.0	10.4	5.5	0.0	0.0	1.9	0.8	0.8	0.0	0.0	0.0	0.0	0.0	0.0	13.1	6.3
Polk County																	
Goodrich Compressor Station	0.0	0.0	4.9	0.8	0.0	0.0	2.3	1.7	0.0	0.0	0.0	0.0	0.0	0.0	0.0	7.2	2.5
Polk County Subtotal	0.0	0.0	4.9	0.8	0.0	0.0	2.3	1.7	0.0	0.0	0.0	0.0	0.0	0.0	0.0	7.2	2.5
Sabine County																	
Magasco Compressor Station	0.0	0.0	9.2	2.3	<0.1	0.0	1.9	0.7	0.0	0.0	0.0	0.0	0.0	0.0	0.0	11.1	3.0
Sabine County Subtotal	0.0	0.0	9.2	2.3	<0.1	0.0	1.9	0.7	0.0	0.0	0.0	0.0	0.0	0.0	0.0	11.1	3.0
Overall Pipeline Facilities Total	560.2	240.7	234.8	105.5	114.4	56.5	117.2	57.8	25.0	15.9	1.9	1.4	1.3	0.5	1,054.8	478.3	
Overall Aboveground Facilities Total	64.8	29.7	38.6	20.4	0.6	0.0	11.7	8.5	1.0	0.0	0.0	0.0	0.0	0.0	116.7	58.6	
Overall Project Total	625.0	270.4	273.4	125.9	115.0	56.5	128.9	66.3	26.0	15.9	1.9	1.4	1.3	0.5	1,171.5	536.9	

Source: Gulf South Resource Report 8 – June 2015.

The numbers in this table have been rounded for presentation purposes. As a result, the totals may not reflect the sum of the addends.

^a Operational land use impacts associated with wetlands have been calculated based on the proposed 50-foot permanent ROW. Per the FERC Procedures, Gulf South would only maintain a 10-foot cleared easement in wetlands with an additional 20-foot tree exclusion zone (total of 30 feet centered on the pipeline) within the permanent easement. Additionally, sections of ROW between HDD entry and exit locations would not be affected by construction or operation to minimize and avoid wetland impacts.

^b Impacts associated with Wilson Compressor Station are inclusive of the Enterprise M&R Station.

^c Impacts associated with the pig launcher and receivers are included in the impact acreage of the facility where they are located (i.e., Wilson Compressor Station, Brazos Compressor Station, TGPL M&R station, Gulf South Index 129 M&R Station, and Stratton Ridge M&R station).

C = Construction

O = Operation

TGPL = Tennessee Gas Pipeline Company, LLC

NGPL = Natural Gas Pipeline Company, LLC

Transco = Transcontinental Gas Pipe Line Company, LLC

HPL-Energy Transfer = Houston Pipeline Company, LP – Energy Transfer Partners, LP

Enterprise = Enterprise Products Partners, LP

APPENDIX N

RESIDENTIAL CONSTRUCTION IMPLEMENTATION PLAN



Gulf South Pipeline Company, LP

Residential Construction Implementation Plan

Coastal Bend Header Project

June 2015

RESIDENTIAL CONSTRUCTION IMPLEMENTATION PLAN

The *Residential Construction Implementation Plan* (Plan) describes the procedures that Gulf South Pipeline Company, LP (Gulf South) and its Contractors will utilize when in close proximity to residences during construction of the Coastal Bend Header Project (Project) located in southeast and east Texas.

Prior to the start of construction in close proximity to a residence, Gulf South will notify the landowners and coordinate with them to the extent practicable to minimize any potential inconveniences associated with construction of the Project. The following outlines construction procedures that will be implemented for residences within 50 feet and residences within 25 feet of the Project workspace.

For residences within 50 feet:

- Construction activities will generally occur during daytime hours wherever feasible;
- Construct safety fencing around the edge of the construction area adjacent to the residence for a distance of 100 feet on either side of the residence;
- As many trees as possible will be left on the property. Branches may be trimmed to allow for safe operation and passage of construction equipment. Any vegetation cleared from the property will be disposed of as negotiated by the landowner and Gulf South;
- Lawns and landscaping will be restored to pre-construction conditions, as will any walls or other structures that were damaged or removed during construction as negotiated by the landowner and Gulf South;
- Topsoil will be segregated where appropriate or at the request of the landowner;
- Gulf South will take all measures necessary to ensure that utilities are not disrupted during construction. If the need to disrupt utilities arises, Gulf South will provide as much notice as possible to the landowner prior to the disruption;
- Clean-up and backfill will occur immediately following installation of the pipeline;
- Revegetation will occur at the first seasonal opportunity;
- Specialized construction techniques designed to minimize disturbances to residences, such as the stovepipe or drag section techniques, will be used where feasible;
- Affected landowners and adjacent landowners will be notified no later than two weeks prior to the start of construction;

- Traffic flow and emergency vehicle access will be maintained on residential roadways. Traffic detail personnel and/or detour signs will be used where appropriate;
- Any section of the trench left open at the end of the workday will be fenced off or covered with a steel plate; and
- Road surfaces near residences will be periodically inspected and, if necessary, cleaned of any soil and other debris.

For residences within 25 feet, the Contractor will implement all of the procedures discussed above for residences within 50 feet as well as:

- The Contractor will comply with all workspace limitations and construction techniques that are outlined in the Plan's site-specific drawings that are referenced on the construction drawings provided to the Contractor;
- The trench will not be excavated until the pipe is ready to be installed and will be backfilled immediately after installation is complete; and
- Access to residences by car will be maintained at all times, or other accommodations will be made with each respective landowner.

If construction in close proximity to residences requires the removal of private property features, such as gates or fences, Gulf South will notify the landowner prior to removal. Following the completion of construction activities within the residential property, Gulf South would restore the property, including landscaping, in accordance with the Federal Energy Regulatory Commission *Upland Erosion Control, Revegetation, and Maintenance Plan* as well as any agreements in place with the landowner.

APPENDIX O

SITE-SPECIFIC RESIDENTIAL CROSSING DRAWINGS

TRACT TX-WH-161.000
WHARTON COUNTY, TEXAS

LEGEND

- PROPOSED 36" LINE
- EXISTING LINE MA
- EXISTING BG&E LINE
- PROPERTY LINE
- OVERHEAD POWER
- BURIED WATER LINE
- BURIED POWER LINE
- BURIED TELEPHONE LINE
- BURIED T.V. LINE
- BURIED FIBER OPTIC CABLE
- STREAM
- DITCH
- TOP OF BANK
- EXISTING FENCE
- TEMPORARY SAFETY FENCE
- EDGE OF WOODS
- EDGE OF VEGETATION
- ROAD
- GUARD RAIL
- EXISTING PERMANENT EASEMENT
- PROPOSED PERMANENT EASEMENT
- TEMPORARY WORKSPACE
- ADDITIONAL TEMPORARY WORKSPACE (ATWS)
- CATCH BASIN
- IRON ROD/PIN
- SINGLE POLE/POWER POLE
- GUY WIRE AND ANCHOR
- UTILITY MARKER
- MISC. SIGN
- SANITARY SEWER MANHOLE
- STORM SEWER MANHOLE
- WATER WELL
- FIRE HYDRANT
- ELECTRIC HAND HOLE
- TELEPHONE HAND HOLE
- WATER VALVE
- GAS VALVE
- MISC. VALVE
- VENT
- SEPTIC TANK
- TREE

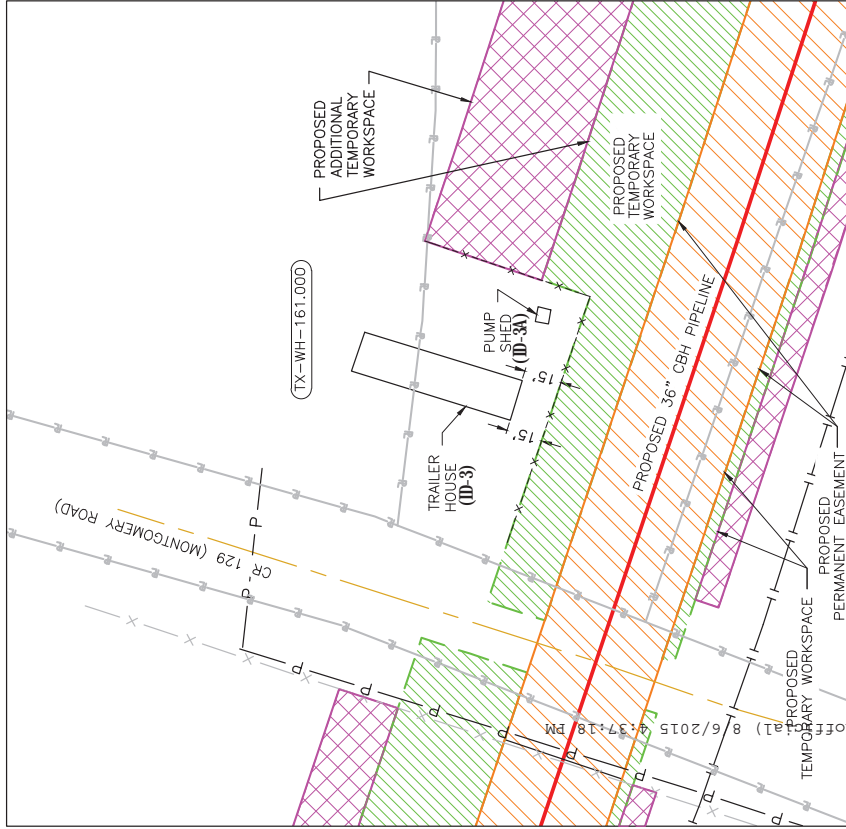

NOTES:

1. CONTRACTOR SHALL INSTALL THE PIPELINE PER THE RESIDENTIAL CONSTRUCTION IMPLEMENTATION PLAN.
2. CONTRACTOR SHALL ERECT A TEMPORARY SAFETY FENCE BETWEEN THE WORK AREA AND ADJACENT STRUCTURES BEFORE EQUIPMENT IS USED IN ANY PART OF THE RIGHT-OF-WAY AND SHALL BE REMOVED ONLY AFTER CONSTRUCTION AND RESTORATION IS COMPLETE.
3. CONTRACTOR SHALL MAINTAIN VEHICLE ACCESS TO THE IMPACTED AREA DURING THE CONSTRUCTION PHASE.
4. CONTRACTOR SHALL PROVIDE FUGITIVE DUST ABATEMENT MEASURES.
5. CONTRACTOR SHALL MINIMIZE VEGETATION REMOVAL.
6. CONTRACTOR SHALL LIMIT WORK IN THIS AREA TO DAYLIGHT HOURS.
7. TOPSOIL AND SUBSOIL STORAGE PILES WILL BE ON THE SPOIL SIDE OF THE PROPOSED PIPELINE.
8. EQUIPMENT TRAVEL LANES WILL BE ON THE WORKING SIDE OF THE PROPOSED PIPELINE.
9. TRENCH WILL NOT BE EXCAVATED UNTIL THE PIPE IS READY TO BE INSTALLED AND WILL BE BACKFILLED AS SOON AS POSSIBLE AFTER PIPE INSTALLATION.
10. NO REFUELING OR STORAGE OF HAZARDOUS MATERIALS WILL OCCUR WITHIN 200 FEET OF A PRIVATE WELL.
11. LANDOWNERS SHALL BE NOTIFIED AT LEAST 5 DAYS PRIOR TO CONSTRUCTION.



PROPOSED 36" CBH PIPELINE RESIDENTIAL CONSTRUCTION		M.P. 13.28 - 13.35	
DATE	02/17/2015	SCALE	0
AWFRIT	TLJ	DRAWING NUMBER	52715-RES-01
DRAWN BY	TLJ	DRAWING CHECK	TLJ
DATE	06/15	REVIEW	
BY		DATE	
NO	ISSUED FOR FERC	REVISIONS	
14CQ-650-P-002-09	ALIGNMENT SHEET	REFERENCE	
DWG. NO.			

14CQ-650-P-002-09	ALIGNMENT SHEET	REFERENCE	
DWG. NO.			

DATE	02/17/2015	SCALE	0
AWFRIT	TLJ	DRAWING NUMBER	52715-RES-01
DRAWN BY	TLJ	DRAWING CHECK	TLJ
DATE	06/15	REVIEW	
BY		DATE	
NO	ISSUED FOR FERC	REVISIONS	
14CQ-650-P-002-09	ALIGNMENT SHEET	REFERENCE	
DWG. NO.			

TRACT TX-BR-390.600 BRAZORIA COUNTY, TEXAS



NOTES:

1. CONTRACTOR SHALL INSTALL THE PIPELINE PER THE RESIDENTIAL CONSTRUCTION IMPLEMENTATION PLAN.
2. CONTRACTOR SHALL ERECT A TEMPORARY SAFETY FENCE BETWEEN THE WORK AREA AND ADJACENT STRUCTURES BEFORE EQUIPMENT IS USED IN ANY PART OF THE RIGHT-OF-WAY AND SHALL BE REMOVED ONLY AFTER CONSTRUCTION AND RESTORATION IS COMPLETE.
3. CONTRACTOR SHALL MAINTAIN VEHICLE ACCESS TO THE IMPACTED AREA DURING THE CONSTRUCTION PHASE.
4. CONTRACTOR SHALL PROVIDE FUGITIVE DUST ABATEMENT MEASURES.
5. CONTRACTOR SHALL MINIMIZE VEGETATION REMOVAL.
6. CONTRACTOR SHALL LIMIT WORK IN THIS AREA TO DAYLIGHT HOURS.
7. TOPSOIL AND SUBSOIL STORAGE PILES WILL BE ON THE SPOIL SIDE OF THE PROPOSED PIPELINE.
8. EQUIPMENT TRAVEL LANES WILL BE ON THE WORKING SIDE OF THE PROPOSED PIPELINE.
9. TRENCH WILL NOT BE EXCAVATED UNTIL THE PIPE IS READY TO BE INSTALLED AND WILL BE BACKFILLED AS SOON AS POSSIBLE AFTER PIPE INSTALLATION.
10. NO REFUELING OR STORAGE OF HAZARDOUS MATERIALS WILL OCCUR WITHIN 200 FEET OF A PRIVATE WELL.
11. LANDOWNERS SHALL BE NOTIFIED AT LEAST 5 DAYS PRIOR TO CONSTRUCTION.
12. GULFSOUTH TO ACQUIRE THE PROPERTY, AND THE ABOVE GROUND STRUCTURES WILL BE REMOVED PRIOR TO CONSTRUCTION.



WILLIAMS ENGINEERS U.S.A. LLC
FIRM REGISTRATION NUMBER: TX 142

GULF SOUTH

PROPOSED 36" CBH PIPELINE RESIDENTIAL CONSTRUCTION		M.P. 57.15 - 57.20	
DRAWN BY:	GPMORR	DATE:	07/29/2015
DRIVING CHECK:	TLJ	DATE:	05/27/2015
REVIEW:		DRAWING NUMBER:	52715-RES-03
		SCALE:	0 30 FT
		ISSUE:	B

LEGEND

- PROPOSED 36" LINE
- EXISTING LINE MA
- EXISTING BG&E LINE
- PROPERTY LINE
- OVERHEAD POWER
- BURIED WATER LINE
- BURIED POWER LINE
- BURIED TELEPHONE LINE
- BURIED T.V. LINE
- BURIED FIBER OPTIC CABLE
- STREAM
- DITCH
- TOP OF BANK
- EXISTING FENCE
- TEMPORARY SAFETY FENCE
- EDGE OF WOODS
- EDGE OF VEGETATION
- ROAD
- GUARD RAIL
- EXISTING PERMANENT EASEMENT
- PROPOSED PERMANENT EASEMENT
- TEMPORARY WORKSPACE
- ADDITIONAL TEMPORARY WORKSPACE (ATWS)
- BUILDINGS TO BE REMOVED
- CATCH BASIN
- IRON ROD/PIN
- SINGLE POLE/POWER POLE
- GUY WIRE AND ANCHOR
- UTILITY MARKER
- MISC. SIGN
- SANITARY SEWER MANHOLE
- STORM SEWER MANHOLE
- WATER WELL
- FIRE HYDRANT
- ELECTRIC HAND HOLE
- TELEPHONE HAND HOLE
- WATER VALVE
- GAS VALVE
- MISC. VALVE
- VENT
- SEPTIC TANK
- TREE

DWG. NO.	REFERENCE	NO	REVISIONS	BY	DATE
14CQ-650-P-39	ALIGNMENT SHEET	A	ISSUED FOR FERC		08/15
		B	ISSUED FOR FERC RESUBMITTAL		08/15

TRACT TX-BZ-OFF-1943.000
 TRACT TX-BZ-OFF-1793.000
 BRAZORIA COUNTY, TEXAS

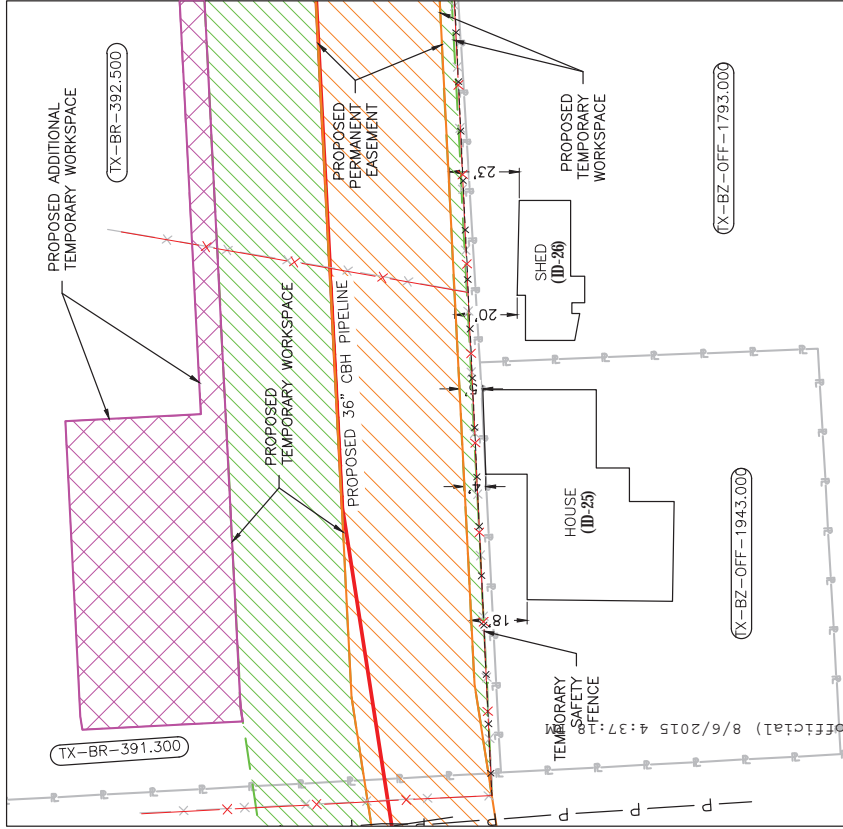

LEGEND

- PROPOSED 36" LINE
- EXISTING LINE MA
- EXISTING B&E LINE
- PROPERTY LINE
- OVERHEAD POWER
- BURIED WATER LINE
- BURIED POWER LINE
- BURIED TELEPHONE LINE
- BURIED T.V. LINE
- BURIED FIBER OPTIC CABLE
- STREAM
- DITCH
- TOP OF BANK
- EXISTING FENCE
- TEMPORARY SAFETY FENCE
- EDGE OF WOODS
- EDGE OF VEGETATION
- ROAD
- GUARD RAIL
- EXISTING PERMANENT EASEMENT
- PROPOSED PERMANENT EASEMENT
- TEMPORARY WORKSPACE
- ADDITIONAL TEMPORARY WORKSPACE (ATWS)
- CATCH BASIN
- IRON ROD/PIN
- SINGLE POLE/POWER POLE
- GUY WIRE AND ANCHOR
- UTILITY MARKER
- MISC. SIGN
- SANITARY SEWER MANHOLE
- STORM SEWER MANHOLE
- WATER WELL
- FIRE HYDRANT
- ELECTRIC HAND HOLE
- TELEPHONE HAND HOLE
- WATER VALVE
- GAS VALVE
- MISC. VALVE
- VENT
- SEPTIC TANK
- TREE

NOTES:

1. CONTRACTOR SHALL INSTALL THE PIPELINE PER THE RESIDENTIAL CONSTRUCTION IMPLEMENTATION PLAN.
2. CONTRACTOR SHALL ERECT A TEMPORARY SAFETY FENCE BETWEEN THE WORK AREA AND ADJACENT STRUCTURES BEFORE EQUIPMENT IS USED IN ANY PART OF THE RIGHT-OF-WAY AND SHALL BE REMOVED ONLY AFTER CONSTRUCTION AND RESTORATION IS COMPLETE.
3. CONTRACTOR SHALL MAINTAIN VEHICLE ACCESS TO THE IMPACTED AREA DURING THE CONSTRUCTION PHASE.
4. CONTRACTOR SHALL PROVIDE FUGITIVE DUST ABATEMENT MEASURES.
5. CONTRACTOR SHALL MINIMIZE VEGETATION REMOVAL. DAYLIGHT HOURS.
6. CONTRACTOR SHALL LIMIT WORK IN THIS AREA TO TOPSOIL AND SUBSOIL STORAGE PILES WILL BE ON THE SPOIL SIDE OF THE PROPOSED PIPELINE.
7. EQUIPMENT TRAVEL LANES WILL BE ON THE WORKING SIDE OF THE PROPOSED PIPELINE.
8. TRENCH WILL NOT BE EXCAVATED UNTIL THE PIPE IS READY TO BE INSTALLED AND WILL BE BACKFILLED AS SOON AS POSSIBLE AFTER PIPE INSTALLATION.
9. NO REFUELING OR STORAGE OF HAZARDOUS MATERIALS WILL OCCUR WITHIN 200 FEET OF A PRIVATE WELL.
10. LANDOWNERS SHALL BE NOTIFIED AT LEAST 5 DAYS PRIOR TO CONSTRUCTION.



WILLIAMS ENGINEERS US, LLC
FIRM REGISTRATION NUMBER: TX-142

PROPOSED 36" CBH PIPELINE RESIDENTIAL CONSTRUCTION	
M.P. 57.21 - 57.28	
DATE: 05/12/2015	SCALE: 0
DRAWN BY: JMWINS	DRAWING NUMBER: 52715-RES-05
DRAFTING CHECK:	ISSUE:
REVIEW:	A

DWG. NO.	REFERENCE	NO	REVISIONS	BY	DATE
14CQ-650-P-002-39	ALIGNMENT SHEET	A	ISSUED FOR FERC		6/15

20150805-5154 FERC PDF (Unofficial) 8/6/2015 4:37:11 PM

TRACT TX-BR-OFF-1938.000 BRAZORIA COUNTY, TEXAS

NOTES:

1. CONTRACTOR SHALL INSTALL THE PIPELINE PER THE RESIDENTIAL CONSTRUCTION IMPLEMENTATION PLAN.
2. CONTRACTOR SHALL ERECT A TEMPORARY SAFETY FENCE BETWEEN THE WORK AREA AND ADJACENT STRUCTURES BEFORE EQUIPMENT IS USED IN ANY PART OF THE RIGHT-OF-WAY AND SHALL BE REMOVED ONLY AFTER CONSTRUCTION AND RESTORATION IS COMPLETE.
3. CONTRACTOR SHALL MAINTAIN VEHICLE ACCESS TO THE IMPACTED AREA DURING THE CONSTRUCTION PHASE.
4. CONTRACTOR SHALL PROVIDE FUGITIVE DUST ABATEMENT MEASURES.
5. CONTRACTOR SHALL MINIMIZE VEGETATION REMOVAL.
6. CONTRACTOR SHALL LIMIT WORK IN THIS AREA TO DAYLIGHT HOURS.
7. TOPSOIL AND SUBSOIL STORAGE PILES WILL BE ON THE SPOIL SIDE OF THE PROPOSED PIPELINE.
8. EQUIPMENT TRAVEL LANES WILL BE ON THE WORKING SIDE OF THE PROPOSED PIPELINE.
9. TRENCH WILL NOT BE EXCAVATED UNTIL THE PIPE IS READY TO BE INSTALLED AND WILL BE BACKFILLED AS SOON AS POSSIBLE AFTER PIPE INSTALLATION.
10. NO REFUELING OR STORAGE OF HAZARDOUS MATERIALS WILL OCCUR WITHIN 200 FEET OF A PRIVATE WELL.
11. LANDOWNERS SHALL BE NOTIFIED AT LEAST 5 DAYS PRIOR TO CONSTRUCTION.

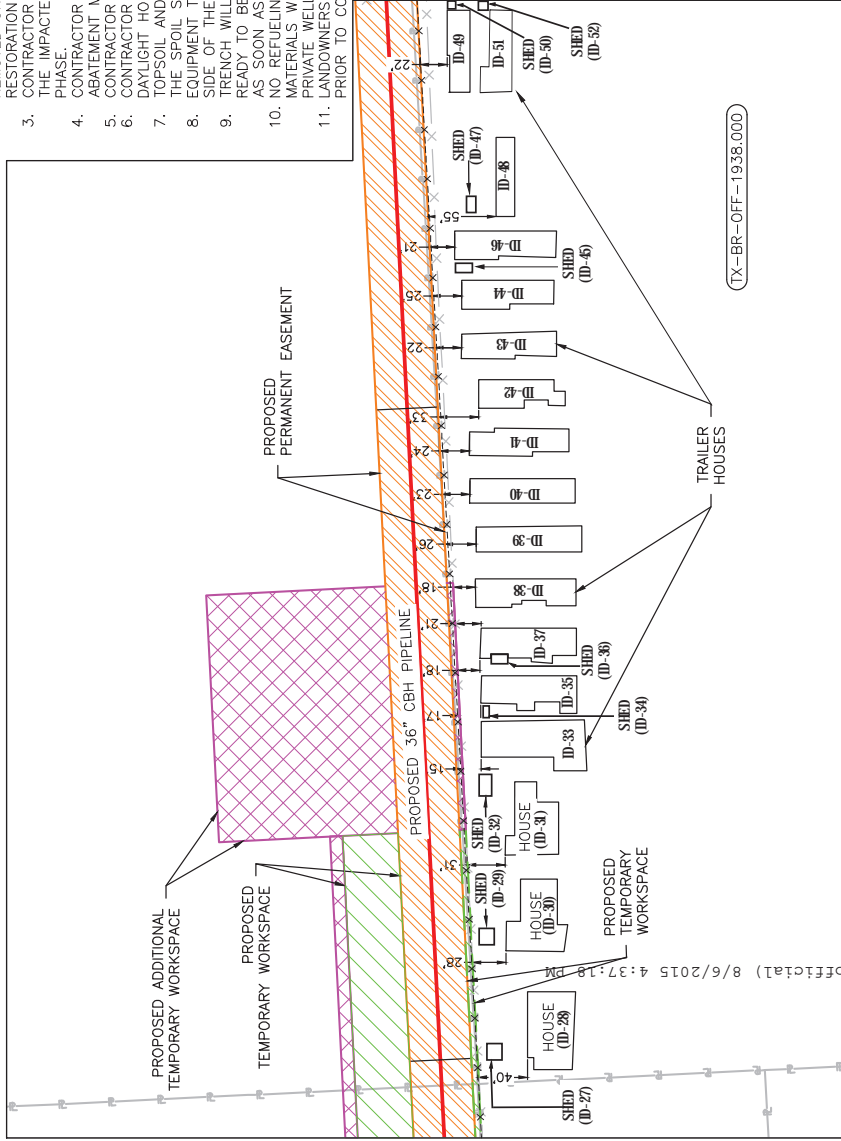

LEGEND

	PROPOSED 36" LINE		EXISTING PERMANENT EASEMENT
	EXISTING LINE MA		PROPOSED PERMANENT EASEMENT
	EXISTING BG&E LINE		TEMPORARY WORKSPACE
	PROPERTY LINE		ADDITIONAL TEMPORARY WORKSPACE (ATWS)
	OVERHEAD POWER		CATCH BASIN
	BURIED WATER LINE		IRON ROD/PIN
	BURIED POWER LINE		SINGLE POLE/POWER POLE
	BURIED TELEPHONE LINE		GUY WIRE AND ANCHOR
	BURIED T.V. LINE		UTILITY MARKER
	BURIED FIBER OPTIC CABLE		MISC. SIGN
	STREAM		SANITARY SEWER MANHOLE
	DITCH		STORM SEWER MANHOLE
	TOP OF BANK		WATER WELL
	EXISTING FENCE		FIRE HYDRANT
	TEMPORARY SAFETY FENCE		ELECTRIC HAND HOLE
	EDGE OF WOODS		TELEPHONE HAND HOLE
	EDGE OF VEGETATION		WATER VALVE
	ROAD		GAS VALVE
	GUARD RAIL		MISC. VALVE
	EXISTING PERMANENT EASEMENT		VENT
	PROPOSED PERMANENT EASEMENT		SEPTIC TANK
	TEMPORARY WORKSPACE		TREE
	ADDITIONAL TEMPORARY WORKSPACE (ATWS)		
	CATCH BASIN		
	IRON ROD/PIN		
	SINGLE POLE/POWER POLE		
	GUY WIRE AND ANCHOR		
	UTILITY MARKER		
	MISC. SIGN		
	SANITARY SEWER MANHOLE		
	STORM SEWER MANHOLE		
	WATER WELL		
	FIRE HYDRANT		
	ELECTRIC HAND HOLE		
	TELEPHONE HAND HOLE		
	WATER VALVE		
	GAS VALVE		
	MISC. VALVE		
	VENT		
	SEPTIC TANK		
	TREE		

PROPOSED 36" CBH PIPELINE RESIDENTIAL CONSTRUCTION		M.P. 57.39 - 57.56
DRAWN BY JMMINS	DATE 05/12/2015	SCALE 0
DRYING CHECK TLJ	DATE 05/27/2015	DRAWING NUMBER 52715-RES-06
REVIEW	BY	ISSUE

NO	DATE	REVISIONS	BY
A	06/15	ISSUED FOR FERC	

14CQ-650-P-002-39 ALIGNMENT SHEET	NO	REFERENCE	
-----------------------------------	----	-----------	--

TX-BR-OFF-1938.000

20150505-5154 FERC PDF (Unofficial) 8/6/2015 4:37:18 PM

APPENDIX O

SITE-SPECIFIC RESIDENTIAL CROSSING DRAWINGS

TRACT TX-WH-161.000
WHARTON COUNTY, TEXAS

LEGEND

- PROPOSED 36" LINE
- EXISTING LINE MA
- EXISTING BG&E LINE
- PROPERTY LINE
- OVERHEAD POWER LINE
- BURIED WATER LINE
- BURIED POWER LINE
- BURIED TELEPHONE LINE
- BURIED T.V. LINE
- BURIED FIBER OPTIC CABLE
- STREAM
- DITCH
- TOP OF BANK
- EXISTING FENCE
- TEMPORARY SAFETY FENCE
- EDGE OF WOODS
- EDGE OF VEGETATION
- ROAD
- GUARD RAIL
- EXISTING PERMANENT EASEMENT
- PROPOSED PERMANENT EASEMENT
- TEMPORARY WORKSPACE
- ADDITIONAL TEMPORARY WORKSPACE (ATWS)
- CATCH BASIN
- IRON ROD/PIN
- SINGLE POLE/POWER POLE
- GUY WIRE AND ANCHOR
- UTILITY MARKER
- MISC. SIGN
- SANITARY SEWER MANHOLE
- STORM SEWER MANHOLE
- WATER WELL
- FIRE HYDRANT
- ELECTRIC HAND HOLE
- TELEPHONE HAND HOLE
- WATER VALVE
- GAS VALVE
- MISC. VALVE
- VENT
- SEPTIC TANK
- TREE

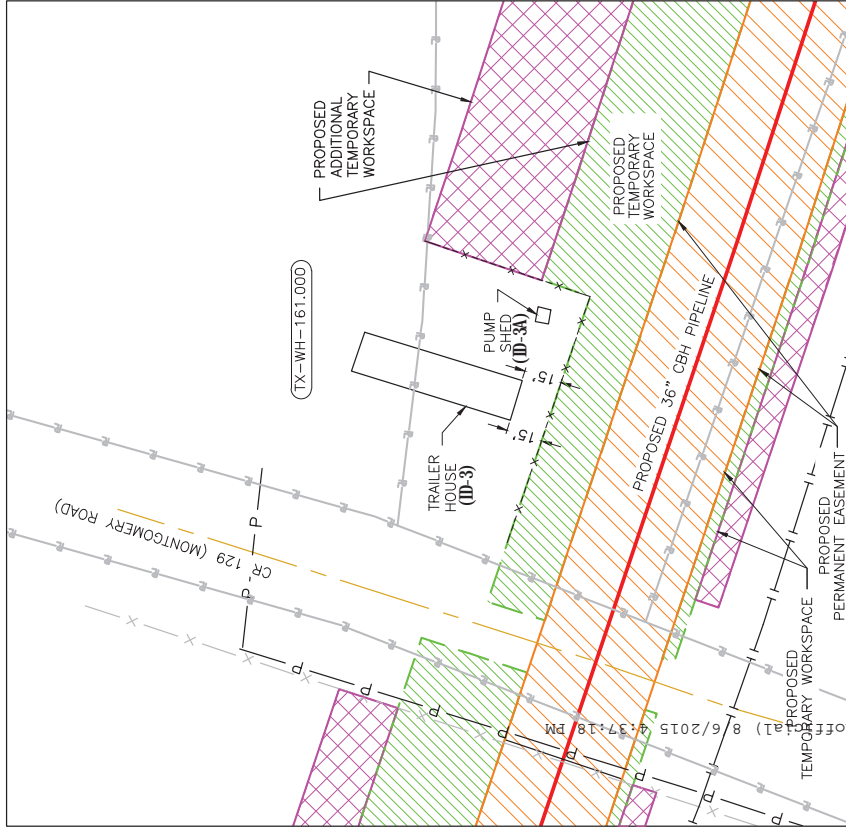

NOTES:

1. CONTRACTOR SHALL INSTALL THE PIPELINE PER THE RESIDENTIAL CONSTRUCTION IMPLEMENTATION PLAN.
2. CONTRACTOR SHALL ERECT A TEMPORARY SAFETY FENCE BETWEEN THE WORK AREA AND ADJACENT STRUCTURES BEFORE EQUIPMENT IS USED IN ANY PART OF THE RIGHT-OF-WAY AND SHALL BE REMOVED ONLY AFTER CONSTRUCTION AND RESTORATION IS COMPLETE.
3. CONTRACTOR SHALL MAINTAIN VEHICLE ACCESS TO THE IMPACTED AREA DURING THE CONSTRUCTION PHASE.
4. CONTRACTOR SHALL PROVIDE FUGITIVE DUST ABATEMENT MEASURES.
5. CONTRACTOR SHALL MINIMIZE VEGETATION REMOVAL.
6. CONTRACTOR SHALL LIMIT WORK IN THIS AREA TO DAYLIGHT HOURS.
7. TOPSOIL AND SUBSOIL STORAGE PILES WILL BE ON THE SPOIL SIDE OF THE PROPOSED PIPELINE.
8. EQUIPMENT TRAVEL LANES WILL BE ON THE WORKING SIDE OF THE PROPOSED PIPELINE.
9. TRENCH WILL NOT BE EXCAVATED UNTIL THE PIPE IS READY TO BE INSTALLED AND WILL BE BACKFILLED AS SOON AS POSSIBLE AFTER PIPE INSTALLATION.
10. NO REFUELING OR STORAGE OF HAZARDOUS MATERIALS WILL OCCUR WITHIN 200 FEET OF A PRIVATE WELL.
11. LANDOWNERS SHALL BE NOTIFIED AT LEAST 5 DAYS PRIOR TO CONSTRUCTION.



WILLIAMS ENGINEERS U.S. LLC
FIRM REGISTRATION NUMBER: TX 142

GULF SOUTH

PROPOSED 36" CBH PIPELINE RESIDENTIAL CONSTRUCTION		M.P. 13.28 - 13.35	
DRAWN BY: AWFRIT	DATE: 02/17/2015	SCALE: 0	50 FT
DRAWING CHECK: TLJ	DATE: 05/22/2015	DRAWING NUMBER: 52715-RES-01	ISSUE: A
REVIEW:	DATE:	BY:	REVISIONS:

14CQ-650-P-002-09	ALIGNMENT SHEET	A	ISSUED FOR FERC
DWG. NO.	REFERENCE	NO	

14CQ-650-P-002-09	ALIGNMENT SHEET	A	ISSUED FOR FERC
DWG. NO.	REFERENCE	NO	

TRACT TX-BR-390.600 BRAZORIA COUNTY, TEXAS



NOTES:

1. CONTRACTOR SHALL INSTALL THE PIPELINE PER THE RESIDENTIAL CONSTRUCTION IMPLEMENTATION PLAN.
2. CONTRACTOR SHALL ERECT A TEMPORARY SAFETY FENCE BETWEEN THE WORK AREA AND ADJACENT STRUCTURES BEFORE EQUIPMENT IS USED IN ANY PART OF THE RIGHT-OF-WAY AND SHALL BE REMOVED ONLY AFTER CONSTRUCTION AND RESTORATION IS COMPLETE.
3. CONTRACTOR SHALL MAINTAIN VEHICLE ACCESS TO THE IMPACTED AREA DURING THE CONSTRUCTION PHASE.
4. CONTRACTOR SHALL PROVIDE FUGITIVE DUST ABATEMENT MEASURES.
5. CONTRACTOR SHALL MINIMIZE VEGETATION REMOVAL.
6. CONTRACTOR SHALL LIMIT WORK IN THIS AREA TO DAYLIGHT HOURS.
7. TOPSOIL AND SUBSOIL STORAGE PILES WILL BE ON THE SPOIL SIDE OF THE PROPOSED PIPELINE.
8. EQUIPMENT TRAVEL LANES WILL BE ON THE WORKING SIDE OF THE PROPOSED PIPELINE.
9. TRENCH WILL NOT BE EXCAVATED UNTIL THE PIPE IS READY TO BE INSTALLED AND WILL BE BACKFILLED AS SOON AS POSSIBLE AFTER PIPE INSTALLATION.
10. NO REFUELING OR STORAGE OF HAZARDOUS MATERIALS WILL OCCUR WITHIN 200 FEET OF A PRIVATE WELL.
11. LANDOWNERS SHALL BE NOTIFIED AT LEAST 5 DAYS PRIOR TO CONSTRUCTION.
12. GULFSOUTH TO ACQUIRE THE PROPERTY, AND THE ABOVE GROUND STRUCTURES WILL BE REMOVED PRIOR TO CONSTRUCTION.

ISSUED FOR FERC
AUGUST - 2015



WILLIAMS ENGINEERS US, LLC
FIRM REGISTRATION NUMBER: TX 142



GULF SOUTH

PROPOSED 36" CBH PIPELINE RESIDENTIAL CONSTRUCTION		M.P. 57.15 - 57.20	
DRAWN BY:	GPMORR	DATE:	07/29/2015
DRIVING CHECK:	TLJ	SCALE:	0
REVIEW:		DRAWING NUMBER:	52715-RES-03
DATE:		ISSUE:	B

LEGEND

- ◌ PROPOSED 36" LINE
- ◌ EXISTING LINE MA
- ◌ EXISTING BG&E LINE
- ◌ PROPERTY LINE
- ◌ OVERHEAD POWER
- ◌ BURIED WATER LINE
- ◌ BURIED POWER LINE
- ◌ BURIED TELEPHONE LINE
- ◌ BURIED T.V. LINE
- ◌ BURIED FIBER OPTIC CABLE
- ◌ STREAM
- ◌ DITCH
- ◌ TOP OF BANK
- ◌ EXISTING FENCE
- ◌ TEMPORARY SAFETY FENCE
- ◌ EDGE OF WOODS
- ◌ EDGE OF VEGETATION
- ◌ ROAD
- ◌ GUARD RAIL
- ◌ EXISTING PERMANENT EASEMENT
- ◌ PROPOSED PERMANENT EASEMENT
- ◌ TEMPORARY WORKSPACE
- ◌ ADDITIONAL TEMPORARY WORKSPACE (ATWS)
- ◌ BUILDINGS TO BE REMOVED
- ◌ CATCH BASIN
- ◌ IRON ROD/PIN
- ◌ SINGLE POLE/POWER POLE
- ◌ GUY WIRE AND ANCHOR
- ◌ UTILITY MARKER
- ◌ MISC. SIGN
- ◌ SANITARY SEWER MANHOLE
- ◌ STORM SEWER MANHOLE
- ◌ WATER WELL
- ◌ FIRE HYDRANT
- ◌ ELECTRIC HAND HOLE
- ◌ TELEPHONE HAND HOLE
- ◌ WATER VALVE
- ◌ GAS VALVE
- ◌ MISC. VALVE
- ◌ VENT
- ◌ SEPTIC TANK
- ◌ TREE

DWG. NO.	REFERENCE	NO	REVISIONS	BY	DATE
14CQ-650-P-39	ALIGNMENT SHEET	A	ISSUED FOR FERC		08/15
		B	ISSUED FOR FERC RESUBMITTAL		08/15

TRACT TX-BZ-OFF-1943.000
 TRACT TX-BZ-OFF-1793.000
 BRAZORIA COUNTY, TEXAS

LEGEND

- PROPOSED 36" LINE
- EXISTING MA
- EXISTING B&E LINE
- PROPERTY LINE
- OVERHEAD POWER
- BURIED WATER LINE
- BURIED POWER LINE
- BURIED TELEPHONE LINE
- BURIED T.V. LINE
- BURIED FIBER OPTIC CABLE
- STREAM
- DITCH
- TOP OF BANK
- EXISTING FENCE
- TEMPORARY SAFETY FENCE
- EDGE OF WOODS
- EDGE OF VEGETATION
- ROAD
- GUARD RAIL
- EXISTING PERMANENT EASEMENT
- PROPOSED PERMANENT EASEMENT
- TEMPORARY WORKSPACE
- ADDITIONAL TEMPORARY WORKSPACE (ATWS)
- CATCH BASIN
- IRON ROD/PIN
- SINGLE POLE/POWER POLE
- GUY WIRE AND ANCHOR
- UTILITY MARKER
- MISC. SIGN
- SANITARY SEWER MANHOLE
- STORM SEWER MANHOLE
- WATER WELL
- FIRE HYDRANT
- ELECTRIC HAND HOLE
- TELEPHONE HAND HOLE
- WATER VALVE
- GAS VALVE
- MISC. VALVE
- VENT
- SEPTIC TANK
- TREE

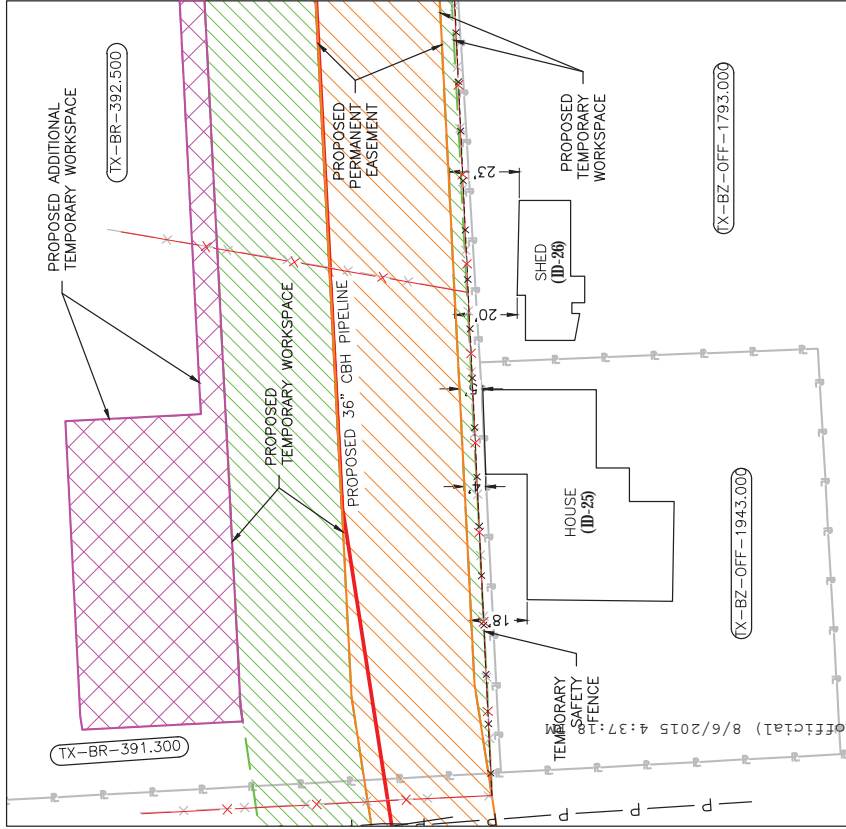

NOTES:

1. CONTRACTOR SHALL INSTALL THE PIPELINE PER THE RESIDENTIAL CONSTRUCTION IMPLEMENTATION PLAN.
2. CONTRACTOR SHALL ERECT A TEMPORARY SAFETY FENCE BETWEEN THE WORK AREA AND ADJACENT STRUCTURES BEFORE EQUIPMENT IS USED IN ANY PART OF THE RIGHT-OF-WAY AND SHALL BE REMOVED ONLY AFTER CONSTRUCTION AND RESTORATION IS COMPLETE.
3. CONTRACTOR SHALL MAINTAIN VEHICLE ACCESS TO THE IMPACTED AREA DURING THE CONSTRUCTION PHASE.
4. CONTRACTOR SHALL PROVIDE FUGITIVE DUST ABATEMENT MEASURES.
5. CONTRACTOR SHALL MINIMIZE VEGETATION REMOVAL. DAYLIGHT HOURS.
6. CONTRACTOR SHALL LIMIT WORK IN THIS AREA TO TOPSOIL AND SUBSOIL STORAGE PILES WILL BE ON THE SPOIL SIDE OF THE PROPOSED PIPELINE.
7. EQUIPMENT TRAVEL LANES WILL BE ON THE WORKING SIDE OF THE PROPOSED PIPELINE.
8. TRENCH WILL NOT BE EXCAVATED UNTIL THE PIPE IS READY TO BE INSTALLED AND WILL BE BACKFILLED AS SOON AS POSSIBLE AFTER PIPE INSTALLATION.
9. NO REFUELING OR STORAGE OF HAZARDOUS MATERIALS WILL OCCUR WITHIN 200 FEET OF A PRIVATE WELL.
10. LANDOWNERS SHALL BE NOTIFIED AT LEAST 5 DAYS PRIOR TO CONSTRUCTION.



WILLIAMS ENGINEERS U.S. LLC
 FIRM REGISTRATION NUMBER: TX-142

GULF SOUTH

PROPOSED 36" CBH PIPELINE
 RESIDENTIAL CONSTRUCTION
 M.P. 57.21 - 57.28

DRAWN BY	JMIMNS	DATE	05/12/2015	SCALE	0
DRAWING CHECK					
REVIEW					

50 FT

DRAWING NUMBER: 52715-RES-05

ISSUE

DWG. NO.	REFERENCE	NO	REVISIONS	BY	DATE
14CQ-650-P-002-39	ALIGNMENT SHEET	A	ISSUED FOR FERC		6/15

TRACT TX-BR-OFF-1938.000 BRAZORIA COUNTY, TEXAS

NOTES:

1. CONTRACTOR SHALL INSTALL THE PIPELINE PER THE RESIDENTIAL CONSTRUCTION IMPLEMENTATION PLAN.
2. CONTRACTOR SHALL ERECT A TEMPORARY SAFETY FENCE BETWEEN THE WORK AREA AND ADJACENT STRUCTURES BEFORE EQUIPMENT IS USED IN ANY PART OF THE RIGHT-OF-WAY AND SHALL BE REMOVED ONLY AFTER CONSTRUCTION AND RESTORATION IS COMPLETE.
3. CONTRACTOR SHALL MAINTAIN VEHICLE ACCESS TO THE IMPACTED AREA DURING THE CONSTRUCTION PHASE.
4. CONTRACTOR SHALL PROVIDE FUGITIVE DUST ABATEMENT MEASURES.
5. CONTRACTOR SHALL MINIMIZE VEGETATION REMOVAL.
6. CONTRACTOR SHALL LIMIT WORK IN THIS AREA TO DAYLIGHT HOURS.
7. TOPSOIL AND SUBSOIL STORAGE PILES WILL BE ON THE SPOIL SIDE OF THE PROPOSED PIPELINE.
8. EQUIPMENT TRAVEL LANES WILL BE ON THE WORKING SIDE OF THE PROPOSED PIPELINE.
9. TRENCH WILL NOT BE EXCAVATED UNTIL THE PIPE IS READY TO BE INSTALLED AND WILL BE BACKFILLED AS SOON AS POSSIBLE AFTER PIPE INSTALLATION.
10. NO REFUELING OR STORAGE OF HAZARDOUS MATERIALS WILL OCCUR WITHIN 200 FEET OF A PRIVATE WELL.
11. LANDOWNERS SHALL BE NOTIFIED AT LEAST 5 DAYS PRIOR TO CONSTRUCTION.

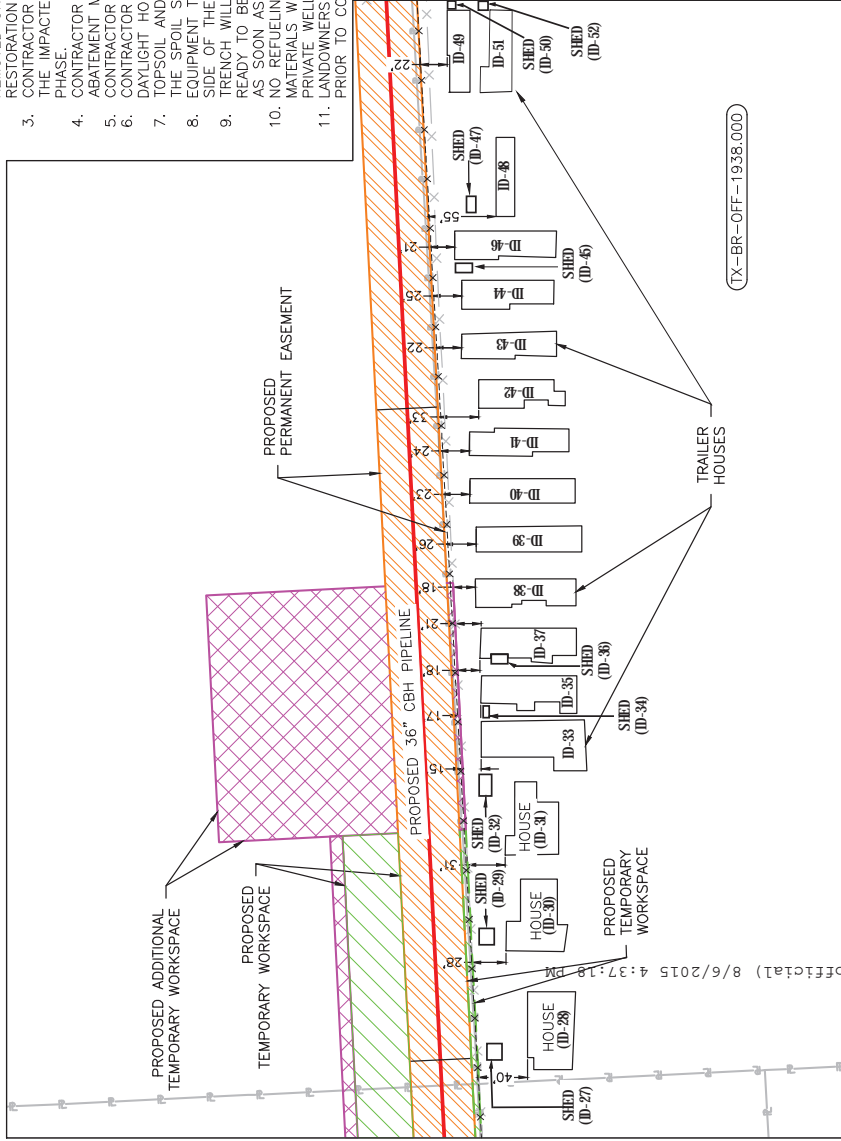

LEGEND

- PROPOSED 36" LINE
- EXISTING LINE MA
- EXISTING BG&E LINE
- PROPERTY LINE
- OVERHEAD POWER
- BURIED WATER LINE
- BURIED POWER LINE
- BURIED TELEPHONE LINE
- BURIED T.V. LINE
- BURIED FIBER OPTIC CABLE
- STREAM
- DITCH
- TOP OF BANK
- EXISTING FENCE
- TEMPORARY SAFETY FENCE
- EDGE OF WOODS
- EDGE OF VEGETATION
- ROAD
- GUARD RAIL
- EXISTING PERMANENT EASEMENT
- PROPOSED PERMANENT EASEMENT
- TEMPORARY WORKSPACE
- ADDITIONAL TEMPORARY WORKSPACE (ATWS)
- CATCH BASIN
- IRON ROD/PIN
- SINGLE POLE/POWER POLE
- GUY WIRE AND ANCHOR
- UTILITY MARKER
- MISC. SIGN
- SANITARY SEWER MANHOLE
- STORM SEWER MANHOLE
- WATER WELL
- FIRE HYDRANT
- ELECTRIC HAND HOLE
- TELEPHONE HAND HOLE
- WATER VALVE
- GAS VALVE
- MISC. VALVE
- VENT
- SEPTIC TANK
- TREE

WILLIAMS ENGINEERS U.S.A. LLC
FIRM REGISTRATION NUMBER: TX-142

PROPOSED 36" CBH PIPELINE RESIDENTIAL CONSTRUCTION		M.P. 57.39 - 57.56
DRAWN BY	JMMINS	DATE
DRAWING CHECK	TLJ	05/27/2015
REVIEW		
SCALE: 0		100FT
DRAWING NUMBER		52715-RES-06
ISSUE		A

NO.	REVISIONS	DATE	BY
A	ISSUED FOR FERC	06/15	
REFERENCE			
NO			

14CQ-650-P-002-39 ALIGNMENT SHEET	
DWG. NO.	

TX-BR-OFF-1938.000

20150615-5154 FERC PDF (Unofficial) 8/6/2015 4:37:18 PM

APPENDIX P

FUGITIVE DUST CONTROL PLAN

FUGITIVE DUST CONTROL PLAN

Construction of the proposed pipelines and facilities will result in fugitive dust emissions, and this *Fugitive Dust Control Plan* (Dust Plan) describes the general control measures to be taken by Gulf South Pipeline Company, LP (Gulf South), construction chief (Chief), environmental inspector(s) (EI), and its contractors (Contractor) to ensure that dust suppression techniques are implemented to control dust sources during construction of the Coastal Bend Header Project (Project). The goal of fugitive dust control is to minimize visible airborne dust to the extent possible. Measures identified herein apply to all work areas and include access roads, temporary workspaces, and other areas used during construction of the Project. Gulf South, the construction Chief, EI(s), and its Contractor will be trained on this Dust Plan prior to initiating construction as part of the Project's Environmental Training Program.

Impacts from fugitive dust would be controlled primarily by the application of water. All source water will be acquired from municipal water sources. The following lists additional dust control measures and best management practices that may be utilized by Gulf South, Chief, EI(s), and its Contractor:

- Take reasonable precautions to minimize fugitive dust emissions from construction activities.
- Apply water, as necessary, to all affected unpaved roads, with special emphasis on locations where residences may be impacted.
- Reduce vehicle speeds on all unpaved roads, and unpaved haul and access roads.
- Clean-up Project ingress and egress points at paved road access intersections, as necessary, to maintain pavement substantially free of mud at all times.
- Construct and maintain construction entrances to prevent tracking mud and soil onto paved roads.
- Soil tracked onto a paved road that extends more than 50 feet from the point of origin will be cleaned up by the Contractor within one hour of discovery.
- Soil tracked onto a paved road that extends less than 50 feet will be cleaned up by the end of the working day.
- Dust will be controlled so that impacts to adjacent residences are kept to a minimum.
- All areas that are not rocked or cultivated will be revegetated following completion of construction in accordance with the Federal Energy Regulatory Commission *Upland*

Erosion Control, Revegetation, and Maintenance Plan and Wetland and Waterbody Construction and Mitigation Procedures.

Both the Chief and the EIs will have stop-work authority if the Contractor does not comply with dust control measures.

APPENDIX Q

ABOVEGROUND FACILITY ALTERNATIVES MAPS

COASTAL BEND HEADER PROJECT - WILSON COMPRESSOR STATION

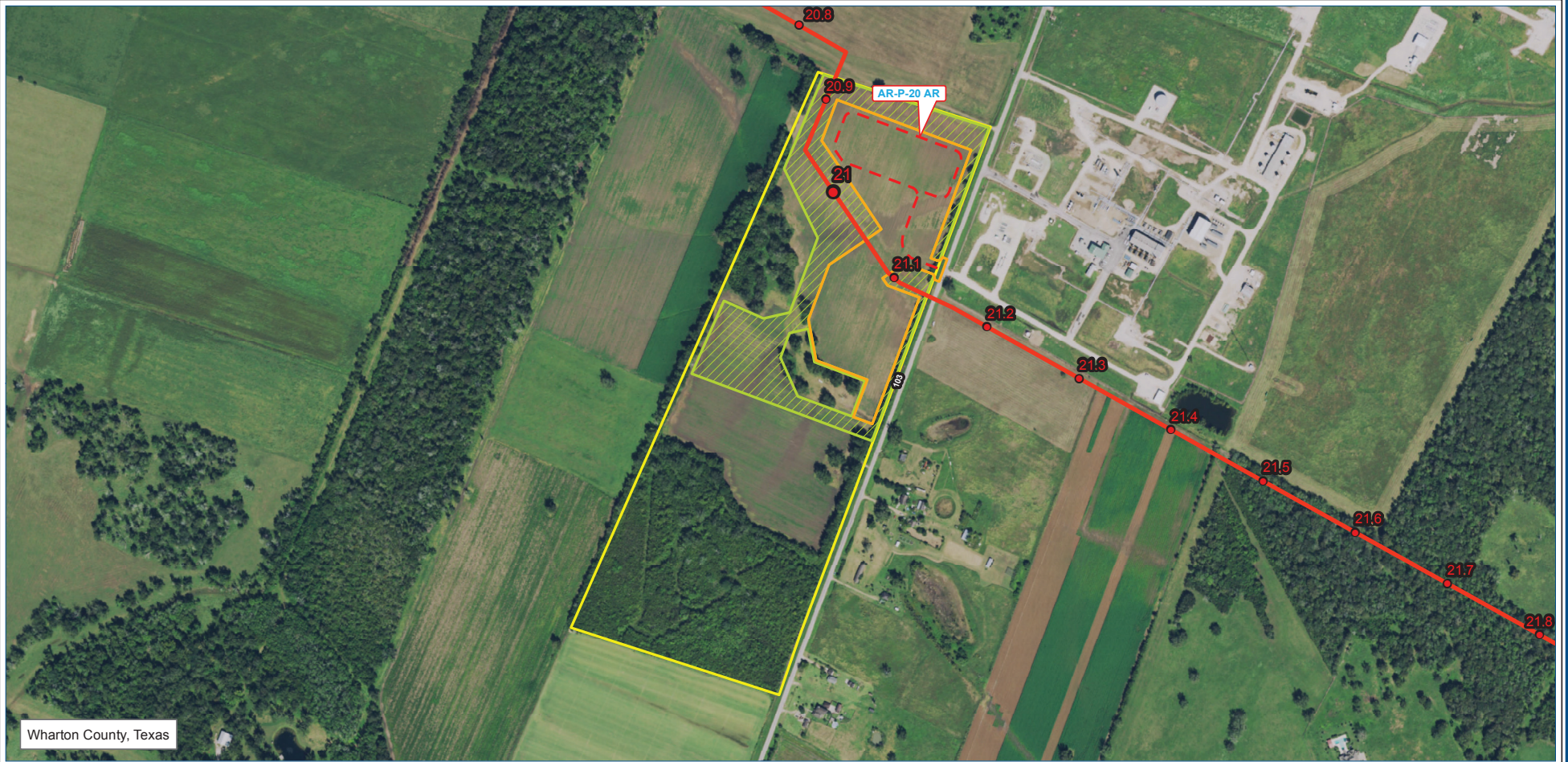

Wharton County, Texas

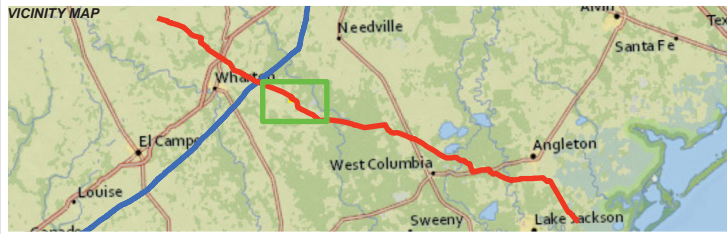

LEGEND

- 10th Milepost
- Milepost
- Coastal Bend Header Project Proposed Pipeline
- ▨ Alternative Site 1 Property Boundary
- ▨ Alternative Permanent Workspace
- ▨ Alternative Temporary Workspace
- - - Access Roads



Date: 7/27/2015 SHEET: 1

COASTAL BEND HEADER PROJECT - WILSON COMPRESSOR STATION



Wharton County, Texas

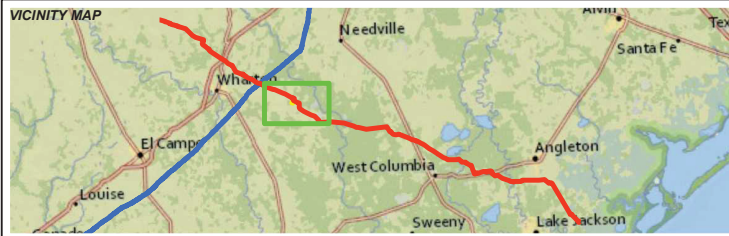

LEGEND

- 10th Milepost
- Milepost
- Coastal Bend Header Project Proposed Pipeline
- ▭ Permanent Workspace
- ▨ Temporary Workspace
- ▭ Proposed Site Property Boundary
- - - Access Roads
- ▨ NWI Wetlands
- NHD Flowline



Date: 6/7/2015 SHEET: 2

COASTAL BEND HEADER PROJECT - WILSON COMPRESSOR STATION



Wharton County, Texas

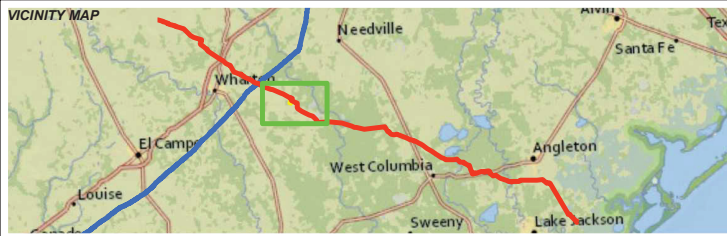

LEGEND

- 10th Milepost
- Milepost
- Coastal Bend Header Project Proposed Pipeline
- Alternative Permanent Workspace
- Alternative Temporary Workspace
- Alternative Site 1 Property Boundary
- - - Access Roads
- ▨ NWI Wetlands
- NHD Flowline



Date: 6/7/2015 SHEET: 3

COASTAL BEND HEADER PROJECT - BRAZOS COMPRESSOR STATION

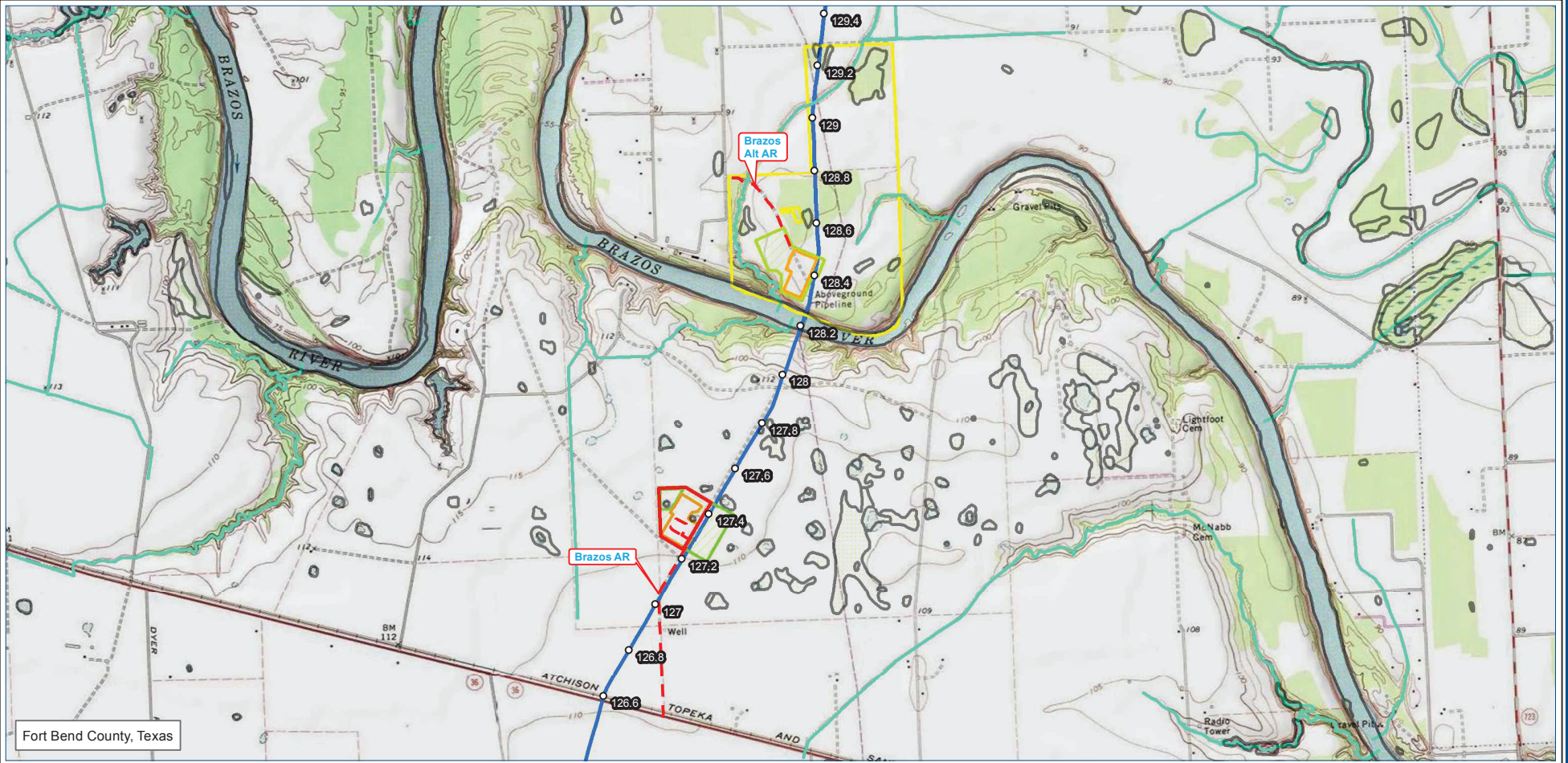

LEGEND

○ Milepost	--- Access Roads
— Existing Index 129 Pipeline	□ Alternative Site 1 Property Boundary
□ Permanent Workspace	— NHD Flowline
□ Temporary Workspace	▨ NWI Wetlands
□ Proposed Site Property Boundary	



GULF SOUTH
PIPELINE
A subsidiary of Boardwalk Pipeline Partners, LP

Date: 6/7/2015 SHEET: 4

COASTAL BEND HEADER PROJECT - BRAZOS COMPRESSOR STATION

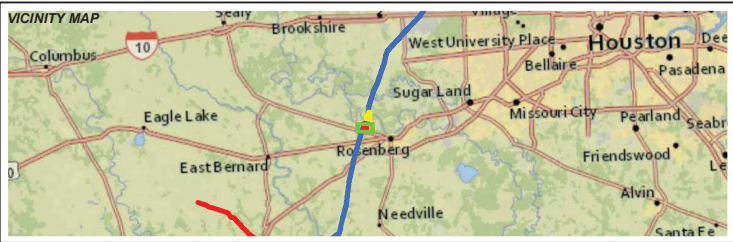
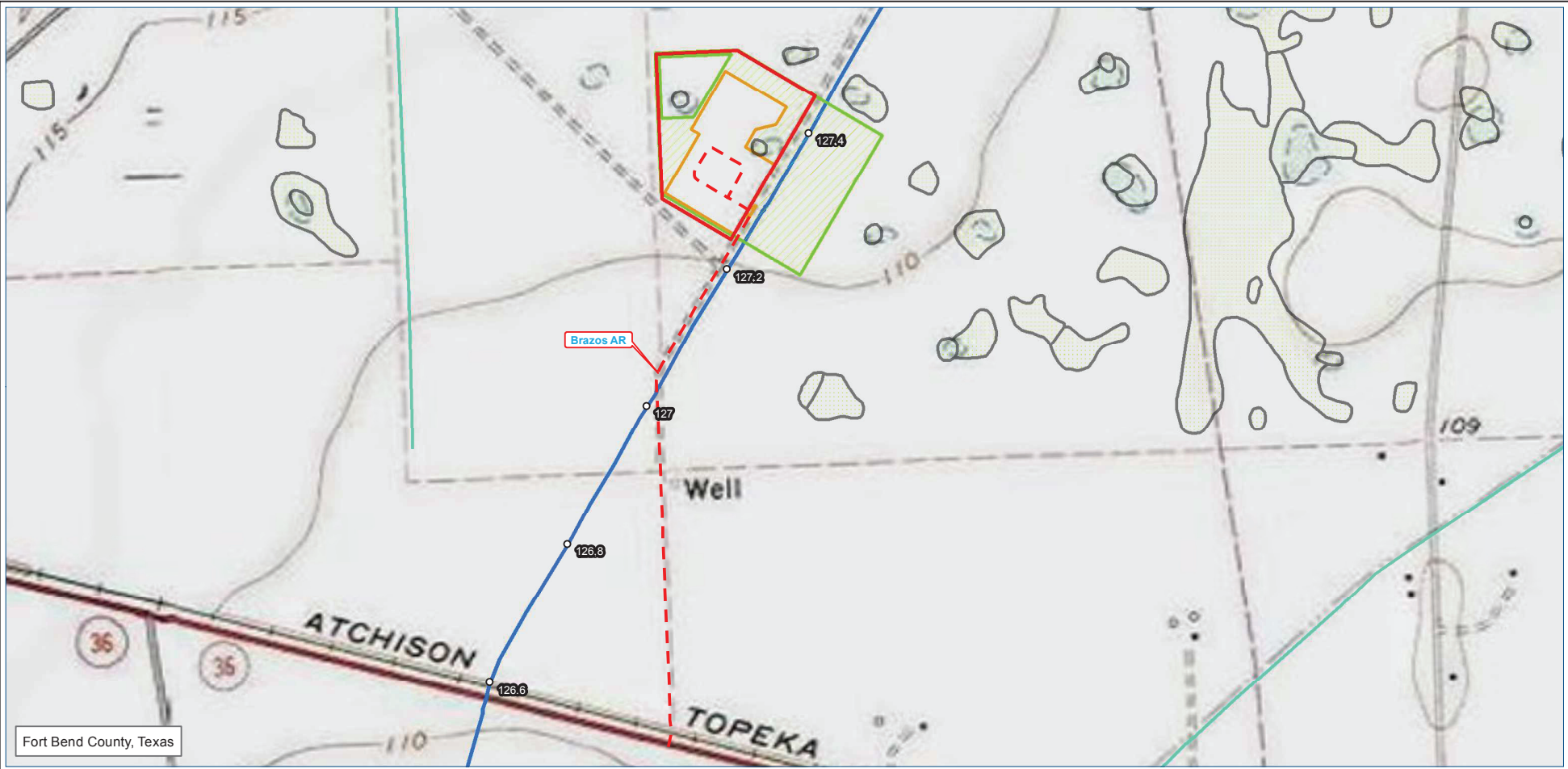

LEGEND

○ Milepost	- - - Access Roads
— Existing Index 129 Pipeline	— NHD Flowline
Permanent Workspace	NWI Wetlands
Temporary Workspace	
Proposed Site Property Boundary	



GULF SOUTH
PIPELINE
A subsidiary of Boardwalk Pipeline Partners, LP

Date: 6/7/2015 SHEET: 5

COASTAL BEND HEADER PROJECT - BRAZOS COMPRESSOR STATION

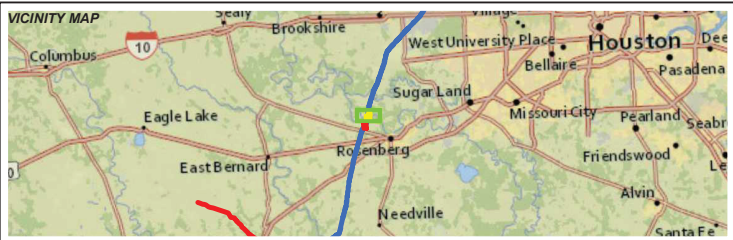
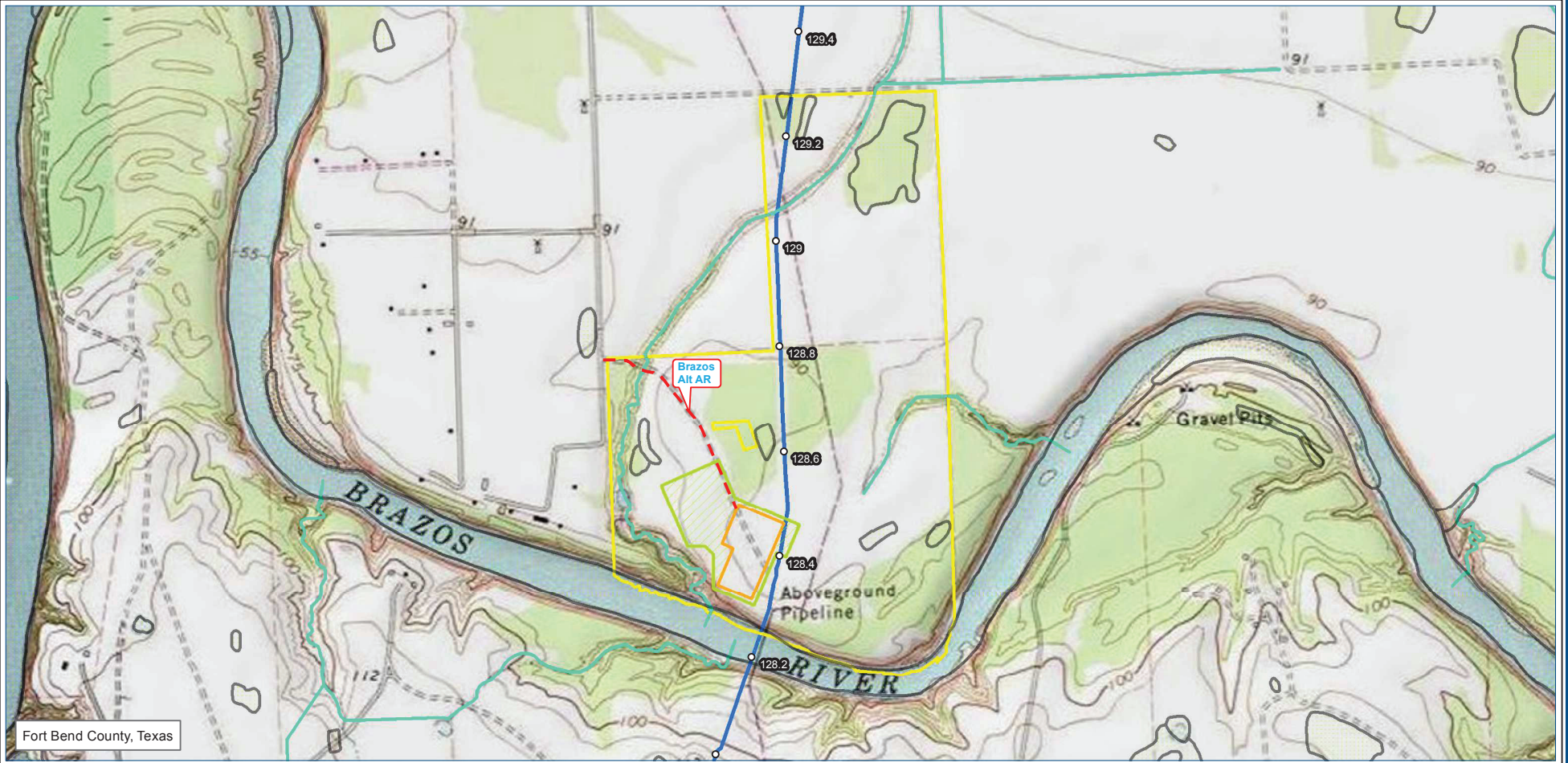

LEGEND

- Milepost
- Existing Index 129 Pipeline
- ▭ Alternative Site 1 Property Boundary
- ▭ Alternative 1 Permanent Workspace
- ▨ Alternative 1 Temporary Workspace
- - - Access Roads
- NHD Flowline
- ▤ NWI Wetlands



GULF SOUTH
PIPELINE
A subsidiary of Boardwalk Pipeline Partners, LP

Date: 6/10/2015 SHEET: 6

COASTAL BEND HEADER PROJECT - NORTH HOUSTON COMPRESSOR STATION



LEGEND

- MP
- Existing Index 129 Pipeline
- ▭ Proposed Site
- ▭ Alternative Sites



GULF SOUTH PIPELINE
A subsidiary of Boardwalk Pipeline Partners, LP

Date: 3/5/2015 SHEET: 7

COASTAL BEND HEADER PROJECT - NORTH HOUSTON COMPRESSOR STATION

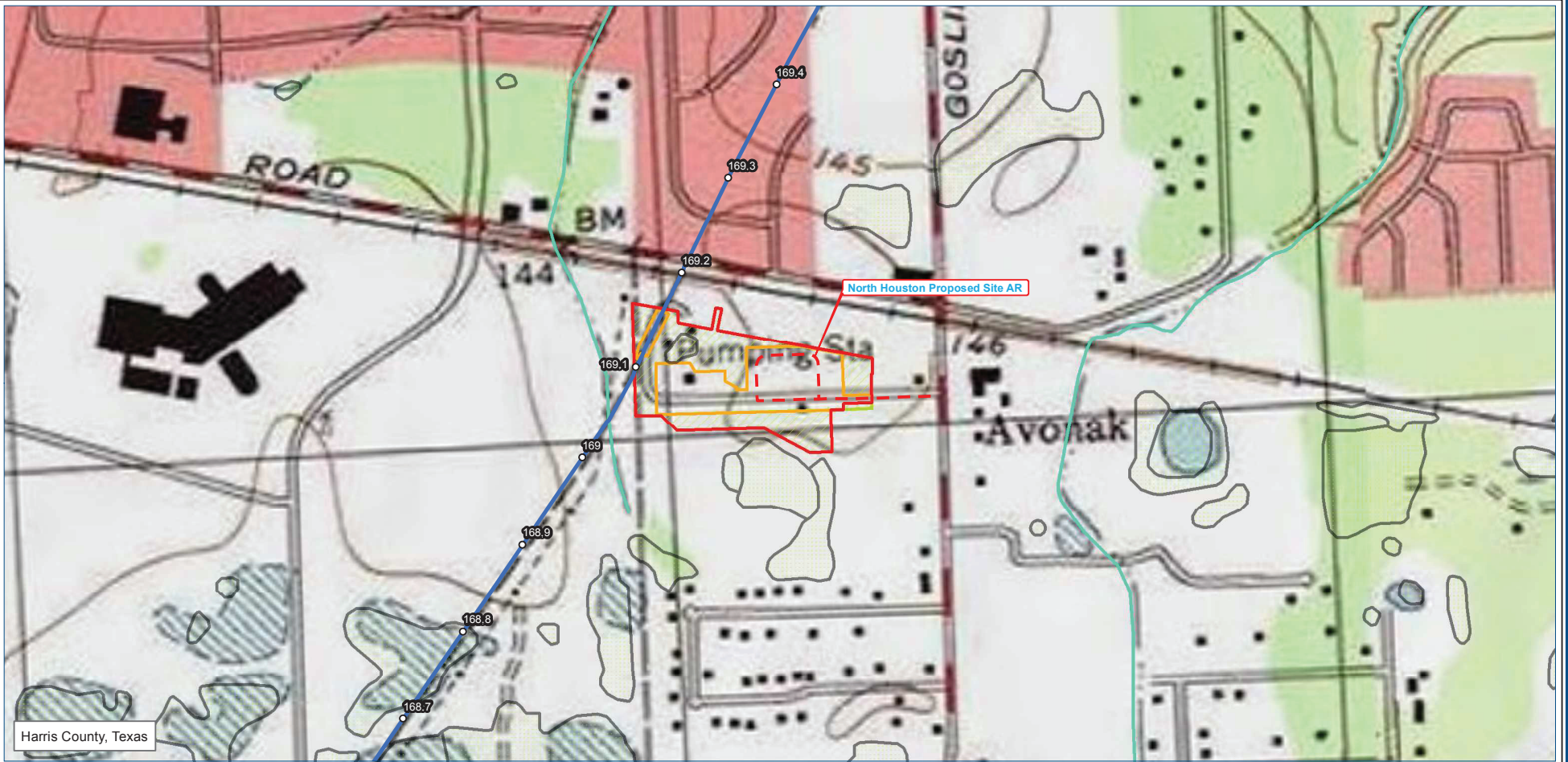

LEGEND

○ Milepost	--- Access Roads
— Existing Index 129 Pipeline	▨ NWI Wetlands
▨ Permanent Workspace	— NHD Flowline
▨ Temporary Workspace	
▭ Reduced Proposed Site Property Boundary	



GULF SOUTH PIPELINE
A subsidiary of Boardwalk Pipeline Partners, LP

Date: 6/8/2015 SHEET: 8

COASTAL BEND HEADER PROJECT - NORTH HOUSTON COMPRESSOR STATION



LEGEND

○ Milepost	- - - Access Roads
— Existing Index 129 Pipeline	▨ NWI Wetlands
▨ Alternative 1 Permanent Workspace	— NHD Flowline
▨ Alternative 1 Temporary Workspace	
▭ Alternative Site 1 Property Boundary	



GULF SOUTH
PIPELINE
A subsidiary of Boardwalk Pipeline Partners, LP

Date: 6/8/2015 SHEET: 9

COASTAL BEND HEADER PROJECT - NORTH HOUSTON COMPRESSOR STATION

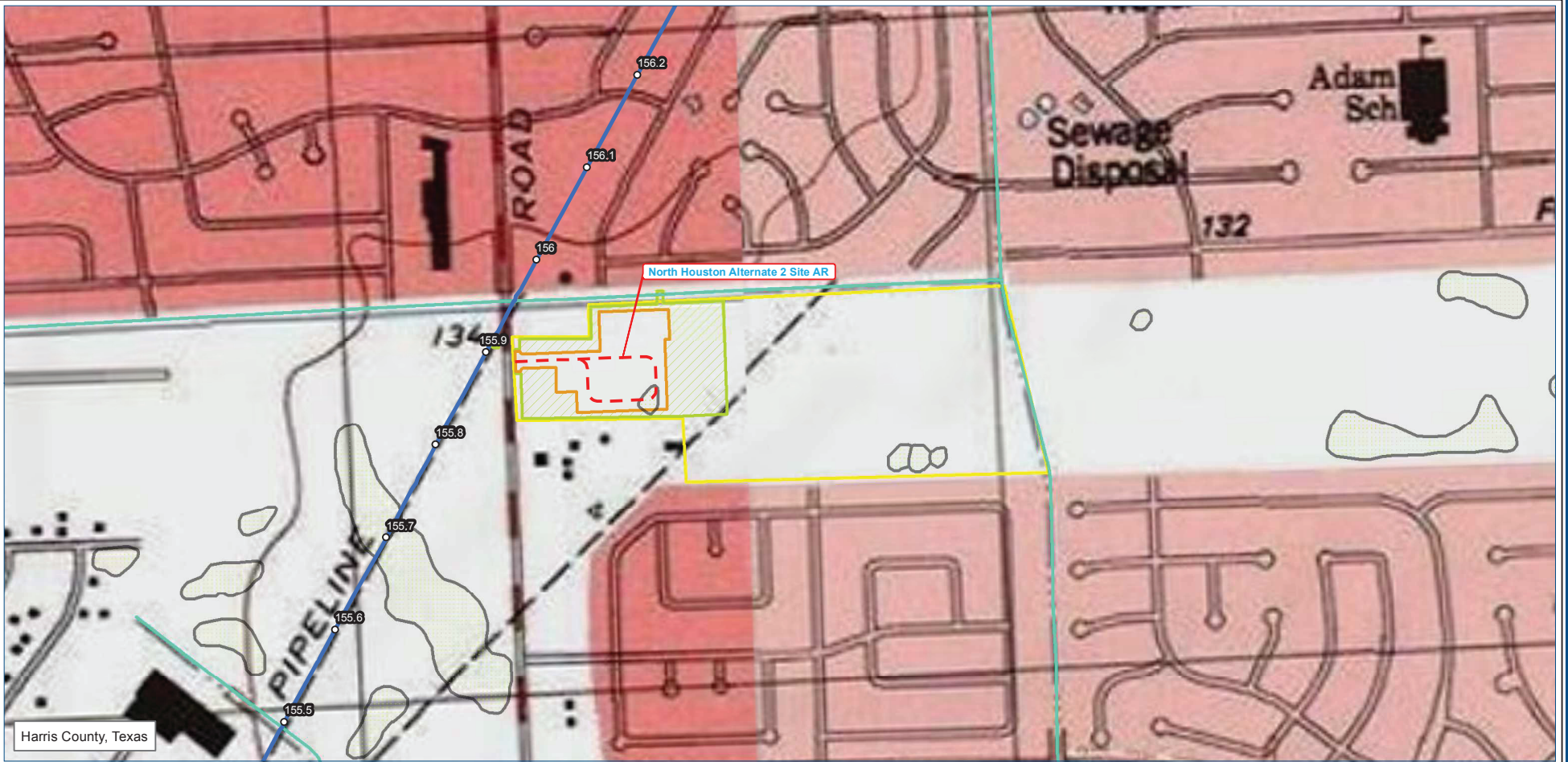

LEGEND

○ Milepost	- - - Access Roads
— Existing Index 129 Pipeline	▨ NWI Wetlands
▨ Alternative 2 Permanent Workspace	— NHD Flowline
▨ Alternative 2 Temporary Workspace	
▭ Alternative Site 2 Property Boundary	



GULF SOUTH PIPELINE
A subsidiary of Boardwalk Pipeline Partners, LP

Date: 6/8/2015 SHEET: 10

Document Content(s)

Volume I Coastal Bend Header Final EA.PDF.....	1-186
Volume II Coastal Bend Header Appendices.PDF.....	187-307
Volume III Coastal Bend Header Appendices.PDF.....	308-419