

The Ecology of the Sapelo Island

National Estuarine Research Reserve



Edited by Alice G. Chalmers, University of Georgia
Marine Institute, Sapelo Island, Georgia



***The Ecology of the Sapelo Island
National
Estuarine Research Reserve***

Alice G. Chalmers
University of Georgia Marine Institute
Sapelo Island, GA 31327

Prepared for the Sapelo Island National Estuarine Research Reserve
and the Georgia Department of Natural Resources

This publication was made possible through grant #NA470R0414
from the National Oceanic and Atmospheric Administration

National Oceanic and Atmospheric Administration
Office of Coastal Resource Management
Sanctuaries and Reserves Division

Georgia Department of Natural Resources
Parks and Historic Sites Division

1997

Preface

Our nation's estuaries are extremely valuable. Human activities such as dredging and filling have damaged many estuaries in modern times. Based on its concern for these areas, the United States Congress, in 1972, enacted the Coastal Zone Management Act to provide federal aid to the individual states to establish and manage natural field laboratories for research and education.

Sapelo Island's Duplin River estuary lies about midway on the Georgia coast between the Savannah and St. Marys rivers. Throughout its history it has received protection by public and private landowners and, since the early 1950s, Sapelo Island has been the focus of ecological and archaeological research. In 1975, the state of Georgia proposed the Duplin estuary as a National Estuarine Sanctuary. The U.S. Department of Commerce studied and approved the Georgia proposal, the state completed its land acquisition and, on December 22, 1976, the site received formal designation as the Sapelo Island National Estuarine Sanctuary, later Estuarine Research Reserve.

Since then, the Department of Commerce has designated 20 other estuarine areas nationwide as part of the National Estuarine Research Reserve program. The National Oceanic and Atmospheric Administration (NOAA) administers this system for Commerce. As part of the national program, Sapelo Island represents Georgia in the Carolinian biogeographic region and it is the focus for NERR support of estuarine scientific research and education in Georgia.

The Duplin River estuary includes unspoiled coastal salt marsh and tidal creeks, areas that are among the earth's most biologically productive systems. They began forming at the present location several thousand years ago; the ability of the tidal marshes to produce food has captured the interest of man since pre-historic times. More recently, people have come to the system for scientific research, education and recreation.

The Sapelo Island National Estuarine Research Reserve has several primary functions, among them to provide opportunities for scientists to investigate the workings of estuarine systems, public education and compatible recreation and to protect and monitor the Reserve's natural and cultural resources. About 6,000 visitors a year participate in the SINERR's public tour program and organized educational activities. The Georgia Department of Natural Resources, the University of Georgia Marine Institute and NOAA have a large public audience for programs about estuaries and the SINERR is excellent location to present these types of programs.

The 16,500 acres that make up Sapelo Island include the SINERR. Sapelo represents a direct investment of some \$5 million in state and federal funds. The Reserve occupies just over one third of the island, comprising the Duplin River estuary and several

upland tracts. In all, the Reserve has 2,100 acres of uplands and 4,000 acres of tidal salt marsh. NOAA provided a grant of \$1.5 million to help the state of Georgia acquire 2,094 acres of the SINERR.

Primary management goals for the SINERR include:

- a. maintaining the integrity of the Reserve for research and educational programs;
- b. protecting its lands and waters from stress and alteration;
- c. promoting quality public access to Sapelo Island for nature interpretation and low-intensity recreation;
- d. promoting and encouraging improved scientific understanding of estuarine ecosystems.

Georgia DNR has administrative offices within the SINERR. In addition the University of Georgia has a major research facility within the Reserve, the UGA Marine Institute. Visitor activities include guided interpretive tours, hunting, fishing, nature study and camping. DNR manages the Reserve for NOAA, coordinates the public tours through a mainland Interpretive Center, presents on-site and off-site educational programming, manages Sapelo Island's wildlife and forest resources, enforces conservation laws on the island and operates a public ferry to provide the primary means of access to the Reserve and the island in general. The Reserve contracts with the UGA Marine Institute to conduct continuous scientific monitoring at four sites on the Reserve with regularly collected data being compiled and reported to NOAA on a quarterly and annual basis.

This comprehensive site ecological profile has been made possible by grant funding provided by NOAA to the Sapelo Island NERR. The UGA Marine Institute was awarded a contract in late 1994 to begin work on the site profile. The Sapelo Reserve is the fourth Reserve in the national system to complete its site profile. NOAA is encouraging the other Reserves in the System to compile similar profiles as well. The SINERR management and staff would like to thank the UGMI and its lead investigator on this project, Dr. Alice Chalmers, for their efforts in compiling this document, which should provide a valuable tool for coastal managers and planners in the future management and protection of Georgia's vital coastal resources.

Buddy Sullivan, Manager
Sapelo Island National Estuarine Research Reserve
March 1997

Table of Contents

Preface	i
Table of Contents	iii
List of Tables	v
List of Figures	v
Introduction by Buddy Sullivan	vii
The Sapelo Island National Estuarine Research Reserve and Sapelo Island	1
REGIONAL SETTING OF SINERR	1
Climate	1
HISTORY OF HUMAN ACTIVITY ON SAPELO ISLAND	4
Prehistoric Indians	4
Early Spanish, French and English	6
Thomas Spalding	7
Howard Coffin	8
R. J. Reynolds	9
CURRENT USE AND OWNERSHIP OF SAPELO ISLAND	10
The Department of Natural Resources	10
SINERR	10
R. J. Reynolds Wildlife Management Area	12
The Sapelo Island Natural Area	12
The Reynolds Mansion	13
The University of Georgia Marine Institute	13
The Hog Hammock Community	13
POPULATION AND DEVELOPMENT OF NEARBY COASTAL AREAS	14
Geological and Hydrological Characterization of SINERR	14
GEOLOGICAL SETTING	14
TIDAL CONDITIONS	15
HYDROLOGY OF THE DUPLIN RIVER	15
GEOMORPHOLOGY OF THE DUPLIN RIVER WATERSHED	16
BEACH MORPHOMETRY AND THE SAND-SHARING SYSTEM	19
Ecological Studies in the SINERR	21
AQUATIC HABITAT	21
INTERTIDAL HABITAT	23
UPLAND HABITAT	27
BEACH AND DUNES	28
PRIMARY PRODUCTION	37
DECOMPOSITION	37
HYPOTHESES AND PARADIGMS	38
CHEMICAL STUDIES IN THE SINERR by James J. Alberts	42
INORGANIC CHEMICALS	42
Atmospheric Inputs	42
Major Elements, Trace Metals and Organometallics	43
Elemental Redox Cycles	43

Iron and Manganese Cycling	44
ORGANIC MATTER	44
Occurrence	44
Plants and POC	45
Polysaccharides	45
LIGNIN	45
HUMIC SUBSTANCES	47
Occurrence	47
Utilization	48
Chemical Characterization	48
CHEMICAL REACTIONS	49
Inorganic Reactions	49
Organic Reactions	49
Flux Calculations	50
MISCELLANEOUS ANTHROPOGENIC CHEMICALS	50
Sewage Sludge, Dredge Spoil and Pulp Mill Effluents	50
RESEARCH NEEDS	51
Research and Monitoring Goals	52
RESEARCH	52
MONITORING	53
The Future of SINERR: Management Questions and Research Needs	54
Acknowledgments	55
References	56
Appendix 1. Vegetation of Sapelo Island	A.1
Appendix 2. Selected List of Invertebrates (Excluding Insects and Arachnids) in Tidal Salt Marshes of the Southeastern Atlantic Coast	A.15
Appendix 3. Selected List of Insect and Arachnid Families in Tidal Salt Marshes of the Southeastern Atlantic Coast	A.19
Appendix 4. Selected List of Fish Found in Estuarine Waters Near Sapelo Island	A.23
Appendix 5. Reptiles and Amphibians Known or Likely to Occur on Sapelo Island	A.27
Appendix 6. Birds of Sapelo Island	A.30
Appendix 7. Mammals Known or Likely to Occur on Sapelo Island	A.37
Appendix 8. List of selected publications from the University of Georgia Marine Institute	A.39

List of Tables

Table 1. Comparison of High Marsh (SS) and Low Marsh (TS) at Sapelo Island.	24
Table 2. Summary of salt marsh energetics (from Teal, 1962).	38

List of Figures

Figure 1. Location of Sapelo Island and SINERR.	1
Figure 2. Temperatures at Sapelo Island, 1964 - 1994. Measured at the National Weather Service station at the University of Georgia Marine Institute.	2
Figure 3. Rainfall at Sapelo Island, measured at the National Weather Service station at the University of Georgia Marine Institute.	3
Figure 4. Storm tracks of hurricanes within 50 miles of Sapelo.	4
Figure 5. Some points of interest on Sapelo Island.	5
Figure 6. The Duplin River Watershed.	6
Figure 7. Administrative units on Sapelo Island.	11
Figure 8. Location of monitoring stations. ML - Marsh Landing; BC - Barn Creek; FD - Flume Dock.	12
Figure 9. Idealized cross-section of an intertidal salt marsh, based on Frey and Basan (1985).	17
Figure 10. Schematic diagram of the three stages of marsh maturation. 1) Youthful, with high drainage density and high proportion of low marsh; 2) Intermediate; 3) Mature, with low drainage density and high proportion of high marsh. (After Frey and Basan, 1985.)	17
Figure 11. Distribution of the three major physiographic regions of the Duplin River tidal salt marshes. (From Wadsworth, 1980.)	18
Figure 12. Patterns of drainage density in the three physiographic regions of the Duplin River salt marshes: a) high drainage density, young marsh; b) intermediate drainage density and age; c) low drainage density, mature marsh. (From Wadsworth, 1980.)	18
Figure 13. Idealized cross-section of Sapelo Island.	19
Figure 14. The black line shows the approximate location of the 1953 shoreline in relation to the 1989 shoreline in the photograph.	20
Figure 15. Temperature, salinity and pH in the Duplin River for 1986 -1994.	22
Figure 16. Network of GPS Control Points.	30
Figure 17. Boundaries of 5 watersheds on Sapelo Island with the water bodies they drain into.	31
Figure 18. Some results of land cover/land use change analysis of Sapelo Island, 1953 - 1989. (From Welch <i>et al.</i> , 1992.)	31
Figure 19. Soil types of Sapelo Island. From McIntosh County, Georgia Soil Survey, 1959. United States Department of Agriculture, Soil Conservation Service.	32
Figure 20a. Legend. Land use/cover for the SINERR and Sapelo Island, 1953 to 1989 based on aerial photographs and generated using the ARC/INFO geographic information system by the Center for Remote Sensing and Mapping Science, Department of Geography, The University of Georgia.	33

Figure 20b. Land use/cover for the SINERR and Sapelo Island, 1953 based on aerial photographs and generated using the ARC/INFO geographic information system by the Center for Remote Sensing and Mapping Science, Department of Geography, The University of Georgia. See Fig. 20a for legend.	34
Figure 20c. Land use/cover for the SINERR and Sapelo Island, 1974 based on aerial photographs and generated using the ARC/INFO geographic information system by the Center for Remote Sensing and Mapping Science, Department of Geography, The University of Georgia. See Fig. 20a for legend.	35
Figure 20d. Land use/cover for the SINERR and Sapelo Island, 1989 based on aerial photographs and generated using the ARC/INFO geographic information system by the Center for Remote Sensing and Mapping Science, Department of Geography, The University of Georgia. See Fig. 20a for legend.	36
Figure 21. Teal's energy flow diagram of the salt marsh. Numbers are kcal m ⁻² yr ⁻¹ . (From Teal, 1962.)	38
Figure 22. Conceptual model summarizing net carbon balance in a Georgia salt marsh. Numbers are g C m ⁻² yr ⁻¹ (Data from Chalmers <i>et al.</i> , 1985.)	39
Figure 23. Diagrammatic representation of pathways of carbon relocation within the marsh. (From Chalmers <i>et al.</i> , 1985.)	40
Figure 24. A conceptual model of the coastal interface system. A = autotroph, H = heterotroph, OM = organic matter. (From Hopkinson and Hoffman, 1984.)	41
Figure 25. Conceptual models of carbon flow in the Georgia Duplin River estuary and nearshore ecosystems. Estuarine subsystems are the salt marsh proper (top) and adjacent tidal creeks and rivers. The whole estuarine system consists of both salt marsh and tidal creeks and rivers. The nearshore is the area out to 3.2 km from shore. Numbers are g C m ⁻² yr ⁻¹	42

Introduction

by Buddy Sullivan

In 1972, Congress passed the Coastal Zone Management Act (CZMA). In the CZMA, and its subsequent reauthorizations, Congress officially recognizes that resources of the coastal zone are of national significance and are rapidly disappearing. The CZMA also recognizes the interrelationships between uplands and tidelands. The "coastal zone" was defined in the Act as including all uplands "to the extent necessary to control shorelands." The CZMA established as a national goal "to preserve, protect, develop and, where possible, to restore and enhance the resources of the nation's coastal zone for this and succeeding generations."

Section 315 of the CZMA of 1972, as amended, establishes the National Estuarine Research Reserve System. Under the system, healthy estuarine ecosystems which typify different regions of the U.S. are designated and managed as sites for long-term research, and used as a base for estuarine education and interpretive programs. The system also provides a framework through which research results and techniques for estuarine education and interpretation can be shared throughout the region and across the nation.

As stated in the Coastal Zone Management Act, the National Estuarine Research Reserve System provides for "the establishment and management, through Federal-state cooperation, of a national system of Estuarine Research Reserves representative of the various regions and ecological types in the United States. Estuarine Research Reserves are established to provide opportunities for long-term research, education and interpretation."

Prior to the establishment of the NERR system, scientific understanding of estuarine processes was increasing slowly and without national coordination. There was no ready mechanism for the detection and measurement of local, regional or national trends in estuarine conditions. Resource managers, governments and the public did not always have access to information about the significance and ecology of their estuaries, could not assess the full impact of past activities, and could not readily anticipate the damaging effects of proposed management and development policies. NERR System research and education can help fill those gaps in knowledge and guide estuarine management for sustained support of commercial and recreational fisheries, tourism and other activities.

NERRS sites serve as laboratories and classrooms where the effects of both natural and human activity can be monitored and studied. There are currently 22 Estuarine Research Reserves comprising 445,000 acres in 17 states and Puerto Rico. Through careful management of these resources, generations of scientists, fishermen, naturalists and others will come to experience the beauty to be found where rivers return to the sea.

The Sapelo Island National Estuarine Research Reserve lies in the midst of an estuary where the currents of Doboy Sound and the Duplin River meet. The Reserve comprises 6,110 acres and encompasses ecologies typical of the Carolinian biogeographic

region and incorporates a coastline characterized by expanses of tidal salt marshes protected by a chain of barrier islands. The SINERR contains about 2,200 acres of upland forest dominated by stands of southern live oak hardwoods, pine (longleaf and loblolly), white-tailed deer, wild turkey and numerous other forms of wildlife. Two-thirds of the Reserve is comprised of expansive belts of salt marsh, which host a wealth of inhabitants. Members of this diverse salt marsh community feed and reproduce in the marshes and along the exposed river and creek banks at low tide. The Reserve also includes large areas of beach and dune communities fronting the Atlantic Ocean, as well as a network of oak, cedar and palm upland hammocks scattered through the marsh and beach areas.

The Reserve annually receives funds from the National Oceanic and Atmospheric Administration (NOAA), supplemented by matching state funds to conduct various educational and scientific monitoring programs. Part of the monitoring program has entailed the preparation of this ecological site characterization profile. This project began in late 1994 with a contract between the Georgia Department of Natural Resources, which manages the Reserve, and the University of Georgia Marine Institute. The UGMI, with funding provided by the Reserve's annual operations grant award from NOAA, has prepared this document based, in part, on the forty-five years of scientific research its resident faculty members have conducted on Sapelo Island, primarily within the boundaries of the Estuarine Research Reserve. This ecological profile contains a diverse range of material, including:

1. The story of human activity on Sapelo Island, current use and ownership of the island and the regional setting of the SINERR, including the commercial and recreational utilization of Georgia estuarine areas;
2. The geological and hydrological characterization of the SINERR, to include the development of lagoonal marshes, tidal conditions, hydrology of the Duplin River, geomorphology of the Duplin River, influence of the Altamaha River and upland runoff, and beach morphology and the sand-sharing system;
3. Ecological habitats of the Reserve, including (a) aquatic, Duplin River and Doboy Sound; and (b) intertidal, mudflats and mudbanks, intertidal creeks, vegetated salt marsh and high marsh, beaches and sand dunes, forested uplands, vegetation patterns and shoreline changes through time utilizing Geographic Information System (GIS) and historical maps and photos to document changes;
4. Chemical characterization of aquatic and marsh habitats, including water column (carbon, nitrogen, phosphorous and silica nutrients), marsh sediments and biota;
5. Primary productivity (water column and salt marsh);
6. Secondary productivity, including the Duplin River (zooplankton, crabs and fish) and salt marsh (fiddler crabs, snails and tidal migratory organisms);
7. Organic matter;

8. Detritus foodweb and outwelling (hypotheses and paradigms about SINERR marshes), including early mass balance studies and models, the salt marsh as a nursery, coupling of marsh to nearshore and riverine influences on marsh and nearshore.
9. The future of the SINERR: management and recommendations.

The Ecological Profile of Sapelo Island is a document to be read and understood by the concerned citizen, by monitoring groups and management agency personnel, and by scientists studying this and similar estuarine systems. Much of the material referenced is necessarily very technical, but the Profile itself should give a useful overview of the ecology of the Sapelo Island National Estuarine Research Reserve to anyone with the interest to read it.

The Sapelo Island National Estuarine Research Reserve and Sapelo Island

The Sapelo Island National Estuarine Research Reserve was established in December 1976 in the Duplin River watershed of McIntosh County, Georgia, on the western side of Sapelo Island (Fig. 1). Sapelo Island and its surrounding marshes have been the focus of ecological and geological research since the early 1950s; archaeological research has

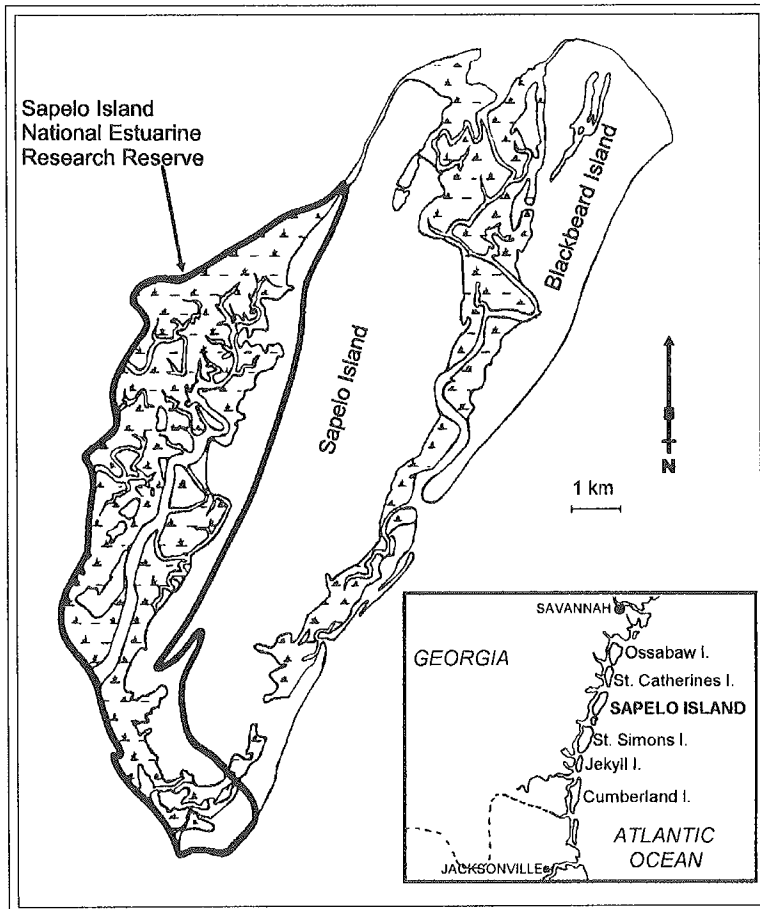

Figure 1. Location of Sapelo Island and SINERR.

been conducted on the uplands of Sapelo Island since the late 1800s. In 1981 *The Ecology of a Salt Marsh* (Pomeroy and Wiegert, 1981) was published, synthesizing much of the research that had been done in the SINERR and describing quite thoroughly our understanding of the ecology of the marsh as it stood at that time. This profile presents an update of *The Ecology of a Salt Marsh*, reviewing research that has been completed since that book was written, and adding some supplemental information that was not included. Some of the material contained in *The Ecology of a Salt Marsh* is included here for the sake of clarity. For further information on research that has been done in the SINERR and elsewhere on Sapelo Island, the reader may consult the original publications on which this review is based. Scientific publications reporting results of research conducted on Sapelo Island are collected by the University of Georgia Marine Institute and published periodically in their Collected Reprints series. A list of selected papers from the Collected Reprints series can be found in Appendix 8.

REGIONAL SETTING OF SINERR

Climate

Sapelo Island has a subtropical climate with short, mild winters and long, hot, humid summers (Fig. 2a and 2b). The ocean has a moderating effect on temperatures, with

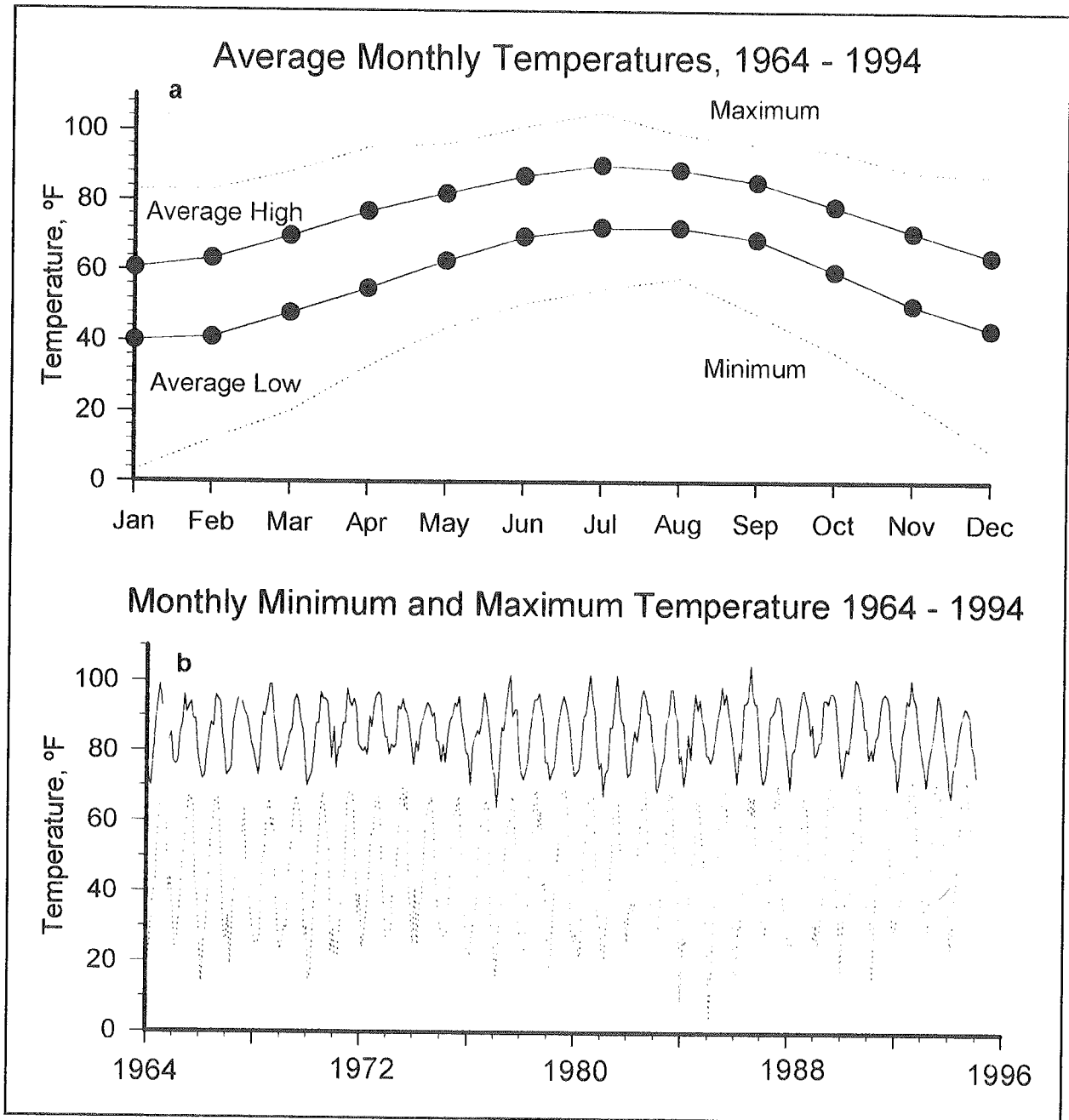

Figure 2. Temperatures at Sapelo Island, 1964 - 1994. Measured at the National Weather Service station at the University of Georgia Marine Institute.

Sapelo Island generally reporting lower maxima and higher minima than are reported from inland areas. Rainfall is heaviest during the summer months (Fig. 3a), when short, intense afternoon thunderstorms are common, and heavy rains associated with hurricanes and tropical storms often impact the area. Total annual rainfall over the 30 year record averaged 51.3 inches, with a minimum of 32.3 and a maximum of 66.9 inches (Fig. 3b). Although there are cycles of wet and dry years (Fig. 3b), it is unusual to have a month

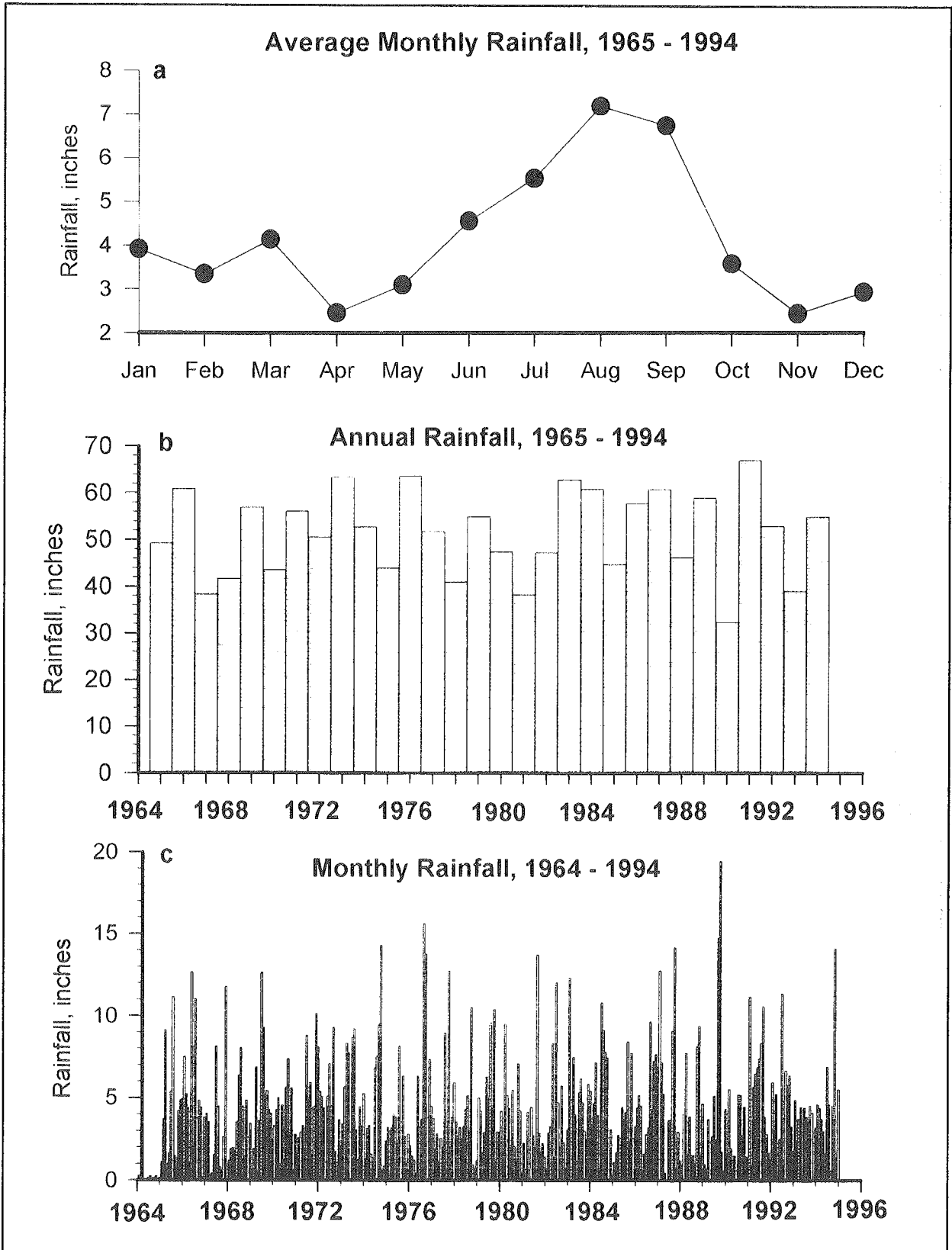

Figure 3. Rainfall at Sapelo Island, measured at the National Weather Service station at the University of Georgia Marine Institute.

go by with no rain; totally dry months occurred only 3 times during the 30 year period (Fig. 3c). On average, there is less than one month a year when rainfall is less than one inch.

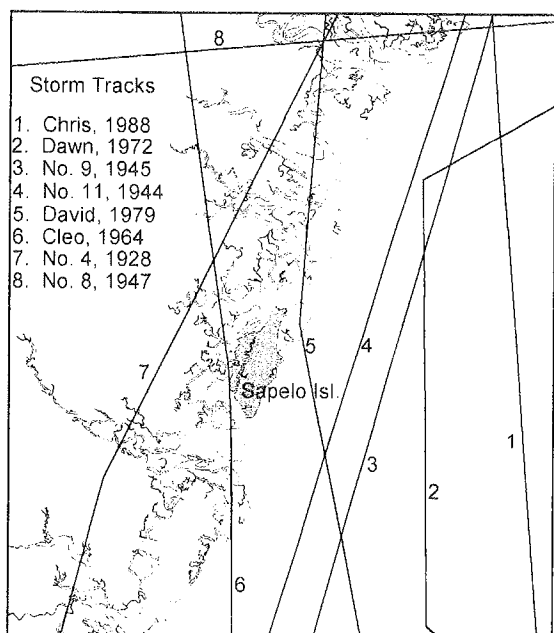

Figure 4. Storm tracks of hurricanes within 50 miles of Sapelo.

Sapelo Island has not suffered severe damage from a hurricane since the late nineteenth century, but has been brushed by several which have caused moderate wind damage and erosion. A database of hurricanes which have hit the U.S. since 1900 contains only 8 storms which passed within 50 miles of Sapelo (Fig. 4). Winter storms (northeasters) have typically caused more beach erosion than hurricanes and tropical storms in recent years.

HISTORY OF HUMAN ACTIVITY ON SAPELO ISLAND

The following account is a brief overview of the history of Sapelo, with emphasis on activities that have some bearing on the ecological conditions on Sapelo today. Sapelo Island has been occupied, protected and managed by its private and, in recent years, public owners for over 200 years. We know little about ways

in which native Americans, the earliest occupants of Sapelo Island, might have altered or managed the environment. We do know that beginning with settlement by Europeans and continuing to the present, major changes have been made in the vegetation and topography of the island.

Prehistoric Indians

The earliest inhabitants of Sapelo Island were prehistoric Indians. Shell middens, mounds, and pottery fragments provide ample evidence of their presence from 4000 BP up through the influx of Europeans during the eighteenth century, when they were known as the Guale. Artifacts excavated from the Shell Ring, on the northwestern side of the island between Chocolate and High Point (Fig. 5), have been carbon-dated to 4120 ± 200 BP (Simpkins, 1975). Excavations at Kenan Field, within the Reserve, and Bourbon Field, on the northeastern side of the island, have shown that villages were located at these two sites (Crook, 1978). The village at Kenan Field covered at least 60 hectares, and artifacts recovered there have been carbon-dated to AD 1155 ± 75 (Crook, 1980).

In general, the sites of Indian habitation occur on Pleistocene sand ridges with elevations of 2 to 5 meters (McMichael, 1977). The vegetation at these sites is described as Maritime Live Oak Forest (Johnson *et al.*, 1974), dominated by live oak (*Quercus virginiana*)

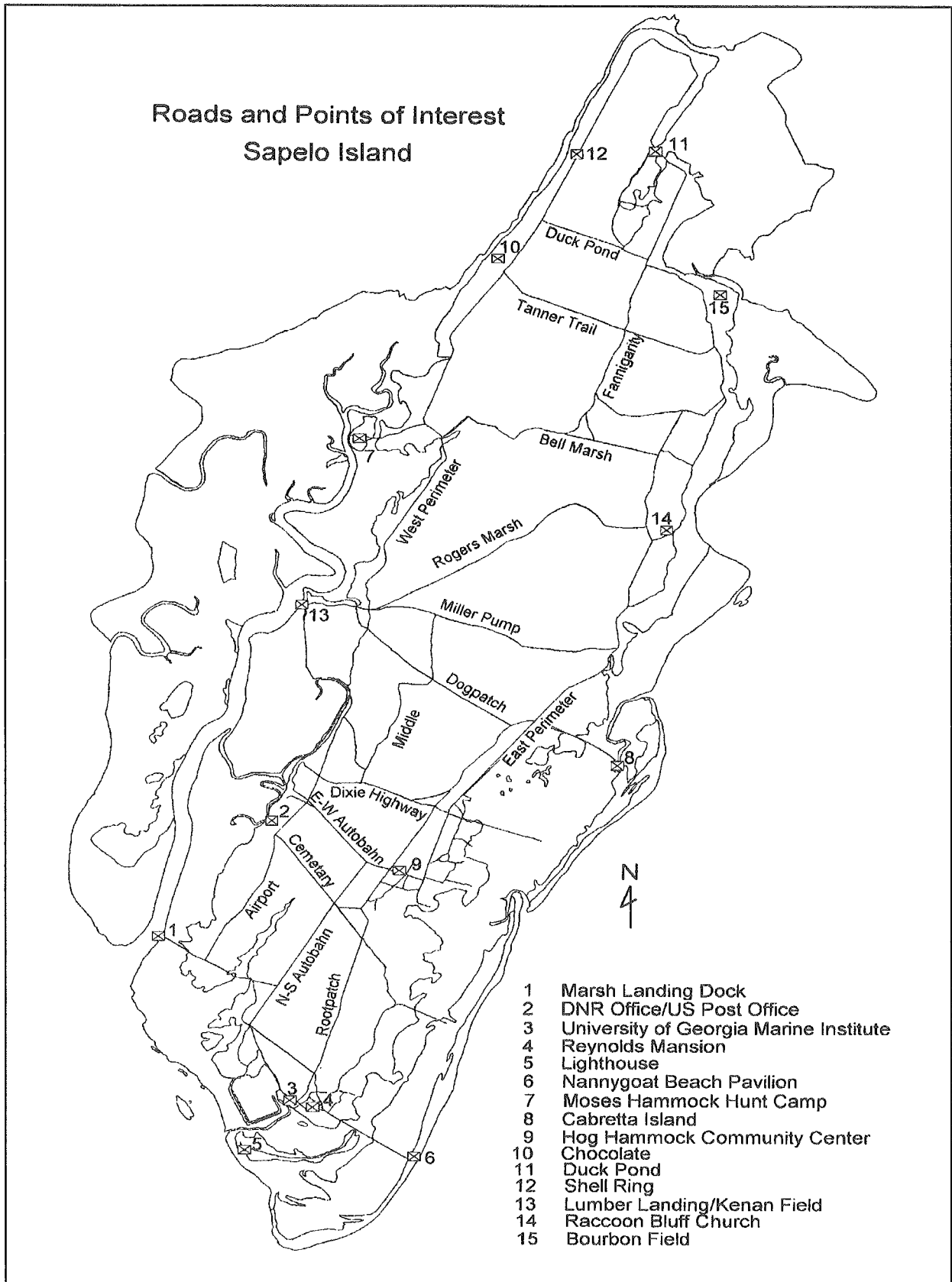

Figure 5. Some points of interest on Sapelo Island.

and Laurel oak (*Q. laurifolia*). Other significant species found in these areas are *Magnolia* spp., pine (*Pinus* spp.), grape (*Vitis* spp.), *Smilax*, red cedar (*Juniperus silicicola*), holly (*Ilex opaca*), mulberry (*Morus rubra*), yaupon (*Ilex vomitoria*), redbay (*Persea borbonia*), sweetbay (*Magnolia virginiana*), hickory (*Carya* spp.), cabbage palm (*Sabal palmetto*), wax myrtle (*Myrica cerifera*), gallberry (*Ilex glabra*), saw palmetto (*Serenoa repens*), and blueberry (*Vaccinium* spp.). All of these species are present on Sapelo today.

In addition to being located at relatively high elevations, sites are usually adjacent to salt marsh rather than at inland sites, and often occur where tidal creeks closely approach the upland (McMichael, 1977). Archaeological evidence indicates that the Indians had a varied diet consisting of nuts; berries, and numerous animals that could be found in and near the marsh and tidal creeks (Crook, 1978, 1980). Excavations of middens at Kenan Field and the Shell Ring produced identifiable remains of mammals such as white-tailed deer (*Odocoileus virginianus*), raccoon (*Procyon lotor*) and rabbit (*Sylvilagus* sp.); reptiles such as diamond-backed terrapin (*Malaclemys terrapin*), aquatic turtles (*Chrysemys* spp.), box turtle (*Terrapene carolina*), chicken turtle (*Deirochelys reticularia*), mud turtle (*Kinosternon subrubrum*) and various snakes; and fish such as gar (*Lepisosteus* sp.), Gafftopsail (*Bagre marinus*) and sea catfish (*Arius felis*), red (*Sciaenops ocellata*) and black drum (*Pogonias cromis*), spotted sea trout (*Cynoscion nebulosus*), Atlantic croaker (*Micropogonias undulatus*), sheepshead (*Archosargus probatocephalus*), mullet (*Mugil* spp.) and herring or shad (*Clupeidae*) (Crook, 1980). By far the most numerous remains were the shells of various mollusks, such as Eastern oyster (*Crassostrea virginica*), Southern quahog (*Mercenaria campechiensis*), periwinkles (family *Littorinidae*), knobbed whelk (*Busycon carica*), channeled whelk (*B. canaliculatum*) and olive (family *Oliviadae*). Whelks were not only useful as food; *Busycon* shells were used extensively as tools such as hammers, picks, hoes and pounders (Simpkins, 1975). The remains of many small fish in refuse middens at the village sites led Crook (1980) to the conclusion that impoundments were used to trap fish in tidal creeks.

Early Spanish, French and English

During the 17th century Spain established missions in what is now coastal Georgia as part of their effort to convert the native Indians to Christianity and to guard their sea routes to Mexico. One of the missions on the coast was named San JosJ de Z<pala, from which the name Sapelo is derived. Although archaeological surveys on Sapelo have located a number of sites where fragments of their pottery attest to the influence of the Spanish in the area, no architectural remains of a Spanish mission have yet been identified on Sapelo (Larson, 1980). Spanish presence in the area declined during the latter part of the 17th century, and by the time that Georgia was established as a British colony in 1733 the coast was occupied by the Creek Indians.

Mary Musgrove, a niece of the Creek chief who served as interpreter for James Oglethorpe, claimed ownership of three of the Georgia barrier islands, St. Catherines, Ossabaw and Sapelo. Her claim was disputed by Colonial authorities, but was eventually validated in part when Governor Henry Ellis granted ownership of St. Catherines to her

and her husband, and turned over to her the proceeds of the sale of Ossabaw and Sapelo in payment for her services as interpreter and for goods she had provided to the colonists. In 1760 Grey Elliot, the purchaser of the islands, was awarded a grant to the islands by King George II. Sapelo was later sold to Patrick Mackay, who was the first to undertake large-scale cultivation on the island. Over the next 40 years, ownership of the island passed through several hands, including a group of Frenchmen who established plantations at several locations on the island. One of these was at Chocolate, on the western side of the island, which was also probably the location of an Indian settlement in earlier years (Sullivan, 1990). Although some crops were cultivated, cattle seemed to be the major interest of these early plantations.

The French syndicate failed, and ownership of most of the island eventually passed to Thomas Spalding. Chocolate was bought by the Marquis de Montalet, who had been a planter in Santo Domingo prior to coming to Georgia. After his death, Chocolate was sold to Edward Swarbreck, a Danish mariner, who built many of the tabby buildings whose remains can be seen there today. His successor, Dr. George Rogers, who bought Chocolate around 1827, built many of the "newer looking" buildings that occupy the field there. These three men, but most importantly Thomas Spalding, had a tremendous influence on Sapelo as we know it today.

Thomas Spalding

In 1802 Thomas Spalding purchased 4000 acres on the south end of Sapelo; he eventually became the owner of all but a small portion of the island. He had learned how to run a successful plantation from his father and was a leader and innovator in the cultivation and processing of sugar and in the cultivation of Sea Island long-staple cotton. Spalding was a proponent of crop rotation and diversification rather than dependence on one crop, experimenting with indigo, silk, olives and oranges; he also was an authority on the cultivation of rice. Spalding wrote extensively for agricultural journals of the day and shared his views on agriculture through an extensive correspondence. He was a promoter of tabby construction, using it in his home, the South End House, a sugar cane mill and several other buildings on Sapelo (Coulter, 1940; O'Grady, 1980; Sullivan, 1990). The present-day Reynolds Mansion was built on the foundations of Spalding's South End House, incorporating some of the original exterior tabby walls (Sullivan, 1990). The first Sapelo Lighthouse was built on the southern end of the island during the Spalding era (Sullivan, 1990).

During Spalding's tenure, much of the land on Sapelo was cleared for cultivation or pasture. John D. Legare, editor of the *Southern Agriculturist* reported after a tour of the south end of Sapelo "...the spectator who visits the island for the first time is struck with the peculiar appearance presented him, instead of meeting with a thick growth of trees, such as is common on all sea-islands on our coast, he suddenly finds himself in a prairie, extending to the north almost as far as can be seen..." (1832, as quoted in Sullivan, 1990). A network of ditches and canals, still evident today, were dug to drain the swampy interior of the island. Thus whatever natural climax forest existed on Sapelo Island largely disappeared during the 1800s, both from upland areas and from the inland swamps. Originally these ditches and canals directed water into the intertidal salt marshes around the island;

today, with artesian wells no longer flowing the canals only fill during periods of heavy, extended rainfall or at times of high spring tides when salt water flows into the canals from the marsh.

Spalding introduced many new plant species to Sapelo, testing for the practicality of using them in cultivation. The few that still reproduce on the island, such as bermuda grass (*Cynodon dactylon*), cherokee rose (*Rosa laevigata*) and mulberry (*Morus* spp.) are quite abundant. Other non-native species, probably introduced by Spalding, are *Paspalum notatum*, *Populus alba*, *Maclura pomifera*, *Nymphaea mexicana*, *Cinnamomum camphora*, *Wisteria sinensis*, *Kummerowia striata*, *Citrus aurantium*, and *Mentha X piperita* (Duncan, 1982).

Thomas Spalding died in 1851 and a long period began during which ownership of Sapelo passed through many hands, many of them descendants of Thomas Spalding. During the Civil War the island was abandoned by owners and was occupied by only a few former slaves. Union troops blockading the southern coast frequently visited Sapelo to hunt and enjoy a change of surroundings. After the war the barrier islands were set aside as reservations for former slaves, and black communities were established at several sites on Sapelo Island. One of them, Hog Hammock, is still an active community. Much of the island was eventually returned to the Spalding family by the Federal government (Sullivan, 1990). During the next forty years, various tracts of land changed hands and several attempts to reestablish profitable agricultural operations failed. By the early 1900s many of the cultivated fields had reverted to forest, serving as habitat for birds and wild game. The south end of the island was developed as a hunting preserve by the Sapelo Island Company, a syndicate of investors from Macon, GA. They partially restored Spalding's South End House for use as a hunting lodge.

Howard Coffin

Howard Coffin of Detroit, developer of the Hudson motor car, first came to Sapelo to hunt in 1911. A year later he purchased much of the island from the Sapelo Island Company and the five families who owned most of the land. He set out to restore the island's agriculture and many of its buildings, including the South End House. The agricultural restorations included clearing of the drainage canals, cultivation of a variety of crops including long staple Sea Island cotton, clearing of pastures for beef and dairy cattle, and building and repair of roads to facilitate access to all parts of the island. With his cousin Alfred W. Jones as manager of Sapelo, Coffin built the dock at Marsh Landing (Fig. 6), the duck pond at the north end of the island and other freshwater ponds, established an oyster and shrimp cannery on Barn Creek, established an oyster farming project in the waters between Sapelo and Little St. Simons, and built a saw mill to provide lumber for buildings and boats. He built a marine railway on South End Creek so that his many boats could be repaired and serviced on the island and built the greenhouse which still stands, though in disrepair, near the South End House. He also had a keen interest in hunting, and raised ring-necked pheasant and turkeys which he and his guests would hunt, aided by dogs from the Sapelo kennels. He introduced the Chachalaca (*Ortalis vetula*) to Sapelo as a game bird; native to Central America, the birds adapted well to the environment on the island. They were well established on the island as recently as the late 1970s, but are

now seen only occasionally. Coffin also planted the many oleanders which line the road from Marsh Landing.

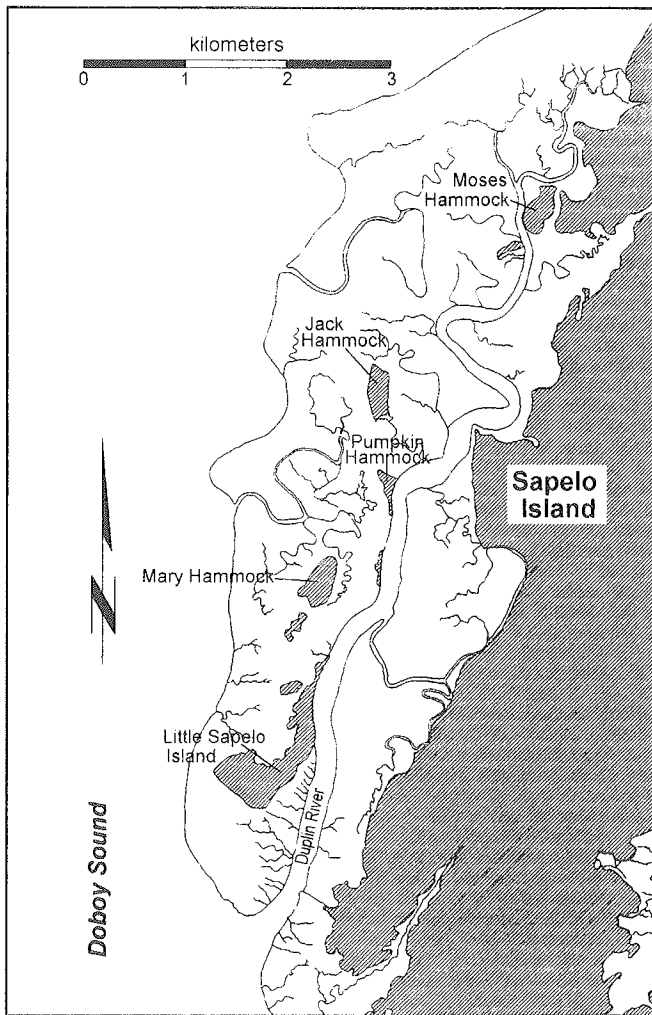

Figure 6. The Duplin River Watershed.

Georgia Marine Institute, remodeled the interior of South End House (the Reynolds Mansion), refurbished buildings at Long Tabby to be used as a camp for underprivileged boys, and for several years opened the Big House and the apartments in the quadrangle complex to vacationers as an exclusive resort.

During the late 1930s and early 1940s, Reynolds attempted to consolidate the land holdings of blacks on the island into one community at Hog Hammock by purchasing their land at Raccoon Bluff, Shell Hammock and other locations or swapping it for land at Hog Hammock. Because of the island's isolation, many among its black population depended on Sapelo's owner for employment, and complied with his wishes even though it meant giving up land that had been theirs for generations. Although some individuals continued

Although much of his time, energy and financial resources were focused on restoring all aspects of the Sapelo Plantation, Coffin's influence and interest extended to other parts of coastal Georgia, most notably St. Simons and Sea Island. He purchased Sea Island, then known as Long Island (Sullivan, 1990), in 1926 and began work to establish an exclusive resort on the island with the Cloister Hotel as its centerpiece. After the stock market crash of 1929, financial pressures forced Coffin to sell Sapelo Island in order to continue the development of Sea Island.

R. J. Reynolds

Richard J. Reynolds, Jr., heir to a tobacco fortune, purchased Sapelo from Howard Coffin in 1934. In many ways, he continued the work done by Coffin, maintaining and enlarging the dairy herd, continuing cultivation of crops in fields on the south end of the island, and trying to make the Sapelo Plantation a self-supporting enterprise. He redesigned and rebuilt most of the buildings in the quadrangle complex that now houses the University of

to claim ownership of parcels of land elsewhere, by the time of his death in 1964, Reynolds claimed ownership of all of Sapelo Island except for some 434 acres at Hog Hammock.

Prompted by his lifelong interest in the sea, in the early 1950s Reynolds invited Eugene Odum and Donald Scott, faculty at the University of Georgia, to prepare a proposal for the use of Sapelo and its surrounding marshes for basic research on the productivity of coastal waters and marshes, which led to the establishment of the Sapelo Island Research Foundation, and of the University of Georgia Marine Institute in 1953. From a modest beginning, the Marine Institute undertook much of the early research on salt marsh ecosystems, describing the biology, hydrology and geology of the waters and marshes around Sapelo Island.

In 1969, his widow, Annemarie Reynolds, sold the northern half of Sapelo Island to the State of Georgia to be administered by the Georgia Department of Natural Resources (DNR) as the R. J. Reynolds Wildlife Refuge. With the exception of the land in Hog Hammock and the land surrounding the lighthouse, the rest of the island came under the ownership of the Sapelo Island Research Foundation. In 1975, the state of Georgia nominated the Duplin River Estuary (Fig. 6) as a national estuarine sanctuary; after approval of the proposal by the U.S. Department of Commerce, the National Oceanic and Atmospheric Administration (NOAA) provided funds for management of the sanctuary and for the purchase of the privately owned land within the sanctuary. In 1976, the state matched the federal funds and completed the purchase of the south end of Sapelo Island from the Foundation, establishing the Sapelo Island National Estuarine Sanctuary, now known as the Sapelo Island National Estuarine Research Reserve (SINERR).

CURRENT USE AND OWNERSHIP OF SAPELO ISLAND

The Department of Natural Resources

The State of Georgia currently owns all but 175.7 hectares of Sapelo Island's 6477.8 ha; the Department of Natural Resources (DNR) is charged with management of the island. They operate the ferry, which makes 3 round trips per day between Sapelo and the mainland, transport fuel to the island in a fuel barge, sell gasoline to island residents, operate a barge which transports vehicles, other large objects and equipment to and from the island, transport garbage off the island to the McIntosh County landfill, maintain roads, and provide a law enforcement presence on the island. In addition to providing transportation to island residents, employees of DNR and the University of Georgia and visitors, the ferry carries mail to and from the island and transports school children during the school year. There are four distinct DNR administrative units on the island, each with different management objectives.

SINERR

The SINERR occupies 2390.74 ha, slightly more than one-third of the area of Sapelo Island. It contains the Duplin River watershed, primarily intertidal salt marsh with some small upland tracts (Fig. 7), and the upland maritime forest, marsh, dune and beach areas

of the southern end of the island, and a light house built in 1820. DNR has plans to restore the lighthouse to working condition using private funds.

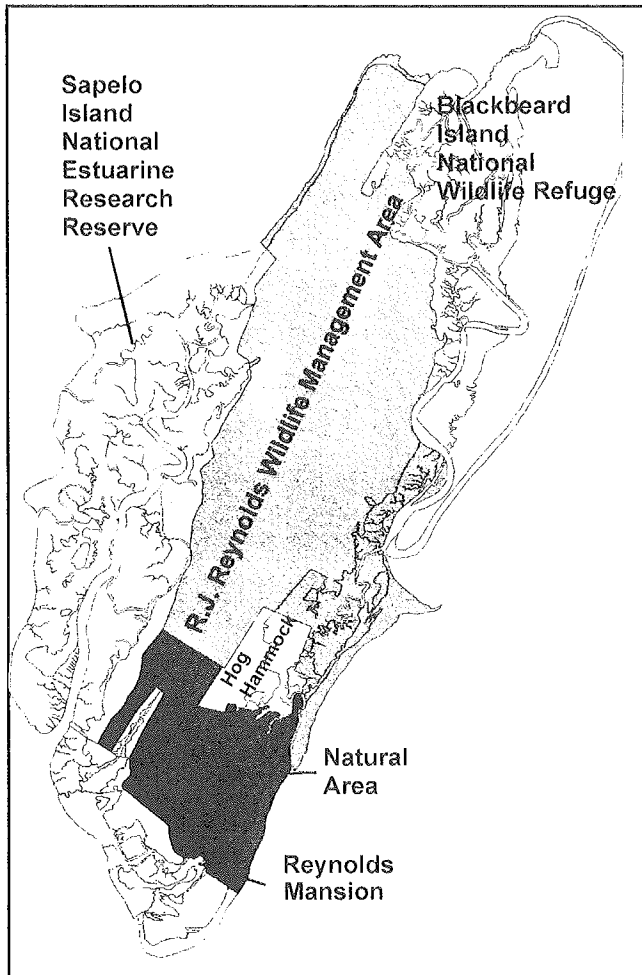

Figure 7. Administrative units on Sapelo Island.

The University of Georgia leases approximately 637.65 ha within the SINERR and the Sapelo Island Natural Area (see below), on which are located the Marine Institute, residences of faculty and staff, administrative offices and other facilities related to the research and educational activities of the Marine Institute.

The DNR's management goals for the land in the SINERR include:

- a. maintaining the integrity of the SINERR for research and educational programs,
- b. protecting its lands and waters from stress and alteration,
- c. promoting increased public access for nature interpretation and low intensity recreation, and
- d. promoting and encouraging improved scientific understanding of estuarine ecosystems (Georgia Department of Natural Resources, 1990).

The SINERR is managed by DNR, but is administered by the National Oceanic and Atmospheric Administration, which provides funds for operations, education and monitoring.

Public access to Sapelo Island is coordinated by SINERR personnel, who conduct tours which visit a tidal salt marsh and creek, the Marine Institute, ruins of a sugar mill built prior to the Civil war, the Hog Hammock Community, the Reynolds Mansion and Nannygoat Beach. In addition to public day tours, special group tours and tours for school field trips are available. In all 200-300 tours are conducted by SINERR staff each year. The Reserve personnel also conduct outreach programs, publish a newsletter about activities in the SINERR, and promote public awareness of the Reserve and the environmental and ecological aspects of Sapelo Island and the other Georgia barrier islands.

The waters and marshes of the SINERR are used by the research faculty of the University of Georgia Marine Institute and other scientists for a variety of projects. Scientific publications by the research faculty and visiting scientists are collected and reprinted

by the University of Georgia Marine Institute (currently, 21 volumes have been produced). With funding from SINERR, NOAA and the University of Georgia, the Marine Institute conducts a meteorological and hydrological monitoring program which provides continuously recorded data on parameters such as wind speed and direction, sunlight, rainfall, barometric pressure, relative humidity, air and water temperature, salinity, conductivity and pH of tidal waters and tide heights at 3 locations in the SINERR. The monitoring stations (Fig. 8) are located in the upper and lower water masses of the Duplin River (see below for explanation of water masses) and in a tidal branch of the Duplin which runs adjacent to the SINERR uplands.

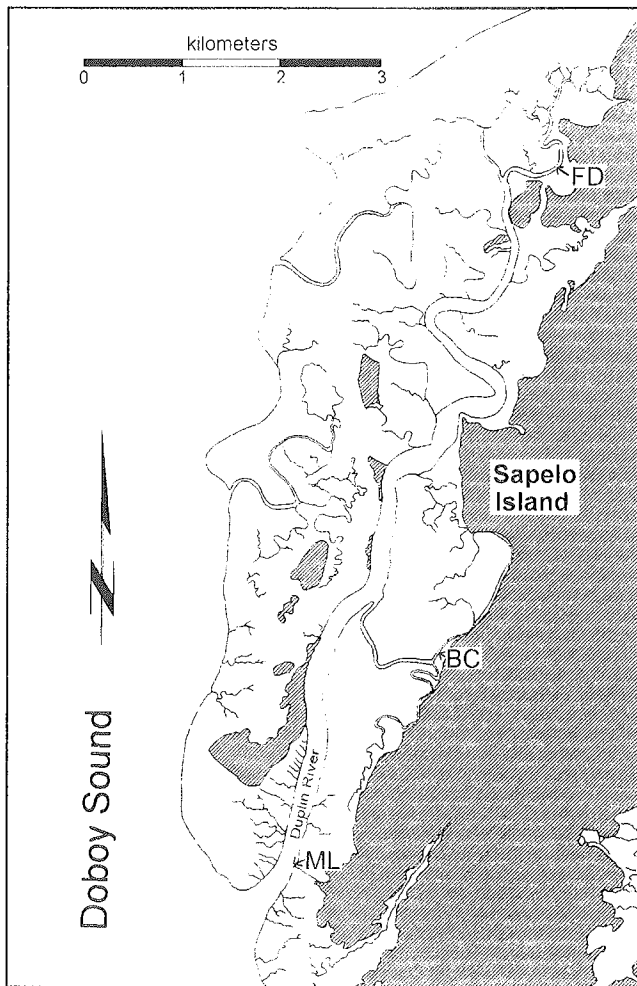

Figure 8. Location of monitoring stations. ML - Marsh Landing; BC - Barn Creek; FD - Flume Dock.

areas to Nannygoat beach. The Natural Area is managed by DNR to provide outdoor

R. J. Reynolds Wildlife Management Area

The R. J. Reynolds Wildlife Management Area occupies approximately 2805 ha on the northern end of Sapelo Island. It was purchased in 1969 with funds from the State of Georgia and with Pittman-Robertson funds from the U.S. Department of Interior. The area is managed for all game and non-game species with the objective of maintaining healthy communities of flora and fauna and to provide for public use of the area through hunting, fishing and camping. Management techniques in use in the RJR WMA are selective timber harvesting, prescribed burning and creation of wildlife openings. The primary large game species are turkey and deer, with DNR sponsoring several managed hunts each year.

The Sapelo Island Natural Area

The Sapelo Island Natural Area occupies 1106 ha of marsh, upland, dunes and beach on the southern end of Sapelo outside the Duplin River watershed, and includes an interpretive trail which begins in an upland area near the Reynolds Mansion and proceeds across intertidal marsh, dunes and inter-dune

recreational opportunities to the general public and for public education about barrier island and dune ecosystems.

The Reynolds Mansion

The Reynolds Mansion, which is physically within the boundaries of the Reserve, is operated and maintained by the Lodge Authority of DNR. It serves as a conference and meeting facility for groups of up to 30 persons, providing lodging, meals and transportation. Educational programs about Sapelo and the SINERR conducted by Reserve personnel are available to each group.

The University of Georgia Marine Institute

The University of Georgia Marine Institute was established in 1953 to serve as a research facility for resident and campus-based faculty and students. Its original objective was to study the productivity of the nearby coastal waters and marshes, and in the years since its establishment the Marine Institute has compiled an extensive database on salt marsh-estuarine ecology. Most of the research has dealt with the functional ecology of salt marsh ecosystems, although there has been extensive related research on the geology of barrier islands and adjacent estuarine environments, the biochemistry of bioluminescence and taxonomy. The ecological research has dealt with several general topics: estuarine hydrography; the detritus food chain; primary productivity; nutrient cycling; energy and carbon flow phenomena; microbial ecology; outwelling of materials and nutrients to the nearshore; utilization of the intertidal marsh by various organisms for refuge, feeding and reproduction; effects of interactions among marsh macrofauna on community and population structure; and the role of fungi in decomposition of organic matter in the marsh. Much of this research has taken place within the SINERR, and forms the basis for this ecological profile. Marine Institute faculty receive funding for their research from the University of Georgia, the Sapelo Island Foundation and a number of federal agencies including National Science Foundation, National Oceanic and Atmospheric Administration (NOAA) Sea Grant and National Estuarine Research Reserve Programs, and the Environmental Protection Agency.

The Hog Hammock Community

The Hog Hammock Community is a privately owned tract occupying 175.7 ha of upland in the south central area of Sapelo Island. Many of its residents are descendants of slaves owned by Thomas Spalding prior to the Civil War, although in recent years a number of "outsiders" have bought or built homes in the community. As has been the case throughout its history, the island's primary landowner is also its primary employer. Many residents of Hog Hammock work for the University of Georgia Marine Institute or for DNR, although others commute daily to the mainland to work. Recently a number of businesses have sprung up in the community to serve the needs of the growing number of tourists and vacationers who visit Sapelo by offering accommodations, transportation and local crafts. The preservation and revitalization of the community and its culture is one of the central concerns of everyone associated with Sapelo Island. The SINERR has indi-

rectly played a role in the development of the new businesses by increasing public awareness of Sapelo Island and the Hog Hammock community through its tours and public outreach.

POPULATION AND DEVELOPMENT OF NEARBY COASTAL AREAS

McIntosh County is one of the smallest and poorest of Georgia's counties. A high proportion of property in the county is owned by state or federal government, and much of the rest is owned by paper companies for cultivation of pine trees. There is little industry or agriculture in the county, and Darien is the largest center of population. Population density in McIntosh County, Georgia, location of Sapelo Island, is 20.32 people per square mile, the lowest in coastal Georgia (Hodler *et al.*, 1994) and its rate of population growth is also low, with a 17.31 percent change in the period 1970-1990, compared to over 100 percent growth during the same period for Camden and Bryan counties and 200% growth for Liberty County (Hodler *et al.*, 1994). Nevertheless, marshfront property in McIntosh County is increasingly attractive to builders and prospective homeowners, and growth rate will no doubt show a larger increase at the time of the next census. Recreational use of the coastal areas of Georgia is increasing, and with that increase the demand on the recreational resources of SINERR can be expected to increase as well.

Because of its distance from the mainland and from major population and industrial areas, water quality in the SINERR has thus far been little affected by the changing conditions in mainland coastal Georgia. The strong tidal currents result in flushing of channels and sounds; mixing of upland runoff with estuarine water dilutes and distributes nutrients and pollutants throughout the nearshore and estuarine zone. The spatial and temporal variability in nutrient distribution and water movement makes the detection of small changes in nutrient and pollutant concentrations almost impossible. The long-term cumulative effects of these small, unmeasurable changes is yet to be determined, but at present they have not been detected in the SINERR.

Geological and Hydrological Characterization of SINERR

GEOLOGICAL SETTING

Sapelo Island and Georgia's other barrier islands are remnants of Pleistocene barriers formed approximately 110,000 to 25,000 years ago, fronted by active Holocene beach ridges formed during the last 4000 - 5000 years (Howard and Frey, 1985). The latest Pleistocene (late Sangamon) beach deposits form the core of most of the modern barrier islands. Following a major drop in sea level during the Wisconsin glaciation, Holocene sea level rise has resulted in reworking of Pleistocene sediments and deposition of a veneer of sediments along the shoreline in the form of the Silver Bluff barrier island deposits which form the core of Sapelo Island (Hoyt *et al.*, 1964; Hails and Hoyt, 1969). The Georgia barrier islands, including the Duplin River watershed, are located in the most recent of a series of six Pleistocene shoreline complexes that increase in age and elevation westward from the present-day coast (Hails and Hoyt, 1968).

The broad expanse of salt marshes and tidal drainages which form most of the SINERR is classed as a salt marsh estuary, as opposed to riverine marsh estuaries which have rivers at their heads, such as the Altamaha (Howard and Frey, 1985). The Duplin River tidal salt marsh sediments consist mainly of reworked Pleistocene muds, eroded and redeposited by the tidal currents. The marshes of the SINERR are in approximate dynamic equilibrium with sea level at present, with deposition being balanced by erosion and sea level change (Letzsch, 1983). Measurement of deposition and erosion at various marsh sites over a 7 year period revealed a mean deposition rate of 0.2 cm/yr (Letzsch, 1983). Erosion and meandering of tidal creek banks is caused by tidal action, slumping and bioturbation (Letzsch and Frey, 1980). Erosion varies greatly from one location to another, but changes in the position of major channels are rare (Letzsch, 1983).

TIDAL CONDITIONS

Tides along the Georgia coast have an average amplitude of 2.4 m and a spring tide range of 3.4 m. The hydraulic energy resulting from the rise and fall of the tides is a major factor in many of the ecological processes active in the marshes (Schelske and Odum, 1961). Most tidal streams are contained within steep banks and natural levees which create a pattern of marsh flooding in which water moves along progressively smaller channels which eventually dissipate in headwaters on the marsh surface. Tidal water flows directly across levees only on the highest spring tides. Motile aquatic organisms follow this same pattern when moving onto and off of the marshes during high tide, although the rising and falling tides make the steep banks and levees available as feeding and refuge sites to them and to those organisms which do not move out of the creeks. In spite of the large tidal amplitude, there are still extensive areas of marsh which are flooded only at spring tide and even more extensive areas which, although flooded daily, are submerged for very short periods of time. Thus the tidal regime maintains a diversity of habitats in the intertidal area.

Tidal currents in the main channel are very strong. It is an ebb-dominated system, as are all of the tidal streams in this region. Friction between the marsh surface and tidal water retards flow out of the marsh on ebb tide, steepening the hydraulic gradient in the channels and increasing ebb tide current speeds when the water finally clears the marsh surface. (Zarillo, 1979).

HYDROLOGY OF THE DUPLIN RIVER

The Duplin River (Fig. 6) is a river in name only. It receives no freshwater input at its head, and is more correctly described as a large tidal creek or embayment. Prior to the 1970's there was a noticeable input of fresh artesian groundwater in the upper Duplin (Kjerfve, 1973), but increased industrial withdrawals along the Georgia coast lowered the water table and ended the flow of artesian water. Now its only freshwater inputs are rainfall, runoff and groundwater discharge from the surrounding uplands.

The Duplin has three tidal prisms along its 12.5 km length, the first ending in the area of Pumpkin Hammock, the second extending to Moses Hammock, and the third encom-

passing the creeks and marshes of the Upper Duplin River (Fig. 6). Strong tidal currents and the lack of freshwater input at the head of the river keep the water column within each tidal prism well-mixed, but result in little net advective transport. Thus the waters of the upper tidal excursion are in effect hydrologically isolated from the waters of the lower reaches of the river and Doboy Sound.

Transport of materials is diffusive except under the relatively rare circumstances of very heavy rainfall occurring at low tide, which can create a lens of freshwater in the upper water mass or even completely replace it (Imberger *et al.*, 1983). The volume of the upper water mass is such that on most tides it is moved completely out of the river and creek channels onto the marsh surface at high tide. On high spring or storm tides water may flow between the upper Duplin River system and the Mud River/Sapelo Sound system to the north. Seasonally, during periods of high discharge from the Altamaha River into Doboy Sound, there can be inputs of lower salinity water at the mouth of the Duplin River.

Some of the earliest research in the SINERR by Ragotzkie and Bryson (1955) and Ragotzkie and Pomeroy (1957) established the importance of water circulation in the ecology of the estuary. The work of Imberger *et al.* (1983) confirmed those early results and extended our understanding of the fluxes of dissolved and particulate materials in relation to the hydrography of the Duplin River. Their approach emphasized the importance of ordering the time scales of the dominant fluxes of materials and then choosing appropriate time and spatial scales of resolution for a sampling program. They separated the effects of water motion and mixing from the variability of a biological component, and thus were able to interpret the variability of the residual. For example, rapidly recycled constituents such as ammonium had a very patchy distribution that was independent of water motion, while more refractory or abundant compounds such as silicate, which was produced in large amounts by the marsh, was exported from the Duplin by longitudinal mixing. The work of Chalmers *et al.* (1985), confirming earlier findings of Sottile (1974), showed that dissolved organic carbon (DOC) has both a refractory and a labile component, with the refractory component being present throughout the year at concentrations of 3 - 5 mg C/l. Chalmers *et al.* (1985) also found that there were concentration gradients of both DOC and particulate organic carbon (POC) throughout the year, with higher concentrations in the Upper Duplin decreasing towards the mouth of the river.

GEOMORPHOLOGY OF THE DUPLIN RIVER WATERSHED

The geomorphology of the Duplin River watershed (variation in elevation, drainage pattern and drainage density) is a result of an interaction of tidal currents, sea level fluctuations, biological activity and sedimentation that has been taking place for thousands of years. Superficially, the marshes of SINERR appear uniform, but there is in fact a great deal of heterogeneity present. Although variations in elevation over much of the marsh surface are in the centimeter range and are not represented on topographic maps of the area, the small variations that do occur produce gradients in physical and chemical conditions in marsh sediments that affect plant growth and zonation. Figure 9 depicts an idealized cross-section through a Georgia salt marsh.

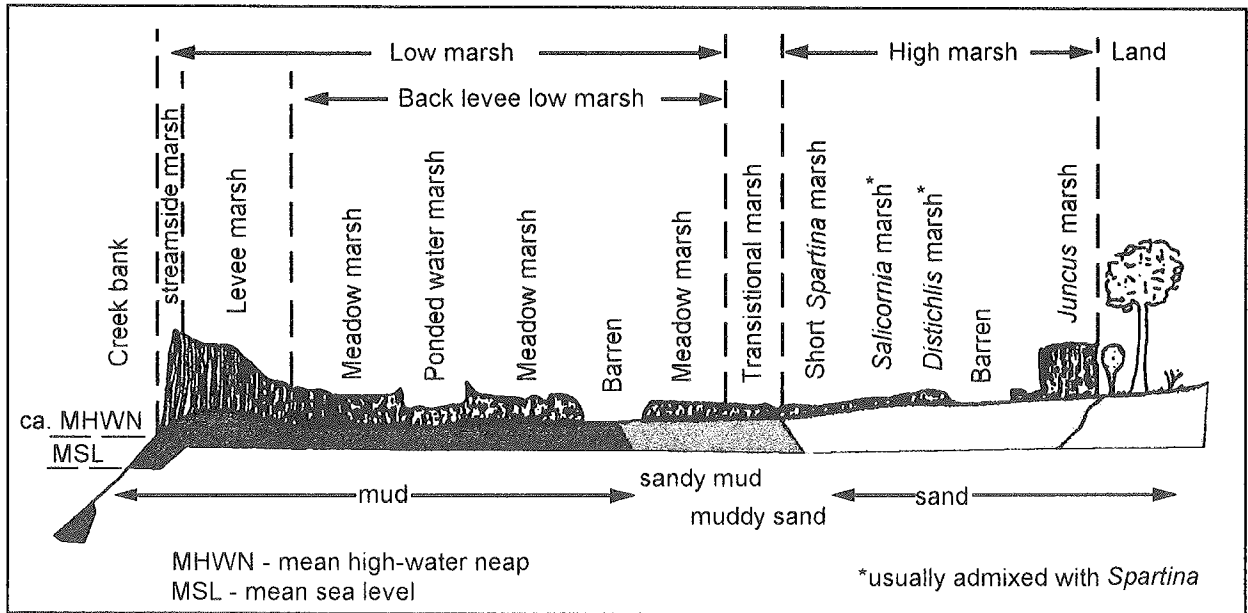

Figure 9. Idealized cross-section of an intertidal salt marsh, based on Frey and Basan (1985).

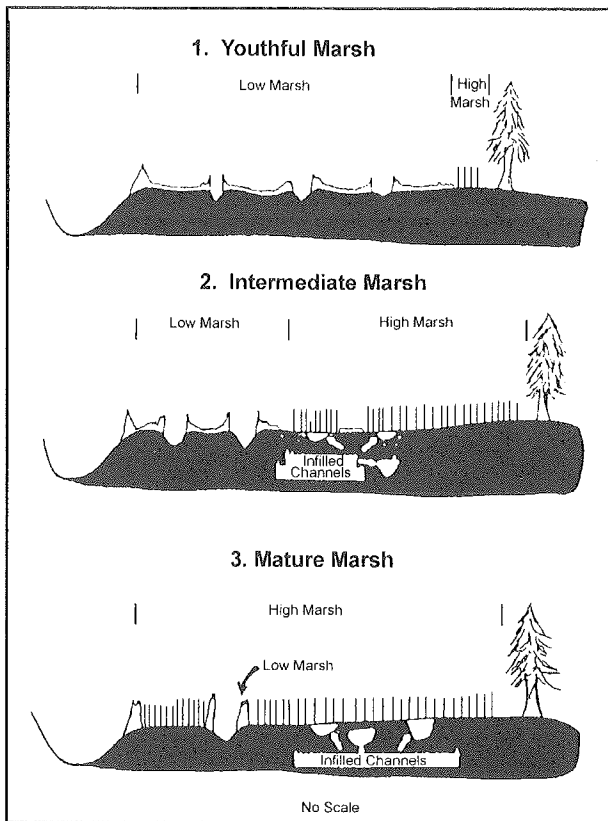

Figure 10. Schematic diagram of the three stages of marsh maturation. 1) Youthful, with high drainage density and high proportion of low marsh; 2) Intermediate; 3) Mature, with low drainage density and high proportion of high marsh. (After Frey and Basan, 1985.)

The centuries-long process of marsh maturation (Frey and Basan, 1985) has produced a succession of stages of marsh development, ranging from youthful marshes intersected by many deep, interconnecting creeks and channels such as those present in the Upper Duplin watershed to geologically mature, stable marshes higher in elevation with fewer, shallower channels (Fig. 10). The youthful marshes, by virtue of their lower elevation and higher density of drainage channels, have a higher proportion of "tall *Spartina alterniflora*" than the mature marshes.

Hypothetically, end-member marshes in a geological evolutionary sequence are those in which the entire area is covered either by high marsh with little aquatic area or low marsh with substantially more aquatic area. However, the coast of Georgia has not been geologically stable long enough to achieve such simple structure (Frey and Basan, 1985). The Duplin River water shed includes

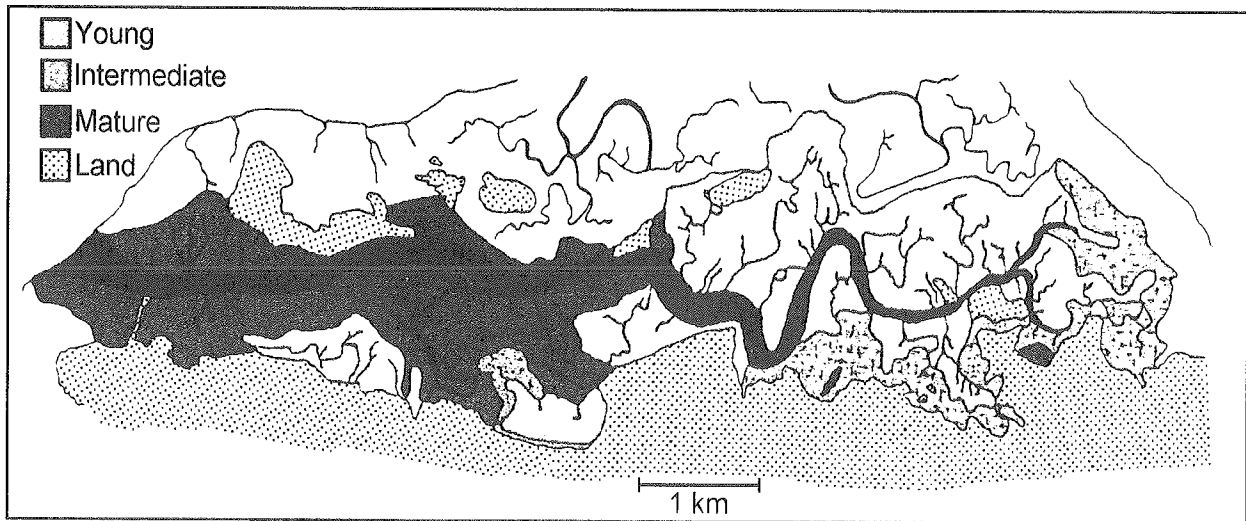

Figure 11. Distribution of the three major physiographic regions of the Duplin River tidal salt marshes. (From Wadsworth, 1980.)

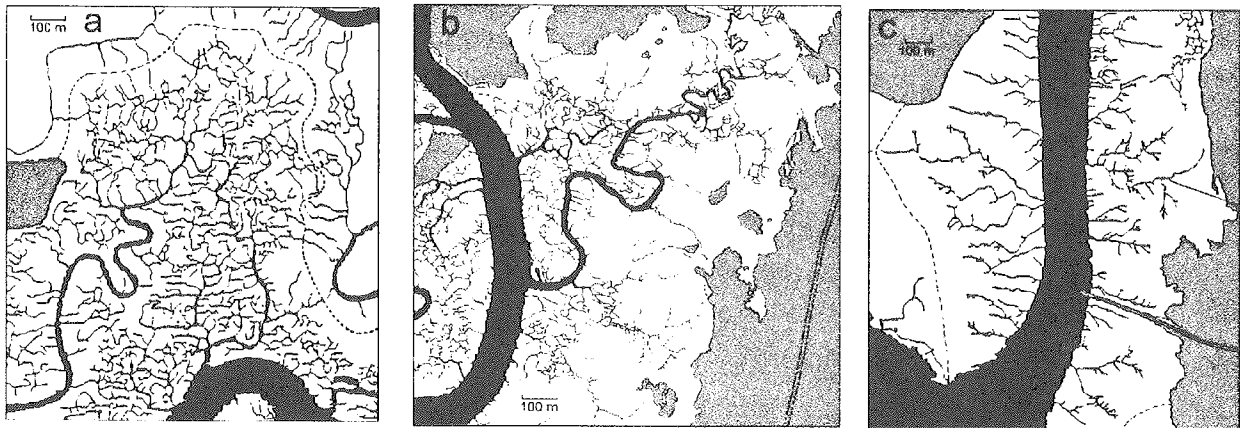

Figure 12. Patterns of drainage density in the three physiographic regions of the Duplin River salt marshes: a) high drainage density, young marsh; b) intermediate drainage density and age; c) low drainage density, mature marsh. (From Wadsworth, 1980.)

marshes at three stages of maturation (Fig. 10), corresponding closely with the three major physiographic provinces (Fig. 11) as established from patterns of drainage networks and drainage density (Fig. 12) (Wadsworth, 1980). The sequence of marsh maturation described by Frey and Basan (1985) is characterized by a progressive filling of the marsh-lagoon, the net effect of which is a gradual increase in elevation and diminution of tidal effect in more mature marsh areas. Marshes at the three stages of maturation portrayed in Fig. 10 differ markedly in rates of surficial sedimentation, slope, frequency, topography, headward erosion and network extension, sediment permeability and response to storm events (Wadsworth, 1980; Frey and Basan, 1985).

The effect of these major geomorphic differences on utilization of the intertidal marsh by aquatic organisms has been studied in the SINERR by Kneib (1991), whose findings

are discussed later in this profile, but many questions remain as to the effect of geomorphic heterogeneity on fundamental ecosystem processes such as gross and net ecosystem production and net ecosystem exchange of materials.

BEACH MORPHOMETRY AND THE SAND-SHARING SYSTEM

On the eastern side of the SINERR is Nannygoat Beach, a broad, gently sloping beach with low wave energy which is a result of the energy-dampening effect of the broad, shallow Continental Shelf present along the Georgia coast. Wave heights average 0.8 - 1.25 m (Henry, 1989). Lateral troughs and bars, or runnels and ridges, which retain water at low tide are commonly present on the beach, formed by breaking waves (Greaves, 1966; Hoyt, 1962). The troughs often have ripples of a variety of shapes determined by the water flows which formed them. Two kinds commonly seen are oscillation ripples, with sharp crests and relatively wide troughs; and current ripples formed by water running out of runnels, with broad, gentle slopes on the upstream side and steep slopes on the downstream side (Hoyt and Henry, 1963).

Above the high tide line, dunes develop when wind-blown sand builds up behind small obstacles such as wrack, culms of dead *S. alterniflora* washed out of the marshes and sounds and deposited on the beach. Fig. 13 depicts a schematic cross-section through a Georgia barrier island, and shows the relationship of the shifting dunes nearest the beachfront, the stable dunes and the maritime forest and salt marsh which they protect from the direct force of breaking waves.

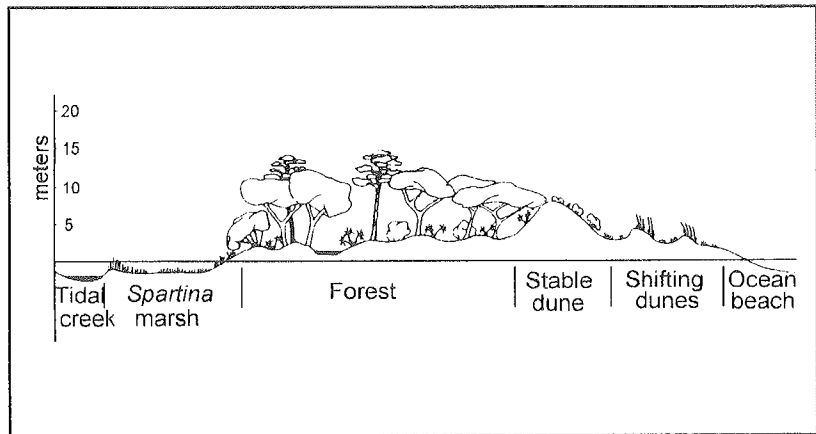

Figure 13. Idealized cross-section of Sapelo Island.

Once an obstacle has begun to capture sand, the dune continues to grow unless high tides or storm tides wash it away. Salt-tolerant foredune plants quickly begin to colonize the new dune, and their roots are important factors in its stabilization. Sea oats, *Uniola paniculata*, is the most important of these plants because of the depth of penetration and lateral spreading of its root systems (Wagner, 1964). Dunes along the Georgia coast often get as high as 3 - 4 m. Even when they have been well-vegetated with sea oats and other species they remain fragile and easily damaged by natural forces as well as by man.

The prevailing longshore current is from north to south (Hoyt *et al.*, 1964; Greaves, 1966; Frey and Howard, 1969), although strong tidal currents sweeping out of the mouth of Doboy Sound often dominate the longshore current locally. An aerial view of the south end of Nannygoat Beach reveals the long-term result of the north-to-south currents, beach and marsh-building on the south end of coastal barrier islands (Fig. 14).

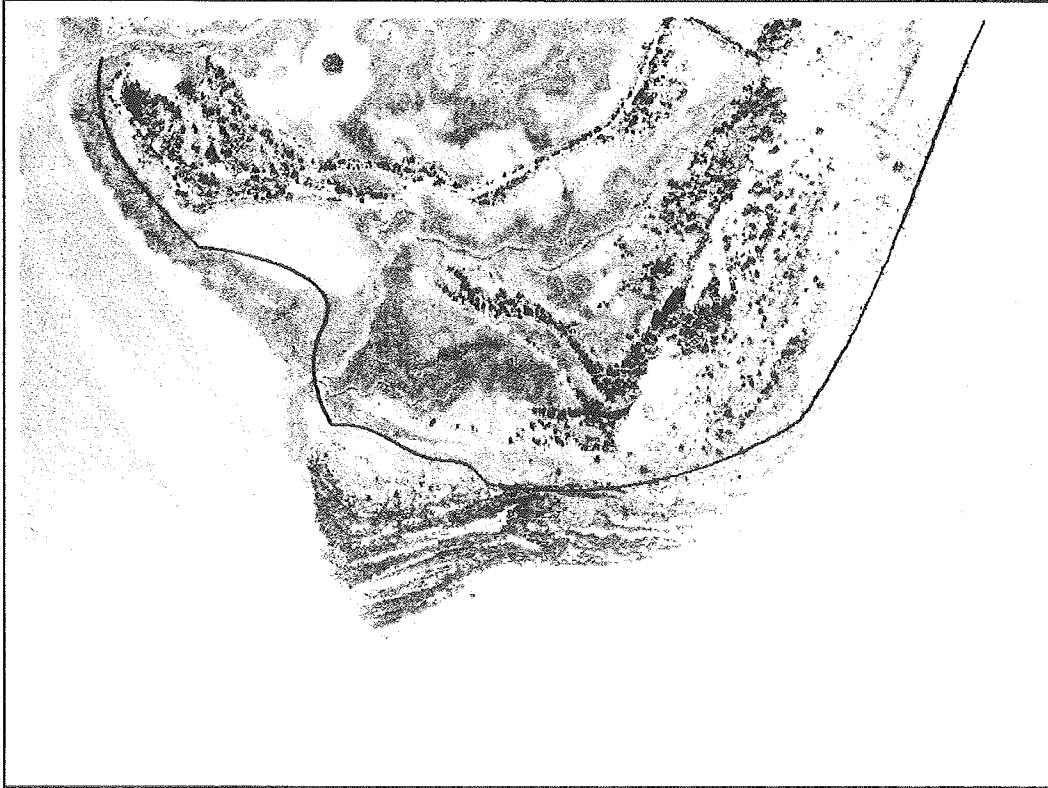

Figure 14. The black line shows the approximate location of the 1953 shoreline in relation to the 1989 shoreline in the photograph. Note the ridged appearance of the added dunes and vegetation, typical of Holocene development.

The beach, dunes and offshore sandbars form a dynamic sand-sharing system driven by tides, longshore currents and wave energy. Sapelo Island is one of the few places on the East Coast of the U.S. where the sand-sharing system operates with minimal interference from human activity. After a long period of accretion, Nannygoat Beach has recently experienced several years of erosion, losing 10 meters or more of dunes. This cycle of erosion and accretion is constantly active, with sand eroded from one area of beach by storm waves being deposited in offshore sandbars and gradually being washed back onto the beach to be trapped and held by dune vegetation. As evidenced by the accretion on the south end of Sapelo during the past 45 years (Fig. 14), some of the sand is transported southward by the prevailing currents.

Fortunately, beach erosion on Sapelo is only a minor problem even when it does occur since there are no major structures near the beach. The boardwalk and pavilion at Nannygoat Beach, built by the Department of Natural Resources to protect the dunes from trampling by tourists and other visitors, have been threatened by the recent erosion, but the prospect of their loss will not result in expensive and sometimes counter-productive protective measures such as those seen on nearby Georgia coastal islands (Henry, 1989). Erosion of Sapelo beaches can be a more serious problem for animals that use

the beaches as nesting areas, such as the Atlantic loggerhead turtle (*Caretta caretta*), and shorebirds such as the American Oystercatcher (*Haematopus palliatus*), Wilson's Plover (*Charadrius wilsonia*), Gull-billed tern (*Sterna nilotica*), Least Tern (*Sterna antillarum*) and Black Skimmer (*Rynchops niger*). Each of these species depends on access to stable beach areas near but above high tide to lay their eggs. One cause of nesting failure is higher than normal tides which submerge or wash away birds' eggs (Corbat, 1990) or erode the area where loggerhead turtles have nested.

Ecological Studies in the SINERR

AQUATIC HABITAT

The aquatic habitat of the SINERR includes the water that remains in tidal creeks and the Duplin River throughout the tidal cycle and the water which covers the marsh at high tide. At low tide this water resides in the Duplin and in the larger tidal channels which do not drain completely. Approximately 80% of the Duplin River watershed is intertidal marsh and mud flat, and the remaining 20% is permanently submerged. Many ecologically important species reside permanently in the subtidal areas of the Duplin River system, while others migrate on and off the marsh surface with the tide. All of the organisms which move onto the marsh surface at high tide try to leave with the receding tide, but some very small individuals may be able to survive until the next flood tide by taking refuge in small puddles of standing water which form in depressions, or even in fiddler crab burrows. Many species spend only part of their life cycle in estuary-marsh areas such as the Duplin.

The aquatic environment is highly variable with fluctuations in water height, salinity, temperature and many other factors which affect biological processes occurring on time scales from hours to months. Figure 15 illustrates that variability in water temperature, salinity and pH at the Marine Institute's Flume Dock hydrological monitoring station within the SINERR. Water temperature (Fig. 15a) follows the expected seasonal trend, with coldest temperatures occurring in January and the warmest in mid-summer. Salinity varies in response to local rainfall, evaporation during hot summer months and river discharge. During periods of high flow in the Altamaha River, or of high discharge from Georgia's other rivers emptying into the Atlantic Ocean, low salinity water can be introduced to Doboy Sound from the Altamaha via the North River and Back River or from the Atlantic Ocean, and some low salinity water can enter the Duplin River on flood tide. Conversely, when river discharge is low and nearshore salinities are high, saltier water can be introduced to the system by flood tides. Thus the pattern of variation in salinity (Fig. 15b) is more variable than that for temperature; pH, which is affected by even more factors than salinity, shows even more variability (Fig. 15c). These graphs depict monthly averages, which hide much of the short-term variability that organisms living in the Duplin River experience.

Other important abiotic components of the aquatic system are less easily measured. Particulate and dissolved materials are carried by tidal currents on and off the marsh and are constantly being redistributed within the estuary. Distributions of these materials, which range from dissolved nutrients such as ammonium, phosphate and nitrate to small

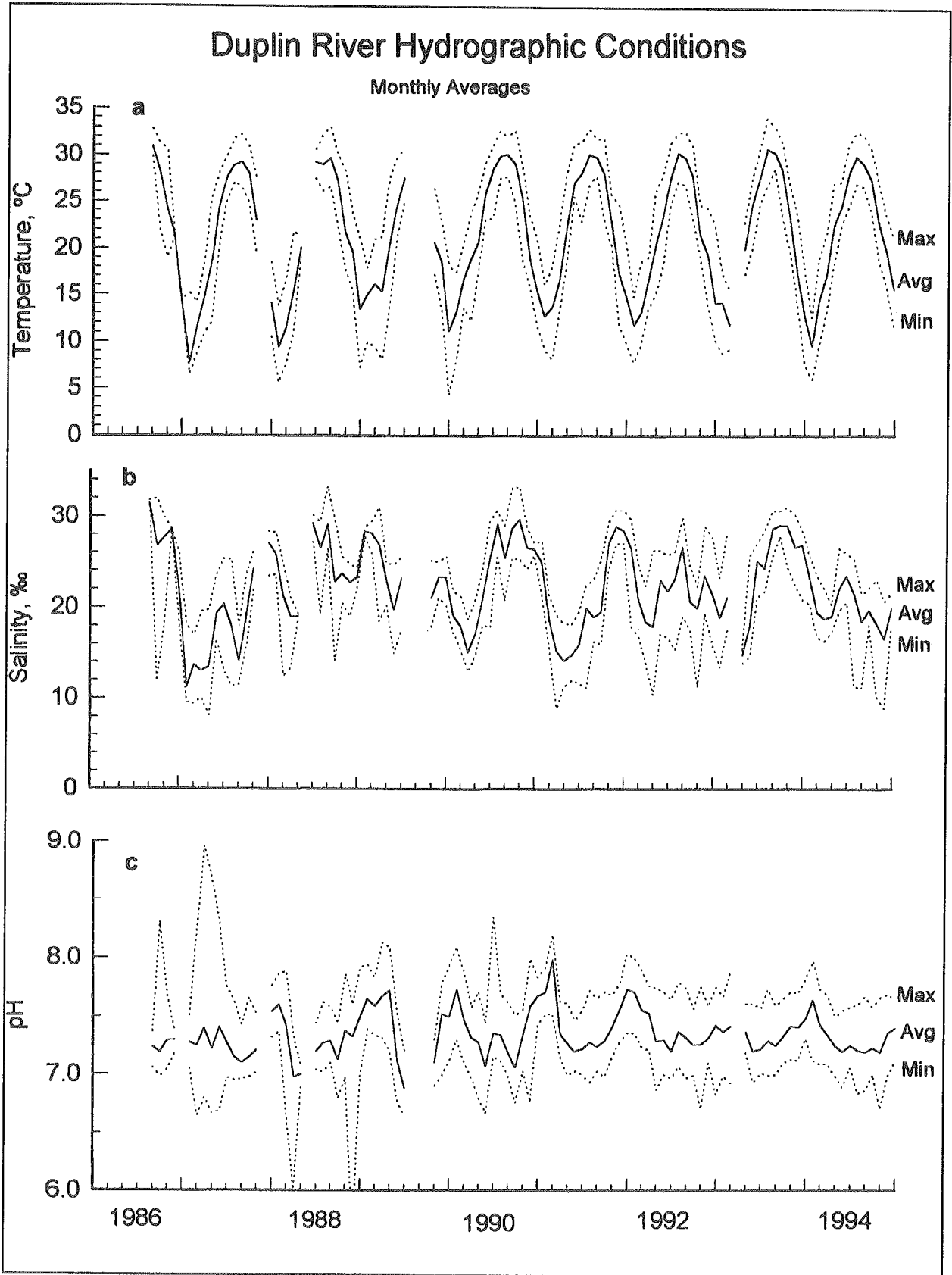

Figure 15. Temperature, salinity and pH in the Duplin River for 1986 -1994.

particles of dead plant material and to large floating rafts of dead plant stems (wrack), are controlled by hydrology and biological activity and, in the case of floating wrack, wind. Dissolved compounds and particulate matter entrained in the water column move with the tidal currents, but net transport is largely a function of diffusive gradients (Imberger *et al.*, 1983; Chalmers *et al.*, 1985).

INTERTIDAL HABITAT

The intertidal habitats of the SINERR consist of unvegetated creek banks and mud flats in the Duplin River and adjacent tidal creeks, including small tidal creeks that drain completely at low tide and the vegetated marsh surface, which contains several distinct zones (Fig. 9). As discussed in the section on geomorphology, the plant zonation is controlled by a combination of interacting factors including elevation and hydrology (Chalmers, 1982; Wiegert *et al.*, 1983). Although the marsh surface is covered by water less than half of each tidal cycle, there is a perched water table which maintains the sediments of all but the highest intertidal elevations in a near waterlogged condition. Near creek channels the hydraulic head created by difference in the level of the water table and water level in the channel results in a slow seepage of interstitial water through the creekbanks into the channels. At a distance from the creeks, however, there is little subsurface water movement except that due to water loss near the surface via evaporation and transpiration. That water is replenished by the subsequent flood tide, but the difference in water exchange near creeks and at a distance from them results in large and constant differences in redox potential, salinity, sulfide concentration and plant productivity (Chalmers, 1982; King *et al.*, 1982; Wiegert *et al.*, 1983). Table 1 shows a comparison of plant, soil, and microbial attributes of low and high *S. alterniflora* zones in Sapelo Island marshes.

The different growth forms of *S. alterniflora*, tall on creekbanks and levees grading into an intermediate height behind the levees and to the short form in areas farthest from creeks, collectively have a rate of annual production that rivals that of any natural ecosystem. In spite of decades of research, the cause of the different growth forms remains unclear. Wiegert *et al.* (1983) found that increasing subsurface drainage in areas with the intermediate growth form could increase height of culms and double production in one growing season. They attributed this increase in growth to removal of end-products of anaerobic decomposition such as sulfide and increased availability of nutrients. The agent of these changes was increased flushing of the sediments with tidal water. Bradley and Dunn (1989) showed that in hydroponic culture sulfide could indeed inhibit growth of *S. alterniflora* at concentrations commonly found in high marsh sediments. They also found evidence that sulfide concentration could be an agent in determining zonation of species in the marsh.

The bare mud banks of the creeks and larger drainage channels also support a flora which has relatively high rates of primary production, even though it is overshadowed by the production of marsh grass in ecosystem budgets (Pomeroy, 1959). The diatoms that form a golden sheen on the surface of the mud when they are not covered by water migrate down into the mud when the tide comes in (Williams, 1963). They live in a nutrient-rich environment due to water seeping through the creek banks (Agosta, 1985), but

Table 1. Comparison of High Marsh (SS) and Low Marsh (TS) at Sapelo Island. A plus sign (+) indicates location where higher value is found. An equal sign (=) indicates that values are the same in each location.

ATTRIBUTE	TS	SS	REFERENCE
<i>Spartina alterniflora</i>			
Height	+		Pomeroy <i>et al.</i> , 1981
Biomass	+		Pomeroy <i>et al.</i> , 1981
Aerial production	+		Pomeroy <i>et al.</i> , 1981
% N	+		Pomeroy <i>et al.</i> , 1981
Root penetration depth	+		Pomeroy <i>et al.</i> , 1981
Belowground production	=		Pomeroy <i>et al.</i> , 1981
Stem density (stems/m ²)		+	Pomeroy <i>et al.</i> , 1981
Soil			
Water flow	+		Nestler, 1977
CO ₂ evolved (soil)	+		Christian <i>et al.</i> , 1981
Eh	+		Giblin & Howarth, 1984
pH	+		Giblin & Howarth, 1984
SO ₄ ²⁻ concentration	+		Oshrain, 1977
Dissolved iron (>7cm)	+		King <i>et al.</i> , 1982
Dissolved iron (surface)		+	King <i>et al.</i> , 1982
Mn-reduced (surface)	+		Spratt and Hodson, 1994
Mn-soluble	+		Spratt and Hodson, 1994
Mn-reduced (>10cm)	=		Spratt and Hodson, 1994
NH ₄ ⁺ , NO ₂ ⁻ , NO ₃ ⁻	=		Chalmers, 1977
Volatile H ₂ S		+	Oshrain, 1977
Salinity		+	Christian <i>et al.</i> , 1981
Dissolved organic carbon		+	Sottile, 1974
Macroorganic matter		+	Gallagher and Plumley, 1979
Microbial			
Benthic algal production	+		Pomeroy <i>et al.</i> , 1981
Adenylate energy charge	+		Wiebe and Bancroft, 1975
Fermentation	+		Christian and Wiebe, 1978
Sulfate reduction rate	+		Skyring <i>et al.</i> , 1979
Nitrogen fixation rate	+		Ubben and Hanson, 1980
Mn oxidation rate	+		Spratt <i>et al.</i> , 1994
ATP (>10 cm depth)	+		Christian <i>et al.</i> , 1975
ATP (top 5-10 cm)		+	Christian <i>et al.</i> , 1975
Denitrification		+	Sherr and Payne, 1978
CH ₄ evolution		+	King and Wiebe, 1978

are heavily grazed by snails (*Ilyanassa obsoleta*) and fiddler crabs (*Uca pugnax*) when they are on the surface photosynthesizing (Pace *et al.*, 1979).

Feeding behavior of fiddler crabs, particularly of the sand fiddler, *Uca pugilator*, was studied extensively by Robertson and his colleagues (Robertson *et al.*, 1980, 1981; Robertson and Newell, 1982a, 1982b) to determine the factors controlling foraging behavior, the efficiency of extraction of food from the substrate and the feeding stimulants which cue their feeding. They found that the pattern of foraging exhibited by the sand fiddler is partially in response to gradients in the food resource, and that the crabs are forced to forage at a distance from their burrows, which serve as a refuge from predation, because of reduction in food density by previous grazing. Paradoxically, Robertson *et al.* (1980) found that sand fiddlers leave behind a significant portion of the food available near their burrows as a consequence of harvesting less than half of the available substrate. Once harvested, food is extracted from the substrate at a high level of efficiency. The favored foods of sand fiddlers are diatoms and blue-green algae (Robertson *et al.*, 1981). Robertson and Newell (1982b) showed that differences in mouth parts cannot totally explain the separation in the distribution of the three species of *Uca* present in the SINERR: *Uca pugilator*, which is found on sandy beaches with low wave activity, bare creekbanks having sand content of 10%-70%, and sandy areas of salt marshes dominated by species of *Salicornia* and *Distichlis*; *U. pugnax*, which is found in the muddy, regularly flooded intertidal marsh as well as in the *Salicornia*—*Distichlis* marshes; and *U. minax*, which is found primarily in the higher elevation short *Spartina* marshes.

Throughout the intertidal marsh, benthic invertebrates, bacteria and algae live in close association with the marsh vegetation, grazing on it, decomposing it, using it as refuge or a substrate for attachment, and serving as a food resource for other marsh residents and for animals which migrate onto the marsh with the tide. Distribution, life history characteristics and energetics of various populations of marsh invertebrates have been the subject of various studies through the years (Teal, 1958, 1959a, 1959b, 1962; Odum and Smalley, 1959; Smalley, 1960; Kuenzler, 1961a, 1961b; Wolf *et al.*, 1975; Montague, 1982; Kneib and Parker, 1991; Covi and Kneib, 1995). In recent years Kneib has focused a great deal of effort on determining what species of nekton utilize vegetated intertidal habitat (Kneib, 1991), how distributions of marsh infauna are affected by predation by foraging nekton (Kneib, 1992) and how geomorphology, spatial scale and physical structure of the marsh affect interactions between nekton and prey species (Kneib, 1994; Lee and Kneib, 1994).

Natant organisms must balance the benefits of swimming onto the flooded marsh to forage with the dangers of being stranded in the marsh by the receding tide. Kneib and Wagner (1994) found that less than a third of the species of fishes, shrimps and swimming crabs which inhabit the SINERR estuary (21 species out of over 75) actually used the intertidal marsh surface during the summer months. Individuals of only four species comprised 95% of all individuals collected. Year-round sampling collected only an additional 12 species using the marsh surface during high tide (Kneib, 1991). Abundance and species richness was greatest in the low intertidal (25 m from the nearest creek), with fewer individuals being found in the high intertidal (90 m from a creek) (Kneib and Wagner, 1994). Variations in stages of the tide when various species were most abundant on the marsh suggested that larger species such as white shrimp, *Penaeus setiferus*, leave the marsh earlier in the ebb tide than some of the smaller species, which may be more toler-

ant of stranding in the marsh. At low tide smaller individuals are abundant in shallow water adjacent to vegetated marsh, but move only a short distance into the marsh at high tide (Kneib and Wagner, 1994), while larger individuals move further into the marsh to forage on the more abundant prey species available at higher elevations (Kneib, 1992, 1995). Mayer (1985) found that juvenile white shrimp, *Penaeus setiferus*, fed extensively on marsh benthic invertebrates such as the polychaete *Nereis succinea*, ostracods, tanaids and dipteran larvae, especially on night-time high tides. Kneib and Wagner (1994) also found that white shrimp were more abundant on the marsh at night.

Behavior in some cases affects what prey species a predator in the intertidal marsh will consume. Kneib and Weeks (1990) found that although the mud crab, *Eurytium limosm*, would readily eat young killifish (*Fundulus heteroclitus*) in laboratory feeding experiments, crabs collected in the marsh did not have killifish remains in their cardiac stomachs, indicating that they were not feeding on killifish in the field. The explanation for this apparent failure to utilize an abundant intertidal prey species is that the mud crab feeds primarily at high tide when young killifish are dispersed in the water column and less vulnerable to benthic predators than during laboratory studies.

Gradients in abiotic and biotic factors produced by tidal flooding can influence distribution of marsh organisms. At lower elevations and on levees adjacent to creeks, the marsh surface and vegetation generally remains damp even during low tide due to the duration of tidal inundation that those areas experience. Organisms such as the amphipod *Uthlorchestia spartinophila* which favor moist conditions are most abundant on the levees (Covi and Kneib, 1995). The structural characteristics of the *Spartina alterniflora* growing there also provide refuge from submergence and predators during high tide. *U. spartinophila* was also abundant at the other end of the tidal gradient, possibly due to lower pressure from predators at that elevation (Covi and Kneib, 1995). Size and abundance of other prey species, such as the marsh periwinkle, *Littoraria irrorata*, can be affected by intertidal migratory behavior of predators. Schindler *et al.* (1994) used the incidence of shell-scarring, evidence of a non-lethal attack by a blue crabs, to estimate intensity in predation of crabs on the snails. They hypothesized that distance from the marsh edge, vegetation density and duration of tidal inundation would affect the ability of crabs to forage in the marsh and the length of time available to them to forage, and predicted lower rates of predation by crabs on snails with increasing intertidal elevation.

Studies of utilization of intertidal marsh by blue crabs, *Callinectes sapidus*, have been conducted by Arnold and Kneib (1983) and Fitz and Wiegert (1991). Although there were some differences in the conclusions of the two studies with respect to frequency with which larger crabs move onto the marsh surface, both agreed that smaller individuals are more frequently found to move onto the marsh during high tide and feed there on invertebrate species such as non-portunid crabs, shrimp and similar crustaceans, gastropods and annelids. Fitz and Wiegert (1991) found that guts of crabs collected on the marsh were fuller at or after high tide than before high tide, confirming that they are feeding while on the marsh during high tide. Mayer (1985) found that juvenile white shrimp (*Penaeus setiferus*) also had near-empty guts at low tide but full guts when captured on the marsh during high tide. These findings support the hypothesis of Chalmers *et al.* (1985) that

nekton which migrate onto the marsh surface to feed and then return to the tidal channels of the estuary when the tide recedes can serve as a significant mechanism for redistribution of organic matter within the ecosystem, specifically removing organic carbon from the marsh and releasing it in the water column where it is more likely to be exported from the estuary to the sounds and nearshore waters.

At the highest elevations of the marsh interstitial salinities can become quite high due to infrequent inundation and evaporation except in areas adjacent to uplands, where groundwater seepage and runoff may alleviate osmotic stress for plants living there. Areas near the uplands often have a fringing band of *Juncus roemerianus*, which also can often be seen as large dark patches in the midst of an expanse of *S. alterniflora*. Often these patches are perched on old beds of the marsh mussel, *Geukensia demissa*. Although clearly able to tolerate inundation with salt water, *J. roemerianus* appears also to occur where it has more freshwater and infrequent inundation, in contrast to the succulent species found in the high marsh such as *Salicornia virginica* and *Sarcocornia perennis*, which are often found fringing salt pans or invading bare areas of marsh with relatively high elevation. Factors influencing zonation of these and other high marsh plants such as *Batis maritima*, *Baccharis angustifolia*, and *Borrchia frutescens* are poorly understood and have received little attention from researchers on Sapelo Island until recently. Dr. Steven Pennings has begun investigating the effects of salinity, competition, shading and other factors on zonation of high marsh plant species.

UPLAND HABITAT

The upland areas of SINERR include hammocks dominated by mature live oak, areas of mixed species maritime forest with an overstory of live oak and other species of oak interspersed with pine, areas dominated by pine which were planted during the R.J. Reynolds era, abandoned clearings in various stages of succession and areas of palmetto, pine and shrubs. Management practices in the upland areas include harvesting of pines to thin mature stands and controlled burning to control underbrush. The effect of these management techniques on the marshes adjacent to the uplands has not been studied. Although the impacts are indirect, the marshes adjacent to the SINERR uplands are affected by runoff and groundwater seepage. These effects would be most important in areas where there is a pronounced elevation difference between marsh and upland, as along much of the eastern edge of the Duplin River watershed.

Several freshwater ponds are found on Sapelo Island, although only a few occur within the SINERR. Almost any area with fresh or brackish water also has a resident population of alligators. The pond near the Marine Institute and the Reynolds Mansion has numerous small and a few large alligators which can be seen floating on the surface among the duckweed and emergent vegetation or on the banks of the small islands in the pond. The alligators frequently move between freshwater areas and the salt marsh during the summer, particularly at night. The upland and dune areas of the island are also populated by Eastern diamondback rattlesnakes (*Crotalus adamanteus*), while the cottonmouth

moccasin (*Agkistrodon piscivorus*) is sometimes found near wet areas. Appendix 5 contains a list of reptiles and amphibians which can be found on Sapelo.

Numerous species of birds can be found in the various habitats of the SINERR and elsewhere on Sapelo Island (Appendix 6). The brown pelican (*Pelecanus occidentalis*), herring gulls (*Larus argentatus*), laughing gulls (*L. atricilla*) with their distinctive black heads, ring-billed gulls (*L. delawarensis*), and double-crested cormorants (*Phalacrocorax auritus*) are among the many birds one might see on the ferry ride to and from the island. Willets (*Catoptrophorus semipalmatus*), American oystercatchers (*Haematopus palliatus*) and sanderlings (*Calidris alba*) are among the many species that frequent the beaches; black skimmers (*Rynchops niger*) can often be seen skimming the surface of tidal sloughs and near the water line at low tide. Numerous heron species and egrets can be seen hunting for food along creek banks, in the marsh and in freshwater areas, with clapper rails (*Rallus longirostris*) being heard more often than they are seen. It is not uncommon to see a flock of white ibis (*Eudocimus albus*) in the marsh, or an occasional wood stork (*Mycteria americana*), with a distinctive black edge on the underside of their wings visible when they fly. Various hawk species, black and turkey vultures (*Coragyps atratus* and *Cathartes aura*, respectively), ospreys (*Pandion haliaetus*) and, occasionally, bald eagles (*Haliaeetus leucocephalus*) can be observed in the SINERR. Black-crowned night herons (*Nycticorax nycticorax*) and American coots (*Fulica americana*) frequent the pond across from the Marine Institute. During the summer, the painted bunting (*Passerina ciris*) is a spectacular sight as it flits among the shrubs and trees lining the road to the beach and elsewhere.

Several mammal species can be seen in the SINERR and elsewhere on the island (Appendix 7). Those most commonly seen are white-tailed deer (*Odocoileus virginianus virginianus*), raccoons (*Procyon lotor solutus*) and opossums (*Didelphis marsupialis*). Sightings of feral hogs are unfortunately becoming more common, as their population grows from the few that were introduced to the island in the early 1990s. Armadillos (*Dasypus novemcinctus*) also began being sighted on the island during the 1990s. Feral cattle, remnants of a herd once belonging to R.J. Reynolds, inhabit the north end of the island, and occasionally are seen on the south end. They are reclusive and cautious, so that sightings are uncommon although signs of their presence, tracks and fecal matter, are more common sights.

BEACH AND DUNES

The beach and dune area with its salt-spray community of plants is one of the least studied habitats in the SINERR. This area has a distinct zonation of plants with a gradient of vegetation from the active dunes with their salt tolerant plant species to the back dune area which is more protected from salt spray and wind. The combined effects of high temperatures, high light intensities, high evaporation, salt spray and wind severely limit the diversity of plants growing in the active dune area. Duncan (1982) recognized four zones in the open dune area, with the most fragile and ephemeral being that at the high tide level and on overwash areas of the beach. Here beach hogwort (*Croton punctatus*), salt wort (*Salsola kali*) and sea-purslane (*Sesuvium portulacastrum*) are among the spe-

cies that can be found. On the active dunes sea oats, railroad vine (*Ipomoea pes-caprae*), beach sand-spur (*Cenchrus tribuloides*), beach pennywort (*Hydrocotyle bonariensis*), Spanish bayonet (*Yucca* spp.) and seashore elder (*Iva imbricata*) are found, along with some of the high tide plants. Older, less active dunes are also more protected from wind and salt spray, and become vegetated by a greater variety of plants, including shrubs and small trees. Wax myrtle (*Myrica cerifera*), prickly pear (*Opuntia humifusa*), yaupon (*Ilex vomitoria*), buckthorn (*Bumelia tenax*), Southern red cedar (*Juniperus silicicola*), hercules club (*Zanthoxylum clava-herculis*) and sand live-oak (*Quercus geminata*). The interdune areas are vegetated by many of the species found on older dunes with many additional grasses and shrub species (Duncan, 1982). In recent years, the Chinese tallow tree (*Sapium sebiferum* Roxb.) has begun invading this area (Fred Hay, DNR, personal communication). There are also a number of small ponds in the interdune area. Between the Reynolds mansion and Nannygoat beach, just east of Dean Creek, is a ridge of high wooded dunes covered by many old and beautiful cedars, oaks and pines along with many of the same species found in the younger dune areas.

Although the beach itself appears nearly devoid of life, there are many species that live there or are dependent on its availability for feeding or nesting. At lower levels of the beach, where the surface sand remains damp throughout low tide, there are often large patches of diatoms which give the surface a golden sheen, similar to diatoms found on exposed mud banks in the intertidal areas of the Duplin River, and during summer and fall the lower beach is often covered by a layer of green which is a flagellated euglenoid alga which migrates up and down in the sand in much the same fashion as the marsh diatoms. The factors controlling their vertical migration and the contribution that their photosynthesis and growth make to the nearshore ecosystem has not been adequately studied.

At low tide it is common to see many small holes in the sand surrounded by a ring of small, brown, cylindrical pellets. The hole is the burrow of the ghost shrimp, *Callinassa major*, and the pellets are fecal matter which has been deposited on the surface by the animal in the burrow. Frankenberg *et al.* (1967) investigated the rate of production of *C. major* fecal pellets and their potential significance as food for animals on the beach and in nearshore waters. The fecal pellets contain bacteria and undigested algal cells and cell fragments, along with clay particles, and could provide a neatly packaged source of organic carbon for deposit feeding animals. Frankenberg *et al.* (1967) found that blue crabs (*Callinectes sapidus*) and pagurid crabs (*Pagurus* spp.) readily ingest *C. major* fecal pellets, suggesting that the fecal pellets may be an important food resource for subtidal species.

One permanent resident of the beach is the ghost crab, *Ocypode quadratus*. Research by Robertson and Pfeiffer (1982) on feeding behavior of these semi-terrestrial crabs revealed that in addition to nocturnal predatory foraging, *O. quadratus* engages in deposit feeding during daylight hours, using its minor chelae to transport substrate to the buccal cavity and then to remove feeding pellets, aggregations of uningested substratum. Their behavior is similar to that of the sand fiddler crab, *Uca pugilator*, which can also be found on some sheltered areas of beach and in sandy substrate high marsh habitats. Both *O. quadratus* and *U. pugilator* are highly efficient at removing algae from sand par-

ticles (Robertson and Pfeiffer, 1982; Robertson *et al.*, 1980). Deposit feeding by ghost crabs was restricted to areas with visibly dense patches of diatoms.

Sea birds nest in some areas of the SINERR beaches, but Corbat (1990) found that the number and success rate of nests on Sapelo and in Georgia in general is lower than that found in nesting areas in adjacent states. This may be due to a shortage of suitable habitat. Nesting shorebirds prefer nesting on a sparsely vegetated wide berm above the high tide line, and although Georgia's beaches are wide and gently sloping, there are not many flat areas above the high tide level. Most of the nests that were observed on Sapelo failed to produce hatchlings. Many were disrupted by raccoons and ghost crabs, and others were inundated by an unusually high tide or were abandoned for unknown reasons (Corbat, 1990). It appeared that there were occasionally good nesting years when hatching rates were somewhat higher, but in any case, shorebird nesting in the SINERR is an activity which is highly sensitive to disturbance from natural events, and one that needs to be protected from human intrusion as much as possible.

Loggerhead turtle nesting in the SINERR is another risky and often unsuccessful activity. DNR has been monitoring nesting activity and success rate since 1987, and the number of nests laid during that time ranged from 24 in 1993 to 79 in 1995 (personal communication, Brad Winn, Georgia DNR). The average number of nests per year during the 10-year monitoring period is 50, with an average of 120 eggs/nest. Hatching success has ranged from 0 to 90%, with the main causes of mortality being predation on the eggs by raccoons and ghost crabs; erosion because of storms, unusually high tides or poor site

selection by the female turtle; and drowning of the nest by an unusually high water table after periods of heavy rain (personal communication, Brad Winn, Georgia DNR). Interestingly, one of the earliest publications from the Marine Institute concerned mortality of loggerhead turtle eggs due to excessive rainfall (Ragotzkie, 1956).

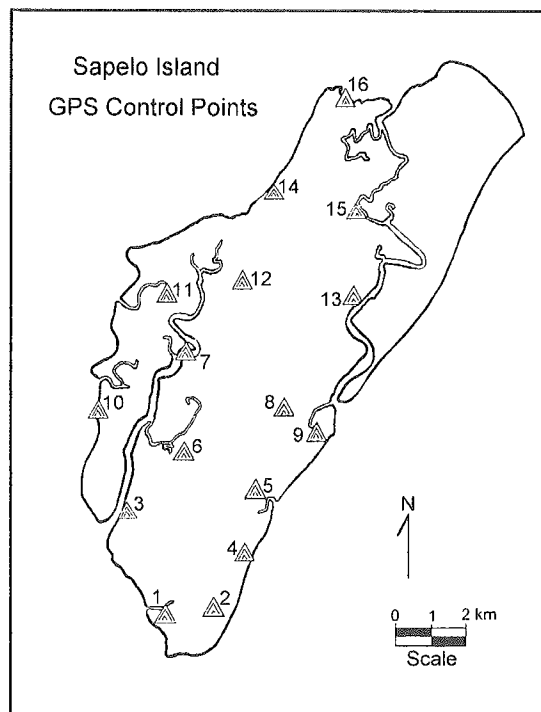

Figure 16. Network of GPS Control Points.

LAND USE, HABITAT AND SHORELINE CHANGE ON SAPELO ISLAND

In 1991, with funding from a NOAA Research Reserve grant, the Center for Remote Sensing and Mapping Science and the Marine Institute of the University of Georgia constructed an integrated resource database for the SINERR to be used for research and educational activities promoting marshland preservation. The original database contained information on topography, planimetry, vegetation, land use and land forms based on photographs

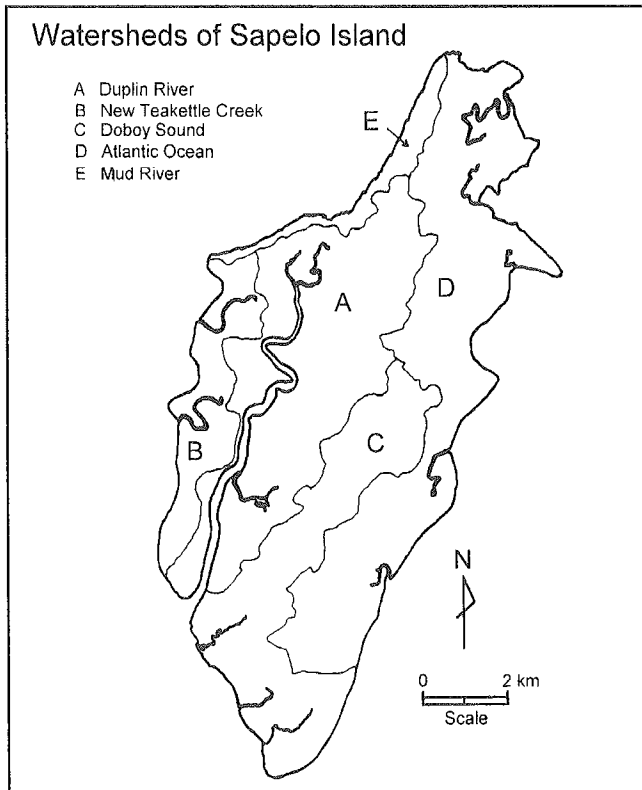

Figure 17. Boundaries of 5 watersheds on Sapelo Island with the water bodies they drain

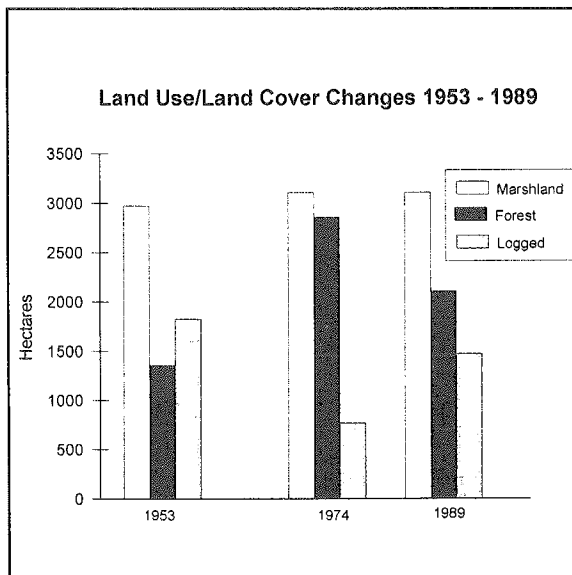

Figure 18. Some results of land cover/land use change analysis of Sapelo Island, 1953 - 1989. (From Welch *et al.*, 1992.)

recorded in 1989. Global Positioning System (GPS) surveys, photogrammetric aerotriangulation and compilation procedures, computer-aided image analyses and air photo interpretation were used to compile the database. A network of 16 GPS control points was established (Fig. 16) and a topographic map with a contour interval 1 m were produced from spot heights measured using 1:16,000-scale film transparencies and a stereo-plotter (Welch *et al.*, 1991).

Subsequent work added drainage basin boundaries (Fig. 17), soils information from the McIntosh County Soils map (Fig. 19) and vegetation and land-use data sets derived from photointerpretation of aerial photographs recorded in 1953 and 1974 (Fig. 20b and 20c) were added to that from 1989 (Fig. 20d). Outlines of polygons of the various land use and vegetation classes were digitized and annotated with attribute information using Arc/Info. Then comparisons of land-use/land-cover were made for the time intervals 1953 - 1974, 1953 - 1989, and 1974 - 1989 (Welch *et al.*, 1992).

Two of the most striking changes were the increase in forested areas during the 36 year interval from 1953 to 1989, most likely due to changes in ownership and management of land in what is now the R. J. Reynolds Wildlife Management Area, and the changes in the area which had been recently logged. During the period 1953 - 1974 there was a large decrease in the logged area (Fig. 18), reflecting a change in management goals during the period that the island was shifting from private to public ownership. During the period from 1974 - 1989, however, logged areas nearly doubled, clearly showing the effect of the return to thinning of the pine forests on the island.

Since the database was created, a GIS laboratory has been established at the Marine Institute so that the database is now maintained and updated on the island. Color infrared aerial photographs were taken of the island in 1992, 1993 and 1994, making it possible for researchers to assess short-term changes in vegetation, land use and shorelines.

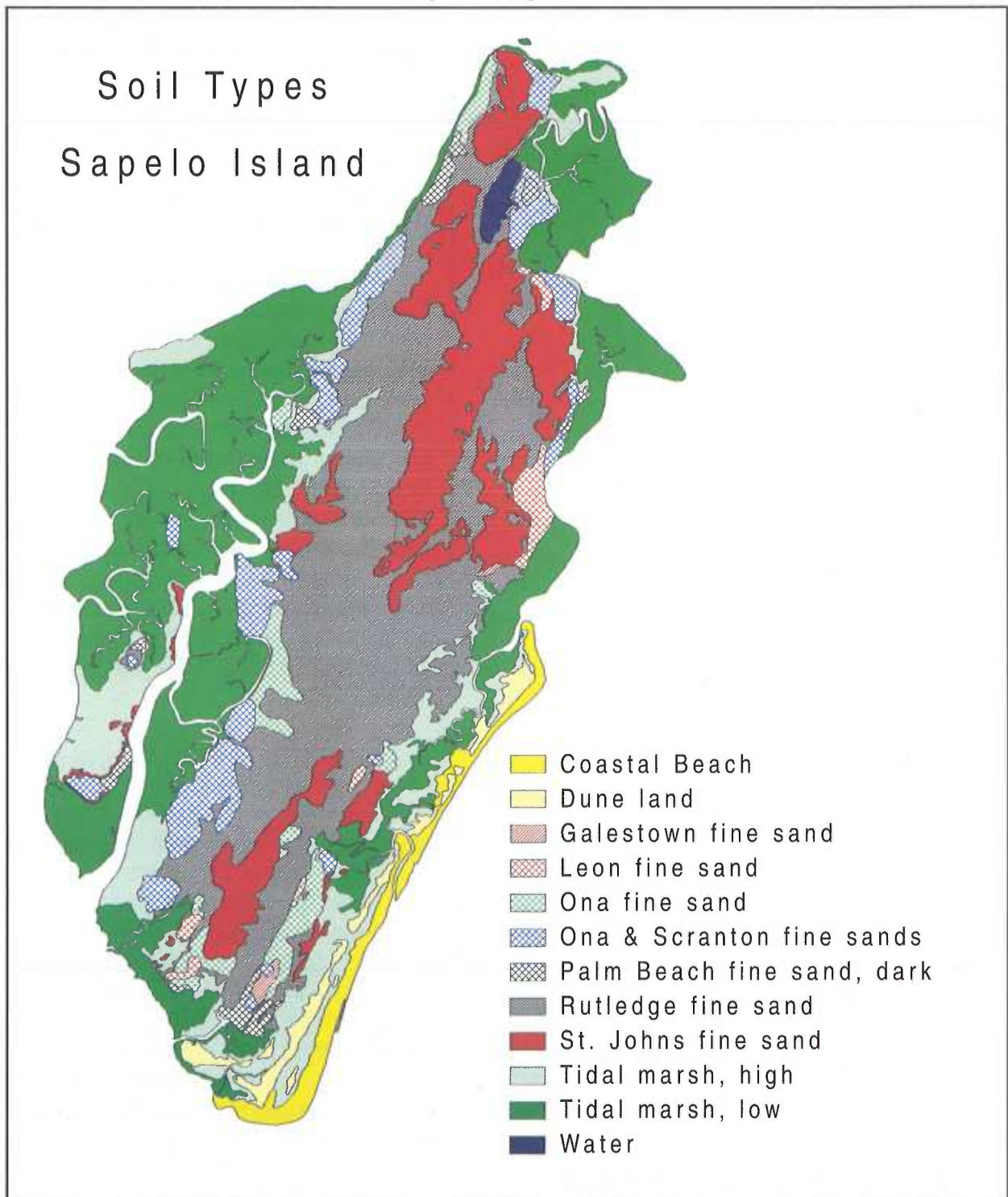

Figure 19. Soil types of Sapelo Island. From McIntosh County, Georgia Soil Survey, 1959. United States Department of Agriculture, Soil Conservation Service.

Land Use/Cover Changes for the SINERR and Sapelo Island 1953 and 1989

LEGEND

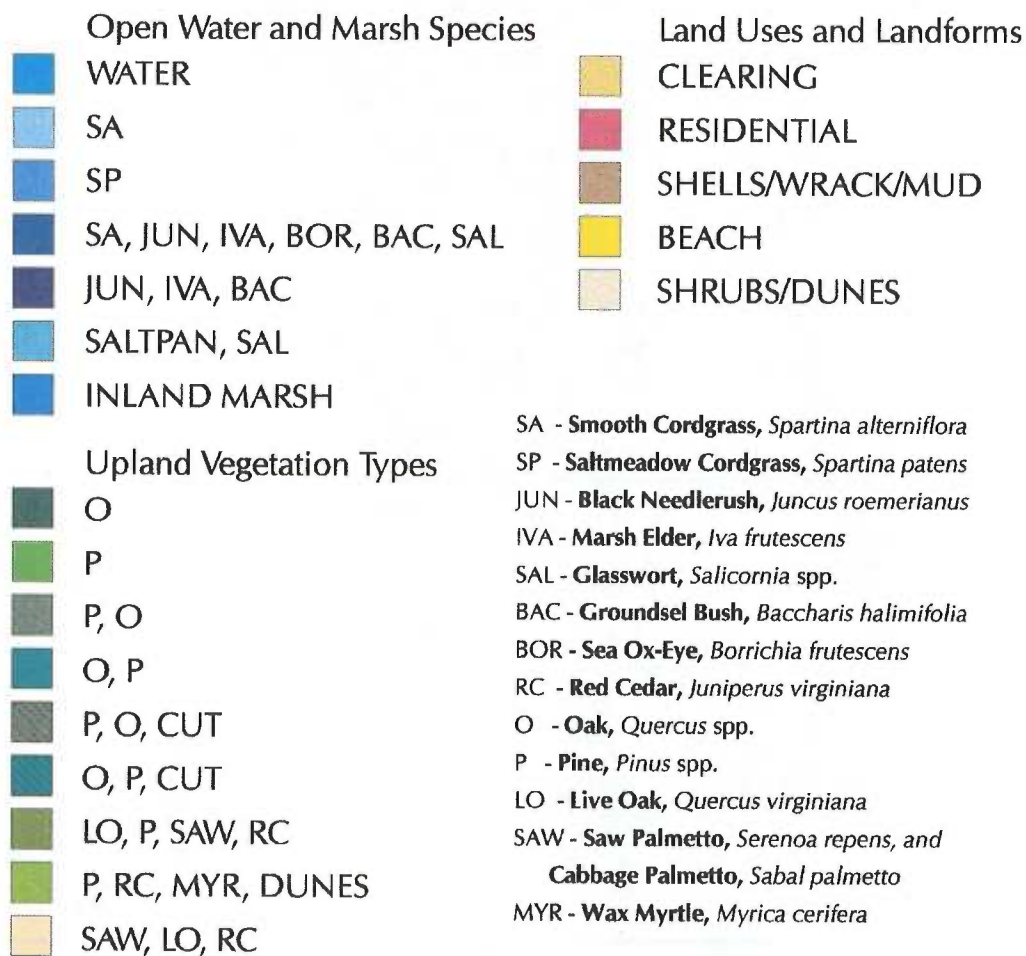

Figure 20a. Legend. Land use/cover for the SINERR and Sapelo Island, 1953 to 1989 based on aerial photographs and generated using the ARC/INFO geographic information system by the Center for Remote Sensing and Mapping Science, Department of Geography, The University of Georgia.

Land Use/Cover SINERR - 1953

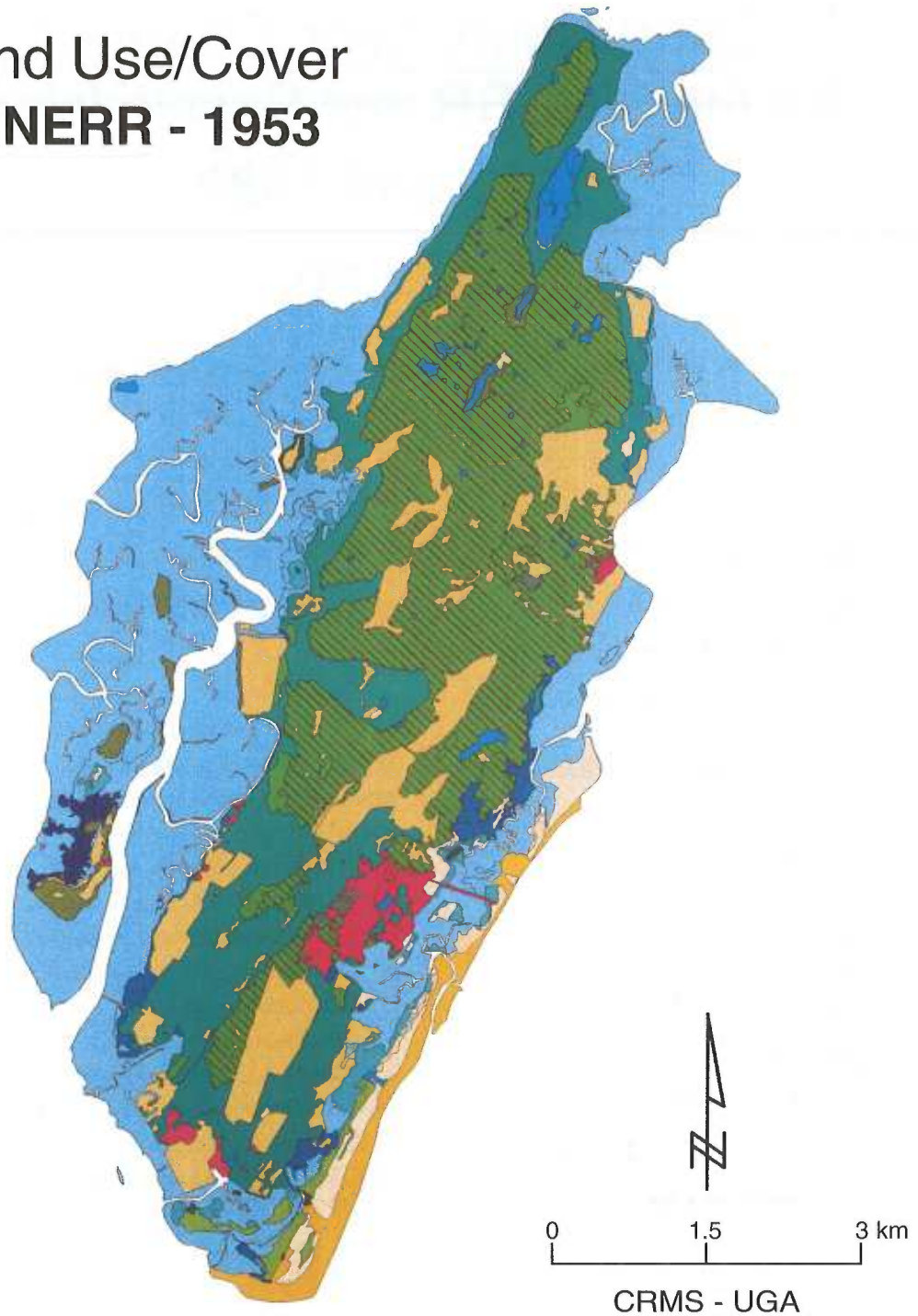

Figure 20b. Land use/cover for the SINERR and Sapelo Island, 1953 based on aerial photographs and generated using the ARC/INFO geographic information system by the Center for Remote Sensing and Mapping Science, Department of Geography, The University of Georgia. See Fig. 20a for legend.

Land Use/Cover SINERR - 1974

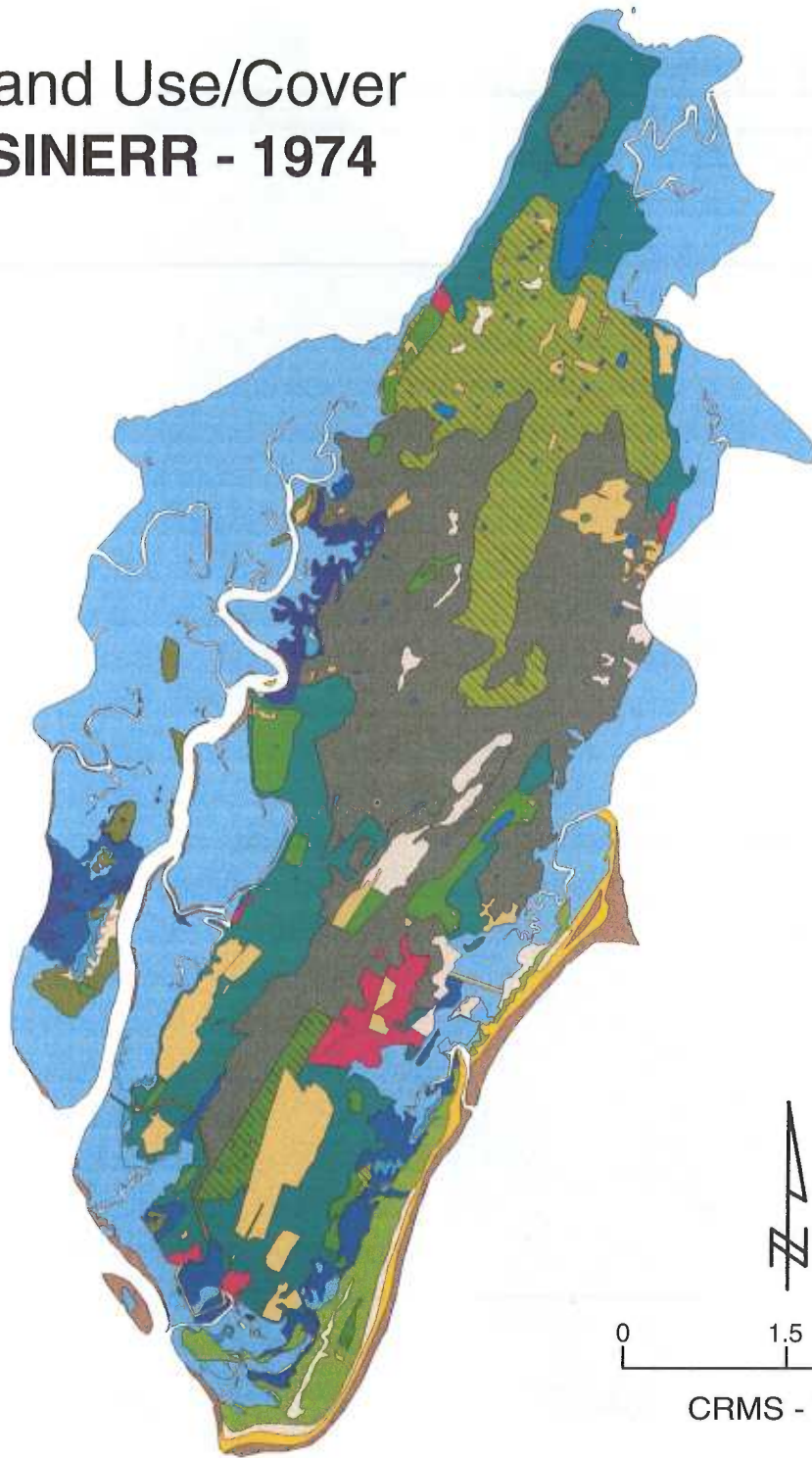

Figure 20c. Land use/cover for the SINERR and Sapelo Island, 1974 based on aerial photographs and generated using the ARC/INFO geographic information system by the Center for Remote Sensing and Mapping Science, Department of Geography, The University of Georgia. See Fig. 20a for legend.

Land Use/Cover SINERR - 1989

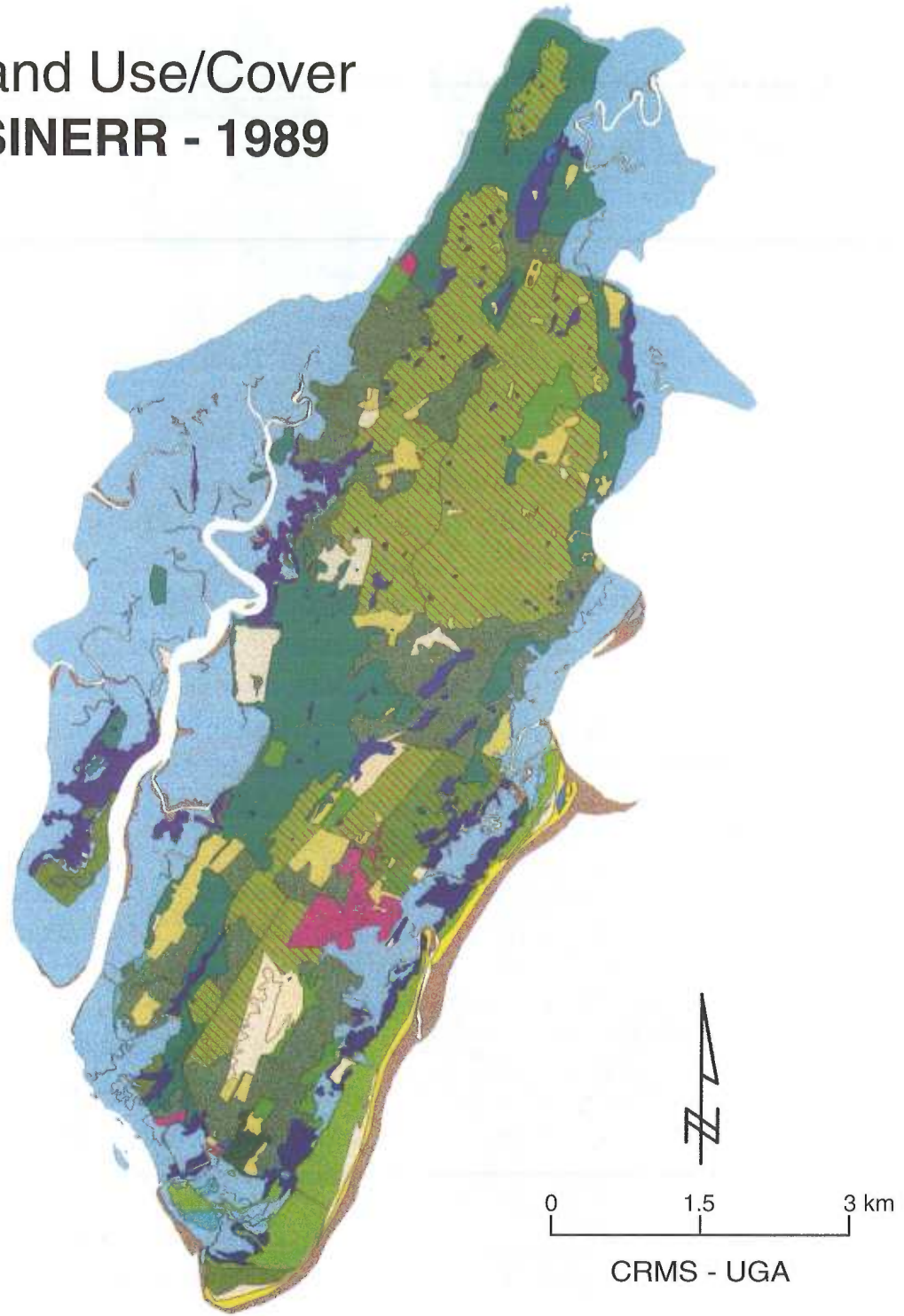

Figure 20d. Land use/cover for the SINERR and Sapelo Island, 1989 based on aerial photographs and generated using the ARC/INFO geographic information system by the Center for Remote Sensing and Mapping Science, Department of Geography, The University of Georgia. See Fig. 20a for legend.

PRIMARY PRODUCTION

Primary production in the water column and in the marsh have been studied intensively in the SINERR. Annual primary production by phytoplankton in the Duplin River has been estimated to be in the range of 250 - 375 g C/m² (Ragotzkie, 1959; Pomeroy and Wiegert, 1981). Rates of photosynthesis in the highly turbid waters of the Duplin River are generally light limited. While standing stocks of nutrients are often low, rapid biological and physicochemical processes maintain a continuous supply of nitrogen and phosphorus large enough for phytoplankton growth (Pomeroy *et al.*, 1972; Haines, 1979a). Whitney *et al.* (Pomeroy and Wiegert, 1981) found that the highest rates of phytoplankton photosynthesis occurred in the water over the marsh on spring high tide.

Benthic and epiphytic algae make a significant contribution to primary productivity in the Duplin River watershed, with net productivity of epibenthic algal assemblages of approximately 190 g C m⁻² yr⁻¹ (Pomeroy and Wiegert, 1981; Whitney and Darley, 1983), nearly 25% of the aerial productivity of *S. alterniflora* (Gallagher *et al.*, 1980). The highest rates of production occur on exposed bare creekbank. Algal biomass and productivity in the marsh is both light and nitrogen limited and heavily grazed by fiddler crabs (Darley *et al.*, 1981; Whitney and Darley, 1983).

The most obvious, and most studied, primary producer in the Duplin River ecosystem is *S. alterniflora*. That research is extensively reviewed in Pomeroy and Wiegert (1981). Early work focused on aerial production, but subsequent research by Gallagher and Plumley (1979) showed that rates of belowground production could equal the aboveground in short *Spartina*, and that although aerial production of tall *Spartina* is 2.5 times that of short, belowground production is roughly the same in both areas, 770 g C m⁻² yr⁻¹. Net aerial production of *Juncus roemerianus* is intermediate between that of tall and short *Spartina* (Gallagher *et al.*, 1980), but when belowground production is considered, it is nearly as productive as tall *Spartina*. Because it occupies only a small portion of the whole watershed, however, its overall contribution to marsh production is small. Likewise, some of the other minor marsh plant species have high rates of net productivity (Linthurst and Reimold, 1978) but make only a small contribution to the total marsh production.

DECOMPOSITION

Decomposition and utilization of *S. alterniflora* has also been the subject of a great deal of research in the SINERR. Early studies of the marsh found that only 5% of the aboveground biomass was lost each year to grazing insects, and little appeared to be degraded on the marsh surface, although it was not building up on or in the sediments. Standing dead *Spartina* disappeared from the marsh, and some pieces and particles were observed in tidal creeks draining the marsh. Furthermore, Ragotzkie (1959) had found that the aquatic portion of the estuary was heterotrophic during most of the year and had postulated that the aquatic system was subsidized by inputs of organic matter from the marsh.

HYPOTHESES AND PARADIGMS

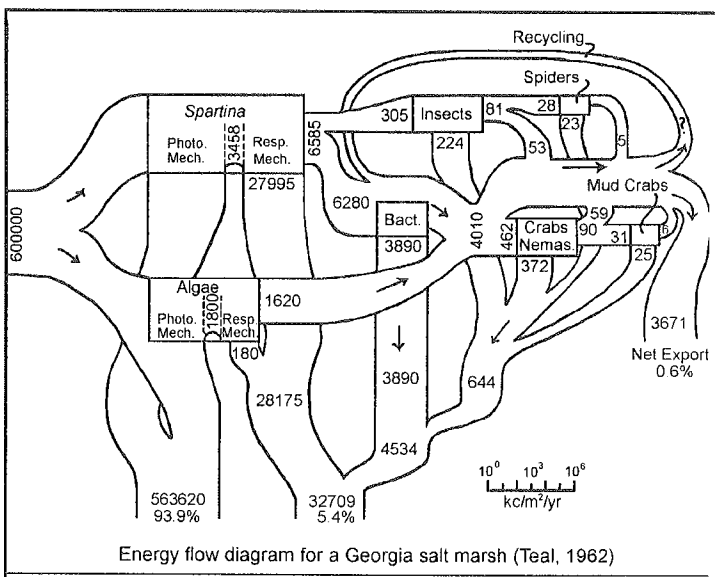

Figure 21. Teal's energy flow diagram of the salt marsh. Numbers are $\text{kcal m}^{-2} \text{yr}^{-1}$. (From Teal, 1962.)

Teal (1962) synthesized these data and other information on the energetics and food web of salt marsh organisms into a model of energy flow in a salt marsh ecosystem (Fig. 21) that estimated that roughly half of the net production by *Spartina* is exported from the marsh into adjacent creeks and bays by the tide. This model used calories as a bookkeeping unit, tracking transfers of energy between components of the salt marsh food web, with sunlight furnishing $600,000 \text{ kcal m}^{-2} \text{yr}^{-1}$, of which $563,620 \text{ kcal m}^{-2} \text{yr}^{-1}$ (93.9%) is lost during photosynthesis. Table 2 summarizes the information in Teal's energy-flow diagram.

Table 2. Summary of salt marsh energetics (from Teal, 1962).

	$\text{kcal m}^{-2} \text{yr}^{-1}$	
Input as sunlight	600,000	
Loss in photosynthesis	563,620	93.9% of total energy input
Gross production	36,380	6.1% of total energy input
Producer respiration	28,175	77% of gross production
Net production	8,205	
Bacterial respiration	3,890	47% of net production
1° consumer respiration	596	7% of net production
2° consumer respiration	48	0.6% of net production
Total energy dissipation by consumers	4,534	55% of net production
Export	3,671	45% of net production

During the same period of time when Teal was collecting the information that led to his energy flow diagram (Teal, 1962), research was being conducted on microbial decomposition of marsh grass and the importance of the decomposing material (detritus) to estuarine food webs by Burkholder (1956), Burkholder and Bornside (1957) at Sapelo and by Darnell (1961, 1967) elsewhere. Their work together with that of Teal (1962) led to the concept of the detrital food chain in the marsh and estuary which was supported by the 45% of *S. alterniflora* production which was washed out of the marsh by the tide. The prevailing view was that this export of excess marsh production supported extensive "nursery grounds" for a number of commercial and sport fish and shellfish (Setzler, 1977). Several

studies were conducted at the Marine Institute on aspects of the detrital food chain, primarily on detritus as a substrate for microbes which are in turn food for detritivores such as mullet (*Mugil cephalus*) (Odum, 1968; Bunker, 1979) and the marsh periwinkle (*Nassarius obsoletus*, now *Ilyanassa obsoleta*) (Wetzel, 1975, 1976; Christian and Wetzel, 1978).

The observations of an extensive detrital foodweb and the excess marsh production were integrated by Odum (1968) into his "outwelling" concept in which he postulated that net primary productivity of marsh-macrophyte dominated estuaries greatly exceeded local degradation and storage of carbon, and that the excess was exported by the tides to the adjacent ocean where it was finally degraded and incorporated into the coastal detrital food web. By the late 1970's, however, the concept of outwelling as well as that of the vast detritus food web was seriously called into question by investigators looking for firm evidence to support those views, which established the importance of intertidal marshes to the entire coastal ecosystem.

Haines (1976b, 1976c, 1977, 1979b) and Haines and Montague (1979) presented evidence based on $^{13}\text{C}/^{12}\text{C}$ ratios (^{13}C) that while most organisms resident in the marsh were feeding on *Spartina*, *Spartina*-derived detritus and the microorganisms living on the detritus, organisms which reside in the creeks and waterways of the estuary were feeding on microalgae and phytoplankton. Also, in 1980 Nixon (1980) published a paper reviewing the concrete evidence for outwelling and export of organic matter from marshes and estuaries. His conclusion was that although the outwelling concept was consistent with the available evidence, it was based on limited information, and that in fact there were virtually no quantitative data to support it. Likewise, Wiegert (1980) concluded that although like Teal (1962) he and his colleagues could not identify mechanisms for consumption or degradation of more than 55% of the net production of the Duplin River watershed ecosystem, neither could they find evidence that it was being exported from the system. Nevertheless, the question of the fate of the excess marsh production remained.

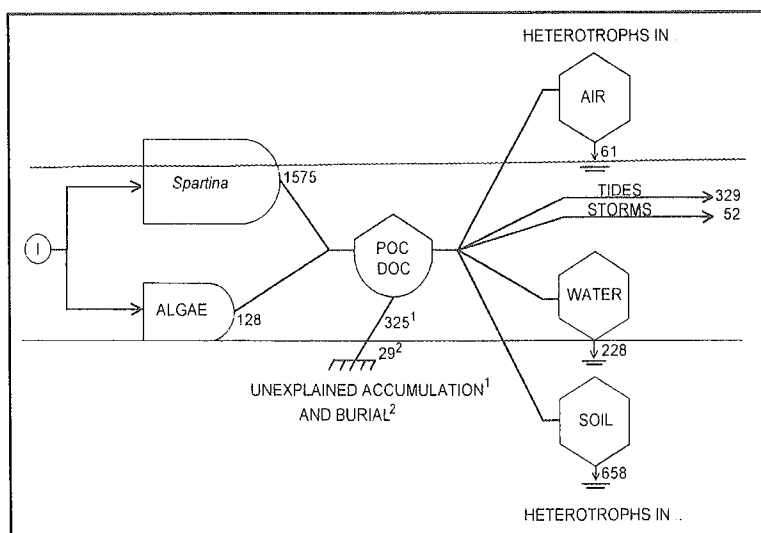

Figure 22. Conceptual model summarizing net carbon balance in a Georgia salt marsh. Numbers are $\text{g C m}^{-2} \text{yr}^{-1}$ (Data from Chalmers *et al.*, 1985.)

Chalmers *et al.* (1985) looked closely at three possible explanations for the "missing" carbon (Fig. 22). They examined the possibility that **1**) a significant portion of the excess production might be leaving the marsh and estuary as large, floating rafts of wrack, which are often deposited high in the marsh, on the beach or piled up against obstructions such as docks in impressively large quantities; **2**) that seasonal concentrations of DOC and POC in the Duplin River had been underestimated, leading to low estimates of diffusive tidal transport

and storm transport (Imberger *et al.*, 1983); **3**) that tidally-mediated fluxes of carbon onto and off of the marsh and storm-driven erosion of carbon from the marsh surface had been underestimated.

They found, however, that the previous estimates of diffusive transport of DOC and POC were too high, so that less carbon was being exported via the Duplin River than previously thought, and that contrary to expectations almost all tidal exchanges within the marsh result in deposition, not export, of carbon (Fig. 22) (Chalmers *et al.*, 1985). Rainfall on the exposed marsh surface was found to subsequently remove most of this deposited carbon, suggesting a mechanism for keeping POC in the thin aerobic surface layer of the marsh where it is most available to detritivores and aerobic microbes (Fig. 23). Finally, they found that although visually impressive, the total standing stock of wrack in the Duplin River system is only a small fraction of the annual production of *S. alterniflora*, and thus its export is a negligible term in the carbon balance equation (Chalmers *et al.*, 1985).

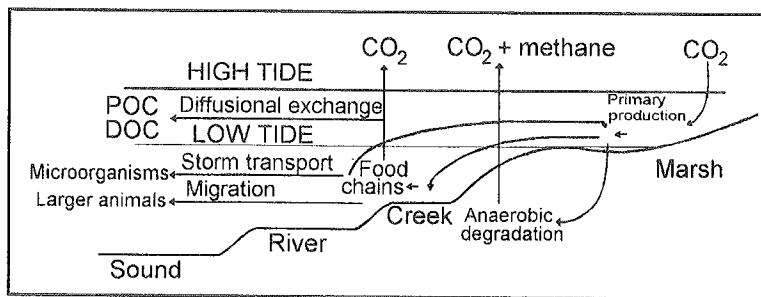

Figure 23. Diagrammatic representation of pathways of carbon relocation within the marsh. (From Chalmers *et al.*, 1985.)

Recent studies by Newell and his colleagues on the decomposition of standing dead *S. alterniflora* and the dynamics of its associated microflora have suggested a whole new means of accounting for the “missing” salt marsh carbon. Their work has necessitated a complete re-assessment of most of the decomposition literature, since they clearly demonstrate the artificiality of conditions in classic

litterbag experiments in which plant material is often cut or ground into small particles and deposited in bags on the marsh surface and weighed and analyzed at intervals to assess loss of material and conversion of chemical constituents. Unlike trees and many other plants which abscise dead leaves, grasses, including *S. alterniflora*, retain their senescent leaves, which begin to decay in the canopy. Environmental conditions in the canopy are significantly different than those present on the marsh surface, and the decomposer communities are well-adapted to exploit those differences (see Newell (1993b) for an extensive review of *Spartina* decomposition.)

Newell *et al.* (1985, 1989) found high rates of microbial respiration and loss of mass from standing, decaying leaves of *S. alterniflora* that were similar to those for detached litter on the sediment surface (Newell and Fallon, 1989). Also, significant rates of microbial nitrogen fixation can occur within standing, decaying leaves (Newell *et al.*, 1992). The early stages of decomposition of the standing dead or decaying *Spartina* are accomplished by ascomycetous fungi, and fungal mass can compose more than 90% of the microbial standing crop associated with the naturally decaying leaves (Newell, 1992, 1993a, 1994). In addition to the food resource that this fungal mass represents for shredder

snails (*Littoraria irrorata*) and other consumers (Bärlocher *et al.*, 1989; Kemp *et al.*, 1990; Newell and Bärlocher, 1993), decomposition of *Spartina* on the marsh surface could go a long way to explaining the difficulty other investigators have had in measuring direct export of *Spartina* detritus. A large portion of the “missing” carbon may be blown off as CO₂ by the microbial community associated with the standing decaying leaves.

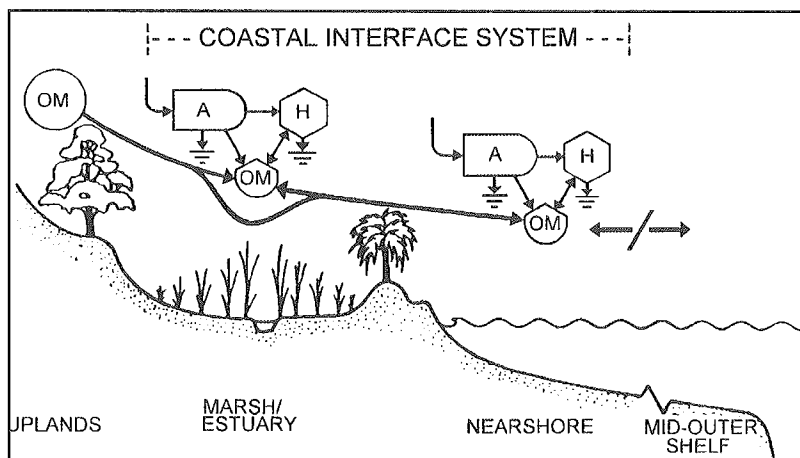

Figure 24. A conceptual model of the coastal interface system. A = autotroph, H = heterotroph, OM = organic matter. (From Hopkins and Hoffman, 1984.)

Taking another approach to solving the problem, Hopkins and Hoffman (1984) and Hopkins (1985) applied the mass balance approach to the entire coastal interface system (Fig. 24). Considering flows between estuarine subsystems, the whole estuarine system, and the nearshore, they concluded that the near-shore system required an input of approximately 210 g C m⁻² yr⁻¹ in addition to local primary production to sustain the high rate of community respiration (Fig. 25). The annual ratio of pri-

mary production to community respiration averaged 0.72 in the nearshore region, clearly indicating that the nearshore was dependent on allochthonous carbon inputs from either terrigenous or marsh/estuarine sources, or both.

The question of the fate of the excess organic production of the marsh and the source of the necessary subsidy of the nearshore system remains unanswered. As Smith (1984) and Hopkins (1989) point out, an ecosystem cannot indefinitely maintain excess net ecosystem production without receiving inputs of nutrients or eventually depleting stored resources. Thus in addition to the question of what happens to the excess production of the marsh/estuary, we must identify the source or sources of new nutrients for the system. Riverine input is the most likely source for our coastal marshes, and evidence of riverine influence on the Duplin River needs to be examined. Also, the potential impact of changes in nutrient loading from riverine watersheds on coastal ecosystems and fisheries needs to be studied.

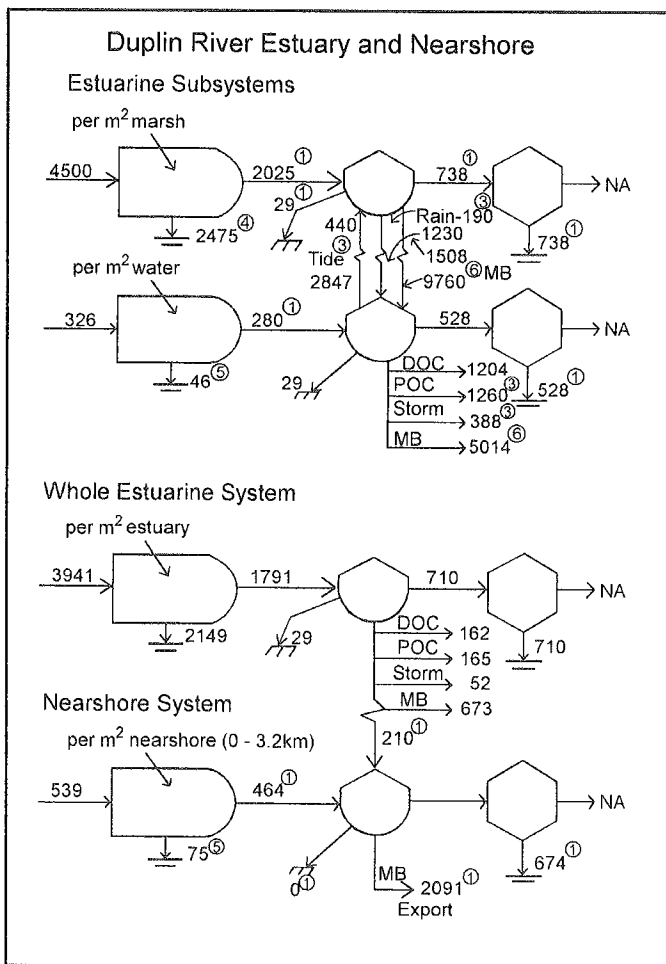

Figure 25. Conceptual models of carbon flow in the Georgia Duplin River estuary and nearshore ecosystems. Estuarine subsystems are the salt marsh proper (top) and adjacent tidal creeks and rivers. The whole estuarine system consists of both salt marsh and tidal creeks and rivers. The nearshore is the area out to 3.2 km from shore. Numbers are g C m² yr⁻¹.

Notes: 1) Hopkinson and Hoffman, 1984; 2) Pomeroy and Wiegert, 1981; 3) Chalmers *et al.*, 1985; 4) assuming 55% of gross production; 5) assuming 14% of gross production; 6) mass balance; 7) discontinuous lines portray scalar differences for donor and recipient systems areas. (From Hopkinson, 1988.)

CHEMICAL STUDIES IN THE SINERR by James J. Alberts

INORGANIC CHEMICALS

Atmospheric Inputs

Chemical studies of atmospheric compounds have been relatively few. A 1975-76 study of rainfall on Sapelo Island showed that average pH of rain was 5.6, which is close to the dissociation constant of carbonic acid, and that dissolved organic nitrogen comprised about 22% of the total dissolved nitrogen in rain (Haines, 1976a). Total nitrogen inputs from rain were calculated to be approximately 0.3 g N/m² per annum, which represents a minor source of nitrogen to the salt marshes relative to riverine and nitrogen fixation sources.

Studies of atmospheric sulfur species conducted in 1989-90 showed that dimethylsulphide (DMS) resulting from numerous biological processes in the marsh was the predominant biogenic sulfur species in the atmosphere over Sapelo. However, fre-

quently continental air masses advecting over Sapelo brought high levels of industrially derived sulfur species to the island (Berresheim, 1993).

Major Elements, Trace Metals and Organometallics

Several studies have been conducted of the major element and trace metal contents primarily of sediments and biota in the SINERR. Almost no analyses of the water column or suspended particulate matter exist. Furthermore, the studies which have been conducted are relatively isolated with no overall synthesis or attempts to systematically determine seasonal or long-term trends.

Bulk sediment elemental data have been reported for eleven metals (Al, Cd, Cr, Cu, Fe, Hg, Mn, Mo, Ni, V and Zn) in the SINERR and these values have been compared to the sediments collected at sites that were exposed to higher industrial activity (Alberts *et al.*, 1990). Only Cr, Cu, Hg, V and Zn were higher in the industrial/port sites by a factor of less than ten relative to the SINERR sediments, while all remaining metals had similar concentrations in all sediments. Concentrations of metals in interstitial waters were often below detection limits in the SINERR sediments (Alberts *et al.*, 1987). A sediment core taken in the SINERR and dated by radiochemical techniques indicate that metal fluxes to the SINERR have decreased by a factor of 0.5-0.8 fold over the past few centuries and that Ni is the strongest anthropogenic signal in the core (Alexander and Wenner, 1995). These latter results are opposite to data for the ACE Basin NERR site.

Most elemental analyses of biota are for *Spartina alterniflora*. However, elemental analyses of the calcareous skeletal material of the intertidal *Crassostrea virginica* and *Balanus eburneus* (Pilkey and Harriss, 1966) and major cation contents of *Sporobolus virginicus* (Gallagher, 1979) have been reported. Comparison of elemental concentrations of *S. alterniflora* from nonpolluted sites within the SINERR and those of more industrialized sites indicate little variation in elemental concentrations, with only Hg showing elevated levels (Newell *et al.*, 1982). The elemental distributions also indicate that *S. alterniflora* apparently does not assimilate Al and Fe, but does take up Cu and Hg and controls the internal concentrations of these elements in its tissues (Alberts *et al.*, 1990). *S. alterniflora* also assimilates inorganic tin through its roots and rhizomes, translocates it to the leaves and methylates the Sn to the trimethyl form (Weber and Alberts, 1990). These studies indicate that *S. alterniflora* apparently has mechanisms that actively control the concentrations of elements in its tissues and that senescence and death lead to loss of these mechanisms and elemental concentrations of the remaining tissue that resemble those of the sediments on which the plants had been growing (Alberts *et al.*, 1995). The studies need to be extended to conclusively demonstrate the nature of these mechanisms so that they may be employed in remediation of impacted marsh sites.

Elemental Redox Cycles

The sediments of the salt marshes in the SINERR are extremely reducing below the relatively thin surface oxidized layer. Although oxidizing conditions can be detected to

relatively great depths in the sediments as a result of oxygen diffusion into tunnels and burrows that occurs in the sediments, the oxygen is consumed rapidly and the oxidized layers are measured in thicknesses of millimeters. Due to these highly reducing conditions and the large area of oxidized/reduced chemical interfaces, cycling of easily oxidized/reduced elements among their oxidation states is wide spread.

Iron and Manganese Cycling

Iron and manganese redox cycling in Sapelo Island sediments are closely linked to the redox cycling of sulfur and anaerobic respiration reactions in the sediments. The dynamics of these cycles have been discussed in several papers (Pomeroy and Wiegert, 1981 and papers cited therein; Howarth and Giblin, 1983; Giblin and Howarth, 1984; Howarth and Merkel, 1984; Howarth and Marino, 1984; Fallon, 1987).

Porewaters of these sediments tend to have higher dissolved Fe and Mn concentrations and lower sulfide concentrations at sites with lower pH. Sedimentary solid phases of iron and manganese are sulfide minerals, while dissolved concentrations of Fe(II) and Mn(II) appear to be undersaturated with respect to carbonates, but the importance of phosphates in this environment is unclear (Giblin and Howarth, 1984).

Manganese (II) is effectively oxidized to Mn(IV) in surface sediments of the SINERR as a result of microbial processes with the formation of manganese oxides (Spratt *et al.*, 1994). The rates of this oxidation were shown to be a function of both temperature and pH and were much higher for creek bank sediments than for high marsh sediments (2.31 ± 0.28 and 0.45 ± 0.14 nmol mg dwt⁻¹ h⁻¹, respectively). These rates were also higher than values reported in other estuarine and water column studies, and from sediments of a mangrove estuary (Spratt and Hodson, 1994).

ORGANIC MATTER

Occurrence

A significant portion of the naturally occurring organic matter in the SINERR results from the primary production of *S. alterniflora* and macroalgae, and their subsequent decay and decomposition. The process of decomposition leads to two potential types of organic matter, dissolved (DOC) and particulate (POC). The importance of these two forms of organic matter have been studied in great detail in the salt marsh estuaries, as they represent a substantial source of energy to the biotic community (Pomeroy and Wiegert, 1981). The biological processes affecting the decomposition and transformation of macrophytes to these available organic pools are discussed in this report. Below, we will summarize the chemical alterations that occur during these processes and some of the ramifications of those changes to the ecosystem.

Plants and POC

At first approximation, the formation of particulate organic matter in the estuary was thought to be primarily the decomposition of *S. alterniflora* (Odum and de la Cruz, 1967). However subsequent studies of the $^{13}\text{C}/^{12}\text{C}$ ratios of seston, sediments and biota of the salt marshes have demonstrated that it is a complex process in which microflora appear to be the primary herbivores of plants (Haines, 1976b,c; 1977; Haines and Hanson, 1979; Haines and Montague, 1979; Sherr, 1982).

The reasons that *S. alterniflora* is not heavily grazed by macroinvertebrates are not clear, though it has been demonstrated that for one major consumer, the periwinkle snail *Littoraria irrorata* (Say), the high phenolic and low protein content of standing plants relative to dead plants may be the reason for the snails preference for the latter (Bärlocher and Newell, 1994). While further studies are needed to determine if other chemical deterrents in the leaves of aboveground *S. alterniflora* plants are responsible for the lack of grazing, studies to date have shown that cellulose, hemicellulose and lignin constitute a significant fraction of the plant biomass (>75%) and that these components are lost at varying rates with time of decomposition (Benner *et al.*, 1987).

Polysaccharides

The carbohydrate signature of standing, undecayed plants has been determined (Wicks *et al.*, 1991) along with those of standing dead plants and some of the major plant components (Alberts *et al.*, 1992). In addition, carbohydrates and proteins in the roots and rhizomes have been shown to cycle with season in the marsh with sugar and starch contents of the roots being relatively low compared to rhizomes throughout the year (Gallagher *et al.*, 1984).

As much as 60% of the primary production of the *S. alterniflora* is lost while the plants are standing in the marsh (Newell and Fallon, 1989; Newell *et al.*, 1989). Only a small fraction of the *S. alterniflora* biomass appears to be lost through leaching into surrounding waters, but this material is efficiently assimilated into microbial biomass (Gallagher *et al.*, 1976). Similarly, carbohydrates are lost from the plants to the surrounding environment (Pakulski, 1986) and free amino acids appear to be released from marine zooplankton and invertebrates (Johannes and Webb, 1965, 1970; Webb and Johannes, 1967). While the potential exists for the uptake of these materials by salt marsh organisms (Darley *et al.*, 1979), the importance of these additions of organic matter to the estuarine foodweb is still poorly defined (Johannes *et al.*, 1969).

LIGNIN

Approximately 75% of the total biomass of *S. alterniflora* is lignocellulose (Maccubbin and Hodson, 1980). Using marsh sediment microflora and ^{14}C -radiolabelled substrates of both ^{14}C -(cellulose)- and ^{14}C -(lignin)- lignocellulose, it was shown that the cellulosic moiety of the labeled lignocellulose initially is decomposed approximately 3 times faster than the lignetic moiety (Hodson *et al.*, 1984). Furthermore, those authors demonstrated that

the rates of decomposition of both moieties were not linear with time, but rather were best fit with an exponentially decreasing rate curve with no fixed "half-life". The apparent cause of this decrease in decomposition rate was the increased refractory nature of the remaining lignocellulose, as more easily attacked components of the biopolymer were decomposed first.

After 576 hr. of incubation under oxic conditions, 30% of the polysaccharide component and between 12 - 18% of the lignetic component of *S. alterniflora* lignocellulose was mineralized by salt marsh sedimentary microflora (Benner *et al.*, 1984a). Under anaerobic conditions, the same consortium of salt marsh sedimentary microflora degraded 30% of the polysaccharide component and 16.9% of the lignin component of *S. alterniflora* lignocellulose in 246 days (Benner *et al.*, 1984b). This biodegradation of lignocellulose under anaerobic conditions was further demonstrated in litterbags, over an 18 month period, with a loss of 55% of the organic carbon in belowground tissue biomass and a significant alteration of the phenolic moieties of lignin (Benner *et al.*, 1991). While the rates of decomposition are much slower in the anaerobic system, the demonstration of anaerobic biodegradation of lignocellulose, has important implications for the cycling of carbon from these biopolymers in the biosphere.

The biodegradation of the cellulosic and lignetic components of lignocellulose are also affected by pH and temperature. Over a pH range of 4-8 the biodegradation of the lignetic component of lignocellulose is only minimally affected, while the biodegradation of the cellulosic component is increased several fold with increasing pH (Benner *et al.*, 1985). Rates of mineralization of lignocellulose from *S. alterniflora* in salt marsh sediments increased eightfold between winter and summer. Therefore, under the hydrologic conditions of Sapelo Island (high rates of water movement due to flushing by semidiurnal tides), the temporal lag between deposition of plant material in the fall and winter and microbial degradation the following spring and summer is a potential mechanism for substantial advective redistribution of lignocellulosic detritus away from sites of production (Benner *et al.*, 1986a). However, the lignin phenolic structure of organic matter from estuarine sediments near Sapelo Island, while containing vascular plant material, indicate that *S. alterniflora* may not be its primary source (Whelan *et al.*, 1986).

Bacteria are the predominant decomposers of lignocellulosic carbon in the salt marsh sediments, with little biodegradation of these biopolymers by the fungal consortium present (Benner *et al.*, 1984c; Benner *et al.*, 1986b). However, *S. alterniflora* plants undergo a significant period of senescence during which the leaves of the plants remain standing upright in the marsh. During this period, significant loss of organic matter and lignin occurs in the plants (Newell and Fallon, 1989; Newell *et al.*, 1989). Up to 25% of the total lignin mass loss of tagged standing plants occurred in 146 days, with >90% of that occurring early in the degradation history (Haddad *et al.*, 1992). Using radiolabelled lignocellulose from *S. alterniflora*, 3.3% of the lignin moiety was mineralized and 22% of the polysaccharides were mineralized in 45 days by the ascomycete *Phaeosphaeria spartinicola* (Bergbauer and Newell, 1992). Transmission electron microscopy studies have shown that the fungi *P. spartinicola* caused both thinning of the lignocellulosic-rich secondary walls of fiber cells from cell lumina outwards, and digestion extending from hyphae within

longitudinal cavities in the secondary wall types. Three other fungal species were also shown to cause either one or the other type of soft rot (Newell *et al.*, 1996). Thus, considerable evidence exists to demonstrate two distinctive mechanisms of biodegradation of the lignocellulosic biopolymers which are promulgated by different microbial consortia and occur at different spatial and temporal points in the plant's life history.

During microbial degradation of lignocellulose, soluble decomposition products are released into the environment. Bergbauer and Newell (1992) report 2.7% of the lignin moiety and 4% of the polysaccharide component of their radiolabelled lignocellulose to be released as dissolved organic carbon (DOC) by the ascomycete *P. spartinicola*, and lignocellulose-derived DOC was produced in laboratory microcosm experiments at rates of 0.7 - 1.0% of the particulate lignocellulose per day (Moran and Hodson, 1989). While much of this dissolved material is mineralized by microbes, the more recalcitrant compounds may play a role in formation of humic substances. In 6 month decomposition studies, DOC accounted for 50 - 60% of the total degradation products of the lignetic component of lignocellulose, while it only accounted for 20 - 30% of the cellulosic products (Moran and Hodson, 1990). However, 34% of the DOC accumulating during the degradation of *S. alterniflora* from southeastern coastal wetlands is humic matter by definition, with lignin being the primary source of 66% of the total dissolved humic substances (Moran and Hodson, 1994). Thus, vascular plants appear to be contributing yet another highly recalcitrant organic pool to the salt marsh environment.

HUMIC SUBSTANCES

Occurrence

In riverine systems of the southeastern United States, the dissolved organic matter is dominated by naturally occurring mixtures of organic compounds that are derived from plants. These mixtures are called humic substances and have been extensively studied for many years both for their contribution to the cycling of essential nutrients, and their ability to interact with numerous potentially toxic organic and inorganic chemicals (Schnitzer and Khan, 1972; Gjessing, 1976; Aiken *et al.*, 1985). Humic substances also occur in the sediments and plants of the marshes. Base extractions of the *S. alterniflora* plants, both living and standing dead, and the sediments underlying these plants have yielded 0.56, 1.09 and 2.17 g dry wt of humic substances/100 g dry wt of source material, respectively (Filip *et al.*, 1988).

Living and dead plant material obtained from the SINERR, when exposed to long-term (10 month) incubations in the presence of sterile seawater, or fungi, bacteria or mixed cultures of organisms indigenous to the SINERR, released humic substances into the seawater under both biotic and abiotic conditions (Filip and Alberts, 1988). While the amount of humic matter released from abiotic control experiments was low relative to the amount of humic matter found in the plant material prior to treatment, both mixed culture treatments and particularly a culture of epiphytic organisms were able to release significant amounts of the plant humic matter (41.1% and 22.0% of the living and dead plant

material, respectively, in the case of the epiphytes). In addition to the release of humic material from plant material, both epiphytic organisms and fungi were capable of humifying living and dead plant material as well as plant extracts (Filip and Alberts, 1993; Alberts and Filip, 1994), which may account for some of the 34% of the dissolved organic matter released from degrading salt marsh grass that were isolated as humic matter (Moran and Hodson, 1994).

Utilization

Salt marsh related microflora are also capable of utilizing humic substances under aerobic and semi-anaerobic conditions, both as the sole sources of C and N and as supplemental sources of nutrients (Filip and Alberts, 1994). The average utilization of humic acids under aerobic and semi-anaerobic conditions followed the order of humic acids from dead *S. alterniflora* < humic acids from sediments < humic acids from fresh *S. alterniflora*. These authors go on to demonstrate that the chemical alterations of the humic substances observed during these incubations were consistent with the processes of sedimentary diagenetic alteration observed in the literature (Alberts and Filip, 1994). Moran and Hodson (1994) found that 24% of the salt-marsh derived humic substances were utilized by marine bacteria in a 7-week period, which was a significantly faster turnover rate than previously noted for humic materials from freshwater environments. Both groups of authors attribute the more rapid turnover of "newer" humic matter to the presence of labile components which have been decomposed from "older" material.

Chemical Characterization

Fulvic and humic acids isolated from living and dead *S. alterniflora* and the surficial sediments underlying them (Alberts *et al.*, 1988) have been studied by numerous spectrochemical and wet chemical techniques. Summarization of those studies are beyond the scope of this text, but may be found in the literature cited below:

Spectrochemical Characteristics

1. Ultraviolet-Visible Spectroscopy: Alberts *et al.*, 1988; Alberts *et al.*, 1992;
2. Fluorescence Spectroscopy: Alberts *et al.*, 1988;
3. Fourier Transform Infrared Spectroscopy (FTIR): Filip *et al.*, 1988; Filip and Alberts, 1988, 1989, 1994;
4. Carbon-13 Nuclear Magnetic Resonance Spectroscopy (¹³C-NMR): Alberts *et al.*, 1991; Filip *et al.*, 1988; Filip *et al.*, 1991;
5. Electron Paramagnetic Resonance Spectroscopy (EPR): Filip *et al.*, 1988; Cheshire *et al.*, 1977.

Chemical Characteristics

1. Elemental Analyses: Filip and Alberts, 1988, 1989; Alberts *et al.*, 1989;
2. Elemental Atomic Ratios: Filip and Alberts, 1988, 1989; Alberts *et al.*, 1992;

3. Lignin, Carbohydrate and Amino Acid Contents: Alberts *et al.*, 1992.

CHEMICAL REACTIONS

Inorganic Reactions

Humic substances are known to strongly bind with Cu^{2+} (Stevenson, 1982; Alberts and Geisy, 1983; Rashid, 1985). The humic and fulvic acids isolated from the plants and sediments of the salt marshes have copper binding capacities (CuBC as $\mu\text{g atm Cu}^{2+} \text{ mg}^{-1}$ humic matter) ranging from 0.12 to 0.27 and 0.06 to 0.23, respectively.

The CuBC values for the salt marsh humic substances do not follow any trend relative to condition of source material, fulvic versus humic acid, nor to total acidities of the humic substances. This latter point is consistent with EPR studies indicating the presence of Cu^{2+} -porphyrin complexing in humic acids from living plants (Filip *et al.*, 1988), as well as several other EPR studies that indicate that copper may be bound to nitrogen-containing structures in the humic substances.

This latter hypothesis is given some support by the positive relationship demonstrated between CuBC and N:C ratio of the salt marsh humic substances (Alberts *et al.*, 1989) and the fact that solvent extraction of the source materials to remove pigments and lipids before extraction of the humic substances does not change the CuBC of either the humic or fulvic acids (Alberts and Filip, 1989).

Organic Reactions

Besides oxygen and nitrogen containing functional groups that can interact with inorganic elements, humic substances are relatively large molecules which contain considerable aliphatic and aromatic organic carbon groups. These groups can interact with other organic molecules, particularly hydrophobic compounds such as polycyclic aromatic hydrocarbons (PAH), through electrostatic or van der Waals interactions to form organic-organic complexes.

The binding constant (K_{oc}) of three PAH compounds was determined with estuarine sedimentary fulvic and humic acids (Alberts *et al.*, 1994). All three PAH compounds bind very strongly to all the humic substances. The K_{oc} values are in general agreement with data for organic colloids from other estuaries (Wijayaratne and Means, 1984a, 1984b). The $\log K_{oc}$ values of the fulvic acids are lower than those of the humic acids, which is consistent with the fact that fulvic acids tend to be smaller more soluble molecules and therefore, would be expected to have smaller hydrophobic surfaces available for binding with other hydrophobic organic molecules.

Flux Calculations

It has been estimated that the standing crop of *S. alterniflora* in the Georgia salt marshes represent $65.5 \text{ g C m}^{-2} \text{ yr}^{-1}$ as fulvic acids and $14.5 \text{ g C m}^{-2} \text{ yr}^{-1}$ as humic acids (Alberts *et al.*, 1988). The values are 216% and 56%, respectively, of the amount C that is sedimented as humic substances in the surficial marsh sediments per annum. Since there is approximately $373,400 \text{ m}^2$ of salt marsh in Georgia (Alexander *et al.*, 1986), it is possible to estimate the annual production and sedimentation of carbon and nitrogen in Georgia's salt marshes.

From our earlier flux estimates of carbon and nitrogen as humic substances entering the estuaries from riverine transport, we can calculate that 13.5% and 7% of the humic substance carbon and nitrogen produced by plants is brought to the estuaries by river flow. Summing these to the plant production and comparing to the sedimentation of these elements as humic and fulvic acids, we estimate that 54.5 thousand tons of carbon, or 39% of the annual input of humic substance carbon, can not be accounted for by sedimentation. Since we know that fulvic acids are produced in the *S. alterniflora* plants in a 200% excess, it is reasonable that the excess carbon produced is either respired by organisms in the marsh or lost to the ocean in the form of soluble fulvic acids.

It is estimated that marshes provide 55% of the terrestrially derived DOC and 38% of the humic carbon input into the coastal ocean of the southeastern U.S. (Moran and Hodson, 1994). However, there is a net 18% deficiency of nitrogen that is sedimented relative to estimated annual inputs. Thus, it seems unlikely that the 54.5 thousand tons of carbon has been exported as fulvic acids, but rather a significant portion of this material must be lost from the system by respiration.

MISCELLANEOUS ANTHROPOGENIC CHEMICALS

Sewage Sludge, Dredge Spoil and Pulp Mill Effluents

Application of sewage sludge to short form *S. alterniflora* plots resulted in a 1/3 to 1/2 increase in plant biomass relative to controls, with little effect on dead biomass, stem density or propagation of new shoots (Haines, 1979c). Furthermore, after 20 months, approximately half of the sludge nitrogen remained in the sediments. It was later shown that sewage sludge had an inhibitory effect on salt marsh denitrifying bacteria (Sherr and Payne, 1981).

An assay technique for the uptake and translocation of contaminants from dredge spoil material to marsh plants showed that neither chlorinated pesticides nor polychlorinated biphenyls appeared to be taken up or translocated by *Distichlis spicata*, *Salicornia virginica*, *S. alterniflora*, or *S. patens*. Although, some problems with experimental conditions may have influenced the results. However, in the case of dredge material with high heavy metal contents, the authors found, "The uptake and translocation question in the heavy metal case tested became inconsequential because all of the plant species that were planted have now died." (Gallagher and Wolf, 1980).

Heterotrophic microbial activity is extremely sensitive to and inhibited by Kraft mill effluents. This finding indicates that detritus based, microbial foodwebs are potentially at higher risk from these materials than the foodwebs whose organic carbon inputs are controlled by photosynthetic processes (Maccubbin *et al.*, 1983).

Pesticides, Herbicides and Polycyclic Aromatic Hydrocarbons

The pesticide toxaphene was shown to be absorbed from anaerobic salt marsh soils through below-ground plant tissue and translocated in both directions from the point of uptake (Gallagher *et al.*, 1979). Highest concentrations of the toxaphene were located in the below-ground plant tissues. In another study (Gallagher and Wolf, 1980), toxaphene injected into marsh sediments were accumulated and translocated by *S. alterniflora* plants to above-ground tissue. Following cessation of the injections, concentrations of toxaphene in living above-ground plant tissue decreased from 43 to 7 ppm, but dead plant material increased to 110 ppm. The dead plant material began to lose toxaphene, perhaps through dilution with newer, less contaminated material and decay and fragmentation, until toxaphene was undetectable after 7 months.

Concern that the increased use of organic arsenical herbicides such as monosodium methanearsonate (MSMA) in the 1970's might eventually impact the salt marsh ecosystem led to several field experiments to test the hypothesis. Applications of MSMA in levels significantly above those expected from tidal flooding led to no measurable detrimental effects and only direct foliar application in massive amounts (90,000 ppm or 30 applications of 10,000 ppm) led to significant damage (Edwards and Davis, 1974; 1975).

The potentially carcinogenic and mutagenic polycyclic aromatic hydrocarbons (PAH) are hydrophobic, naturally occurring organic compounds that are found widely in the environment. Studies have shown that PAH compounds bind strongly to naturally occurring humic and fulvic acids which are found in the SINERR (Alberts *et al.*, 1989; 1994); thus making them either more or less available to estuarine organisms. One of these compounds, benzo(a)pyrene, is a known cancer agent and has been shown to dissolve in the dietary fat of the killifish, *Fundulus heteroclitus* (Vetter *et al.*, 1985). The latter study indicates that this association may be a partial explanation of the observed link between high fat diets and some cancers.

RESEARCH NEEDS

A large majority of the chemical research conducted in the SINERR has involved the production, decomposition, transport and chemical reactions of naturally occurring organic matter. These studies were the natural outgrowth of a major focus of research at the Marine Institute, which is the understanding of the processes controlling foodwebs and energy flow of the salt marsh. While considerable work has been undertaken in this area, further studies involving organic matter in this environment are still required:

What is the fate of DOC generated from particle decomposition?

What are the physical and chemical reactions that newly formed DOC undergo?

How does organic matter react with anthropogenic organic and inorganic compounds and do these reactions increase or decrease the bioavailability and toxicity of the materials?

What types of natural products are produced in the salt marsh and do they act as stimulants or deterrents to plant/animal interactions?

While the natural organic matter of the system has been studied, though hardly exhaustively, the studies of inorganic chemicals are even less advanced. Basic biological and geochemical questions still exist such as:

What are the elemental and trace metal distributions in various biota and how do they change temporally and spatially?

What mechanisms are active in biota to control the uptake and toxicity of inorganic elements?

What are the atmospheric exchanges in the marsh, both as gaseous losses and elemental sources?

What are the distributions of and geochemical processes affecting inorganic elements in water and sediment?

Are inorganic elemental inputs to the marsh increasing, decreasing or remaining unchanged over time scales representative of man's activities on land?

The research activities in the SINERR have been dominated by biological and geological studies. There is a definite need for numerous chemical studies to supplement the knowledge already gained and to advance our understanding of the chemical mechanisms which are important.

Research and Monitoring Goals

RESEARCH

SINERR personnel, in consultation with the SINERR advisory committee, have identified several goals for research and management in the Reserve. They include:

1. Assess the cultural resources within the SINERR, including sites of archaeological interest and of historic significance, with the objective of documenting and protecting them.
2. Increase knowledge and understanding of the basic processes involving water movement, water mixing, and natural variation in water parameters within the SINERR. Objectives include measuring the relative contributions of upland and groundwater runoff, freshwater exchanges with mainland rivers and the ocean; estimating effects of climate change on hydrological processes; determining the effects of manmade and natural disturbances.
3. Increase knowledge and understanding of sediment transport and transformation in the SINERR, including current and historical trends in accretion and erosion and the effects of human activities and management practices on these processes.

4. Increase knowledge and understanding of the natural variability of nutrient and other chemical inputs into the salt marsh, including the effects of watershed management practices on nutrient flows, and the effects of nonpoint source inputs of nutrients, metals, organics, bacteria and biochemical oxygen demand on water and sediment quality.

5. Improve knowledge and understanding of the life cycles of important species which depend upon salt marsh estuaries, and quantify the importance of the salt marsh and adjacent upland areas. Objectives include determining the importance of the marsh to estuarine and coastal fisheries through direct food-web and habitat interactions, biotic resources and dynamics of fisheries and recruitment in the SINERR, the extent of coupling between primary and secondary production and the effect of abiotic processes on that coupling, and the effects of upland management practices and other human activities on marine and non-marine wildlife species in the upland/marine transitional zone.

6. Evaluate the effects of management decisions on the health and stability of the SINERR's ecosystem, including the effects of forest management and vessel traffic in the Duplin River.

7. Establish a comprehensive database of baseline and research data which allows rapid, user-friendly access to research and monitoring information gathered within the SINERR. Establish a database for archaeological findings.

MONITORING

One function of the NERR system is to provide benchmark information on estuarine ecosystems to researchers, coastal communities and ecosystem managers. The monitoring program in the SINERR is designed to provide that information. Its mission is to improve the ability of resource managers to detect, quantify and predict both short- and long-term changes in the health and viability of estuarine ecosystems. Trend monitoring of hydrological and meteorological parameters is conducted in the SINERR by the University of Georgia Marine Institute under contract to DNR, continuing a program begun by UGMI in 1986. As discussed earlier in this profile, data are collected at three sites within the Duplin River watershed. Summary reports are published quarterly; data is available on request to UGMI.

DNR's Environmental Protection Division (EPD) monitored a number of water column, sediment and tissue accumulation parameters in the Duplin River estuary from 1985 through 1994. The parameters measured included dissolved oxygen, pH, conductance, chlorophyll, 5-day biological oxygen demand, coliform bacteria concentrations, water color and alkalinity, nitrogen, phosphorus, organic compounds and metals. They hope to reimplement the program in the near future. DNR's Coastal Resources Division has monitored several of these same parameters at monthly intervals at seven locations in the Duplin River since 1984. In addition, NOAA has established a mussel-watch station near the mouth of the Duplin River, analyzing tissue samples from oysters for a wide variety of contaminants.

The Future of SINERR: Management Questions and Research Needs

Throughout this document we have pointed out research needs and questions that remain unresolved. In addition to those we have identified, there are many other important and useful research projects that investigators can and will formulate. These may be related to questions of basic research which have no obvious immediate application to management issues, but as we have seen in the past, issues and needs change and hypotheses and paradigms that seem to explain the observations we make are not necessarily correct. Thus just because a subject has received attention in the past or does not seem pertinent to today's problems should not exclude it from eligibility for funding and support.

Beyond the research questions identified in the previous sections, there are major issues facing managers of Sapelo Island and the Research Reserve which need to be addressed. A high priority must be to objectively and scientifically determine the carrying capacity of Sapelo Island. There are factors to be considered beyond the most obvious ones, because of the logistics involved in transporting people and materials to and from the island. In addition to questions of how many vehicles the Marsh Landing parking area can accommodate and how the increasingly cramped parking situation can be resolved without sacrificing the integrity of the marshes near the dock, we must determine how many people and how much freight can reasonably be carried by the ferry. The often competing interests of island residents and visitors, who bring welcome revenue to small businesses on the island, must be balanced. In the push to accommodate the general public, the legitimate requirements of island residents should not be ignored.

The question of waste disposal is a critical one. It may be possible to decrease, or at least minimize, the expense of barging solid waste off the island by engaging in some form of recycling, composting or compaction of the garbage before it is loaded onto the barge. In addition to solid wastes, the question of capacity of the island's soils to absorb septic effluents must be examined. In areas where septic tanks are concentrated, is there evidence of effects of increased nutrient loading to the marshes? What are the alternatives to septic tanks for this environment?

What are the effects of increased boat traffic in the Duplin River and its associated tidal creeks? Should there be limits on traffic to control noise or wake?

The island has recently seen the introduction by some means of at least 2 species of animal not found here in the recent past, the armadillo and feral pigs. Both create substantial disturbance of the ground as they root for food, and the habitat destruction by feral pigs is well known. At least in the case of the pigs, DNR is making an effort to limit the population. Should eradication of these animals be advocated and pursued? What should be done about invasions of exotic plant species not already established on Sapelo, such as the Chinese tallow tree? Should efforts be made to eradicate them or to control their distribution?

Although it is a sensitive issue that has been raised several times already, the use of management practices like controlled burning and timber harvesting within the SINERR should not be ignored. The effects of those practices on adjacent marshes of the SINERR has never been studied. Detection of effects is probably not possible within the time-frame of the usual one to three year funding cycle that most research programs support, and could be taken on as an aspect of the monitoring program of the Reserve scientific staff. Atmospheric inputs during burn cycles, direct runoff to the marshes and groundwater seepage are the most likely pathways that should be evaluated, although populations of infauna and vegetation near the upland transition zone should not be neglected.

Finally, what are the long-term prospects for the integrity of the water supply for Sapelo Island? Already some Georgia coastal areas are experiencing problems with intrusion of salt water into groundwater wells.

The increasing numbers of visitors to Sapelo put additional demands on all of the natural resources and the infrastructure of the island. The question of how many of these demands can be met without destroying the very resource that makes the island increasingly attractive to visitors is not unique to the Sapelo Island National Estuarine Research Reserve, and is not an easily answered one, but it is one that should be seriously addressed with the best available information and not just the opinions and desires of policymakers, residents and visitors. The commitment of all parties to formulating an integrated management plan for the entire island is a promising beginning.

Acknowledgments

This publication was prepared for the Sapelo Island National Estuarine Research Reserve under a contract between the Georgia Department of Natural Resources and Alice G. Chalmers and James J. Alberts of the University of Georgia Marine Institute. Funds for its preparation were provided by grant #NA470R0414 from the National Oceanic and Atmospheric Administration.

Figures 20a-d were provided by Roy Welch and Marguerite Remillard of the Center for Remote Sensing and Mapping Science of the University of Georgia. All other figures were prepared by Alice G. Chalmers. We wish to thank Buddy Sullivan, Stuart Stevens, Joanne Sharpe, Jim Henry, Dwight Trueblood and Steve Ross for their helpful reviews. Joanne Sharpe provided invaluable updates to the list of common names in Appendix 1.

References

- Agosta, K. 1985. The effect of tidally induced changes in the creekbank water table on pore water chemistry. *Estuar. Coast. Shelf Sci.* 221:389-400.
- Aiken, G.R., McKnight, D.M., Wershaw, R.L. and MacCarthy, P. 1985. *Humic Substances in Soil, Sediment and Water*. John Wiley and Sons, New York.
- Alberts, J.J. and Filip, Z. 1989. Sources and characteristics of fulvic and humic acids from a salt marsh estuary. *Sci. Total Environ.* 81/82:353-361.
- Alberts, J.J. and Filip, Z. 1994. Effect of organic solvent pre-extraction of source substrates on elemental composition, Fourier Transform Infrared spectra and copper binding in estuarine humic and fulvic acids. In: Senesi, N. and Miano, T.M. (Eds.) *Humic Substances in the Global Environment and Implications of Human Health*. Elsevier Science, p. 781-790.
- Alberts, J.J., Filip, Z. and Leversee, G.J. 1989. Interaction of estuarine organic matter with copper and benzo(a)pyrene. *Mar. Chem.* 28:77-87.
- Alberts, J.J., Filip, Z., Price, M.T., Hedges, J.I. and Jacobsen, T.R. 1992. CuO-oxidation products, acid hydrolyzable monosaccharides and amino acids of humic substances occurring in a salt marsh estuary. *Org. Geochem.* 18:171-180
- Alberts, J.J., Filip, Z., Price, M.T., Williams, D.J. and Williams, M.C. 1988. Elemental composition, stable carbon isotope ratios and spectrophotometric properties of humic substances occurring in a salt marsh estuary. *Org. Geochem.* 12:455-467
- Alberts, J.J. and Giesy, J.P. 1983. In: Christman, R.F. and Gjessing, E.T. (Eds.) *Aquatic and Terrestrial Humic Materials*. Ann Arbor Science, Ann Arbor, Michigan, p. 333-348.
- Alberts, J.J., Griffin, C., Gwynne, K. and Leversee, G.J. 1994. Binding of natural humic matter to polycyclic aromatic hydrocarbons in rivers of the southeastern United States. *Wat. Sci. Tech.* 30:199-205.
- Alberts, J.J., Hatcher, P.G., Price, M.T. and Filip, Z. 1991. Carbon-13 nuclear magnetic resonance analysis, lignin content and carbohydrate composition of humic substances from salt marsh estuaries. In: Allard, B., Borén, H. and Grimvall, A. (Eds.) *Humic Substances in the Aquatic and Terrestrial Environment*. Springer-Verlag, Berlin-Heidelberg-New York, p. 195-203.
- Alberts, J.J., Newell, S.Y. and Price, M.T. 1987. Translocation and physiological state as controlling mechanisms for Al, As, Cu, Fe, Mn and Sn in salt marsh cordgrass. In: Lindberg, S.E. and Hutchinson, T.C. (Eds.) *Heavy Metals in the Environment*. CEP Consultants LTD, Edinburgh, UK, Vol. 2, p. 396-398.
- Alberts, J.J., Newell, S.E. and Price, M.T. 1995. Elemental concentrations in senescing leaves of the salt-marsh grass, *Spartina alterniflora* (Loisel.). unpublished manuscript.
- Alberts, J.J., Price, M.T. and Kania, M. 1990. Metal concentrations in tissues of *Spartina alterniflora* (Loisel.) and sediments of Georgia salt marshes. *Estuar. Coast. Shelf Sci.* 30:47-58.
- Alexander, C.E., Broutman, M.A. and Field, D.W. 1986. *An Inventory of Coastal Wetlands of the USA*. NOAA, U.S. Dept. Commerce, Washington, DC.
- Alexander, C.R. and Wenner, B. 1995. Evaluating the historical record of non-point source pollution in the ACE Basin and Sapelo Island National Estuarine Research Reserves. Final Report submitted, Oct. 4, 1995, NOAA, 35 p.

- Arnold, W.S. and Kneib, R.T. 1983. The size distribution of blue crabs (*Callinectes sapidus* Rathbun) along a tidal gradient in a Georgia salt marsh. *Ga. J. Sci.* 41:93-94. (abstract).
- Bärlocher, F. and Newell, S.Y. 1994. Phenolics and protein affecting palatability of *Spartina* leaves to the gastropod *Littoraria irrorata*. *Marine Ecology* 15:65-75.
- Bärlocher, F., Newell, S.Y. and Arsuffi, T. 1989. Digestion of *Spartina alterniflora* material with and without fungal constituents by the periwinkle *Littorina irrorata* (Mollusca:Gastropoda). *Journal of Experimental Marine Biology and Ecology* 130:45-53.
- Benner, R., Fogel, M.L. and Sprague, E.K. 1991. Diagenesis of belowground biomass of *Spartina alterniflora* in salt-marsh sediments. *Limnol. Oceanogr.* 36:1358-1374.
- Benner, R., Fogel, M.L., Sprague, E.K. and Hodson, R.E. 1987. Depletion of ¹³C in lignin and its implications for stable isotope studies. *Nature (Lond.)* 329:708-710.
- Benner, R., Maccubbin, A.E. and Hodson, R.E. 1984a. Preparation, characterization, and microbial degradation of specifically radiolabeled [¹⁴C]lignocelluloses from marine and freshwater macrophytes. *Appl. Environ. Microbiol.* 47:381-389.
- Benner, R., Maccubbin, A.E. and Hodson, R.E. 1984b. Anaerobic biodegradation of lignin and polysaccharide components of lignocellulose and synthetic lignin by sediment microflora. *Appl. Environ. Microbiol.* 47:998-1004.
- Benner, R., Maccubbin, A.E. and Hodson, R.E. 1986a. Temporal relationship between the deposition and microbial degradation of lignocellulosic detritus in a Georgia salt marsh and the Okefenokee Swamp. *Microbial Ecol.* 12:291-298.
- Benner, R., Moran, M.A. and Hodson, R.E. 1985. Effects of pH and plant source on lignocellulose biodegradation rates in two wetland ecosystems, the Okefenokee Swamp and a Georgia salt marsh. *Limnol. Oceanogr.* 30:489-499.
- Benner, R., Moran, M.A. and Hodson, R.E. 1986b. Biogeochemical cycling of lignocellulosic carbon in marine and freshwater ecosystems: relative contributions of procaryotes and eucaryotes. *Limnol. Oceanogr.* 31:89-100.
- Benner, R., Newell, S.Y., Maccubbin, A.E. and Hodson, R.E. 1984c. Relative contributions of bacteria and fungi to rates of degradation of lignocellulosic detritus in salt-marsh sediments. *Appl. Environ. Microbiol.* 48:36-40.
- Bergbauer, M. and Newell, S.Y. 1992. Contribution to lignocellulose degradation and DOC formation from a salt marsh macrophyte by the ascomycete *Phaeosphaeria spartinicola*. *FEMS Microbiol. Ecol.* 86:341-348.
- Berresheim, H. 1993. Distribution of atmospheric sulphur species over various wetland regions in the southeastern USA. *Atmos. Environ.* 27:211-221.
- Bradley, P. and Dunn, E.L. 1989. Effects of sulfide on the growth of three salt marsh halophytes of the southeastern United States. *American Journal of Botany* 76:1707-1713.
- Bunker, S.M. 1979. Retention of various components of *Spartina alterniflora* detritus by the striped mullet, *Mugil cephalus*. M.S. Thesis, University of Georgia, Athens, GA.
- Burkholder, P.R. 1956. Studies on the nutritive value of *Spartina* grass growing in the marsh areas of coastal Georgia. *Bulletin of the Torrey Botanical Club* 83:327-334.
- Burkholder, P.R. and Bornside, G.H. 1957. Decomposition of marsh grass by aerobic marine bacteria. *Bulletin of the Torrey Botanical Club* 84:366-383.

- Chalmers, A.G. 1977. Pools of nitrogen in a Georgia salt marsh. Ph.D. dissertation, University of Georgia, Athens, GA.
- Chalmers, A.G. 1982. Soil dynamics and productivity of *Spartina alterniflora*. In: V.S. Kennedy, (ed.). *Estuarine Comparisons*. Academic Press, New York. p. 231-242.
- Chalmers, A.G., Wiegert, R.G., and Wolf, P.L. 1985. Carbon balance in a salt marsh: interactions of diffusive export, tidal deposition and rainfall-caused erosion. *Estuarine, Coastal and Shelf Science* 21:757-771.
- Cheshire, M.V., Berrow, M.L., Goodman, B.A. and Mundie, C.M. 1977. Metal distribution and nature of some Cu, Mn and V complexes in humic and fulvic acid fractions of soil organic matter. *Geochim. Cosmochim. Acta* 41:1131-1138.
- Christian, R.R., Bancroft, K. and Wiebe, W.J. 1975. Distribution of adenosine triphosphate in salt marsh sediments at Sapelo Island, Georgia. *Soil Sci.* 119:89-97.
- Christian, R.R., Hanson, R.B., Hall, J.R. and Wiebe, W.J. 1981. Aerobic microbes and meiofauna. In: L.R. Pomeroy and R.G. Wiegert, editors. *The Ecology of a Salt Marsh*. Springer-Verlag, New York. p. 113-135.
- Christian, R.R. and Wetzel, R. L. 1978. Interactions between substrate microbes and consumers of *Spartina* "detritus" in estuaries. In: M. Wiley, (ed.). *Estuarine Interactions*. Academic Press, New York. p. 93-114.
- Christian, R.R. and Wiebe, W.J. 1978. Anaerobic microbial community metabolism in *Spartina alterniflora* soils. *Limnol. Oceanogr.* 23:328-336.
- Corbat, C. 1990. Nesting ecology of selected beach-nesting birds in Georgia. Ph.D. dissertation, University of Georgia. 174 p.
- Covi, M.P. and Kneib, R.T. 1995. Intertidal distribution, population dynamics and production of the amphipod *Uhlorechestia spartinophila* in a Georgia, USA, salt marsh. *Marine Biology* 121:447-455.
- Coulter, E.M. 1940. *Thomas Spalding of Sapelo*. Louisiana State University Press, University, LA. 334 p.
- Crook, M.R., Jr. 1978. Spatial associations and distribution of aggregate village sites in a southeastern Atlantic coastal community. *The Florida Anthropologist* 31:21-34.
- Crook, M.R., Jr. 1980. Archaeological indications of community structures at the Kenan Field site. In: D.P. Juengst (ed.), *Sapelo Papers: Researches in the History and Prehistory of Sapelo Island, Georgia*. West Georgia College Studies in the Social Sciences, Vol 19. p. 89-100.
- Dahlberg, M. 1975. *Guide to Coastal Fishes of Georgia and Nearby States*. Univ. of Georgia Press, Athens, GA. 186 p.
- Darley, M.W., Montague, C.L., Plumley, F.G., Sage, W.W., and Psalidas, A.T. 1981. Factors limiting edaphic algal biomass and productivity in a Georgia salt marsh. *Journal of Phycology* 17:122-128.
- Darley, W.M., Ohlman, C.T. and Wimpee, B.B. 1979. Utilization of dissolved organic carbon by natural populations of epibenthic salt marsh diatoms. *J. Phycol.* 15:1-5.
- Darnell, R.M. 1961. Trophic spectrum of an estuarine community based on studies of Lake Ponchartrain, Louisiana. *Ecology* 42:553-568.
- Darnell, R.M. 1967. Organic detritus in relation to the estuarine ecosystem. In: *Estuaries*. Lauff, G.H. (ed.). AAAS Publication 83: 376-382.

- Duncan, W.H. 1982. *The Vascular Vegetation of Sapelo Island*. Botany Dept., Univ. of Georgia and Ga. Department of Natural Resources, 75 p.
- Duncan, W.H. and Duncan, M.B. 1987. *Seaside Plants of the Gulf and Atlantic Coasts*. Smithsonian Institution Press, Washington, DC. 409 p.
- Duncan, W.H. and Duncan, M.B. 1988. *Trees of the Southeastern United States*. The University of Georgia Press, Athens, GA. 322 p.
- Edwards, A.C. and Davis, D.E. 1974. Effects of herbicides on the *Spartina* salt marsh. In: Reimold, R.J. and Queen, W.H. (eds.) *Ecology of Halophytes*. Academic Press, Inc., p. 531-545.
- Edwards, A.C. and Davis, D.E. 1975. Effects of an organic arsenical herbicide on a salt marsh ecosystem. *J. Environ. Qual.* 4:215-219.
- Fallon, R. D. 1987. Sedimentary sulfides in the nearshore Georgia Bight. *Estuar. Coast. Shelf Sci.* 25:607-619.
- Filip, Z. and Alberts, J.J. 1988. The release of humic substances from *Spartina alterniflora* (Loisel.) into sea water as influenced by salt marsh indigenous microorganisms. *Sci. Total Environ.* 73:143-157.
- Filip, Z. and Alberts, J.J. 1989. Humic substances isolated from *Spartina alterniflora* (Loisel.) following long-term decomposition in sea water. *Sci. Total Environ.* 83:273-285.
- Filip, Z. and Alberts, J.J. 1993. Formation of humic-like substances by fungi epiphytic on *Spartina alterniflora*. *Estuaries* 16:385-390.
- Filip, Z. and Alberts, J.J. 1994. Microbial utilization resulting in early diagenesis of salt marsh humic acids. *Sci. Total Environ.* 144:121-135.
- Filip, Z., Alberts, J.J., Cheshire, M.V., Goodman, B.A. and Bacon, J.R. 1988. Comparison of salt marsh humic acid with humic-like substances from the indigenous plant species *Spartina alterniflora* (Loisel.). *Sci. Total Environ.* 71:157-172.
- Filip, Z., Newman, R.H. and Alberts, J.J. 1991. Carbon-13 nuclear magnetic resonance characterization of humic substances associated with salt marsh environments. *Sci. Total Environ.* 101:191-199.
- Fitz, H.C. and Wiegert, R.G. 1991. Utilization of the intertidal zone of a salt marsh by the blue crab, *Callinectes sapidus*: density, return frequency, and feeding habits. *Marine Ecology-Progress Series* 76:249-260.
- Frankenberg, D., Coles, S. L. and Johannes, R.E. 1967. The potential trophic significance of *Callinasa major* fecal pellets. *Limnol. Oceanogr.* 12:113-120.
- Frey, R.W. and Basan, P. 1985. Coastal salt marshes. In: Davis, R.A., Jr., (ed.), *Coastal Sedimentary Environments*, 2nd Expanded Edition. Springer-Verlag, New York. p. 225-301.
- Frey, R.W. and Howard, J.D. 1969. A profile of biogenic sedimentary structures in a holocene barrier island- salt marsh complex, Georgia. *Trans. Gulf Coast Assoc. Geol. Soc.* 19:427-444.
- Gallagher, J.L. 1979. Growth and elemental compositional responses of *Sporobolus virginicus* (L.) Kunth to substrate, salinity and nitrogen. *Amer. Midland Natur.* 102:68-75.
- Gallagher, J.L., Pfeiffer, W.J. and Pomeroy, L.R. 1976. Leaching and microbial utilization of dissolved organic carbon from leaves of *Spartina alterniflora*. *Estuar. Coast. Mar. Sci.* 4:467-471.

- Gallagher, J.L. and Plumley, F.G. 1979. Underground biomass profiles and productivity in Atlantic coastal marshes. *American Journal of Botany* 66:156-161.
- Gallagher, J.L., Reimold, R.J., Linthurst, R.A., and Pfeiffer, W.J. 1980. Aerial production, mortality, and mineral accumulation dynamics in *Spartina alterniflora* and *Juncus roemerianus* in a Georgia salt marsh. *Ecology* 61:303-312.
- Gallagher, J.L., Robinson, S.E., Pfeiffer, W.J. and Seliskar, D.M. 1979. Distribution and movement of toxaphene in anaerobic saline marsh soils. *Hydrobiol.* 63:3-9.
- Gallagher, J.L. and Wolf, P.L. 1980. Field bioassays for the role of plants as vectors in contaminant transfer from dredged material. In: Baker, R.A. (ed.) *Contaminants and Sediments, Vol. 2*. Ann Arbor Sci. Pub., Ann Arbor, MI, p. 445-463.
- Gallagher, J.L., Wolf, P.L. and Pfeiffer, W.J. 1984. Rhizome and root growth rates and cycles in protein and carbohydrate concentrations in Georgia *Spartina alterniflora* Loisel. plants. *Amer. J. Bot.* 71:165-169.
- Gjessing, E.T. 1976. *Physical and Chemical Characteristics of Aquatic Humus*. Ann Arbor Science, Ann Arbor, MI.
- Giblin, A.E. and Howarth, R.W. 1984. Porewater evidence for a dynamic sedimentary iron cycle in salt marshes. *Limnol. Oceanogr.* 29:47-63.
- Greaves, J. 1966. Some aspects of modern barrier beach development. In: J.H. Hoyt, V.J. Henry, Jr. and J.D. Howard (eds.), *Pleistocene and Holocene sediments, Sapelo Island, Georgia and vicinity*. Geol. Soc. Amer., Southeast Sect., Guidebook for Field Trip No. 1. p. 40-63.
- Haddad, R.I., Newell, S.Y., Martens, C.S. and Fallon, R.D. 1992. Early diagenesis of lignin-associated phenolics in the salt marsh grass *Spartina alterniflora*. *Geochim. Cosmochim. Acta* 56:3751-3764.
- Hails, J.R. and Hoyt, J.H. 1968. Barrier development of submerged coasts: Problems of sea-level changes from a study of the Atlantic coastal plain of Georgia, U.S.A., and parts of the east Australian coast. *Zeitschr. Geomorphologie* 7:24-55.
- Hails, J.R. and Hoyt, J.H. 1969. An appraisal of the evolution of the lower Atlantic coastal plain of Georgia, U.S.A. *Trans. Inst. Br. Geogr.* 46:53-68.
- Haines, E.B. 1976a. Nitrogen content and acidity of rain on the Georgia coast. *Wat. Resources Bull.* 12:1223-1231.
- Haines, E.B. 1976b. Stable carbon isotope ratios in the biota, soils and tidal water of a Georgia salt marsh. *Estuar. Coast. Mar. Sci.* 4:609-616.
- Haines, E.B. 1976c. Relation between the stable carbon isotope composition of fiddler crabs, plants, and soils in a salt marsh. *Limnol. Oceanogr.* 21:880-883.
- Haines, E.B. 1977. The origins of detritus in Georgia salt marsh estuaries. *Oikos* 29:54-260.
- Haines, E.B. 1979a. Nitrogen pools in Georgia coastal waters. *Estuaries* 2:34-39.
- Haines, E.B. 1979b. Interactions between Georgia salt marshes and coastal waters: A changing paradigm. In: R.J. Livingston, (ed.). *Ecological Processes in Coastal and Marine Systems*. Plenum Press, New York. p. 35-46.
- Haines, E.B. 1979c. Growth dynamics of cordgrass, *Spartina alterniflora* Loisel., on control and sewage sludge fertilized plots in a Georgia salt marsh. *Estuaries* 2:50-53.
- Haines, E.B. and Hanson, R. 1979. Experimental degradation of detritus made from the salt marsh plants *Spartina alterniflora* Loisel., *Salicornia virginica* L., and *Juncus roemerianus* Steele. *J. Exp. Mar. Biol. Ecol.* 40:27-40.

- Haines, E.B. and Montague, C.L. 1979. Food sources of estuarine invertebrates analyzed using $^{13}\text{C}/^{12}\text{C}$ ratios. *Ecology* 60:48-56.
- Henry, V.J. 1989. Geological development of the Georgia coast past, present and future. In: *Diagnosis and Prognosis - Barrier Island/Salt Marsh Estuaries, Southeast Atlantic Coast: Issues, Resources, Status and Management*. NOAA Estuary-of-the-Month Seminar Series No. 12, U.S. Dept. of Commerce, Washington, D.C. p. 17-29.
- Hodler, T.W., Lawson, N., Schretter, H.A. and Torguson, J. 1994. *The Interactive Atlas of Georgia*. Institute of Community and Area Development, University of Georgia, Athens, GA.
- Hodson, R.E., Christian, R.R. and Maccubbin, A.E. 1984. Lignocellulose and lignin in the salt marsh grass *Spartina alterniflora*: initial concentrations and short-term, post-depositional changes in detrital matter. *Mar. Biol.* 81:1-7.
- Hopkinson, C.S., Jr. 1985. Shallow water benthic and pelagic metabolism: evidence of heterotrophy in the nearshore Georgia Bight. *Mar. Biol.* 87:19-32.
- Hopkinson, C.S., Jr. 1988. Patterns of organic carbon exchange between coastal ecosystems: The mass balance approach in salt marsh ecosystems. In: B.-O. Jansson, (ed.). *Coastal-Offshore Ecosystems Interactions*. Springer-Verlag, Berlin/Heidelberg. p. 122-154.
- Hopkinson, C.S., Jr. 1989. The Upland/Estuary/Nearshore couple. In: *Barrier Island/Salt Marsh Estuaries, Southeast Atlantic Coast: Issues, Resources, Status, and Management*. NOAA Estuary-of-the-Month Seminar Series No. 12. p. 77-87.
- Hopkinson, C.S. and Hoffman, F.A. 1984. The estuary extended—A recipient-system of estuarine outwelling in Georgia. In: V.S. Kennedy, (ed.). *The Estuary as a Filter*. Academic Press, New York. p. 313-330.
- Hoyt, J.H. 1962. High angle beach stratification, Sapelo Island, Georgia. *J. Sed. Petrol.* 32:309-311.
- Hoyt, J.H. and Henry, V.J., Jr. 1963. Rhomboid ripple mark, indicator of current direction and environment. *J. Sed. Petrol.* 33:604-608.
- Hoyt, J.H., Weimer, R.J. and Henry, V.J., Jr. 1964. Late Pleistocene and recent sedimentation, Central Georgia Coast, U.S.A. In: *Developments in Sedimentology, Vol. 1, Deltaic and Shallow Marine Deposits*. van Straaten, L.M.J.U., (ed). Elsevier Publishing, Amsterdam. p. 170-176.
- Howard, J.D. and Frey, R.W. 1985. Physical and biogenic aspects of backbarrier sedimentary sequences, Georgia coast, U.S.A. *Marine Geology* 63:77-127.
- Howarth, R.W. and Giblin, A. 1983. Sulfate reduction in the salt marshes at Sapelo Island, Georgia. *Limnol. Oceanogr.* 28:70-82.
- Howarth, R.W. and Marino, R. 1984. Sulfate reduction in salt marshes with some comparisons to sulfate reduction in microbial mats. In: Chen, Y., Castenholz, R.W. and Halvorson, H.O. (eds.) *Microbial Mats: Stromatolites*. Alan R. Liss, Inc. New York. p. 245-263.
- Howarth, R.W. and Merkel, S. 1984. Pyrite formation and the measurement of sulfate reduction in salt marsh sediments. *Limnol. Oceanogr.* 29:598-608.
- Imberger, J., Berman, T., Christian, R.R., Sherr, E.B., Whitney, D.E., Pomeroy, L.R., Wiegert, R.G. and Wiebe, W.J. 1983. The influence of water motion on the distribution and transport of materials in a salt marsh estuary. *Limnol. Oceanogr.* 28:201-214.

- Johannes, R.E., Coward, S.J. and Webb, K.L. 1969. Are dissolved amino acids an energy source for marine invertebrates? *Comp. Biochem. Physiol.* 29:283-288.
- Johannes, R.E. and Webb, K.L. 1965. Release of dissolved amino acids by marine zooplankton. *Science* 150:76-77.
- Johannes, R.E. and Webb, K.L. 1970. Release of dissolved organic compounds by marine and fresh water invertebrates. In: D.W. Hood (ed.), *Organic Matter in Natural Waters*. Univ. of Alaska, College, Alaska. p. 257-273.
- Johnson, A.S., Hillestad, H.O., Shanholtzer, S.F. and Shanholtzer, G.F. 1974. An Ecological Survey of the Coastal Region of Georgia. National Park Service Scientific Monograph Series, No. 3. U.S. Government Printing Office, Washington, DC. 233 p.
- Kemp, P.F., Newell, S.Y., and Hopkinson, C.S. 1990. Importance of grazing on the salt-marsh grass *Spartina alterniflora* to nitrogen turnover in a macrofaunal consumer, *Littorina irrorata*, and to decomposition of standing-dead *Spartina*. *Marine Biology* 104:311-319.
- King, G., Klug, M., Wiegert, R.G., and Chalmers, A.G. 1982. Relation of soil water movement and sulfide concentration to *Spartina alterniflora* productivity in a Georgia salt marsh. *Science* 218:61-63.
- King, G.M. and Wiebe, W.J. 1978. Methane release from soils of a Georgia salt marsh. *Geochim. Cosmochim. Acta.* 42:343-348.
- Kjerfve, B. 1973. Volume Transport, Salinity Distribution and Net Circulation in the Duplin Estuary, Georgia. Environmental Resources Center, Georgia Institute of Technology, Atlanta, GA. 30 pages.
- Kneib, R.T. 1991. Flume weir for quantitative collection of nekton from vegetated intertidal habitats. *Mar. Ecol. Prog. Ser.* 75:29-38.
- Kneib, R.T. 1992. Population dynamics of the tanaid *Hargeria rapax* (Crustacea:Peracarda) in a tidal marsh. *Marine Biology* 113:437-445.
- Kneib, R.T. 1994. Spatial pattern, spatial scale, and feeding in fishes. In: D. Stouder and K. Fresh, (eds.). *Theory and Application in Fish Feeding Ecology*. University of South Carolina Press, Columbia, SC. p. 171-185.
- Kneib, R.T. 1995. Behaviour separates potential and realized effects of decapod crustaceans in salt marsh communities. *Journal of Experimental Marine Biology and Ecology* 193:239-256.
- Kneib, R.T. and Parker, J.H. 1991. Gross conversion efficiencies of mummichog and spotfin killifish larvae from a Georgia salt marsh. *Transactions of the American Fisheries Society* 120:803-809.
- Kneib, R.T. and Wagner, S.L. 1994. Nekton use of vegetated marsh habitats at different stages of tidal inundation. *Marine Ecology Progress Series* 106:227-238.
- Kneib, R.T. and Weeks, C.A. 1990. Intertidal distribution and feeding habits of the mud crab, *Eurytium limosum*. *Estuaries* 13:462-468.
- Kuenzler, E.J. 1961a. Structure and energy flow of a mussel population in a Georgia salt marsh. *Limnology and Oceanography* 6:191-204.
- Kuenzler, E.J. 1961b. Phosphorus budget of a mussel population. *Limnology and Oceanography* 6:400-415.

- Larson, L.H., Jr. 1980. The Spanish on Sapelo. In: D.P. Juengst (ed.), *Sapelo Papers: Researches in the History and Prehistory of Sapelo Island, Georgia*. West Georgia College Studies in the Social Sciences, Vol 19. p. 35-45.
- Lee, S.Y. and Kneib, R.T. 1994. Effects of biogenic structure on prey consumption by the xanthid crabs *Eurytium limosum* and *Panopeus herbstii* in a salt marsh. *Marine Ecology Progress Series* 104:39-47.
- Letzsch, W.S. 1983. Seven year's measurement of deposition and erosion, Holocene salt marsh, Sapelo Island, Georgia. *Senckenbergiana Maritima* 15:157-165.
- Letzsch, W.S. and Frey, R.W. 1980. Deposition and erosion in a Holocene salt marsh, Sapelo Island, Georgia. *J. Sed. Petrol.* 50:529-542.
- Linthurst, R.A. and Reimold, R.J. 1978. Estimated net aerial primary productivity for selected estuarine angiosperms in Maine, Delaware, and Georgia. *Ecology* 59:945-955.
- Maccubbin, A.E. and Hodson, R.E. 1980. Mineralization of detrital lignocelluloses by salt marsh sediment microflora. *Appl. Environ. Microbiol.* 40:735-740.
- Maccubbin, A.E., Benner, R. and Hodson, R.E. 1983. Interactions between pulp mill effluents and microbial populations in coastal waters and sediments. In: Oxley, T.A. and Barry, S. (eds.) *Biodeterioration 5*. John Wiley and Sons Ltd, New York, p. 246-256.
- Mayer, M.A. 1985. Ecology of juvenile white shrimp, *Penaeus setiferus* Linnaeus, in the salt marsh habitat. Master's Thesis, Georgia Institute of Technology, Atlanta, GA. 62 p.
- McMichael, A.E. 1977. A model for barrier island settlement pattern. *The Florida Anthropologist* 30:179-195.
- Montague, C.L. 1982. The influence of fiddler crab burrows and burrowing on metabolic processes in salt marsh sediments. In: V.S. Kennedy, (ed.). *Estuarine Comparisons*. Academic Press, New York. p. 283-301.
- Moran, M.A. and Hodson, R.E. 1989. Formation and bacterial utilization of dissolved organic carbon derived from detrital lignocellulose. *Limnol. Oceanogr.* 34:1034-1047.
- Moran, M.A. and Hodson, R.E. 1990. Contributions of degrading *Spartina alterniflora* lignocellulose to the dissolved organic carbon pool of a salt marsh. *Mar. Ecol. Prog. Ser.* 62:161-168.
- Moran, M.A. and Hodson, R.E. 1994. Dissolved humic substances of vascular plant origin in a coastal marine environment. *Limnol. Oceanogr.* 39:762-771.
- Nestler, J. 1977. A preliminary study of the sediment hydrology of a Georgia salt marsh using rhodamine WT as a tracer. *Southeastern Geol.* 18:265-271.
- Newell, S.Y. 1992. Estimating fungal biomass and productivity in decomposing litter. In: G.C. Carroll and D.T. Wicklow, (eds.). *The Fungal Community*. Marcel Dekker, Inc., New York. p. 521-561.
- Newell, S.Y. 1993a. Membrane-containing fungal mass and fungal specific growth rate in natural samples. In: P.F. Kemp, B.F. Sherr, E.B. Sherr and J.J. Cole, (eds.). *Current Methods in Aquatic Microbial Ecology*. Lewis Pubs., Boca Raton, FL. p. 579-586.
- Newell, S.Y. 1993b. Decomposition of shoots of a saltmarsh grass. In: J.G. Jones, (ed.). *Advances in Microbial Ecology*. Volume 13. Plenum Press, New York. p. 301-326.
- Newell, S.Y. 1994. Total and free ergosterol in mycelia of saltmarsh ascomycetes with access to whole leaves or aqueous extracts of leaves. *Applied and Environmental Microbiology* 60:3479-3482.

- Newell, S.Y. and Bärlocher, F. 1993. Removal of fungal and total organic matter from decaying cordgrass leaves by shredder snails. *Journal Experimental Marine Biology and Ecology* 171:39-49.
- Newell, S.Y. and Fallon, R.D. 1989. Litterbags, leaf tags, and decay of nonabscised intertidal leaves. *Can. J. Bot.* 67:2324-2327.
- Newell, S.Y., Fallon, R.D., Cal Rodriguez, R.M., and Groene, L.C. 1985. Influence of rain, tidal wetting and relative humidity on release of carbon dioxide by standing-dead salt-marsh plants. *Oecologia* 68:73-79.
- Newell, S.Y., Fallon, R.D. and Miller, J.D. 1989. Decomposition and microbial dynamics for standing, naturally positioned leaves of the salt-marsh grass *Spartina alterniflora*. *Mar. Biol.* 101:471-481.
- Newell, S.Y., Hicks, R.E. and Nicora, M. 1982. Content of mercury in leaves of *Spartina alterniflora* Loisel., in Georgia, USA: an update. *Estuar. Coast. Shelf Sci.* 14:465-469.
- Newell, S.Y., Hopkinson, C.S., and Scott, L.A. 1992. Patterns of nitrogenase activity (acetylene reduction) associated with standing decaying shoots of *Spartina alterniflora*. *Estuarine, Coastal and Shelf Science* 35:127-140.
- Newell, S.Y., Porter, D. and Lingle, W.L. 1996. Lignocellulosis by ascomycetes (fungi) of a saltmarsh grass (smooth cordgrass). *Microscopy Res. Tech.* 33: 32-46.
- Nixon, S.W. 1980. Between coastal marshes and coastal water—A review of twenty years of speculation and research on the role of salt marshes in estuarine productivity and water chemistry. In: P. Hamilton and K. MacDonald (eds.), *The Role of Terrestrial and Aquatic Organisms in Decomposition Processes*. Blackwell Scientific, London. p. 437-525.
- Odum, E.P. 1968. A research challenge: Evaluating the productivity of coastal and estuarine water. *Proc. 2nd Sea Grant Conf.*, Grad. School Oceanography, University of Rhode Island, Newport. p. 63-64.
- Odum, E.P. and de la Cruz, A.A. 1967. Particulate organic detritus in a Georgia salt marsh-estuarine ecosystem. In: Lauff, G.H., (ed.), *Estuaries*. Amer. Assoc. Advance. Sci., No. 83, p. 383-388.
- Odum, E.P. and Smalley, A.E. 1959. Comparison of population energy flow of a herbivorous and a deposit-feeding invertebrate in a salt marsh ecosystem. *Proceedings of the National Academy of Science of the USA* 45:617-622.
- Odum, W.E. 1968. The ecological significance of fine particle selection by striped mullet, *Mugil cephalus*. *Limnology and Oceanography* 13:92-98.
- O'Grady, P.D. 1980. The occupation of Sapelo Island since 1733. In: D.P. Juengst (ed.), *Sapelo Papers: Researches in the History and Prehistory of Sapelo Island, Georgia*. West Georgia College Studies in the Social Sciences, Vol 19. p. 1-8.
- Oshrain, R.L. 1977. Aspects of anaerobic sulfur metabolism in salt marsh soils. M.S. Thesis, University of Georgia, Athens, GA.
- Pace, M.L., Shimmel, S., and Darley, W.M. 1979. The effect of grazing by a gastropod, *Nassarius obsoletus*, on the benthic microbial community of a salt marsh mudflat. *Estuarine and Coastal Marine Science* 9:121-134.
- Pakulski, J.D. 1986. The release of reducing sugars and dissolved organic carbon from *Spartina alterniflora* in a Georgia salt marsh. *Estuar. Coast. Mar. Sci.* 22:385-394.

- Pilkey, O.H. and Harriss, R.C. 1966. The effect of intertidal environment on the composition of calcareous skeletal material. *Limnol. Oceanogr.* 11:381-385.
- Pomeroy, L.R. 1959. Algal productivity in salt marshes of Georgia. *Limnology and Oceanography* 4:386-397.
- Pomeroy, L.R., Shenton, L.R., Jones, R.D.H. and Reimold, R.J.. 1972. Nutrient flux in estuaries. In: *Nutrients and Eutrophication*. Spec. Symposium, AAAS 1:274-291.
- Pomeroy, L.R., Darley, W.M., Dunn, E.L., Gallagher, J.L., Haines, E.B. and Whitney, D.M. 1981. Primary production. In: L.R. Pomeroy and R.G. Wiegert. *The Ecology of a Salt Marsh*. Springer-Verlag, New York. p. 39-67.
- PoPomeroy, L.R. and Wiegert, R.G. 1981. *The Ecology of a Salt Marsh*. Springer-Verlag, New York. 271 p.
- Rashid, M.A. 1985. *Geochemistry of Marine Humic Compounds*. Springer-Verlag, Berlin-New York.
- Ragotzkie, R.A. 1956. Mortality of loggerhead turtle eggs from excessive rainfall. *Ecology* 40:303-305.
- Ragotzkie, R.A. 1959. Plankton productivity in estuarine waters of Georgia. *Institute of Marine Science, University of Texas* 6:146-158.
- Ragotzkie, R.A. and Bryson, R.A. 1955. Hydrography of the Duplin River, Sapelo Island, Georgia. *Bulletin of Marine Science of the Gulf and Caribbean* 5:297-314.
- Ragotzkie, R.A. and Pomeroy, L.R. 1957. Life history of a dinoflagellate bloom. *Limnology and Oceanography* 2:62-69.
- Robertson, J.R., Bancroft, K., Vermeer, G., and Plaisier, K. 1980. Experimental studies on the foraging behavior of the sand fiddler crab *Uca pugilator* (Bosc, 1802). *Journal Experimental Marine Biology and Ecology* 44:67-83.
- Robertson, J.R., Fudge, J.A., and Vermeer, G. 1981. Chemical and live feeding stimulants of the sand fiddler crab *Uca pugilator* (Bosc). *Journal Experimental Marine Biology and Ecology* 52:47-64.
- Robertson, J.R. and Newell, S.Y. 1982a. Experimental studies of particle ingestion by the sand fiddler crab *Uca pugilator* (Bosc). *Journal Experimental Marine Biology and Ecology* 59:1-21.
- Robertson, J.R. and Newell, S.Y. 1982b. A study of particle ingestion by three fiddler crab species foraging on sandy sediments. *Journal Experimental Marine Biology and Ecology* 65:11-17.
- Robertson, J.R. and Pfeiffer, W.J. 1982. Deposit feeding by the ghost crab *Ocypode quadrata*. *Journal Experimental Marine Biology and Ecology* 56:165-177.
- Sandifer, P.A., Miglarese, J.V., Calder, D.R., Manzi, J.J. and Barclay, L.A. 1980. Ecological Characterization of the Sea Island Coastal Region of South Carolina and Georgia. Vol. 3. U.S. Fish and Wildlife Service, U.S. Department of the Interior, Washington, DC.
- Schelske, C.L. and Odum, E.P. 1961. Mechanisms maintaining high productivity in Georgia estuaries. *Gulf Carib. Fish. Inst. Proc.* 14:75-80.
- Schindler, D.E., Johnson, B.M., MacKay, N.A., Bouwes, N. and Kitchell, K.F. 1994. Crab:snail size-structured interactions and salt marsh predation gradients. *Oecologia* 97:49-61.

- Schnitzer, M. and Khan, S.U. 1972. *Humic Substances in the Environment*. Marcel Dekker, New York.
- Setzler, E.M. 1977. A quantitative study of the movement of larval and juvenile Sciaenidae and Engraulidae in the estuarine nursery grounds of Doboy Sound, Sapelo Island, Georgia. Ph.D. dissertation, University of Georgia, Athens, GA.
- Sherr, E.B. 1982. Carbon isotope composition of organic seston and sediments in a Georgia salt marsh estuary. *Geochim. Cosmochim. Acta* 46:1227-1232.
- Sherr, B.F. and Payne, W.J. 1978. Effect of the *Spartina alterniflora* root-rhizome system on salt marsh soil denitrifying bacteria. *Appl. Environ. Microbiol.* 35:724-729.
- Sherr, B.F. and Payne, W.J. 1981. The effect of sewage sludge on salt-marsh denitrifying bacteria. *Estuaries* 4:146-149.
- Simpkins, D.L. 1975. A preliminary report on test excavations at the Sapelo Island Shell Ring, 1975. *Early Georgia* 3:15-37.
- Skyring, G.W., Oshrain, R.L. and Wiebe, W.J. 1979. Assessment of sulfate reduction rates in Georgia marshland soils. *Geomicrobiology J.* 1:389-400.
- Smalley, A.E. 1960. Energy flow of a salt marsh grasshopper population. *Ecology* 41:785-790.
- Smith, S.V. 1984. Phosphorus versus nitrogen limitation in the marine environment. *Limnol. Oceanogr.* 29:1149-1160.
- Sottile, W.S. 1974. Studies of microbial production and utilization of dissolved organic carbon in a Georgia salt marsh-estuarine ecosystem. Ph.D. Dissertation, University of Georgia, Athens, GA.
- Spratt, Jr., H.G. and Hodson, R.E. 1994. The effect of changing water chemistry on rates of manganese oxidation in surface sediments of a temperate saltmarsh and a tropical mangrove estuary. *Estuar. Coast. Shelf Sci.* 38:119-135.
- Spratt, Jr., H.G., Siekmann, E.C. and Hodson, R.E. 1994. Microbial manganese oxidation in saltmarsh surface sediments using a leuco crystal violet manganese oxide detection technique. *Estuar. Coast. Shelf Sci.* 38:91-112.
- Stevenson, F.J. 1982. *Humus Chemistry Genesis, Composition, Reactions*. John Wiley and Sons, New York.
- Sullivan, B. 1990. *Early Days on the Georgia Tidewater: The Story of McIntosh County & Sapelo*. McIntosh County Board of Commissioners, Darien, GA. 842 p.
- Teal, J.M. 1958. Distribution of fiddler crabs in Georgia salt marshes. *Ecology* 39:185-193.
- Teal, J.M. 1959a. Respiration of crabs in Georgia salt marshes and its relation to their ecology. *Physiological Zoology* 32:1-14.
- Teal, J.M. 1959b. Birds of Sapelo Island and vicinity. *The Oriole* 24:1-14,17-20.
- Teal, J.M. 1962. Energy flow in the salt marsh ecosystem of Georgia. *Ecology* 43:614-624.
- Ubben, M.S. and Hanson, R.B. 1980. Tidal induced regulation of nitrogen fixation activity in a Georgia salt marsh, Sapelo Island, Georgia. *Estuar. Coast. Mar. Sci.* 10:445-453.
- Vetter, R.D., Carey, M.C. and Patton, J.S. 1985. Coassimilation of dietary fat and benzo(a)pyrene in the small intestine: An adsorption model using the killifish. *J. Lipid Res.* 26:428-434.
- Wadsworth, J.R. 1980. Geomorphic characteristics of tidal drainage networks in the Duplin River System, Sapelo Island, Georgia. Ph.D. Dissertation, University of Georgia, Athens, GA.

- Wagner, R.H. 1964. The ecology of *Uniola paniculata* L. in the dune-strand habitat of North Carolina. *Ecol. Monogr.* 34:79-96.
- Webb, K.L. and Johannes, R.E. 1967. Studies of the release of dissolved free amino acids by marine zooplankton. *Limnol. Oceanogr.* 12:376-382.
- Weber, J.H. and Alberts, J.J. 1990. Methylation of Sn(IV) by hydroponically incubated *Spartina alterniflora*. *Environ. Technol.* 11:3-8.
- Welch, R., Remillard, M., and Alberts, J.J. 1991. Integrated resource databases for coastal management. *GIS World* 4:86-89. (680)
- Welch, R., Remillard, M., and Alberts, J.J. 1992. Integration of GPS, Remote sensing & GIS techniques for coastal resource management. *Photogrammetric Engineering and Remote Sensing* 58:1571-1578. (706)
- Wetzel, R.L. 1975. An experimental study of detrital carbon utilization in a Georgia salt marsh. Ph.D. Dissertation, University of Georgia, Athens, GA.
- Wetzel, R.L. 1976. Carbon resources of a benthic salt marsh invertebrate *Nassarius obsoletus* Say (Mollusca:Nassariidae). In: M. Wiley, (ed.). *Estuarine Processes, Vol. II, Circulation, Sediments and Transfer of Material in the Estuary*. Academic Press, Inc., New York. p. 293-308.
- Whelan, J.K., Tarafa, M.E. and Sherr, E.B. 1986. Phenolic and lignin pyrolysis products of plants, seston, and sediments in a Georgia estuary. In: Sohn, M.L. (ed.) *Organic Marine Geochemistry*, ACS Symp. Ser. 305, Amer. Chem. Soc., p. 62-75.
- Whitney, D.E. and Darley, W.M. 1983. Effect of light intensity upon salt marsh benthic microalgal photosynthesis. *Marine Biology* 75:249-252.
- Wicks, R.J., Moran, M.A., Pittman, L.J. and Hodson, R.E. 1991. Carbohydrate signatures of aquatic macrophytes and their dissolved degradation products as determined by a sensitive high-performance ion chromatography method. *Appl. Environ. Microbiol.* 57:3135-3143.
- Wiebe, W.J. and Bancroft, K. 1975. The use of adenylate energy charge ratio to measure growth state of natural microbial communities. *Proc. Nat'l. Acad. Sci. USA* 72:2112-2115.
- Wiegert, R.G. 1980. Modelling salt marshes and estuaries: Progress and problems. In: P. Hamilton and K.B. McDonald, (eds.). *Estuarine and Wetland Processes with Emphasis on Modelling*. p. 527-540.
- Wiegert, R.G., Chalmers, A.G., and Randerson, P.F. 1983. Productivity gradients in salt marshes: the response of *Spartina alterniflora* to experimentally manipulated soil water movement. *Oikos* 41:1-6.
- Wiegert, R.G. and Freeman, B.J. 1990. *Tidal Salt Marshes of the Southeast Atlantic Coast: A Community Profile*. U.S. Dept. of the Interior, Fish and Wildlife Service, Washington, D.C. 70 p.
- Wijayarathne, R.D. and Means, J.C. 1984a. Sorption of polycyclic aromatic hydrocarbons by natural estuarine colloids. *Mar. Environ. Res.* 11:77-89.
- Wijayarathne, R.D. and Means, J.C. 1984b. Affinity of hydrophobic pollutants for natural estuarine colloids in aquatic environments. *Environ. Sci. Technol.* 18:121-123.
- Williams, R.B. 1963. Use of netting to collect motile benthic algae. *Limnology and Oceanography* 8:360-361.

- Wolf, P.L., Shanholtzer, S.F., and Reimold, R.J. 1975. Population estimates for *Uca pugnax* (Smith, 1870) on the Duplin estuary marsh, Georgia, U.S.A. (Decapoda Brachyura, Ocypodidae). *Crustaceana* 29:79-91.
- Zarillo, G.A. 1979. Interrelation of hydrodynamics and sediment transport in a salt marsh estuary. Ph.D. Dissertation, University of Georgia, Athens, GA. 222 p.

Appendix 1. Vegetation of Sapelo Island¹

PTERIDOPHYTA

OSMUNDACEAE

<i>Osmunda cinnamomea</i> L.	Cinnamon fern	C ²
<i>Osmunda regalis</i> L. var. <i>spectabilis</i> (Willd.) Gray	Royal fern	I

POLYPODIACEAE

<i>Polypodium polypodioides</i> (L.) Watt.	Resurrection fern	C
--	-------------------	---

DENNSTAEDTACEAE

<i>Pteridium aquilinum</i> (L.) Kuhn var. <i>pseudocaudatum</i>	Bracken fern	C
---	--------------	---

ASPLENIACEAE

<i>Asplenium platyneuron</i> (L.) Oakes ex. D.C. Eaton	Spleenwort	C
<i>Thelypteris kunthii</i> (Deav.) Morton	Southern shield fern	I
<i>Thelypteris palustris</i> Schott var. <i>haleana</i> Fern.	Marsh fern	I

BLECHNACEAE

<i>Woodwardia areolata</i> (L.) Moore	Netted chain fern	C
<i>Woodwardia virginica</i> (L.) J. Sm.	Virginia chain fern	R

SALVINIACEAE

<i>Salvinia minima</i> Baker	Salvinia	R
------------------------------	----------	---

AZOLLACEAE

<i>Azolla caroliniana</i> Willd.	Mosquito fern	R
----------------------------------	---------------	---

SPERMATOPHYTA

PINACEAE

<i>Pinus elliottii</i> Engelm.	Slash pine	TC
<i>Pinus palustris</i> Mill.	Longleaf pine	TC
<i>Pinus serotina</i> Dougl.	Pond pine	TC
<i>Pinus taeda</i> L.	Loblolly pine	TC

TAXODIACEAE

<i>Taxodium ascendens</i> Brongn.	Pond cypress	TI
-----------------------------------	--------------	----

CUPRESSACEAE

<i>Juniperus silicicola</i> (Small) Bailey	Southern red cedar	TC
--	--------------------	----

TYPHACEAE

<i>Typha domingensis</i> Pers.	Southern cattail	C
--------------------------------	------------------	---

POTAMOGETONACEAE

<i>Potamogeton nodosus</i> Poir.	Pondweed	R
<i>P. illinoensis</i> Morong.	Pondweed/fishweed	R
<i>Ruppia maritima</i> L.	Widgeon grass	I

NAJADACEAE

<i>Najas guadalupensis</i> (Spreng.) Magnus	Southern naiad	I
---	----------------	---

SCHEUCHZERIAEAE

<i>Triglochin striata</i> R. & P.	Arrow-grass	R
-----------------------------------	-------------	---

ALISMATAEAE

<i>Sagittaria graminea</i> Michx. var. <i>chapmanii</i> J. G. Sm.	Narrow-leaved Sagittaria	I
<i>S. lancifolia</i> L.	Lance-leaved Sagittaria	I
<i>S. subulata</i> (L.) Buch.		I

HYDROCHARITACEAE

<i>Vallisneria americana</i> Michx.	American wild celery	R
<i>Limnobium spongia</i> (Bosc) Steud.	Frog's bit	R

POACEAE

<i>Tripsacum dactyloides</i> (L.) L.	Gamma grass	R
<i>Erianthus coarctatus</i> Fern.	Plume grass	I
<i>E. giganteus</i> (Walt.) Muhl.	Giant plume grass	C
<i>Coelorachis rugosa</i> (Nutt.) Nash		R
<i>Andropogon glomeratus</i> (Walt.) B.S.P.	Bushy broomsedge	C
<i>A. longiberbis</i> Hack.	Sand broomsedge	I
<i>A. ternarius</i> Michx.	Splitbeard	C
<i>A. virginicus</i> L. var. <i>virginicus</i>	Virginia Broomsedge	C
<i>A. virginicus</i> L. var. <i>glaucopsis</i> (Ell.) Hitchc.	Virginia Broomsedge	I
<i>Schizachyrium stoloniferum</i> Nash	Bluestem	I
<i>Sorghastrum elliottii</i> (Mohr) Nash	Elliot's woodgrass	C
<i>S. secundum</i> (Ell.) Nash	Indian grass	I
<i>Sorghum halepense</i> (L.) Pers.	Johnson grass	C
<i>Paspalum boscianum</i> Flugge	Bullgrass	I
<i>P. difforme</i> LeConte		I
<i>P. dilatatum</i> Poir.	Dallis grass	C
<i>P. dissectum</i> (L.) L.	Bullgrass	I
<i>P. distichum</i> L.	Knotgrass	C
<i>P. floridanum</i> Michx. var. <i>floridanum</i>	Tall Paspalum	I
<i>P. giganteum</i> Baldw. ex Vasey		I
<i>P. laeve</i> Hichx. var. <i>laeve</i>	Field paspalum	I
<i>P. laeve</i> Michx. var. <i>pilosum</i> Schribn.		R
<i>P. notatum</i> Flugge var. <i>saurae</i> Parodi	Bahia grass	C
<i>P. praecox</i> Walt.		I
<i>P. setaceum</i> Michx. var. <i>ciliatifolium</i> (Michx.) Vasey	Fringe-leaved paspalum	C
<i>P. setaceum</i> Michx. var. <i>longipedunculatum</i> (LeConte) Wood		I
<i>P. setaceum</i> Michx. var. <i>supinum</i> (Bosc ex Poir.) Fern.		I
<i>P. urvillei</i> Steud.	Vasey grass	C
<i>P. vaginatum</i> Sw.	Seashore paspalum	C
<i>Axonopus affinis</i> Chase	Common carpet grass	C
<i>A. furcatus</i> (Flugge) Hitchc.	Big carpet grass	C
<i>Eriochloa michauxii</i> (Poir.) Hitchc.	Longleaf cup grass	R
<i>Panicum amarum</i> Ell. var. <i>amarum</i>	Seaside panicum	I
<i>P. dichotomiflorum</i> Michx.	Fall panic grass	I
<i>P. rhizomatum</i> Hitchc. & Chase	Flat-stemmed panic grass	C
<i>P. rigidulum</i> Bosc. ex Nees		C
<i>P. verrucosum</i> Muhl.	Warty panic grass	C
<i>P. virgatum</i> L. var. <i>virgatum</i>	Switchgrass	C
<i>Dichantherium aciculare</i> (Desv. ex Poir.) Gould & Clark		C
<i>D. acuminatum</i> (Sw.) Gould & Clark var. <i>acuminatum</i>	Wooly panic grass	C
<i>D. acuminatum</i> (Sw.) Gould & Clark var. <i>implicatum</i> (Schribn.) Gould & Clark		R
<i>D. commutatum</i> (Schult.) Gould		C
<i>D. consanguineum</i> (Kunth) Gould & Clark		I
<i>D. dichotomum</i> (L.) Gould var. <i>ensifolium</i> (Bald. ex Ell.) Gould & Clark		C
<i>D. laxiflorum</i> (Lam.) Gould		C
<i>D. leucoblepharis</i> (Trin.) Gould & Clark var. <i>leucoblepharis</i>		I
<i>D. oligosanthes</i> (Schult.) Gould var. <i>oligosanthes</i>		C
<i>D. ovale</i> (Ell.) Gould & Clark var. <i>ovale</i>		I
<i>D. sabulorum</i> (Lam.) Gould & Clark var. <i>patulum</i> (Scribn. & Merr.) Gould & Clark		C
<i>D. sabulorum</i> (Lam.) Gould & Clark var. <i>thinium</i> (Hitchc. & Chase) Gould & Clark		C

<i>D. scabriusculum</i> (Ell.) Gould & Clark		C
<i>D. scoparium</i> (Lam.) Gould	Velvet panic grass	I
<i>Sacciolepis striata</i> (L.) Nash	Baggy knees	C
<i>Echinochloa walteri</i> (Pursh) Heller	Salt marsh millet	C
<i>Digitaria sanguinalis</i> (L.) Scop.	Hairy crab grass	C
<i>D. serotina</i> (Walt.) Michx.	Blanket crab grass	I
<i>D. villosa</i> (Walt.) Pers.		C
<i>Oplismenus hirtellus</i> (L.) Beauv. ssp. <i>setarius</i> (Lam.) Mez ex Ekman	Woodgrass	R
<i>Setaria corrugata</i> (Ell.) Schult.	Bristlegrass	C
<i>S. geniculata</i> (Lam.) Beauv.	Knotroot bristlegrass	C
<i>S. macrosperma</i> (Scribn. & Merr.) K. Schum.	Foxtail grass	R
<i>S. magna</i> Griseb.	Giant foxtail grass	I
<i>Cenchrus echinatus</i> L.	Southern sandspur	C
<i>C. incertus</i> M. A. Curtis	Coastal sandspur	C
<i>C. tribuloides</i> L.	Dune sandspur	C
<i>Stenotaphrum secundatum</i> (Walt.) Kuntze	St. Augustine grass	C
<i>Luziola fluitans</i> (Michx.) Terrel & H. Robins.	Water grass	R
<i>Phalaris caroliniana</i> Walt.	Canary grass	R
<i>Anthoxanthum odoratum</i> L.		C
<i>Aristida lanosa</i> Muhl. ex Ell.	Three awn grass	I
<i>A. purpurascens</i> Poir.	Arrowfeather three awn grass	C
<i>A. spiciformis</i> Ell.	Bottlebrush three awn grass	I
<i>A. virgata</i> Trin.	Trinius three awn	C
<i>Stipa avenacea</i> L.	Black seed needle grass	C
<i>Muhlenbergia filipes</i> M. A. Curtis	Pink muhly, sweet grass	C
<i>Sporobolus clandestinus</i> (Biehler) Hitchc.	Hidden dropseed	C
<i>S. indicus</i> (L.) R. Br.	Smut grass	C
<i>S. virginicus</i> (L.) Kunth	Dropseed	C
<i>Polypogon maritimus</i> Willd.	Mediterranean polypogon	C
<i>Agrostis scabra</i> Willd.		I
<i>Sphenopholis obtusata</i> (Michx.) Scribn. var. <i>obtusata</i>	Prairie wedgescale	C
<i>Cynodon dactylon</i> (L.) Pers.	Bermuda grass	C
<i>Spartina alterniflora</i> Loisel.	Smooth cordgrass	C
<i>S. bakeri</i> Merr.	Bunch cordgrass	C
<i>S. cynosuroides</i> (L.) Roth	Giant cordgrass	R
<i>S. patens</i> (Ait.) Muhl.	Saltmeadow cordgrass	C
<i>Eustachys petraea</i> (Sw.) Desv.	Finger grass	C
<i>Eleusine indica</i> (L.) Gaertn.	Goosegrass	C
<i>Tridens flavus</i> (L.) Hitchc. var. <i>flavus</i>	Purple top	C
<i>Triplasis purpurea</i> (Walt.) Chapm.	Purple sandgrass	C
<i>Eragrostis elliottii</i> S. Wats.	Love grass	C
<i>E. refracta</i> (Hubl.) Scribn	.Coastal love grass	I
<i>Melica mutica</i> Walt.	Twoflower melic	C
<i>Uniola paniculata</i> L.	Sea oats	C
<i>Chasmanthiu laxum</i> (L.) Yates	Spike grass	C
<i>C. sessiliflorum</i> (Poir.) Yates	Spangle grass	C
<i>Distichlis spicata</i> (L.) Greene	Salt grass	C
<i>Poa annua</i> L.	Annual bluegrass	C
<i>Vulpia octoflora</i> (Walt.) Rydb.	Annual fescue	C
<i>Elymus virginicus</i> L.	Wild rye grass	I
<i>Arundinaria gigantea</i> (Walt.) Muhl. ssp. <i>tecta</i> (Walt.) McClure	Cane	SR
CYPERACEAE		
<i>Cyperus brevifolius</i> (Rottb.) Endl. ex Hassk.	One-headed flatsedge	C

<i>C. filicinus</i> Vahl	Umbrella sedge	C
<i>C. globulosus</i> Aubl.	Flatsedge nutgrass	C
<i>C. haspan</i> L.	Flatsedge	C
<i>C. odoratus</i> L.	Flatsedge	I
<i>C. ovularis</i> (Michx.) Torr.		I
<i>C. polystachyos</i> Rottb. var. <i>texensis</i> (Torr.) Fern.	Sedge	C
<i>C. pseudovegetus</i> Steud.		I
<i>C. retrorsus</i> Chapm. var. <i>retrorsus</i>	Flatsedge	C
<i>C. rotundus</i> L.	Sedge	C
<i>Fuirena breviseta</i> (Cov.) Cov.		C
<i>Scirpus americanus</i> Pers.	Swordgrass	C
<i>S. tabernaemontanii</i> K. C. Gmel.	Soft-stem bulrush	I
<i>Eleocharis albida</i> Torr.	Spikerush	C
<i>E. flavescens</i> (Poir.) Urban var. <i>flavescens</i>	Spikerush	C
<i>E. parvula</i> (R. & S.) Link ex Buff. & Fingerh.	Dwarf spikerush	R
<i>E. tricostata</i> Torr.		I
<i>E. tuberculosa</i> (Michx.) R. & S.	Spikerush	R
<i>Fimbristylis autumnalis</i> (L.) R. & S.		I
<i>F. caroliniana</i> (Lam.) Fern.	Water ash	C
<i>F. castanea</i> (Michx.) Vahl	Fimbristylis	C
<i>Bulbostylis barbata</i> (Rottb.) Clarke	Water grass	I
<i>B. stenophylla</i> (Ell.) Clarke		I
<i>Dichromena colorata</i> (L.) Hitchc.	Star-rush	I
<i>Rhynchospora caduca</i> Ell.		R
<i>R. cephalantha</i> Gray var. <i>cephalantha</i>		R
<i>R. corniculata</i> (Lam.) Gray	Horned beaked rush	C
<i>R. fascicularis</i> (Michx.) Vahl. var. <i>fascicularis</i>		C
<i>R. filifolia</i> Gray		I
<i>R. plumosa</i> Ell.	Plumed beak rush	I
<i>R. rariflora</i> (Michx.) Ell.		I
<i>Scleria ciliata</i> Michx. var. <i>glabra</i> (Chapm.) Fairey	Nut rush	R
<i>S. reticularis</i> Michx. var. <i>reticularis</i>		I
<i>S. triglomerata</i> Michx.	Nut rush	C
<i>Carex cherokeensis</i> Schwein.	Sedge	C
<i>C. glaucescens</i> Ell.		I
<i>C. longii</i> Mack.		I
<i>C. verrucosa</i> Muhl.		R
<i>C. walteriana</i> Bailey	Walter's sedge	I
ARECACEAE		
<i>Sabal minor</i> (Jacq.) Pers.	Dwarf palmetto	SC
<i>S. palmetto</i> (Walt.) Lodd ex Schult. & Schult.	Cabbage Palmetto	TI
<i>Serenoa repens</i> (Bartr.) Small	Saw palmetto	TC
LEMNACEAE		
<i>Spirodela polyrhiza</i> (L.) Schleid.	Big duckweed	R
<i>Lemna aequinoctialis</i> Welwitsch	Duckweed	I
<i>Lemna obscura</i> (Austin) Daubs		I
<i>Lemna valdiviana</i> Phil.	Duckweed	C
<i>Wolffia columbiana</i> Karst	Water-meal	I
<i>Wolffiella gladiata</i> (Hegehm.) Hegehm.	Eastern wolffiella	R
XYRIDACEAE		
<i>Xyris caroliniana</i> Walt.	Yellow-eyed grass	I
ERIOCAULACEAE		
<i>Eriocaulon compressum</i> Lam.	Pipewort	R
<i>E. decangulare</i> L.	Pipewort	R

BROMELIACEAE		
	<i>Tillandsia usneoides</i> (L.) L.	Spanish moss C
COMMELINACEAE		
	<i>Commelina erecta</i> L. var. <i>angustifolia</i> (Michx.) Fern.	Dayflower C
	<i>C. benghalensis</i> L.	R
	<i>Tradescantia ohiensis</i> Raf. var. <i>ohiensis</i>	Spiderwort C
PONTEDERIACEAE		
	<i>Pontederia cordata</i> L.	Pickereelweed C
JUNCACEAE		
	<i>Juncus effusus</i> L. var. <i>solutus</i> Fern. & Wieg.	Soft rush C
	<i>J. marginatus</i> Rostk.	Rush C
	<i>J. megacephalus</i> M. A. Curtis	C
	<i>J. polycephalus</i> Michx.	Flat-leaved rush R
	<i>J. repens</i> Michx.	Creeping rush I
	<i>J. roemerianus</i> Scheele	Black needlerush C
	<i>J. scirpoides</i> Lam.	Needlepod rush I
	<i>J. tenuis</i> Willd	Path rush C
LILIACEAE		
	<i>Nothoscordum bivalve</i> (L.) Britt.	False garlic I
	<i>Yucca</i> — See AGAVACEAE	
	<i>Asparagus officinalis</i> L.	R
	<i>Smilax</i> — See SMILACEAE	
AMARYLLIDACEAE		
	<i>Hypoxis juncea</i> Sm.	Yellow star grass R
AGAVACEAE		
	<i>Yucca aloifolia</i> L.	Spanish bayonet TI
	<i>Y. flaccida</i> Haw.	Bear-grass SI
	<i>Y. gloriosa</i> L.	Mound-lily yucca TI
SMILACACEAE		
	<i>Smilax auriculata</i> Walt.	Dune greenbrier SC
	<i>S. bona-nox</i> L.	Fringed greenbrier SI
	<i>S. glauca</i> Walt.	Sawbrier SC
	<i>S. laurifolia</i> L.	Bamboo-vine SC
	<i>S. pumila</i> Walt.	Sarsaparilla-vine SC
IRIDACEAE		
	<i>Iris virginica</i> L.	Blue flag I
	<i>Sisyrinchium albidum</i> Raf.	Blue-eyed grass I
CANNACEAE		
	<i>Canna flaccida</i> Salisb.	Golden canna lily R
ORCHIDACEAE		
	<i>Platanthera cristata</i> (Michx.) Lindl.	R
	<i>Habenaria quinqueseta</i> (Miebx.) A. A. Eaton	R
	<i>Spiranthes praecox</i> (Walt.) Wats.	Green-leaved ladies' tresses I
	<i>S. tuberosa</i> Raf.	Autumn ladies' tresses I
	<i>S. vernalis</i> Engelm. & Gray	Spring ladies' tresses I
	<i>Zeuxine strateumatica</i> (L.) Schltr.	R
	<i>Corallorhiza wisteriana</i> Conrad	Spring coral root R
	<i>Hexalectris spicata</i> (Walt.) Barnh.	Crested coral root R
	<i>Pteroglossaspis ecristata</i> (Fern.) Rolfe	R
SAURURACEAE		
	<i>Saururus cernuus</i> L.	Lizard's tail C
SALICACEAE		
	<i>Populus alba</i> L.	White or silver poplar TR
	<i>Salix caroliniana</i> Michx.	Swamp willow TC

MYRICACEAE		
	<i>Myrica cerifera</i> L.	Wax myrtle TC
JUGLANDACEAE		
	<i>Carya glabra</i> (Mill.) Sweet	Pignut hickory TI
	<i>C. illinoensis</i> (Wang.) K. Koch	Pecan TR
	<i>C. ovalis</i> (Wang.) Sarg.	Sweet pignut hickory TR
BETULACEAE		
	<i>Betula nigra</i> L.	River birch TR
FAGACEAE		
	<i>Castanea pumila</i> (L.) Mill. var. <i>ashei</i> Sudw.	Chinquapin TR
	<i>Quercus chapmanii</i> Sarg.	Chapman oak TR
	<i>Q. geminata</i> Small	Sand live oak TC
	<i>Q. hemispherica</i> Bartr.	Laurel oak TC
	<i>Q. myrtifolia</i> Willd.	Myrtle oak TR
	<i>Q. nigra</i> L.	Water oak TI
	<i>Q. stellata</i> Wang.	Post oak TR
	<i>Q. virginiana</i> Mill.	Live oak TC
ULMACEAE		
	<i>Celtis laevigata</i> Willd.	Hackberry TI
MORACEAE		
	<i>Morus rubra</i> L. T	Red mulberry TI
	<i>Maclura pomifera</i> (Raf. ex Sarg.) Schneid.	Osage orange TR
	<i>Cudrania tricuspidata</i> (Carr.) Bur. ex Lavallee	TR
URTICACEAE		
	<i>Boehmeria cylindrica</i> (L.) Sw.	False nettle C
	<i>Parietaria floridana</i> Nutt.	Pellitory C
LORANTHACEAE		
	<i>Phoradendron serotinum</i> (Raf.) M.C. Jonst.	Mistletoe SC
POLYGONACEAE		
	<i>Rumex hastatulus</i> Baldw. ex Ell.	Wild sorrel C
	<i>Polygonum glaucum</i> Nutt.	Seaside knotweed R
	<i>P. hydropiperoides</i> Michx. var. <i>hydropiperoides</i>	Water pepper C
	<i>P. punctatum</i> L. var. <i>confertiflorum</i> (Meisn.) Fassett	Water smartweed I
	<i>P. scandens</i> L. var. <i>cristatum</i> (Engelm. & Gray) Gl.	Climbing false buckwheat C
CHENOPODIACEAE		
	<i>Chenopodium album</i> L.	Lamb's quarters C
	<i>C. ambrosioides</i> L.	Wormseed; Mexican tea C
	<i>Atriplex pentandra</i> (Jacq.) Standl.	C
	<i>Salicornia bigelovii</i> Torrey	Glasswort C
	<i>S. europaea</i> L.	Glasswort I
	<i>S. virginica</i> L.	Perennial glasswort C
	<i>Suaeda linearis</i> (Ell.) Moq.	Sea-blite C
	<i>Salsola kali</i> L.	Russian thistle C
AMARANTHACEAE		
	<i>Amaranthus gracilis</i> Desf.	I
	<i>A. spinosus</i> L.	C
	<i>Froelichia floridana</i> (Nutt.) Moq.	Cottonweed R
	<i>Iresine rhizomatosa</i> Standl.	Bloodleaf I
NYCTAGINACEAE		
	<i>Boerhavia erecta</i> L.	Erect spiderling R
BATAACEAE		
	<i>Batis maritima</i> L.	Saltwort SC
PHYTOLACCACEAE		
	<i>Phytolacca rigida</i> Small	Pokeweed C

MOLLUGINACEAE			
	<i>Mollugo verticillata</i> L.	Carpetweed/Indian chickweed	C
AIZOACEAE			
	<i>Sesuvium maritimum</i> (Walt.) B.S.P.	Sea purslane	I
	<i>S. portulacastrum</i> L.	Sea purslane	I
PORTULACACEAE			
	<i>Portulaca oleracea</i> L.	Common purslane	I
	<i>P. pilosa</i> L.	Hairy portulaca	I
CARYOPHYLLACEAE			
	<i>Stellaria media</i> (L.) Vill.	Common chickweed	C
	<i>Cerastium glomeratum</i> Thuill.	Mouse-ear chickweed	C
	<i>Sagina decumbens</i> (Ell.) T. & G. ssp. <i>decumbens</i>	Birdseye	C
	<i>Arenaria lanuginosa</i> (Michx.) Rohrb. Ssp. <i>lanuginosa</i>	Perennial sandwort	I
	<i>A. serphyllifolia</i> L.	Thymeleaf sandwort	C
	<i>Paronychia baldwinii</i> (T. & G.) Chapm. ssp. <i>baldwinii</i>		C
	<i>P. fastigiata</i> (Raf.) Fern.		I
	<i>Silene antirrhina</i> L. Sleepy catchfly		I
NYMPHAEACEAE			
	<i>Nymphaea mexicana</i> Zucc.	Banana waterlily	I
	<i>N. odorata</i> Ait. var. <i>odorata</i>	White waterlily	C
	<i>N. odorata</i> Ait. X <i>N. mexicana</i> Zucc.	Waterlily	R
CERATOPHYLLACEAE			
	<i>Ceratophyllum demersum</i> L.	Coontail	R
MENISPERMACEAE			
	<i>Cocculus carolinus</i> DC.		SC
MAGNOLIACEAE			
	<i>Magnolia grandiflora</i> L.	Southern magnolia/Bullbay	TC
	<i>M. virginiana</i> L.	Sweetbay	TI
ANNONACEAE			
	<i>Asimina parviflora</i> (Michx.) Dunal	Pawpaw	TR
LAURACEAE			
	<i>Cinnamomum camphora</i> (L.) Presl	Camphor tree	TI
	<i>Persea borbonia</i> (L.) Spreng. var. <i>borbonia</i>	Redbay	TC
	<i>P. palustris</i> (Raf.) Sarg.	Swampbay	TC
	<i>Sassafras albidum</i> (Nutt.) Nees	Sassafras	TI
PAPAVERACEAE			
	<i>Argemone albiflora</i> Hornem.	Prickly poppy	I
BRASSICACEAE			
	<i>Lepidium virginicum</i> L.	Peppergrass/pepperwort	C
	<i>Coronopus didymus</i> (L.) Sm.	Wart-cress/carpet-cress	I
	<i>Cakile edentula</i> (Bigel.) Hook. spp. <i>harperi</i> (Small) Rodman	Sea rocket	C
	<i>Cardamine debilis</i> D. Don	Bitter cress	I
	<i>C. pensylvanica</i> Muhl. ex Willd.	Spring cress	I
	<i>Capsella brusa-pastoris</i> (L.) Medic.	Shepherd's purse	I
	<i>Descurainia pinnata</i> (Walt.) Britt. ssp. <i>pinnata</i>	Tansey mustard	C
DROSERACEAE			
	<i>Drosera brevifolia</i> Pursh	Sundew	C
	<i>D. capillaris</i> Poir.	Sundew	R
SAXIFRAGACEAE			
	<i>Itea virginica</i> L.	Virginia willow	SI
HAMMELIDACEAE			
	<i>Liquidambar styraciflua</i> L.	Sweet gum	TI
	<i>Hamamelis virginiana</i> L.	Witch-hazel	TR

ROSACEAE

<i>Aronia arbutifolia</i> (L.) Pers.	Red Chokeberry	SI
<i>Rubus betulifolius</i> Small	Blackberry	SI
<i>Rubus trivialis</i> Michx.	Dewberry	SI
<i>Rosa laevigata</i> Michx.	Cherokee rose	SI
<i>Prunus angustifolia</i> Marsh.	Chicksaw plum	TR
<i>P. serotina</i> Ehrh. var. <i>serotina</i>	Black cherry	TC

FABACEAE

<i>Cassia aspera</i> Muhl. ex Ell.	Partridge-pea	C
<i>C. fasciculata</i> Michx. var. <i>fasciculata</i>	Partridge-pea	C
<i>C. nictitans</i> L.	Partridge-pea	I
<i>C. obtusifolia</i> L.	Coffee-weed/Sickle-pod	I
<i>Crotalaria brevidens</i> Benth.		R
<i>C. rotundifolia</i> (Walt.) Poir. var. <i>vulgaris</i> Windler	Rabbit-bells	I
<i>Medicago arabica</i> (L.) Huds.	Spotted medick	C
<i>M. lupulina</i> L.	Black medick	I
<i>M. polymorpha</i> L.	Bur-clover/Medick	I
<i>Melilotus indica</i> (L.) All.	Sour clover	I
<i>Trifolium carolinianum</i> Michx.	Clover	C
<i>T. repens</i> L.	White clover	I
<i>Indigofera caroliniana</i> Mill.	Carolina indigo	I
<i>Amorpha glabra</i> Desf. ex Poir.	Mountain indigo	SR
<i>Wisteria sinensis</i> (Sims) Sweet	Wisteria	SR
<i>Sesbania macrocarpa</i> Muhl.	Sesbania	I
<i>S. vesicaria</i> (Jacq.) Ell.	Bladder-pod	C
<i>Daubentonia punicea</i> (Cav.) DC.	Rattle-bush	SR
<i>Aeschynomene indica</i> L.	Joint-vetch	I
<i>A. viscidula</i> Michx.	Littleleaf tickclover	R
<i>Desmodium ciliare</i> (Muhl. ex Willd.) DC.	Panicled tickclover	C
<i>D. paniculatum</i> (L.) DC. var. <i>paniculatum</i>	Beggar-ticks	C
<i>Lespedeza hirta</i> (L.) Hornem. ssp. <i>hirta</i>	Lespedeza	C
<i>Kummerowia striata</i> (Thunb.) Schindl.		I
<i>Vicia acutifolia</i> Ell.	Sand vetch	C
<i>Clitoria mariana</i> L.	Butterfly-pea	I
<i>Centrosema virginianum</i> (L.) Benth.	Climbing butterfly-pea	C
<i>Erythrina herbacea</i> L.	Cardinal spear/Coral bean	SR
<i>Apios americana</i> Medic.	American potato bean	R
<i>Galactia elliotii</i> Nutt.	Elliots's milk-pea	C
<i>G. volubilis</i> (L.) Britt.	Milk-pea	C
<i>Rhynchosia difformis</i> (Ell.) DC.	Least rhynchosia	I
<i>R. minima</i> (L.) DC.	Climbing rhynchosia	I
<i>Strophostyles helvola</i> (L.) Ell.	Wild bean	C
<i>S. umbellata</i> (Muhl. ex Willd.) Britt.	Pink wild bean	I

GERANIACEAE

<i>Geranium carolinianum</i> L.	Carolina cranesbill	C
---------------------------------	---------------------	---

OXALIDACEAE

<i>Oxalis corymbosa</i> DC.	Wood-sorrel	I
<i>O. dillenii</i> Jacq. ssp. <i>dillenii</i>		I
<i>O. dillenii</i> Jacq. ssp. <i>filipes</i> (Small) Eiten		C

LINACEAE

<i>Linum medium</i> (Planch.) Britt. var. <i>texanum</i> (Planch.) Fern.	Wild flax	C
--	-----------	---

RUTACEAE

<i>Zanthoxylum clava-herculis</i> L.	Hercules-club	TC
<i>Citrus aurantium</i> L.	Sour orange	TR

MELIACEAE			
	<i>Melia azedarach</i> L.	Chinaberry	TR
POLYGALACEAE			
	<i>Polygala cymosa</i> Walt.	Polygala	R
	<i>P. incarnata</i> L.	Slender polygala	I
	<i>P. lutea</i> L.	Candyweed	R
EUPHORBIACEAE			
	<i>Croton glandulosus</i> L. var. <i>septentrionalis</i> Muell.-Arg.	Croton	C
	<i>C. punctatus</i> Jacq.		C
	<i>Acalypha gracilens</i> Gray ssp. <i>gracilens</i>	Three-seeded mercury	C
	<i>A. ostraefolia</i> Ridd.		I
	<i>Tragia urens</i> L.	Noseburn	I
	<i>Cnidioscolus stimulosus</i> (Michx.) Engels. & Gray	Bull-nettle	C
	<i>Euphorbia cyathophora</i> Murr.		I
	<i>Chamaesyce bombensis</i> (Jacq.) Dug.	Seaside spurge	I
	<i>C. hirta</i> (L.) Millsp.	Hairy spurge	I
	<i>C. nutans</i> (Lag.) Small	Eyebane/Wartweed	C
	<i>C. ophthalmica</i> (Pers.) Burch		I
	<i>C. polygonifolia</i> (L.) Small	Seaside spurge	C
CALLITRICHACEAE			
	<i>Callitriche peploides</i> Nutt.		I
ANACARDIACEAE			
	<i>Rhus copallina</i> L.	Winged sumac	TI
	<i>Toxicodendron radicans</i> (L.) Kuntze var. <i>radicans</i>	Poison ivy	SC
CYRILLACEAE			
	<i>Cyrilla racemiflora</i> L.	Summer titi	TR
AQUIFOLIACEAE			
	<i>Ilex ambigua</i> (Michx.) Torr.	Carolina holly	SR
	<i>I. cassine</i> L.	Dahoon holly	TR
	<i>I. glabra</i> (L.) Gray	Inkberry/Bitter gallberry	SC
	<i>I. opaca</i> Ait.	American holly	TC
	<i>I. vomitoria</i> Ait.	Yaupon	TC
ACERACEAE			
	<i>Acer rubrum</i> L. var. <i>rubrum</i>	Red maple	TI
	<i>A. rubrum</i> L. var. <i>trilobum</i> (T. & G.) K. Koch		TI
HIPPOCASTANACEAE			
	<i>Aesculus pavia</i> L.	Red buckeye	TR
SAPINDACEAE			
	<i>Sapindus marginatus</i> Willd.	Florida soapberry	TR
RHAMNACEAE			
	<i>Berchemia scandens</i> (Hill) K. Koch	Rattan-vine/Supple jack	SI
	<i>Sageretia minutifolia</i> (Michx.) Trel.	Buckthorn	SR
	<i>Rhamnus caroliniana</i> Walt.	Carolina buckthorn	TR
VITACEAE			
	<i>Vitis aestivalis</i> Michx.	Summer grape/Pigeon grape	SI
	<i>V. rotundifolia</i> Michx.	Muscadine/Scuppernong	SC
	<i>V. vulpina</i> L.		SC
	<i>Parthenocissus quinquefolia</i> (L.) Planch.	Virginia-creeper/Woodbine	SC
	<i>Ampelopsis arborea</i> (L.) Koehne	Pepper-vine	SC
MALVACEAE			
	<i>Abutilon theophrasti</i> Medic.	Velvet-leaf/Butter-print	R
	<i>Modiola caroliniana</i> (L.) G. Don	Carolina modiola	I
	<i>Sida rhombifolia</i> L.	Sida	C
	<i>Hibiscus grandiflorus</i> Michx.	Great rose-mallow	R
	<i>H. moscheutos</i> L.	Swamp rose-mallow	I

<i>Kosteletzkya virginica</i> (L.) Presl ex Gray	Seashore mallow	R
STERCULIACEAE		
<i>Melochia corchorifolia</i> L.	Chocolate-weed	I
CLUSIACEAE		
<i>Hypericum cistifolium</i> Lam.		R
<i>H. crux-andreae</i> (L.) Crantz		SR
<i>H. gentianoides</i> (L.) B.S.P.	Pinweed/Orange-grass	C
<i>H. hypericoides</i> (L.) Crantz ssp. <i>hypericoides</i>		SC
<i>H. mutilum</i> L.	Hypericum	C
<i>H. myrtifolium</i> Lam.	Myrtle leaf St. John's wort	SR
<i>H. tetrapetalum</i> Lam.		SR
<i>Triadenum virginicum</i> (L.) Raf.	Marsh St. John's wort	I
CISTACEAE		
<i>Helianthemum corymbosum</i> Michx.	Sunrose	SI
<i>H. georgianum</i> Chapm.	Sunrose	R
<i>Lechea pulchella</i> Raf. var. <i>pulchella</i>	Pinweed	I
<i>L. villosa</i> Ell.	Hairy pinweed	C
VIOLACEAE		
<i>Viola lanceolata</i> L. ssp. <i>vittata</i> (Greene) Russell	Lance-leaved violet	R
<i>V. floridana</i> Brainerd		R
PASSIFLORACEAE		
<i>Passiflora incarnata</i> L.	Passion-flower	R
<i>P. lutea</i> L.	Passion-flower	R
CACTACEAE		
<i>Opuntia ficus-indica</i> (L.) Mill.	Indian-fig/Prickly-pear	SI
<i>O. humifusa</i> (Raf.) Raf. var. <i>humifusa</i>	Eastern prickly-pear	SI
<i>O. pusilla</i> (Haw.) Haw.	Devil-joint	SI
<i>O. stricta</i> (Haw.) Haw. var. <i>stricta</i>	Southern prickly-pear	SI
LYTHRACEAE		
<i>Ammannia latifolia</i> L.		I
<i>Decodon verticillatus</i> (L.) Ell.	Water-willow/Swamp loosestrife	SR
MELASTOMACEAE		
<i>Rhexia cubensis</i> Griseb.	Meadow-beauty	I
<i>R. nashii</i> Small	Meadow-beauty	I
<i>R. virginica</i> L.	Common meadow-beauty	I
ONAGRACEAE		
<i>Ludwigia leptocarpa</i> (Nutt.) Hara		I
<i>L. linearis</i> Walt.	Narrow-leaved ludwigi	C
<i>L. uruguayensis</i> (Comb.) Hara	Seed-box/Primrose-willow	I
<i>L. maritima</i> Harper	Slender seed-box	C
<i>L. palustris</i> (L.) Ell.	Trailing Ludwigia	C
<i>L. repens</i> Forst.	Water purslane/Marsh purslane	I
<i>L. suffruticosa</i> Walt.		C
<i>Oenothera humifusa</i> Nutt.	Dunes evening primrose	C
<i>O. laciniata</i> Hill	Cut-leaved Oenothera	C
<i>O. speciosa</i> Nutt.	Showy evening primrose	C
<i>Gaura angustifolia</i> Michx.	Gaura	C
HALORAGIDACEAE		
<i>Myriophyllum pinnatum</i> (Walt.) B.S.P.	Water milfoil	I
<i>Proserpinaca pectinata</i> Lam.	Mermaid-weed	C
ARALIACEAE		
<i>Aralia spinosa</i> L.	Hercules-club/ Devil's walking stick	TC
APIACEAE		
<i>Hydrocotyle bonariensis</i> Comm. ex Lam.	Seaside pennywort	C

<i>H. umbellata</i> L.	Marsh pennywort	I
<i>H. verticillata</i> Thunb. var. <i>verticillata</i>	Pennywort	I
<i>Centella asiatica</i> (L.) Urban	Chinaman's shield	C
<i>Sanicula canadensis</i> L.	Canada snakeroot	I
<i>Chaerophyllum tainturieri</i> Hook.	Wild chervil	C
<i>Cicuta mexicana</i> Coult. & Rose	Water-hemlock	C
<i>Ptilimnium capillacem</i> (Michx.) Raf. Mock	Bishop's-weed	C
<i>Foeniculum vulgare</i> Mill.	Common fennel	R
<i>Oxypolis filiformis</i> (Walt.) Britt.	Leafless cowbane	R
NYSSACEAE		
<i>Nyssa biflora</i> Walt.	Swamp blackgum	TC
CORNACEAE		
<i>Cornus asperifolia</i> Michx.	Stiff-cornel dogwood	TI
ERICACEAE		
<i>Monotropa uniflora</i> L.	Indian-pipe	R
<i>Kalmia hirsuta</i> Walt.	Hairy wicky	SI
<i>Lyonia fruticosa</i> (Michx.) G. S. Torrey	Stagger-bush	SI
<i>L. ferruginea</i> (Walt.) Nutt	Stagger-bush	SC
<i>L. lucida</i> (Lam.) R. Koch	Fetterbush	SC
<i>Gaylussacia dumosa</i> (Andr.) T. & S.	Dwarf Huckleberry	SI
<i>G. frondosa</i> (L.) T. & G. ex Torr. var. <i>tomentosa</i> Gray	Dangleberry	SI
<i>Vaccinium arboreum</i> Marsh.	Sparkleberry/Tree blueberry	TC
<i>V. corymbosum</i> L.	Highbush blueberry	SC
<i>V. myrsinites</i> Lam.	Evergreen blueberry	SC
<i>V. stamineum</i> L. var. <i>stamineum</i>	Deerberry	SC
PRIMULACEAE		
<i>Samolus valerandi</i> L. ssp. <i>parviflorus</i> (Raf.) Hulten	Water pimpernel	C
<i>Anagallis minima</i> (L.) Krause		I
PLUMBAGINACEAE		
<i>Limonium carolinianum</i> (Walt.) Britt.	Sea-lavender/Marsh rosemary	C
SAPOTACEAE		
<i>Bumelia tenax</i> (L.) Willd.	Southern buckthorn	TC
EBENACEAE		
<i>Diospyros virginiana</i> L.	Persimmon	TC
SYMPLOCACEAE		
<i>Symplocos tinctoria</i> (L.) L'Her.	Sweetleaf/Horsesugar	TI
OLEACEAE		
<i>Fraxinus profunda</i> (Bush) Bush	Pumpkin ash	TR
<i>Osmanthus americanus</i> (L.) Benth. & Hook. f. ex Gray	Devilwood/Wild-olive	TI
<i>Forestiera segregata</i> (Jacq.) Krug & Urban var. <i>segregata</i>	Florida privet	TR
LOGANIACEAE		
<i>Gelsemium sempervirens</i> (L.) St.-Hil.	Yellow jasmine	SI
<i>Cynoctonum mitreola</i> (L.) Britt.	Miterwort	I
<i>Polypremum procumbens</i> L.	Polypremum	C
GENTIANACEAE		
<i>Sabatia stellaris</i> Pursh	Common marsh-pink	C
<i>Bartonia verna</i> (Michx.) Muhl.	Vernal bartonia	R
APOCYNACEAE		
<i>Apocynus cannabinum</i> L.	Indian hemp	I
ASCLEPIADACEAE		
<i>Asclepias lanceolata</i> Walt.	Red milkweed	R
<i>A. pedicellata</i> Walt.	Milkweed	R
<i>Cynanchum angustifolium</i> Pers.	Sand-vine	C

<i>Matelea carolinensis</i> (Jacq.) Woods.	Spiny-pod	R
<i>M. gonocarpos</i> (Walt.) Shinnars	Angle-pod	I
CONVOLVULACEAE		
<i>Cuscuta pentagona</i> Engeln.	Dodder	R
<i>Dichondra carolinensis</i> Michx.	Pony-foot	C
<i>Ipomoea pandurata</i> (L.) Mey.	Wild potato-vine	I
<i>I. pes-caprae</i> (L.) R. Br.	Railroad-vine	C
<i>I. quamoclit</i> L.		I
<i>I. sagittata</i> Poir.	Arrow-leaf morning-glory	C
<i>I. stolonifera</i> (Cyr.) Poir.	Fiddleleaf Morning-glory	C
<i>I. trichocarpa</i> Ell.	Coastal morning-glory	I
POLEMONIACEAE		
<i>Phlox drummondii</i> Hook.	Annual phlox	C
BORAGINACEAE		
<i>Heliotropium curassavicum</i> L.	Marsh heliotrope	C
VERBENACEAE		
<i>Verbena officinalis</i> L.	Vervain	I
<i>V. scabra</i> Vahl	Vervain	C
<i>Lantana camara</i> L. var. <i>camara</i>	Shrub-verbena/Lantana	SR
<i>L. montevidensis</i> (Spreng.) Briq.	Trailing lantana	SR
<i>Phyla nodiflora</i> (L.) Greene	Frog-fruits	C
<i>Callicarpa americana</i> L. var. <i>americana</i>	Beautyberry/French-mulberry	SC
<i>Clerodendron indicum</i> (L.) Kuntze	India tubeflower	R
LAMIACEAE		
<i>Teucrium canadense</i> L. var. <i>hypoleucum</i> Griseb.	Germander/Wood-sage	C
<i>Trichostema dichotomum</i> L.	Blue-curly	C
<i>Scutellaria integrifolia</i> L.	Northern skullcap	I
<i>Lamium amplexicaule</i> L.	Henbit	C
<i>Salvia coccinea</i> Juss. ex J. Murr	Scarlet sage	I
<i>S. lyrata</i> L.	Lyre-leaved sage	C
<i>Monarda punctata</i> L.	Horse mint	I
<i>Mentha X piperita</i> L. nm. <i>piperita</i>		R
<i>Hyptis alata</i> (Raf.) Shinnars	Bitter mint	I
SOLOANACEAE		
<i>Physalis angulata</i> L.	Cutleaf ground-cherry	I
<i>P. pubescens</i> L. var. <i>pubescens</i>	Downy ground-cherry	I
<i>P. viscosa</i> L. ssp. <i>maritima</i> (H. A. Curtis) Waterfall	Sand ground-cherry	C
<i>Solanum carolinense</i> L. var. <i>carolinense</i>	Horse-nettle/Bull-nettle	C
<i>S. americanum</i> Mill.	Black nightshade	I
<i>S. sisymbriifolium</i> Lam.	Spiny nightshade	I
<i>S. pseudogracile</i> Heiser	Black nightshade	C
SCROPHULARIACEAE		
<i>Verbascum thapsus</i> L.	Woolly mullein/Flannel-plant	I
<i>Linaria canadensis</i> (L.) Dum.-Cours.	Toadflax	C
<i>Gratiola pilosa</i> Michx.	Hairy gratiola	I
<i>G. ramosa</i> Walt.		I
<i>Bacopa caroliniana</i> (Walt.) Robins.	Blue water-hyssop	I
<i>B. monnieri</i> (L.) Penn.	Smooth water-hyssop	C
<i>Micranthemum umbrosum</i> (Walt.) Blake	Micranthemum	I
<i>Veronica peregrina</i> L. var. <i>xalapensis</i> (H.B.K.) Penn.	Purslane/Speedwell	I
<i>Agalinis purpurea</i> (L.) Penn.	Gerardia	C
<i>Buchnera americana</i> L.	Blue-hearts	I
BIGNONIACEAE		
<i>Bignonia capreolata</i> L.	Cross-vine	SI
<i>Campsis radicans</i> (L.) Seem. ex Bureau	Trumpet-creeper/Cow-itch	SI

LENTIBULARIACEAE		
<i>Pinguicula pumila</i> Michx.	Dwarf bitterroot	I
<i>Utricularia gibba</i> L.	Bladderwort	I
<i>U. inflata</i> Walt.	Floating bladderwort	R
<i>U. subulata</i> L.	Wiry bladderwort	C
ACANTHACEAE		
<i>Ruellia caroliniensis</i> (J. F. Gmel.) Steud. ssp. <i>caroliniensis</i> var. <i>caroliniensis</i>	Carolina Ruellia	I
PLANTAGINACEAE		
<i>Plantago virginica</i> L.	Hoary plantain	C
RUBIACEAE		
<i>Hedyotis procumbens</i> (Walt. ex J. F. Gmel.) Fosb.	Trailing bluet	C
<i>H. uniflora</i> (L.) Lam.	Oldenlandia	C
<i>Cephalanthus occidentalis</i> L.	Buttonbush	TC
<i>Richardia scabra</i> L.	Mexican clover	I
<i>Diodia teres</i> Walt.	Rough buttonweed	C
<i>D. virginia</i> L.	Buttonweed	C
<i>Galium aparine</i> L.	Bedstraw/Catchweed	I
<i>G. hispidulum</i> Michx.	Purple galium	C
<i>G. pilosum</i> Ait. var. <i>laevicaule</i> Weath. & Blake		I
<i>G. tinctorium</i> L.	Dye bedstraw	I
CAPRIFOLIACEAE		
<i>Sambucus simpsonii</i> Rehd.	Common elderberry	SC
<i>Lonicera japonica</i> Thunb.	Japanese honeysuckle	SI
<i>L. sempervirens</i> L.	Coral honeysuckle	SI
CUCURBITACEAE		
<i>Melothria pendula</i> L. var. <i>pendula</i>	Creeping cucumber	R
CAMPANULACEAE		
<i>Triodanis perfoliata</i> (L.) Nieuw. var. <i>perfoliata</i>	Venus' looking-glass	I
<i>T. perfoliata</i> (L.) Nieuw. var. <i>biflora</i> (R. & P.) Bradley		I
<i>Lobelia glandulosa</i> Walt.	Purple lobelia	I
ASTERACEAE		
<i>Elephantopus nudatus</i> Gray	Elephant's-foot	I
<i>E. tomentosus</i> L.	Elephant's-foot	C
<i>Eupatorium anomalum</i> Nash	Narrow-leaved Eupatorium	I
<i>E. aromaticum</i> L.	Coastal white snakeroot	I
<i>E. capillifolium</i> (Lam.) Small	Dog-fennel	C
<i>E. leptophyllum</i> DC.	Dog-fennel	I
<i>E. recurvans</i> Small		C
<i>E. rotundifolium</i> L. var. <i>rotundifolium</i>	Broad-leaved eupatorium	C
<i>E. serotinum</i> Michx.	Late eupatorium	I
<i>Mikania scandens</i> (L.) Willd.	Climbing hempweed	C
<i>Liatris graminifolia</i> (Walt.) Willd. var. <i>graminifolia</i>	Blazing-star	R
<i>Carphephorus odoratissimus</i> (J. F. Gmel.) Herb.	Deer-tongue/Vanilla-plant	I
<i>C. paniculatus</i> (J. F. G. et.) Herb.		I
<i>Heterotheca subaxillaris</i> (Lam.) Britt. & Busby	Camphorweed	C
<i>Pityopsis graminifolia</i> (Michx.) Nutt. var. <i>microcephala</i> (Small) Semple in ed.	Grass-leaved golden aster	C
<i>Solidago odora</i> Ait. var. <i>chapmannii</i> (T. & G.) Cronq.	Sweet goldenrod	C
<i>S. sempervirens</i> L. var. <i>mexicana</i> (L.) Fern.	Seaside goldenrod	C
<i>Euthamia tenuifolia</i> (Pursh) Nutt.	Flat-topped goldenrod	C
<i>Aster dumosus</i> L.	Many-flowered aster	C
<i>A. reticulatus</i> Pursh		I
<i>A. subulatus</i> Michx. var. <i>subulatus</i>	Annual saltmarsh aster	I
<i>A. tenuifolius</i> L.	Perennial saltmarsh aster	I

<i>Erigeron quercifolius</i> Lam.	Oak-leaf erigeron	C
<i>E. vernus</i> (L.) T. & G.	Robin's plantain	I
<i>Conyza bonariensis</i> (L.) Cronq.	Hairy fleabane	I
<i>C. canadensis</i> (L.) Cronq. var. <i>pusilla</i> (Nutt.) Cronq.	Horseweed	C
<i>Baccharis angustifolia</i> Michx.	False-willow	SC
<i>B. glomeruliflora</i> Pers.	Groundsel tree	SR
<i>B. halimifolia</i> L.	Silverling/Groundsel tree	TC
<i>Pluchea odorata</i> (L.) Cass. var. <i>odorata</i>	Marsh fleabane	I
<i>P. rosea</i> Godfrey	Stinkweed	I
<i>Pterocaulon pycnostachyum</i> (Michx.) Ell.	Blackroot	I
<i>Gnaphalium obtusifolium</i> L. var. <i>obtusifolium</i>	Rabbit-tobacco/Everlasting	I
<i>G. purpureum</i> L. var. <i>purpureum</i>	Purple cudweed	C
<i>Polymnia uvedalia</i> L.	Bearsfoot	I
<i>Iva annua</i> L.	Annual marsh elder	R
<i>I. frutescens</i> L.	Marsh elder	SC
<i>I. imbricata</i> Walt.	Seashore-elder	SC
<i>Ambrosia artemisiifolia</i> L. var. <i>artemisiifolia</i>	Common ragweed	C
<i>Xanthium strumarium</i> L. var. <i>strumarium</i>	Cocklebur	I
<i>Eclipta prostrata</i> (L.) L.	Eclipta	I
<i>Borrchia frutescens</i> (L.) DC.	Sea ox-eye	SC
<i>Helianthus angustifolius</i> L.	Narrow-leaved sunflower	I
<i>Melanthera nivea</i> (L.) Small	Melanthera	I
<i>Verbesina occidentalis</i> (L.) Walt.	Crown-beard/Wingstem	C
<i>V. virginica</i> L. var. <i>virginica</i>	Tickweed	C
<i>Coreopsis lanceolata</i> L.	Coreopsis	R
<i>Bidens bipinnata</i> L.	Spanish-needles	I
<i>B. laevis</i> (L.) B.S.P.	Wild-goldenglow/Bur-marigold	I
<i>Helenium amarum</i> (Raf.) Rock	Bitterweed	C
<i>Gaillardia pulchella</i> Foug.	Gaillardia/Fire-wheel	C
<i>Erechtites hieracifolia</i> (L.) Raf. ex DC.	Fireweed	C
<i>Cirsium horridulum</i> Michx.	Yellow-thistle	C
<i>C. nuttallii</i> DC.	Thistle	I
<i>Krigia virginica</i> (L.) Willd.	Dwarf-dandelion	C
<i>Sonchus asper</i> (L.) Hill	Prickly sow-thistle	I
<i>S. oleraceus</i> L.	Common sow-thistle	I
<i>Lactuca graminifolia</i> Michx.	Wild lettuce	I
<i>Pyrrhopappus georgianus</i> Shinnars	False dandelion	C
<i>Youngia japonica</i> (L.) DC.		R
<i>Hieracium gronovii</i> L.	Leafy hawkweed	I
<i>H. megacephalon</i> Nash	Hawkweed	R

¹ From Duncan, 1982; Duncan and Duncan, 1987, 1988.

² Unless identified as tree (T) or shrub (S), listed species are herbaceous. Abundance is indicated as common (C), infrequent (I) or rare (R).

Appendix 2. Selected List of Invertebrates (Excluding Insects and Arachnids) in Tidal Salt Marshes of the Southeastern Atlantic Coast¹

Phylum Cnidaria

Class Anthozoa

Order Actiniaria

Family Edwardsiidae

Nematosella vectensis

Heteromastus filiformis

Phylum Rhynchocoela

Class Anopla

Order Paleonemertea

Family Carinomidae

Carinoma tremaphoras

Order Heteronemertea

Family Lineidae

Lineus socialis

Class Enopla

Order Hoplonemertea

Family Amphiporidae

Amphiporus ochraceus

Phylum Annelida

Class Oligochaeta

Order Tubificida

Family Enchytraeidae

Enchytraeus spp.

Family Naididae

Paranais frici

Family Tubificidae

Monopylephorus evertus

Tubificoides brownae

Class Polychaeta

Subclass Errantia

Order Eunicida

Family Arabellidae

Drilonereis magna

Family Lumbrineridae

Lumbrineris tenuis

Family Onuphidae

Diopatra cuprea

Order Phyllodocida

Family Glyceridae

Glycera americana

Family Nereidae

Laenonereis culveri

Namalycastis abiuma

Neanthes succinea

Family Phyllodocidae

Subclass Sedentaria

Order Capitellida

Family Capitellidae

Capitella capitata

Family Maldanidae

Branchioasychis americana

Order Orbiniida

Family Orbiniidae

Haploscoloplos robustus

Scoloplos fragilis

Order Sabellida

Family Sabellidae

Manayunkia aestuarina

Order Spionida

Family Spionidae

Streblospio benedicti

Order Terebellida

Family Ampharetidae

Hobsonia florida

Family Pectinariidae

Cistenides gouldii

Family Terebellidae

Amphitrite ornata

Phylum Mollusca

Class Gastropoda

Subclass Prosobranchia

Order Archaeogastropoda

Family Neritidae

Neritina usnea

Order Mesogastropoda

Family Assimineidae

Assiminea succinea

Family Hydrobiidae

Hydrobia spp.

Littoridinops tenuipes

Onobops jacksoni

Family Littorinidae

Littorina irrorata

Family Potamididae

Cerithidea costata

C. scalariformis

Order Neogastropoda

Family Nassariidae

Ilyanassa obsoleta

Subclass Pulmonata

Order Basommatophora

Family Ellobiidae

Decracia floridana

Melampus bidentatus

Class Bivalvia

Subclass Pteriomorphia

Order Mytiloida

Family Mytilidae

Amygdalum papyrium

Geukensia demissa

Iscahdium recurvum

Family Ostreidae

Crassostrea virginica

Subclass Heterodonta

Order Veneroida

Family Corbiculidae

Polymesoda caroliniana

Family Cyrenoididae

Cyrenoida floridana

Family Mactridae

Mulinia lateralis

Family Solecurtidae

Tagelus plebeius

Family Venendae

Gemma gemma

Phylum Arthropoda

Subphylum Crustacea

Class Cirripedia

Order Thoracica

Family Chthamalidae

Chthamalus fragilis

Class Malacostraca

Order Decapoda

Suborder Pleocyemata

Infraorder Caridea

Family Alpheidae

Alpheus heterochaelis

Family Palaemonidae

Palaemonetes pugio

P. vulgaris

Infraorder Brachyura

Family Grapsidae

Sesarma cinerium

S. reticulatum

Family Ocypodidae

Uca minax

U. pugilator

U. pugnax

Family Pinnotheridae

Pinnixia chaetoptera

Family Portunidae

Callinectes sapidus

Family Xanthidae

Eurypanopeus depressus
Eurytium limosum
Panopeus obesus
Rithropanopeus harrisi
Superorder Peracarida
Order Tanaidacea
 Family Paratanaidae
 Hargeria rapax
Order Isopoda
 Family Anthuridae
 Cyathura polita
 Family Bopyridae
 Probopyrus pandalicolaon
 P. pugio
 Family Idoteidae
 Edotea montosa
 Family Munnidae
 Munna reynoldsi
 Family Sphaeromidae
 Cassinidea ovalis
Order Mysidacea
 Neomysis americana
Order Amphipoda
 Family Aoridae
 Grandidierella bonnieroides
 Family Gammaridae
 Cammarus mucronatus
 C. palustris
 Family Hyalidae
 Parhyale hawaiiensis
 Family Melitidae
 Melita nitida
 Family Talitridae
 Orchestia grillus
 O. platensis
 O. uhleri

¹ From Wiegert and Freeman, 1990.

**Appendix 3. Selected List of Insect and Arachnid Families in
Tidal Salt Marshes of the Southeastern Atlantic Coast ¹**

Class Arachnida

Order Pseudoscorpionida

Family Cheliferae

Order Araneae

Family Dictynidae

Family Gnaphosidae

Family Clubionidae

Family Thomisidae

Family Salticidae

Family Pisauridae

Family Lycosidae

Family Theridiidae

Family Araneidae

Family Tetragnathidae

Family Micryphantidae

Order Acarina

Family Trombidiidae

Class Insecta

Subclass Apterygota

Order Collembola

Family Isotomidae

Family Entomobryidae

Family Sminthuridae

Family Exopterygota

Subclass Terygota

Order Odonata

Family Aeschnidae

Family Libellulidae

Family Agrionidae

Order Dermaptera

Family Forficulidae

Order Orthoptera

Family Mantidae

Family Gryllidae

Family Tetrigidae

Family Acrididae

Family Tettigoniidae

Order Hemiptera

Family Scutellaridae

Family Corimelaenidae

Family Pentatomidae

Family Coreidae

Family Neididae

Family Lygaeidae

Family Reduviidae

- Family Nabidae
- Family Miridae
- Family Hydrometridae
- Family Mesoveliidae
- Family Gerridae
- Family Saldidae
- Family Belostomatidae
- Family Corixidae
- Order Homoptera
 - Family Cicadidae
 - Family Membracidae
 - Family Cercopidae
 - Family Cicadellidae
 - Family Cixiidae
 - Family Derbidae
 - Family Acanaloniidae
 - Family Dictyopharidae
 - Family Issidae
 - Family Delphacidae
 - Family Aphidae
 - Family Pysyllidae
 - Family Pseudococcidae
 - Family Diaspididae
- Order Thysanoptera
 - Family Thripidae
 - Family Phloeothripidae
- Endopterygota**
 - Order Neuroptera
 - Family Mantispidae
 - Family Myrmeleonidae
 - Order Coleoptera
 - Family Cicindellidae
 - Family Dytiscidae
 - Family Gyrinidae
 - Family Hydrophyllidae
 - Family Staphylinidae
 - Family Scarabaeidae
 - Family Eucinetidae
 - Family Buprestidae
 - Family Elateridae
 - Family Cantharidae
 - Family Lampyridae
 - Family Cleridae
 - Family Melyridae
 - Family Mordellidae
 - Family Oedemeridae
 - Family Languriidae
 - Family Coccinellidae
 - Family Orthoperidae
 - Family Chrysomelidae

Family Phalacridae
Family Anthribidae
Family Curculionidae
Order Lepidoptera
Family Pyralidae
Family Noctuidae
Family Lycaenidae
Family Hesperidae
Order Diptera
Family Tipulidae
Family Culicidae
Family Ceratopogonidae
Family Chironomidae
Family Sciaridae
Family Tabanidae
Family Asilidae
Family Empididae
Family Dolichopodidae
Family Phoridae
Family Pipunculidae
Family Conopidae
Family Otitidae
Family Platystomatidae
Family Tephritidae
Family Sciomyzidae
Family Ephydriidae
Family Chamaemyiidae
Family Chloropidae
Family Anthomyiidae
Family Muscidae
Family Callophoridae
Family Sarcophagidae
Order Hymenoptera
Family Braconidae
Family Ichneumonidae
Family Eulophidae
Family Encyrtidae
Family Eupelmidae
Family Pteromalidae
Family Eurytomidae
Family Chalcididae
Family Elasmidae
Family Cynipidae
Family Scelionidae
Family Formicidae
Family Chrysididae
Family Tiphidae
Family Multillidae
Family Vespidae
Family Pompilidae

Family Sphecidae
Family Halictidae
Family Apidae

¹ From Wiegert and Freeman, 1990.

Appendix 4. Selected List of Fish Found in Estuarine Waters Near Sapelo Island ¹

Subphylum Vertebrata

Superclass Pisces

Class Elasmobranchiomorpha

Order Lamniformes

Family Carcharhinidae

Carcharhinus acronotus (Poey)—Blacknose shark

Carcharhinus isodon (Valenciennes)—Finetooth shark

Carcharhinus limbatus (Valenciennes)—Blacktip shark

Carcharhinus plumbeus (Nardo)—Sandbar shark

Galeocerdo cuvier (Peron and Lesueur)—Tiger shark

Negaprion brevirostris (Poey)—Lemon shark

Family Sphyrnidae

Sphyrna lewini (Griffith and Smith)—Scalloped hammerhead shark

Order Rajiformes

Family Rajidae

Raja eglanteria Bosc—Clearnose skate

Family Dasyatidae

Dasyatis americana (Hildebrand and Schroeder)--southern stingray

Dasyatis sabina (Lesueur)—Atlantic stingray

Gymnura micrura (Schneider)—Smooth butterfly ray

Class Osteichthyes

Order Acipenseriformes

Family Acipenseridae

Acipenser oxyrhynchus Mitchill—Atlantic sturgeon

Order Lepisosteiformes

Family Lepisosteidae

Lepisosteus osseus (Linnaeus)—Longnose gar

Order Elopiformes

Family Elopidae

Elops saurus Linnaeus--ladyfish

Megalops atlanticus Valenciennes—Tarpon

Order Anguilliformes

Family Anguillidae

Anguilla rostrata (Lesueur)—American eel

Family Ophichthidae

Myrophis punctatus Lütken--speckled worm eel

Order Clupeiformes

Family Clupeidae

Brevoortia smithi Hildebrand--yellowfin menhaden

Brevoortia tyrannus (Latrobe)—Atlantic menhaden

Dorosoma cepedianum (Lesueur)—gizzard shad

Dorosoma petenense (Günther)—threadfin shad

Harengula jaguana Poey--scaled sardine

Opisthonema oglinum (Lesueur)—Atlantic thread herring

Family Engraulidae

- Anchoa hepsetus* (Linnaeus)—striped anchovy
- Anchoa mitchilli* (Valenciennes)—bay anchovy
- Order Siluriformes
 - Family Ariidae
 - Bagre marinus* (Mitchill)—Gafftopsail catfish
 - Arius felis* (Linnaeus)—hardhead catfish
- Order Gadiformes
 - Family Gadidae
 - Urophycis floridana* (Bean and Dresel)—Southern hake
 - Urophycis regia* (Walbaum)—Spotted hake
 - Family Ophidiidae
 - Ophidion marginatum* (DeKay)—striped cusk-eel
- Order Batrachoidiformes
 - Family Batrachoididae
 - Opsanus tau* (Linnaeus)—oyster toadfish
- Order Atheriniformes
 - Family Belontiidae
 - Strongylura marina* (Walbaum)—Atlantic needlefish
 - Family Cyprinodontidae
 - Cyprinodon variegatus* Lacepède--sheepshead minnow
 - Fundulus confluentus* Goode and Bean--marsh killifish
 - Fundulus diaphanus* (Lesueur)--banded killifish
 - Fundulus heteroclitus* (Linnaeus)—mummichog
 - Fundulus luciae* (Baird)—spotfin killifish
 - Fundulus majalis* (Walbaum)--striped killifish
 - Lucania parva* (Baird and Girard)—rainwater killifish
 - Family Poeciliidae
 - Gambusia affinis* (Baird and Girard)—western mosquitofish
 - Heterandria formosa* Agassiz—Least killifish
 - Poecilia latipinna* (Lesueur)—sailfin molly
 - Family Atherinidae
 - Membras martinica* (Valenciennes)—rough silverside
 - Menidia beryllina* (Cope)—inland silverside
 - Menidia menidia* (Linnaeus)—Atlantic silverside
- Order Gasterosteiformes
 - Family Syngnathidae
 - Syngnathus fuscus* Storer—Northern pipefish
 - Syngnathus louisianae* Günther--chain pipefish
- Order Scorpaeniformes
 - Family Scorpaenidae
 - Scorpaena plumieri* Bloch--spotted scorpionfish
 - Family Triglidae
 - Prionotus evolans* (Linnaeus)—striped searobin
 - Prionotus tribulus* Cuvier--bighead searobin
- Order Perciformes
 - Family Centropomidae
 - Centropomus undecimalis* (Bloch)—common snook
 - Family Serranidae
 - Centropristis philadelphica* (Linnaeus)—Rock sea bass

Centropristis striata (Linnaeus)—black sea bass
Diplectrum formosum (Linnaeus)—Sand perch
Mycteroperca microlepis (Goode and Bean)—gag
 Family Pomatomidae
Pomatomus saltatrix (Linnaeus)—bluefish
 Family Carangidae
Caranx crusos (Mitchill)—Blue runner
Caranx hippos (Linnaeus)—Crevalle jack
Caranx latus Agassiz--horse-eye jack
Chloroscombrus chrysurus (Linnaeus)—Atlantic bumper
Oligoplites saurus (Schneider)—leatherjacket
Selene vomer (Linnaeus)—lookdown
Trachinotus carolinus (Linnaeus)—Florida pompano
Trachinotus falcatus (Linnaeus)—permit
Trachinotus goodei Jordan and Evermann—Palometa
 Family Lutjanidae
Lutjanus griseus (Linnaeus)—gray snapper
Lutjanus synagris (Linnaeus)—lane snapper
 Family Gerreidae
Diapterus auratus Ranzani--Irish pompano
Diapterus plumieri (Cuvier)—striped mojarra
Eucinostomus argenteus Baird and Girard--spotfin mojarra
 Family Haemulidae
Orthopristis chrysoptera (Linnaeus)--pigfish
 Family Sparidae
Archosargus probatocephalus (Walbaum)--sheepshead
Lagodon rhomboides (Linnaeus)—pinfish
Stenotomus chrysops (Linnaeus)—scup
 Family Sciaenidae
Bairdiella chrysoura (Lacepède)—silver perch
Cynoscion nebulosus (Cuvier)—spotted seatrout
Cynoscion nothus (Holbrook)—silver seatrout
Cynoscion regalis (Bloch and Schneider)—weakfish
Larimus fasciatus Holdbrook--banded drum
Leiostomus xanthurus Lacepède--spot
Menticirrhus littoralis (Holbrook)—gulf kingfish
Menticirrhus saxatilis (Bloch and Schneider)--northern kingfish
Micropogonias undulatus (Linnaeus)--Atlantic croaker
Pogonias cromis (Linnaeus)—black drum
Sciaenops ocellatus (Linnaeus)—red drum
Stellifer lanceolatus (Holbrook)—star drum
 Family Mugilidae
Mugil cephalus Linnaeus--striped mullet
Mugil curema Valenciennes--white mullet
 Family Ehippidae
Chaetodipterus faber (Broussonet)—Atlantic spadefish
 Family Uranoscopidae
Astroscopus y-graecum (Cuvier)—southern stargazer
 Family Blenniidae

- Chasmodes bosquianus* (Lacepède)—striped blenny
- Hypsoblennius hertz* (Lesueur)—feather blenny
- Hypsoblennius ionthas* (Jordan and Gilbert)—freckled blenny
- Family Eleotridae
 - Dormitator maculatus* (Bloch)—fat sleeper
- Family Gobiidae
 - Gobionellus boleosoma* (Jordan and Gilbert)—darter goby
 - Gobionellus oceanicus* (Girard)—highfin goby
 - Gobiosoma bosc* (Lecepède)—naked goby
 - Gobiosoma ginsburgi* Hildebrand and Schroeder--seaboard goby
- Family Stromateidae
 - Peprilus alepidotus* (Linnaeus)—harvestfish
 - Peprilus triacanthus* (Peck)—butterfish
- Order Pleuronectiformes
 - Family Bothidae
 - Ancylosetta quadrocellata* Gill--ocellated flounder
 - Citharichthys spilopterus* Gunther--bay whiff
 - Etropus crossotus* Jordan and Gilbert--fringed flounder
 - Etropus rimosus* Goode and Bean--gray flounder
 - Paralichthys albigutta* Jordan and Gilbert--Gulf flounder
 - Paralichthys dentatus* (Linnaeus)—summer flounder
 - Paralichthys lethostigma* Jordan and Gilbert--southern flounder
 - Scophthalmus aquosus* (Mitchill)—windowpane
 - Family Soleidae
 - Symphurus plagiusa* (Linnaeus)—blackcheek tonguefish
 - Trinectes maculatus* (Bloch and Schneider)—hogchoker
- Order Tetraodontiformes
 - Family Balistidae
 - Aluterus schoepfi* (Walbaum)—orange filefish
 - Monacanthus hispidus* (Linnaeus)—planehead filefish
 - Family Tetraodontidae
 - Chilomycterus schoepfi* (Walbaum)—striped burrfish

¹ From Dahlberg, 1975.

Appendix 5. Reptiles and Amphibians Known or Likely to Occur on Sapelo Island ¹

Order Caudata: Salamanders

Family Ambystomatidae: Mole Salamanders

- Ambystoma cingulatum*—Flatwoods salamander
- Ambystoma opacum*—Marbled salamander
- Ambystoma talpoideum*—Mole salamander
- Ambystoma tigrinum tigrinum*—Eastern tiger salamander

Family Amphiumidae: Amphiumas

- Amphiuma means*—Two-toed amphiuma

Family Plethodontidae: Woodland Salamanders

- Desmognathus auriculatus*—Southern dusky salamander
- Eurycea quadridigitata*—Dwarf salamander
- Plethodon glutinosus glutinosus*—Slimy salamander
- Pseudotriton montanus* ssp.—Mud salamander
- Pseudotriton ruber vioscai*—Southern red salamander
- Stereochilus marginatus*—Many-lined salamander

Family Proteidae: Mud Puppies and Waterdogs

- Necturus punctatus*—Dwarf waterdog

Family Salamandridae: Newts

- Notophthalmus viridescens*—Newt

Family Sirenidae: Sirens

- Pseudobranchius striatus striatus*—Broad-striped dwarf siren
- Siren intermedia intermedia*—Eastern lesser siren
- Siren lacertina*—Greater siren

Order Anura: Frogs and Toads

Family Pelobatidae: Spadefoot Toads

- Scaphiopus holbrooki*—Eastern spadefoot toad

Family Ranidae: True Frogs

- Rana areolata* ssp.—Crawfish frog
- Rana catesbeiana*—Bullfrog
- Rana clamitans clamitans*—Bronze frog
- Rana grylio*—Pig frog
- Rana heckscheri*—River frog
- Rana sphenoccephala*—Southern leopard frog
- Rana virgatipes*—Carpenter frog

Family Microhylidae: Narrowmouth Toads

- Gastrophryne carolinensis*—Eastern narrowmouth toad

Family Bufonidae: Toads

- Bufo quercicus*—Oak toad
- Bufo terrestris*—Southern toad

Family Hylidae: Tree, Cricket and Chorus Frogs

- Acris gryllus gryllus*—Southern cricket frog
- Hyla cinerea*—Green treefrog
- Hyla crucifer*—Spring peeper
- Hyla femoralis*—Pine woods treefrog
- Hyla gratiosa*—Barking treefrog

Hyla squirella—Squirrel treefrog
Hyla versicolor—Gray treefrog
Limnaeodius ocellaris—Little grass frog
Pseudacris nigrita—Southern chorus frog
Pseudacris ornata—Ornate chorus frog

Order Testudinata: Turtles

Family Chelydridae: Snapping Turtles

Chelydra serpentina serpentina—Common snapping turtle

Family Kinosternidae: Mud Turtles

Kinosternon bauri palmarum—Striped mud turtle
Kinosternon subrubrum subrubrum—Eastern mud turtle
Sternotherus odoratus—Stinkpot

Family Emydidae: Box and Water Turtles

Chrysemys concinna concinna—Eastern river cooter
Chrysemys floridana floridana—Florida cooter
Chrysemys scripta scripta—Yellowbelly slider
Clemmys guttata—Spotted turtle
Deirochelys reticularia reticularia—Eastern chicken turtle
Malaclemys terrapin centrata—Carolina diamondback terrapin
Terrapene carolina carolina—Eastern box turtle

Family Trionychidae: Soft-shelled Turtles

Trionyx ferox—Florida softshell
Trionyx spiniferus asperus—Gulf Coast spiny softshell

Family Chelonidae: Sea Turtles

Caretta caretta caretta—Atlantic loggerhead

Order Crocodylia: Crocodylians

Family Alligatoridae: Alligators

Alligator mississippiensis—American alligator

Order Squamata

Suborder Lacertilia: Lizards

Family Iguanidae: Iguanid Lizards

Anolis carolinensis—Green anole
Sceloporus undulatus undulatus—Southern fence lizard

Family Scinidae: Skinks

Eumeces egregius similis—Northern mole skink
Eumeces fasciatus—Five-lined skink
Eumeces inexpectatus—Southeastern five-lined skink
Eumeces laticeps—Broad-headed skink
Scincella lateralis—Ground skink

Family Teiidae: Whiptails

Cnemidophorus sexlineatus sexlineatus—Six-lined racerunner

Family Anguillidae: Lateral-fold Lizards

Ophisaurus attenuatus longicaudus—Eastern slender glass lizard
Ophisaurus compressus—Island glass lizard
Ophisaurus ventralis—Eastern glass lizard

Suborder Serpentes: Snakes

Family Colubridae

Carphophis amoenus amoenus—Eastern worm snake

Cemophora coccinea copei—Northern scarlet snake
Diadophis punctatus punctatus—Southern ringneck snake
Drymarchon corais couperi—Eastern indigo snake
Elaphe guttata guttata—Corn snake
Elaphe obsoleta quadrivittata—Greenish rat snake
Farancia abacura abacura—Eastern mud snake
Farancia erytrogramma ssp.—Rainbow snake
Heterodon platyrhinos—Eastern hognose snake
Heterodon simus—Southern hognose snake
Lampropeltis calligaster rhombomaculata—Mole kingsnake
Lampropeltis getulus getulus—Eastern kingsnake
Lampropeltis triangulum elapsoides—Scarlet kingsnake
Masticophis flagellum flagellum—Eastern coachwhip
Nerodia cyclopion floridana—Florida green water snake
Nerodia erythrogaster erythrogaster—Redbelly water snake
Nerodia fasciata fasciata—Banded water snake
Nerodia taxispilota—Brown water snake
Opheodrya aestivus—Rough green snake
Pituophis melanoleucus ssp.—Pine snake
Regina rigida rigida—Glossy crayfish snake
Rhadinaea flavilata—Pine woods snake
Seminatrix pygaea—Black swamp snake
Storeria dekayi—Brown snake
Storeria occipitomaculata—Redbelly snake
Thamnophis sirtalis sirtalis—Eastern garter snake
Thamnophis sauritus sauritus—Eastern ribbon snake
Virginia striatula—Rough earth snake
Virginia valeriae valeriae—Eastern earth snake
Coluber constrictor priapus—Southern black racer
Tantilla coronata—Southeastern crowned snake

Family Viperidae: Vipers

Agkistrodon contortrix contortrix—Southern copperhead
Agkistrodon piscivorus ssp.—Cottonmouth
Crotalus adamanteus—Eastern diamondback rattlesnake
Crotalus horridus atricaudatus—Canebrake rattlesnake
Sistrurus miliarius—Pygmy rattlesnake

Family Elapidae: Coral Snakes, Cobras

Micrurus fulvius fulvius—Eastern coral snake

¹ Johnson *et al.*, 1974; Sandifer *et al.*, 1980; Wiegert and Freeman, 1990.

Appendix 6. Birds of Sapelo Island ¹

Class Aves

Order Graviformes

Family Gaviidae

Gavia immer—Common loon

Gavia stellata—Red-throated loon

Order Podicipediformes

Family Podicipedidae

Podiceps auritus—Horned grebe

Podiceps nigricollis—Eared grebe

Podilymbus podiceps—Pied-billed grebe

Order Procellariiformes

Family Hydrobatidae

Oceanites oceanicus—Wilson's storm petrel

Puffinus gravis—Greater shearwater

Puffinus griseus—Sooty shearwater

Puffinus lherminieri—Audubon's shearwater

Order Pelecaniformes

Family Sulidae

Morus bassanus—Gannet

Family Pelecanidae

Pelecanus occidentalis—Brown pelican

Family Phalacrocoracidae

Phalacrocorax auritus—Double-crested cormorant

Family Anhingidae

Anhinga anhinga—Anhinga

Order Ciconiiformes

Family Ardeidae

Botaurus lentiginosus—American bittern

Ixobrychus exilis—Least bittern

Ardea herodias—great blue heron, great white heron

Casmerodius albus—great egret

Egretta thula—snowy egret

Egretta caerulea—little blue heron

Egretta tricolor—Louisiana heron

Bubulcus ibis—Cattle egret

Butorides striatus—green-backed heron

Nycticorax nycticorax—black-crowned night-heron

N. violacea—yellow-crowned night-heron

Family Threskiornithidae

Eudocimus albus—white ibis

Plegadis falcinellus—glossy ibis

Family Ciconiidae

Mycteria americana—wood stork

Order Anseriformes

Family Anatidae

- Aix sponsa*—Wood duck
- Anas acuta*—Pintail
- Anas americana*—American wigeon/Baldpate
- Anas clypeata*—Shoveler/Northern shoveler
- Anas crecca*—green-winged teal
- Anas discors*—Blue-winged teal
- Anas platyrhynchos*—Mallard
- Anas rubripes*--American black duck
- Anas strepera*—Gadwall
- Aythya affinis*—Lesser scaup
- Aythya americana*—Redhead
- Aythya collaris*—Ring-necked duck
- Aythya marila*—Greater scaup
- Aythya valisineria*—Canvasback
- Branta canadensis*—Canada goose
- Bucephala albeola*—Bufflehead
- Bucephala clangula*—Common goldeneye
- Lophodytes cucullatus*—Hooded merganser
- Melanitta fusca*—White-winged scoter
- Melanitta nigra*—Black scoter
- Melanitta perspicillata*—Surf scoter
- Mergus serrator*—Red-breasted merganser
- Oxyura jamaicensis*—Ruddy duck

Order Falconiformes

Family Cathartidae

- Coragyps atratus*—black vulture
- Cathartes aura*--turkey vulture

Family Accipitridae

- Accipiter cooperii*—Cooper's hawk
- Accipiter striatus*—Sharp-shinned hawk
- Buteo jamaicensis*—Red-tailed hawk
- Buteo lineatus*—Red-shouldered hawk
- Circus cyaneus*—northern harrier
- Pandion haliaetus*—Osprey
- Haliaeetus leucocephalus*--bald eagle

Family Falconidae

- Falco sparverius*—American kestrel
- Falco columbarius*—Merlin
- Falco peregrinus*--peregrine falcon

Order Galliformes

Family Cracidae

- Ortalis vetula*—Chachalaca

Family Meliagridae

- Meliagris gallopavo*—Wild Turkey

Order Gruiformes

Family Rallidae

- Coturnicops noveboracensis*—Yellow rail
- Fulica americana*—American coot
- Gallinula chloropus*—Common gallinule
- Laterallus jamaicensis*—Black rail
- Porphyryla martinica*—Purple gallinule
- Porzana carolina*--sora
- Rallus elegans*—King rail
- Rallus limicola*—Virginia rail
- Rallus longirostris*--clapper rail

Order Charadriiformes

Family Charadriidae

- Charadrius alexandrinus*—Snowy plover
- Charadrius melodus*—Piping plover
- Charadrius semipalmatus*—Semipalmated plover
- Charadrius vociferus*--killdeer
- Charadrius wilsonia*--Wilson's plover

Family Haematopodidae

- Haematopus palliatus*--American oystercatcher

Family Recurvirostridae

- Himantopus mexicanus*—black-necked stilt
- Recurvirostra americana*--American avocet

Family Scolopacidae

- Actitis macularia*—spotted sandpiper
- Arenaria interpres*—ruddy turnstone
- Calidris alba*—Sanderling
- Calidris alpina*—dunlin
- Calidris bairdii*—Baird's sandpiper
- Calidris canutus*—Red knot
- Calidris fuscicollis*—White-rumped sandpiper
- Calidris maritima*—Purple sandpiper
- Calidris mauri*—Western sandpiper
- Calidris melanotos*—Pectoral sandpiper
- Calidris minutilla*—least sandpiper
- Calidris pusilla*—semipalmated sandpiper
- Capella gallinago*—Common snipe
- Catoptrophorus semipalmatus*—willet
- Limnodromus griseus*—short-billed dowitcher
- Limnodromus scolopaceus*—Long-billed dowitcher
- Limosa fedoa*—Marbled godwit
- Numenius americanus*—Long-billed curlew
- Numenius phaeopus*—Whimbrel
- Philobela minor*—American woodcock
- Pluvialis squatarola*—Black-bellied plover
- Tringa melanoleuca*—greater yellow legs
- Tringa flavipes*—lesser yellowlegs
- Tringa solitaria*—Solitary sandpiper

Family Stercorariidae

- Stercorarius parasiticus*—Parasitic jaeger
- Stercorarius pomarinus*—Pomarine jaeger
- Family Laridae
 - Chlidonias nigra*--black tern
 - Gelochelidon nilotica*—gull-billed tern
 - Larus argentatus*—Herring gull
 - Larus atricilla*—Laughing gull
 - Larus delawarensis*—Ring-billed gull
 - Larus marinus*—Great black-backed gull
 - Larus philadelphia*—Bonaparte's gull
 - Sterna antillarum*—least tern
 - Sterna caspia* Pallas--Caspian tern
 - Sterna forsteri*—Forster's tern
 - Sterna hirundo*—Common tern
 - Sterna maxima maxima* Boddaert--royal tern
 - Sterna sandvicensis*—Sandwich tern
- Family Rhynchopidae
 - Rynchops niger*--black skimmer
- Order Columbiformes
 - Family Columbidae
 - Columba livia*—Rock dove
 - Columbina passerina*—Ground dove
 - Zenaida macroura*—Mourning dove
- Order Cuculiformes
 - Family Cuculidae
 - Coccyzus americanus*—Yellow-billed cuckoo
 - Coccyzus erythrophthalmus*—Black-billed cuckoo
- Order Strigiformes
 - Family Strigidae
 - Bubo virginianus*—Great horned owl
 - Otus asio*—Screech owl
 - Strix varia*—Barred owl
 - Tyto alba*—Barn owl
- Order Caprimulgiformes
 - Family Caprimulgidae
 - Caprimulgus carolinensis*—Chuck-will's-widow
 - Chordeiles minor minor*—Nighthawk
- Order Micropodiformes
 - Family Micropodidae
 - Chaetura pelagica*—Chimney swift
 - Family Trochilidae
 - Archilochus colubris*—Ruby-throated hummingbird
- Order Coraciiformes
 - Family Alcedinidae
 - Megaceryle alcyon*—belted kingfisher

Order Piciformes

Family Picidae

- Centurus carolinus*—Red-bellied woodpecker
- Colaptes auratus*—Common flicker
- Dryocopus pileatus*—Pileated woodpecker
- Melanerpes erythrocephalus*—Red-headed woodpecker
- Picoides pubescens*—Downy woodpecker
- Picoides villosus*—Hairy woodpecker
- Sphyrapicus varius*—Yellow-bellied sapsucker

Order Passeriformes

Family Tyrannidae

- Contopus virens*—Eastern wood pewee
- Empidonax virescens*—Acadian flycatcher
- Myiarchus crinitus*—Great crested flycatcher
- Sayornis phoebe*—Eastern phoebe
- Tyrannus tyrannus*—Eastern kingbird

Family Hirundinidae

- Hirundo rustica*—Barn swallow
- Iridoprocne bicolor*—Tree swallow
- Petrochelidon pyrrhonota*—Cliff swallow
- Progne subis*—Purple martin
- Stelgidopteryx ruficollis*—Rough-winged swallow

Family Corvidae

- Corvus ossifragus*—fish crow
- Corvus brachyrhynchos*—Common crow
- Cyanocitta cristata*—Blue jay

Family Paridae

- Parus bicolor*—Tufted titmouse
- Parus carolinensis*—Carolina chickadee

Family Sittidae

- Certhia familiaris*—Brown creeper
- Sitta canadensis*—Red-breasted nuthatch
- Sitta carolinensis*—White-breasted nuthatch
- Sitta pusilla*—Brown-headed nuthatch

Family Troglodytidae

- Cistothorus platensis*—sedge wren
- Cistothorus palustris*—marsh wren
- Thryothorus indovicianus*—Carolina wren
- Troglodytes aedon*—House wren
- Troglodytes troglodytes*—Winter wren

Family Sylviidae

- Polioptila caerulea*—Blue-gray gnatcatcher
- Regulus calendula*—Ruby-crowned kinglet
- Regulus satrapa*—Golden-crowned kinglet

Family Turdidae

- Catharus guttatus*—Hermit thrush
- Catharus ustulatus*—Swainson's thrush
- Dumetella carolinensis*—Catbird
- Hylocichla mustelina*—Wood thrush

Mimus polyglottos—Mockingbird
Sialia sialis—Eastern bluebird
Toxostoma rufum—Brown thrasher
Turdus migratorius—Robin
 Family Motacillidae
 Anthus spinoletta—Water pipit
 Family Bombycillidae
 Bombycilla cedrorum—Cedar waxwing
 Family Laniidae
 Lanius ludovicianus—Loggerhead shrike
 Family Sturnidae
 Sturnus vulgaris—Starling
 Family Vireonidae
 Vireo flavifrons—Yellow-throated vireo
 Vireo griseus—White-eyed vireo
 Vireo olivaceus—Red-eyed vireo
 Vireo solitarius—Solitary vireo
 Family Parulidae
 Dendroica caerulescens—Black-throated blue warbler
 Dendroica coronata—Yellow-rumped warbler
 Dendroica discolor—Prairie warbler
 Dendroica dominica—Yellow-throated warbler
 Dendroica magnolia—Magnolia warbler
 Dendroica palmarum—Palm warbler
 Dendroica petechia—Yellow warbler
 Dendroica pinus—Pine warbler
 Dendroica tigrina—Cape May warbler
 Dendroica virens—Black-throated green warbler
 Geothlypis trichas—Yellowthroat
 Icteria virens—Yellow-breasted chat
 Mniotilta varia—Black-and-white warbler
 Parula americana—Northern parula
 Protonotaria citrea—Prothonotary warbler
 Seiurus aurocapillus—Ovenbird
 Seiurus motacilla—Louisiana waterthrush
 Seiurus noveboracensis—Northern waterthrush
 Setophaga ruticilla—American redstart
 Vermivora celata—Orange crowned warbler
 Vermivora chresoptera—Golden-winged warbler
 Vermivora pinus—Blue-winged warbler
 Wilsonia citrina—Hooded warbler
 Family Thraupidae
 Piranga olivacea—Scarlet tanager
 Piranga rubra—Summer tanager
 Family Fringillidae
 Cardinalis cardinalis—Cardinal
 Guiraca caerulea—Blue grosbeak
 Passerina ciris—Painted bunting
 Passerina cyanea—Indigo bunting

Family Emberizidae

Ammospiza caudacuta—sharp-tailed sparrow
Ammospiza maritima—seaside sparrow
Aimophila aestivalis—Bachman's sparrow
Junco hyemalis—Dark-eyed junco
Melospiza georgiana—Swamp sparrow
Melospiza melodia atlantica—Song sparrow
Passerculus sandwichensis—Savannah sparrow
Passerella iliaca—Fox sparrow
Pipilo erythrophthalmus—Rufous-sided towhee
Poocetes gramineus—Vesper sparrow
Spizella passerina—Chipping sparrow
Spizella pusilla—Field sparrow
Zonotrichia albicollis—White-throated sparrow

Family Icteridae

Agelaius phoeniceus—red-winged blackbird
Dolichonyx oryzivorus—Bobolink
Icterus galbula—Northern oriole
Icterus spurius—Orchard oriole
Molothrus ater—Brown-headed cowbird
Quiscalus major Vieillot—boat-tailed grackle
Quiscalus quiscula—Common grackle
Sturnella magna—Eastern meadowlark

¹ From "Birds of Sapelo Island," Georgia DNR.

Appendix 7. Mammals Known or Likely to Occur on Sapelo Island ¹

Class Mammalia

Order Marsupialia

Family Didelphiidae

Didelphis marsupialis—Opossum

Order Insectivora

Family Soricidae

Blarin brevicauda—Short-tailed shrew

Cryptotis parva parva (Say)—least shrew

Family Talpidae

Scalopus aquaticus howelli (Jackson)—eastern mole

Order Chiroptera

Family Vespertilionidae

Myotis austroriparius—Southeastern myotis

Myotis lucifugus lucifugus—Little brown myotis

Pipistrellus subflavus subflavus—Eastern pipistrelle

Eptesicus fuscus fuscus—Big brown bat

Lasiurus borealis borealis—Red bat

Lasiurus cinereus cinereus—Hoary bat

Lasiurus intermedius floridanus—Northern yellow bat

Lasiurus seminolus—Seminole bat

Nycticeius humeralis humeralis—Evening bat

Plecotus rafinesquii macrotis—Rafinesque's big-eared bat

Family Molossidae

Tadarida brasiliensis cynocephala—Brazilian free-tailed bat

Order Primates

Family Hominidae

Homo sapiens L.--human

Order Lagomorpha

Family Leporidae

Sylvilagus palustris palustris (Bachman)—marsh rabbit

Order Rodentia

Family Sciuridae

Sciurus carolinensis—Gray squirrel

Family Muridae

Microtus pennsylvanicus pennsylvanicus (Ord)—meadow vole

Mus musculus—House mouse

Oryzomys palustris palustris (Harlan)—marsh rice rat

Peromyscus gossypinus gossypinus (LeConte)—cotton mouse

Sigmodon hispidus hispidus Say and Ord--cotton rat

Rattus norvegicus norvegicus (Berkenhout)—Norway rat

Rattus rattus—Roof rat, Black rat

Order Carnivora

Family Procyonidae

Procyon lotor solutus Nelson and Goldman--raccoon

Lutra canadensis lataxina F. Cuvier--river otter

Mustela vison lutensis (Bangs)—mink

Order Artiodactyla

Family Suidae

Sus scrofa domesticus—Domestic hog

Family Cervidae

Odocoileus virginianus virginianus (Zimmerman)—white-tailed deer

Family Bovidae

Bostaurus—Cow

Order Xenarthra

Family Dasypodidae

Dasypus novemcinctus—Nine-banded armadillo

Order Sirenia

Family Trichechidae

Trichechus manatus latirostris—Florida manatee/West Indian manatee

Order Cetacea

Family Delphinidae

Tursiops truncatus (Montague)—bottle-nosed dolphin

¹ Johnson *et al.*, 1974; Sandifer *et al.*, 1980; Wiegert and Freeman, 1990.

Appendix 8. List of selected publications from the University of Georgia Marine Institute

(Collected reprint volume and contribution numbers in parentheses)

- Alberts, J.J., Ertell, J.R., and Case, L. 1990. Characterization of organic matter in rivers of the southeastern United States. *Verhandlungen Internationale Vereinigung Limnologie* 24:260-262. (22-638)
- Alberts, J.J. and Filip, Z. 1989. Sources and characteristics of fulvic and humic acids from a salt marsh estuary. *Science of the Total Environment* 81/82:353-361. (21-620)
- Alberts, J.J. and Filip, Z. 1994. Effect of organic solvent pre-extraction of source substrates on elemental composition, Fourier Transform Infrared spectra and copper binding in estuarine humic and fulvic acids. In: N. Senesi and T.M. Miano, editors. *Humic Substances in the Global Environmental and Implications on Human Health*. Elsevier Science B.V., p. 781-790. (712)
- Alberts, J.J. and Filip, Z. 1994. Humic substances in rivers and estuaries of Georgia, USA. *Trends in Chemical Geology* 1:143-162. (751)
- Alberts, J.J., Filip, Z., and Hertkorn, N. 1992. Fulvic and humic acids isolated from groundwater: compositional characteristics and cation binding. *Journal Contaminant Hydrology* 11:317-330. (707)
- Alberts, J.J., Filip, Z., and Leversee, G.J. 1989. Interaction of estuarine organic matter with copper and benzo(a)pyrene. *Marine Chemistry* 28:77-87. (22-630)
- Alberts, J.J., Filip, Z., Price, M.T., Hedges, J.I., and Jacobsen, T.R. 1992. CuO-oxidation products, acid hydrolyzable monosaccharides and amino acids of the humic substances occurring in a salt marsh estuary. *Organic Geochemistry* 18:171-180. (686)
- Alberts, J.J., Filip, Z., Price, M.T., Williams, D.J., and Williams, M.C. 1988. Elemental composition, stable carbon isotope ratios and spectrophotometric properties of humic substances occurring in a salt marsh estuary. *Organic Geochemistry* 12:455-467. (21-605)
- Alberts, J.J. and Griffin, C. 1996. Formation of particulate organic carbon (POC) from dissolved organic carbon (DOC) in salt marsh estuaries of the Southeastern United States. *Archiv für Hydrobiologie* 47:401-409. (750)
- Alberts, J.J., Hatcher, P.G., Price, M.T., and Filip, Z. 1991. Carbon-13 nuclear magnetic resonance analysis, lignin content and carbohydrate composition of humic substances from salt marsh estuaries. *Lecture Notes in Earth Science* 33:195-203. (22-639)
- Alberts, J.J., Newell, S.Y., and Price, M.T. 1987. Translocation and physiological state of controlling mechanisms for Al, As, Cu, Mn, and Sn in salt marsh cordgrass. In: *Proceedings of International Conference on Heavy Metals in the Environment*, Sept. 15-18, 1987, New Orleans, La., New Orleans. p. 396-398. (587)
- Alberts, J.J., Newell, S.Y., and Price, M.T. In press. Elemental concentrations in senescing leaves of the salt-marsh grass *Spartina alterniflora* (Loisel.). *Estuarine, Coastal and Shelf Science*. (753)
- Alberts, J.J., Price, M.T., and Kania, M. 1990. Metal concentrations in tissues of *Spartina alterniflora* (Loisel.) and sediments of Georgia salt marshes. *Estuarine, Coastal and Shelf Science* 30:47-58. (637)
- Alberts, J.J., Price, M.T., and Lewis, S. 1991. Lignin oxidation product and carbohydrate composition of plant tissues from the Southeastern United States. *Estuarine, Coastal and Shelf Science* 33:213-222. (674)
- Albright, L.J., Sherr, E.B., Sherr, B.F., and Fallon, R.D. 1987. Grazing of ciliated protozoa on free and particle-attached bacteria. *Marine Ecology-Progress Series* 38:125-129. (580)
- Antfingher, A.E. and Dunn, E.L. 1979. Seasonal patterns of CO₂ and water vapor exchange of three salt marsh succulents. *Oecologia* 43:249-260. (14-391)
- Antfingher, A.E. and Dunn, E.L. 1983. Water use and salt balance in three salt marsh succulents. *American Journal of Botany* 70:561-567. (17-486)
- Antoine, J.W. and Henry, V.J., Jr. 1965. Seismic refraction study of shallow part of continental shelf off Georgia coast. *Bulletin of the American Association of Petroleum Geologists* 49:601-604. (5-86)
- Balderston, W.L., Sherr, B., and Payne, W.J. 1976. Blockage by acetylene of nitrous oxide reduction in *Pseudomonas perfectomarinus*. *Applied and Environmental Microbiology* 31:504-508. (12-314)
- Bancroft, K., Paul, E.A., and Wiebe, W. 1976. The extraction and measurement of adenosine triphosphate from marine sediments. *Limnology and Oceanography* 21:473-480. (11-289)
- Bärlocher, F., Arsuffi, T.L., and Newell, S.Y. 1989. Digestive enzymes in the salt marsh periwinkle *Littorina irrorata* (Gastropoda). *Oecologia* 80:39-43. (21-614)
- Bärlocher, F. and Newell, S.Y. 1994. Growth of the saltmarsh periwinkle *Littoraria irrorata* on fungal and cordgrass diets. *Marine Biology* 118:109-114. (728)
- Bärlocher, F. and Newell, S.Y. 1994. Phenolics and proteins affecting palatability of *Spartina* leaves to the gastropod *Littoraria irrorata*. *Marine Ecology* 15:65-75. (737)

- Bärlocher, F., Newell, S.Y., and Arsuffi, T. 1989. Digestion of *Spartina alterniflora* material with and without fungal constituents by the periwinkle *Littorina irrorata* (Mollusca: Gastropoda). *Journal Experimental Marine Biology and Ecology* 130:45-53. (22-635)
- Basan, P.B. 1979. Classification of low marsh habitat in a Georgia salt marsh. *Georgia Journal of Science* 37:139-154. (14-374)
- Basan, P.B., Chamberlain, C.K., Frey, R.W., Howard, J.D., Seilacher, A., and Warne, J.E. 1978. Sedimentology and trace fossils. In: P.B. Basan, editor. *Trace Fossil Concept*. SEOM Short Course No. 5, p. 13-47. (352*)
- Basan, P.B. and Frey, R.W. 1977. Actual-palaeontology and neoichnology of salt marshes near Sapelo Island, Georgia. In: T.P. Crimes and J.C. Harper, editors. *Trace Fossils II*. Geological Journal, Special Issue 9, p. 41-70. (12-326)
- Basan, P.B. and Frey, R.W. 1982. Size reduction with deliccation of modern internal molds of the mussel *Geukensia demissa*. *Journal of Paleontology* 56:970-972. (16-444)
- Benner, R., Fogel, M.L., and Sprague, E.K. 1991. Diagenesis of belowground biomass of *Spartina alterniflora* in salt-marsh sediments. *Limnology and Oceanography* 36:1358-1374. (717)
- Benner, R., Fogel, M.L., Sprague, E.K., and Hodson, R.E. 1987. Depletion of ^{13}C in lignin and its implications for stable carbon isotope studies. *Nature* 329:708-710. (21-594)
- Benner, R., Maccubbin, A.E., and Hodson, R.E. 1984. Preparation, characterization, and microbial degradation of specifically radiolabeled (^{14}C) lignocelluloses from marine and freshwater macrophytes. *Applied and Environmental Microbiology* 47:381-389. (17-502)
- Benner, R., Maccubbin, A.E., and Hodson, R.E. 1984. Anaerobic biodegradation of the lignin and polysaccharide components of lignocellulose and synthetic lignin by sediment microflora. *Applied and Environmental Microbiology* 47:998-1004. (17-505)
- Benner, R., Maccubbin, A.E., and Hodson, R.E. 1986. Temporal relationship between the deposition and microbial degradation of lignocellulosic detritus in a Georgia salt marsh and the Okefenokee Swamp. *Microbial Ecology* 12:291-298. (550)
- Benner, R., Moran, M.A., and Hodson, R.E. 1985. Effects of pH and plant source on lignocellulose biodegradation rates in two wetland ecosystems, the Okefenokee Swamp and a Georgia salt marsh. *Limnology and Oceanography* 30:489-499. (18-527)
- Benner, R., Moran, M.A., and Hodson, R.E. 1986. Biogeochemical cycling of lignocellulosic carbon in marine and freshwater ecosystems: relative contributions of procaryotes and eucaryotes. *Limnology and Oceanography* 31:89-100. (536)
- Benner, R., Newell, S.Y., Maccubbin, A.E., and Hodson, R.E. 1984. Relative contributions of bacteria and fungi to rates of degradation of lignocellulosic detritus in salt-marsh sediments. *Applied and Environmental Microbiology* 48:36-40. (18-513)
- Bergbauer, M. and Newell, S.Y. 1992. Contribution to lignocellulose degradation and DOC formation from a salt marsh macrophyte by the ascomycete *Phaeosphaeria spartinicola*. *FEMS Microbiol Ecology* 86:341-348. (693)
- Berman, T. and J., W.W. 1983. Effects of organic substrate additions on size partitioning of heterotrophic activity in estuarine and nearshore bacteria. In: H. Shoval, editor. *Developments in Ecology and Environmental Quality*. Balaban Int. Sci. Serv. Rehovot, Philadelphia. p. 367-375. (17-482)
- Berman, T.B. 1983. Phosphorous uptake by microplankton in estuarine and coastal shelf water near Sapelo Island, Georgia, U.S.A. *Estuaries* 6:160-166. (15-427)
- Berresheim, H. 1993. Distribution of atmospheric sulphur species over various wetland regions in the southeastern U.S.A. *Atmospheric Environment* 27a:211-221. (715)
- Bohlool, B.B. and Wiebe, W.J. 1978. Nitrogen-fixing communities in an intertidal ecosystem. *Canadian Journal of Microbiology* 24:932-938. (14-395)
- Bradley, P. and Dunn, E.L. 1989. Effects of sulfide on the growth of three salt marsh halophytes of the southeastern United States. *American Journal of Botany* 76:1707-1713. (22-636)
- Burkholder, P.R. 1956. Studies on the nutritive value of *Spartina* grass growing in the marsh areas of coastal Georgia. *Bulletin of the Torrey Botanical Club* 83:327-334. (1-3)
- Burkholder, P.R. and Bornside, G.H. 1957. Decomposition of marsh grass by aerobic marine bacteria. *Bulletin of the Torrey Botanical Club* 84:366-383. (1-7A)
- Burkholder, P.R. and Burkholder, L.M. 1956. Vitamin B₁₂ in suspended solids and marsh muds collected along the coast of Georgia. *Limnology and Oceanography* 1:202-208. (1-4)
- Chalmers, A.G. 1979. The effects of fertilization on nitrogen distribution in a *Spartina alterniflora* salt marsh. *Estuarine and Coastal Marine Science* 8:327-337. (13-362)
- Chalmers, A.G. 1982. Soil dynamics and productivity of *Spartina alterniflora*. In: V.S. Kennedy, editor. *Estuarine Comparisons*. Academic Press, New York. p. 231-242. (16-449)
- Chalmers, A.G. 1988. Experimental manipulations of drainage in a Georgia salt marsh: Lessons learned. *Oceans* 1988:1-4. (21-621)
- Chalmers, A.G. and Christian, R.R. 1982. Residual effects of scientific manipulation: a salt marsh revisited. *Georgia Journal of Science* 40:85-90. (16-461)

- Chalmers, A.G., Haines, E.B., and Sherr, B.F. 1976. Capacity of a *Spartina* salt marsh to assimilate nitrogen from secondarily treated sewage. Environmental Resources Center Tech. Report ER - XXXC 0776, Ga. Inst. Technology, Atlanta, Ga.:88 p. (316*)
- Chalmers, A.G., Wiegert, R.G., and Wolf, P.L. 1985. Carbon balance in a salt marsh: interactions of diffusive export, tidal deposition and rainfall-caused erosion. *Estuarine, Coastal and Shelf Science* 21:757-771. (18-520)
- Chapman, R.L. 1971. The macroscopic marine algae of Sapelo Island and other sites on the Georgia coast. *Bulletin of the Georgia Academy of Science* 29:77-89. (8-211)
- Chapman, R.L. 1973. An addition to the macroscopic marine algal flora of Georgia: the genus *Cladophora*. *Bulletin of the Georgia Academy of Science* 31:147-150. (10-265)
- Chernow, R.M., Frey, R.W., and Ellwood, B.B. 1986. Biogenic effects on development of magnetic fabrics in coastal Georgia sediments. *Journal of Sedimentary Petrology* 56:160-172. (538)
- Christian, R., Bancroft, K., and Wiebe, W.J. 1975. Distribution of microbial adenosine triphosphate in salt marsh sediments at Sapelo Island, Georgia. *Soil Science* 119:89-97. (11-287)
- Christian, R.R., Bancroft, K., and Wiebe, W.J. 1978. Resistance of the microbial community within salt marsh soils in selected perturbations. *Ecology* 59:1200-1210. (14-370)
- Christian, R.R. and Hall, J.R. 1976. Experimental trends in sediment microbial heterotrophy: Radioisotopic techniques and analysis. In: B. Coull, editor. *Ecology of Marine Benthos*. University of South Carolina Press, Columbia, S. C. p. 67-87. (11-296)
- Christian, R.R., Hansen, J.A., Hodson, R.E., and Wiebe, W.J. 1983. Relationships of soil, plant, and microbial characteristics in silt-clay and tall-form *Spartina alterniflora*. *Estuaries* 6:43-49. (15-426)
- Christian, R.R., Hanson, R.B., and Newell, S.Y. 1982. Comparison of methods for measurement of bacterial growth rates in mixed batch cultures. *Applied and Environmental Microbiology* 43:1160-1165. (16-451)
- Christian, R.R. and Wetzel, R.L. 1991. Synergism between research and simulation models of estuarine microbial food webs. *Microbial Ecology* 22:111-125. (22-655)
- Christian, R.R. and Wiebe, W.J. 1978. Anaerobic microbial community metabolism in *Spartina alterniflora* soils. *Limnology and Oceanography* 23:328-336. (13-353)
- Christian, R.R. and Wiebe, W.J. 1978. Three experimental regimes in the study of sediment microbial ecology. In: C.D. Litchfield and P.L. Seyfried, editors. *Methodology for Biomass Determinations and Microbial Activities in Sediments*. Astm, Stp, p. 148-155. (14-386)
- Covi, M.P. and Kneib, R.T. 1995. Intertidal distribution, population dynamics and production of the amphipod *Uhlorechestia spartinophila* in a Georgia, USA, salt marsh. *Marine Biology* 121:447-455. (752)
- Coward, S.J., Gerhardt, C.M., and Crockett, D.T. 1970. Behavior variation in national populations of two species of fiddler crabs (*Uca*) and some preliminary observations on directed modification. *Journal of Biological Psychology* 12:24-31. (8-205)
- Dahlberg, M.D. 1968. Natural hybrids between two minnows, *Campostoma anomalum* and *Notropis chrosomus*, from the Coosa River system. *Bulletin of the Georgia Academy of Science* 26:155-159. (7-162)
- Dahlberg, M.D. 1969. Incidence of the isopod *Olencira praegustator* and copepod *Lernaeenicus radiatus*, in three species and hybrid menhaden (*Brevoortia*) from the Florida coasts, with five new host records. *Transactions of the American Fisheries Society* 98:111-115. (7-155)
- Dahlberg, M.D. 1969. Fat cycles and condition factors of two species of menhaden, *Brevoortia* (Clupeidae), and natural hybrids from the Indian River of Florida. *American Midland Naturalist* 82:117-126. (7-168)
- Dahlberg, M.D. 1970. Frequencies of abnormalities in Georgia estuarine fishes. *Transactions of the American Fisheries Society* 99:95-97. (7-184)
- Dahlberg, M.D. 1970. Atlantic and Gulf of Mexico menhadens, genus *Brevoortia* (Pisces:Clupeidae). *Bulletin of the Florida State Museum* 15:91-162. (8-192)
- Dahlberg, M.D. 1970. A completely reversed blackcheek tonguefish, *Symphurus plagiusa*, from Duplin River, Georgia. *Chesapeake Science* 11:260-261. (8-203)
- Dahlberg, M.D. and Odum, E.P. 1970. Annual cycles of species occurrence, abundance, and diversity in Georgia estuarine fish populations. *American Midland Naturalist* 83:382-392. (7-182)
- Dahlberg, M.D. and Scott, D.C. 1971. Freshwater fishes of Georgia. *Bulletin of the Georgia Academy of Science* 29:1-64. (8-212)
- Dahlberg, M.D. and Smith, F.G. 1970. Mortality of estuarine animals due to cold on the Georgia coast. *Ecology* 51:931-933. (8-201)
- Dai, T. and Wiegert, R.G. 1996. Ramet population dynamics and net aerial primary productivity of *Spartina alterniflora*. *Ecology* 77:276-288. (776)
- Dai, T. and Wiegert, R.G. 1996. Estimation of the primary productivity of *Spartina alterniflora* using a canopy model. *Ecography* 19:410-423. (785)
- Dai, T. and Wiegert, R.G. In Press. A field study of photosynthetic capacity and its response to nitrogen fertilization in *Spartina alterniflora*. *Estuarine, Coastal and Shelf Science*. (786)

- Darby, D.G. and Hoyt, J.H. 1964. An upper miocene fauna dredged from tidal channels of coastal Georgia. *Journal of Paleontology* 38:67-73. (4-61)
- Darley, M.W., Montague, C.L., Plumley, F.G., Sage, W.W., and Psalidas, A.T. 1981. Factors limiting edaphic algal biomass and productivity in a Georgia salt marsh. *Journal of Phycology* 17:122-128. (15-423)
- Darley, W.M., Dunn, E.L., Holmes, K.S., and Larew, H.G., III. 1976. A ¹⁴C method for measuring epibenthic microalgal productivity in air. *Journal Experimental Marine Biology and Ecology* 25:207-217. (12-319)
- Darley, W.M., Ohlman, C.T., and Wimpee, B.B. 1979. Utilization of dissolved organic carbon by natural populations of epibenthic salt marsh diatoms. *Journal of Phycology* 15:1-5. (13-361)
- Deery, J.R. and Howard, J.D. 1977. Origin and character of washover fans on the Georgia coast, U.S.A. *Transactions-Gulf Coast Association of Geological Societies* 27:259-271. (13-336)
- DePratter, C.B. and Howard, J.D. 1977. History of shoreline changes determined by archaeological dating: Georgia coast, U.S.A. *Transactions-Gulf Coast Association of Geological Societies* 27:252-258. (13-337)
- Doyle, L.J., Cleary, W.J., and Pilkey, O.H. 1968. Mica: Its use in determining self-depositional regimes. *Marine Geology* 6:381-389. (6-136)
- Driscoll, E.G., Gibson, J.W., and Mitchell, S.W. 1971. Larval selection of substrate by the Bryozoa *Discoporella* and *Cupuladria*. *Hydrobiologia* 37:347-359. (8-194)
- Durant, C.J. and Reimold, R.J. 1972. Effects of estuarine dredging on toxaphene-contaminated sediments in Terry Creek, Brunswick, Ga. (1971). *Pesticides Monitoring Journal* 6:94-96. (230*)
- Dörjes, J., Frey, R.W., and Howard, J.D. 1986. Origins of, and mechanisms for, mollusk shell accumulations on Georgia beaches. *Senckenbergiana Maritima* 18:1-43. (18-526)
- Edwards, A.C. and Davis, D.E. 1974. Effects of herbicides on the *Spartina* salt marsh. In: R.J. Reimold and W.H. Queen, editors. *Ecology of Halophytes*. Academic Press, Inc., New York. p. 531-545. (10-261)
- Edwards, A.C. and Davis, D.E. 1975. Effects of an organic arsenical herbicide on a salt marsh ecosystem. *Journal of Environmental Quality* 4:215-219. (11-306)
- Edwards, J.M. and Frey, R.W. 1977. Substrate characteristics within a Holocene salt marsh, Sapelo Island, Georgia. *Senckenbergiana Maritima* 9:215-259. (12-327)
- Eisele, F.L. and Berresheim, H. 1992. High-pressure chemical ionization flow reactor for real-time spectrometric detection of sulfur gases and unsaturated hydrocarbons in air. *Analytical Chemistry* 64:283-288. (702)
- Ertel, J.R., Alberts, J.J., and Price, M.T. 1991. Transformation of riverine organic matter in estuaries. In: K.J. Hatcher, editor. *Proceedings of the 1991 Georgia Water Resources Conference*. Inst. Natural Resources, Athens, GA. p. 309-313. (687)
- Fallon, R.D. 1987. Sedimentary sulfides in the nearshore Georgia Bight. *Estuarine, Coastal and Shelf Science* 25:607-619. (584)
- Fallon, R.D. and Newell, S.Y. 1986. Thymidine incorporation by the microbial community of standing-dead *Spartina alterniflora*. *Applied and Environmental Microbiology* 52:1206-1208. (20-565)
- Fallon, R.D. and Newell, S.Y. 1989. Use of ELISA for fungal measurement in standing-dead *Spartina alterniflora* Loisel. *Journal of Microbiological Methods* 9:239-252. (22-631)
- Fallon, R.D., Newell, S.Y., and Groene, L.C. 1985. Phylloplane algae of standing dead *Spartina alterniflora*. *Marine Biology* 90:121-127. (19-539)
- Fallon, R.D., Newell, S.Y., and Hopkinson, C.S. 1983. Bacterial productivity in marine sediments: Will cell specific measures agree with whole-system metabolism? *Marine Ecology-Progress Series* 11:119-127. (16-473)
- Fallon, R.D., Newell, S.Y., Sherr, B.F., and Sherr, E.B. 1986. Factors affecting bacterial biomass and growth in the Duplin River estuary and coastal Atlantic Ocean. In: *Deuxieme Colloque International De Bacteriologie Marine* CNRS, Brest, 1-5 Oct. 1985, Actes De Colloques, 3, 1986., p. 137-145. (19-535)
- Fell, J.W. and Newell, S.Y. In Press. Biochemical and molecular methods for the study of marine fungi. In: K.E. Cooksey, editor. *Molecular Approaches to the Study of the Oceans*. Chapman and Hall, London. (779)
- Filip, Z. and Alberts, J.J. 1988. The release of humic substances from *Spartina alterniflora* (Loisel.) into sea water as influenced by salt marsh indigenous microorganisms. *Science of the Total Environment* 73:143-157. (21-598)
- Filip, Z. and Alberts, J.J. 1989. Humic substances isolated from *Spartina alterniflora* (Loisel.) following long-term decomposition in sea water. *Science of the Total Environment* 83:273-285. (21-625)
- Filip, Z. and Alberts, J.J. 1992. Humic substances and some microbial analogs from two thermal sites in Iceland. *Science of the Total Environment* 117/118:227-239. (22-656)
- Filip, Z. and Alberts, J.J. 1993. Formation of humic-like substances by fungi epiphytic on *Spartina alterniflora*. *Estuaries* 16:385-390. (726)
- Filip, Z. and Alberts, J.J. 1994. Microbial utilization resulting in early diagenesis of salt marsh humic acids. *Science of the Total Environment* 144:121-135. (724)
- Filip, Z. and Alberts, J.J. 1994. Adsorption and transformation of salt marsh related humic acids in quartz and clay minerals. *Science of the Total Environment* 153:141-150. (735)
- Filip, Z., Alberts, J.J., Chesire, M.V., Goodman, B.A., and Bacon, J.R. 1988. Comparison of salt marsh humic acid with humic-like substances from the indigenous plant species *Spartina alterniflora* (Loisel.). *Science of the Total Environment* 71:157-172. (21-596)

- Filip, Z., Newman, R.H., and Alberts, J.J. 1991. Carbon-13 nuclear magnetic resonance characterization of humic substances associated with salt marsh environments. *Science of the Total Environment* 101:191-199. (675)
- Filip, Z., Trubetskoj, O.A., and Alberts, J.J. 1995. Electrophoretic evidence of the structural similarity of different salt marsh related humic substances. *Scientia Agriculturae Bohemica* 26:219-225. (770)
- Fitt, W.K. and Coon, S.L. 1992. Evidence for ammonia as a natural cue for recruitment of oyster larvae to oyster beds in a Georgia salt marsh. *Biological Bulletin* 182:401-408. (711)
- Fitz, C.H. and Wiegert, R.G. 1992. Local population dynamics of estuarine blue crabs: abundance, recruitment and loss. *Marine Ecology-Progress Series* 87:23-40. (713)
- Fitz, H.C. and Wiegert, R.G. 1991. Tagging juvenile blue crabs, *Callinectes sapidus*, with microwire tags: retention, survival, and growth through multiple molts. *Journal Crustacean Biology* 11:229-235. (672)
- Fitz, H.C. and Wiegert, R.G. 1991. Utilization of the intertidal zone of a salt marsh by the blue crab, *Callinectes sapidus*: density, return frequency, and feeding habits. *Marine Ecology-Progress Series* 76:249-260. (682)
- Fornes, A.O. and Reimold, R.J. 1973. The estuarine environment: Location of mean high water—its engineering, economic and ecological potential. In: *Proceedings of the American Society of Photogrammetry Fall Convention, Lake Buena Vista, Florida, October 2-5, 1973.* p. 938-978. (10-276)
- Frankenberg, D. 1965. A new species of *Cyathura* (Isopoda, Anthuridae) from coastal waters off Georgia, U.S.A. *Crustaceana* 8:206-212. (4-62)
- Frankenberg, D. 1965. An anomalous position for the appendix masculina of an anthurid isopod. *Crustaceana* 8:111-112. (4-67)
- Frankenberg, D. 1966. Southern limit of *Nassarius trivittatus*. *Nautilus* 79:89-90. (5-91)
- Frankenberg, D. 1968. Seasonal aggregation in *Amphioxus*. *BioScience* 18:877-878. (7-159)
- Frankenberg, D. 1971. Dynamics of benthic communities off Georgia, U.S.A. *Thalassia Jugoslavica, Special Volume* 7:49-55. (9-225)
- Frankenberg, D. 1976. Oxygen in a tidal river: low tide concentration correlates linearly with location. *Estuarine and Coastal Marine Science* 4:455-460. (12-315)
- Frankenberg, D. and Burbanck, W.D. 1963. A comparison of the physiology and ecology of the estuarine isopod *Cyathura polita* in Massachusetts and Georgia. *Biological Bulletin* 125:81-95. (4-54)
- Frankenberg, D., Coles, S.L., and Johannes, R.E. 1967. The potential trophic significance of *Callinassa major* fecal pellets. *Limnology and Oceanography* 12:113-120. (6-122)
- Frankenberg, D. and Giles, R.T. 1970. Acid treatment of organic materials and the removal of calcium carbonate. *Journal of Sedimentary Petrology* 40:1046-1048. (200*)
- Frankenberg, D. and Menzies, R.J. 1966. A new species of asellote marine isopod, *Munna (Uromunna) reynoldsi* (Crustacea: Isopoda). *Bulletin of Marine Science* 16:200-208. (5-97)
- Frankenberg, D. and Smith, K.L., Jr. 1967. Coprophagy in marine animals. *Limnology and Oceanography* 12:443-450. (6-139)
- Frankenberg, D. and Westerfield, C. 1968. Oxygen demand and oxygen depletion capacity of sediments from Wassaw Sound, Georgia. *Bulletin of the Georgia Academy of Science* 26:160-171. (7-161)
- Frey, R.W. 1971. Ichnology—The study of fossil and recent lebensspuren. *LSU School of Geosciences Misc. Publ.* 71-1:91-125. (8-213)
- Frey, R.W. 1972. Review of "Coastal Lagoons, A Symposium". A. S. Castanares and F. B. Phlegar (eds.). *Journal of Paleontology* 46:461-462. (9-233)
- Frey, R.W. 1973. Concepts in the study of biogenic sedimentary structures. *Journal of Sedimentary Petrology* 43:6-19. (250*)
- Frey, R.W. 1987. Distribution of ark shells (*Bivalvia: Anadara*), Cabretta Island Beach, Georgia. *Southeastern Geology* 27:155-163. (20-562)
- Frey, R.W. 1987. Hermit crabs: Neglected factors in taphonomy and palaeoecology. *Palaios* 2:313-322. (586)
- Frey, R.W. and Basan, P. 1985. Coastal salt marshes. In: R.A. Davis Jr., editor. *Coastal Sedimentary Environments*, 2nd Expanded Edition. Springer-Verlag, New York. p. 225-301. (17-499)
- Frey, R.W. and Basan, P.B. 1978. Coastal salt marshes. In: R.A. Davis Jr., editor. *Coastal Sedimentary Environments*. Springer-Verlag, New York. p. 101-169. (13-345)
- Frey, R.W. and Basan, P.B. 1981. Taphonomy of relict Holocene salt marsh deposits, Cabretta Island, Georgia. *Senckenbergiana Maritima* 13:111-155. (16-439)
- Frey, R.W., Basan, P.B., and Scott, R.M. 1973. Techniques for sampling salt marsh benthos and burrows. *American Midland Naturalist* 89:228-234. (9-248)
- Frey, R.W., Basan, P.B., and Smith, J.M. 1987. Rheotaxis and distribution of oysters and mussels, Georgia tidal creeks and salt marshes, U.S.A. *Palaeogeography, Palaeoclimatology, Palaeoecology* 61:1-16. (20-578)
- Frey, R.W., Curran, H.A., and Pemberton, S.G. 1984. Tracemaking activities of crabs and their environmental significance: the ichnogenus *Psilonichnus*. *Journal of Paleontology* 58:333-350. (17-498)
- Frey, R.W. and Dorjes, J. 1988. Fair- and foul-weather shell accumulations on a Georgia beach. *Palaios* 3:561-576. (21-601)

- Frey, R.W. and Dorjes, J. 1988. Carbonate skeletal remains in beach-to-offshore sediments, Pensacola, Florida. *Senckenbergiana Maritima* 20:31-57. (21-608)
- Frey, R.W. and Henderson, S.W. 1987. Left-right phenomena among bivalve shells: Examples from the Georgia Coast. *Senckenbergiana Maritima* 19:223-247. (19-583)
- Frey, R.W. and Howard, J.D. 1969. A profile of biogenic sedimentary structures in a Holocene barrier island-salt marsh complex, Georgia. *Transactions-Gulf Coast Association of Geological Societies* 19:427-444. (7-180)
- Frey, R.W. and Howard, J.D. 1972. Georgia Coastal Region, Sapelo Island, U.S.A.: Sedimentology and Biology. VI. Radiographic study of sedimentary structures made by beach and offshore animals in aquaria. *Senckenbergiana Maritima* 4:169-182. (246*)
- Frey, R.W. and Howard, J.D. 1980. Physical and biogenic processes in Georgia estuaries. II. Intertidal facies. In: S.B. McCann, editor. *Sedimentary Processes and Animal-Sediment Relationships in Tidal Environments*. Geological Association of Canada, Short Course, p. 183-220. (410*)
- Frey, R.W. and Howard, J.D. 1986. Taphonomic characteristics of offshore mollusk shells, Sapelo Island, Georgia. *Tulane Studies in Geology and Paleontology* 19:51-62. (541)
- Frey, R.W. and Howard, J.D. 1986. Mesotidal estuarine sequences: A perspective from the Georgia Bight. *Journal of Sedimentary Petrology* 56:911-924. (19-553)
- Frey, R.W. and Howard, J.D. 1988. Beaches and beach-related facies, Holocene barrier island of Georgia. *Geological Magazine* 125:621-640. (21-597)
- Frey, R.W., Howard, J.D., and Pryor, W.A. 1978. *Ophiomorpha*: Its morphologic, taxonomic, and environmental significance. *Palaeogeography, Palaeoclimatology, Palaeoecology* 23:119-229. (12-330)
- Frey, R.W. and Mayou, T.V. 1971. Decapod burrows in Holocene barrier island beaches and washover fans, Georgia. *Senckenbergiana Maritima* 3:53-77. (227*)
- Frey, R.W. and Pemberton, S.G. 1986. Vertebrate lebensspuren in intertidal and supratidal environments, Holocene barrier islands, Georgia. *Senckenbergiana Maritima* 18:45-95. (19-533)
- Frey, R.W. and Pemberton, S.G. 1987. The *Psilonichnus* ichnocoenose, and its relationship to adjacent marine and nonmarine ichnocoenoses along the Georgia coast. *Bulletin of Canadian Petroleum Geology* 35:333-357. (20-563)
- Frey, R.W. and Pinet, P.R. 1978. Calcium-carbonate content of surficial sands seaward of Altamaha and Doboy Sounds, Georgia. *Journal of Sedimentary Petrology* 48:1249-1256. (14-372)
- Frey, R.W., Voorhies, M.R., and Howard, J.D. 1975. Estuaries of the Georgia coast, U.S.A.: Sedimentology and biology. VIII. Fossil and recent skeletal remains in Georgia estuaries. *Senckenbergiana Maritima* 7:257-295. (12-325)
- Fry, B. and Sherr, E.B. 1984. ^{13}C measurements as indicators of carbon flow in marine and freshwater ecosystems. *Contributions in Marine Science* 27:13-47. (18-512)
- Gallagher, J.L. 1974. Remote sensing as a tool for studying the ecology of halophytes. In: R.J. Reimold and W.H. Queen, editors. *Ecology of Halophytes*. Academic Press, New York. p. 511-523. (10-258)
- Gallagher, J.L. 1974. Sampling macro-organic matter profiles in salt marsh plant root zones. *Soil Science Society of America Proceedings* 38:154-155. (273*)
- Gallagher, J.L. 1975. The significance of the surface film in salt marsh plankton metabolism. *Limnology and Oceanography* 20:120-123. (11-281)
- Gallagher, J.L. 1975. Effect of an ammonium nitrate pulse on the growth and elemental composition of natural stands of *Spartina alterniflora* and *Juncus roemerianus*. *American Journal of Botany* 62:644-648. (11-285)
- Gallagher, J.L. 1977. Zonation of wetlands vegetation. In: J.R. Clark, editor. *Coastal Ecosystem Management*. Wiley-Interscience, New York. p. 752-758. (13-340)
- Gallagher, J.L. 1978. Decomposition processes: Summary and recommendations. In: R. Good, D. Whigham and R. Simpson, editors. *Freshwater Wetlands: Ecological Processes and Management Potential*. Academic Press, Inc., New York. p. 145-151. (338*)
- Gallagher, J.L. 1978. Estuarine angiosperms: productivity and initial photosynthate dispersion in the ecosystem. In: M. Wiley, editor. *Estuarine Interactions*. Academic Press, Inc., New York. p. 131-143. (359*)
- Gallagher, J.L. 1979. Growth and element compositional responses of *Sporobolus virginicus* (L.) Kunth. to substrate salinity and nitrogen. *American Midland Naturalist* 102:68-75. (13-350)
- Gallagher, J.L. 1979. Ecological consideration of biosaline resource utilization. In: A. Hollaender, editor. *The Biosaline Concept*. Plenum Publishing Corp., New York. p. 371-378. (14-371 (also duplicate entry 15-415))
- Gallagher, J.L. and Kibby, H. 1980. Marsh plants as vectors in trace mineral dynamics in Oregon tidal marshes. *American Journal of Botany* 67:1069-1074. (364*)
- Gallagher, J.L. and Pfeiffer, W.J. 1977. Aquatic metabolism of the communities associated with attached dead shoots of salt marsh plants. *Limnology and Oceanography* 22:562-565. (12-320)
- Gallagher, J.L., Pfeiffer, W.J., and Pomeroy, L.R. 1976. Leaching and microbial utilization of dissolved organic carbon from leaves of *Spartina alterniflora*. *Estuarine and Coastal Marine Science* 4:467-471. (11-292)
- Gallagher, J.L. and Plumley, F.G. 1979. Underground biomass profiles and productivity in Atlantic coastal marshes. *American Journal of Botany* 66:156-161. (14-363)

- Gallagher, J.L. and Reimold, R.J. 1973. Tidal marsh plant distribution and productivity patterns from the sea to fresh water—a challenge in resolution and discrimination. In: Proceedings of the 4th Biennial Workshop on Color Aerial Photography. p. 166-183. (10-274)
- Gallagher, J.L., Reimold, R.J., Linthurst, R.A., and Pfeiffer, W.J. 1980. Aerial production, mortality, and mineral accumulation dynamics in *Spartina alterniflora* and *Juncus roemerianus* in a Georgia salt marsh. *Ecology* 61:303-312. (322*)
- Gallagher, J.L., Reimold, R.J., and Thompson, D.E. 1971. Remote sensing and salt marsh productivity. In: Proceedings of the 38th Annual Meeting, American Society of Photogrammetry, Washington, D.C., p. 338-348. (9-239)
- Gallagher, J.L., Robinson, S.E., Pfeiffer, W.J., and Seliskar, D.M. 1979. Distribution and movement of toxaphene in anaerobic saline marsh soils. *Hydrobiologia* 63:3-9. (13-348)
- Gallagher, J.L. and Wolf, P.L. 1980. Field bioassays for the role of plants as vectors in contaminated transfer from dredged material. In: R.A. Baker, editor. *Sediments and Contaminants, Vol. 2*. Ann Arbor Sci. Publ., Inc., Ann Arbor. p. 445-463. (387*)
- Gallagher, J.L., Wolf, P.L., and Pfeiffer, W.J. 1984. Rhizome and root growth rates and cycles in protein and carbohydrate concentrations in Georgia *Spartina alterniflora* Loisel. plants. *American Journal of Botany* 71:165-169. (18-521)
- Giblin, A.E. and Howarth, R.W. 1984. Porewater evidence for a dynamic sedimentary iron cycle in salt marshes. *Limnology and Oceanography* 29:47-63. (18-524)
- Giles, R.T. and Pilkey, O.H. 1965. Atlantic beach and dune sediments of the southern United States. *Journal of Sedimentary Petrology* 35:900-910. (5-87)
- Giurgevich, J.R. and Dunn, E.L. 1978. Seasonal patterns of CO₂ and water vapor exchange of *Juncus roemerianus* Scheele in a Georgia salt marsh. *American Journal of Botany* 65:502-510. (13-357)
- Giurgevich, J.R. and Dunn, E.L. 1979. Seasonal patterns of CO₂ and water vapor exchange of the tall and short height forms of *Spartina alterniflora* Loisel. in a Georgia salt marsh. *Oecologia* 43:139-156. (14-401)
- Giurgevich, J.R. and Dunn, E.L. 1981. A comparative analysis of the CO₂ and water vapor responses of two *Spartina* species from Georgia coastal marsh. *Estuarine and Coastal Marine Science* 12:561-568. (15-412)
- Giurgevich, J.R. and Dunn, E.L. 1982. Seasonal patterns of daily net photosynthesis, transpiration, and net primary productivity of *Juncus roemerianus* and *Spartina alterniflora* in a Georgia salt marsh. *Oecologia* 52:404-410. (15-435)
- Gleason, M.L. and Dunn, E.L. 1982. Effects of hypoxia on root and shoot respiration of *Spartina alterniflora*. In: V.S. Kennedy, editor. *Estuarine Comparisons*. Academic Press, New York. p. 243-253. (16-454)
- Goldstein, S. and Bagwell-Harben, E. 1993. Taphofacies implications of infaunal foraminiferal assemblages in a Georgia salt marsh, Sapelo Island. *Micropaleontology* 39:53-62. (705)
- Goldstein, S.T. and Barker, W.W. 1988. Test ultrastructure and taphonomy of the monothalamous agglutinated foraminifer *Cribothalammina* n. gen. *Alba* (Heron-Allen Earland). *Journal of Foraminiferal Research* 18:130-136. (21-595)
- Goldstein, S.T. and Barker, W.W. 1990. Gametogenesis in the monothalamous agglutinated foraminifer. *Journal of Protozoology* 37:20-27. (22-640)
- Goldstein, S.T. and Frey, R.W. 1986. Salt marsh foraminifera, Sapelo Island, Georgia. *Senckenbergiana Maritima* 18:97-121. (19-537)
- Goldstein, S.T. and Moodley, L. 1993. Gametogenesis and the life cycle of the foraminifer *Ammonia beccarii* (Linne) forma *Tepida* (Cushman). *Journal of Foraminiferal Research* 23:213-220. (721)
- Goldstein, S.T., Watkins, G.T., and Kuhn, R.M. In Press. Microhabitats of salt marsh foraminifera: St. Catherines Island, Georgia, U.S.A. *Marine Micropaleontology*. (759)
- Gonzales, J.M., Sherr, E.B., and Sherr, B.F. 1990. Size-selective grazing on bacteria by natural assemblages of estuarine flagellates and ciliates. *Applied and Environmental Microbiology* 56:583-589. (22-649)
- Gross, M.F., Hardisky, M.A., Wolf, P.L., and Klemas, V. 1991. Relationship between aboveground and belowground biomass of *Spartina alterniflora* (smooth cordgrass). *Estuaries* 14:180-191. (689)
- Haddad, R.I., Newell, S.Y., Martens, C.S., and Fallon, R.D. 1992. Early diagenesis of lignin-associated phenolics in the saltmarsh grass *Spartina alterniflora*. *Geochimica et Cosmochimica Acta* 56:3751-3764. (699)
- Hails, J.R. and Hoyt, J.H. 1968. Barrier development of submerged coasts: Problems of sea-level changes from a study of the Atlantic coastal plain of Georgia, U.S.A., and parts of the east Australian coast. *Zeitschrift für Geomorphologie* 7:24-55. (6-135)
- Hails, J.R. and Hoyt, J.H. 1969. An appraisal of the evolution of the lower Atlantic coastal plain of Georgia, U.S.A. *The Institute of British Geographers Publications Trans. Publ. No. 46:53-68*. (6-151)
- Hails, J.R. and Hoyt, J.H. 1969. The significance and limitations of statistical parameters for distinguishing ancient and modern sedimentary environments of the lower Georgia coastal plain. *Journal of Sedimentary Petrology* 39:559-580. (7-163)
- Haines, B.L. and Dunn, E.L. 1976. Growth and resource allocation responses of *Spartina alterniflora* Loisel. to three levels of NH₄-N, Fe, and NaCl in solution culture. *Botanical Gazette* 137:224-230. (12-329)
- Haines, B.L. and Dunn, E.L. 1985. Coastal salt marshes. In: H.A. Mooney and B.F. Chabot, editors. *Physiological Ecology of North American Plant Communities*. Chapman & Hall, London. p. 323-347. (16-452)

- Haines, E.B. 1976. Stable carbon isotope ratios in the biota, soils, and tidal water of a Georgia salt marsh. *Estuarine and Coastal Marine Science* 4:609-619. (11-307)
- Haines, E.B. 1976. Relation between the stable carbon isotope composition of fiddler crabs, plants and soils in a salt marsh. *Limnology and Oceanography* 21:880-883. (11-310)
- Haines, E.B. 1976. Nitrogen content and acidity of rain on the Georgia coast. *Water Resources Bulletin* 12:1223-1231. (12-313)
- Haines, E.B. 1977. The origin of detritus in Georgia salt marsh estuaries. *Oikos* 29:254-260. (13-334)
- Haines, E.B. 1979. Growth dynamics of cordgrass, *Spartina alterniflora* Loisel., on control and sewage sludge fertilized plots in a Georgia salt marsh. *Estuaries* 2:50-53. (13-346)
- Haines, E.B. 1979. Nitrogen pools in Georgia coastal waters. *Estuaries* 2:34-39. (13-356)
- Haines, E.B. 1979. Interactions between Georgia salt marshes and coastal waters: A changing paradigm. In: R.J. Livingston, editor. *Ecological Processes in Coastal and Marine Systems*. Plenum Press, New York. p. 35-46. (14-382)
- Haines, E.B., Chalmers, A., Hanson, R., and Sherr, B. 1977. Nitrogen pools and fluxes in a Georgia salt marsh. In: M. Wiley, editor. *Estuarine Processes, Vol. II, Circulation, Sediments and Transfer of Material in the Estuary*. Academic Press, Inc., New York. p. 241-254. (11-308)
- Haines, E.B. and Hanson, R.B. 1979. Experimental degradation of detritus made from the salt marsh plants *Spartina alterniflora* Loisel., *Salicornia virginica* L., and *Juncus roemerianus* Scheele. *Journal Experimental Marine Biology and Ecology* 40:27-40. (14-383)
- Haines, E.B. and Montague, C.L. 1979. Food sources of estuarine invertebrates analyzed using $^{13}\text{C}/^{12}\text{C}$ ratios. *Ecology* 60:48-56. (13-360)
- Hall, A.M. and Fritz, W.J. 1984. Armored mud balls from Cabretta and Sapelo Barrier Islands, Georgia. *Journal of Sedimentary Petrology* 54:831-835. (17-496)
- Hanson, R.B. 1977. Comparison of nitrogen fixation activity in tall and short *Spartina alterniflora* salt marsh soils. *Applied and Environmental Microbiology* 33:596-602. (13-332)
- Hanson, R.B. 1977. Nitrogen fixation (acetylene reduction) in a salt marsh amended with sewage sludge and organic carbon and nitrogen compounds. *Applied and Environmental Microbiology* 33:846-852. (13-333)
- Hanson, R.B. 1983. Nitrogen fixation activity (acetylene reduction) in the rhizosphere of salt marsh angiosperms, Georgia, USA. *Botanica Marina* 26:49-59. (16-467)
- Hanson, R.B., Robertson, C.Y., Yoder, J.A., Verity, P.G., and Bishop, S.S. 1990. Nitrogen recycling in coastal waters of southeastern U. S. during summer of 1986. *Journal of Marine Research* 48:641-660. (666)
- Hanson, R.B. and Snyder, J. 1979. Microheterotrophic activity in a salt-marsh estuary, Sapelo Island, Georgia. *Ecology* 60:99-107. (14-369)
- Hanson, R.B. and Snyder, J.S. 1979. Enzymatic determination of glucose in marine environments: Improvement and note of caution. *Marine Chemistry* 7:353-362. (14-388)
- Hanson, R.B. and Snyder, J.S. 1980. Glucose exchanges in a salt marsh estuary: Biological activity and chemical measurement. *Limnology and Oceanography* 25:633-642. (389*)
- Hanson, R.B. and Wiebe, W.J. 1977. Heterotrophic activity associated with particulate size fractions in a *Spartina alterniflora* salt-marsh estuary, Sapelo Island, Georgia U.S.A., and the continental shelf waters. *Marine Biology* 42:321-330. (13-331)
- Harvey, H.R., Fallon, R.D., and Patton, J.S. 1986. The effect of organic matter and oxygen on the degradation of bacterial membrane lipids in marine sediments. *Geochimica et Cosmochimica Acta* 50:795-804. (19-547)
- Harvey, H.R., Fallon, R.D., and Patton, J.S. 1989. Methanogenesis and microbial lipid synthesis in anoxic salt marsh sediments. *Biogeochemistry* 7:111-130. (22 -643)
- Healy, B. 1994. New species of *Marionina* (Annelida:Oligochaeta: Enchytraeidae) from *Spartina* marshes on Sapelo Island, Georgia, USA. *Proceedings of the Biological Society of Washington* 107:164-173. (733)
- Healy, B. and Walters, K. 1994. Oligochaeta in *Spartina* stems: the microdistribution of Enchytraeidae and Tubificidae in a salt marsh, Sapelo Island, USA. *Hydrobiologia* 278:111-123.
- Heard, R.W. 1970. Parasites of the clapper rail, *Rallus longirostris* Boddaert. II. Some trematodes and cestodes from *Spartina* marshes of the eastern United States. *Proceedings Helminthological Society Washington* 37:147-153. (183*)
- Heard, R.W. 1975. Feeding habits of white catfish from a Georgia estuary. *Florida Scientist* 38:20-28. (11-283)
- Heard, R.W., III and Sikora, W. 1971. A new species of *Corophium* Latreille, 1806 (Crustacea:Amphipoda) from Georgia brackish waters with some ecological notes. *Proceedings of the Biological Society of Washington* 84:467-476. (9-218)
- Heard, R.W., III and Sikora, W.B. 1969. *Probolocoryphe otagaki*, 1958 (Trematoda:Microphallidae), a senior synonym of *Mecynophallus* Cable, Connor, and Balling, 1960, with notes on the genus. *Journal of Parasitology* 55:674-675. (7-172)
- Henderson, S.W. and Frey, R.W. 1986. Taphonomic redistribution of mollusk shells in a tidal inlet channel, Sapelo Island, Georgia. *Palaos* 1:3-16. (19-540)
- Henry, V.J., Jr. 1968. Marine science programs at the University of Georgia Marine Institute, Sapelo Island, Georgia. In: D.S. Maney, F.C. Marland and C.B. West, editors. *The Future of the Marshlands and Sea Islands of Georgia*. University of Georgia Marine Institute and Coastal Area Planning and Development Commission, p. 15-17. (175*)

- Henry, V.J., Jr. 1971. Origin of capes and shoals along the southeastern coast of the United States: Reply. *Geological Society of America Bulletin* 82:3541-3542. (9-222)
- Henry, V.J., Jr. and Hoyt, J.H. 1968. Quaternary paralic and shelf sediments of Georgia. *Southeastern Geology* 9:195-214. (6-150)
- Hicks, R.E. and Newell, S.Y. 1982. Gas chromatographic analysis of muramic acid and glucosamine for microbial biomass determinations. University of Georgia Sea Grant Technical Report 82-2 51 p. (466*)
- Hicks, R.E. and Newell, S.Y. 1983. An improved gas chromatographic method for measuring glucosamine and muramic acid concentrations. *Analytical Biochemistry* 128:438-445. (16-471)
- Hicks, R.E. and Newell, S.Y. 1984. A comparison of glucosamine and biovolume conversion factors for estimating fungal biomass. *Oikos* 42:355-360. (17-487)
- Hicks, R.E. and Newell, S.Y. 1984. The growth of bacteria and the fungus *Phaeosphaeria typharum* (Desm.) Holm (Eumycota:Ascomycotina) in salt-marsh microcosms in the presence and absence of mercury. *Journal Experimental Marine Biology and Ecology* 78:143-155. (17-500)
- Ho, H.H., Nakagiri, A., and Newell, S.Y. 1992. A new species of *Halophytophthora* from Atlantic and Pacific subtropical islands. *Mycologia* 84:548-554. (696)
- Hodson, R.E., Benner, R., and Maccubbin, A.E. 1982. Microbial degradation of natural and pollutionally-derived lignocellulosic detritus in wetland ecosystems. In: Tech. Rept. OWRT. 58 p. (479*)
- Hodson, R.E., Benner, R., and Maccubbin, A.E. 1983. Transformations and fate of lignocellulosic detritus in marine environments. In: T.A. Oxley, editor. *Biodeterioration. Volume 5*. John Wiley & Son, p. 185-195. (17-475)
- Hodson, R.E., Christian, R.R., and Maccubbin, A.E. 1984. Lignocellulose and lignin in the salt marsh grass *Spartina alterniflora*: initial concentrations and short-term, post-depositional changes in detrital matter. *Marine Biology* 81:1-7. (18-515)
- Hodson, R.E., Maccubbin, A.E., Benner, R., and Murray, R. 1982. Microbial transformation of detrital carbon in wetland ecosystems. In: J. Larson, editor. *Ecological Aspects of Wetland Treatment of Municipal Wastes*. Univ. Mass. Press, p. 277-297. (17-477)
- Hodson, R.E., Moran, M.A., and Benner, R. 1987. Modeling the persistence of lignocellulosic detritus in wetland ecosystems. In: G.C. Llewellyn and C.E. O'Rear, editors. *Biodeterioration Research Vol. I*. Plenum Publ. Corp., New York. p. 357-374. (20-579)
- Hoese, H.D. 1966. Ectoparasitism by juvenile sea catfish, *Galeichthys felis*. *Copeia* 4:880-881. (5-109)
- Hoese, H.D. 1967. Effect of higher than normal salinities on salt marshes. *Contributions in Marine Science* 12:249-261. (6-120)
- Hoese, R. 1971. Dolphin feeding out of water in a salt marsh. *Journal of Mammalogy* 52:222-223. (9-217)
- Hopkinson, C.S. 1985. Shallow-water benthic and pelagic metabolism: evidence of heterotrophy in the nearshore Georgia Bight. *Marine Biology* 87:19-32. (18-530)
- Hopkinson, C.S. 1987. Nutrient regeneration in shallow-water sediments of the estuarine plume region of the nearshore Georgia Bight, USA. *Marine Biology* 94:127-142. (558)
- Hopkinson, C.S. 1988. Patterns of organic carbon exchange between coastal ecosystems: The mass balance approach in salt marsh ecosystems. In: B.-O. Jansson, editor. *Coastal-Offshore Ecosystems Interactions*. Springer-Verlag, Berlin/Heidelberg. p. 122-154. (20-577)
- Hopkinson, C.S., Day, J.W., and Kjerfve, B. 1985. Ecological significance of summer storms in a shallow water estuarine system. *Contributions in Marine Science* 28:69-77. (18-529)
- Hopkinson, C.S. and Dunn, E.L. 1984. Rapid sampling of organic matter in flooded soils and sediments. *Estuaries* 7:181-184. (17-484)
- Hopkinson, C.S., Fallon, R.D., Jansson, B.O., and Schubauer, J.P. 1991. Community metabolism and nutrient cycling of Gray's Reef, a hard bottom habitat in the Georgia Bight. *Marine Ecology-Progress Series* 73:105-120. (667)
- Hopkinson, C.S. and Hoffman, F.A. 1984. The estuary extended—A recipient-system of estuarine outwelling in Georgia. In: V.S. Kennedy, editor. *The Estuary as a Filter*. Academic Press, New York. p. 313-330. (17-503)
- Hopkinson, C.S. and Schubauer, J.P. 1984. Static and dynamic aspects of nitrogen cycling in the salt marsh graminoid *Spartina alterniflora*. *Ecology* 65:961-969. (17-489)
- Hopkinson, C.S., Sherr, B.F., and Wiebe, W.J. 1989. Size-fractionated metabolism of coastal microbial plankton. *Marine Ecology-Progress Series* 51:155-166. (21-619)
- Hopkinson, C.S. and Wetzel, R.L. 1982. In situ measurements of nutrient and oxygen fluxes in a coastal benthic community. *Marine Ecology-Progress Series* 10:29-35. (16-462)
- Hopkinson, C.S., Wetzel, R.L., and Day, J.W. 1988. Simulation models of coastal wetland and estuarine systems: Realization of goals. In: W.J. Mitsch, M. Straskraba and S. Jorgensen, editors. *Wetland Modelling*. Elsevier Science Publishers B. V., Amsterdam. p. 67-97. (20-582)
- Hopkinson, C.S., Jr. 1989. The Upland/Estuary/Nearshore couple. In: *Barrier Island/Salt Marsh Estuaries, Southeast Atlantic Coast: Issues, Resources, Status, and Management*. NOAA Estuary-of-the-Month Seminar Series No. 12, p. 77-87. (21-607)

- Howard, J.D. 1968. X-ray radiography for examination of burrowing in sediments by marine invertebrate organisms. *Sedimentology* 11:249-258. (7-164)
- Howard, J.D. 1969. Depositional control of Upper Cretaceous coal units. *The Mountain Geologist* 6:143-146. (7-177)
- Howard, J.D. 1969. Radiographic examination of variations in barrier island facies: Sapelo Island, Georgia. *Transactions-Gulf Coast Association of Geological Societies* 19:217-232. (7-181)
- Howard, J.D. 1971. Comparison of the beach-to-offshore sequence in modern and ancient sediments. In: *Recent Advances in Paleoeecology and Ichnology* AGI Short Course Lecture Notes. p. 149-182. (240*)
- Howard, J.D. 1971. Trace fossils in paleoecological tools. In: *Recent Advances in Paleoeecology and Ichnology* AGI Short Course Lecture Notes. p. 183-212. (241*)
- Howard, J.D. 1971. Amphipod bioturbate textures in Recent and Pleistocene beach sediments. In: *Recent Advances in Paleoeecology and Ichnology* AGI Short Course Lecture Notes. p. 213-223. (242*)
- Howard, J.D. 1971. Trace fossils as criteria for recognizing shorelines as stratigraphic record. In: J.K. Rigby and W.K. Hamblin, editors. *Recognition of Ancient Sedimentary Environments*. Volume 16. SEPM Sp. Publ., p. 215-225. (9-226)
- Howard, J.D. and Edlers, C.A. 1971. Burrowing patterns of haustoriid amphipods from Sapelo Island, Georgia. In: T.P. Crimes and J.C. Harper, editors. *Trace Fossils*. Seel House Press, Liverpool. p. 243-262. (193*)
- Howard, J.D. and Frey, R.W. 1973. Characteristic physical and biogenic sedimentary structures in Georgia estuaries. *Bulletin of the American Association of Petroleum Geologists* 57:1169-1184. (10-264)
- Howard, J.D. and Frey, R.W. 1975. Estuaries of the Georgia coast, U.S.A.: Sedimentology and biology. I. Introduction. *Senckenbergiana Maritima* 7:1-31. (12-323)
- Howard, J.D. and Frey, R.W. 1975. Estuaries of the Georgia coast, U.S.A.: Sedimentology and biology. II. Regional animal-sediment characteristics of Georgia estuaries. *Senckenbergiana Maritima* 7:33-103. (12-324)
- Howard, J.D. and Frey, R.W. 1980. Physical and biogenic processes in Georgia estuaries. In: S.B. McCann, editor. *Sedimentary Processes and Animal-Sediment Relationships in Tidal Environments*. Geological Association of Canada, Short Course, p. 153-182. (409*)
- Howard, J.D. and Frey, R.W. 1980. Physical and biogenic processes in Georgia estuaries. III. Vertical sequences. In: S.B. McCann, editor. *Sedimentary Processes and Animal-Sediment Relationships in Tidal Environments*. Geological Association of Canada, Short Course, p. 221-232. (411*)
- Howard, J.D. and Frey, R.W. 1980. Holocene depositional environments of the Georgia coast and continental shelf. In: J.D. Howard, C.B. DePratter and R.W. Frey, editors. *Excursions in Southeastern Geology: The Archaeology-Geology of the Georgia Coast*, Vol. 20. Georgia Geological Survey Guidebook, p. 66-134. (417*)
- Howard, J.D. and Frey, R.W. 1985. Physical and biogenic aspects of backbarrier sedimentary sequences, Georgia coast, U.S.A. *Marine Geology* 63:77-127. (18-511)
- Howard, J.D., Frey, R.W., and Reineck, H.E. 1972. Georgia coastal region, Sapelo Island, U.S.A.: Sedimentology and biology. IV. Physical and biogenic sedimentary structures of the nearshore shelf. *Senckenbergiana Maritima* 4:81-123. (251*)
- Howard, J.D., Frey, R.W., and Reineck, H.E. 1973. Holocene sediments of the Georgia coastal area. In: R.W. Frey, editor. *The Neogene of the Georgia Coast*. Univ. Ga., Dept. Geol., Guidebook, 8th Ann. Ga. Geol. Soc. Field Trip, p. 1-58. (10-268)
- Howard, J.D. and Henry, V.J., Jr. 1966. Sampling device for semiconsolidated and unconsolidated sediments. *Journal of Sedimentary Petrology* 36:818-820. (5-104)
- Howard, J.D. and Henry, V.J., Jr. 1967. Use of X-radiography in the study of bioturbate textures. Preprint, 7th International Sedimentological Congress:4p. (6-144)
- Howarth, R.W. and Giblin, A. 1983. Sulfate reduction in the salt marshes at Sapelo Island, Georgia. *Limnology and Oceanography* 28:70-82. (17-509)
- Howarth, R.W. and Marino, R. 1984. Sulfate reduction in salt marshes, with some comparisons to sulfate reduction in microbial mats. In: Y. Cohen, R.W. Castenholz and H.O. Halvorson, editors. *Microbial Mats: Stromatolites*. Alan R. Liss, New York. p. 245-263. (18-523)
- Howarth, R.W. and Merkel, S. 1984. Pyrite formation and the measurement of sulfate reduction in salt marsh sediments. *Limnology and Oceanography* 29:598-608. (18-525)
- Hoyt, J.H. 1962. High angle beach stratification, Sapelo Island, Georgia. *Journal of Sedimentary Petrology* 32:309-311. (3-41)
- Hoyt, J.H. 1966. Air and sand movements to the lee of dunes. *Sedimentology* 7:137-143. (6-115)
- Hoyt, J.H. 1967. Barrier island formation. *Geological Society of America Bulletin* 78:1125-1136. (6-128)
- Hoyt, J.H. 1967. Occurrence of high-angle stratification in littoral and shallow neritic environments, central Georgia coast, U.S.A. *Sedimentology* 8:229-238. (6-131)
- Hoyt, J.H. 1967. Intercontinental correlation of late Pleistocene sea levels. *Nature* 215:612-614. (6-132)
- Hoyt, J.H. 1967. Review of "Processes of Coastal Development" by V. P. Zenkovich. *Journal of Geology* 76:606-607. (6-153)
- Hoyt, J.H. 1967. Theory of barrier island facies association. In: Preprint, 7th International Sedimentological Congress., p. 1-4. (6-134)

- Hoyt, J.H. 1968. Barrier island formation: Reply. *Geological Society of America Bulletin* 79:947. (6-147)
- Hoyt, J.H. 1968. Barrier island formation: Reply. *Geological Society of America Bulletin* 79:1427-1432. (6-152)
- Hoyt, J.H. 1968. Geology of the Golden Isles and lower Georgia coastal plain. **In:** D.S. Maney, F.C. Marland and C.B. West, editors. *The Future of the Marshlands and Sea Islands of Georgia*. University of Georgia Marine Institute and Coastal Area Planning and Development Commission, P. 18-34. (166*)
- Hoyt, J.H. 1968. Genesis of sedimentary deposits along coasts of submergence. **In:** XXIII International Geological Congress, Vol. 8., P. 311-321. (6-146)
- Hoyt, J.H. 1969. Chenier versus barrier, genetic and stratigraphic distinction. *American Association of Petroleum Geologists* 53:299-306. (7-165)
- Hoyt, J.H. 1969. Late Cenozoic structural movements, northern Florida. *Transactions of the Gulf Coast Association Geological Society* 19:1-9. (7-178)
- Hoyt, J.H. 1970. Development and migration of barrier islands, northern Gulf of Mexico: Discussion. *Geological Society of America Bulletin* 81:3779-3782. (8-202)
- Hoyt, J.H. 1971. Field Guide to Beaches. Houghton Mifflin Co., Boston 46 p. (190*)
- Hoyt, J.H. 1972. Shoreline processes. *Journal of Geological Education* 10:16-22. (8-198)
- Hoyt, J.H. and Hails, J.R. 1967. Pleistocene and shoreline sediments in coastal Georgia: Deposition and modification. *Science* 155:1541-1543. (6-125)
- Hoyt, J.H. and Hails, J.R. 1967. Pleistocene shorelines in a relatively stable area, southeastern Georgia, U.S.A. *Giornale di Geologia* XXXV:105-117. (7-133)
- Hoyt, J.H. and Hails, J.R. 1971. Regional distortions along the southeastern United States coast. *Quaternaria* 15:51-63. (187)
- Hoyt, J.H. and Hails, J.R. UNKNOWN YEAR. Pleistocene stratigraphy of southeastern Georgia. *Geological Society of America Bulletin*. (130*)
- Hoyt, J.H. and Henry, V.J., Jr. 1963. Rhomboid ripple mark, indicator of current direction and environment. *Journal of Sedimentary Petrology* 33:604-608. (4-59)
- Hoyt, J.H. and Henry, V.J., Jr. 1963. Development and geologic significance of soft beach sand. *Sedimentology* 3:44-51. (4-65)
- Hoyt, J.H. and Henry, V.J., Jr. 1967. Influence of island migration on barrier island sedimentation. *Geological Society of America Bulletin* 78:77-86. (6-116)
- Hoyt, J.H. and Henry, V.J., Jr. 1971. Origin of capes and shoals along the southeastern coast of the United States. *Geological Society of America Bulletin* 82:59-66. (8-208)
- Hoyt, J.H., Henry, V.J., Jr., and Weimer, R.J. 1968. Age of late-Pleistocene shoreline deposits, coastal Georgia. **In:** R.B. Morrison and H.E. Wright Jr., editors. *Means of Correlation of Quaternary Successions*. University of Utah Press, Salt Lake City. P. 381-393. (6-107)
- Hoyt, J.H., Howard, J.D., and Henry, V.J., Jr. 1966. Pleistocene and Holocene Sediments, Sapelo Island, Georgia and Vicinity. *Geological Society of America, Southeastern Section Guidebook* 78 p. (105)
- Hoyt, J.H. and Weimer, R.J. 1963. Comparison of modern and ancient beaches, central Georgia coast. *Bulletin of the American Association of Petrology and Geology* 47:529-531. (4-50)
- Hoyt, J.H., Weimer, R.J., and Henry, V.J., Jr. 1964. Late pleistocene and recent sedimentation, central Georgia coast, U.S.A. **In:** L.M.U. Van Stratten, editor. *Developments in Sedimentology, Vol. 1, Deltaic and Shallow Marine Deposits*. Elsevier Publ. Co., Amsterdam. P. 170-176. (4-46)
- Hughes, E.H. and Sherr, E.B. 1983. Subtidal food webs in a Georgia estuary: ¹³C analysis. *Journal Experimental Marine Biology and Ecology* 67:227-242. (16-472)
- Imberger, J., Berman, T., Christian, R.R., Sherr, E.B., Whitney, D.E., Pomeroy, L.R., Wiegert, R.G., and Wiebe, W.J. 1983. Influence of water motion on the distribution and transport of materials in a salt marsh estuary. *Limnology and Oceanography* 28:201-214. (398*)
- Incze, L.S., Mayer, L.M., Sherr, E.B., and Macko, S.A. 1982. Carbon inputs to bivalve mollusks: a comparison of two estuaries. *Canadian Journal of Fisheries and Aquatic Sciences* 39:1348-1352. (16-464)
- Jacobs, J. 1968. Animal behaviour and water movement as co-determinants of plankton distribution in a tidal system. *Sarsia* 34:355-370. (6-141)
- Johannes, R. 1965. Influence of marine protozoa on nutrient regeneration. *Limnology and Oceanography* 10:434-442. (5-85)
- Johannes, R.E. 1964. Phosphorus excretion and body size in marine animals; microzooplankton and nutrient regeneration. *Science* 146:923-924. (4-68)
- Johannes, R.E. 1968. Nutrient regeneration in lakes and oceans. **In:** C.M. Droop and E.J.F. Wood, editors. *Advances in Marine Microbiology*. Academic Press, Inc., New York. P. 203-213. (6-145)
- Johannes, R.E., Coward, S.J., and Webb, K.L. 1969. Are dissolved amino acids an energy source for marine invertebrates? *Comparative Biochemistry and Physiology* 29:283-288. (7-167)
- Johannes, R.E. and Satomi, M. 1966. Composition and nutritive value of fecal pellets of a marine crustacean. *Limnology and Oceanography* 11:191-197. (5-106)

- Johannes, R.E. and Satomi, M. 1967. Measuring organic matter retained by aquatic invertebrates. *Journal of the Fisheries Research Board of Canada* 24:2467-2471. (6-140)
- Johannes, R.E. and Webb, K.L. 1965. Release of dissolved amino acids by marine zooplankton. *Science* 150:76-77. (5-93)
- Johannes, R.E. and Webb, K.L. 1969. Release of dissolved organic compound by marine and freshwater invertebrates. In: *Organic Matter in Natural Waters*. Univ. of Alaska. Pergamon Press. Virginia Inst. of Mar. Sci., Gloucester Point, Va., p. 257-273. (8-160)
- Johnson, A.S., Hillestad, H.O., Fanning, S., and Shanholtzer, G.F. 1974. An ecological survey of the coastal region of Georgia. National Park Service Report, U.S. Gov't Printing Office, Washington, D.C. 233 p. (256*)
- Kale, H.W. and Teal, J.M. 1958. Royal tern nesting on Little Egg Island. *The Oriole* 23:36-37. (1-7B)
- Kale, H.W., II. 1964. Nesting of purple martins aboard a ship. *Wilson Bulletin* 76:62-67. (4-56)
- Kale, H.W., II. 1964. Food of the long-billed marsh wren, *Telmatodytes palustris griseus*, in the salt marshes of Sapelo Island, Georgia. *The Oriole* 29:47-66. (5-81)
- Kale, H.W., II. 1965. Ecology and bioenergetics of the long-billed marsh wren, *Telmatodytes palustris griseus*, in a salt marsh ecosystem. Nuttall Ornithological Club No. 5016 142 p. (75*)
- Kale, H.W., II. 1966. Plumage and molts in the long-billed marsh wren. *The Auk* 83:140-141. (5-82)
- Kale, H.W., II. 1967. Water sources of the long-billed marsh wren in Georgia salt marshes. *The Auk* 84:589-591. (6-137)
- Kale, H.W., II. 1967. Recoveries of black skimmers banded on Little Egg Island, Georgia. *The Oriole* 32:13-16. (6-138)
- Kale, H.W., II and Hyypio, P.A. 1966. Additions to the birds of Sapelo Island and vicinity. *The Oriole* 31:1-11. (5-103)
- Kale, H.W., II, Sciple, G.W., and Tomkins, I.R. 1965. The royal tern colony of Little Egg Island, Georgia. *Bird Banding* 36:21-27. (4-64)
- Karkhanis, Y.D. and Cormier, M.J. 1971. Isolation and properties of *Renilla reniformis* luciferase, a low molecular weight energy conversion enzyme. *Biochemistry* 10:317-326. (8-210)
- Kemp, P.F. 1986. Direct uptake of detrital carbon by the deposit-feeding polychaete *Euzonus mucronata* (Treadwell). *Journal Experimental Marine Biology and Ecology* 99:49-61. (19-551)
- Kemp, P.F. 1987. Potential impact on bacteria of grazing by a macrofaunal deposit-feeder, and the fate of bacterial production. *Marine Ecology-Progress Series* 36:151-161. (20-569)
- Kemp, P.F. 1988. Bacterivory by benthic ciliates: Significance as a carbon source and impact on sediment bacteria. *Marine Ecology-Progress Series* 49:163-169. (21-611)
- Kemp, P.F. 1990. The fate of benthic bacterial production. *Reviews in Aquatic Science* 2:109-124. (21-617)
- Kemp, P.F., Newell, S.Y., and Hopkinson, C.S. 1990. Importance of grazing on the salt-marsh grass *Spartina alterniflora* to nitrogen turnover in a macrofaunal consumer, *Littorina irrorata*, and to decomposition of standing-dead *Spartina*. *Marine Biology* 104:311-319. (22-645)
- Kemp, P.F., Newell, S.Y., and Krambeck, C. 1990. Effects of filter-feeding by the ribbed mussel *Geukensia demissa* on the water-column microbiota of a *Spartina alterniflora* saltmarsh. *Marine Ecology-Progress Series* 59:119-131. (22-642)
- Kemp, P.F. and Swartz, R.C. 1988. Acute toxicity of interstitial and particle-bound cadmium to a marine infaunal amphipod. *Marine Environmental Research* 26:135-153. (21-618)
- Kiene, R.P. 1990. Dimethyl sulfide production from dimethylsulfoniopropionate in coastal seawater samples and bacterial cultures. *Applied and Environmental Microbiology* 56:3292-3297. (22-658)
- Kiene, R.P. 1991. Evidence for the biological turnover of thiols in anoxic marine sediments. *Biogeochemistry* 13:117-135. (668)
- Kiene, R.P. 1991. Production and consumption of methane in aquatic systems. In: J.E. Rogers and W.B. Whitman, editors. *Microbial Production and Consumption of Greenhouse Gases: Methane, Nitrogen, Oxides, and Halomethanes*. American Society Microbiology, Washington, D. C. (669)
- Kiene, R.P. 1992. Dynamics of dimethyl sulfide and dimethylsulfoniopropionate in oceanic water samples. *Marine Chemistry* 37:29-52. (685)
- Kiene, R.P. In press. Microbial cycling of organosulfur gases in marine and freshwater environments. In: D. Adams, P. Crill and S. Seitzinger, editors. *Cycling of reduced gases in the hydrosphere*. Stuttgart. (662)
- Kiene, R.P. 1993. Measurement of dimethylsulfide (DMS) and dimethylsulfoniopropionate (DMSP) in seawater and estimation of DMS turnover rates. In: P.F. Kemp, B.F. Sherr, E.B. Sherr and J.J. Cole, editors. *Handbook of methods in aquatic microbial ecology*. Lewis Pubs., Boca Raton, FL.. p. 601-610. (701)
- Kiene, R.P. 1993. Microbial sources and sinks for methylated sulfur compounds in the marine environment. In: J.C. and D. P. Kelly, editors. *Microbial Growth on C1 Compounds*. Intercept Ltd., Andover England. p. 15-33. (714)
- Kiene, R.P. and Bates, T.S. 1990. Biological removal of dimethyl sulphide from sea water. *Nature* 345:702-705. (22-653)
- Kiene, R.P., Malloy, K.D., and Taylor, B.F. 1990. Sulfur-containing amino acids as precursors of thiols in anoxic coastal sediments. *Applied and Environmental Microbiology* 56:156-161. (22-644)
- Kiene, R.P. and Service, S.K. 1991. Decomposition of dissolved DMSP and DMS in estuarine waters: dependence on temperature and substrate concentration. *Marine Ecology-Progress Series* 76:1-11. (683)

- Kiene, R.P. and Service, S.K. 1993. The influence of glycine betaine on dimethyl sulfide and dimethylsulfoniopropionate concentrations in seawater. In: R.S. Oremland, editor. *The Biogeochemistry of Global Change: Radiatively Active Trace Gases*. Chapman and Hall, New York. p. 654-671. (710)
- Kiene, R.P. and Taylor, B.F. 1988. Demethylation of dimethylsulfoniopropionate and production of thiols in anoxic marine sediments. *Applied and Environmental Microbiology* 54:2208-2212. (21- 609)
- Kiene, R.P. and Taylor, B.F. 1989. Metabolism of acrylate and 3-mercaptopropionate, decomposition products of dimethylsulfoniopropionate, in anoxic marine sediments. In: E. Saltzman and W. Cooper, editors. *Biogenic Sulfur in the Environment*. ACS Symposium Series, American Chemical Society, Washington, D. C. P. 222-229. (21-622)
- King, G., Klug, M., Wiegert, R.G., and Chalmers, A.G. 1982. Relation of soil water movement and sulfide concentration to *Spartina alterniflora* productivity in a Georgia salt marsh. *Science* 218:61-63. (16-470)
- King, G.M., Berman, T., and Wiebe, W.J. 1981. Methane formation in acidic peats of Okefenokee Swamp, Georgia. *American Midland Naturalist* 105:386-389. (15-414)
- King, G.M. and Wiebe, W.J. 1978. Methane release from soils of a Georgia salt marsh. *Geochimica et Cosmochimica Acta* 42:343-348. (343*)
- King, G.M. and Wiebe, W.J. 1980. Regulation of sulfate concentration in methanogenesis in salt marsh soil. *Estuarine and Coastal Marine Science* 10:215-223. (397*)
- King, G.M. and Wiebe, W.J. 1980. Trace analysis of methanogenesis in salt marsh soils. *Applied and Environmental Microbiology* 39:877-881. (15-413)
- Kirchman, D. and Hodson, R.E. 1984. Inhibition by peptides of amino acid uptake by bacterial populations in natural waters: implications for the regulation of amino acid transport and incorporation. *Applied and Environmental Microbiology* 47:624-631. (17-506)
- Kirchman, D., K'nees, E., and Hodson, R.E. 1985. Leucine incorporation and its potential as a measure of protein synthesis by bacteria in natural aquatic systems. *Applied and Environmental Microbiology* 49:599-607. (19-532)
- Kneib, R.T. 1981. Reanalysis of conversion efficiencies for larval *Fundulus heteroclitus*. *Marine Biology* 63:213-215. (15-422)
- Kneib, R.T. 1981. Size-specific effects of density on the growth, fecundity and mortality of the fish *Fundulus heteroclitus* in an intertidal salt marsh. *Marine Ecology-Progress Series* 6:203-212. (15-436)
- Kneib, R.T. 1982. The effects of predation by wading birds (*Ardeidae*) and blue crabs (*Callinectes sapidus*) on the population size structure of the common mummichog, *Fundulus heteroclitus*. *Estuarine, Coastal and Shelf Science* 14:159-165. (15-431)
- Kneib, R.T. 1982. Habitat preference, predation, and intertidal distribution of gammaridean amphipods in a North Carolina salt marsh. *Journal Experimental Marine Biology and Ecology* 59:219-230. (15-437)
- Kneib, R.T. 1984. Patterns in the utilization of the intertidal salt marsh by larvae and juveniles of *Fundulus heteroclitus* (Linnaeus) and *Fundulus luciae* (Baird). *Journal Experimental Marine Biology and Ecology* 83:41-51. (18-518)
- Kneib, R.T. 1984. Patterns of invertebrate distribution and abundance in the intertidal salt marsh: causes and questions. *Estuaries* 7:392-412. (18-522)
- Kneib, R.T. 1985. Predation and disturbance by grass shrimp, *Palaemonetes pugio* Holthuis, in soft-substratum benthic invertebrate assemblages. *Journal Experimental Marine Biology and Ecology* 93:91-102. (19-542)
- Kneib, R.T. 1986. The role of *Fundulus heteroclitus* in salt marsh trophic dynamics. *American Zoologist* 26:259-269. (18-514)
- Kneib, R.T. 1986. Size-specific patterns in the reproductive cycle of the killifish, *Fundulus heteroclitus* (Pisces: Fundulidae) from Sapelo Island, Georgia. *Copeia* 1986:342-351. (19-534)
- Kneib, R.T. 1987. Predation risk and use of intertidal habitats by young fishes and shrimp. *Ecology* 68:379-386. (20-557)
- Kneib, R.T. 1988. Testing for indirect effects of predation in an intertidal soft-bottom community. *Ecology* 69:1795-1805. (21-604)
- Kneib, R.T. 1991. Flume weir for the quantitative collection of nekton from vegetated intertidal habitats. *Marine Ecology-Progress Series* 75:29-38. (681)
- Kneib, R.T. 1991. Indirect effects in experimental studies of marine soft-sediment communities. *American Zoologist* 31:874-885. (673)
- Kneib, R.T. 1992. Population dynamics of the tanaid *Hargeria rapax* (Crustacea:Peracarda) in a tidal marsh. *Marine Biology* 113:437-445. (692)
- Kneib, R.T. 1993. Growth and mortality in successive cohorts of fish larvae within an estuarine nursery. *Marine Ecology-Progress Series* 94:115-127. (720)
- Kneib, R.T. 1994. Spatial pattern, spatial scale, and feeding in fishes. In: D. Stouder and K. Fresh, editors. *Theory and application in fish feeding ecology*. University of South Carolina Press, Columbia, SC. P. 171-185. (722)
- Kneib, R.T. 1995. Behaviour separates potential and realized effects of decapod crustaceans in salt marsh communities. *Journal of Experimental Marine Biology and Ecology* (761) 193:239-256. (761)
- Kneib, R.T. 1996. Abstracts of research reports from the University of Georgia Marine Institute Student Intern Programs, 1992-1995. *Georgia Journal of Science* 54:211-218. (771)
- Kneib, R.T. 1996. The University of Georgia Marine Institute. *Georgia Journal of Science* 54:201-209. (777)
- Kneib, R.T. In Press. Early life stages of resident nekton in intertidal marshes. *Estuaries*. . (783)

- Kneib, R.T. and Knowlton, M.K. 1995. Stage-structured interactions between seasonal and permanent residents of an estuarine nekton community. *Oecologia* 103:425-434. (764)
- Kneib, R.T. and Parker, J.H. 1991. Gross conversion efficiencies of mummichog and spotfin killifish larvae from a Georgia salt marsh. *Transactions of the American Fisheries Society* 120:803-809. (678)
- Kneib, R.T. and Stiven, A.E. 1980. Stable carbon isotope ratios in *Fundulus heteroclitus* (L.) muscle tissue and gut contents from a North Carolina *Spartina* salt marsh. *Journal Experimental Marine Biology and Ecology* 46:89-98. (15-408)
- Kneib, R.T. and Stiven, A.E. 1982. Benthic invertebrate responses to size and density manipulations of the common mummichog, *Fundulus heteroclitus* (L.) in an intertidal salt marsh. *Ecology* 63:1518-1532. (16-446)
- Kneib, R.T. and Wagner, S.L. 1994. Nekton use of vegetated marsh habitats at different stages of tidal inundation. *Marine Ecology Progress Series* 106:227-238. (742)
- Kneib, R.T. and Weeks, C.A. 1990. Intertidal distribution and feeding habits of the mud crab, *Eurytium limosum*. *Estuaries* 13:462-468. (22-650)
- Kneib, T.R. 1987. Seasonal abundance, distribution and growth of postlarval and juvenile grass shrimp (*Palaemonetes pugio*) in a Georgia, USA, salt marsh. *Marine Biology* 96:215-223. (20-576)
- Kopell, G. 1993. On the diets of calanoid copepods. *Marine Ecology Progress Series* 99:183-195. (730)
- Kraeuter, J. 1974. Offshore currents, larval transport, and establishment of southern populations of *Littorina littorea* Linne along the U.S. Atlantic coast. *Thalassia Jugoslavica* 10:159-170. (11-294)
- Kraeuter, J. 1976. Biodeposition by salt-marsh invertebrates. *Marine Biology* 35:215-223. (11-295)
- Kraeuter, J. and Setzler, E. 1975. The seasonal cycle of *Scyphozoa* and *Cubozoa* in Georgia estuaries. *Bulletin of Marine Science* 25:66-74. (11-280)
- Kraeuter, J.N. 1972. Dentaliid taxa referred to the *Siphonodentaliidae* (Mollusca:Scaphopoda) with a description of a new species. *The Veliger* 15:21-28. (9-247)
- Kraeuter, J.N. 1973. *Pycnogonida* from Georgia. *Journal of Natural History* 7:493-498. (9-232)
- Kraeuter, J.N. 1973. Notes on mollusks *Ostrea* and *Siphonaria* from Georgia (U.S.A.). *Nautilus* 87:75-77. (10-267A)
- Kraeuter, J.N. and Thomas, R.F. 1975. Cephalopod mollusks from the waters off Georgia, U.S.A. *Bulletin of Marine Science* 25:301-303. (11-286B)
- Kraeuter, J.N. and Wolf, P.L. 1974. The relationship of marine macroinvertebrates to salt marsh plants. In: R.J. Reimold and W.H. Queen, editors. *Ecology of Halophytes*. Academic Press, Inc., New York. P. 449-462. (10-259)
- Krambeck, C., Krambeck, H.J., Schroder, D., and Newell, S.Y. 1990. Sizing bacterioplankton: a juxtaposition of bias due to shrinkage, halos subjectivity in image interpretation and asymmetric distributions. *Binary* 2:11-20. (22-652)
- Kreiss, P. and Cormier, M.J. 1967. Inhibition of *Renilla reniformis* bioluminescence by light: Effects on luciferase and its substrates. *Biochimica et Biophysica Acta* 141:181-183. (6-129)
- Kudela, R., Covi, M., Robinson, J., Babin, M., Berchok, C.L., Reynolds, K., Gaylor, M.O., Gran, J.E., Griffin, C.A., Hagy, J.D., III, Poteet, M.F., Wagner, S.L., and Rejwan, C. 1991. Research reports presented to The University of Georgia Marine Institute Student Intern Program, 1987-1991. *Georgia Journal of Science* 49:162-168. (716)
- Kuenzler, E.J. 1961. Structure and energy flow of a mussel population in a Georgia salt marsh. *Limnology and Oceanography* 6:191-204. (2-28)
- Kuenzler, E.J. 1961. Phosphorus budget of a mussel population. *Limnology and Oceanography* 6:400-415. (2-32)
- Kurata, H., Heard, R.W., and Martin, J.W. 1981. Larval development under laboratory conditions of the xanthid mud crab *Eurytium limosum* (Say, 1818) (Brachyura:Xanthidae) from Georgia. *Gulf Research Reports* 7:19-25. (15-424)
- Land, L.S. 1964. Eolian cross-bedding in the beach dune environment, Sapelo Island, Georgia. *Journal of Sedimentary Petrology* 34:389-394. (4-57)
- Land, L.S. and Hoyt, J.H. 1966. Sedimentation in a meandering estuary. *Sedimentology* 6:191-207. (5-78)
- Lauff, G.H. 1961. Limnological relationships. The role of limnological factors in the availability of algal nutrients. In: *Algae and Metropolitan Wastes Trans. 1960 Seminar*, U. S. Public Health Service, R. A. Taft Sanitary Eng. Center, Cincinnati. P. 96-99. (2-22)
- Lee, S.Y. and Kneib, R.T. 1994. Effects of biogenic structure on prey consumption by the xanthid crabs *Eurytium limosum* and *Panopeus herbstii* in a salt marsh. *Marine Ecology Progress Series* 104:39-47. (738)
- Letzsch, W.S. 1983. Seven year's measurement of deposition and erosion, Holocene salt marsh, Sapelo Island, Georgia. *Senckenbergiana Maritima* 15:157-165. (18-510)
- Letzsch, W.S. and Frey, R.W. 1980. Organic carbon in a Holocene salt marsh, Sapelo Island, Georgia. *Georgia Journal of Science* 39:15-23. (15-405)
- Letzsch, W.S. and Frey, R.W. 1980. Erosion of salt marsh tidal creek banks, Sapelo Island, Georgia. *Senckenbergiana Maritima* 12:201-212. (15-406)
- Letzsch, W.S. and Frey, R.W. 1980. Deposition and erosion in a Holocene salt marsh, Sapelo Island, Georgia. *Journal of Sedimentary Petrology* 50:529-542. (15-407)
- Leuchtmann, A. and Newell, S.Y. 1991. *Phaeosphaeria spartinicola*, a new species on *Spartina*. *Mycotaxon* XLI:1-7. (22-663)
- Linton, T.L. 1968. Proceedings of Oyster Culture Workshop. In: *University of Georgia Marine Institute and Georgia Game and Fish. Volume 83 p., . (156*)*

- Linton, T.L. 1969. Feasibility study of methods of improving oyster production in Georgia. In: . University of Georgia Marine Institute and Georgia Game and Fish Commission, . (172 p.)
- Linton, T.L. and Rickards, W.L. 1965. Young common snook on the coast of Georgia. Quarterly Journal of the Florida Academy of Sciences 28:185-189. (5-92)
- Maccubbin, A.E., Benner, R., and Hodson, R.E. 1983. Interactions between pulp mill effluents and microbial populations in coastal waters and sediments. In: T.A. Oxley, editor. *Biodeterioration*. Volume 5. John Wiley & Son, P. 246-256. (17-476)
- Maccubbin, A.E. and Hodson, R.E. 1980. Mineralization of detrital lignocelluloses by salt marsh sediment microflora. Applied and Environmental Microbiology 40:735-740. (15-420)
- Maney, D.S., Marland, F.C., and West, C.L. 1968. Conference on the Future of the Marshlands and Sea Islands of Georgia. Published by University of Georgia Marine Institute and Coastal Area Planning and Development Commission 128 p. (176*)
- Marcus, E. and Marcus, E. 1967. Some opisthobranchs from Sapelo Island, Georgia, U.S.A. Malacologia 6:199-222. (6-143)
- Marland, F.C. 1968. The impending crisis—phosphate mining off the Georgia coast. In: D.S. Maney, F.C. Marland and C.B. West, editors. The Future of the Marshlands and Sea Islands of Georgia. University of Georgia Marine Institute and Coastal Area Planning and Development Commission, P. 55-58. (174*)
- Marples, T. 1966. A radionuclide tracer study of arthropod food chains in a *Spartina* salt marsh ecosystem. Ecology 47:270-277. (5-89)
- Martof, B.S. 1963. Some observations on the herpetofauna of Sapelo Island, Georgia. Herpetologica 19:70-72. (3-42)
- Mishima, J. and Odum, E.P. 1963. Excretion rate of ⁶⁵Zn by *Littorina irrorata* in relation to temperature and body size. Limnology and Oceanography 8:39-44. (4-49)
- Montague, C.L. 1980. A natural history of temperate western Atlantic fiddler crabs (genus *Uca*) with reference to their impact on the salt marsh. Contributions in Marine Science 23:25-55. (15-416)
- Montague, C.L. 1982. The influence of fiddler crab burrows and burrowing on metabolic processes in salt marsh sediments. In: V.S. Kennedy, editor. Estuarine Comparisons. Academic Press, New York. P. 283-301. (16-453)
- Moore, J.N., Fritz, W.J., and Futch, R.S. 1984. Occurrence of megaripples in a ridge and runnel system, Sapelo Island, Georgia: Morphology and processes. Journal of Sedimentary Petrology 54:615-625. (17-490)
- Moran, M.A., Benner, R., and Hodson, R.E. 1989. Kinetics of microbial degradation of vascular plant material in two wetland ecosystems. Oecologia 79:158-167. (22-629)
- Moran, M.A. and Hodson, R.E. 1989. Formation and bacterial utilization of dissolved organic carbon derived from detrital lignocellulose. Limnology and Oceanography 34:1034-1047. (22-634)
- Moran, M.A. and Hodson, R.E. 1990. Contributions of degrading *Spartina alterniflora* lignocellulose to the dissolved organic carbon pool of a salt marsh. Marine Ecology-Progress Series 62:161-168. (22-646)
- Moran, M.A. and Hodson, R.E. 1994. Dissolved humic substances of vascular plant origin in a coastal marine environment. Limnology and Oceanography 39:762-771. (757)
- Moran, M.A., Pomeroy, L.R., Sheppard, L.S., Atkinson, L.P., and Hodson, R.E. 1991. Distribution of terrestrially derived dissolved organic matter on the southeastern U. S. Continental shelf. Limnology and Oceanography 36:1134-1149. (691)
- Moran, M.A., Rutherford, L.T., and Hodson, R.E. 1995. Evidence for indigenous *Streptomyces* populations in a marine environment determined with a 16S rRNA Probe. Applied and Environmental Microbiology 61:3695-3700. (769)
- Moran, M.A., Torsvik, V.L., Torsvik, T., and Hodson, R.E. 1993. Direct extraction and Purification of rRNA for ecological studies. Applied and Environmental Microbiology 59:915-918. (723)
- Munson, D.A. 1992. Marine amoebae from Georgia coastal surface waters. Transactions of the American Microscopical Society 111:360-364. (731)
- Nakagiri, A., Newell, S.Y., Ito, T., and Tan, T.K. In Press. Biodiversity and Ecology of the Oomycetous fungus, *Halophytophthora*. In: I.M. Turner, C.H. Diong, S.S.L. Lim and P.K.L. Ng, editors. *Biodiversity and the Dynamics of Ecosystems*. Volume 1. Diwpa, Singapore. (782)
- Nelson, D.J. 1960. Improved chlorophyll extraction method. Science 132:351. (2-23)
- Nestler, J. 1977. A preliminary study of the sediment hydrology of a Georgia salt marsh using Rhodamine WT as a tracer. Southeastern Geology 18:265-271. (12-317)
- Nestler, J. 1977. Interstitial salinity as a cause of ecophenic variation in *Spartina alterniflora*. Estuarine and Coastal Marine Science 5:707-714. (12-318)
- Newell, S.Y. 1984. Modification of the gelatin-matrix method for enumeration of respiring bacterial cells for use with salt-marsh water samples. Applied and Environmental Microbiology 47:873-875. (17-504)
- Newell, S.Y. 1984. Bacterial and fungal productivity in the marine environment: a contrastive overview. In: International Colloquium for Marine Bacteriology, Marseille, France, May 1982., P. 133-139. (16-463)
- Newell, S.Y. 1992. Estimating fungal biomass and productivity in decomposing litter. In: G.C. Carroll and D.T. Wicklow, editors. The Fungal Community. Marcel Dekker, Inc., New York. P. 521-561. (665)

- Newell, S.Y. 1993. Membrane-containing fungal mass and fungal specific growth rate in natural samples. In: P.F. Kemp, B.F. Sherr, E.B. Sherr and J.J. Cole, editors. *Current Methods in Aquatic Microbial Ecology*. Lewis Pubs., Boca Raton, FL. P. 579-586. (700)
- Newell, S.Y. 1993. Decomposition of shoots of a saltmarsh grass. In: J.G. Jones, editor. *Advances in Microbial Ecology*. Volume 13. Plenum Press, New York. P. 301-326. (729)
- Newell, S.Y. 1994. Total and free ergosterol in mycelia of saltmarsh ascomycetes with access to whole leaves or aqueous extracts of leaves. *Applied and Environmental Microbiology* 60:3479-3482. (755)
- Newell, S.Y. 1994. Ecomethodology for organoosmotrophs: Prokaryotic unicellular versus eucaryotic mycelial. *Microbial Ecology*. (756)
- Newell, S.Y. 1995. Minimizing ergosterol loss during preanalytical handling and shipping of samples of plant litter. *Applied and Environmental Microbiology* 61:2794-2797. (767)
- Newell, S.Y. 1996. Established and potential impacts of eukaryotic mycelial decomposers in marine/terrestrial ecotones. *Journal Experimental Marine Biology and Ecology* 200:187-206. (780)
- Newell, S.Y. In Press. The [¹⁴C]acetate-to-ergosterol method: factors for conversion from acetate incorporated to organic fungal mass synthesized. *Soil Biology and Biochemistry*. (781)
- Newell, S.Y., Arsuffi, T.L., and Fallon, R.D. 1988. Fundamental procedures for determining ergosterol content of decaying plant material by liquid chromatography. *Applied and Environmental Microbiology* 54:1876-1879. (21-603)
- Newell, S.Y., Arsuffi, T.L., and Palm, L.A. In Press. Misting and nitrogen fertilization of shoots of a saltmarsh grass: effects upon fungal decay of leaf blades. *Oecologia*. (784)
- Newell, S.Y., Arsuffi, T.S., Kemp, P.F., and Scott, L.A. 1991. Water potential of standing-dead shoots of an intertidal grass. *Oecologia* 85:321-326. (22-657)
- Newell, S.Y. and Bärlocher, F. 1993. Removal of fungal and total organic matter from decaying cordgrass leaves by shredder snails. *Journal Experimental Marine Biology and Ecology* 171:39-49. (727)
- Newell, S.Y. and Christian, R.R. 1981. Frequency of dividing cells as an estimator of bacterial productivity. *Applied and Environmental Microbiology* 42:23-31. (15-429)
- Newell, S.Y. and Fallon, R.D. 1982. Bacterial productivity in the water column and sediments of the Georgia (USA) coastal zone: estimates via direct counting and parallel measurement of thymidine incorporation. *Microbial Ecology* 8:33-46. (16-458)
- Newell, S.Y. and Fallon, R.D. 1983. Study of fungal biomass dynamics within dead leaves of cordgrass: Progress and potential. In: *Proceedings of the International Symposium on Aquatic Macrophytes*, Nijmegen, The Netherlands., P. 150-160. (17-493)
- Newell, S.Y. and Fallon, R.D. 1989. Litterbags, leaf tags and decay of non-abscised intertidal leaves. *Canadian Journal of Botany* 67:2324-2327. (21-613)
- Newell, S.Y. and Fallon, R.D. 1991. Toward a method for measuring instantaneous fungal growth rates in field samples. *Ecology* 72:1547-1559. (22-664)
- Newell, S.Y., Fallon, R.D., Cal Rodriguez, R.M., and Groene, L.C. 1985. Influence of rain, tidal wetting and relative humidity on release of carbon dioxide by standing-dead salt-marsh plants. *Oecologia* 68:73-79. (19-544)
- Newell, S.Y., Fallon, R.D., and Miller, J.D. 1986. Measuring fungal-biomass dynamics in standing-dead leaves of a salt marsh vascular plant. In: S.T. Moss, editor. *Biology of Marine Fungi*. Cambridge University Press, P. 19-25. (19-548)
- Newell, S.Y., Fallon, R.D., and Miller, J.D. 1989. Decomposition and microbial dynamics for standing, naturally positioned leaves of a salt-marsh grass, *Spartina alterniflora*. *Marine Biology* 101:471-481. (22-627)
- Newell, S.Y., Fallon, R.D., Sherr, B.F., and Sherr, E.B. 1988. Mesoscale temporal variation in bacterial standing crop, percent active cells, productivity and output in a saltmarsh tidal river. *Verhandlungen Internationale Vereinigung Limnologie* 23:1839-1845. (570)
- Newell, S.Y., Fallon, R.D., and Tabor, P.S. 1986. Direct microscopy of natural assemblages. In: J.S. Poindexter and E.R. Leadbetter, editors. *Bacteria in Nature*, Vol. 2. Plenum Publ. Corp., P. 1-48. (17-488)
- Newell, S.Y. and Fell, J.W. 1982. Near-ultraviolet light in incubation of marine leaf-litter samples. *Mycologia* 74:508-510. (16-440)
- Newell, S.Y. and Fell, J.W. 1982. Surface sterilization and the active mycoflora of leaves of a seagrass. *Botanica Marina* 25:339-346. (16-459)
- Newell, S.Y. and Fell, J.W. 1995. Do halophytophthoras (marine Pythiaceae) rapidly occupy fallen leaves by intraleaf mycelial growth? *Can. J. Bot.* 73:761-765. (765)
- Newell, S.Y. and Fell, J.W. 1996. Cues for zoospore release by marine oomycetes in naturally decaying submerged leaves. *Mycologia* 88:934-938. (787)
- Newell, S.Y., Fell, J.W., Statzell-Tallman, A., Miller, C., and Cefalu, R. 1984. Carbon and nitrogen dynamics in decomposing leaves of three coastal marine vascular plants of the subtropics. *Aquatic Botany* 19:183-192. (17-501)
- Newell, S.Y. and Hicks, R.E. 1982. Direct-count estimates of fungal and bacterial biovolume in dead leaves of smooth cordgrass (*Spartina alterniflora* Loisel.). *Estuaries* 5:246-260. (16-468)
- Newell, S.Y., Hicks, R.E., and Nicora, M. 1982. Content of mercury in leaves of *Spartina alterniflora* Loisel. in Georgia, U.S.A. *Estuarine, Coastal and Shelf Science* 14:465-469. (16-447)

- Newell, S.Y., Hopkinson, C.S., and Scott, L.A. 1992. Patterns of nitrogenase activity (acetylene reduction) associated with standing decaying shoots of *Spartina alterniflora*. *Estuarine, Coastal and Shelf Science* 35:127-140. (695)
- Newell, S.Y., Miller, J.D., and Fallon, R.D. 1987. Ergosterol content of salt-marsh fungi: Effect of growth conditions and mycelial age. *Mycologia* 79:688-695. (20-581)
- Newell, S.Y., Miller, J.D., and Fallon, R.D. In Press. Responses of bacterioplankton to tidal inundations of a saltmarsh in a flume and adjacent mussel enclosures. *Journal Experimental Marine Biology and Ecology*. (760)
- Newell, S.Y., Miller, J.D., and Fell, J.W. 1987. Rapid and pervasive occupation of mangrove leaves by a marine zoosporic fungus. *Applied and Environmental Microbiology* 53:2464-2469. (21-588)
- Newell, S.Y., Moran, M.A., Wicks, R., and Hodson, R.E. In Press. Productivities of microbial decomposers during early stages of decomposition of shoots of a freshwater sedge. *Freshwater Biology*. (762)
- Newell, S.Y., Porter, D., and Lingle, W.L. In press. Lignocellulolysis by ascomycetes (Fungi) of a saltmarsh grass (smooth cordgrass). *Microscopy Research and Technique (Special Issue: Aquatic Microorganisms)*. (747)
- Newell, S.Y., Sherr, B.F., Sherr, E.B., and Fallon, R.D. 1983. Bacterial response to presence of eukaryote inhibitors in water from a coastal marine environment. *Marine Environmental Research* 10:147-157. (17-483)
- Newell, S.Y. and Statzell-Tallman, A. 1982. Factors for conversion of fungal biovolume values to biomass, carbon, and nitrogen: variation with mycelial ages, growth conditions, and strains of fungi from a salt marsh. *Oikos* 39:261-268. (16-442)
- Newell, S.Y. and Wasowski, J. 1995. Sexual productivity and spring intramarsh distribution of a key saltmarsh microbial secondary producer. *Estuaries* 18:241-249. (758)
- Nichols, J.A. 1979. The occurrence of the subfamily *xyalininae* (Nematoda, Monhysteroidea) in the Georgia Bight with a description of two new species. *Cahiers De Biologie Marine* 22:151-159. (378)
- Nichols, J.A. 1979. A simple flotation technique for separating meiobenthic nematodes from fine-grained sediments. *Transactions of the American Microscopical Society* 98:127-130. (344B)
- Nichols, J.A. and Robertson, J.R. 1979. Field evidence that the eastern mud snail, *Ilyanassa obsoleta*, influences nematode community structure. *Nautilus* 93:44-46. (14-379)
- Odum, E.P. 1961. Factors which regulate primary productivity and heterotrophic utilization in the ecosystem. In: *Algae and Metropolitan Wastes* Trans. 1960 Seminar, U. S. Public Health Service, R. A. Taft Sanitary Eng. Center, Cincinnati., P. 65-71. (2-20)
- Odum, E.P. 1961. The role of tidal marshes in estuarine production. In: Information Leaflet, June-July 1961, N. Y. State Conservation Dept., P. 12-15,35. (2-29)
- Odum, E.P. 1968. A proposal for a marshbank and the strategy of ecosystem development for the estuarine zone of Georgia. In: D.S. Maney, F.C. Marland and C.B. West, editors. *The Future of the Marshlands and Sea Islands of Georgia*. University of Georgia Marine Institute and Coastal Area Planning and Development Commission, P. 74-85. (170*)
- Odum, E.P. and de la Cruz, A.A. 1963. Detritus as a major component of ecosystems. *American Institute of Biological Science Bulletin* 13:39-40. (4-55)
- Odum, E.P. and de la Cruz, A.A. 1967. Particulate organic detritus in a Georgia salt marsh estuarine ecosystem. In: G. Lauff, editor. *Estuaries*. AAAS Publ. No. 83, P. 383-388. (6-118)
- Odum, E.P. and Fanning, M. 1973. Comparison of productivity of *Spartina alterniflora* and *Spartina cynosuroides* in Georgia coastal marshes. *Bulletin of the Georgia Academy of Science* 31:1-12. (9-238)
- Odum, E.P. and Smalley, A.E. 1959. Comparison of population energy flow of a herbivorous and a deposit-feeding invertebrate in a salt marsh ecosystem. *Proceedings of the National Academy of Science of the USA* 45:617-622. (2-14)
- Odum, W.E. 1968. The ecological significance of fine particle selection by striped mullet, *Mugil cephalus*. *Limnology and Oceanography* 13:92-98. (6-142)
- Odum, W.E. 1968. Mullet grazing on the dinoflagellate bloom. *Chesapeake Science* 9:202-204. (7-154)
- Oertel, G.F. 1973. A sedimentary framework of the substrates adjacent to Georgia tidal inlets. In: R.W. Frey, editor. *The Neogene of the Georgia Coast*. Univ. Ga., Dept. Geol., Guidebook, 8th Ann. Ga. Geol. Soc. Field Trip, P. 59-66. (10-269)
- Oshrain, R. and Wiebe, W.J. 1979. Arylsulfatase activity in salt marsh soils. *Applied and Environmental Microbiology* 38:337-340. (14-390)
- Pace, M.L., Shimmel, S., and Darley, W.M. 1979. The effect of grazing by a gastropod, *Nassarius obsoletus*, on the benthic microbial community of a salt marsh mudflat. *Estuarine and Coastal Marine Science* 9:121-134. (14-373)
- Pakulski, J.D. 1992. Foliar release of soluble reactive phosphorus from *Spartina alterniflora* in a Georgia (USA) salt marsh. *Marine Ecology Progress Series* 90:53-60. (725)
- Pakulski, J.D. and Kiene, R.P. 1992. Foliar release of dimethylsulfoniopropionate from *Spartina alterniflora*. *Marine Ecology-Progress Series* 81:277-287. (697)
- Paterek, J.R. and Paynter, M.J.B. 1988. Populations of anaerobic phototrophic bacteria in a *Spartina alterniflora* salt marsh. *Applied and Environmental Microbiology* 54:1360-1364. (21-606)

- Payne, W.J. and Wiebe, W. 1978. Growth yield and efficiency in chemosynthetic microorganisms. *Annual Review of Microbiology* 32:155-183. (13-355)
- Peaver, D.R. and Pilkey, O.H. 1966. Phosphorite in Georgia continental shelf sediments. *Geological Society of American Bulletin* 77:849-858. (5-112)
- Pedros-Alio, C. and Newell, S.Y. 1989. Microautoradiographic study of thymidine uptake of brackish waters around Sapelo Island, Georgia. *Marine Ecology-Progress Series* 55:83-94. (21-624)
- Pennings, S.C. 1996. Testing for synergisms between chemical and mineral defenses. *Ecology* 77:1948-1950. (774)
- Pennings, S.C. and Callaway, R.M. 1996. Impact of a parasite plant on the structure and dynamics of salt marsh vegetation. *Ecology* 77:1410-1419. (772)
- Perkins, R. and Dahlberg, M.D. 1971. Fat cycles and condition factors of Altamaha River shad. *Ecology* 52:359-362. (9-215)
- Pevear, D.G. 1966. The estuarine formation of United States Atlantic coastal plain phosphorite. *Economic Geology* 61:251-256. (96*)
- Pfeiffer, W.J., Linthurst, R.A., and Gallagher, J.L. 1973. Photographic imagery and spectral properties of salt marsh vegetation as indicators of canopy characteristics. **In:** *Proceedings of the American Society of Photogrammetry Fall Convention, Lake Buena Vista, Fla., October 2-5, 1973., P. 1004-1015.* (10-267B)
- Pierce, J.W. and Howard, J.D. 1969. An inexpensive portable vibrocorer for sampling unconsolidated sands. *Journal of Sedimentary Petrology* 39:385-390. (7-171)
- Pilkey, O.H. 1963. Heavy minerals of the U. S. South Atlantic continental shelf and slope. *Geological Society of American Bulletin* 74:641-648. (4-51)
- Pilkey, O.H. 1964. Mineralogy of the fine fraction in certain carbonate cores. *Bulletin of Marine Science of the Gulf and Caribbean* 14:126-139. (4-60)
- Pilkey, O.H. 1964. The size distribution and mineralogy of the carbonate fraction of United States and south Atlantic shelf and upper slope sediments. *Marine Geology* 2:121-136. (4-72)
- Pilkey, O.H., Blackwelder, B.W., Doyle, L.J., Estes, E., and Terlecky, P.M. 1969. Aspects of carbonate sedimentation on the Atlantic continental shelf off the southern United States. *Journal of Sedimentary Petrology* 39:744-768. (7-173)
- Pilkey, O.H. and Frankenberg, D. 1964. The relict-recent sediment boundary on the Georgia continental shelf. *Bulletin of the Georgia Academy of Science* 22:37-40. (4-63)
- Pilkey, O.H. and Giles, R.T. 1965. Bottom topography of the Georgia continental shelf. *Southeastern Geology* 7:15-18. (5-95)
- Pilkey, O.H. and Harriss, R.C. 1966. The effect of the intertidal environment on the composition of calcareous skeletal material. *Limnology and Oceanography* 11:381-385. (5-111)
- Pilkey, O.H. and Richter, D.M. 1964. Beach profiles of a Georgia barrier island. *Southeastern Geology* 6:11-19. (4-71)
- Pilkey, O.H., Schnitker, D., and Pevear, D.R. 1966. Oolites on the Georgia continental shelf edge. *Journal of Sedimentary Petrology* 36:462-467. (5-108)
- Pinet, P.R. and Frey, R.W. 1977. Organic carbon in surface sands seaward of Altamaha and Doboy Sounds, Georgia. *Geological Society of American Bulletin* 88:1731-1739. (12-328)
- Pinet, P.R. and Morgan, W.P. 1979. Implications of clay-provenance studies in two Georgia estuaries. *Journal of Sedimentary Petrology* 49:575-580. (14-385)
- Pomeroy, L.R. 1959. Algal productivity in salt marshes of Georgia. *Limnology and Oceanography* 4:386-397. (2-8)
- Pomeroy, L.R. 1960. Residence time of dissolved phosphate in natural waters. *Science* 131:1731-1732. (2-17)
- Pomeroy, L.R. 1961. Productivity and how to measure it. Methods of measurement of primary production in natural waters. **In:** *Algae and Metropolitan Wastes* Trans. 1960 Seminar, U. S. Public Health Service, R. A. Taft Sanitary Eng. Center, Cincinnati., P. 61-65. (2-19)
- Pomeroy, L.R. 1963. Experimental studies of the turnover of phosphate in marine environments. **In:** V. Schultz and A.W. Klement Jr., editors. *Radioecology*. Reinhold Publ. Corp., New York. P. 163-166. (3-33)
- Pomeroy, L.R. 1963. Isotopic and other techniques for measuring benthic primary production. **In:** M.S. Doty, editor. *Primary Productivity Measurement, Marine and Freshwater*. Proceedings of the Conference on Primary Productivity Measurement, Marine and Freshwater. Office of Technical Services, Washington, D. C. (TID-7633), P. 97-102. (3-34)
- Pomeroy, L.R. 1975. Mineral cycling in marine ecosystems. **In:** F.G. Howell, J.B. Gentry and M.H. Smith, editors. *Mineral Cycling in Southeastern Ecosystems*. Energy Research and Development Administration Symposium Series (CONF-740513), P. 209-223. (11-282)
- Pomeroy, L.R., Bancroft, K., Breed, J., Christian, R.R., Frankenberg, D., Hall, J.R., Maurer, L.G., Wiebe, W.J., Wiegert, R.G., and Wetzel, R.L. 1975. Flux of organic matter through a salt marsh. **In:** M. Wiley, editor. *Estuarine Processes, Vol. II, Circulation, Sediments and Transfer of Material in the Estuary*. Academic Press, Inc., New York. P. 270-279. (11-298)
- Pomeroy, L.R., Haskin, H.H., and Ragotzkie, R.A. 1956. Observations on dinoflagellate blooms. *Limnology and Oceanography* 1:54-60. (1-2A)
- Pomeroy, L.R. and Johannes, R.E. 1966. Total plankton respiration. *Deep-Sea Research* 13:971-973. (5-102)

- Pomeroy, L.R., Johannes, R.E., Odum, E.P., and Roffman, B. 1969. The phosphorus and zinc cycles and productivity of a salt marsh. In: D.J. Nelson and F.C. Evans, editors. Proceedings of the Second National Symposium on Radioecology. Clearinghouse for Federal Sci. Tech. Information, Springfield, VA. P. 412-418. (6-149)
- Pomeroy, L.R., Mathews, H.M., and Min, H.S. 1963. Excretion of phosphate and soluble organic phosphorus compounds of zooplankton. *Limnology and Oceanography* 8:50-55. (3-45)
- Pomeroy, L.R., Odum, E.P., Johannes, R.E., and Roffman, B. 1966. Flux of ^{32}P and ^{65}Zn through a salt marsh ecosystem. In: *Disposal of Radioactive Wastes in Seas, Oceans and Surface Waters.*, Vienna. P. 177-188. (5-101)
- Pomeroy, L.R., Shenton, L.R., Jones, R.D.H., and Reimold, R.J. 1972. Nutrient flux in estuaries. *Nutrients and Eutrophication Spec. Symp. AAAS* 1:274-291. (9-219)
- Pomeroy, L.R., Smith, E.E., and Grant, C.M. 1965. The exchange of phosphate between estuarine water and sediments. *Limnology and Oceanography* 10:167-172. (5-76)
- Porter, D. and Lingle, W.L. 1992. Endolithic thraustochytrid marine fungi from planted shell fragments. *Mycologia* 84:289-299. (709)
- Porter, D., Newell, S.Y., and Lingle, W.L. 1989. Tunneling bacteria in decaying leaves of seagrass. *Aquatic Botany* 35:395-401. (22-626)
- Porter, K.G., Sherr, E.B., Sherr, B.F., Pace, M., and Sanders, R.W. 1985. Protozoa in planktonic food webs. *Journal of Protozoology* 32:409-415. (18-528)
- Ragotzkie, R.A. 1956. Mortality of loggerhead turtle eggs from excessive rainfall. *Ecology* 40:303-305. (2-9)
- Ragotzkie, R.A. 1959. Plankton productivity in estuarine waters of Georgia. *Institute of Marine Science, University of Texas* 6:146-158. (2-21)
- Ragotzkie, R.A. and Bryson, R.A. 1955. Hydrography of the Duplin River, Sapelo Island, Georgia. *Bulletin of Marine Science of the Gulf and Caribbean* 5:297-314. (1-1)
- Ragotzkie, R.A. and Pomeroy, L.R. 1957. Life history of a dinoflagellate bloom. *Limnology and Oceanography* 2:62-69. (1-5)
- Rasmussen, E. 1994. *Namalycastis abiuma* (Muller in Grube) 1871, an aberrant nereidid polychaete of a Georgia salt marsh area and its faunal associations. *Gulf Research Reports* 9:17-28. (746)
- Rasmussen, E. and Heard, R.W. 1995. Observations on extant populations of the softshell clam, *Mya arenaria* Linne, 1758 (Bivalvia: Myidae), from Georgia (USA) estuarine habitats. *Gulf Research Reports* 9:85-96. (763)
- Reaves, C. 1986. Organic matter metabolizability and calcium carbonate dissolution in nearshore marine muds. *Journal of Sedimentary Petrology* 56:486-494. (20-564)
- Reichert, M.J.M. and van der Veer, H.W. 1991. Settlement, abundance, growth and mortality of juvenile flatfish in a subtropical tidal estuary (Georgia, U.S.A.). *Netherlands Journal of Sea Research* 27:375-391. (677)
- Reimold, R.J. 1972. The movement of phosphorus through the salt marsh cord grass, *Spartina alterniflora* Loisel. *Limnology and Oceanography* 17:606-611. (9-231)
- Reimold, R.J. 1974. Mathematical modelling *Spartina*. In: R.J. Reimold and W.H. Queen, editors. *Ecology of Halophytes*. Academic Press, Inc., New York. P. 393-406. (10-257)
- Reimold, R.J. and Durant, C.J. 1974. Toxaphene content of estuarine fauna and flora before, during, and after dredging toxaphene-contaminated sediments. *Pesticides Monitoring Journal* 44:44-49. (11-300)
- Reimold, R.J., Gallagher, J.L., Linthurst, R.A., and Pfeiffer, W.J. 1973. Detritus production in coastal Georgia salt marshes. In: L.E. Cronin, editor. *Estuarine Research*. Academic Press, Inc., New York. P. 217-228. (10-275)
- Reimold, R.J., Gallagher, J.L., and Thompson, D.E. 1972. Coastal mapping with remote sensors. In: Proc. Coastal Mapping Symposium. Amer. Soc. Photogrammetry, Washington, D. C. P. 99-112. (9-228)
- Reimold, R.J., Gallagher, J.L., and Thompson, D.E. 1973. Remote sensing of tidal marsh. *Photogrammetric Engineering* 39:477-488. (10-262)
- Reimold, R.J. and Linthurst, R.A. 1973. Ecological importance of wetlands. In: Proceedings of the American Congress on Surveying and Mapping Fall Convention, P. 200-204. (277*)
- Reimold, R.J. and Linthurst, R.A. 1975. Remote sensing - wetlands. In: Preprint from ASCE National Meeting on Water Resources Eng., Jan. 21-25, 1975, Los Angeles, California., P. 1-19. (11-301)
- Reimold, R.J., Linthurst, R.A., and Wolf, P.L. 1975. Effects of grazing on a salt marsh. *Biological Conservation* 8:105-125. (303*)
- Rhodes, M.E. and Payne, W.J. 1962. Further observations on effects of cations on enzyme induction in marine bacteria. *Antonie van Leeuwenhoek* 28:302-314. (3-35)
- Richardson, J.P. 1986. Additions to the marine macroalgal flora of coastal Georgia. *Georgia Journal of Science* 44:131-135. (20-585)
- Richardson, J.P. 1987. Floristic and seasonal characteristics of inshore Georgia macroalgae. *Bulletin of Marine Science* 40:210-219. (21- 599)
- Rickards, W.L. 1968. Ecology and growth of juvenile tarpon *Megalops atlanticus*, in a Georgia salt marsh. *Bulletin of Marine Science* 18:220-239. (6-148)
- Riemann, B., Bjornsen, P.K., Newell, S.Y., and Fallon, R.D. 1987. Calculation of cell production of coastal marine bacteria based on measured incorporation of $[3\text{H}]$ thymidine. *Limnology and Oceanography* 32:471-476. (559)

- Robert, H.C., Teal, J.M., and Odum, E.P. 1956. Summer birds of Sapelo Island, Georgia: A preliminary list. *The Oriole* 21:37-48. (1-6)
- Robertson, J.R. 1979. Evidence for tidally correlated feeding rhythms in the eastern mud snail, *Ilyanassa obsoleta*. *Nautilus* 93:38-40. (14-380)
- Robertson, J.R. 1983. Predation by estuarine zooplankton on tintinnid ciliates. *Estuarine, Coastal and Shelf Science* 16:27-36. (16-465)
- Robertson, J.R., Bancroft, K., Vermeer, G., and Plaisier, K. 1980. Experimental studies on the foraging behavior of the sand fiddler crab *Uca pugilator* (Bosc, 1802). *Journal Experimental Marine Biology and Ecology* 44:67-83. (15-404)
- Robertson, J.R., Fudge, J.A., and Vermeer, G. 1981. Chemical and live feeding stimulants of the sand fiddler crab *Uca pugilator* (Bosc). *Journal Experimental Marine Biology and Ecology* 52:47-64. (15-421)
- Robertson, J.R. and Newell, S.Y. 1982. Experimental studies of particle ingestion by the sand fiddler crab *Uca pugilator* (Bosc). *Journal Experimental Marine Biology and Ecology* 59:1-21. (16-448)
- Robertson, J.R. and Newell, S.Y. 1982. A study of particle ingestion by three fiddler crab species foraging on sandy sediments. *Journal Experimental Marine Biology and Ecology* 65:11-17. (16-460)
- Robertson, J.R. and Pfeiffer, W.J. 1982. Deposit feeding by the ghost crab *Ocypode quadrata*. *Journal Experimental Marine Biology and Ecology* 56:165-177. (15-438)
- Salazar-Jiminez, A., Frey, R.W., and Howard, J.D. 1982. Concavity orientations of bivalve shells in estuarine and nearshore shelf sediments. *Journal of Sedimentary Petrology* 52:565-586. (16-443)
- Satomi, M. and Pomeroy, L.R. 1965. Respiration and phosphorus excretion in some marine populations. *Ecology* 46:877-881. (5-79)
- Schindler, D.E., Johnson, B.M., MacKay, N.A., Bouwes, N., and Kitchell, J.F. 1994. Crab:snail size-structured interactions and salt marsh predation gradients. *Oecologia* 97:49-61. (733)
- Schoenberg, S.A., Benner, R., Armstrong, A., Sobecky, P., and Hodson, R.E. 1990. Effects of acid stress on aerobic decomposition of algal and aquatic macrophyte detritus: direct comparison in a radiocarbon assay. *Applied and Environmental Microbiology* 56:237-244. (22-651)
- Schubauer, J.P. and Hopkinson, C.S. 1984. Above- and belowground emergent macrophyte production and turnover in a coastal marsh ecosystem, Georgia. *Limnology and Oceanography* 29:1052-1065. (18-519)
- Shanholtzer, G.F. 1970. Breeding records and distribution of the glossy ibis on the Georgia coast. *The Oriole* 35:37-39. (9-221)
- Shanholtzer, G.F. 1974. Relationship of vertebrates to salt marsh plants. In: R.J. Reimold and W.H. Queen, editors. *Ecology of Halophytes*. Academic Press, Inc., New York. P. 463-474. (10-260)
- Shanholtzer, G.F., Kuenzel, W.J., and Mahoney, J.J. 1970. Twenty-one years of the McKinney's pond rookery. *The Oriole* 35:23-28. (9-220)
- Sharp, H. 1967. Food ecology of the rice rat, *Oryzomys palustris* (Harlan), in a Georgia salt marsh. *Journal of Mammalogy* 48:557-563. (6-119)
- Sherr, B.F. and Payne, W.J. 1978. Effect of the *Spartina alterniflora* root-rhizome system on salt marsh soil denitrifying bacteria. *Applied and Environmental Microbiology* 35:724-729. (13-354)
- Sherr, B.F. and Payne, W.J. 1979. Role of the salt marsh grass *Spartina alterniflora* in the response of soil-denitrifying bacteria to glucose enrichment. *Applied and Environmental Microbiology* 38:747-748. (14-400)
- Sherr, B.F. and Payne, W.J. 1981. The effect of sewage sludge on salt-marsh denitrifying bacteria. *Estuaries* 4:146-149. (15-430)
- Sherr, B.F. and Sherr, E.B. 1983. Enumeration of heterotrophic microprotozoa by epifluorescence microscopy. *Estuarine, Coastal and Shelf Science* 16:1-7. (16-457)
- Sherr, B.F. and Sherr, E.B. 1984. Role of heterotrophic protozoa in carbon and energy flow in aquatic ecosystems. In: M.J. Klug and C.A. Reddy, editors. *Current Perspectives in Microbial Ecology*, P. 412-423. (17-497)
- Sherr, B.F., Sherr, E.B., Andrew, T.L., Fallon, R.D., and Newell, S.Y. 1986. Trophic interactions between heterotrophic protozoa and bacterioplankton in estuarine water analyzed with selective metabolic inhibitors. *Marine Ecology-Progress Series* 32:169-170. (20-561)
- Sherr, B.F., Sherr, E.B., and Berman, T. 1982. Decomposition of organic detritus: A selective role for microflagellate protozoa. *Limnology and Oceanography* 27:765-769. (16-441)
- Sherr, B.F., Sherr, E.B., and Berman, T. 1983. Grazing, growth, and ammonium excretion rates of a heterotrophic microflagellate fed with four species of bacteria. *Applied and Environmental Microbiology* 45:1196-1201. (17-485)
- Sherr, B.F., Sherr, E.B., Berman, T., and McCarthy, J.J. 1982. Differences in nitrate and ammonia uptake among components of a phytoplankton population. *Journal of Plankton Research* 4:961-965. (16-455)
- Sherr, B.F., Sherr, E.B., and Fallon, R.D. 1987. Use of monodispersed, fluorescently labeled bacteria to estimate in situ protozoan bacterivory. *Applied and Environmental Microbiology* 53:958-965. (20-568)
- Sherr, B.F., Sherr, E.B., and Hopkinson, C.S. 1988. Trophic interactions within pelagic microbial communities: Indications of feedback regulation of carbon flow. *Hydrobiologia* 159:19-26. (20-571)
- Sherr, B.F., Sherr, E.B., and McDaniel, J. 1992. Effects of protistan grazing on the frequency of dividing cells in bacterioplankton assemblages. *Applied and Environmental Microbiology* 58:2381-2385. (708)

- Sherr, B.F., Sherr, E.B., and Newell, S.Y. 1984. Abundance and productivity of heterotrophic nanoplankton in Georgia coastal waters. *Journal of Plankton Research* 6:195-202. (17-495)
- Sherr, B.F., Sherr, E.B., and Pedros-Alio, C. 1989. Simultaneous measurement of bacterioplankton production and protozoan bacterivory in estuarine water. *Marine Ecology-Progress Series* 54:209-219. (22-632)
- Sherr, B.F., Sherr, E.B., and Rassoulzagedan, F. 1988. Rates of digestion of bacteria by marine phagotrophic protozoa: Temperature dependence. *Applied and Environmental Microbiology* 54:1091-1095. (21-600)
- Sherr, E.B. 1982. Carbon isotope composition of organic seston and sediments in a Georgia salt marsh estuary. *Geochimica et Cosmochimica Acta* 46:1227-1232. (16-450)
- Sherr, E.B. 1988. Direct use of high molecular weight polysaccharide by heterotrophic flagellates. *Nature* 335:348-351. (21-615)
- Sherr, E.B. and Sherr, B.F. 1983. Double-staining epifluorescence technique to assess frequency of dividing cells and bacterivory in natural populations of heterotrophic microprotozoa. *Applied and Environmental Microbiology* 46:1388-1393. (17-494)
- Sherr, E.B. and Sherr, B.F. 1987. High rates of consumption of bacteria by pelagic ciliates. *Nature* 325:710-711. (20-567)
- Sherr, E.B. and Sherr, B.F. 1988. Role of microbes in pelagic food webs: A revised concept. *Limnology and Oceanography* 33:1225-1227. (21-616)
- Sherr, E.B. and Sherr, B.F. 1991. Proportional distribution of total numbers, biovolume, and bacterivory among size classes of 2-20 μm nonpigmented marine flagellates. *Marine Microbial Food Webs* 5:227-237. (679)
- Sherr, E.B. and Sherr, B.F. 1991. Planktonic microbes: tiny cells at the base of the ocean's food web. *Trends in Ecology & Evolution* 6:50-54. (22-660)
- Sherr, E.B., Sherr, B.F., and Albright, L.J. 1987. Bacteria: Link or Sink? *Science* 235:88-89. (20-575)
- Sherr, E.B., Sherr, B.F., Berman, T., and Hadas, O. 1991. High abundance of picoplankton-ingesting ciliates during late fall in Lake Kinneret, Israel. *Journal of Plankton Research* 13:789-799. (676)
- Sherr, E.B., Sherr, B.F., Fallon, R.D., and Newell, S.Y. 1986. Small, aloricate ciliates as a major component of the marine heterotrophic nanoplankton. *Limnology and Oceanography* 31:177-183. (19-543)
- Sherr, E.B., Sherr, B.F., and McDaniel, J. 1991. Clearance rates of < 6 μm fluorescently labeled algae (FLA) by estuarine protozoa: potential grazing impact of flagellates and ciliates. *Marine Ecology-Progress Series* 69:81-92. (22-661)
- Sherr, E.B., Sherr, B.F., and Paffenhofer, G.-A. 1986. Phagotrophic protozoa as food for metazoans: a "missing" trophic link in marine pelagic food webs. *Marine Microbial Food Webs* 1:61-80. (19-554)
- Sikora, W.B., Heard, R.W., III, and Dahlberg, M.D. 1972. The occurrence and food habits of two species of hake, *Urophycis regius* and *U. floridanus* in Georgia estuaries. *Transactions of the American Fisheries Society* 101:513-525. (9-245)
- Skyring, G.W., Oshrain, R.L., and Wiebe, W.J. 1978. Sulfate reduction rates in Georgia marshland soils. *Geomicrobiology Journal* 1:389-400. (14-381)
- Smalley, A.E. 1959. Pigmy sperm whale in Georgia. *Journal of Mammalogy* 40:452. (2-10)
- Smalley, A.E. 1960. Energy flow of a salt marsh grasshopper population. *Ecology* 41:785-790. (2-24)
- Smith, F.G. 1970. A preliminary report on the incidence of lymphocystis disease in the fish of the Sapelo Island, Georgia, area. *Journal Wildlife Disease* 6:469-471. (8-206)
- Smith, J.M., Arnold, W.S., Stites, D.L., Donavan, L.A., Trott, T.J., and Jansma, P.L. 1983. Research reports presented to the University of Georgia Marine Institute by summer-research participants, 1980-1982. *Georgia Journal of Science* 41:93-96. (17-492)
- Smith, J.M. and Frey, R.W. 1985. Biodeposition by the ribbed mussel *Geukensia demissa* in a salt marsh, Sapelo Island, Georgia. *Journal of Sedimentary Petrology* 55:817-828. (19-531)
- Smith, K.L. 1971. A device for sampling immediately above the sediment-water interface. *Limnology and Oceanography* 16:675-677. (8-214)
- Sobecky, P.A., Schell, M.A., Moran, M.A., and Hodson, R.E. 1996. Impact of a genetically engineered bacterium with enhanced alkaline phosphatase activity on marine phytoplankton communities. *Applied and Environmental Microbiology* 62:6-12. (775)
- Spratt, H.G., Jr. and Hodson, R.E. 1994. The effect of changing water chemistry on rates of manganese oxidation in surface sediments of a temperate saltmarsh and a tropical mangrove estuary. *Estuarine, Coastal and Shelf Science* 38:119-135. (740)
- Spratt, H.G., Jr., Siekmann, E.C., and Hodson, R.E. 1994. Microbial manganese oxidation in saltmarsh surface sediments using a leuco crystal violet manganese oxide detection technique. *Estuarine, Coastal and Shelf Science* 38:91-112. (739)
- Starr, T.J. 1956. Relative amounts of vitamin B₁₂ in detritus from oceanic and estuarine environments near Sapelo Island, Georgia. *Ecology* 37:658-664. (1-2)
- Taylor, B.F. and Kiene, R.P. 1989. Microbial metabolism of dimethyl sulfide. In: E.S. Saltzman and W.J. Cooper, editors. *Biogenic Sulfur in the Environment*. ACS Symposium Series, American Chemical Society, Washington, D.C. P. 203-221. (21-623)
- Taylor, M.H. 1986. Environmental and endocrine influences on reproduction of *Fundulus heteroclitus*. *American Zoologist* 26:159-171. (17-508)
- Teal, J.M. 1958. Distribution of fiddler crabs in Georgia salt marshes. *Ecology* 39:185-193. (1-7)

- Teal, J.M. 1959. Respiration of crabs in Georgia salt marshes and its relation to their ecology. *Physiological Zoology* 32:1-14. (1-11)
- Teal, J.M. 1959. Birds of Sapelo Island and vicinity. *The Oriole* 24:1-14,17-20. (2-12)
- Teal, J.M. 1960. A technique for separating nematodes and small arthropods from marine muds. *Limnology and Oceanography* 5:341-342. (2-13)
- Teal, J.M. 1962. Energy flow in the salt marsh ecosystem of Georgia. *Ecology* 43:614-624. (3-38)
- Teal, J.M. and Kanwisher, J. 1961. Gas exchange in a Georgia salt marsh. *Limnology and Oceanography* 6:388-399. (2-30)
- Thomas, J. 1971. Release of dissolved organic matter from natural populations of marine phytoplankton. *Marine Biology* 11:311-323. (9-224)
- Thompson, D.E., Ragsdale, J., Reimold, R.J., and Gallagher, J.L. 1973. Seasonal aspects of remote sensing coastal resources. In: F. Shahrokhi, editor. *Remote Sensing of Earth Resources*. U. of Tenn. Press, P. 1201-1249. (10-263)
- Trott, T.J. and Robertson, J.R. 1984. Chemical stimulants of cheliped flexion behavior by the Western Atlantic ghost crab *Ocypode quadrata* (Fabricius). *Journal Experimental Marine Biology and Ecology* 78:237-252. (17-491)
- Ubben, M.S. and Hanson, R.B. 1980. Tidal induced regulation of nitrogen fixation activity (C_2H_4 production) in a Georgia salt marsh. *Estuarine and Coastal Marine Science* 10:445-453. (396*)
- Vetter, E.F. and Hopkinson, C.S. 1985. Influence of white shrimp (*Penaeus setiferus*) on benthic metabolism and nutrient flux in a coastal marine ecosystem: measurements *in situ*. *Contributions in Marine Science* 28:95-107. (19-552)
- Vetter, R. and Hodson, R.E. 1984. Adenylate energy charge and adenylate concentrations as indicators of pollutional stress in marine organisms. In: H. White, editor. *Meaningful Measures of Marine Pollution*. P. 471-498. (17-480)
- Vetter, R.D., Carey, M.C., and Patton, J.S. 1985. Coassimilation of dietary fat and benzo(a)pyrene in the small intestine: an absorption model using the killifish. *Journal of Lipid Research* 26:428-434. (18-517)
- Vetter, R.D. and Hodson, R.E. 1983. Energy metabolism in a rapidly developing marine fish egg, the red drum (*Sciaenops ocellata*). *Canadian Journal of Fisheries and Aquatic Sciences* 40:627-634. (17-478)
- Vetter, R.D., Hwang, H.-M., and Hodson, R.E. 1986. Comparison of glycogen and adenine nucleotides as indicators of metabolic stress in mummichog. *Transactions of the American Fisheries Society* 115:47-51. (19-549A)
- Vetter, R.D. and Patton, J.S. 1984. The effect of dietary fat on the bioavailability of DDT, a PCB, and benzo(a)pyrene in the killifish. *American Journal of Physiology*.
- Voorhies, M.R. 1973. Vertebrate fossils of coastal Georgia: A field geologist's guide. In: R.W. Frey, editor. *The Neogene of the Georgia Coast*. Univ. Ga., Dept. Geol., Guidebook, 8th Ann. Ga. Geol. Soc. Field Trip, P. 81-102. (10-271)
- Walters, K., Jones, E., and Etherington, L. 1996. Experimental studies of predation on metazoans inhabiting *Spartina alterniflora* stems. *Journal Experimental Marine Biology and Ecology* 195:251-265. (766)
- Walters, K. and Shanks, A.L. 1996. Complex trophic and nontrophic interactions between meiobenthic copepods and marine snow. *Journal of Experimental Marine Biology and Ecology* 195:131-145. (768)
- Webb, K.L. 1966. NaCl effects on growth and transpiration in *Salicornia bigelovii*, a salt marsh halophyte. *Plant and Soil* 24:261-268. (5-80)
- Webb, K.L. and Burley, J.W.A. 1964. Stachyose translocation in plants. *Plant Physiology* 39:973-977. (4-73)
- Webb, K.L. and Burley, J.W.A. 1965. Dark fixation of $^{14}CO_2$ by obligate and facultative salt marsh halophytes. *Canadian Journal of Botany* 43:281-285. (5-77)
- Webb, K.L. and Johannes, R.E. 1967. Studies of the release of dissolved free amino acids by marine zooplankton. *Limnology and Oceanography* 12:376-382. (6-123)
- Weber, J.H. and Alberts, J.A. 1990. Methylation of Sn(IV) by hydroponically incubated *Spartina alterniflora*. *Environmental Technology* 11:3-8. (22-647)
- Welch, R., Remillard, M., and Alberts, J.J. 1991. Integrated resource databases for coastal management. *GIS World* 4:86-89. (680)
- Welch, R., Remillard, M., and Alberts, J.J. 1992. Integration of GPS, Remote sensing & GIS techniques for coastal resource management. *Photogrammetric Engineering and Remote Sensing* 58:1571-1578. (706)
- Wetzel, R.L. 1975. Carbon resources of a benthic salt marsh invertebrate *Nassarius obsoletus* Say (Mollusca:Nassariidae). In: M. Wiley, editor. *Estuarine Processes, Vol. II, Circulation, Sediments and Transfer of Material in the Estuary*. Academic Press, Inc., New York. P. 293-308. (11-309)
- Wetzel, R.L. and Wiegert, R.G. 1983. Ecosystem simulation models: Tools for the investigation and analysis of nitrogen dynamics in coastal and marine ecosystems. In: E.J. Carpenter and C.G. Capone, editors. *Nitrogen in the Marine Environment*. Academic Press, P. 869-892. (16-445)
- Wheeler, J.R. 1976. Fractionation by molecular weight of organic substances in Georgia coastal water. *Limnology and Oceanography* 21:846-852. (11-299)
- Wheeler, J.R. 1977. Dissolved organic carbon: Spectral relationships in coastal waters. *Limnology and Oceanography* 22:573-575. (12-311)
- Wheeler, P.A. and Kirchman, D.L. 1986. Utilization of inorganic and organic nitrogen by bacteria in marine systems. *Limnology and Oceanography* 31:998-1009. (21- 591)

- Whelan, J.K., Tarata, M.E., and Sherr, E.B. 1986. Phenolic and lignin pyrolysis products of plants, sestion, and sediment in a Georgia estuary. In: M.L. Sohn, editor. *Organic Marine Geochemistry*. ACS Symposium Series 305, American Chemical Society, Washington, D. C. P. 62-75. (19-546)
- Whitney, D.E. and Darley, W.M. 1979. A method for the determination of chlorophyll *a* in samples containing degradation products. *Limnology and Oceanography* 24:183-186. (13-349)
- Whitney, D.E. and Darley, W.M. 1983. Effect of light intensity upon salt marsh benthic microalgal photosynthesis. *Marine Biology* 75:249-252. (17-481)
- Wicks, R.J., Moran, M.A., Pittman, L.J., and Hodson, R.E. 1991. Carbohydrate signatures of aquatic macrophytes and their dissolved degradation products as determined by a sensitive high-performance ion chromatography. *Applied and Environmental Microbiology* 57:3135-3143. (690)
- Wiebe, W. and Bancroft, K. 1975. Use of the adenylate energy charge ratio to measure growth state of natural microbial communities. *Proceedings of the National Academy of Science of the USA* 72:2112-2115. (11-290)
- Wiebe, W. and Pomeroy, L.R. 1972. Microorganisms and their association with aggregates and detritus in the sea: A microscopic study. In: U. Melchiorri-Santolini and J.W. Hopton, editors. *Detritus and its Role in Aquatic Ecosystems*, IBP-UNESCO, Palianza, Italy. P. 325-352. (9-234)
- Wiebe, W.J. 1979. Anaerobic benthic microbial processes: Changes from the estuary to the Continental Shelf. In: R.J. Livingston, editor. *Ecological Processes in Coastal and Marine Systems*. Plenum Press, New York. P. 469-485. (14-392)
- Wiebe, W.J. 1985. Aquatic microbial ecology—research questions and opportunities. In: J.H. Cooley and F.B. Golley, editors. *Trends in Ecological Research for the 1980s*. Plenum Press, P. 35-49. (18-507)
- Wiebe, W.J., Paerl, H., and Webb, K.L. 1979. Nitrogen fixation in aquatic environments. In: W.F. Brougham, editor. *Environmental Nitrogen Fixation*. (394*)
- Wiedemann, H. 1971. Shell deposits and shell preservation in Quaternary and Tertiary estuarine sediments in Georgia, U.S.A. *Sedimentary Geology* 7:103-125. (8-209)
- Wieger, R.G. 1979. Modeling coastal, estuarine and marsh ecosystems: State-of-the-art. In: G.P. Patil and M. Rosenzweig, editors. *Contemporary Quantitative Ecology and Related Economics*. International Cooperative Publ. House, Fairland, MD. P. 319-341. (14-393)
- Wieger, R.G. 1979. Ecological processes characteristic of coastal *Spartina* marshes of the southeastern U.S.A. In: T. Davey and R. Jeffries, editors. *Ecological Processes in Coastal Environments*. Blackwells, London. P. 467-490. (13-344)
- Wieger, R.G. 1980. Modeling salt marshes and estuaries: Progress and problems. In: P. Hamilton and K.B. McDonald, editors. *Estuarine and Wetland Processes with Emphasis on Modelling*. P. 527-540. (15-434)
- Wieger, R.G. 1986. Modeling spatial and temporal variability in a salt marsh: sensitivity to rates of primary production, tidal migration and microbial degradation. In: D.A. Wolfe, editor. *Estuarine Variability*. Academic Press, New York. P. 405-426. (19-549B)
- Wieger, R.G., Chalmers, A.G., and Randerson, P.F. 1983. Productivity gradients in salt marshes: the response of *Spartina alterniflora* to experimentally manipulated soil water movement. *Oikos* 41:1-6. (16-469)
- Wieger, R.G., Christian, R.R., Gallagher, J.L., Hall, J.R., Jones, R.D.H., and Wetzel, R.L. 1975. A preliminary ecosystem model of coastal Georgia *Spartina* marsh. In: L.E. Cronin, editor. *Estuarine Research*, Vol. I. Academic Press, Inc., New York. P. 583-601. (11-288)
- Wieger, R.G. and Wetzel, R.L. 1978. Simulation experiments with a 14-compartment model of a *Spartina* salt marsh. In: R. Dame, editor. *Marsh-Estuarine Systems Simulation*. Univ. South Carolina Press, Columbia, SC. P. 7-39 (13-347)
- Williams, R.B. 1963. Use of netting to collect motile benthic algae. *Limnology and Oceanography* 8:360-361. (4-52)
- Williams, R.B. 1964. Division rates of salt marsh-dwelling pennate diatoms in relation to salinity and cell size. *Ecology* 45:877-880. (4-69)
- Williams, R.B. 1966. Unusual motility of tube-dwelling pennate diatoms. *Journal of Phycology* 1:145-156. (100*)
- Winker, C.D. and Howard, J.D. 1977. Plio-Pleistocene paleogeography of the Florida Gulf coast interpreted from relict shorelines. *Transactions-Gulf Coast Association of Geological Societies* 27:409-420. (13-335)
- Wolf, P.L., Shanholtzer, S.A., and Reimold, R.J. 1972. First occurrence of the violet goby in Georgia. *Quarterly Journal of the Florida Academy of Sciences* 35:81-84. (9-229)
- Wolf, P.L., Shanholtzer, S.F., and Reimold, R.J. 1975. Population estimates for *Uca pugnax* (Smith, 1870) on the Duplin estuary marsh, Georgia, U.S.A. (Decapoda Brachyura, Ocypodidae). *Crustaceana* 29:79-91. (11-304)
- Wolfe, G.V. and Kiene, R.P. 1993. Effects of methylated, organic, and inorganic substrates on microbial consumption of dimethyl sulfide in estuarine waters. *Applied and Environmental Microbiology* 59:2723-2726. (734)
- Wolfe, G.V. and Kiene, R.P. 1993. Radiisotope and chemical inhibitor measurements of dimethyl sulfide consumption rates and kinetics in estuarine waters. *Marine Ecology Progress Series* 99:261-269. (741)
- Woolsey, R., Henry, V.J., and Hunt, J. 1975. Backshore heavy-mineral concentration on Sapelo Island, Georgia. *Journal of Sedimentary Petrology* 45:280-284. (11-291)
- Yotka, J. and Wiebe, W.J. 1974. Ecological application of antibiotics as respiratory inhibitors of bacterial populations. *Applied Microbiology* 28:1033-1039. (11-284)