

Neutron and X-ray Detectors

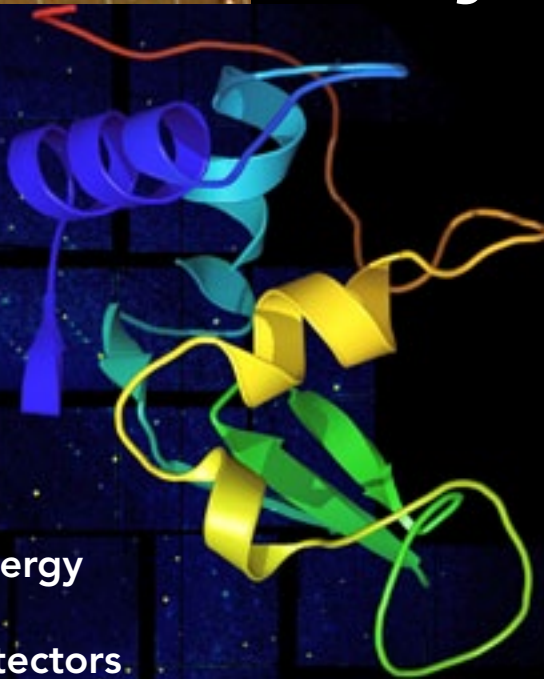

Report of the Basic Energy
Sciences Workshop on
Neutron and X-ray Detectors.

August 1-3, 2012

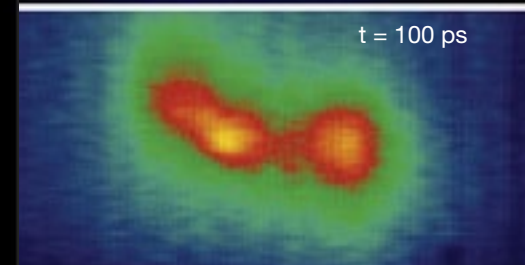
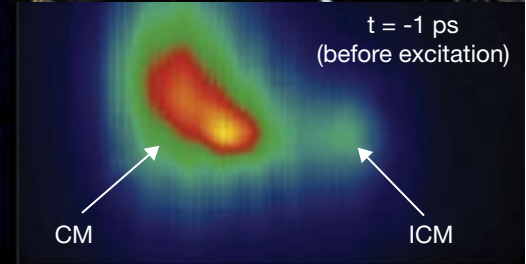

**Front Cover**

From top left to right: Diffraction pattern from the Protein Crystallography Station at LANSCE using custom BNL gas detectors, fuel-spray movie at APS using Cornell pixel detector, direct ionization neutron detector for very high-rate applications, SNS wavelength shifting fiber detector, soft X-ray spectroscopy at LCLS using LBNL FastCCD, lysozyme structural model against its X-ray diffraction pattern using Cornell-SLAC PAD at LCLS.

This document was prepared as an account of work sponsored by the United States Government. While this document is believed to contain correct information, neither the United States Government nor any agency thereof, nor any of their employees, nor any of their contractors, subcontractors, or their employees, makes any warranty, express or implied, or assumes any legal liability or responsibility for the accuracy, completeness, or any third party's use or the results of such use of any information, apparatus, product, or process disclosed, or represents that its use would not infringe privately owned rights. Reference herein to any specific commercial product, process, or service by its trade name, trademark, manufacturer, or otherwise, does not necessarily constitute or imply its endorsement, recommendation, or favoring by the United States Government or any agency thereof or its contractors or subcontractors. The views and opinions of authors expressed herein do not necessarily state or reflect those of the United States Government or any agency thereof or its contractors or subcontractors.

Neutron and X-ray Detectors

**Report of the Basic Energy Sciences Workshop
on Neutron and X-ray Detectors**

Gaithersburg, MD / August 1-3, 2012

Organizing Committee

Gabriella Carini
SLAC National Accelerator Laboratory

Peter Denes
Lawrence Berkeley National Laboratory

Sol Gruner
Cornell University

Office of Basic Energy Sciences Contact

Eliane Lessner
Scientific User Facilities Division, Office of Basic Energy Sciences



This work was supported by the U.S. Department of Energy,
Office of Science, Office of Basic Energy Sciences.

Executive Summary	2
Introduction	5
X-ray and Neutron Detectors	13
Detector Components	13
Workshop	14
Priority Research Directions	16
X-ray Detectors	22
General Properties	23
State of the Art	24
Unmet Detector Needs	26
Technical Challenges	30
Neutron Detectors	41
General Properties	42
State of the Art in Neutron Detectors	43
Unmet Detector Needs	47
Technical Challenges	53
Context	56
Activities outside the United States	57
Current Activities at U.S. Facilities	60
Infrastructure	64
Leveraging Laboratory Resources	68
Data	70
Appendices	77
Appendix 1: Workshop Agenda	77
Appendix 2: Workshop Participants	80
Appendix 3: Additional Discussion Topics	83
Appendix 4: Notation and Abbreviations	84

Executive Summary

The Basic Energy Sciences (BES) X-ray and neutron user facilities attract more than 12,000 researchers each year to perform cutting-edge science at these state-of-the-art sources. While impressive breakthroughs in X-ray and neutron sources give us the powerful illumination needed to peer into the nano- to mesoscale world, a stumbling block continues to be the distinct lag in detector development, which is slowing progress toward data collection and analysis. Urgently needed detector improvements would reveal chemical composition and bonding in 3-D and in real time, allow researchers to watch “movies” of essential life processes as they happen, and make much more efficient use of every X-ray and neutron produced by the source.

The immense scientific potential that will come from better detectors has triggered worldwide activity in this area. Europe in particular has made impressive strides, outpacing the United States on several fronts. Maintaining a vital U.S. leadership in this key research endeavor will require targeted investments in detector R&D and infrastructure.

To clarify the gap between detector development and source advances, and to identify opportunities to maximize the scientific impact of BES user facilities, a workshop¹ on Neutron and X-ray Detectors was held August 1-3, 2012, in Gaithersburg, Maryland. Participants from universities, national laboratories, and commercial organizations from the United States and around the globe participated in plenary sessions, breakout groups, and joint open-discussion summary sessions.





Sources have become immensely more powerful and are now brighter (more particles focused onto the sample per second) and more precise (higher spatial, spectral, and temporal

resolution). To fully utilize these source advances, detectors must become faster, more efficient, and more discriminating. In supporting the mission of today's cutting-edge neutron and X-ray sources, the workshop identified six detector research challenges (and two computing hurdles that result from the corresponding increase in data volume) for the detector community to overcome in order to realize the full potential of BES neutron and X-ray facilities.

Resolving these detector impediments will improve scientific productivity both by enabling new types of experiments, which will expand the scientific breadth at the X-ray and neutron facilities, and by potentially reducing the beam time required for a given experiment. These research priorities are summarized in the table below. Note that multiple, simultaneous detector improvements are often required to take full advantage of brighter sources.

High-efficiency hard X-ray sensors: The fraction of incident particles that are actually detected defines detector efficiency. Silicon, the most common direct-detection X-ray sensor material, is (for typical sensor thicknesses) 100% efficient at 8 keV, 25%

Research Direction	Areas of Required Detector Improvement		
	 speed	 efficiency	 resolution
More efficient sensors, to make better use of each X-ray and neutron			
High-efficiency hard X-ray sensors		X	
Replacement for ³ He (helium-3) for neutron detectors	X	X	
Detector improvements for time-resolved imaging and new chemically sensitive microscopies			
Fast-framing X-ray detectors	X	X	
High-speed spectroscopic X-ray detectors	X	X	X
Very high-energy-resolution X-ray detectors		X	X
Low-background, high-spatial-resolution neutron detectors		X	X
Computing advances to make detectors usable and experiments possible			
Improved acquisition and visualization tools			
Improved analysis work flows			

¹ Complete information on the workshop is at <http://www.orau.gov/detector2012/>
Presentations available at https://portal.slac.stanford.edu/sites/conf_public/nxd2012/

efficient at 20 keV, and only 3% efficient at 50 keV. Other materials are needed for hard X-rays.

Replacement for ^3He for neutron detectors: ^3He has long been the neutron detection medium of choice because of its high cross section over a wide neutron energy range for the reaction $^3\text{He} + n \rightarrow ^3\text{H} + ^1\text{H} + 0.764 \text{ MeV}$. ^3He stockpiles are rapidly dwindling, and what is available can be had only at prohibitively high prices. Doped scintillators hold promise as ways to capture neutrons and convert them into light, although work is needed on brighter, more efficient scintillator solutions. Neutron detectors also require advances in speed and resolution.

Fast-framing X-ray detectors: Today's brighter X-ray sources make time-resolved studies possible. For example, hybrid X-ray pixel detectors, initially developed for particle physics, are becoming fairly mature X-ray detectors, with considerable development in Europe. To truly enable time-resolved studies, higher frame rates and dynamic range are required, and smaller pixel sizes are desirable.

High-speed spectroscopic X-ray detectors: Improvements in the readout speed and energy resolution of X-ray detectors are essential to enable chemically sensitive microscopies. Advances would make it possible to take images with simultaneous spatial and chemical information.

Very high-energy-resolution X-ray detectors: The energy resolution of semiconductor detectors, while suitable for a wide range of applications, is far less than what can be achieved with X-ray optics. A direct detector that could rival the energy resolution of optics could dramatically improve the efficiency of a multitude of experiments, as experiments are often repeated at a number of different energies. Very high-energy-resolution detectors could make these experiments parallel, rather than serial.

Low-background, high-spatial-resolution neutron detectors: Low-background detectors would significantly improve experiments that probe excitations (phonons, spin excitations, rotation, and diffusion in polymers and molecular substances, etc.) in condensed matter. Improved spatial resolution

would greatly benefit radiography, tomography, phase-contrast imaging, and holography.

Improved acquisition and visualization tools: In the past, with the limited variety of slow detectors, it was straightforward to visualize data as it was being acquired (and adjust experimental conditions accordingly) to create a compact data set that the user could easily transport. As detector complexity and data rates explode, this becomes much more challenging. Three goals were identified as important for coping with the growing data volume from high-speed detectors:

- Facilitate better algorithm development. In particular, algorithms that can minimize the quantity of data stored.
- Improve community-driven mechanisms to reduce data protocols and enhance quantitative, interactive visualization tools.
- Develop and distribute community-developed, detector-specific simulation tools.
- Aim for parallelization to take advantage of high-performance analysis platforms.

Improved analysis work flows: Standardize the format of metadata that accompanies detector data and describes the experimental setup and conditions. Develop a standardized user interface and software framework for analysis and data management.

The diversity of detector improvements required is necessarily as broad as the range of scientific experimentation at BES facilities. This workshop identified a variety of avenues by which detector R&D can enable enhanced science at BES facilities. The Research Directions listed above will be addressed by focused R&D and detector engineering, both of which require specialized infrastructure and skills. While U.S. leadership in neutron and X-ray detectors lags behind other countries in several areas, significant talent exists across the complex. A forum of technical experts, facilities management, and BES could be a venue to provide further definition.

Introduction

X-rays and neutrons have been used to expand our understanding in physical and biological sciences for decades. With their short wavelengths and ability to penetrate a range of depths, together they provide powerful probes of the structure and dynamics of matter at the meso- and nanoscale. As X-rays interact primarily with the electrons around a nucleus, and neutrons interact with the nucleus itself, they provide complementary information.

Dozens of large-scale X-ray and neutron facilities serve tens of thousands of users worldwide each year. Driven by ingenuity, investment, and technical advances, sources have made astounding progress. X-ray sources have increased the brightness of their pulses by 9 orders of magnitude in the past 35 years. Over the same period, neutron sources have become 100 times as bright. Until recently, however, X-ray and neutron detector performance has been stagnant; dramatic increases in detector performance are urgently needed because the detector is now often the greatest limitation.

- **Imaging experiments**, representing a variety of microscopies that can give direct spatial information, require a detector with good spatial resolution and high dynamic range and/or high readout speed. Today's tomography and radiography (and for X-rays, scanning microscopies) are slow and inefficient, and time-resolved studies at relevant timescales are often impossible because detectors are too slow.
- **Scattering experiments**, which provide structural information, require similar detectors, but often with very high dynamic range and excellent spatial resolution. As an example, for X-ray Photon Correlation Spectroscopy (XPCS), the temporal resolution with which an incoming X-ray can be tagged requires orders-of-magnitude improvement. In general, neutron-scattering experiments, such as macromolecular crystallography, require compact detectors with 1 or 2 orders of magnitude count-rate improvement, and spatial resolution of less than 1 mm, so that larger angular coverage can be more easily achieved. For both imaging and scattering, more efficient neutron and hard X-ray detectors will reduce the time to do experiments.
- **Spectroscopy experiments**, in which tuning the incident energy or measuring the outgoing energy provides information on chemical composition and bonding, require an X-ray detector with good energy (if a direct energy measurement is made) and/or excellent spatial resolution (if used with a spectrometer). For

neutrons, these experiments are performed by measuring neutron time of arrival, which should be measured to better than 1 μ s in order to yield improved energy resolution for a range of spectrometers/diffractometers.

When the source is pulsed, these studies can be extended from static observations to dynamic ones approaching the time resolution of the source pulse width.

XPCS provides a simple illustration of the need for better detectors: Modern synchrotron radiation sources provide copious fluxes of coherent X-radiation, with properties similar to the more familiar visible laser light. The difference between the two is that X-rays have a 10,000-times shorter wavelength than visible light, and hence can "see" much smaller objects — in fact, they can see atomic-scale objects. Shining such a beam onto a sample generates a complicated intensity pattern that can be observed by an X-ray imaging detector, and used to understand the atomic-scale structure of the sample. If the sample changes its atomic arrangement with time, this diffraction pattern will also change. Measuring the time evolution of the pattern gives information about the motion of the atoms. Typical materials exhibit a range of timescales of this motion, but by far the most interesting is in the nanosecond-to-microsecond regime. Current imaging detectors are simply not capable of recording images with such a high time resolution.

Figure 1 shows a typical experimental setup to probe the interaction of a sugar with a lipid membrane. An understanding of the characteristic relaxation times of the surface oscillations can provide insights into the mechanism of toughening of the lipids by the sugar, a phenomenon used by organisms exhibiting resistance to extreme heat and extreme drought. This mechanism is not yet understood.

XPCS will become a much more powerful technique once detectors are faster (able to tag individual photons on the μ s to ns timescale), more efficient (samples are usually weak scatterers, and the accuracy of the result depends strongly on efficiently detecting all photons arriving at the detector), and

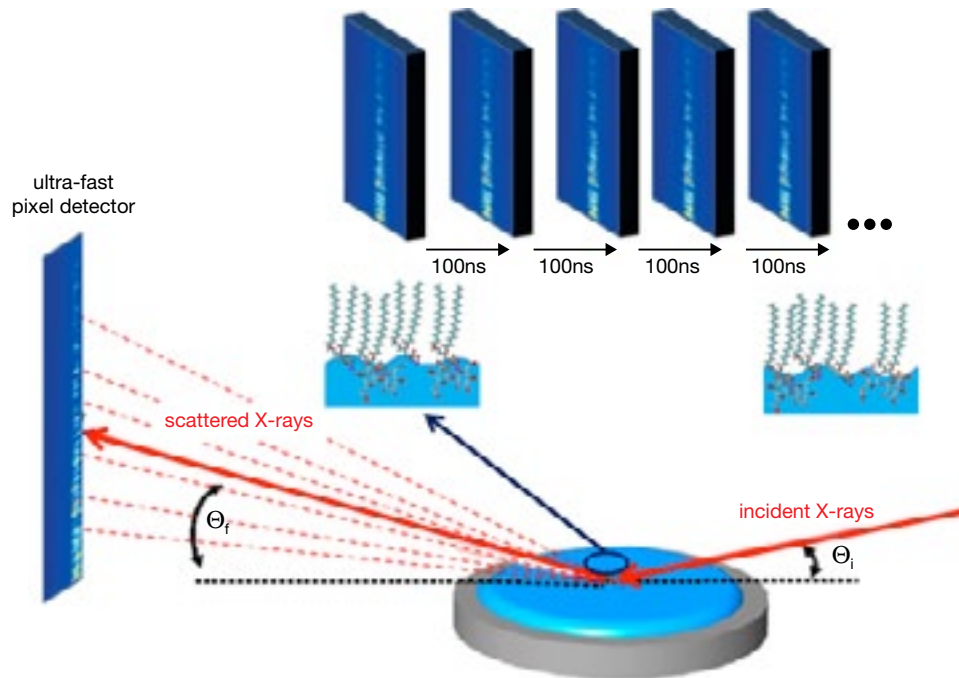

Figure 1 Photon correlation spectroscopy experiment.

have better spatial resolution (with numerous small pixels, to match the size of the interference features in the diffraction pattern — poor spatial resolution spoils the diffraction pattern contrast).

Although there are myriad specific experimental techniques, and often the techniques listed above are combined, from a detection point of view the incident particles are either elastically or inelastically scattered off the sample. The measured properties of the detected outgoing particles² are used to infer the sample's characteristics or behaviors. The capabilities and limitations of the source and the detector together thus determine the range of experiments that can be performed.

Operationally, the source has three key parameters:

- **Brightness:** the number of incident probe particles / (unit time x unit area x unit solid angle). Higher brightness generally means the experiment can be done faster.
- **Energy spectrum:** the primary energy and the

distribution of the probe particles. Often, a very narrow energy spectrum is desired.

- **Time structure:** whether the source is continuous or pulsed (and if pulsed, with what pulse width).

Additional features of the source (for example, coherence or polarization) may be critical for a particular experiment, but do not directly affect detector design. Temporally,

- Reactor neutron sources (e.g., the High Flux Isotope Reactor [HFIR] at Oak Ridge National Laboratory [ORNL]) are continuous.
- Spallation neutron sources (e.g., the Los Alamos Neutron Science Center [LANSCE] at Los Alamos National Laboratory and the Spallation Neutron Source [SNS] at ORNL) are pulsed, and have higher peak brightness than reactor sources.
- Storage-ring light sources (e.g., the Advanced Light Source [ALS] at Lawrence Berkeley National Laboratory (Berkeley Lab), the Advanced Photon

² Certain experimental techniques make use of secondary particles, such as electrons or ions, rather than the probe particles themselves. For the sake of brevity, this report is limited to detection of the X-ray or neutron probe particles.

Source [APS] at Argonne National Laboratory, the National Synchrotron Light Source [NSLS-I/II] at Brookhaven National Laboratory, and the Stanford Synchrotron Radiation Lightsource [SSRL]) are pulsed, and while used for time-resolved studies, are more often used as continuous sources (since the pulse repetition rate is quite high) and cover a wide range of X-ray energies (10-100 eV to 10-100 keV).

- X-ray free electron lasers (e.g., the Linac Coherent Light Source [LCLS-I/II] at Stanford) are pulsed, with exceedingly bright and short pulses.

Time-resolved (dynamic) studies are enabled by the temporal properties of both the source and the detector. For reversible processes, pump-probe techniques (where a pump, e.g., an optical laser, prepares a state, and particles from the source are

used to probe the state) are well demonstrated. For irreversible processes, Figure 2 illustrates how an integrating detector (analogous to a camera) can be used. When the time to record a frame is shorter than the pulse-repetition rate, the detector takes frame-by-frame snapshots.

Modern facilities have achieved dramatic improvements in higher brightness and better spatial, temporal, and energy resolution.

- SNS began operation five years ago as the world's most intense pulsed neutron source.
- LCLS began operation three years ago as the world's first hard X-ray laser, and is currently being upgraded.
- The APS is being upgraded to provide brighter, higher-energy X-rays and shorter pulses.

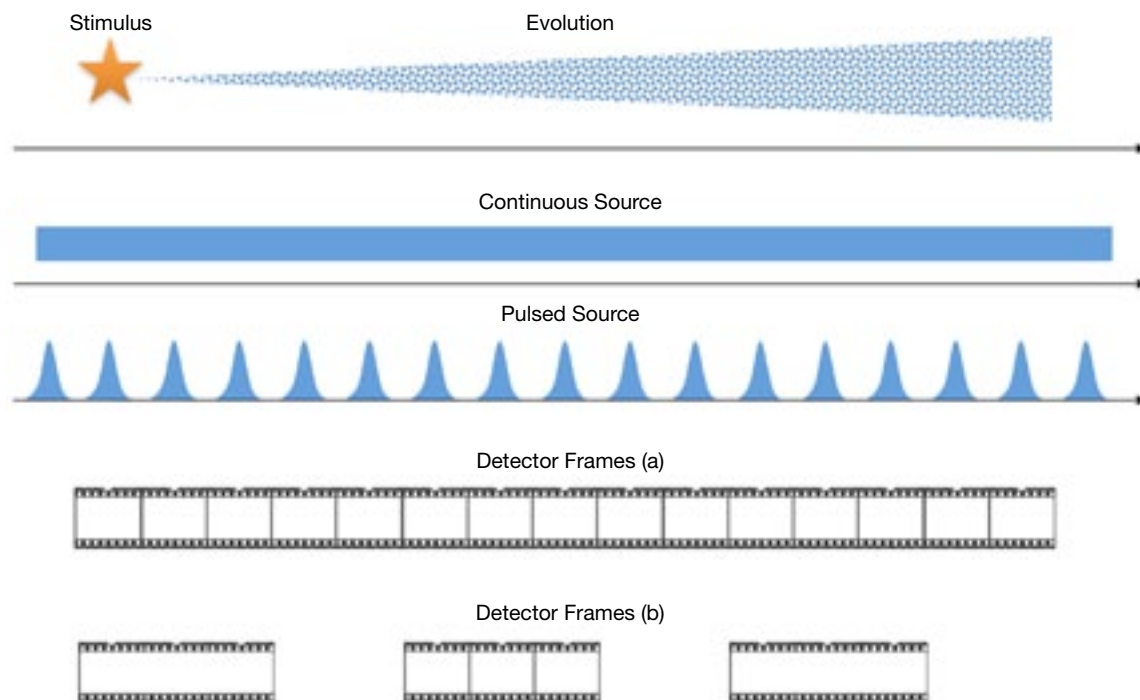

Figure 2 Illustration of how the temporal properties of the source and the detector are related in recording an irreversible dynamic process. With a continuous source, movies can be made with a high-frame-rate detector (a) or with a slower detector (b), which is insensitive during the time an image is being read out. For a pulsed source, (a) the frame rate may equal the pulse rate (as is the desired case for free electron lasers [FELs]) or (b) the detector may integrate over several pulses, and have a dead time associated with readout. As storage-ring light sources become brighter, there is growing need for detector speeds that can approach the pulse rate (a).

- NSLS-II, when complete, will provide exceptionally narrowly focused X-ray beams with very high-energy resolution.

To best take advantage of these improvements in source capabilities, three key detector advances are required:



speed

Readout speed: How quickly can the detector “take a picture”? The pulse width of the source determines the temporal resolution with which action can be

frozen, but the detector readout speed determines how many frames per second the movie has.



efficiency

Detector efficiency: What fraction of the particles to be detected actually are? Neutrons and hard X-rays are especially useful for their ability to penetrate deep

into bulk matter. Soft X-rays are nonpenetrating, and thus ideal to probe surfaces, but have difficulty getting through the detector entrance electrode. Neutrons are especially challenging to detect. The ideal sensor must stop everything, while letting anything in.



resolution

Sensitivity / energy resolution: How well can the detector distinguish between 0, 1, 2 ... particles? How well can the detector distinguish between two

particles of different energies? The ideal detector either measures the precise energy of the incoming particle, or noiselessly counts them.

Imaging, scattering, spectroscopy, and time-resolved experiments will benefit by advances in the above areas. Further, technological limitations of real detectors must be addressed. Three related detector enhancements are needed to fully realize the scientific promise of today’s facilities:



time

Detector speed: How quickly can the detector respond: With what temporal precision can the detector assign the arrival time of a particle? How much time

between two particles is required to distinguish them? The limitations may be intrinsic to the sensor, or may be related to the time needed to transport an electrical signal.



intensity

Dynamic range: What is the maximum range of signal that the detector element or pixel can record? If the detector pixel only counts single particles, what is the largest number, N , of counts that can be stored? How many false counts are recorded? If the pixel integrates the signal from multiple particles before digitizing, what is the equivalent largest number of particles that can be recorded before the pixel saturates, and what is the minimum signal it can reliably discriminate from noise?



size

Spatial resolution: With what accuracy can the impact point on the detector be determined? Conversely, in several cases the challenge is: How large can the detector be (or how much solid angle can be covered)?

Advances are usually required in more than one area simultaneously. Further, an improvement in one area may be detrimental in another — a faster detector is generally noisier; smaller pixels (better spatial resolution) often mean smaller dynamic range. In the same way that a complement of sources is required, a variety of detector improvements will be essential to maximize the utility of those sources.

Three examples illustrate how advances in detector capabilities will enhance our ability to use X-ray and neutron sources as tools for understanding the composition, properties, and behavior of materials at the nano- and mesoscale.

Examples

Fast hard X-ray detectors for studies of materials under extreme conditions

High-energy (>50 keV) X-ray diffraction is an extremely useful tool for bulk, nondestructive imaging of mesoscale materials. The penetrating power of high-energy X-rays allows a look inside large (mm) samples and through windows of sample environmental chambers (furnaces, high-pressure cells, etc.) with micron resolution. Because the photon flux falls off at high energies, even at high-electron-energy sources like the APS, it is important to make every photon count. An important future direction of high-energy diffraction will be the exploration of the time dependence of in situ processing and deformation studies of materials such as in reaction synthesis, friction-stir welding, and dynamic deformation studies, as shown schematically in Figure 3. Researchers would like to interrogate these events every couple of nanoseconds over the time of the deformation (perhaps up to a microsecond).

The challenge



speed



efficiency



intensity

Filming these irreversible processes requires a detector far beyond what is available today.

- Very high-frame-rate detectors, approaching storage-ring pulse repetition rates (e.g., nanoseconds between frames) — many orders of magnitude beyond what is currently possible — must be developed. These detectors will also require very high dynamic range, since the X-ray intensity can vary by 6 orders of magnitude or more across the image.
- High-speed sensor materials, fast enough to record X-rays at these rates, with high quantum efficiency for very hard X-rays, must be developed.

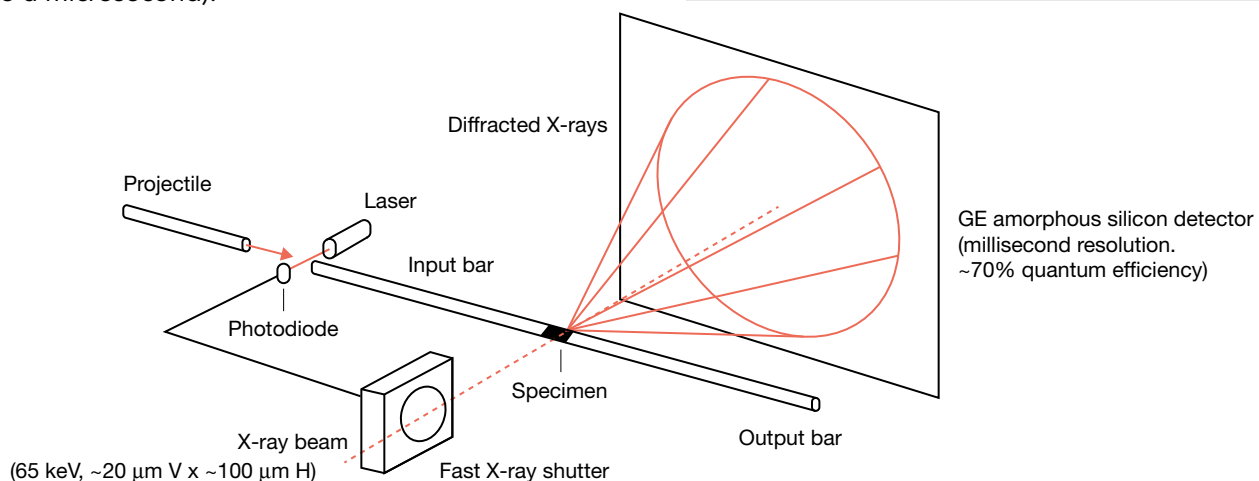

Figure 3 Studies of materials undergoing high strain rates generated by a Kolsky bar arrangement. The fast shutter is used to determine the temporal resolution of the experiment, as the detector is currently too slow and therefore the X-rays must be shuttered. The detector shown is what is currently available at the APS.

Fast energy-resolving X-ray detectors for chemical composition and structure determination at the mesoscale

Modern synchrotron sources can produce exquisitely fine (hundreds of nanometer) beams that can be raster-scanned across the specimen to successively probe its various parts. Energy-resolving detectors enable a variety of spectromicroscopies:

- X-ray fluorescence is a classic method to identify the atomic composition of materials. Here, the X-rays excite a small area of the illuminated specimen. The specimen's excited atoms emit X-rays of an energy characteristic of the atom, providing an atomic fingerprint of the elemental composition of the specimen. Other fluorescent methods involve rotation of the specimen and/or the use of confocal X-ray optics to allow capture of the X-ray fluorescence from micron-size voxels (volumetric pixels) of the specimen. This provides enormous potential to nondestructively probe an object's atomic composition. Examples include the analysis of metal uptake in plants, the study of inhomogeneous catalysts, revealing paintings hidden beneath other paintings (an estimated 20% of all great works of art hide paintings underneath), analysis of toxic metals in soils and sludges, study of ash and soot, electromigration, etc.
- Polychromatic Laue microdiffraction is another example of a scanning technique that can be used to provide structural information of complex systems.

The challenge



Both these techniques are presently limited by detector speed and efficiency. The fluorescent X-rays are emitted in all directions, so efficiency requires detectors that are not only sensitive and fast, but also offer a very wide solid angle of detection.

- Very high frame rates are needed, as these techniques require the measurement of individual photons, and today's high-brightness sources are capable of very high fluences.
- The accuracy of X-ray energy measurement depends on properties of the sensor and of the readout electronics. Since thermal noise increases as the square root of the readout rate, new advances in electronics and detector design are required. New kinds of sensors, able to provide much higher intrinsic resolution, are an alternate approach.

Enhanced neutron detectors for in situ probes of functional materials

Neutrons and X-rays provide complementary information because their scattering processes are different. Unlike X-rays, neutrons are sensitive to light elements, and easily penetrate thick samples. The neutron's weak magnetic moment is a probe for investigating magnetic materials. Also, because they scatter off of nuclei, neutrons are particularly useful for studying microstructurally complex materials. At neutron powder diffractometers today, experiments are parametric: Multiple measurements are made as a function of several changing condition(s) such as temperature, magnetic field, diamond-anvil-applied pressure, and cyclic strain. The outcome of these experiments is determined by how many condition points can be completed, and each point requires a complete diffraction profile to be collected. Ironically, it is increasingly the case that the most novel and interesting materials are initially difficult to produce and therefore forefront science uses small samples, e.g., of total mass <500 mg. For an SNS powder diffractometer such as POWGEN, a single measurement may take four hours on a small sample; over the course of a typical beam-time allocation of three days, an investigator is extremely

limited, as only about 15 condition points can be collected. Higher throughput from these instruments requires higher-efficiency 2-D area detectors and an increase in solid-angle coverage.

The challenge



efficiency



resolution



size

In order to be able to discern more subtle structural distortions, neutron detectors with high efficiency and improved spatial resolution are needed.

- Peak / background ratios often determine the measurement time needed, so that lower-background detectors, with lower gamma sensitivity, will dramatically improve performance.
- Due to the scarcity of ^3He , scintillator-based detectors are promising alternatives. Brighter scintillators are needed in order to provide similar performance.

X-ray and Neutron Detectors

Despite the wide variety of detector types used today, in essence a “detector” can be considered a 2-D array of individual detection elements. In a typical experiment to determine structure via crystallography, individual diffraction patterns (see Figure 4) are recorded at different orientations of the sample with respect to the beam (or, in the case of a free-electron laser [FEL], different samples are used for each shot). Reconstruction quality is determined by the precision with which each element “counts” the number of incident particles, and how many elements there are. The time it takes to perform the experiment, especially with today’s brighter sources, now depends more on how long it takes to read out each individual pattern rather than on properties of the source.

Such a 2-D diffraction detector consists of many individual detection elements, each of which can accurately record 0, 1, 2, ... N particles. For X-rays in the past 50 years, this kind of detector has evolved from photographic film (slow, low sensitivity, nonlinear, low dynamic range — i.e., N is a small number); to image plates (slow, higher sensitivity, higher dynamic range); to scintillators read out by, for example, charge-coupled devices (faster); to hybrid pixel detectors, where each element includes a solid-state detector, signal-processing electronics, and digital counters.

A counting (single-particle-sensitive) detector would ideally measure $[x \pm \delta x, y \pm \delta y, E \pm \delta E, t \pm \delta t]$ for each incident particle, with the smallest possible values for δx , δy , δE , and δt , and the highest possible efficiency, ϵ . An integrating detector measures the charge deposited, $Q(x,y)$, with a frame time of δT . Both types can be used for the static crystallography experiment described above, but in the case of an FEL, where all the photons arrive simultaneously, only an integrating detector can be used.

Detector Components

What is commonly referred to as a “detector” is in fact a system that, for the purposes of this workshop, has three components:

The sensor:



X-rays and neutrons are electrically neutral, so the sensor must be able to convert the incident particles to an electrical signal with high efficiency, ϵ (see boxes *How an X-ray Detector Works* and *How a Neutron Detector Works*). Properties of a given sensor critically determine performance, and often present intrinsic limitations to ultimate detector performance.

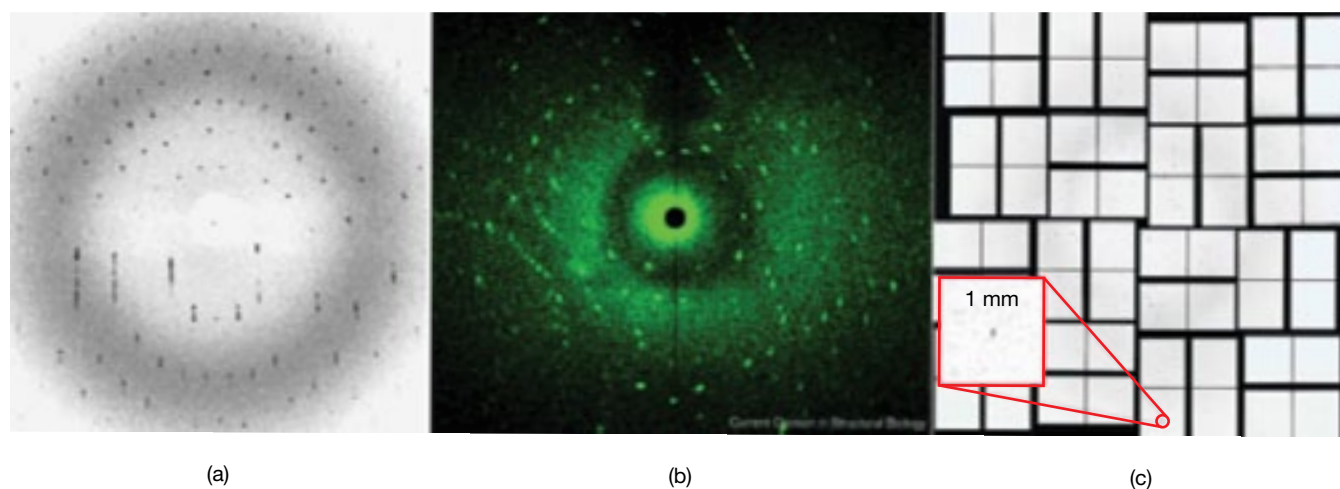

Figure 4 (a) X-ray, (b) neutron, (c) single-shot FEL diffraction patterns.

The readout:

The electronics and data acquisition that convert the electrical signal from the sensor into a digital number are ultimately stored on archival media. The readout also determines performance, and can present intrinsic limitations.

Software and computing: While not formally detector components, how the data are stored and visualized can be fundamental to the success of an experiment. As detectors become significantly faster and data volumes continue to dramatically increase, advances in this area are required as well.

Workshop

The purpose of the Neutron and X-ray Detectors workshop, held August 1-3, 2012, in Gaithersburg, Maryland, was to identify emerging detector R&D needs and opportunities to maximize the scientific impact of the DOE BES user facilities. The community has long recognized the need for detector improvement^{3,4,5} and, more broadly, the international community has actively advanced neutron and X-ray detector development.

Attendees represented universities, national laboratories, and commercial organizations from the United States and around the globe. The workshop comprised plenary sessions, breakout groups, and joint open-discussion summary sessions. Before the meeting, attendees submitted additional discussion topics (Appendix 3) that they believed represented upcoming challenges.

Presentations of these highlights were used to seed discussions.

This workshop focused on assessing state-of-the-art and future detector development requirements, emphasizing the underlying engineering, science, and technology needed to realize the next generation of detectors and to advance neutron- and photon-based science. In this report, we summarize the workshop conclusions on:

- The present state of the art in neutron and photon detectors
- Gaps in current detector capabilities and what developments should have high priority to support current and future neutron- and photon-based science
- Engineering, science, and technology challenges
- Connections to data-intensive computing and high-speed networking capabilities
- Models for deploying and supporting laboratory-developed detectors, including roles for industry

The first day of the workshop focused on the science drivers for synchrotron and FEL X-ray detectors, neutron detectors, and activities in Europe and Asia. Two parallel sessions explored the state of the art for detectors. The second day focused on crosscutting issues: sensors, electronics, and computing. An additional discussion topic, vital for detector development, was to find ways to go from detector R&D to deployed systems on beamlines.

Key Workshop Findings

There is worldwide activity to address the limitations in X-ray and neutron detectors. In some cases, the limitations are intrinsic, and require, for example, advances in sensor materials. In other cases,

³ *A Program in Detector Development for the U.S. Synchrotron Radiation Community*, Report of a Workshop held in Washington, DC, Oct. 30-31, 2000.

⁴ *Detector Development for Synchrotron Facilities*, Report of a Workshop held at the Advanced Photon Source, Dec. 8-9, 2005.

⁵ *Detector Advances for Light Sources*, Report of a Workshop held at the 16th Pan-American Synchrotron Radiation Instrumentation Conference, SRI2010 at the Advanced Photon Source, Sept. 21, 2010.

primarily engineering challenges — occasionally daunting — must be overcome.

As described above, the principal overarching areas requiring improvement are speed, efficiency, and sensitivity. The detector community is approaching these challenges in the following ways:



speed

Currently deployed X-ray detectors have continuous frame rates of 10^2 – 10^3 megapixels/s. Detectors under development for the European X-ray Free

Electron Laser (XFEL) will be able to record and store hundreds of megapixel frames at 5 MHz rates, and then read them out more slowly.



efficiency

For X-rays⁶, direct detection in silicon is becoming standard.

- For hard X-rays, silicon becomes transparent, and denser sensor materials are required. Cadmium telluride (CdTe), cadmium zinc telluride (CdZnTe or CZT), gallium arsenide (GaAs), and germanium (Ge) are candidates.
- For very hard X-rays, scintillators are still the most efficient sensors. Structured scintillators are attractive, as they can be thick, yet preserve reasonable spatial resolution.
- For soft X-rays, the inactive layer on the entrance side of the detector must be carefully minimized.
- For neutrons, a replacement for gaseous ^3He is a critical need. Certain scintillators with high neutron cross-section dopants are promising, but further development is required. Doped semiconductors offer high potential performance, but are at an early stage.



resolution

Particle detectors convert the passage of a particle into an electric charge. Often, the amount of electric charge produced is proportional to the energy of the incident particle — so that a measurement

of the resulting charge corresponds to a measurement of the incident particle's energy. The charge resolution of detectors, in which the signal is obtained by ionization, is intrinsically Fano-limited (i.e., limited by statistics in the ionization process). Advances in electronics will further improve semiconductor X-ray detectors. Superconducting detectors offer much higher energy resolution, but often at the expense of other parameters (speed, geometric efficiency, number of elements).

Additional areas where improvements are required are spatial and temporal resolution, dynamic range, and detector area. As brighter sources enable higher-repetition-rate time-resolved experiments, and as detector readout speed increases, an exploding amount of data will be generated. The design of experiments, detectors, and computing — while largely disjoint so far — must become more integrated.







The following chapters provide detailed summaries of workshop findings on X-ray and neutron detectors, as well as data acquisition and computing. In addition, the workshop looked carefully at the full context of detector development. Designing and then deploying a complex detector on a beamline has four components:

1. R&D to demonstrate a laboratory prototype that meets the requirements
2. Systems engineering to scale up the prototype to a full-size, robust detector system
3. Detector deployment, debugging, and tailoring to the beamline, and finalization of calibration routines
4. Ensuring detector maintenance

The development process is often iterative, as areas for improvement emerge as the detector is put to use. Further, the cost of engineering a deployable

⁶ X-rays are photons with energies between roughly 100 eV and 100 keV. This range is logarithmically divided into soft, tender, hard, and very hard X-rays. Using silicon as a standard, "soft" X-rays are <1 keV, "hard" X-rays are $10 \pm \text{few keV}$, and very hard X-rays are >25 keV.

Table 1 Source Advances and Corresponding Required Detector Improvements.

Source Improvement	Detector Improvement Needed	 speed	 efficiency	 resolution	 time	 intensity	 size
Brighter sources		X	X			X	
with better energy resolution		X	X	X			X
with better spatial resolution		X	X			X	X
with better temporal resolution		X	X		X		

detector may outweigh the R&D. In the *Context* chapter of this report, international activities along with those at U.S. facilities are summarized to explain the breadth of skills and infrastructure required.

The United States, Europe, and Asia are all investing in X-ray and neutron detector development to ensure the most scientifically productive use of their facilities. In most cases, the technology developments grew out of particle physics, but the capabilities of modern sources now demand sophisticated, custom-designed detector solutions. Europe has a distributed, collaborative model, which can take advantage of expertise across a large base. Investment levels are also significantly higher in Europe than elsewhere, resulting in cutting-edge development there.

While it is often obvious how improvements in the source benefit all experiments, detector improvements are more subtle. In many areas, source improvements have far outstripped detector advances — so that rather than reap the benefits of improved source brightness, neutrons and photons are frequently unused or — worse — carefully attenuated. Focused detector developments would deliver better detectors, enabling new techniques that would foster new science. Improving detector performance to match the advances in source performance is the single most effective way to realize the full potential of the BES arsenal of tools.

Priority Research Directions



X-ray and neutron sources are becoming ever more powerful probes of the nano- and mesoscale, thanks to improvements in brightness and resolution (spatial, temporal, and spectral). Corresponding detector improvements in the same capabilities are required to fully enable the scientific missions of the facilities.

Table 1 shows areas where sources have been, are, or will make dramatic advances. Each of these advances in producing more — or more useful — X-rays and neutrons requires a corresponding improvement in detecting X-rays and neutrons. These advances often improve several source parameters at the same time, so multiple simultaneous detector improvements are required to take advantage of source enhancements.

Increased brightness benefits from more efficient detectors, with faster frame rates and wider dynamic range capabilities. This will enable:

- In situ movies of nonreversible phenomena at relevant timescales
- Improved ability to use hard X-rays and neutrons as bulk matter probes
- Improved ability to capture the full signal in single-shot FEL scattering experiments

Table 2 Priority Research Directions.

Research Direction	Detector Areas Affected			Detector Improvements Required		
	Sensor	Readout	Data	 speed	 efficiency	 resolution
High-efficiency hard X-ray sensors	X				X	
Replacement for ^3He for neutron detectors					X	
Fast-framing X-ray detectors	X	X		X	X	
High-speed spectroscopic X-ray detectors	X	X		X	X	X
Very high-energy-resolution X-ray detectors	X	X			X	X
Low-background, high-spatial-resolution neutron detectors	X	X			X	X
Improved acquisition and visualization tools			X	(X)		
Improved analysis work flows			X			

Brighter sources with increased energy and spatial resolution require detectors with the improvements shown in Table 1, along with better energy resolution (if the detector directly measures the particle's energy) or better spatial resolution (when the detector is used with a dispersive spectrometer, which translates energy into position). This will enable:

- A variety of chemically selective spectromicroscopies
- Improved inelastic X-ray and neutron experiments, when the detector's spatial resolution directly translates into improved energy resolution

Lastly, better temporal resolution necessitates improvements in all detector areas. This will enable:

- Storage-ring X-ray experiments that can use the time structure of the beam

- Dramatically enhanced correlation spectroscopies

Because multiple simultaneous detector enhancements are generally required in order to improve a given experiment, the research areas are clear, but do not lend themselves to prioritization. Table 2 lists the Priority Research Directions identified at the workshop, and indicates technical challenges to be overcome, as well as areas of the detector affected.

High-efficiency hard X-ray sensors: Silicon, the most common direct-detection X-ray sensor material, is (for typical sensor thicknesses) 100% efficient at 8 keV, 25% efficient at 20 keV, and only 3% efficient at 50 keV. Other semiconductor materials with higher densities are attractive candidates, but work is required on materials properties and pixilation techniques. A handful of

groups worldwide has pursued these developments for astroparticle physics and synchrotron radiation research. For very hard X-rays, scintillators may still be the best option. Structured scintillators offer a way to have a thick sensor without significant degradation in spatial resolution.

Replacement for ^3He for neutron detectors:

Perhaps the most significant challenge for neutron detectors today is the shortage of ^3He , a rare, nonradioactive isotope of helium that is a byproduct of the radioactive decay of tritium, itself a byproduct of nuclear-weapons stockpiles. As demand for it increases, ^3He stockpiles are rapidly dwindling, and what is available can be had only at prohibitively high prices. The decay of tritium in the U.S. National Nuclear Security Administration (NNSA) stockpile produces about 8,000 liters of ^3He per year, and a large SNS detector requires about 7,000 liters. The “gold standard” ^3He detectors, which make up over 90% of installed detector systems at U.S. facilities, have served the neutron-scattering community well for many years. Alternatives include ^6Li -doped scintillators, although work is needed on brighter, more efficient scintillator solutions. ^{10}B -doped silicon sensors would allow the types of pixel detectors now used for X-rays to be employed for neutron detection; however, efficiencies are still quite low.

Fast-framing X-ray detectors: Hybrid X-ray pixel detectors are becoming fairly mature, with considerable development in Europe. To enable time-resolved studies, higher frame rates and dynamic range are required, and smaller pixel sizes are desirable. Advances in readout architectures will allow custom-tailored experiments for the $\sim 5\text{-}10$ keV X-ray energy range. Improved hard X-ray sensors can extend these techniques to harder X-ray energies. Sensors with gain, such as avalanche photodiode arrays, can extend these techniques to softer X-ray energies.

High-speed spectroscopic X-ray detectors: The Fano-limited resolution of semiconductors makes them attractive sensors for fast, energy-resolving detectors; similar microelectronic techniques that have proved so useful for hybrid pixel detectors can be applied to these detectors. Achieving low noise

at high speed is a design challenge (since electronic noise tends to increase as the square root of the speed). Also, sensor processing can be quite exacting, as minimal impurities are desired (to ensure good charge collection and excellent spatial resolution). Once speeds are fast enough to ensure single X-ray detection, these detectors will enable transformational spectromicroscopies.

Very high-energy-resolution X-ray detectors:

The energy resolution of semiconductor detectors, while suitable for a wide range of applications, is far less than what can be achieved with X-ray optics. A direct detector that could rival the energy resolution of optics could dramatically improve the efficiency of a multitude of experiments. Superconducting detectors, which are successful in astronomy and cosmology, are capable of high energy resolution but are generally slow, difficult to make many element arrays of, and have limited geometric efficiency (fill factor). Improvements are needed on these properties, and in adapting techniques from the astronomy community to the synchrotron community.

Low-background, high-spatial-resolution neutron detectors: Scintillator-based detectors currently have gamma-ray sensitivities of $\sim 10^{-4}\text{-}10^{-6}$; however, low gamma-ray sensitivity ($10^{-6}\text{-}10^{-8}$) would significantly improve inelastic scattering experiments that probe the weak intensities from excitations (phonons, spin excitations, rotation, and diffusion in polymers and molecular substances, etc.) in condensed matter. Improving spatial resolution from the current state-of-the-art ~ 1 mm to $10\ \mu\text{m}$ or so would greatly benefit radiography, tomography, phase-contrast imaging, and holography.

Improved acquisition and visualization tools: In the past, with the limited variety of slow detectors, it was straightforward to visualize data as it was being acquired (and adjust experimental conditions accordingly) to create a compact data set that the user could easily transport. As detector complexity and data rates explode, this becomes much more challenging. Four goals were identified as important for coping with the growing data volume from high-speed detectors:

- Facilitate better algorithm development. In particular, algorithms that can minimize the quantity of data stored.
- Improve community-driven mechanisms to reduce data protocols and enhance quantitative, interactive visualization tools.
- Develop and distribute community-developed, detector-specific simulation tools.
- Aim for parallelization to take advantage of high-performance analysis platforms.

Improved analysis work flows: Standardize the format of metadata that accompanies detector

data and describes the experimental setup and conditions. Develop a standardized user interface and software framework for analysis and data management.

By nature, these research directions are overlapping. Not only will improvements in one area benefit another, but there are many examples where a detector developed for one application finds serendipitous use in another. After all, the charge-coupled device (CCD) was invented for digital storage, perfected for satellite imagery, and ushered in the age of digital photography. A coordinated strategy for better X-ray and neutron detectors can be a singularly effective way to realize the full potential of today's facilities.

How an X-ray Detector Works

An X-ray impinging on the detector will generally suffer one of three fates: (1) It can scatter elastically (and thereby go undetected); (2) it can inelastically scatter, emitting an electron with less energy than the X-ray ; or (3) it can be photoelectrically absorbed, giving up all its energy to the electron.

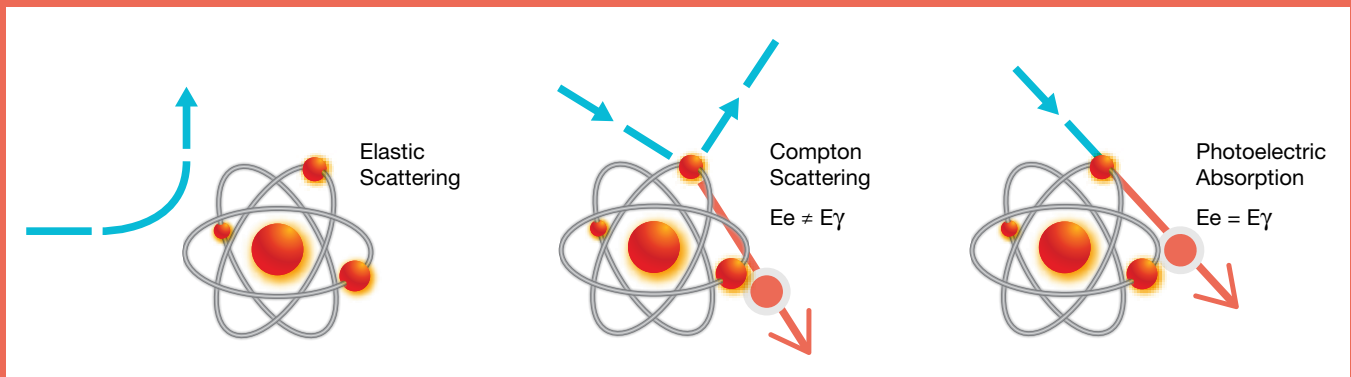

The excited electron can then undergo ionization loss in a material (free charges in a gaseous detector, visible light created in a scintillator, or charge collected in a semiconductor), leading to a detectable signal.

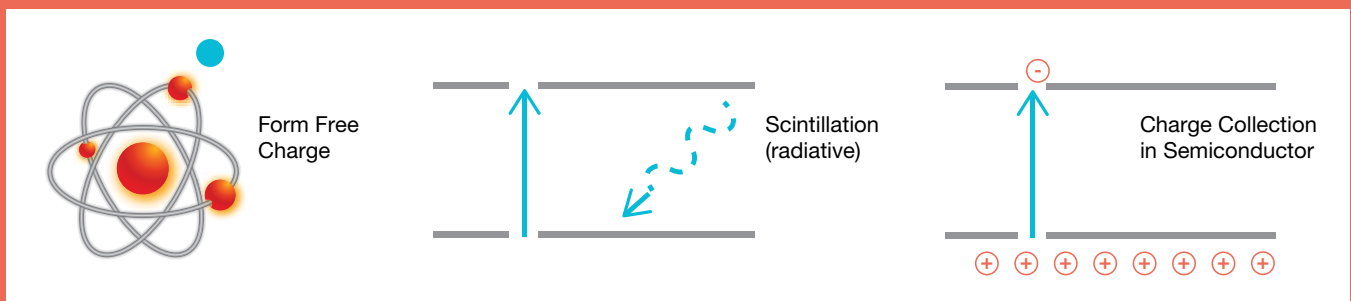

In each of these cases, a certain energy, η , is required to create those secondary quanta, so that $N = E_e / \eta$ secondary quanta are created. If the X-ray was photoelectrically absorbed, in which case $E_e = E_\gamma$, then a measurement of N is a measurement of the X-ray's energy.

How a Neutron Detector Works

In the same way an X-ray creates an electron that undergoes ionization loss in a gas, scintillator, or semiconductor detector in order to be detected, a neutron must create a daughter ionization particle generated through a neutron capture reaction with nuclei in the detector material. The challenge for neutron detectors is that there are only a few appropriate isotopes with high-capture cross sections for thermal neutron detection: ^3He , ^6Li , ^{10}B , ^{155}Gd , and ^{157}Gd .

In gaseous detectors, the reaction $^3\text{He} + n \rightarrow p + ^3\text{H}$ will generate a proton (0.573 MeV) and a triton (^3H , 0.191 MeV), which ionize the ^3He gas (or gas mixture).

For scintillation detection, ^6Li is an attractive thermal-neutron converter based on the reaction: $^6\text{Li} + n \rightarrow ^3\text{H}$ (2.75 MeV) + ^4He (2.05 MeV). In a $^6\text{LiF}:\text{ZnS}[\text{Ag doped}]$ scintillator screen, the daughter triton and alpha (^4He) particles will generate secondary electrons and holes in ZnS neighboring microparticles, and their recombination at Ag^+ sites produces large scintillation light pulses. As shown below, this can take the form of an Anger camera (left) with a 2-D array of photodetectors (or a pixilated photodetector) recording the scintillation light; or (right) two 1-D arrays of fibers recording the scintillation light.

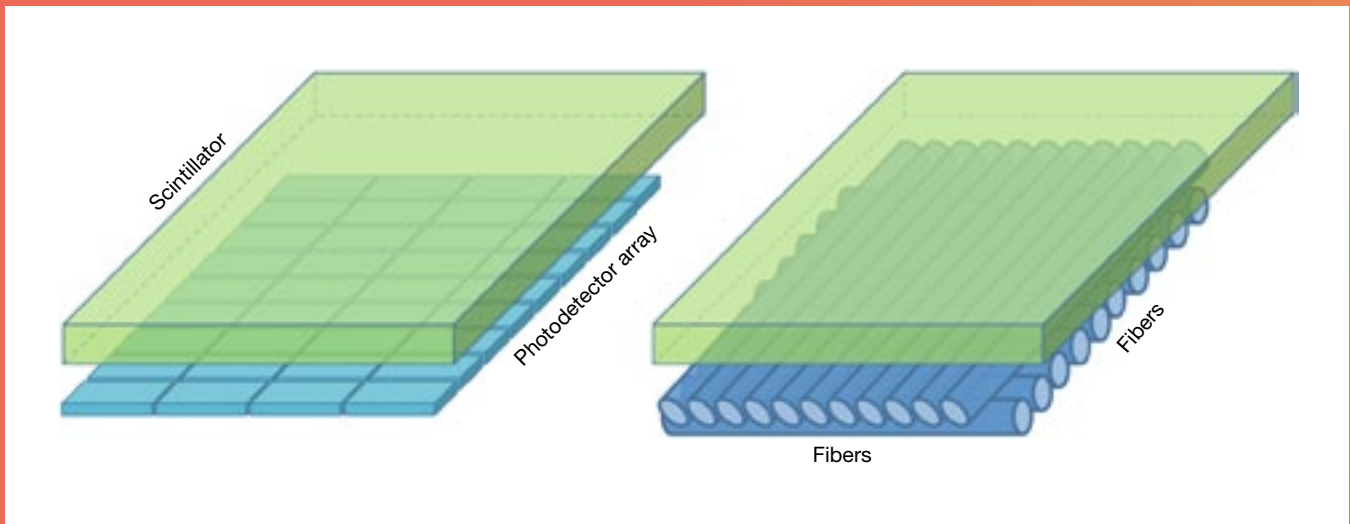

X-ray Detectors

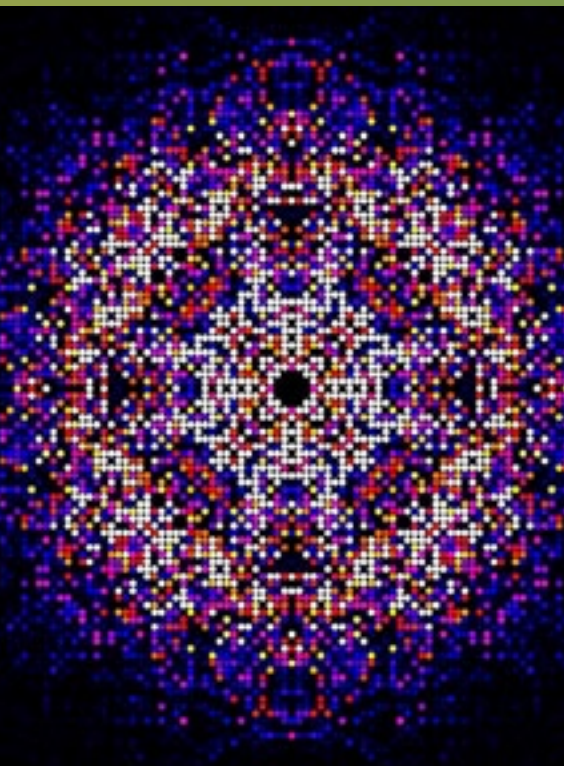

X-ray user facilities have proved to be remarkably successful and efficient as scientific research tools that enable discovery across the sciences, engineering, and even cultural studies. User facilities utilize a single source, such as a storage ring, to simultaneously illuminate many experiments. But the source is only part of any experiment: X-ray experiments additionally need detectors to capture the X-rays emanating from the sample. While a single source enables a multitude of experimental techniques, the detector required by each technique varies. Thus, while source improvements such as higher brightness may benefit all experiments at the facility, detectors and detector improvements vary from experiment to experiment. The result is that source enhancements have far outstripped detector improvements, to the point that detector limitations are now the single largest constraint on many experiments, and limit the output of the user facilities.

In this section, general properties and typical applications of X-ray detectors are described. The state of the art is surveyed, with particular emphasis on areas where detectors are limiting the exploitation of source capabilities. Technical challenges, and corresponding research directions, are listed.

General Properties

An ideal X-ray detector (Figure 5) consists of a seamless 2-D array of detection elements (pixels) with a pitch (size) p . For FEL sources or single-bunch measurements from synchrotron sources, where all photons arrive at the same time, each pixel *integrates* the total charge produced by the X-rays impinging on the pixel. For most storage-ring experiments, the source can be viewed as continuous (in time), offering the option to have each pixel *count* individual photons.

Detector key parameters include:

- **Quantum efficiency:** The probability that an X-ray will be detected.
- **Count rate:** For counting detectors, the maximum rate at which a pixel can distinguish (and thus count) individual photons.
- **Noise:** The rms electronic noise in each pixel. For counting pixels, the threshold (the minimum energy an X-ray requires to be detected) is proportional to the noise. For integrating pixels, noise adds an uncertainty to the number of photons detected.
- **Dynamic range:** The maximum number of X-rays that a pixel can store.
- **Spatial resolution:** Pixel pitch, p , determines the accuracy with which the X-ray's impact point on the detector can be determined. The total area of the detector is $D = (p_x \times N_x)(p_y \times N_y)$ for pixels of area $p_x \times p_y$, and where $N_x \times N_y$ is the number of pixels. This (and the distance from the sample to the detector) defines the *solid angle* that a detector can cover.

- **Temporal resolution:** The timing precision with which the arrival time of an individual X-ray can be measured by a counting detector, or the rate at which an integrating detector can be read out.
- **Energy resolution:** The precision with which a counting detector (or an integrating detector in the single-photon regime) can measure the energy of an individual X-ray, or the accuracy with which an energy threshold or window can be set for a counting detector.

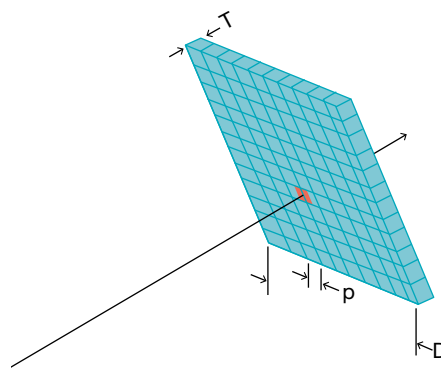

Figure 5
Pixel (or "2-D" or "area") detector.

Because of the scientific versatility of X-ray sources, a broad variety of techniques is currently available to investigate different sample properties. This requires detectors with different characteristics: No single detector type meets, or is expected to meet, the needs of all researchers.

Many experiments, such as protein crystallography, require quantitative X-ray imaging. The imaging X-ray detectors used may broadly be divided into **photon counters** and **integrators**.

Photon counters discriminate the signal resulting from each stopped X-ray to differentiate the signal from noise, and immediately allocate a count to digital memory. The popular Pixel apparatuses for the Swiss Light Source (PILATUS) series of detectors (developed at the Paul Scherrer Institute [PSI] and commercialized by Dectris, Ltd.) are examples of photon counters. Because it takes some time, generally tens of nanoseconds, for the signal from the stopped X-ray to be collected and processed, photon counters have limited instantaneous count

rates. However, they can reject the slow accumulation of “dark” current (the leakage current that occurs in a biased sensor) and thus are ideal for measuring very low-count-rate signals. They may also read out continuously at rates limited only by the readout electronics.

Integrators sum the charge generated from stopped X-rays and subsequently digitize it. Phosphor-coupled and direct X-ray detection CCDs and integrating pixel array detectors (PADs), such as the Cornell-SLAC PAD (CSPAD), are examples of integrators. Because the X-ray signals are processed in aggregate, integrators can handle very high instantaneous photon rates. Thus, integrators are the only practical alternative for many XFEL experiments. Many integrators have sufficiently low-noise electronics that they can readily identify single X-ray events. However, due to the accumulation of dark current, integrators are most practical for shorter frame times. Further, the integrated signals must at some point be digitized and read out, which usually introduces image frame-rate limitations.

Irreversible or single-shot experiments pose a greater challenge, in that as much data as possible must be collected at each sampling time. Pump-probe techniques allow one to follow the temporal evolution of fully repeatable processes by varying the time between pump and probe in a controlled way. For these experiments, **fast-framing** X-ray area detectors are frequently used for imaging and diffraction data collection. To provide the required spatial or momentum resolution for imaging and diffraction experiments, respectively, a large number of small pixels are often desired for the area detectors. Typical area detectors might have from several hundred thousand to a few million pixels that must be cleared so the detector is ready for the burst of X-rays. For nonreversible processes, onboard frame storage is a must.

Another class of experiments necessitates **energy-dispersive** detectors, where the energy of each photon is measured. At ~ 100 eV resolution, one can separate the fluorescent photons from different elements and thus measure elemental

concentrations at high sensitivity. Conventional semiconductor detectors provide this rather modest energy resolution (Fano-limited resolution in silicon is around $\sigma [\text{eV}] \approx \sqrt{0.4 E [\text{eV}]}$). Important developments involve increasing the solid angle over which the signal is collected, while simultaneously increasing the maximum count rate so that one can measure trace species alongside major constituents. One approach to meeting these goals is to use pixelated detectors such as the Maia detector (see box *Maia Detector Enables X-ray Fluorescence Microprobe*), while other approaches involve large-area silicon-drift detectors with high-speed readout electronics. At ~ 1 eV energy resolution or better, information on chemical bonding states is provided. Wavelength-dispersive detectors, involving X-ray collection optics and crystal spectrometers, can achieve this, but only over a restricted solid angle and energy range. Alternatives such as superconducting detectors can provide high-energy resolution over a wide energy range but are count-rate limited.

The energy of the X-ray itself may also impose detection challenges: Soft X-rays ($E \lesssim 2$ keV) require very low-noise electronics, since they deposit comparatively little energy; and ultrathin entrance contacts, since they are absorbed in short distances. Conversely, hard X-rays ($E \gtrsim 10\text{--}20$ keV) require sensors with high stopping power. This usually means the sensors are thick, which compromises the spatial resolution. With silicon, an electron-hole (e-h) pair is produced for each 3.6 eV deposited, and a 300 μm thick sensor is 100% efficient up to about 8 keV. Hybrid pixel detectors, in which a pixelated sensor array is bump-bonded to a readout integrated circuit, typically have electronic noise equivalent to >100 electrons, which, for 5σ sensitivity, gives a minimum threshold of about 2 keV.

State of the Art

An overview of detectors representing the current state of the art in each of the categories discussed was surveyed during the workshop. Detectors are briefly described and their defining technical characteristics reported in the corresponding tables.

The current state of the art in counting detectors at energies around 8 keV is represented by the PILATUS detector, and summarized in Table 3. Due to its readout rate, count rate, and large area, this detector has greatly improved the throughput of protein crystallography beamlines.

Table 3 State-of-the-Art X-ray Counting Detectors — Pilatus 3.

Count rate	>1 MHz
Pixel size	172 μm
Area	423.6 x 434.6 mm^2 (6 Mpixel)
Readout rate	600 Mpixel/s
Minimum threshold	~3 keV

Table 4 State-of-the-Art Hard X-ray Integrating Detectors — MMPAD.

Pixel size	150 μm
Area	~20 mm x 20 mm per 3-side buttable module
Full-well (maximum signal a pixel can store)	3×10^7 10 keV photons/pixel/frame
Frame rate	1000 Hz
Noise	1.5 keV

Table 5 CSPAD Properties.

Pixel size	110 μm
Area	326 cm^2 (2.3 Mpixel)
Full-well	2700 8 keV photons/pixel/ frame (low gain) 350 8keV photons/pixel/ frame (high gain)
Frame rate	120 Hz
Noise	~3.5 keV (low gain), ~1 keV (high gain)

For integrating detectors, the state of the art is represented by the Mixed-Mode PAD (MMPAD, the result of a collaboration between Cornell University and Area Detector Systems Corporation in Poway, CA) and the Cornell-SLAC PAD (CSPAD). The properties are summarized in Table 4 and Table 5.

The MMPAD is designed to have a very wide dynamic range. It does this by integrating charges resulting from the X-ray signal, but with the inclusion of a special circuit that helps prevent amplifier saturation: As the output of the integrating amplifier approaches saturation, an in-pixel circuit is engaged to remove a “bolus” of charge, B , from the integrator, to prevent saturation, and to increment an in-pixel digital counter. This operation introduces no dead-time since it can occur simultaneously with continued integration of signal charge. Thus, the pixel counts the number of times a bolus of charge was removed during an exposure. The size of the bolus of charge, N_{bolus} , may be set to be as large as the equivalent of several hundred X-rays. At the end of the exposure, the number, N , on the digital counter is read out and any remaining signal on the integrating amplifier is digitized, $N_{\text{remainder}}$. The total exposure signal is then $N_{\text{remainder}} + N \times (B \times N_{\text{bolus}})$. Thus, $N_{\text{remainder}}$ assures high sensitivity for low X-ray signals, whereas $N \times (B \times N_{\text{bolus}})$ is generally better than Poisson statistics for large X-ray signals.

The CSPAD is a hybrid pixel X-ray camera developed for coherent diffraction imaging of single proteins and viruses at LCLS. SLAC built the camera system around an application-specific integrated circuit (ASIC) designed by Cornell with the features described in Table 5. The camera comprises 2.3 Mpixels organized in four water-cooled quadrants, which can be radially moved in situ to precisely vary the beam aperture width from 1 to 9.4 mm, avoiding the extraordinarily intense FEL beam while optimizing angular acceptance. The hybrid pixel architecture makes it possible to take advantage of the pulsed nature of the LCLS FEL by electronic shuttering. A short (typically 3 μs) integration window, along with power cycling (running the analog and digital sections in sequence), allows the camera to operate at room temperature without suffering from dark current noise. Warm

operation greatly simplifies system integration, maintenance, and running, and in some cases allows variants of the camera to be used in direct proximity to warm samples.

For soft X-rays, the current state of the art is represented by two monolithic detectors based on CCDs implemented on thick substrates of high-resistivity silicon: the FastCCD (a conventional metal oxide semiconductor [MOS] CCD produced by Berkeley Lab) and the pnCCD (based on a CCD

structure formed by implanted diodes rather than MOS gates, produced by the Max Planck Institute [MPI]), as shown in Table 6. The FastCCD has been used at ALS, APS, and LCLS. The pnCCD has most recently been used in the CFEL-ASG Multi-Purpose (CAMP) end station, built by the Max Planck Advanced Study Group (ASG) at the Center for Free Electron Laser Science (CFEL) in Germany. The pnCCDs have been used in all the currently operating FELs.

Spectroscopic detectors, generally with far fewer pixels than the detectors described above, utilize semiconductor and superconductor technology. The United States has a leadership position in the development of the various superconducting detector technologies, including transition edge sensors (TES's), as shown in Table 7, and other technologies like microwave kinetic induction devices (MKIDs).

Although this type of detector provides much better resolution than semiconductor detectors (Fano-limited resolution), they still do not have the throughput of semiconductor detectors by order of magnitude. Experiments at synchrotrons, particularly in the energy range above 4 keV, are very high-flux experiments. The Maia detector can be considered the current state of the art for these applications (Table 8).

Unmet Detector Needs

As source characteristics improve, areas of scientific investigation open up that are no longer limited by the source, but by the detector. X-ray detectors universally benefit from improvements in increased efficiency, higher count-rate capability, lower noise, etc. Many experiments additionally benefit from the measurement of specific properties of the X-ray being detected, or by geometric enhancement (pixel size, detector area, etc.). Given the broad range of science conducted at X-ray facilities, the catalog of unmet detector needs is quite large. We concentrate, therefore, on a subset of potential improvements likely to have the largest impact for the community.

Table 6 State-of-the-Art Soft X-ray Integrating Detectors — pnCCD and FastCCD.

Pixel size	75 μm (pnCCD), 30 μm (FastCCD)
Area	74 x 78 mm^2 (pnCCD)
Full-well	$\sim 250,000 e^-$ (pnCCD), $10^5\text{--}10^6 e^-$ (FastCCD)
Frame rate (1 megapixel)	>200 Hz
Noise	35–70 eV

Table 7 State of the Art for Transition Edge Sensors.

Energy resolution	1.6 eV at 6 keV
Count rate	≤ 300 Hz per element
Elements	256
Area	5.76 cm^2

Table 8 Maia Properties.

Energy resolution	~ 270 eV (2 μs) / ~ 350 eV (0.5 μs) – at 6 keV
Count rate	~ 30 k (2 μs) / ~ 100 k (0.5 μs) – per pixel
Element	384
Area	3.84 cm^2

A counting (single-photon-sensitive) X-ray detector would ideally measure $[x \pm \delta x, y \pm \delta y, E \pm \delta E, t \pm \delta t]$ for each photon, with the smallest possible values for δx , δy , δE , and δt . An integrating detector measures the charge deposited, $Q(x,y)$ at a rate f .

An enabling breakthrough would be to greatly increase the readout rate in order to allow movies to be made to study nonreversible processes. Many phenomena differ slightly each time they occur. Examples include the evolution of turbulence in fluid jets, cavitation, crack propagation and the materials' response to ballistic impacts, chemical changes, and electrical stimulation. X-rays are frequently needed to probe these phenomena in situ while the process is ongoing. Today's storage-ring and XFEL sources provide sufficient numbers of X-ray photons per electron bunch to capture the relevant information, if there were imaging X-ray detectors capable of framing at the requisite repetition rates. The ideal setup would be efficient, high-sensitivity detectors capable of capturing wide-dynamic-range, high-spatial-resolution images down to the few-nanosecond bunch spacing at storage rings.

These movies could be made by recording at a continuous rate, with a time between frames Δt_1 given by the readout time of the detectors, or in a "burst" mode, with a time Δt_2 between frames, where Δt_2 is the time required to readout the detector into onboard storage in the detector (and read out at leisure). In this approach, Δt_2 can be much less than Δt_1 , although the number of frames that can be stored is limited in the case of onboard storage.

Integrating detectors operating in burst mode enable the study of nonrepeatable dynamic phenomena, as described in the Introduction. Such detectors will also have a huge impact on a new beamline under construction at the Advanced Photon Source (APS) for the study of dynamic compression of materials. This program, the Dynamic Compression Sector (DCS), held a 2012 workshop to better define the scientific case and develop the scientific community, and concluded

that⁷ "... advances in X-ray capabilities such as those provided by modern synchrotron sources enable the generation of bright, high-energy, and tunable X-rays that can be used to probe dynamic compression phenomena in real time and with unprecedented temporal and spatial resolutions. A key scientific feature of dynamic compression experiments coupled to high-energy, tunable X-ray probes is their ability to provide time-resolved, atomistic-scale investigations of condensed matter phenomena 'on-the-fly' or as they occur.

"While advances in high-performance computing continue to extend the range of length scales available for numerical simulations, extending the time scales of such simulations to experimentally observable processes in materials is generally challenging and remains very much an active area of research. Consequently, an important overarching goal of time- and space-resolved investigations of dynamically compressed condensed matter is to perform experiments on the time and length scales of numerical simulations and to bridge this knowledge gap. This is the frontier of dynamic compression science. Recent community-based workshops have concluded that in-situ, time-resolved measurements at microscopic length scales constitute the overarching science need for achieving a fundamental understanding of the mechanisms governing time-dependent condensed matter phenomena (structural transformations, inelastic deformation and fracture, and chemical reactions) under dynamic loading."

The report went on to say, "The most challenging aspect of preparation for DCS is the limitations of current detector technologies. A broad suite of detector technologies over a wide range of X-ray energies will be required to fully exploit the information present in the brief, intense DCS events. The scientific challenge is the development of detectors to record shock movies, that is, in-situ multi-frame imaging and diffraction. Ideally, DCS should be capable of delivering a shock movie using X-rays of energies from $\sim 10 - 35$ keV with the time

⁷ *New Research Opportunities in Dynamic Compression Science*, a Report on the DCS User Workshop June 2012, Institute for Shock Physics, Washington State University, Pullman, WA 99164.

between frames matched to possible bunch spacings at the APS, that is 153.4 ns, 11.4 ns or 2.8 ns. It is highly unlikely that detector developments for other light sources will universally meet the demands of the DCS community.”

To enable these experiments at APS and other facilities (e.g., SSRL [Stanford Synchrotron Radiation Lightsource] with a fill pattern of 96 ns), developments to decrease the recording time of present detectors and increase the full-scale charge per pixel are required.

Many experiments involve extremely high count rates. An example is time-resolved radiography of liquid jets, shock waves, crack propagation, and ballistic compression, where local count rates may

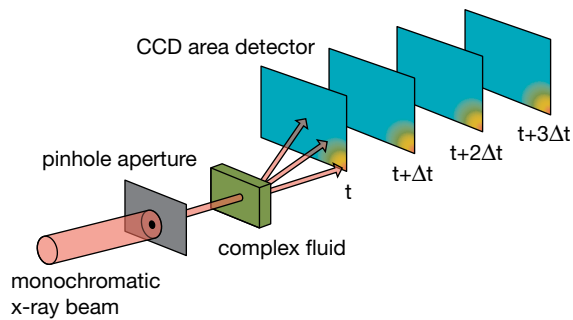

Figure 6 Illustration of a sequence of coherent scattering patterns used in X-ray photon correlation spectroscopy (XPCS).

exceed 10^{10} X-rays/pixel/s. Other experiments have a span of very high to very low intensities in each frame and have to be captured rapidly in successive frames. Examples include coherent X-ray diffraction imaging of thin specimens and time-resolved solution scattering. In both cases, single images may have spans of data that run from less than 1 X-ray/pixel/s to $>10^8$ X-ray/pixel/s. There is a need for detectors capable of capturing this span of data in each image while framing at KHz (or faster) rates.

For single-photon-sensitive detectors, reducing δt would dramatically improve X-ray Photon Correlation Spectroscopy (XPCS) experiments, in which the evolution of systems far from equilibrium can be studied (Figure 6). XPCS is used to study mesoscale systems, and covers a temporal range of $\sim 10^{-8} - 10^3$ s. This requires developing the ability to time-tag each photon to ~ 10 ns.

For single-photon-sensitive detectors, reducing δE would enable polychromatic Laue microdiffraction of complex samples. Microdiffraction is another powerful probe of mesoscale systems, and for complex samples often requires scanning monochromatic X-rays across the sample. By being able to measure the energy of each photon as it arrives (Figure 7), a user can avoid the need for scans at multiple energies. To be efficient, much higher readout rates are required.

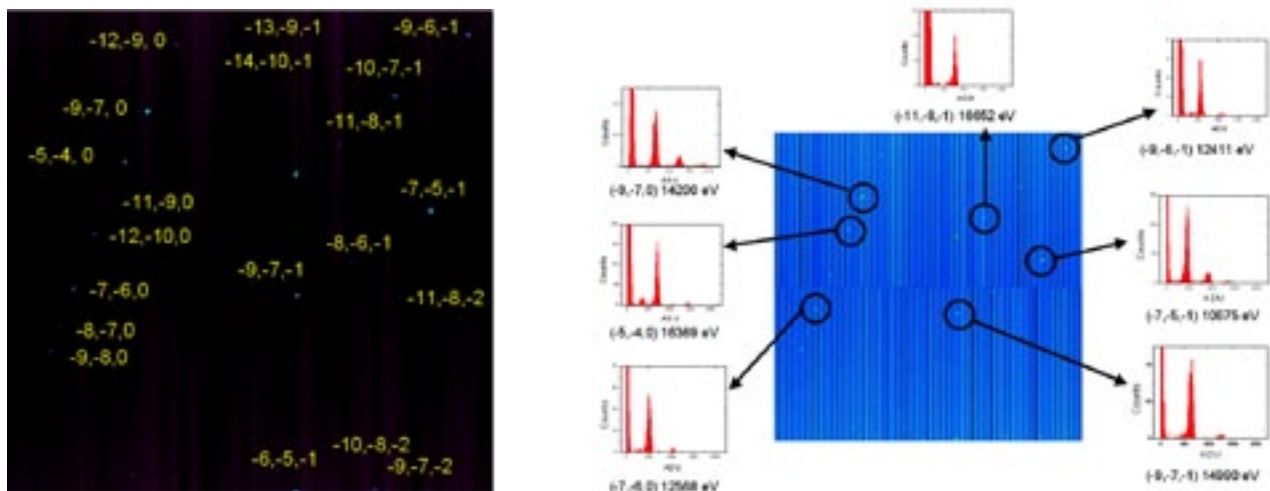

Figure 7 White light microdiffraction at ALS BL 12.3.2 with Berkeley Lab FastCCD.

Dramatically reducing δE would enhance and/or enable many areas of research, such as inelastic scattering, trace-element analysis where signal discrimination above the noise is critical, partial-fluorescence-yield absorption spectroscopy, X-ray emission spectroscopy of eV-scale chemical shifts, and spectroscopies with strong (characteristic) line overlap.

While X-ray optics can focus beams to dimensions of 20 nm or smaller, imaging over very large fields of view (e.g., 0.2–20 millimeters) requires a detector with an appropriate combination of area and intrinsic spatial resolution. Detectors used today for X-ray tomography, propagation-based phase-contrast imaging, and wide-field imaging of dynamic processes all use at present a scintillator-lens (visible) CCD camera system for recording the image. Achieving a ~ 1 micrometer resolution in such detection systems requires the use of scintillators only a few tens of micrometers thick. This limits signal spreading in the scintillator and is compatible with the depth of focus of the high-resolution light-microscope objective lenses used to magnify the scintillation image onto a visible-light camera. This, however, dramatically limits the efficiency of the detector system, since only a small fraction of the X-rays are absorbed in such a thin scintillator. Structured scintillators provide a potential solution, wherein thicker scintillation material is confined within columnar structures that confine the light output to an exit plane that is then imaged onto the visible-light camera. Structured scintillators with ~ 30 micrometer resolution are now commercially available (e.g., ScintX), but there is a serious need for structured scintillators with ~ 1 micrometer resolution for some hard X-ray imaging applications. Such detectors would dramatically improve the throughput of X-ray tomography experiments so that they could image dynamic processes happening over tens of milliseconds instead of seconds, and they would allow new beamlines such as the APS's planned Wide Field Imaging beamline to decrease exposure times for phase-contrast imaging by 2 orders of magnitude.

Photon-in photon-out spectroscopy is a general class of techniques that includes inelastic X-ray scattering

and emission spectroscopy. The incoming photons (i.e., photon-in) from the light source are scattered off the sample being investigated and the energy of the outgoing photons (i.e., photon-out) is measured. The photon-out can either be an inelastically scattered photon-in (i.e., inelastic X-ray scattering [IXS]) or fluorescence photons (i.e., X-ray emission spectroscopy [XES]). In IXS, the energy loss of the photon-out is measured and the spectrum of energy loss (i.e., energy transfer) imprints the intrinsic electronic excitations of the sample. The excitations with lifetimes above 1 eV include plasmons, core-shell electrons, and Compton recoil. In addition, IXS has two variants: resonant and nonresonant, referring to whether or not the photon-in energy coincides with one of the atomic X-ray transitions of the system. In XES, the photon-out is a fluorescence photon emitted after the filling of the core hole with valence electrons. XES probes the radiative decay of a core hole created by an X-ray with incident energy far from an absorption edge. XES provides information about the occupied orbitals or the density of electronic-transition states. Photon-in photon-out spectroscopy has been applied to virtually every field of science, including catalysis science, biology, chemistry, and geophysics. However, photon-in photon-out spectroscopy has been possible only at dedicated beamlines with spherically bent crystal analyzer spectrometers. These spectrometers are complex mechanical instruments with crystal analyzers that must be changed frequently and are dedicated to an individual beamline. In addition, the crystal analyzers must typically be positioned 1-2 meters from the sample, and thus have small solid-angle collection efficiencies. Improvements in energy-resolving detectors are required. Superconducting sensors show considerable promise for photon-in photon-out spectroscopy. Their resolution, ranging from a few eV to tens of eV, is not as good as the best wavelength-dispersive instruments, but their efficiency can be 2 or more orders of magnitude better. A National Institute of Standards and Technology (NIST) TES spectrometer at the NSLS recently demonstrated its performance in emission spectroscopy experiments.

The diversity of X-ray techniques means that there will never be a universal detector. However, it is clear

that improvements in efficiency; rate; maximum signal; and temporal, spatial, and energy resolution are enabling characteristics for a wide range of science. In addition, specific advancements are needed for both hard X-rays ($E > 10\text{-}20$ keV) and soft X-rays ($E \leq 2$ keV).

Hard X-rays are key for addressing some of DOE's grand challenges, like the study of mesoscale materials and in situ measurements of materials under extreme conditions. They have high penetration through dense materials (the penetration of hard X-rays through most materials increases by an order of magnitude going from 10 keV to 30 keV) and large momentum transfer (Q space). Hard X-rays are thus capable of penetrating inside the windows of low-temperature cryostats, high-temperature furnaces, high-pressure cells, etc., to explore the properties of materials under extreme conditions. Their penetrating abilities also allow samples to be studied in situ in cells and growth chambers where materials are synthesized. Hard X-rays also facilitate nondestructive in situ investigations of materials during service and far from their interfaces, where behavior is fundamentally distinct from surface regions.

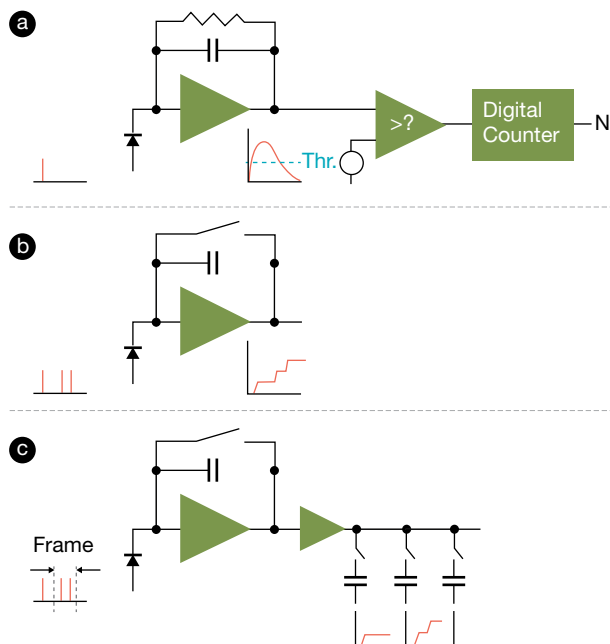

Figure 8 Different pixel architectures: (a) counting, (b) integrating, (c) fast-framing.

Such X-rays may be valuable for the study of radioactive materials in containment systems.

The penetrating nature of hard X-rays makes them useful as a probe, but also makes them harder to detect. Efforts are needed to improve the detection efficiency of hard X-ray detectors.

Soft X-rays provide chemical specificity and the ability to probe electronic structure. Angle-resolved photoemission and other spectroscopies are key to understanding collective phenomena such as high-temperature superconductors, colossal magnetoresistance, etc. Unlike hard X-rays, soft X-rays are not penetrating (and thus useful for understanding surfaces).

Here, too, efforts are needed to improve detection efficiency, but whereas the challenge for hard X-rays is to contain them, the challenge for soft X-rays is to capture them (and measure the small signal they produce).

Technical Challenges

Fulfilling unmet detector needs will require overcoming a number of technical challenges. In this chapter, we describe a series of fundamental challenges, along with possible approaches. In the next chapter, we provide a national and international context for work in this field. It is important to keep in mind that X-ray detectors are systems, comprising a sensor, electronics, mechanics, and software — all of which must work, and work together (frequently, mundane items like mechanics and cooling require considerable time and effort to implement properly and reliably).

Faster hard X-ray detectors

Faster hard X-ray imagers would be especially beneficial for investigation of nonrepeatable dynamic phenomena and XPCS experiments. The brightness of third- and fourth-generation light sources enables the study of nonreversible processes and generates a full image in very short timescales, down to single bunch or pulse timing; current detectors are many-orders-of-magnitude slower. Faster readout



speed



size



time



intensity



efficiency

Technical Objective 1⁸ Faster framing integrating detectors

Goal	State of the Art
10-20 μm pixels	55 μm (Medipix)
$\geq 10^7$ 8 keV X-rays maximum charge (per shot for FELs)	10^4 in development for EXFEL
Seamless (no gaps between pixels)	4 cm regions without gaps
>10 MHz frame rate with $\geq 10^3$ sample storage	EXFEL detectors in development are 6 MHz frame rate with ≤ 512 sample storage
High efficiency for >20 keV X-rays (see <i>Technical Objective 2</i>)	-

architectures and high-speed data transport to the data acquisition system are necessary.

Increasing the frame rate of hard X-ray imagers imposes significant technical challenges. Current state-of-the-art detectors can achieve high performance in one or more technical areas, but not all of them simultaneously.

Figure 8 shows different pixel architecture styles. All architectures amplify the pixel charge, but a counting detector digitally counts the number of hits above a threshold within a certain time window and an integrating pixel stores the total amount of charge within a certain time window. A fast-framing detector contains a number of storage elements (the example in Figure 8 has analog storage in the form of a switched capacitor array; other variants are possible) and for a limited number of frames, this makes a “write fast/read slow” mode possible. As discussed in the previous section, reducing the frame time and increasing the number of storage elements will make a variety of dynamic experiments (e.g., movies) possible.

As an output of the Workshop, Priority Research Directions were determined. We list these in this report as Technical Objectives, and describe each objective with a goal — and compare the goal with the current state of the art. Technical Objective 1 is to develop efficient, fast-framing detectors.

More efficient hard X-ray detectors

Nearly all area detectors available today (both CCDs and hybrid pixels) use silicon as the sensor material. However, the quantum efficiency of silicon detectors drops significantly for energy above 20 keV, as does their radiation tolerance. There is growing interest in the photon science community in the use of X-rays with energies greater than 20 keV, taking advantage of their higher penetration and larger momentum transfer, as a means to study in situ materials under extreme conditions.

Table 9 Physical Properties of Potential Sensor Materials for Hard X-ray Detectors.

Material	Atomic Number	Density (g/cm ³)	Band Gap (eV)
Silicon (Si)	14	2.3	1.12
Germanium (Ge)	32	5.3	0.67
Gallium arsenide (GaAs)	31 & 33	5.3	1.42
Selenium	34	4.8	1.8-2.0
Cadmium telluride (CdTe)	48 & 52	5.8	1.44
Cadmium zinc telluride (CdZnTe)	48, 30 & 52	~5.8	1.4-2.2

⁸ Technical Objectives are numbered for clarity, but not ranked.

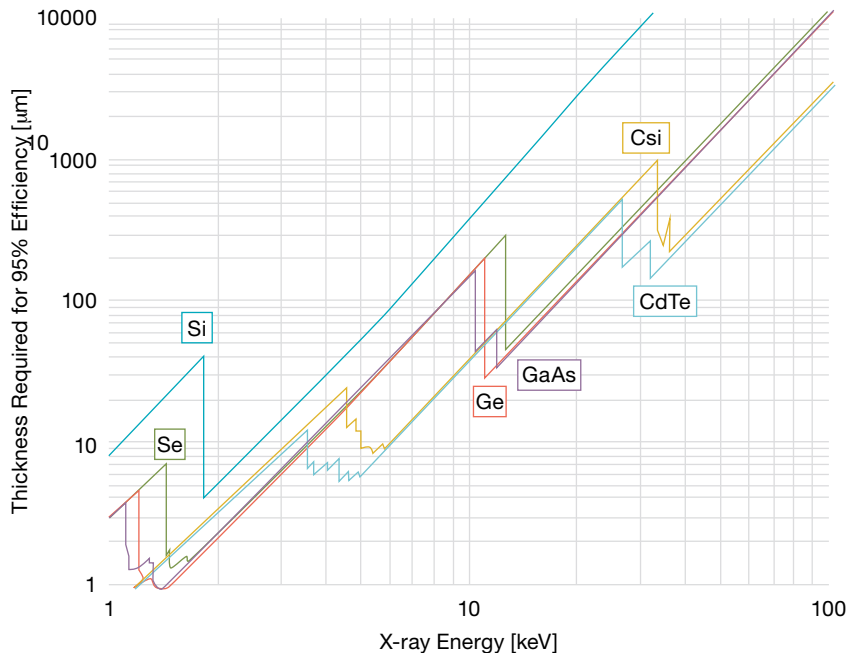

Figure 9 Thickness required for 95% X-ray efficiency as a function of X-ray energy for potential sensor materials.

In the photon spectra from storage rings, even high-energy rings such as the Advanced Photon Source (APS), brightness falls off an order of magnitude from its peak value above 40 or 50 keV. To take full advantage of the hard X-ray flux available at such facilities, detector efficiency must be improved in this energy range.

There are two approaches to this problem: (1) replacement of the present silicon sensors with higher-atomic-number sensors; and (2) conversion of hard X-rays to visible light, which can be efficiently collected by silicon sensors.

R&D is taking place on several fronts, with the aim of replacing silicon with higher-atomic-number materials such as cadmium telluride (CdTe), cadmium zinc telluride (CdZnTe or CZT), gallium arsenide (GaAs), germanium (Ge), and amorphous selenium (Se), listed in Table 9. Directly replacing the silicon sensor with a high-atomic-number material would significantly improve detector sensitivity, providing all the advantages of direct conversion (i.e., good energy resolution, good spatial resolution, and high detection efficiency). Figure 9 shows the sensor thickness required for

95% X-ray sensitivity (typical sensor thicknesses are a few hundred microns). More effort is needed to improve the quality of the starting material and/or the technology for device fabrication, and currently none of these materials can be considered a valid alternative to silicon.

Another option is to convert the hard X-rays using high-atomic-number scintillators with high light yield and short decay times capable of maintaining good spatial resolution. This still carries intrinsic limitations of poor energy

resolution and detection efficiency, typical of an indirect-detection scheme. For modest field-of-view applications, single-crystal scintillators (e.g., YAG:Ce and GGG:Eu screens with micron-thick doped layers) are commercially available from the European Synchrotron Radiation Facility (ESRF) and from laser vendors. However, this approach is limited by the thickness of the doped layer, which determines the stopping power of these scintillators against high-energy X-rays.

Structured scintillators (i.e., scintillators with some internal structure to limit spread of scintillation light and to maintain high spatial resolution) may be an attractive option. Structured scintillators can be made thick for better efficiency at high energies, but the structure helps preserve the modulation-transfer function. Structured scintillators can be natural (e.g., grown needles of CsI:Tl) or man-made structures filled with a scintillating material.

This leads to Technical Objective 2.

Technical Objective 2 Improve hard X-ray sensor quantum efficiency



Goal

>95% Quantum efficiency

State of the Art

Silicon — 25% QE at 20 keV for 300 μm sensor

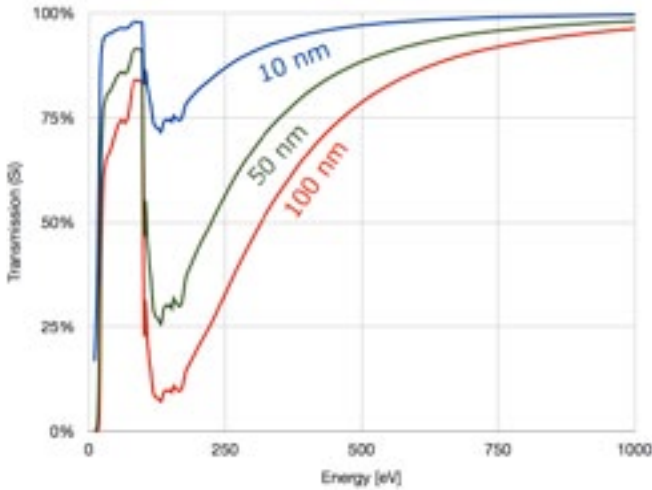

Figure 10 Transmission vs. energy for different thicknesses of entrance window.

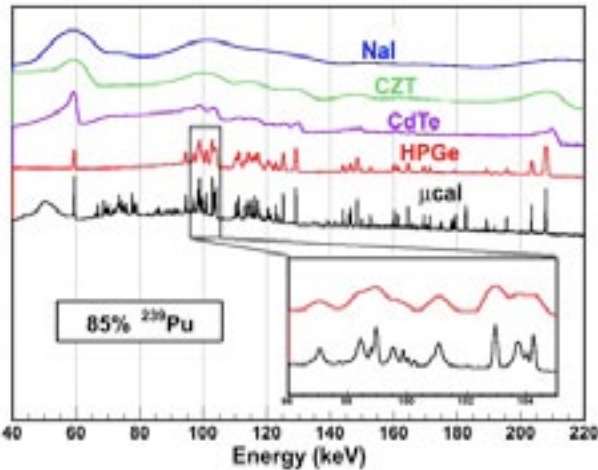

Figure 11 Comparison of scintillator (NaI), room-temperature semiconductor (CdTe), cryogenic semiconductor (Ge), and superconducting calorimeter energy resolution for very hard X-rays. Figure courtesy NIST/LANL.

High-speed spectroscopic and soft X-ray detectors

Several examples above (fluorescence, microdiffraction, spectro-ptychography) demonstrate the power of being able to detect individual photons with a pixilated detector and measure their energy.

The Fano-limited energy resolution (δE) afforded by semiconductor sensors is a powerful capability for (integrating) single-photon-sensitive detectors. To be single-photon sensitive, the integration (or pulse shaping) time, τ , is proportional to the time between X-rays in a pixel. Series noise (proportional to

detector capacitance) is proportional to $\frac{1}{\sqrt{\tau}}$ whereas parallel noise (leakage or “dark current”) is proportional to $\sqrt{\tau}$. Generally, then, as readout speed increases (so that τ decreases), noise will increase as the square-root of the readout speed.

Soft X-ray detectors that can read continuous frames at high rates enable synchrotron experiments with scanning beams (STXM, ptychography, etc.), dynamics, as well as FEL experiments. The primary challenge for both spectroscopic and soft X-ray detectors is noise — a ~ 280 eV carbon K-edge photon produces about 80 e-h pairs, combined with a high readout rate. For a 5σ noise threshold, <10 e⁻ noise per pixel is required. These noise levels have only been achieved with monolithic (not hybrid) detectors. Detectors with gain (e.g., avalanche photodiodes operating in the linear or Geiger regime) could be attractive solutions, if high fill factors can be obtained.

In addition, fully depleted detectors require conductive entrance windows, and for soft X-ray detectors, these must be extremely thin. Figure 10 shows X-ray transmission for different window thicknesses. To assure high efficiency, 10 nm windows are required.

This leads to Technical Objective 3.

Technical Objective 3
 resolution
  speed
  intensity
  efficiency

High-speed spectroscopic and soft X-ray detectors

Goal	State of the Art
<10 e ⁻ noise	5-20 e ⁻ (pnCCD, FastCCD)
10^{5-6} MPixel/s readout	~ 200 MPixel/s (10,000 MPixel/s in development)
High quantum efficiency at low energy	$>80\%$ at 250 eV

Detectors with very high energy resolution

Superconducting detectors, which were developed for astronomy and cosmology, can achieve exceptional

energy resolution, at the expense of readout rate and number of pixels. Figure 11 compares the energy resolution obtained with scintillators, solid-state detectors, and superconducting microcalorimeters. Clearly, superconducting detectors are capable of very high energy resolution. The challenges with such detectors have been the small number of pixels possible in an array, the low readout rate, the low fill factor (active/total area) and the need for sub-Kelvin cooling.

The most mature superconducting-detector technology is the transition edge sensor (TES) microcalorimeter, a superconducting thin film that is electrically biased into the resistive transition between its superconducting and normal-metal states. An incident X-ray photon with energy E_γ heats the detector by $\Delta T = E_\gamma / C$, where C is the detector's heat capacity. The heat then leaks out through a thermal weak link to the cryogenic bath. Heating causes a change in resistance that is ultimately read out as a current pulse via a superconducting quantum interference device (SQUID) ammeter. The current pulse height is proportional to the energy of the X-ray.

To overcome the small size and slow response times of individual detectors, TES microcalorimeters are built into arrays to increase the collecting area and total count rate. The main challenge to achieving large-format TES arrays is readout — a separate SQUID current amplifier and wire harness for each detector would overwhelm the cryogenics. To reduce

wire count and power dissipation, the readout of TES arrays is multiplexed, so that multiple detectors are read out through the same amplifier chain. Time-division and code-division SQUID multiplexing are increasingly mature technologies. Present SQUID multiplexing architectures can reach the kilopixel scale. Other multiplexing schemes (e.g., microwave resonator SQUIDs) have been demonstrated as paths to megapixel arrays, but additional development of these approaches is needed. The long-term potential for spectrometers based on superconducting sensors is dramatic. A megapixel TES array could provide 100-300 megacounts/sec, $E/\Delta E > 3000$, and nearly 2π solid angle coverage.

Modern millikelvin cryogenics eliminates the historical ease-of-use barrier to superconducting detector operation at a synchrotron beamline. These refrigerators are based on commercially available cryostats and require no liquid cryogenes. The resulting instrument is compact enough to be mated to virtually any sample chamber and is straightforward to operate.

In addition to TES's, microwave kinetic inductance detectors (MKIDs) and magnetic microcalorimeters (MMCs) are promising technologies. Besides astrophysical applications, superconducting detectors are finding applications in the fields of electron microscopy and homeland security.

This leads to Technical Objective 4.

Technical Objective 4

Develop a high-energy resolution detector for synchrotron radiation sources



Goal	State of the Art
Resolving power: $E/\Delta E \sim 3000\text{--}4000$	10 eV above 1 keV (STJ) 1.6 eV @ 6 keV / 22 eV @ 97 KeV (TES) 62 eV @ 6 keV (MKIDs)
1 MHz total count rate	10 kHz/pixel (STJ) <300 Hz/pixel (TES) 500-1000 Hz/pixel (MKID)
Large arrays	256-pixel TES detector at NIST currently largest calorimeter array Approx. 100 pixel arrays for STJ
Quantum efficiency >90%	>50%

Maia Detector Enables X-ray Fluorescence Microprobe

The most overdemanded beamlines at the National Synchrotron Light Source (NSLS) are the two X-ray fluorescence microprobe beamlines. These beamlines traditionally have relied on commercial germanium detectors, or more recently, individual silicon drift detectors, combined with step-and-repeat type scanning techniques. This typically results in small areas being imaged over a long time. A single-shift experiment might provide an image of 100 x 100 pixels. This severely restricts the completeness of an

examination of a sample, where the samples are usually highly inhomogeneous. In collaboration with the Commonwealth Scientific and Industrial Research Organization (CSIRO) in Melbourne, Australia, the NSLS detector group developed a new system, Maia, consisting of a massively parallel detector array and a new collection algorithm, combined with on-the-fly scanning of the sample stage. Experiments that would formerly have required weeks of beam time are now possible within one shift.

One example of such measurements is a study of metal sequestration by *Alyssum murale*, a plant frequently used in bioremediation. The image shows the elemental distribution in a leaf of this plant. The image is 420 x 700 pixels, and the data was collected at beamline X27A in two hours.

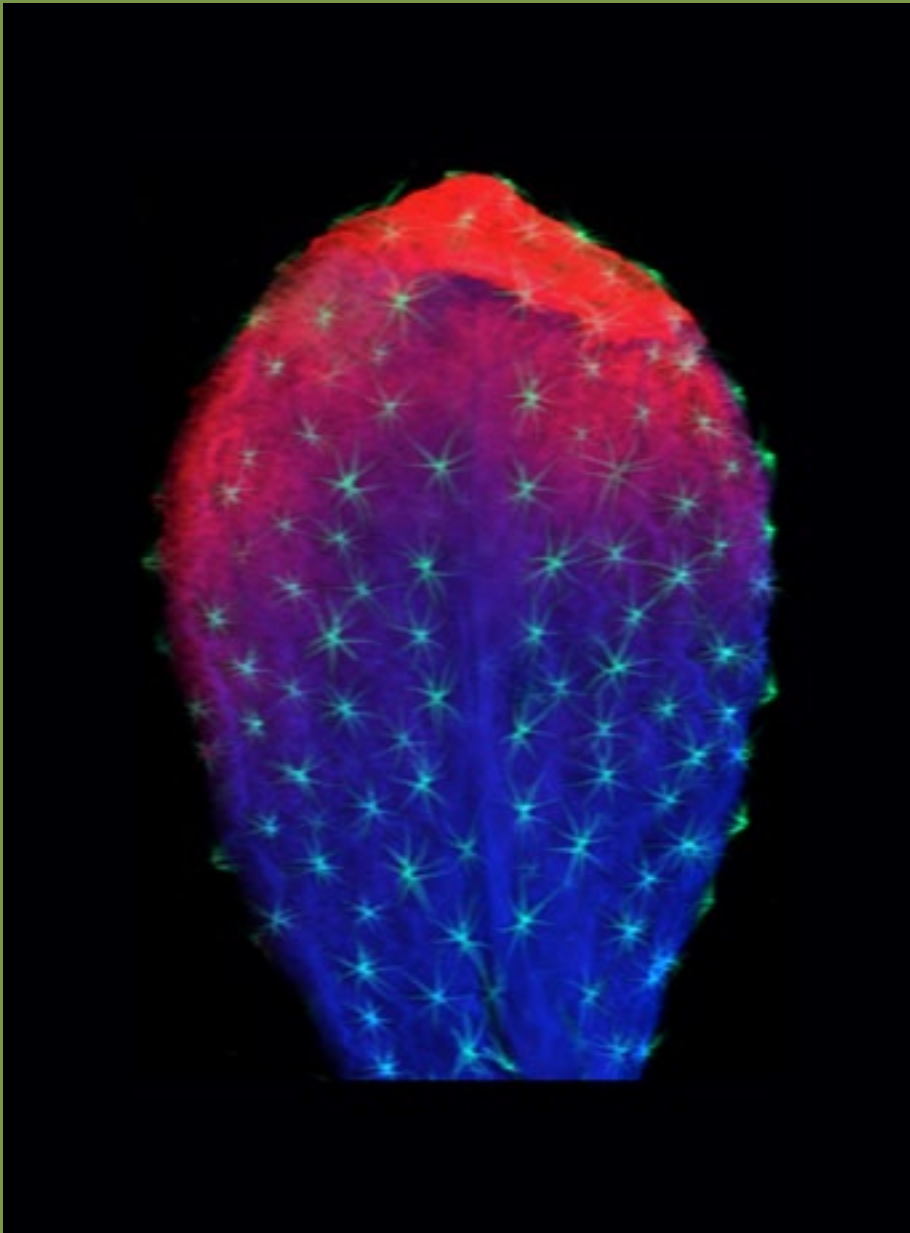

X-ray fluorescence microscopy image of a hydrated leaf from a cobalt hyperaccumulator plant (*Alyssum murale*), showing the elements cobalt (red), calcium (green), and potassium (blue). The image area is 4.22 mm x 7 mm, and has 420 x 700 pixels. The data was collected at a bending-magnet beamline (X27A) in only two hours.

Examples

Melting of materials under high pressure

The potential

High-pressure melting is of fundamental importance for estimates of temperatures in planetary interiors, on the dynamics of dynamos creating magnetic fields, and on the dynamics of motion in planetary mantles and plate tectonics. Experimentally, very high pressures are achieved in one of two ways: statically, by squeezing micron-size volumes of materials between two diamonds while heating them with a laser; and dynamically, by impacting a material with a supersonic projectile. The melting temperatures of both metals and silicates/oxides measured statically in laser-heated diamond cells are in serious disagreement with those obtained from shock experiments. This has serious implications not only for fundamental science of planetary interiors, but also for a host of defense applications and for peaceful uses of explosives technology. Synchrotron sources are capable of delivering very short pulses of X-rays to probe the detailed behavior of materials when these materials are dynamically compressed by impact with a small supersonic projectile.

The challenge



The impacting event occurs over a very short period of time, generally tens of nanoseconds. These experiments lack a sensitive imaging detector that can record a very rapid sequence of hard X-ray images that are closely spaced in time, e.g., nanoseconds apart.

High spatial resolution, hard X-ray imaging

The potential

The first and one of the most important applications of X-rays is to nondestructively visualize structure inside objects. In cases where the object is very thin, say less than a few millimeters thick, very hard X-rays, generally considerably greater than 20 keV in energy, are required to penetrate the object. Classic X-ray imaging uses absorption contrast between different constituent elements to differentially absorb the incident X-rays. Revolutionary modern methods introduced over the past 15 years allow use of phase contrast — the small-scale changes imposed on the phase of the X-ray waves — to provide up to 1,000 times higher contrast in many objects, allowing visualization of many new types of objects. Examples include soft animal tissues, fossilized insects in amber or in rocks, defects in polymeric objects, and turbulence in liquids.

The challenge



Both absorption and phase contrast suffer from a lack of high-efficiency detectors that can resolve spatially close features. High-resolution X-ray imagers typically involve stopping the X-rays in a thin absorbing material, such as film, a luminescent phosphor, or a semiconductor layer. The very same high-energy feature that allows X-rays to penetrate thick objects makes them difficult to stop in thin layers. The reduction in the fraction of X-rays detected results in inefficient detection, which is the norm for present-day high-spatial-resolution detectors. This matters little in cases where the specimen is static, insensitive to radiation damage, and the time required to do the experiment is not a consideration. However, this is a severe limitation for nonstatic specimens, practically all organic materials, and for cases where speed impacts productivity. There is great need for new approaches of efficient X-ray detection that can provide micron spatial resolution for X-rays of energy up to 100 keV.

Wide-dynamic-range X-ray imaging

The potential

Fast optical laser spectroscopy has revolutionized the understanding of the dynamics of electrons in matter. However, we still know very little about the movement of atoms in matter on timescales shorter than tens of nanoseconds. This is largely because classic probes of atomic structure, specifically X-rays, involved sources that produced pulses of X-rays that were either too weak or too long in time to be effective in fast time-resolved experiments. This situation has fundamentally changed with the introduction of X-ray free electron lasers and single-bunch Laue imaging at storage rings. These sources produce pulses that are both intense yet sufficiently short in duration (<100 ps) to provide ultrafast X-ray snapshots of matter in motion. They have the potential to provide unprecedented opportunities to understand the dynamic structure of matter. Examples include photo-, chemically, and electrically initiated activity in proteins, phonons and charge density waves, transient laser-produced warm dense matter of the types found in planetary interiors and stars, explosions, electrical discharges, crack formation in materials, etc.

The challenge

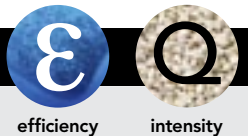

efficiency

intensity

Many of these phenomena have structural changes that vary in detail from one specimen to the next, requiring so-called single-shot experiments. In many of these cases, the X-ray intensity in the resultant image varies by 6 orders of magnitude or more across the image. Although snapshot-integrating detectors exist, they typically are inefficient, noisy, or have very limited dynamic range. There is great need for quantitative, wide-dynamic-range detectors. Specifically, there is need for hard X-ray detectors that are sensitive and efficient at the single X-ray level, yet can simultaneously record parts of the image where the local X-ray dose might be greater than a million X-rays. This need is especially acute for effective utilization of XFELs.

Fast, energy-resolving, wide-solid-angle detectors

The potential

X-ray fluorescence is a classic method to identify the atomic structure of materials. In an X-ray fluorescence experiment, a specimen is excited by hard X-rays. The excited atoms in the specimen emit X-rays of an energy characteristic of the atom, providing an atomic fingerprint of the elemental composition of the specimen. Modern synchrotron sources can produce exquisitely fine (hundreds of nanometer) beams that can be raster-scanned across the specimen to successively probe different parts of the specimen. Other fluorescent methods involve rotation of the specimen and/or the use of confocal X-ray optics to allow capture of the X-ray fluorescence from micron-size voxel of the specimen. This provides enormous potential to nondestructively probe the atomic composition of objects. Examples include the revealing of paintings hidden underneath other paintings (an estimated 20% of all great works of art hide paintings underneath), analysis of toxic metals in soils and sludges, study of ash and soot, electromigration, etc.

The challenge



speed

resolution

X-ray fluorescence is presently always limited by detector speed and efficiency. The fluorescent X-rays are emitted in all directions, so efficiency requires detectors that are not only sensitive and fast, but also offer a very wide solid-angle of detection. In an X-ray fluorescence experiment, one must necessarily accurately measure the energy of each detected X-ray, a process that tends to be limited by the speed of energy-resolving electronics. Low-atomic-weight elements fluoresce at relative low X-ray energies, presenting severe challenges for both efficient detection and energy resolution. There is great need for improvement in practically all aspects of X-ray fluorescence detection.

Nondestructive 3-D imaging of mesoscale materials

The potential

High-energy X-ray diffraction microscopy (HEDM) is a powerful technique to determine crystallite orientations, strain states, etc., inside bulk materials. Coupling these results with state-of-the-art computational modeling provides a platform for development of new materials and a better understanding of existing materials.

A schematic of high-energy diffraction microscopy setup is shown at left in the figure below. Images of the diffracted beams are collected and a 3-D microstructure of the sample (in this case, copper) can be built up, as shown at right, where the colors represent the crystal lattice orientations. In the experiment shown here, typically over 1 million Bragg peaks would be collected, resulting in terabyte-size data sets. The computational power of a 1,000-core parallel processing unit is required to go from the 2-D images collected to the 3-D orientation map.

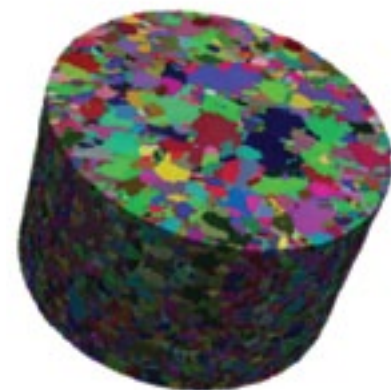
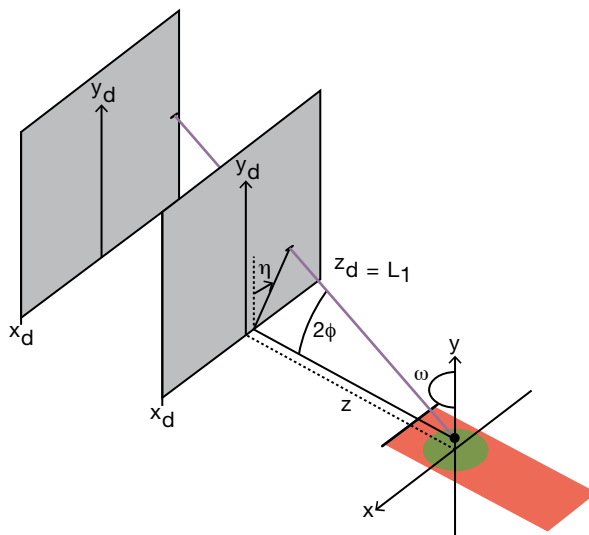

The challenge



efficiency



speed

For the experiment illustrated here, a CCD with a scintillator converter was used. The detector's spatial resolution ($1.5 \mu\text{m}$) and size ($3 \text{ mm} \times 3 \text{ mm}$) set the microstructure map resolution and field of view. But to get the $1.5 \mu\text{m}$ resolution, the scintillator had to be very thin, resulting in low X-ray efficiency at high X-ray energies. Currently, the speed of detector is also limited by the afterglow of the scintillator. This CCD/scintillator detector will be the rate-limiting factor for data collection when the APS upgrade is complete and improved high-energy insertion devices are installed. Better area detectors for hard X-rays — i.e., more efficient, larger area, higher spatial resolution — are required to take full advantage of the APS upgrade.

Fast, energy-resolving, high-energy detectors for high-pressure spectroscopy studies

The potential

High-pressure spectroscopy experiments, such as emission and fluorescence spectroscopy, or even X-ray Raman, currently use crystal analyzers to achieve the required energy resolution (a few to 10 eV). In particular, (inelastic) X-ray Raman scattering allows a user to measure the X-ray absorption fine structure (XAFS) of low-atomic-number elements with the hard X-rays required to penetrate the diamond anvil cells that produce the high pressures. Crystal analyzers at these high energies are often very inefficient; an effective replacement of analyzers with high (energy) resolution detectors could be very useful because they would allow for high collimation in collecting the scattering signals from embedded small samples in high-pressure cells. The limiting factor in many high-pressure inelastic scatterings is the signal/noise ratio. If such detectors with requisite high-energy resolution were indeed available, they might provide a new way to improve the signal/noise and to increase throughput.

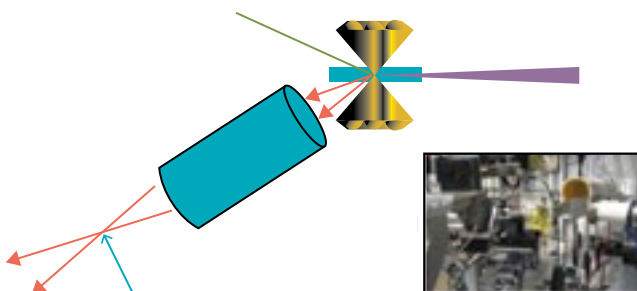
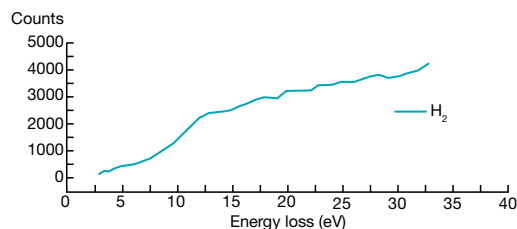
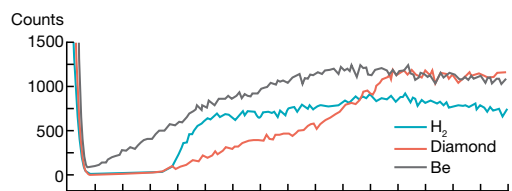

The challenge



Detectors with 5-10 eV resolution capable of high count rates and good efficiency at hard X-ray energies (20 keV and above) do not currently exist. The development of such detectors, most likely superconducting transition edge sensors (TES's), microwave kinetic inductance detectors (MKIDs), and/or magnetic microcalorimeters (MMCs), would have an impact not only on the high-pressure community, but also on other communities employing inelastic-scattering techniques.

Since the early years of quantum mechanics, it has been predicted that hydrogen molecules will dissociate into an alkali metal-like atomic form, becoming a dense metal at sufficiently high pressure. The established high-pressure X-ray Raman technique at APS is a direct experimental tool to address this pursuit, by measuring the change and closure of the hydrogen bandgap as a result of compression and phase transitions. However, such measurements are just beginning to be possible due to small sample in the diamond anvil cell and low scattering of hydrogen. The recent use of polycapillary optics allows us for the first time to effectively eliminate the unwanted scattering signals from surroundings and obtain the electron excitation signals of hydrogen at high pressure. Yet the measurements are still limited at pressures below 50 GPa. If the current analyzer-based spectrometer can be replaced by high-energy-resolving detectors, both the throughput and the signal collimation may be significantly improved, which will enable the study of the "holy grail" of metallic hydrogen.

Soft X-ray spectro-ptychography

The potential

Soft X-rays have wavelengths from 1–10 nm and typically have attenuation lengths of several microns in matter. This makes them ideally suited for studying morphology in mesoscale materials that have feature sizes inaccessible to optical microscopy and sample volumes too thick for electron microscopy. Diffractive optics, such as circular zone plate lenses, easily achieve 20–30 nm spot size with efficiencies of 5%–10%. However, the resolution of these optics is fundamentally limited by the smallest diffracting feature (the outermost zone width) that can be generated by electron beam lithography. Achieving higher resolutions with high efficiency and practical focal depths requires a fundamentally different imaging scheme.

The imaging technique, called X-ray ptychography, achieves high-resolution imaging without high-resolution optics, thus removing the limitations of standard X-ray microscopes. A ptychographic microscope operates much like a scanning transmission X-ray microscope (STXM) in that the sample is scanned on a regular grid through a focused X-ray beam and data is recorded at each sample position. In an STXM, the data is simply the integrated transmitted intensity, while in a ptychographic microscope, a full coherent diffraction pattern is recorded. Such data can be recorded to a resolution well beyond the numerical aperture of the focusing optic and hence the imaging scheme becomes wavelength-limited rather than spot-size-limited. A powerful application of soft X-ray spectro-ptychography would be the study of nanoscale connectivity and the electrochemistry of nanocomposite materials. For instance, mesoporosity has been shown to increase the gravimetric capacity of TiO_2 films while the shape of the nano building blocks can dramatically affect the electrochemical durability. Spectro-ptychography can potentially provide direct insight into the chemical reactions at the critical length scales in these materials.

The challenge



speed



resolution

Hard X-ray ptychography has been developed internationally and successfully applied to problems primarily in hard X-ray biomedical imaging, where current facilities show a resolution enhancement of up to a factor of 20 over the X-ray spot size. For soft X-rays, high speed, extremely low noise (a single photon at the carbon K-edge only generates about 80 electrons of charge in silicon), and wide dynamic range are required. Although in principle the resolution in ptychography is not limited to the spot size, a larger spot requires higher dynamic range. Since the diffraction intensity falls as the fourth power of the spot size, obtaining 2 nm resolution with a 30 nm spot requires a pixel that can hold $(30/2)^4 \sim 50,000$ photons at kHz frame rates. A detector with these capabilities would allow for efficient use of currently existing sources and would be equivalent to a multiple-order-of-magnitude increase in brightness. This would revolutionize X-ray microscopy by enabling wavelength-limited imaging without any further technological advances in X-ray optics.

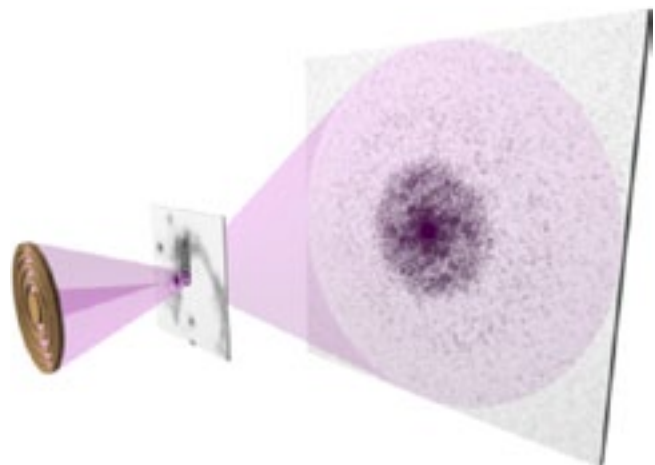

Neutron Detectors



Ever since the first neutron-diffraction experiments in the late 1940s, the neutron has become a key probe in many fields of science, with sources around the world now oversubscribed. The Spallation Neutron Source (SNS) in the United States, the Japan Proton Accelerator Research Complex (J-PARC) in Japan, and the upcoming European Spallation Source (ESS) are high-intensity sources that exemplify the importance of neutron scattering as an invaluable tool in a wide range of scientific, medical, and commercial endeavors. Many of these applications require the recording of an image of the neutron signal in one, two, or three dimensions. Important characteristics required from neutron detectors are high position resolution of sub mm to a few mm, excellent position linearity and stability, electrical stability, high count-rate capability, and insensitivity to gamma background. It is impossible to attain all these characteristics in one detector type, and careful choice of the appropriate technology must be made according to the application.

Because they are uncharged, neutrons are perhaps among the most difficult particles to detect. Indeed, only a few elements in nature have a high cross section for neutron capture. Figure 12 shows the neutron absorption cross section versus its energy for the most commonly used energy range in neutron scattering.

General Properties

Key neutron detector parameters include:

- **Neutron detection efficiency.** This is the most important parameter: Neutron-scattering instruments need high detection efficiency so that data-collection times are shortened and throughput is improved. High detection efficiency also allows small samples to be studied.
- **Background.** Low intrinsic background (<1 Hz/m²) and low gamma-ray sensitivity (10^{-6} – 10^{-8}) are required by most instruments, especially inelastic scattering instruments that probe the weak intensities from excitations (phonons, spin excitations, rotation and diffusion in polymers and molecular substances) in condensed matter. In diffraction-type instruments, low background allows the detection of weak features induced by factors such as impurities, defects, superlattices, strain, minority phases, and clusters in the sample.
- **Count-rate capability** (or dynamic range). The highest count rate at which no saturation occurs in a detector must be large for some diffraction-type instruments. When the incident neutron flux is high, neutrons at certain Bragg diffraction peaks may create hot spots and induce detector saturation. Single crystal diffractometers and small angle scattering are two examples.
- **Spatial resolution.** High-spatial-resolution (1.0–5.0 mm) detectors are needed for the majority of user experiments. Exceptional spatial resolution on the order of order 10 μ m is required for radiography, tomography, phase contrast imaging, and holography. If the time-of-flight (TOF) measurement is involved, the high-

resolution detectors must have a time-stamp function for neutron events.

- **Time resolution.** Most TOF neutron-scattering instruments need a time resolution of 1–10 μ s, which can be satisfied by ³He detectors and scintillator detectors. However, energy selective neutron imaging with VENUS and some intensity modulation instruments such as neutron spin echo (NSE) need a time resolution below 1 μ s. Higher time resolution in NSE instruments is needed to more precisely record the intermediate scattering function versus Fourier time.

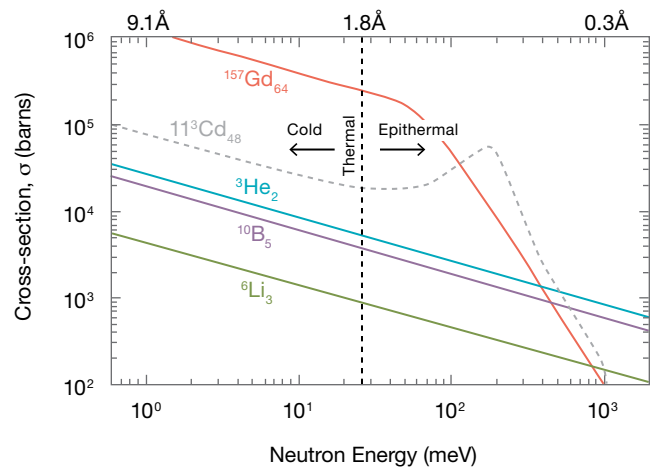

Figure 12 Neutron absorption cross section vs. neutron energy.

Most radiation detectors rely on the creation of free-charge carriers as the primary process on which they operate. Neutrons have no net charge, and can be detected either by direct collision with and displacement of nuclei, or by nuclear reactions. For thermal neutrons, insufficient energy is available for collision displacements, therefore nuclear reactions are the dominant process in neutron-detection methods. Figure 12 shows the neutron absorption cross section versus neutron energy for the capture reactions most relevant to instruments for the user community.

The two most important groups are:

1. Reactions with cross sections that decrease

as the square root of the neutron energy:

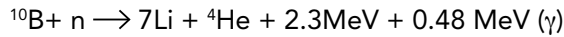
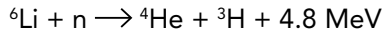
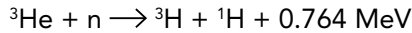

2. Reactions that are (n,γ) resonances in which γ -ray emission is inhibited and energy is transferred to the orbital electrons. This class of reactions gives rise to complex γ -ray and conversion electron spectra:

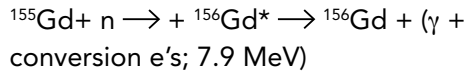

The main electron energies are 39 and 81 keV.

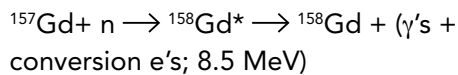

The main electron energies are 29, 71, 78, and 131 keV.

A common feature of the reactions in (1) is that the products are ejected in directly opposite directions, and in general give rise to ionization tracks that extend several microns (solid) or millimeters (gas) from the neutron conversion location. In lithium, for example,

the combined range of the alpha and triton is of the order of 100 μm . The (n,γ) reactions in (2) have a high probability of internal conversion, and the conversion electrons ejected are much more easily stopped than γ -rays, providing much more accurate position information. The (useful) isotopes in (1) and (2) above are shown in Table 10, in their most common physical forms. Tabulations of the reaction product energies and ranges, and absorption length for neutrons with energy 0.025 eV (1.8 \AA), are also given. These numerical values are most valuable in determining the isotope's utilization in position-sensitive detectors. Neutron-scattering facilities use thermal and cold neutrons and almost all current instruments use either ${}^3\text{He}$ or scintillator-based detectors. It should be noted that although Figure 12 illustrates that cadmium has a very high neutron capture cross-section, its use is limited to shielding, and has not been successfully used in detector technology.

State of the Art in Neutron Detectors

Gas-filled detectors and scintillator-based detectors are the two main detectors used in neutron-scattering instruments. Gas-filled detectors consist of the linear position sensitive detectors (LPSDs) and area detectors such as the multiwire proportional counter (MWPC). The scintillator-based detectors use either the wavelength-shifting fiber detector or the Anger

Table 10 The most useful neutron-absorbing isotopes and the key features of the neutron interactions at 25 meV. Cross sections, σ , are tabulated to the nearest 10 barns, and to the nearest 1000 barns for Gd. This helps emphasize the huge stopping power of Gd relative to the other isotopes.

Isotope	State	σ (barns)	Neutron absorption length	Particle energies (keV)		Approximate Range R particle range
				p: 573	t: 191	
${}^3\text{He}$	Gas	5330	70 mm.atm	p: 573	t: 191	3.8 mm.atm C_3H_8
${}^6\text{Li}$	Solid	940	230 μm	t: 2727	α : 2055	130 μm
${}^{10}\text{B}$	Solid	3840	20 μm	α : 1472	${}^7\text{Li}$: 840	3 μm
${}^{10}\text{BF}_3$	Gas	3840	97 mm.atm	α : 1472	${}^7\text{Li}$: 840	4.2 mm.atm
Nat. Gd	Solid	49000	6.7 μm	Conv ⁿ electrons: -30-200		12 μm
${}^{157}\text{Gd}$	Solid	254000	1.3 μm	Conv ⁿ electrons: -30-200		12 μm

camera. These technologies are described in the following sections. To a large extent, the instrument sizes and requirements determine the detector technology to be used.

Large-area detectors (>10 m²) — scintillator based

The wavelength-shifting (WLS) fiber detector is the state of the art of neutron detectors that do not use He3. Its 5 mm position resolution, high efficiency at short wavelength (60% at 1 Å), and microsecond time resolution meet most requirements of powder diffraction. It is the most advanced technology among the ³He alternatives and its relatively low cost (\$250,000/m²) makes it very attractive. The WLS technology uses solid scintillating materials (e.g., ⁶LiF/ZnS:Ag), which emit blue light when struck by a neutron. ⁶Li, which is used rather than ³He to detect neutrons, has a large neutron-capture probability.

The resulting charged particles (⁴He and ³H) deposit energy (4.8 MeV) in the scintillating material, exciting electrons in ZnS crystals, the de-excitation of which results in the emission of blue light. Some of this light is captured by optical fibers (Figure 13), which cover one or both sides of the scintillator sheet. The optical fiber is doped with a special dye

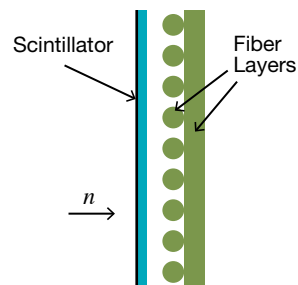

Figure 13 Cross section of WLS fiber detector, with crossed fibers placed to collect cone of scintillation light after neutron conversion in scintillator.

that absorbs the blue photons from the scintillator and re-emits the photons at a longer (green) wavelength (hence the name “wavelength-shifting”), some of which then travel to the ends of the fibers.

The fiber ends are optically coupled to the face of 1 of 32 photomultiplier tubes (PMTs). These PMTs respond to the photons by issuing an electrical signal that is detected and processed by the detector’s electronics. By using two orthogonal planes of these fibers, and distributing the fiber ends in a special coded manner among the PMTs (there are roughly 20 times more fiber ends than PMTs), the pattern of PMTs receiving signal provides a unique determination of the location of the neutron event. The time of occurrence with respect to an event, such as the start of an SNS accelerator pulse, can also be determined. Two SNS instruments (POWGEN and VULCAN) are currently using these detectors.

Figure 14 shows one module of the fiber detector, and Figure 15 illustrates placement of a number of modules at the POWGEN beamline of SNS.

Improvements in this detector technology are focused in two areas:

1. Reducing the ghosting and the gamma sensitivity
2. Increasing the light output uniformity: This requires improvements in both the scintillator and the algorithm development.

Large-area detectors (>10 m²) — He³ based

The LPSDs using ³He remain the dominant technology at major neutron-scattering facilities



Figure 14 The WLS fiber detector, in daylight (left) and dark (right). The flat scintillator has an area of 77 × 38 cm², and scintillation light is coupled by 308 and 152 fibers feeding 25 and 7 photomultipliers, respectively, for the X and Y axes.

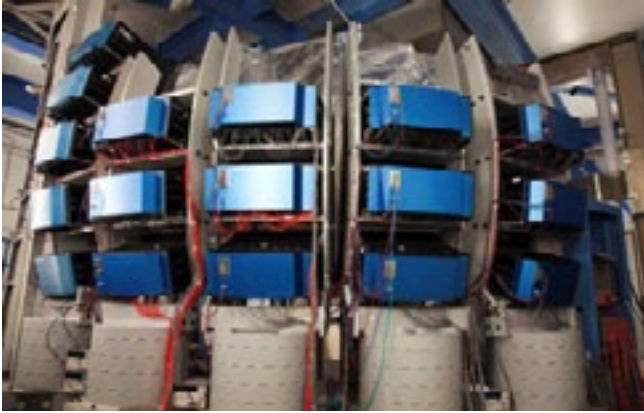

Figure 15 WLS fiber detector modules installed on POWGEN at the SNS.



Figure 16 Front and rear-side of the SNS 8-pack.

such as the SNS and Institut Laue-Langevin (ILL) in Grenoble, France. The SNS LPSDs are mounted in a single module called the 8-pack, containing eight tubes mounted vertically and front-end electronics, as shown in Figure 16. Position information is determined in the vertical direction by use of charge division on the resistive anode wire, and the position horizontally is from the tube that fires. To improve efficiency, two layers of tubes are stacked, one behind the other, with a displacement of the radius of one tube. Some care is required in handling — the tubes are mounted vertically because with a cathode diameter of only 8 mm, there is a potential

for the cylindrical cathode to bend, which may result in discharge between cathode and anode.

Large areas can be covered with these 8-pack modules. Two examples are shown in Figure 17.

Small-area detectors (<math><1 \text{ m}^2</math>) — various technologies

A range of technologies is being used successfully in specific instruments:

Brookhaven National Laboratory (BNL) MWPCs currently used for neutron detection have several

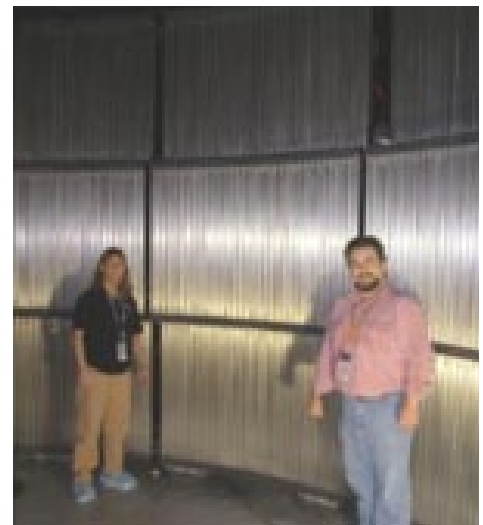

Figure 17 View of the large-area LPSD detectors at SNS Nanoscale-Ordered Materials Diffractometer (NOMAD) (left) and Wide Angular-Range Chopper Spectrometer (ARCS) (right) instruments.

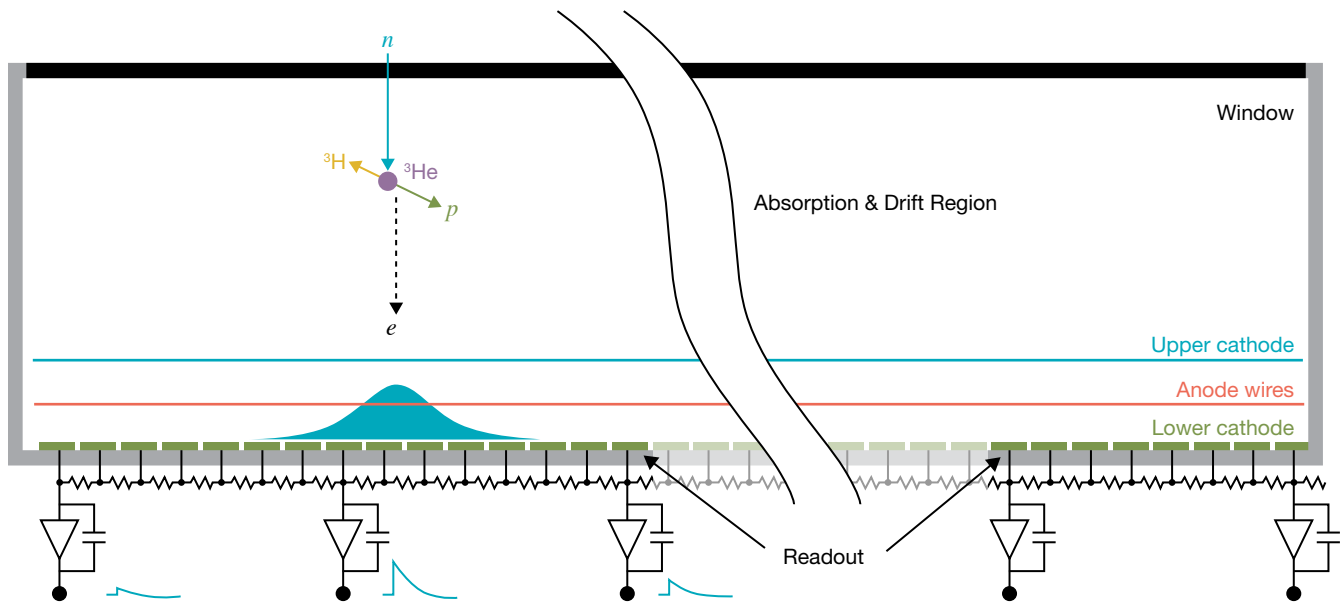

Figure 18 Schematic of advanced He-3 filled multiwire chamber.

attractive features (mm spatial resolution, low gamma sensitivity, and high reliability) for neutron scattering. Figure 18 shows schematically a typical ^3He -filled proportional chamber.

In an MWPC, neutrons convert in the gas in the absorption region. The resulting primary ionization then drifts to the anode plane to undergo multiplication. Position information in X and Y coordinates can be found from the cross-wire cathodes by resistive charge division. Refinement of charge-division schemes has led to very large signal-to-noise ratios, such that the limit to position

resolution is solely due to the range of the reaction products.

Gas proportional chambers can be fabricated in a wide range of sizes and configurations, which has made them particularly popular in imaging experiments at the world's reactor and spallation sources. Figure 19 shows two detectors from BNL.

When fabricated correctly, gas-filled detectors are very stable over long periods of time and possess very good absolute-count-rate reproducibility. Even with reasonable count-rate capabilities (several times $\sim 10^4 \text{ s}^{-1}$ globally) these current detectors can reach counting limitations in experiments at new, high-flux neutron-scattering facilities. Efforts to improve the rate capability (by pixilation or strip readout) should be the main focus of current ^3He gaseous detectors. BNL's pixel array detector (PAD) with operation in ionization mode is very promising in this regard.



Figure 19 BNL detectors of the type shown left and center ($20 \times 20 \text{ cm}^2$) have been in operation for a number of years at the SNS magnetism and liquids reflectometers and at NIST. Advanced detectors of the type on the right ($1.5 \text{ m} \times 20 \text{ cm}$) have recently been installed at LANSCE and the Australian Nuclear Science and Technology Organization (ANSTO).

Various ^3He -based detectors developed at ILL are being used in many of their instruments. They include the Millimetre Resolution Large Area Neutron Detector (MILAND), which is an MWPC detector technology, and the microstrip gas chamber (MSGC). The latter uses a charge division technique, where each anode is read out individually on both

ends for position measurement. In the MSGC, the anode and cathode wires of an MWPC are replaced by metallic strips on a glass or plastic substrate. These electrodes can be registered with high precision by photolithography, potentially leading to more automated fabrication processes, better position resolution across the anodes, and higher count rates. A section of an anode bounded on each side by a cathode is shown in Figure 20. Both ILL detectors (Figure 21) offer a relatively higher local count-rate capability even though they are below the rate requirements for neutron reflectometers.

The Anger camera first developed for gamma detection analyzes the light distribution pattern from a scintillating material to determine the position of particle capture in the scintillator. It is a mature and viable technology for ^3He alternatives. Its 1 mm resolution and 90% efficiency with good uniformity satisfy most crystallographic applications. It is also the least-expensive detector technology for ~ 1 mm resolution. The SNS Anger camera neutron detector uses the enriched Li glass GS20 with a Ce^{+3} activator as the scintillator and multi-anode photomultiplier tubes (PMTs) for the light detector. When ^6Li , the neutron convertor, absorbs a neutron, the ^6Li is converted to two energetic decay particles. These

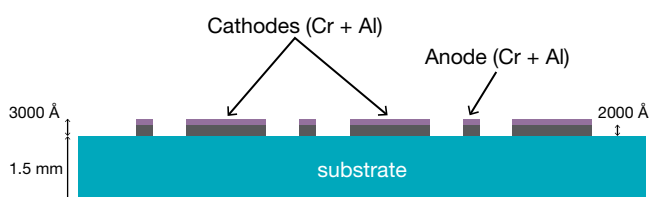

Figure 20 Cross-sectional view of micro-strip gas chamber (MSGC).

energetic particles create electrons and holes that recombine at Ce^{+3} trap centers in the glass, producing a scintillating light “flash.”

Each of the anodes in the multi-anode phototubes converts the light it detects into an electric signal that is proportional to the brightness of light incident upon it. The relative magnitude of light detected in each PMT is used to determine the position of neutron capture in the scintillator via a simple centroid or other fitting method.

Figure 22 shows a complete SNS Anger camera assembly. It consists of three major sections: the optics package (which contains the scintillator and PMTs described above), the preamplifier stage, and the A/D conversion and position calculation stage (Digital Electronics).

J-PARC is actively involved in the development of new scintillators such as a $\text{ZnS}/^{10}\text{B}_2\text{O}_3$ ceramic scintillator to increase performances in counting rate, detection efficiency, and gamma-ray discrimination (Figure 23). Like the SNS Anger camera, this detector is designed to meet the requirement of the single-crystal diffractometer.

Unmet Detector Needs

Neutron detector instrumentation is a critical tool for research and technological development across many scientific and engineering domains within academic and industrial communities. The following sections describe three main groups of techniques, together with the detector technologies presently employed, that are key for achieving the world leading science mission of BES neutron user facilities:

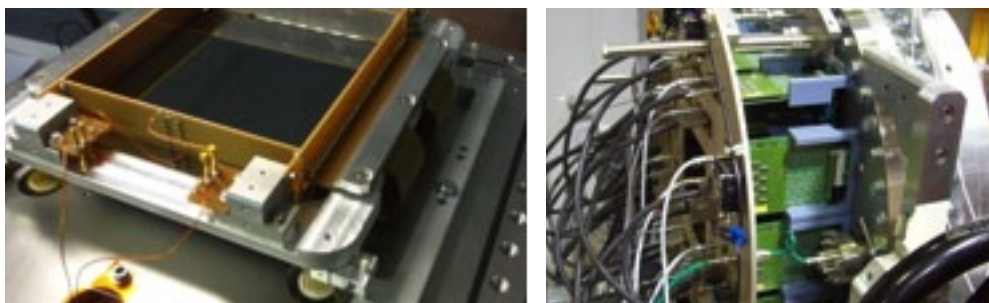

Figure 21 View of the MSGC and the MILAND detectors developed at ILL.

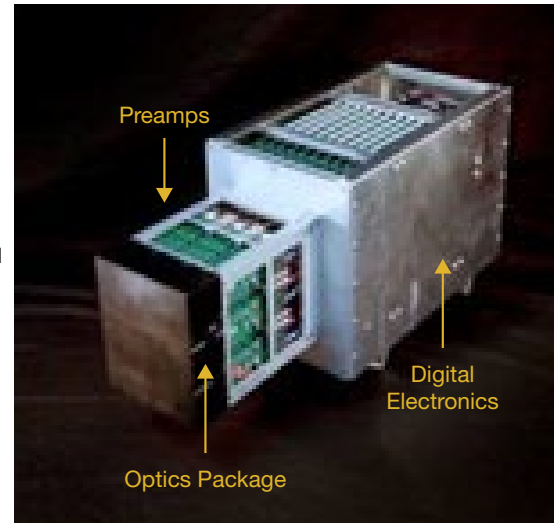
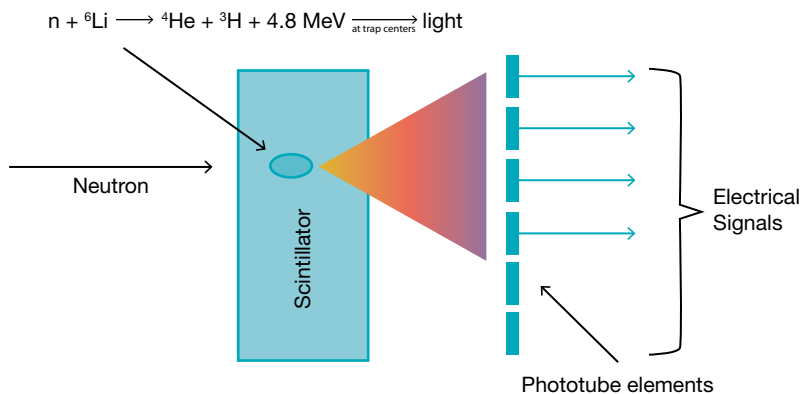

Figure 22 Schematic of Anger camera (left) and one module with $15 \times 15 \text{ cm}^2$ sensitive area (right).

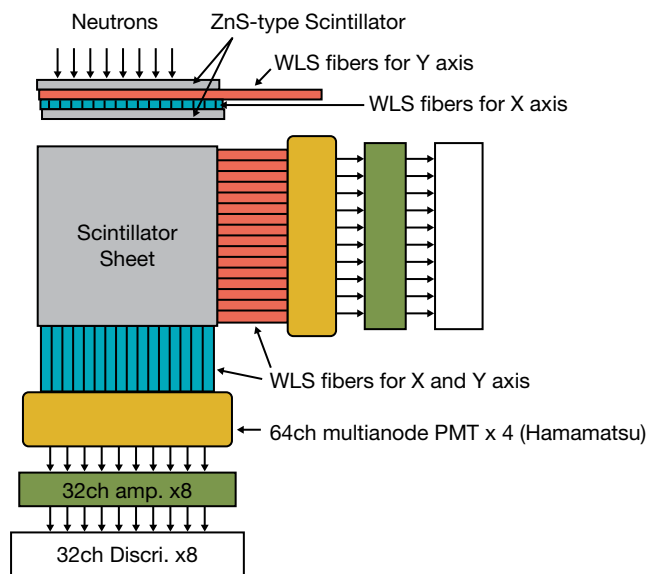

Figure 23 Key elements of the J-PARC scintillator detector.

experiments at the multiple single-crystal, powder, and engineering diffractometer beamlines.

1. Powder diffraction and crystallography applications are innovative avenues of research in pursuit of superior materials and understanding of biological processes involved in human diseases. New, first-generation scintillator-based detector technologies have successfully been developed to address the ${}^3\text{He}$ shortage for a small number of instrument types and have recently been deployed on a modest scale at the SNS. Improving the resolution by developing brighter scintillators will enable more challenging science

2. Neutron reflectometry and small-angle scattering are used successfully to study nanostructures and magnetic properties at surfaces and interfaces using traditional ${}^3\text{He}$ -based multiwire detectors. The small quantity of ${}^3\text{He}$ required to fulfill these requirements suggests continuing the development of ${}^3\text{He}$ -based detector technologies for the high rate and high dynamic range required for such applications. Detectors with such features will enable the performance of "complete reflectometry" experiments on nanosystems. Complete reflectometry includes TOF reflectometry, off-specular scattering, and grazing-incidence small-angle neutron scattering (GISANS) geometry in "one shot."

3. Detector technology to meet requirements for advanced neutron imaging (radiography, tomography, and phase-contrast imaging) will be critical for supporting materials and energy research. These detectors will require high position (micron) and timing (submicrosecond) capabilities to accurately record the 2-D images of all scattering and reaction processes occurring in a sample. The spatial and temporal resolutions of the detection system are the critical parameters defining the accuracy of neutron transmission spectroscopic

measurements needed for obtaining the stress distribution, textures, magnetic domains in materials, electrode stabilities in lithium batteries, and water distribution in plants and fuel cells. No present detection system meets these specifications, impeding significant progress in these valued science areas.

Summary and future challenges

Instruments focused on scientific leadership in materials science and engineering are essential for future technologies and our nation's economy. Among these instruments, powder diffractometers are often the first choice for investigating any new technologically important solid-state material as they provide direct information about a material's phase composition and atomic structure. Specialized sample environments of practically any type can be inserted on powder diffractometers, allowing materials to be investigated under extreme conditions. Experiments performed on neutron powder diffractometers are parametric, multiple measurements being made as a function of a single or multiple changing parameters, including temperature, magnetic field, applied pressure, and cyclic strain. Because the intensity of neutron beams at facilities is effectively fixed and the quantity of beam time that can be allocated to each investigator is limited, the parametric quality is determined by the speed of collecting each diffraction profile.

Often the most novel and interesting materials are initially difficult to produce and so forefront science has to be done using small samples, e.g., of total mass <500 mg. There are two ways to increase the speed of collecting each diffraction profile and hence the overall scientific output of the experiment. Obviously, adding more neutron detectors to an instrument decreases the individual counting time, but this approach suffers from diminishing returns as an instrument's useable field of view is increasingly populated. More valuable is to increase the detection efficiency and spatial resolution of the instrument's detectors. The counting time of single measurements is not determined by total measured diffracted neutrons, but rather by achieving a peak/background (or signal/noise) ratio above a certain threshold at

short-d-spacings. Improving detector resolution sharpens the peaks, improving peak/background ratio across the entire profile. Any resolution improvement applies to all the detectors and so may leverage all detectors currently on an instrument if retrofitting is possible. Wavelength-shifting fiber detectors, a proven viable alternative to ^3He technology, have good spatial and time resolution, but in general the time resolution is not a limiting factor for powder diffraction.

Spatial resolution for detector modules on POWGEN and VULCAN instruments is currently ~ 6 mm across the applicable horizontal direction. If spatial resolution were halved to ~ 3 mm, significant improvement could be made to overall instrument performance. On POWGEN, it also would allow an increase in usable field of view to more extreme forward-scattering angles, resulting in increased d-spacing range collected on each measurement. A greater d-spacing range means less signal is missed, so better determination of the precise symmetry of atomic structures and observation of more magnetic reflections required for accurate spin-structure determination can be achieved. The improved resolution also allows the discernment of more subtle structural distortion transitions. In the case of an engineering diffractometer such as VULCAN at the SNS, not only would there be greater parametric quality but finer radial collimators could be used, allowing spatially finer strain mapping and quantitative texture analysis of engineering components such as those needed for high-efficiency automotive engines, aircraft, and materials for the International Thermonuclear Experimental Reactor (ITER).

Research examples benefitting from improved detectors

The development of brighter scintillators will improve spatial resolution, one of main targets of future efforts on the cross-fiber detector development described above as well as the Anger camera; these detectors are suited for crystallography instruments. They have very high efficiency and provide high timing and position resolution with low background, at a reduced cost — characteristics that make them attractive for

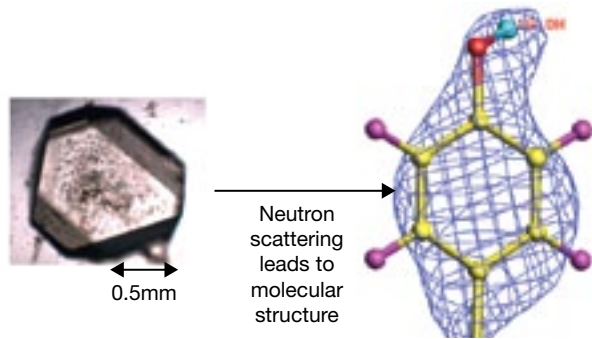

Figure 24 Uox-purine inhibitor complex. This typical biological crystal (left) is no bigger than a grain of sand. Precise determination of its detailed structure (right) helps in the understanding of diseases and other biological processes.

medical, biological, and general scientific research. An example of the small size of samples is shown in Figure 24. A 1 mm³ sample is considered large for complex biological crystals, which are typically 0.5 mm across or smaller.

Future efforts on the Anger camera development (similar to the cross fiber described above) are directed toward scintillators with higher light output. Without a higher-resolution detector, many important crystals cannot be measured.

Neutron reflectometry and small-angle scattering

Small-angle neutron scattering (SANS) and reflectometry are two applications where ³He-based detectors have been widely used. Their very low background and relatively low ³He gas volume requirements make them useful for these applications. Reflectometry and SANS instruments in most of the world's neutron-scattering facilities successfully use 2-D ³He detectors.

SANS is used in a wide range of scientific applications. In structural biology, it occupies a unique place in revealing the functional mechanism of many proteins and other biomolecules. When combined with the technique of hydrogen/deuterium substitution and contrast variation, SANS is often the only structural method that can reveal the structures of proteins in different functional

states. In other soft condensed matters, SANS is used to study the bulk structure of many materials that are not of crystalline form, such as gels, liquids, and surfactants. Due to its low resolution feature, SANS is also ideally suited for the study of domain structures of magnetic materials, etc.

Today, reflectometers are used for the investigation of hard- as well as soft-material films. The investigation of hard materials is mostly connected to magnetic systems in spintronic and electronic devices. Soft materials comprise polymers, chemical aggregations, organic materials, biological membranes, surfactants, gels, and liquids. These thin films and multilayers are very important due to their versatile application in daily life and technical applications, including the wide field of functional nanostructures at surfaces and interfaces. In neutron reflectometry science studies (Figure 25), for example, the incorporation of a filler of nanoparticles into a polymer multilayer imparts magnetic properties, creates new interfaces, and modifies the characteristics of the polymer-polymer interfaces.

Conventional reflectometry — specular reflection — is used to investigate the structure of films or multilayers perpendicular to their surfaces, and delivers information about the depth profile of the mean scattering length density (SLD) averaged over the whole illuminated sample surface. Existing detectors are limited in counting-rate capabilities and sizes. It is therefore important to develop new high-rate, high-resolution detector technologies to match the neutron flux available. These new detector technologies will enable 3-D (or complete reflectometry) experiments on nanosystems. Complete reflectometry includes TOF reflectometry, off-specular scattering, and GISANS geometries in “one shot.” These measurements reveal the structure of scattering objects and their correlations among themselves and with the host matrix (Figure 26).

Current road maps for transforming our energy economy to a more distributed lower-carbon footprint require substantial improvements in our electrochemical power systems, such as Li-ion rechargeable batteries and fuel cells (both solid oxide fuel cell [SOFC] and polymer electrolyte

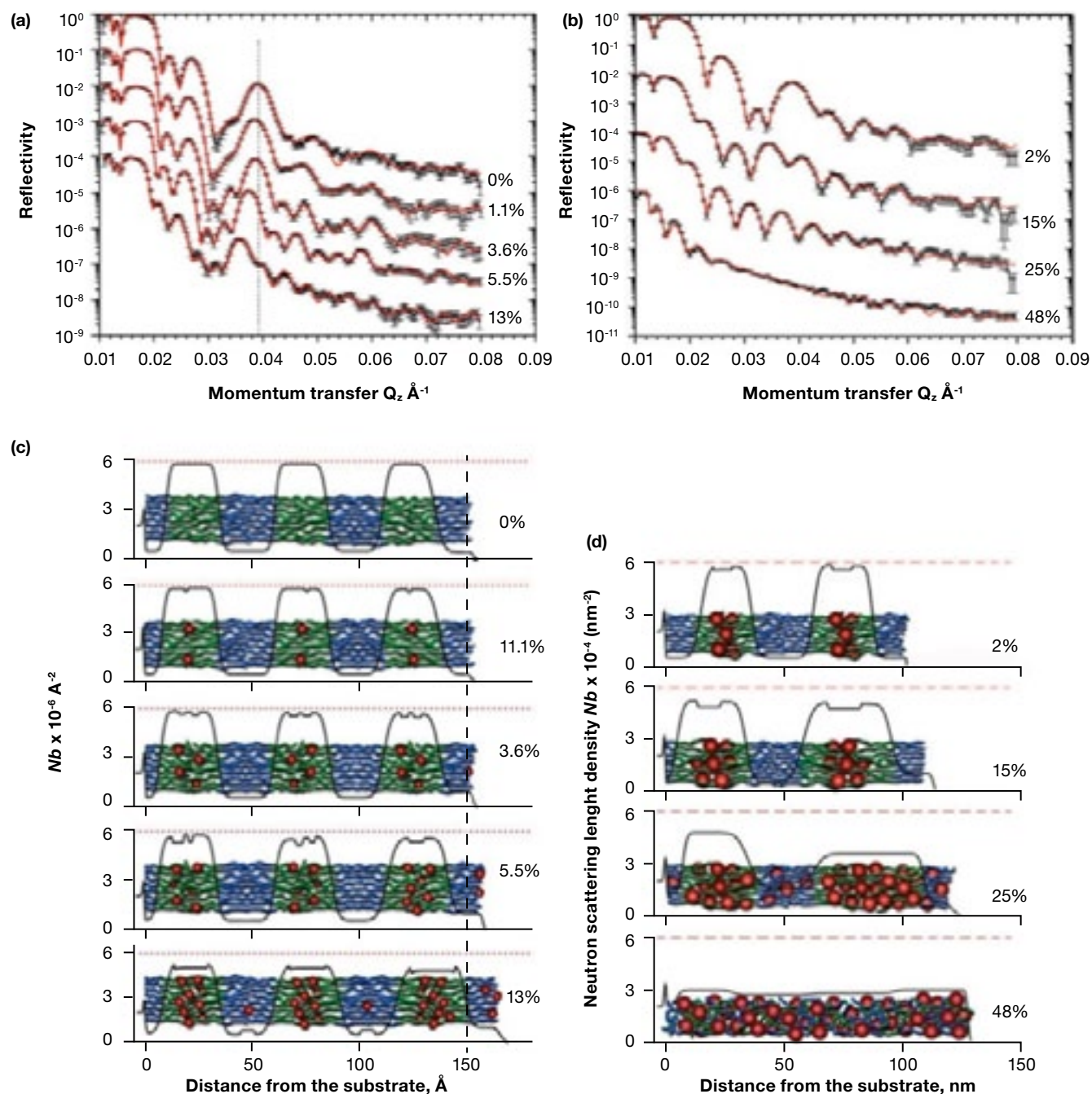

Figure 25 (a,b) Reflectivity profiles of symmetric (PS-d-b-PBMA) copolymer multilayers with different concentrations of small nanoparticles in (c) and big nanoparticles in (d). The volume fraction of nanoparticles is indicated in percent.

membrane [PEM] types). The operation, power longevity, and downfall, whether benign or catastrophic, of all these systems are plagued by a lack of understanding of what is occurring at the microstructural level in operandi. These complex, relatively large constructs must be interrogated as complete systems to determine precisely the detrimental mechanisms that impede their role for

high-power applications such as transportation and home-based electricity generators. Neutron 2-D imaging and 3-D tomography are very promising techniques for studying complete batteries, battery packs, and fuel cells — under operating as well as under undue stress conditions. To meet this need, exploratory experiments on such systems as Li-air electrodes and complete diesel-exhaust catalysts

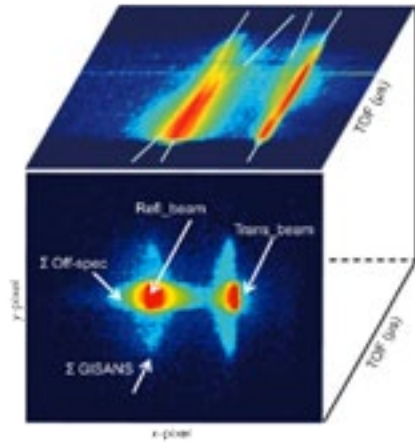

Figure 26 3-D intensity projections of specular and off-specular scattering, and GISANS in TOF from a polymer multilayer (PS-b-PBMA) film.

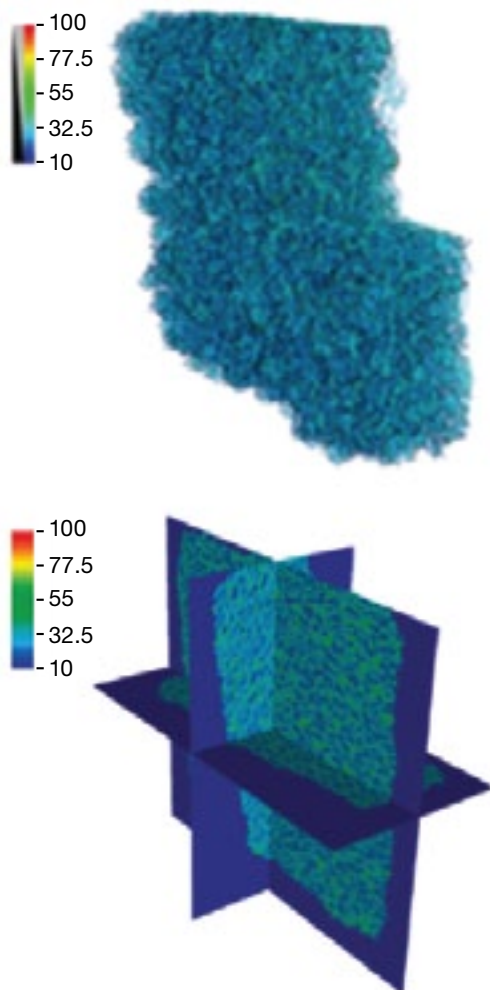

Figure 27 An ex situ neutron tomographic snapshot of the evolution (suspended) of lithium oxide loading of a carbon graphite foam battery electrode. Microstructural resolution is at the 50 μm size range.

have been carried out at ORNL. These investigations have helped to identify the most important detector requirements, such as fast, efficient capture for time-dependent evolution.

In situ neutron imaging (and tomography) at improved spatial resolution can provide significant breakthroughs in mapping the local ion concentration in 3-D across the spatial dimensions of the electrode in real time. For example, estimating the local lithium concentration inside electrode bulk at a micron or submicron spatial resolution under real operating conditions can provide vital clues about possible transport-limiting cases when ions move under an electric field inside a porous electrode (Figure 27 and Figure 28). The transport bottlenecks in an electrode can originate from electron and/or ion motion. This compromises the power and capacity utilization of a battery. Advance real-space neutron imaging can resolve the electrode pore structure and track lithium (or other ions) ion movement along the void spaces.

Further, isotopic substitution of electrolyte or electrode materials can be utilized to tune the scattering length density (SLD) to improve image contrast. However, current state-of-the-art neutron imaging has a spatial resolution of about 40 μm and is mostly limited by detector resolution. Under this scenario, it is impossible to obtain any relevant information about the electrochemical transport at a microstructural level.



Figure 28 3-D Li distribution (Li_2O_2) in coarser foam matrix, which can help to address interfacial transport and the Li transport in complex electrodes (degradation issues).

Technical Challenges

Dealing with the ^3He shortage

At present, the majority of the nation's ^3He supply for science is used in linear position sensitive detectors (LPSDs) for large-area coverage in major user experiments (e.g., ARCS at SNS, see earlier). This is a questionable use for such a scarce and expensive resource, given the relatively poor position resolution performance of LPSDs and the emerging alternatives to ^3He for at least some instruments. One approach is to continue study of boron-lined gas-filled detectors, and the potential for using BF_3 instead of ^3He . Because of the superlative properties of ^3He , the neutron community must argue that a proportion of it be kept in reserve for advanced, unique, gas-filled detectors that exhibit characteristics no other detector can achieve. One example is a BNL-designed neutron pixel array detector operating in ionization mode for SANS. The anode-pad array and use of application-specific integrated circuits of this 550 cm^2 advanced detector are shown in Figure 29.

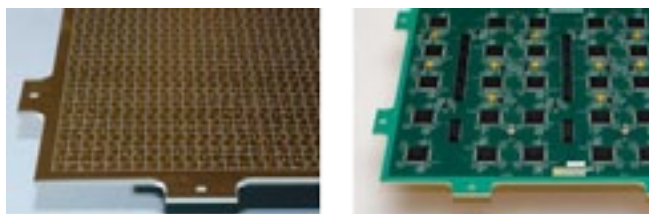

Figure 29 Sections of anode-pad board, showing independent $5\text{ mm} \times 5\text{ mm}$ pads (left) and ASICs on the underside of the board (right) to collect, measure, and digitize neutron signals.

Technical Objective 5 Replacements for ^3He -based detectors



efficiency

Goal	Present State of the Art
Substitute for ^3He	^3He -based detectors

Improved neutron detectors

Scintillator-based detectors are promising candidates for improved neutron detectors. Scintillator efficiency must be improved by exploring and optimizing other scintillator materials while balancing optical transparency against neutron absorption. Transparent scintillators or double scintillators with the fibers in sandwich are interesting options to investigate. The light output (or brightness) of the scintillator is highly critical, as it improves position resolution and reduces remnant “ghosting,” i.e., when neutron events appear to be at incorrect locations. Gamma discrimination, although good for many neutron-scattering applications, needs to be improved. Scintillator gamma-to-neutron ratio is higher than that typical of ^3He neutron detectors.

A new location determination algorithm and calibration method should be developed to ensure the detector has the desired spatial resolution (centroid measurement) to increase its counting rate.

From a previous workshop⁹, the state of the art and the improvements required for typical SNS instruments lead to Technical Objective 6.

Technical Objective 6
Improved neutron detectors

efficiency

speed

time

size

Goal	Present State of the Art
90% efficiency at 1 \AA	60% at 1 \AA
500 kHz / cm^2 count rate	<5 kHz / cm^2
<0.1 Hz background rate	<0.1 Hz
10^{-8} gamma sensitivity	10^{-4} – 10^{-6}
<1 μs time resolution	5 μs
<10 μm position resolution	1,000 μm
Polarized neutron detection capability	None

⁹ A Program for Neutron Detector Research and Development, a white paper on a workshop at ORNL (2003). Cooper, R., I. Anderson, C. Britton, K. Crawford, L. Crow, P. DeLurgio, C. Hoffmann, D. Hutchison, R. Klann, I. Naday, and G. Smith.

Examples

Tomography for materials studies

The potential

Neutron 2-D imaging and 3-D tomography are very promising techniques for studying complete batteries, battery packs, and fuel cells under both regular and stressed operating conditions. At SNS, a new instrument to meet this need (VENUS) is in the design stage, and exploratory experiments on systems such as Li-air electrodes and complete diesel-exhaust catalysts have been carried out. These investigations have helped identify the most important detector requirements, including fast, efficient capture for time-dependent evolution and a very high spatial resolution of $<10\ \mu\text{m}$, when combined with the other attributes, to determine the evolution of fine microstructure in 3-D. To date, these have been carried out with image plates, which have the best position resolution of any technology (a few tens of microns) — not good enough; a further drawback is that the images are not captured in real time.

The challenge



New sensors are required that can capture images in a second or so, buffer the data, and continue high-resolution imaging. Microchannel plates doped with boron have shown encouraging position resolution in the $10\ \mu\text{m}$ scale, and can be read out quickly. However, the efficiency of a single plate is less than 10%, and these or other technologies require serious research effort.

Time-resolved scattering studies with high count-rate capability

The potential

As discussed earlier, understanding electrochemical power systems requires a better knowledge of what happens at the microstructure level in operation.

The challenge



Probing the microstructure of large and complex systems during operation requires a detector that simultaneously has high temporal resolution ($\sim 10\ \mu\text{s}$), high spatial resolution (better than $500\ \mu\text{m}$), and very low background sensitivity. This is one example where development of purpose-designed, high-pressure He^3 devices would make a positive impact.

Powder diffraction with very low background sensitivity

The potential

Newly developed neutron detectors are advancing our understanding of many energy materials. Modern thermoelectric materials, which convert heat to electricity, are at the heart of the Mars Curiosity rover's power supply and are strong candidate materials for regenerating useful power from excess waste heat in trucks and automobiles. Optimizing the latest thermoelectric materials for widespread use requires precise visualization and the ability to model an atom's motion as it responds to thermal heat. Scientific studies on this issue are being carried out on the POWGEN powder diffractometer, where the relatively high-spatial, high-efficiency, and high-temporal resolution of the wavelength-shifting fiber detector combine to reveal the highest-Q diffraction peaks, as seen on the right side of the data in the figure. Without this high-Q data, there would be no resolving power to see the unusual thermal motion of the key atoms. One such atom is shown as a contour surface-volume inset. The very weak intensities of the high-Q peaks, which are less than 1/100th of the strongest, highlight the need for higher detector efficiency. For example, this single diffraction pattern took 12 hours to collect.

The challenge



efficiency



resolution

A requirement is needed for high-efficiency detectors (improving scintillator brightness) that possess extremely low background sensitivity — either new scintillator material or improvement in ^3He supply for use in advanced, high-resolution ionization chambers.

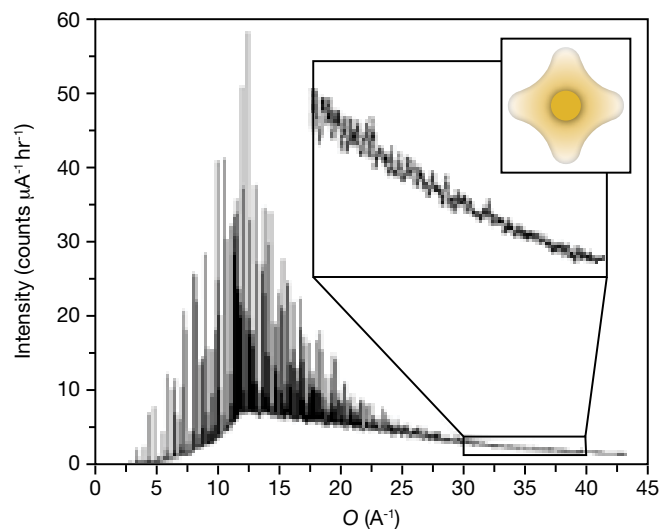

Context



Developing a complex detector is a lengthy process, given the design and fabrication time for each component, the effort of integration, and time needed for characterization. One goal of this workshop was to learn from the international community what approaches have been successful. Below we summarize both international and domestic development activities, and provide context for the infrastructure and support required to successfully design and deploy sophisticated detectors.

In addition to R&D, which is heavily emphasized in this report, significant effort is required (and often underestimated) to advance from a laboratory prototype (operated by its developers) to a detector system on a beamline, with which a user can easily and reliably acquire data (illustrated in the box *Detector Systems*). These efforts can be classified in three phases:

1. **Prototype to system.** In this phase, detector research shifts toward deployment, in which:
 - The prototype detector is scaled up to full size, which may require additional dedicated design and development.
 - The detector is mechanically engineered to be robust, properly cooled, vacuum-compatible, etc.
 - Software and firmware to make the detector “useable” are written.
2. **Deploy and debug.** In this phase, the detector is delivered to a beamline and integrated into the end station. Calibration techniques and operational modes are investigated and perfected.
3. **Service and maintenance.** Local user-facility staff must be able to keep the detector operational. The developing institution must have resources on hand to perform major repairs in case of a system failure.

A principal goal of the workshop was to compare worldwide models for detector development, and to identify the supporting infrastructure and technology required. Further, while big data is a ubiquitous problem, at X-ray and neutron sources it is the detectors that produce the data, so that detectors, data acquisition, and computing are inexorably linked. Below we describe:

- Activities outside of the United States, in particular in Europe and Japan
- Activities at U.S. facilities

- Key infrastructure needs, with emphasis on microelectronics and semiconductor detectors
- Methods of detector deployment
- The data challenges engendered by high-speed detectors

Activities outside the United States

Europe has a rich culture of instrumentation development in general and detector development in particular. Among the range and scope of efforts, perhaps the most successful project known in the synchrotron community is the PixeL apparATUs for the Swiss Light Source (PILATUS) detector, developed by the Paul Scherrer Institute (PSI) near Zurich for protein crystallography experiments at the Swiss Light Source (SLS). PILATUS has successfully passed from R&D to a commercial product made by a spinoff company, Dectris, Ltd. Part of its success is that the development was extremely focused and had a very specific target market. That market, very large on the scale of synchrotron radiation (SR) experiments, was ideally positioned to gain significantly from advanced detector technology.

The PILATUS is based on a hybrid pixel detector (Figure 30) consisting of a sensor array, where each pixel implant is connected by a “bump bond” to a readout channel, on a custom-designed application-specific integrated circuit (ASIC). This detector

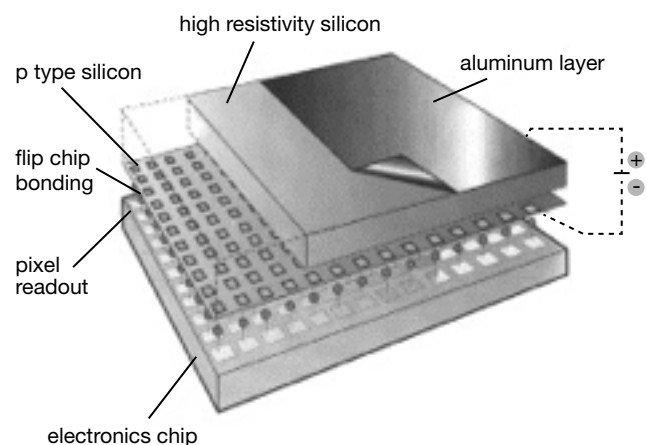

Figure 30 Hybrid pixel detector.

format, appearing in the late 1980s, was perfected by substantial investments from the two Large Hadron Collider (LHC) proton-proton experiments: the Compact Muon Solenoid (CMS) and A Toroidal LHC Apparatus (ATLAS).

The PILATUS development arose from PSI's involvement with detectors for CMS at the European Organization for Nuclear Research (CERN). (PSI led the development of the CMS pixel detector. The ATLAS pixel detector was developed by a large, international consortium; in the United States, Berkeley Lab led the ASIC design and the University of New Mexico had a leading role in the sensor design.) As part of that effort, PSI expanded its skilled in-house ASIC design team, which has gone on to be involved in other detectors, such as PILATUS and detectors for the European X-ray Free Electron Laser (XFEL), under construction in Hamburg.

The emphasis on imaging applications is a result of several needs. The requirements of high-energy physics (HEP) led to the development of the hybrid pixel detector, a structure that separated the function of detector readout from the ionization sensor. An HEP detector needs a large volume of such sensors, which allowed commercial semiconductor vendors to supply them. Thus, the main effort for physicists was to design the readout ASIC, which can also be commercially produced. The Europractice program in Europe made very expensive design tools available to academics at minimal cost, providing low-cost fabrication routes to make prototyping feasible. The United States invented the concept of multi-project wafers (MPWs) as a cost-saving technique, and implemented the Metal Oxide Semiconductor Implementation Service (MOSIS) to organize these MPW fabrication runs. MOSIS — initially a Defense Advanced Research Projects Agency (DARPA) project to stimulate involvement of small companies and academics in ASIC design — has become a self-supporting organization. Good software tools are still a significant expense for U.S. national laboratories, as tool vendors do not consider the labs to be academic institutions, in contrast to their stance in Europe.

In its category of detectors, PILATUS has achieved the highest visibility, but other significant development efforts have taken place in Europe, some associated with synchrotron facilities, others with various research institutes. Examples include efforts at CERN (Medipix) associated with Soleil (XPAD), and with the Max Planck Institute (MPI) in Munich (drift detectors and related products).

Medipix is an interesting example. It is organized as a collaboration, and members pay an annual fee that entitles them to acquire ASICs at cost. The collaboration has gone through many revisions and seems set to continue indefinitely. It has traditionally focused on the medical and industrial community rather than the SR community. Recently, several synchrotron facilities joined the collaboration and are beginning to have an impact. At a recent SRI satellite workshop on detector development, at least two projects were featured that use Medipix chips.

As described above, all of these examples have essentially been ASIC design projects. The actual X-ray sensor for a typical hybrid is a simple monolithic photodiode array, typically purchased from a commercial vendor. The exception to this is the series of detectors fabricated by the MPI Semiconductor Laboratory in Munich. That laboratory took the idea — introduced by Pavel Rehak of BNL and Emilio Gatti of Milan University, Italy — of the silicon drift detector, and has produced a range of X-ray detectors with outstanding spectroscopic performance, primarily for X-ray astronomical purposes but with obvious applications in the synchrotron community. These detectors implement the readout system's most sensitive elements directly into the sensor. Along with single-element detectors aimed at X-ray spectroscopy, they have taken the drift principles further and made imaging detectors with exceptionally low readout noise, again initially aimed at the astronomy community. Several of their imagers have gone into space missions. Most recently, one of these sensors was used in the first experiments at LCLS.

In Hamburg, several developments are under way for both storage ring and FEL applications at the Deutsches Elektronen-Synchrotron (DESY) and

XFEL. The Large Area Medipix-Based Detector Array (LAMBDA) is intended to be a modular hybrid pixel detector that is compatible with high-Z materials for higher hard-X-ray efficiency. Prototypes have been demonstrated with silicon sensors, germanium sensors (commercially produced), and a small GaAs sensor produced in Russia. XFEL has seen three main developments, all proceeding as European collaborations, and each costing tens of millions of euros:

- The Adaptive Gain Integrating Pixel Detector (AGIPD), developed by PSI, DESY, and the Universities of Hamburg and Bonn, is an integrating hybrid pixel detector with a floating-point front end.
- The DEPMOS Sensor with Signal Compression (DSSC), developed by the MPI HLL and the University of Heidelberg, is a monolithic pixel detector based on HLL's buried gate Depleted P-channel Field Effect Transistor (DEPFET). Here, the DEPFET structure is designed to be nonlinear as a means to increase the maximum charge that can be stored.

- The Large Pixel Detector (LPD), developed by the Science and Technology Facilities Council (STFC) Rutherford Appleton Laboratory (RAL), is an integrating hybrid pixel detector with three gains per pixel, followed by three analog pipeline stages.

PILATUS, together with the other developments described above, demonstrates that hard X-ray hybrid pixel photon counting detectors are becoming a mature technology for synchrotron radiation. In addition to the Cornell CSPAD developments in the United States, within the past decade Europe has become predominant in hybrid pixel photon counting detectors, both in detector R&D and subsequent commercialization, as shown in Table 11.

In Japan, similar developments are taking place at SPring-8, for storage rings, and the SPring-8 Angstrom Compact free electron Laser (SACLA), for FELs. SPring-8 has been developing prototypes that use CdTe as a high-Z sensor material, produced by Acrorad, together with Pilatus readout chips. SACLA has focused on monolithic multigain detectors based on the silicon-on-insulator (SOI) technology initially

Table 11 Counting Pixel Detector Development in Europe.

Detector	Features			Status
	Pixel Size	Number of MPixels	Rate	
Pilatus I	217 μm	1	2 MPixel/s	PSI (SLS) 2002, since commercialized by DECTRIS
Pilatus 2	172 μm	6	50 MPixel/s	PSI (SLS) 2007, since commercialized by DECTRIS
Eiger	75 μm	9	Potentially 12,000 (8 bit) frame/s	PSI (SLS) in development
XPAD	130 μm	1	500 frame/s	CPPM (2006), since commercialized by imXPAD
PiXirad (CdTe)	60 μm	1	13.6 frame/s	INFN, since commercialized by PiXirad
Medipix-based	55 μm	-	2 MPixel/s	MAXIPIX (ESRF), LAMBDA (DESY), Excalibur (DIAMOND)

developed by KEK for high-energy physics applications. In particular, as part of SACLA's program, a stitching process was developed for SOI technology that makes it possible to produce seamless large-area detectors.

For neutron detectors, European neutron-scattering facilities focus on various detection technologies such as wavelength-shifting fiber detectors (ISIS, Juelich), boron-lined detectors (ILL, European Spallation Source [ESS]), and ^3He or BF_3 -based gaseous detectors (ILL, Zentrale Wissenschaftliche Einrichtung Forschungs-Neutronenquelle Heinz Maier-Leibnitz II [ZWE FRM-II]). In Asia, the emphasis is on scintillator-based detectors (J-PARC, Japan) and ^3He -based detectors (South Korea). The Japanese have developed $\text{LiF}_6/\text{B}_2\text{O}_3$ scintillators that are being used in J-PARC instruments and the technology has been transferred to private industry.

Europe is gaining dominance in most areas of detector development, not least in the important pixel-array area of the imaging X-ray detector field. Several key differences between detector development practices in Europe and North America have led to this situation.

One important factor is Europe's preference for consistently supported long-term R&D involving large teams. Some elements of the PSI model, as elaborated during the workshop:

- An estimate for the cost to design, implement, and deploy a detector project is completed up front; funds are then fully committed for the complete development.
- Funds include contingencies.
- Funding continues until the detector is fully working for the intended application on the beamline (typically at least one year after delivery of the hardware).

PSI's experience is that a "simple" detector takes three to four years (six to eight FTE) and a "complex"

one takes five to eight years (40 FTE). Further, overall planning ensures that new detector projects start soon after current ones complete, to avoid gaps. DESY's experience is that a detector development is a 10-year commitment at about 1 million euros per year, and that collaboration is an effective means to realize detectors.

Funding in the United States for synchrotron-related developments tends to be short-term, single-investigator funding, with unclear distinction of what is to be financed from R&D funds, facility operating funds, and equipment funds.

Another (but related) factor in Europe is its much higher degree of interaction and diversification of effort among universities, research institutes, and industry than what takes place in the United States. For example, the 14th International Workshop on Radiation Imaging Detectors that took place in Portugal in July 2012¹⁰ showcased an exciting and broad range of projects across the radiation detector field, including a number of commercial startups. The conference had about 200 participants, only about 4% of whom came from North America. The great majority came from Europe and Asia. Of registered participants, about 60% were from universities, 30% from national laboratories and institutes, and 10% from industry.

Current Activities at U.S. Facilities

As in Europe, much detector R&D in the United States derives from skills initially fostered by nuclear and particle physics. In contrast, unlike many international neutron and X-ray sources, every BES user facility is embedded within a national laboratory, providing a potential foundation for detector development (with PSI and DESY as European examples of how laboratory infrastructure can enhance development). Activities at U.S. facilities are described below, to catalog existing capabilities.

Activities at Argonne

The Advanced Photon Source (APS) Detector Group is engaged in several areas of detector

¹⁰ <http://iworld2012.fis.uc.pt/>

development, including microwave kinetic inductance detectors (MKIDs), high-speed detectors, and associated electronics.

Through a DOE Early Career Award, APS has started a research program to develop superconducting detectors for X-ray science applications. The group has focused its attention on MKIDs, which are promising for multiplexing but require R&D to bring to maturity. MKIDs are superconducting energy-resolving detectors with an energy resolution of a few tens of eV today, and a future goal of a few eV. The high-count-rate environment of X-ray light sources demands improvements in the pixel count and thus the ability to multiplex. The beauty of MKIDs lies in the ability to frequency multiplex the readout of MKID arrays to build detectors capable of high count rates, yet MKIDs still must be proven to have energy resolution comparable to TES microcalorimeters. The long-term funding from the Early Career Award has allowed the group to build the necessary infrastructure to go from design to fabrication to testing (i.e., software, deposition system, microwave electronics, and cryostat) and in-house expertise to have a leading role in developing superconducting detectors for X-ray light sources. It should be noted that MKIDs (i.e., superconducting resonators) can either be the sensor or part of the superconducting electronics to read out other detectors (e.g., microwave-SQUIDs to read out TES arrays). The group is engaged in a number of collaborations and partnerships with superconducting detector groups at the University of California at Santa Barbara, Fermilab, and the National Institute of Standards and Technology (NIST).

The FastCCD collaboration with Berkeley Lab is aimed at developing X-ray-sensitive charge-coupled device (CCD) cameras with small pixel sizes and highly parallelized readout electronics, with a goal of continuous, shutterless collection of 960 x 960 pixel image frames at 200 Hz frame rate. The CCD sensor and charge digitization electronics are developed at Berkeley Lab, and the back-end clock and readout electronics are developed at ANL.

Smaller-scale detector-development projects include customized avalanche photodiode systems for fast

timing experiments; R&D on pixel array detectors (PADs) aimed at picosecond-scale time-stamping of the arrival of individual photons, and PADs with analog charge integration for the recording of images of fuel sprays; custom CCD cameras based on commercial sensors; and a lightweight CCD that can be mounted on a goniometer for powder-diffraction experiments.

The group also has developed custom interfaces and electronics for synchronizing experiments, such as an improved interface for synchronizing four GE Revolution flat-panel detectors at beamline and high-speed synchronization electronics for pump-probe experiments.

Finally, along with the APS Optics Group, a new Optics and Detectors Testing Beamline (1-BM) is being implemented. This beamline will provide rapid access for detector testing during development projects, including testing of timing and energy-resolving capabilities as well as quantum efficiency.

Activities at Berkeley

Berkeley Lab has a long history of detector development, from nuclear physics (e.g., high-purity germanium, which continues today) to high-energy physics (e.g., time projection chambers [TPCs] and silicon strip and pixel detectors) to particle astrophysics (e.g., CCDs with extended red and blue sensitivity). To support BES facilities at the Laboratory, detector developments focus on soft X-ray detectors and detectors for very-high-resolution electron microscopy. Because soft X-ray detectors present specific challenges, emphasis is placed on microelectronic-enabled monolithic pixel detectors.

The FastCCD, described above, has been in use for several years at the Advanced Light Source (ALS), APS, and LCLS, and is being upgraded and delivered to the National Synchrotron Light Source (NSLS-II) and EXFEL. A Very FastCCD (10,000 megapixels per second) is in the prototype phase, as is a fine-pitch CCD for spectroscopy. Active pixel sensors, in both bulk complementary metal-oxide semiconductor (CMOS) and SOI, are being developed for soft X-ray applications.

The MicroSystems Laboratory (MSL) is a high-purity, 6-inch-wafer foundry specializing in high-resistivity detectors. The thick, fully depleted Berkeley Lab CCD structure was developed there, and MSL is used for all CCD developments.

The Integrated Semiconductor Laboratory grew out of HPGe development (and recently delivered Ge strip detectors to the Diamond Light Source) and is now used to develop the ultra-thin, low-temperature contacts essential for high-efficiency soft X-ray detectors.

The Integrated Circuit (IC) Design Group is the largest of its kind in the Office of Science, specializing in high-channel-count, highly integrated mixed-mode system-on-chip solutions. The 65 nm CMOS pipelined analog to digital converter (ADC) for the Very FastCCD was the first complex development by the detector community using such an advanced technology.

ALS beamline 5.3.1 has been used for detector and optics developments for several years, and — like all test beamlines — is an invaluable resource for detector development.

Activities at Brookhaven

BNL has several facilities related to X-ray and neutron detector development. It has a small silicon foundry capable of fabricating sensors in high-resistivity silicon. It has a strong ASIC development group that specializes in ultra-low-noise designs suitable for spectroscopy applications, among others, and a close connection to the NSLS and NSLS-II user community through the NSLS Detector Development Group. It has expertise in DAQ electronics, particularly in the use of field-programmable gate arrays (FPGAs) for fast data acquisition. It also has two synchrotron beamlines available for testing of optics or detectors. These elements work together synergistically to produce systems driven by user science requirements. BNL also has an active neutron-detector program based primarily on ^3He , which provides advanced systems to neutron facilities around the world.

X-rays

A small group at the NSLS with extensive synchrotron experience works closely with Instrumentation Division staff to develop detectors suitable for SR applications. The silicon sensor foundry is a key feature of the Instrumentation Division. Since it began in the early 1980s, the foundry has produced prototype sensors for many HEP projects and more recently for photon science. It also has a very productive ASIC design team that specializes in the design of very low-noise systems.

Current R&D includes a Mark II Maia system, which will be a silicon drift detector designed for X-ray correlation spectroscopy using 3-D integration to achieve additional functionality and a hyperspectral imaging detector, which will have moderate pixel size (250 μm) but an excellent energy-resolution spectrometer ($\sim 10\text{e}^-$ noise) in each pixel.

Neutrons

Using neutron conversion in ^3He , which yields a large signal with excellent gamma-ray background rejection capability, the BNL research program focuses on improving the rate capability, resolution, efficiency, and long-term stability of detectors for neutron-scattering studies. The program has developed a suite of detectors using proportional chambers, the latest being an array of curved, multiwire segments with interpolating cathode-strip electrodes operating simultaneously and seamlessly in a single gas volume. With a count-rate capability of nearly 1 MHz, these instruments have significantly advanced the state of the art for protein crystallography and powder diffractometry. Systems have been in operation for some years at the Protein Crystallography Station (PCS) at the Los Alamos Neutron Science Center (LANSCE), and the high-intensity powder diffractometer at the Australian Nuclear Science and Technology Organization (ANSTO), with no downtime and excellent long-term stability.

To attain even higher count rates, a new concept based on operation in the ionization mode is being explored¹¹, in which the primary ionization from

¹¹ Thermal Neutron Detectors with Discrete Anode Pad Readout, B. Yu et al. 2008 IEEE Nuclear Science Symposium Conference Record, 1878 - 1881

a neutron conversion is collected with unity gain on one of many pads, or pixels, that form the anode plane. Each pad is implemented with charge-sensitive electronics, using purpose-designed, application-specific integrated circuits. A prototype device with 48 by 48 pads (each pad being 5 mm x 5 mm) has been successfully developed. The global count rate of this device is extremely high, at least 2 orders of magnitude greater than the wire chambers.

Activities at Cornell

Cornell University's X-ray detector development takes place primarily in the Department of Physics, with synergies and testing performed at the Cornell High Energy Synchrotron Source (CHESS), national laboratories, and abroad. The project emphasizes integrating PADs for high flux and time-resolved X-ray applications, and training graduate students in X-ray detector design. The group's successful projects include a prototype integrating PAD that was the first PAD applied at synchrotrons for a variety of applications, including the dynamics of fuel-injector sprays, carbon-nanotube growth, and the phase behavior of reactive metal foils. The capacitor storage architecture used in this device is expected to be used for two of the PADs under development at the European XFEL. The group also designed the PAD chips used at LCLS at SLAC National Accelerator Laboratory.

The Cornell group is currently engaged in three integrating PAD projects. The first is a PAD collaboratively developed with the Area Detector Systems Corporation (ADSC; Poway, CA). The project is based on an analog-digital mixed-mode pixel array detector (MMPAD) architecture that yields single-photon sensitivity, a wide dynamic range ($>10^7$ 8 keV X-rays/pixel/frame), and a 1 KHz frame rate. MMPADs with 256 x 384 pixel formats have been successfully applied at the APS, CHESS, and the Positron-Electron Tandem Ring Accelerator (PETRA-III). ADSC is developing an enhanced version of this architecture for commercialization. The second project is an upgraded version of the prototype PAD mentioned in the previous paragraph. It is designed to capture up to eight successive single-bunch images with minimum time

between images of 150 ns. The third project's goal is to move functionality from the hardware integrated circuit into closely coupled field programmable gate arrays. This would allow the PAD to be programmed in firmware to emulate hardware functions without loss of speed or generality.

Activities at Oak Ridge

The ORNL Neutron Sciences Directorate (NScD) operates two major neutron source facilities: the Spallation Neutron Source (SNS) and the High Flux Isotope Reactor (HFIR). The two facilities have about 30 operational experimental beamlines, with more under construction, and all require thermal neutron detection systems. The Detector Group consists of six detector scientists, two graduate students, and eight technicians. The group works closely with the Data Acquisition System (DAS) Group of equal size to make sure that the detector arrays are integrated into a global data acquisition and analysis network. The SNS is leading the R&D effort in ^3He alternatives and has developed three detector types that have been transferred to private companies for commercialization.

Since 2000, the group has developed and installed three best-in-class detector systems and has an ongoing effort to develop new detectors to meet the unfulfilled requirements for neutron beamlines. These include a patented 8-pack module for linear position-sensitive proportional detectors (LPSDs) that is optimized for high event rates and can be operated in a vacuum. To date, approximately 3,000 LPSDs have been installed in SNS instruments. This design won an R&D100 award in 2007. For applications needing good position resolution, the group developed a high-efficiency Anger camera with segmented anode PMTs. These cameras have 1 mm or better position resolution and can time-tag each neutron to 1 μs . Thirty-two cameras have been installed and are operational on the SNAP and TOPAZ diffractometers at SNS. The third detector system is the cross-fiber system (2012 R&D100 award winner), designed for instruments that need large-area coverage, up to 45 m². This detector uses scintillator screens that are read out with wavelength-shifting fiber into a set of photomultipliers that encode the position of

the neutron event on the screen. These detector modules, presently in use at the POWGEN and VULCAN diffractometers at SNS, have 0.3 m² active areas and can be tiled for large-area coverage. This patent-pending system is considered a prime candidate for replacing ³He-based detectors for large-area neutron-scattering science applications.

Activities at Stanford/SLAC

SLAC has designed and implemented detectors for particle physics and astrophysics for more than 30 years. With the turn-on of LCLS, and the lack of availability of cameras suitable for FELs, the laboratory effort in the area of X-ray detectors has increased significantly. SLAC has an experienced detector R&D team whose expertise encompasses sensors, integrated circuits, micropackaging and interconnects, advanced electronics, DAQ, computing, analysis, interdisciplinary concurrent system design, and large-scale system integration. SLAC also has a long history of using the Nanofabrication Facility, Nanocharacterization Laboratory, and the Nano Center on the Stanford University campus for sensor fabrication and general micro- and nano-processing. Detector development is supported with beam time for testing and characterization at SLAC's X-ray facilities, SSRL and LCLS. This permits a close interaction with the user community, driving the development of instrumentation for photon science.

In the past three years, three 2.3 Mpixel and more than ten 140 kpixel X-ray detectors based on the CSPAD platform have been developed, assembled, tested, deployed, and supported for operation at LCLS, SSRL, APS, and SACLA (Japan).

The main systems being developed are integrating PADs for (hard) X-rays that are built around the ePix, a novel class of front-end ASIC architectures based on a common platform. In particular, the ePix-100 ASIC is optimized for applications requiring ultra-low noise (less than 100e⁻ rms), good spatial resolution (50 μm x 50 μm pixel size), and low dynamic range (100 photons at 8 keV). A second ASIC, the ePix-10k, is optimized for high-dynamic-range applications (10k photons at 8 keV) with a pixel size of

100 μm x 100 μm and a resolution of better than 350e⁻ rms. The full-reticle size ASICs in their final versions will be able to sustain a frame rate of 360 Hz.

SLAC's Integrated Circuits department specializes in high-channel count, low-noise X-ray sensor readout circuits and has designed a significant number of successful mixed-signal ASICs for fast-frame detectors. Several additional designs are in progress, one of them in support of pump-probe experiments at SSRL and other synchrotron short ps bunches.

The experience of these past years has shown that modular and scalable detectors with a common interface are key to providing time- and cost-effective cameras that are easy to adapt and support. Each part of these systems is designed to maximize commonalities. Prototypes are designed to implement extended debugging and scalability. As already demonstrated with the design of the eLine class of ASICs, this approach reduces development time and expands the possibility of integration of detector modules in size, shape, or functionality, since different modules can be assembled in the same camera.

Infrastructure

In addition to X-ray and neutron detector physicists, a broad range of supporting infrastructure is essential to ensure successful detector developments. All detectors require skilled technical staff for assembly and integration, electronics, firmware and software support, and test facilities. Microelectronic-enabled detectors require, in addition, ASIC design, interconnect technology, and sensor fabrication facilities. We describe below the range of supporting infrastructure required, and some examples in U.S. facilities.

Integrated circuit design

Starting in the 1980s, laboratory and university detector groups began to design custom-integrated circuits. At that time, semiconductor processes were rather unreliable, but design complexity was also limited. Semiconductor technology has dramatically

improved since then, and design requirements have become more daunting (the design manual for a $1.2\ \mu\text{m}$ feature-size CMOS process back then was 18 pages. For a 65 nm process today, it is 750 pages.).

Nowadays a vast portfolio of technologies is available and designers can tailor their systems to maximize performance and minimize costs. Many applications in our field require ultra-low noise, analog-centric designs with moderate speed and segmentation; for those, technologies between $0.25\ \mu\text{m}$ and $0.13\ \mu\text{m}$ are the most attractive and cost effective. On the other hand, when high segmentation, speed, and digital processing are required, very deep submicron technologies, typically used in the digital market, are a necessity. In such cases, in addition to complexity, cost is a barrier to entry.

Moore's law, the doubling of transistor density every two years, has been accomplished through a reduction in feature size. With that reduction, the costs of lithography increase dramatically. Figure 31 shows cost as a function of feature size, with a timeline of Berkeley Lab technology usage. With reduced feature size, performance improves — there is almost no reason today for custom-integrated circuits not to work on the first iteration — but the complexity of design and development has greatly

increased. As has the cost, which increases exponentially as feature size decreases, so that our community typically lags behind the state of the art by several years, simply due to cost.

Electronics

The development of complex detectors requires a variety of electronics activities. These include, but are not limited to, schematic capture, printed circuit-board design, firmware design, system simulation, and board assembly. The process of schematic and board design requires skilled electronics engineers and in-house layout technicians as well as a suite of professional-grade computer-aided design (CAD) tools. Complex firmware designs require professional-grade simulation and tools used by experienced digital designers. While board assembly is commonly performed by outside vendors, the availability of in-house assembly technicians can accelerate prototype development and facilitate reworking of boards.

The past few years have seen a need for new electronics to support neutron-detector efforts where newer higher-rate and higher-resolution detectors are required. The Millimetre Resolution Large Area Neutron Detector (MILAND) developed at ILL is one example of how electronics development was needed to push a 2-D gas detector's resolution to

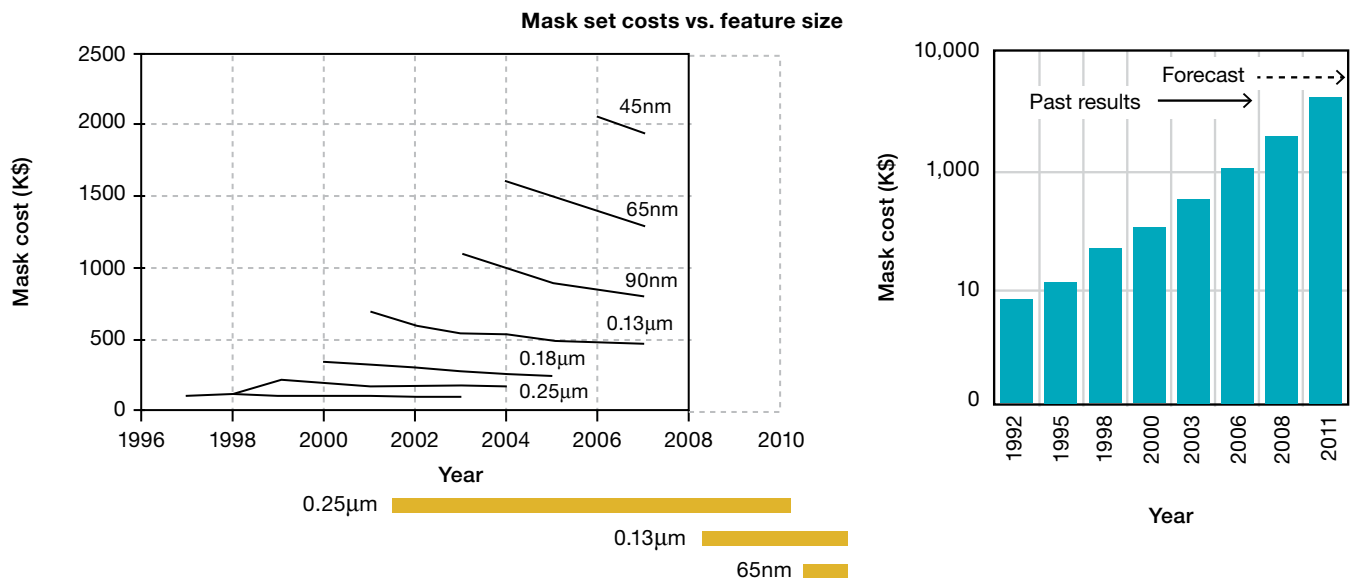

Figure 31 IC design history at Berkeley Lab.

1.0 mm with 1 MHz count-rate capability. A second example is the ASIC development at BNL where, to reduce noise to a minimum, ASICs were developed to be placed inside the detecting gas volume. This ASIC was also designed with extremely high rate capability. The BNL detector is projected to have a neutron count-rate capability of greater than 10 million counts per second.

The challenges of electronics development are similar to those experienced in the detection of other particles, i.e., the density of electronics and the channel count continue to increase. Neutron detectors could benefit from ASIC development, where high channel count on a single chip can be achieved, especially with many A/D converters having 10-bit accuracy or better and conversion times of 1 usec or less. Another benefit could be the development of charge-sensitive preamplifier circuits with novel programmable peaking times with peak hold circuitry. Other areas of investigation would be electronics with lower power consumption and lower cost per electronics channel. For high-count-rate detectors, electronics allowing the communication of digital data over newly available digital channels such as 10 GBit Ethernet or Infiniband would be useful.

Radiation hardness

Today's X-ray sources can, depending on the X-ray energy, present extraordinary radiation hardness challenges for detector designers: The focused beam of an X-ray FEL can easily drill through a detector. The particle physics community for high-luminosity hadron collider applications was extremely successful in adapting submicron CMOS integrated circuits — with special layout techniques — to high-radiation environments, and is currently using nanometer CMOS technologies (with no special layout techniques) as a vehicle. The effects and mitigations for X-ray detectors at energies ~ 10 keV are quite different than that experienced in HEP detectors. There, the primary issue is atomic displacement damage. X-rays below several hundred keV do not cause such damage, but generate trapped charges in oxide and other insulating structures. This type of damage is poorly studied, and work in this area is sorely lacking.

Laboratory foundries

The revolution in X-ray detectors has come about through the use of semiconductor sensors, prepared using microelectronics technology. When sufficiently developed, these sensors can be commercially procured, but in the R&D phase, laboratory and university semiconductor fabrication facilities (“fabs” or “foundries”) are essential. Many universities used to operate small fabrication facilities to train students in microelectronic technology. As the technology moved to smaller feature sizes, most of those labs were repurposed to pursue microfabrication and nanoscience-related activities. While these valuable resources are used in part for detector development today, they often lack the capabilities for the development of large-area sensors (for example, high-resistivity silicon, the heart of all of today's advanced X-ray detectors, requires careful control of materials and impurities, which are often beyond what a student fab can guarantee). Within the non-defense scientific community, prominent examples of such fabs were established for aerospace (the Halbleiterlabor [HLL] of the Max Planck Institute and the Microdevices Laboratory of the Jet Propulsion Laboratory), and within the Office of Science (the Semiconductor Detector Development and Processing Lab [SDDPL] at BNL and the MicroSystems Laboratory [MSL] at Berkeley Lab).

In Germany, the MPI HLL comprises many tens of FTEs, whereas in the United States, the SDDPL and MSL are a few FTEs each. In addition to the challenge of maintaining staff, these facilities require semiconductor fab equipment only a few generations behind the state of the art. MSL, for example, contains donated equipment (from Silicon Valley), and secondhand equipment purchased through Berkeley Lab funds. While MSL is currently primarily supported by HEP, BES funds are being used to implement a Molecular Beam Epitaxy (MBE) capability for very thin contacts.

There are very few of these detector foundries worldwide, and they represent a vital resource. The capabilities they enable take years to achieve (The MSL was started in the late 1980s to bring Silicon Valley expertise to silicon strips for HEP. The SDDPL was started around the same time.).

Support infrastructure

In addition to ASIC design and sensor fabrication, microelectronic-enabled detectors require additional support infrastructure (and skilled, trained staff). Interconnection of the detector and ASIC, whether by wire bonding, bump bonding, or other techniques, is a specialized skill — available in industry for “routine” operation, but often requiring considerable in-house development. (For example, the LHC hybrid pixel detectors required a 50 μm bump-bonding pitch, which was less than the industry standard of 200 μm . Achieving this was a major effort, requiring many years and significant investment.)

Figure 32 shows the BNL Maia detector, where a 2-D pixel array is wire-bonded to a series of 1-D readout ASICs. The wire bonding is quite complex and nonroutine, and institutions engaged in this kind of development need to be able to maintain the infrastructure to support such complex developments.

Interconnection technologies

The means by which a semiconductor sensor pixel is connected to its corresponding readout (Figure 33) is a critical detector technology. Today, there are roughly four methods:

1. **Intrinsically monolithic detectors:** The sensor and the readout are on the same piece of (to date) silicon. The most obvious example is the CMOS Active Pixel Sensor, better known as the camera in cell phones. The CCD-based detectors described above as well as the SOI detectors are examples.

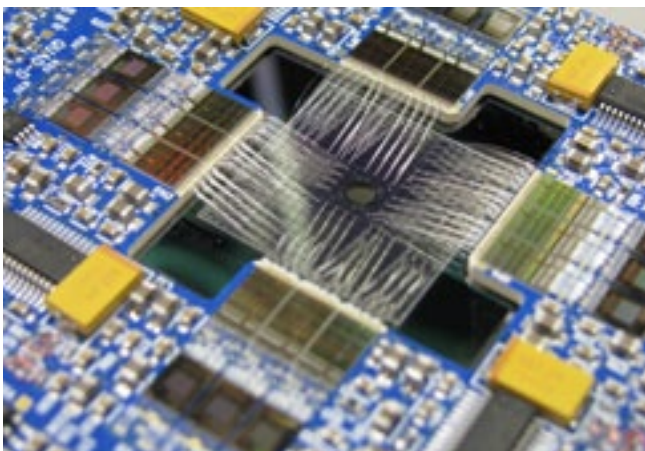

Figure 32 Maia detector showing intricate wire bonds.

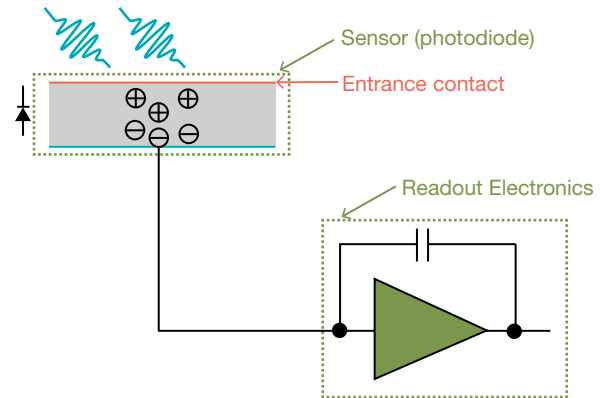

Figure 33 Connection of the sensor to its electronics.

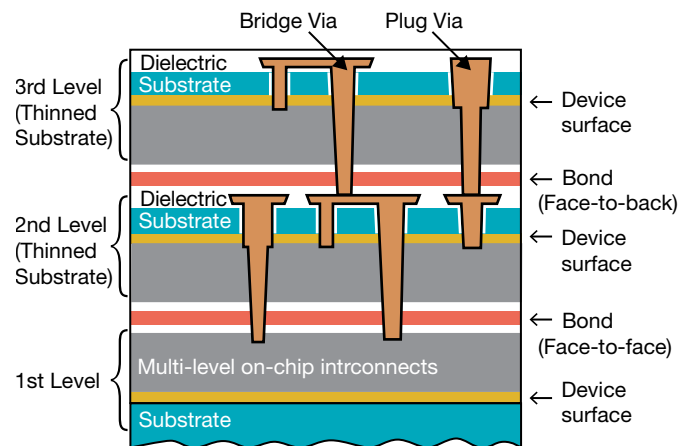

Figure 34 3-D interconnection.

2. **Wirebonding:** This is the most common interconnect technology in the semiconductor industry. Here, thin conductive wires connect to the periphery of integrated circuits, although 2-D configurations are possible (c.f. the Maia detector).
3. **Bump bonding:** This is the 2-D interconnect technology used today for high-density interconnect. It is also the basis for the hybrid pixel detector (Figure 30). It took considerable effort for the HEP community to drive the LHC bump-bonding pitch below the industry standard of 200 μm to 50 μm .
4. **3-D interconnect:** This modern interconnect technology (Figure 34) is based on (a) thinned integrated circuits, (b) the ability to provide interconnects through these thinned circuits

(through-silicon vias), and (c) micro-bump-bonding technology in order to allow a stack of homogeneous (or heterogeneous) semiconductor technologies. This technology is generating excitement in the community as a potential successor to bump-bonded hybrid pixels. A Fermilab / BNL collaboration is actively pursuing this technology to enable so-called “smart detectors.” It is labor- and cost-intensive work, and progress is slow, partly due to the low-volume nature of scientific processing, which results in science projects receiving the lowest priority in the foundries. Current projects are dealing directly with the foundries, instead of submitting via MOSIS. We are expecting that MOSIS will provide a 3-D option in the near future, which will greatly facilitate developments by the detector community.

Leveraging Laboratory Resources

When planning detector development, the full life cycle must be considered. Typically, the detector’s technical challenges overwhelm the human resources available, and the complexity of the detector must be balanced with available resources and the scientific goals of the experimenters. The interface between scientist and detector developer is extremely important if the result is to fulfill the scientists’ expectations. The development of a detector does not end until it is routinely taking scientific data on the beamline. Routine operation requires a user-friendly software interface that includes online data inspection and analysis so that the end-user can resolve problems with the sample. Given the high expense of beam time, it is critical to be able to determine problems with the data at the beamline. In addition, detector development does not end until the detector has been fully calibrated to remove any instrumental artifacts that could affect scientific results. This calibration requires that detector developers and end-users work together. Finally, clear scientific motivation/focus is necessary to avoid straying from the scope of the development. This focus can come from frequent and routine end-user interaction with a scientific advisory committee for detector development projects.

Deployment models

As detector needs become more challenging and specialized, development and deployment will fall increasingly onto the community. This happened in the nuclear and particle physics experimental communities, where a long period of commercially available general-purpose instrumentation was by necessity followed by a period of community-developed detectors. For BES facilities, both commercially and institutionally developed detectors will serve future user needs — and each case has advantages (to be maximized) and disadvantages (to be mitigated).

Commercialization

The advantages of commercially produced detectors are that they are generally rugged and the vendor provides both hardware and software support. Community-developed detectors can, in many cases, be transferred to commercial production. Generally, this involves a trade-off between the expected market and detector complexity. Simple (to produce) detectors with wide appeal are ripe candidates for commercialization. Complex (hard to produce) or specialized (small market share) detectors may remain with the facilities.

In Europe, many detector developments are successfully spun off as start-up companies (with the consequence that the detector developers leave their research institutions for these start-ups). This pattern is not unique to detectors, and is well known in many areas of scientific instrumentation. In the United States, the Small Business Innovation Research / Small Business Technology Transfer (SBIR/STTR) program remains a poorly tapped resource for both neutron and X-ray technology transfer to industry.

Nonetheless, there are several success stories. An X-ray detector example is described in the box *Commercialization of Phosphor / Fiber-Optic CCD Detectors*, and neutron detector examples include:

- Linear position-sensitive detectors, also called 8-packs, which are the most widely used detectors at SNS. The technology was developed at SNS and has been transferred to GE Reuter Stokes.

- Wavelength-shifting scintillator neutron detector, developed and used in many SNS instruments, and now transferred to PartTec, Ltd., for commercialization
- Anger cameras, developed for three SNS instruments, also transferred to PartTec, Ltd., which is commercializing the technology
- High-resolution (<50 μm) microchannel plate detectors commercialized by NOVA Scientific, Inc., for applications such as tomography or radiology. Due to the limited number of users, however, its commercialization is facing challenges, illustrating the limitations of commercialization for specialized detectors.

Interfacility cooperation

In some cases, community-developed detectors are so specialized (too small a market) or so complex (too high a cost to market) that commercialization may not be viable. Nonetheless, significant investments were required to produce the first article, and often other facilities can benefit from these developments. A model for interfacility cooperation will enable deployment and support of small quantities of custom-built detectors that cannot be commercialized.

The challenges to be addressed are:

- How does interfacility cooperation fit into the metrics by which facilities are evaluated?
- What are models for support (how does Facility A support the deployment of its development at Facility B)?
- How is infrastructure (for fabrication and service) maintained?
- How are the different skills at the facility's laboratories best leveraged?

BES, the facilities' management, and detector technical experts should work together to explore solutions to these challenges; there are indeed case studies of successful collaborations:

CSPAD — CORNELL-LCLS CO-DEVELOPMENT

An example of a successful collaboration between institutions is the development of the Cornell-SLAC Pixel Array Detectors, now operating as primary imaging devices at SLAC's LCLS FEL. It was evident as soon as the LCLS construction project started that better imaging detectors would be needed than existed at the time. In particular, the single-particle coherent X-ray imaging experiment, one of the flagship experiments planned for the LCLS, posed stringent detector requirements. An imaging detector was required that would have very high single 8 keV X-ray sensitivity, a dynamic range of at least several thousand X-rays per pixel per LCLS pulse, many pixels, and the ability to frame continuously at the 120 Hz LCLS repetition rate. SLAC engaged Sol Gruner's group at Cornell University and the Cornell High Energy Synchrotron Source (CHESS) in a collaboration to produce a suitable detector. Extensive work by both the Cornell group and SLAC was required to move from concept to full-size, functioning detectors integrated into the LCLS infrastructure. Communication between the two teams was crucial to this success. The effort required a half-decade and about \$9 million. The resulting detectors are now a mainstay at LCLS and have been used by many hundreds of researchers in a very wide variety of experiments. A second generation of the CSPAD is starting production at SLAC. It is an example of a productive collaboration among DOE- and National Science Foundation-supported national facilities and a university. SLAC is hoping to attract a commercial vendor to sell modules based on the technology.

FASTCCD — ALS-APS CO-DEVELOPMENT

Another highly successful collaboration, carried out by Berkeley Lab and ANL, resulted in the development of the FastCCD 200 megapixel/second direct-detection CCD. The initial concept was developed under a Berkeley Lab Laboratory Directed Research and Development (LDRD), but quickly Berkeley's ALS and Argonne's APS detector groups formed a partnership in which no money changed hands — labor and materials were contributed "in-kind" by each facility. This collaboration, which continues today, has proved an excellent match between the skills at Berkeley for CCD and ASIC

design, and the skills at Argonne for data acquisition and software. Prototypes of the FastCCD are used at APS Beamline 8-ID for XPCS, and form the basis for the Nanosurveyor at ALS. The FastCCD has also served as the soft X-ray (SXR) imaging detector for the SXR Beamline at LCLS since its inception. American Recovery and Reinvestment Act (ARRA) funds of ~\$2 million enabled the development of an 8x larger detector, with eight such detectors being delivered to ALS and two to APS. These FastCCDs are also being provided to NSLS-II and the European XFEL under work-for-others contracts.

Data

State-of-the-art detectors produce data at rates on the order of 1 GB/s, and that rate will increase as technology enables it, and science requires (see box *All That Data: A Growing Problem*). The storage and analysis of the data produced by detectors is beyond the provenance of the detector builder, and the growing¹² void can only be filled by a combination of detector designers in concert with X-ray/neutron and computing scientists. Key areas requiring attention include:

1. Data validation and fast feedback to the user
2. A software tool framework to efficiently and effectively deal with the large data sets that high-speed detectors generate
3. Techniques for reducing the overall data volume

The latter area directly requires the detector designer to modify or develop firmware (or hardware) to implement relevant algorithms. Particle physics experiments are able to implement “triggers” as a means to vastly reduce data volumes. This is possible because (a) data are generally sparse (a given event deposits signal in a small fraction of the total detector channels) and (b) one can develop relatively simple “signatures” whereby a small portion of an event can indicate if the event itself is

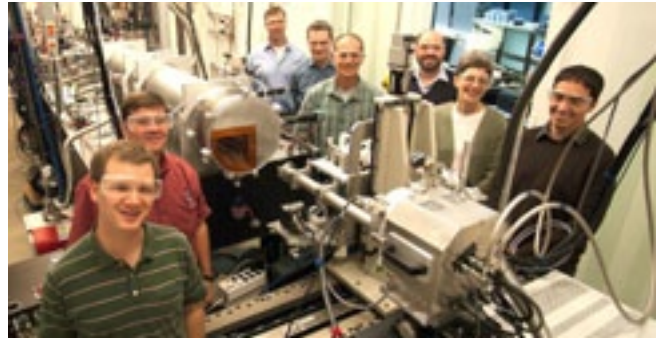

Figure 35 ALS-APS team with FastCCD at APS 8-ID.

worth saving. It is easy to reject an event in simple cases, such as when an FEL pulse misses the injected sample. More generally, the quality of the data taken can only be determined from the data itself.

Computing, data acquisition, data analysis

With successes in detector development, DOE facilities’ responsibilities to its users will change, motivating new advances to help users reach their scientific goals. To meet this need, DOE facilities must expand computing and computational services in a thoughtful, collaborative way that makes the best use of limited resources.

Developmental advances have led to an ever-increasing volume of data from the detectors due to faster readouts, increased resolution, and higher channel counts. Integrating data from different sources, such as beamline and background monitors, might form a more accurate picture of the conditions associated with data collection. Data-reduction and -discrimination techniques are needed at various levels, from the detector to points deeper down the data pipeline. User-involved data-reduction techniques are needed to ascertain the data’s scientific value before it is archived in a permanent store.

Beam time is a precious commodity. We present three technical objectives in the data acquisition and computing area to make more effective use of beam time:

- Facilitate the development of algorithms and tools. Sophisticated detectors require highly

¹² See, for example, the report from the Data and Communications in Basic Energy Sciences workshop, March 2012.

tuned algorithms to optimize signal-to-noise ratio, suppress null channels, and potentially discard unwanted information prior to readout.

- Distribute community-developed simulations and simulation tool kits that can predict the performance of beamlines and specific detectors.
- Make optimal use of existing algorithms and tools through parallelization to take advantage of higher-performance platforms. This activity will train algorithm developers and foster further algorithm development in support of the first goal.

Better acquisition and analysis tools

Detector technology improvements will require comparable development of software tools and algorithms to understand detector performance and to maximize users' scientific productivity, together with data-acquisition (DAQ) systems that can provide "fast" feedback to users in near-real time, allowing them to make adjustments to the beam or detector during data collection.

Onboard algorithm development for detectors is currently not a standardized activity, nor is there an organized effort to develop simulation tools for detectors deployed in BES user facilities. This leads to inefficiencies. Other scientific disciplines have developed community tool kits for Monte Carlo simulation, and some of those could be adapted to the simulation of neutron or photon detectors.

Additional efforts that could maximize effective use of beam time and improve the scientific content of the data collected include:

- Develop and provide for online computing resources that, where needed, integrate with the end-station DAQ systems. Interoperability between on- and offline versions of frameworks would enable scientists to develop matching and pattern-discovery code — using simulated and/or existing experimental data — prior to arriving at the end station, saving them valuable beam time.

- Keep the number of data-stream protocols to a minimum: An ever-increasing number of such protocols increases the heterogeneity and complexity of DAQ systems. DAQ and detector designers should, together, define a limited set of protocols and standards.
- Develop quantitative, interactive visualization tools. Powerful visualization software that allows quantitative comparison of simulation and experiment, including whole-image comparison or feature extraction, will aid in large-scale data processing, and will improve the quantity, quality, and reproducibility of the resulting science.

Improved work flows

- Standardize metadata formats. As an example, the NeXus initiative¹³ is a collaboration among facilities across the globe to create a data format common to neutron, X-ray, and muon science. It is one of the most widespread scientific data format-standardization efforts, supervised by an advisory committee of representatives from institutions in North America, Europe, and Asia. As of August 2012, the NeXus format is in use by 15 neutron, X-ray, and muon facilities worldwide.
- Develop an intuitive user interface and software framework for analysis and data management. No such general framework exists. Facilitating data-analysis processing with appropriate tools, services, and computing resources would streamline scientific work flow and enable faster publication of scientific results.

Metadata is the information required to understand the particulars of a data set in summary. It can include information about the owner, the facility, the experimental conditions, and the types of detectors used, to name a few. Some metadata standardization is necessary to allow automated tools to discover and make sense of data sets in a repository. Data formats should be optimized for the particulars of an experiment and detector setup. Any set of newly developed tools that operates on an experiment's data should be format-agnostic.

¹³ <http://www.nexusformat.org>

Data management is the set of services handling the data's movement from the detector to local or remote storage, as well as the storage and retrieval of (meta)data. It permits secure access to data for authorized users, which is particularly important for a repository containing data from multiple facilities. Data management also covers the movement of data from facility-associated storage to user storage, which, ideally, should be fault-tolerant, automated, and fast. Developing such an intuitive software framework in common use across several facilities would provide consistency for users and lower the support burden for instrument scientists. Collaboration among facilities to standardize these frameworks would allow for interfacility software portability, and would ease the user-support burden. Additionally, users who conduct experiments at various facilities would be able to switch between setups with little to no need for retraining.

Data management is currently end-station specific, and typically consists of user-owned portable storage. For facilities with existing data-management infrastructure, each solution is ad hoc. The current state of the art is not sustainable or scalable due to the complexity and increasing volume of data from next-generation detectors.

In many science domains, the solutions involve a mix of specially developed software, the use of general facilities such as the Energy Sciences Network (ESnet) for networking, and general tools such as gridFTP, provided by Globus. The distribution of many general tools is provided by the Virtual Data Toolkit (VDT), distributed by the Open Science Grid (OSG).

Data challenges

While the charge of this workshop is to focus on detector development, it is clear that the development of high-rate detectors cannot be divorced from the need to deal with the copious volume of data produced. Movement and analysis of these rapidly acquired, large data sets present computing challenges that may require the defining, or redefining, of the boundaries of responsibility and service to users.

Technological challenges breed policy issues

The whole question of what we do in the long term with all the data we collect using new, advanced detector systems is very important, but is outside of the scope of this workshop. It could easily consume an entire workshop in its own right. Before we can propose engineering solutions to the problems, there must be policy decisions to steer those solutions and, of course, funding to implement the policies when they are set.

Even now, some user facilities experience delays in their ability to copy data to the user before the user departs the facility. Similarly, the user's home institution may not be able to manage the transfer of large data sets without extensive help from user-facility staff, who are also assisting other users during the next allocation of beam time. Will user facilities assume primary responsibility for curation of these large data sets? How long will user facilities need to take on that role? Large Advanced Scientific Computing Research (ASCR)-supported centers such as NERSC do not act as the primary and sole repository for user data — users must make arrangements for data storage at their home institutions. Should BES user facilities adopt the same practice? These questions are a matter of policy, not engineering.

Data and analysis strategies

Over the coming years, data strategy will significantly affect productivity of BES user facilities. With the deployment of new detectors, on-site data storage and analysis could rapidly consume user-facility equipment and operating budgets. If solutions are beamline-based or user-facility-based without any coordination, the end result will be an extremely diverse array of solutions, confusing for those who use multiple beamlines or user facilities.

Consider a user who has just generated a huge data set and has managed to get it to the home institution, but who lacks access to sufficient computing resources to analyze it before applying for new beam time. Do BES user facilities have a responsibility to reduce the data sets to something more manageable to address the needs of such users? That would require significant investment in hardware and people.

Rather than tackling these challenges on their own, user facilities could alternatively partner with other Office of Science resources such as those deployed by the Office of ASCR. Pilot programs at NERSC and ESnet are exploring alternative solutions. The goals of those efforts, focusing on tomography data from the Advanced Light Source (ALS) and the Linac Coherent Light Source (LCLS), include automatic transfer of data from detectors to professionally managed storage facilities at NERSC, and the development of a user portal that will allow an authorized user to access his or her own data in the storage facility. Once analysis codes are ported to the high-performance platforms, an authorized user might be able to analyze a data set and reduce it to manageable size, facilitating transfer to the user's home institution. These nascent efforts appear promising and require further development.

Future of publicly supported facility-derived data

Because scientific data has value beyond the individual experiment, a user facility partnership with facilities like NERSC may address the needs of the growing population of data users. Although beyond the scope of this report, the activity of data users begs the question of public data sets and the associated BES/Office of Science policies toward them.

No one solution to the data tsunami resulting from the success of better, bigger, and faster detectors will be applicable for every beamline or user facility. Commonalities and shared best practices will be necessary to avoid roadblocks to enabling science at BES user facilities.

Detector Systems

Going from a detector prototype to a system involves more than merely scaling the readout electronics. The figures below, from the LCLS CSPAD development, visually demonstrate the complex mechanics and cooling challenges (a, b), the complexity of connecting the detector to the readout (c), incorporation of readout into the constrained detector volume (d, e), and the work required to adapt the detector mechanics to the beamline (f, g).

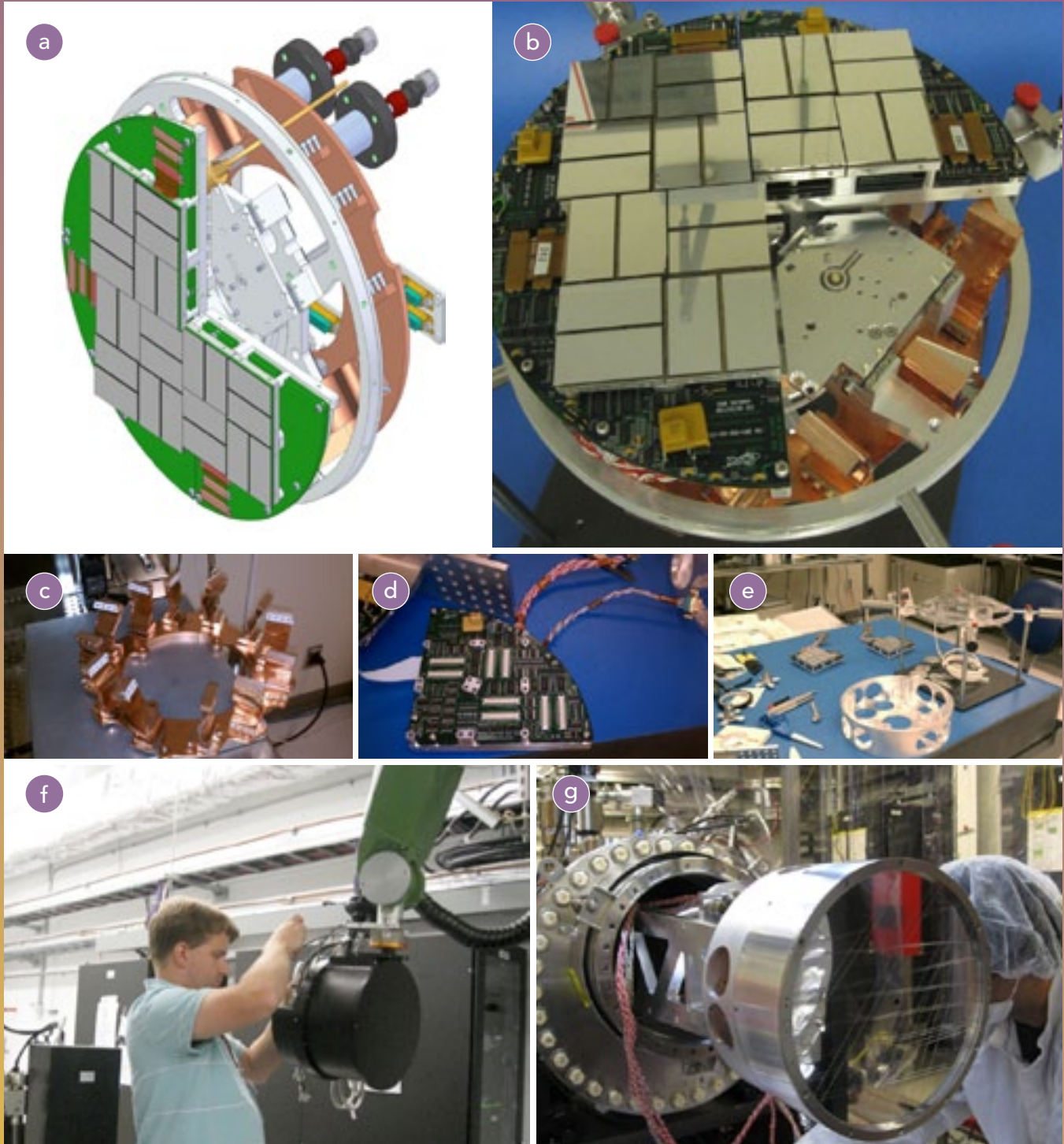

Commercialization of Phosphor / Fiber-Optic CCD Detectors

By the early 1990s, macromolecular crystallography was becoming an important experiment at synchrotron sources. The experiment was being carried out with X-ray film, mechanically manipulated storage phosphors, or severely count-rate-limited imaging gas proportional counters. In 1989, Sol Gruner's group at Princeton University collaborated with the Cornell High Energy Synchrotron Source (CHESS) to build and test X-ray detectors based on the fiber-optic coupling of thin phosphor screens to cooled, scientific CCDs. The first tests took place in 1992 and a dedicated detector was installed at the CHESS F1 station in 1993. Reports soon filtered through the community about fabulous data acquired with the detector. For example, Wladek Minor, one of the authors of the now-popular HKL-2000 software suite, used it to acquire a 1.4 Å resolution data set on lipoxygenase, an 839 amino acid protein, in a single evening. The data set consisted of 1.1 million observations and was 96% complete with a R_{sym} of 3.6%, which, at the time, was an astonishing accomplishment. CHESS soon had users clamoring to use the station and the detector. These successful results were soon followed by Ed Westbrook's group at ANL, which was also developing a phosphor-coupled CCD detector. The development of both detectors was largely a result of support by the Biological and Environmental Research division of the DOE (DOE-BER). The Princeton/CHESS work also was supported by the National Science Foundation (NSF).

Vendors quickly became interested in CCD detectors, in response to demands from user groups at other synchrotrons. This was highly welcomed, as it was obvious that neither a small university group nor a national laboratory group could meet the rapidly increasing demand for CCD detectors, nor could they provide the requisite long-term support. The Princeton group's technology was soon available through ADSC in Poway, CA, which rapidly became one of the dominant vendors of macromolecular X-ray detectors. This stimulated other vendors to compete, and by the end of the decade users could choose from a variety of phosphor-coupled CCD detector vendors. Today, most protein structures that have been solved use data acquired with phosphor-coupled CCD detectors.

Macromolecular crystallography is a case of an experiment sufficiently broad in scope and importance that almost all synchrotron sources support several crystallography stations. This is unusual, though. The more typical experiment does not have such a large user base, and the consequent attraction of detectors tailored for the experiment will be smaller, with perhaps one devoted station at a given large synchrotron source (for example, high-resolution powder pattern diffractometry).

All That Data: A Growing Problem

Experiments at BES user facilities generate staggering amounts of data. A lone detector could output data at a rate equivalent to streaming 10 high-definition movies simultaneously, a speed that would fill the storage of a typical desktop computer in just a few minutes. Add up all of the experiments at all of the stations at a single facility, and you have a data-storage challenge not unlike those faced by many modern-day "cloud computing" companies. With new facilities and detectors on the horizon, the transport and storage of scientific data will only become more resource-intensive.

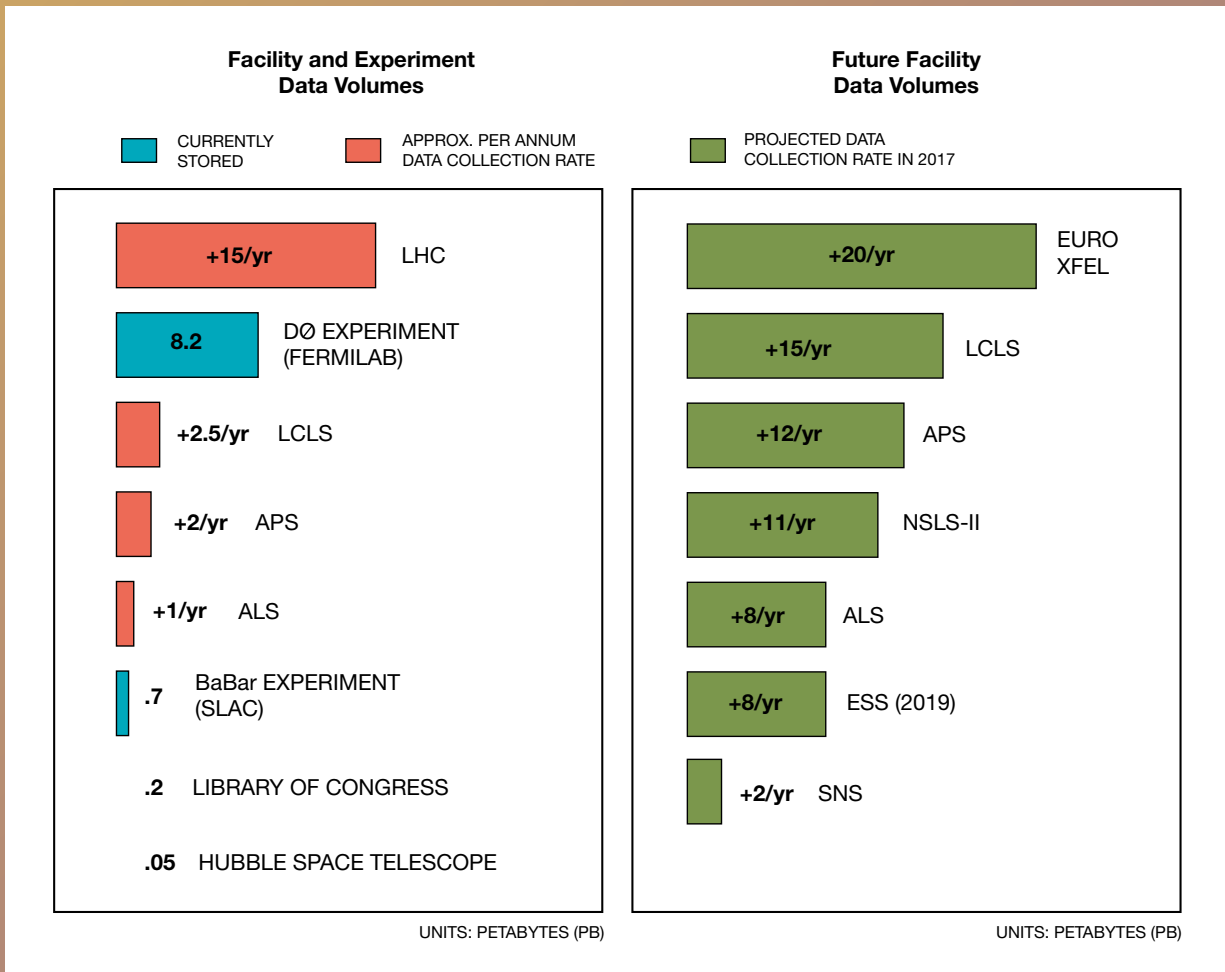

Appendix 1:

Workshop Agenda

Wednesday, August 1, 2012

Plenary Sessions	8:30 am – 8:45 am	Overview and Perspectives / Session Chair: Peter Denes	
	8:45 am – 9:15 am	BES Perspectives, <i>Harriet Kung</i>	
	9:15 am – 9:45 am	Synchrotron Needs (Science Drivers, User Needs, Gaps), <i>Jin Wang</i>	
	9:45 am – 10:15 am	FEL Needs (Science Drivers, User Needs, Gaps), <i>Jerry Hastings</i>	
	10:30 am – 11:00 am	n Source Needs (Science Drivers, User Needs, Gaps), <i>Jason Hodges</i>	
	11:00 am – 11:30 am	Activities in Europe, <i>Heinz Graafsma</i>	
	11:30 am – 12:00 pm	Activities in Japan, <i>Yasuo Arai</i>	
Breakout Sessions	1:00 pm – 5:45 pm	X-ray Detectors Session Chairs: <i>Peter Siddons - BNL</i> <i>Dennis Mills - ANL</i> Scribe: <i>Antonino Miceli - ANL</i>	n Detectors Session Chairs: <i>Yacouba Diawara - SNS</i> Scribe: <i>Philip Bingham - SNS</i>
	1:00 pm – 1:15 pm	Introduction, <i>Sol Gruner</i>	Introduction, <i>Yacouba Diawara</i>
	1:15 pm – 1:45 pm	Integrating Hybrid Pixel Detectors, <i>Mark Tate</i>	Scintillation Detectors at the SNS, <i>Richard Riedel</i>
	1:45 pm – 2:15 pm	Photon Counting Detectors, <i>Mike Campbell</i>	Gas-based Neutron Detectors, <i>Veljko Radeka</i>
	2:30 pm – 3:00 pm	Fast CCDs, <i>Peter Denes</i>	Summary of Workshops on Alternatives to Helium-3, <i>Richard Kouzes</i>
	3:00 pm – 3:30 pm	Discussion	Discussion
	3:30 pm – 4:00 pm	Speckle Detectors, <i>Grzegorz Deptuch</i>	European Detector Developments, <i>Bruno Guerard</i>
	4:15 pm – 4:45 pm	Energy-resolving Fluorescence Detectors, <i>Pete Siddons</i>	MCP Detector Development, <i>Bruce Feller</i>
	4:45 pm – 5:15 pm	Superconducting Bolometer Arrays, <i>Joel Ullom</i>	Development of Scintillator Detectors at JPARC/MLF, <i>Kazuhiko Soyama</i>
	5:15 pm – 5:45 pm	Discussion	Discussion
	5:45 pm – 6:15 pm	Synthesis and Discussion	

Thursday August 2, 2012

Plenary Sessions

Cross-cutting Areas / Session Chair: Peter Denes

8:30 am – 9:00 am	Electronics, <i>Helmuth Spieler</i>
9:00 am – 9:30 am	Data Acquisition, <i>Amedeo Perazzo</i>
9:30 am – 10:00 am	From R&D to Production, <i>Bernd Schmitt</i>
10:00 am – 10:30 am	Discussion

Cross-cutting Areas / Panelist: Gabriella Carini

Breakout Sessions

	Electronics Session Chairs: <i>Paul O'Connor - BNL</i> <i>Charles Britton - ORNL</i> Scribe: <i>Marianne Hromalik - SUNY</i>	Sensors Session Chairs: <i>Craig Tindall - LBL</i> <i>Sherwood Parker - U. of Hawaii</i> Scribe: <i>John Smedley - BNL</i>	Computing & DAQ Session Chairs: <i>Michael Banda - ALS</i> <i>Amber Boehnlein - SLAC</i> Scribe: <i>Karl Gumerlock - SLAC</i>
10:45 am – 11:00 am	Introduction, Session Chair	Introduction, Session Chair	Introduction, Session Chair
11:00 am – 11:30 am	Wide-bandwidth Electronics, <i>Ryan Herbst</i>	3D and Edgeless Sensors, <i>Chris Kenney</i>	Computing-Intensive Photon Science, <i>Alexander Hexemer</i>
11:30 am – 12:00 pm	Advanced ASIC Design, <i>Carl Grace</i>	Scintillating Fibers, <i>Clifford Bueno</i>	Networking, <i>Eli Dart</i>
12:00 pm – 12:30 pm	Detector Deployment at ALS, <i>Dionisio Doering</i>	Diamond Sensors, <i>John Smedley</i>	Big Data Structure, <i>Arie Shoshani</i>
1:30 pm – 2:00 pm	Frontend Electronics for FEL Detectors, <i>Angelo Dragone</i>	Thin Contacts for Soft X-ray Sensors, <i>Craig Tindall</i>	HEP & PS DAQ, <i>Matt Weaver</i>
2:00 pm – 2:30 pm	Scalability: From Prototypes to Instruments, <i>Sven Herrmann</i>	Cd(Zn)Te Detectors – from Material to Packaging, <i>Csaba Szeles</i>	Neutron - DAQ, <i>Steve Hartman</i>
2:30 pm – 3:00 pm	Neutron Detector Electronics, <i>Richard Riedel</i>	Microwave Kinetic Inductance Detectors, <i>Ben Mazin</i>	Work Flow, <i>Adam Lyon</i>
3:00 pm – 3:30 pm	Preparation for Common Discussion	Preparation for Common Discussion	Preparation for Common Discussion
3:45 pm – 5:30 pm	Cross-cutting Areas (Discussion, Selected Short Presentations) X-ray , Room: Goshen-A / Neutron , Room: Goshen-B Electronics , Room: Montgomery / Sensors , Room: Washingtonian Comp. & DAQ , Room: Potomac		
5:45 pm – 6:15 pm	Synthesis and Discussion		
7:00 pm	Working Dinner HEP Detector Development Experience, <i>Carl Haber</i>		

Friday August 3, 2012

9:00 am – 10:00 am	Working Group Reports / Meeting Room: Goshen
10:00 am – 11:00 am	Discussion
11:00 am	Workshop Adjourns
11:00 am – 2:00 pm	Report Preparation - Workshop Chairs, Session Chairs, and Scribes
11:00 am – 2:00 pm	X-ray, Neutron, Electronics, Sensors, Comp. & DAQ



Appendix 2:

Workshop Participants

Yasuo Arai

KEK High Energy Accelerator
Research Organization, Japan

E-MAIL: yasuo.arai@kek.jp

John Arthur

Linac Coherent Light Source

E-MAIL: jarthur@slac.stanford.edu

Klaus Attenkofer

National Synchrotron
Light Source

E-MAIL: kattenkofer@bnl.gov

Michael Banda

Advanced Light Source

E-MAIL: MJBanda@lbl.gov

Philip Bingham

Advanced Photon Source

E-MAIL: binghampr@ornl.gov

Amber Boehnlein

SLAC National
Accelerator Laboratory

E-MAIL: amber@slac
.stanford.edu

Bob Bradford

Advanced Photon Source

E-MAIL: rbradford@aps.anl.gov

Chuck Britton

Oak Ridge National Laboratory

E-MAIL: brittoncl@ornl.gov

Clifford Bueno

General Electric Global Research

E-MAIL: Bueno@ge.com

Mike Campbell

European Organization
for Nuclear Research CERN

E-MAIL: michael.campbell@cern.ch

Gabriella Carini

SLAC National
Accelerator Laboratory

E-MAIL: carini@slac.stanford.edu

Eli Dart

Lawrence Berkeley
National Laboratory

E-MAIL: EDDart@lbl.gov

Peter Denes

Lawrence Berkeley
National Laboratory

E-MAIL: pdenes@lbl.gov

Grzegorz Deptuch

Fermi National
Accelerator Laboratory

E-MAIL: deptuch@fnal.gov

Yacouba Diawara

Spallation Neutron Source

E-MAIL: diawaray@ornl.gov

Dionisio Doering

Lawrence Berkeley
National Laboratory

E-MAIL: DDoering@lbl.gov

Angelo Dragone

SLAC National Accelerator
Laboratory

E-MAIL: dragone@slac
.stanford.edu

Roger Falcone
Advanced Light Source
E-MAIL: rwfalcone@lbl.gov

Bruce Feller
Nova Scientific
E-MAIL: bfeller@novascientific.com

Andrei Fluerasu
National Synchrotron Light Source
E-MAIL: fluerasu@bnl.gov

Heinz Graafsma
*HASYLAB Deutsches
 Elektronen-Synchrotron DESY*
E-MAIL: heinz.graafsma@desy.de

Carl Grace
*Lawrence Berkeley
 National Laboratory*
E-MAIL: CRGrace@lbl.gov

Sol Gruner
Cornell University
E-MAIL: smg26@cornell.edu

Bruno Guerard
Institut Laue-Langevin
E-MAIL: guerard@ill.fr

Karl Gumerlock
*SLAC National
 Accelerator Laboratory*
E-MAIL: karl@slac.stanford.edu

Carl Haber
*Lawrence Berkeley
 National Laboratory*
E-MAIL: CHHaber@lbl.gov

Steve Hartman
Spallation Neutron Source
E-MAIL: hartmansm@ornl.gov

Jerry Hastings
Linac Coherent Light Source
E-MAIL: jbh@slac.stanford.edu

Ryan Herbst
*SLAC National
 Accelerator Laboratory*
E-MAIL: rherbst@slac.stanford.edu

Sven Herrmann
*SLAC National
 Accelerator Laboratory*
E-MAIL: herrmann@slac
 .stanford.edu

Alexander Hexemer
Advanced Light Source
E-MAIL: AHexemer@lbl.gov

Jason Hodges
Spallation Neutron Source
E-MAIL: hodgesj@ornl.gov

Marianne Hromalik
*State University of
 New York Oswego*
E-MAIL: msh@cs.oswego.edu

Chris Jacobsen
Advanced Photon Source
E-MAIL: cjacobsen@anl.gov

Erik Johnson
*National Synchrotron
 Light Source*
E-MAIL: johnson@bnl.gov

Chi-Chang Kao
*Stanford Synchrotron
 Radiation Lightsource*
E-MAIL: ckao@slac.stanford.edu

Chris Kenney
*SLAC National
 Accelerator Laboratory*
E-MAIL: kenney@slac.stanford.edu

Richard Kouzes
*Pacific Northwest
 National Laboratory*
E-MAIL: RKouzes@pnnl.gov

Adam Lyon
*Fermi National
 Accelerator Laboratory*
E-MAIL: lyon@fnal.gov

Nick Maliszewskyj
*National Institute of
 Standards and Technology*
E-MAIL: nickm@nist.gov

Ben Mazin
University of California Santa Barbara
E-MAIL: bmazin@physics.ucsb.edu

Antonino Miceli
Advanced Photon Source
E-MAIL: amiceli@aps.anl.gov

Denny Mills
Advanced Photon Source
E-MAIL: dmm@aps.anl.gov

Paul O'Connor
Brookhaven National Laboratory
E-MAIL: poc@bnl.gov

Colin Ophus
*National Center for Electron
 Microscopy*
E-MAIL: clophus@lbl.gov

Sherwood Parker
*SLAC National Accelerator
 Laboratory*
E-MAIL: sher@slac.stanford.edu

Amedeo Perazzo
SLAC National Accelerator
E-MAIL: perazzo@slac.stanford.edu

Veljko Radeka
Brookhaven National Laboratory
E-MAIL: radeka@bnl.gov

Richard Riedel
Spallation Neutron Source
E-MAIL: riedelra@ornl.gov

Bernd Schmitt
Swiss Light Source
E-MAIL: bernd.schmitt@psi.ch

Arie Shoshani
*Lawrence Berkeley
 National Laboratory*
E-MAIL: AShoshani@lbl.gov

Pete Siddons
*National Synchrotron
 Light Source*
E-MAIL: siddons@bnl.gov

John Smedley
*Brookhaven National
 Laboratory*
E-MAIL: smedley@bnl.gov

Michael Soltis
*Stanford Synchrotron
 Radiation Lightsource*
E-MAIL: soltis@slac.stanford.edu

Kazuhiko Soyama
*Japan Atomic Energy
 Agency - J-PARC*
E-MAIL: soyama.kazuhiko@jaea.go.jp

Helmuth Spieler
*Lawrence Berkeley
 National Laboratory*
E-MAIL: HGSpieler@lbl.gov

Csaba Szeles
*Endicott Interconnect
 Technologies*
E-MAIL: Csaba.Szeles@eitny.com

Mark Tate
Cornell University
E-MAIL: mwt5@cornell.edu

Craig Tindall
*Lawrence Berkeley
 National Laboratory*
E-MAIL: CSTindall@lbl.gov

Joel Ullom
*National Institute of Standards
 and Technology*
E-MAIL: ullom@boulder.nist.gov

Cai-Lin Wang
Spallation Neutron Source
E-MAIL: wangc@ornl.gov

Jin Wang
Advanced Photon Source
E-MAIL: wangj@aps.anl.gov

Matt Weaver
*SLAC National
 Accelerator Laboratory*
E-MAIL: weaver@slac.stanford.edu

Garth Williams
Linac Coherent Light Source
E-MAIL: gjwillms@slac.stanford.edu

Paul Zschack
National Synchrotron Light Source
E-MAIL: pzschack@bnl.gov

Yasuo Arai
*KEK High Energy Accelerator
 Research Organization, Japan*
E-MAIL: yasuo.arai@kek.jp

John Arthur
Linac Coherent Light Source
E-MAIL: jarthur@slac.stanford.edu

Klaus Attenkofer
National Synchrotron Light Source
E-MAIL: kattenkofer@bnl.gov

DOE Representatives

Fred Borcharding
Office of High Energy Physics DOE
E-MAIL: frederick.borcharding@science.doe.gov

Mihal Gross
Office of Basic Energy Sciences DOE
E-MAIL: Mihal.Gross@science.doe.gov

Helen Kerch
Office of Basic Energy Sciences DOE
E-MAIL: Helen.Kerch@science.doe.gov

Jeff Krause
Office of Basic Energy Sciences DOE
E-MAIL: Jeff.Krause@science.doe.gov

Philip Kraushaar
Office of Basic Energy Sciences DOE
E-MAIL: Philip.Kraushaar@science.doe.gov

Harriet Kung
Office of Basic Energy Sciences DOE
E-MAIL: Harriet.Kung@science.doe.gov

Peter Lee
Office of Basic Energy Sciences DOE
E-MAIL: Peter.Lee@science.doe.gov

Eliane Lessner
Office of Basic Energy Sciences DOE
E-MAIL: Eliane.Lessner@science.doe.gov

Other Representatives

Guebre Tessema
National Science Foundation
E-MAIL: gtessema@nsf.gov

Appendix 3:

Additional Discussion Topics

Detector Needs of Spectroscopy

Klaus Attenkofer – NSLS

Detector Initiatives Supporting the APS Upgrade

Bob Bradford – APS

Single X-ray Photon Counting Pixel Systems

Mike Campbell – CERN

Dynamics of Materials with X-ray Photon Correlation Spectroscopy

Andrei Fluerasu – NSLS

Data Acquisition, Handling and Analysis at APS

Chris Jacobsen – APS

Superconducting Detectors for X-ray Science

Antonino Miceli – APS

Power Dissipation Tradeoffs in Analog Front-end Electronics

Paul O'Connor – BNL

Observations from an LCLS Scientist

Garth Williams – LCLS

Appendix 4:

Notation and Abbreviations

ADC	analog to digital converter
ADSC	Area Detector Systems Corporation
AGIPD	Adaptive Gain Integrative Pixel Detector
ALS	Advanced Light Source
AMS	analog and mixed signal
APS	Advanced Photon Source
ARRA	American Recovery and Reinvestment Act
ASCR	Advanced Scientific Computing Research
ASG	Advanced Study Group
ASIC	application-specific integrated circuit
ATLAS	A Toroidal LHC Apparatus
BES	Basic Energy Sciences
BNL	Brookhaven National Laboratory
CAD	computer-aided design
CAMP	CFEL-ASG Multi-Purpose end station
CCD	charge-coupled device
CdTe	cadmium telluride
CERN	European Organization for Nuclear Research
CFEL	Centre for Free Electron Laser Science
CHESS	Cornell High Energy Synchrotron Source
cm	centimeter
CMOS	complementary metal-oxide semiconductor
CMS	Compact Muon Solenoid
CPPM	Centre de Physique des Particules de Marseille
CSIRO	Commonwealth Scientific and Industrial Research Organization
CSPAD	Cornell-SLAC Pixel Array Detector
CXI	Coherent X-ray Imaging
CZT	cadmium zinc telluride
DAQ	data acquisition
DARPA	Defense Advanced Research Projects Agency
DAS	Data Acquisition System
DCS	Dynamic Compression Sector
DEPFET	Depleted P-channel Field Effect Transistor

DSSC	DEPMOS Sensor with Signal Compression
DESY	Deutsches Elektronen-Synchrotron
DOE	Department of Energy
ESRF	European Synchrotron Radiation Facility
e-h	electron hole pair
ESnet	Energy Sciences Network
ESS	European Spallation Source
eV	electronvolt
XFEL	European X-ray Free Electron Laser
fab	fabrication facility
FEL	free electron laser
Fermilab	Fermi National Accelerator Laboratory
FLASH	Free Electron Laser in Hamburg
FPGA	field-programmable gate array
FTE	full-time equivalent
GaAs	gallium arsenide
Ge	germanium
GGG:Eu	gadolinium gallium garnet doped with europium
GMR	giant magnetoresistance
GOTTHARD	Gain Optimizing microsTrip system with Analog Readout
HEP	high-energy physics
HERMES	powder diffraction diffractometer
HFIR	High Flux Isotope Reactor
HLL	Halbleiterlabor
Hz	Hertz
IC	Integrated Circuit
ILL	Institut Laue-Langevin
IMR	Institute for Materials Research
INFN	Istituto Nazionale di Fisica Nucleare
IXS	inelastic X-ray scattering
JAEA	Japan Atomic Energy Agency
J-PARC	Japan Proton Accelerator Research Complex
K	Kelvin
KEK	High-Energy Accelerator Research Organization (Japan)
keV	kilo electron volt
kHz	kilohertz
LAMBDA	Large-Area Medipix-3-Based Detector Array
LANSCE	Los Alamos Neutron Science Center
LBNL	Lawrence Berkeley National Laboratory
LCLS	Linac Coherent Light Source
LDRD	Laboratory Directed Research and Development
LHC	Large Hadron Collider

LPD	Large Pixel Detector
LPSD	linear position-sensitive detector
LYSO:Ce	lutetium-yttrium oxyorthosilicate, Ce+3 doped
MaNDI	Macromolecular Neutron Diffractometer
MBE	Molecular Beam Epitaxy
MeV	mega electron volt
MHz	megahertz
MILAND	Millimetre Resolution Large Area Neutron Detector
mK	millikelvin
MKID	microwave kinetic induction detector
mm	millimeter
MMPAD	mixed-mode pixel array detector
MOS	metal oxide semiconductor
MOSIS	Metal Oxide Semiconductor Implementation Service
MPI	Max Planck Institute
MPW	multi-project wafer
ms	millisecond
MSL	MicroSystems Laboratory
mux	multiplexer
MWPC	multiwire proportional chamber
NASA	National Aeronautics and Space Administration
NERSC	National Energy Research Scientific Computing Center
NIST	National Institute of Standards and Technology
NNSA	National Nuclear Security Administration
NScD	Neutron Sciences Directorate
NSE	neutron spin-echo
NSF	National Science Foundation
NSLS	National Synchrotron Light Source
ORNL	Oak Ridge National Laboratory
OSG	Open Science Grid
PAD	pixel array detector
PCS	protein crystallography station
PEM	polymer electrolyte membrane
PETRA	Positron-Electron Tandem Ring Accelerator
PILATUS	Pixel apparatus for the Swiss Light Source
PMT	photomultiplier tube
PNR	polarized neutron reflection
POWGEN	powder diffractometer at the Spallation Neutron Source
PSI	Paul Scherrer Institute
QE	quantum efficiency
RAL	Rutherford Appleton Laboratory
R&D	research and development

rms	root-mean-square
RTL	register-transfer level
SACLA	Sub-Angstrom Compact free electron Laser
SBCA	spherically bent crystal analyzer
SBIR/STTA	Small Business Innovation Research / Small Business Technology Transfer
SDD	Silicon drift detector
SDDPL	Semiconductor Detector Development and Processing Lab
Se	selenium
Si	silicon
SLS	Swiss Light Source
SNAP	Spallation Neutrons and Pressure Diffractometer
SNS	Spallation Neutron Source
SOFC	solid oxide fuel cell
SOI	silicon on insulator
SPRING-8	Super Photon ring-8 GeV
SQUID	superconducting quantum interference device
SR	synchrotron radiation
SSRL	Stanford Synchrotron Radiation Lightsource
STFC	Science and Technology Facilities Council
STJ	superconducting tunnel junction
STXM	scanning transmission X-ray microscope
SXR	soft X-ray
TES	transition edge sensor
TOF	time of flight
TOPAZ	Single-crystal Diffractometer
TPC	time projection chamber
UHV	ultrahigh vacuum
VDT	virtual data toolkit
VEGA	versatile neutron powder diffractometer
VENUS	Versatile Neutron Imaging Instrument at SNS
VUV	vacuum ultraviolet
WLS	wavelength shifting
XES	X-ray emission spectroscopy
XFEL	X-ray free electron laser
XPCS	X-ray photon correlation spectroscopy
XPP	X-ray Pump-Probe
xtal	crystal
YAG:Ce	yttrium aluminum garnet doped with cerium
Z	atomic number
ZWE FRM-II	Zentrale Wissenschaftliche Einrichtung Forschungs-Neutronenquelle Heinz Maier-Leibnitz II

