



**Pacific Northwest**  
NATIONAL LABORATORY

*Proudly Operated by **Battelle** Since 1965*

© 2015 Battelle Memorial Institute. All rights reserved.

# **System Architecture as a Tool for Managing Complex Systems: Application to Electric Grids**

Jeffrey D. Taft, PhD

Chief Architect for Electric Grid Transformation

Pacific Northwest National Laboratory

Revised 26 Mar 2015

PNNL-SA-109838

# System Architecture Definition/Purpose

- ▶ A *system architecture* is a model of a (complex) system whose purpose is to help think about the overall shape of the system, its attributes, and how the parts interact
- ▶ Some Uses of System Architecture
  - Help manage complexity (and therefore risk)
  - Assist communication among stakeholders
  - Remove barriers and define essential limits
  - Identify gaps in theory, technology, organization, regulation...
  - Identify/define interfaces and platforms
  - Enable prediction of system qualities

The discipline arises from work at various organizations



Software Engineering Institute  
Carnegie Mellon



  
Pacific Northwest  
NATIONAL LABORATORY

# Elements of System Architecture (1)

## ► Abstract components

- The individual parts, viewed as “black boxes”
- Example: storage battery
  - At this level we do not specify how the battery works
  - Care about externally visible characteristics like storage capacity, max power rating
- But thoroughly grounded in reality
  - no “magic” boxes or anti-gravity

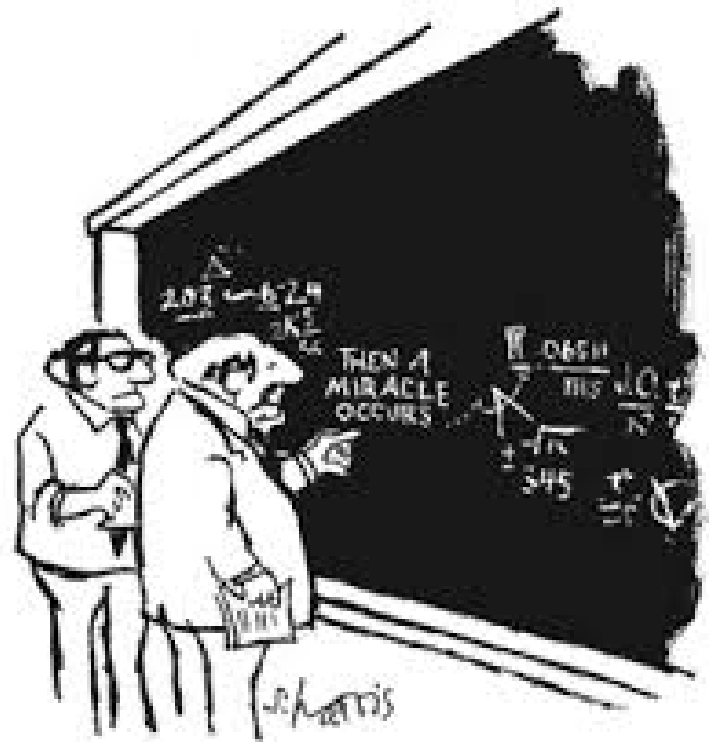

"I THINK YOU SHOULD BE MORE EXPLICIT HERE IN STEP TWO."

# Elements of System Architecture (2)

## ▶ Abstract components

- The individual parts, viewed as “black boxes”
- But thoroughly grounded in reality (no “magic” boxes)

## ▶ Structures

- The overall shape of the system and how components interact
- Any complex system has multiple structures, requiring **multiple views**
- No real architecture can be represented in a single diagram

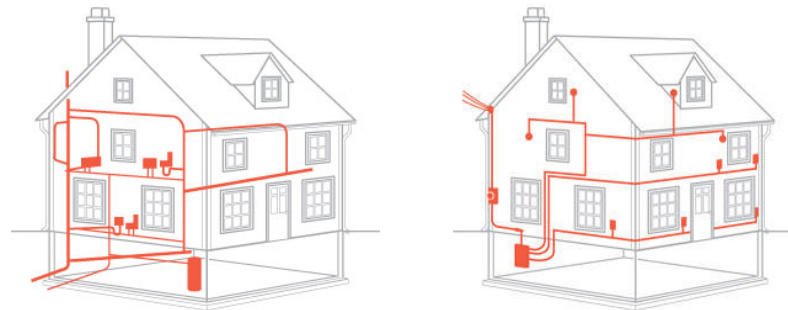

# Elements of System Architecture (3)

## ▶ Abstract components

- The individual parts, viewed as “black boxes”
- But thoroughly grounded in reality (no “magic” boxes)

## ▶ Structures

- The overall shape of the system and how components interact
- Any complex system has multiple structures, requiring multiple views
- No real architecture can be represented in a single diagram

## ▶ Externally visible properties

- Of components
- Of structures
- Of the whole system

# What Goes Into A System Architecture?

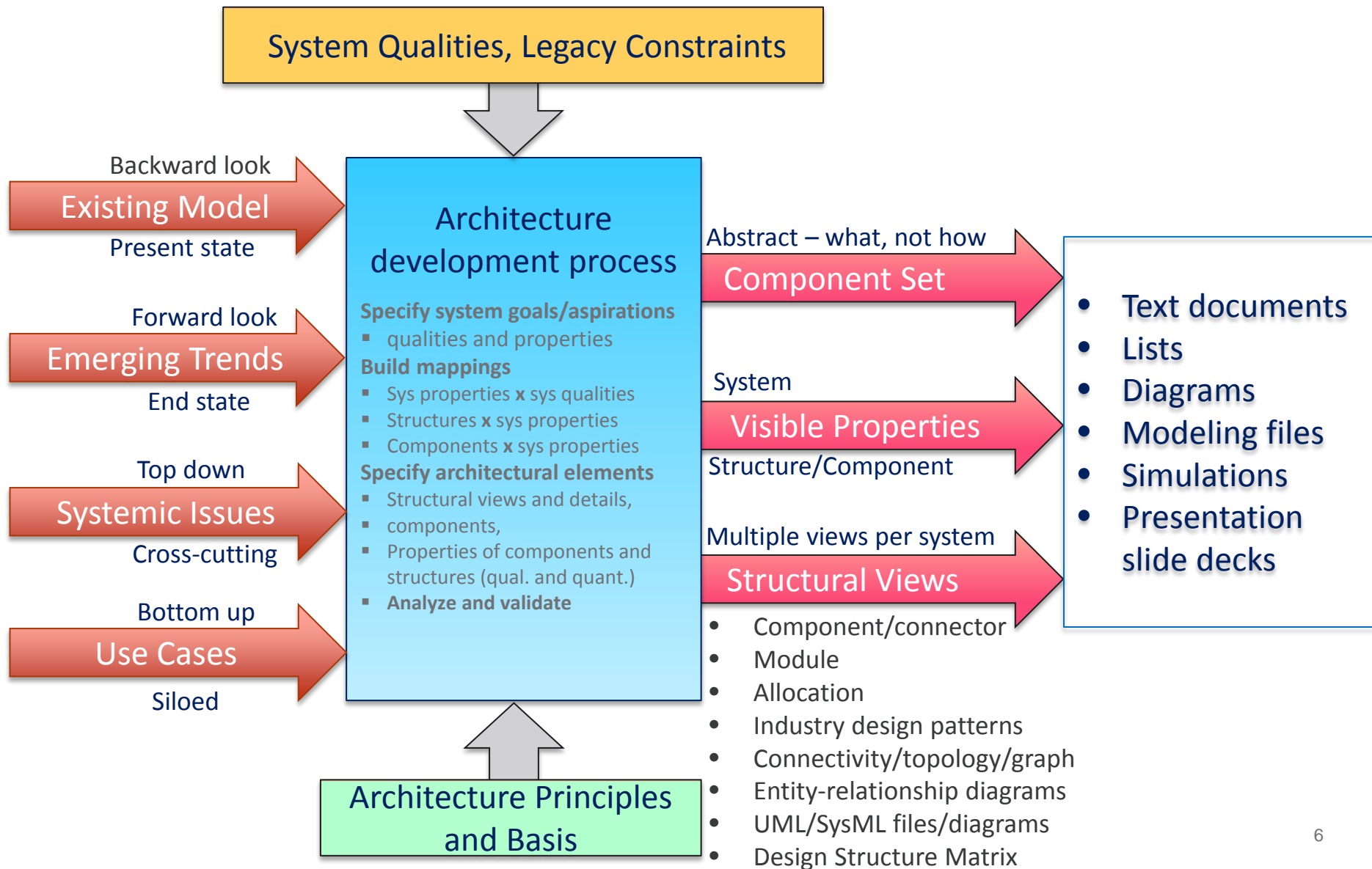

## ▶ System Qualities

- Desired characteristics of the final or end state system (not just the architecture)
- Think of as high level requirements expressed qualitatively or quantitatively

## ▶ Architectural Properties (externally visible)

- System properties
  - characteristics of the architecture as a whole that enable key capabilities
  - system properties are what enable the system qualities to be manifest
  - system properties emerge from structure, components, and their properties
- Structural properties – characteristics inherent in the architecture's structures
- Component properties – characteristics of individual components

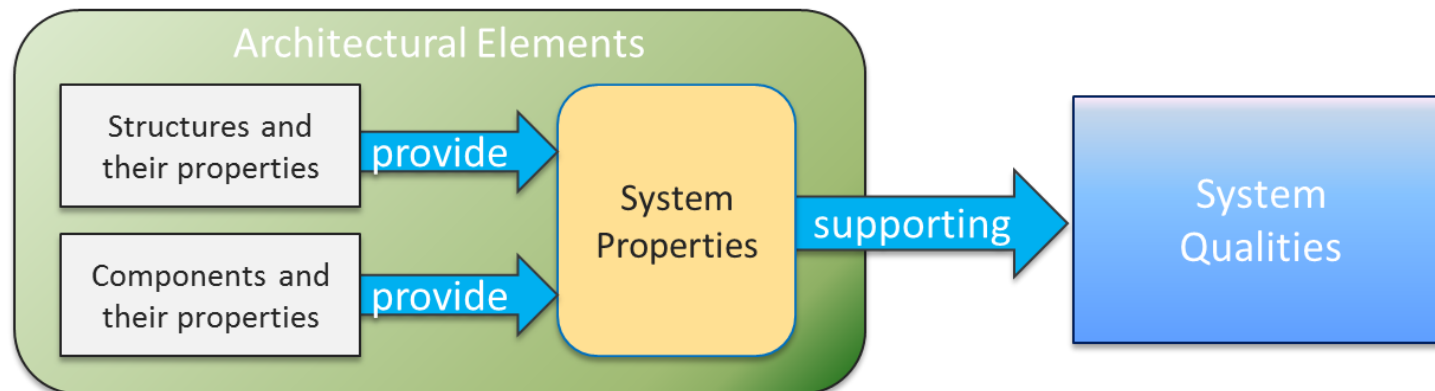

# System Architecture Synthesis

- ▶ System Qualities come from the consumer viewpoint
- ▶ System Properties come from the provider viewpoint

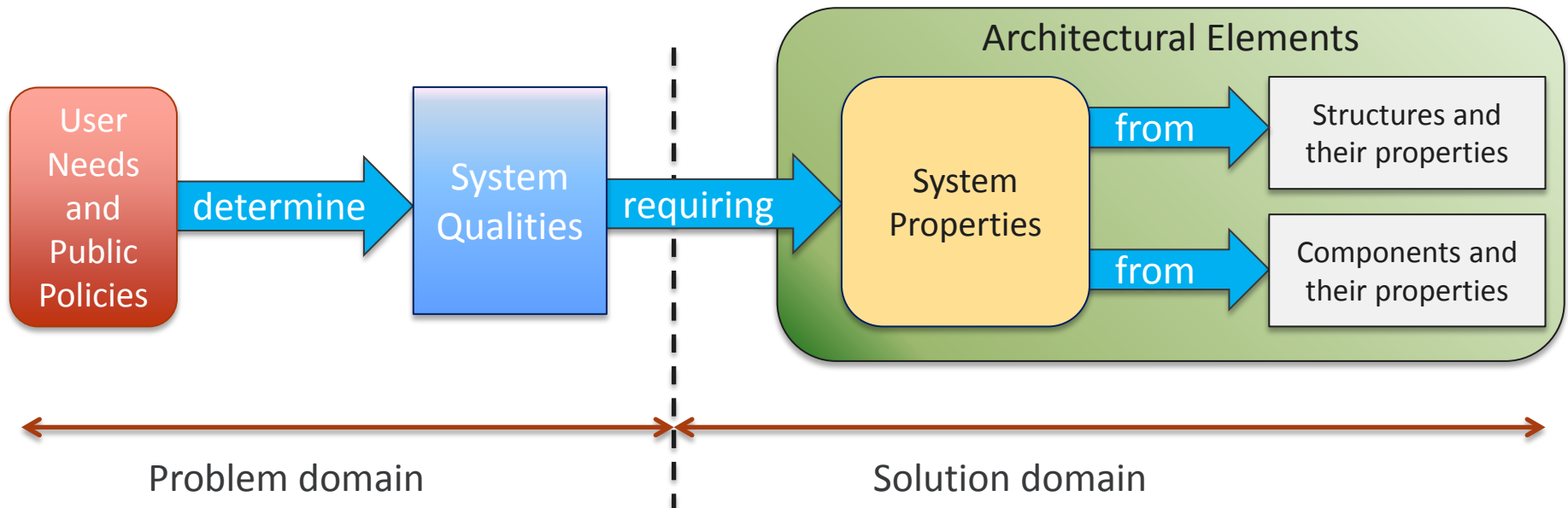



# What is Grid Architecture?

- ▶ Grid architecture is system architecture for power delivery chains
- ▶ Focus primarily on structure
- ▶ It is not enterprise IT architecture, nor is it “smart grid architecture”

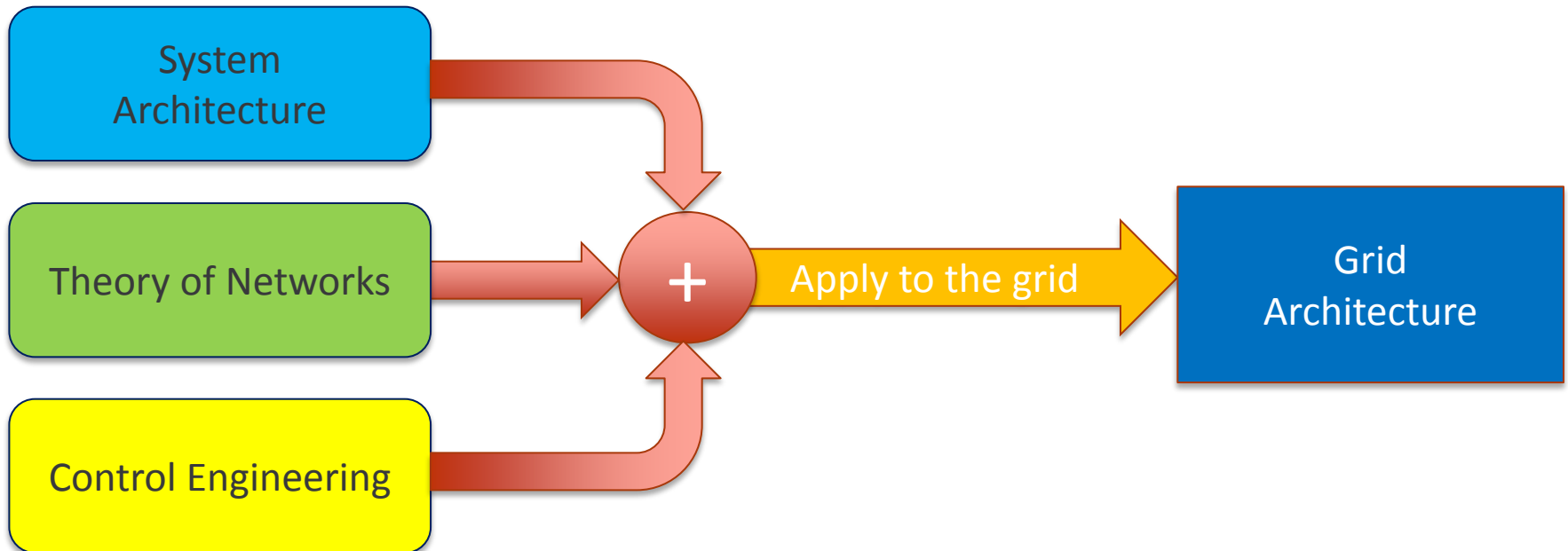



# Grid Architecture Methods and Paradigms

- ▶ Network of (interacting) Structures
- ▶ Ultra-Large Scale Systems paradigm
- ▶ Coordination Framework
- ▶ Network Convergence and Platform Identification
- ▶ Advanced characteristics:
  - Control federation and disaggregation
    - Objective and constraint fusion
  - Local selfish optimization inside global coordination
  - Multi-scale views and layered decomposition
- ▶ Some of the key methods we use include:
  - Mappings: qualities/properties/elements; actors/roles
  - Architecture quantification: graph theory, matrix methods, optimization
  - Architecture Validation
    - Multi-Structure Simulations
    - DSM
    - Optimization

# Mapping of Elements, Properties, and Qualities Enables Architectural Optimization

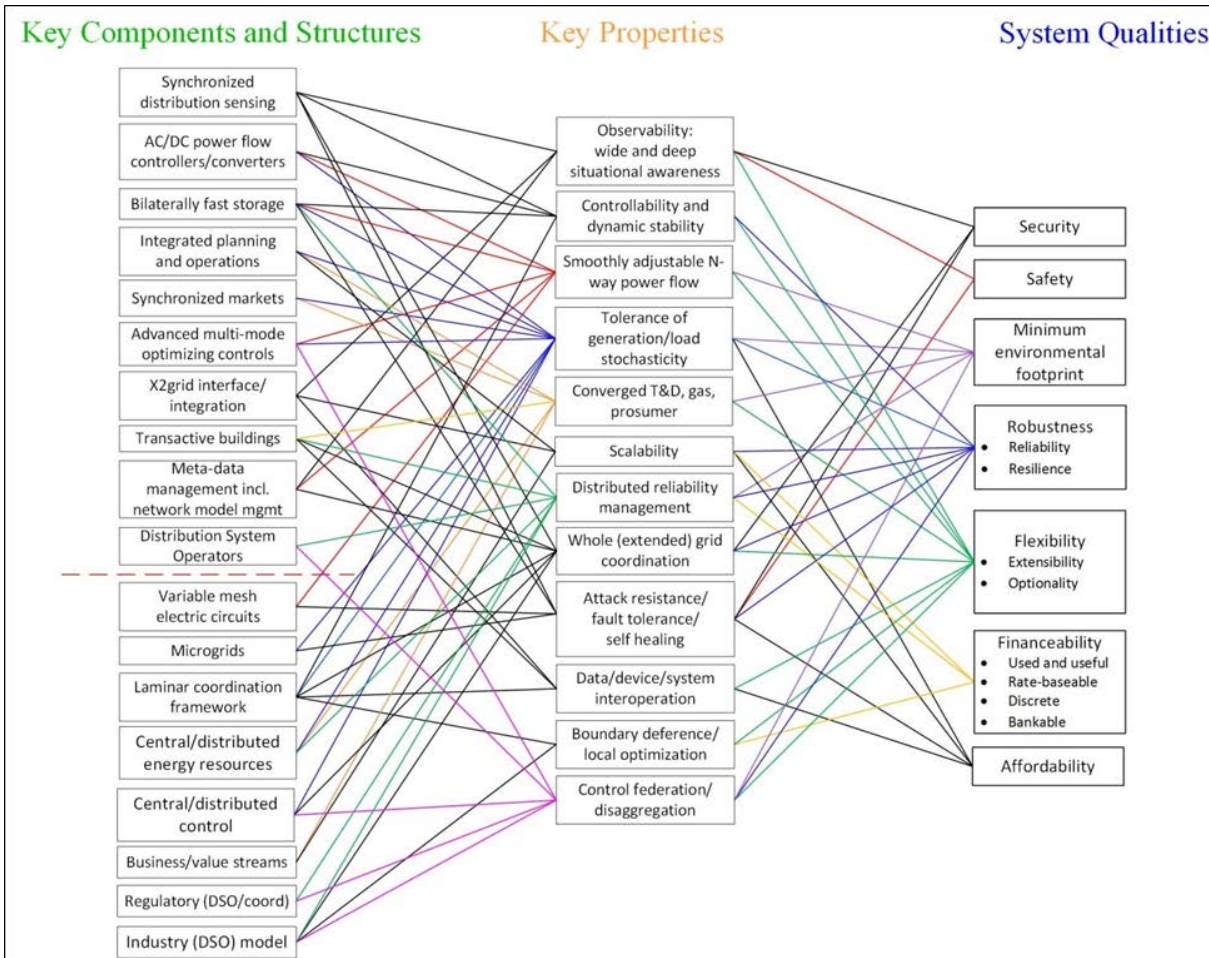

Architectural Insight

The ability to quantitatively analyze and optimize architectures is crucial due to the complexity of modern grids. The development and validation of the mappings is a critical early phase step in the architecture development process.



# Some System Architecture Principles

- A good architecture is one that meets the needs of the stakeholders (especially the users) to their satisfaction, does not violate established principles of system architecture, and takes into account the relevant “ilities” by allowing for maintenance, evolution, further development, embedding, etc. as the customer requires.
- Essential functionality drives complexity, not architectural “elegance.”
- The architect must be cognizant of the global system when optimizing subsystems.
- Stakeholders should be involved in the process as much as possible, giving frequent and honest feedback on all aspects of the system architecture.
- Architecture must be consumable (i.e. understandable) by the users.

# The Grid is a Complex Network of Structures

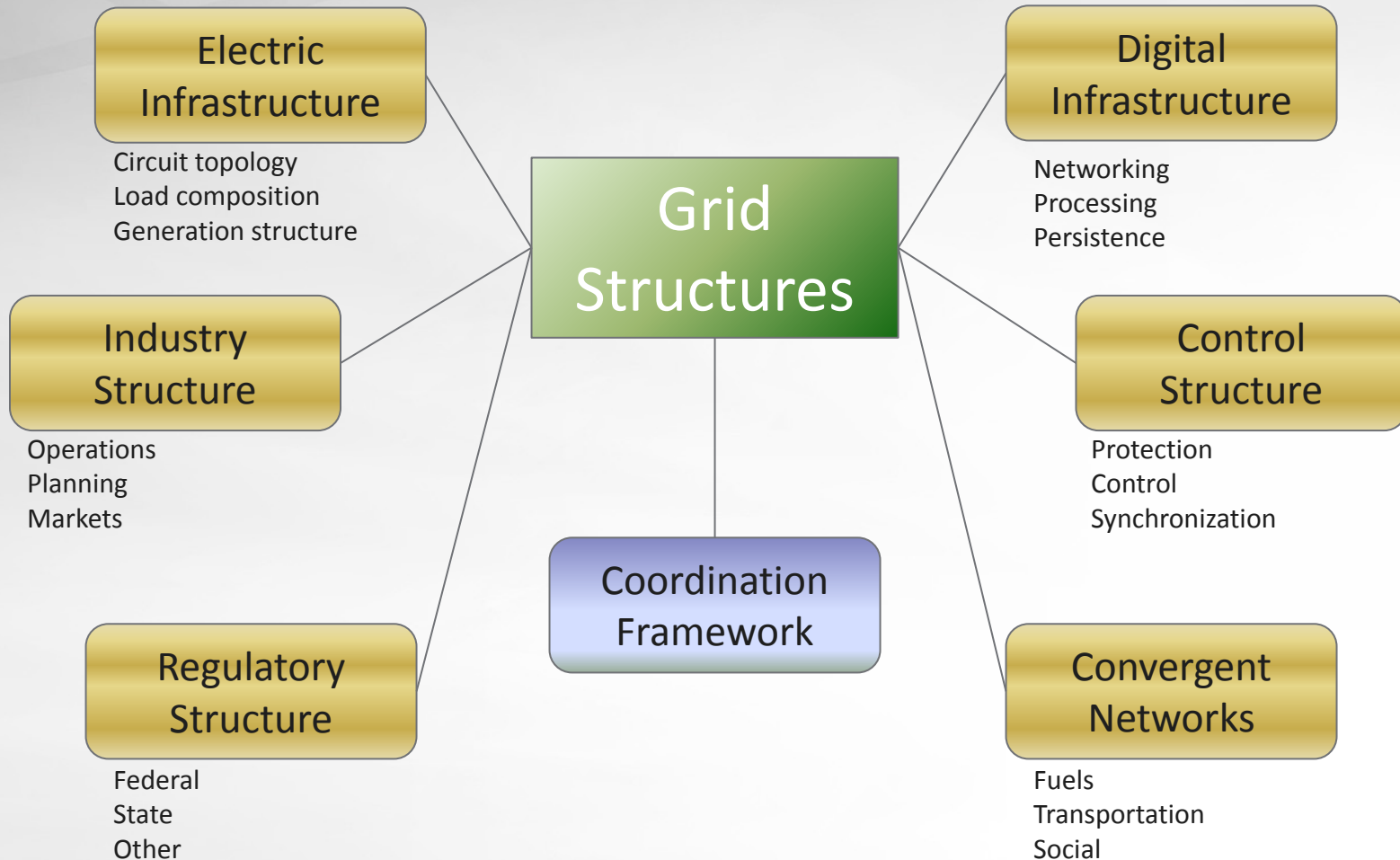

# Grid Architecture Provides Means to Understand Grid Complexity

## Architectural Insight

Grid architecture provides the discipline to manage the complexity and the risk associated with changing the grid in a manner that significantly reduces the likelihood of unintended consequences.

### Key Question

#### Where Does the Discipline of System Architecture Come From?

System architecture has arisen from the development of complex systems in several fields, and key work on the methods has been done at institutions such as California Institute of Technology, Carnegie Mellon University Software Engineering Institute, MIT, Princeton, and elsewhere. Some of its methods trace back as far as the 1960's but much of the work is more recent, having emerged in response to the exponentially increasing complexity of intelligent systems.

Grid architecture is a specialization of system architecture that includes additional elements from control engineering, communications/networking, data management, organizational structure, energy/power markets, and utility regulatory structure.



**Pacific Northwest**  
NATIONAL LABORATORY

*Proudly Operated by **Battelle** Since 1965*

# some insights on present architecture





- ▶ Built in the form of Entity-Relationship diagrams
- ▶ Each box represents a class of entities, not a single organization (unless the class has only one member)
- ▶ Relationships are collections of behaviors between two connected entity classes
- ▶ Behaviors may be bilateral (“transactions”) or unilateral (“transfers”) and a relationship may involve several such behaviors
  
- ▶ The next slide shows an industry model in interactive form
  - Click on green buttons to turn on various layers
  - Click on red buttons to turn off layers
- ▶ Similar models exist with appropriate variations for vertically integrated utilities and for Public Power, co-operatives and municipal utilities

# Industry Structure Model, ISO Version

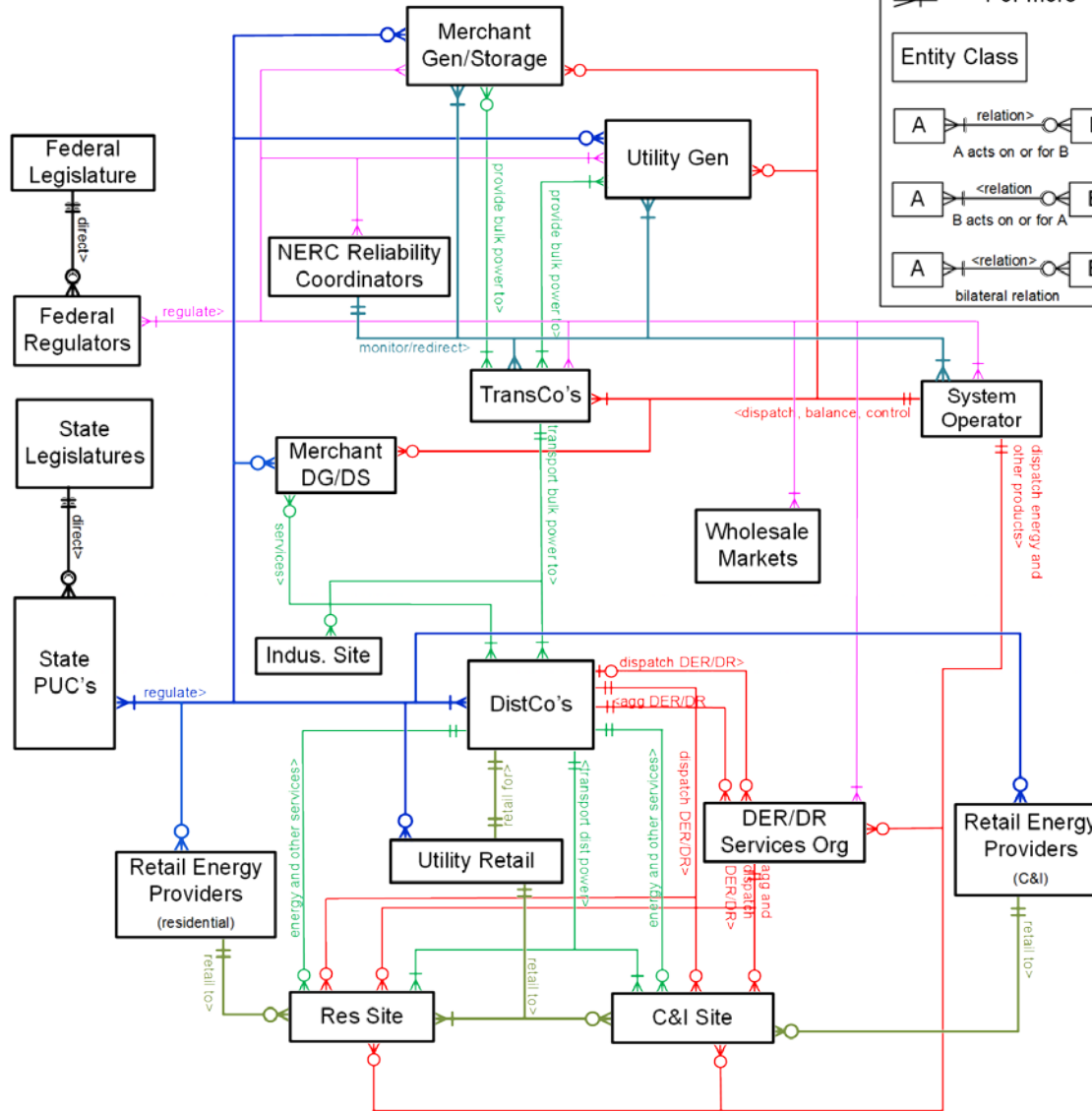
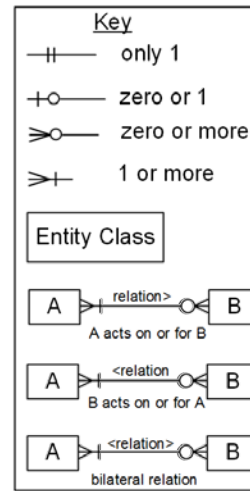

Notes: 1) Markets incl. bilateral and structured markets.  
 2) Other relationships exist for utility planning.

# Industry Structure Model, ISO Version (non-interactive)

Disaggregated U.S. Utility Industry Operational Structure (Post 2000)

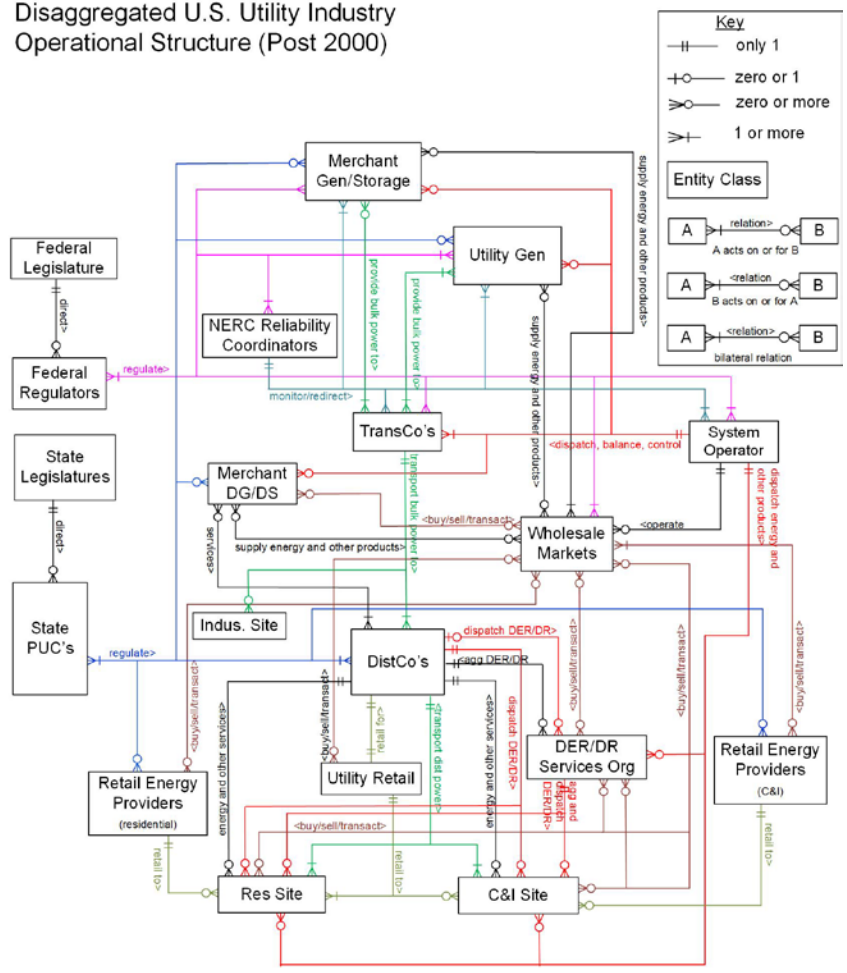

Notes: 1) Markets incl. bilateral and structured markets.  
2) Other relationships exist for utility planning.

- ▶ Industry Structure is closely related to control and coordination structure
- ▶ Industry re-structuring therefore can impact not just multiple entities but also how control must function
- ▶ This in turn can affect digital structure, including communications networking
- ▶ Proper re-structuring can remove inherent barriers to innovation and simplify control structure

# A Model of Potential Distribution System Operator Structure

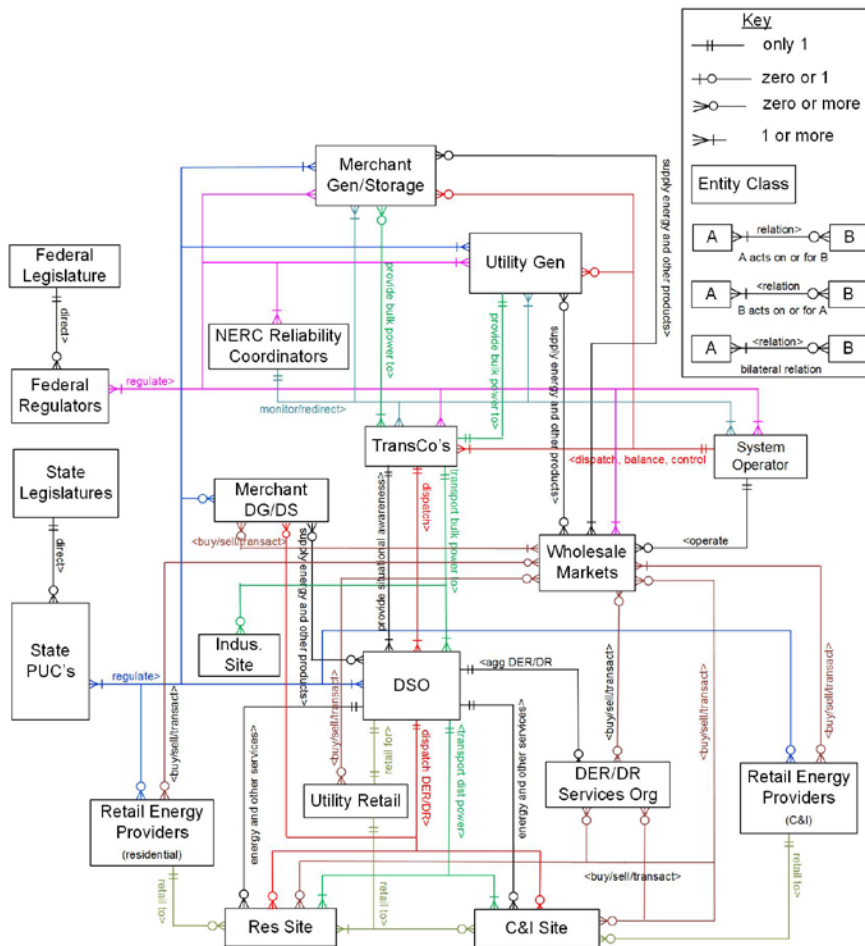

Notes: 1) Markets incl. bilateral and structured markets.  
2) Other relationships exist for utility planning.

- ▶ Some States are considering ways to restructure Distribution
- ▶ Those models are not yet settled but all have implications for coordination structure
- ▶ By considering a potential model for DSO-based industry structure, we can get at the implications for system coordination

# Coordination is Being Recognized as Key Issue in Grid Modernization

- ▶ Coordination is how disparate elements of a system are focused to solve a common problem, in this case grid operation
- ▶ Coordination may exist inside control systems or as interaction rules between organizations, for example
- ▶ The importance of coordination is amplified by the emergence of non-utility asset interactions with the grid.

## Architectural Insight

Note in particular the red lines in the industry structure diagrams. The relationships involved are various aspects of system control, and have direct relationships to reliability roles and responsibilities. Instances exist in the ISO and PUD/Muni/Cooperative cases in particular where bypassing of distribution utilities instead of working through them in a coordinated fashion, occurs.

# Present Coordination Structure

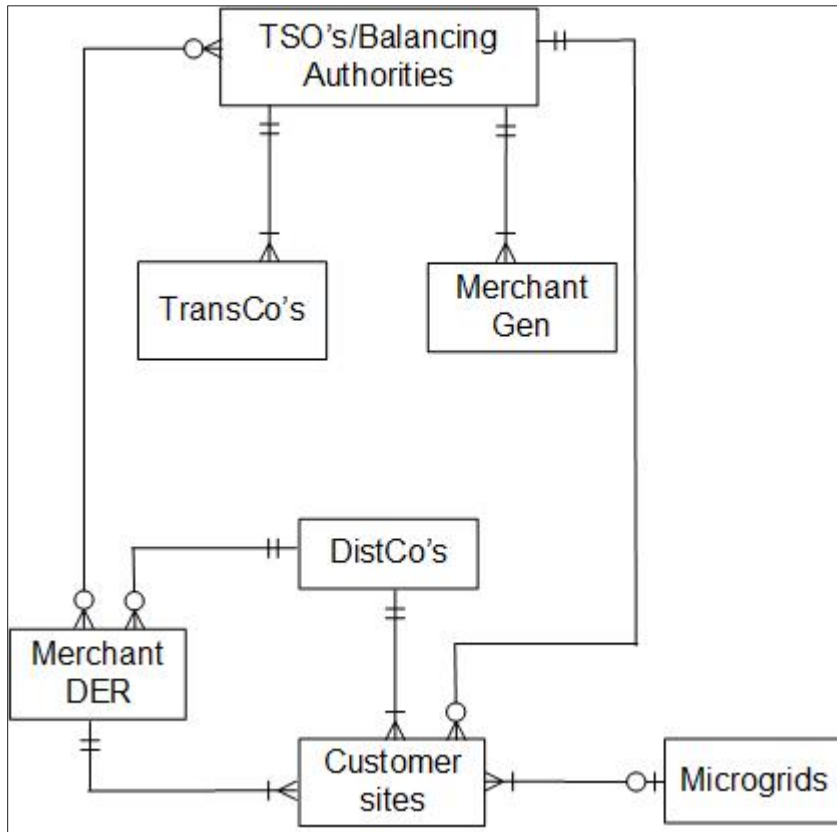

- ▶ Structurally problematic
  - no formal basis
- ▶ Tier bypassing leads to destabilization
- ▶ Ad hoc form limits understanding of properties
  - emergent (read unintended) behavior
- ▶ Scalability problems
- ▶ Unnecessary connectivity raises extra cyber-security issues

# Potential DSO-Based Coordination Structure



Pacific Northwest  
NATIONAL LABORATORY

Proudly Operated by **Battelle** Since 1965

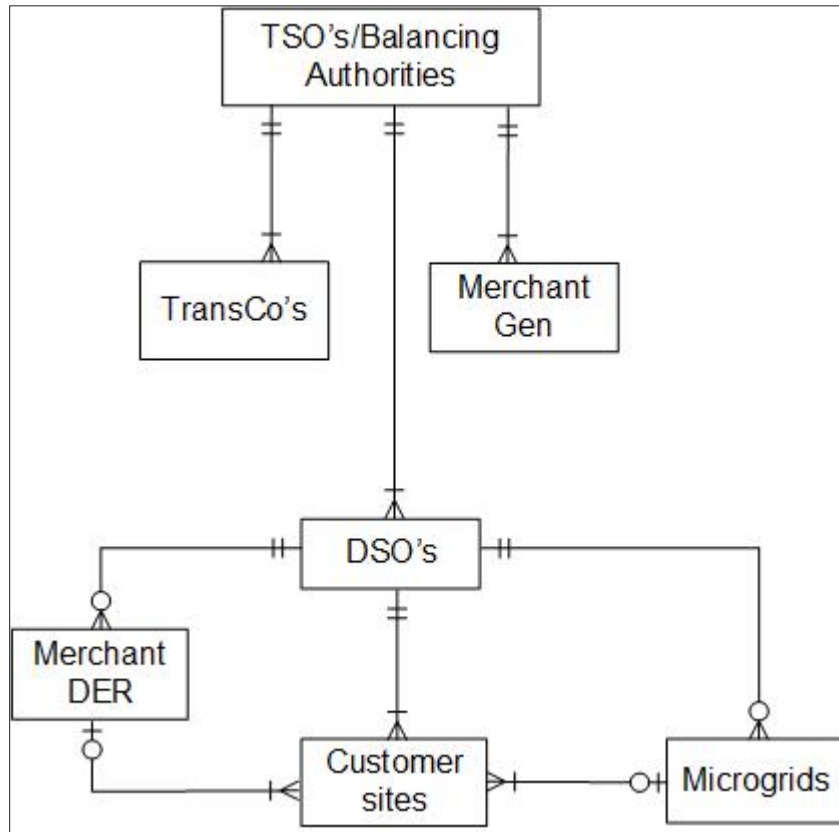

- ▶ Structurally sound
  - formal basis available
- ▶ No tier bypassing
- ▶ Normalized form allows for property design and analysis
  - Boundary deference
  - Coordination/constraint fusion
- ▶ Scalable implementations available
- ▶ Connectivity and data flow patterns easier to secure

# Coupling Complicates Grid Operation

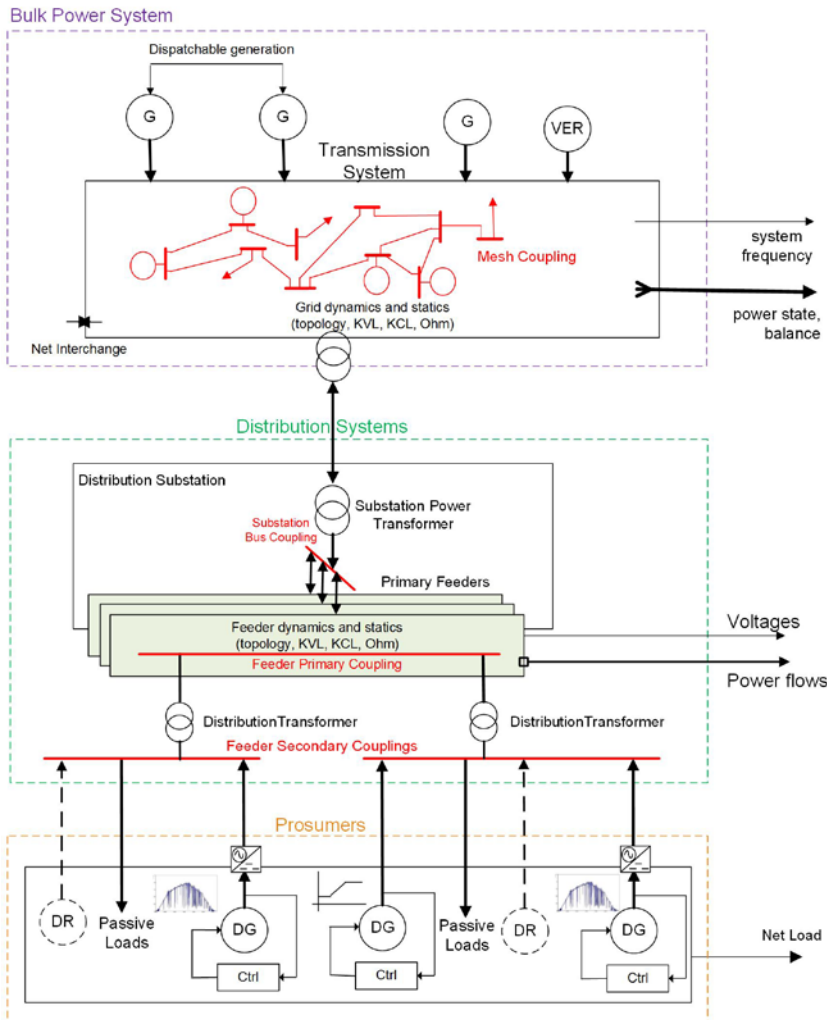

## Architectural Insight

While basic coupling occurs electrically at multiple levels in the grid, coupling can and does occur in other ways, some of which can be quite subtle. Coupling can occur through controls, markets, communications networks, fuel systems, loads, and social interactions of customers/prosumers.

Unsuspected coupling is a hazard of increasing grid complexity.

Even basic electric coupling can have subtle consequences. DG with reverse power flow on a radial feeder can cause false circuit breaker trips on that feeder due to a fault on a *different* feeder connected to the same substation bus. DG can also interfere with breaker/fuse coordination. On dense urban meshes, DG can cause unintentional islanding due to tripping of network protectors (islanding is not just for microgrids—DG can cause or support islanding in a variety of ways). The list of interactions is growing as the penetration of new devices and functionality increases.



# Whole System Control Model

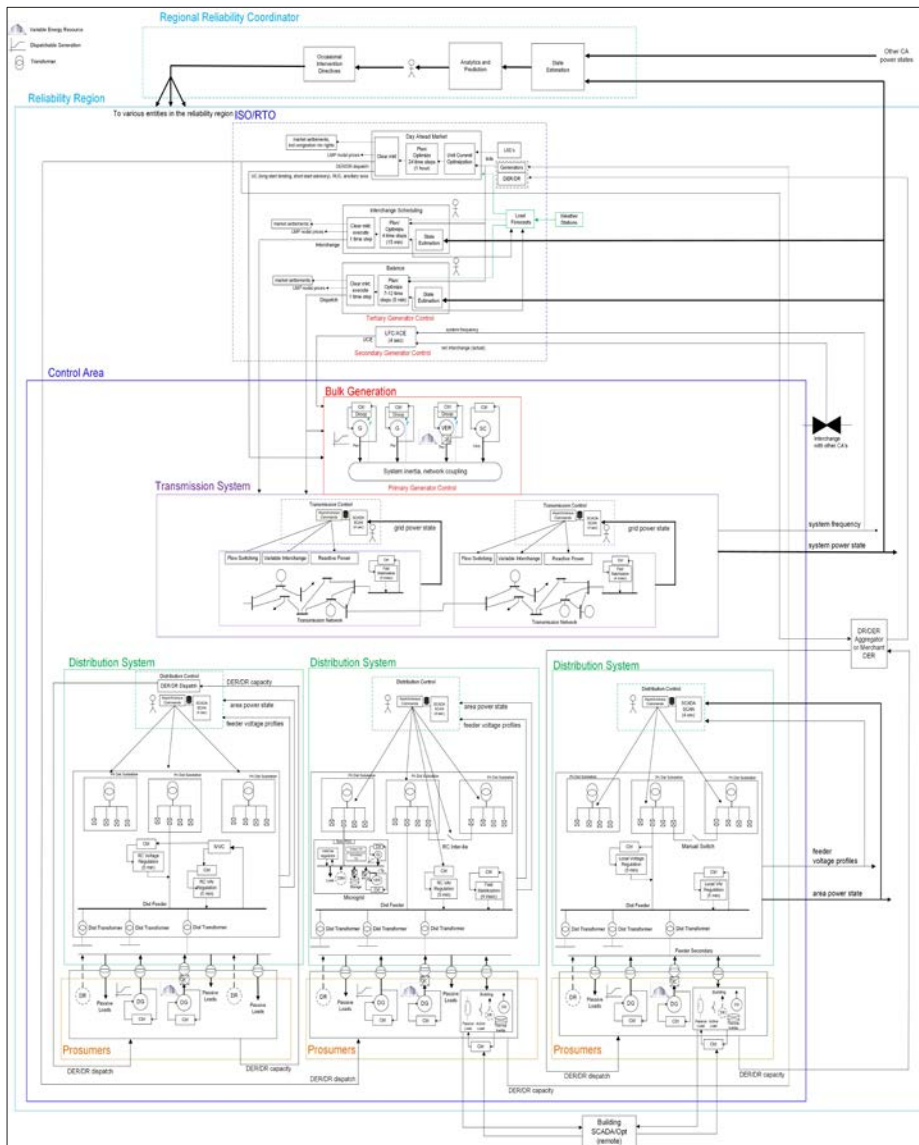

- ▶ Increasing grid interactions make it necessary to consider grid control as a whole, rather than in siloes
- ▶ Grid control involves multiple layers and many entities
- ▶ Due to changes coming at the Distribution level, understanding the interaction of control and markets is of increasing importance
- ▶ Multiple models exist for control just as variations exist in industry structure

# Wholesale Markets Are Part of Bulk System Control Loops

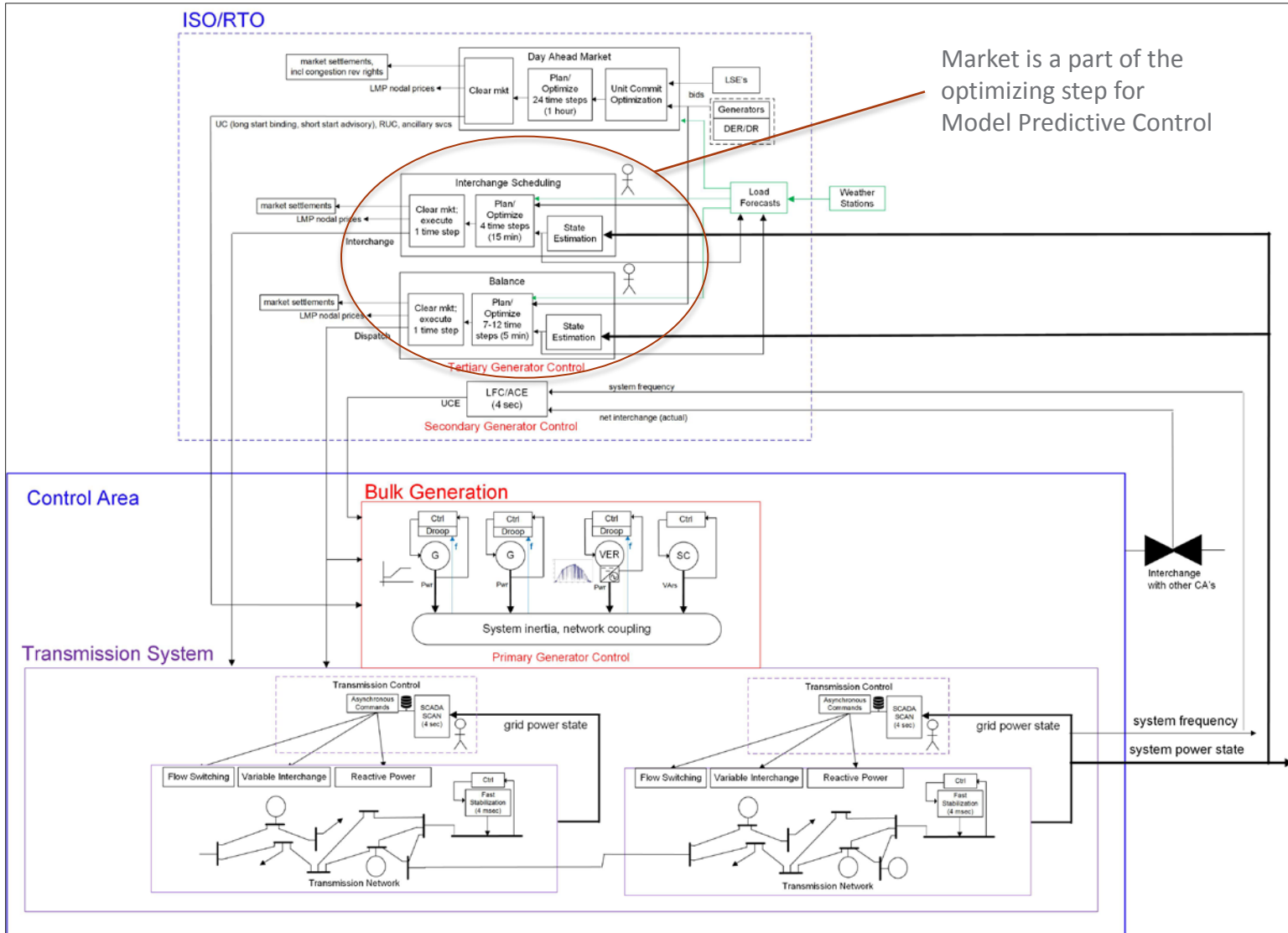

Market is a part of the optimizing step for Model Predictive Control

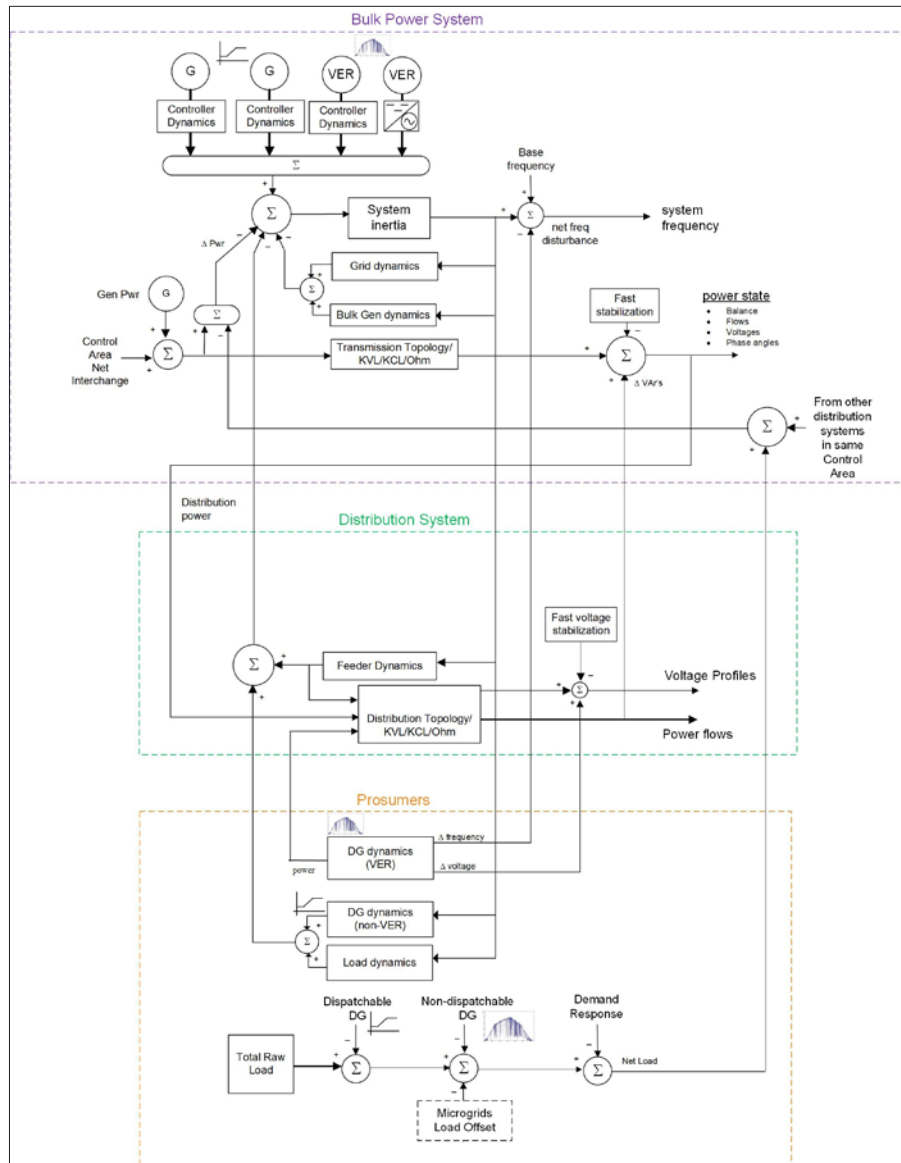

- ▶ Interactions between Distribution and Bulk system are increasing in importance
- ▶ Modeling of whole grids to understand these new interactions is needed to develop appropriate control and grid management tools

## Architectural Insight

In the chaos theory view of grid stability, the seeds of wide area blackouts and other manifestations of instability *are inherent in basic grid structure*. This viewpoint, which is not universally accepted, arose even before the recognition of stochastic generation and reduction of grid inertia as destabilizing influences. However, time and again, **the structure of the grid determines important system properties and basic limits.**

# Architecture Can Assist in Understanding Value Stream Allocation in Grids

## Hybrid Markets (e.g. California)

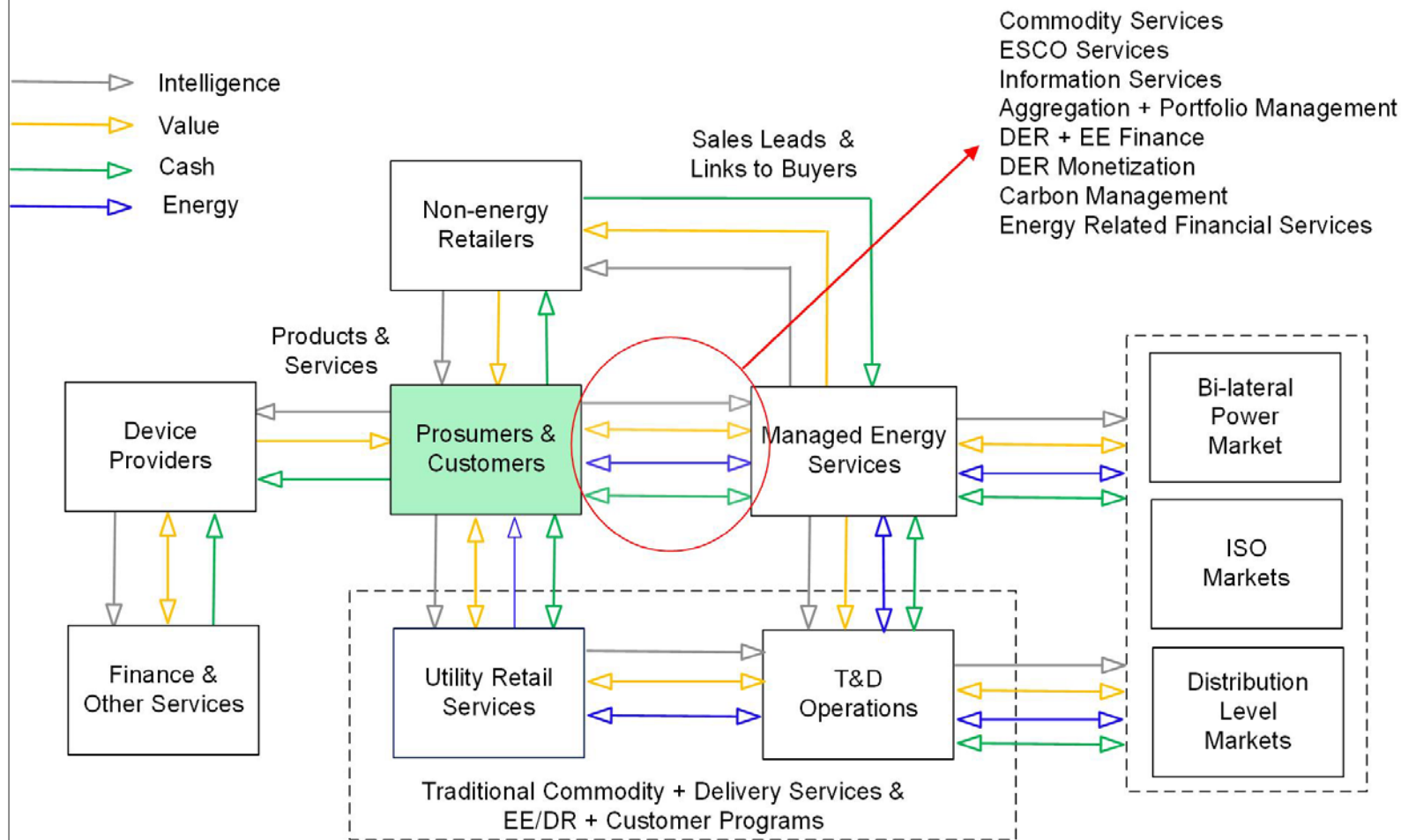

Source: Paul De Martini

## Architectural Insight

It is practical to partition value stream sources (e.g. products and services) into those with high growth and value production potential, and those with limited potential. With the exception of the customer/prosumer, any box that touches a commodity stream (blue arrows) should be considered within the limited potential category, because optimization of the energy stream is essentially a zero-sum proposition. This means that value shifting can occur between entities, but opportunities for new value creation are limited, at best. In fact, some new device providers (such as solar PV leasing entities) prefer to be classified as offering “net load” rather than as energy producers, in order to stay on the non-regulated side, away from the commodity streams. The main reason is that state regulatory interconnection rules usually pass interconnection costs for customer side connections to all customers - whereas merchant DER has to pay for the interconnection costs solely. In addition, the merchant DER providers wish to minimize the amount of regulation they encounter.



**Pacific Northwest**  
NATIONAL LABORATORY

*Proudly Operated by **Battelle** Since 1965*

# selected forward views

## Architectural Insight

Key limiting issues on distribution are lack of adequate observability, lack of advanced protection systems to address multi-directional power flow, and lack distributed control and coordination systems.

Distribution grids suffer from poor observability (lack of sensing) and very little effort has gone into developing observability strategies and tools for design of distribution grid sensor networks. Advanced distribution grids must have excellent observability, so these issues must be addressed.

As DER penetration increases, adjustable flow control can be used to provide flexibility in electric circuit operation. It can also be used to cut or limit the effect of some kinds of constraints that exist in present circuits, such as unwanted cross feeder flows or unscheduled flows to the transmission system.

Partial meshing provides more paths for power flow (with flow controllers directing the “traffic”) so that it becomes possible to make more effective use of DER, meaning that cost effectiveness of such assets is enhanced two ways: better sharing of the assets, and enablement of new value streams and innovations.

# Impact of Storage, Power Electronics, and Advanced Control

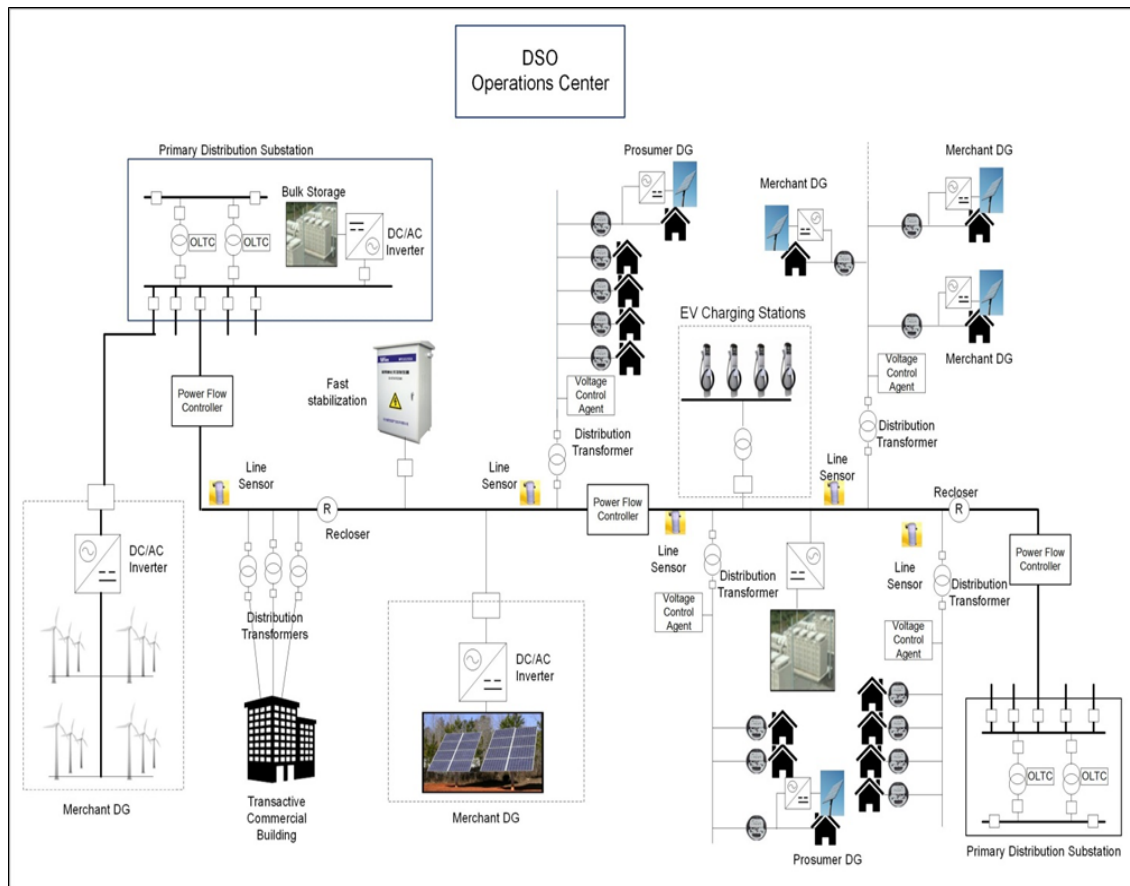

## Key Question What is potential impact of storage on the grid?

Storage is unique in that it can be capable of taking energy or power from the grid, adding energy or power to the grid, and supplying a wide range of grid services on short (sub-second) and long (hours) time scales. It can supply a variety of services simultaneously. *The combination of fast bilateral storage, flexible grid interface mechanisms, and advanced optimizing control is a general purpose grid element as fundamental as power transformers and circuit breakers*, a conclusion recently arrived at by a group of more than thirty participants during a roundtable session at the CleanTech100 Summit in Washington, DC, October 6–7, 2014.

One of the most significant impacts of storage will be the ability to *decouple generation and load volatilities*. Since it is known that the impact of storage can be location-dependent, there is a need for new planning tools and procedures to make use of storage as a standard grid component, and to optimize storage location and size.



# Joint Gas/Electric Structure

Given some of the statements made by PJM, MISO, and the Western Interstate Energy Board, it appears that gas (especially shale gas) and electricity are undergoing more than just integration; this appears to be the beginning of a convergence.

Convergence is the transformation of two or more networks or systems to share resources and interact synergistically via a common and seamless architecture.

Early stage convergence drives tighter coupling of network (gas and electric in this case), so when activities like harmonization of markets and cross-observability implementation begin to occur, combined with the structural interconnection seen above, then convergence becomes a possibility. Ultimately, late stage convergence can result in the formation of new value streams, and while this does not appear to be happening yet, it is worth being aware of the possibility so that convergence is not unnecessarily hampered and innovation can occur.

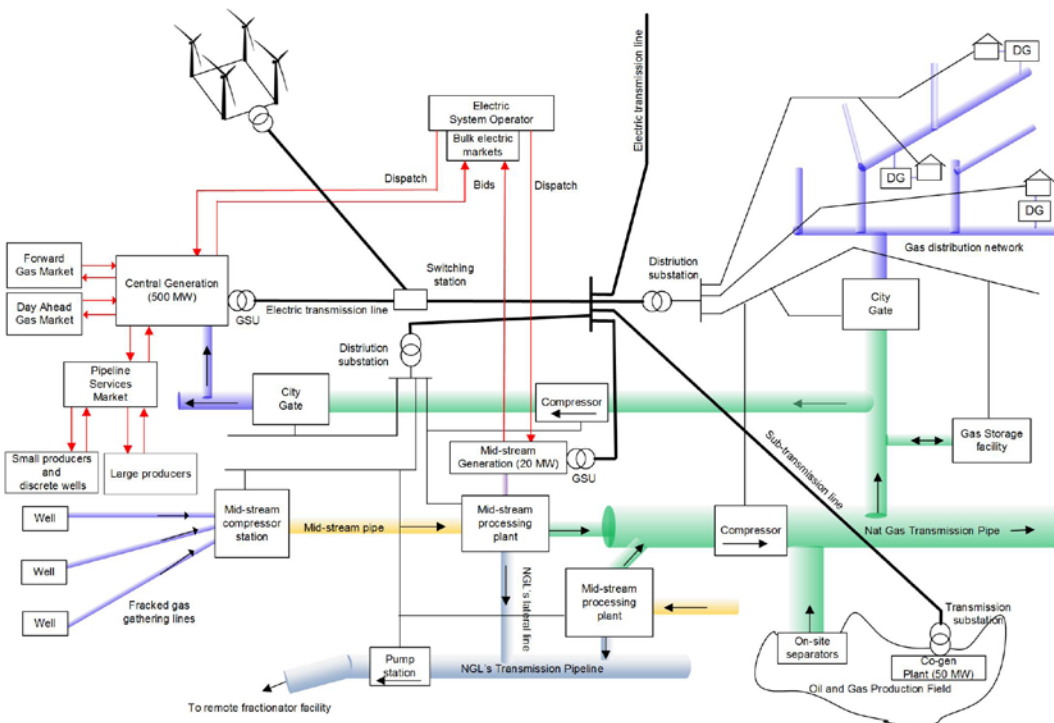

# Gas/Electric Double Loop Structure

- ▶ Shale gas and electric generation can form local closed loops
- ▶ Such loops would be detrimental to resilience
- ▶ The addition of mid-stream generation creates another inner loop
- ▶ This inner loop can add resilience back into the system
  
- ▶ Joint architecture and planning tools can aid in maximizing resilience in such cases

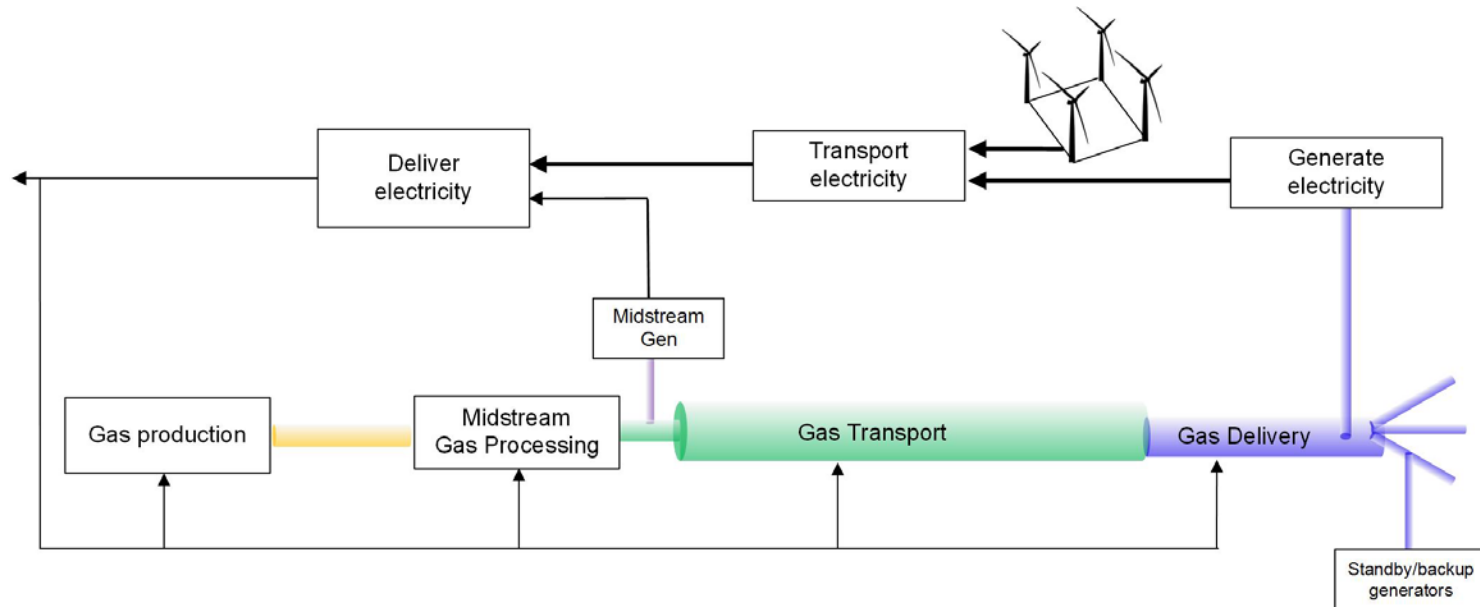

# Laminar Coordination

- ▶ Rigorous basis for coordination framework structure
- ▶ Uses structural decomposition approach:
  - Layered decomposition
- ▶ Structure is implied by stepwise decomposition
- ▶ Interfaces are also indicated
- ▶ Method can provide both general structure and specific design methods

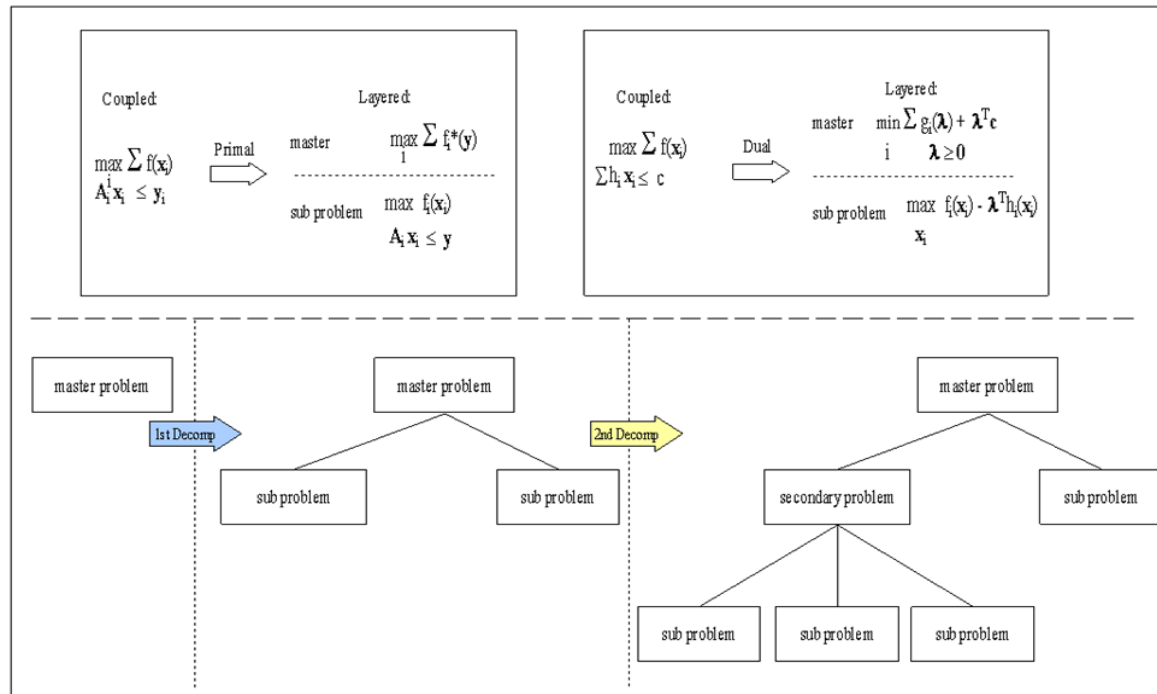

# Laminar Coordination Can Be Mapped to Grid Physical or Logical Structure

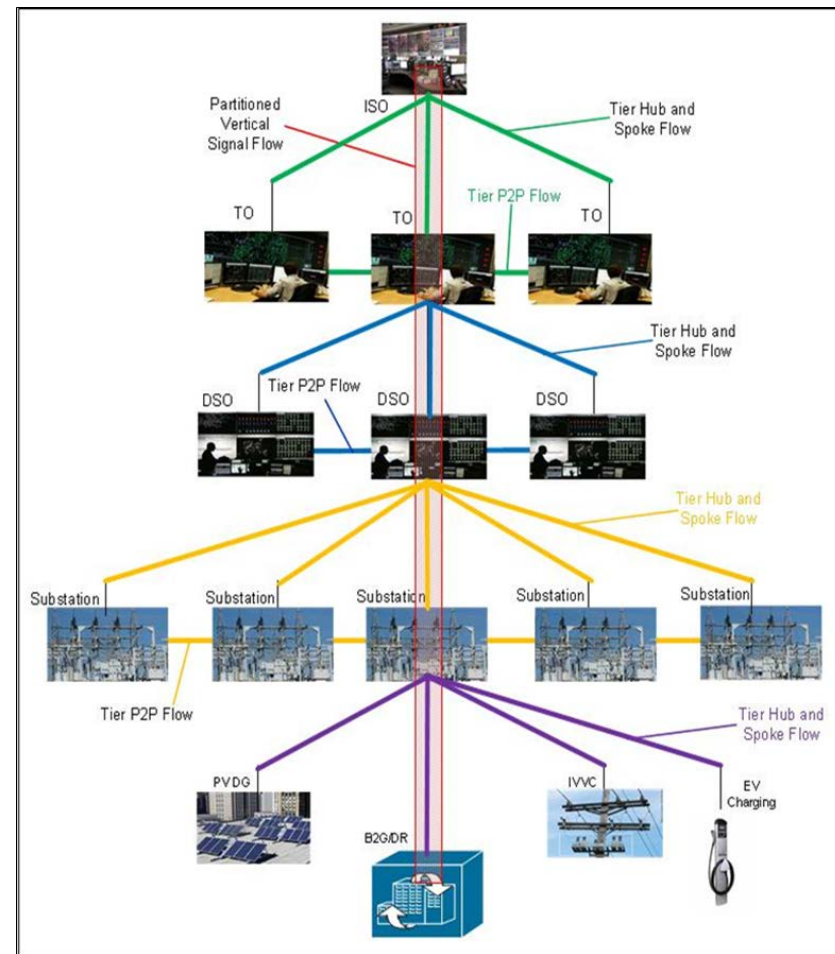
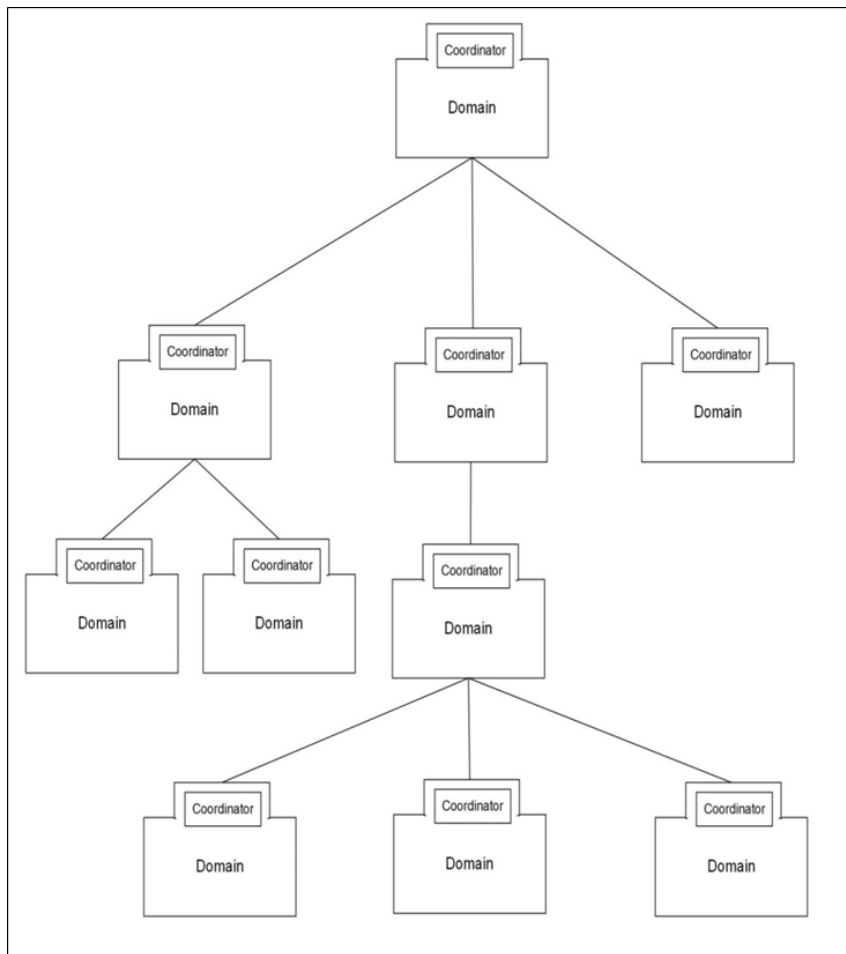

# Laminar Coordination Clarifies Interfaces, Communications, and Scalability

## Architectural Insight

The key principle for a mix of centralized and distributed control that provides properties such as boundary deference, control federation and disaggregation, and scalability is:

**Local Optimization Inside**  
**Global Coordination**

Note that coordination is not control, although goal decomposition coordination mechanisms can be used to solve control problems if desired.

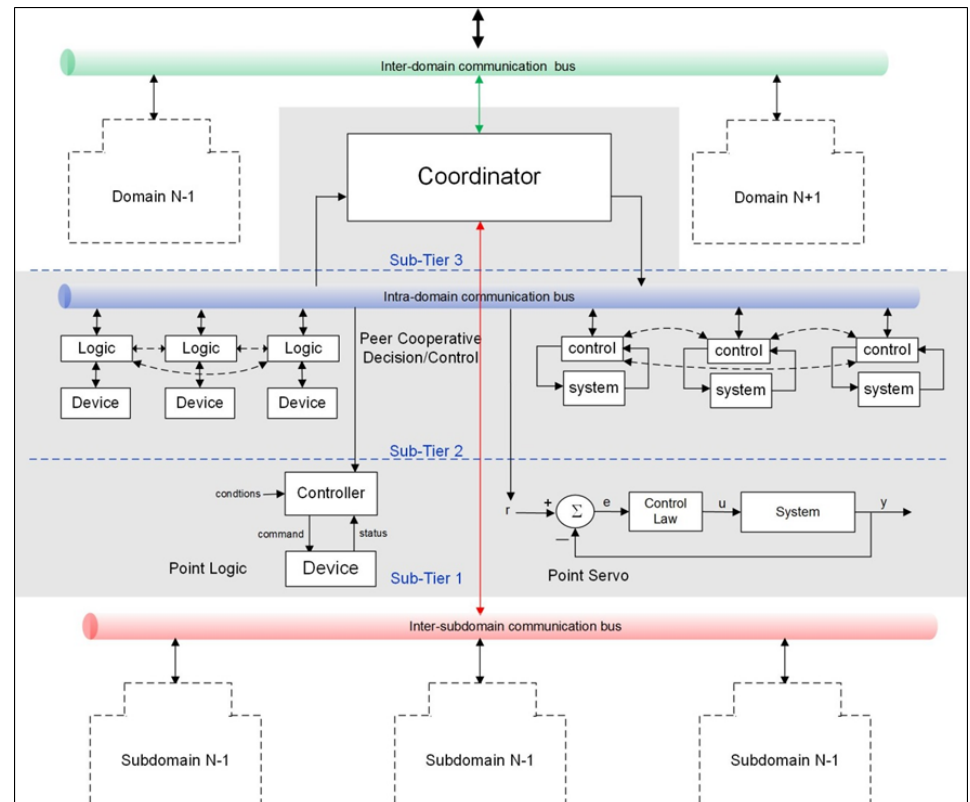

Scalable Structure with Well-Defined Interfaces



**Pacific Northwest**  
NATIONAL LABORATORY

*Proudly Operated by **Battelle** Since 1965*

# recent impact





**Pacific Northwest**  
NATIONAL LABORATORY

*Proudly Operated by **Battelle** Since 1965*

# thank you

Jeffrey D. Taft, PhD  
Chief Architect for Electric Grid Transformation  
Pacific Northwest National Laboratory

[jeffrey.taft@pnnl.gov](mailto:jeffrey.taft@pnnl.gov)