

Measurements of Atmospheric NH_3 , NO_y/NO_x , and NO_2 and Deposition of Total Nitrogen at the Beaufort, NC CASTNET Site (BFT142)

Measurements of Atmospheric NH₃, NO_y/NO_x, and NO₂ and Deposition of Total Nitrogen at the Beaufort, NC CASTNET Site (BFT142)

Ralph E. Baumgardner, Jr.
Environmental Sciences Division
National Exposure Research Laboratory
Research Triangle Park, NC

Christopher M. Rogers
AMEC Environment & Infrastructure, Inc.
Jacksonville, FL

Melissa R. Puchalski
Clean Air Markets Division
Office of Air and Radiation
Washington, DC

Thomas F. Lavery
Cranston, RI

Kevin P. Mishoe
AMEC Environment & Infrastructure, Inc.
Newberry, FL

Garry L. Price
AMEC Environment & Infrastructure, Inc.
Newberry, FL

Nathan S. Hall
University of North Carolina at Chapel Hill
Institute of Marine Sciences
Morehead City, NC

Although this work was reviewed by EPA and approved for publication, it may not necessarily reflect official Agency policy. Mention of trade names and commercial products does not constitute endorsement or recommendation for use.

U.S. Environmental Protection Agency
Office of Research and Development
Washington, DC 20460

Measurements of Atmospheric NH₃, NO_y/NO_x, and NO₂ and Deposition of Total Nitrogen at the Beaufort, NC CASTNET Site (BFT142)

Ralph E. Baumgardner, Jr.
Environmental Sciences Division
National Exposure Research Laboratory
Research Triangle Park, NC

Christopher M. Rogers
AMEC Environment & Infrastructure, Inc.
Jacksonville, FL

Melissa R. Puchalski
Clean Air Markets Division
Office of Air and Radiation
Washington, DC

Thomas F. Lavery
Cranston, RI

Kevin P. Mishoe
AMEC Environment & Infrastructure, Inc.
Newberry, FL

Garry L. Price
AMEC Environment & Infrastructure, Inc.
Newberry, FL

Nathan S. Hall
University of North Carolina at Chapel Hill
Institute of Marine Sciences
Morehead City, NC

**National Exposure Research Laboratory
Office of Research and Development
Research Triangle Park, NC 27711**

Table of Contents

1.0 Introduction	1
a. Background	1
b. Purpose of Study	1
2.0 Site Characteristics and Monitoring Equipment: Beaufort, NC (BFT142)	4
3.0 Results of the NH₃ Measurement Study	10
a. Overview	10
b. Comparison of ADS and AMoN NH ₃ Concentrations	11
c. Comparison of 24-Hour and Weekly ADS NH ₃ Concentrations	11
d. Comparison of ADS and CASTNET Filter Pack Concentrations	14
4.0 Deposition of Atmospheric Nitrogen and Sulfur	24
5.0 Results of the NO_y Measurement Program	26
a. Overview	26
b. Field Evaluation and Quality Assurance	26
c. Data Evaluation and Completeness	27
d. Comparison of Weekly Average NO _y Concentrations with Weekly Filter Pack Total Nitrate Concentration Data	28
e. Time Series of Weekly NO _y , NO _x , NO ₂ , NO _z , NO, and O ₃ Concentrations	29
f. Time Series of Monthly NO _y , NO _x , NO ₂ , NO _z , NO, and O ₃ Concentrations	29
g. Ratios of Weekly NO _x and NO _y Concentrations	31
h. Diurnal Plots of Aggregated Nitrogen Species and O ₃ Concentrations	32
6.0 Summary of Measurements	33
7.0 References	36

List of Figures

- Figure 1.** CASTNET Monitoring Sites
- Figure 2.** AMoN Monitoring Sites
- Figure 3.** CASTNET NO_y Monitoring Sites
- Figure 4.** Small Scale Google Aerial Photograph of BFT142, NC
- Figure 5.** Large Scale Google Aerial Photograph of BFT142, NC and Open Grounds Farm
- Figure 6.** BFT142 Site Including NO_y Tower
- Figure 7.** NO_y Converter at 10 meters
- Figure 8.** Analyzers inside the BFT142 Shelter
- Figure 9.** NO-NO_x-NO_y Sampling Configuration
- Figure 10.** Annular Denuder System (ADS) and Related Sampling Systems at BFT142
- Figure 11.** Sampling Schedule
- Figure 12.** Radiello NH₃ Sampler
- Figure 13.** Time Series of Measured NH₃ Concentrations (µg/m³)
- Figure 14.** AMoN Annual Mean NH₃ Concentrations (µg/m³) for 2011

List of Figures (continued)

- Figure 15.** AMoN Annual Mean NH₃ Concentrations (µg/m³) for 2012
- Figure 16.** NH₃ Concentrations Collected by BFT142 ADS and NC06 AMoN Samplers
- Figure 17.** NH₃ Concentrations Collected by BFT142 ADS Weekly and 24-Hour Samplers
- Figure 18.** Time Series of Measured SO₄²⁻ Concentrations (µg/m³)
- Figure 19.** SO₄²⁻ Concentrations (µg/m³) Measured by Weekly ADS/FP and CASTNET FP
- Figure 20.** SO₄²⁻ Concentrations (µg/m³) Collected by ADS Weekly and 24-Hour Samplers
- Figure 21.** Time Series of Measured SO₂ Concentrations (µg/m³)
- Figure 22.** SO₂ Concentrations (µg/m³) Measured by Weekly ADS/FP and CASTNET FP
- Figure 23.** Time Series of Measured NO₃⁻ Concentrations (µg/m³)
- Figure 24.** NO₃⁻ Concentrations (µg/m³) Measured by Weekly ADS/FP and CASTNET FP
- Figure 25.** Time Series of Measured HNO₃ Concentrations (µg/m³)
- Figure 26.** HNO₃ Concentrations (µg/m³) Measured by Weekly ADS/FP and CASTNET FP
- Figure 27.** Time Series of Measured NH₄⁺ Concentrations (µg/m³)
- Figure 28.** NH₄⁺ Concentrations (µg/m³) Measured by Weekly ADS/FP and CASTNET FP
- Figure 29.** Time Series of Measured Total NO₃⁻ Concentrations (µg/m³)
- Figure 30.** Total NO₃⁻ Concentrations (µg/m³) Measured by ADS/FP and CASTNET FP
- Figure 31.** Components of Total Nitrogen Deposition (kg/ha/yr)
- Figure 32.** Components of Total Sulfur Deposition (kg/ha/yr)
- Figure 33.** Weekly Total NO₃⁻ and Weekly Average NO_y Concentrations (ppb)
- Figure 34.** Weekly NO_y, NO_x, NO₂, NO_z, NO, and O₃ Concentrations (ppb)
- Figure 35.** Time Series of Monthly Average Nitrogen Species Concentrations and O₃ Concentrations (ppb)
- Figure 36.** Time Series of Ratios of Weekly NO_x to NO_y Concentrations
- Figure 37.** Composite Diurnal Distribution of Ratios of Weekly NO_x to NO_y Concentrations
- Figure 38.** Composite NO_y, NO_x, NO₂, NO_z, NO, and O₃ Concentrations (ppb)

List of Tables

- Table 1.** 1-Week and 2-Week NH₃ Concentrations (µg/m³)
- Table 2.** Weekly Versus Aggregated 24-Hour ADS Concentration Regression Statistics
- Table 3.** Contributions to Total Deposition
- Table 4.** Quality Control Checks for NCore Analyzers

1.0 Introduction

a. Background

The Clean Air Status and Trends Network (CASTNET) is a long-term environmental monitoring program that measures trends in ambient air quality and atmospheric dry pollutant deposition across the United States. CASTNET has been operating since 1987 and currently consists of 89 monitoring stations nationwide (Figure 1). The Environmental Protection Agency (EPA) operates a majority of the CASTNET sites. The National Park Service (NPS) currently operates 24 stations in cooperation with EPA. Other federal and state agencies participate in network operation. For example, the Bureau of Land Management (BLM) currently operates five CASTNET sites in Wyoming. For more information on CASTNET, see EPA's CASTNET website: <http://java.epa.gov/castnet/> (EPA, 2014).

Figure 1. CASTNET Monitoring Sites

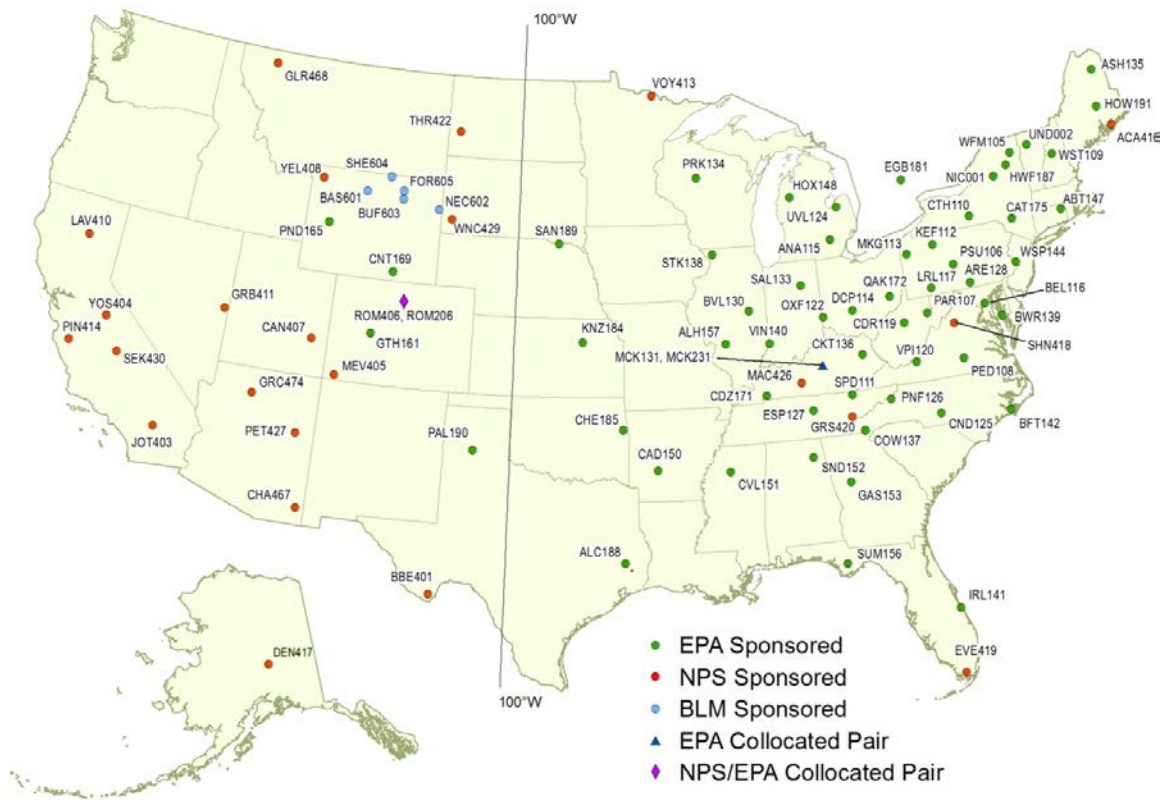

b. Purpose of Study

CASTNET has a 25-year record of weekly atmospheric nitrogen, sulfur, and ozone measurements collected at rural/remote sites in the United States. CASTNET initially featured approximately 50 sites mostly in the eastern United States but has grown to currently include over 90 sites across the contiguous United States and Alaska. The ambient nitrogen measurements taken at CASTNET sites are nitric acid (HNO_3), particulate nitrate (NO_3^-), and ammonium (NH_4^+). In addition, particulate sulfate

(SO_4^{2-}), sulfur dioxide (SO_2), and ozone concentrations are measured. CASTNET also produces estimated dry deposition fluxes of these compounds. However, some key contributors to the atmospheric nitrogen budget have not been measured. For example, ammonia (NH_3) and total reactive oxidized nitrogen (NO_y) had not been measured routinely. To remedy this, many CASTNET sites began participating in the Ammonia Monitoring Network (AMoN) (Figure 2), which was initiated by the National Atmospheric Deposition Program (NADP) in 2007 to establish a nationwide network of passive NH_3 monitors. For more information, view the website: <http://isws.illinois.edu/amon> (NADP, 2013).

A few commercial off-the-shelf instruments are available to measure NO_y ($\text{NO} + \text{NO}_2 + \text{NO}_3$) and NO_x ($\text{NO} + \text{NO}_2$). NO_z includes the nitrogen species HNO_3 , nitrous acid (HNO_2), peroxy acetyl nitrate (PAN), other organic nitrates, and particulate nitrates. In practice, NO_z is calculated as $\text{NO}_y - \text{NO}_x$. Since 2005, CASTNET has measured NO_y at Beltsville, MD (BEL116). During 2012, NO_y measurements were added at Bondville, IL (BVL130) and Huntington Wildlife Forest, NY (HWF187). In 2013, the CASTNET NO_y network further expanded to include Pinedale, WY (PND165), Cranberry, NC (PNF126), and Rocky Mountain National Park, CO (ROM206). Figure 3 displays the CASTNET sites with NO_y measurements.

CASTNET has also operated other nitrogen measurement studies in the past several years to supplement and enhance the filter pack and AMoN measurements, including two projects at the Beaufort, NC site (BFT142) located in an agricultural area of coastal North Carolina. The results from these two studies are presented in this report.

Figure 2. AMoN Monitoring Sites

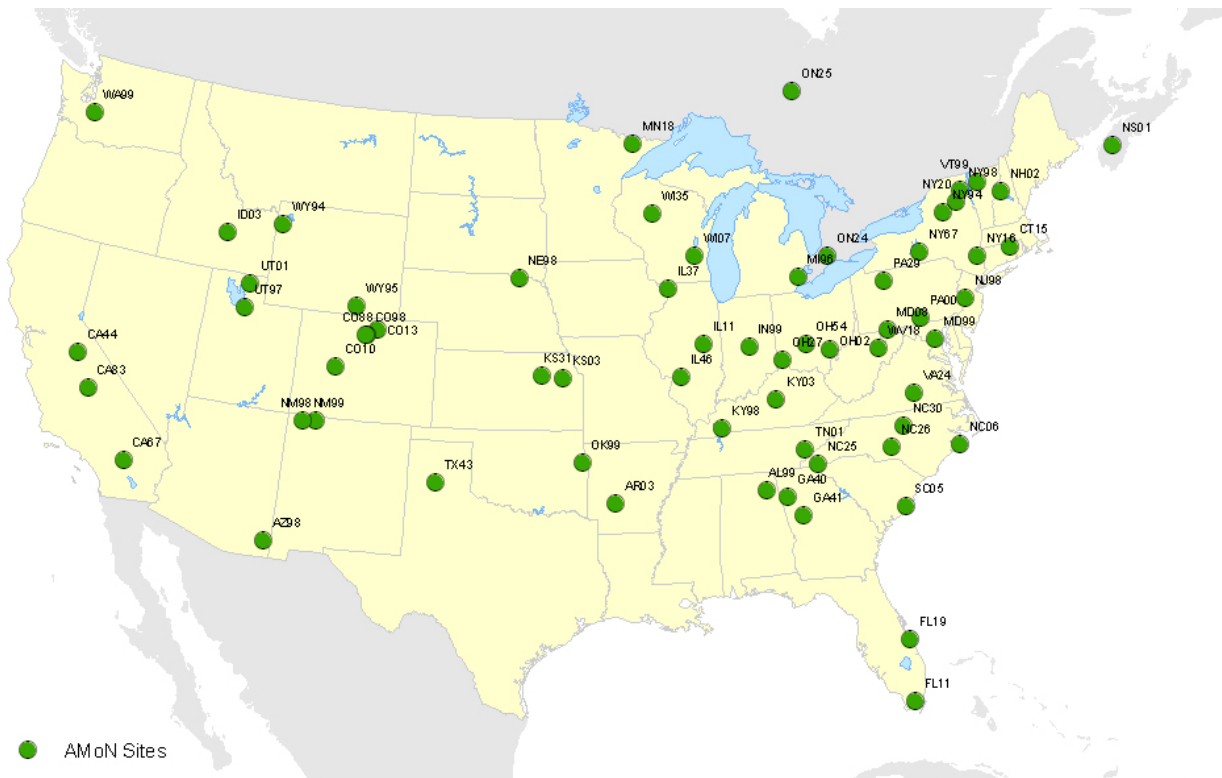
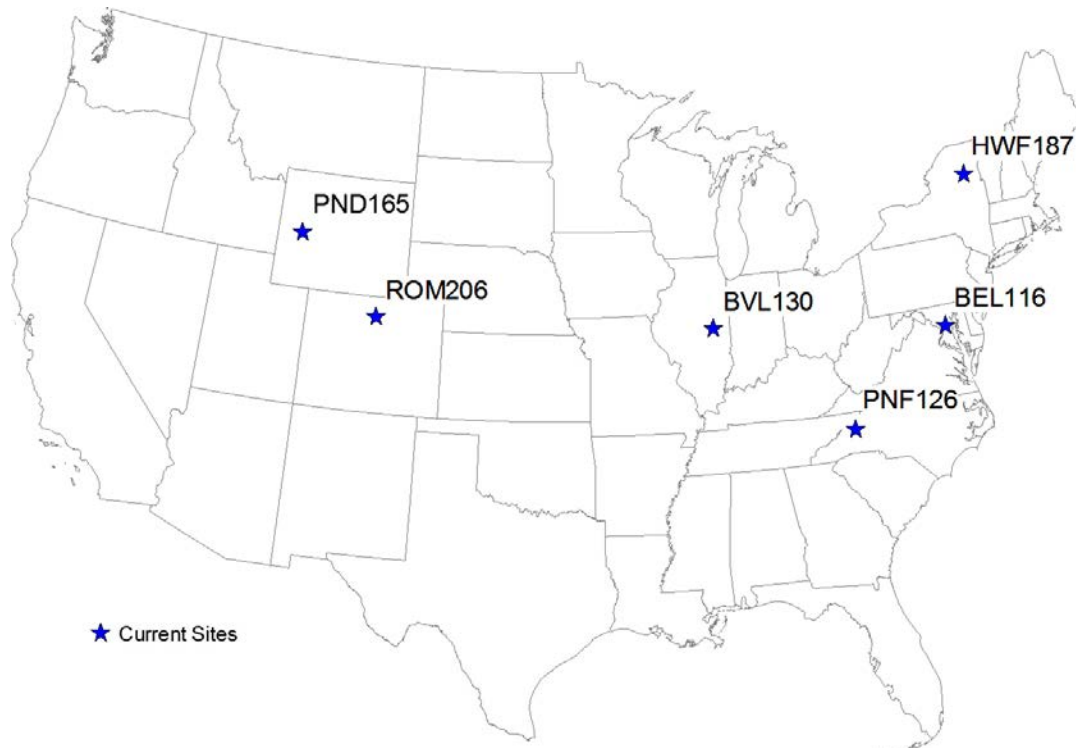

Figure 3. CASTNET NO_y Monitoring Sites



The first Beaufort study included NH₃ measurements based on the deployment of a weekly, dual annular denuder system (ADS) during designated measurement weeks. Additionally, the Beaufort ammonia study operated daily ADS sampling for comparison with the weekly integrated ADS sample. The daily ADS ran for a 24-hour period to collect standard CASTNET constituents and ammonia. Measurements were conducted from May 2011 through November 2012, operating on a two out of every six weeks schedule. The Beaufort studies also included combining model estimates of dry deposition velocities with the measured concentrations to estimate dry deposition of the nitrogen and sulfur species. The dry deposition fluxes were added to measured wet deposition rates to obtain total deposition. The results of the NH₃ measurement study are presented in Section 3. Estimates of deposition of atmospheric nitrogen and sulfur are presented in Section 4.0.

The second study at Beaufort focused on measuring NO_y continuously from February 2012 through May 2013. Measurements of trace-level NO_y were obtained using a commercially produced instrument with an optional configuration using a second converter that allowed for the collection of NO_x in addition to NO_y and NO. Using a difference method (NO_x - NO), an NO₂ concentration was obtained. Similarly, NO_z was calculated as the difference between measured NO_y and measured NO_x. These results are presented in Section 5.0. Section 6.0 presents a summary of the ADS and continuous measurements and estimates of nitrogen and sulfur deposition.

2.0 Site Characteristics and Monitoring Equipment: Beaufort, NC (BFT142)

The CASTNET monitoring site is located about 10 miles north of the Town of Beaufort, NC and is situated on western edge of Open Grounds Farm (OGF), a massive 57,000-acre farm northeast of Beaufort. OGF produces soybeans, corn, and some wheat and cotton. The sidebar summarizes the BFT142 site characteristics. Figures 4 and 5 illustrate the location of the monitoring site on Google aerial photographs. The NO_y inlet with a NO_y converter was located atop a 10-m tower, which is shown in Figure 6 along with the ADS, filter pack, and meteorological sampling towers. Figure 7 shows the NO_y converter at 10 meters. A NO_x converter was located in the shelter adjacent to the NO_y instrument. Figure 8 shows the BFT142 site instruments. Figure 9 illustrates the NO-NO_x-NO_y sampling configuration. The BFT142 CASTNET site also hosts a NADP/NTN wet deposition monitoring system (NC06) and an AMoN (NC06) passive NH₃ monitoring device. An OGF-operated fertilizer and chemical plant is located about three miles east-southeast of BFT142 on Nelson Bay Road.

Beaufort, NC Site Characteristics	
Site name and ID	Beaufort, NC, BFT142
County with state abbreviation	Carteret, NC
Latitude; decimal degrees	34.8847
Longitude; decimal degrees	-76.6207
Elevation	5 meters
Operating agency and start date	EPA, 12/28/1993
Primary Land Use	Agricultural (primarily soybeans and corn)
Terrain surrounding site	Flat
Nearest NADP site code	NC06
Distance to nearest NADP site	0.04 kilometers
Does site conform to deposition model assumptions?	Yes

Figure 4. Small Scale Google Aerial Photograph of BFT142, NC



Figure 5. Large Scale Google Aerial Photograph of BFT142, NC and Open Grounds Farm

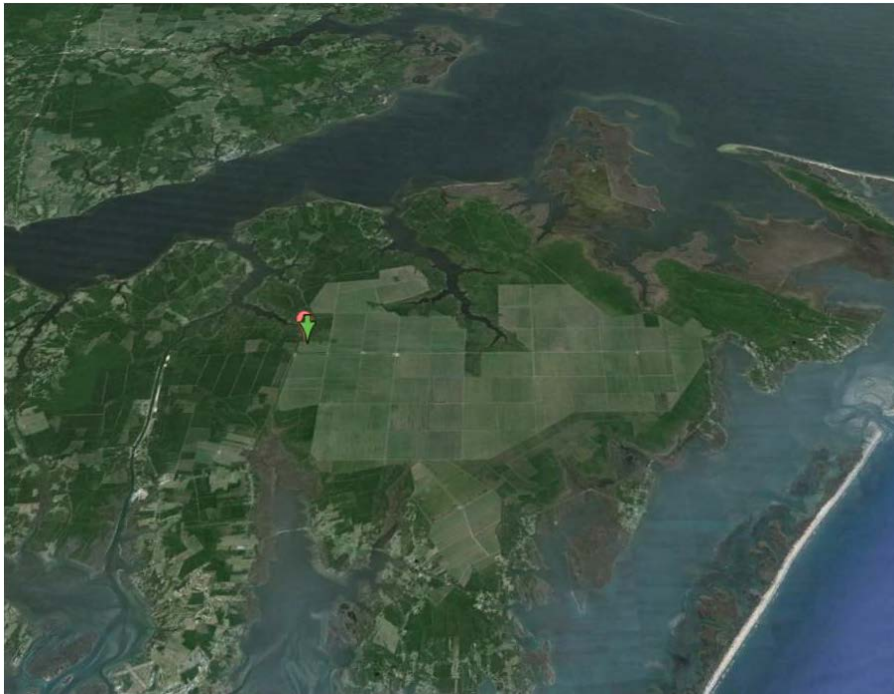

Figure 6. BFT142 Site Including NO_y Tower



Beaufort, NC (BFT142)

Note: 1 NADP/NTN precipitation sampling systems
2 AMoN sampler
3 Meteorological tower
4 NO_y converter tower
5 Filter pack and ADS tower

Figure 7. NO_y Converter at 10 meters



Figure 8. Analyzers inside the BFT142 Shelter



Figure 9. NO-NO_x-NO_y Configuration

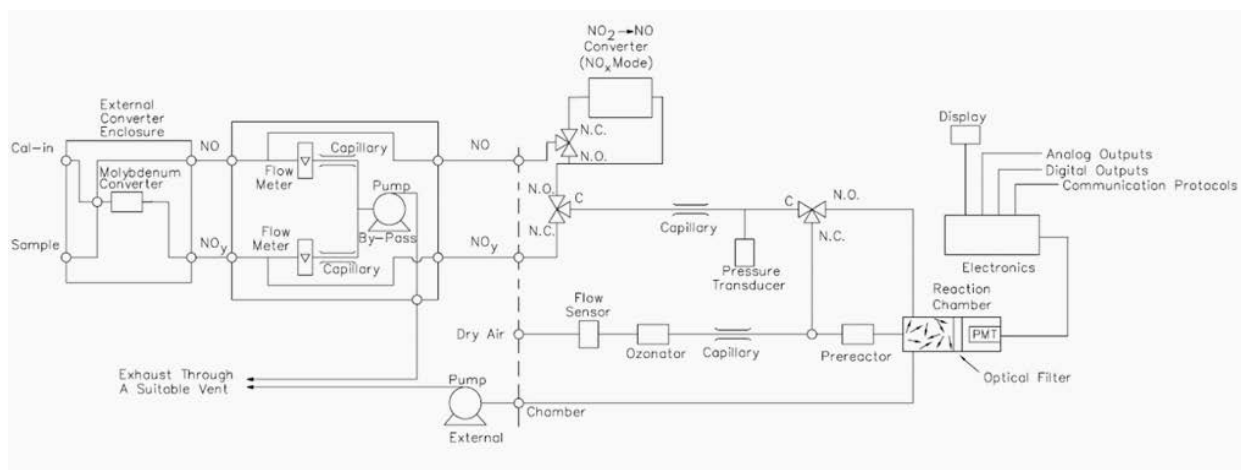

The goals of the Beaufort studies were to continue and expand analyses that began during the Ammonia CASTNET CSN Study (ACCS; EPA, in press), and to add NO_y-related measurements in an effort to estimate the components of total dry nitrogen deposition from nitrogen species not collected by the typical CASTNET filter pack. The Beaufort location expanded ACCS to include a coastal site located in an area of interest for ammonia monitoring because of its proximity to agricultural/crop production “i.e.,” OGF and animal production “e.g.,” Prestage Farms [“pork” and “turkey”] in eastern North Carolina.

Sampling Equipment

• Dual Denuder ADS for Measuring NH_3 and Other Species

The heart of the NH_3 sampling system consisted of nine dual denuder ADS (Figure 10) with a 3-stage filter pack arranged to collect seven daily samples, one field blank, and one weekly sample.

ADS featured:

1. A sodium carbonate (Na_2CO_3)-coated annular denuder for collecting gaseous HNO_3 and SO_2 analyzed by ion chromatography (IC) using deionized water (DIW) as the extraction fluid.
2. A phosphorus acid (H_3PO_3)-coated annular denuder for collecting gaseous NH_3 analyzed by automated colorimetry (AC) using DIW as the extraction fluid.
3. A 3-stage CASTNET-style filter pack consisting of:
 - a. A Teflon filter for collecting SO_4^{2-} , NO_3^- , and NH_4^+ analyzed by IC.
 - b. A nylon filter for collecting SO_2 (as SO_4^{2-}) and HNO_3 (as NO_3^-) analyzed by IC. No measurable SO_2 was collected on the nylon filter.
 - c. A H_3PO_3 -impregnated filter for collecting any extra NH_x either from denuder capture inefficiency or loss of NH_4^+ through volatilization off the nylon filter (or both), which was analyzed by AC using DIW as the extraction fluid.

The ADS were installed and operated at 10 meters. AMEC personnel created a solenoid system and a data logger program that permitted unattended daily and weekly sampling. The BFT142 ADS was the same as used in ACCS. The ADS used a cyclonic separator for removing particles with mean aerodynamic diameter greater than $2.5 \mu\text{m}$. The weekly ADS used a flow rate of 3.0 liters per minute (lpm) and the daily sampling was based on a flow of 16.7 lpm.

Figure 10. Annular Denuder System (ADS) and Related Sampling Systems at BFT142

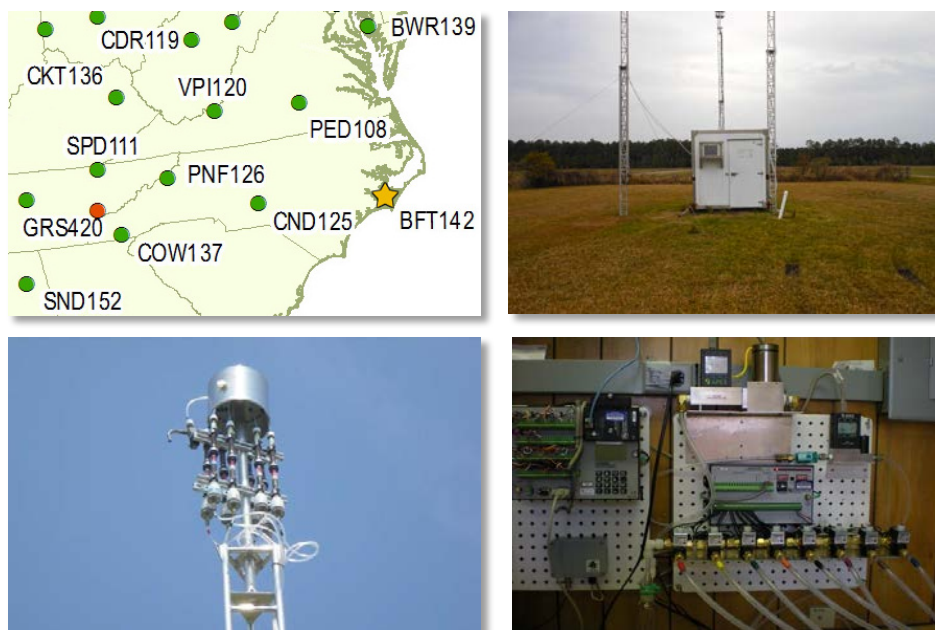

The sampling schedule (Figure 11) was similar to ACCS:

- Daily ADS ran for one week, then again five weeks later.
- Weekly ADS ran for one week in conjunction with daily ADS then a second consecutive week for comparison with AMoN.
- ADS sampling occurred from May 2011 through November 2012.

Figure 11. Sampling Schedule

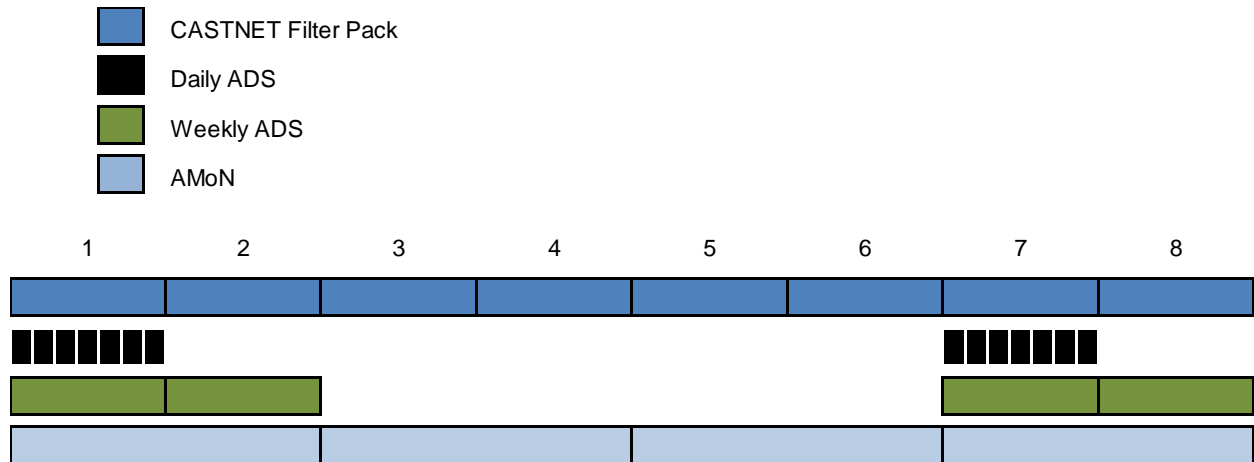

Figure 12. Radiello NH₃ Sampler



- **AMoN Radiello Sampler for Measuring NH₃**

A Radiello NH₃ passive sampler was deployed as part of the NC06 AMoN sampling to collect 2-week NH₃ concentrations (Figure 12). The Radiello sampler was chosen by NADP for use in the AMoN based on comparisons with other samplers and annular denuder measurements (Puchalski et al., 2011).

- **Three-stage CASTNET filter pack**

A 3-stage CASTNET filter pack was deployed for each sampling period as part of the base operations of the core CASTNET program. The filter pack sampled gaseous SO₂ and HNO₃; particulate SO₄²⁻, NO₃⁻, and NH₄⁺; base cations; and chloride ion (Cl⁻). The CASTNET filter pack system did not utilize a cyclonic separator to remove large particles (mean aerodynamic diameter greater than 2.5 μm).

- **NO/NO_x/NO_y/ Measurements**

Trace-level NO_y measurements were obtained using a Thermo Scientific (Thermo) Model 42i-Y NO_y analyzer, which is a chemiluminescent trace-level gas analyzer that measures all reactive oxides of nitrogen in the ambient air. AMEC deployed an optional configuration at BFT142 using a second converter that permitted the collection of NO_x in addition to NO_y and NO. Thus NO₂ could be calculated using a difference method (NO_x - NO). Continuous NO_y measurements began in February 2012 and were completed in May 2013. The configuration produces hourly concentrations of NO_y, NO_x, and NO and calculated NO₂, and calculated NO_z. All measurements and model calculations made by AMEC during these studies followed the CASTNET Quality Assurance Project Plan (QAPP; AMEC, 2012).

- **Supporting Measurement Systems**

Hourly O₃ concentrations were collected at BFT142 as part of routine CASTNET operations. The continuous gaseous measurements were supported by a dynamic dilution calibration system and a zero air system. The sampling by all instruments was controlled by a Campbell Scientific Instruments (CSI) CR3000 data logger.

- **Meteorological Measurements**

Meteorological instruments were operated on a 10-m tower at the BFT142 site. The measurements included wind speed and direction, sigma theta (standard deviation of the wind direction), solar radiation, relative humidity, temperature at 9 m and 2 m, precipitation, and surface wetness. The meteorological measurements were archived as 1-hour averages. The data were used as input to the Multi-Layer Model (MLM) to estimate values of deposition velocity (V_d) (Meyers, 1998). The V_d values were used to estimate dry deposition of HNO₃, particulate NO₃⁻, particulate NH₄⁺, SO₂, and particulate SO₄²⁻. All meteorological measurements followed the CASTNET QAPP.

3.0 Results of the NH₃ Measurement Study

a. Overview

Figure 13 presents time series of daily, weekly, and daily-averaged-to-weekly NH₃ concentrations from BFT142 measurements. The figure also presents 2-week average NH₃ concentrations collected using the AMoN Radiello passive sampler at the collocated NC06 site. The data in this figure provide a good synopsis of the BFT142 19-month NH₃ measurement program. ADS measurements of weekly NH₃ concentrations were higher in the spring and summer of 2011. Table 1 summarizes the NH₃ measurements collected during the 19-month study. The weekly ADS NH₃ concentrations were typically higher than the average of the seven daily samples. There was no consistent bias between the 2-week average ADS concentrations and the AMoN samples. The average of weekly (twice per five weeks) BFT142 NH₃ values was 1.15 µg/m³, and the average (2-week values) for NC06 was 1.00 µg/m³. The weekly 2-week average BFT142 ADS values ranged from 0.43 to 2.89 µg/m³ with a standard deviation of 0.84.

Figure 13. Time Series of Measured NH₃ Concentrations (µg/m³)

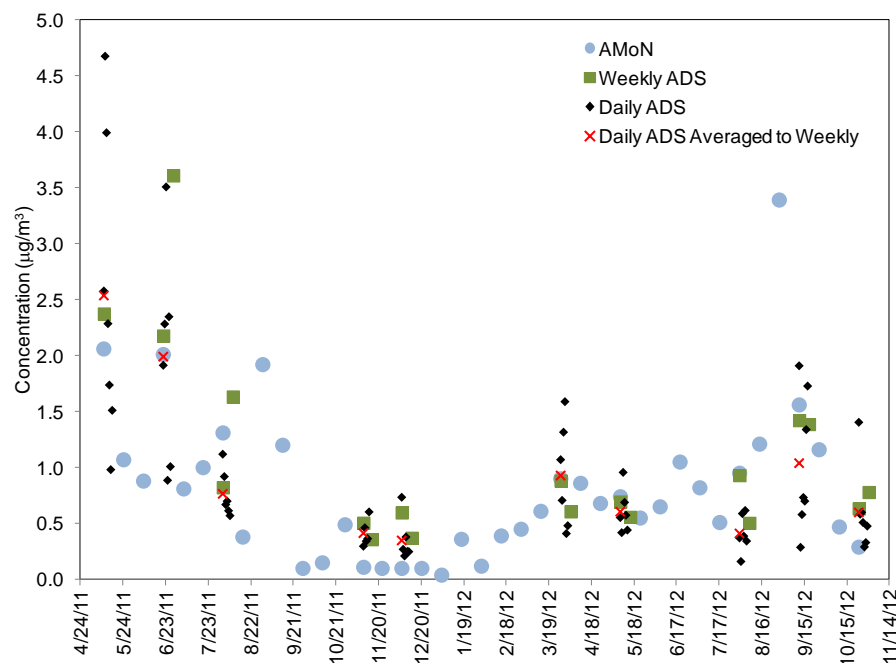

Figures 14 and 15 provide maps of 2011 and 2012 annual mean NH₃ concentrations measured by AMoN. In 2011, nine sites measured annual mean concentrations greater than or equal to 2.0 µg/m³. The highest concentration (3.2 µg/m³) was measured at AMoN site CA83/CASTNET SEK430, CA. The 2011 mean concentration for NC06 was 2.3 µg/m³, which was higher than the mean AMoN value collected only during the BFT142 sampling period. The annual mean value at NC06 was affected by a concentration of 32.38 µg/m³, which was measured during the two weeks beginning 4/12/2011. Without the outlier, the annual mean concentration is 1.2 µg/m³. Twelve sites

measured concentrations greater than or equal to 2.0 $\mu\text{g}/\text{m}^3$ in 2012. The highest 2012 concentration (15.1 $\mu\text{g}/\text{m}^3$) was measured at Logan, UT (UT01), a site that was added to AMoN during late 2011 and is not included on Figure 14. NC06 measured a mean concentration of 0.7 $\mu\text{g}/\text{m}^3$ during 2012.

b. Comparison of ADS and AMoN NH₃ Concentrations

The 2-week average of the weekly BFT142 values and the 2-week NC06 values shown in Figure 13 and Table 1 compare reasonably well. A linear regression based on ADS values aggregated to two weeks versus the 2-week AMoN concentrations is shown in Figure 16. The regression equation is

$$y = 0.7792x + 0.0963,$$

with an R² value of 0.8178 where x = average weekly ADS concentration and y = AMoN bi-weekly concentration.

c. Comparison of 24-Hour and Weekly ADS NH₃ Concentrations

Similarly, the averages (“x” in Figure 13) of the seven 24-hour NH₃ concentrations compare well to the sampled weekly values (Figure 13). A linear regression based on the ADS values and corresponding 10 averages of the 24-hour concentrations is shown in Figure 17. The regression equation is

$$y = 1.0527x - 0.1998,$$

with an R² value of 0.9265 where x = average weekly ADS concentration and y = average hourly ADS concentration.

Table 1. 1-Week and 2-Week NH₃ Concentrations ($\mu\text{g}/\text{m}^3$)

Date On	Average of 7 24-Hour ADS Values	Weekly ADS Values			AMoN
		1st Week Only	2nd Week Only	2-Week Average	2-Week Sample
05/10/11	2.54	2.38	NA	2.38	2.06
06/21/11	1.99	2.18	3.61	2.89	2.01
08/02/11	0.77	0.82	1.64	1.23	1.31
11/09/11	0.42	0.51	0.36	0.43	0.11
12/06/11	0.35	0.60	0.37	0.49	0.10
03/27/12	0.93	0.89	0.61	0.75	0.90
05/08/12	0.61	0.70	0.56	0.63	0.74
07/31/12	0.41	0.93	0.51	0.72	0.95
09/11/12	1.04	1.42	1.39	1.41	1.56
10/23/12	0.60	0.64	0.78	0.71	0.29
Mean	0.97	1.11	1.09	1.15	1.00
Standard Deviation	0.73	0.67	1.04	0.84	0.73

Note: NA = not available

Figure 14. AMoN Annual Mean NH₃ Concentrations (µg/m³) for 2011

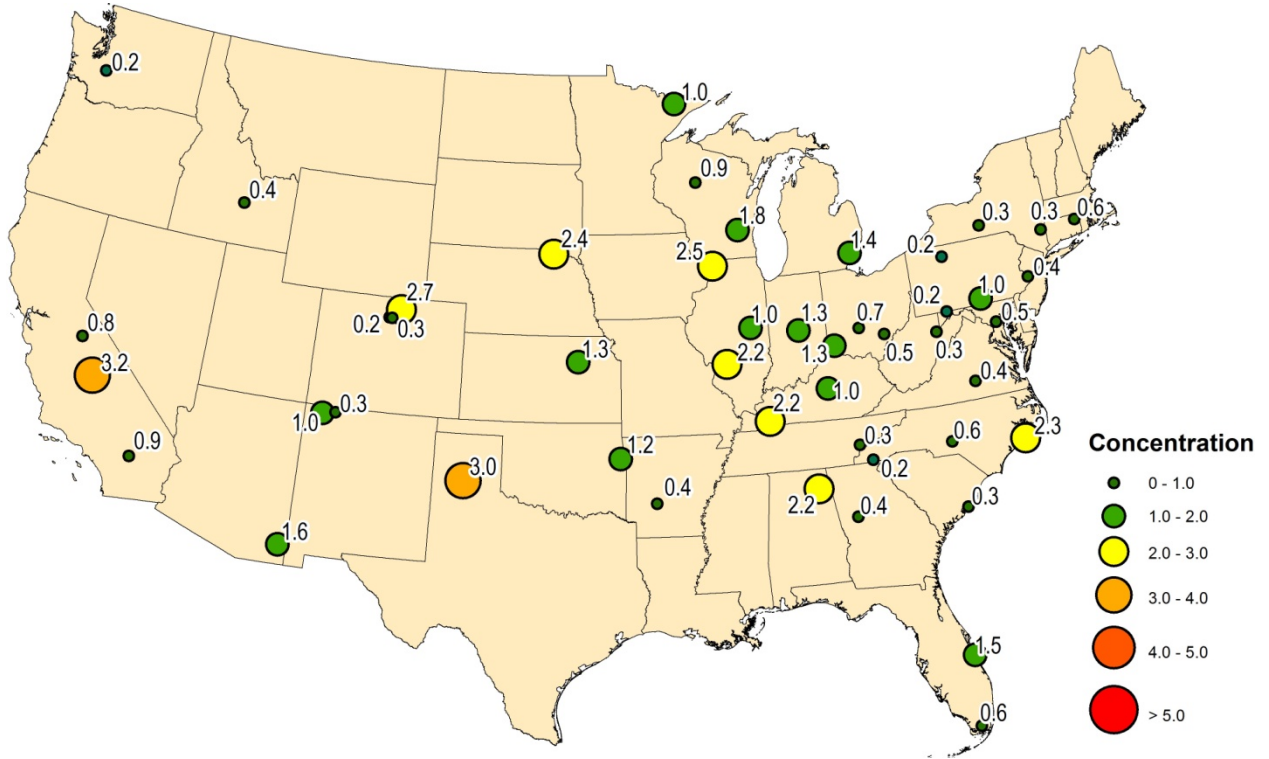

Figure 15. AMoN Annual Mean NH₃ Concentrations (µg/m³) for 2012

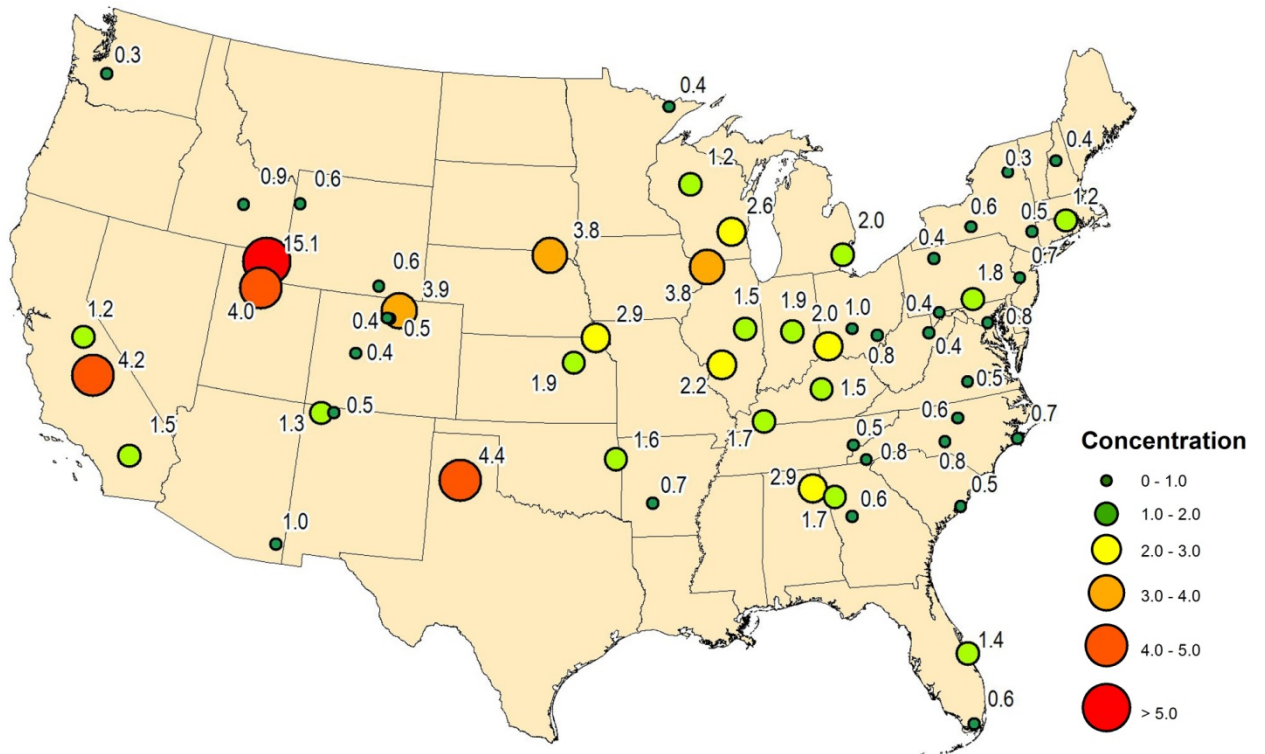

Figure 16. NH₃ Concentrations Collected by BFT142 ADS and NC06 AMoN Samplers

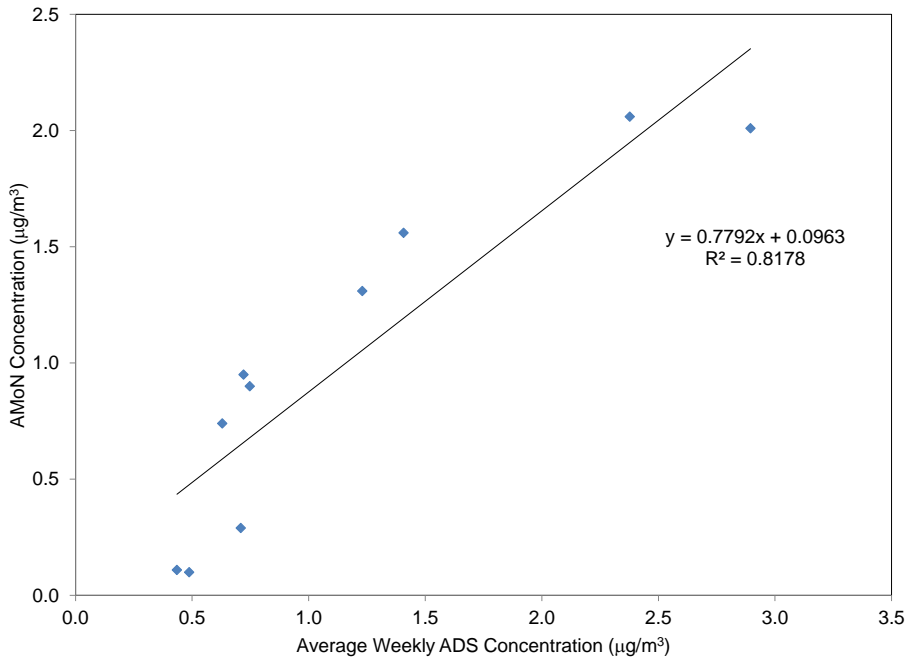
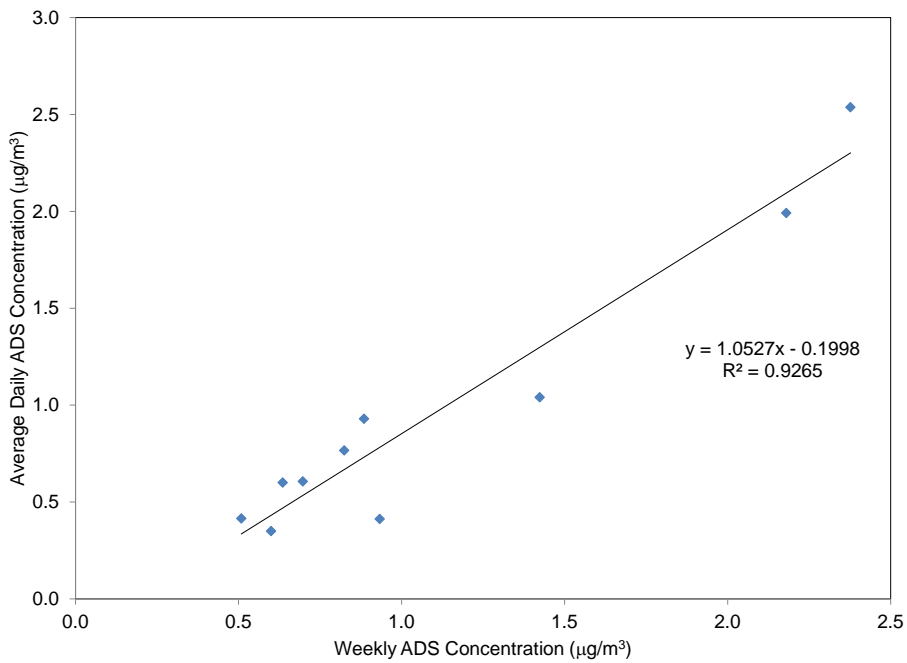

Figure 17. NH₃ Concentrations Collected by BFT142 ADS Weekly and 24-Hour Samplers



d. Comparison of ADS and CASTNET Filter Pack Concentrations

In addition to the NH₃ concentrations discussed previously, the ADS, including its back-end filter pack component, and the CASTNET filter pack (FP) sampling system measured concentrations of gaseous HNO₃ and SO₂ and particulate SO₄²⁻, NO₃⁻, and NH₄⁺. HNO₃ and NO₃⁻ were summed to produce total NO₃⁻ concentrations.

- **Particulate SO₄²⁻**

Because the measurement of atmospheric SO₄²⁻ is considered relatively straightforward, it represents a good quality control check for the measurement system. Satisfactory results indicate the likely success in measuring the other parameters. Figure 18 presents a time series of weekly ADS, daily ADS, daily averaged to weekly ADS, and weekly FP SO₄²⁻ data. Qualitatively, the four data sets show good agreement. A scatter plot of ADS versus FP weekly SO₄²⁻ concentration measurements is given in Figure 19 and provides a quantitative estimate of the relationship between the ADS and FP SO₄²⁻ data. The regression equation fit through the data is

$$y = 0.9718x + 0.4025,$$

with an R² value of 0.8190.

Other than a couple of minor outliers, the comparisons are good over an order of magnitude range of SO₄²⁻ concentrations with a high correlation coefficient.

Figure 18. Time Series of Measured SO₄²⁻ Concentrations (µg/m³)

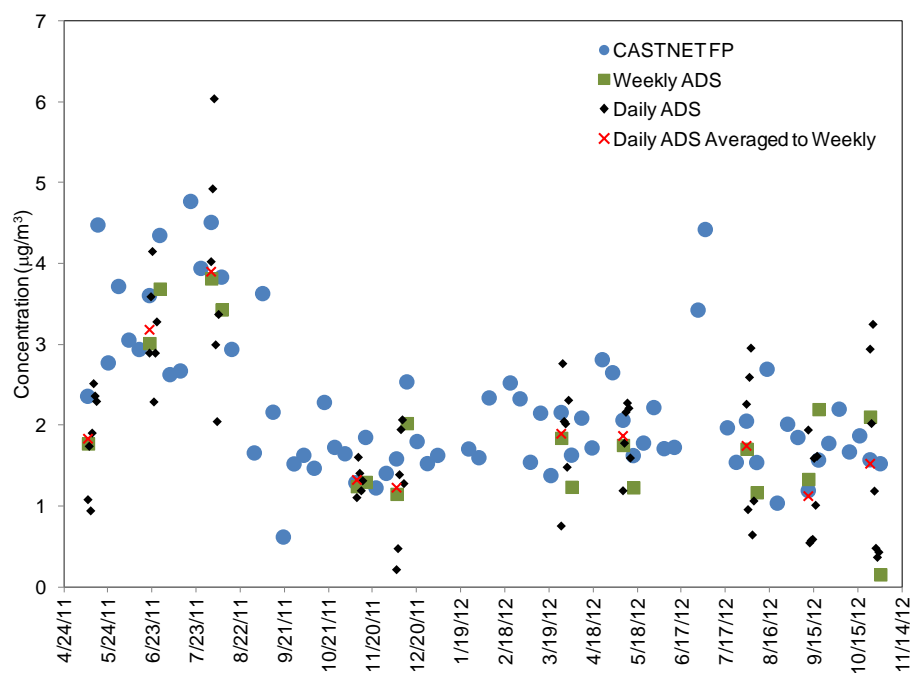

Figure 19. SO_4^{2-} Concentrations ($\mu\text{g}/\text{m}^3$) Measured by Weekly ADS/FP and CASTNET FP

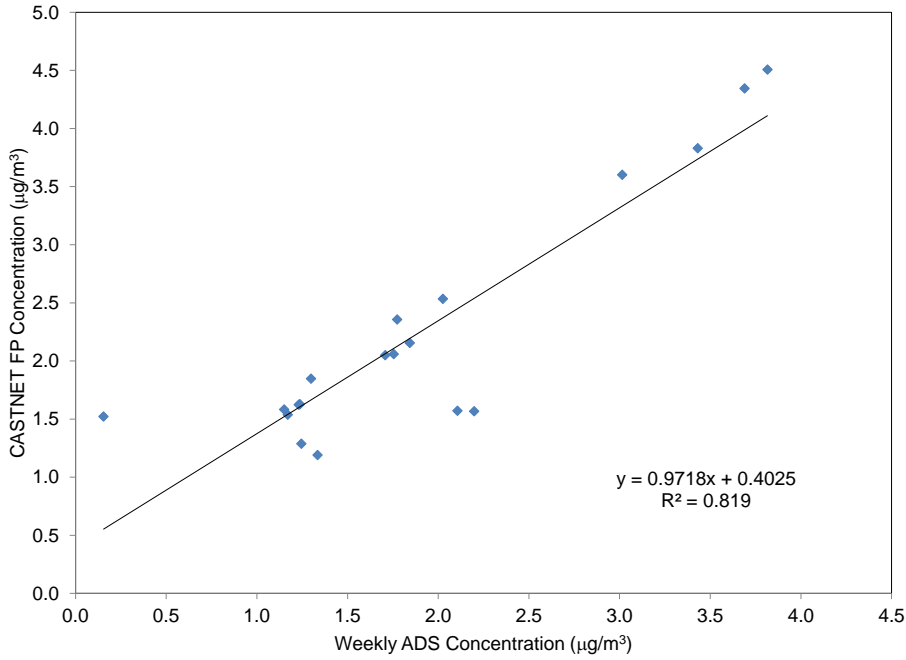
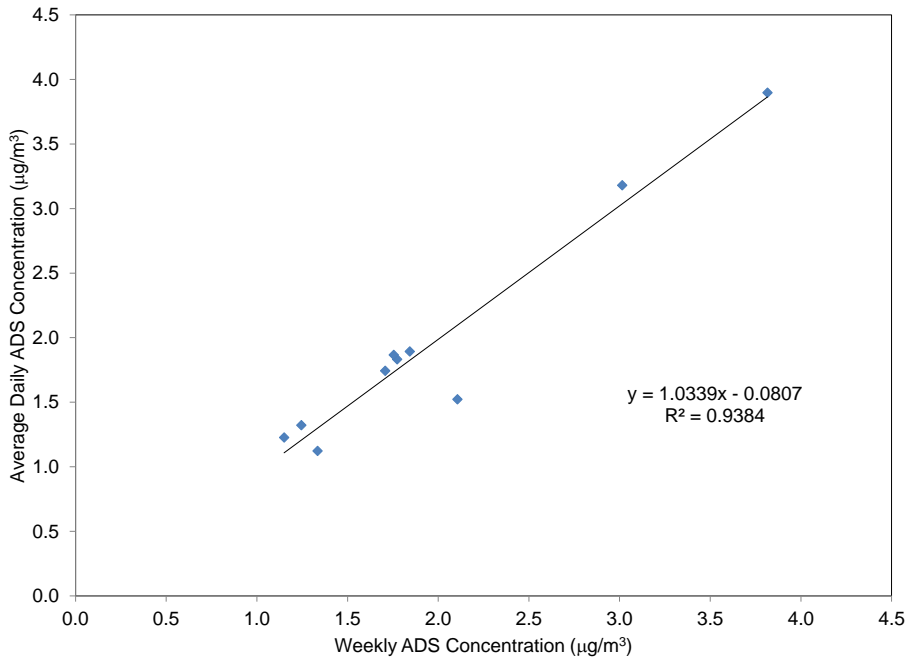

Figure 20. SO_4^{2-} Concentrations ($\mu\text{g}/\text{m}^3$) Collected by ADS Weekly and 24-Hour Samplers



The weekly ADS SO_4^{2-} measurements were also compared to the 24-hour concentrations aggregated over a week. The values (“x” in Figure 18) of the 10 24-hour SO_4^{2-} concentration averages compare well to the sampled weekly values. A linear regression based on the ADS values and corresponding 10 averages of the 24-hour concentrations is shown in Figure 20. The regression equation is

$$y = 1.0339x - 0.0807,$$

with an R^2 value of 0.9384.

Instead of presenting figures for all of the weekly ADS and 24-hour measurements aggregated over a week, Table 2 summarizes the linear regression statistics for SO_4^{2-} , NH_3 , SO_2 , NO_3^- , HNO_3 , NH_4^+ , and total NO_3^- with x as the average weekly ADS concentration and y as the average hourly ADS concentration. The weekly and aggregated 24-hour concentrations compared reasonably well with the exception of HNO_3 and total NO_3^- . In these cases, the weekly ADS values were higher than the aggregated 24-hour measurements.

Table 2. Weekly Versus Aggregated 24-Hour ADS Concentration Regression Statistics

Pollutant	Slope	Y-Intercept	Correlation
SO_4^{2-}	1.0339	-0.0807	0.9384
NH_3	0.7792	0.0963	0.8178
SO_2	0.8099	0.0139	0.8192
NO_3^-	1.0298	0.0002	0.9413
HNO_3	1.3034	-0.0438	0.7577
NH_4^+	1.0337	0.0207	0.8865
Total NO_3^-	1.4705	0.6181	0.6609

- **SO_2**

Time series of daily, weekly, and daily-averaged-to-weekly SO_2 concentrations from BFT142 measurements are presented in Figure 21. The figure also presents weekly average SO_2 concentrations collected using the CASTNET filter pack at BFT142.

A scatter plot of ADS versus CASTNET FP weekly SO_2 concentration measurements is given in Figure 22. The regression equation fit through the data is

$$y = 0.7332x + 0.1706,$$

with an R^2 value of 0.7862.

The scatter diagram of weekly ADS and CASTNET FP measurements shows reasonably good comparisons over the range of SO₂ concentrations. However, the SO₂ data show more scatter and a lower correlation coefficient than the SO₄²⁻ measurements.

Figure 21. Time Series of Measured SO₂ Concentrations (µg/m³)

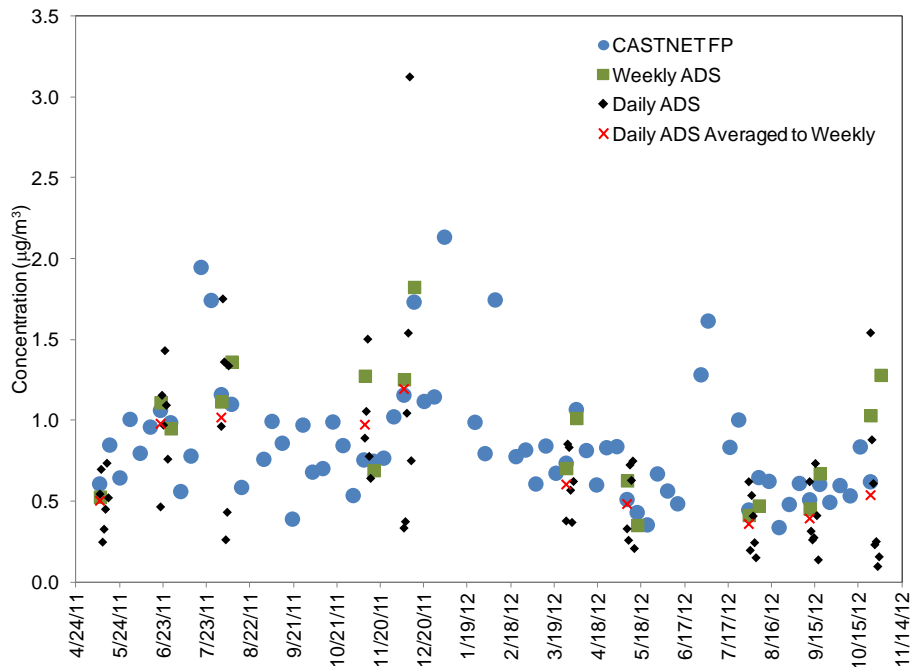
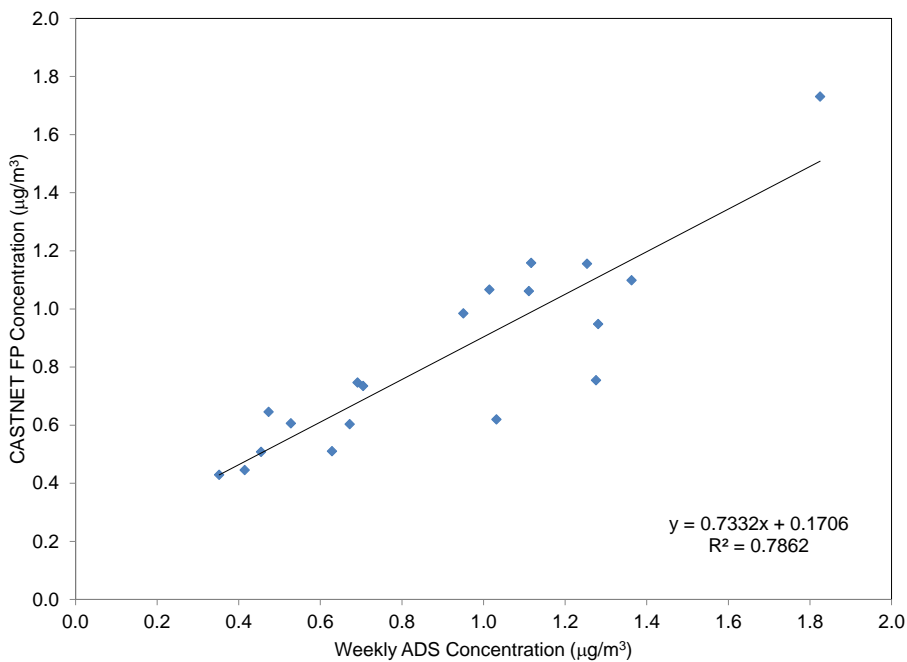

Figure 22. SO₂ Concentrations (µg/m³) Measured by Weekly ADS/FP and CASTNET FP



- **Particulate NO₃⁻**

Figure 23 presents time series of daily, weekly, and daily-averaged-to-weekly particulate NO₃⁻ concentrations from BFT142 measurements collected over a 19-month period. The figure also presents weekly average NO₃⁻ concentrations collected using the CASTNET filter pack at BFT142.

Figure 24 presents a scatter plot of ADS versus CASTNET FP weekly NO₃⁻ concentration measurements. The regression equation fit through the data is

$$y = 1.0262x + 0.5914,$$

with an R² value of 0.1750.

Figure 23. Time Series of Measured NO₃⁻ Concentrations (µg/m³)

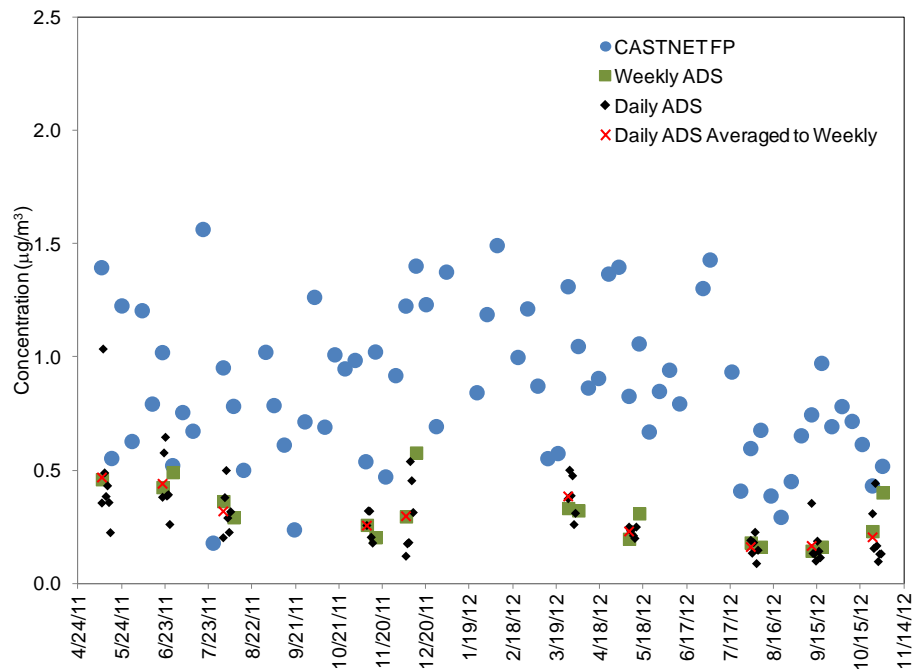
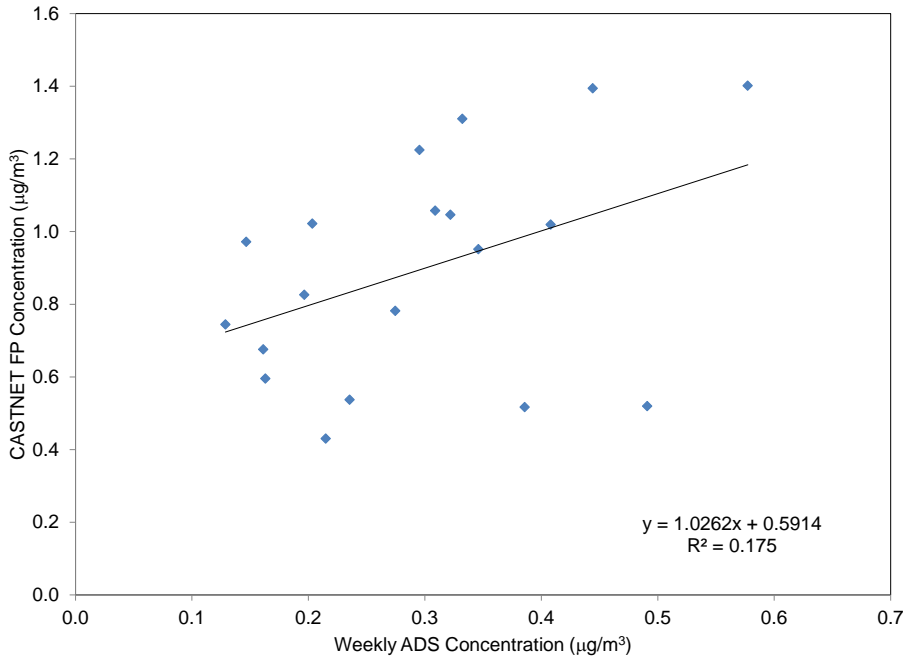

Figure 24. NO₃⁻ Concentrations (µg/m³) Measured by Weekly ADS/FP and CASTNET FP



The scatter diagram shows that, although the slope of the linear regression is near 1.0, the correlation coefficient is low indicating that the distribution is random. In contrast, the results for particulate SO₄²⁻ have a much higher correlation coefficient of 0.819 with a similar slope, primarily because SO₄²⁻ particles exist in the atmosphere in the submicron range. The results for NO₃⁻ were likely caused by the lack of a cyclone separator on the CASTNET filter pack system and the subsequent sampling of large NO₃⁻ particles (Lavery *et al.*, 2009) in the form of NH₄NO₃ in the farm environment.

- **HNO₃**

Figure 25 presents time series of daily, weekly, and daily-averaged-to-weekly HNO₃ concentrations from BFT142 measurements collected over a 19-month period. The figure also presents weekly average HNO₃ concentrations collected using the CASTNET filter pack at BFT142.

Figure 26 presents a scatter plot of ADS versus CASTNET FP weekly HNO₃ concentration measurements. The regression equation fit through the data is

$$y = 1.3034x - 0.0438,$$

with an R² value of 0.7577.

Figure 25. Time Series of Measured HNO₃ Concentrations (µg/m³)

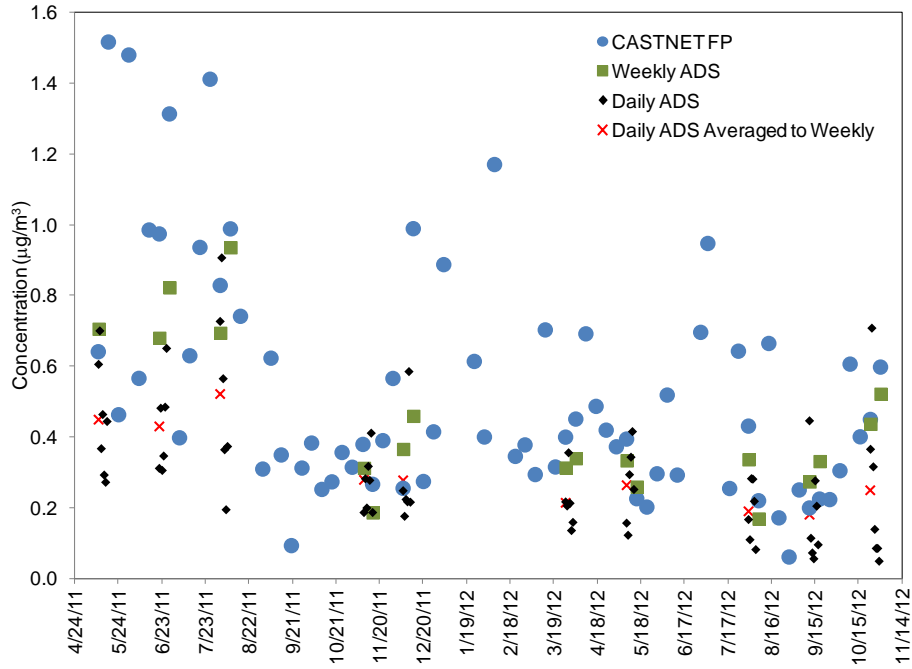
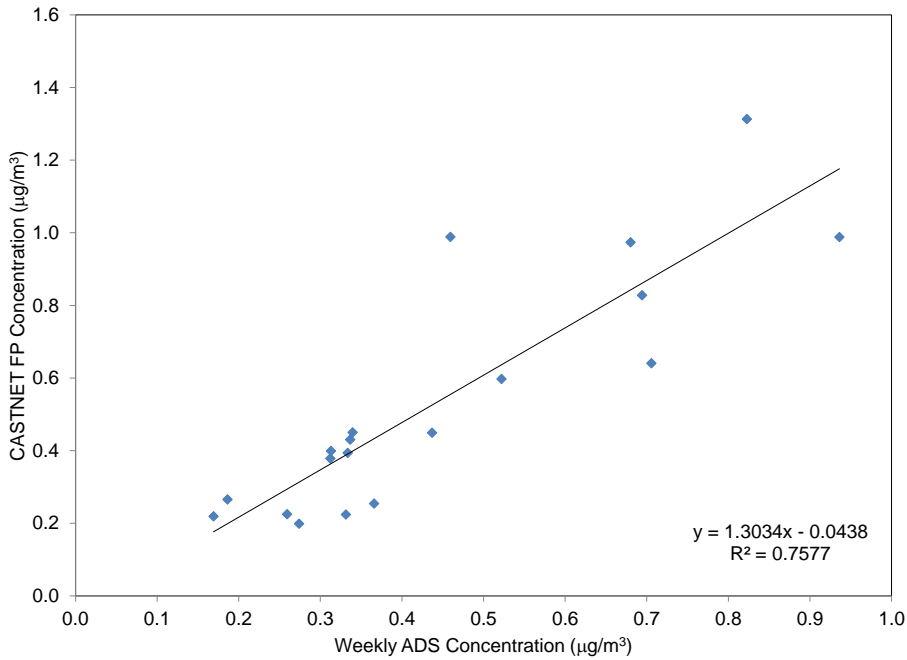

Figure 26. HNO₃ Concentrations (µg/m³) Measured by Weekly ADS/FP and CASTNET FP



The scatter diagram shows good comparisons over the range of HNO₃ concentrations with a high correlation coefficient, even though the regression line suggests HNO₃ levels measured by the filter pack are typically higher than those measured by the ADS.

- **Particulate NH₄⁺**

Time series of daily, weekly, and daily-averaged-to-weekly NH₄⁺ concentrations from BFT142 ADS measurements are displayed in Figure 27. The figure also presents weekly average NH₄⁺ concentrations collected using the CASTNET filter pack at BFT142.

Figure 28 presents a scatter plot of ADS versus CASTNET FP weekly NH₄⁺ concentration measurements. The regression equation fit through the data is

$$y = 0.3177x + 0.3153,$$

with an R² value of 0.2687.

Figure 27. Time Series of Measured NH₄⁺ Concentrations (µg/m³)

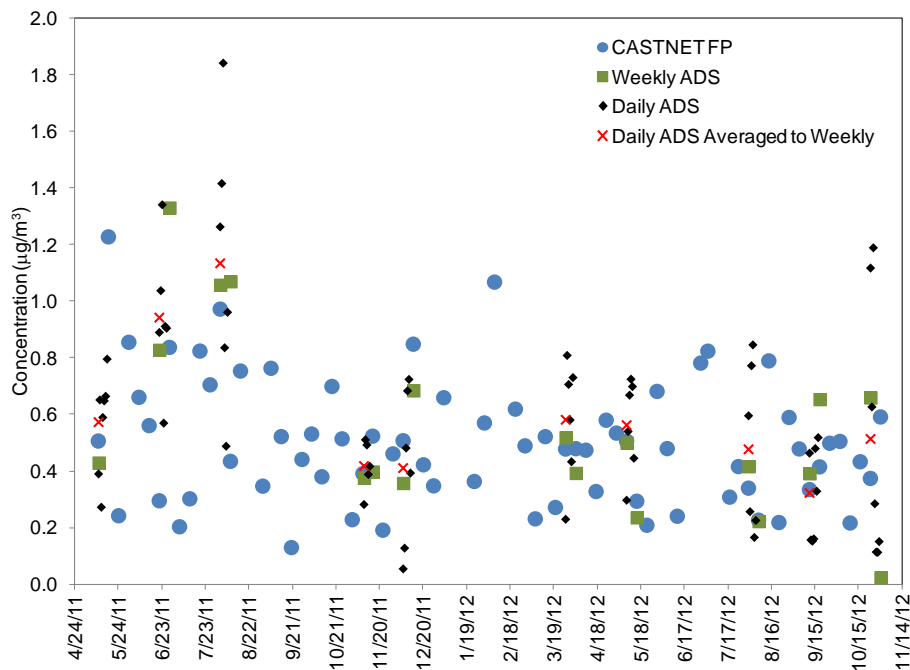
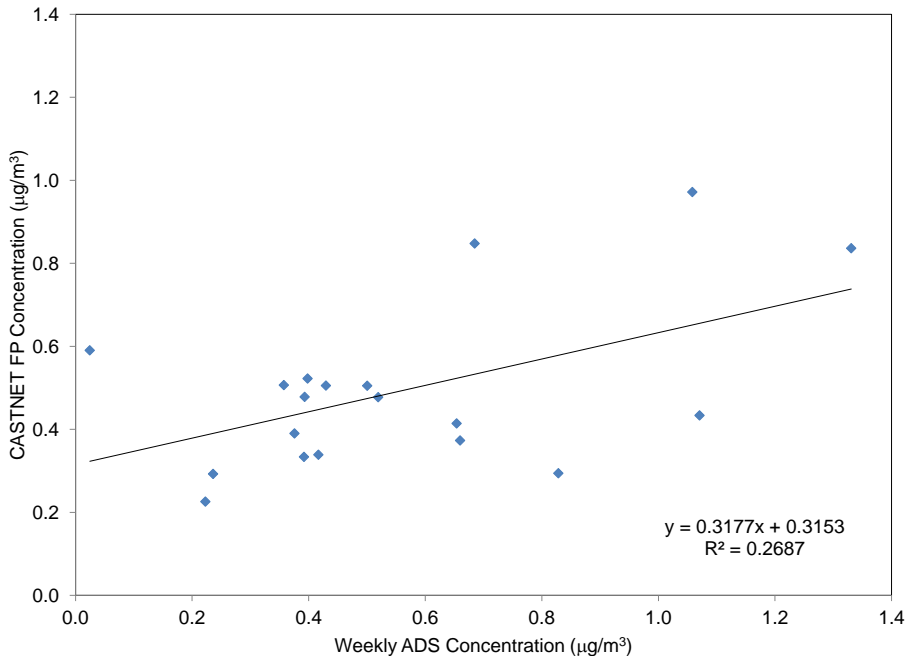

Figure 28. NH_4^+ Concentrations ($\mu\text{g}/\text{m}^3$) Measured by Weekly ADS/FP and CASTNET FP



The scatter diagram shows poor comparisons over the range of NH_4^+ concentrations with a weak correlation coefficient. NH_4^+ concentrations are typically collected as NH_4NO_3 in the atmosphere. Consequently, any sampling issues with NO_3^- concentrations on the CASTNET filter pack will affect NH_4^+ measurements. In particular, the results for HNO_3 , NH_4^+ and NO_3^- were likely caused by volatilization of NH_4NO_3 particles following collection on the Teflon filter. Volatilization results in some loss of NH_4^+ from the Teflon filter as NH_3 . The volatilized NO_3^- is then collected as HNO_3 on the nylon filter (Lavery *et al.*, 2009).

- **Total NO_3^-**

Figure 29 shows time series of daily, weekly, and daily-averaged-to-weekly total NO_3^- concentrations from BFT142 ADS measurements. The figure also presents weekly average total NO_3^- concentrations collected using the CASTNET FP at BFT142. The time series plots show the FP estimates were consistently higher than the ADS/FP measurements over the lifetime of the sampling program.

Figure 30 presents a scatter plot of ADS versus CASTNET FP weekly total NO_3^- concentration measurements. The regression equation fit through the data is

$$y = 1.4705x + 0.6181,$$

with an R^2 value of 0.6609.

Figure 29. Time Series of Measured Total NO₃⁻ Concentrations (µg/m³)

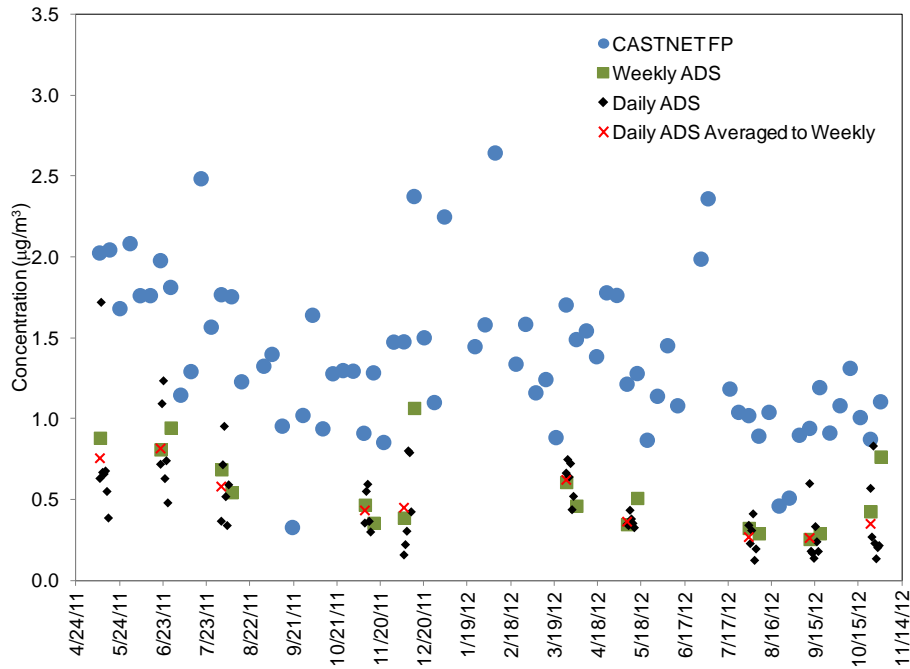
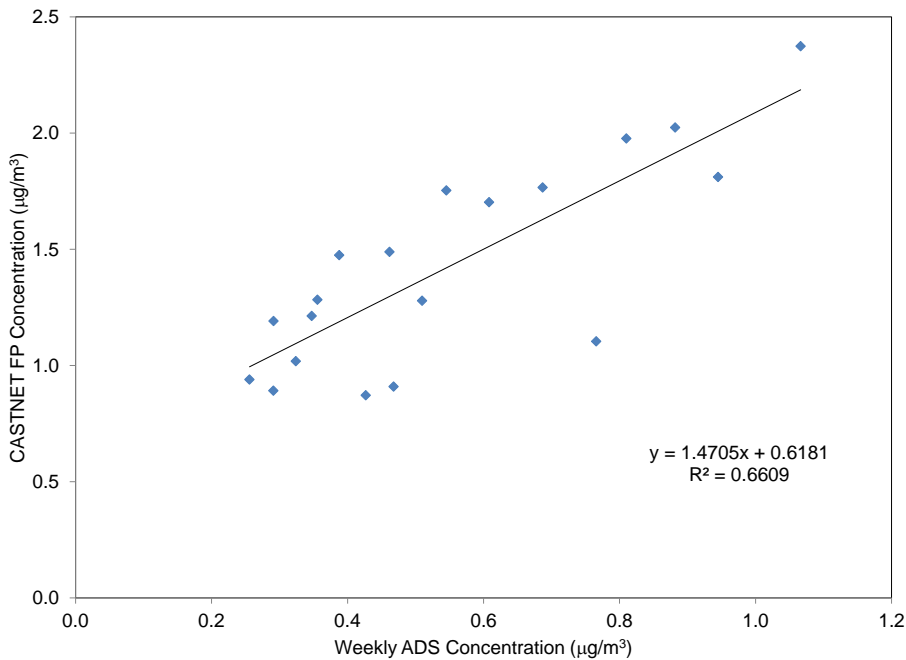

Figure 30. Total NO₃⁻ Concentrations (µg/m³) Measured by ADS/FP and CASTNET FP



Similar to the results for NO₃⁻ sampling, the higher total NO₃⁻ concentrations on the CASTNET FP were likely caused by the lack of a cyclone separator on the filter pack system and the subsequent sampling of large NO₃⁻ particles (Lavery *et al.*, 2009) in the environment around OGF.

4.0 Deposition of Atmospheric Nitrogen and Sulfur

Estimates of dry atmospheric deposition of nitrogen and sulfur species were obtained from measured concentrations and Multi-Layer Model (MLM)-modeled hourly deposition velocities (V_d), with the exception of V_d for NH_3 . The dry flux of NH_3 was estimated from the concentrations measured at BFT142, NC and a V_d value of 0.81 centimeters per second (cm/sec) selected from a 2002 Community Multiscale Air Quality Modeling System (CMAQ) model run (EPA, 2011). The MLM calculations of V_d were based on onsite meteorological measurements and land use data approximated for an area within a 1 km radius around the BFT142 site. Wet deposition was based on NADP/NTN onsite measurements using the seven seasonal deposition values covering the study period averaged and scaled to the year.

Figure 31 provides a pie chart that illustrates the estimates of individual component contributions to total nitrogen (as N) deposition in kilograms per hectare per year (kg/ha/yr). Flux data used in the pie chart are taken from the entire study period and scaled to one calendar year. The small component labeled as being NH_x is from the H_3PO_3 -impregnated backup filter and likely represents either NH_3 gas not captured by the denuder or particulate NH_4^+ that volatilized from the Teflon filter and was collected by the backup filter. Figure 32 shows the contributions to total sulfur (as S) deposition. The species contributions to total deposition and their percentages are summarized in Table 3. The dominant contributors to total nitrogen deposition at this site are dry NH_3 deposition, which is particularly notable because NH_3 has not been routinely measured at CASTNET sites prior to inclusion of AMoN measurements, wet NH_4^+ deposition, and wet NO_3^- deposition. The largest contributor to total sulfur deposition is wet SO_4^{2-} deposition.

Figure 31. Components of Total Nitrogen Deposition (kg/ha/yr)

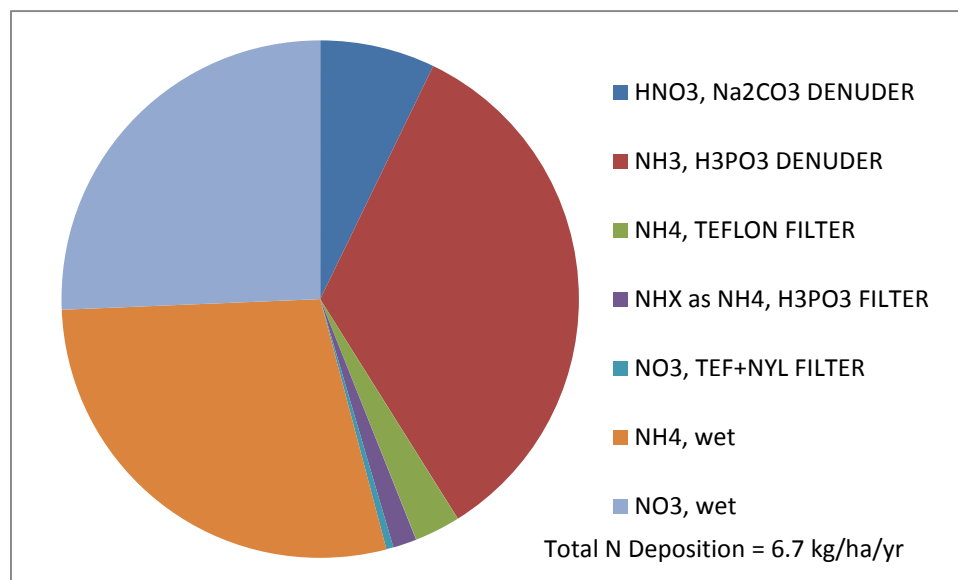

Figure 32. Components of Total Sulfur Deposition (kg/ha/yr)

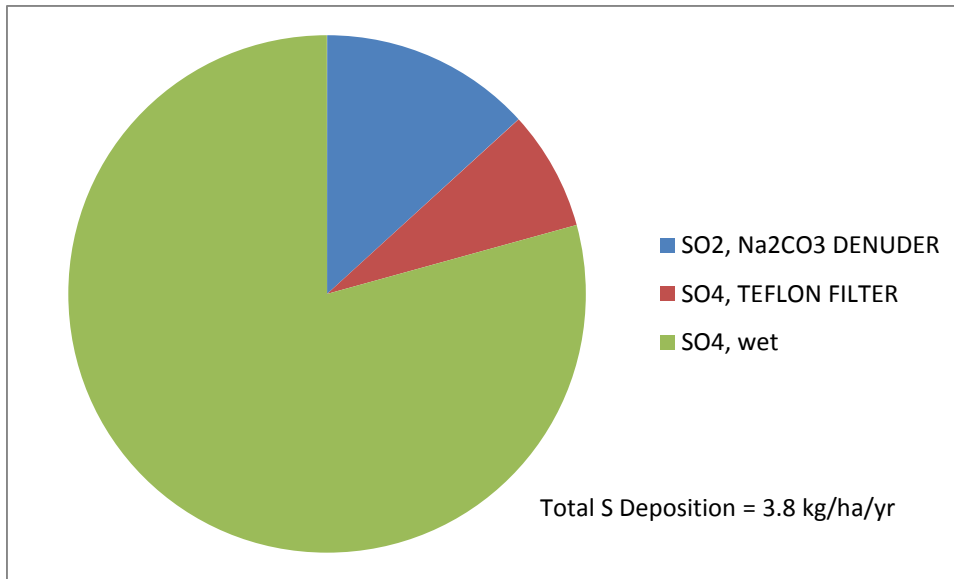

Table 3. Contributions to Total Deposition

	Nitrogen (kg/ha/yr) as N		Sulfur (kg/ha/yr) as S		
	Dry	Percent		Dry	Percent
HNO ₃	0.48	7.1	SO ₂	0.50	13.2
NH ₃	2.28	33.9	SO ₄ ²⁻	0.28	7.4
NH ₄ ⁺	0.19	2.8			
NH _x	0.10	1.5			
NO ₃ ⁻	0.03	0.5			
	Wet			Wet	
NH ₄ ⁺	1.92	28.5	SO ₄ ²⁻	3.01	79.4
NO ₃ ⁻	1.73	25.7			
	Total		Total		
N	6.74	100.0	S	3.80	100.0

5.0 Results of the NO_y Measurement Program

a. Overview

The Beaufort Study collected hourly average NO, NO_x, and NO_y concentrations from February 2012 through May 2013. The measurements were collected using a Thermo 42i-Y analyzer with two converters. One converter was located at 10 m for NO_y and the second at the analyzer for NO_x. For every minute of data collection, 20 seconds were dedicated to the NO measurement, 20 seconds to a pre-reactor measurement, and 10 seconds each to NO_y and NO_x measurements. Performance of the data logger programs was verified at the AMEC field laboratory before deployment to BFT142. NO₂ was calculated as the difference between NO_x and NO. All concentration data were archived as hourly averages.

b. Field Evaluation and Quality Assurance

Appendix 11 of the CASTNET QAPP describes the field evaluation methods used to control and check the operation of the trace-level gas instruments (AMEC, 2012). This appendix covers site operations, data collection, and QC requirements. All supplies used to conduct monitoring and sampling meet the specifications of EPA and Teledyne Advanced Pollution Instrumentation (TAPI). The calibration gases used for the gaseous criteria monitors are traceable to the National Institute of Standards and Technology (NIST) and are protocol gases. The analyzers are mounted inside a secure trailer, which is temperature controlled.

Zero, span, and precision (ZSP) checks of the NO_y analyzers are performed automatically every other day based on the concentration levels listed in Table 4. TAPI multigas calibration and zero air systems, and protocol gas cylinders produce the calibration gases, and the CR3000 data logger controls the process. CASTNET data analysts review data, including NO_y data, for the previous day for all EPA-sponsored CASTNET sites. A data analyst will note questionable values and enter observations per site into the CASTNET Problem Tracking System. Precision and span checks are judged successful if the results are within ± 10 percent of the test values. Zeroes must be within 3 percent of full scale values. If the ZSP results exceed the criteria, data are invalidated back to the previous successful ZSP and forward to the next passing ZSP. Troubleshooting is performed to determine root cause, and appropriate corrective action is implemented. Instrument calibration is performed only if troubleshooting reveals that it is necessary.

Field calibrations are critical to achieving and maintaining data quality indicator (DQI) criteria. Every six months, AMEC or subcontractor technicians visit each site to perform routine calibration and maintenance of all sensors and instruments. AMEC personnel may calibrate the NO_y sensors independent of the routine calibration visit. The concentration levels listed in Table 4 are used for the multipoint calibrations, again using the TAPI multigas calibration and zero air systems and the CR3000 data logger.

Table 4. Quality Control Checks for NCore Analyzers

Zero, Span, and Precision Checks Every Other Day			
Parameter	Zero (ppb)	Span (ppb)	Precision (ppb)
SO ₂	± 3.0	90 ± 10%	25 ± 10%
NO/NO _y /NPN	± 3.0	90 ± 10%	15 ± 10%
CO	± 40.0	1800 ± 10%	250 ± 10%

Notes: The n-propyl nitrate (NPN) QC checks are performed exclusively at span level at a frequency of every fourth day. Span concentrations are 90 percent of full scale. If the ZSP results exceed criteria, data are invalidated back to the previous successful ZSP and forward to the next passing ZSP.

Multipoint Calibrations Every Six Months						
Parameter	Calibration Concentration Levels (ppb)					
SO ₂	90	40	15	7	4	0.0
NO/NO _y /NPN	90	40	15	7	4	0.0
CO	1800	800	300	150	80	0.0

c. Data Evaluation and Completeness

Section 4.0 and Appendix 11 (NCore Air Monitoring Equipment) of the CASTNET QAPP describe the data validation procedures implemented for all CASTNET measurements. These apply to NO/NO_y data as well. In general, continuous measurements undergo three levels of validation.

After daily polling of all CASTNET stations, Level 1 validation procedures are initiated. Level 1 validation consists of a set of automated screening protocols that initiate the transfer of data between tables, the translation of data status flags and data screening, and they create the data template, generate reports on the completeness of the data and the results of data screening and archive the data. Data status flags are listed in Table 4-8 in Section 4.0 of the CASTNET QAPP.

The purpose of Level 2 validation is to develop a complete database. The process involves a data analyst reviewing data at the end of a month and retrieving missing data using LoggerNet data collection software. Essentially, this step represents a double check of the daily review process. Level 2 validation is complete when the data for all time periods for all of the sampling sites have been accounted for, data have been recovered from the on-site data loggers and entered into the database, and sources of missing data are documented.

Level 3 validation involves a more detailed evaluation of the data. The site status report form (SSRF), site narrative log sheets, ZSP data, calibration data, and audit results are reviewed for each site. In addition, data are screened using tools that identify potential problems such as values greater than the expected range and invalid combinations of status flags, values, and spikes. All review and editing activities are documented both electronically and on hard copy forms.

Perhaps the most important assessment of NO/ NO_x/ NO_y measurements is the review of ZSP checks. If the ZSP results exceed criteria, troubleshooting is performed to determine root cause and appropriate corrective action is implemented. Unscheduled instrument calibration is performed as a corrective action only if the review reveals it is necessary. Routine 6-month field calibrations are also critical to achieving and maintaining DQI criteria. Results from the ZSP checks and the 6-month and unscheduled calibrations are used to assess NO/ NO_x/ NO_y data validity.

All BFT NO_y and related data underwent the three levels of validation discussed above. These validation steps resulted in 87 percent valid data. Another criterion used specifically for the BFT database was to require both valid (called Category A) and suspect (flagged S) NO_y data (called Category B) to be greater than or equal to NO_x concentrations. These requirements resulted in a NO_y data percent completeness of 54 percent. The low data completeness was likely caused by incomplete conversion of NO_y at the 10-m converter or collection of NO_z species in the NO_x sample line and eventual release and sampling of these species as NO_x. The valid NO_y and related data were used to complete the analyses summarized in this section.

d. Comparison of Weekly Average NO_y Concentrations with Weekly Filter Pack Total Nitrate Concentration Data

HNO₃ and particulate NO₃⁻ are measured on CASTNET filter packs and the sum is defined as total NO₃⁻. To evaluate the components of NO_y measurements, NO_y concentrations were compared with CASTNET filter pack total NO₃⁻ concentrations. Since NO_y species include HNO₃ and particulate NO₃⁻ the ratio of total NO₃⁻ to NO_y should always be less than or equal to 1.0. Figure 33 provides a time series of weekly total NO₃⁻ and weekly average NO_y concentrations collected at BFT142. Other than for one week, the NO_y concentrations were consistently higher than the total NO₃⁻ levels, as expected. Qualitatively, the two measurements follow similar temporal patterns throughout the study period. For this analysis, all valid NO_y measurements were used regardless of their relationship to NO_x measurements.

Figure 33. Weekly Total NO₃ and Weekly Average NO_y Concentrations (ppb)

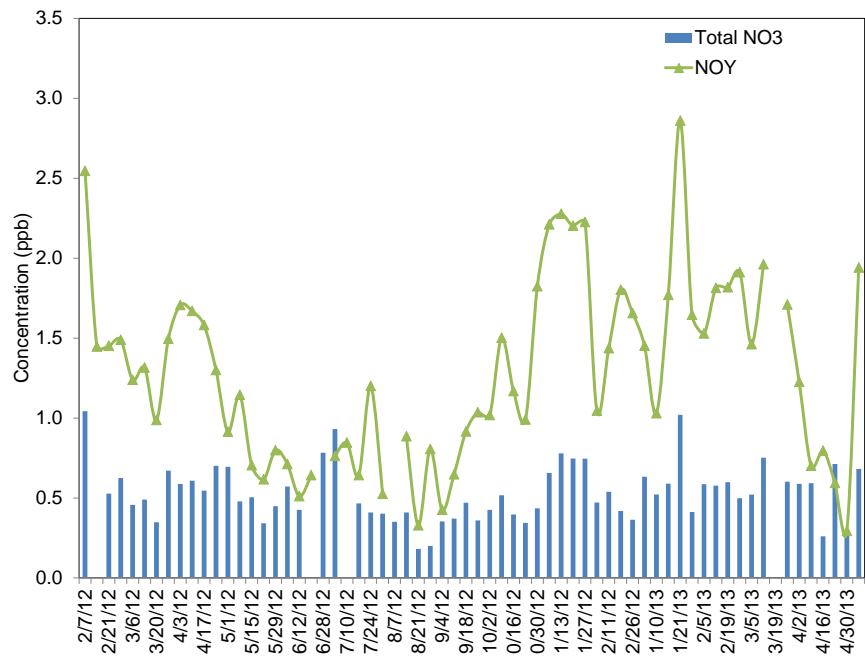

e. Time Series of Weekly NO_y, NO_x, NO₂, NO_z, NO, and O₃ Concentrations

Figure 34 provides graphs of valid weekly NO_y, NO_x, NO₂, NO_z, NO, and O₃ concentrations collected over the entire measurement period. The NO₂ and NO_z concentrations are calculated values. The O₃ measurements were plotted only for those weeks that met a 60 percent completeness requirement. The seasonal pattern for O₃ and the nitrogen species is evident with ozone peaking in the warm summer months while the highest concentrations for the nitrogen species are evident during the winter months.

f. Time Series of Monthly NO_y, NO_x, NO₂, NO_z, NO, and O₃ Concentrations

Time series of monthly average nitrogen species concentrations and O₃ concentrations are given in Figure 35. Similar to Figure 34, the highest O₃ concentration occur during the summer season and the highest concentrations for the nitrogen species are seen during the winter months.

Figure 34. Weekly NO_y, NO_x, NO₂, NO_z, NO, and O₃ Concentrations (ppb)

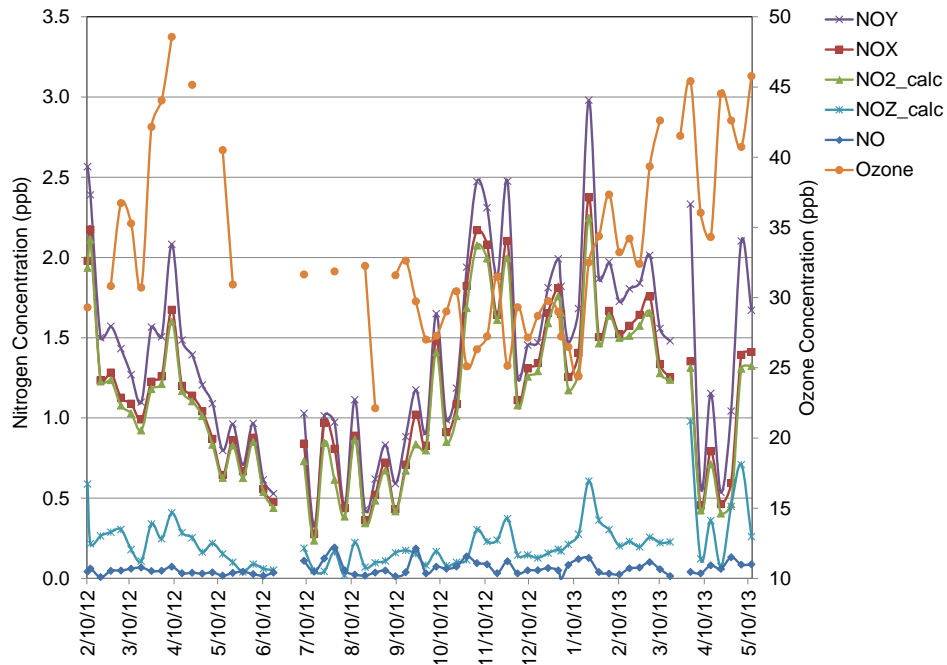
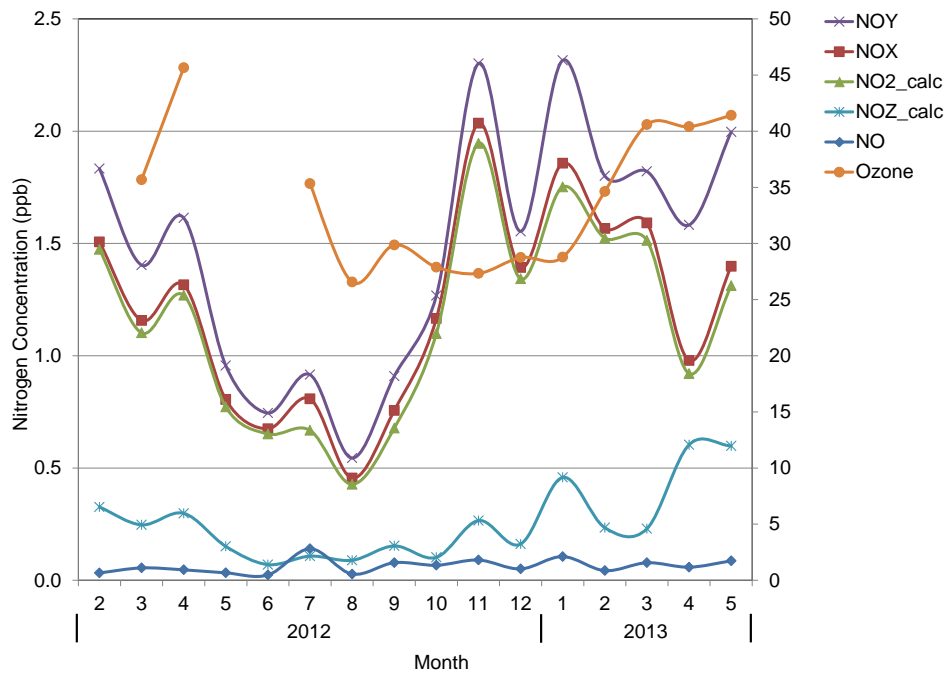

Figure 35. Time Series of Monthly Average Nitrogen Species Concentrations and O₃ Concentrations (ppb)



g. Ratios of Weekly NO_x and NO_y Concentrations

Figure 36 provides time series of ratios of weekly NO_x to NO_y concentrations. The ratios range from about 0.58 to 1.0. For most of the study period, the ratio is constant in the middle of the range. Figure 37 presents a composite diurnal distribution of the ratios. The ratios peaked during the morning and evening rush hours when NO_x was produced from fresh vehicular emissions. The NO_x/NO_y ratio decreased during the day as photochemistry depleted some of the NO_x . However, the measurements indicate the $\text{NO}_x - \text{O}_3$ photochemistry was not depleted entirely, with sufficient NO_x available to produce O_3 farther downwind.

Figure 36. Time Series of Ratios of Weekly NO_x to NO_y Concentrations

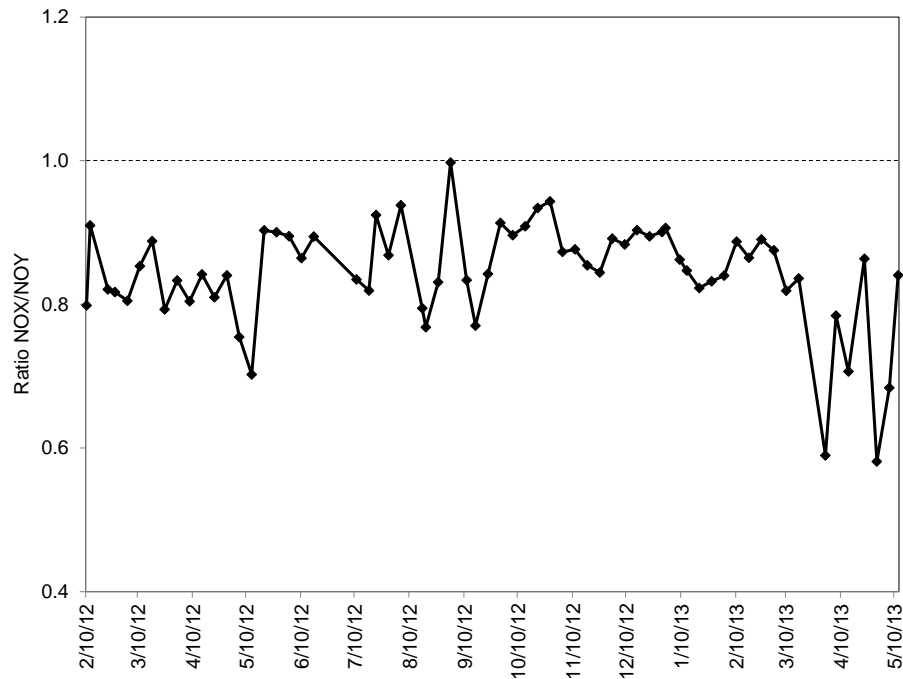
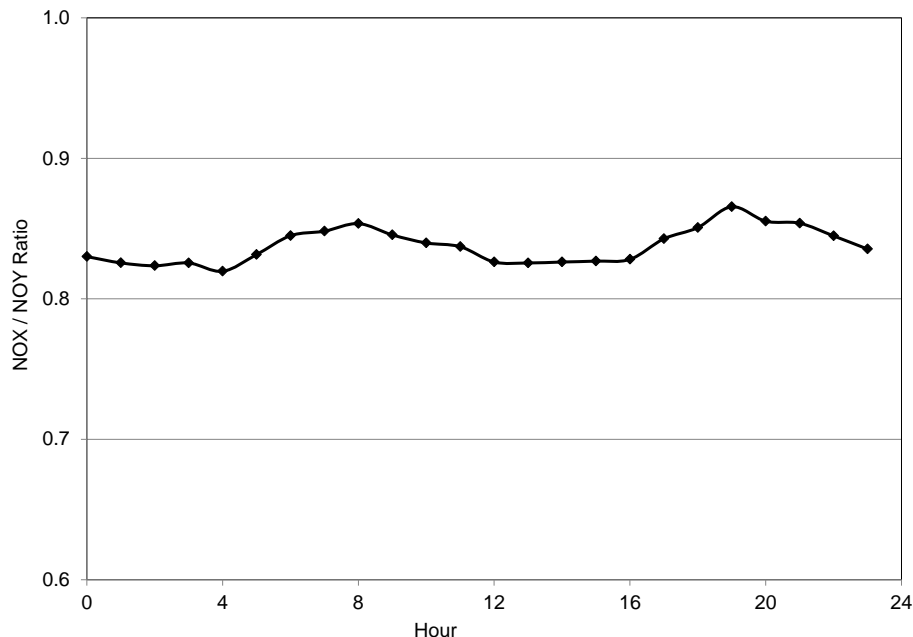

Figure 37. Composite Diurnal Distribution of Ratios of Weekly NO_x to NO_y Concentrations



h. Diurnal Plots of Aggregated Nitrogen Species and O_3 Concentrations

Figure 38 shows six plots of composite NO_y , NO_x , NO_2 , NO_z , NO , and O_3 concentrations. The curves were constructed by averaging all hours for each hour of the day for each parameter for the entire measurement period. The results show typical temporal distributions with NO values at 0.0 for much of the night due to oxidation by O_3 and conversion to NO_2 . NO_2 levels showed little variation during the day. NO_y , NO_x , and NO_2 levels increased after sunrise with fresh NO emissions produced by vehicular traffic and other sources. O_3 concentrations peaked around 1500 local time. The growth of the convective boundary layer, photochemical transformations, and dry deposition decreased nitrogen concentrations during the day as O_3 levels increased. A secondary smaller peak in NO_y , NO_x , and NO_2 concentrations was observed in the evening. Estimated daytime NO_2 concentrations ranged from about 1.0 to 1.5 ppb, typical of rural settings. The typical daytime O_3 concentration increase was about 15 ppb for the Beaufort site.

Figure 38. Composite NO_y, NO_x, NO₂, NO_z, NO, and O₃ Concentrations (ppb)

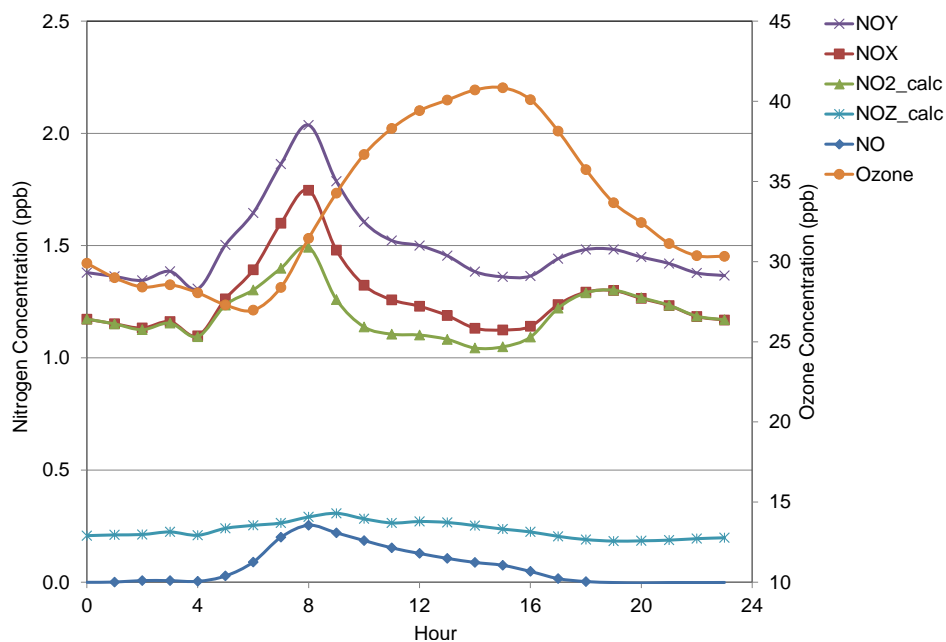

6.0 Summary of Measurements

Atmospheric pollutant concentrations were collected using an ADS/FP system at the CASTNET BFT142 site near Beaufort, NC. ADS measurements generally compared reasonably well with AMoN and CASTNET filter pack data. The ADS data corroborate the use of 2-week passive Radiello samples to measure NH₃. The ADS/FP data also compared well with standard CASTNET FP measurements with the exception of particulate NO₃⁻, particulate NH₄⁺, and total NO₃⁻. Because the CASTNET filter pack system does not use a cyclone separator to collect large particles, CASTNET measurements of NO₃⁻ and total NO₃⁻ were higher than the corresponding ADS/FP measurements. The scatter diagram for NH₄⁺ shows fair comparisons over the range of NH₄⁺ concentrations with a weak correlation coefficient. These results were likely affected by the collection of larger NH₄NO₃ particles on the CASTNET filter pack. Also, any volatilization of NH₄NO₃ can result in loss of NH₄⁺ as NH₃ and collection of particulate NO₃⁻ as HNO₃.

Total nitrogen and sulfur deposition were estimated for the Beaufort, NC site. Dry deposition was estimated from measured concentrations of nitrogen and sulfur species and modeled dry deposition velocities. Wet deposition rates were measured onsite and obtained from NADP/NTN. Dry and wet deposition fluxes were summed to obtain total deposition (Table 3). Dry NH₃, wet NH₄⁺, and wet NO₃⁻ fluxes were the main contributors to nitrogen deposition. Wet SO₄²⁻ contributed more than 75 percent of total sulfur deposition.

Direct measurements of NO, NO_x, NO_y, and O₃ concentrations were made at the Beaufort, NC site during the 19-month sampling program. Concentrations of NO₂ and NO_z were estimated as

differences between the other nitrogen measurements. Apparent problems with the NO_y converter atop the 10-m tower and other sampling issues resulted in 87 percent data completeness for the NO_y measurements. Screening the data with an additional criterion requiring NO_y concentrations to be greater than or equal to NO_x values resulted in a data set with a completeness of 54 percent for use in this report. Subsequent analyses, e.g., those shown in Figure 33, suggest most of the problems were with the NO_x measurements and that the NO_y data were largely valid. NO_x measurements may have been affected by the difference in inlet height from those used in typical NO_x monitoring configurations. For this study, ambient air was sampled at the 10-m height of the NO_y converter even though NO_x monitoring is usually performed at inlet heights of less than 4 m. A vertical gradient in HNO₃ concentrations with lower concentrations near the ground may have led to higher HNO₃ being sampled by the NO_x channel at 10 m. Also, sampling at 10 m required longer sampling tubing than a typical NO_x installation. Adsorption and desorption of nitrogen species, such as HNO₃, might have led to nitrogen components of NO_z being sampled as NO_x. The various analyses presented in Figures 33 through 38 show that, following screening, the behavior of the nitrogen species and O₃ concentrations were consistent with expected atmospheric behavior/models.

This study identifies a portion of the nitrogen deposition budget not typically characterized by routine CASTNET measurements. Specifically, as shown by Figure 34, information on the components of NO_y, other than HNO₃ and NO₃⁻, is gained by the addition of these nitrogen species measurements. These data provide a better estimate of the nitrogen burden in the atmosphere. The development of a NO_y network within CASTNET will provide more data and increase understanding of the importance of these nitrogen compounds. The NO_y study at BFT142 demonstrates that value can be added to existing NO_y sites by the inclusion of converters specific to the measurement of other components of total nitrogen, such as NO_x and, by difference, NO₂. Future research should examine the artifacts produced by converters, such as the molybdenum converter used in this study, and investigate other options that may produce improved results, such as an LED-based photolytic converter for NO_x.

The information in this document has been funded wholly under EPA contract EP-W-09-028, managed and collaborated by the United States Environmental Protection Agency's Office of Research and Development and Office of Air Programs. It has been subjected to the Agency's peer and administrative review and has been approved for publication as an EPA document.

7.0 References

- AMEC Environment & Infrastructure, Inc. (AMEC). 2012. *Clean Air Status and Trends Network (CASTNET) Quality Assurance Project Plan Revision 8.0*. Prepared for the U.S. Environmental Protection Agency (EPA), Office of Air and Radiation, Clean Air Markets Division, Washington, D.C. Contract No. EP-W-09-028. Gainesville, FL.
- Environmental Protection Agency Clean Air Status and Trends Network Home Page. See <http://java.epa.gov/castnet/> (accessed October 2013).
- EPA/ ORD/ NERL. *Summary Report of the Special Reactive Nitrogen (Nr) Inter-Comparison Study: Ammonia CASTNET CSN Study (ACCS)*. Research Triangle Park, NC: GPO, In Press.
- Lavery, T. F., C. M. Rogers, R. E. Baumgardner Jr., K. P. Mishoe. (2009). Intercomparison of CASTNET NO_3^- and HNO_3 measurements with data from other monitoring programs. *J. Air & Waste Manage. Assoc.*, 59, 214-226.
- Meyers, T.P., Finkelstein, P., Clarke, J., Ellestad, T.G., and Sims, P.F. 1998. A Multilayer Model for Inferring Dry Deposition Using Standard Meteorological Measurements. *J. Geophys. Res.*, 103D17:22,645-22,661. National Atmospheric Deposition Program / Ammonia Monitoring Network Home Page. See <http://nadp.sws.uiuc.edu/nh3net/> (accessed October 2013).
- Puchalski, M. A., M. E. Sather, J. T. Walker, C. M. B. Lehmann, D. A. Gay, J. Mathewe, W. P. Robarge. (2011). Passive ammonia monitoring in the United States: Comparing three different sampling devices. *J. Environ. Monit.*, 13, 3156



Please make all necessary changes on the below label, detach or copy and return to the address in the upper left hand corner.

If you do not wish to receive these reports CHECK HERE ; detach, or copy this cover, and return to the address in the upper left hand corner.

PRESORTED STANDARD
POSTAGE & FEES PAID
EPA PERMIT No. G-35

Office of Research
and Development (8101R)
Washington, DC 20460

Official Business
Penalty for Private Use
\$300

EPA/600/R-14/182
August 2014
www.epa.gov



Recycled/Recyclable
Printed with vegetable-based ink on
paper that contains a minimum of
50% post-consumer fiber content
processed chlorine free