

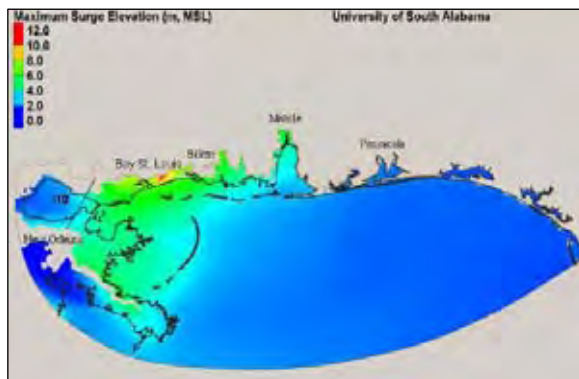

U.S. Department  
of Transportation  
Federal Highway  
Administration

Publication No. FHWA-NHI-07-096  
June 2008

Hydraulic Engineering Circular No. 25

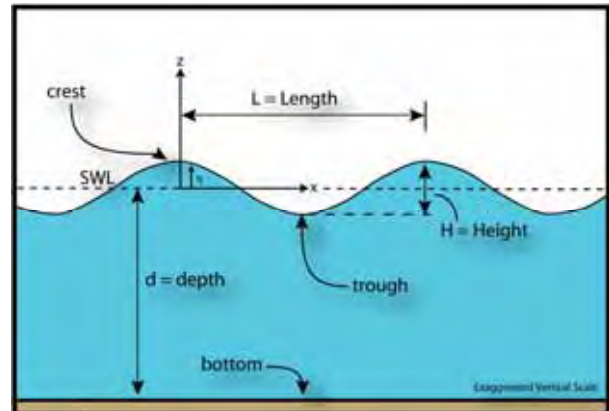

# Highways in the Coastal Environment

Second Edition



**Technical Report Documentation Page**

1. Report No. FHWA NHI-07-096		2. Government Accession No.		3. Recipient's Catalog No.	
4. Title and Subtitle  HIGHWAYS IN THE COASTAL ENVIRONMENT Hydraulic Engineering Circular 25 Second Edition				5. Report Date  June 2008	
				6. Performing Organization Code	
7. Author(s)  Scott .L. Douglass and Joe Krolak				8. Performing Organization Report No.	
9. Performing Organization Name and Address  Department of Civil Engineering University of South Alabama 307 University Boulevard Mobile, Alabama 36688				10. Work Unit No. (TR AIS)	
				11. Contract or Grant No.  DTFH61-03-C-00015	
12. Sponsoring Agency Name and Address  Office of Bridge Technology Federal Highway Administration 400 Seventh Street, S.W. Washington, D.C. 20590				13. Type of Report and Period Covered	
				14. Sponsoring Agency Code	
15. Supplementary Notes  Project Manager: Joe Krolak, FHWA Office of Bridge Technology Technical Reviewers: Richard Weggel, Billy Edge, Kevin Bodge, Rick Renna, Dave Henderson, Larry Arneson					
16. Abstract This report provides guidance for the analysis, planning, design and operation of highways in the coastal environment. The focus is on roads near the coast that are always, or occasionally during storms, influenced by coastal tides and waves. A primary goal of this report is the integration of coastal engineering principles and practices in the planning and design of coastal highways. It is estimated that there are over 60,000 road miles in the United States that can be called "coastal highways." Some of the physical coastal science concepts and modeling tools that have been developed by the coastal engineering community, and are applicable to highways, are briefly summarized. This includes engineering tools for waves, water levels, and sand movement. Applications to several of the highway and bridge planning and design issues that are unique to the coastal environment are also summarized. This includes coastal revetment design, planning and alternatives for highways that are threatened by coastal erosion, roads that overwash in storms, and coastal bridge issues including wave loads on bridge decks.					
17. Key Words			18. Distribution Statement		
19. Security Classif. (of this report)  Unclassified		20. Security Classif. (of this page)  Unclassified		21. No. of Pages  246	22. Price
<b>Form DOT F 1700.7 (8-72)</b>			<b>Reproduction of completed page authorized</b>		

*Page Intentionally Left Blank*

# Table of Contents

Table of Contents.....	i
List of Figures .....	vi
List of Tables.....	xii
List of Symbols.....	xiii
Acknowledgements.....	xvi
Glossary .....	Glossary: 1 of 18
Part 1 – Background & Context .....	1
Chapter 1 - Introduction .....	3
1.1 Purpose.....	3
1.2 Target Audience .....	3
1.3 Organization .....	4
1.4 Units in this Document .....	5
Chapter 2 - Coastal Highways .....	7
2.1 What are Coastal Highways? .....	7
2.2 Estimating the Extent of Coastal Roads and Bridges.....	8
2.3 Societal Demand for Coastal Highways .....	8
2.4 Natural Coastal Processes Impacting Highways.....	9
2.4.1 Water Level Change.....	10
2.4.2 Storm Surge .....	10
2.4.3 Major Weather Events .....	10
2.4.4 Waves.....	13
2.4.5 Shoreline Erosion .....	13
2.4.6 Littoral Drift .....	13
2.4.7 Shoreline Recession.....	14
2.4.8 Tsunamis .....	14
2.4.9 Upland Runoff.....	15
2.4.10 High-Velocity Flows .....	15
2.4.11 Other Processes.....	15
2.5 Coastal Highway Planning and Design .....	15

Table of Contents

2.6	Coastal Engineering as a Specialty Area .....	16
2.6.1	Education.....	16
2.6.2	State-of-Practice .....	16
2.6.3	Resources .....	17
2.7	Coastal Engineering in the Highway Community .....	17
Part 2 – Principles of Coastal Science & Engineering .....		19
Chapter 3 - Tides, Storm Surge and Water Levels .....		21
3.1	Astronomical Tides.....	21
3.1.1	Characteristics of Astronomical Tides .....	21
3.1.2	Tidal and Survey Datums .....	23
3.2	Storm Surge .....	24
3.2.1	Modeling Approaches.....	25
3.2.2	Design Water Levels .....	28
3.3	Sea Level Rise .....	29
3.4	Lake Water Level Fluctuations .....	32
Chapter 4 - Waves .....		33
4.1	Definitions, Theories, and Properties of Waves .....	33
4.2	Wave Transformation and Breaking.....	41
4.3	Irregular Waves .....	47
4.3.1	Numerical Models.....	50
4.4	Wave Generation .....	51
4.5	Tsunamis.....	53
4.6	Ship Wakes .....	54
Chapter 5 - Coastal Sediment Processes .....		55
5.1	Overview of Coastal Geomorphology.....	55
5.2	Beach Terminology .....	59
5.3	Coastal Sediment Characteristics .....	63
5.4	Cross-Shore Sand Transport and Dune Erosion Modeling .....	65
5.5	Longshore Sand Transport and Shoreline Change Modeling .....	69
5.6	Tidal Inlets.....	71
5.7	Physical Models in Coastal Engineering .....	76
Part 3 – Issues and Approaches in Coastal Highway Design.....		79

Chapter 6 - Coastal Revetments for Wave Attack .....	81
6.1 Types of Revetments and Seawalls .....	81
6.2 Hudson's Equation for Armor Stone Size .....	89
6.3 Design Wave Heights for Revetment Design .....	90
6.4 Practical Issues for Coastal Revetment Design .....	92
Chapter 7 - Roads in Areas of Receding Shorelines .....	99
7.1 Examples of Issues .....	99
7.2 Quantifying Shoreline Change Rates .....	103
7.3 Estimating Future Shoreline Positions .....	106
7.3.1 Shortcomings of Shoreline Change Assumptions .....	108
7.3.2 Sediment Budgets .....	108
7.4 Vulnerability Studies for Coastal Roads and Bridges .....	110
7.5 Relocation Considerations .....	111
7.5.1 Shoreline Stabilization Options .....	112
7.6 Coastal Structures .....	112
7.6.1 Beach Nourishment .....	115
7.6.2 Combining Beach Nourishment with Structures .....	117
7.6.3 Non-traditional/Innovative Solutions .....	122
Chapter 8 - Highway Overwashing .....	125
8.1 Description of Issue .....	125
8.2 The Coastal Weir-Flow-Damage Mechanism .....	126
8.2.1 Coastal Weir-Flow Damage Mechanism Investigations .....	131
8.3 Strategies for Roads that Overwash .....	135
8.3.1 Road Location Considerations .....	135
8.3.2 Road Elevation Considerations .....	135
8.3.3 Construction of Sand Dunes .....	136
8.3.4 Armoring of Shoulders .....	138
Chapter 9 - Coastal Bridges .....	141
9.1 Locations of Coastal Bridges .....	142
9.1.1 Bridges at Inlets .....	142
9.1.2 Bridge Causeways .....	143
9.1.3 Bridges spanning Tidal arms / Embayments .....	144
9.1.4 River Mouth Bridge Crossings .....	145
9.2 Coastal Bridge Scour .....	146

Table of Contents

9.2.1	Coastal Bridge Scour Policy, Guidance, and Research .....	146
9.2.2	Coastal Bridge Scour Hydrology and Hydraulics.....	146
9.2.3	Types of Coastal Bridge Scour.....	148
9.2.4	Wave Scour .....	151
9.2.5	Examples of Coastal Bridge Scour.....	152
9.3	Coastal Bridge Wave Forces.....	156
9.3.1	Some Specific Damaged Bridges.....	156
9.3.2	Wave Loads – A Potential Bridge Failure Mechanism .....	158
9.3.3	Available Literature on Wave Forces and Loads.....	159
9.3.4	Wave Load Constituents .....	160
9.3.5	Methods for Estimating Wave Loads on Bridge Decks .....	161
9.3.6	Wave Load Mitigation: Designs and Countermeasures .....	161
9.4	Other Coastal Bridge Issues .....	165
9.5	Selection of Design Storm Surge & Design Wave Heights .....	166
9.5.1	Design Storm Surge SWL .....	166
9.5.2	Design Wave Heights .....	167
9.5.3	Coastal Engineer Involvement.....	167
	Chapter 10 - References.....	169
	Appendix A - Metric System, Conversion Factors, and Water Properties .....	A.1
	Appendix B – Coastal Roadway Study .....	B.1
B.1	Study Approach.....	B.1
B.2	Application of Reduction Factor .....	B.1
B.3	Study Outcomes.....	B.1
B.4	Study Caveats .....	B.6
	Appendix C – Estimation of Wave Height and Period.....	C.1
	Appendix D – Scour Policy, Guidance, and Research.....	D.1
D.1	Coastal Scour Policy, Guidance, and Research .....	D.1
D.1.1	Technical Advisory T 5140.23 – Evaluating Scour at Bridges.....	D.1
D.1.2	Highway Engineer Circular 18 – Evaluating Scour at Bridges.....	D.1
D.1.3	Bridge Scour Countermeasures .....	D.1
D.2	Coastal Scour Research and Studies .....	D.2
D.2.1	American Society of Civil Engineer efforts .....	D.2
D.2.2	Pooled Fund Study .....	D.2



D.2.3	Florida DOT Sponsored Research .....	D.2
D.2.4	University of South Alabama Studies .....	D.3
Appendix E – A Method for Estimating Wave Forces on Bridges.....		E.1
E.1	Wave-Induced “Varying” Loads.....	E.1
E.2	Impact Loads.....	E.4
E.3	Example Application of Wave Load Equations.....	E.5
E.4	Discussion of Recommended Method.....	E.5

## List of Figures

Figure 2.1. A Coastal Highway in the United States. ....	7
Figure 2.2. Bridge on the Pacific Coast Highway (California Route 1). ....	8
Figure 2.3. Estimates of road mileage in the 100-year coastal floodplain. ....	9
Figure 2.4. Coastal water level fluctuations. ....	12
Figure 2.5. US Highway 90 bridge across Biloxi Bay, Mississippi, after Hurricane Katrina. (photo looking northeast from Biloxi 9/21/05). ....	13
Figure 2.6. Breaches in Outer Bank barrier island caused by Hurricane Isabel in 2002 (NC 12 ROW is dotted line). ....	14
Figure 3.1. Basic Definitions of Tides modified from <a href="http://tidesandcurrents.noaa.gov">http://tidesandcurrents.noaa.gov</a> . ....	22
Figure 3.2. An example of the relationship between the survey and tidal datums. ....	24
Figure 3.3. Storm surge at Galveston, Texas, from Hurricane Alicia in 1983. ....	25
Figure 3.4. Example of a numerical grid for a coastal hydrodynamic model (from Douglass, et al. 2006) ....	26
Figure 3.5. Estimates of the peak storm surge caused by Hurricane Katrina (from Douglass, et al. 2006) ....	27
Figure 3.6. Storm surge hydrograph as estimated by ADCIRC modeling for Hurricane Katrina at the US 90 bridge across Biloxi Bay, Mississippi (from Douglass, et al. 2006) ....	27
Figure 3.7. Sea levels along the US Atlantic and Gulf coasts for the past century. ....	30
Figure 3.8. Sea levels along the US Pacific coast for the past century. ....	31
Figure 4.1. Wave parameter definitions. ....	34
Figure 4.2. Water particle paths under waves in deep water. ....	38
Figure 4.3. Water particle paths under waves in shallow and intermediate water depths .....	38
Figure 4.4. Stokes 2 <sup>nd</sup> order wave theory water surface profile. ....	39
Figure 4.5. Bending of wave crests as they approach the shore due to refraction (from USACE 2002). ....	42
Figure 4.6. Wave energy focused on headland by a wave refraction and diffraction (from USACE 2002). ....	43
Figure 4.7. Depth-limited wave breaking in shallow water. ....	44
Figure 4.8. Wave breaker types (Sorensen 1993). ....	46
Figure 4.9. An example of a plunging breaker (from Douglass 2002). ....	46
Figure 4.10. An example of a “collapsing” breaker (Morro Bay, California). ....	47
Figure 4.11. A train of long-period swell approaching the coast. ....	48
Figure 4.12. Irregular waves on San Francisco Bay, California. ....	48
Figure 4.13. A storm-driven, irregular, sea state. ....	49

Figure 4.14. Example of wave generation equations applied to a specific site.....	52
Figure 4.15. SWAN estimates of maximum significant wave heights generated during Hurricane Katrina in immediate vicinity of U.S. 90 bridge over Biloxi Bay. ....	53
Figure 5.1. Erosional features associated with rocky coasts (from Komar 1998) .....	56
Figure 5.2. Sea cliff in San Diego California with pocket beach .....	56
Figure 5.3. Features associated with depositional coasts (from Komar 1998) .....	57
Figure 5.4. Barrier islands of the Outer Banks of North Carolina.....	57
Figure 5.5. Sea level change curves for the past 20,000 years (adapted from Davis 2004) .....	58
Figure 5.6. Terminology used to describe processes of waves and currents in the surf zone (Komar 1998).....	59
Figure 5.7. Terminology used to describe the beach profile .....	60
Figure 5.8. Sand bar and trough exposed at low tide .....	60
Figure 5.9. A beach scarp.....	61
Figure 5.10. Beach profile surveying crew using a traditional level-rod and tag line system .....	62
Figure 5.11. A CRAB (Coastal Research Amphibious Buggy) used to measure beach profiles during beach nourishment .....	62
Figure 5.12. Dean’s equilibrium beach profile shape definition sketch .....	64
Figure 5.13. Examples of colors of US beach sands (from Douglass 2002) .....	65
Figure 5.14. Example grain size distribution based on a sieve analysis for beach sand .....	66
Figure 5.15. Typical beach profile changes in response to cross-shore transport of sand.....	67
Figure 5.16. Kriebel’s dune erosion model results example .....	68
Figure 5.17. Definition sketch of wave angle at breaking .....	69
Figure 5.18. The CERC equation model for longshore sand transport rate plotted with field data (adapted from USACE 1984) .....	71
Figure 5.19. Two tidal inlets on the southwest Florida coast (New Pass and Big Sarasota Pass). Lido Key is the barrier island between the two inlets. Net longshore sand transport is to the south. ....	72
Figure 5.20. Typical inlet morphology .....	73
Figure 5.21. Idealized ocean-inlet-bay system (adapted from USACE 1984) .....	74
Figure 5.22. Tidal prism versus minimum inlet throat area for all major inlets on the Atlantic, Gulf, and Pacific coasts (USACE 1984) .....	75
Figure 5.23. Physical model test of wave loads on bridge decks (Texas A&M photo).....	77
Figure 6.1. A revetment protecting a coastal highway. Bayfront Road, Mobile, Alabama (2001).....	82
Figure 6.2. Types of shore protection walls. ....	82
Figure 6.3. Galveston Seawall. Seawall Boulevard (1983).....	83
Figure 6.4. San Francisco’s Great Highway Seawall. California Highway 35 (1991).....	83

List of Figures

Figure 6.5. Seawall protecting a coastal highway. Venice, Florida (2001) ..... 84

Figure 6.6. Seawall protecting a coastal highway. Pacific Coast Highway, Pacific Palisades, California (2003) ..... 84

Figure 6.7. Seawall protecting a coastal highway. Florida Highway A1A, Flagler Beach, FL..... 85

Figure 6.8. Seawall protecting a coastal highway. US 101, Curry County, Oregon (2001) ..... 85

Figure 6.9. Revetment protecting a highway along a bay shoreline. Florida Highway 60, Tampa Bay, Florida (2003)..... 86

Figure 6.10. Revetment protecting a highway along a bay shoreline. Washington State Route 105, Willapa Bay, Washington (2003) ..... 87

Figure 6.11. Seawall protecting a local road. West Cliff Drive, Santa Cruz, California..... 88

Figure 6.12. Concrete seawall designed to look like the natural rock formation built on an eroding sea cliff to protect a local road. East Cliff Drive, Santa Cruz, California ..... 88

Figure 6.13. Typical coastal revetment design cross-section ..... 90

Figure 6.14. Example of a failed attempt at embankment protection (USACE archives photo) ..... 92

Figure 6.15. A revetment with rocks too small to withstand wave attack..... 93

Figure 6.16. An example of splash damage behind seawall..... 94

Figure 6.17. Wave runup definition sketch..... 95

Figure 6.18. Example of rigid concrete-block revetment failure (Florida Highway A1A, Delray Beach, circa 1972; University of Florida and USACE archive photos) ..... 96

Figure 6.19. Example of failed block revetment (Louisiana Highway 87, circa 1980, USACE archives photos)..... 96

Figure 6.20. Example of rigid revetment failure on a coastal highway bridge approach..... 97

Figure 7.1. A road initially built inland of a receding shoreline is now in the sea. Stump Hole area of Cape San Blas, Florida (2005 FDOT photo)..... 99

Figure 7.2. A highway initially built inland now threatened by long-term shoreline erosion. Cape Shoalwater area of Washington State Road 105 (2003) ..... 100

Figure 7.3. A local road threatened by long-term shoreline recession. Ocean Drive, Whale Beach area of Cape May County Road 619, Ludlam Island, New Jersey (2003)..... 101

Figure 7.4. A local road being undermined by bluff erosion and long-term shoreline recession on the Great Lakes. Painesville, Ohio (2001) ..... 102

Figure 7.5. Road destroyed by shoreline recession: a) broken pavement on the beach at the old location; b) south end of the closed section; c) location map. Texas Highway 87, Jefferson County (2002) ..... 103

Figure 7.6. An example of historical shorelines based on USC&GS/NOS surveys updated with modern technology. Cape Shoalwater, Washington (Kaminsky, et al. 1999) ..... 104

Figure 7.7. An example of shoreline position changes through time. Stump Hole area of St. Joseph's Peninsula, Florida .....	105
Figure 7.8. An example of shoreline change rates along 30,000 feet of coast showing temporal and spatial variations but a significant recessional trend. Western-facing shoreline of St. Joseph's Peninsula, Florida.....	106
Figure 7.9. Example of projected future shoreline positions at Stump Hole (FDOT figure) .....	107
Figure 7.10. Example of a coastal sediment budget (Coastal Tech and Preble-Rish, Inc. 1998) .....	109
Figure 7.11. Example of coverage for a vulnerability study (North Carolina DOT) .....	111
Figure 7.12. Groin field in Long Beach, New York (New York Sea Grant photo).....	113
Figure 7.13. Groin field in Long Branch, New Jersey (2006) .....	113
Figure 7.14. Severe shoreline recession and beach erosion downdrift of a groin field (West Hampton, New York, circa 1985, New York Sea Grant photo) .....	114
Figure 7.15. A beach nourishment project under construction. Gulf Shores, Alabama (2001) .....	115
Figure 7.16. Beach nourishment project with constructed dune on top of old, failed revetment protecting road. Florida Highway A1A, Delray Beach (2001).....	116
Figure 7.17. Beach nourishment seaward of a seawall protecting a road. New Jersey State Highway 35, Sea Bright, New Jersey (2001).....	117
Figure 7.18. Offshore segmented breakwaters with tombolos in beach nourishment protecting a highway (Louisiana Highway 82, Holly Beach) (American Shore and Beach Preservation Association photo, circa 2003).....	118
Figure 7.19. Offshore segmented breakwaters with salients in beach nourishment (USACE archive photo, circa 1980).....	119
Figure 7.20. Offshore segmented breakwater system at Presque Isle, Pennsylvania.....	120
Figure 7.21. Empirical guidance for shoreline effect of offshore segmented breakwaters. (after Pope and Dean 1986, and USACE 2002). .....	121
Figure 7.22. Offshore segmented breakwaters with groins and beach nourishment on Corpus Christi Bay (Ocean Drive, Corpus Christi, Texas).....	121
Figure 7.23. Constructed pocket beach stabilized with a T-head groin breakwater system (Point Clear, Alabama).....	122
Figure 7.24. Beach nourishment project stabilized as pocket beaches with a headland breakwater system protecting a road (Water Street, Yorktown, Virginia).....	122
Figure 8.1. A coastal road being overwashed during a storm. North Carolina Highway 12, November 23, 2006 (North Carolina DOT photo).....	125
Figure 8.2. Example of pavement damage due to storm surge. Florida 292 on Perdido Key, Florida after Hurricane Ivan (Sept. 2004).....	126
Figure 8.3. Example of pavement damaged by Hurricane Ivan. (photo looking west on Florida 399, J. Earle Bowden Way, Gulf Islands National Seashore, September 2005).....	127

List of Figures

Figure 8.4. Flow regimes leading to failure of embankments in riverine flooding situations (after Clopper and Chen 1988)..... 128

Figure 8.5. Embankment failure mechanisms (after Clopper and Chen 1988)..... 128

Figure 8.6. Pavement destroyed by the weir-flow mechanism (Ft. Pickens Road, Gulf Islands National Seashore, near Pensacola, Florida). ..... 129

Figure 8.7. Weir-flow damage beginning. (Florida 399, Fort Pickens Road, Gulf Islands National Seashore; July 2005; FHWA photo)..... 130

Figure 8.8. Weir-flow damage occurring. (Florida 399, Fort Pickens Road, Gulf Islands National Seashore; July 2005; FHWA photo)..... 130

Figure 8.9. USA/TAMU laboratory experiment model setup schematic..... 131

Figure 8.10. Schematic of USA/TAMU laboratory experiments test run one result ..... 131

Figure 8.11. Schematic of USA/TAMU laboratory experiments test run two result..... 132

Figure 8.12. Laboratory tests of the weir-flow damage mechanism showing scour destroying the downstream shoulder and beginning to undermine the edge of pavement. (USA/TAMU flume tests, June 2005). ..... 132

Figure 8.13. Laboratory tests of the weir-flow damage mechanism showing scour has continued to point of undermining failure of 3 sections (6 feet) of roadway surface. (USA/TAMU flume tests, June 2005). ..... 133

Figure 8.14. Pavement moved landward by overwash processes. (Gulf Islands National Seashore, Perdido Key, Florida after Hurricane Ivan; 2004)..... 134

Figure 8.15. Evidence of weir-flow damage to the seaward edge of pavement due to return flow late in the storm (West Beach Blvd., Alabama 182, Hurricane Ivan, Gulf Shores, Alabama)..... 134

Figure 8.16. Schematic of sand erosion and deposition on a barrier island resulting from overwash. .... 135

Figure 8.17. Example of road buried by overwash and opened by plowing sand off..... 136

Figure 8.18. Artificial sand dune constructed seaward of a highway to protect the highway (North Carolina Highway 12) ..... 137

Figure 8.19. Schematic summarizing three approaches (bayward location, low elevation, constructed sand dunes near road) to minimize damage to roads that overwash. .... 137

Figure 8.20. Sheet pile, with buried gabions for scour protection, at edge of pavement to resist pavement damage due to coastal storm surge overwash. (Florida DOT figure). .... 138

Figure 8.21. Gabions at edge of pavement to resist pavement damage due to coastal storm surge overwash. (Florida DOT figure) ..... 139

Figure 8.22. Conceptual design to resist pavement damage due to coastal storm surge overwash ..... 140

Figure 9.1. Conceptual schematic of four typical bridge locations within the coastal environment..... 142

Figure 9.2. Bridge spanning small inlet (SH 182 in Gulf Shores, Alabama)..... 143

Figure 9.3. Ben Sawyer causeway bridge between Mount Pleasant and Sullivan’s Island, SC. ....	144
Figure 9.4. West Coast River Mouth Crossings.....	145
Figure 9.5. Scour at a Coastal Bridge Pier .....	149
Figure 9.6. Time Dependent Contraction Scour Results (Zevenbergen, et al. 2004) .....	151
Figure 9.7. Wave scour hole formed by Hurricane Katrina.....	152
Figure 9.8. Indian River Inlet, Delaware (USACE photo).....	153
Figure 9.9. Johns Pass, Florida (2002).....	154
Figure 9.10. Jensen Beach Causeway bridge.....	155
Figure 9.11. Jensen Beach Causeway bridge post event scour bathymetry (2005).....	155
Figure 9.12. Location map of some of the highway bridges damaged by hurricanes in the last 40 years along the north-central Gulf coast.....	156
Figure 9.13. Interstate-10 bridge across Escambia Bay, Florida, after Hurricane Ivan. Photo looking east from Pensacola at dawn September 16, 2004. (Pensacola News Journal photo) .....	157
Figure 9.14. US 90 bridge over Biloxi Bay, Mississippi showing the spans at higher elevations were not removed (photo looking southwest from Ocean Springs 2/19/06.) .....	158
Figure 9.15. Schematic of wave-induced uplift and lateral loads on a bridge deck.....	159
Figure 9.16. Schematic of typical time-history of wave loads on rigid structures.....	161
Figure 9.17. Definition sketch of wave parameters and water levels for determining elevation of bridge deck for clearance from wave crests .....	162
Figure B.1. Estimates of road mileage in the 100-year floodplain. ....	B.3
Figure B.2. Estimates of road mileage in 100-year floodplain “V-zones”.....	B.4
Figure B.3. Estimates of coastal highway mileage per State.....	B.7
Figure E.1. Horizontal and vertical wave-induced loads on bridge decks.....	E.3
Figure E.2. Definition sketch for $\Delta Z_h$ , $\Delta Z_v$ , $A_h$ , $A_v$ , and $\eta_{max}$ used for estimating wave loads on elevated bridge decks .....	E.3
Figure E.3. Alternative definition sketch for $\Delta z_v$ .....	E.7

## List of Tables

Table 4.1. Wave height statistics in irregular seas.....	50
Table B.1. Coastal State mileage in 100-year coastal floodplains and v-zones. ....	B.2
Table B.2. Atlantic and Gulf coastal county mileage in 100-year floodplains and v-zones. ....	B.5
Table B.3. Pacific and Great Lake States coastal county mileage in 100-year floodplains. ....	B.6
Table B.4. Summary of state coastal road miles and “reduction factors.” .....	B.8



## List of Symbols

$A$	= parameter in Dean's equilibrium profile shape
$A_h$	= the area of the projection of the bridge deck onto the vertical plane
$A_v$	= area of the bridge contributing to vertical uplift (i.e. the projection of the bridge deck onto the horizontal plane)
$A_x$	= horizontal component of water particle acceleration
$A_z$	= vertical component of water particle acceleration
$B_x, B_y$	= baroclinic pressure gradients in the two horizontal directions
$C$	= wave celerity, the speed of wave movement
$c$	= empirical coefficient
$C_D$	= drag coefficient
$C_g$	= wave group velocity
$C_{gb}$	= wave group velocity at breaking
$C_{h-im}$	= an empirical coefficient for the horizontal "impact" load on bridge decks
$C_M$	= coefficient of mass or inertia
$C_o$	= deepwater wave celerity
$C_r$	= reflection coefficient
$c_r$	= coefficient to account for horizontal loads due to bridge girders
$C_{va-h}$	= empirical coefficient for the horizontal, wave-induced "varying" load on bridge decks
$C_{va-v}$	= empirical coefficient for the vertical, wave-induced "varying" load on bridge decks
$C_{v-im}$	= an empirical coefficient for the vertical, wave-induced "impact" load on bridge decks
$d$	= water depth
$d_{50}$	= median diameter of sand grains
$d_s$	= design depth at the toe of the structure
$D$	= diameter of pile in Morison's equation
$\bar{E}$	= total energy in a wave train per unit area of sea averaged over one wavelength
$f$	= Coriolis parameter
$f_D$	= drag force per unit length of pile in Morison's equation
$f_i$	= inertial force per unit length of pile in Morison's equation
$f_p$	= horizontal force per unit length of a vertical pile in Morison's equation
$F$	= fetch length
$(F_h)_{max}$	= maximum of the horizontal wave-induced load
$(F_v)_{max}$	= maximum of the vertical wave-induced load
$Fh^*$	= a "reference" horizontal load
$Fv^*$	= a "reference" vertical load
$g$	= acceleration due to gravity
$H$	= wave height
$\bar{H}_1$	= average of the highest 1% of waves
$\bar{H}_5$	= average of the highest 5% of waves
$\bar{H}_{10}$	= average of the highest 10% of waves
$H_{1\%}$	= height exceeded by 1% of waves
$H_{10\%}$	= height exceeded by 10% of waves
$(H/d)_{max}$	= maximum ratio of wave height to water depth

## List of Symbols

$H/L$	=	incident wave steepness
$H_b$	=	wave height at breaking
$H_i$	=	incident wave height
$H_{max}$	=	maximum wave height
$H_{m_o}$	=	spectral-based significant wave height
$H_o'$	=	unrefracted deepwater wave height
$H_r$	=	reflected wave height
$H_s$	=	significant wave height
$K$	=	an empirical coefficient in CERC equation for longshore sand transport rate
$k$	=	wave number = $2\pi/L$
$K_D$	=	empirical coefficient in Hudson's equation for revetment stone size for wave attack
$K_s$	=	shoaling coefficient
$L$	=	wavelength
$L_o$	=	deepwater wavelength
$M_x, M_y$	=	horizontal momentum diffusion components
MHW	=	mean high water datum
MHHW	=	mean higher high water datum
MLW	=	mean low water datum
MLLW	=	mean lower low water datum
MSL	=	mean sea level
$n$	=	ratio of wave group velocity to wave celerity
$N$	=	the number of girders supporting the bridge span deck
NAVD 88	=	North American Vertical Datum of 1988
NGVD 29	=	National Geodetic Vertical Datum of 1929
$\bar{P}$	=	wave energy flux propagating across a vertical plane perpendicular to the direction of wave propagation and extending down the entire depth
$P_{is}$	=	wave energy flux factor
$Q$	=	longshore sand transport rate
$r$	=	roughness coefficient
$R_u$	=	vertical extent of wave runup
$R_{u,2\%}$	=	runup level exceeded by 2% of runups in an irregular sea
$S_r$	=	specific gravity of stone
SWL	=	stillwater level
$t$	=	time
$T$	=	wave period
$T_a$	=	air temperature
$T_p$	=	wave period corresponding with the peak of the energy density spectrum
$T_w$	=	water temperature
$u$	=	horizontal component of water particle velocity
$U$	=	windspeed not adjusted for air-sea temperature difference
$U, V$	=	depth-averaged velocity components in the x and y directions
$U'$	=	windspeed adjusted for air-sea temperature difference
$U_{3600}$	=	windspeed averaged for one hour
$U_a$	=	adjusted windspeed
$U_l$	=	windspeed over land
$U_t$	=	equivalent windspeed averaged for a duration $t$
$U_w$	=	windspeed over water
(Vol)	=	volume of erosion from the sand dune above the storm surge elevation per unit length of shoreline

$w$	= vertical component of water particle velocity
$W_{50}$	= median weight of armor stone
$W_r$	= unit weight of stone
$x$	= horizontal position
$Y_{\max}$	= difference between the SWL elevation and wave crest elevation for the maximum wave in the design sea-state
$z$	= vertical direction (measured from SWL)
$\alpha$	= the angle of the breaking wave crest with the shoreline
$\gamma$	= unit weight of water (64 lb/ft <sup>3</sup> for saltwater)
$\Delta_{zh}$	= difference between the elevation of the crest of the maximum wave and the elevation of the centroid of $A_h$
$\Delta_{zv}$	= difference between the elevation of the crest of the maximum wave and the elevation of the underside of the bridge deck
$\zeta$	= surf similarity parameter
$\eta$	= water surface elevation
$\bar{\eta}$	= water surface elevation with waves removed (used in hydrodynamic modeling)
$\eta_{\max}$	= maximum elevation of wave crest
$\theta$	= Slope
$\rho$	= density of water
$\sigma$	= wave frequency = $2\pi/T$
$\tau_{bx}, \tau_{by}$	= bottom shear stresses in hydrodynamic modeling
$\tau_{sx}, \tau_{sy}$	= sea surface stresses in hydrodynamic modeling

## Acknowledgements

A technical advisory panel oversaw the development of this document. Members of that panel were Kevin Bodge, Billy Edge, Dave Henderson, Rick Renna, and J. Richard Weggel.

This is the second edition of HEC-25. This second edition is a new document with a new title. The authors of the first edition, entitled "Tidal Hydrology, Hydraulics and Scour at Bridges," were L.W. Zevenbergen, P.F. Lagasse, and B.L. Edge. This second edition incorporates and presents more comprehensive discussions of highways in the coastal environment.

A number of faculty and students at the University of South Alabama provided input into this document including Qin "Jim" Chen, Lauren McNeill, Bret Webb, Caren Reid, Patrick Keith, Joel Richards, and Jason Shaw.

The majority of this document was written by Scott L. Douglass, Professor of Civil Engineering at the University of South Alabama. The project manager, Joe Krolak, FHWA Office of Bridge Technology, provided some significant contributions.

## Glossary

**AASHTO:** American Association of State Highway and Transportation Officials

**ACCRETION:** The extension of a beach out into the water by deposition of sand. Accretion is often used to refer to a net seaward movement of the shoreline over a specified time.

**AEOLIAN:** Pertaining to the wind, especially used with deposits of wind-blown sand such as sand dunes.

**ALONGSHORE:** Parallel to and near the shoreline; longshore.

**ARMOR LAYER:** Protective layer on the outside or top of a revetment or seawall composed of armor units.

**ASTRONOMICAL TIDE:** The tidal levels and character which would result from gravitational effects, e.g. of the Earth, Sun, and Moon, without any atmospheric influences.

**ATTENUATION:** A lessening of the height or amplitude of a wave with distance.

**BACKSHORE:** The zone of the shore or beach lying between the foreshore and the coastline comprising the berm or berms and acted upon by waves only during severe storms, especially when combined with exceptionally high water.

**BAR:** A submerged or emerged embankment of sand, gravel, or other unconsolidated material built on the sea floor in shallow water by waves and currents.

**BARRIER ISLAND:** An unconsolidated, elongated body of sand or gravel lying above the high-tide level and separated from the mainland by a lagoon or marsh. It is commonly between two inlets, has dunes, vegetated areas, and swampy terrains extending from the beach into the lagoon.

**BATHYMETRY:** The depths of water in oceans, seas, and lakes.

**BAY:** 1) a body of water almost completely surrounded by land but open to some tidal flow communications with the sea. 2) a recess in the shore or an inlet of a sea between two capes or headlands, not so large as a gulf but larger than a cove.

**BEACH:** The zone of unconsolidated material, typically sand, that extends landward from closure depths where sand is moved by waves to the place where there is marked change in material or physiographic form, or to the line of permanent vegetation (usually the effective limit of storm waves).

**BEACH FILL:** Sand placed on a beach; beach nourishment

**BEACH BERM:** A nearly horizontal part of the beach or backshore formed by the deposit of material by wave action. Some beaches have no berms, others have one or several.

**BEACH EROSION:** The carrying away of beach materials by wave action, tidal currents, littoral currents, or wind.

**BEACH FACE** The section of the beach normally exposed to the action of the wave uprush. The foreshore of a beach. (Not synonymous with shoreface.)

**BEACH NOURISHMENT:** The direct placement of large amounts of good quality sand on the beach to widen the beach.

## Glossary

**BEACH PROFILE:** A cross-section taken perpendicular to a given beach contour; the profile may include the face of a dune or sea wall; extend over the backshore, across the foreshore, and seaward underwater into the nearshore zone.

**BEACH SCARP:** An almost vertical slope along the beach caused by erosion by wave action. It may vary in height from a few cm to a meter or so, depending on wave action and the nature and composition of the beach.

**BEACH WIDTH:** The horizontal dimension of the beach measured normal from some defined location landward of the shoreline.

**BED FORMS:** Any deviation from a flat bed that is readily detectable by eye and higher than the largest sediment size present in the parent bed material; generated on the bed of an alluvial channel by the flow.

**BENCH MARK:** A permanently fixed point of known elevation. A primary bench mark is one close to a tide station to which the tide staff and tidal datum originally are referenced.

**BERM:** 1) On a beach: a nearly horizontal plateau on the beach face or backshore, formed by the deposition of beach material by wave action or by means of a mechanical plant as part of a beach renourishment scheme. Some natural beaches have no berm, others have several. 2) On a structure: a nearly horizontal area, often built to support or key-in an armor layer.

**BERM BREAKWATER:** Rubble mound structure with horizontal berm of armor stones at about sea level, which is allowed to be (re)shaped by the waves.

**BLUFF:** A high, steep bank or cliff.

**BORE:** A broken wave propagating across the surf zone characterized by turbulent white water.

**BOUNDARY CONDITIONS:** Environmental conditions, e.g. waves, currents, drifts, etc. used as boundary input to physical or numerical models.

**BREACH:** Gap in a barrier island or spit or dune caused by a storm.

**BREAKER:** A wave breaking on a shore, over a reef, etc. Breakers may be classified into four types: collapsing, plunging, spilling, and surging.

**BREAKER ZONE:** The zone within which waves approaching the coastline commence breaking caused by the reduced depths.

**BREAKING:** Reduction in wave energy and height. In the surf zone breaking is due to limited water depth.

**BREAKWATER:** A structure protecting a shore area, harbor, anchorage, or basin from waves.

**BULKHEAD:** A structure or partition to retain or prevent sliding of the land. A secondary purpose is to protect the upland against damage from wave action.

**CANYON:** A relatively narrow, deep depression with steep slopes, the bottom of which grades continuously downward. May be underwater (submarine) or on land (subaerial).

**CAUSEWAY:** A raised road across wet or marshy ground, or across water.

**CAUSTIC:** In refraction of waves, the name given to a region of crossed orthogonals and high wave convergence.

**CELERITY:** Wave speed.

**CERC:** Coastal Engineering Research Center. US Army Corps of Engineers laboratory that was the predecessor for the Coastal Hydraulics Laboratory

**CHANNEL:** 1) A natural or artificial waterway of perceptible extent which either periodically or continuously contains moving water, or which forms a connecting link between two bodies of water. 2) The part of a body of water deep enough to be used for navigation through an area otherwise too shallow for navigation. 3) A large strait, as the English Channel. 4) The deepest part of a stream, bay, or strait through which the main volume or current of water flows.

**CHART:** A special-purpose map, esp. one designed for navigation such as a bathymetric chart.

**CLIFF:** A high, steep face of rock; a precipice.

**CLIMATE:** The characteristic weather of a region, particularly regarding temperature and precipitation, averaged over some significant interval of time (years).

**CLOSURE DEPTH:** The water depth beyond which repetitive profile surveys (collected over several years) do not detect vertical sea bed changes, generally considered the seaward limit of littoral transport. The depth can be determined from repeated cross-shore profile surveys or estimated using formulas based on wave statistics. Note that this does not imply the lack of sediment motion beyond this depth.

**CNOIDAL WAVE:** A type of wave in shallow water (i.e., where the depth of water is less than 1/8 to 1/10 the wavelength).

**COASTAL AREA:** The land and sea area bordering the shoreline.

**COASTAL CURRENTS:** Those currents near the shore that constitutes a relatively uniform velocity. These currents may be tidal currents, transient wind-driven currents, longshore currents driven by breaking waves in the surf zone, or currents associated with the distribution of mass in local waters.

**COASTAL ENGINEERING:** The planning, design, construction and operation of infrastructure in the wave, tide and sand environment that is unique to the coast. A well established specialty area of civil engineering that focuses on the coastal zone and coastal processes.

**COASTAL PROCESSES:** Collective term covering the action of natural forces on the shoreline and nearshore seabed.

**COASTAL ZONE:** The transition zone where the land meets water, the region that is directly influenced by marine and lacustrine hydrodynamic processes. Extends offshore to the continental shelf break and onshore to the first major change in topography above the reach of major storm waves. On barrier coasts, includes the bays and lagoons between the barrier and the mainland.

**COASTLINE:** Commonly, the line that forms the boundary between the land and the water, esp. the water of a sea or ocean.

**COBBLE:** A rock fragment between 64 and 256 mm in diameter, usually rounded. Also called a cobblestone.

**COHESIVE SEDIMENT:** Sediment containing significant proportion of silts or clays, the electromagnetic properties of which cause the sediment to bind together

**COLLAPSING BREAKER:** Breaking occurs over lower half of wave, with minimal air pocket. Bubbles and foam present.

## Glossary

**CONTEXT-SENSITIVE DESIGN:** A collaborative, interdisciplinary approach that involves all stakeholders to develop a transportation facility that fits its physical setting and preserves scenic, aesthetic, historic, and environmental resources, while maintaining safety and mobility.

**CONTINENTAL SHELF:** 1) The zone bordering a continent extending from the line of permanent immersion to the depth, usually about 100 m to 200 m, where there is a marked or rather steep descent toward the great depths of the ocean. 2) The area under active littoral processes during the Holocene period. 3) The region of the oceanic bottom that extends outward from the shoreline with an average slope of less than 1:100, to a line where the gradient begins to exceed 1:40 (the continental slope).

**CONTOUR:** A line on a map or chart representing points of equal elevation with relation to a datum. Also called depth contour.

**CORIOLIS EFFECT:** Force due to the Earth's rotation, capable of generating currents. It causes moving bodies to be deflected to the right in the Northern Hemisphere and to the left in the Southern Hemisphere. The "force" is proportional to the speed and latitude of the moving object. It is zero at the equator and maximum at the poles.

**CREST OF WAVE:** 1) The highest part of a wave. 2) That part of the wave above still-water level.

**CREST OF BERM:** The highest, typically seaward, part of a berm. Also called berm edge.

**CRITICAL FLOW:** The flow condition where the specific energy of flow is at a minimum and the Froude number for the flow is one; term from open-channel flow hydraulics. Related terms are sub-critical flow and super-critical flow.

**CROSS-SHORE:** Perpendicular to the shoreline.

**CURRENT:** 1) The flowing of water, 2) That portion of a stream of water which is moving with a velocity much greater than the average or in which the progress of the water is principally concentrated. 3) Ocean currents can be classified in a number of different ways. Some important types include the following: A) Periodic - due to the effect of the tides; such Currents may be rotating rather than having a simple back and forth motion. The currents accompanying tides are known as tidal currents; B) Temporary - due to seasonal winds; C) Permanent or ocean - constitute a part of the general ocean circulation. The term drift current is often applied to a slow broad movement of the oceanic water; D) Nearshore - caused principally by waves breaking along a shore.

**CYCLONE:** A system of winds that rotates about a center of low atmospheric pressure. Rotation is clockwise in the Southern Hemisphere and anti-clockwise in the Northern Hemisphere. In the Indian Ocean, the term refers to the powerful storms called hurricanes in the Atlantic.

**DATUM:** Any permanent line, plane, or surface used as a reference datum to which elevations are referred.

**DEEPWATER:** Water so deep that surface waves are little affected by the ocean bottom. Generally, water deeper than one-half the surface wavelength is considered deep water.

**DEEPWATER WAVES:** A wave in water the depth of which is greater than one-half the wavelength.

**DENSITY:** Mass (in kg) per unit of volume of a substance;  $\text{kg/m}^3$ . For pure water, the density is  $1000 \text{ kg/m}^3$ , for seawater the density is usually more. Density increases with increasing salinity, and decreases with increasing temperature. For stone and sand, usually a density of  $2600 \text{ kg/m}^3$  is assumed. Concrete is less dense, in the order of  $2400 \text{ kg/m}^3$ . Some types of basalt may reach  $2800 \text{ kg/m}^3$ . For sand, including the voids, one may use  $1600 \text{ kg/m}^3$ .



**DENSITY-DRIVEN CIRCULATION:** Variations in salinity create variations in density in estuaries. These variations in density create horizontal pressure gradients, which drive estuarine circulation.

**DESIGN STORM:** A hypothetical extreme storm whose wave's coastal protection structures will often be designed to withstand. The severity of the storm (i.e. return period) is chosen in view of the acceptable level of risk of damage or failure. A design storm consists of a design wave condition, a design water level and a duration.

**DESIGN WAVE:** In the design of harbors, harbor works, etc., the type or types of waves selected as having the characteristics against which protection is desired.

**DESIGN WAVE CONDITION:** Usually an extreme wave condition with a specified return period used in the design of coastal works.

**DIFFRACTION:** The phenomenon by which energy is transmitted laterally along a wave crest. When a part of a train of waves is interrupted by a barrier, such as a breakwater, the effect of diffraction is manifested by propagation of waves into the sheltered region within the barrier's geometric shadow.

**DIFFRACTION COEFFICIENT:** Ratio of diffracted wave height to deep water wave height.

**DIURNAL:** Having a period or cycle of approximately one tidal day.

**DIURNAL INEQUALITY:** The difference in height of the two high waters or of the two low waters of each day. Also, the difference in velocity between the two daily flood or ebb currents of each day.

**DIURNAL TIDE:** A tide with one high water and one low water in a tidal day.

**DOWNDRIFT:** The direction of predominant movement of littoral materials.

**DREDGING:** Excavation or displacement of the bottom or shoreline of a water body. Dredging can be accomplished with mechanical or hydraulic machines. Most is done to maintain channel depths or berths for navigational purposes; other dredging is for shellfish harvesting, for cleanup of polluted sediments, and for placement of sand on beaches.

**DRIFT:** 1) Sometimes used as a short form for littoral drift. 2) The speed at which a current runs.

**DUNES:** 1) Ridges or mounds of loose, wind-blown material, usually sand.

**DURATION:** In wave forecasting, the length of time the wind blows in nearly the same direction over the fetch (generating area).

**DYNAMIC EQUILIBRIUM:** Short term morphological changes that do not affect the morphology over a long period.

**EBB:** Period when tide level is falling; often taken to mean the ebb current which occurs during this period.

**EBB TIDAL DELTA:** The bulge of sand formed at the seaward mouth of tidal inlets as a result of interaction between tidal currents and waves. Also called outer bar.

**EBB TIDE:** The period of tide between high water and the succeeding low water; a falling tide.

**EL NIÑO:** Global climatologic phenomenon associated with warm equatorial water which flows southward along the coast of Peru and Ecuador during February and March of certain years. During many El Niño years, storms, rainfall, and other meteorological phenomena in the Western Hemisphere are measurably different than during non-El Niño years.

**EMBAYMENT:** An indentation in the shoreline forming an open bay.

## Glossary

**EPOCH:** Tidal epoch is about 19 years.

**EROSION:** The wearing away of land by the action of natural forces. On a beach, the carrying away of beach material by wave action, tidal currents, littoral currents, or by deflation.

**ESTUARY:** 1) The region near a river mouth in which the fresh water of the river mixes with the salt water of the sea and which received both fluvial and littoral sediment influx. 2) The part of a river that is affected by tides.

**EUSTATIC SEA LEVEL CHANGE:** Change in the volume of the world's ocean basins and the total amount of ocean water.

**FDEP:** Florida Department of Environmental Protection

**FEMA:** Federal Emergency Management Agency

**FETCH:** The distance or area in which wind blows across the water forming waves. Sometimes used synonymously with fetch length and generating area.

**FETCH-LIMITED:** Situation in which wave energy (or wave height) is limited by the size of the wave generation area (fetch).

**FETCH LENGTH:** The horizontal distance (in the direction of the wind) over which a wind generates seas or creates a wind setup.

**FLOOD:** 1) Period when tide level is rising; often taken to mean the flood current which occurs during this period. 2) A flow beyond the carrying capacity of a channel.

**FLOOD CURRENT:** The tidal current toward shore or up a tidal stream. Usually associated with the increase in the height of the tide.

**FLOOD TIDAL DELTA:** The bulge of sand formed at the landward mouth of tidal inlets as a result of flow expansion.

**FLOOD TIDE:** The period of tide between low water and the succeeding high water; a rising tide.

**FORESHORE:** The part of the shore, lying between the crest of the seaward berm (or upper limit of wave wash at high tide) and the ordinary low-water mark, that is ordinarily traversed by the uprush and backrush of the waves as the tides rise and fall.

**FREEBOARD:** 1) the vertical distance between the water level and the top of a coastal levee or dike. 2) the distance from the waterline to the low-chord of the bottom of a suspended deck such as a bridge deck or offshore platform. or 3) the distance from the crest of the design wave to the low-chord of the bottom of a suspended deck such as a bridge deck or offshore platform.

**FROUDE NUMBER:** The dimensionless ratio of the inertial force to the force of gravity for a given fluid flow. It may be given as  $Fr = V / \sqrt{Lg}$  where  $V$  is a characteristic velocity,  $L$  is a characteristic length, and  $g$  the acceleration of gravity - or as the square root of this number.

**FULLY-ARISEN SEA:** The waves that form when wind blows for a sufficient period of time across the open ocean. The waves of a fully developed sea have the maximum height possible for a given wind speed, fetch and duration of wind.

**GABION:** 1) Steel wire-mesh basket to hold stones or crushed rock to protect a bank or bottom from erosion. 2) Structures composed of masses of rocks, rubble or masonry held tightly together usually by wire mesh so as to form blocks or walls. Sometimes used on heavy erosion areas to retard wave action or as a foundation for breakwaters or jetties.

**GALE:** A wind between a strong breeze and a storm. A continuous wind blowing in degrees of moderate, fresh, strong, or whole gale and varying in velocity from 28 to 47 nautical miles per hour.

**GEOMORPHOLOGY:** 1) That branch of physical geography which deals with the form of the Earth, the general configuration of its surface, the distribution of the land, water, etc. 2) The investigation of the history of geologic changes through the interpretation of topographic forms.

**GEOTEXTILE:** A synthetic fabric which may be woven or non-woven used as a filter.

**GIS:** Geographical Information System

**GLACIER:** A large body of ice moving slowly down a slope of valley or spreading outward on a land surface (e.g., Greenland, Antarctica) and surviving from year to year.

**GLOBAL POSITIONING SYSTEM:** Commonly called GPS. A navigational and positioning system developed by the U.S. Department of Defense, by which the location of a position on or above the Earth can be determined by a special receiver at that point interpreting signals received simultaneously from several of a constellation of special satellites.

**GORGE:** 1) The deepest portion of an inlet, the throat. 2) A narrow, deep valley with nearly vertical rock walls.

**GRAVITY WAVE:** A wave whose velocity of propagation is controlled primarily by gravity. Water waves more than 5 cm long are considered gravity waves. Waves longer than 2.5 cm and shorter than 5 cm are in an indeterminate zone between capillary and gravity waves.

**GROIN:** Narrow, roughly shore-normal structure built to reduce longshore currents, and/or to trap and retain littoral material. Most groins are of timber or rock and extend from a seawall, or the backshore, well onto the foreshore and rarely even further offshore.

**GULF:** 1) A relatively large portion of the ocean or sea extending far into land; the largest of various forms of inlets of the sea. 2) The Gulf of Mexico.

**HEADLAND:** A promontory extending out into a body of water

**HEADLAND BREAKWATER:** A rock breakwater constructed to function as a headland by retaining an adjacent sandy pocket beach.

**HIGH TIDE:** The maximum elevation reached by each rising tide.

**HIGH WATER:** Maximum height reached by a rising tide. The height may be solely due to the periodic tidal forces or it may have superimposed upon it the effects of prevailing meteorological conditions. Nontechnically, also called the high tide.

**HIGHER HIGH WATER:** The higher of the two high waters of any tidal day. The single high water occurring daily during periods when the tide is diurnal is considered to be a higher high water.

**HINDCASTING:** In wave prediction, the retrospective forecasting of waves using measured wind information.

**HOLOCENE:** An epoch of the quaternary period, from the end of the Pleistocene, about 12,000 to 20,000 years ago, to the present time. This is the geologic time period of the most recent rise in eustatic sea level in response to global warming.

**HURRICANE:** An intense tropical cyclone in which winds tend to spiral inward toward a core of low pressure, with maximum surface wind velocities that equal or exceed 33.5 m/sec (75 mph or 65 knots) for several minutes or longer at some points. Tropical storm is the term applied if

## Glossary

maximum winds are less than 33.5 m/sec but greater than a whole gale (63 mph or 55 knots). Term is used in the Atlantic, Gulf of Mexico, and eastern Pacific.

HYDROGRAPH: 1) The graph of the variation of SWL with time. 2) the graph of discharge with time.

ICE AGE: A loosely-used synonym of glacial epoch, or time of extensive glacial activity; specifically of the latest period of widespread continental glaciers, the Pleistocene Epoch.

INLET: 1) A short, narrow waterway connecting a bay, lagoon, or similar body of water with a large parent body of water. 2) An arm of the sea (or other body of water) that is long compared to its width and may extend a considerable distance inland.

INLET GORGE: Generally, the deepest region of an inlet channel.

INSHORE: In beach terminology, the zone of variable width extending from the low water line through the breaker zone. Also inshore zone or shoreface.

IRREGULAR WAVES: Waves with random wave periods (and in practice, also heights), which are typical for natural wind-induced waves.

JETTY: 1) (United States usage) On open seacoasts, a structure extending into a body of water, which is designed to prevent shoaling of a channel by littoral materials and to direct and confine the stream or tidal flow. Jetties are built at the mouths of rivers or tidal inlets to help deepen and stabilize a channel. 2) (British usage) Wharf or pier.

JONSWAP SPECTRUM: Wave spectrum typical of growing deep water waves developed from field experiments and measurements of waves and wave spectra in the Joint North Sea Wave Project.

KEY: A cay, esp. one of the low, insular banks of sand, coral, and limestone off the southern coast of Florida.

KINETIC ENERGY (OF WAVES): In a progressive oscillatory wave, a summation of the energy of motion of the particles within the wave.

KNOT: The unit of speed used in navigation equal to 1 nautical mile (6,076.115 ft or 1,852 m) per hour.

LAGGING OF TIDE: The periodic retardation in the time of occurrence of high and low water due to changes in the relative positions of the moon and sun.

LAGOON: A shallow body of water, like a pond or sound, partly or completely separated from the sea by a barrier island or reef. Sometimes connected to the sea via an inlet.

LEEWARD: The direction toward which the wind is blowing; the direction toward which waves are traveling.

LITTORAL: Of or pertaining to a shore, especially of the sea.

LITTORAL CELL: A reach of the coast that is isolated sedimentologically from adjacent coastal reaches and that features its own sources and sinks. Isolation is typically caused by protruding headlands, submarine canyons, inlets, and some river mouths that prevent littoral sediment from one cell to pass into the next. Cells may range in size from a multi-hundred meter pocket beach in a rocky coast to a barrier island many tens of kilometers long.

LITTORAL TRANSPORT The movement of beach material in the littoral zone by waves and currents. Includes movement parallel (longshore drift) and sometimes also perpendicular (cross-shore transport) to the shore. Also known as littoral drift.

**LITTORAL TRANSPORT RATE:** Rate of transport of sedimentary material parallel or perpendicular to the shore in the littoral zone. Usually expressed in cubic meters (cubic yards) per year. Commonly synonymous with longshore transport rate.

**LITTORAL ZONE:** In beach terminology, an indefinite zone extending seaward from the shoreline to just beyond the breaker zone.

**LONGSHORE:** Parallel to and near the shoreline; alongshore.

**LONGSHORE BAR:** A sand ridge or ridges, running roughly parallel to the shoreline and extending along the shore outside the trough, that may be exposed at low tide or may occur below the water level in the offshore.

**LONGSHORE CURRENT:** The littoral current in the breaker zone moving essentially parallel to the shore, usually generated by waves breaking at an angle to the shoreline.

**LONGSHORE DRIFT:** Movement of (beach) sediments approximately parallel to the coastline.

**LOW TIDE:** The minimum elevation reached by each falling tide.

**LOW WATER:** The minimum height reached by each falling tide. Nontechnically, also called low tide.

**LOWER LOW WATER:** The lower of the two low waters of any tidal day. The single low water occurring daily during periods when the tide is diurnal is considered to be a lower low water.

**LUNAR TIDE:** The portion of the tide that can be attributed directly to attraction to the moon.

**MANAGED RETREAT:** The deliberate setting back (moving landward) of the existing line of sea defense in order to obtain engineering or environmental advantages - also referred to as managed landward realignment. Sometimes refers to moving roads and utilities landward in the face of shore retreat.

**MARSH:** 1) A tract of soft, wet land, usually vegetated by reeds, grasses and occasionally small shrubs. 2) Soft, wet area periodically or continuously flooded to a shallow depth, usually characterized by a particular subclass of grasses, cattails and other low plants.

**MEAN HIGH WATER:** The average height of the high waters over a 19-year period. For shorter periods of observations, corrections are applied to eliminate known variations and reduce the results to the equivalent of a mean 19-year value. All high water heights are included in the average where the type of tide is either semidiurnal or mixed. Only the higher high water heights are included in the average where the type of tide is diurnal. So determined, mean high water in the latter case is the same as mean higher high water.

**MEAN HIGHER HIGH WATER:** The average height of the higher high waters over a 19-year period. For shorter periods of observation, corrections are applied to eliminate known variations and reduce the result to the equivalent of a mean 19-year value.

**MEAN LOW WATER:** The average height of the low waters over a 19-year period. For shorter periods of observations, corrections are applied to eliminate known variations and reduce the results to the equivalent of a mean 19-year value. All low water heights are included in the average where the type of tide is either semidiurnal or mixed. Only lower low water heights are included in the average where the type of tide is diurnal. So determined, mean low water in the latter case is the same as mean lower low water.

**MEAN LOWER LOW WATER:** The average height of the lower low waters over a 19-year period. For shorter periods of observations, corrections are applied to eliminate known variations and reduce the results to the equivalent of a mean 19-year value. Frequently abbreviated to lower low water.

## Glossary

**MEAN SEA LEVEL:** The average height of the surface of the sea for all stages of the tide over a 19-year period, usually determined from hourly height readings. Not necessarily equal to mean tide level.

**MEAN TIDE LEVEL:** A plane midway between mean high water and mean low water

**MHHW:** Mean Higher High Water

**MHW:** Mean High Water

**MINIMUM DURATION:** The time necessary for steady-state wave conditions to develop for a given wind velocity over a given fetch length.

**MIXED TIDE:** A type of tide in which the presence of a diurnal wave is conspicuous by a large inequality in either the high or low water heights, with two high waters and two low waters usually occurring each tidal day. In strictness, all tides are mixed, but the name is usually applied without definite limits to the tide intermediate to those predominantly semidiurnal and those predominantly diurnal.

**MLLW:** Mean Lower Low Water

**MLW:** Mean Low Water

**MONOCHROMATIC WAVES:** A series of waves generated in a laboratory, each of which has the same length and period.

**MORPHODYNAMICS:** 1) The mutual interaction and adjustment of the seafloor topography and fluid dynamics involving the motion of sediment. 2) The coupled suite of mutually interdependent hydrodynamic processes, seafloor morphologies, and sequences of change.

**MORPHOLOGY:** River/estuary/lake/seabed form and its change with time.

**MSL:** Mean Sea Level

**NAVD 88:** North American Vertical Datum of 1988

**NEAP TIDE:** Tide of decreased range occurring semimonthly as the result of the moon being in quadrature. The neap range of the tide is the average semidiurnal range occurring at the time of neap tides and is most conveniently computed from the harmonic constants. The neap range is typically 10 to 30 percent smaller than the mean range where the type of tide is either semidiurnal or mixed. While, technically of no practical significance where the type of tide is diurnal, the term is commonly used to refer to the portion of the lunar month with reduced tide range. The average height of the high waters of the neap tide is called neap high water or high water neaps, and the average height of the corresponding low water is called neap low water or low water neaps.

**NEARSHORE:** 1) In beach terminology an indefinite zone extending seaward from the shoreline well beyond the breaker zone. 2) The zone which extends from the swash zone to the position marking the start of the offshore zone, typically at water depths of the order of 20 m.

**NEARSHORE CURRENT:** A current in the nearshore zone.

**NGVD:** National Geodetic Vertical Datum

**NOAA:** National Oceanic and Atmospheric Administration

**NOS:** National Ocean Service. A part of NOAA. The successor to the USC&GS.

**NUMERICAL MODELING:** Refers to analysis of coastal processes using computational models.

**OCEANOGRAPHY:** The study of the sea, embracing and indicating all knowledge pertaining to the sea's physical boundaries, the chemistry and physics of seawater, marine biology, and marine geology.

**OFFSHORE:** 1) In beach terminology, the comparatively flat zone of variable width, extending from the shoreface to the edge of the continental shelf. It is continually submerged. 2) The direction seaward from the shore. 3) The zone beyond the nearshore zone where sediment motion induced by waves alone effectively ceases and where the influence of the sea bed on wave action is small in comparison with the effect of wind. 4) The breaker zone directly seaward of the low tide line.

**ONSHORE:** A direction landward from the sea.

**ORBITAL VELOCITY:** The flow of water accompanying the orbital movement of the water particles in a wave. Not to be confused with wave-generated littoral currents.

**OSCILLATORY WAVE:** A wave in which each individual particle oscillates about a point with little or no permanent change in mean position. The term is commonly applied to progressive oscillatory waves in which only the form advances, the individual particles moving in closed or nearly closed orbits.

**OUTCROP:** A surface exposure of bare rock not covered by soil or vegetation.

**OVERTOPPING:** Passing of water over the top of a structure as a result of wave runup or surge action.

**OVERWASH:** 1) The part of the uprush that runs over the crest of a berm or structure or barrier island and does not flow directly back to the ocean or lake. 2) The effect of waves overtopping a coastal defense, often carrying sediment landwards which is then lost to the beach system.

**PARTICLE VELOCITY:** The velocity induced by wave motion with which a specific water particle moves within a wave.

**PASS:** In hydrographic usage, a navigable channel through a bar, reef, or shoal, or between closely adjacent islands. On the Gulf of Mexico coast, inlets are often known as passes.

**PEAK PERIOD:** The wave period determined by the inverse of the frequency at which the wave energy spectrum reaches its maximum.

**PEBBLES:** Beach material usually well-rounded and between about 4 mm to 64 mm diameter.

**PENINSULA:** An elongated body of land nearly surrounded by water and connected to a larger body of land by a neck or isthmus.

**PHASE:** In surface wave motion, a point in the period to which the wave motion has advanced with respect to a given initial reference point, e.g. the crest of the wave is a phase of the wave.

**PHYSICAL MODELING:** Refers to the investigation of coastal or hydraulic processes using a scaled model.

**PIER:** A structure, usually of open construction, extending out into the water from the shore, to serve as a landing place, recreational facility, etc., rather than to afford coastal protection. In the Great Lakes, a term sometimes applied to jetties.

**PILE:** A long, heavy timber or section of concrete or metal that is driven or jettied into the earth or seabed to serve as a support or protection.

**PINEAPPLE EXPRESS:** Occurs when the jet stream dips into the vicinity of Hawaii (thus the "pineapple") and carries a fast, moisture laden storm system to Washington, Oregon, and

## Glossary

California. Unlike tropical events, these winter storms do not behave as cyclonic systems; instead they are characterized by high winds that drive waves onto coastal areas.

**PLANFORM:** The outline or shape of a body of water as determined by the still-water line.

**PLEISTOCENE:** An epoch of the Quaternary Period characterized by several glacial ages.

**PLUNGING BREAKER:** Crest curls over air pocket; breaking is usually with a crash.

**POCKET BEACH:** A beach, usually small and curved, in a coastal embayment between two headland littoral barriers.

**POTENTIAL ENERGY OF WAVES:** In a progressive oscillatory wave, the energy resulting from the elevation or depression of the water surface from the undisturbed level.

**PROTOTYPE:** In laboratory usage, the full-scale structure, concept, or phenomenon used as a basis for constructing a scale model or copy.

**RANDOM WAVES:** The laboratory simulation of irregular sea states that occur in nature.

**RANGE OF TIDE:** The difference in height between consecutive high and low waters. The mean range is the difference between mean high water and mean low water. The great diurnal range or diurnal range is the difference in height between mean higher high water and mean lower low water. Where the type of tide is diurnal, the mean range is the same as the diurnal range.

**RAYLEIGH DISTRIBUTION:** A model probability distribution, commonly used in analysis of waves.

**RECESSION:** Landward movement of the shoreline. A net landward movement of the shoreline over a specified time.

**REEF:** Offshore consolidated rock. Often refers to coral fringing reefs in tropical waters.

**REFLECTED WAVE:** That part of an incident wave that is returned seaward when a wave impinges on a steep beach, barrier, or other reflecting surface.

**REFLECTION:** The process by which the energy of the wave is returned seaward.

**REFRACTION:** The process by which the direction of a wave moving in shallow water at an angle to the contours is changed: the part of the wave advancing in shallower water moves more slowly than that part still advancing in deeper water, causing the wave crest to bend toward alignment with the underwater contours.

**REFRACTION COEFFICIENT:** The ratio of the refracted wave height at any point to the deepwater wave height.

**REFRACTION DIAGRAM:** A drawing showing positions of wave crests and/or orthogonals in a given area for a specific deepwater wave period and direction.

**REGULAR WAVES:** Waves with a single height, period, and direction.

**RETURN PERIOD:** Average period of time between occurrences of a given event.

**REVETMENT:** A layer or layers of stone, concrete, etc., to protect an embankment, or shore structure, against erosion by wave action or currents.

**RIP CURRENT:** A strong surface current flowing seaward from the shore that is part of a nearshore circulation cell driven by incident wave energy. A rip current is often miscalled a rip tide.



**RIPRAP:** A protective layer or facing of quarystone, usually well graded within a wide size limit, randomly placed to prevent erosion, scour, or sloughing of an embankment or bluff; also the stone so used.

**RISK:** Chance or probability of failure due to all possible environmental inputs and all possible mechanisms.

**ROCK:** An aggregate of one or more minerals

**RUBBLE:** Rough, irregular fragments of broken rock.

**RUBBLE-MOUND STRUCTURE:** A mound of random-shaped and random-placed stones protected with a cover layer of selected stones

**RUNUP:** The upper level reached by a wave on a beach or coastal structure, relative to still-water level.

**SALIENT:** Coastal formation of beach material developed by wave refraction and diffraction and long shore drift comprising of a bulge in the coastline towards an offshore island or breakwater, but not connected to it as in the case of a tombolo.

**SALINITY:** Number of grams of salt per thousand grams of sea water, usually expressed in parts per thousand.

**SAND:** Sediment particles, often largely composed of quartz, with a diameter of between 0.062 mm and 2 mm, generally classified as fine, medium, coarse or very coarse. Beach sand may sometimes be composed of organic sediments such as calcareous reef debris or shell fragments.

**SAND BAR:** A submerged or emerged embankment of sand built on the sea floor in shallow water by waves and currents.

**SAND BYPASSING:** Hydraulic or mechanical movement of sand from the accreting updrift side to the eroding downdrift side of an inlet or harbor entrance. The hydraulic movement may include natural movement as well as movement caused by man.

**SAND DUNE:** A dune formed of sand.

**SAND SPIT:** A narrow sand embankment, created by an excess of deposition at its seaward terminus, with its distal end (the end away from the point of origin) terminating in open water.

**SCOUR:** Removal of underwater material by waves and currents, especially at the base or toe of a structure.

**SCOUR PROTECTION:** Protection against erosion of the seabed.

**SEA:** 1) Waves caused by wind at the place and time of observation. 2) State of the ocean or lake surface, in regard to waves.

**SEA CLIFF:** A cliff situated at the seaward edge of the coast.

**SEA LEVEL RISE:** The long-term trend in mean sea level.

**SEA STATE:** Description of the sea surface with regard to wave action.

**SEAS:** Waves caused by wind at the place and time of observation.

**SEAWALL:** A structure, often concrete or stone, built along a portion of a coast to prevent erosion and other damage by wave action. Often it retains earth against its shoreward face. A seawall is typically more massive and capable of resisting greater wave forces than a bulkhead.

## Glossary

**SEDIMENT:** 1) Loose, fragments of rocks, minerals or organic material which are transported from their source for varying distances and deposited by air, wind, ice and water. Other sediments are precipitated from the overlying water or form chemically, in place. Sediment includes all the unconsolidated materials on the sea floor. 2) The fine grained material deposited by water or wind.

**SEDIMENT SINK:** Point or area at which beach material is irretrievably lost from a coastal cell, such as an estuary, or a deep channel in the seabed.

**SEDIMENT SOURCE:** Point or area on a coast from which beach material is supplied, such as an eroding cliff, or river mouth.

**SEDIMENT TRANSPORT:** The main agencies by which sedimentary materials are moved are: gravity (gravity transport); running water (rivers and streams); ice (glaciers); wind; the sea (currents and longshore drift).

**SEMIDIURNAL:** Having a period or cycle of approximately one-half of a tidal day (12.4 hours). The predominating type of tide throughout the world is semidiurnal, with two high waters and two low waters each tidal day. The tidal current is said to be semidiurnal when there are two flood and two ebb periods each day.

**SETBACK:** A required open space, specified in shoreline master programs, measured horizontally upland from a perpendicular to the ordinary high water mark.

**SHALLOW WATER:** 1) Commonly, water of such a depth that surface waves are noticeably affected by bottom topography. 2) More strictly, in hydrodynamics with regard to progressive gravity waves, water in which the depth is less than  $1/25$  the wavelength.

**SHALLOW WATER WAVE:** A progressive wave which is in water less than  $1/25$  the wave length in depth.

**SHINGLE:** flat or flattish pebbles.

**SHOAL:** 1) (noun) A detached area of any material except rock or coral. The depths over it are a danger to surface navigation. Similar continental or insular shelf features of greater depths are usually termed banks. 2) (verb) To become shallow gradually. 3) To cause to become shallow. 4) To proceed from a greater to a lesser depth of water.

**SHOALING:** Decrease in water depth. The transformation of wave profile as they propagate inshore.

**SHOALING COEFFICIENT:** The ratio of the height of a wave in water of any depth to its height in deep water with the effects of refraction, friction, and percolation eliminated.

**SHORE:** The narrow strip of land in immediate contact with the sea, including the zone between high and low water lines. A shore of unconsolidated material is usually called a beach. Also used in a general sense to mean the coastal area (e.g., to live at the shore).

**SHOREFACE:** The narrow zone seaward from the low tide shoreline, covered by water, over which the beach sands and gravels actively oscillate with changing wave conditions.

**SHORELINE:** The intersection of a specified plane of water with the shore or beach (e.g., the high water shoreline would be the intersection of the plane of mean high water with the shore or beach). The line delineating the shoreline on National Ocean Service nautical charts and surveys approximates the mean high water line.

**SIGNIFICANT WAVE HEIGHT:** The primary measure of energy in a sea state. that is calculated either as the average height of the one-third highest waves or via energy density spectral analysis methods.

**SOLITARY WAVE:** A wave consisting of a single elevation (above the original water surface), whose height is not necessarily small compared to the depth, and neither followed nor preceded by another elevation or depression of the water surfaces.

**SORTING:** Process of selection and separation of sediment grains according to their grain size (or grain shape or specific gravity).

**SPILLING BREAKER:** Bubbles and turbulent water spill down front face of wave. The upper 25 percent of the front face may become vertical before breaking. Breaking generally occurs over quite a distance.

**SPIT:** A small point of land or a narrow shoal projecting into a body of water from the shore.

**SPRING RANGE:** The average semidiurnal range occurring at the time of spring tides and most conveniently computed from the harmonic constants. It is larger than the mean range where the type of tide is either semidiurnal or mixed, and is of no practical significance where the type of tide is diurnal.

**SPRING TIDE:** A tide that occurs at or near the time of new or full moon (syzygy) and which rises highest and falls lowest from the mean sea level.

**STACK:** An isolated, pillar-like rocky island isolated from a nearby headland by wave erosion; a needle or chimney rock.

**STILLWATER LEVEL:** Commonly abbreviated to SWL. The surface of the water if all wave and wind action were to cease.

**STONE:** Quarried or artificially-broken rock for use in construction.

**STORM SURGE:** A rise in average (typically over several minutes) water level above the normal astronomical tide level due to the action of a storm. Storm surge results from wind stress, atmospheric pressure reduction, and wave setup.

**STORM SURGE HYDROGRAPH:** Graph of the variation in the rise in SWL with time due to a storm.

**SUBSIDENCE:** Sinking or downwarping of a part of the earth's surface.

**SUPER-CRITICAL FLOW:** Flow for which the Froude number is greater than unity; surface disturbances will not travel upstream.

**SURF:** 1) Collective term for breakers. 2) The wave activity in the area between the shoreline and the outermost limit of breakers. 3) In literature, the term surf usually refers to the breaking waves on shore and on reefs when accompanied by a roaring noise caused by the larger waves breaking. 4) the recreational riding of waves.

**SURF ZONE:** The zone of wave action extending from the water line (which varies with tide, surge, set-up, etc.) out to the most seaward point of the zone (breaker zone) at which waves approaching the coastline commence breaking, typically in water depths of between 5 to 10 meters.

**SURGING BREAKER:** Wave peaks up, but bottom rushes forward from under wave, and wave slides up beach face with little or no bubble production. Water surface remains almost plane except where ripples may be produced on the beachface during runback.

**SWASH:** The rush of water up onto the beach face following the breaking of a wave.

**SWASH ZONE:** The zone of wave action on the beach, which moves as water levels vary, extending from the limit of run-down to the limit of runup.

## Glossary

**SWELL:** Wind-generated waves that have traveled out of their generating area. Swell characteristically exhibits a more regular and longer period and has flatter crests than waves within their fetch (seas).

**SWL:** Still Water Level

**T-GROIN:** A groin built in the shape of a letter "T" with the trunk section connected to land.

**TECTONIC FORCES:** Forces generated from within the earth that result in uplift, movement, or deformation of part of the earth's crust.

**TERMINAL GROIN:** A groin, often at the end of a barrier spit, intended to prevent sediment passage into the channel beyond.

**TIDAL BENCH MARK:** A bench mark whose elevation has been determined with respect to mean sea level at a nearby tide gauge; the tidal bench mark is used as reference for that tide gauge.

**TIDAL CURRENT:** The alternating horizontal movement of water associated with the rise and fall of the tide caused by the astronomical tide-producing forces.

**TIDAL INLET:** 1) An inlet maintained by tidal flow. 2) Loosely, any inlet in which the tide ebbs and flows.

**TIDAL PERIOD:** The interval of time between two consecutive, like phases of the tide.

**TIDAL PRISM:** 1) The total amount of water that flows into a bay or out again with movement of the tide, excluding any fresh water flow. 2) The volume of water between mean low and mean high tide.

**TIDAL RANGE:** The difference in height between consecutive high and low (or higher high and lower low) waters.

**TIDAL SHOALS:** Shoals that accumulate near inlets due to the transport of sediments by tidal currents associated with the inlet.

**TIDAL WAVE:** 1) The wave motion of the tides. 2) In popular usage, any unusually high and destructive water level along a shore. It usually refers to storm surge or tsunamis.

**TIDE:** The periodic rising and falling of the water that results from gravitational attraction of the Moon and Sun and other astronomical bodies acting upon the rotating Earth. Although the accompanying horizontal movement of the water resulting from the same cause is also sometimes called the tide, it is preferable to designate the latter as tidal current, reserving the name tide for the vertical movement.

**TOE:** Lowest part of a revetment or seawall slope, generally forming the transition to the seabed.

**TOMBOLO:** A bar or spit that connects or "ties" an island to the mainland or to another island. Also applied to sand accumulation between land and a detached breakwater.

**TROPICAL STORM:** A tropical cyclone with maximum winds less than 34 m/sec (75 mile per hour). Less strength when compared with hurricane or typhoon (winds greater than 34 m/sec).

**TROUGH:** A long and broad submarine depression with gently sloping sides.

**TROUGH OF WAVE:** The lowest part of a waveform between successive crests. Also, that part of a wave below still-water level.

**TSUNAMI:** A long-period wave caused by an underwater disturbance such as a volcanic eruption or earthquake. Commonly miscalled "tidal wave."

**TYPHOON:** The term typhoon is applied to tropical cyclones in the western Pacific Ocean. Known as a hurricane in the Atlantic Ocean, Gulf of Mexico, and eastern Pacific Ocean.

**USACE:** US Army Corps of Engineers

**USC&GS:** US Coast and Geodetic Survey

**UPDRIFT:** The direction opposite that of the predominant movement of littoral materials.

**VELOCITY OF WAVES:** The speed at which an individual wave advances.

**VISCOSITY:** That molecular property of a fluid that enables it to support tangential stresses for a finite time and thus to resist deformation. Resistance to flow.

**V-ZONE:** FEMA's estimates of where coastal waves greater than 3 feet high will exist during the 100-year storm.

**WAVE:** A ridge, deformation, or undulation of the surface of a liquid.

**WAVE AMPLITUDE:** The magnitude of the displacement of a wave from a mean value. An ocean wave has an amplitude equal to the vertical distance from still-water level to wave crest. For a sinusoidal wave, the amplitude is one-half the wave height.

**WAVE CELERITY:** The speed of wave propagation.

**WAVE CLIMATE:** The seasonal and annual distribution of wave height, period and direction.

**WAVE DIRECTION:** The direction from which a wave approaches.

**WAVE DIRECTIONAL SPECTRUM:** Distribution of wave energy as a function of wave frequency and direction.

**WAVE FORECASTING:** The theoretical determination of future wave characteristics, usually from observed or predicted meteorological phenomena.

**WAVE FREQUENCY:** The inverse of wave period.

**WAVE GROUP:** A series of waves in which the wave direction, wavelength, and wave height vary only slightly.

**WAVE HEIGHT:** The vertical distance between a crest and the preceding trough.

**WAVE PERIOD:** The time for a wave crest to traverse a distance equal to one wavelength. The time for two successive wave crests to pass a fixed point.

**WAVE RAY:** On a wave-refraction diagram, a line drawn perpendicularly to the wave crests; also known as orthogonals.

**WAVE SETUP:** Superelevation of the water surface over normal surge elevation due to onshore mass transport of the water by wave action alone.

**WAVE SPECTRUM:** In ocean wave studies, a graph, table, or mathematical equation showing the distribution of wave energy as a function of wave frequency. The spectrum may be based on observations or theoretical considerations.

**WAVE STEEPNESS:** The ratio of wave height to wavelength.

**WAVE TRAIN:** A series of waves from the same direction.

**WAVE TRANSFORMATION:** Change in wave energy due to the action of physical processes.

**WAVE TROUGH:** The lowest part of a wave form between successive crests. Also that part of a wave below still-water level.

## Glossary

**WAVE VELOCITY:** The speed at which an individual wave advances.

**WAVELENGTH:** The horizontal distance between similar points on two successive waves measured perpendicular to the crest.

**WEIR:** A low dam or wall across a stream to raise the upstream water level.

**WELL-SORTED:** Clastic sediment or rock that consists of particles all having approximately the same size. Example: sand dunes.

**WETLANDS:** Lands whose saturation with water is the dominant factor determining the nature of soil development and the types of plant and animal communities that live in the soil and on its surface (e.g. Mangrove forests).

**WHITECAP:** On the crest of a wave, the white froth caused by wind.

**WIND SEA:** Wave conditions directly attributable to recent winds, as opposed to swell.

**WIND SETUP:** On reservoirs and smaller bodies of water: 1) the vertical rise in the still-water level on the leeward side of a body of water caused by wind stresses on the surface of the water; 2) the difference in still-water levels on the windward and the leeward sides of a body of water caused by wind stresses on the surface of the water.

**WIND STRESS:** The way in which wind transfers energy to the sea surface.

**WIND WAVES:** 1) Waves being formed and built up by the wind. 2) Loosely, any wave generated by wind.

**WINDWARD:** The direction from which the wind is blowing

## **Part 1 – Background & Context**

*Page Intentionally Left Blank*



# Chapter 1 - Introduction

## 1.1 Purpose

The purpose of this HEC-25 document is to provide guidance for the analysis, planning, design and operation of highways in the coastal environment (HICE). The focus is on roads and bridges (highways) near the coast that are always, or occasionally during storms, influenced by coastal tides and waves.

This document is intended to be a reference guidance document for Federal Highway Administration (FHWA), State Departments of Transportation (SDOT), the American Association of State Highway and Transportation Officials (AASHTO), consultants to these organizations, and others.

This is nominally the second edition of HEC-25. The first edition was entitled “Tidal Hydrology, Hydraulics and Scour at Bridges” and reflected results of a SDOT pooled fund study investigating coastal scour. This second edition is a completely new document and incorporates and presents more comprehensive discussions of the coastal environment.

Nationally, there are few transportation (and specifically highway related) documents that focus on the coastal environment. The existing guidance most similar to this document is a Chapter of the “Highway Drainage Guidelines” published by AASHTO.<sup>1</sup> This HEC-25 HICE document provides additional details on many of the topics discussed in those AASHTO guidelines.

## 1.2 Target Audience

The target audience for HEC-25 is civil engineers, coastal engineers, hydraulic engineers, roadway designers, field inspectors, construction supervisors, planners, and other technical personnel involved with transportation systems in the coastal environment.

This HEC-25 document should assist persons with little experience in coastal engineering to understand; and as appropriate, apply; scientific methods and engineering approaches that are unique to the coast. For experienced coastal engineers, HEC-25 should also serve as a reference document in providing specific highway-oriented assistance and consultation for FHWA and State DOT projects.

The State-of-Practice in the coastal environment is complex, with many major constituents and principles not well understood by a typical FHWA or State DOT hydraulic engineering unit. Some areas related to highways in the coastal environment are still undergoing research to determine appropriate practices.

The document does not attempt to “simplify” this complex practice into mechanistic, “one-size-fits-all” approaches. Rather the document provides the highway hydraulic community with an overview and awareness of constituents of good coastal hydraulic analysis and design. The result of this awareness will allow practitioners to seek appropriate technical documentation and expertise for specific projects.

---

<sup>1</sup> Specifically, “Volume XI – Guidelines for Highways Along Coastal Zones and Lakeshores,” prepared by the Task Force on Hydrology and Hydraulics, AASHTO Highway Subcommittee on Design (AASHTO 2005).

### **1.3 Organization**

This HICE document is organized into three major parts:

- Part 1 (Chapters 1 and 2) discusses the background and context of highways in the coastal environment.
- Part 2 (Chapters 3 through 5) presents some of the principles of coastal science and engineering.
- Part 3 (Chapters 6 through 12) presents some of the issues and applications of coastal engineering and science in highway planning and design.

Of interest within Part 1 of this document:

- Chapter 2 outlines what is meant by coastal highways and provides an estimate of the extent of them in the United States.
- Chapter 2 also briefly discusses some of the societal and natural changes that likely will make the planning, design and operation of coastal highways even more challenging in the future.
- Chapter 2 concludes with a description and explanation of the field of coastal engineering and some brief discussion of how coastal engineering can be better integrated into the highway engineering process.

Part 2 very briefly summarizes some of the science that is unique to the coast. This includes water levels, waves and sand movement with a focus on coastal highways. The planning, design and construction of highways in the coastal environment can require an understanding of some unique aspects of that environment. These are parts of the sciences of coastal oceanography, coastal geology, and coastal meteorology. Each of these earth sciences has extensive bodies of knowledge focused specifically on the coastal areas. For example, nearshore physical oceanography is the subdiscipline of oceanography that focuses on the edge of the oceans where deepwater waves, currents, and tides interact with the land. Coastal geomorphology is the subdiscipline of geology that focuses on the resulting changes in coastal landforms. These aspects of this unique design environment are not important in the design of highways not located near the coast.

- Chapter 3 discusses tides and water levels including tidal datums, storm surge, and sea level rise. Tides and other water level fluctuations control the location of wave attack on the shoreline.
- Chapter 4 discusses water waves and engineering models of water waves. Waves are often the primary hydraulic force of interest in coastal engineering.
- Waves and tides generate currents in the coastal zone including those that can move sand near the coast and cause important changes in shorelines and inlets. Chapter 5 provides a broad introduction to some of the coastal sediment processes including an overview of coastal geology, coastal sediment characteristics and transport, tidal inlet dynamics, and the role of physical models in coastal engineering.

Note that Part 2 summarizes a relatively small subset of the coastal engineering sciences with specific emphasis on areas with applications to the engineering of coastal highways. Other references; including summary manuals, textbooks, and original sources in the coastal sciences and engineering fields; are cited for further details.

This HICE document is not meant as a substitute for more in-depth study of these fields but rather as a very basic, entry-level primer for someone with a general civil engineering background. Part 2 of this document introduces some of the terminology and concepts used in the engineering tools discussed in Part 3.

Part 3 addresses several of the highway and bridge planning and design issues that are unique to the coastal environment including coastal revetment design, planning and alternatives for highways that are threatened by coastal erosion, roads that overwash in storms, and wave loads on bridge decks.

- Chapter 6 addresses one of the most common coastal highway issues - the design of revetments or seawalls to resist wave attack.
- Chapter 7 describes broader issues of what can be done with highways that are threatened by coastal shoreline recession.
- Chapter 8 presents some engineering strategies for some coastal roads that, because of their location and elevation, are occasionally overwashed by storms.
- Chapter 9 discusses issues related to bridges near the coast including general locations, scour, and wave loads on bridge decks. By discussing example situations, this chapter outlines some of the available engineering and analysis tools for addressing the issues and cite references in the coastal and transportation engineering literature for further details. A qualified, experienced coastal engineer should be an integral part of the analysis and related design team for most of the issues outlined here.

Other materials in this document include references cited (Chapter 13), a glossary of terms (following the references), and several appendices:

- Appendix A - Units and conversions.
- Appendix B - An estimate of the extent of coastal highways in the U.S.
- Appendix C - Equations for estimating fetch-limited waves in shallow water.
- Appendix D - Discussion of Scour Policies, Guidelines, and Research
- Appendix E - A method for estimating wave loads on bridge decks.

## **1.4 Units in this Document**

To the extent possible, this document avoids specifying units in most equations and examples. When needed, the document provides only a single set (either SI or CU). Appendix A provides information on units and unit conversions.

*Page Intentionally Left Blank*

## Chapter 2 - Coastal Highways

### 2.1 *What are Coastal Highways?*

Coastal highways are those roads influenced by their presence in or near the water level, wave, and sand transport environment unique to a coast. While normally associated with the oceans, the coastal environment includes the Great Lakes and any other non-riverine water bodies that can be affected by coastal storm events. Every coastal state has highways that are flooded and damaged in coastal storms. Some of these roads are perpendicular to the coast and serve as access and evacuation routes. Some of these roads are parallel to the coast either right along or inland from the shore (see Figure 2.1). Some of these roads are major highways that run across or along bays or estuaries.



Figure 2.1. A Coastal Highway in the United States.

Two of American society's most storied love affairs – beaches and cars – come together on coastal highways. Some of our coastal roads are famous to the point of being a part of the national culture. Examples of famous coastal roads include Florida's *A-1-A* and California's *Pacific Coast Highway* (see Figure 2.2). Not only do Americans drive their cars to the beach on coastal highways, but these same highways can influence the quality of the beach itself in some situations. Thus, context-sensitive design principles should be appropriately applied along the coast.



Figure 2.2. Bridge on the Pacific Coast Highway (California Route 1).

## **2.2 Estimating the Extent of Coastal Roads and Bridges**

A study by the University of South Alabama estimated that there are roughly 60,000 road miles in the United States that are occasionally exposed to coastal waves and surge (Douglass, et al. 2005). This value of coastal road mileage was estimated by measuring the road miles in flood zones near the coast. Figure 2.3 illustrates the number of roadway miles within FEMA's 100-year floodplain in coastal counties on a State-by-State basis. The 60,000 mile nationwide total is based on estimates of the portion of those miles which are "coastal" as opposed to upland riverine flooding. The study only considered those coastal States within the conterminous United States – excluding Alaska and Hawaii. However, the basic approach would be applicable for these States as well. Appendix B details the approach and specific outcomes associated with the study.

After Hurricane Katrina, FHWA conducted an assessment of coastal bridges potentially vulnerable to failure from coastal storm events. Using very broad criteria, the assessment estimated that there are over 36,000 bridges within 15 nautical miles of coasts (FHWA 2007). Of these, over 1,000 bridges may possibly be vulnerable to the same failure modes as those associated with recent coastal storms (FHWA 2005/2007).

## **2.3 Societal Demand for Coastal Highways**

Millions of Americans want to live near the coast and millions more want to vacation there. Beaches are the most popular tourist destinations in the nation and tourism is the largest industry in the nation. The primary way that Americans get to the beach is by automobile on roads.

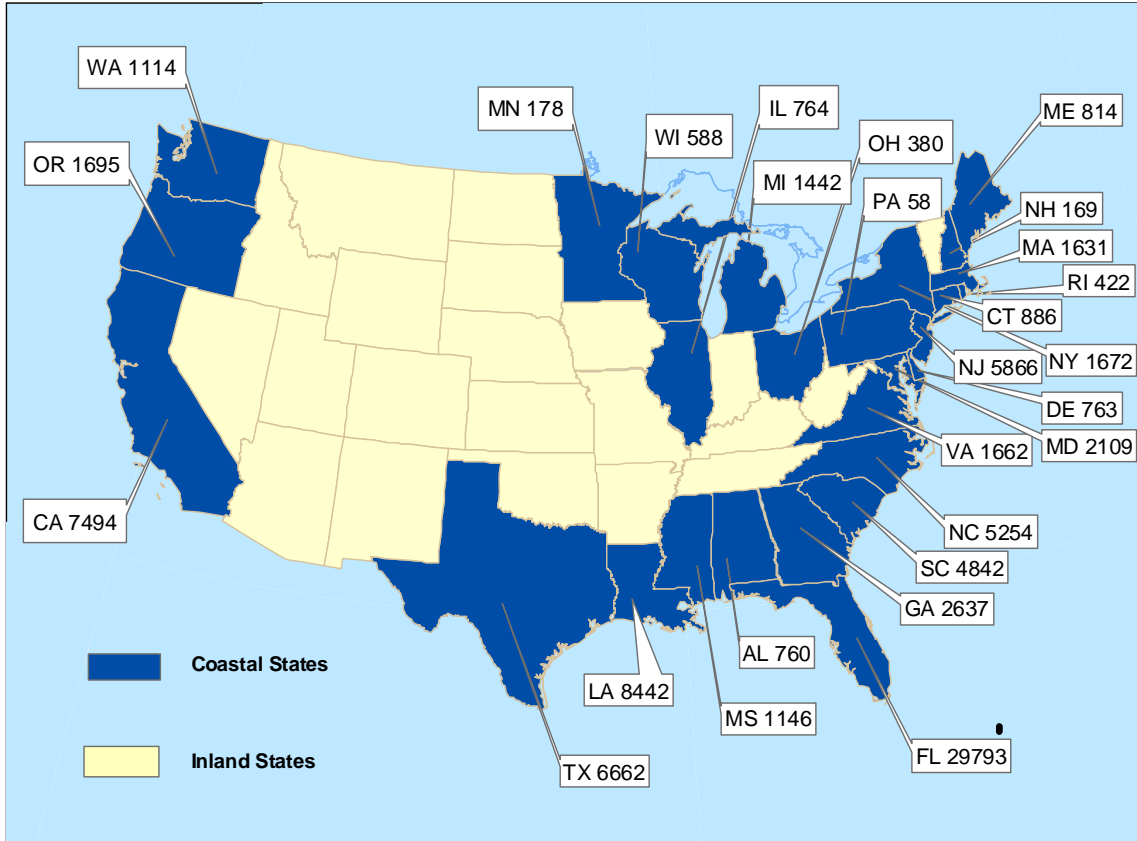

Figure 2.3. Estimates of road mileage in the 100-year coastal floodplain.

There are clear, multi-decadal trends of coastal state and coastal county population increases. Within the last three decades, more than 37 million people and 18 million homes have been added to America’s coastal areas (US Commission on Ocean Policy 2004). The economic growth in coastal counties is increasing at a higher rate than inland counties. Because much of the actual "beachfront" property is already developed in America, much of the growth and new development is in the area near the coast but some miles inland from the water. The implication is that these people will want to use the road system to get to the beach and, therefore, demand for coastal roads will increase.

Given these demands, in the coming decades America’s coastal highway system – as part of the overall civil engineering infrastructure – will most likely face a multitude of societal and natural stresses. The coastal roadway system can be considered as a subset of the transportation system with these unique design challenges.

## 2.4 Natural Coastal Processes Impacting Highways

Many different natural processes and forces impact roads and bridges near the coast. The natural stresses on the coast are challenging today and may be increasing in a number of ways. This document focuses on the natural processes that are not typically experienced by inland roads but present unique challenges for coastal roads.

## Part 1 – Background & Context

### 2.4.1 Water Level Change

Water levels are constantly changing along the coast. Tides rise and fall daily along all the ocean coasts. The range of tides varies dramatically along the United States coast. Near Anchorage, Alaska, the tide range is often over 20 feet. Near Pensacola, Florida, the tide range can essentially be zero during some days of the month. The Great Lakes have fluctuations in average water level throughout the year in response to seasonal rainfall differences that can approach two feet as well as multi-year fluctuations in response to drought cycles that can approach five feet in elevation.

However, these changes are not always related to astronomical tides and rainfall variations. Sea level has been rising along most United States coasts (relative sea level rise) at rates that vary by location but average about six inches per century. Many climatologists expect global warming will cause an increase in sea level rise rates as well as increased storm frequencies and intensities.

### 2.4.2 Storm Surge

Storm surge can cause significant changes in the water level along the coast in addition to the tides. Storm surge is an increase in water level along the coast in response to the storm winds and pressures. Storm surge in Hurricane Katrina (2005) along the Mississippi coast exceeded 27 feet (*Douglass, et.al. 2006*). The Great Lakes can experience water level changes of up to ten feet in response to a severe storm.

### 2.4.3 Major Weather Events

Major weather patterns cause high storm surge and waves. The great coastal storms of the southeast include tropical storms and hurricanes. The major coastal storms of the northeast include those as well as extra-tropical storms including “Nor’easters.” The great coastal storms of the west coast include the El Niño related storms and the “pineapple expresses.” The major storms of the Great Lakes include the winter north winds associated with arctic high pressure systems and their related weather fronts.

#### 2.4.3.1 Tropical Storms and Hurricanes

A hurricane is a type of tropical cyclone, the general term for all rotating weather systems (counterclockwise in the Northern Hemisphere) over tropical waters. Tropical cyclones are classified as follows:

- Tropical Depression - an organized system of clouds and thunderstorms with a defined circulation and maximum sustained winds of 38 mph
- Tropical Storm - an organized system of strong thunderstorms with a defined circulation and maximum sustained winds of 39 to 73 mph
- Hurricane - an intense tropical weather system with a well defined circulation and maximum sustained winds of 74 mph or higher

The term "sustained wind" refers to surface wind speeds (10 m above the surface) that persist for durations of one minute.

Hurricanes are created in the tropical oceans, frequently in the eastern Atlantic Ocean and are then powered by the heat from the sea. The hurricanes typically are steered westward by easterly trade winds. The Coriolis effect provides the characteristic cyclonic spin of these storms. Around their core, winds grow with great velocity, generating violent seas. As the fierce winds accompanied by the low pressure move ashore, the storm surge grows and creates



extensive flooding. In addition, the hurricane carries with it torrential rains and can produce tornadoes.

Hurricanes are often classified by the Saffir-Simpson scale:

- Category 1 - winds 74-95 mph
- Category 2 - winds 96-110 mph
- Category 3 - winds 111-130 mph
- Category 4 - winds 131-155 mph
- Category 5 - winds > 155 mph

The original Saffir-Simpson scale also included bands of minimum central pressure and maximum storm surge limits. However, modern meteorology typically focuses exclusively on wind speeds when categorizing storms.

The use of the Saffir-Simpson scale as the basis for coastal engineering design decisions can be problematic because the scale is based solely on windspeed and not the critical phenomena of storm surge elevations and waves.

Damages from hurricanes extend well inland. Frequently, the most noted or newsworthy aspect of hurricane damage results from flooding along the coastal area. This is particularly important in low-lying areas such as the coastal barrier islands. Of course, the flooding will continue upstream in every inlet open to the ocean. The damages for each level of hurricane increase with the intensity of the storm.

#### 2.4.3.2 Extratropical and Nor'easter Events

Cyclonic events such as extratropical storms form when unstable air produces significant temperature and pressure differences. At times, such systems may stall off the coast and produce long (i.e., several days) periods of high winds and inland rainfall. These events rarely obtain hurricane level wind speeds; however, they can cause significant coastal hydrological effects and wave damages.

Many historically significant events on the upper Mid-Atlantic and New England coasts were a result of Nor'easters. The "Ash Wednesday" storm of March 1962 was formed by the combination of several slow moving coastal low pressure systems along the Atlantic seaboard. This combined storm resulted in hurricane force winds and water levels 9 or more feet above mean low water level in areas of Maryland and Delaware over a period of several days (to contrast, for this same region, the 1933 "hurricane of record" produced water elevations 7 feet above mean low water). Likewise, the popularized 1991 "All Hallow's Eve" or "Perfect Storm" produced 5 days of high wave action, coastal erosion, and washover (USGS 2003). These extratropical events are not limited to the Atlantic Coast; Florida's west coast experiences severe flooding from such events. During one March 1993 event, at a location north of Tampa Bay, the resulting inundation (and damages) was similar to those predicted to occur from a Category 1 hurricane (Citrus County 2000). Likewise, the Great Lakes coastal regions endure wave damages during winter extratropical events (USGS 2003).

#### 2.4.3.3 Long-term Fluctuations

There are also longer-term fluctuations in mean sea level along our coasts in response to weather systems. One such fluctuation, El Niño, refers to a periodic rise in equatorial Pacific Ocean surface temperatures that affect global weather patterns. The mean sea level along the Pacific coast can be over six inches higher, when averaged over an entire year, during El Niño

## Part 1 – Background & Context

years. Historical data reveal a relationship between El Niño and Southern California tropical cyclones and flood events (USGS 2003, FEMA 2004). Additionally, El Niño is responsible for increases of water surface elevation as eastward flowing water accumulates on the West Coast shore (USGS 2003). Some research indicates that both El Niño and La Niña episodes have some relationship in affecting wind conditions and the California current (Schwing and Bograd 2003). Figure 2.4 illustrates differences in coastal water surface elevations at a Northern California bridge waterway during El Niño (October 1997) and after El Niño (April 1998) (USGS 1998) episodes.



During El Niño event



Following El Niño event

Figure 2.4. Coastal water level fluctuations.

#### 2.4.4 Waves

Waves are one of the major forces affecting coastal systems including roads and bridges. Large, damaging waves occur during the great coastal storms mentioned above. Waves have the ability to generate tremendous forces and cause considerable damage when they are riding on top of storm surge and are thus able to strike roads and bridges that are not typically designed for such forces. For example, the waves in the Gulf Coast hurricanes of 2004-2005 caused \$ billions in damage to bridges including moving bridge deck spans that weighed over 340,000 lbs each (see Figure 2.5).



Figure 2.5. US Highway 90 bridge across Biloxi Bay, Mississippi, after Hurricane Katrina. (photo looking northeast from Biloxi 9/21/05).

#### 2.4.5 Shoreline Erosion

Storm waves have the ability to erode coastal dunes and bluffs. Roads can be damaged by this erosion. Storm surge contributes greatly to this erosion by allowing the waves to attack the dunes or bluff at higher elevations than normal. The combination of storm surge and waves can cause overtopping and overwash on some low elevation roads. Overwash in Hurricane Isabel (2002) caused portions of the barrier island west of Cape Hatteras, North Carolina (Pea Island), to breach and form a new inlet (Figure 2.6). This overwash and breach completely removed a stretch of road, North Carolina Highway 12 (NC 12), which could not be repaired until the barrier island was artificially rebuilt. Similar vulnerable areas exist on this and other barrier islands and coastal regions.

#### 2.4.6 Littoral Drift

Waves also have the ability to move tremendous amounts of sand down the coast in littoral drift or longshore sand transport. Thus, our shorelines are always changing locations in response to

## Part 1 – Background & Context

changes in wave conditions and local sand supplies. Barrier spits, islands, and inlets migrate. Shorelines accrete or recede over the long-term in response to changes in the sand transport.



Figure 2.6. Breaches in Outer Bank barrier island caused by Hurricane Isabel in 2002 (NC 12 ROW is dotted line).

### 2.4.7 Shoreline Recession

Most of the United States coast is experiencing long-term shoreline recession. The causes of this are natural, e.g. responding to sea level rise, and man-made, e.g. interruptions in sand movement along the coast by ship channels. Roads that are located near the shoreline can often be threatened or even destroyed by this coastal erosion. For example, a twenty mile long portion of Texas Highway 87 has been completely closed and destroyed by coastal erosion.

### 2.4.8 Tsunamis

Tsunamis ("tidal waves") normally result from an underwater disturbance (usually an earthquake) that triggers a series of waves that can travel many hundreds or thousands of miles. In the open ocean, the waves may move 450 miles per hour. Reaching shallower waters, the waves decrease speed, but gain amplitude. Tsunamis appear on the coast as a series of successive waves where the period from wave crest to wave crest can range between 2 and 90 minutes (but normally between 10 and 45 minutes). Typically, the first of these waves is not the largest. A 1964 Alaskan earthquake sent tsunami waves between 10 and 20 feet high along the coasts of Washington, Oregon, and California. In regards to frequency, Hawaii and Alaska can expect a damaging tsunami on the average of once every seven years, while the West Coast experiences a damaging tsunami once every seventeen years (FEMA September 1993).

#### 2.4.9 Upland Runoff

Upland runoff can affect storm surge heights and flow conditions in tidal waterways if significant runoff discharges occur during the surge. Hurricanes can produce significant amounts of rainfall and extreme flooding in river systems much farther inland than the flooding caused by the surge. Upland flood discharges can reduce incoming flood tides and increase outgoing ebb tides.

#### 2.4.10 High-Velocity Flows

Floodwaters moving at high velocities can lead to hydrodynamic forces on structural elements in the water column, including drag forces in the direction of flow and lift forces perpendicular to the direction of flow. Oscillations in lift forces correspond to the repeated shedding of vortices from alternate sides of the structural element (for example, these vortices can often be seen in the wakes behind bridge pilings in rapidly moving water). High-velocity flows can also move large quantities of sediment and debris. Current FEMA Flood Insurance Study (FIS) “V” zone mapping procedures cannot accurately predict locations where high-velocity flows and their impacts will be felt.

High velocity flows can be created or enhanced by the presence of manmade or natural obstructions along the shoreline and by “weak points” or “hot spots” formed by bridges or shore-normal canals, channels, and drainage features. For example, anecdotal evidence after Hurricane Opal struck Navarre Beach, Florida, in 1995 suggests that large engineered buildings channeled flow between them, causing deep scour channels across and washing out roads and homes situated farther landward. Observations of damage caused by Hurricane Fran in 1996 at North Topsail Beach, North Carolina, show a correlation between storm cuts across the area and ditches and bridge locations along the frontage road (FEMA 1999).

#### 2.4.11 Other Processes

Other coastal processes that can affect coastal roads include common coastal ice problems in northern climates, wave overtopping and flooding, and wave spray.

### **2.5 Coastal Highway Planning and Design**

Some highway planning and design issues are unique to the coast. For example, the design of revetments that are exposed to wave attack can require additional considerations beyond those in non-coastal situations. These revetments can provide embankment protection along roads or at approaches to bridges.

Another issue is the possible relocation of roads in response to coastal erosion. Historically, some coastal roads have been abandoned or relocated landward due to shoreline migrations. The coastal engineering options for stabilizing shorelines (coastal structures and beach nourishment) can be considered when a road is threatened by erosion. The elevation of coastal roads and bridges can be manipulated to avoid some of the unique coastal forces. For example, the bridges that were destroyed by Hurricanes Ivan and Katrina are being rebuilt at much higher elevations. A related issue is the wave loads and subsequent vulnerability of existing bridges that might be exposed to similar conditions. Each of these issues is discussed in later Chapters in this document.

The coast presents many unique challenges for roads including some unique environmental and aesthetic issues. Coastal roads traverse bays, estuaries, beaches, dunes and bluffs. These are some of the most unique and treasured habitats for humans as well as a variety of plants and

animals. The list of endangered species requiring these coastal habitats for survival includes numerous sea turtles, birds, mammals, rodents, amphibians and fishes.

## **2.6 Coastal Engineering as a Specialty Area**

As described earlier, this document intends to provide the typical State DOT and FHWA hydraulics unit with sufficient information for them to understand issues in the coastal environment. For many coastal projects – especially complex or major projects – a State DOT should consider obtaining specialized assistance or review from coastal engineers.

Coastal engineering is a well established specialty area of civil engineering. Coastal engineering is the planning, design, construction and operation of infrastructure projects in the unique wave, water level and sand transport climate along the coast. Coastal engineering makes extensive use of the sciences of nearshore oceanography and coastal geomorphology as well as geotechnical, environmental, structural and hydraulic engineering principles. Traditional coastal engineering projects involved improving navigation or developing beach erosion solutions. Over time, the scope of coastal engineering projects has broadened from these traditional ones to include, among other purposes, new beaches for recreational purposes and projects to improve coastal water quality. There have been some coastal engineering projects related to coastal highways.

The design environment; the coastal water level, wave and sand environment; is the primary distinguishing factor of coastal engineering from other civil engineering disciplines. The design environment is very challenging. It varies with time, since design conditions are often affected by storms that contain much more energy and induce very different loadings from those normally experienced. Two characteristics of a good coastal engineer are a formal education in coastal engineering and experience in coastal engineering.

### **2.6.1 Education**

Coastal engineering is primarily taught at the graduate level in the United States and abroad. The formal graduate education in coastal engineering, like any other specialty area of civil engineering, is unique and extensive. Thus, the formal education of coastal engineers is significantly different than the education of most civil engineers. Most coastal engineering graduate programs include three or more graduate courses in wave mechanics, two or more courses in other coastal hydrodynamics such as tidal circulation and modeling, two or more courses in coastal sediment transport, and several courses in the functional and structural design of built infrastructure in this environment.

Roughly two dozen American universities have some formal graduate level coastal engineering program with a few faculty members teaching in the field. At least four universities; the University of Florida, the University of Delaware, Oregon State University, and Texas A&M University; have four to eight faculty members in coastal engineering.

### **2.6.2 State-of-Practice**

The practice of coastal engineering is still much of an art. This is for a variety of reasons including that the physical processes are so complex, often too complex for adequate theoretical description, and the design level of risk is often high. Consequently, practitioners should have a broad base of practical coastal engineering experience and should exercise sound judgment based on that experience. There is no substitute for the judgment that comes from coastal engineering experience.

There is no formal code of practice or specialty certification in coastal engineering in the United States today. There is an organization called the Association of Coastal Engineers (ACE) that requires a formal education and experience in the field for full membership ([www.coastalengineers.org](http://www.coastalengineers.org)).

### 2.6.3 Resources

The field of coastal engineering is summarized in a few textbooks including Kamphuis (2000) and Sorensen (2006). Significant portions of the field are summarized in other textbooks that are mentioned in subsequent Chapters. The USACE has produced a Coastal Engineering Manual (USACE 2002) (CEM) that attempts to summarize the aspects of the field that are of most importance to that agency's mission. The CEM is over 2500 pages and a foot wide on the bookshelf. The CEM replaces the Shore Protection Manual (SPM) (USACE 1984) that, with its predecessor editions, was often called the "bible of coastal engineering." Another coastal engineering manual is Herbich (2000).

The breadth and the changes in the field of coastal engineering are best captured by professional specialty conferences and journals. The International Coastal Engineering Conference series is held every two years and typically has 400 to 500 presentations. There are several series of American Society of Civil Engineers (ASCE) sponsored specialty conferences including the "Coastal Sediments" conferences, the "Coastal Structures" conferences, the "Solutions to Coastal Disasters" conferences, the "Ports" conferences, and the "Coastal Zone" conferences; as well as others. Each of these conference series has a longer, formal title that is more explanatory but these are the commonly used names. These conference series also have hundreds of presentations. Most of these conferences publish written proceedings. The ASCE Journal of Waterway, Port, Coastal and Ocean Engineering is published six times per year. Other journals with coastal engineering research results include the Journal of Coastal Engineering, Shore and Beach, and the Journal of Coastal Research. The National Beach Preservation Technology conference is sponsored annually by the Florida Shore and Beach Preservation Association. There are many related conferences and journals beyond these.

## **2.7 Coastal Engineering in the Highway Community**

A goal of this document is to encourage the better integration of coastal engineering principles and practices in the planning and design of roads along the coast. Later chapters address some of the coastal engineering applications related to highways.

As American society continues its great migration to the coasts in the face of changing natural stresses on the coast, the opportunities for fruitful integration of coastal engineering in the transportation engineering process will increase. Some coastal states are already encouraging, and even requiring, the inclusion of coastal engineers in multi-disciplinary teams addressing highway and bridge projects near the coast. This document should aid the transportation professional in understanding when input from a trained coastal engineer would be helpful to the design team.

*Page Intentionally Left Blank*



## **Part 2 – Principles of Coastal Science & Engineering**

*Page Intentionally Left Blank*

## Chapter 3 - Tides, Storm Surge and Water Levels

Water level fluctuations include astronomical tides, storm surges, and long-term sea level rise or fall. Water level is important in coastal processes and engineering in part because it controls the location of wave influence on shorelines and structures. Geologically, sea level controls the overall location and shape of the continental shoreline. The definitions of tidal datums and surveying datums can be important for the design of engineering works near the coast. Storm surge, which temporarily raises the water level, can control the design water level for engineering. Tidal currents can be significant as tides and storm surges enter and exit coastal bays through inlets.

The portion of the water level fluctuation controlled by the astronomical bodies, the moon and the sun, are referred to as the astronomical tide. Additionally, coastal water levels are often affected by meteorological conditions including storm surge in response to winds and waves and local rainfall.

### 3.1 *Astronomical Tides*

The tide is the slow rise and fall of the ocean waters in response to the gravitational pull of the moon and the sun. The tide is essentially a very long ocean wave with a wave period of 12.4 hours. The usual interval between successive high tides is 12.4 hours as the arrival of the crests of these waves represent high tide. The moon exerts a greater influence on the tides than does the sun.

The astronomical tide is well understood and can be predicted for any time at many locations. Tidal predictions are well understood by most coastal residents and are often included in local daily newspapers and weather forecasts. NOAA's National Ocean Survey provides on-line tidal forecasts as well as other information about tides around the nation.<sup>2</sup> Along most coasts bordered by the ocean, the astronomical tide forecasts are within 1 ft of the actual tide elevation 90% of the time. The difference between the forecasts and actual water elevation measurements is normally a result of weather related phenomena (e.g., wind blowing from same direction over some period, i.e. a storm surge). Understanding some of the characteristics of tides is helpful in understanding some of the terminology used to define tides and tidal datums.

#### 3.1.1 Characteristics of Astronomical Tides

In most locations in the United States, there are two high tides and two low tides every lunar day (24.8 hours). These are called "semidiurnal" tides (see Figure 3.1). At many locations the two high tides that occur each day are roughly of the same elevation. But at many other locations, there is a "mixed tide" with a clear "diurnal inequality" in the high tides as one is significantly higher than the other. Some places, like portions of the Gulf of Mexico, have only one high tide and one low tide per day. These tides are called "diurnal" tides.

---

<sup>2</sup> <http://tidesandcurrents.noaa.gov>

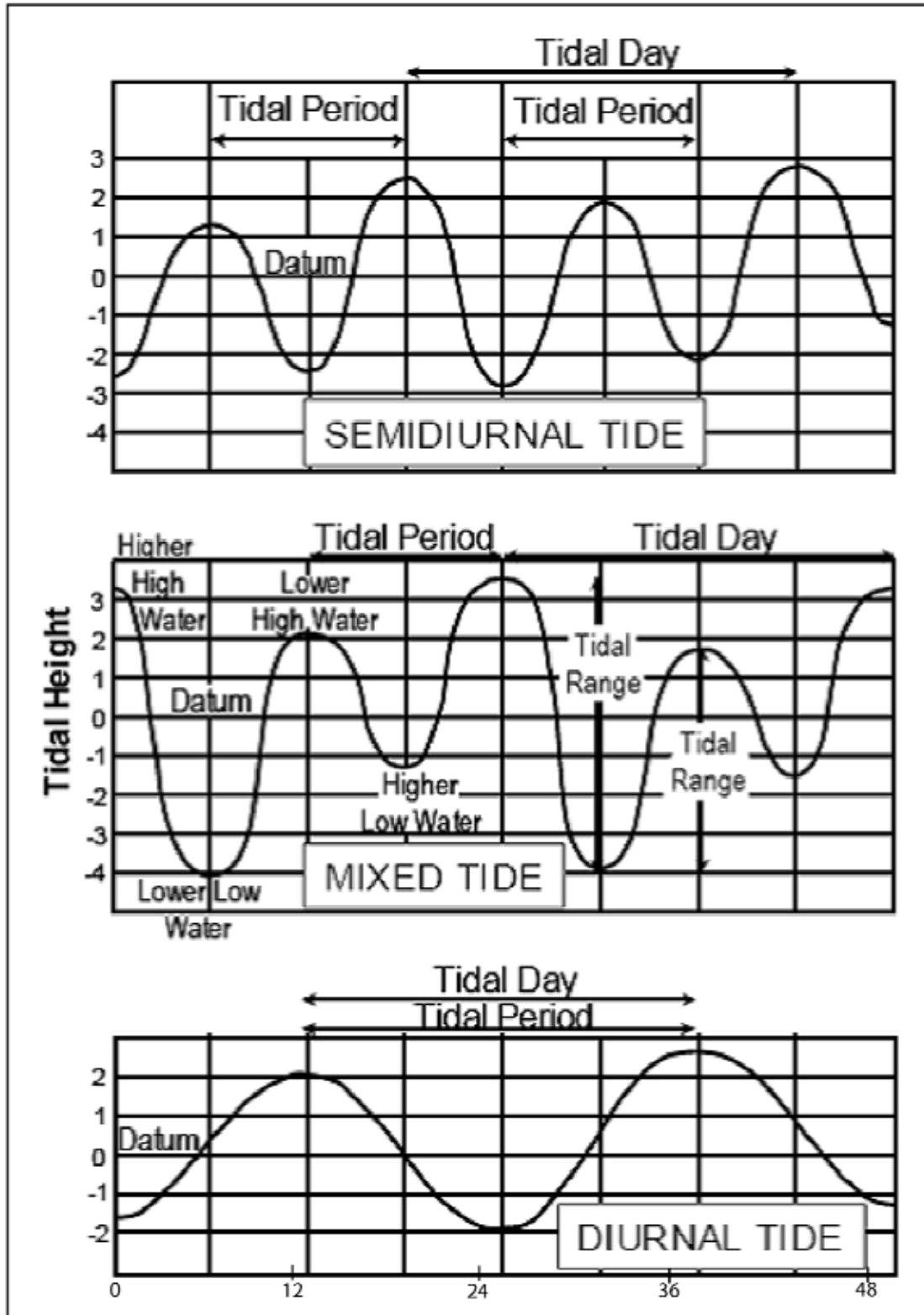

Figure 3.1. Basic Definitions of Tides modified from <http://tidesandcurrents.noaa.gov>.

Large differences in tide range occur at the same location throughout the month. The highest tides which occur at intervals of half a lunar month are called “spring tides.” They occur at or near the time when the moon is new or full, i.e., when the sun, moon and earth fall in-line, and the tide generation forces of the moon and sun are additive. When the tide range is at its lowest during the lunar month, the “neap tides” occur.

Large differences in the magnitude of the daily tide range occur at different locations in the US. These differences are caused by the interactions of the oceanic tidal motions with the continental land mass and the depths and shape of coastal bays and shelves. At Anchorage, Alaska, the tide range can vary up to almost 30 feet between high and low tide. At Pensacola, Florida, however the range can be less than 2 feet throughout a day. These differences in tidal range can occur within short distances along the coast and up bays. For example, the average tide range at Sandy Hook, New Jersey is about 5 feet but is only 2 feet just 125 miles away at Montauk Point, New York.

The basic astronomical tide producing forces go through a “tidal epoch,” a cycle that lasts approximately 18.6 years. Thus, water level statistics related to tides, such as mean sea level, are computed by averaging over a complete epoch.

### 3.1.2 Tidal and Survey Datums

The distinction between tidal datums and surveying datums can be important in the design, construction, and operation of engineering works near the coast. Tidal datums are vertical datums based on the epoch-averaged tide levels at a specific location. Tidal datums are based on actual measurements at a specific tide gage. Since sea level is changing over the long-term, the tidal datums are re-established after every tidal epoch. The most recent tidal epoch ended in 2001 and NOAA’s National Ocean Survey has re-established the tidal datums for most of the United States’ tide gage locations for the 1983 -2001 tidal epoch.

There are a number of tidal datums. The mean high water datum (MHW) is the average, over an 18.6-year tidal epoch, of the high water elevations at a specific location. The mean higher high water datum (MHHW) is the average of the higher high water elevations. The difference between these two datums, MHW and MHHW, is greatest at locations with the greatest “diurnal inequality” in high tides during a typical day. Likewise, the mean low water datum (MLW) is an average of the low tide elevations and the mean lower low water datum (MLLW) is an average of the lower low tide elevations. MLLW is the basis for most navigation charts because it provides mariners with a consistent, somewhat conservative, estimate of the depth. The mean sea level datum (MSL) is the average of all the observations of water level over a tidal epoch.

Survey datums are specified for geodetic surveying and set by the NOAA’s National Geodetic Survey. The National Geodetic Vertical Datum of 1929 (NGVD 29) and the North American Vertical Datum of 1988 (NAVD 88) are the two primary vertical survey datums used in the US. The older NGVD 29 geodetic datum was originally established using estimates of mean sea level at 26 tide gages around the nation. Thus, it was often referred to as just “mean sea level.”

However, it has long been recognized that it was not the mean sea level because mean sea level changes through time and survey datums do not. The National Geodetic Survey has not called NGVD 29 the “mean sea level” for decades. NAVD 88 was an improvement to the NVGD 29 and has now replaced it as the primary vertical datum for surveying. It normally will be near the mean sea level at the open coast but it is not the mean sea level.

The relationship between the survey datum, NAVD 88, and the tidal datums, e.g. MSL or MLLW, has been calculated by the NOAA National Ocean Service for many of the tide gages around the US. An example is shown in Figure 2.18 using the values for Charleston, South

Carolina. The distances from a local tide station datum to the NAVD 88 and to the tidal datums for the 1983 to 2001 epoch are shown. The local tide station datum is meaningless except for that specific gage record. What are significant are the relative relationships between the survey datum and the tidal datums.

Figure 3.2 shows that the mean sea level (1983 to 2001 epoch) at Charleston, SC is -0.21 feet NAVD 88. This relationship is not the same at other locations around the nation.

The relationship between the tidal datums and NAVD88 for different locations around the nation can be obtained directly from the NOAA/NOS website ([www.tidesandcurrents.noaa.gov](http://www.tidesandcurrents.noaa.gov), in November 2006). Investigating the relationship between site specific upland surveys and tidal datums can be important.

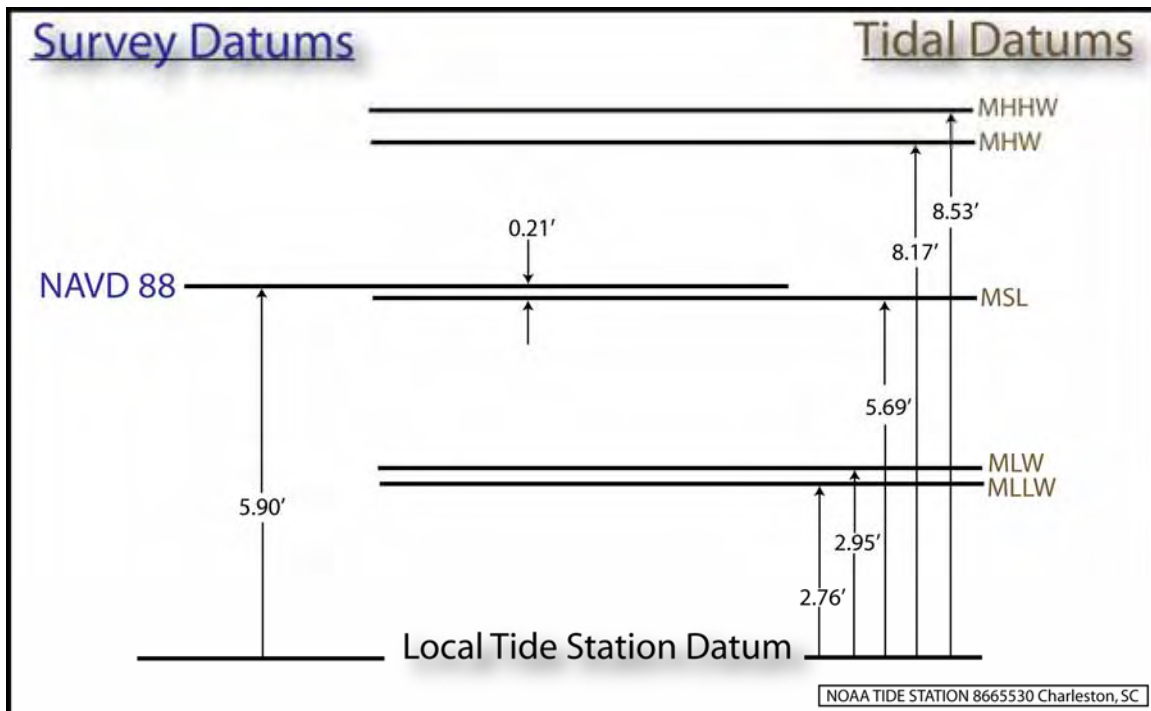

Figure 3.2. An example of the relationship between the survey and tidal datums.

### 3.2 Storm Surge

Storm surge is the rise of water level above the astronomical tide as a result of meteorological forcing. This forcing is primarily wind but also includes the barometric pressure and, for some coastal locations, local rainfall runoff. Storm surge can be negative, i.e. winds can decrease water levels from the astronomical tide levels. Storm surge is highly influenced by geography including the shape of the coast and its bays, the nearshore bathymetry, and the flooded topography. High storm surges occur along the coast where the landmass stops the hydrodynamic movements. The highest storm surge can occur in bays. Wind affects storm surge by placing a stress on the water surface, by generating oceanic currents and by generating waves. Breaking waves can contribute to storm surge by adding a component of mean water surface elevation called wave setup. Storm surge is an important coastal process for the design of coastal infrastructure primarily because it increases the design still water level and allows waves to attack higher elevations. Surge also can be an important component in tidal inlet hydrodynamics.

Figure 3.3 is an example of hurricane storm surge. The predicted tide is plotted along with measurements from a tide gage located on a pier in the Gulf of Mexico. The surge, the difference between the predicted and actual water level, extends for several days with a very dramatic peak of over 7 feet above the predicted high tide early on August 18. That high peak corresponds with the time that the hurricane made landfall with its eye just to the southwest of the tide gage.

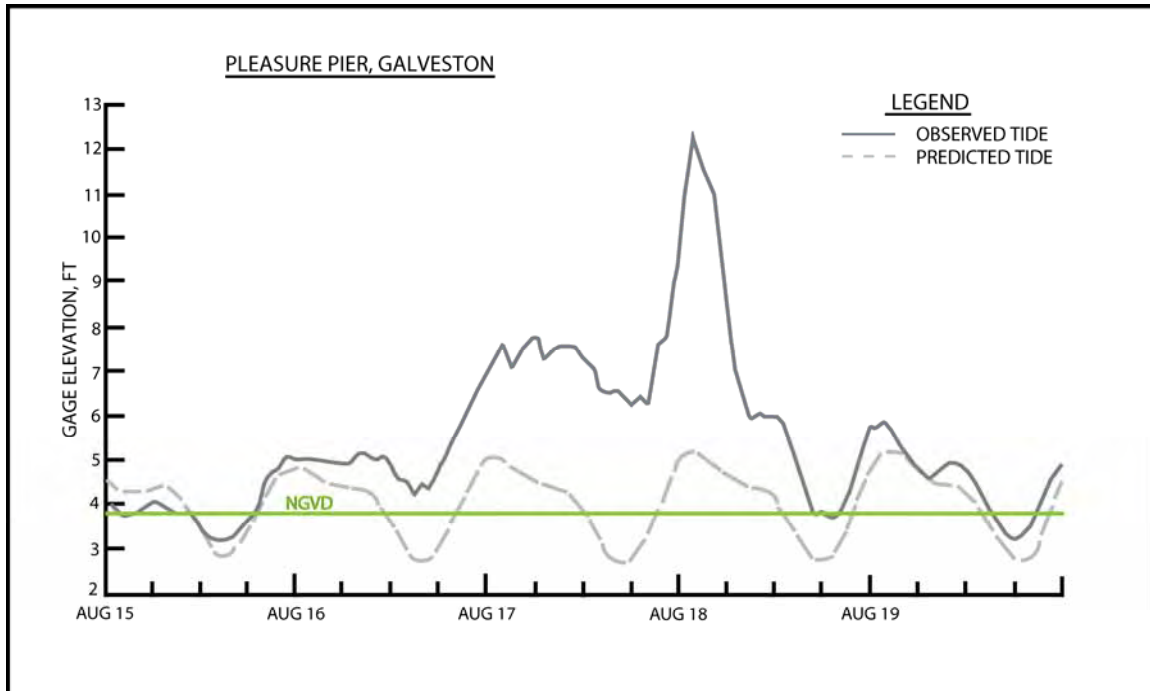

Figure 3.3. Storm surge at Galveston, Texas, from Hurricane Alicia in 1983.

The hydrograph of a coastal storm surge is usually considered as the time variation of water surface elevation at a specific location. Both the magnitude and duration of a coastal storm surge can be important. During the most destructive coastal storm in United States history, Hurricane Katrina in 2005, the water level rose 27 feet higher than its predicted tide elevation due to storm surge along much of the coast near Bay St. Louis, Mississippi. Several inland locations had mean high-water marks over 30 feet in elevation. This storm surge was unprecedented in United States history. But the previous high storm surge, 21 feet, was along this same stretch of coast in Hurricane Camille of 1969. Another of the most destructive storms in American history, the Nor'easter Ash Wednesday Storm of 1962, caused much of its damage due to its relatively long duration. The storm surge lasted for 2½ days over five semi-diurnal high tides, or "five high-tides." This long duration allowed beach storm erosional processes to act that long and cause extensive property damage along the Atlantic coast.

### 3.2.1 Modeling Approaches

Storm surge hydrographs from specific storms can be modeled with modern hydrodynamic modeling techniques. The numerical modeling of coastal hydrodynamics is based on solving the fundamental fluid mechanics of motion, the continuity equation and the momentum equation, in a manner that is most efficient and appropriate for the problem. Different formulations of the equations and solution algorithms have been applied to the coastal hydrodynamics situation and there is a rich history of this modeling that has developed over the past thirty years in both the

nearshore physical oceanography and coastal engineering research communities. Much of the research and development of these models was done with funding from federal agencies with coastal interests including NOAA and the USACE. Research papers with the models and applications are available in a variety of publications. Many of the applications and models were presented at a series of specialty conferences called the International Estuarine and Coastal Modeling conferences that began in the early 1990's and continue.

One of the available hydrodynamic models that can be used to estimate a storm surge hydrograph, as well as currents, associated with a specific storm is the storm surge and circulation model, ADCIRC (ADvanced CIRCulation, Luettich, et al. 1992; Blain, et al. 1994; Scheffner, et al. 1994; Westerink, et al. 1993; and Westerink, et al. 1994). ADCIRC's two-dimensional version uses a finite element approach to solve the depth-integrated, nonlinear momentum and continuity equations in the time domain.

Input to ADCIRC includes the topography and bathymetry, distributions of wind velocity vector, and bottom drag coefficient, as well as boundary conditions. The output of ADCIRC includes the time series of surge elevation (this is the still water elevation without the wave crest elevations) at any location, the two-dimensional surface elevation and the water velocity fields at all grid locations.

The ADCIRC model has been used to develop an estimate of the storm surge hydrograph for Hurricane Katrina (Douglass, et al. 2006). The numerical grid used is shown in Figure 3.4. The grid extends out into the Gulf of Mexico beyond the shallow continental shelf but is focused on the shoreline and upland areas that flooded. A map of the estimated maximum surge predicted by the storm surge model is shown in Figure 3.5. The highest surge reached 33 ft (10 m) above the mean sea level (MSL). This value agrees with those reported in post-storm surveys.

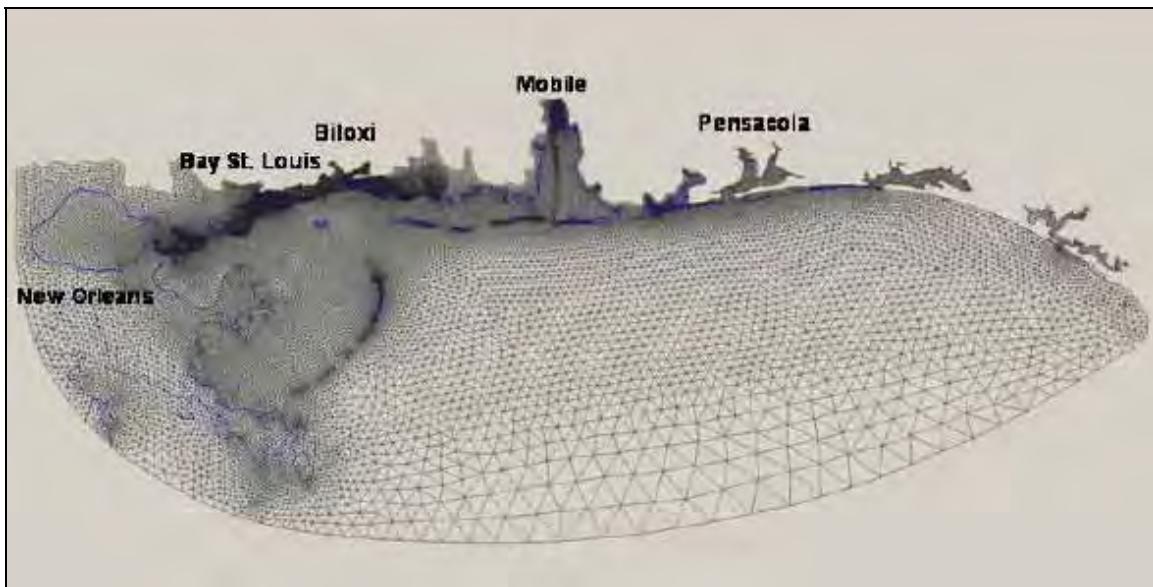

Figure 3.4. Example of a numerical grid for a coastal hydrodynamic model (from Douglass, et al. 2006)

The detailed, estimated storm surge hydrograph at the location of the US Highway 90 bridge across Biloxi Bay that was destroyed by Katrina is shown in Figure 3.6. The peak surge is estimated to be 21.5 feet at 10:30 a.m. Also shown on Figure 3.6 are estimates of wave height



from a SWAN model (see Douglass, et al. 2006). The shape of the hydrograph indicates that the bridge was exposed to surge elevations above 15 feet for three hours.

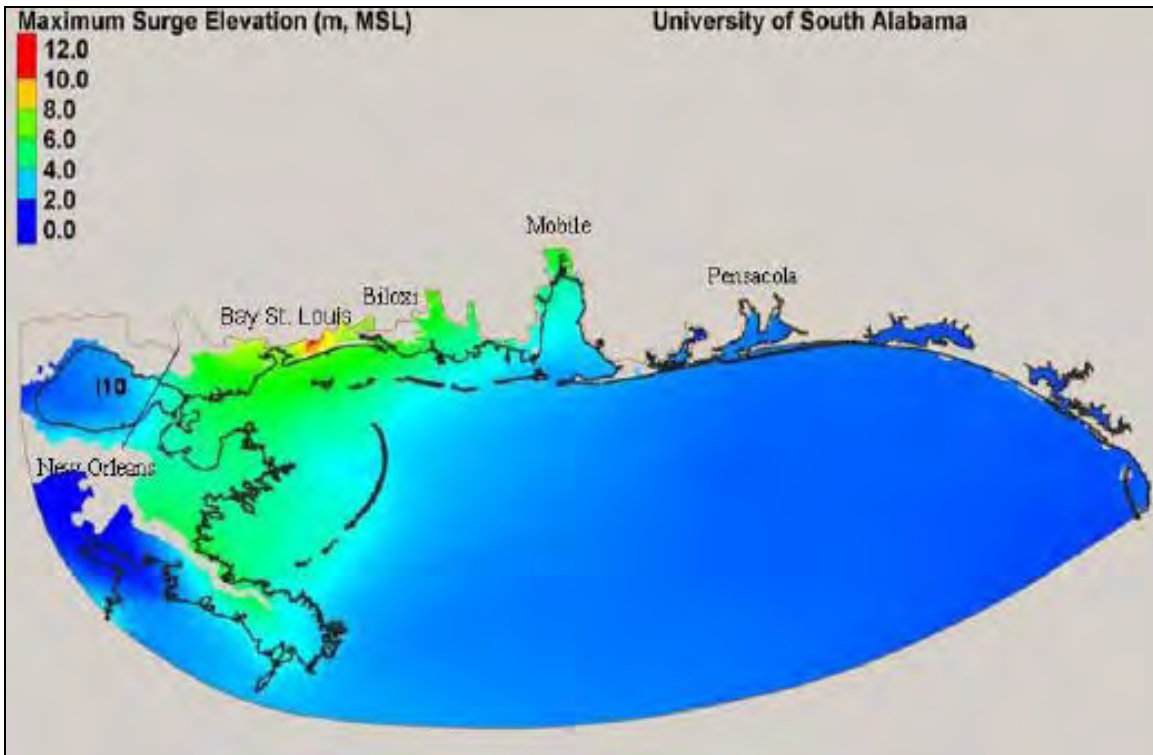

Figure 3.5. Estimates of the peak storm surge caused by Hurricane Katrina (from Douglass, et al. 2006)

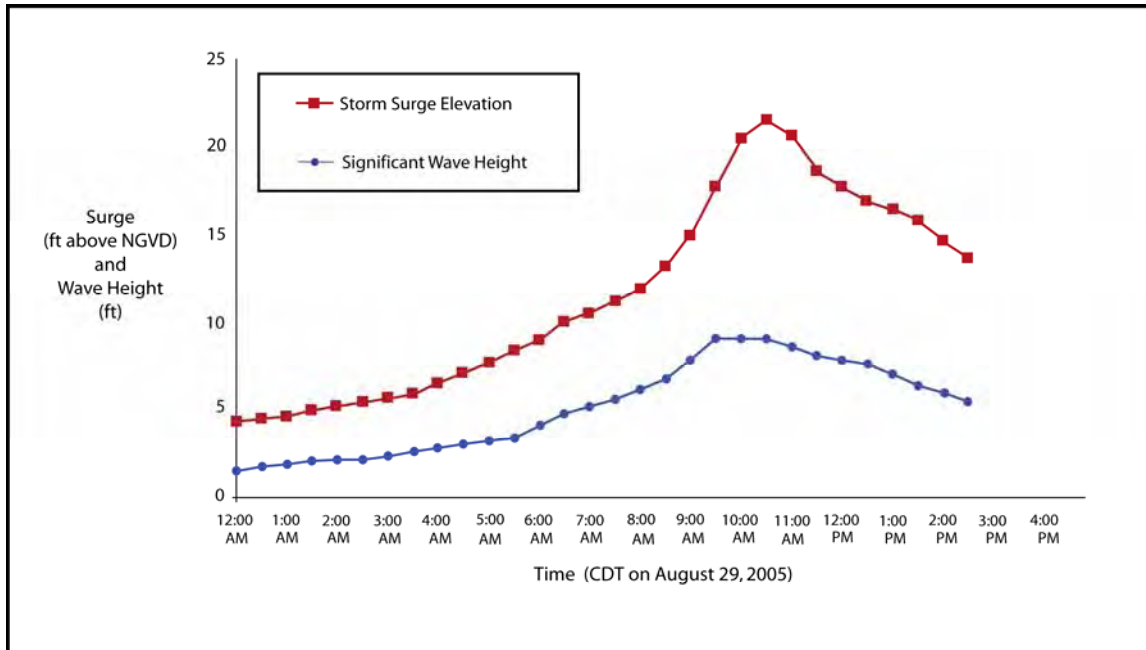

Figure 3.6. Storm surge hydrograph as estimated by ADCIRC modeling for Hurricane Katrina at the US 90 bridge across Biloxi Bay, Mississippi (from Douglass, et al. 2006)

### 3.2.2 Design Water Levels

The selection of a design water level can be one of the most critical coastal engineering decisions for the designs and structures discussed in Part 3 of this document. For example, the design water level often controls the design wave height, stone size and extent of armoring on coastal revetments. Also, wave loads on elevated bridge decks are extremely sensitive to water level. Essentially, the water level dictates where waves can reach and attack.

Design water level decisions should be addressed using the traditional, risk-based approach of a "design return period" as is common in hydraulic engineering. For example, the "100-year storm surge level" is the surge elevation with a 1%-annual risk of exceedance. Each year, there is a 1% chance that a storm surge of this magnitude (or greater) will occur. Some coastal designs may justify a lower return period (e.g., 25- year or 50-year) in certain areas – balancing the greater risks affiliated with such design with engineering and economic considerations.

Three approaches for developing site-specific water level-return period relationships are: 1) use of available analyses, 2) historical analysis, and 3) numerical simulations with historic inputs. There is a great deal of literature and information on each of these approaches (including plusses and minuses). This document will only provide a brief synopsis of the key elements in each approach.

Some limited information on return periods for water levels is available from state and Federal agencies. FEMA, as part of their flood insurance mission, has estimated 100-year flood levels and areas of subsequent inundation along much of the United States coast. However, the precision of the FEMA results can be limited and they should be evaluated carefully before use in design.

Many emergency management agencies have coastal inundation maps that are based on results from hydrodynamic models. One commonly applied model is called SLOSH (Sea, Lake, and Overland Surges from Hurricanes). The SLOSH model is usually used to estimate the worst possible flood level for each of the Saffir-Simpson scale storm categories. These may provide an estimate of extremely rare storms but do not provide risk-based information for design. Some USACE Districts have developed their own water level-return period relationship for design at many coastal locations. Some state resource management agencies, e.g. Florida's Department of Environmental Protection's Bureau of Beaches and Coastal Systems, have developed estimates of surge-return period relationships along the coast.

All available estimates of the surge-return period relationship should be collocated and evaluated carefully before use in design. Available estimates are often not adequate for design of site-specific coastal works without the review by a qualified coastal engineer. The Florida DOT has researched application of such analyses and developed a protocol that may be useful for others to review and adopt (Sheppard and Miller 2003).

Historical analysis on long-term tide gage data can provide water level-return period information. Typically, determining the return period associated with these tide station record involves application of log-Pearson Type III (or similar) statistical methods. Either graphical or analytical statistical approaches can be used. However, such analyses are typically restricted to locations near one of the NOAA/NOS long-term tide stations or a tide station operated by the USACE; other local, state, or Federal agencies; or universities. In a situation familiar to practitioners trying to use riverine gaging station data, these tide stations are rarely close enough to the actual project site to allow direct application. However, unlike those stream flow driven riverine gages, the tide station may allow a practitioner to apply engineering judgment (and other, more formal techniques) and establish a reasonable "transfer function" that relates water levels at a

location with a tide record to another nearby location. This could provide a reasonable estimate of the relationship for some locations.

New, independent analysis of the relationship between water level and return period is often appropriate for design of coastal highway solutions. For major projects, a probabilistic, numerical approach which uses a hydrodynamic model for storm surge simulations (see Section 3.2.1) and historical storm information can be used. The model must be calibrated appropriately. Input storm conditions for historical hurricanes for the past 150 years are available from the NOAA HURDAT database. There are two general approaches to assigning the proper probability to historical storms and other "hypothetical storms;" 1) the Joint Probability Method (JPM) which is typically used by FEMA in their coastal flood studies, and 2) the Empirical Simulation Technique (EST) which was developed by the USACE to develop site-specific water level-return period relationships (US Army 2002 CEM). This sort of analysis likely requires the integration of a qualified, coastal engineer or scientist into the design team.

### **3.3 Sea Level Rise**

The level of the oceans of the world has been gradually increasing for thousands of years. The important change is the relative sea level change, the combined effect of the ocean water elevation and the land-mass elevation change. Some of the United States land-mass near the coast is subsiding due to a variety of geologic factors including compaction and man-induced factors such as groundwater or oil and gas extraction. Some of the United States land-mass near the coast, however, is rebounding or emerging, due to glacial retreat. Relative sea level change, rise or fall, is the difference between these two, the ocean and the land elevation. The sea level fluctuations of the past twenty thousand years and the geologic impacts on beaches are discussed below.

Tide gages have measured relative sea level changes around the nation for the last century. Figure 3.7 (Atlantic and Gulf coasts) and Figure 3.8 (Pacific coast) show the variation in the average annual mean sea level (MSL) for a number of locations around the United States coast for the past century. The values are plotted relative to the MSL of the 1983 to 2001 tidal epoch. There is a clear upward trend, i.e. relative sea level rise, along much of the United States coasts. There are, however, some places with no clear trend or even a negative trend. For example, near the California/Oregon border and in much of Alaska, there is a relative sea level fall in the last century. The rate of sea level rise (or fall) varies significantly along the United States coast with the highest rates of rise in the areas with the most land-mass subsidence along the Gulf Coast.

The rate of relative sea level rise or fall can be evaluated by the change in mean sea level as measured at specific NOAA tide gages from one tidal epoch to the next. The change in mean sea level from the 1960 to 1978 tidal epoch to the 1983 to 2001 tidal epoch was +0.25 feet (sea level rise) at Charleston, South Carolina, and was -0.03 feet (sea level fall) at Juneau, Alaska.

The world-wide, average sea level, with land-mass subsidence effects removed, is called the eustatic sea level. The estimated eustatic sea level has been rising at a rate of 2 mm/year for the past century. In a very active research field, many atmospheric scientists have concluded that the earth is warming and that sea level rise rates will accelerate in response. While no acceleration in sea level rise rate has been measurable yet, the U.S. Environmental Protection Agency (USEPA) and many others have suggested future sea level rise acceleration scenarios for planning.

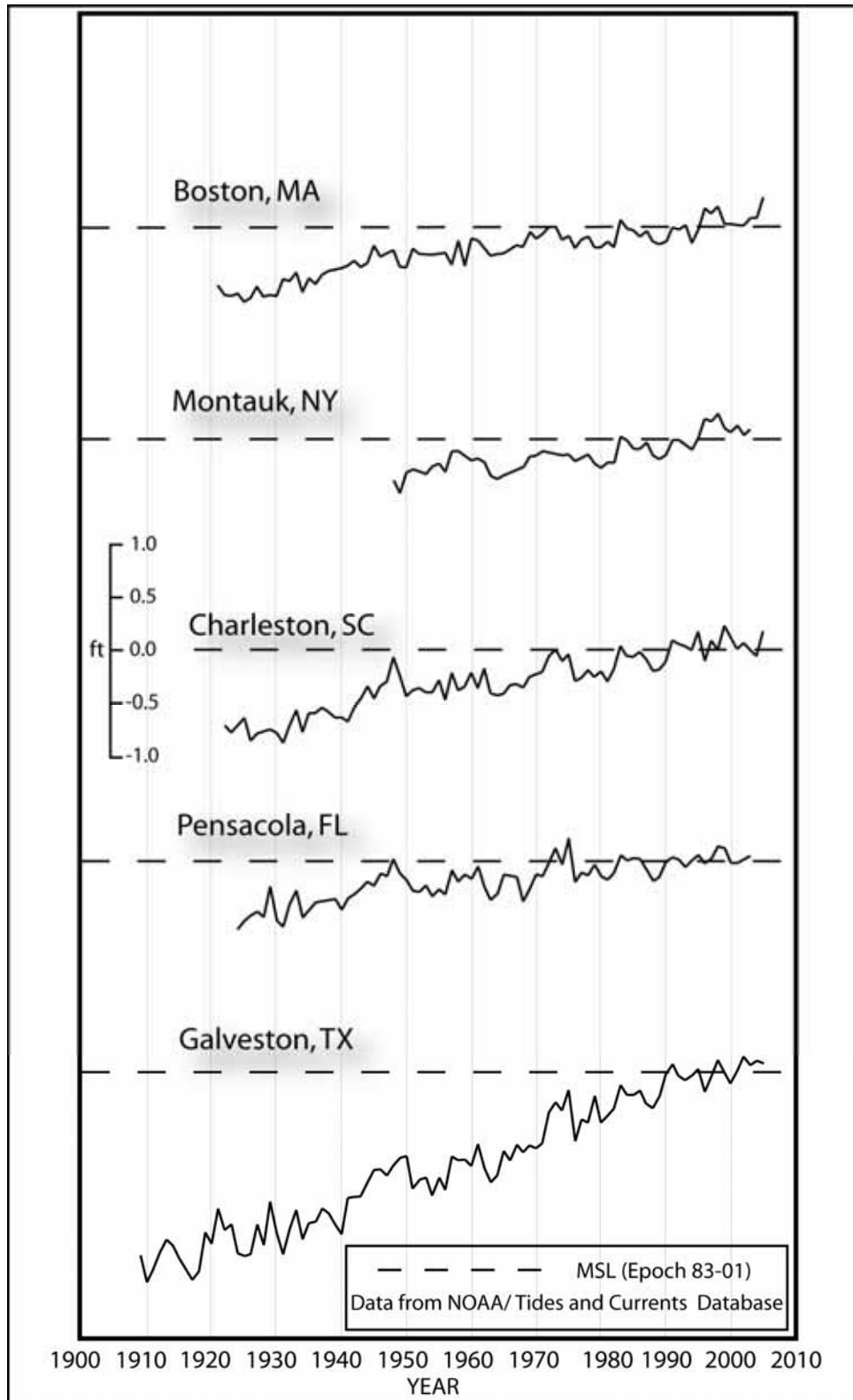

Figure 3.7. Sea levels along the US Atlantic and Gulf coasts for the past century.

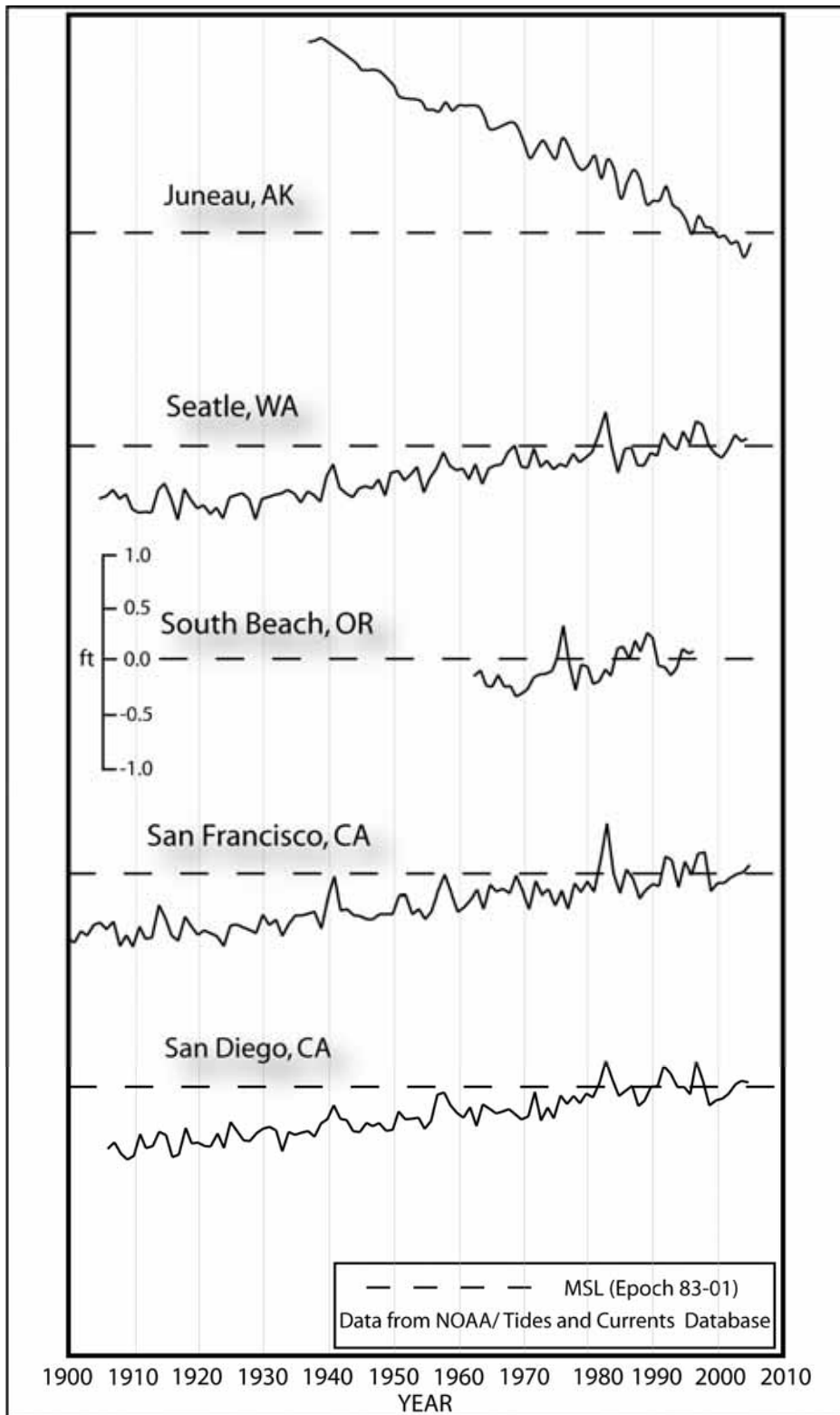

Figure 3.8. Sea levels along the US Pacific coast for the past century.

The impact of long-term sea level rise has rarely been taken directly into account in the design and planning of coastal highways. It has, however, been indirectly taken into account because of its effect on epoch-based tidal datums and its fundamental controlling effect on shoreline change and other coastal processes. It is likely that long-term sea level rise and other global climate change phenomenon, such as an increase in storminess, have already significantly impacted our coastal highway system. For example, it is possible that the frequency of coastal flooding and damage to highways has increased in the past several decades. Thus, long-term sea level rise probably will be more often accounted for in the planning and design of engineered systems near the coast in the coming decades.

### **3.4 *Lake Water Level Fluctuations***

The Great Lakes, the Great Salt Lake, and other very large inland lakes are tideless. They are completely separated from the oceans and are too small for any astronomical tides of their own. Water levels in these large inland lakes have significant fluctuations however in response to rainfall in their drainage basins. For example, there is an annual rise and fall of between 1 and 2 feet on Lake Erie due to snowmelt in the spring. Multi-year wet and dry periods cause 3 to 5 feet of decadal-scale fluctuations. Many of these very large lakes have their own local lake level datums that are used for science and engineering related to the water level. A bulletin describing lake levels for the Great Lakes is available from the Detroit District of the USACE online at [www.lre.usace.army.mil/glhh](http://www.lre.usace.army.mil/glhh).

## Chapter 4 - Waves

Waves cause some of the primary hydraulic forces in coastal engineering applications. Water waves are caused by a disturbance of the water surface. The original disturbance may be caused by winds, boats or ships (wakes), or other disturbances such as underwater landslides due to earthquakes (tsunamis). Most waves are generated by wind. After waves are formed, they can propagate across the surface of the sea for thousands of miles. When waves break on a shoreline or coastal structure, they have fluid velocities and accelerations that can impart significant forces.

Practical wave mechanics is a blend of theories and empirical evidence. Several wave theories including the small-amplitude wave theory and Stokes 2<sup>nd</sup> order wave theory developed in the late 1800's are still used today. Much of the practical scientific study of coastal waves changed during World War II. Plans for amphibious landings such as at Normandy on D-Day and on the Pacific Islands later in the war required as good a prediction as possible of the surf conditions that the landing craft could expect. Research led to equations for forecasting wave heights based on wind speeds as well as equations for estimating how waves break in shallow water. That research revolutionized nearshore oceanography and led to predecessors of the coastal engineering tools still used today and summarized briefly below.

### ***4.1 Definitions, Theories, and Properties of Waves***

This section introduces the basic definitions used in wave mechanics, very briefly introduces several of the most important wave theories, and presents some of the more useful engineering properties of waves. Many engineering applications of wave theories rely on the small-amplitude wave theory. However, there are several important engineering properties that can only be explained by more complex theories or by empirical methods.

Figure 4.1 depicts the basic parameter definitions in the simplest model of water waves. The wave in Figure 4.1 is assumed to be progressing toward the right. The individual waves are assumed to be long-crested (such that the 2-dimensional plane shown in Figure 4.1 is sufficient) and part of an infinite train of repeating waves. The basic length scales used to define the wave are the wavelength ( $L$ ) defined as the distance between wave crests, and the wave height ( $H$ ) defined as the difference between the elevation of the crest and the trough of an individual wave. Waves are called monochromatic waves in this simplest model since the waves are all the same wavelength. The water depth ( $d$ ) is defined as measured to the still water level (SWL), the level of the water if the waves were not present. Wave period ( $T$ ) is the time required for a wave to travel one wavelength.

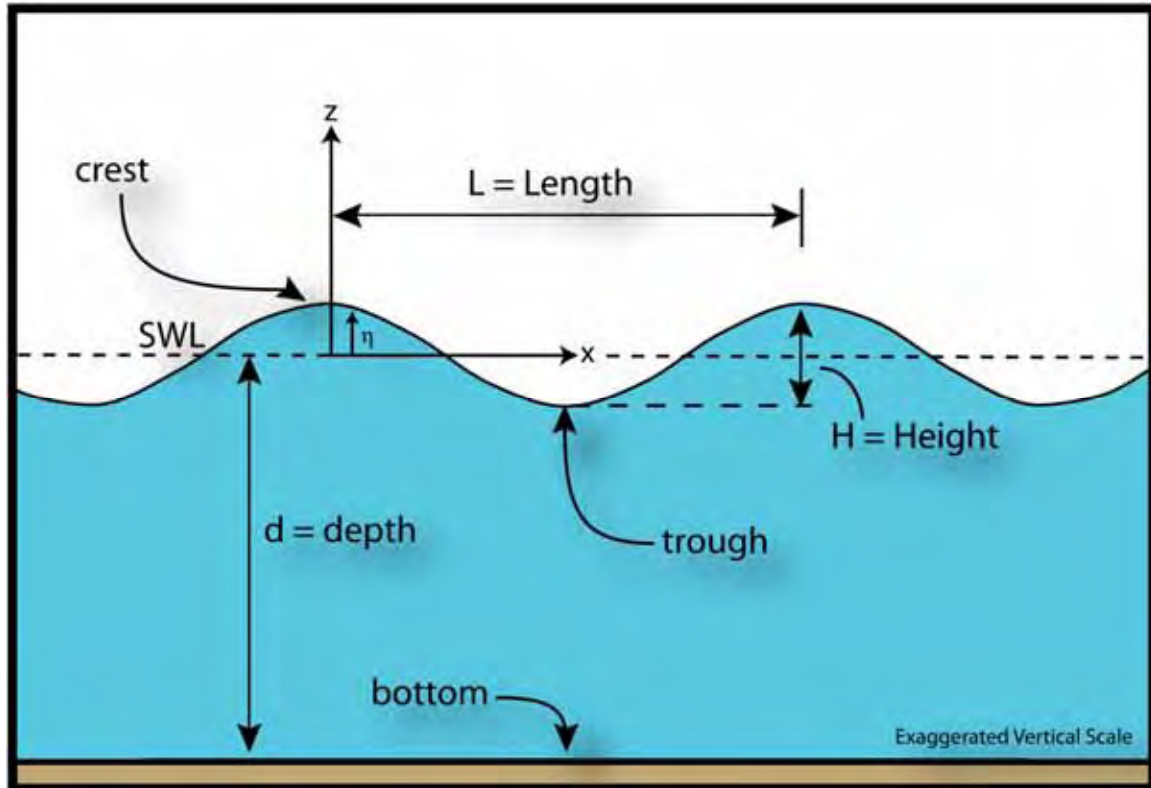

Figure 4.1. Wave parameter definitions.

Small amplitude wave theory provides estimates of many of the basic engineering properties of the monochromatic wave train on a fixed water depth. The result is a progressive, monochromatic wave solution to the boundary value problem consisting of the governing equations of motion for irrotational motion of an inviscid fluid (Laplace's Equation) and the appropriate boundary conditions.

A fundamental assumption in the theoretical development of the theory is that the wave amplitude is small. Amplitude is defined as  $a=H/2$ . The small-amplitude wave theory is often called "linear wave theory" because the small-amplitude assumption allows for the boundary conditions to be mathematically "linearized" and thus solved.

In spite of the seemingly limiting assumption of small waves, many of the basic properties of waves are well estimated by small-amplitude theory. For more information on the theoretical basis and results of small-amplitude wave theory, see Dean and Dalrymple (1991) or Sorensen (1993).

The primary small-amplitude theory solution for the water surface elevation,  $\eta$ , is a cosine wave (as shown in Figure 4.1) described by Equation 4.1.

$$\eta = \frac{H}{2} \cos\left(\frac{2\pi x}{L} - \frac{2\pi t}{T}\right) \quad (4.1)$$

where:

- $\eta$  = water surface elevation (as measured from the SWL)
- $H$  = wave height
- $x$  = horizontal position



t = Time  
 L = Wavelength  
 T = wave period

Small-amplitude wave theory indicates that three of the four basic parameters describing the basic wave model are not independent. Specifically, the wavelength, L, is a function of water depth and wave period, T (Equation 4.2):

$$L = \frac{gT^2}{2\pi} \tanh\left(\frac{2\pi d}{L}\right) \quad (4.2)$$

where:

g = acceleration due to gravity  
 d = water depth  
 tanh = hyperbolic tangent function

In deepwater, where the depth is greater than one-half the wavelength ( $d > L/2$ ), Equation 4.2 reduces to:

$$L_o = \frac{gT^2}{2\pi} \quad (4.3)$$

where:

$L_o$  = wavelength in deepwater

Wave speed, or celerity, is the speed at which the wave form moves across the ocean surface. Based on the parameters above, this is:

$$C = \frac{L}{T} \quad (4.4)$$

where:

C = wave celerity

In deepwater, Equation 4.4 becomes:

$$C_o = \frac{gT}{2\pi} \quad (4.5)$$

where:

$C_o$  = wave celerity in deep water

Note that Equation 4.5 suggests that waves of different periods move at different speeds in deep water.

In shallow water, where depth is less than one-twenty-fifth of the wavelength (i.e.,  $d < L/25$ ), Equation 4.4 becomes:

$$C = \sqrt{g d} \quad (4.6)$$

Equation 4.6 indicates that all waves move at the same speed in shallow water regardless of wave period and that waves slow down as they move into shallower water.

Equation 4.2 is an implicit equation for  $L$ . One explicit approximation to Equation 4.2 is Eckart's approximation:

$$L \approx L_o \sqrt{\tanh\left(\frac{2\pi d}{L_o}\right)} \quad (4.7)$$

Equation 4.7 gives results within 5% of those from Equation 4.2. Given the lack of precision of input conditions in many coastal design situations as well as the uncertainty inherent in the analytical methods this accuracy is often acceptable for engineering purposes.

Instantaneous water particle velocities in waves are given by the small-amplitude theory as:

$$u = \frac{\pi H}{T} \left( \frac{\cosh [k (d + z)]}{\cosh [kd]} \right) \cos (kx - \sigma t) \quad (4.8)$$

and

$$w = \frac{\pi H}{T} \left( \frac{\sinh [k (d + z)]}{\cosh [kd]} \right) \sin (kx - \sigma t) \quad (4.9)$$

where:

- $u$  = horizontal component of water particle velocity
- $w$  = vertical component of water particle velocity
- $k$  = wave number =  $2\pi/L$
- $\sigma$  = wave frequency =  $2\pi/T$
- $z$  = vertical direction (measured from the SWL, see Figure 4.1)
- $\cosh$  = hyperbolic cosine function
- $\sinh$  = hyperbolic sine function

Note that the velocity field in waves is oscillatory with respect to the wave phase or the position of the wave crest. There are essentially three parts to the velocity equations: (1) an oscillatory term with the sine or cosine function, (2) a hyperbolic function of  $z$  which is an exponential decrease in velocity with distance below the free surface, and (3) a magnitude term,  $\pi H/T$ .

Maximum velocities occur when the phase is such that the sine or cosine term equals 1.0, e.g. when  $\cos(kx-\sigma t)=1$  for Equation 4.8. Considering the vertical variation in velocity, maximum velocity occurs at the free surface ( $z=0$ ).

Note that, based on the assumptions inherent in the small amplitude theory, the free-surface is taken as  $z=0$  instead of at some higher elevation such as  $z=\eta$ . The maximum forward water particle velocity occurs on the free surface of the crest of the wave and is:

$$u_{\max, z=0} = \frac{\pi H}{T} \quad (4.10)$$

The wave-induced horizontal velocity on the bottom ( $z=-d$ ), which can control sediment movement on the bottom, becomes:

$$u_{z=-d} = \frac{\pi H}{T} \left( \frac{1}{\cosh [kd]} \right) \cos (kx - \sigma t) \quad (4.11)$$

with a maximum value where  $\cos(kx-\sigma t)=1$  of

$$u_{\max, z=-d} = \frac{\pi H}{T} \left( \frac{1}{\cosh [kd]} \right) \quad (4.12)$$

The instantaneous water particle accelerations in a wave field are given by:

$$a_x = \frac{g\pi H}{L} \left( \frac{\cosh [k(d+z)]}{\cosh [kd]} \right) \sin (kx - \sigma t) \quad (4.13)$$

and

$$a_z = \frac{g\pi H}{L} \left( \frac{\sinh [k(d+z)]}{\cosh [kd]} \right) \cos (kx - \sigma t) \quad (4.14)$$

where:

- $a_x$  = horizontal component of water particle acceleration.
- $a_z$  = vertical component of water particle acceleration.

Water particle displacements or the paths of individual water particles in water waves can be estimated by small-amplitude wave theory. In deepwater the paths are circular with the magnitude of the circular motion decreasing with distance below the free surface (Figure 4.2). At a depth of about one-half the wavelength the wave-induced orbital movements die out (see Dean & Dalrymple 1991; Sorensen 1993; or USACE 2002 for the particle equations). Below the depth,  $d=L/2$ , no surface wave motion is felt.

Figure 4.3 illustrates how particle paths are elliptical in intermediate and shallow depths as shown in Figure 4.3. The vertical amplitude of the elliptical motion decreases with increasing depth. At the bottom, the water particles move back and forth along the bottom. Scuba divers in shallow water are familiar with this back and forth motion and often refer to it as “surge.” The

magnitude of the motion can cause difficult working conditions for divers and the corresponding accelerations can make for nauseous conditions.

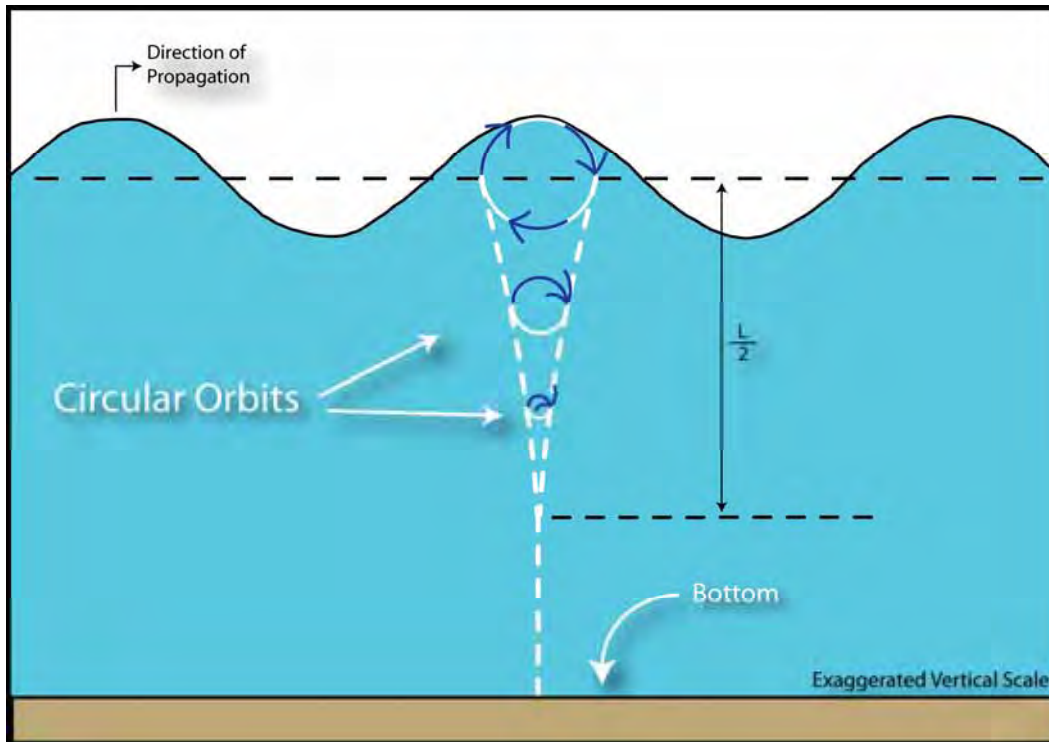

Figure 4.2. Water particle paths under waves in deep water.

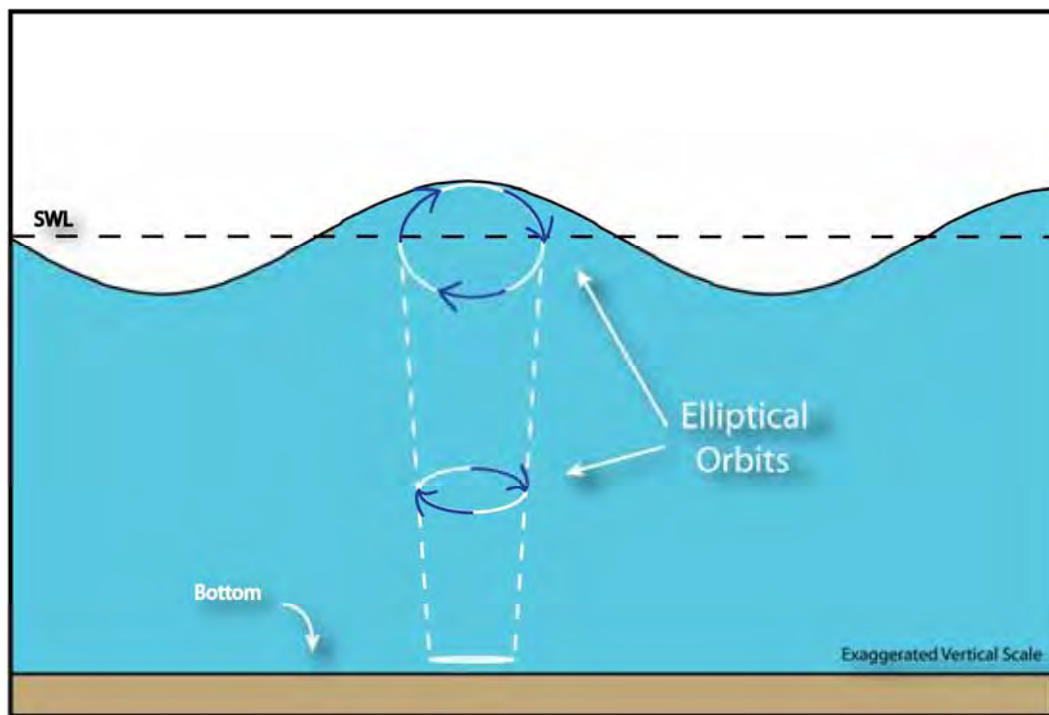

Figure 4.3. Water particle paths under waves in shallow and intermediate water depths

The small-amplitude wave theory provides adequate approximations of the kinematics of wave motion for many engineering applications. However, when waves are very large or in very shallow water, small-amplitude theory results may not be adequate. Higher-order wave theories, such as higher order Stokes wave theories, cnoidal wave theory, and solitary wave theory address these important situations more appropriately. Numerical wave theories, however, have the broadest range of applicability.

Small-amplitude wave theory may not adequately predict the distortion of the water surface profile for large waves or for shallow water waves. The sinusoidal shape of the free surface of a water wave (shown in Figure 4.1) is a reasonable engineering model of the free surface of smaller waves in deepwater.

However, larger waves are known to have water surface profiles that are more like those shown in Figure 4.4. Stokes 2<sup>nd</sup> order theory predicts water surface profiles that are the sum of two phase-locked sinusoidal waves with the smaller having half the wavelength of the first. The resulting water surface profile has more sharply peaked crests and flatter troughs than the sinusoidal profile from small-amplitude theory.

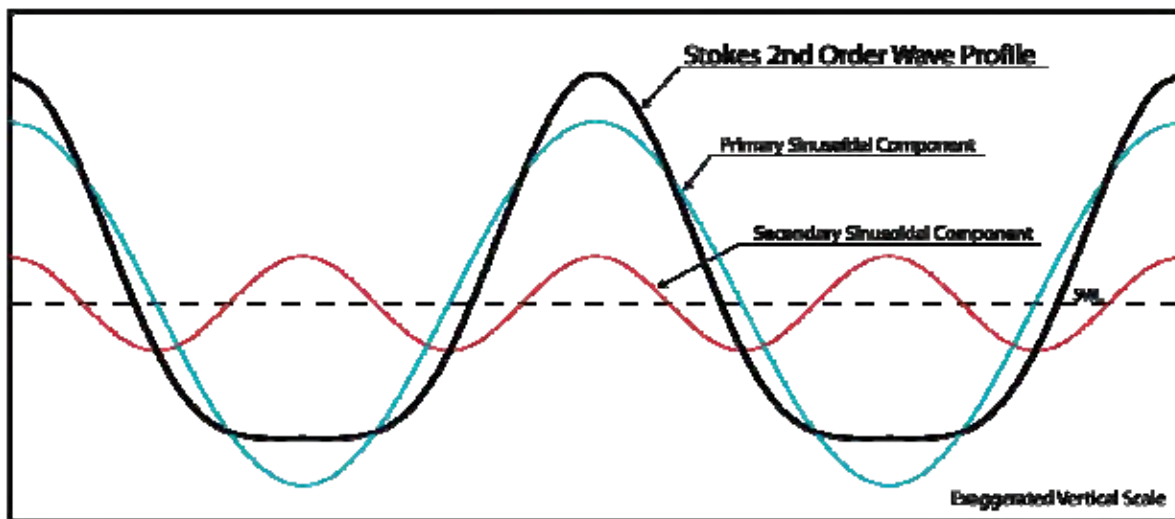

Figure 4.4. Stokes 2<sup>nd</sup> order wave theory water surface profile.

Numerical wave theories can predict water surface shape and kinematics for large waves in deep or shallow water to any level of accuracy. The iterative power of the computer is used to more precisely solve the governing equations and appropriate boundary conditions. The most commonly available numerical wave theories are Dean's streamfunction wave theory (Dean 1965, Dean 1974) and Rienecker and Fenton's potential theory (Rienecker and Fenton 1981).

Two shallow water wave theories are the solitary wave theory and the cnoidal wave theory. These are both analytical theories for waves in very shallow water. The solitary wave considers a single wave. The cnoidal wave is part of a train of monochromatic waves.

The phenomenon of a non-sinusoidal shape of the water surface profile can become obvious for swell in shallow water. Cnoidal waves or the numerical theories can model this phenomenon well.

The wave kinematics, including orbital velocities and accelerations, predicted by higher-order wave theories vary from those predicted by the small-amplitude theory. The velocities and accelerations under the crests of the waves will be larger but of shorter duration than those

predicted by linear theory. However, the variation from the small-amplitude theory is often less than 20-30%. This can be important for wave loads.

The total wave energy of a wave train is the sum of its kinetic energy and its potential energy. The kinetic energy is that part of the total energy due to water particle velocities associated with the orbital wave-induced motion discussed above. Potential energy is that part of the energy resulting from part of the fluid mass in the wave crest being above the wave trough. The total energy density (energy per unit surface area) in a wave train is given by small-amplitude wave theory as:

$$\bar{E} = \frac{\gamma H^2}{8} \quad (4.15)$$

where:

- $\bar{E}$  = total energy in a wave train per unit area of sea averaged over one wavelength
- H = wave height
- $\gamma$  = specific weight of water

The implication of Equation 4.15 is that energy in a sea state is directly related to the square of the wave height. Wave height can be used as a measure of energy in a sea-state. Energy is very sensitive to wave height and doubling the wave height increases the energy in the sea-state four fold.

Waves propagate energy across the sea by moving in wave groups. Interestingly, the groups of waves, and thus the energy in the waves, can move at different speeds than the individual waves. The wave group velocity ( $C_g$ ), or the velocity at which energy is propagated, is related to the individual wave celerity as:

$$C_g = nC \quad (4.16)$$

where:

- n = ratio of wave group velocity to wave celerity (given by Equation 4.17 below)
- C = wave celerity (defined by Equation 4.4)

$$n = \frac{1}{2} \left( 1 + \frac{\frac{4\pi d}{L}}{\sinh\left(\frac{4\pi d}{L}\right)} \right) \quad (4.17)$$

The value n varies from ½ to 1. In deepwater, it approaches n = ½. In shallow water, it approaches n = 1. Thus, in deepwater, the wave energy is propagated at about one-half (½) of the individual wave celerity.

However, in shallow water the energy moves at the individual wave celerity:

$$C_g = C \approx \sqrt{gd} \quad (4.18)$$

The wave power, or wave energy flux in a wave train, is given by:

$$\bar{P} = \bar{E} C_g \quad (4.19)$$

where:

$$\begin{aligned} \bar{P} &= \text{wave power} \\ \bar{E} &= \text{total wave energy density (defined in Equation 4.15)} \\ C_g &= \text{wave group velocity (defined in Equation 4.16)} \end{aligned}$$

Wave energy flux entering the surf zone has been related to the longshore sediment transport rate, wave setup in the surf zone, and other surf zone dynamics as discussed in Chapter 5.

## 4.2 Wave Transformation and Breaking

As waves move toward the coast into shallower water depths, they undergo transformations and ultimately, they break. The wave period of individual waves remains constant through the transformations until breaking but the direction of propagation and the wave height can change significantly. Transformations include shoaling, refraction, diffraction, attenuation and reflection. There are different ways that waves break when they hit a shoreline or structure. The concept of a depth-limited wave height in shallow water can be very valuable in some coastal engineering applications.

As a wave moves into shallower water the wavelength decreases (recall Equation 4.2) and the wave height increases. For two-dimensional propagation, i.e. straight toward shore, the increase in wave height can be theoretically shown, by conservation of wave energy considerations, to be:

$$K_s = \frac{H}{H_o'} = \sqrt{\frac{2n}{\tanh\left(\frac{2\pi d}{L}\right)}} \quad (4.20)$$

where:

$$\begin{aligned} K_s &= \text{shoaling coefficient} \\ H &= \text{wave height} \\ H_o' &= \text{deepwater wave height} \end{aligned}$$

The shoaling coefficient increases from  $K_s = 1.0$  up to perhaps as much as  $K_s = 1.5$  as the individual wave moves into shallower water until the wave breaks via the depth-limited mechanism discussed below.

Wave crests bend as they move into shallower water via refraction. As waves approach the beach at an angle, a portion of the wave is in shallower water and moving more slowly than the rest of the wave. Viewed from above (Figure 4.5) the wave crest begins to bend and the direction of wave propagation changes. Refraction changes the height of waves as well as the direction of propagation.

There are two general types of models for monochromatic wave refraction. Wave-ray models, the older type of model, estimate the path of wave rays, lines perpendicular to the wave crests. These wave ray models are based on Snell's Law. They can provide reasonable estimates of

refraction but have problems with crossing wave rays or “caustics.” These are physically impossible since they imply an infinite wave height. Grid-based refraction models solve some form of governing differential equation for the wave height field across arbitrary bottom contours and avoid this “caustic” problem.

Diffraction is the bending of wave crests as they spread out into quieter waters. An example of wave diffraction is the spreading of wave energy around the tip of a breakwater into the lee of the breakwater. The wave crest, as viewed from above, can wrap itself around the tip of the breakwater and appears to be propagating from that tip location into the quieter water. Diffraction also occurs in open water as waves propagate across varying depths. Thus, wave diffraction and refraction often occur together and any separation of the two mechanisms can be problematic in engineering modeling.

The combination of wave refraction and diffraction can cause wave energy to be focused on headlands or reefs and de-focused in embayments as shown in Figure 4.6. Thus wave heights can be increased on headlands and decreased in embayments.

Numerical wave refraction models are often combined with diffraction models. One such combined model is the REF/DIF model originally developed by Kirby and Dalrymple (1983).

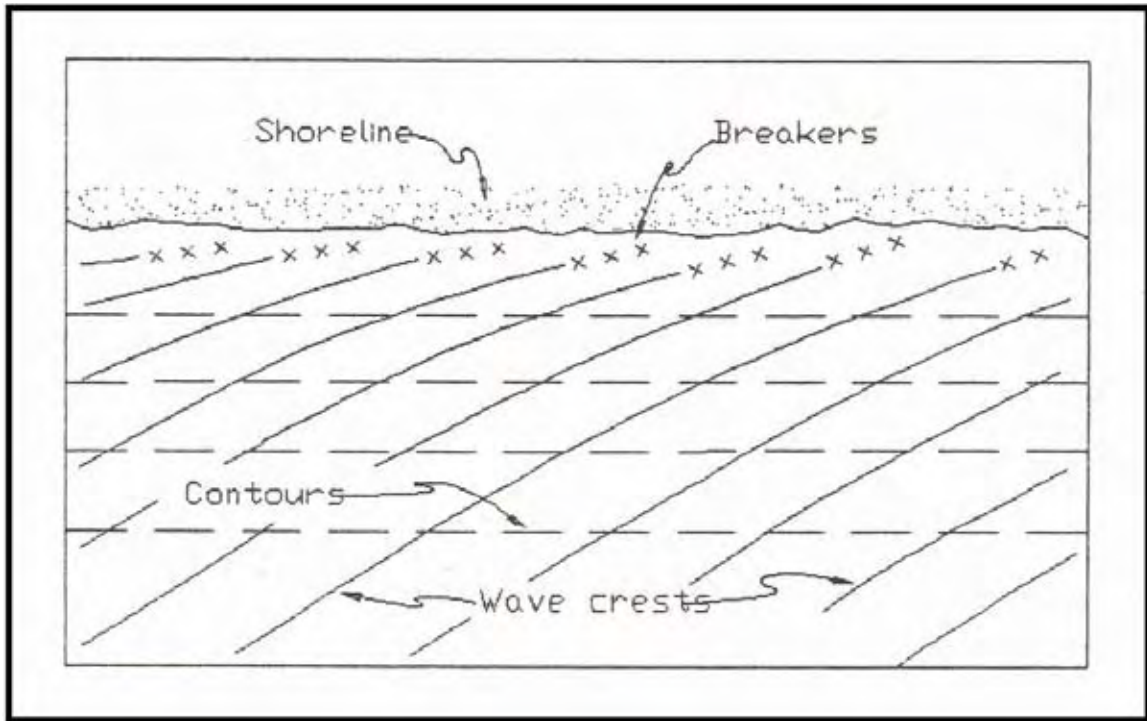

Figure 4.5. Bending of wave crests as they approach the shore due to refraction (from USACE 2002).



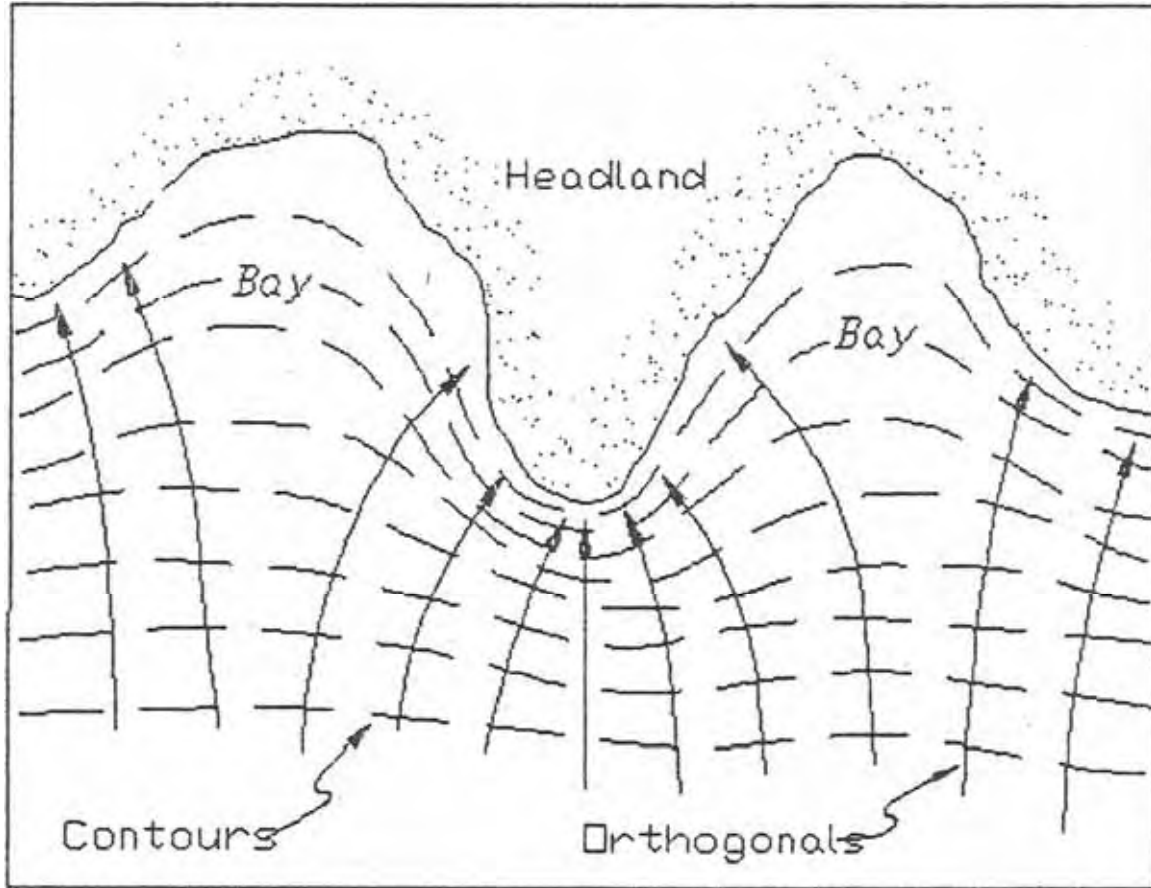

Figure 4.6. Wave energy focused on headland by a wave refraction and diffraction (from USACE 2002).

Wave energy has the ability to propagate very long distances across the ocean with very little loss of energy. However, wave height can decrease as a wave propagates across flat bottoms in shallow water. Energy can be lost due to bottom friction and other processes. These energy losses, or attenuation, can significantly reduce heights. Wave breaking across a shallow bar or reef is also sometimes referred to as wave attenuation.

Wave energy is usually partially reflected when it hits a shoreline or structure. The reflection coefficient is defined as the ratio of the incident wave height to the reflected wave height:

$$C_r = \frac{H_r}{H_i} \quad (4.21)$$

where:

- $C_r$  = reflection coefficient
- $H_r$  = reflected wave height
- $H_i$  = incident wave height

The reflection coefficient can vary from  $0 < C_r < 1$  depending on the shoreline or structure type. Smooth, vertical walls have reflection coefficients of  $0.9 < C_r < 1.0$ . Reflection from sloping walls, revetments and beaches is very sensitive to slope and can vary from 0.05 to 0.9 for different smooth slopes. The lower values are for very flat slopes. Typical values of reflection

coefficient for sandy beaches and rubble-mound structures are  $0 < C_r < 0.45$  and  $0 < C_r < 0.55$  respectively (USACE 1984).

Waves break at two general limits:

- In deepwater, waves can become too steep and break when the wave steepness defined as,  $H/L$ , approaches  $1/7$ .
- In shallow water, waves break when they reach a limiting depth (see Figure 4.7).

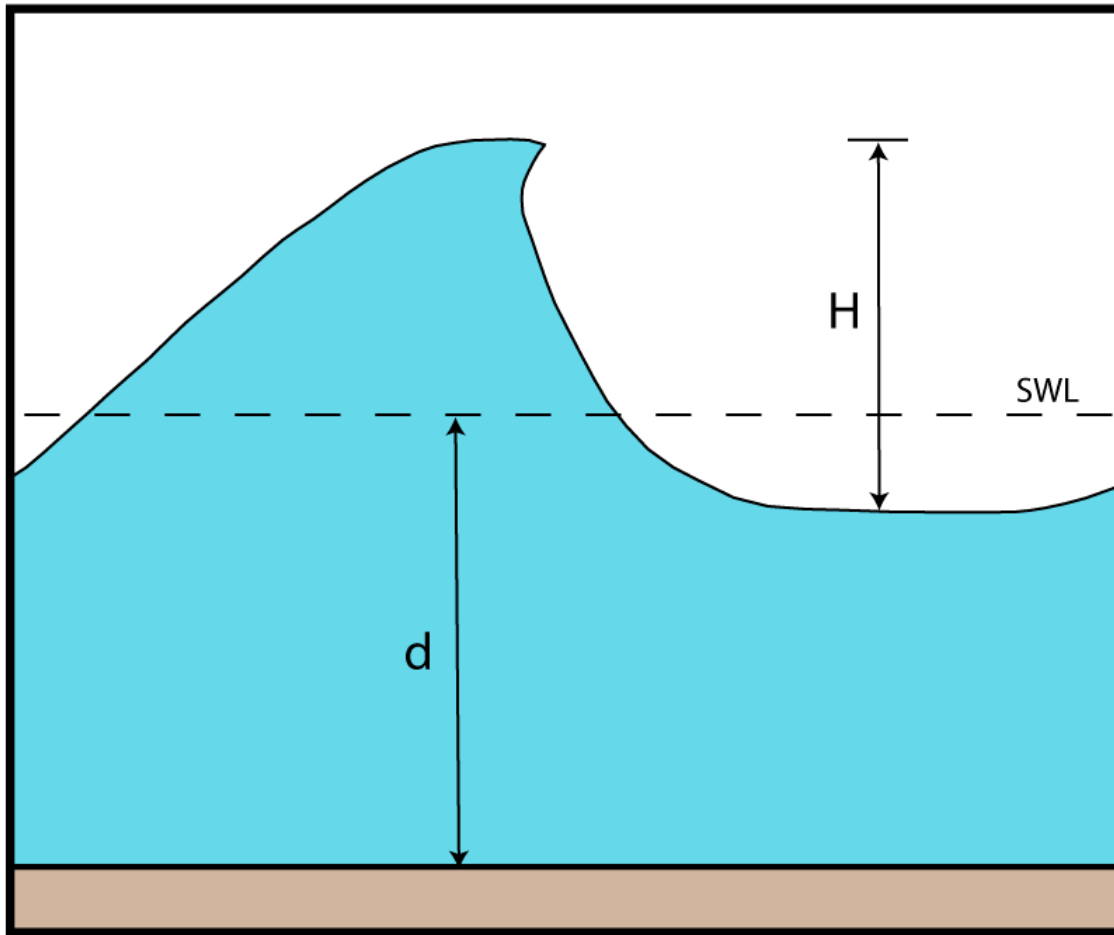

Figure 4.7. Depth-limited wave breaking in shallow water.

This depth-limited breaking can be very important in the design of coastal revetments protecting highways. For an individual wave, the limiting depth is roughly equal to the wave height and lies in the practical range:

$$0.8 < \left( \frac{H}{d} \right)_{\max} < 1.2 \quad (4.22)$$

where:

$$\left(\frac{H}{d}\right)_{\max} = \text{maximum ratio of wave height to water depth.}$$

The variation expressed in Equation 4.22 is due to nearshore slope and incident wave steepness,  $H/L$ .

Steeper nearshore slopes result in higher values of  $\left(\frac{H}{d}\right)_{\max}$ .

A practical value when there is a mild sandy slope offshore of the structure is:

$$\left(\frac{H}{d}\right)_{\max} \approx 0.8 \quad (4.23)$$

Which corresponds with a theoretical limit from solitary wave theory of:

$$\left(\frac{H}{d}\right)_{\max} = 0.78$$

The depth-limited wave height can be expressed as:

$$H_{\max} \approx 0.8 d \quad (4.24)$$

where:

$$\begin{aligned} H_{\max} &= \text{maximum wave height} \\ d &= \text{Depth of water (as shown in Figure 4.7)} \end{aligned}$$

Equation 4.24 is often useful in selecting an upper limit for a design wave height for coastal structures in shallow water. Given an estimate of the water depth at the structure location, the maximum wave height  $H_{\max}$  that can exist in that depth of water is known. Any larger waves would have broken farther offshore and been reduced to this  $H_{\max}$ . Equation 4.24 is a nominal limit and is not conservative on sloped bottoms. Note that depth,  $d$ , must be the total water depth, including tides and design surge levels, and allowances for scour if applicable.

There are four different types of breaking waves. Typical water surface profiles for these breaker types are shown in Figure 4.8. Breaker type is controlled by wave steepness ( $H/L$ ), beach or structure slope, and local wind direction.

Spilling and plunging are the most common breaker types on sandy beaches. An example of a plunging wave is shown in Figure 4.9. When waves plunge, the wave form stands up in vertical face that then plunges over often forming a “tube” of the sort that good surfers like. If a breaker plunges immediately offshore of a vertical structure such as a seawall, a pocket of air can be trapped between the water and the structure. The air pocket can be compressed and produce extremely large, short duration loads on the vertical structure.

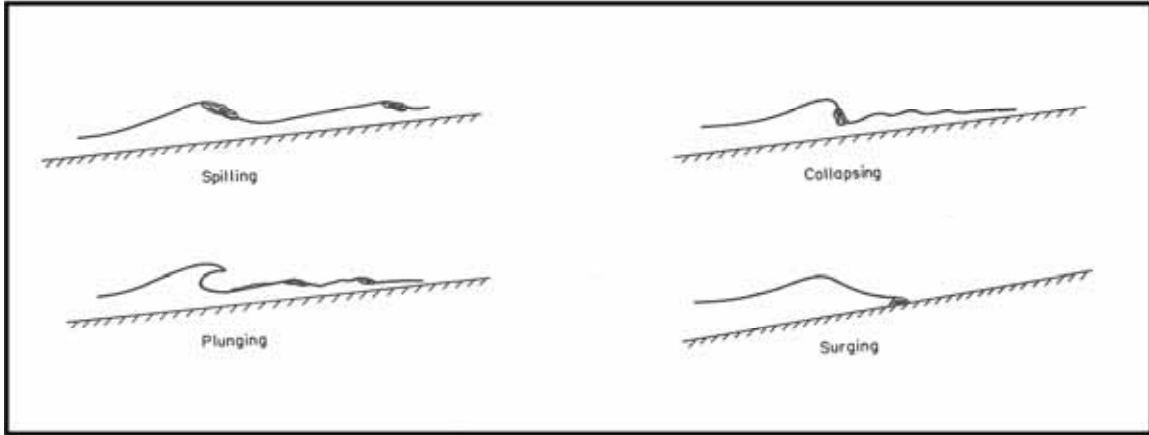

Figure 4.8. Wave breaker types (Sorensen 1993).



Figure 4.9. An example of a plunging breaker (from Douglass 2002).

Surging breakers occur on very steeply sloped beaches and on coastal structures. The surging breaker type is really just a form of wave reflection. The collapsing breaker is intermediate between the plunging and surging types. Collapsing breakers are often the most damaging to coastal structures, particularly rubble-mound structures, because the entire wave front collapses on the structure generating extremely high wave particle velocities and accelerations. Figure 4.10 shows a rock breakwater being struck by a collapsing wave.



Figure 4.10. An example of a “collapsing” breaker (Morro Bay, California).

### 4.3 Irregular Waves

The smooth water surfaces of monochromatic wave theories are not often realistic representations of the sea state on real ocean or bay surfaces. Figure 4.11 shows a long period swell approaching the Pacific coast. For long-period swell situations such as this one, the monochromatic theories are appropriate. Note in the background that there is a continuous train of waves that are of almost the same height with long, straight wave crests (except where they begin to refract and break). The wave profiles show some of the behavior of sharp crests and flat troughs discussed above for Stokes 2<sup>nd</sup> order wave and cnoidal wave theories.

Another, more typical, water surface is shown in Figure 4.12. Individual smooth wave trains are not obvious and the sea state in the bay looks much more chaotic and short-crested. Figure 4.13 shows an even more extreme case of an actively growing sea state. This photograph was taken from an offshore platform in the Gulf of Mexico during a tropical storm. The more typical sea-states, like those shown in Figure 4.12 and Figure 4.13, can be referred to as “irregular waves,” or random waves, since they do not have the smooth, repeating shapes of monochromatic theories.



Figure 4.11. A train of long-period swell approaching the coast.



Figure 4.12. Irregular waves on San Francisco Bay, California.



Figure 4.13. A storm-driven, irregular, sea state.

“Significant wave height,”  $H_s$ , is a term with a long history of use in oceanography and coastal engineering. Two different sets of tools have been developed by oceanographers to describe realistic sea states and thus, significant wave height. One is a statistical representation of the individual wave heights in a sea state. This leads to a primary wave height definition called a “significant wave height”, the average height of the one-third highest waves. The other is a frequency spectrum representation of the water surface elevation that leads to a primary wave height definition that is also called the “significant wave height.” In the literature, the notation for the statistically-based  $H_s$  is often:

$$H_s = \overline{H_{1/3}} \quad (4.25)$$

and the notation used for the spectral significant wave height is:

$$H_s = H_{m_0} \quad (4.26)$$

The two definitions lead to values of significant wave height ( $H_s$ ) that are approximately equal in deepwater seas. However, in shallow water, and especially in the surf zone, the two parameters diverge. The term “significant wave height” probably arose as a way for ship-board observers to estimate the wave height. Some argue that there is nothing truly “significant” about either

definition since there are very few individual waves in an irregular sea that will be of the same height as the significant wave height. The significant wave height ( $H_s$ ) for a sea state is a statistical artifact. However,  $H_s$  (with either definition) provides a consistent, meaningful measurement of the energy in a given sea state and thus most modern engineering methods use it.

Individual wave heights vary in an irregular sea state. The distribution of individual wave heights follows a Rayleigh probability distribution (see USACE 2002). This one-parameter distribution allows for estimation of other wave heights that are sometimes used in design. Table 4.1 provides the relation of some of these other wave heights to  $H_s$ . There are two types of statistics shown in Table 4.1:

- Those that are the average of waves with heights above a certain level ( $\overline{H}_{10}$ ,  $\overline{H}_5$ ,  $\overline{H}_1$ )
- Those that are the wave height exceeded by a given percentage of waves in the irregular sea state ( $H_{10\%}$ ,  $H_{1\%}$ ).

Table 4.1. Wave height statistics in irregular seas.

Wave statistic	Description	Multiple of $H_s = \overline{H}_{1/3}$
$\overline{H}_{10}$	average of the highest 10% of waves	1.27
$\overline{H}_5$	average of the highest 5% of waves	1.38
$\overline{H}_1$	average of the highest 1% of waves	1.67
$H_{10\%}$	height exceeded by 10% of waves	1.07
$H_{1\%}$	height exceeded by 1% of waves	1.52

Each of the wave transformations discussed above for the simpler monochromatic wave train model occur in irregular seas. This includes refraction, diffraction, shoaling, attenuation, and depth-limited breaking. A number of numerical approaches have been developed to model these wave transformations. This is an area of active research and rapid technology development.

#### 4.3.1 Numerical Models

One model for the transformation of irregular waves developed by the USACE is STWAVE. It has now been used on a number of engineering project studies (Smith and Smith, 2001). STWAVE is a finite-difference model designed to simulate the nearshore transformation of a directional spectrum of wave energy. A typical application is to take known offshore wave conditions, such as those measured by a NOAA buoy, and transform them over complex nearshore bathymetry, often to the point of nearshore breaking. Typical coverage areas are 10-20 km in the offshore direction and 20-40 km along the shore, with grid cell sizes ranging from 25 to 100 m. STWAVE is described in detail in Smith, et al. (2001).



## 4.4 Wave Generation

Almost all water waves in the ocean and on bays are caused by winds. Wind first ripples the water surface and then begins to increase the heights of the ripples until they become small waves that propagate on their own. Wave heights continue to increase as the wind blows farther or harder across the water surface. If the water body is large enough, eventually the wave heights will stop growing unless the wind speed increases more. Once they are generated, waves often propagate for hundreds or thousands of miles across the ocean. They travel beyond the storm that generated them. Most waves that hit the shoreline were generated far out at sea. Waves that have traveled out of the winds that generated them are called “swell.” Waves that are still being acted upon by the winds that created them are called “sea.”

Fetch (F) is the distance across the water that a wind blows to generate waves. For enclosed bays, this is the maximum distance across the water body in the direction of the wind. Duration is the time that a wind blows. Waves are called “fetch-limited” if their height is limited by the available fetch distance. Waves are called “duration-limited” if their height is limited by the duration that the wind has blown. If winds blow long enough across a limited fetch until the sea state is no longer duration-limited, the sea is considered “fully-arisen.”

One of the products that came out of the World War II efforts to forecast surf and wave conditions for amphibious landings was an empirical method for estimating wave generation (Sverdrup and Munk 1947). That method was improved by Bretschneider to form the method now known as the SMB method after those investigators. The USACE Shore Protection Manual (USACE 1984) replaced the SMB method with a similar method based on more recent research in the JONSWAP experiments (Hasselmann, et al. 1980).

Appendix C presents a method to estimate wave height and period for shallow bays and lakes. The method has been placed in a spreadsheet model (Weggel 2005). A graph can then be plotted from the results helping to estimate the range of wave heights and periods at any specific location given the fetch and water depth. Figure 4.14 shows an example of such an analysis.

On the open ocean, waves are almost never fetch-limited and they continue to move after the wind ceases or changes. Swell wave energy can propagate very long distances and into other storms. Waves striking the shore at any moment in time may include swells from several different locations plus a local wind sea. Modern wave modeling can numerically solve wave generation and propagation equations using a grid across the entire ocean. These models can include wave generation as well as the transformations of refraction and depth-limited breaking. There are a number of available models including the Wave Analysis Model (WAM) (Komen, et al. 1994) and the Simulating Waves Nearshore (SWAN), (Booij, et al. 1999). This is an active area of research and the technology is still being developed and debated in the oceanography community. However, on a daily basis throughout the world, these and other models are used to forecast waves.

The same models used for wave forecasting can be used for wave “hindcasting.” Hindcasting is the application of the model to estimate wave conditions that occurred in the past. This can be done for historical storms or for long-term simulations. Figure 4.15 shows results from a hindcast of Hurricane Katrina using the SWAN model. The figure shows the maximum wave heights that occurred at each location in the immediate vicinity of the US 90 bridge across Biloxi Bay. The dashed line shows the bridge location. The colors refer to estimated significant wave heights for each location and the arrows indicate wave direction.

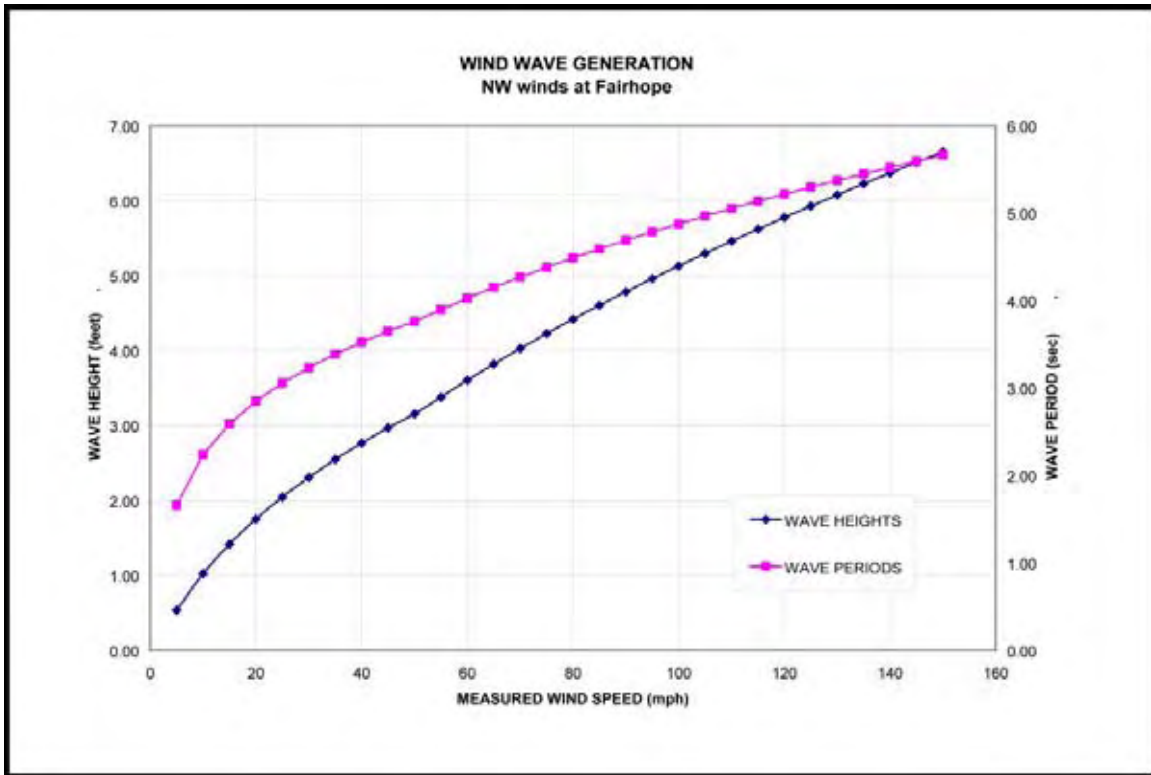

Figure 4.14. Example of wave generation equations applied to a specific site

The USACE Wave Information Study (WIS) has developed a hindcast database of wave conditions at hundreds of locations around the United States coastline. An ocean wave generation model (Resio 1981, Hubertz 1992) was used with 40 years of wind estimates generated from historical barometric pressure fields across the world. The results are estimates of wave conditions;  $H_s$ ,  $T_p$  and wave direction; every 3 hours between 1956 and 1995.

The resulting data and summaries are available on-line at the USACE Coastal Hydraulics Laboratory web-site (<http://chl.erdc.usace.army.mil/chl/> 2006). These hindcast WIS data have been used to develop estimates of long-term wave statistics for engineering design and estimating longshore sand transport rates. Care should be taken in using these hindcast wave statistics for design since these results are not based on actual measurements but rather computer simulations.

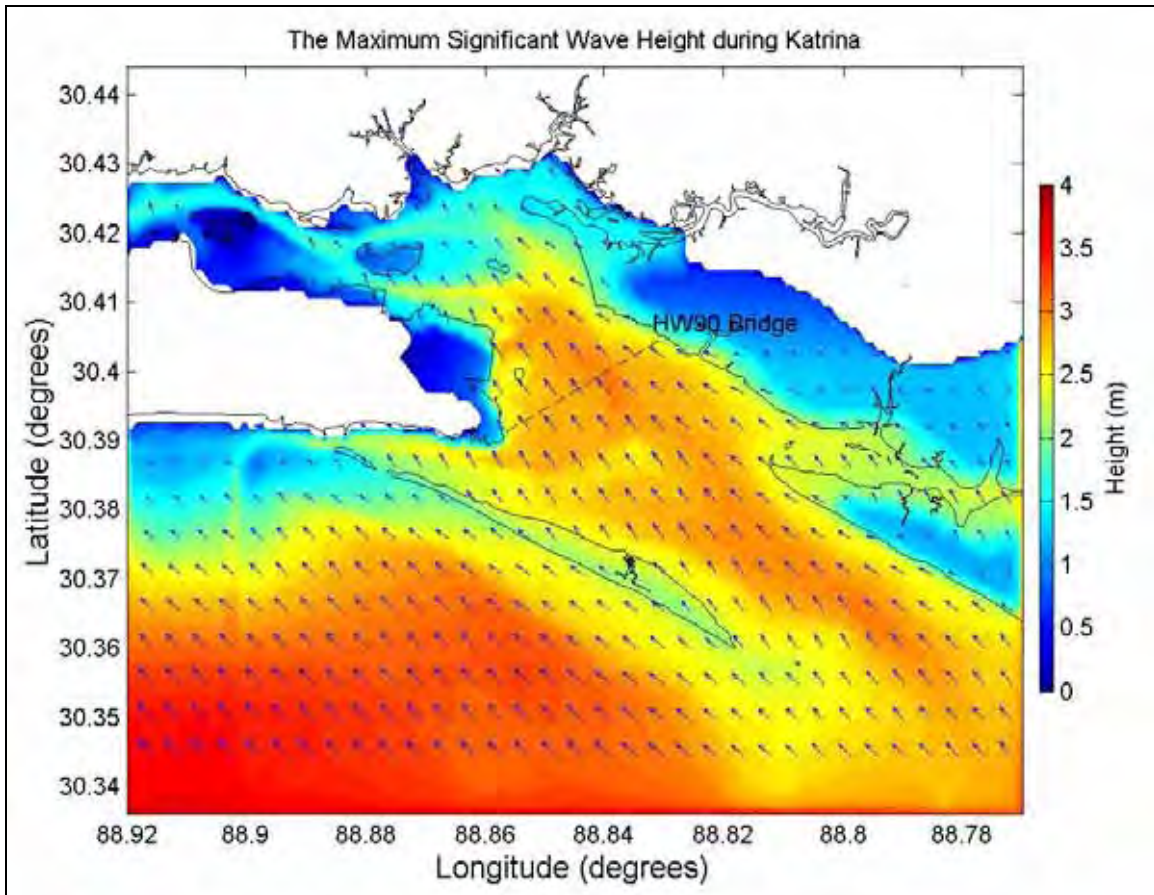

Figure 4.15. SWAN estimates of maximum significant wave heights generated during Hurricane Katrina in immediate vicinity of U.S. 90 bridge over Biloxi Bay.

#### 4.5 Tsunamis

Tsunamis are waves generated by underwater landslides caused by earthquakes. Tsunamis are the world's most powerful water waves because they have extremely long wavelengths that transform significantly as they propagate into shallow water. Tsunamis are sometimes improperly called "tidal waves" even though they have nothing to do with the tides.

The "Boxing Day" tsunami of December 26, 2004 was one of the worst natural disasters of the past century. The runup from the tsunami around the Indian Ocean killed over 225,000 people and destroyed entire cities and villages. A tsunami that hit the Pacific coast of the United States in 1964 killed 12 people and caused millions of dollars in damages in northern California and Oregon. In 1946, a tsunami hit Hilo, Hawaii, killing 150 people.

The generation and propagation of tsunamis is an active area of oceanography research. The flow dynamics of a tsunami runup, including how it interacts with built infrastructure such as buildings and roads, can be very complex and is also an active area of civil engineering research. The destructive flows due to tsunami wave breaking and runup can vary greatly from location to location for the same tsunami based on local bathymetry and topography.

The Pacific coasts of the United States are clearly more susceptible to tsunami damage than the rest of the nation. Large portions of the United States Pacific coast and Hawaii have tsunami warning systems in place in recognition of the threat. However, tsunamis can occur along the

Atlantic and Gulf coasts. The “Boxing Day” tsunami was generated in an area that had previously been thought to be unlikely for major tsunami generation.

While some State DOTs may have designed highways or bridges to account for potential tsunamis, the actual number and extent is not known. What is clear is that some portion of the transportation infrastructure, on all coasts, is clearly in the potential damage zone from tsunamis.

#### **4.6 Ship Wakes**

Ship wakes are sometimes the largest waves that occur at sheltered locations and thus can be the design waves for revetments or other structures. Large ships can generate wakes with wave heights exceeding  $H=10$  ft and smaller vessels (including tugboats) can generate wakes of  $H=5$  feet.

The wake depends on the size, hull shape, speed of the vessel and distance from the sailing line. Engineering judgment based on observations can be used to establish a reasonable upper limit on wake size if the maximum speeds from all possible vessels are considered. Several methodologies for estimating ship wakes are available including Weggel and Sorensen (1986) and Kriebel, et al. (2003) for large vessels and Bottin, et al. (1993) for some smaller recreational watercraft.

## Chapter 5 - Coastal Sediment Processes

The coastline is a unique geological environment. Sediments along the coast are constantly being reshaped by waves and other currents. These processes, primarily sand movement, can have significant implications for engineers tasked with working in this environment. The study of coastal sediment processes includes several specialty areas of coastal geology including coastal geomorphology, the study of coastal landforms and features, and coastal sedimentology, the study of the properties of beach sands. A good understanding of the terminology and concepts of coastal geology is valuable for coastal engineering.

The design function of many coastal engineering projects is to positively affect coastal sediment processes. Two of the primary functions of coastal engineering projects, beach erosion control and navigation improvement, are often contradictory, however. Many coastal engineering projects which have improved navigation, such as inlet or harbor jetties and dredging, have caused nearby beach erosion. An improved understanding the coastal processes and the geological framework at work at each location can lead to better designed coastal engineering projects.

This Chapter provides a brief introduction to some coastal sediment processes including an overview of coastal geology, beach terminology, coastal sediment characteristics and transport, and tidal inlets. Just a few of the other textbooks and references with much more detail on these topics include Komar (1998), Dean & Dalrymple (2002), Kamphuis (2000), Davis & Fitzgerald (2004), Davis (1994), and the CEM (USACE 2002) and the SPM (USACE 1984).

### 5.1 Overview of Coastal Geomorphology

America's coast has many different characteristics. Coastlines in the United States include the extensive barrier islands systems of the south Atlantic and Gulf coast as well as the coastal bluffs of New England, the Pacific, and the Great Lakes. A few coasts are muddy shorelines (the "big bend" of Florida) or vegetated shorelines (mangroves of southwestern Florida) but these are the exceptions. Some coasts are rock cliffs that extend into the sea and are pounded by relentless ocean waves. But, most of America's coasts have some form of sandy shoreline.

Beaches, the accumulations of loose sediments along the shoreline can either be barrier islands or just short pocket beaches between two rock headlands. The type of coast and beach at each location is partially controlled by the "geologic framework" that created it. This framework includes the local geologic formations and the interplay between plate tectonics, sea-level changes and waves that have created each beach.

Coastal geomorphology is the study of coastal landforms. Many of the most obvious coastal landforms are products of either erosional processes or depositional processes. Sea cliffs, stacks, arches, caves and wave cut terraces are some erosional features found on retreating rocky coasts (see Figure 5.1). Figure 5.2 shows a sea cliff on the Pacific coast. Note that there is a small beach at the base of the cliff. This is a pocket beach that forms from sand eroded out of the cliff and off the immediate uplands and is held in place by the headlands where the cliffs extend to the sea at the ends of the beach.

Barrier Islands, spits, bays and lagoons are some depositional features found on along much of the United States sandy coasts (Figure 5.3). Figure 5.4 shows the barrier island chain of the Outer Banks of North Carolina.

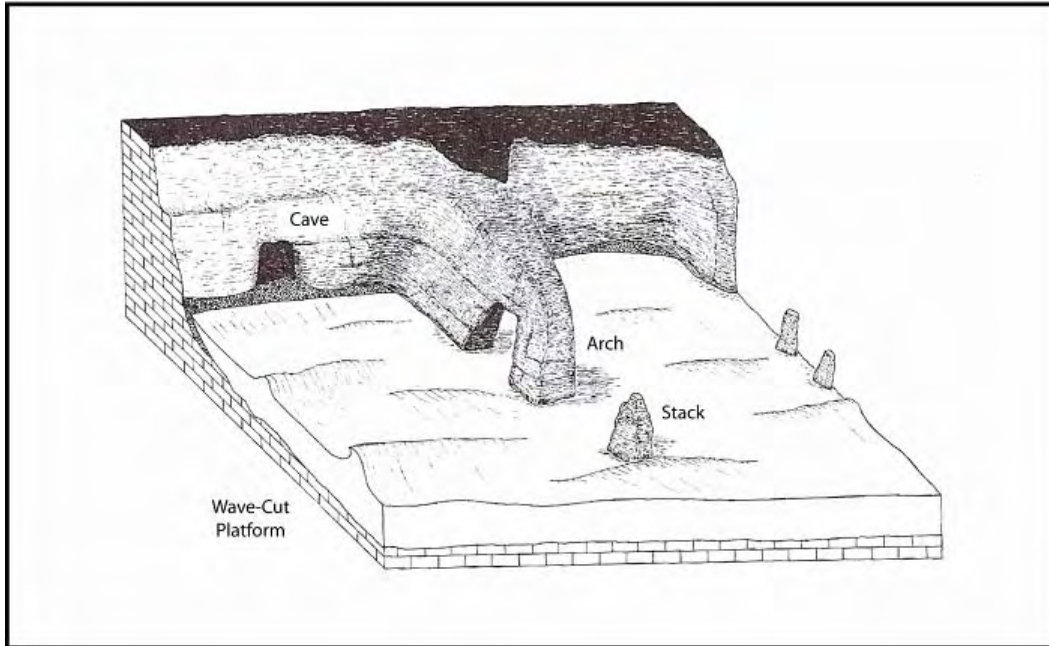

Figure 5.1. Erosional features associated with rocky coasts (from Komar 1998)



Figure 5.2. Sea cliff in San Diego California with pocket beach

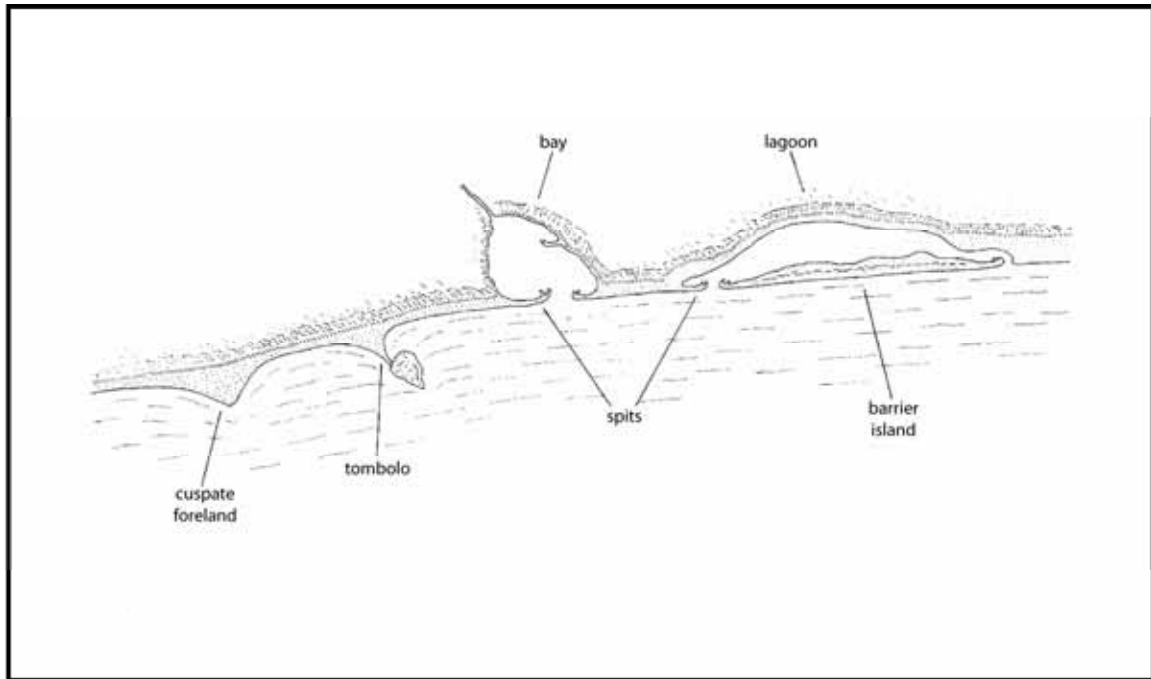

Figure 5.3. Features associated with depositional coasts (from Komar 1998)



Figure 5.4. Barrier islands of the Outer Banks of North Carolina

One of the fundamental geologic controls on shoreline position and characteristics is sea level. Sea level has fluctuated tremendously throughout the past two million years. Chapter 3 discusses the sea level change experienced along the United States shorelines during the past century. However, the history of sea level changes over the past 2 million years, and particularly the past 20,000 years has had an impact on the coastlines we have today. During the ice ages, worldwide sea level fell as glaciations increased and rose as the glaciers receded.

The worldwide, eustatic (with land elevation changes removed), sea level was probably 100 m lower 20,000 years ago than it is today according to geologist's estimates. One estimate of the rate of sea level rise in the past 20,000 years is shown in Figure 5.5. This time period, particularly the past 12,000 to 20,000 years, is the Holocene Epoch at the end of the Quaternary Era. It is characterized by the rise of global sea level in response to the melting of the last of the Wisconsin ice-age glaciers (Davis and Fitzgerald 2004).

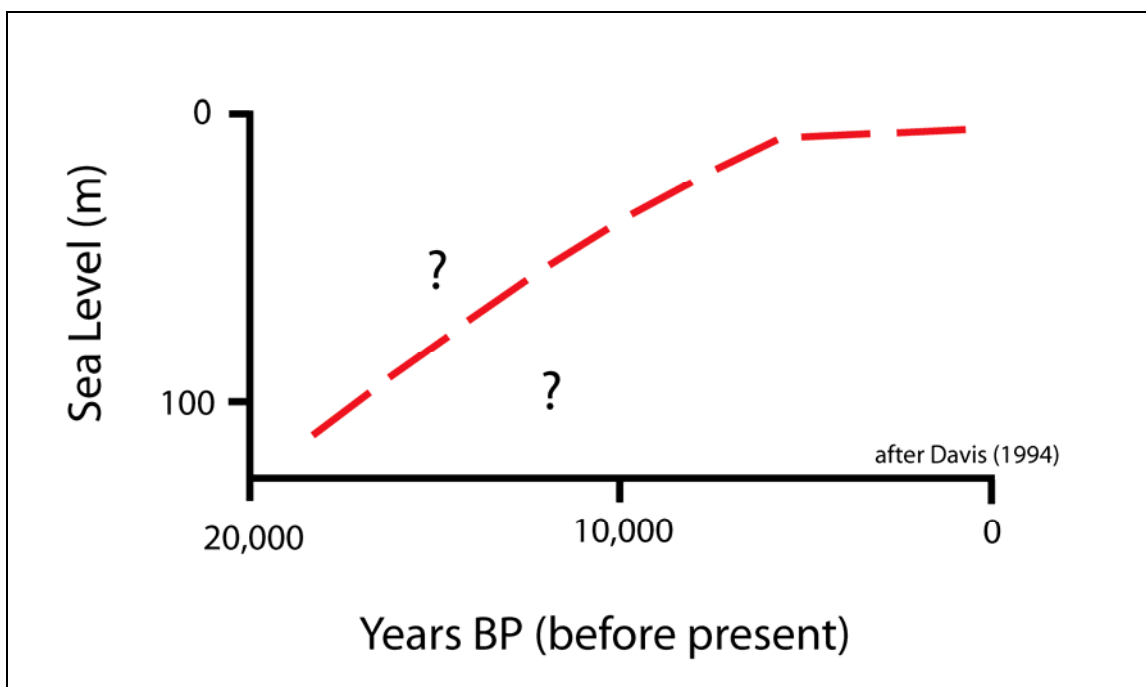

Figure 5.5. Sea level change curves for the past 20,000 years (adapted from Davis 2004)

The Holocene rise in sea level (Figure 5.5) has two distinct portions. Prior to about 5,000 to 7,000 years ago, sea level rose at a much faster rate. The rate of sea level rise was about 10 mm/year or 1 m/century. When the sea level was rising at such a fast rate, it is possible that the coastline moved very inland and mature barrier islands did not have the time to form. The rate of rise slowed significantly about 5,000 years ago. This allowed the shorelines to become more stable and wave-driven longshore sand movement to create the barrier island systems along many of our shores today.

The question marks shown on Figure 5.5 represent the uncertainty about the way that the Holocene rise in sea level occurred. Some investigators postulate that there was significant fluctuation and others do not. Most, however, agree with the general shape of the curve shown.

The position and characteristics of shorelines are partially controlled by global plate tectonics (Inman and Nordstrom 1971). The Pacific coast of the United States is on the “leading” edge of the North American plate and the Atlantic coast is on the “trailing” edge of the plate. The difference explains some of the general differences in shoreline characteristics including the



presence of mountain ranges and a narrow continental shelf near the Pacific Coast but not the Atlantic coast (Davis 1994). These are contributing factors to the lack of barrier island systems on the Pacific Coast and their extensive presence on the Atlantic coast.

## 5.2 Beach Terminology

The beach can be defined as the accumulation of unconsolidated sediment (sand, gravel, and/or cobbles) extending from some upland location, such as a sea cliff or sand dune or vegetation line, to the water line and extending out below the water to a depth where the sediment is not moved by wave action. The beach is commonly synonymous with the term "littoral" referring to this same area where waves can move sand (Komar 1998). The offshore limit of the littoral zone can be very deep during large storms but is often just assumed to be a depth of 20 to 60 feet depending on the wave climate.

Terminology used to describe the processes of waves and currents in the nearshore is shown in Figure 5.6. The nearshore zone extends from the upper limit of wave runup on the beach to just beyond where the waves are breaking. The breaker zone or line is the portion of the nearshore region in which waves arriving from offshore become unstable and break (see Chapter 4). The swash zone is the portion where the beach face is alternately covered by the run-up of the wave swash and then exposed by the backwash. The surf zone is the portion of the nearshore between the breaker line and swash zone. The surf zone can have bore-like, breaking or broken waves propagating across it. The field of "surf zone dynamics" is an active area of research that focuses on the hydrodynamic motions of waves and currents as well as the sediment response to those motions in the surf zone.

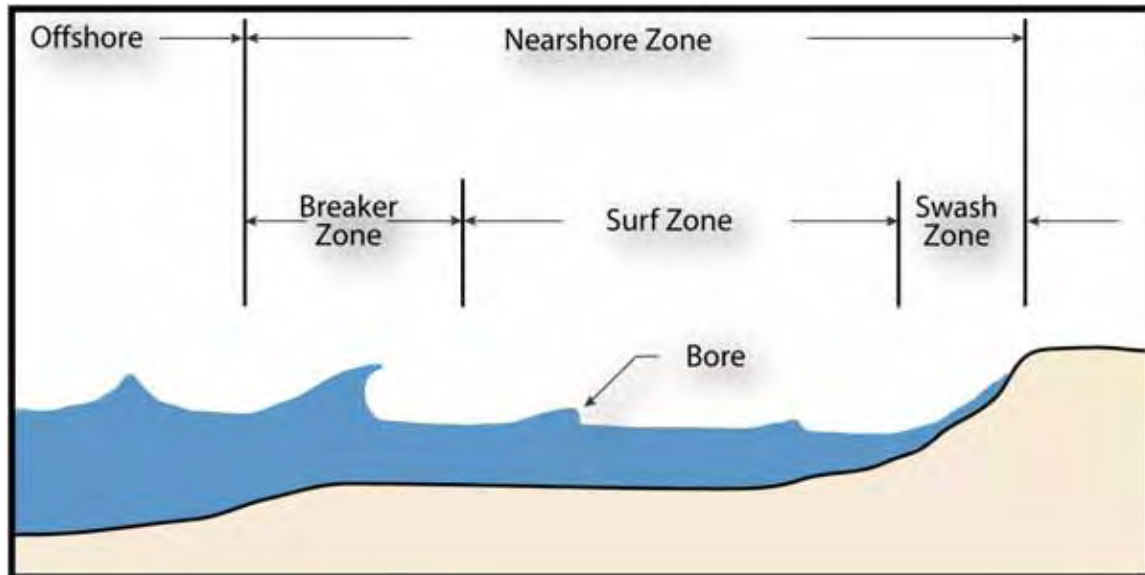

Figure 5.6. Terminology used to describe processes of waves and currents in the surf zone (Komar 1998)

The shape of a beach profile, or transect or cross-section, has some typical features. The terminology used to describe the beach profile is shown in Figure 5.7. A longshore bar, or sand bar, is an underwater ridge of sand running roughly parallel to the shore. Sand bars can be exposed at low tide in areas with large tide ranges. Figure 5.8 shows a sand bar exposed at low tide at a location along the South Carolina coast that has a tide range of about 7 feet. Because of the beach slope, the intertidal area here is several hundred feet wide. A longshore trough is a

depression inside of a sand bar. The beach face is the area of the swash zone. The beach berm is the nearly horizontal portion of the beach formed by the deposition of sediments by waves. Some beaches have more than one berm at slightly different levels separated by a scarp. A scarp is a nearly vertical cut into the berm portion of the beach profile by wave erosion. Scarps are usually found at the top of the beach face when erosion is occurring. A scarp along a southern California beach is shown in Figure 5.9. Waves were actively eroding the berm at the time the photograph was taken.

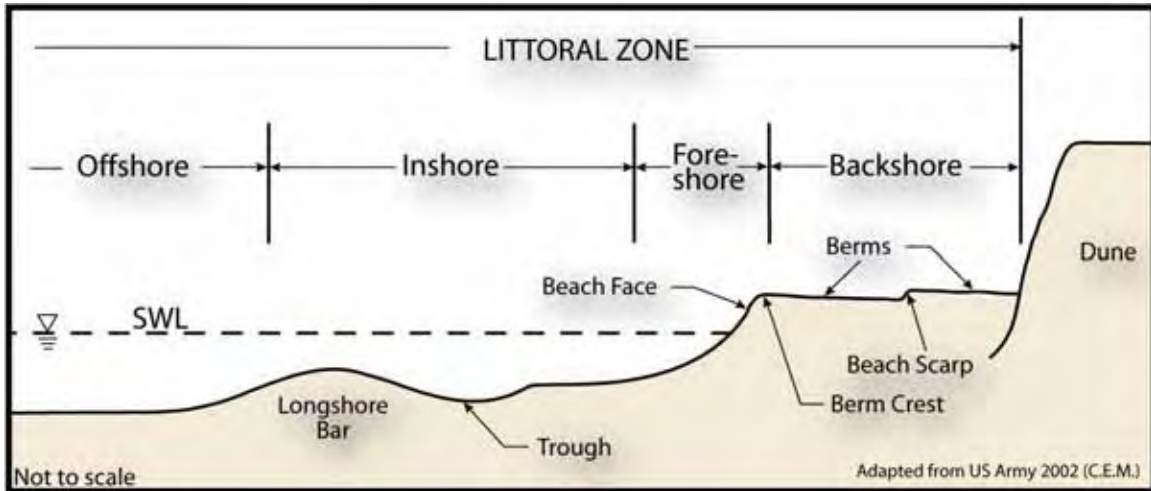

Figure 5.7. Terminology used to describe the beach profile



Figure 5.8. Sand bar and trough exposed at low tide



Figure 5.9. A beach scarp

Repetitive measurements of beach profiles are a common tool in quantifying erosion and other coastal processes. Elevation of the top of the profile's sand surface, both above the waterline and below the water, is measured. There are a variety of techniques that have evolved over the years for obtaining these measurements. The problem is that neither traditional land surveying techniques nor traditional marine surveying techniques can easily span the offshore, the surf zone, and the upland portions of the beach profile.

Figure 5.10 shows a beach surveying crew using a traditional land surveyor's level to measure the profile. The rod-man has to wade and swim in the surf zone and this can become problematic in large surf. Distance offshore can be measured with a "tag-line" (see yellow line on beach in Figure 5.10) or an optical or eye-safe-laser rangefinder. One highly specialized modification of this approach is shown in the left side of the photograph in Figure 5.11 where a staff gauge or total reflector station is attached to a CRAB (Coastal Research Amphibious Buggy) that drives out through the surf zone while measurements are made. The CRAB shown in Figure 5.11 is privately owned and used exclusively for measuring beach profiles in beach nourishment projects.



Figure 5.10. Beach profile surveying crew using a traditional level-rod and tag line system



Figure 5.11. A CRAB (Coastal Research Amphibious Buggy) used to measure beach profiles during beach nourishment

Marine surveying techniques have been adapted for the surf zone by placing fathometers and GPS or total stations on jet-skis (personal watercraft). This can improve the ability of the vessel to obtain data in very shallow water.

A relatively recent advance in measuring beach elevations is airborne LIDAR, laser-based elevation measurements, from a helicopter or airplane. One LIDAR system that has been used to make topographic measurements of beach elevation is a joint system of the NASA/USGS/NOAA (see their web-site <http://coastal.er.usgs.gov/lidar/>).

LIDAR technology has the capability of measuring the dry beach elevation and the underwater portion of the profile at the same time with the same equipment. A LIDAR system that measures water depth is the SHOALS system of the Joint Airborne LIDAR Bathymetry Technical Center of Expertise (JALBTCX) which is a joint effort of the USACE, the US Navy, and NOAA (see their web-site <http://shoals.sam.usace.army.mil/>). The water depth measuring LIDAR has some operational limitations related to water clarity and surf zone breaking. The laser can only penetrate water if it is clear enough and the air bubbles in white-capping in the surf zone can cause problems. However, the ability of LIDAR to collect large amounts of precise measurements over large distances in short periods of time is a significant advance for beach profile surveying.

Many beach profiles have similar shapes. If the sand bar is ignored, many beach profiles are concave upward with slopes that are much milder than the angle of repose of the same sands on dry land. This shape is a response to the wave energy present in the surf zone. A useful concept is that of an “equilibrium beach profile” where the shape of the profile is in equilibrium with the wave energy. The shape of the offshore portion of the profile has been modeled with a variety of different expressions. One is shown in Figure 5.12. This simple relationship between depth and distance offshore fits many sandy beach profiles at different locations and has some physical meaning related to the dissipation of energy in the surf zone (Dean 1974, Dean and Dalrymple 2002). The addition of more parameters, including the use of a variable exponent in place of  $2/3$ , can improve the fit of the relationship to any particular profile or set of profiles. The value of the “A” parameter has been shown to be a function of the sand grain size (typically between  $0.1 < A < 0.2$ ).

### **5.3 Coastal Sediment Characteristics**

The sediments on most American beaches are whatever hard, loose sediments are available, based on the local geology. The majority of coastal sediments are sands. Exceptions include the many cobble beaches of the Pacific, New England, and the Great Lakes. Cobbles are round stones and shingles are flatter stones.

Most sand-size sediments on American beaches are quartz or some other hard mineral. Exceptions to this general rule are the many beaches consisting of shell hash, ground up coral reefs, or other carbonate materials that exist in Florida, Hawaii, and to a lesser extent, along many other beaches. The mineral composition of the sand grains depends on the local geologic framework. Figure 5.13 shows the variation in color of beach sands throughout the nation.

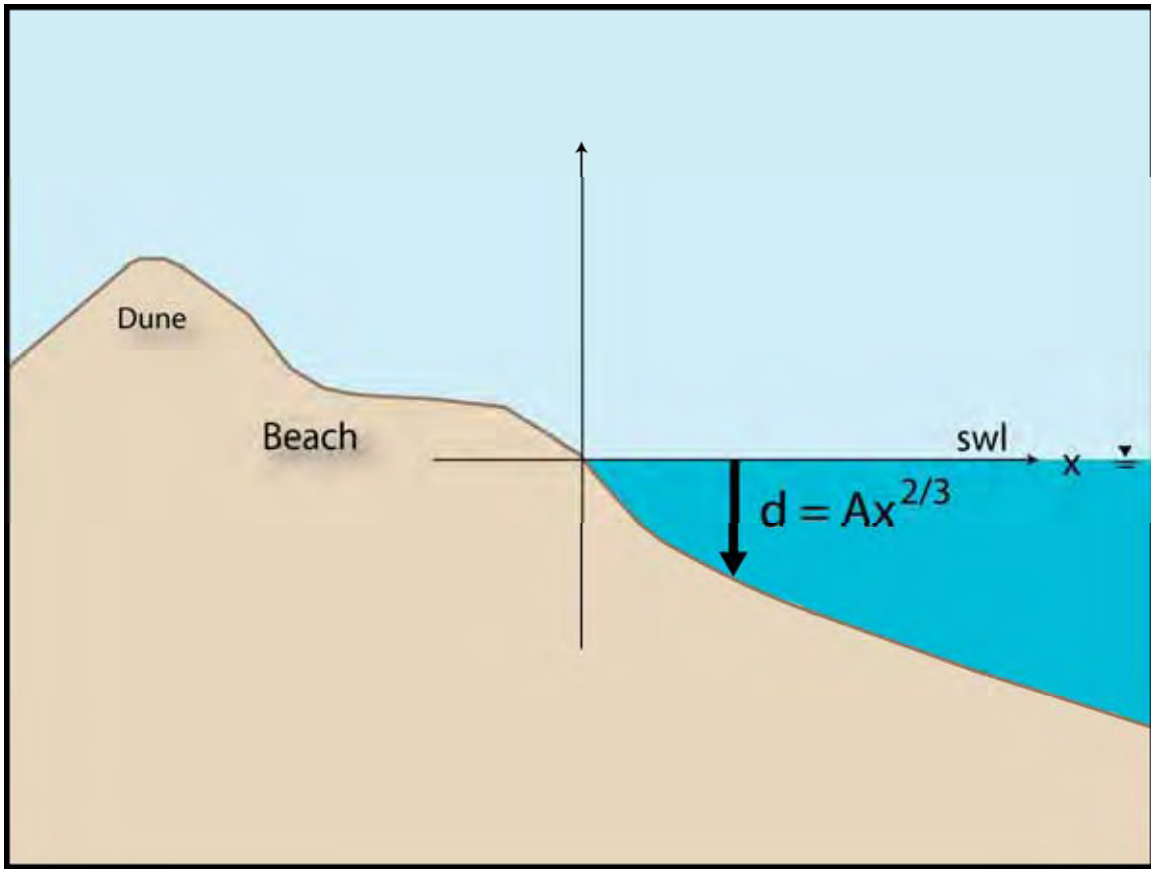

Figure 5.12. Dean's equilibrium beach profile shape definition sketch

The size of the sand grains influences the way a beach behaves and can be important in beach nourishment engineering. Beach sand grain size can vary significantly. Beach sediment grain size can be evaluated with a sieve analysis much like grain size in other civil geotechnical engineering analyses. The median diameter ( $D_{50}$ ) is the most common measure of sand grain size. Typical median grain sizes for American beaches are 0.15 to 0.60 mm.

The results of a grain size analysis on beach sand are shown in Figure 5.14. The median diameter is about  $D_{50} = 0.25$  mm. Figure 5.14 shows an important characteristic of beach sand grain size distribution - they can be extremely well-sorted. Essentially, waves can winnow all the other grain sizes away. Since almost all the grains are of the same size, care should be taken to include the full complement of available sieve sizes in order to adequately differentiate beach sand grain sizes with sieve analysis.



Figure 5.13. Examples of colors of US beach sands (from Douglass 2002)

#### **5.4 Cross-Shore Sand Transport and Dune Erosion Modeling**

Waves have the capacity to move tremendous amounts of sand in the surf zone. This sand movement on beaches can be conveniently considered as either longshore or cross-shore sand transport. This distinction, cross-shore vs. longshore transport, is somewhat artificial, in that the individual grains of sand may be moved both in the cross-shore and longshore directions at the same time. The movement of individual sand grains in response to wave motion and currents in the surf zone is extremely complex. Movement is related to instantaneous near-bottom water velocities under breaking irregular waves, the resulting shear stress on the bottom sand grains, and the subsequent transport of sand including the rich variations in transport mechanisms (bedload, suspended load, ripple and other bedform effects, bed ventilation effects). The complexities of surf zone dynamics and sediment transport processes preclude any meaningful analytic approaches. Thus, coastal engineers and scientists typically look for simplifications of the dynamics of the processes that can be modeled and compared with empirical results. One of the simplifications adopted is the separation of transport into the cross-shore and longshore directions.

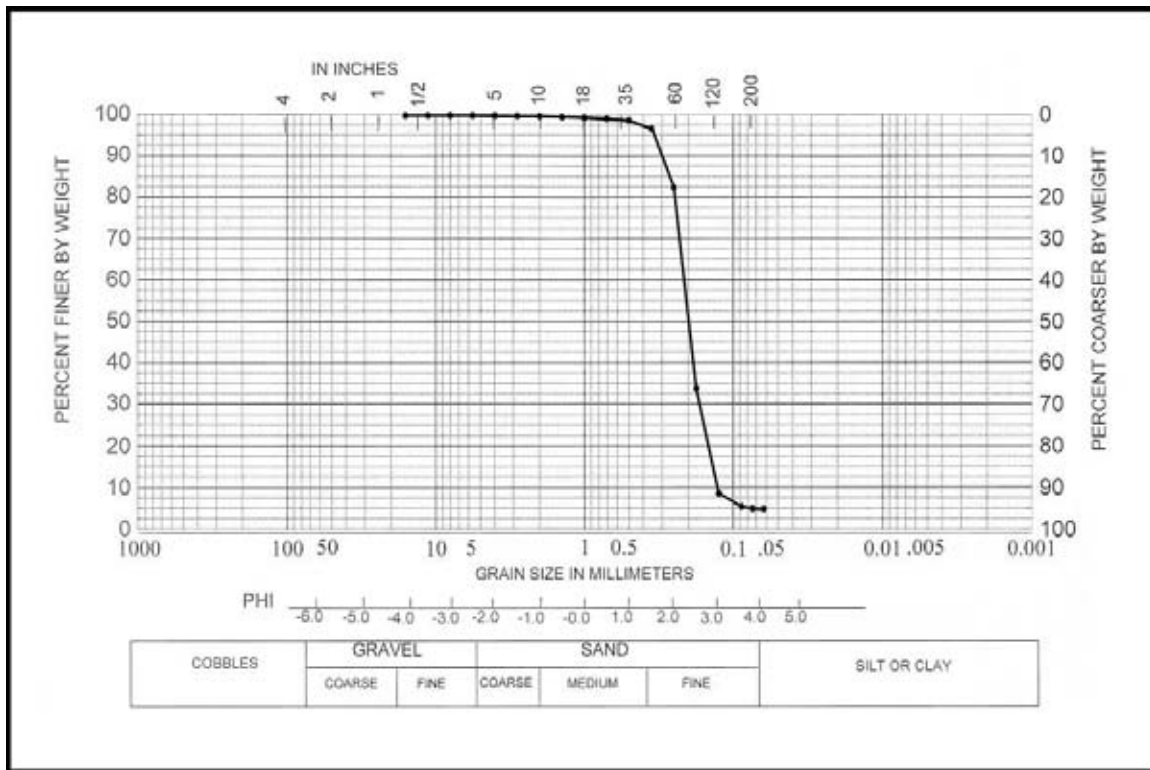

Figure 5.14. Example grain size distribution based on a sieve analysis for beach sand

Coastal practitioners have long understood that sand moves back and forth across a beach profile in response to changes in incident wave energy. This is shown schematically in Figure 5.15.

Wave steepness, the ratio of wave height to wave length,  $H/L$ , has a significant impact on whether sand bars are moving onshore or offshore. When the wave steepness is low, such as with swell, sand bars typically migrate to the shore. The sand bars sometimes can move all the way into the dry beach and build up the berm making the dry portion of the beach wider. These low steepness wave conditions typically occur in the summer on the United States Atlantic and Pacific coasts and thus this profile shape, with a wide beach berm, is called a “summer profile.” When waves are steep, such as with a locally generated short period wind sea, sand is eroded out of the berm and the sand bars form or are pulled farther offshore. These sea wave conditions typically occur in the winter and thus, this profile shape is called a “winter profile.” The beach is narrower than for the summer profile. Essentially, the beach profile shape is just moving toward a new equilibrium with the incoming waves. Since incoming waves are always changing steepness through time, the beach may never really reach an equilibrium shape but just always be approaching one.

These seasonal shifts of sand on the beach profile, while they cause a narrowing of the dry, visible beach are not typically the cause of real beach erosion and long-term shoreline changes. However, shoreline recession along a coast which is eroding because of a longshore deficit of sand will appear most obviously after storms. Also, in very large storms, sand can be moved out into sand bar formations and take several years to return to the nearshore system.



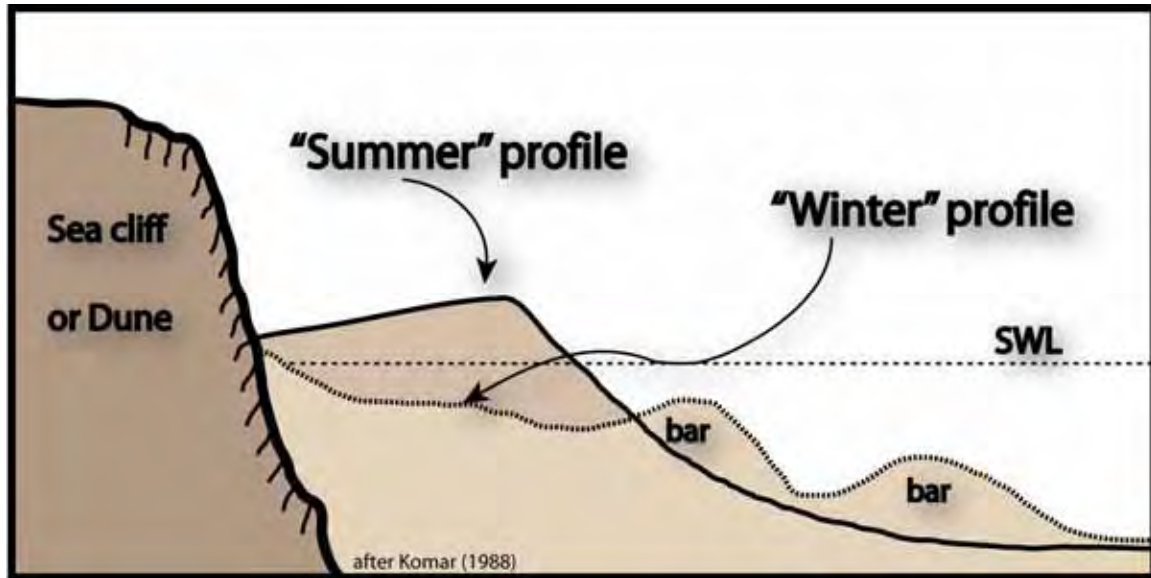

Figure 5.15. Typical beach profile changes in response to cross-shore transport of sand

When storm surge temporarily raises the still water level; sand in the berm and dune can be moved out to sea into sand bars. This storm-induced dune erosion can destroy large dune fields in a single major storm. There are several available models for storm-induced dune erosion.

Kriebel (1994) developed a computer-based model, EDUNE, which simulates storm-induced dune erosion by repetitively applying a form of Dean's energy dissipation concept for equilibrium beach profile shapes. As storm surge rises, the waves begin to attack the berm and dune face and move the sand out into the offshore profile. EDUNE simulates this cross-shore sand movement as the beach profile shape begins to move toward a new equilibrium with the higher water levels.

Inputs into EDUNE are the time histories of the storm surge hydrograph and incident wave heights. There is an empirical coefficient,  $A$ , that is the same as that for Dean's equilibrium beach profile shape and can be related to grain size, but is often used as a calibration coefficient.

Figure 5.16 shows some results of an EDUNE simulation with actual measured dune face erosion. EDUNE has been found to give reasonable results for a variety of major storms and forms of it have been adopted by Florida and Alabama in the management of those state's coastal construction lines. Unfortunately, EDUNE has not been modernized to run on a Windows-based platform but it still can be used as a compiled FORTRAN program.

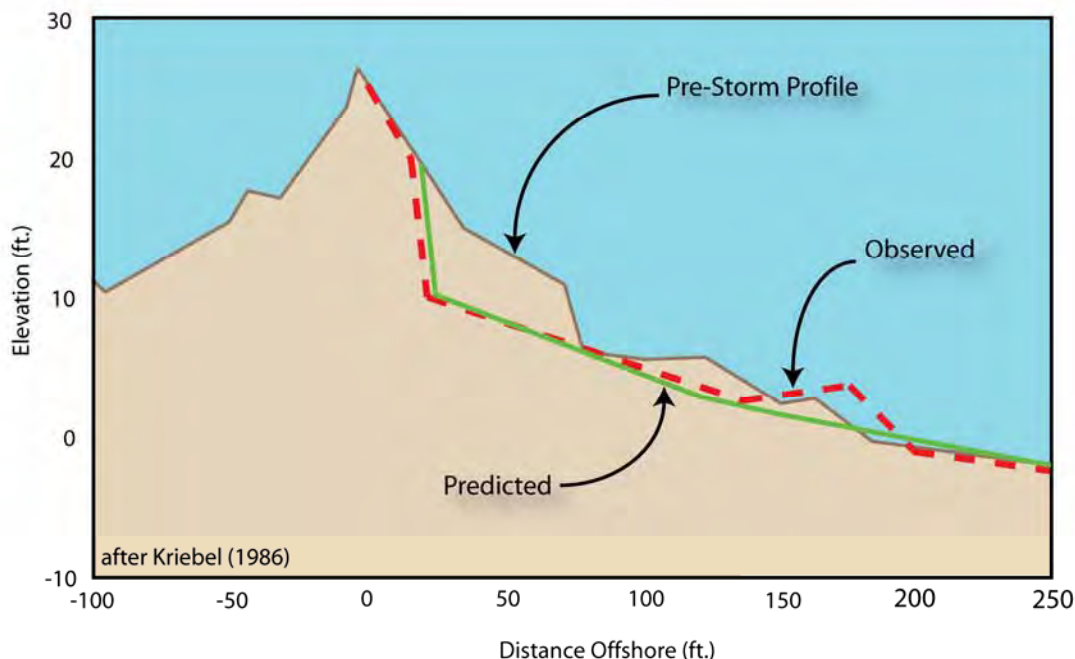

Figure 5.16. Kriebel's dune erosion model results example

The FEMA has adopted a simpler model for storm-induced dune erosion for the purposes of mapping coastal flood plains. FEMA's model is based on an empirical relationship that relates the volume of sand eroded from the dune directly to the storm return period (Hallermeier & Rhodes 1988):

$$(Vol) = c T^{0.4} \quad (5.1)$$

where:

- (Vol) = volume of erosion from the sand dune above the storm surge elevation per unit length of shoreline
- T = return period of storm in years
- C = empirical coefficient:  $c = 86$  when (Vol) is in  $ft^2$ ;  $c = 8$  when (Vol) is in  $m^2$

Equation 5.1 estimates the volume of erosion for the 100-year and 5-year storm levels as  $20 \text{ yd}^3$  and  $6 \text{ yd}^3$  of sand per foot of shoreline, respectively. These values are for the volume of sand above the storm surge elevation (which can be much higher for the 100-year storm). This dune erosion model has been incorporated into FEMA's Coastal Hazard Analysis Model (CHAMP) model that is available on-line (FEMA 2002).

SBEACH is a computer-based model of cross-shore sand transport developed by the USACE (Larson and Kraus 1989). The model considers four or five different morphodynamic regions (e.g. sand bar, swash zone, dune face) across the surf zone and beach profile and uses empirical models to estimate the beach response in each region while preserving the total amount of sand on the profile. SBEACH can be used for a variety of analyses including cross-shore transport and offshore sand bar movement under the water during non-storm conditions. There are a number of calibration coefficients that can be adjusted to fit actual profile response data. SBEACH can also be used to estimate storm-induced dune erosion but it has been found

to be difficult to calibrate to very large storms (it can underestimate erosion). SBEACH is available as a part of the coastal engineering software package Coastal Engineering Design and Analysis System (CEDAS) that is commercially available.

### 5.5 Longshore Sand Transport and Shoreline Change Modeling

As wave energy enters the surf zone, some of the energy is transformed into nearshore currents and expended in sand movement. The nearshore current field is driven by the incident wave energy and the local winds. The largest currents, in terms of absolute magnitude, are the oscillatory currents associated with the waves. However, several forms of mean currents; including the longshore current, rip currents associated with nearshore circulation cells, and downwelling or upwelling associated with winds; can be important to sand transport.

Longshore current is the mean current along the shore between the breaker line and the beach that is driven by an oblique angle of wave approach (see Figure 5.17). The waves provide the power for the mean current and also provide the wave-by-wave agitation to suspend sand in the longshore current. The resulting movement of sand down the beach is littoral drift or longshore sand transport. This process has been likened to a “river of sand” that flows along all our sandy shorelines. The amount or rate of longshore sand transport can be tremendous during large storms. When averaged over a year, it can exceed a million cubic yards per year moving down the beach some along parts of the American coast. Longshore sand transport, unlike rivers, reverses direction frequently in response to changes in the direction of wave approach. Thus, the net longshore transport rate is significantly less than the gross rate.

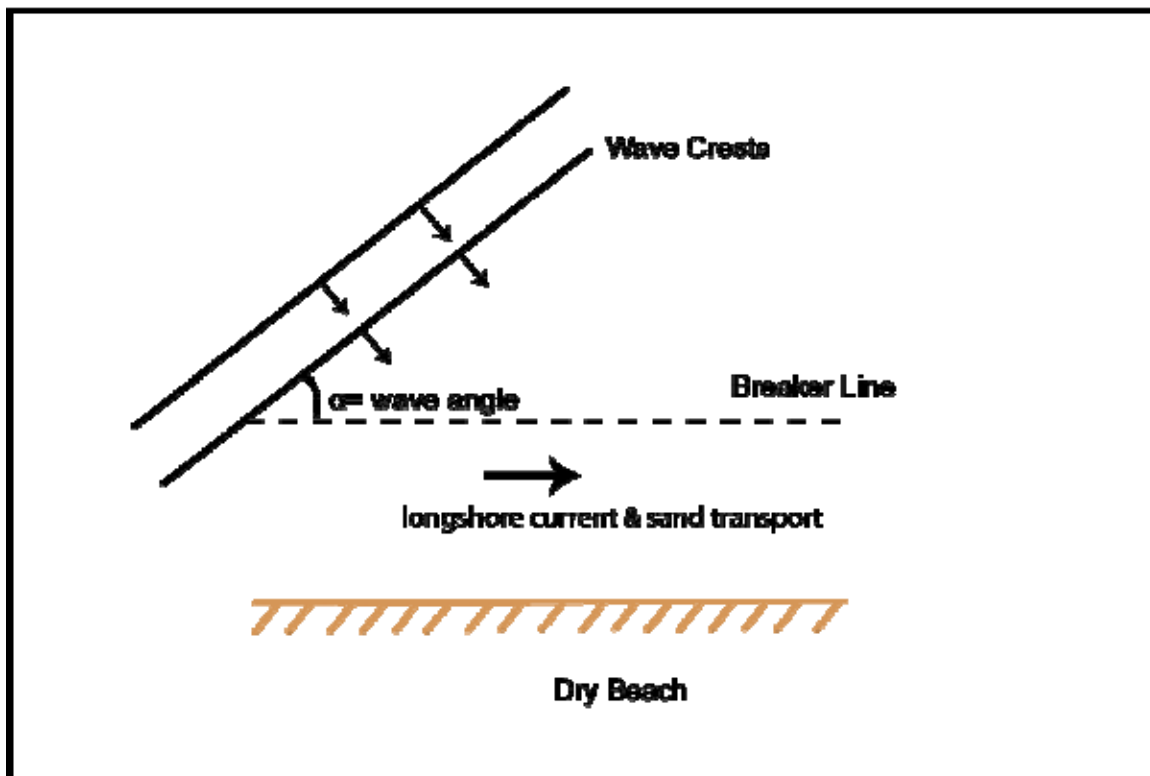

Figure 5.17. Definition sketch of wave angle at breaking

If longshore sand transport is interrupted by a ship channel or other engineering works like a jetty system to stabilize an inlet for shipping, erosion can occur for many miles downdrift. The

total amount of sand that has been removed, or permanently trapped elsewhere, from America's beach system by engineering works has been estimated at over 1,000,000,000 yd<sup>3</sup> (Douglass, et al. 2003).

The most common equation for estimating longshore sand transport rate is the so-called "CERC Equation" or energy-flux method (USACE 2002). It estimates the sand transport rate based on the longshore component of energy flux or wave power entering the surf zone. Using the expressions for wave power from Chapter 4, the wave-energy flux factor (as evaluated at breaking) can be derived as:

$$P_{ls} = \frac{\gamma}{16} H_b^2 C_{gb} \sin(2\alpha) \quad (5.2)$$

where:

- $P_{ls}$  = wave energy flux factor
- $H_b$  = wave height at breaking
- $C_{gb}$  = wave celerity at breaking
- $\alpha$  = angle of the breaking wave crest with the shoreline
- $\gamma$  = specific weight of water

The CERC Equation relating this to longshore sand transport can be written as:

$$Q = K P_{ls} \quad (5.3)$$

where:

- $Q$  = longshore sand transport
- $K$  = Empirical coefficient ( $K=7500$  when  $Q$  is expressed in yd<sup>3</sup>/year and  $P_{ls}$  in lb/s)

The relationship between transport rate and energy flux factor is not a precise relationship as shown in Figure 5.18 with field data. Also, there is often uncertainty in estimating the input wave parameters, such as  $H_b$  in the CERC equation. In many situations, the CERC equation can be considered as a good order of magnitude estimate of transport.

Shoreline change models simulate the temporal change in shoreline position, i.e. the movement of the shoreline. The CERC equation, or some derivative of it, is used to estimate the longshore sand transport rate at all locations along the shoreline and then conservation of sand down the coast is modeled. The equations are solved repetitively in time for a discretized shoreline. Wave refraction and diffraction have been incorporated into most shoreline change models. The results of shoreline change models are estimates of the changes in shoreline position due to the construction of engineering works such as groins or beach nourishments. Several shoreline change models that are available are Perlin and Dean (1983), GENESIS (Hanson and Kraus 1989), and ONELINE (Dabees and Kamphuis 1998).

Since shoreline change models are essentially multiple applications of the CERC equation or some other longshore sand transport model their results include all the uncertainties inherent in such modeling. Thus, shoreline change models must be adequately calibrated and verified.

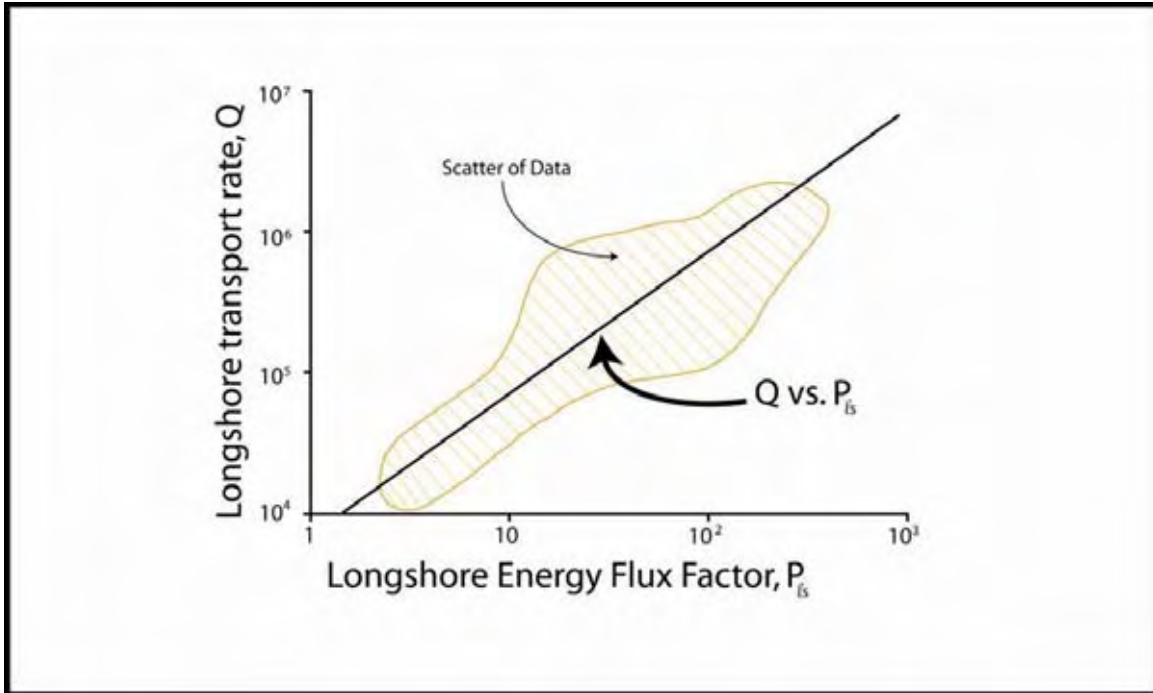

Figure 5.18. The CERC equation model for longshore sand transport rate plotted with field data (adapted from USACE 1984)

## 5.6 Tidal Inlets

Barrier islands are breached by tidal inlets that allow the ocean water to flow into and out of estuarine bays. Two tidal inlets are shown in Figure 5.19. There are hundreds of tidal inlets of various sizes in the US. Oregon Inlet, North Carolina, is an example of a large, unstabilized inlet. Tidal inlets are dynamic parts of the barrier island system that have important influences on the bays and the nearby beaches.

While every inlet is unique, there are some common geomorphological features as shown in Figure 5.20. The flood tide is the movement of water into the inlet and the ebb-tide is the flow of water out of the bay back to the ocean. Typical patterns of the strongest ebb-tide and flood-tide flows are shown by the flow arrows in Figure 5.20. The shoal, or bulge of sand, formed just seaward of an inlet is called the ebb-tidal delta or ebb-tidal shoal. Likewise, a shoal just inside of an inlet is called the flood-tidal delta or shoal. The outer bar of the ebb-tidal delta permits longshore sand transport to naturally bypass an inlet to the downdrift beaches. There are often other shoals inside the outer bar of the ebb-tidal shoal.

The gorge or throat section of the inlet is the main flow channel. It is typically the deepest part of the inlet and has the highest, most concentrated ebb- and flood-tidal flows.



Figure 5.19. Two tidal inlets on the southwest Florida coast (New Pass and Big Sarasota Pass). Lido Key is the barrier island between the two inlets. Net longshore sand transport is to the south.

Tidal inlets are essentially in some dynamic equilibrium between the longshore sand transport system of the adjacent barrier island system and the tidal currents (Bruun 1966). The wave-driven longshore sand transport would seal off the inlet if not for the tidal currents scouring the sand out of the throat and depositing it on the inlet shoals. Most inlets are not symmetrical about their throat like that shown schematically in Figure 5.20 but rather skewed in the direction of net longshore sand transport (e.g. Figure 5.19).

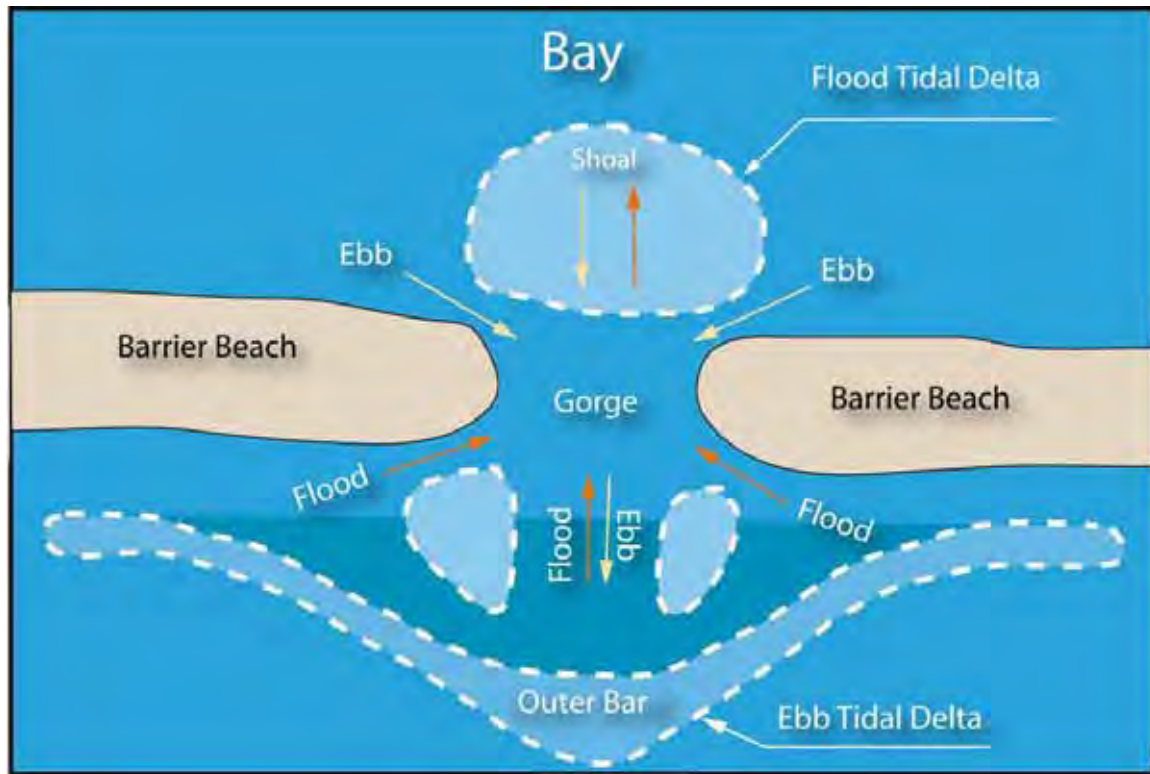

Figure 5.20. Typical inlet morphology

The hydraulics of tidal flows through inlets can be extremely complex due to the shoals, waves and currents. The primary tidal flows can be idealized as shown in Figure 5.21. Water flows into the inlet when the tide in the ocean has risen to a level that exceeds the elevation of the water surface in the bay. This vertical difference in elevation, the head difference, between the ocean and the bay drives the flow much as the downslope gradient in river elevation drives the flow in rivers. The flow in the inlet will continue to “flood” until the tide level in the ocean falls to an elevation below that in the bay. Thus, the bay tide always “lags” the ocean tide. The tidal lag can vary significantly depending on the shape of the bay and inlet.

The amplitude, or range, of the tide in the bay can also be much smaller than in the ocean. This results in an attenuation of the tide range. This is common when the inlet is constricted to a level that does not allow enough time for the bay to completely fill up during the rising ocean tide before the ocean tide begins to fall. In many cases, the tide range can actually increase farther up an estuary due to inertial effects. There are a number of quasi-analytical models of the solutions to the idealized ocean-inlet-bay system including solutions for maximum velocity in the inlet and bay tidal range amplitude (USACE 1984). Other models relate to the stability of inlet systems.

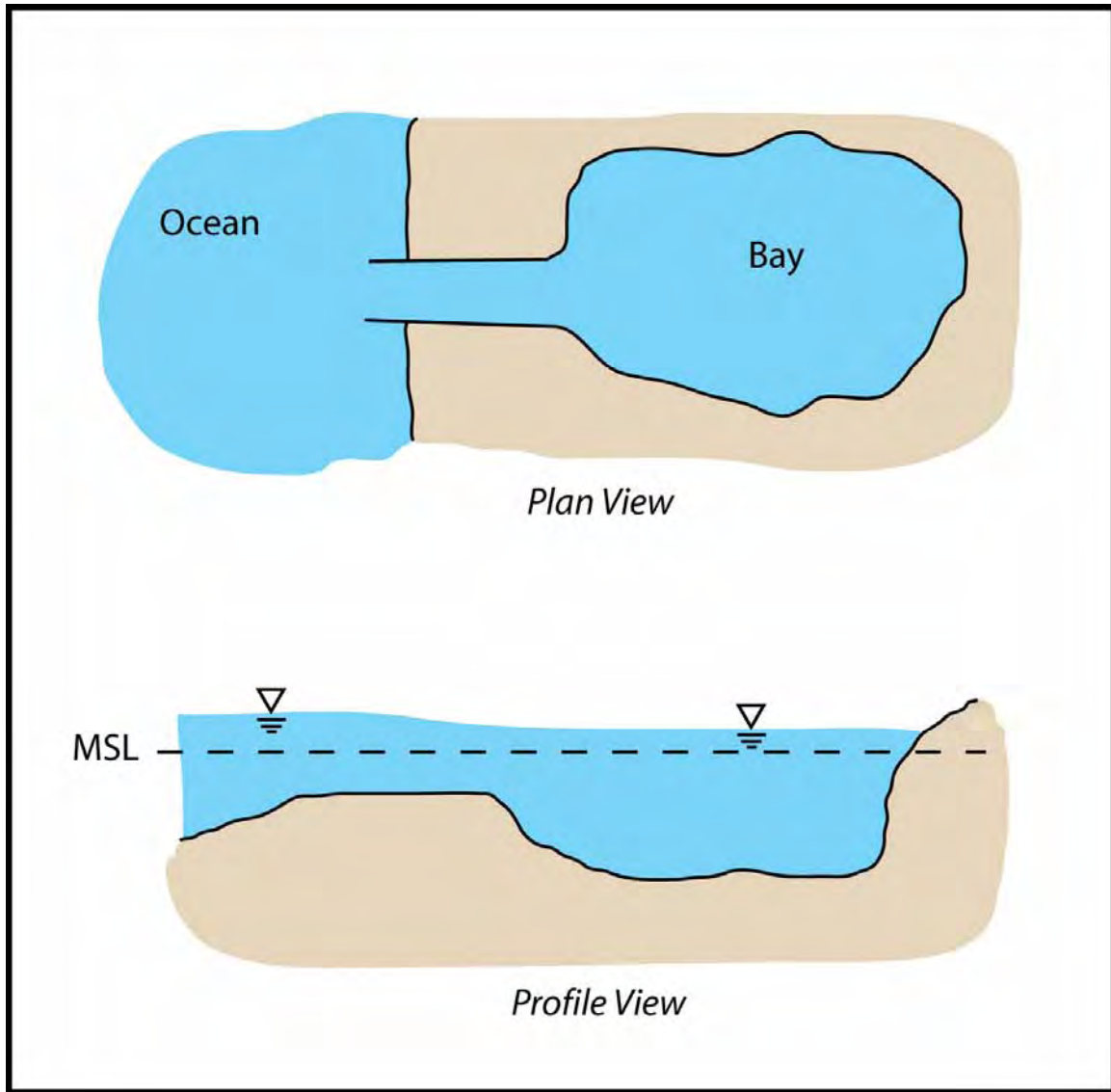

Figure 5.21. Idealized ocean-inlet-bay system (adapted from USACE 1984)

Beaches adjacent to and near tidal inlets are part of the dynamic littoral system of the inlet and exhibit much more shoreline change than beaches farther from inlets. Sometimes the shoreline movement is erosion and sometimes it is accretion. The beaches near inlets can increase dramatically in width as some of the shoals migrate onshore. Inlet geometry can change dramatically in both the short-term and the long-term. A single storm can move hundreds of thousands of cubic yards of sand shoals into or out of an inlet. Some inlets have a tendency to migrate along the coast. Some migrate in the direction of net longshore sand transport and some migrate in the other direction.

There are a number of empirical relationships that have been recognized between the components of tidal inlet systems. Figure 5.22 shows one empirical relationship between tidal prism and inlet throat area. Tidal prism is defined as the amount of water that moves into and out of a tidal inlet during a tidal cycle. It is essentially the area of the bay multiplied by the bay tide range.



All tidal inlets are evolving and changing over the long-term. This evolution is in response to many changing factors including sea level rise, changes in longshore sand transport rate and changes in tidal prisms. These factors change naturally but also can be changed by engineering. Engineered changes to the ocean-inlet-bay system include the stabilization of the inlet with jetties or the dredging of the inlet or bay for navigation.

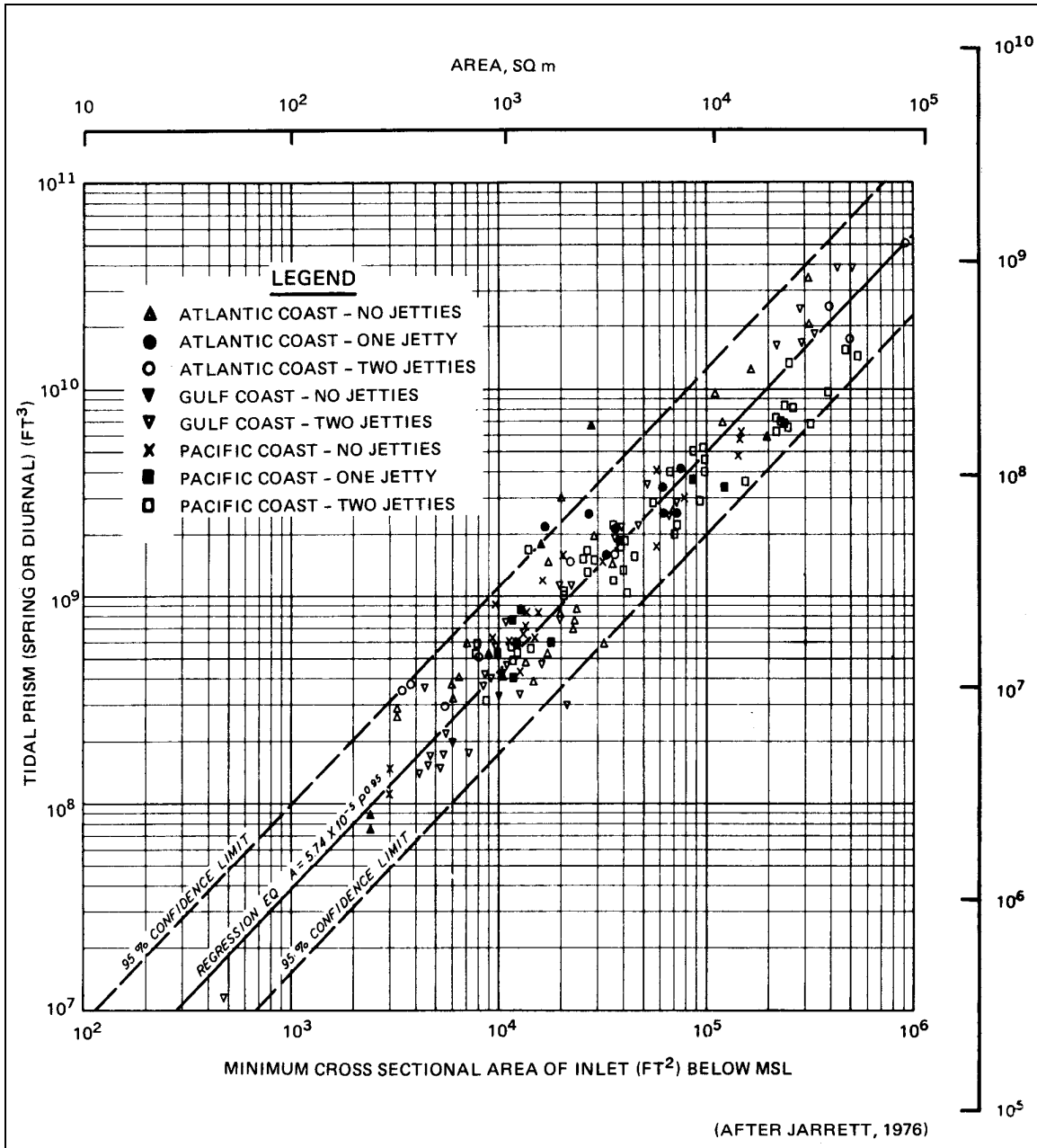

Figure 5.22. Tidal prism versus minimum inlet throat area for all major inlets on the Atlantic, Gulf, and Pacific coasts (USACE 1984)

Less obvious changes include the impact of engineering works in the bay that affect the tidal prism. This can be the filling of wetlands or the construction of causeways in the bay. The

implication of the relationship shown in Figure 5.22 is that any change in the tidal prism of a bay can affect the inlet and, vice-versa, changes in the inlet; including shoaling, scour, dredging and engineered structures; can affect the tidal flow.

The two inlets shown in Figure 5.19 are evolving in response to a number of factors including the original creation of Lido Key by filling many decades ago and the construction of causeways not shown inside the bay. Another factor in the evolution of those two inlets is the complexities added to the tidal hydraulics by the interconnectedness of the multiple inlets to the bay. Multiple inlet systems can evolve as one inlet captures more of the tidal prism and expands while allowing others to close.

## **5.7 Physical Models in Coastal Engineering**

Coastal engineering, like the broader field of hydraulic engineering, relies on three complementary techniques to deal with the complex fluid flows typical of many projects: field measurements and observations, laboratory measurements and observations, and mathematical calculations (Hughes 1993). Laboratory studies are generally termed physical models because they are miniature reproductions of a physical system. In parallel to the physical model is the numerical model, which is a mathematical representation of a physical system based on assumed governing equations and solved using a computer (Hughes 1993).

The use of physical models in coastal engineering has evolved in response to the development of numerical models. For example, in the mid-1900's, large physical models of tidal estuary systems were used to understand the complex flows and analyze the influence of major engineering works. However, "large physical models of tidal estuary systems have now been almost totally replaced with numerical models that can predict flows with a good degree of success" (Hughes 1993).

There is still a critically important role for physical models in coastal engineering to address other types of problems (beyond the estuary tidal circulation problem). This is particularly true for understanding complex flows around structures where wave and current-induced turbulence issues reduce the usefulness of mathematical-numerical approaches. This is also true for newer fluid-structure-sediment-interaction problems that have not been tested extensively. Physical model tests are often performed to calibrate empirical coefficients in the numerical model or to validate the results of the numerical models. "Hybrid modeling" is the use of both physical and numerical models together to complement each technique (Hughes 1993).

There is a role for physical models in coastal engineering applications to highways for both reasons given above; the complex flows and the newer problems. For example, the problem of wave loads on bridge decks (Chapter 10) has recently been investigated with physical models in several different laboratories. Figure 5.23 shows an instrumented, 1:15 scale model of a bridge deck subjected to waves in one of those tests. The instrumented section is the middle section made of clear plastic. This problem of wave loads on bridge decks involves extremely complex flows. They have recently been the cause of significant damage to United States highways.

The use of physical models in coastal engineering is very much of an art as well as a science. Model to prototype similarity issues are extremely complex. There are a number of wave basins and flumes in universities and government laboratories that can conduct physical model tests. Hughes (1993) summarizes the issues and capabilities of physical models and laboratory techniques in coastal engineering.



Figure 5.23. Physical model test of wave loads on bridge decks (Texas A&M photo)

*Page Intentionally Left Blank*

## **Part 3 – Issues and Approaches in Coastal Highway Design**

*Page Intentionally Left Blank*

## Chapter 6 - Coastal Revetments for Wave Attack

This section addresses the design of revetments on embankments for protection from wave attack. The design of an earthen highway embankment is primarily a geotechnical engineering problem with rock or rip-rap revetments sometimes employed as slope protection. Revetments can be used for protection from four different types of hydraulic situations: direct rainfall impacts, overland flow, stream or river currents, and waves. This section addresses only wave attack.

HEC-11 (Brown and Clyde 1989) provides procedures for the design of riprap revetments for channel bank protection on larger streams and rivers where the active force of the flowing water exceeds the bank material's ability to resist movement. Flow in a stream or river is unidirectional and typically aligned parallel to the banks. Waves produce oscillatory velocities and accelerations that can be in almost any direction on a revetment. HEC-11 recommends Hudson's equation to estimate stone size for revetments subject to wave action.

This section recommends an approach based on determining a design wave and using Hudson's equation to size the stones in the outer layer of a rock revetment. This approach can lead to designs with larger stones and narrower stone gradations than designs for non-wave situations. The difference is due to the higher forces caused by waves. Situations where riverine and wave flows are significant, the design engineer should consider both design approaches and develop a conservative design.

### 6.1 Types of Revetments and Seawalls

Figure 6.1 shows a revetment along a bay shoreline designed to protect a local road from erosion by waves during storms. This design has a stone revetment extending from below the water surface up to a sheet pile wall and pile cap near the roadway shoulder. Storm surges can exceed the pavement elevation here.

The distinction between revetments, seawalls, and bulkheads is one of functional purpose (USACE 1984). Revetments are layers of protection on the top of a sloped surface to protect the underlying soil. Seawalls are walls designed to protect against large wave forces. Bulkheads are designed primarily to retain the soil behind a vertical wall in locations with less wave action. Design issues such as tie-backs, depth of sheets are primarily controlled by geotechnical issues. Given the relationship between wave height and fetch (distance across the water body) Figure 6.2 provides a conceptual distinction between the three types of coastal protection. Bulkheads are most common where fetches and wave heights are very small. Seawalls are most common where fetches and wave heights are very large. Revetments are often common in intermediate situations such as on bay or lake shorelines.

Seawalls can be rigid structures or rubble-mound structures specifically designed to withstand large waves. Two very large, rigid, concrete seawalls with recurved tops to minimize overtopping are the Galveston Seawall (Figure 6.3) and San Francisco's Great Highway Seawall (Figure 6.4). Such massive structures are not commonly constructed in the US. Vertical sheet pile seawalls with concrete caps are common but require extensive marine structural design. A more common seawall design type in the United States is a rubble-mound that looks very much like a revetment with larger stones to withstand the design wave height. Thus, the two terms, seawalls and revetments, can be used interchangeably with the former typically used for the larger wave environments. Figure 6.5, Figure 6.6, Figure 6.7, and Figure 6.8 are examples of rubble-mound seawalls protecting coastal roads exposed to open-coast storm waves.



Figure 6.1. A revetment protecting a coastal highway. Bayfront Road, Mobile, Alabama (2001)

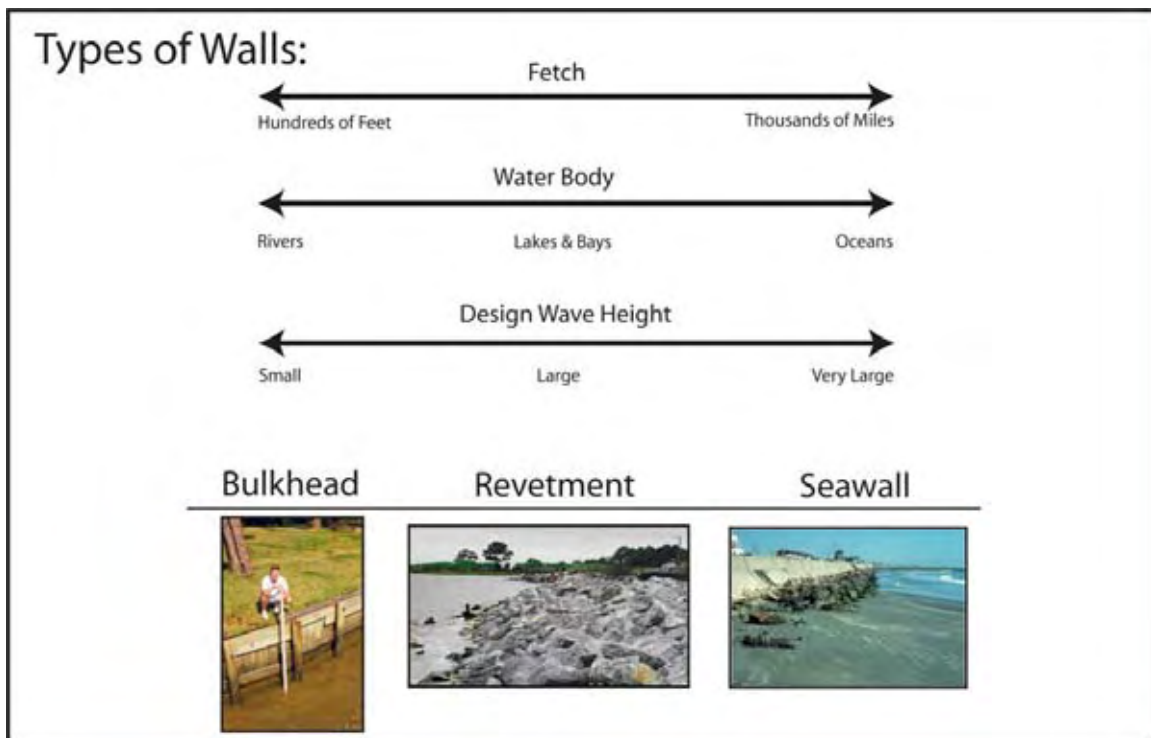

Figure 6.2. Types of shore protection walls.





Figure 6.3. Galveston Seawall. Seawall Boulevard (1983)



Figure 6.4. San Francisco's Great Highway Seawall. California Highway 35 (1991)



Figure 6.5. Seawall protecting a coastal highway. Venice, Florida (2001)



Figure 6.6. Seawall protecting a coastal highway. Pacific Coast Highway, Pacific Palisades, California (2003)



Figure 6.7. Seawall protecting a coastal highway. Florida Highway A1A, Flagler Beach, FL



Figure 6.8. Seawall protecting a coastal highway. US 101, Curry County, Oregon (2001)

Figure 6.9 and Figure 6.10 (as well as Figure 6.1) are examples of rubble-mound revetments protecting highways along coastal bays. Revetments are common on bay or lake shorelines where design waves are short-period, fetch-limited, locally-generated storm waves.



Figure 6.9. Revetment protecting a highway along a bay shoreline. Florida Highway 60, Tampa Bay, Florida (2003)



Figure 6.10. Revetment protecting a highway along a bay shoreline. Washington State Route 105, Willapa Bay, Washington (2003)

Revetments have been criticized for a variety of reasons, including their aesthetics. Figure 6.11 and Figure 6.12 show two different types of protection designed for local roads that were threatened by bluff erosion. Figure 6.11 shows a rock revetment and Figure 6.12 shows a concrete wall that has been designed to look much like the natural bluff. The engineered seawall is in the middle of the Figure 6.12 image. The more aesthetically pleasing seawall (Figure 6.12) was designed more recently than the rock revetment. This is an example of the evolving nature of seawall design in the United States.



Figure 6.11. Seawall protecting a local road. West Cliff Drive, Santa Cruz, California



Figure 6.12. Concrete seawall designed to look like the natural rock formation built on an eroding sea cliff to protect a local road. East Cliff Drive, Santa Cruz, California

## 6.2 Hudson’s Equation for Armor Stone Size

A well-designed and constructed rubble-mound revetment can protect embankments from waves. The underlying philosophy of the rubble-mound is that a pile of stones is efficient at absorbing wave energy and robust in design in that damage is often not catastrophic. It also can be relatively inexpensive. Some of the oldest coastal structures in the world are rubble-mounds. They have the inherent ability to survive storms in excess of their design storm. In the words of an old advertisement for a brand of watches, rubble-mound revetments “can take a licking and keep on ticking.” This ability to continue to provide some function even after experiencing storms that are more severe than their design storm is valuable in a coastal environment where costs often preclude selection of extremely rare design storms.

Hudson’s equation (USACE 1984) provides a basis for estimating the required stone size in a sloped revetment. The required median weight for the outer, or armor layer, stones is:

$$W_{50} = \frac{w_r H^3}{K_D (S_r - 1)^3 \cot \theta} \quad (6.1)$$

where:

$W_{50}$	=	median weight of armor stone
$w_r$	=	unit weight of stone (~165 lb/ft <sup>3</sup> )
$H$	=	design wave height
$K_D$	=	empirical coefficient (=2.2 for rip-rap gradations)
$S_r$	=	specific gravity of stone (~2.65)
$\theta$	=	slope

Hudson’s equation accounts for the most important variables including design wave height, different structure slopes, different stone densities and angularities. Steeper slopes require larger stones. However, the range of recommended slopes here is up to 2:1 (horizontal:vertical). Note that, by definition, the  $\cot\theta=2$  for a 2:1 slope and  $\cot\theta=3$  for a 3:1 slope, etc. Revetment structure slopes greater than 1½:1 (horizontal:vertical) are not recommended (USACE 1984).

The empirical coefficient in Hudson’s Equation,  $K_D$ , is based on laboratory tests and varies to include the effect of stone angularity/roundness, number of layers of armor stone, distribution of individual stone sizes about the median size, and interlocking characteristics. The value suggested here,  $K_D = 2.2$ , is for a layer of rough-angular quarrystone at least two stones thick. The stones have a gradation of weights that varies between  $0.125 W_{50} < W < 4W_{50}$ . Other values of  $K_D$  for other situations, including artificial concrete armor units, are discussed in USACE (1984) and USACE (2002).

For typical conditions of specific gravity of stone ( $S_r=2.65$  for granite) and unit weight of stone ( $w_r=165$  lb/ft<sup>3</sup>), with the empirical coefficient set to  $K_D=2.2$ , Equation 6.1 can be written as:

$$W_{50} = \frac{16.7H^3}{\cot \theta} \quad (6.2)$$

where:

$W_{50}$	=	median weight of armor stone (lbs)
$H$	=	design wave height (feet)
$\theta$	=	slope

Figure 6.13 shows a typical revetment design cross-section. The armor layer stones have a median weight given by Hudson's equation. One component of the design is a filter cloth geotextile or composite geotextile/geogrid between the rocks and the underlying soil. A geotextile that provides rapid transfer of water through the material while holding soil particles and is strong enough to survive the construction process without puncturing by the overlying rocks is recommended. The modern use of a plastic grid integrally welded to the geotextile can provide some additional strength to bridge soft underlying soils. The geotextile should be designed to not allow the rocks to slide down the surface. The use of an underlayer of stones between the armor layer and the geotextile/grid is common except when the stone size is less than 200 lb. The underlayer should have a median weight no smaller than one-tenth that of the armor layer stones (USACE 1984). Smaller underlayer stones can be pulled out between the gaps of the armor stones.

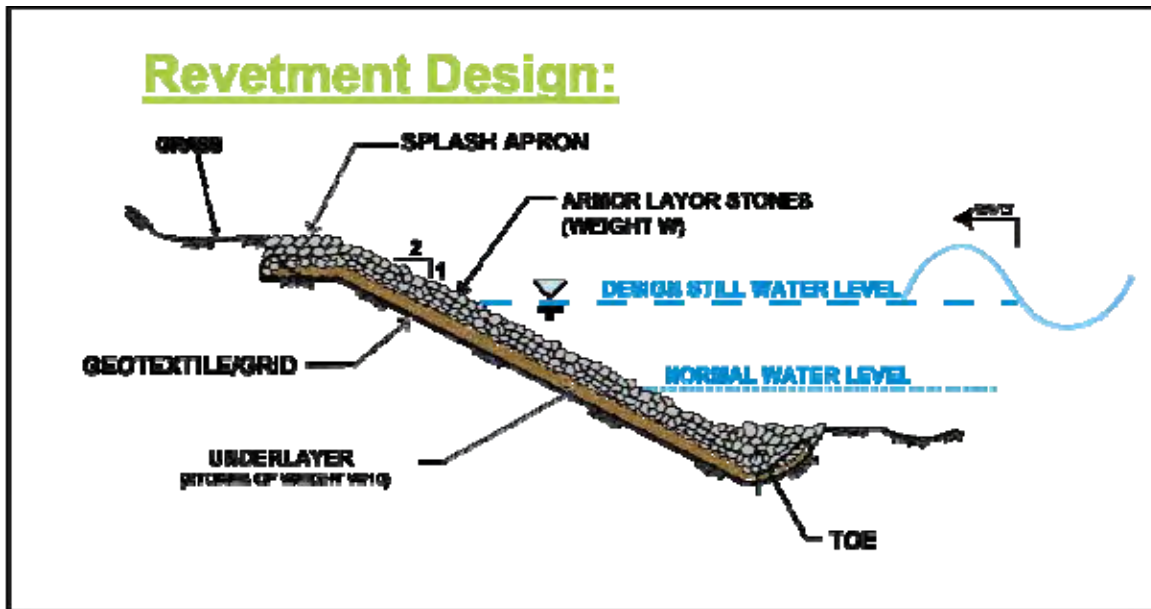

Figure 6.13. Typical coastal revetment design cross-section

### 6.3 Design Wave Heights for Revetment Design

The estimate of the required armor stone size from Hudson's equation is sensitive to wave height. The proper wave height for Hudson's equation above for coastal revetment design is either the depth-limited maximum wave height or the average of the highest 10% of all wave heights in the design sea-state ( $\overline{H}_{10}$ ) whichever is lesser (USACE 1984).

This recommendation is based on interpretation considering the origin of the equation. Hudson's equation was originally derived based on monochromatic laboratory tests. Thus, the proper selection of a corresponding wave height statistic from an irregular sea-state is not obvious. Experience has found that the use of the significant wave height,  $H_s$ , in Hudson's equation is not conservative and can lead to undesired levels of damage to the revetment.

Some researchers have suggested that the proper irregular wave height statistic for use in Hudson's equation is  $\overline{H}_{10}$ . To be conservative, some engineers use the average of the highest



5% of all wave heights in the design sea-state ( $\overline{H}_5$ ). The relationships (see Table 4.1) between significant wave height and these other statistics are  $\overline{H}_{10} = 1.27 H_s$  and  $\overline{H}_5 = 1.38 H_s$ .

Coastal revetments are often located where the design sea-state is depth-limited, i.e. the depths are so shallow immediately offshore of the location of the revetment that the storm waves have broken and the largest waves are on flat offshore slopes,

$$H_b = 0.8 d_s \quad (6.3)$$

where:

$H_b$  = maximum breaking wave height  
 $d_s$  = design depth at the toe of the structure

To account for the distance over which waves travel as they break, a depth some distance offshore of the toe (say one wavelength) sometimes is used in Equation 6.3. For non flat slopes see USACE (1984) and USACE (2002).

A depth-limited design wave height used in Hudson's equation should account for any long-term erosion that may change the depths immediately offshore. The construction of a revetment, while it protects the upland, does not address the underlying cause of erosion. The depths at the toe of the revetment will likely increase if the erosion process continues. The presence of a revetment or seawall can increase the vertical erosion at its base. The revetment or seawall does not allow the material in the bluff to naturally nourish the beach.

Hudson's equation has no factor-of-safety. Hudson established the  $K_D$  values such that there was some small level of damage to the structure. The damage level was defined as the level where 5% of the rocks on the revetment structure armor layer face moved. Thus, it is entirely appropriate for some conservatism or factor of safety to be added to the design process based on engineering judgment. The factor of safety could be included through the selection of a conservative design wave height used (such as  $\overline{H}_5$ ) in Hudson's equation or it could be through an increase in the specified design median rock weight.

Applications of Hudson's equation in situations with a design significant wave height of  $H = 5$  feet or less have performed well. This range of design wave heights encompasses many coastal revetments along highway embankments. When design wave heights get very large and the design water depths get very large, problems with the performance of rubble-mound structures can occur. These problems relate in part to wave groupiness (back to back large waves), design sea-state specification, constructability and other issues. Seawalls with design wave heights much greater than  $H=5$  feet require more judgment and more experience and input from a trained, experienced coastal engineer. Other details about the design of rubble-mound revetments are discussed in the Coastal Engineering Manual (USACE 2002).

One alternative to the two-layer design of Figure 6.13, is a "dynamic revetment" (or "berm revetment") which contains a significantly larger volume of smaller stones with a wider gradation. A dynamic revetment allows the stones to move in response to storm waves into an equilibrium shape much like a cobble or sand beach.

An alternative to the use of extremely large stones in the armor layer is to use concrete armor units. These typically are lighter since they interlock better than quarrystone and thus have higher  $K_D$  values. They can be cast on site. There are a number of shapes of artificial concrete armor units including several patented shapes requiring the payment of license fees.

## 6.4 Practical Issues for Coastal Revetment Design

The stone gradations recommended above for coastal revetments are much narrower than those typically used for highways. For example, FHWA's Standard Specifications for Class 5 rip-rap call for a median weight of  $W_{50} = 770$  lbs, with 10% of the stones weighing 0 to 55 lbs., 40% weighing 55 to 770 lbs, 30% weighing 770 to 1540 lbs, and 20% weighing 1540 to 2200 lbs (USDOT 2003).

A footnote to the FHWA specification table says “furnish spalls and rock fragments graded to provide a stable dense mass.” However, the gradation recommended above for Hudson's equation for coastal revetment for the same median weight of  $W_{50} = 770$  lbs, calls for all stones to weigh between 100 and 3000 lbs. Thus, the recommended coastal revetment gradation precludes the smaller stones and allows for some larger stones. These smaller stones are typically not included in coastal revetments because of their tendency to move in response to wave action. If there is a potential for the smaller stones that are removed from the revetment during storms causing other damage as projectiles, then the narrower gradation, without the smaller rocks, should be required. This typically results in higher unit costs for the stone.

There are five typical failure mechanisms for coastal revetments:

1. inadequate armor layer design for wave action,
2. inadequate under layer,
3. flanking,
4. toe scour, and
5. overtopping splash.

A revetment's strength depends on the underlying soil. If wave action can remove that soil via any mechanism, the revetment will collapse. Each of the four typical failure mechanisms involves failure to protect that underlying soil. Each can be prevented by careful design by an experienced engineer.

Figure 6.14 shows a failed attempt to protect an embankment. The slope protection used concrete slab panels. The concrete panels were available from some other project and were set on the surface of the eroding bluff. Although the panels were heavy enough to withstand the wave action itself, wave action during storms likely pulled, or pumped, the underlying soil out from between the gaps in the slabs. Consequently, the panels collapsed. The second photograph shows the panels after collapse. A rock revetment was subsequently placed farther back on the bluff. The original panel design did not adequately protect the underlying soil and did not have the flexibility of a rubble-mound revetment.



Figure 6.14. Example of a failed attempt at embankment protection (USACE archives photo)

Hudson’s equation can usually be used to select the stone size in the outer layer of a revetment subjected to wave attack and it was specifically developed for that situation. However, careful engineering judgment based on experience should be used when the design cross-section varies from that in Figure 6.13. Figure 6.15 shows a revetment protecting a highway that has a small, vertical bulkhead with stones on the seaward side and an almost flat stone section landward. This cross-section design essentially “trips” breaking waves when storm surge raises the water level and begins to inundate the highway. Thus, breaking waves can plunge directly on the stones and move them onto and across the roadway during major storms. For very mild slopes, Hudson’s equation estimates very small armor stone and adjustments may be needed. A larger stone weight would prevent this type of failure.



Figure 6.15. A revetment with rocks too small to withstand wave attack

Flanking occurs when adjacent, unprotected shorelines continue to recede. Erosion at the end of the wall allows wave action to remove the soil from behind the wall starting at the ends, then progressing along the walls it fails. Flanking can be avoided by extending the revetment or wall to meet an existing revetment or a wall or natural rock outcropping, or by using a return wall. A return wall is aligned perpendicular to the shoreline. The length of the return wall should exceed the expected long-term and storm-induced recession of the adjacent shorelines.

Vertical scour at the toe of a revetment or seawall can cause the underlying soil to be exposed to waves. One solution to toe scour problems is shown in the recommended revetment cross-section in Figure 6.13. A significant volume of stones is placed at the toe. This toe is designed to collapse into any toe scour hole that develops without loss of the stones on the slope. For very erosive areas, more stones can be used in the toe.

Overtopping splash at the top of a revetment or seawall can also lead to failure by exposing the underlying soil to waves. If the wall does not extend to a high enough elevation, waves will overtop the wall. Figure 6.16 shows indications of overtopping splash damage at the top of rock seawall.



Figure 6.16. An example of splash damage behind seawall

A solution to overtopping splash problems is to provide a splash apron as is shown in the revetment cross-section in Figure 6.13. The rocks extend some distance back from the break in slope. The width of the splash apron varies depending on the severity of the expected overtopping. A minimal splash apron width is 5 to 10 feet.

The elevation of the top of the revetment in Figure 6.13 was based on the elevation of the top of an existing embankment. It was assumed that wave runup would allow some limited overtopping at the design conditions. The splash apron was thus included. For situations where the embankment elevation is much higher than the expected level of wave runup during design conditions, a decision regarding the height of the revetment is required. The height of wave runup ( $R_u$ ) is shown in Figure 6.17. It can be estimated using:

$$\frac{R_{u,2\%}}{H_s} = 1.6 r \xi_{op} \quad \text{with a maximum of } 3.2 r \quad (6.4)$$

where:

- $R_{u,2\%}$  = runup level exceeded by 2% of the runups in an irregular sea
- $H_s$  = significant wave height near the toe of slope
- $r$  = a roughness coefficient ( $r = 0.55$  for the stone revetments)
- $\xi_{op}$  = the surf similarity parameter as defined below

$$\xi_{op} = \frac{\tan \theta}{\sqrt{\frac{2 \pi H_s}{g T_p^2}}} \quad (6.5)$$

where:

- $\theta$  = angle of slope of structure (see Figure 6.17)
- $H_s$  = significant wave height
- $T_p$  = wave period, peak period
- $g$  = acceleration of gravity

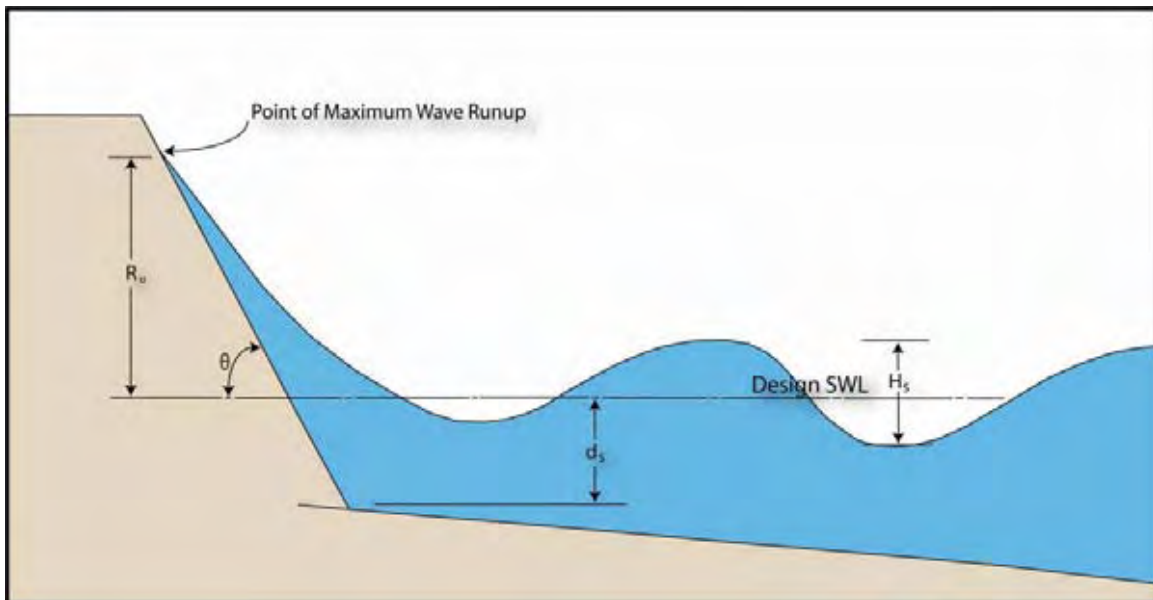

Figure 6.17. Wave runup definition sketch

The level given by Equation 6.4 is for the 2% runup level. This runup level is defined as the runup level exceeded by 2% of the incoming waves. Thus, 2% of the waves will run up higher than this level. The roughness coefficient ( $r$ ) accounts for the roughness of the surface of the revetment with  $r = 1$  for smooth slopes. For rock revetments such as shown in Figure 6.11, the recommended value for  $r$  is 0.55. For  $r=0.55$ , Equation 6.4 has an upper limit of  $3.2r = 1.76$ . Thus, the 2% level of runup is  $\leq 1.76H_s$ . Equation 6.4 is adapted from a methodology developed by Van der Meer and summarized by Pilarczyk (1999). More detail including other structure geometries can be found in that reference.

Wave overtopping of revetments and seawalls occurs when runup exceeds the top or crest of the structure. Building seawalls high enough to completely prevent overtopping is often unacceptable because of aesthetics and costs. Wave overtopping onto coastal roads is fairly common in some parts of the country. Two aspects of overtopping of interest to the design engineer are the time-averaged volumetric rate of overtopping and the intensity or force of a single wave overtopping event. Accurately estimating volumetric overtopping rates can be vital to design of seawall crest elevations if inland flooding is caused. Unfortunately, accurately estimating overtopping rates can be very difficult for many situations and input to the design team from a trained coastal engineer is likely appropriate. Guidance on estimating overtopping can be found in Goda (1985) and USACE (2002).

A commonly proposed alternative to rubble mound revetments is a concrete block revetment. Some of these have some physical interlocking between individual blocks and others do not. The performance of interlocking blocks in severe coastal environments has not been good. One problem is that minor damage can lead to failure of a large portion of the revetment. Two examples are shown in Figure 6.18 and Figure 6.19. The failed revetment in Figure 6.18 has been covered by a sand beach through beach nourishment (see Figure 7.16 ). The failed revetment in Figure 6.19 has been replaced by a sand beach through beach nourishment and stabilized by offshore segmented breakwaters (see Figure 7.18). Problems with concrete block revetments in coastal situations often develop at the ends of the revetment where the blocks abut a more rigid structure. Even a small amount of settlement can affect the aesthetics of block revetments.



Figure 6.18. Example of rigid concrete-block revetment failure (Florida Highway A1A, Delray Beach, circa 1972; University of Florida and USACE archive photos)



Figure 6.19. Example of failed block revetment (Louisiana Highway 87, circa 1980, USACE archives photos)

Another commonly proposed alternative to rubble mound revetments are rigid concrete panel designs. Performance of rigid concrete panels in severe coastal environments also has not been good. A concrete panel revetment on a bridge approach that suffered damage in a hurricane is shown in Figure 6.20. The underlying soil was not adequately protected from wave attack. Neither interlocking blocks nor concrete panels match the performance and flexibility of stone revetments. The Florida DOT does not allow rigid revetments in wave situations.



Figure 6.20. Example of rigid revetment failure on a coastal highway bridge approach

Other revetment systems include articulated concrete mats, flexible rock-filled marine mattresses, gabions, and sand-filled geotextile tubes or bags. Articulated concrete mats have concrete blocks interconnected by strong cables. The size and weight of the blocks are a function of the wave height, slope, currents, etc. Proper installation requires adequate filtration material and secure anchoring at the top of the slope. The toe is sometimes unsecured to allow it to settle (scour). Flexible rock-filled marine mattresses are used as foundations and for scour control underneath marine structures; but they are not generally recommended for slope protection by themselves. Gabions are rock-filled "baskets" composed of steel wire or polypropylene grid which are stacked for embankment protection. Their use in energetic coastal environments, where wave heights may routinely exceed 1 to 3 feet, is not generally recommended. Sand-filled geotextile containers (tubes or bags) are typically only used for temporary, interim embankment protection in the coastal zone. Where used, they are best buried within the existing grade and become exposed only during storm erosion (an example is illustrated in Figure 7.3). The structures are prone to damage or failure by vandalism, rolling, and natural deterioration when exposed.

*Page Intentionally Left Blank*



## Chapter 7 - Roads in Areas of Receding Shorelines

Much of the American coastline is experiencing long-term recession. When a highway is near one of these receding shorelines, it can eventually be subjected to wave attack and erosion. This section outlines how long-term shoreline changes can be quantified and used to estimate future shoreline positions, ways to evaluate the vulnerability of coastal highways, the general options available for roadway relocation, and alternative shoreline stabilization techniques available for protecting a highway in place.

### 7.1 *Examples of Issues*

Figure 7.1 shows a roadway with a rubble mound revetment seawall protecting it from waves. In the 1970's this road was located over 300 feet landward of the shoreline. The beach here is eroding at a high rate so that the shoreline has been moving toward the road at an average rate of 15 feet per year for the past 35 years. Shoreline recession progressively narrowed the beach until an emergency rock revetment/seawall was constructed. The revetment has not slowed the recession of the adjacent beaches. There are exposed tree stumps in the surf and on the beach face as a result of the recession. Shoreline recession has continued on both sides of the revetment and the road is extending farther out into the sea. The revetment is now protecting the road and functioning like an artificial headland.



Figure 7.1. A road initially built inland of a receding shoreline is now in the sea. Stump Hole area of Cape San Blas, Florida (2005 FDOT photo)

Figure 7.2 through Figure 7.5 show other examples of roads threatened by long-term shoreline recession. The problem occurs in a variety of coastal settings including coastal bluffs and low-lying barrier islands.

Figure 7.2 shows Cape Shoalwater area of Washington State Road 105 built along a rapidly receding shoreline. At the time of this photograph (April, 2003) there was a rock revetment at the base of the bluff and a groin in the background. There had been some limited beach nourishment.



Figure 7.2. A highway initially built inland now threatened by long-term shoreline erosion. Cape Shoalwater area of Washington State Road 105 (2003)

Figure 7.3 shows a road on a narrow, low-lying barrier island in New Jersey. The road parallels the beach on one side and a back-bay wetland on the other. The shoreline here has been receding for decades and the road is threatened. Several shoreline stabilization and roadway protection projects have been attempted. The sand-filled geotextile tube was built and covered with a sand dune to protect the highway is being repaired after a storm in 2003.



Figure 7.3. A local road threatened by long-term shoreline recession. Ocean Drive, Whale Beach area of Cape May County Road 619, Ludlam Island, New Jersey (2003)

Figure 7.4 shows a local road undermined by bluff erosion on Lake Erie. This road used to continue straight ahead until bluff erosion undermined the pavement. The bluff erosion has been exacerbated by sand starvation of the beaches at the base of the bluff by an updrift jetty system.



Figure 7.4. A local road being undermined by bluff erosion and long-term shoreline recession on the Great Lakes. Painesville, Ohio (2001)

Figure 7.5 shows Texas Highway 87 along the east Texas coast of the Gulf of Mexico destroyed by shoreline recession. A twenty-mile stretch of this highway along the coast is now closed. It has been closed since 1989 when a storm caused significant pavement damage. Four-wheel drive access is permitted now but is not feasible when tides are high.



Figure 7.5. Road destroyed by shoreline recession: a) broken pavement on the beach at the old location; b) south end of the closed section; c) location map. Texas Highway 87, Jefferson County (2002)

## 7.2 Quantifying Shoreline Change Rates

Coastal erosion rates are often given in terms of the change in average annual shoreline position with time, e.g. 2 feet per year. These are actually shoreline change rates rather than erosion rates. The terms “recession” and “accretion” are typically used to describe the direction of shoreline movements. A beach that is widening in response to sand deposition has an accreting shoreline. A beach that is narrowing in response to erosion has a receding shoreline.

Shoreline change rates typically vary with location and time. Shoreline change rates should be looked over as long a time period as possible with as many observations as possible. “Long-term” shoreline change usually refers to multi-decadal time scales. Many observations in a single year can give some estimate of the seasonal variability in shoreline position as sand moves cross-shore on the profile. Typically these data are not useful for developing “long-term” shoreline change trends.

Historical shoreline data are available from a variety of sources including state coastal resource agencies, federal agencies that deal with the coast, and universities.

One example is the USGS results for the Atlantic and Gulf coasts (<http://coastal.er.usgs.gov/shoreline-change/> 2006). A state resource agency example is the State of Florida’s Department of Beaches and Coastal Systems database and analyses results (<http://www.dep.state.fl.us/beaches/> 2006).

There is no accepted national standard for shoreline change analyses. The quantity and quality of shoreline change data vary significantly. Each location has different types of historical data and analyses. The most problematic shoreline recession areas in the United States have likely been studied by a variety of agencies and researchers. Developing a clear understanding of historic shoreline changes for a project can require new analysis of existing data.

Historical shoreline positions can be measured by repetitive surveys or by remote sensing such as air photograph interpretation. Historical and current vertical air photographs can provide the basis for shoreline location data with proper interpretation and positioning analysis. One source for estimates of older historic shoreline locations is NOAA's National Ocean Survey surveys and the surveys of their predecessor organization, the US Coast & Geodetic Survey (USC&GS). One example of the variability of historic shoreline positions from these surveys is shown in Figure 7.6. High-quality estimates of shoreline position can extend as far back as the 1850's. The USC&GS significantly improved the accuracy of coastal surveys at about that time. Pre-1840 estimates of shoreline position done by the USC&GS are typically not as accurate as those done after 1850. USC&GS "t-sheets" and "h-sheets" are the summary plots of specific surveys and correspond with the dates of the actual survey. Navigation charts, however, are updated continuously and the date of the chart does not correspond with the date of all of the information shown on it. Accuracy of these historical shoreline estimates often can be adequate for the purpose of shoreline change analysis (Crowell, et al. 1991).

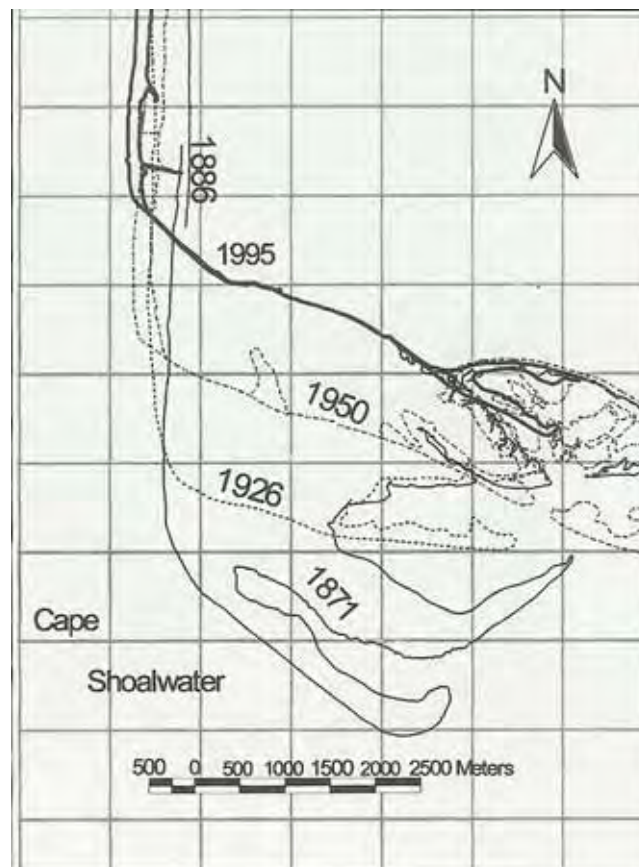

Figure 7.6. An example of historical shorelines based on USC&GS/NOS surveys updated with modern technology. Cape Shoalwater, Washington (Kaminsky, et al. 1999)

An example of a shoreline change analysis is shown in Figure 7.7. The plot is for five locations, spaced 1000 feet apart, centered on the location where the road in Figure 7.1 extends into the sea. The plot shows the measured shoreline locations through time and the lines are splines fit to the data for visual convenience. A recessional (negative) trend is obvious at all five locations and is very consistent at four of the five locations. There is some variability in the overall trend at station R-106 that may be explained by effect of the revetment protecting the road (the nomenclature and designations of the stations are those of the Florida Department of Environmental Protection). Given the natural temporal variability of shoreline location, the strong trends shown in Figure 7.7 are not typical. Similar plots often show much more variability through time and the trend is not always clear. The site analyzed in Figure 7.7 has a very clearly recessional shoreline. Figure 7.7 shows a non-linear trend in shoreline position through time. The recession rate appears to be greatest in the most recent years. A relatively large number of major storms have impacted this coast since 1997.

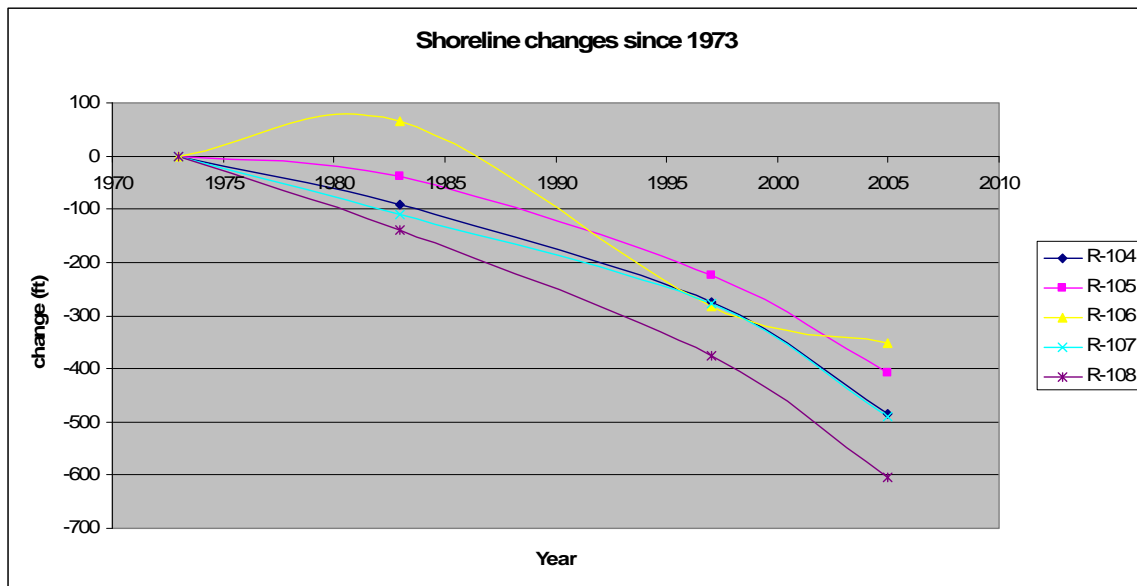

Figure 7.7. An example of shoreline position changes through time. Stump Hole area of St. Joseph’s Peninsula, Florida

More results from the same shoreline change analysis are shown in Figure 7.8. The average annual recession rate along 30,000 feet of shoreline on the west-facing shoreline of St. Joseph Peninsula is shown. The average annual rate depends on location and the time period over which the average is taken. Clearly the recession rate is much greater to the south (higher R-monument numbers).

Recession rates shown in Figure 7.8 have been calculated by the “end-point method” which averages the change in shoreline position from the beginning to the end of the time period. An alternative to the end-point method is linear regression (Crowell, et al. 1997). Linear regression is typically preferred to the end-point method because it uses all the available data and is less sensitive to one spurious or aberrant value.

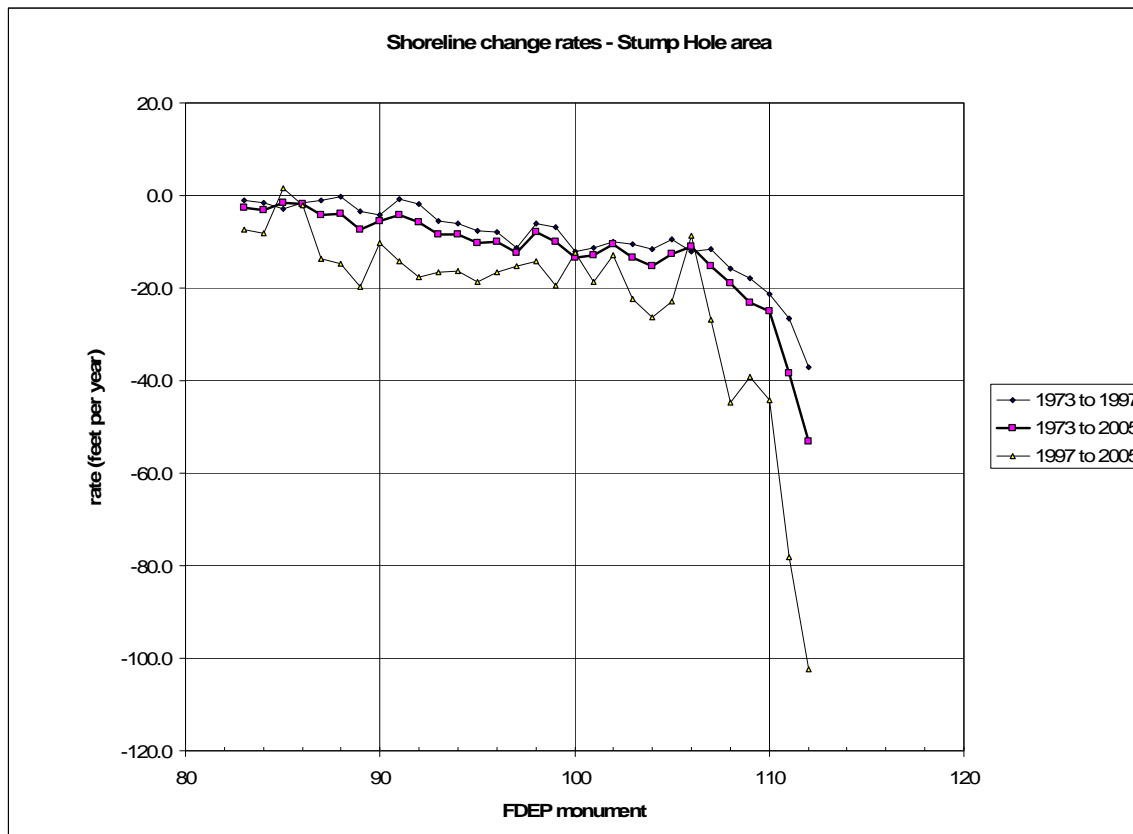

Figure 7.8. An example of shoreline change rates along 30,000 feet of coast showing temporal and spatial variations but a significant recessional trend. Western-facing shoreline of St. Joseph’s Peninsula, Florida

### 7.3 Estimating Future Shoreline Positions

An estimate of future shoreline locations can be valuable in planning highways near areas of receding shorelines. The most common method for estimating future shoreline positions is direct extrapolation of historic shoreline change rates to the present shoreline (Crowell, et al. 1997). Figure 7.9 shows some historic shoreline positions as well as projected future positions at one location. The historic shoreline data was obtained from the FDEP on-line database. Florida originally obtained the older (1868 and 1934) data from the USC&GS, made appropriate datum corrections and added their own data from beach profile surveys. The projected shorelines are extrapolations from the 2005 shoreline location, at 1000 foot intervals along the coast based on the average annual rate of shoreline recession. The average annual rate of shoreline recession was based on the most recent 32 years (1973 to 2005). The result shows that more and more of the highway will be threatened by recession in the coming decades. This information and its graphical presentation, can be valuable in planning alternative responses.



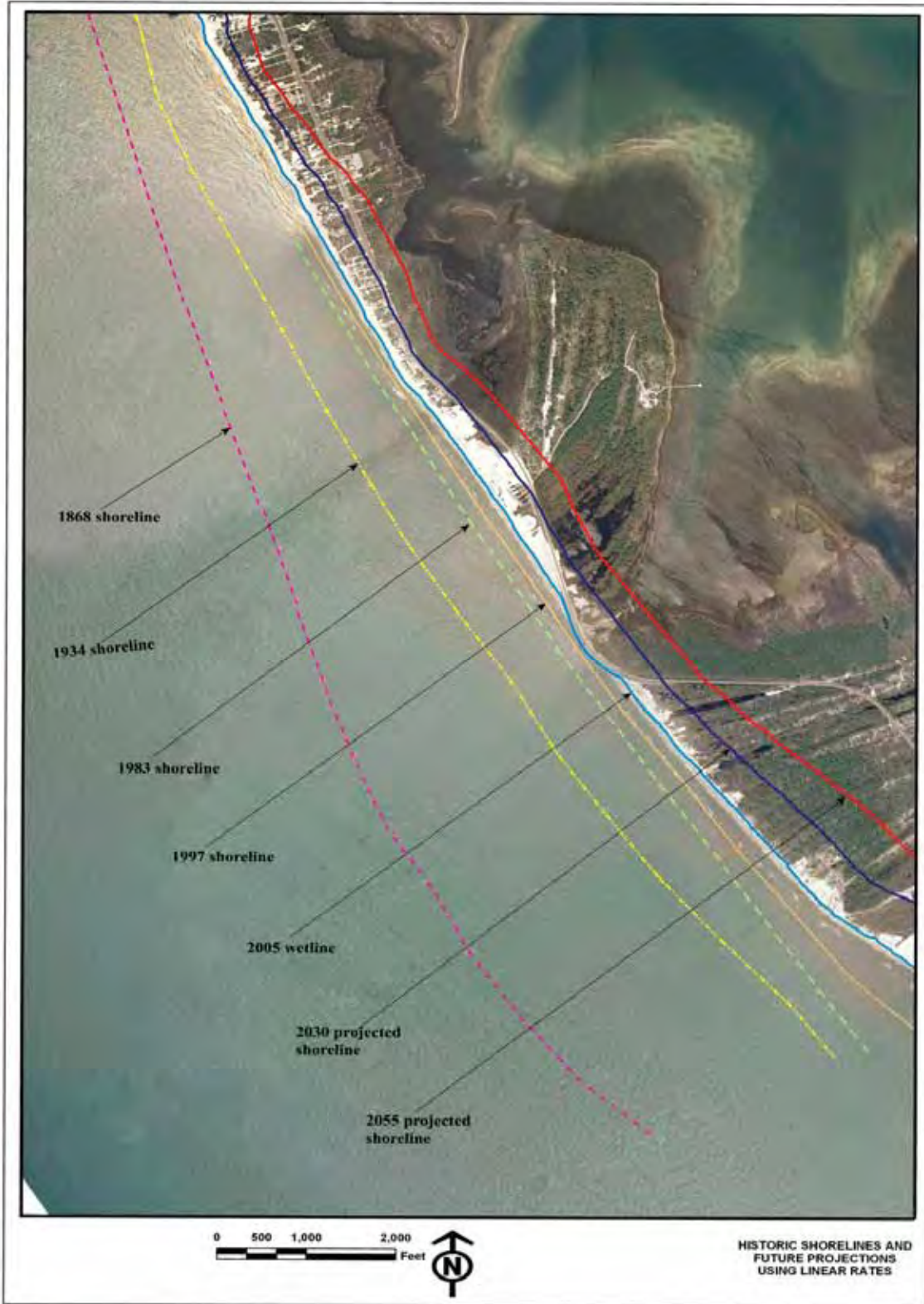

Figure 7.9. Example of projected future shoreline positions at Stump Hole (FDOT figure)

### 7.3.1 Shortcomings of Shoreline Change Assumptions

There are theoretical and practical shortcomings with the underlying assumptions in using historic shoreline change rates to estimate future shoreline position. They include:

1. Natural shoreline change processes are often not linear in time.
2. Engineering may have influenced historic shoreline changes.
3. Engineering may influence future shoreline changes.

It has long been recognized that shoreline change can be episodic. An individual storm may cause significant erosion or even trigger the beginning of an erosional period. The natural dynamic equilibrium on some beaches involves years of recovery after major storms. Large storms on low-lying barrier islands can cause island rollover and migration. Large storms on some coasts may remove large amounts of sand from the beach, via longshore and cross-shore sand transport and cause bluff erosion. Subsequent times of lesser storm activity can result in the replacement of much of that sand by similar processes.

Shoreline position in many US locations has been influenced either positively or negatively by engineering works. Engineering works can include seawalls, groins, breakwaters, inlet jetties, dams (on the US West Coast), dredging of ship channels, and beach nourishment. For example, a groin that traps sand will often widen an updrift beach while narrowing a downdrift beach. Over 1 billion cubic yards of sand have been trapped or removed from US beaches by the works of man (Douglass, et al. 2003). Beach nourishment projects can widen beaches significantly. Roughly 0.5 billion cubic yards of sand have been placed on 200 areas along the US coast (Campbell and Benedet 2004).

### 7.3.2 Sediment Budgets

Sediment budgets can be used to estimate future shoreline positions. Sediment budgets are estimates of the rate at which sand is entering, leaving a specific reach along the coast. The difference between the volume entering and the volume leaving an area yields the volume gained or lost by that area. Sediment budgets typically require much more data and analysis than simple shoreline change extrapolation. An example coastal sediment budget for Florida's St. Joseph's Peninsula is shown in Figure 7.10. Sediment budgets are often developed to understand a specific erosion problem and to develop alternative solutions. Input data usually include historic shoreline change rates or beach profile data. The sediment budget shown in Figure 7.10 was based on volumetric changes between 1973 and 1997. The sediment budget shows that the "Stump Hole" area just north of R-110 is losing an average of 185,000 cubic yards of sand per year. This is the cause of the shoreline recession threatening the road in Figure 7.1.

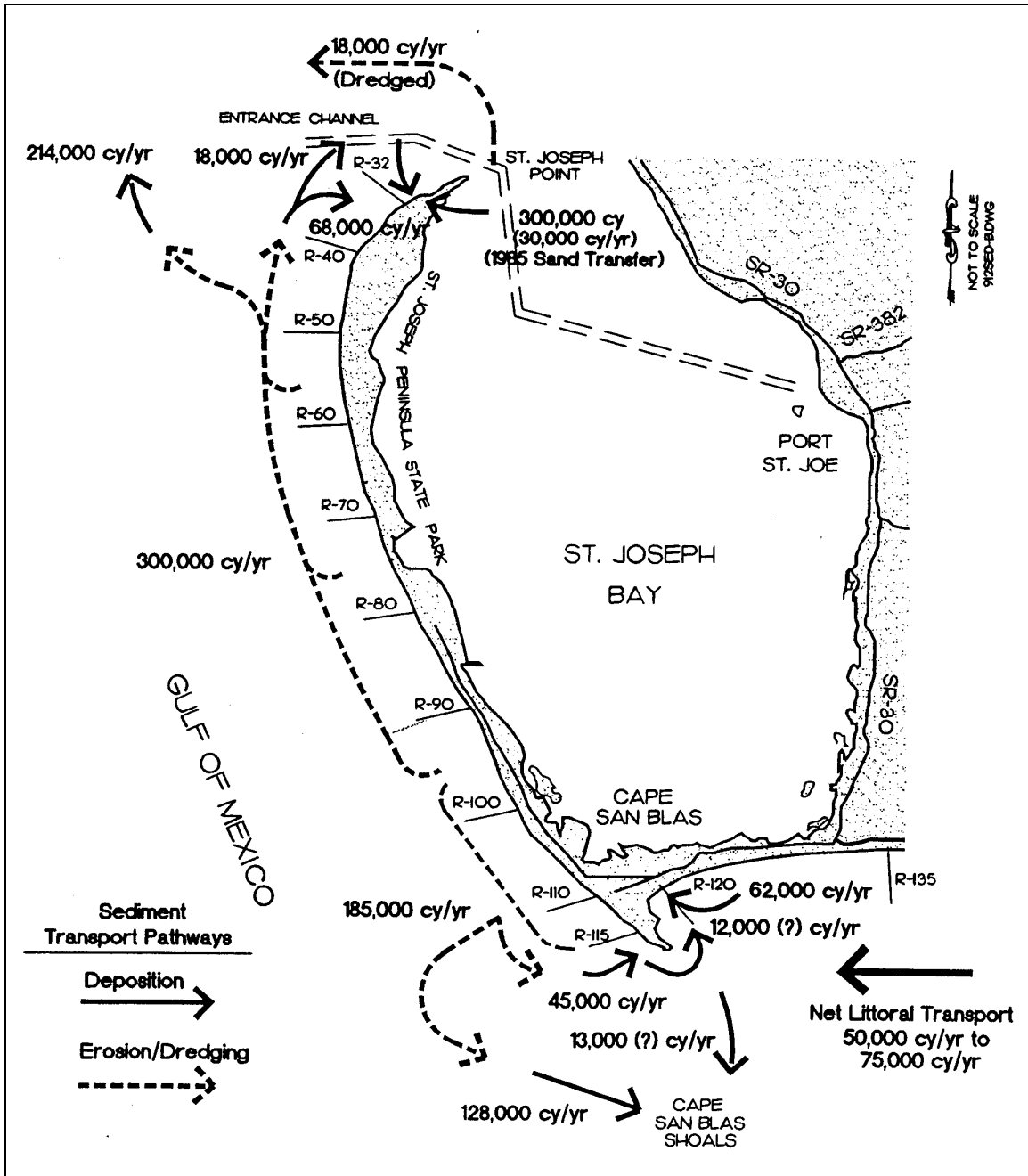

Figure 7.10. Example of a coastal sediment budget (Coastal Tech and Preble-Rish, Inc. 1998)

## **7.4 Vulnerability Studies for Coastal Roads and Bridges**

Some fraction of the over 60,000 highway miles in the United States that are occasionally exposed to coastal waves and surge have already been damaged and will be damaged in the future. “The long-term expectation of continued highway damage requires comprehensive and continuing studies of highway vulnerability” (AASHTO Highway Drainage Guidelines 1999). Clearly, some of these coastal road miles are more vulnerable than others. Planning decisions related to repair, protect, or relocate these highways may be accomplished in a cost-effective manner based on a vulnerability study.

The decision to repair, protect, or relocate coastal highways requires an assessment of many variables including shoreline recession rates, protection afforded by existing and projected beach width, dune size, bluff geology, present and future transportation needs, and costs. A systematic method to anticipate future erosion problems along coastal highways and to evaluate responses for their repair and protection needs to be developed. The following objectives should be addressed by such studies (AASHTO Highway Drainage Guidelines):

- Identify the relative vulnerability of highway actions in the coastal zone to long-term erosion including the effects of storms and hurricanes
- Evaluate feasible engineering solutions for protecting and repairing coastal highways.
- Review and document prior highway damage, causes, remedial actions, costs, and effectiveness of solutions.
- Develop and test a methodology for matching repair and protection strategies to highway sections for different vulnerability scenarios.
- Use the model to estimate the location of all vulnerable sections and identify protection actions and costs for a predefined planning period.

Details of the model depend on the local coastal processes threatening the highway. In areas where dunes protect highways, available dune erosion models can be used to evaluate the level of protection. Vulnerability means that the coastal highway is susceptible to excessive overwash or undermining of the highway base. Transportation officials usually perceive a vulnerability problem when maintenance crews are required to make repairs several times per year (AASHTO Highway Drainage Guidelines).

Coastal highway vulnerability models are built from two databases:

1. A digitized map with elevations and shoreline position
2. An estimate of long-term shoreline recession rates.

This data can be integrated and organized for presentation on base maps and spreadsheets. When completed, this data will identify specific locations of vulnerable highways (AASHTO Highway Drainage Guidelines). For example, Figure 7.11 shows transects evaluated for vulnerability along a portion of North Carolina Highway 12. Each transect was evaluated using a model that incorporated both long-term shoreline change rates and storm-induced dune erosion (Moffat & Nichol 2005).

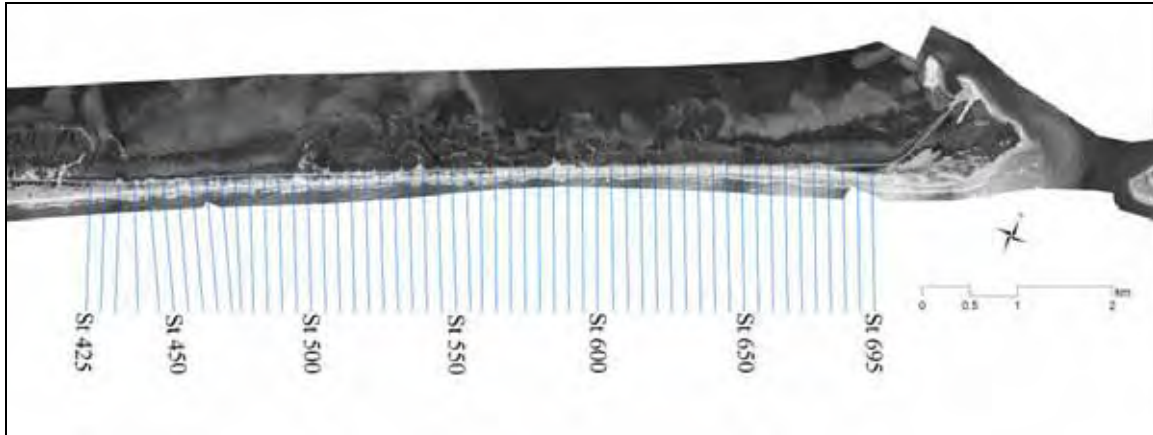

Figure 7.11. Example of coverage for a vulnerability study (North Carolina DOT)

Highway vulnerability studies based on the dominant, local coastal processes have proven to be an effective planning tool. For example, much of the damage to North Carolina Highway 12 caused by Hurricane Isabel in 2003 occurred in areas previously designated as highly vulnerable “hot spots” (Overton and Fisher 2004a). The models used in North Carolina have been developed for that coast using some of the principles and tools (SBEACH, ADCIRC, Kriebel’s dune erosion model, etc.) outlined earlier (Judge, et al. 2003, Krynock, et al. 2005).

Vulnerability study methodology should evolve as part of a permanent highway assessment program. For example, North Carolina’s methodology has been refined through time with the inclusion of modern research results (Stone, et al. 1991, Overton and Fisher 2004b). As another example, Florida DOT began a process of evaluating the vulnerability of all their coastal bridges after the hurricane of 2004 and 2005 proved that some were vulnerable to waves on storm surge.

## 7.5 Relocation Considerations

One obvious solution to the problem of a roadway threatened by shoreline recession is to relocate the road. Roads have been moved or abandoned at different locations along the US coast for decades. One example is Washington State Road 105 in the Cape Shoalwater area (see Figure 7.1). This road was moved several times since this area has experienced some of the highest, long-term shoreline recession rates in the nation. In 1998, a rock groin and revetment were built to protect the existing highway. Relocation of the road had again been considered but not selected as the preferred alternative.

One example of an abandoned road is Texas Highway 87 between High Island and Sabine (see Figure 7.5). The road was closed indefinitely due to damage by Hurricane Jerry in 1989. Prior to that, the road had been damaged repeatedly by coastal storms. A road in that location had been there for over a century and the local government in Jefferson County is working to re-open the road.

A primary issue when considering road relocation is the new route. The logical location is farther inland from a receding shoreline. However, those areas are often already occupied by private property or wetlands. Developing private property is extremely expensive due to its location near the coast. Wetlands maybe productive coastal wetlands protected for their habitat value.

The stretch of Texas Highway 87 that is closed today is in front of wetlands that are part of the McFadden National Wildlife Refuge. Relocating the road landward would require filling the wetlands. Likewise, relocation of CR 30E in the Stump Hole area of Cape San Blas (see Figure 7.1) would require the filling of wetlands currently managed by the state as an aquatic preserve. Alternative relocation options considered for Washington Highway 105 in the Cape Shoalwater area included private cranberry bog farms.

### 7.5.1 Shoreline Stabilization Options

An option along a receding shoreline is some form of shore stabilization or protection. Stabilization is essentially holding the line and resisting the recession. The shore protection generally is in one of two forms. One, some form of “hard” structural shoreline protection such as a seawall or groins or breakwaters. Two, some form of “soft” sand shoreline protection such as beach nourishment. There are many combinations of structures with nourishment.

## 7.6 Coastal Structures

Coastal structures can be categorized in terms of their primary function as follows:

1. seawalls, revetments, bulkheads – shore-parallel structures on the shoreline designed to protect upland property from waves
2. groins – shore perpendicular structures designed to control longshore sand transport
3. breakwaters – shore-parallel structures located seaward of the shoreline to reduce the wave energy in their lee and to control longshore sand transport,
4. hybrid structures – some functional combination of groins and breakwaters including “t-head groins” or “headland breakwaters”

Groins were probably the most common shoreline stabilization technique in the first half of the 20<sup>th</sup> century. Figure 7.12 and Figure 7.13 shows two groin fields. Groins are typically placed as shown in groups or “fields.” They are often called “jetties” but that term is typically reserved by the US coastal engineering community for structures that stabilize inlets. Groins can stabilize a shoreline via two mechanisms if there is adequate sand in the littoral system:

- Groins can locally realign the shoreline (shown in Figure 7.12) to reduce the longshore sand transport rate.
- Groins can shelter the area adjacent to them from the wave energy especially when waves approach the shore at an angle.



Figure 7.12. Groin field in Long Beach, New York (New York Sea Grant photo)



Figure 7.13. Groin field in Long Branch, New Jersey (2006)

Groins can trap sand on one side while causing erosion on the other. The shoreline on the updrift side of a groin accretes while the shoreline on the downdrift side recedes. Thus, groins are often built in groin fields so the one just downdrift stabilizes the next portion of the shore. Shoreline recession downdrift of the last groin at the end of a groin field can be severe (see Figure 7.14). Groins are much less acceptable today as a shoreline stabilization technique than they were prior to the 1960's. New groins are discouraged or prohibited in many states today because of their potential downdrift negative impacts.



Figure 7.14. Severe shoreline recession and beach erosion downdrift of a groin field (West Hampton, New York, circa 1985, New York Sea Grant photo)



### 7.6.1 Beach Nourishment

Beach nourishment is the placement of large volumes of good quality sand to widen a beach. Sand dunes can be constructed at the back of a nourished beach. “Beach nourishment is a viable engineering alternative for shore protection” (National Research Council 1995). Nourishment also has become the principal technique for beach restoration.

Figure 7.15 shows a beach nourishment project under construction. Sand is being pumped from an offshore dredge (not shown) to the beach and then down the beach to where the sand-water slurry discharges from the pipe. The beach is then shaped by bulldozers. As the new beach extends farther down the beach, the dredge pipe is extended.



Figure 7.15. A beach nourishment project under construction. Gulf Shores, Alabama (2001)

Beach nourishment projects usually need to be maintained through subsequent renourishment as the sand moves out of the project limits. Many of the policy, management, and engineering issues related to beach nourishment projects are qualitatively described in Douglass (2002). Many of the quantitative engineering tools used in beach nourishment planning and design are presented in Dean (2002). The available quantitative tools for beach nourishment engineering for shoreline stabilization include methods for evaluating the performance of potential nourishment sands, estimating the short-term performance and the long-term renourishment intervals, and evaluating the ability of structures (if desired) to extend the renourishment interval. Each of these can be critical aspects of beach nourishment planning and design.

Beach nourishment projects protect a number of roads in the US. Two examples are shown in Figure 7.16 and Figure 7.17. The beach and dune in Figure 7.16 was constructed by the City of Delray Beach on top of the failed seawall shown in Figure 6.18. The sidewalk and parapet wall on the crest of the seawall in Figure 6.18 is the same as the sidewalk and bench shown in Figure 7.16. Since originally constructed in 1973 this beach nourishment project has protected the road while providing a beach. The site has been renourished four times since 1973.



Figure 7.16. Beach nourishment project with constructed dune on top of old, failed revetment protecting road. Florida Highway A1A, Delray Beach (2001)

The nourishment project at Sea Bright, New Jersey, shown in Figure 7.17 is a federal shore protection project funded through the USACE's shore protection authority. The beach was constructed in 1994 directly seaward of the seawall. Nourishment was the preferred alternative to further seawall repairs.

Proponents for beach nourishment projects have typically not been DOTs, even when the project protects a state highway. Rather, local government, a state resource management or economic development agency, the USACE, or a private entity typically sponsors beach nourishment. There have, however, been several beach nourishment projects sponsored or co-sponsored by a SDOT.

The USACE shore protection program has the authority to consider and build either beach nourishment or seawalls to protect upland property. Almost all of the USACE's federally authorized beach nourishment projects require a significant (35% to 50%) matching cost contribution from a non-federal sponsor. The USACE shore protection program typically has an annual budget of around \$100 million and the program has not grown significantly during the past several decades.

Beach nourishment should be considered by transportation engineers where a road is threatened by a receding shoreline because of nourishment's effectiveness and its broader societal benefits of aesthetics, recreation and environmental enhancement.



Figure 7.17. Beach nourishment seaward of a seawall protecting a road. New Jersey State Highway 35, Sea Bright, New Jersey (2001)

### 7.6.2 Combining Beach Nourishment with Structures

Modern coastal engineering shoreline stabilization solutions often combine beach nourishment with coastal structures. The purpose of the structures is to extend the interval between periodic renourishment. Some of these “hybrid” soft-hard solutions attempt to emulate natural geomorphological features such as pocket beaches and tombolos. The names of these “hybrid” solutions are still evolving.

Figure 7.18 shows a nearshore segmented breakwater with beach nourishment protecting a highway. This is the highway once protected by the concrete block revetment in Figure 6.19. The nourishment extends out to the nearshore breakwaters as tombolos forming a series of small pocket beaches.



Figure 7.18. Offshore segmented breakwaters with tombolos in beach nourishment protecting a highway (Louisiana Highway 82, Holly Beach) (American Shore and Beach Preservation Association photo, circa 2003).

Figure 7.19 and Figure 7.20 show another system that uses nearshore segmented breakwaters and nourishment sand. In this system, tombolos do not form, the beach does not extend out to the breakwaters. The bulges in the shoreline in the lee of the breakwaters are called “salients.” This system reduces longshore sand transport in the lee of the breakwaters. The tombolos of the headland breakwater system shown in Figure 7.18 eliminate longshore sand transport, inside the breakwaters during normal conditions.

The formation of salients or tombolos is controlled by the geometry of the breakwater system as shown in Figure 7.21. The Coastal Engineering Manual (USACE 2002) provides more guidance on the functional design of nearshore segmented breakwaters.



Figure 7.19. Offshore segmented breakwaters with salients in beach nourishment (USACE archive photo, circa 1980).

Figure 7.22 shows a nearshore segmented breakwater system with terminal groins used to build a small recreation beach. The beach was created with nourishment on the bay side of a long seawall that protected a road but did not have any sandy beach. The breakwater and groin structure system were designed to retain the nourishment sand. The beach was built to provide access to the bay for wind surfers and others.

Figure 7.23 and Figure 7.24 show headland breakwater-pocket beach systems designed to retain beach nourishment sands on bay shorelines. Both were constructed in front of seawalls that had previously been damaged by erosion. These headland breakwater-pocket beach systems use structures to retain sand by providing artificial headlands. Figure 7.23 shows a headland breakwater that incorporates a “t-head groin” in the middle. The structures in Figure 7.24 do not include the stem of the “t” because tombolos were expected to form. The State DOT was a partial sponsor of the project in Figure 7.24 since the system protected a short stretch of road.



Figure 7.20. Offshore segmented breakwater system at Presque Isle, Pennsylvania

Functional design parameters for the design of headland breakwater-pocket beach systems include the distance offshore as well as the gap spacing. The functional goal is the creation of a pocket beach with the sand fill. The shorelines as shown in Figure 7.23 and Figure 7.24 are curved because they have responded to the wave energy coming through the gaps in the artificial headland structures. Wave heights and directions are modified as waves diffract through the gaps. The structure layout can essentially be “tuned” to the local, site-specific wave climate to produce a beach with a desired curved shape and width (Bodge 1998). More guidance for the design of these systems including methods for estimating the final equilibrium shoreline shape and location are given in Silvester and Hsu (1993) and Hardaway and Gunn (2000). An experienced, qualified coastal engineer is recommended for the design of these solutions which combine nourishment and structures.

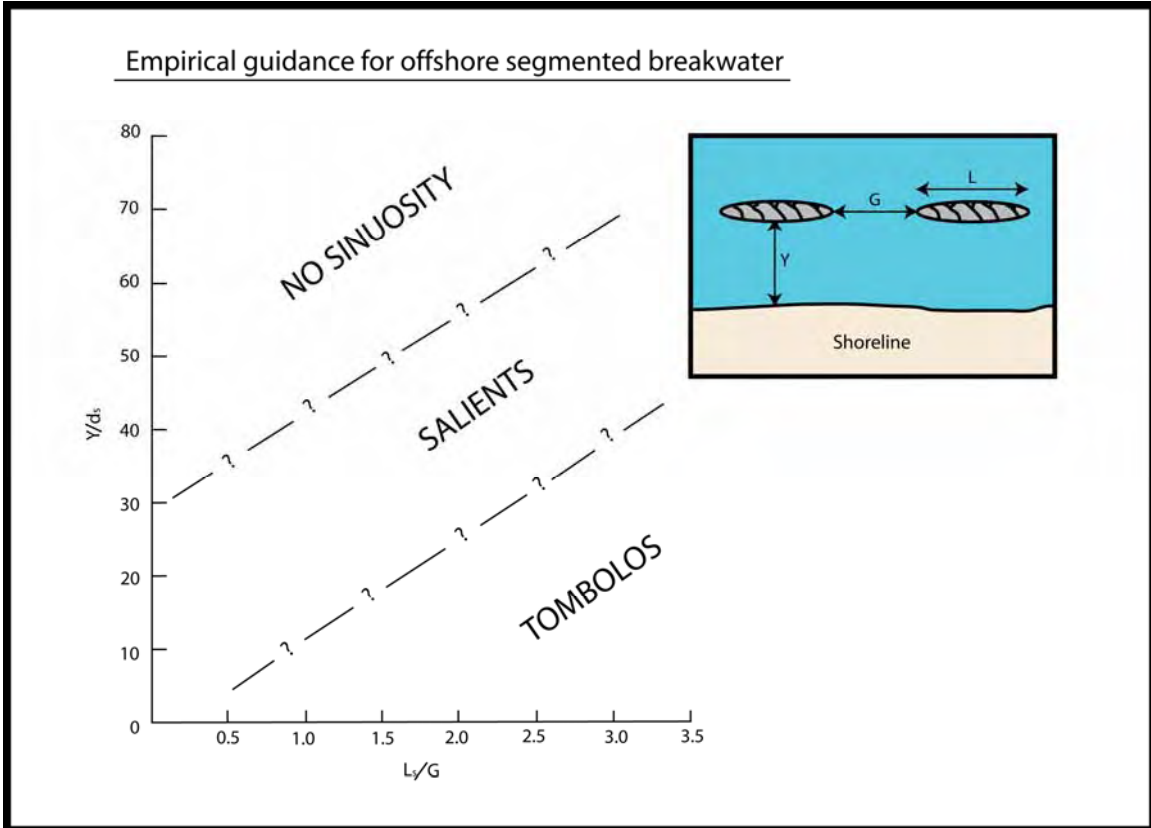

Figure 7.21. Empirical guidance for shoreline effect of offshore segmented breakwaters. (after Pope and Dean 1986, and USACE 2002).



Figure 7.22. Offshore segmented breakwaters with groins and beach nourishment on Corpus Christi Bay (Ocean Drive, Corpus Christi, Texas).



Figure 7.23. Constructed pocket beach stabilized with a T-head groin breakwater system (Point Clear, Alabama).

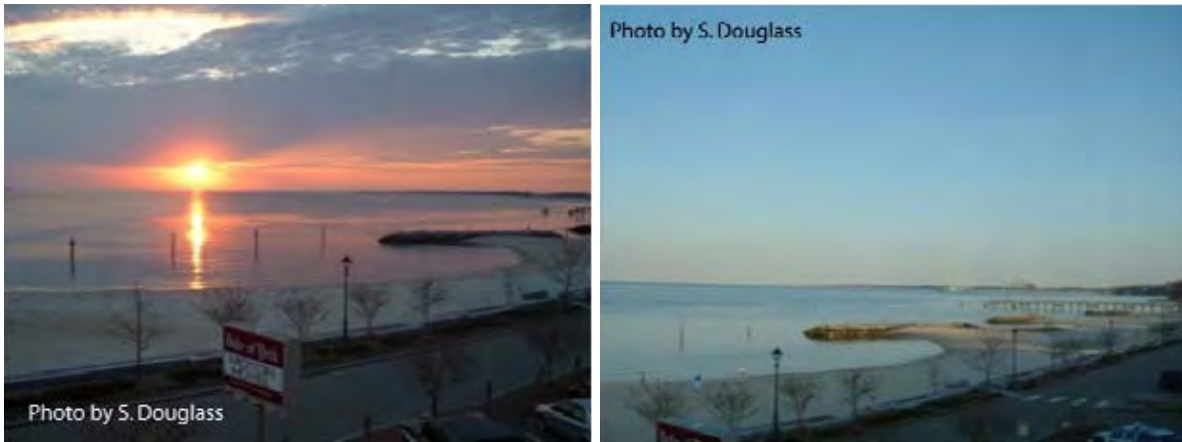

Figure 7.24. Beach nourishment project stabilized as pocket beaches with a headland breakwater system protecting a road (Water Street, Yorktown, Virginia)

### 7.6.3 Non-traditional/Innovative Solutions

The history of coastal engineering has seen many innovative attempts at shore protection and stabilization solutions. These have included many expensive, patented devices and systems. Each of these innovative approaches functions differently but all must follow the same general principles of physics including mass (sand) conservation. If the placement of a device or apparatus in the surf causes beach sands to deposit, it functions much like the more traditional structures described above.



Some of the innovative solutions to beach erosion that have been tried are artificial seaweed, used tire breakwaters, different types and shapes of rigid submerged and emergent devices and beach dewatering. Most innovative solutions are serious attempts to address a challenging problem but some are unproven and highly questionable. Unproven, innovative shore protection solutions for highway applications should be pursued very judiciously.

While the evaluation of new innovative solutions to beach erosion problems should continue in the research and development community, prudent engineering planning and design should focus on proven solutions: relocation, nourishment, structures or some combination of those approaches.

*Page Intentionally Left Blank*

## Chapter 8 - Highway Overwashing

### 8.1 Description of Issue

Some roads are flooded and damaged by coastal storm surges because of their nearshore location and low elevation. An example is shown in Figure 8.1, North Carolina Highway 12, which provides access along the Outer Banks barrier island chain.

During a Thanksgiving Day 2006 storm a portion of NC 12 was being overwashed due to storm surge and waves. NCDOT personnel attempting to keep the road open are visible to the right of the photo. A small, recently constructed sand dune is shown at the left of the photo. Individual waves are washing across the road in the center of the photo and a new deposit of sand is visible on the barrier island.



Figure 8.1. A coastal road being overwashed during a storm. North Carolina Highway 12, November 23, 2006 (North Carolina DOT photo)

Post-storm damage from overwashing during Hurricane Ivan (2004) is shown in Figure 8.2. The road pavement elevation was about +8 feet (NAVD) and the storm surge peak from Hurricane Ivan was roughly 11 feet (NAVD). This chapter outlines mechanisms causing damage to pavements due to overwash and suggests strategies to minimize damage.



Figure 8.2. Example of pavement damage due to storm surge. Florida 292 on Perdido Key, Florida after Hurricane Ivan (Sept. 2004)

## **8.2 The Coastal Weir-Flow-Damage Mechanism**

There are several mechanisms that damage pavements subject to overwash. One is direct wave attack on the seaward shoulder of the road. Another is flow across the road and down the landward shoulder. This is a “weir-flow” damage mechanism. A third mechanism is flow parallel to the road as water moves to “breaches” or lower spots in the road as the storm surge recedes.

Paradoxically, much of the damage to road pavements observed after Hurricane Ivan (2004) was on the landward side of the road. The Gulf of Mexico is to the right side of Figure 8.2 (behind the buildings). Figure 8.3 shows another example of similar damage. There was partial pavement undermining on the landward side of the road. Hurricane Ivan damaged over 50 miles of roads with partial damage as shown or complete damage. It is speculated that weir-flow was the primary cause of the failure mode with contributions from parallel flow.



Figure 8.3. Example of pavement damaged by Hurricane Ivan. (photo looking west on Florida 399, J. Earle Bowden Way, Gulf Islands National Seashore, September 2005)

The specifics of the damage mechanism are: the road embankment acts like a broad-crested weir to the incoming storm surge and the pavement is essentially the crest of the broad-crested weir. As the surge elevation exceeds the elevation of the crown of the road, water flows across the road. Flow across a broad-crested weir passes through the critical flow. Flow down the landward shoulder is super-critical. Supercritical flows scour the shoulder material. If the scour reaches the edge of the pavement, water continuing to flow over the edge of the pavement forms a hydraulic jump and undermines the pavement. The same mechanism is scour caused by flow down the seaward shoulder later in the storm as the surge returns to the sea.

The same general mechanism is responsible for damage to road embankments in a riverine environment (Chen and Anderson 1987, Clopper and Chen 1988). Figure 8.4 shows the general flow regimes that are established when a roadway embankment is overtopped. Damage can occur with or without tailwater (see Figure 8.5).

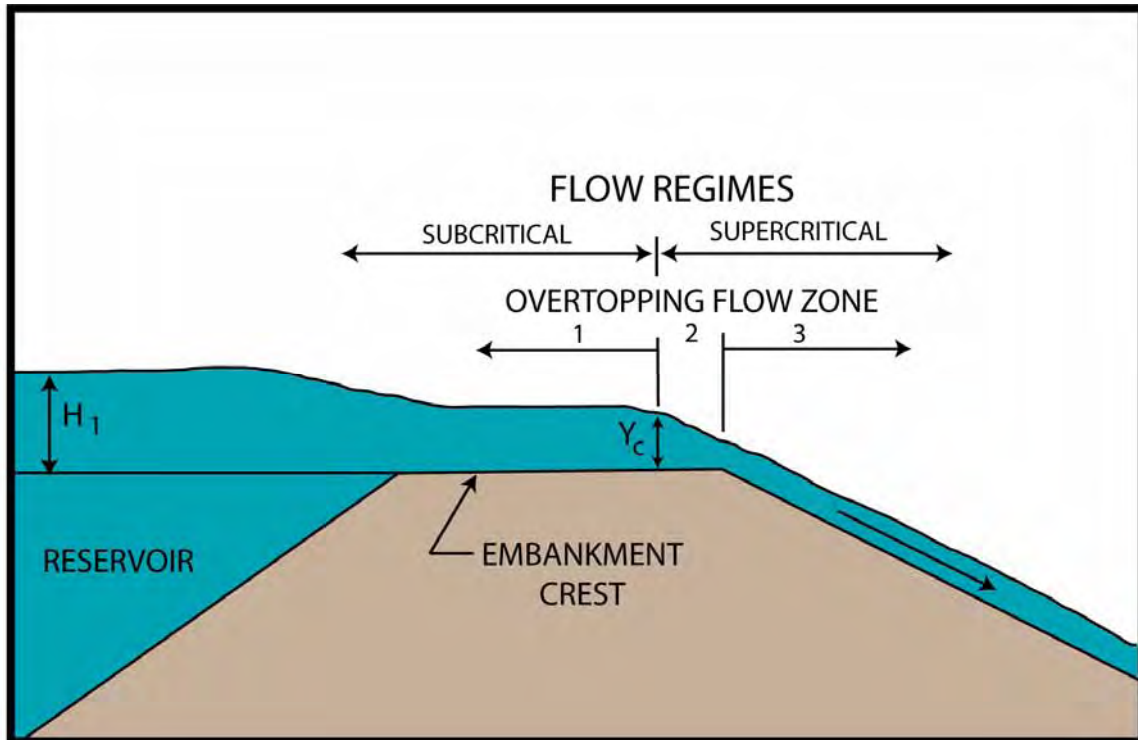

Figure 8.4. Flow regimes leading to failure of embankments in riverine flooding situations (after Clopper and Chen 1988).

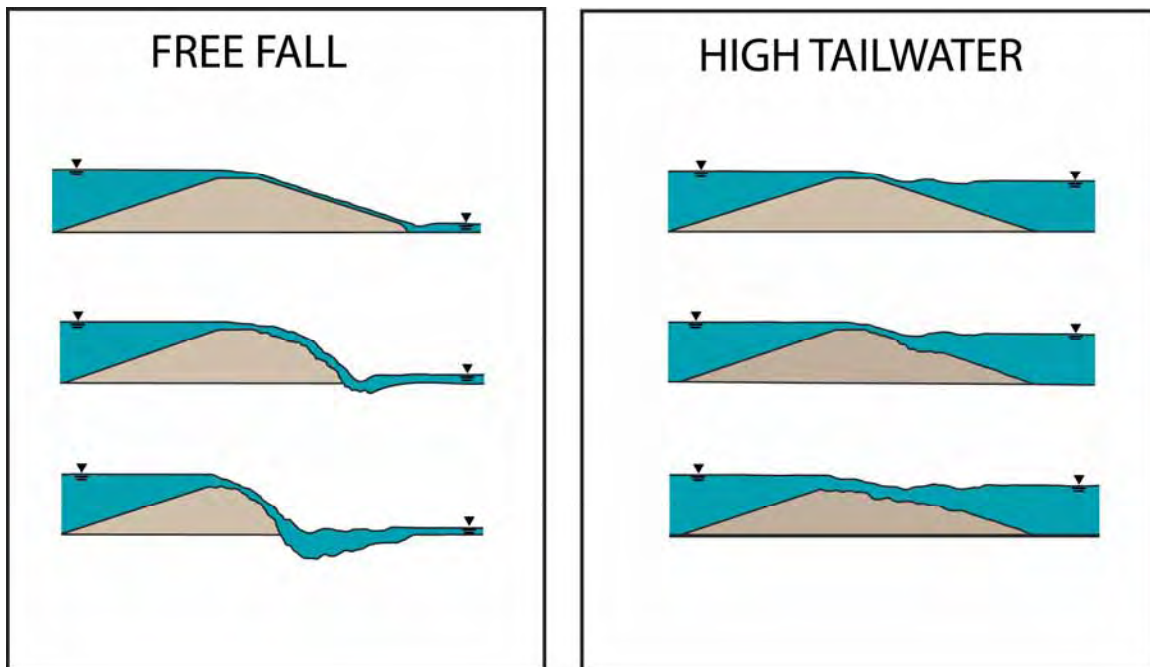

Figure 8.5. Embankment failure mechanisms (after Clopper and Chen 1988)

Figure 8.6 shows a road destroyed during Tropical Storm Arlene (June 2005). This road was under construction after having been destroyed the previous year by Hurricane Ivan (September 2004). Hurricane Ivan removed all the sand dunes and allowed this portion of the barrier island to overwash during smaller storms.



Figure 8.6. Pavement destroyed by the weir-flow mechanism (Ft. Pickens Road, Gulf Islands National Seashore, near Pensacola, Florida).

During several small storms in 2005, weir-flow was observed. Prior to those storms, the barrier islands were typically evacuated during major storms and the islands had sand dunes that prevented overwash during minor storms. Figure 8.7 and Figure 8.8 show the mechanism at two different locations during Tropical Storm Cindy (July 2005). The storm surge flow direction is from the ocean to a bay in both pictures. Flow is from right to left across the pavement in Figure 8.7 and in the opposite direction in Figure 8.8. There is a small hydraulic jump on the downstream side in each picture due to the elevation drop across the edge of the pavement.



Figure 8.7. Weir-flow damage beginning. (Florida 399, Fort Pickens Road, Gulf Islands National Seashore; July 2005; FHWA photo).



Figure 8.8. Weir-flow damage occurring. (Florida 399, Fort Pickens Road, Gulf Islands National Seashore; July 2005; FHWA photo).



### 8.2.1 Coastal Weir-Flow Damage Mechanism Investigations

The coastal weir-flow damage mechanism has been investigated at prototype-scale in a laboratory in an FHWA-funded study conducted jointly by the University of South Alabama (USA) and Texas A&M University (TAMU). Figure 8.9 shows a schematic of the laboratory set-up and Figure 8.10 and Figure 8.11 show schematics of the results from tests conducted in June 2005 at the Haynes Coastal Engineering Laboratory at TAMU. The experiment was conducted in a 12-foot wide and 10-foot deep flume. A sandy road embankment was constructed in the flume with a roadway on its crest consisting of 12, 2-foot wide concrete slabs. The sand shoulders were unconsolidated typical of many coastal highways. Water was pumped across the road section until failure as shown in Figure 8.10 and Figure 8.11. Figure 8.12 and Figure 8.13 show the failure. The USA/TAMU tests showed that the weir-flow is the likely cause of pavement damage observed in post-storm damage assessments. The damage can occur with only a little depth of water flowing across the road.

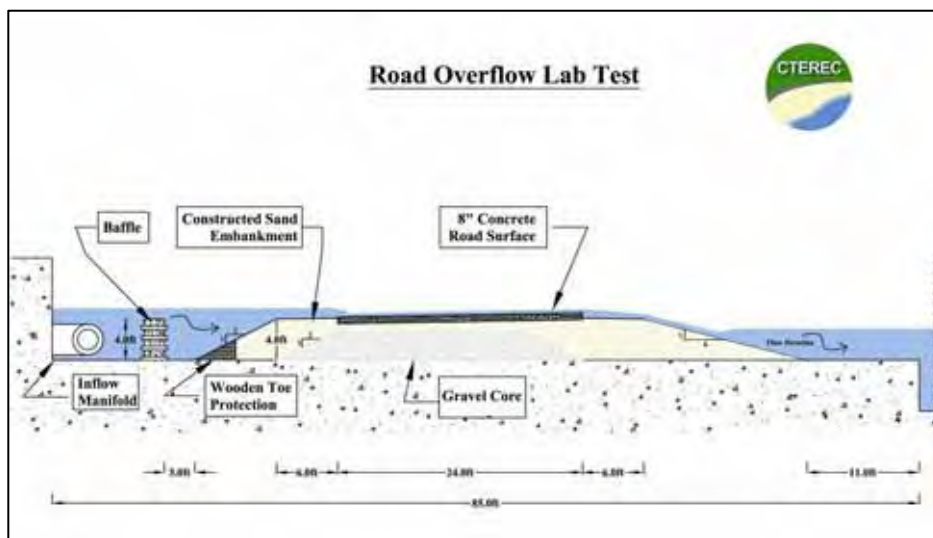

Figure 8.9. USA/TAMU laboratory experiment model setup schematic

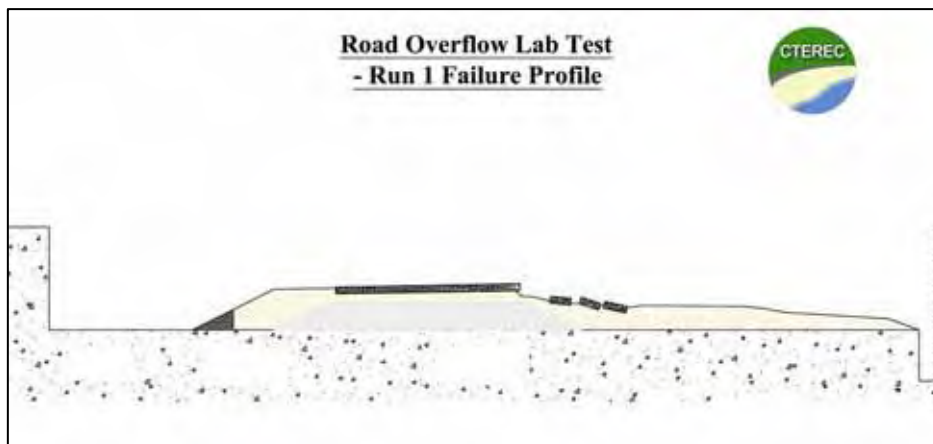

Figure 8.10. Schematic of USA/TAMU laboratory experiments test run one result

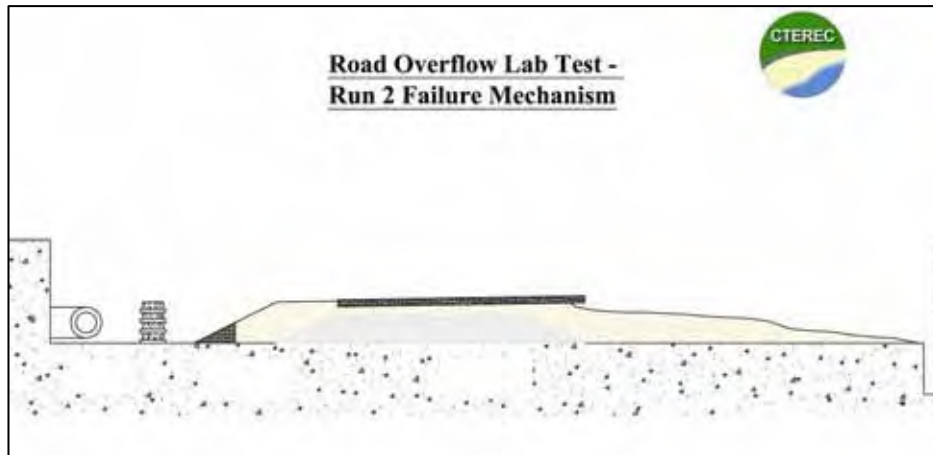

Figure 8.11. Schematic of USA/TAMU laboratory experiments test run two result



Figure 8.12. Laboratory tests of the weir-flow damage mechanism showing scour destroying the downstream shoulder and beginning to undermine the edge of pavement. (USA/TAMU flume tests, June 2005).



Figure 8.13. Laboratory tests of the weir-flow damage mechanism showing scour has continued to point of undermining failure of 3 sections (6 feet) of roadway surface. (USA/TAMU flume tests, June 2005).

It is likely that waves exacerbate the weir-flow damage mechanism. Waves moving across the pavement on the storm surge will increase the instantaneous flow velocities on the downstream shoulder which lead to more scour. No guidance is available to estimate scour due to this phenomenon at this time. Some levee failures in the greater New Orleans area during Hurricane Katrina were also due to downstream erosion due to overtopping waves.

Clopper and Chen (1988) discuss uplift on overtopped pavements on a riverine embankment. Uplifting may be an even greater problem in the coastal environment because of the easier transmittal of pore-pressure under the pavement due to the sandy nature of the coastal road bases. There was some evidence of pavement lifting during Hurricane Ivan as shown in Figure 8.14.

The same weir-flow mechanism that can damage the landward shoulder of a coastal road can damage the seaward shoulder too. Later in the storm, as the storm surge recedes, the water elevation on the landward side of the road embankment may be higher than the elevation on the seaward side. Flow is back to the sea and the downstream shoulder is now the seaward shoulder. Figure 8.15 shows pavement damage likely due to return flow.

Another related damage mechanism is parallel flow (parallel to the road direction) along the landward side of the coastal highway embankment as the storm surge recedes. Late in the storm, the embankment can begin to act like a dam holding the flood waters on the barrier island. If a portion of the embankment is lower due to failure or breaching, then water will flow laterally toward the low spot in the embankment. This flow scours the foundation material along the shoulder and contributes to its damage or failure. Lateral flow along the shoulders during coastal storms has been observed by Florida DOT personnel at US 98 near Destin, Florida. There is post-storm evidence of this flow in many locations (including the photo shown in Figure 8.2).



Figure 8.14. Pavement moved landward by overwash processes. (Gulf Islands National Seashore, Perdido Key, Florida after Hurricane Ivan; 2004).

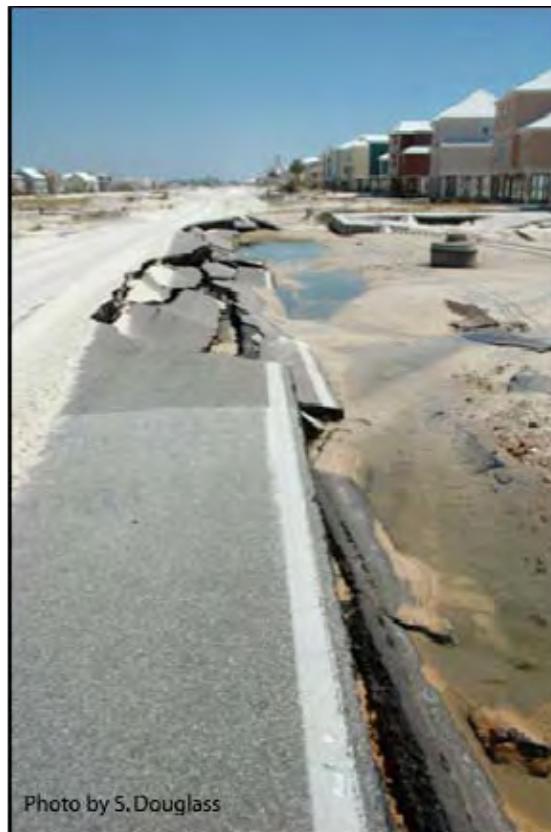

Figure 8.15. Evidence of weir-flow damage to the seaward edge of pavement due to return flow late in the storm (West Beach Blvd., Alabama 182, Hurricane Ivan, Gulf Shores, Alabama).

### 8.3 Strategies for Roads that Overwash

Four strategies for minimizing pavement damage due to overwash have been successful for coast-parallel roads on barrier islands. They can be used in combination with each other:

1. re-locating the road to a portion of the barrier island where sand will likely bury the road during overwash,
2. lowering the elevation of the road to be at or below much of the existing grade to encourage burial by sand during overwash,
3. constructing a sand dune seaward of the road to reduce the likelihood of overwashing and to provide a reservoir of sand to bury the pavement when overwashing occurs.
4. armoring of the shoulders of the road to resist erosion during overwashing.

#### 8.3.1 Road Location Considerations

Storm overwash on barrier islands often naturally erodes elevation from the front portion of the island and deposits sand on the landward portion of the island. This process is shown schematically in Figure 8.16. Frontal dunes are often the highest elevations on a barrier island. These dunes and the beach berm seaward of them often erode in major storms through dune erosion and overwash processes. Sand is pulled offshore until the dune crest is breached or overtopped by the storm surge. Then sand moves landward and is deposited in lower elevations on the back of the island. These deposits, called overwash fans, can extend back into the bay.



Figure 8.16. Schematic of sand erosion and deposition on a barrier island resulting from overwash.

If the road way is located where cross-section erodes, it will be subjected to severe wave attack and scour. If, however, it is located in the deposition zone, it can be buried by sand early in the overwashing event. Some roads, found under this layer of sand after a coastal storm, have been undamaged. A bulldozer blade can scrape the sand off the road and the road can be opened to traffic shortly after the storm.

#### 8.3.2 Road Elevation Considerations

Another approach to reducing damage due to the weir-flow is to lower the elevation of the road to at or below adjacent ground elevations. This can prevent the weir flow from occurring since the crest of the pavement is not the highest portion of the grade. Figure 8.17 shows a road buried by overwash sand that survived a major hurricane. The piles of sand along the road were scraped off the road as part of the post-storm maintenance. There is some practical limit to lowering the road which depends on drainage and safety. Lower roads may also require more

maintenance such as sand sweeping. Installation of sand fencing and vegetation can significantly reduce drifting sand and the frequency of sweeping requirements. Experience in west Florida suggests that constructing a typical road embankment elevated above the adjacent ground elevations can result in significant damage even if the road is relocated away from the ocean.



Photo by S. Douglass

Figure 8.17. Example of road buried by overwash and opened by plowing sand off

### 8.3.3 Construction of Sand Dunes

Sand dunes can be encouraged or constructed seaward of roads to reduce the likelihood of overwashing and to provide a reservoir of sand to bury the pavement when overwashing occurs. Many states and local government have attempted to construct sand dunes seaward of roads to protect against storm surge and waves. North Carolina has used this approach to protect portions of North Carolina Highway 12 along the Outer Banks. Figure 8.18 shows a portion of that highway north of Buxton, North Carolina, where a large, artificial sand dune has been constructed on the seaward side of the highway.



Figure 8.18. Artificial sand dune constructed seaward of a highway to protect the highway (North Carolina Highway 12)

Dune erosion modeling tools can be used to design the size and shape of the dune. Construction of a healthy sand dune usually requires vegetative plantings to stabilize the dune and to establish a dune that functions like a natural dune.

All three of the above approaches to reducing damage to pavements during overwashing can be implemented together. The schematic of Figure 8.19 shows a new road located as far from the ocean as practical, built at a low elevation, with small dunes constructed near it. The dune vegetation also acts to reduce wind-blown sand from covering the road during normal (non-storm) conditions.

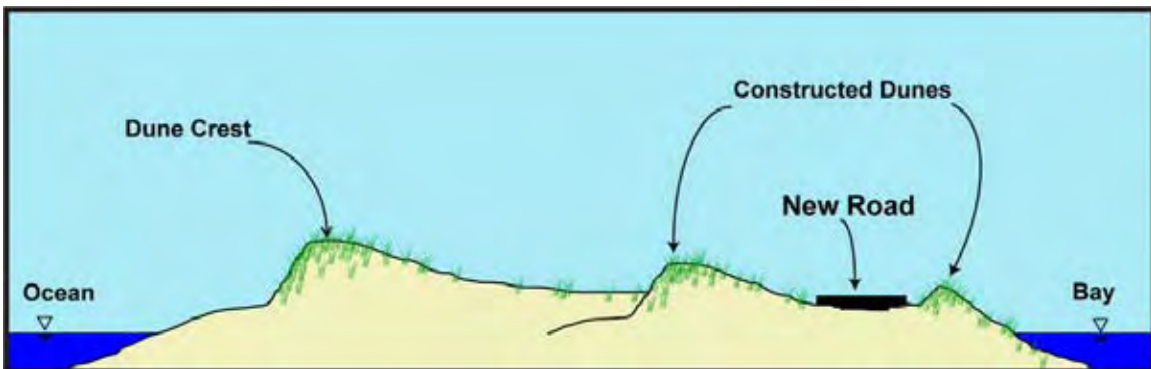

Figure 8.19. Schematic summarizing three approaches (bayward location, low elevation, constructed sand dunes near road) to minimize damage to roads that overwash.

### 8.3.4 Armoring of Shoulders

The downstream shoulder of roads that experience overwashing damage can be armored to withstand high velocity flows. This approach has been adopted to protect a section of US Highway 98 along the Florida coast west of Destin. The armoring includes sheet piling (Figure 8.20) and gabions (Figure 8.21). The sheet piling is located on the shoulder of the pavement farthest from the sea. This is the edge of pavement that has suffered the most damage due to the overwash mechanism in past hurricanes. Buried gabions are used where the overwashing flow may be lower but parallel to the road during the storm is expected to be strong enough to cause damage. This design was constructed in 2005, after Hurricane Ivan, and had not been tested by a major overwashing event at the time this document was written.

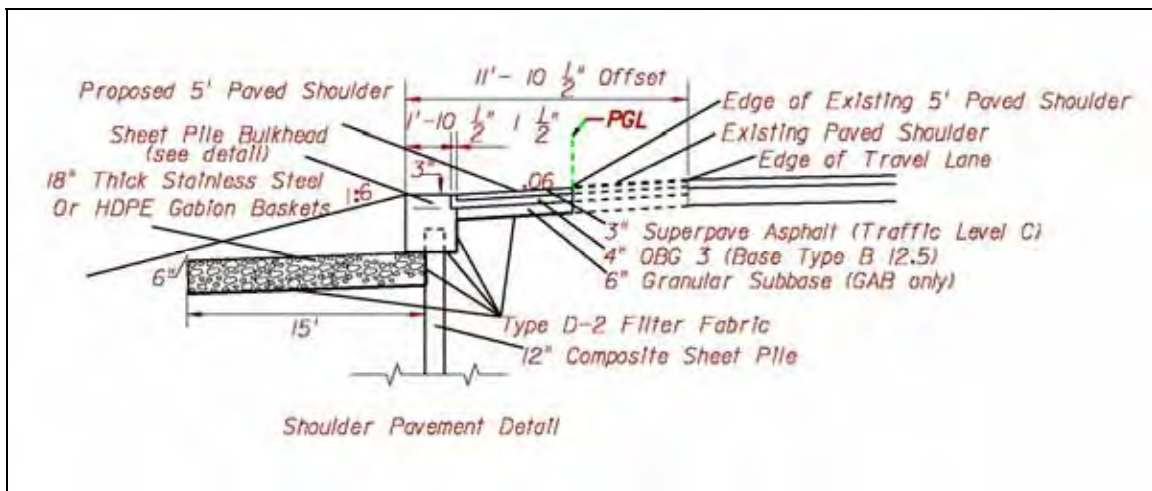

Figure 8.20. Sheet pile, with buried gabions for scour protection, at edge of pavement to resist pavement damage due to coastal storm surge overwash. (Florida DOT figure).



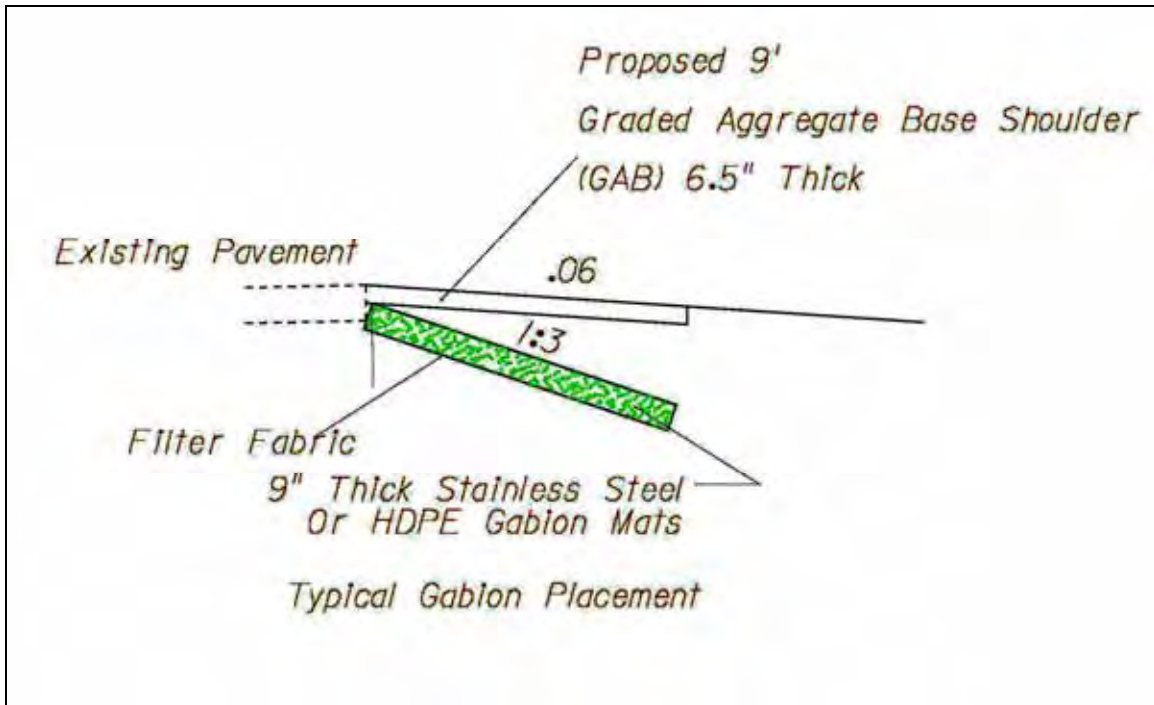

Figure 8.21. Gabions at edge of pavement to resist pavement damage due to coastal storm surge overwash. (Florida DOT figure)

Clopper and Chen (1988) provide guidance for armoring shoulders that might be applicable to the coastal problem. They conducted laboratory experiments on different possible countermeasures to resist the flow of water across a highway embankment. Their tests were based on riverine overflow situations and focused on soil types not as sandy as those typically found at the coast. They only considered current flow forces and not wave forces. However, Clopper and Chen (1988) found that a concrete block revetment system with relatively heavy blocks, horizontal and vertical interlocking cables, and anchors was able to resist the hydraulic forces due to overtopping better than a number of other alternatives. They tested flow rates generated by up to 4 feet of differential head over the embankment. Figure 8.22 is a sketch of how that concept could be implemented as a retrofit to protect a coastal highway. The capabilities of interlocking blocks to withstand the overtopping condition was confirmed by laboratory tests by Clopper (1989).

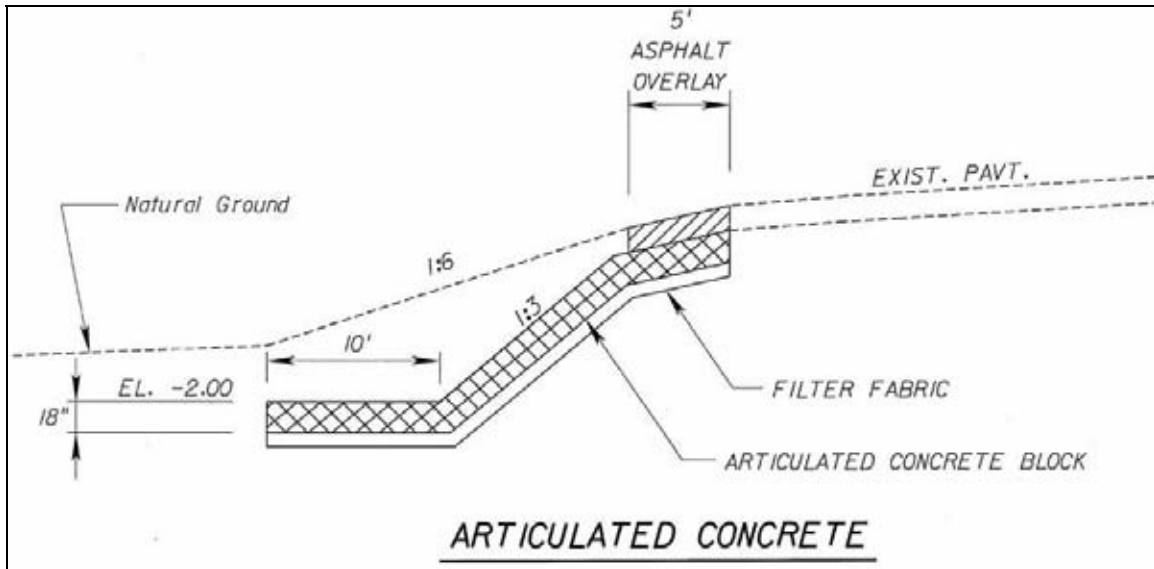

Figure 8.22. Conceptual design to resist pavement damage due to coastal storm surge overwash

## Chapter 9 - Coastal Bridges

The FHWA estimates that there are over 36,000 bridges located within 15 miles of coastal waters of the United States (FHWA 2007). While a notable number of structures, this only represents 6 percent of the approximately 600,000 bridges contained within the National Bridge Inventory (NBI) (FHWA 2007)<sup>3</sup>.

For perhaps this reason, many SDOT drainage manuals apply riverine based hydraulic design concepts and approaches to these coastal bridges. For example, flow and water surface elevations at riverine bridges can frequently be fairly well represented by assuming steady uniform flow with reasonably long flow durations. This justifies use of relatively straight forward hydrologic approaches (regression equations, rainfall/runoff models) to develop peak design flows. Likewise, given these peak flows, practitioners generally use steady flow, one-dimensional models to estimate velocities, backwater, and other hydraulic design constituents.

However, the complicated hydrologic and hydraulic processes in the coastal environment may render such assumptions inappropriate for coastal bridges. Astronomical tides have reversing flows and may also have substantial ranges. These result in associated depths and velocities that vary significantly over a relatively short period of time. In addition to tidal fluctuations, hydraulic analyses need to consider and determine design storm surge and design wave heights, increasing the complexity.

Typical modeling assumptions and approaches (i.e., use of steady flow, one-dimensional models) usually do not apply to coastal bridges and may lead to problematic results and interpretations. For example, some analyses attempt to equate design flow and design surge elevation. This is a faulty assumption. During a flood event in a riverine system, the channel cross sections defining the floodplain also provide the limits of flow conveyance and thus the associated flow depth of that flood (i.e., flood quantity determines water elevation). During a design surge event, the water levels extend over a much larger geographical area with water depths limited by those factors described in section 3.2, “Storm Surge.” Therefore, at any particular location, the water elevation (head) determines flow quantity (i.e., water elevation determines flow). Additionally, as described earlier, the highly time dependent nature of coastal hydrologic and hydraulic processes (described above) preclude steady flow approaches, adding intricacy to the modeling effort.

Coastal bridge complexities are not just related to hydrologic and hydraulic processes. The orientation of the coastal bridge to “flow” direction may be quite different than a typical riverine bridge. At such riverine bridges the goal is to place the bridge as perpendicular as possible to the natural design flood flows direction. In many cases coastal bridges are not transverse the stream thalweg, but are in-line with the direction of the surge. Do such surges induce velocities sufficient for scour formation? Or a bridge located within an embayment may be, depending on storm direction, be subject to wave scour or wave loads, whereas for other storm directions, the bridge could be reasonably safe.

Therefore, even more so than riverine bridges, the level of engineering for coastal bridges requires consideration of forces and processes unique to the coastal environment including tidal bridge scour potential and hydrodynamic loads from waves and tidal currents. Wave and current

---

<sup>3</sup> The 36,000 bridge estimate also does not include bridges and culvert systems with less than a 20 foot span (nor are these smaller spans included in the NBI).

loads on the sub-structure components of coastal bridges such as piles, pile caps, etc. are unavoidable and require investigation.

This Chapter provides an overview on several related hydraulic aspects of bridges in the coastal environment. These include the location of the bridge within the coastal floodplain, coastal bridge scour, coastal wave loads, and other important issues.

## 9.1 Locations of Coastal Bridges

Coastal bridges can be found at four general locations within the coastal environment: inlets, causeways, tidal arms/embayments, and river mouth crossings (Figure 9.1). Each type of location presents different issues and challenges for the hydraulic and coastal practitioner.

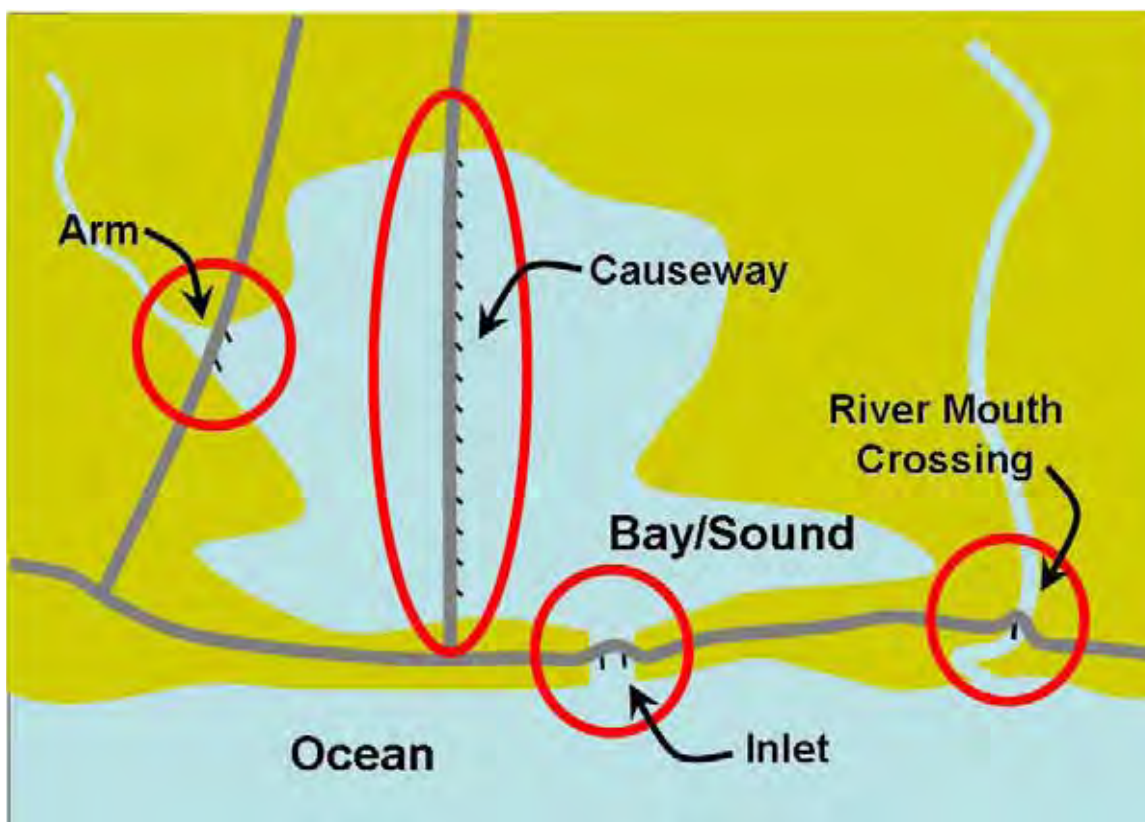

Figure 9.1. Conceptual schematic of four typical bridge locations within the coastal environment.

### 9.1.1 Bridges at Inlets

Inlets are where the tides move between the ocean and a bay (see Section 5.6, “Tidal Inlets”). Inlets are the entrance to many estuaries and other water bodies of ecological importance. These interior bays and estuaries can store significant volumes of water. Inlets experience complex hydrodynamics, some with extremely intricate interactions between currents and sands. Most shoreline change is near inlets; many are “evolving” geologically in response to engineering and natural changes. There can be multiple inlets to the interior water body (bay, sound, etc).

The United States has over 600 tidal inlets, of which many have bridges across their throat. These can range from very large structures (e.g., Golden Gate Bridge) to relatively small spans (Gulf Shores, Alabama; seen in Figure 9.2). Depending on the exact configuration of the bridge

and tidal inlet, the bridge will exhibit varying levels of hydraulic control between the ocean and interior water body. Even bridges “spanning” the inlet during daily astronomical tides fluctuations may exhibit some hydraulic control when surge and wave levels reach a certain point.



Figure 9.2. Bridge spanning small inlet (SH 182 in Gulf Shores, Alabama).

### 9.1.2 Bridge Causeways

Causeway bridges typically link coastal and barrier islands and peninsulas to the mainland. They can consist of bridges or a combination of bridges and elevated embankments. The floodplain crossing can be some combination of open water and wetlands (or other low-lying crossing floodplain system. For example, Figure 9.3 depicts the Ben Sawyer causeway bridge near Charleston, South Carolina. The causeway bridge leads from Mount Pleasant (mainland) to Sullivan’s Island. The causeway bridge (like many such structures) serves as an evacuation route during storm events. The NBI records the actual bridge length as 1150 feet, straddling the Intercoastal Waterway (FHWA 2007)<sup>4</sup>. However, the embankment portion of the causeway extends many thousands of feet (arrows differentiate between bridge and embankment).

This causeway bridge also illustrates some of the hydrologic and hydraulic complexities affiliated with such structures - direction of surge relative to the bridge and orientation. The FEMA FIS flood insurance rate map (FIRM) describes that the 100-year stillwater surge elevation will reach 14 to 15 feet (plus any additional waves on top of that stillwater) (FEMA 2004). However, the FIRM appears to indicate the surge direction is roughly perpendicular with

---

<sup>4</sup> The Ben Sawyer bridge was damaged by Hurricane Hugo in 1989.

the direction of beach orientation – surge “moves” in the same (longitudinal) direction as the bridge and embankment. While the Ben Sawyer causeway bridge crosses marsh regions, other causeway bridges may span a lake, sound or other open water body (making them occasionally prone to wind and fetch affiliated wave issues, depending on storm wind direction). Some implications related to coastal bridges will be described later in this Chapter.



Figure 9.3. Ben Sawyer causeway bridge between Mount Pleasant and Sullivan's Island, SC.

### 9.1.3 Bridges spanning Tidal arms / Embayments

A common location for coastal bridge crossings are found on tidal arms or embayments. As opposed to inlet bridges, these bridges are located in interior water bodies or a distance “upstream” on an open bay or estuary. These are also distinct from causeway bridges in that they are in open waters and more likely subject to wave action and wave transformations<sup>5</sup>. Examples can range from a small tidally influenced creek to large tidally influenced waterbodies such as Mobile Bay (Alabama), Knik Arm (Alaska), and most of the major bridges affected by Hurricanes Ivan and Katrina.

These locations might also include bridges upstream of rivers with confluence to the ocean, bay, or other large water body. Such rivers are still tidally influenced and, just as importantly, have some storage capacity. Examples of such locations are the Columbia River, Hudson River, Cooper River, etc.

---

<sup>5</sup> Wave transformation described in greater detail in section 4.2, “Wave Transformation and Breaking.”

The bridges at these locations can vary in width and span length – from 2 lane, 20 foot spans over a tidal creek to multi-mile Interstate spans. As will be described later in this Chapter, the size, orientation, and potential surge and wave effects dictate the level of analyses needed at such bridge locations.

#### 9.1.4 River Mouth Bridge Crossings

Along the West Coast of the United States are numerous bridges crossing at or near the mouths of smaller river and creeks. These rivers differ from the other locations described above because the local geographical features (mostly hills and mountains extending to the shoreline) often result in a narrower floodplain. These in turn affect the available storage and the extent of the tidal prism. Figure 9.4 depicts four of these types of crossings (Figure 2.4 also provided an example of a bridge and river mouth crossing).



Big Creek in Oregon



Pistol River in Oregon



Redwood Creek in California



Yachats River in Oregon

Figure 9.4. West Coast River Mouth Crossings.

Some of these rivers carry a notable sediment load to the littoral zone. These rivers and creeks may exhibit severe lateral migration, especially within the backshore beach zone. Breakwaters are constructed at some river mouths to control this migration and provide other stabilization measures. When encountering such situations, good practice would be to consult with a qualified coastal engineer (see section 2.6, “Coastal Engineering as a Specialty Area”).

## **9.2 Coastal Bridge Scour**

Scour is the most common cause of bridge failures in the United States. Bridge scour is the erosion caused by water of the soil surrounding a bridge piers and abutments.

Research has produced a vast body of knowledge for evaluating and estimating scour at bridges. Mostly oriented towards the riverine environment, research represents riverine conditions by assuming steady uniform flow with reasonably long flow durations.

Recommended procedures for estimating scour at these bridges rely heavily on these assumptions. The FHWA has produced the document HEC-18 “Evaluating Scour at Bridges” (fourth edition) (HEC-18) (Richardson and Davis 2001), as well as other documents and material to provide guidelines for designing new bridges to resist scour, evaluating existing bridges for vulnerability to scour, inspecting bridges for scour, and improving the state-of-practice of estimating scour at bridges.

### **9.2.1 Coastal Bridge Scour Policy, Guidance, and Research**

Significant resources have been devoted to the bridge scour problem, yielding a growing body of knowledge and products. The FHWA uses these products to develop and provide national scour policy and guidance.

The position of the FHWA is that these policies and guidance cover both riverine and coastal situations. However, the FHWA also recognizes that conditions in the coastal environment may necessitate moving away from a “one size fits all” technical approach in certain case-by-case situations. Of vital importance when considering deviating from these national approaches is that the SDOT recognize the risk associated with the scour methods to be applied to a specific project. This risk assessment includes endorsement by the local FHWA Division Offices and, as needed, knowledgeable scour experts.

Appendix D provides some background and commentary on coastal scour related policy and guidance, including scour estimation and potential countermeasures. Appendix D also provides a brief synopsis of some relevant research efforts.

### **9.2.2 Coastal Bridge Scour Hydrology and Hydraulics**

For coastal bridges, the applicable hydrology and hydraulics are influenced by waves, tides, storm surges, longshore sand transport, inlet dynamics and stability, and other coastal processes. Therefore, before any scour analyses occur, the practitioner needs to resolve these technical issues, including some especially relevant to bridges over coastal waters.

Hurricane storm surges often produce extreme flow conditions for time periods of only a few hours. This leads to an observation of another important difference between riverine and coastal bridge hydraulics – the distinction in analyzing coastal flood conditions and scour conditions.

Coastal flooding will manifest itself in several ways: first the effects of the storm surge (and waves) on the coastal floodplain. Since coastal areas are generally at low elevations and flat, the extent of the flooding is widespread – inundating properties, infrastructure, and open spaces. Secondly, the elevated surge acts as a downstream control for storm related rainfall runoff. Until the surge has receded, this runoff does not have anywhere else to go, increasing the backwater and flooding effects. This flooding may occur over some time – possibly more time than the storm surge duration. Additionally, the probability of exceedance of the resulting flood level may be much greater than the frequency of both the storm surge event and the rainfall event, so a storm with a 10-year surge and 15-year rainfall might combine to produce a 100-year flooding event.



These optimal flooding conditions may not necessarily be the same conditions as those that would produce the worst scour. This is because when comparing the effects of the two primary hydraulic variables associated with scour – velocity and water depth – velocity has a greater role.

Therefore, optimal coastal scour formation conditions likely occur when the velocity would be the greatest value. Specifically occurring during two situations: first, when surge is entering the inlet or embayment at the fastest; and secondly, during the recessional period, when combined surge and the storm affiliated rainfall flows back to the ocean (similar to the weir-flow damage mechanism discussed in section 8.2).

To model these conceptual conditions, for hydrologic boundary conditions, a conservative scour analysis would (1) consider a surge “hydrograph” having a short duration entering into a bay while the bay was at MLLW; (2) consider a design runoff hydrograph (including residual surge volume) returning to the ocean at MLLW. Clearly, this approach is conservative, which is why larger studies often apply more refined techniques (see section 3.2, “Storm Surge” and section 9.5, “Selection of Design Storm Surge & Design Wave Heights”).

Once the design parameters have been determined it is necessary to estimate the magnitudes of flow depths and velocities (and possibly other values as well). The determination of flow parameters for coastal bridges almost always require the use of a surface water model that can analyze unsteady flows. HEC-18 describes a “three-level qualitative approach” protocol to assist in defining the amount of required analyses. Once again, consultation with a qualified coastal engineer can serve to refine this overall protocol.

#### 9.2.2.1 Level One Approach

The use of a HEC-18 based level one qualitative approach is never suitable for coastal bridge hydraulic design or scour estimates on its own. However, a level one approach can be useful in determine the potential level of effort required for a specific project.

#### 9.2.2.2 Level Two Approach

The use of a level two (tidal prism) approach is suitable only for smaller bridges or low ADT bridges in well protected tidal arms and embayments. The use of this approach is not recommended for bridges at inlets or causeway bridges.

The range used in the analysis should be combination of the highest daily astronomical tidal elevation (MHHW) and design event storm surge still-water-level (if not already combined).

As with the level one approach, a level two analysis can provide generally conservative estimates of potential scour. When applying a tidal prism approach, the areas of uncertainty will be area of the bay, stage-storage characteristics, and the ability to determine the hydraulics performance of the bridge section.

#### 9.2.2.3 Level Three Approach

Level three approaches apply varying degree of analyses. Smaller bridges (or systems of bridges) at a single inlet, or embayments or river mouths can be analyzed with one-dimensional unsteady flow models. The model would apply the hydrologic boundary conditions described above.

Causeway bridges, bridges with unusual configurations, and larger and more complicated bridges (or systems of bridges) require the use of two-dimensional unsteady flow models. Generally, scour analyses of complex piers and bridges necessitate application of two-dimensional numerical hydraulic models.

The tradeoff is that the small amount of additional modeling effort produces additional confidence in the velocity and depth parameters. The potential results of these more site focused values may be smaller foundation elements (new bridges) and reduced scour countermeasure material quantities (existing bridges).

Some specific and critical bridges may require advanced numerical and physical modeling. These advanced numeric models may couple hydrodynamic, wave, and sediment transport modules while the physical model simulates the actual processes using a scaled down version of the physical feature with representative hydrodynamics, waves, and sediments.

Once the flow parameters have been properly determined, they are applied to the various scour types and methods described below to estimate the magnitudes of scour at the bridge.

### 9.2.3 Types of Coastal Bridge Scour

The types of scour that occur at bridges in the coastal environment include the same general categories (local (pier and abutment) and contraction) as found at riverine bridges. Additionally, coastal bridges can experience scour as a result of wave action (wave scour) and localized areas of high velocities flows. Finally, HEC-18 recognizes that sea-level rise might occur over the life of the structure, so that consideration should also be incorporated into scour analyses. As described below, even for the general categories, the practitioner must consider important caveats and differences associated with the coastal environment.

#### 9.2.3.1 Local (Pier and Abutment) Scour

Local scour includes pier and abutment scour. In riverine local scour mechanisms, the scour hole typically forms near the upstream structure face. Some bed material deposition occurs near the downstream face. Given the flood and ebb associated with the coastal environment, sediment transport mechanisms can differ, resulting a scour hole can forming around the entire pier. Figure 9.5 depicts such an example of scour forming around entire pier. The scour is exacerbated by debris accumulation. Debris accumulation is not uncommon during coastal storm events.

##### 9.2.3.1.1 *General Approach for Local Scour*

As long as the design hydraulic conditions are determined based on appropriate hydrodynamic methods, local scour equations such as those found in HEC-18 can be applied to coastal bridges. At a minimum this includes sites suitable for level one analysis and smaller coastal bridges in protected embayments.

##### 9.2.3.1.2 *Wide and Complex Pier Geometry*

HEC-18 includes methods to compute pier scour for standard and complex pier geometries. The HEC-18 equations include wide pier correction factors that may be applicable to bascule piers when the pier is wide in comparison to the flow depth. HEC-18 also outlines a procedure for evaluating scour at complex piers that include a combination of pile groups, piles caps, and piers. Other local scour equations are presented in Hoffman and Verheij (1997), Melville and Coleman (2000) and Sheppard (2003).



Figure 9.5. Scour at a Coastal Bridge Pier

#### 9.2.3.1.3 Time Dependent Local Scour

Time dependent scour equations have been suggested as more appropriate in the coastal environment. In addition to the typical physical processes that are described (Richardson and Davis 2001), the short duration of the typical design storm must be considered. Also, piers that are impacted by waves are subjected to very short duration pressure gradient fluctuations that result in a difficult to quantify shear stress variations.

The University of Florida has conducted research and developed such a set of equations (Gosselin and Sheppard 1998; Miller 2003). The Florida equations require a time-marching solution for the depth of scour adjacent to bridge piers. Input requires time-varying estimates of depth-averaged storm surge velocities at the bridge based on numerical modeling of the hydrodynamics. The Florida equations include calibration coefficients which are primarily based on laboratory investigations. Miller (2003) discusses how the equations can be used to estimate scour at prototype coastal bridges.

Gosselin and Sheppard (1998) concluded that more research is needed before meaningful relationships can be developed for time dependent local scour. This is because most of the research has been conducted on clear-water conditions (approach velocity less than the critical velocity for sediment transport) and at small laboratory versus prototype scales. It is generally accepted that local scour in live-bed conditions occurs much more rapidly than for clear-water conditions. As this area of research evolves there may be benefits to computing time dependent local scour amounts. One additional complication is that the time dependent local scour amounts would have to be added to ultimate local scour amounts produced by daily tides.

### 9.2.3.2 Contraction Scour

In a riverine context, contraction scour involves the removal of material from the bed and banks across all or most of the channel width. This component of scour results from a contraction of the flow area at the bridge which causes an increase in velocity and shear stress on the bed at the bridge. The contraction can be caused by the bridge or from a natural narrowing of the stream channel.

Contraction scour occurs in the coastal environment, but formation can greatly depend on the location and orientation of the bridge (inlet vs. causeway vs. embayment) and embankments. For example, a bridge crossing an inlet on a barrier island may have contraction limited only by the touchdown embankment length. Surge and waves could inundate the roadway approaches and allow water passage at those locations (as well as through the bridge opening).

#### 9.2.3.2.1 General Approach for Contraction Scour

HEC-18 contraction scour equations can be applied to coastal bridges (given similar hydraulic caveats as described for local scour). Contraction scour should be computed based on the live-bed or clear-water equations depending on the velocity of flow approaching the bridge in the un-constricted waterway. The location of the approach flow will depend on whether worst case conditions occur during the flood/ebb tide or surge/post-storm hydraulics.

If astronomical tide currents have high velocities, scour should be computed for these conditions in addition to design velocities produced by hurricane or storm surge conditions. Surges can produce extreme velocities that could produce very deep scour. The HEC-18 equations may be overly conservative for surge conditions because these equations were developed for ultimate scour conditions. While the surge may produce extreme velocity, the high velocity condition may persist for such a short duration that ultimate scour cannot be reached. Additional sediment transport analysis and judgment may be necessary for computing scour in tidal waterways.

#### 9.2.3.2.2 Time Dependent Contraction Scour

Computing contraction scour using procedures outlined in HEC-18 will produce ultimate conditions that may not be reasonable. Ultimate contraction scour is reached when the sediment supply from upstream is matched by the sediment transport capacity in the scoured bridge opening. Equating sediment transport capacity to upstream supply results in the HEC-18 live-bed contraction scour equation, which uses a simplification of the Laursen sediment transport equation (Larsen 1960). Sediment transport relationships could also be used directly to compute ultimate contraction scour. Applying sediment transport formulas to contraction scour is recommended in HEC-18 for more complex situations. Specifically, HEC-18 states:

*“Both the live-bed and clear-water contraction scour equations are the best that are available and should be regarded as a first level of analysis. If more detailed analysis is warranted, a sediment transport model should be used.”*

A sediment transport model, such as the USACE’s HEC-RAS (USACE 2008) could be used to compute ultimate contraction scour conditions for variable flow rates using a stepped hydrograph as long as sufficient simulation duration is used and the steady-state gradually-varied flow assumptions are not violated. It could also be estimated for shorter duration rapidly-varied flow conditions used the unsteady flow modeling capability of the model. Similarly, sediment transport relationships could be used directly to make estimates of the rate of sediment transport. Once the volumetric rate of sediment transport is known, contraction scour hole geometry can be assumed, and the depth of time dependent contraction scour for an assumed storm can be determined.

Figure 9.6 shows the results from a time dependent scour analysis using the approach described above. Figure 9.6 demonstrates scour development through the time required to reach ultimate conditions. It also shows the ultimate scour estimates from HEC-18 (Laursen) and a sediment transport function, and the intermediate value of scour for 3-hour duration. No specific time is associated with the HEC-18 result as it is for "ultimate" conditions.

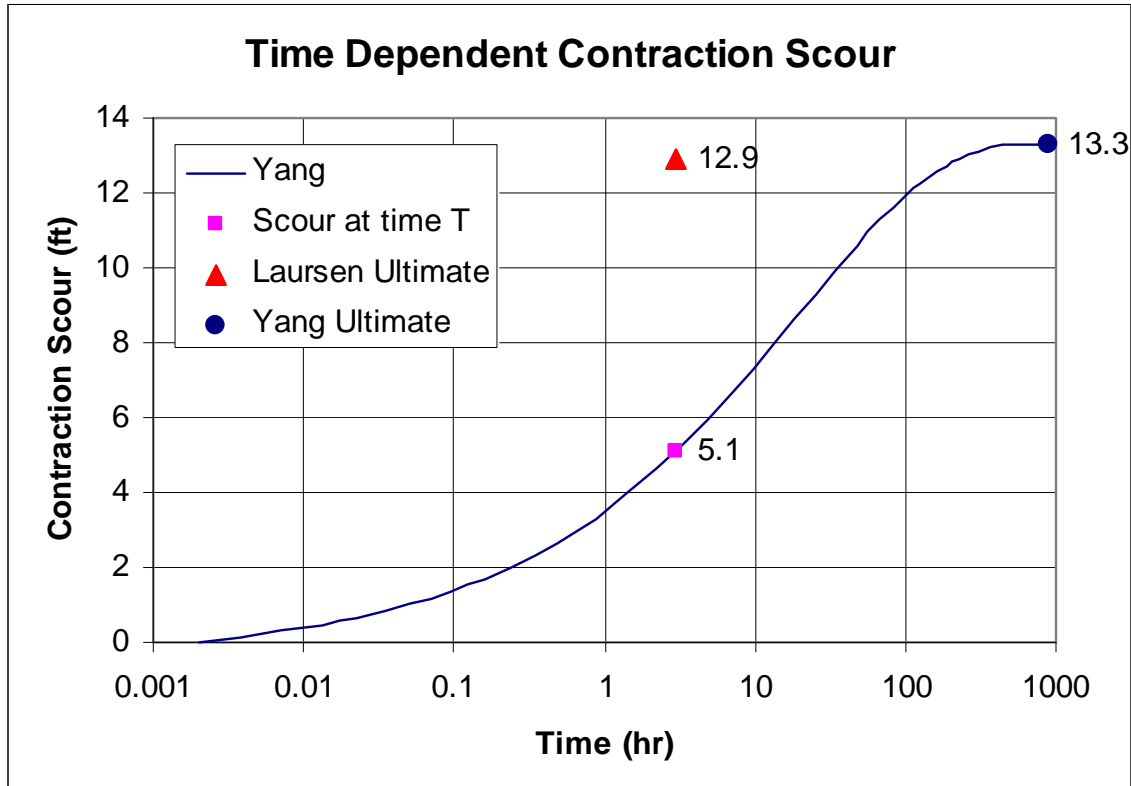

Figure 9.6. Time Dependent Contraction Scour Results (Zevenbergen, et al. 2004)

Figure 9.6 illustrates that 5.1 feet of contraction scour can occur in 3 hours and that it would require approximately 400 hours to reach ultimate contraction scour conditions. The sediment transport function predicts 13.3 feet of ultimate scour compared with 12.9 feet using the HEC-18 equation. Contraction scour for live-bed conditions is generally less extreme than equivalent clear-water conditions. However, live-bed scour reaches ultimate conditions in less time than equivalent clear-water conditions. For relatively small amounts of live-bed scour, three hours can be sufficient to reach the ultimate scour.

This approach of applying sediment transport calculations can result in a prediction of considerably less scour than the HEC-18 equation in some situations. By using the peak hydraulic conditions and steep upstream and downstream scour hole slopes, the method should produce conservative results.

#### 9.2.4 Wave Scour

Wave scour is a phenomenon associated with coastal structures. While bridge specific research is scarce, researchers have conducted experimental investigations into the topic area for many years (Sumer and Froedsoe 1991). Many of the physical formation elements are familiar to those knowledgeable with riverine pier scour: horseshoe vortices in front of the pile, lee wake vortices behind the pile (with and without vortex shedding). However, the presence of waves

adds reflection and diffraction, and the possibility of wave breaking into the overall process. Researchers acknowledge the difficulty in modeling this phenomenon, recent efforts have attempted to apply three-dimensional modeling techniques (Umeda 2006; Rouland 2005)

The research tends to suggest that wave scour is less than local scour associated with a constant current or flow (general local scour case). However, the research also indicated that the combination of wave and current might increase the scour rate and increase the total scour depth.

Breaking waves, as might occur during a storm event, would exacerbate the scour. The FHWA and SDOTs have documented several situations where significant scour occurred during severe coastal events. For example, during Hurricane Katrina, normally “dry” portions of the US-90 Biloxi Bay bridge became subject to surge and waves. As seen in Figure 9.7, a large scour hole formed in the vicinity of a pier section. While bridge failure occurred for other reasons (as described in section 9.3, “Coastal Bridge Wave Forces”), the size and extent of the scour hole was significant.



Figure 9.7. Wave scour hole formed by Hurricane Katrina.

### 9.2.5 Examples of Coastal Bridge Scour

While scour has been reported at all four types of bridge location classes, some of the most problematic scour problems occur at inlets that are changing shape and size as part of their evolution. Inlets are constantly evolving in response to many factors including their initial creation, stabilization with jetties, changes to their bay systems including dredging and filling and causeway construction, and changes to other inlets connected to their bays.

### 9.2.5.1 Indian River Inlet

Indian River Inlet, Delaware (see Figure 9.8) has experienced progressive scour since it was originally dredged and stabilized with jetties in the 1930's. Scour holes near the bridge piers exceeded depths of 100 feet in 2000. As the inlet has deepened and its minimum cross-sectional throat area increased, more tidal flow has moved through it. Thus, its tidal prism has increased. And as the tidal prism has increased, it has continued to scour out the throat area. Essentially, the artificially constructed and stabilized inlet has not reached its evolutionary equilibrium since its original opening in the 1930's.



Figure 9.8. Indian River Inlet, Delaware (USACE photo).

### 9.2.5.2 Johns Pass

Another inlet with a history of bridge scour issues is Johns Pass, Florida (see Figure 9.9). Johns Pass also is still evolving in response to engineering that occurred decades ago. Most of Florida's inlets have been artificially created, stabilized by engineering works, and have had their tidal prisms significantly affected by engineering of the bays and by other inlets connected to those bays.

Johns Pass illustrates two important lessons regarding scour and coastal bridges. First, because of its relative size, the presence of a Bascule pier will have a larger than normal effects on the resulting scour prediction. This usually requires application of HEC-18's wide or complex pier scour approaches (the Florida Department of Transportation (FDOT) has their own complex pier scour approach, see section D.2.3). Secondly, the multiple inlets into the bay illustrate an important concern about attempts to numerically model such bridges and locations. Each inlet could require a separate boundary conditions to ensure overall hydrodynamic circulation.

Additionally, the direction of the surge event could complicate the hydrodynamic, and thus adequacy of the modeling results.



Figure 9.9. Johns Pass, Florida (2002).

#### 9.2.5.3 Jensen Beach Causeway

Bridge scour can occur at bridge locations other than across inlets. In 2005, the Jensen Beach, Florida causeway (Figure 9.10) experienced wave scour episodes. The passage of two successive tropical events<sup>6</sup> along similar storm tracks produced waves within the embayment. These waves struck the causeway abutments and bridge piers – producing scour to depths of over 30 feet (Figure 9.11). FDOT engineers had concerns about structural integrity of the foundations should a third storm event occur (and before installation of scour countermeasures).

In trying to determine what had occurred, FDOT expressed concerns that standard HEC-18 approaches did not predict such scour depths (even when using advanced two-dimensional hydrodynamic and wave modeling). Only when investigators also considered (and modeled) sediment transport did the simulations agree with post-event measurements.

---

<sup>6</sup> Hurricane Frances (9/5/2005) and Hurricane Jeanne (9/25/2005)





Figure 9.10. Jensen Beach Causeway bridge.

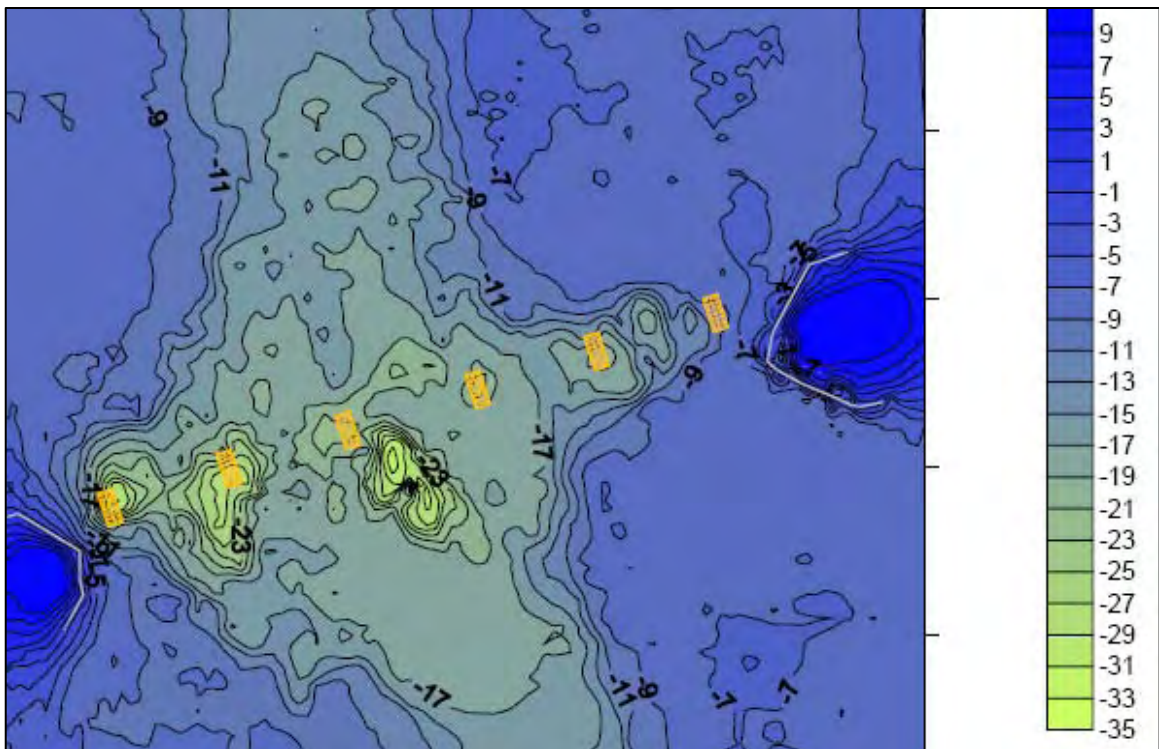

Figure 9.11. Jensen Beach Causeway bridge post event scour bathymetry (2005).

### 9.3 Coastal Bridge Wave Forces

Highway bridges along the north-central United States Gulf coast were damaged during landfall of Hurricanes Ivan (2004) and Katrina (2005). These include the I-10 bridge across Escambia Bay in Florida, the I-10 bridge across Lake Pontchartrain in Louisiana, the US 90 bridges across Biloxi Bay and Bay St. Louis in Mississippi, and an on-ramp to the I-10 bridge across Mobile Bay in Alabama (see location map, Figure 9.12).



Figure 9.12. Location map of some of the highway bridges damaged by hurricanes in the last 40 years along the north-central Gulf coast.

Other bridges in the region were damaged during Katrina by collisions by vessels that had broken their moorings. A comprehensive listing of bridges damaged by Hurricane Katrina can be found in the ASCE Technical Council on Lifeline Earthquake Engineering (TCLEE) report (2006).

#### 9.3.1 Some Specific Damaged Bridges

Reviewing information related to several of these damaged bridges reveals potential failure modes and commonalities. Specifically, this document will describe the I-10 Escambia Bridge in Florida and the US-90 Biloxi Bay Bridge in Alabama. The investigations and lessons taken from these two bridges could similarly describe many of other wave load impacted bridges.

### 9.3.1.1 I-10 Escambia Bridge (Hurricane Ivan)

Figure 9.13 shows a photograph of damage to the I-10 bridge across Escambia Bay, Florida, as a result of Hurricane Ivan. At the time of this photo, the storm surge elevation had already dropped a few feet below its maximum.



Figure 9.13. Interstate-10 bridge across Escambia Bay, Florida, after Hurricane Ivan. Photo looking east from Pensacola at dawn September 16, 2004. (Pensacola News Journal photo)

Note that the spans in the right/center of the photograph have been moved to the left (in the direction of wave propagation) and some have fallen off the pile caps.

The spans in the foreground, which are at the same elevation as the ones in the center, have not moved. Potentially, wave heights here were slightly lower due to the partial sheltering of shore and slightly shallower water near the shore.

The spans in the background have not moved because they are elevated above the waves. The spans on the westbound bridge (left side of photo) are less damaged than the ones on the eastbound bridge because the eastbound bridge provided shelter during the peak of the storm and reduced wave heights at the westbound bridge. Indications are that the wave-induced loads were just large enough to begin to move the decks at the peak of the storm surge. Some were moved far enough to topple off the pile caps; others were just displaced a short distance by the waves.

### 9.3.1.2 US-90 Biloxi Bay (Hurricane Katrina)

Figure 9.14 (and Figure 2.5) show the US Highway 90 bridge across Biloxi Bay, Mississippi after Hurricane Katrina. The extreme storm surge during the hurricane raised the water level to an elevation where waves could impact and inundate the bridge superstructure. The simply supported-span bridge decks were moved off the pile caps to landward (sea is to the left in Figure 9.14). However, no pile cap movement occurred at higher deck elevations (i.e., the approach to a ship channel - shown between the deckless pile caps and an open drawbridge across that channel).



Figure 9.14. US 90 bridge over Biloxi Bay, Mississippi showing the spans at higher elevations were not removed (photo looking southwest from Ocean Springs 2/19/06.)

### 9.3.2 Wave Loads – A Potential Bridge Failure Mechanism

As part of a synthesis of the existing body of knowledge related to wave forces on highway bridge decks Douglass, et al. (2006) concluded that wave loads (see Figure 9.15) were the primary force causing much of the damage to coastal bridges in the north, central Gulf coast due to Hurricanes Ivan (2004) and Katrina (2005). The likely damage mechanism was waves that struck the simple-span bridge decks because the storm surge raised the water level.

The likely failure mechanism was individual waves producing both an uplift force and a horizontal force on the simple-span bridge deck. The magnitude of the maximum resultant wave force is able to overcome the weight of the decks and the small, lateral resistance provided by the connections (Douglass, et al. 2006).

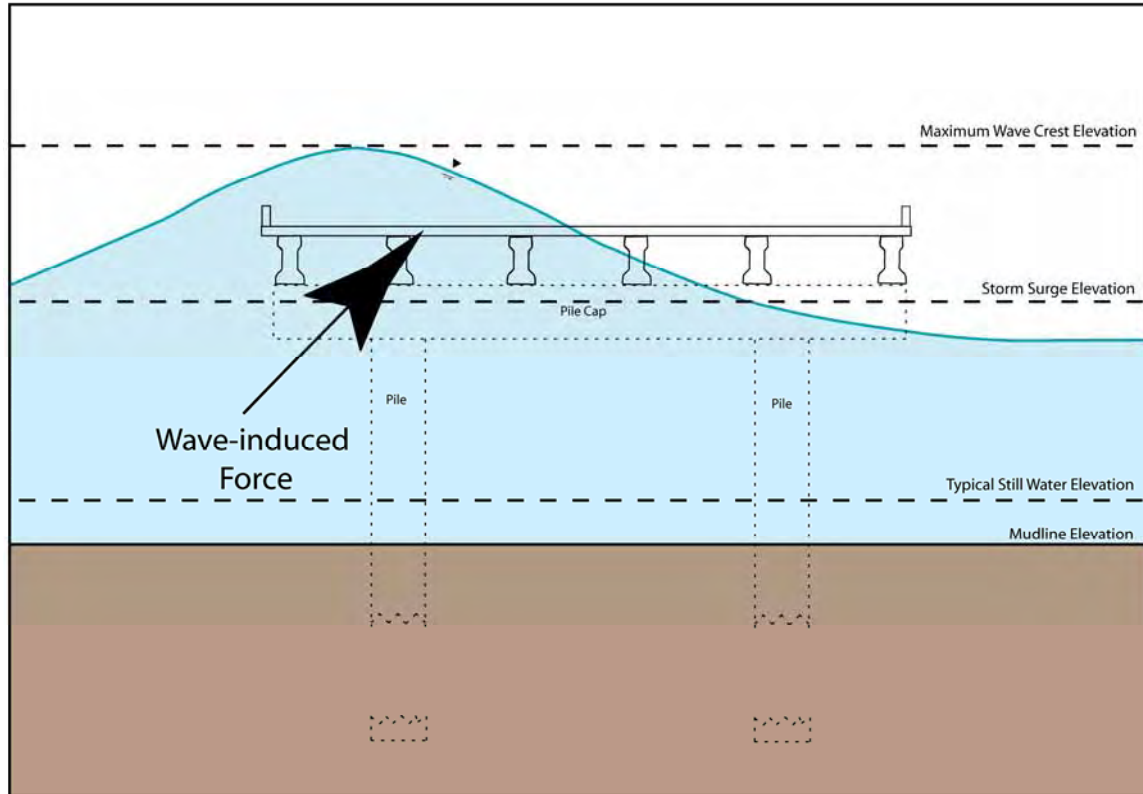

Figure 9.15. Schematic of wave-induced uplift and lateral loads on a bridge deck.

### 9.3.3 Available Literature on Wave Forces and Loads

The available engineering literature provides little information and limited guidance on wave forces on highway bridge decks. There is, however, a substantial body of literature on wave forces on other types of rigid structures including vertical walls, cylindrical pilings, pipelines, etc. in the ocean and coastal engineering fields. Of particular relevance are investigations of wave loads on decks of piers near or at the coast and on decks of offshore oil and gas exploration and production platforms. Some of the methods from the coastal and ocean engineering literature can be adapted to provide preliminary estimates of wave loads on highway bridge decks for the case of deck elevations at or above the storm surge elevation.

A number of investigators, in small-scale laboratory tests, have measured wave uplift loads on horizontal decks subjected to waves (e.g. El Ghamry 1963; Wang 1970; French 1970; Isaacson and Bhat 1995). Those investigators considered primarily monochromatic waves. McConnell, et al. (2004) report on more recent tests with irregular waves and present a method for estimating lateral and vertical loads on decks with underlying beams. Kaplan, et al. (1995) and Bea, et al. (1999) present methods developed for estimating lateral loads on offshore oil platforms. All three of these investigators only considered relatively high decks with significant clearance above the still-water-level which is typical of the offshore industry. The only testing of highway bridge cross-sections in the existing literature has been by Denson (1978, 1980), Cruz-Castro, et.al. (2006), and Douglass, et al (2007).

Of these existing methods in the literature, McConnell, et al. (2004) may be the most readily adaptable to the highway bridge deck problem. It is an empirical approach calibrated with laboratory results; it is based on relatively simple concepts; it is similar to and more comprehensive than Wang (1970), French (1970), or Overbeek and Klappers (2001). The

laboratory experiments were conducted with irregular waves using modern wave-generation capabilities. The weaknesses of McConnell's method for the highway bridge application were that it was not based on a highway deck geometry, it has not been repeated by other investigators or at other scales, it is perhaps overly complex in its separate treatment of internal and external beams and decks, and it was not developed for decks at or below the still-water elevation.

The two existing approaches developed for the offshore oil industry, Bea, et al. (1999) and Kaplan, et al. (1995), can be used to estimate loads on bridge decks with significant extensions and adaptations. The strengths of these two approaches include their theoretical, physics-based background with Morison's equation (discussed later in this Chapter) and their implicit inclusion of the body of knowledge developed over the past five decades of offshore rig design. Their weaknesses include the complexity of application, the substantial difference in cross-section geometry (including the fact that most offshore platforms have open-grid decks to reduce vertical loads), and that they were specifically developed and tested for structures with very high clearance between the still-water elevation and the bottom of the deck. There is another potential theoretical weakness in that the Morison's equation assumes that the structures are "thin" as compared to the wavelength which is much more questionable for coastal bridges than it is for offshore platform decks. Morison's equation assumes that the structure does not significantly affect the fluid velocities in the wave.

None of the above mentioned methods adequately estimate loads for the case where the bridge deck is completely submerged below the still-water level. The investigators did not test or consider this condition.

#### 9.3.4 Wave Load Constituents

Figure 9.16 shows a schematic of an assumed, typical time-history of one component (either vertical or horizontal) of wave-induced loads on a rigid structure like a bridge deck. Such loading is consistent with measured laboratory loads reported in the literature by numerous investigators.

One part of the wave-induced force is a longer-duration slowly "varying" force. This "varying" force changes magnitude and direction with the phase (crest or trough) of the wave as the wave passes under or across the structure. This part of the wave-induced load has been called "quasi-static," or simply "wave" force by others in the coastal engineering literature. The duration of the "varying" load corresponds with the period of the incident waves that is typically on the order of 3 to 15 seconds. The horizontal slowly varying loads are in the landward direction (based on direction of wave propagation) for the wave crest but can reverse to the seaward direction in the wave trough. Likewise, the vertical slowly varying loads are directed up (i.e. lift) for part of the wave but can be downward for part of the wave. The downward-directed wave load can be due to both the mass and downward momentum of the portion of the wave crest above the bridge deck. The uplift loads appear to be typically greater than the downward-directed loads.

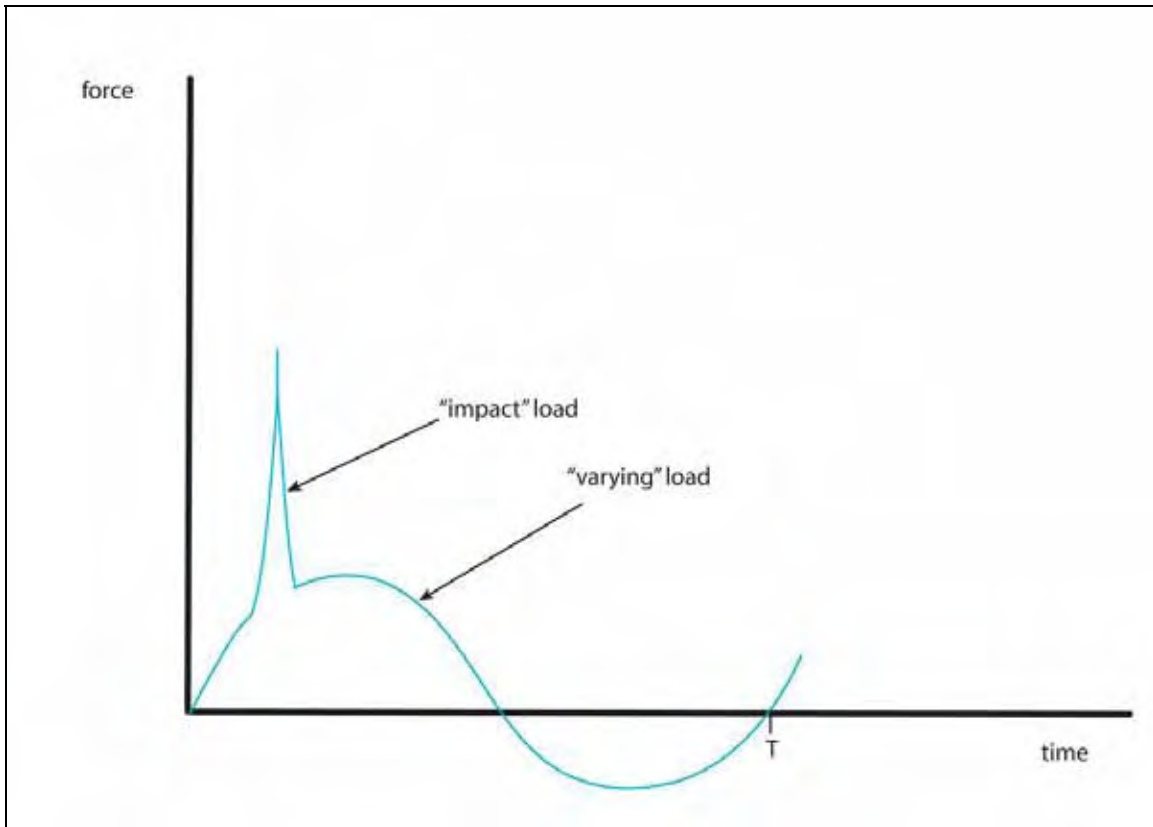

Figure 9.16. Schematic of typical time-history of wave loads on rigid structures.

The other part of the wave-induced load shown in Figure 9.16 is a very short-duration (maybe less than 0.1 to 0.001 seconds long) “impact” force as the wave crest first begins to hit the deck. This force is directed in the horizontal direction of wave propagation and in the upward vertical direction. This impact force does not typically reverse direction. The impact force is often associated with the trapping of a small pocket of air between the structure and the wave face, and is sometimes referred to as the 'slamming' force. Wave impact loads have been studied most for horizontal, wave-induced loads on vertical walls.

### 9.3.5 Methods for Estimating Wave Loads on Bridge Decks

Several of the methods in the literature discussed above have been used to develop estimates of wave-induced loads on bridges. These include applications of McConnell, et al. (2004), modifications of Kaplan (1995), and a method suggested in Douglass et al. (2006). The Douglass et al. (2006) method is summarized in Appendix E of this document.

At the time of the preparation of this document, a joint AASHTO/FHWA task committee was developing guidance for the design of retrofit solutions for bridges exposed to wave loads (Shelden 2007).

### 9.3.6 Wave Load Mitigation: Designs and Countermeasures

Concerns related to this phenomenon include the vulnerability of existing bridges, an interest in appropriate design of retrofits to existing bridges to avoid similar failures, and for the design of new bridges that span coastal waters.

### 9.3.6.1 Bridge Deck Elevation

The most common design approach is to avoid superstructure wave forces by elevating the bridge so that the storm waves crests pass under the low-chord of the bridge. This elevation is shown schematically in Figure 9.17.

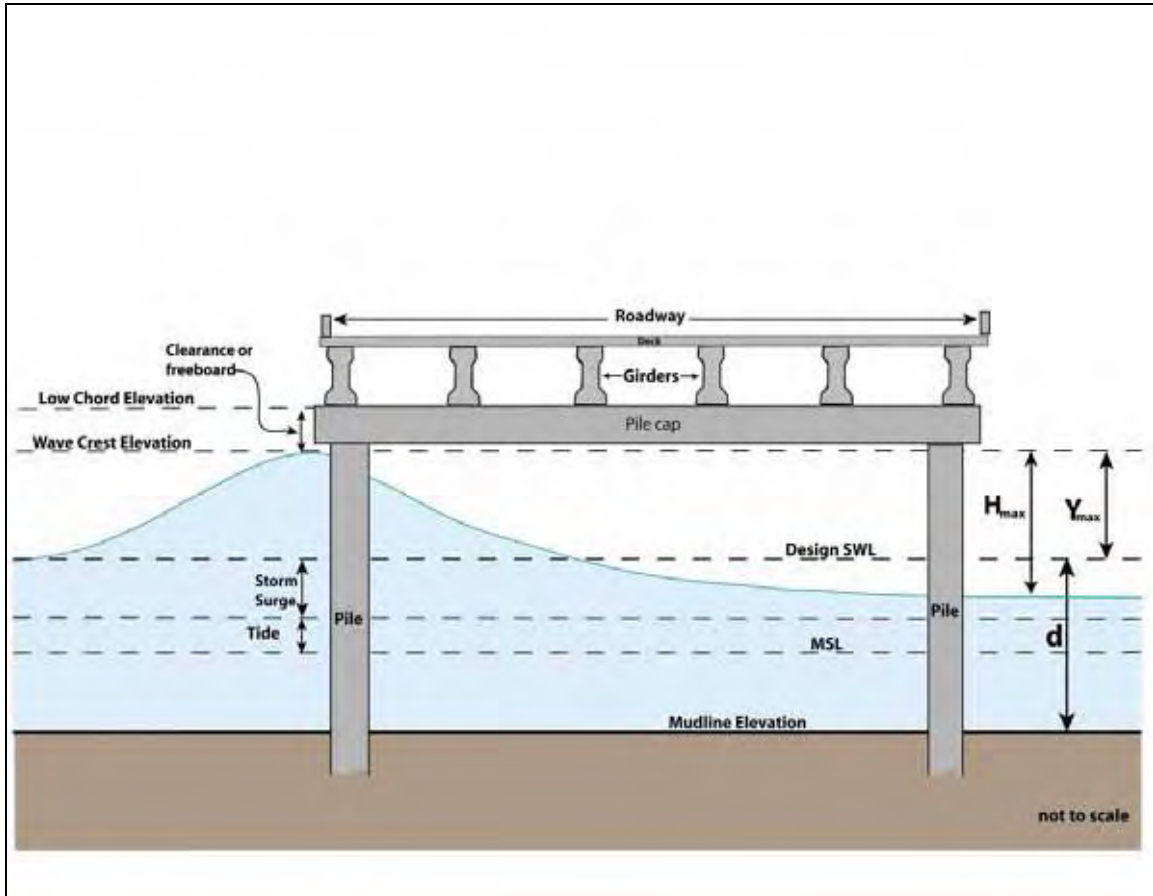

Figure 9.17. Definition sketch of wave parameters and water levels for determining elevation of bridge deck for clearance from wave crests

The elevation can be set by adding some additional clearance or freeboard above the crest of the largest wave in the design sea state:

$$(\text{low chord elevation}) = (\text{wave crest elevation})_{\text{max}} + \text{freeboard} \quad (9.1)$$

The low chord elevation is taken as the elevation of the bottom of the girders (see Figure 9.17). The maximum wave crest elevation can be calculated as:

$$(\text{wave crest elevation})_{\text{max}} = (\text{design storm surge SWL}) + Y_{\text{max}} \quad (9.2)$$

where:

- SWL = design still water level
- $Y_{\text{max}}$  = difference between the SWL elevation and wave crest elevation for the maximum wave in the design sea-state (defined below)



In general, the value for Y is the portion of the wave height, H, above the SWL. A useful engineering estimate of Y for this purpose is 75% of H. Thus  $Y_{\max}$  above can be estimated as:

$$Y_{\max} = 0.75 H_{\max} \quad (9.3)$$

where:

$$H_{\max} = \text{design maximum wave height (defined below)}$$

#### 9.3.6.1.1 Nominal Maximum Wave Height Approach

The design maximum wave height ( $H_{\max}$ ) depends on the site-specific conditions. The design sea-state can be estimated using a wave generation model applied to that site for specific wind and water level conditions. Given a design significant wave height ( $H_s$ ), the design maximum wave height can reasonably be set as:

$$H_{\max} = 1.7 H_s \quad (9.4)$$

The value of 1.7 given in Equation 9.4 corresponds with a wave height statistic on the Rayleigh Distribution (see Table 4.1) that is slightly higher than the average of the highest 1% of wave heights ( $\bar{H}_1$ ). This 1.7 value corresponds with the probable maximum wave height for 200 waves. This is a reasonable number of waves for the typical durations of the peak of a storm surge and average wave periods in storm surges<sup>7</sup>. For example this would be roughly 24 minutes with average wave periods of  $T = 7$  s.

Combining Equations 9.3 and 9.4 yields:

$$Y_{\max} = 1.3 H_s \quad (9.5)$$

#### 9.3.6.1.2 Depth Limited Maximum Wave Height Approach

In some cases however, the maximum wave height might be depth-limited, i.e., very large waves in very shallow water. Larger waves in the design sea state may break farther offshore of the bridge and the largest waves will not reach the bridge. In this case, check the depth-induced breaking criterion (or similar criteria):

$$\left(\frac{H}{d}\right)_{\max} \approx 0.8 \quad (9.6)$$

This can be written as:

$$H_{\max} = 0.8 d_s \quad (9.7)$$

where:

$$d_s = \text{depth at bridge structure during design conditions (i.e. including the storm surge)}$$

For the depth limited case, combining Equations 9.3 and 9.7 yields:

---

<sup>7</sup> The Longuet-Higgins (1952) equation (as presented in the Coastal Engineering Manual, USACE 2002) provides a more complex approach than Equation 9.4 for estimating  $H_{\max}$ .

$$Y_{\max} = 0.6 d_s \quad (9.8)$$

### 9.3.6.1.3 Estimating the Maximum Wave Crest Elevation

The difference between the SWL elevation and wave crest elevation for the maximum wave in the design sea-state ( $Y_{\max}$ ) used in Equation 9.2 should be the lesser of the values yielded from Equation 9.5 and Equation 9.8. Therefore, considering the potential for non-depth-limited and depth-limited maximum wave heights, the primary equation estimating the elevation of the maximum wave crest (see Figure 9.17) becomes:

$$(\text{wave crest elevation})_{\max} = (\text{design storm surge SWL}) + (1.3 H_s \text{ or } 0.6 d_s)_{\min} \quad (9.9)$$

This equation can be used to set the elevation of the low-chord of bridge decks that span coastal waters. The next section discusses the use of additional freeboard above this elevation and the determination of the input surge and wave height to Equation 9.9.

### 9.3.6.2 Freeboard Considerations

“Freeboard” can be added to the maximum wave crest elevation found from Equation 9.9. The approach outlined above does not provide “freeboard” above the wave crests. In riverine systems, State DOTs may require one or two feet of “freeboard” to be added above the design water surface elevation to account for wave action or debris as well as for uncertainty in the analysis. This freeboard, if added in the coastal situation, will also account for higher waves in the sea-state. The uncertainties involved in coastal surge SWL analysis are likely at least as great as those in the riverine situation (if not significantly greater). Thus, some additional freeboard for the low-chord elevation of coastal bridges may be appropriate.

However, complete clearance from all wave forces may not be needed to ensure bridge integrity during major coastal storms. Post-storm inspections of damage to bridge decks along the north-central Gulf coast in 2004 and 2005 indicate that some bridge decks survived that were exposed to some wave loads. Apparently, the loads were small enough that they did not cause damage. The damage pattern suggests that there was a critical elevation at each location for that specific bridge deck design and those site-specific and storm-specific surge and wave conditions. Spans below that critical elevation were displaced off the pile caps; spans above that elevation were not. The critical elevation was below the elevation for complete wave clearance given by Equation 9.9. This is likely due to resistance to wave forces provided by the weight of the bridge spans and the limited connections.

For example, Figure 9.14 shows some simply-supported spans on the US 90 bridge across Biloxi Bay, Mississippi still in-place even after removal of other spans. These remaining spans had a higher low chord elevation than those displaced. The critical elevation for the bridge damage was a low-chord elevation of roughly 23 feet (Douglass et.al. 2006) (all bridge span elevations in this discussion are average elevations of the bottom of the outer girder relative to NGVD). There may have been damage at higher elevations that was not visible from shore.

On the east side of the drawbridge shown in Figure 9.14, the span at elevation 24.5 feet (low-chord) stayed in place and the next lower span (elevation = 22.9 feet) moved. The estimated maximum storm surge SWL elevation at this location during Hurricane Katrina was 21.5 feet (NGVD) with an estimated significant wave height of  $H_s = 9.8$  feet (see Figure 3.5). The Equation 9.9 procedure would estimate that the crest of the maximum wave was at + 34.2 feet.

Applying this example of Katrina damage to the Biloxi bridge: the maximum wave crest elevation was + 34.2 feet, yet a bridge span as low as + 24.5 feet “survived.” Thus, the bridge span with a low-chord elevation almost 10 feet lower than the maximum wave crest elevation

apparently did not move. One conjecture about this observation is that the wave loads were insufficient to overcome the weight of the decks and the connection resistance.

Some researchers have suggested that simply-supported bridge decks with low chord elevations above the elevation of the crest of the significant wave survived wave attack in the hurricanes of 2004 and 2005 (Chen 2005). This would suggest the  $Y_{max}$  could be set to  $0.75H_s$  and not require any additional freeboard. A preferable approach is to set the deck elevations based on an improved understanding of the wave loads. The discussion above also assumes that the pile cap design can withstand wave loads.

## 9.4 Other Coastal Bridge Issues

This section very briefly discusses other design and maintenance issues related to coastal bridges including increased concrete spalling due to wave splash, and lateral loads on pilings.

Some low-elevation coastal bridges have suffered increased concrete damage near their landward end just above vertical retaining walls. Wave splash during storms sprays salt water on the underside of the bridge deck concrete and, over time, these areas can become areas of concern for bridge inspectors. The use of reinforced concrete in the marine environment typically requires additional engineering considerations, including the use of air entrainment admixtures and increased minimum thickness of specified concrete cover over reinforcing bars. Newer bridges, with higher clearance requirements and longer, higher approach sections, often avoid this problem by elevating all of the bridge deck well above the elevation of splash. Wave runup and splash on existing low bridges could be reduced by placing rip-rap on the vertical walls. Clearance issues for coastal bridges over navigation channels are primarily controlled by the US Coast Guard.

Lateral loads on bridge pilings and pile groups in a coastal situation can be increased due to waves. These loads in riverine situations are well modeled by the traditional fluid mechanics approach of estimating drag as a function of the water velocity squared and an empirical drag coefficient (e.g. Standard Specifications for Highway Bridges, AASHTO 2002). However, the nature of wave motion produces loads beyond those due just to drag. The oscillatory water particle motion below waves can impart significant forces on structures due to the fluid accelerations as well as the velocities. Thus, it is neither adequate nor appropriate to just increase the velocity used in the drag equations to account for the maximum wave orbital velocity. The acceleration generated forces, also called inertia forces, should be considered.

Morison's equation from ocean engineering estimates the horizontal force per unit length of a vertical pile in waves as:

$$f_p = f_i + f_D = C_M \rho \frac{\pi D^2}{4} a_x + C_D \rho D u |u| \quad (9.10)$$

where:

- $f_p$  = horizontal force per unit length of a vertical pile
- $f_i$  = inertial force per unit length of pile
- $f_D$  = drag force per unit length of pile
- $D$  = diameter of pile
- $\rho$  = density of water (1025 k/m<sup>3</sup> for seawater)
- $u$  = horizontal water particle velocity at the axis of the pile (as if the pile were not there)
- $a_x$  = horizontal water particle acceleration at the axis of the pile (as if the pile were not there)

$C_D$  = drag coefficient  
 $C_M$  = inertia or mass coefficient

The first term in Morison's equation accounts for the dynamic force on the structure due to the acceleration in the waves. It is called the inertia term. The second term is the drag term and it is analogous to the drag load on a piling in unidirectional flow. The absolute value is used in the drag term because the load reverses direction with wave phase. In a wave, the water particle velocity, direction and acceleration at different points are constantly changing with phase. They also vary with depth below the surface and the total force on the pile is the depth-integrated sum of these changing loads. The two terms are out of phase and thus not maximum at the same time.

More information, including values for the coefficients and appropriate applications, on Morison's equation can be found in other references (Sarpkaya and Isaacson 1981; USACE 1984).

An inherent assumption in Morison's equation is the "thin piling" assumption that velocity and acceleration do not vary over the structure in the direction of wave propagation and that the piling is thin enough to not cause much of an effect on the wave. Because of the complexities involved in applications of Morison's equation, a coastal or ocean engineer should be included in the design or analysis team for estimating wave loads on pilings. Empirical consideration of these forces is described in Wiegel R. L. (1964) and NAVFAC DM 26.2 (1982). In cases of shallow water and/or wave breaking, where water particle velocities and accelerations will be significantly under-predicted by simple linear wave theory, higher-order theories, discussed in Chapter 4, are required. Dean's stream-function approach is a non-linear wave theory that was developed to predict wave kinematics and forces on structures in deep and shallow water settings (Dean 1965).

## **9.5 Selection of Design Storm Surge & Design Wave Heights**

### **9.5.1 Design Storm Surge SWL**

The selection of the design storm surge SWL (still-water-level) can be based on an analysis of historic storm surge elevations at the specific site or on an analysis that incorporates site-specific modeling of historical (hindcast) storm surges (see section 3.2 and specifically section 3.2.2 for additional details).

As described in section 3.3.2, FEMA FISs and FIRMs provide SWL for many coastal areas. These may be suitable sources for these data, as long as study and methodological caveats are well understood.

A nearby tide gage may provide a reasonable first approximation of surge at a site. In particular when a bridge location along a coast is between two tide gages, a reasonable estimate of the storm surge at the site might be generated by comparing the long-term statistics from the two gage locations. However, care should be taken that typical storm surges are not significantly different from those at the nearest tide gage. This could be the case for bridge crossings in areas that can magnify the storm surge due to local bathymetry and geography. Storm surge elevations can vary significantly from location to location.

Site-specific modeling of historical (i.e. hindcast) storm surges is appropriate for the design of new bridges and decisions concerning modifications to existing bridges. The potential damage justifies a comprehensive hydrodynamic surge analysis. Developing a probabilistic basis for this design storm surge elevation is consistent with both the process for riverine bridge design

considerations as well as risk-based flood maps for coastal management done by FEMA and other agencies. Both approaches, historical gage analysis and historical storm modeling analysis, can be used. The historical gage analysis can be used as a check on the reasonableness of the results of the modeling approach.

### 9.5.2 Design Wave Heights

The design wave height ( $H_s$ ) used in Equation 9.9 is the significant wave height at the bridge location during design conditions. This can be determined by using the appropriate techniques outlined in Chapter 4. For fetch-limited situations, the parametric wind-wave generation modeling method (Appendix C) may be adequate. For some situations in shallow water without much storm-surge, depth-limited wave conditions may apply. Many situations, including those exposed to open ocean storm waves, may require probabilistic oceanic wave modeling.

As a check, some FEMA FISs contain wave height estimates. However these may not report  $H_s$ , but some other wave height statistic. Apply such estimates with knowledge of these and other study caveats.

### 9.5.3 Coastal Engineer Involvement

Given the importance and complexity of these considerations to the integrity of the highway structure, the involvement of a qualified coastal engineer in the project's design or pre-construction review is highly recommended.

*Page Intentionally Left Blank*

## Chapter 10 - References

- AASHTO. (1999) "Guidelines for Highways Along Coastal Zones and Lakeshores." Volume XI. Prepared by the Task Force on Hydrology and Hydraulics. American Association of State Highway and Transportation Officials. Washington, D.C.
- AASHTO. (2002) "Standard Specifications for Highway Bridges" 17<sup>th</sup> ed. American Association of State Highway and Transportation Officials. Washington, D.C.
- ASCE/SEI (2005) ASCE Standard No. 7: Minimum Design Loads for Buildings and Other Structures, ASCE/SEE-7. American Society of Civil Engineers/Structural Engineering Institute, 424 pp.
- ASCE TCLEE. (2006) "Performance of Transportation Systems During Hurricane Katrina." Report by the American Society of Civil Engineers Technical Council on Lifeline Earthquake Engineering. Reston, Virginia.
- Bea, R.G., Xu, T., Stear, J., and Ramos, R. (1999) "Wave Forces on Decks of Offshore Platforms." *Journal of Waterway, Port, Coastal, and Ocean Engineering*. American Society of Civil Engineers. May/June, Volume 125, No. 3. p. 136-144.
- Blain, C.A., Westerink, J.J., Luettich, R.A., Jr., and Scheffner, N.W. (1994) ADCIRC: An Advanced Three-Dimensional Model for Shelves, Coasts, and Estuaries. "Report 4: Hurricane Storm Surge Modeling Using Large Domains." U.S. Army Corps of Engineers. Washington, D.C. 55 pp.
- Bodge, K.R. (1998) "Beach Fill Stabilization with Tuned Structures: Experience in the Southeastern U.S.A. and Caribbean." *Proceedings of Coastlines, Structures and Breakwaters '98*.
- Booij, N., Ris, R.C., and Holthuijsen, L.H. (1999) "A Third-Generation Wave Model for Coastal Regions, Part I: Model Description and Validation." *Journal of Geophysical Research*. Volume 104, No. C4. p. 7649-7666.
- Bottin, R.R. Jr., McCormick, J.W., and Chasten, M.A. (1993) *Maryland Guidebook for Marina Owners and Operators on Alternatives Available for the Protection of Small Craft Against Vessel-Generated Waves*. Prepared for the Maryland Department of Natural Resources. Coastal Engineering Research Center. Vicksburg, Mississippi. 92 pp.
- Brown, S.A. and Clyde, E.S. (1989) "Design of Riprap Revetment." Report No. FHWA-IP-89-016, Hydraulic Engineering Circular 11. March 1989. 169 pp.
- Bruun, P. (1966) *Tidal Inlets and Littoral Drift. Volume 2, Stability of Coastal Inlets*. University Book Company. Oslo, Norway. 193 pp.
- Campbell, T.J and Benedet, L. (2004) "Beach Nourishment Magnitudes and Trends in the US." *Journal of Coastal Research, Special Issue 39*.
- Chen, Q. (2005) "How to Determine Surge and Wave Conditions near Coastal Bridges." Presentation at Wave Force Symposium Organized by FHWA. Turner-Fairbank Highway Research Center, McLean, Virginia. December 5, 2005.
- Chen, Y.H. and Anderson, B.A. (1987) "Development of a Methodology for Estimating Embankment Damage Due to Flood Overtopping." Simons, Li, and Associates report to FHWA. Report No. FHWA/RD-86/126. March 1989. 219 pp.

## References

- Cialone, M.A., Butler, H.L., and Amein, M. (1993) DYNLET1 Application to Federal Highway Administration Projects, Miscellaneous Paper CERC-93-6. U.S. Army Engineer Waterways Experiment Station.
- Citrus County, Florida (2000) "Citrus County Local Mitigation Strategy", Final Report, March 2000.
- Clopper, P.E. and Chen, Y. (1988) "Minimizing Embankment Damage During Overtopping Flow." Simons, Li, and Associates report to FHWA. Report No. FHWA/RD-188/181. November 1988. 226 pp.
- Clopper, P.E. (1989) "Hydraulic Stability of Articulated Concrete Block Revetment Systems During Overtopping Flow." Simons, Li, and Associates report to FHWA. Report No. FHWA-RD-89-199. November 1989. 131 pp.
- Coastal Tech and Preble-Rish, Inc. (1998) "Hurricane Evacuation Route and Beach Management on St. Joseph Peninsula." Feasibility and Design Study for Florida Department of Environmental Protection. November 30, 1998. 68 pp.
- Crowell, M., Leatherman, S.P., and Buckley, M.K. (1991) "Historical Shoreline Change: Error Analysis and Mapping Accuracy." Journal of Coastal Research, Volume 7, No. 3. p. 839-852.
- Crowell, M., Douglas, B.C., and Leatherman, S.P. (1997) "On Forecasting Future U.S. Shoreline Positions: A Test of Algorithms." Journal of Coastal Research. Volume 13, No. 4. p. 1245-1255.
- Cruz-Castro, O., Edge, B.L., and Douglass, S.L. (2006) "Hurricane Forces Measurements on Bridge Decks." Proceedings of CoastLab 2006. 9 pp.
- Dabees, M.A. and Kamphuis, J.W. (1998) "ONELINE, A Numerical Model for Shoreline Change." Proceedings of the 26th International Conference on Coastal Engineering, American Society of Civil Engineers. p. 2668-2681.
- Davis, R.A. Jr. (1994) The Evolving Coast. Scientific American Library, New York. 231 pp.
- Davis, R. A. Jr. and FitzGerald, D.M. (2004) Beaches and Coasts. Blackwell Publishing, Oxford. 419 pp.
- Dean, R.G. (1965) "Stream Function Representation of Nonlinear Ocean Waves." Journal of Geophysical Research. Volume 70, No. 18. p. 4561-4572
- Dean, R.G. (1974) "Compatibility of Borrow Material for Beach Fills." Proceedings from the 14th Coastal Engineering Conference. New York. American Society of Civil Engineers.
- Dean, R.G. (2002) Beach Nourishment: Theory and Practice. Advanced Series on Ocean Engineering – Volume 18. World Scientific, New Jersey. 399 pp.
- Dean, R.G. and Dalrymple, R.A. (1991) Water Wave Mechanics for Engineers and Scientists. Singapore. World Scientific Press. 353 pp.
- Dean, R.G. and Dalrymple, R.A. (2002) Coastal Processes with Engineering Applications. Cambridge University Press. Cambridge, UK.
- Denson, K.H. (1978) "Wave Forces on Causeway-Type Coastal Bridges." Water Resources Research Institute, Mississippi State University. 42 pp.
- Denson, K.H. (1980) "Wave Forces on Causeway-Type Coastal Bridges: Effects of Angle of Wave Incidence and Cross-Section Shape." Water Resources Research Institute, Mississippi State University. 242 pp.



- Douglass, S.L., Schroeder, W.W., and Robinson, J.T. (1992) "Wave Forecasting for Construction in Mobile Bay." Coastal Engineering Practice '92. Specialty Conference Proceedings, ed. S. Hughes, American Society of Civil Engineers. p. 713-727.
- Douglass, S.L. (2002) Saving America's Beaches: The Causes of and Solutions to Beach Erosion. Advanced Series on Ocean Engineering – Volume 19. World Scientific, New Jersey. 91 pp.
- Douglass, S.L., Bobe, A., and Chen, Q. (2003) "The Amount of Sand Removed from America's Beaches by Engineering Works," Proceedings of Coastal Sediments '03 Conference (CD-ROM). American Society of Civil Engineers.
- Douglass, S.L., Lindstrom, J., Richards, J.M., and Shaw, J. (2005) "An Estimate of the Extent of U.S. Coastal Highways." Presentation to the AFB06 Committee of the Transportation Research Board.
- Douglass, S.L., Chen, Q., Olsen, J.M., Edge, B.L., and Brown, D. (2006) "Wave Forces on Bridge Decks." report by the Coastal Transportation Engineering Research and Education Center of the University of South Alabama to FHWA. Washington D.C. 74 pp.
- Douglass, S.L., McNeill, L.P., and Edge, B. (2007) "Wave Loads on US Highway Bridges," Proceedings of the Coastal Structures '07 International Conference, Venice, Italy, World Scientific Press, July 2, 2007.
- Edge, B.L., Scheffner, N.W., Fisher, J.S., and Vignet, S.N. (1998) "Determination of Velocity in Estuary for Bridge Scour Computations." Journal of Hydraulic Engineering. Volume 124, Issue 6. p. 619-628.
- El Ghamry, O.A. (1963) "Wave Forces on a Dock, Hydraulic Engineering Laboratory." Institute of Engineering Research Technical Report HEL-9-1. University of California, Berkeley, California. 206 pp.
- FEMA (2002) CHAMP: Coastal Hazard Analysis Modeling Program: User's Manual, Version 1.1.
- FEMA (2004) Flood Insurance Rate Map. Charleston County, South Carolina and Incorporated Areas. Panel 539 of 835. Map Number 45019C0539J. Effective Date: November 17, 2004.
- FHWA (2005/2007), Office of Bridge Technology, Potential Vulnerability of National Bridge Inventory to Coastal Storms. Unpublished analyses to support Congressional information requests and testimony.
- FDOT (2008), Roadway Design Office, State Drainage Office, Bridge Scour Policy and Guidance website: [www.dot.state.fl.us/rddesign/dr/Bridgescour/Bridge-Scour-Policy-Guidance](http://www.dot.state.fl.us/rddesign/dr/Bridgescour/Bridge-Scour-Policy-Guidance).
- French, J.A. (1970) "Wave Uplift Pressures on Horizontal Platforms." Proceedings of the Civil Engineering in the Oceans Conference, American Society of Civil Engineers. p. 187-202.
- Gosselin, M.S. and Sheppard, D.M. (1998) "A Review of the Time of Local Scour Research." Stream Stability and Scour at Highway Bridge – Compendium, E.V. Richardson and P.F. Lagasse, eds., American Society of Civil Engineers. 1040 pp.
- Hallermeier, R.J. and Rhodes, P.E. (1988) "Generic Treatment of Dune Erosion for a 100-Year Event." Proceedings of the 21st International Conference on Coastal Engineering. American Society of Civil Engineers. p. 1197-1211.
- Hanson, H. and Kraus, N.C. (1989) "GENESIS: Generalized Model for Simulating Shoreline Change." Technical Report CERC-89-19. US Army Engineer Waterways Experiment Station, Vicksburg, Mississippi. 247 pp.

## References

- Hardaway, C.S. Jr. and Gunn, J.R. (2000) "Shoreline Protection: Design Guidelines for Pocket Beaches in Chesapeake Bay, USA." Carbonate Beaches 2000, Proceedings from the First International Symposium on Carbonate Sand Beaches. American Society of Civil Engineers, p. 126-139.
- Hasselmann, D.E., Dunckel, M., AND Ewing, J. A. (1980) "Directional Wave Spectra Observed During Jonswap 1973." Journal of Physical Oceanography. Volume 10. p. 1264-1280.
- Herbich, J.B. (2000) Handbook of Coastal Engineering. McGraw-Hill Handbook. New York.
- Hubertz, J.M. (1992) "User's Guide to the Wave Information Studies (WIS) Wave Model, Version 2.0." WIS Report 27 (AD A254 313), U.S. Army Engineer Waterways Experiment Station, Vicksburg, MS.
- Hughes, S.A. (1993) Physical Models and Laboratory Techniques in Coastal Engineering. Advanced Series on Ocean Engineering – Volume 7. World Scientific, New Jersey. 568 pp.
- Inman, D.L. and Nordstrom, C.F. (1971) "On the Tectonic and Morphologic Classification of Coasts," Journal of Geology. Volume 79. p. 1-21.
- Isaacson, M. and Bhat, S. (1996) "Wave Forces on a Horizontal Plate." International Journal of Offshore and Polar Engineering. Volume 6, No. 1. p. 19-26.
- Jarrett, J.T. (1976) "Tidal Prism-Inlet Area Relationships." General Investigation of Tidal Inlets, Report 3. US Army Engineer Waterways Experiment Station, Vicksburg, Mississippi. 32 pp..
- Judge, E.K., Overton, M.F., and Fisher, J.S. (2003) "Vulnerability Indicators for Coastal Dunes." Journal of Waterway, Port, Coastal and Ocean Engineering, American Society of Civil Engineers, vol. 129, no. 6, pp. 270-278.
- Kaminsky, G.M., Daniels, R.C., Huxford, R., McCanless, D., and Ruggiero, P. (1999) "Mapping Erosion Hazard Areas in Pacific County, Washington." Journal of Coastal Research. Special Issue 28, "Coastal Erosion Mapping and Management." ed. M. Crowell and S.P. Leatherman. p. 158-170.
- Kamphuis, J.W. (2000) Introduction to Coastal Engineering and Management. Advance Series on Ocean Engineering. World Scientific: River Edge, New Jersey. Volume 16.
- Kaplan, P., Murray, J.J., and Yu, W.C. (1995) "Theoretical Analysis of Wave Impact Forces on Platform Deck Structure." Proceedings of the 14th International Conference on Offshore Mechanics and Arctic Engineering. American Society of Mechanical Engineers, Volume 1-A. p. 189-198.
- Kirby, J.T. and Dalrymple, R.A. (1983) "A Parabolic Equation for the Combined Refraction-Diffraction of Stokes Waves by Mildly Varying Topography." Journal of Fluid Mechanics. Volume 136. p. 453-466.
- Komar, P.D. (1998) Beach Processes and Sedimentation. Second Edition. Prentice Hall. Englewood Cliffs, New Jersey. 544pp.
- Komen, G.J., Cavaleri, L., Donelan, M., Hasselmann, K., Hasselmann, S., and Janssen, P.A.E.M. (1994) Dynamics and Modelling of Ocean Waves. Cambridge University Press. 532 pp.
- Kriebel, D.L., Seelig, W., and Judge, C. (2003) "A Unified Description of Ship-Generated Waves." Proceedings of the PIANC Passing Vessel Workshop. Portland, Oregon.
- Kriebel, D.L. (1986) "Verification Study of a dune erosion model." Shore & Beach, Volume 54, No. 3. p. 13-21.

- Kriebel, D.L. (1994) User's Manual for Dune Erosion Model: EDUNE. Release Number 2. United States Naval Academy. 89 pp.
- Krynock, L.W., Shelden, J.G., and Martin, J.D. (2005) "Highway Vulnerability Along NC 12 – Ocracoke Island, North Carolina." Proceedings of Solutions to Coastal Disasters Conference. American Society of Civil Engineers, pp. 423-432.
- Larson, M. and Kraus, N.C. (1989) SBEACH: Numerical Model for Simulating Storm-Induced Beach Change. Report 1: Empirical Foundation and Model Development. Technical Report CERC-89-9. US Army Engineer Waterways Experiment Station, Vicksburg, Mississippi. 256 pp.
- Lagasse, P., Zevenbergen, L., Schall, J., Clopper, P. (2001) "Bridge Scour And Stream Instability Countermeasures." Second Edition. Report No. FHWA NHI 01-003. Hydraulic Engineering Circular 23. March 2001.
- Li, Y., and Huang, L. (1997) "An Experimental Study on the Wave Uplift Force on the Superstructure of Piers." Harbor Engineering, Volume 6. p. 9-13. (In Chinese)
- Longuet-Higgins, M.S. (1952) "The Statistical Distribution of the Heights of Sea Waves." Journal of Marine Research. Volume 11. p. 245–266.
- Luetlich, R.A., Jr., Westerink, J.J., and Scheffner, N.W. (1992) "ADCIRC: An Advanced Three-Dimensional Model for Shelves, Coasts, and Estuaries." Report 1: Theory and Methodology of ADCIRC-2DDI and ADCIRC-3DL. US Army Corps of Engineers. Washington, D.C. 137 pp.
- McConnell, K., Allsop, W., and Cruickshank, I. (2004) Piers, Jetties, and Related Structures Exposed to Waves: Guidelines for Hydraulic Loadings. Thomas Telford Press, London. 148 pp.
- Miller, W. (2003) "Model for the Time Rate of Local Sediment Scour at a Cylindrical Structure." Ph.D. dissertation, University of Florida, 244 pp.
- Moffat and Nichol (2005) "Highway vulnerability along NC 12 – Ocracoke Island." report to North Carolina DOT.
- National Research Council (1995) Beach Nourishment and Protection. Committee on Beach Nourishment and Protection. National Academy Press, Washington D.C. 334 pp.
- NAVFAC DM 26.2 (1982) Coastal Protection. Washington D.C. 314 pp.
- Overbeek, J., and Klabbers, I.M. (2001) "Design of Jetty Decks for Extreme Vertical Loads." Proceedings of the Ports 2001 Conference. American Society of Civil Engineers. 10 pp.
- Overton, M.F. and Fisher, J.S. (2004a) "Hurricane Isabel and the NC 12 Hotspots." Shore & Beach. vol. 72, no. 2, pp. 30-35.
- Overton, M.F. and Fisher, J.S. (2004b) "North Carolina Coastal Highway Vulnerability Study." report to North Carolina DOT from NC State University.
- Perlin, M. and Dean, R.G. (1983) A Numerical Model to Simulate Sediment Transport in the Vicinity of Coastal Structures. Miscellaneous Report MR-83-10. US Army Corps of Engineers, Coastal Engineering Research Center Report.
- Pilarczyk, K.W., (1999) "Design of Dikes and Revetments—Dutch Practice." Handbook of Coastal Engineering, ed. J.B. Herbich. McGraw-Hill, New York. p. 3.1-3.104.
- Pope, J. and Dean, J. (1986) "Development of Design Criteria for Segmented Breakwaters." Proceedings from the 20th International Coastal Engineering Conference. American Society of Civil Engineers. p. 2144-2158

## References

- Resio, D.T. (1981) "The Estimation of Wind-Wave Generation in a Discrete Spectral Model." *Journal of Physical Oceanography*. Volume 2, No. 4. p. 510-525.
- Resio, D.T. and Vincent, C.L. (1977) "Estimation of Winds Over the Great Lakes." *Journal of the Waterway, Port, Coastal, and Ocean Division*. Volume 103, No. 2. p. 265-283.
- Richardson, E.V. and Davis, S.R. (2001) "Evaluating Scour at Bridges." Fourth Edition. Report No. FHWA-NHI-01-001. Hydraulic Engineering Circular 18. May 2001.
- Richardson, E.V. and Lagasse, P.F. (1999) *Stream Stability and Scour at Highway Bridges. Compendium of Papers from ASCE Water Resources Engineering Conferences between 1991 and 1998*, American Society of Civil Engineers.
- Richardson, E.V., Edge, B.L., Zevenbergen, L.W., Richardson, J.R., Lagasse, P.F., Fisher, J.S., and Greneir, R. (1994) "Development of Hydraulic Computer Models to Analyze Tidal and Coastal Stream Hydraulic Conditions at Highway Structures, Phase I Report." Report No. FHWA-SC-94-4. Federal Highway Administration. Washington, D.C.
- Rienecker, M.M. and Fenton, J.D. (1981) "A Fourier Approximation Method for Steady Water Waves." *Journal of Fluid Mechanics*. Volume 104. p. 119-137.
- Rouland, Sumer, Fredsoe and Michelsen (2005) "Numerical and experimental investigation of flow and scour around a circular pile." *Journal of Fluid Mechanics*. Volume 534. pp.351-401.
- Sarpkaya, T. and Isaacson, M. (1981) *Mechanics of Wave Forces on Offshore Structures*, van Nostrand Reinhold, New York, 651 pp.
- Scheffner, N.W., Mark, D.J., Blain, C.A., Westerink, J.J., and Luettich, R.A., Jr. (1994) ADCIRC: An Advanced Three-Dimensional Model for Shelves, Coasts, and Estuaries. "Report 5: A Tropical Storm Database for the East and Gulf of Mexico Coasts of the United States." U.S. Army Corps of Engineers. Washington, D.C. 48 pp.
- Shelden, J. (2007) "Design of Coastal Bridges for Wave and Surge Forces," presentation at Coastal Structures '07 International Conference, Venice, Italy, July 2, 2007.
- Sheppard, D.M. and Miller, W., Jr. (2003) "Design Storm Surge Hydrographs for the Florida Coast." Final Report to Florida Department of Transportation. 140 pp.
- Silvester, R., and Hsu, J.R.C. (1993) *Coastal Stabilization*. Prentice Hall, Englewood Cliffs, New Jersey. 578 pp.
- Smith, J.M., Sherlock, A.R., and Resio, D.T. (2001) "STWAVE: Steady-State Spectral Wave Model User's Manual for STWAVE, Version 3.0." Special Rep. ERDC/CHL SR-01-1, U.S. Army Engineer Waterways Experiment Station, Vicksburg, Miss.
- Smith, S.J., and Smith, J.M. (2001) "Numerical Modeling of Waves at Ponce de Leon Inlet, Florida." *Journal of Waterway, Port, Coastal, and Ocean Engineering*., American Society of Civil Engineers. Volume 127, No.3. p. 176-184.
- Sorensen, R.M., (2006) *Basic Coastal Engineering*. Third Edition. Springer Science, New York. 324 pp.
- Sorensen, R.M. (1993) *Basic Wave Mechanics for Coastal and Ocean Engineers*. John Wiley and Sons. 284 pp.
- Stone, J., Fisher, J.S., and Overton, M.F. (1991) "North Carolina Coastal Highways Vulnerable to Long Term Erosion," report to North Carolina DOT from NC State University, 87 pp.
- Sverdrup, H.U. and Munk, W.H. (1947) "Wind, Sea and Swell: Theory of Relations for Forecasting." Hydrographic Office, U.S. Navy. Publication 601. Washington D.C. 50 pp.

- Umeda, Cheng, Yuhi and Ishida (2006). "Three-dimensional Numerical Model of Flow and Scour around a Vertical Cylinder." *Proceedings of Coastal Engineering*. pp.2354-2366.
- U.S. Army Corps of Engineers. (1984) *Shore Protection Manual*. 4th ed., 2 vols. U.S. Army Engineer Waterways Experiment Station, Coastal Engineering Research Center, U.S. Government Printing Office, Washington D.C.
- U.S. Army Corps of Engineers. (2002) *Coastal Engineering Manual*. Engineer Manual 1110-2-1100, U.S. Army Corps of Engineers, Washington, D.C.
- U.S. Commission on Ocean Policy. (2004) "Preliminary Report of the U.S. Commission on Ocean Policy, Governor's Draft." Washington, D.C. April 2004.
- U.S. Department of Transportation. (1991) "Evaluating Scour at Bridges." Technical Advisory – T 5140.23. Federal Highway Administration. 4 pp.
- U.S. Department of Transportation. (2003) *Standard Specifications for Construction of Roads and Bridges on Federal Highway Projects*. Federal Highway Administration Manual. FP-03. U.S. Government Printing Office. 700 pp.
- U.S. Geological Survey. (2003) "An Overview of Coastal Land Loss: With Emphasis on the Southeastern United States", USGS Open File Report 03-337
- U.S. Geological Survey. (1998) "Coastal Erosion Along the U.S. West Coast During the 1997-98 El Niño: Expectations and Observations".
- Wang, H. (1970) "Water Wave Pressure on Horizontal Plate." *Journal of the Hydraulics Division*. American Society of Engineers. Volume 96, No. HY10. p. 1997-2017.
- Weggel, J.R. and Douglass, S.L. (1985) "An Interactive BASIC Program to Calculate Shallow Water, Limited Fetch Wave Conditions." *Hydraulics and Hydrology Laboratory Report 85-1*. Drexel University. 11 pp.
- Weggel, J.R. and Sorensen, R.M. (1986) "Ship Wave Prediction for Port and Channel Design." *Proceedings from the Ports '86 Conference*. American Society of Civil Engineers. p. 794-814.
- Weggel, J.R. (1997) "Breaking-Wave Loads on Vertical Walls Suspended Above Mean Sea Level." Discussion of paper by Chan, et al. *Journal of Waterway, Port, Coastal, and Ocean Engineering*. American Society of Civil Engineers. Volume 123, No. 3. p. 143-146.
- Weggel, J.R. (2005) personal communication
- Westerink, J.J., Blain, C.A., Luettich, R.A., Jr., and Scheffner, N.W. (1994) ADCIRC: An Advanced Three-Dimensional Model for Shelves, Coasts, and Estuaries. "Report 2: User's Manual for ADCIRC-22DI." U.S. Army Corps of Engineers. Washington, D.C. 68 pp.
- Westerink, J.J., Luettich, R.A., Jr., and Scheffner, N.W. (1993) ADCIRC: An Advanced Three-Dimensional Model for Shelves, Coasts, and Estuaries. "Report 3: Development of a Tidal Constituent Database for the Western North Atlantic and Gulf of Mexico." U.S. Army Corps of Engineers. Washington, D.C. 28 pp.
- Wiegel, R.L., (1964) *Oceanographical Engineering*. Prentice Hall, Englewood Cliffs, New Jersey. 532 pp.
- Zevenbergen, L.W., Lagasse, P.F., and Edge, B.L. (2004) "Tidal Hydrology, Hydraulics, and Scour at Bridges." Ayres Associates report to FHWA, Publication Number FHWA-NHI-05-077, Hydraulic Engineering Circular No. 25 (first edition). Federal Highway Administration, Washington D.C. December 2004. 168 pp.

## References

Zevenbergen, L.W., Edge, B.L., Hunt, J.H., Fisher, J.S., Richardson, E.V., and Lagasse, P.F. (2002) "Tidal Hydraulic Modeling for Bridges." Ayres Associates Report. March 2002.

Zevenbergen, L.W., J., Richardson, Edge, B.L., Lagasse, P.F., and Fisher, J.S. (1997) "Development of Hydraulic Computer Models to Analyze Tidal and Coastal Stream Hydraulic Conditions at Highway Structures, Phase II Report." Report No. FHWA-SC-97-04. Federal Highway Administration. Washington, D.C.

Zevenbergen, L.W., Edge, B.L., Lagasse, P.F., and Richardson, E.V. (2002) "Development of Hydraulic Computer Models to Analyze Tidal and Coastal Stream Hydraulic Conditions at Highway Structures, Phase III Report." Report No. FHWA-SC-02-03. Federal Highway Administration. Washington, D.C.

## Appendix A - Metric System, Conversion Factors, and Water Properties

The following information is summarized from the Federal Highway Administration, National Highway Institute (NHI) Course No. 12301, "Metric (SI) Training for Highway Agencies." For additional information, refer to the Participant Notebook for NHI Course No. 12301.

In SI there are seven base units, many derived units and two supplemental units (Table A.1). Base units uniquely describe a property requiring measurement. One of the most common units in civil engineering is length, with a base unit of meters in SI. Decimal multiples of meter includes the kilometer (1000 m), the centimeter (1 m/100) and the millimeter (1 m/1000). The second base unit relevant to highway applications is the kilogram, a measure of mass which is the inertial of an object. There is a subtle difference between mass and weight. In SI, mass is a base unit, while weight is a derived quantity related to mass and the acceleration of gravity, sometimes referred to as the force of gravity. In SI the unit of mass is the kilogram and the unit of weight/force is the Newton. Table A.2 illustrates the relationship of mass and weight between SI and English (i.e., customary units or CU). The unit of time is the same in SI as in the CU system (seconds). The measurement of temperature is Centigrade. The following equation converts Fahrenheit temperatures to Centigrade,  $^{\circ}\text{C} = 5/9 (^{\circ}\text{F} - 32)$ .

Derived units are formed by combining base units to express other characteristics. Common derived units in highway drainage engineering include area, volume, velocity, and density. Some derived units have special names (Table A.3).

Table A.4 provides useful conversion factors from CU to SI units. The abbreviations presented in this table for metric units, including the use of upper and lower case (e.g., kilometer is "km" and a Newton is "N") are the standards that should be followed. Table A.5 provides the standard SI prefixes and their definitions.

Tables A.6 and A.7 provide physical properties of water at atmospheric pressure in SI and CU systems of units, respectively. Table A.8 gives the sediment grade scale and Table A.9 gives some common equivalent hydraulic units.

Table A.1. Overview of SI.		
	Units	Symbol
Base units		
length	meter	m
mass	kilogram	kg
time	second	s
temperature*	kelvin	K
electrical current	ampere	A
luminous intensity	candela	cd
amount of material	mole	mol
Derived units	**	
Supplementary units		
angles in the plane	radian	rad
solid angles	steradian	sr
* Use degrees Celsius (°C), which has a more common usage than kelvin.		
** Many derived units exist (see Table A.3 for some common derived units).		

Table A.2. Relationship of Mass and Weight.			
	Mass	Weight or Force of Gravity	Force
CU	slug pound-mass	pound pound-force	pound pound-force
SI	kilogram	newton	newton



Quantity	Name	Symbol	Expression
Frequency	hertz	Hz	$s^{-1}$
Force	newton	N	$Kg \cdot m/s^2$
Pressure, stress	pascal	Pa	$N/m^2$
Energy, work, quantity of heat	joule	J	$N \cdot m$
Power, radiant flux	watt	W	J/s
Electric charge, quantity	coulomb	C	$A \cdot s$
Electric potential	volt	V	W/A
Capacitance	farad	F	C/V
Electric resistance	ohm	$\Omega$	V/A
Electric conductance	siemens	S	A/V
Magnetic flux	weber	Wb	$V \cdot s$
Magnetic flux density	tesla	T	$Wb/m^2$
Inductance	henry	H	Wb/A
Luminous flux	lumen	Lm	$cd \cdot sr$
Illuminance	lux	Lx	$lm/m^2$

Quantity	From CU (English)	To SI (Metric) Units	Multiplied by*
Length	Mile	km	1.609
	yard	m	0.9144
	foot	m	0.3048
	inch	mm	25.4
Area	square mile	$km^2$	2.590
	acre	$m^2$	4047
	acre	hectare	0.4047
	square yard	$m^2$	0.8361
	square foot	$m^2$	0.092 90
	square inch	$mm^2$	645.2

Table A.4. Useful Conversion Factors (continued).			
Quantity	From CU (English)	To SI (Metric) Units	Multiplied by*
Volume	acre foot	m <sup>3</sup>	1 233
	cubic yard	m <sup>3</sup>	0.7646
	cubic foot	m <sup>3</sup>	0.028 32
	cubic foot	L (1000 cm <sup>3</sup> )	28.32
	100 board feet	m <sup>3</sup>	0.2360
	gallon	L (1000 cm <sup>3</sup> )	3.785
	cubic inch	cm <sup>3</sup>	16.39
Mass	Lb	kg	0.4536
	kip (1000 lb)	metric ton (1000 kg)	0.4536
Mass/unit length	plf	kg/m	1.488
Mass/unit area	psf	kg/m <sup>2</sup>	4.882
Mass density	pcf	kg/m <sup>3</sup>	16.02
Force	lb	N	4.448
	kip	kN	4.448
Force/unit length	plf	N/m	14.59
	klf	kN/m	14.59
Pressure, stress, modulus of elasticity	psf	Pa	47.88
	ksf	kPa	47.88
	psi	kPa	6.895
	ksi	MPa	6.895
Bending moment, torque, moment of force	ft-lb	N · m	1.356
	ft-kip	kN · m	1.356
Moment of mass	lb · ft	kg · m	0.1383
Moment of inertia	lb · ft <sup>2</sup>	kg · m <sup>2</sup>	0.042 14
Second moment of area	in <sup>4</sup>	mm <sup>4</sup>	416 200
Section modulus	in <sup>3</sup>	mm <sup>3</sup>	16 390
Power	ton (refrig)	kW	3.517
	Btu/s	kW	1.054
	hp (electric)	W	745.7
	Btu/h	W	0.2931

Table A.4. Useful Conversion Factors (continued).			
Quantity	From CU (English)	To SI (Metric) Units	Multiplied by*
Volume rate of flow	ft <sup>3</sup> /s	m <sup>3</sup> /s	0.028 32
	cfm	m <sup>3</sup> /s	0.000 471 9
	cfm	L/s	0.4719
	mgd	m <sup>3</sup> /s	0.0438
Velocity, speed	ft/s	m/s	<u>0.3048</u>
Acceleration	f/s <sup>2</sup>	m/s <sup>2</sup>	<u>0.3408</u>
Momentum	lb · ft/sec	kg · m/s	0.1383
Angular momentum	lb · ft <sup>2</sup> /s	kg · m <sup>2</sup> /s	0.042 14
Plane angle	degree	rad	0.017 45
		mrad	17.45
* 4 significant figures; underline denotes exact conversion			

Table A.5. Prefixes					
Submultiples			Multiples		
Deci	10 <sup>-1</sup>	d	deka	10 <sup>1</sup>	da
Centi	10 <sup>-2</sup>	c	hecto	10 <sup>2</sup>	h
Milli	10 <sup>-3</sup>	m	kilo	10 <sup>3</sup>	k
Micro	10 <sup>-6</sup>	μ	mega	10 <sup>6</sup>	M
Nano	10 <sup>-9</sup>	n	giga	10 <sup>9</sup>	G
Pico	10 <sup>-12</sup>	p	tera	10 <sup>12</sup>	T
femto	10 <sup>-15</sup>	f	peta	10 <sup>15</sup>	P
atto	10 <sup>-18</sup>	a	exa	10 <sup>18</sup>	E
zepto	10 <sup>-21</sup>	z	zeta	10 <sup>21</sup>	Z
yocto	10 <sup>-24</sup>	y	yotta	10 <sup>24</sup>	Y



Table A.6. Physical Properties of Water at Atmospheric Pressure in SI Units

Temperature		Density	Specific Weight	Dynamic Viscosity	Kinematic Viscosity	Vapor Pressure	Surface Tension <sup>1</sup>	Bulk Modulus
Centigrade	Fahrenheit	kg/m <sup>3</sup>	N/m <sup>3</sup>	N · s/m <sup>2</sup>	m <sup>2</sup> /s	N/m <sup>2</sup> abs.	N/m	GN/m <sup>2</sup>
0°	32°	1,000	9,810	1.79 x 10 <sup>-3</sup>	1.79 x 10 <sup>-6</sup>	611	0.0756	1.99
5°	41°	1,000	9,810	1.51 x 10 <sup>-3</sup>	1.51 x 10 <sup>-6</sup>	872	0.0749	2.05
10°	50°	1,000	9,810	1.31 x 10 <sup>-3</sup>	1.31 x 10 <sup>-6</sup>	1,230	0.0742	2.11
15°	59°	999	9,800	1.14 x 10 <sup>-3</sup>	1.14 x 10 <sup>-6</sup>	1,700	0.0735	2.16
20°	68°	998	9,790	1.00 x 10 <sup>-3</sup>	1.00 x 10 <sup>-6</sup>	2,340	0.0728	2.20
25°	77°	997	9,781	8.91 x 10 <sup>-4</sup>	8.94 x 10 <sup>-7</sup>	3,170	0.0720	2.23
30°	86°	996	9,771	7.97 x 10 <sup>-4</sup>	8.00 x 10 <sup>-7</sup>	4,250	0.0712	2.25
35°	95°	994	9,751	7.20 x 10 <sup>-4</sup>	7.24 x 10 <sup>-7</sup>	5,630	0.0704	2.27
40°	104°	992	9,732	6.53 x 10 <sup>-4</sup>	6.58 x 10 <sup>-7</sup>	7,380	0.0696	2.28
50°	122°	988	9,693	5.47 x 10 <sup>-4</sup>	5.53 x 10 <sup>-7</sup>	12,300	0.0679	
60°	140°	983	9,643	4.66 x 10 <sup>-4</sup>	4.74 x 10 <sup>-7</sup>	20,000	0.0662	
70°	158°	978	9,594	4.04 x 10 <sup>-4</sup>	4.13 x 10 <sup>-7</sup>	31,200	0.0644	
80°	176°	972	9,535	3.54 x 10 <sup>-4</sup>	3.64 x 10 <sup>-7</sup>	47,400	0.0626	
90°	194°	965	9,467	3.15 x 10 <sup>-4</sup>	3.26 x 10 <sup>-7</sup>	70,100	0.0607	
100°	212°	958	9,398	2.82 x 10 <sup>-4</sup>	2.94 x 10 <sup>-7</sup>	101,300	0.0589	

<sup>1</sup>Surface tension of water in contact with air

Temperature		Density	Specific Weight	Dynamic Viscosity	Kinematic Viscosity	Vapor Pressure	Surface Tension <sup>1</sup>	Bulk Modulus
Fahrenheit	Centigrade	Slug/ft <sup>3</sup>	Weight lb/ft <sup>3</sup>	lb-sec/ft <sup>2</sup>	ft <sup>2</sup> /sec	lb/in <sup>2</sup>	lb/ft	lb/in <sup>2</sup>
32°	0°	1.940	62,416	0.374 x 10 <sup>-4</sup>	1.93 x 10 <sup>-5</sup>	0.09	0.00518	1.99
39.2°	4.0°	1.940	62,424	0				
40°	4.4°	1.940	62,423	0.323	1.67	0.12	0.00514	2.05
50°	10.0°	1.940	62,408	0.273	1.41	0.18	0.00508	2.11
60°	15.6°	1.939	62,366	0.235	1.21	0.26	0.00504	2.16
70°	21.1°	1.936	62,300	0.205	1.06	0.36	0.00497	2.20
80°	26.7°	1.934	62,217	0.180	0.929	0.51	0.00492	2.23
90°	32.2°	1.931	62,118	0.160	0.828	0.70	0.00486	2.25
100°	37.8°	1.927	61,998	0.143	0.741	0.95	0.00479	2.27
120°	48.9°	1.918	61,719	0.117	0.610	1.69	0.0466	2.28
140°	60°	1.908	61,386	0.0979	0.513	2.89		
160°	71.1°	1.896	61,006	0.0835	0.440	4.74		
180°	82.2°	1.883	60,586	0.0726	0.385	7.51		
200°	93.3°	1.869	60,135	0.0637	0.341	11.52		
212°	100°	1.847	59,843	0.0593	0.319	14.70		

<sup>1</sup>Surface tension of water in contact with air, weight of sea water approximately 63.93 lb/ft<sup>3</sup> @ 15°C

Table A.8. Sediment Particles Grade Scale.						
Size				Approximate Sieve Mesh Opening per Inch		Class
Millimeters		Microns	Inches	Tyler	U.S. Standard	
4000-2000	----	----	160-80	----	----	Very large boulders
2000-1000	----	----	80-40	----	----	Large boulders
1000-500	----	----	40-20	----	----	Medium boulders
500-250	----	----	20-10	----	----	Small boulders
250-130	----	----	10-5	----	----	Large cobbles
130-64	----	----	5-2.5	----	----	Small cobbles
64-32	----	----	2.5-1.3	----	----	Very coarse gravel
32-16	----	----	1.3-0.6	----	----	Coarse gravel
16-8	----	----	0.6-0.3	2 1/2	----	Medium gravel
8-4	----	----	0.3-0.16	5	5	Fine gravel
4-2	----	----	0.16-0.08	9	10	Very fine gravel
2-1	2.00-1.00	2000-1000	----	16	18	Very coarse sand
1-1/2	1.00-0.50	1000-500	----	32	35	Coarse sand
1/2-1/4	0.50-0.25	500-250	----	60	60	Medium sand
1/4-1/8	0.25-0.125	250-125	----	115	120	Fine sand
1/8-1/16	0.125-0.062	125-62	----	250	230	Very fine sand
1/16-1/32	0.062-0.031	62-31	----	----	----	Coarse silt
1/32-1/64	0.031-0.016	31-16	----	----	----	Medium silt
1/64-1/128	0.016-0.008	16-8	----	----	----	Fine silt
1/128-1/256	0.008-0.004	8-4	----	----	----	Very fine silt
1/256-1/512	0.004-0.0020	4-2	----	----	----	Coarse clay
1/512-1/1024	0.0020-0.0010	2-1	----	----	----	Medium clay
1/1024-1/2048	0.0010-0.0005	1-0.5	----	----	----	Fine clay
1/2048-1/4096	0.0005-0.0002	0.5-0.24	----	----	----	Very fine clay

Table A.9. Common Equivalent Hydraulic Units								
Volume								
Unit	Equivalent							
	cubic inch	liter	u.s. gallon	cubic foot	cubic yard	cubic meter	acre-foot	sec-foot-day
liter	61.02	1	0.264 2	0.035 31	0.001 308	0.001	810.6 E - 9	408.7 E - 9
u.s. gallon	231.0	3.785	1	0.1337	0.004 951	0.003 785	3.068 E - 6	1.547 E - 6
cubic foot	1728	28.32	7.481	1	0.037 04	0.028 32	22.96 E - 6	11.57 E - 6
cubic yard	46,660	764.6	202.0	27	1	0.746 6	619.8 E - 6	312.5 E - 6
meter <sup>3</sup>	61,020	1000	264.2	35.31	1.308	1	810.6 E - 6	408.7 E - 6
acre-foot	75.27 E + 6	1,233,000	325,900	43 560	1.613	1 233	1	0.504 2
sec-foot-day	149.3 E + 6	2,447,000	646,400	66 400	3 200	2 447	1.983	1
Discharge (Flow Rate, Volume/Time)								
Unit	Equivalent							
	gallon/min	liter/sec	acre-foot/day	foot <sup>3</sup> /sec	million gal/day	meter <sup>3</sup> /sec		
gallon/minute	1	0.063 09	0.004 419	0.002 228	0.001 440	63.09 E-6		
liter/second	15.85	1	0.070 05	0.035 31	0.022 82	0.001		
acre-foot/day	226.3	14.28	1	0.504 2	325 9	0.014 28		
feet <sup>3</sup> /second	448.8	28.32	1.983	1	0.646 3	0.028 32		
meter <sup>3</sup> /second	15,850	1000	70.04	35.31	22.83	1		





*Page Intentionally Left Blank*

## **Appendix B – Coastal Roadway Study**

### ***B.1 Study Approach***

This appendix documents an analysis by the University of South Alabama and originally presented orally at the 2005 Transportation Research Board meeting. The primary result of the study is the estimate that there are roughly 60,000 road miles in the US which are occasionally exposed to coastal surge and waves.

The study applied a Geographical Information System (GIS) to process and analyze FEMA Q3 Digital Flood Data (and associated flood zones) and commercially developed street and roadway map coverages. The flood zones considered were the Special Flood Hazard Areas, which correspond with FEMA's estimates of 100-year flood plain, and the V-zone flood areas, which are FEMA's estimates of where coastal waves greater than 3 feet high will exist during the 100-year storm. Overlaying the road data with the flood zone data resulted in the length of roads contained in the flood zones. This analysis was done for each available coastal county in the FEMA dataset.

### ***B.2 Application of Reduction Factor***

One weakness with this approach is that the flood data do not differentiate between coastal and riverine flooding with the coastal county. In order to enhance the estimate to reflect more of a "coastal" focus, the study then developed a subjective "reduction factor" approach. Researchers reviewed the GIS overlay for each coastal county throughout the US and visually estimated the percentage of the flooded roads that were immediately along the coast (likely flooded due to coastal storm surge and not rainfall runoff-induced riverine flooding).

This "heads up" visual estimation was based primarily on the location of the flooded roads within the county. If the flooded road was not near the coast or an obvious estuary but rather along a river some distance inland, it was not considered coastal flooding. This subjective percentage estimate of a "reduction factor" was made for each county and then averaged for each coastal state. This "reduction factor" was then applied to reduce the more precise, GIS-based road mileage value for each state.

### ***B.3 Study Outcomes***

Three study outcomes include the road miles in the 100-year flood zones, the road miles in the V-zones, and the road miles in the coastal 100-year flood zone (as "reduced"). This latter value results in the total 60,000 road miles estimate. As explained below, this is likely a low estimate.

As revealed in Table B.1, there are 89,243 miles of roads located in the evaluated 100-year floodplains. Table B.1 (and Figure B.1) also shows the mileage of roads in the 100-year floodplain by State. As not all States have V-zone information, those values could not be included in the study (and table).

Table B.1. Coastal State mileage in 100-year coastal floodplains and v-zones.

State	Road miles in 100-year floodplain	Road miles in V- zones
Alabama	760	74
California	7494	
Connecticut	886	34
Delaware	763	12
Florida	29793	827
Georgia	2637	167
Illinois	764	
Louisiana	8442	
Maine	814	63
Maryland	2109	28
Massachusetts	1631	167
Michigan	1442	
Minnesota	178	
Mississippi	1146	74
New Hampshire	169	3
New Jersey	5866	95
New York	1672	199
North Carolina	5254	124
Ohio	380	
Oregon	1695	
Pennsylvania	58	
Rhode Island	422	81
South Carolina	4842	223
Texas	6662	23
Virginia	1662	88
Washington	1114	
Wisconsin	588	
Nationwide totals	89243	2282

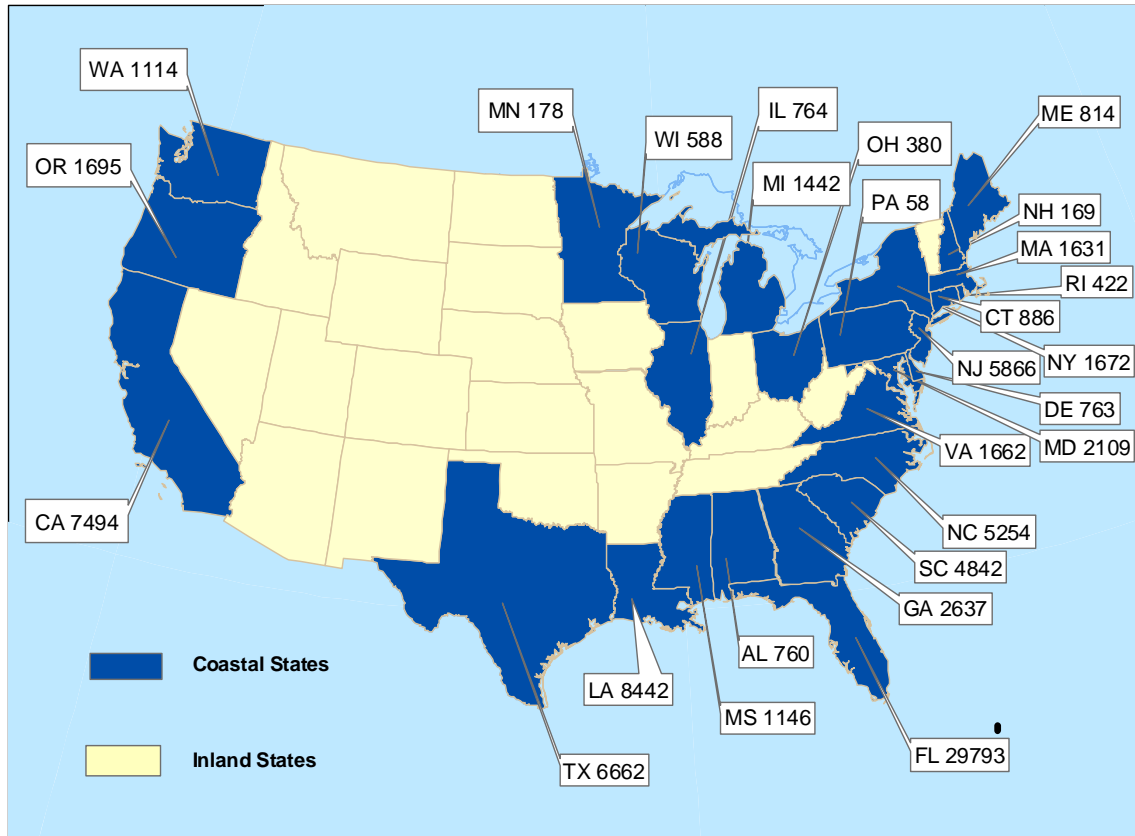

Figure B.1. Estimates of road mileage in the 100-year floodplain.

Table B.2 presents the county-by-county breakdown of these values for the Atlantic and Gulf coast states (including floodplains and v-zones). Table B.3 presents the county-by-county breakdown of these values for the Pacific coast and Great Lakes states (floodplains only).

Nationwide, 2,282 miles of road are located in the V-zones in the coastal counties evaluated. As described earlier, these values exclude all the Pacific and Great Lakes states since FEMA only maps V-zones in some Atlantic and Gulf coast states. Figure B.2 shows the mileage in the V-zones for States having such analyses available.

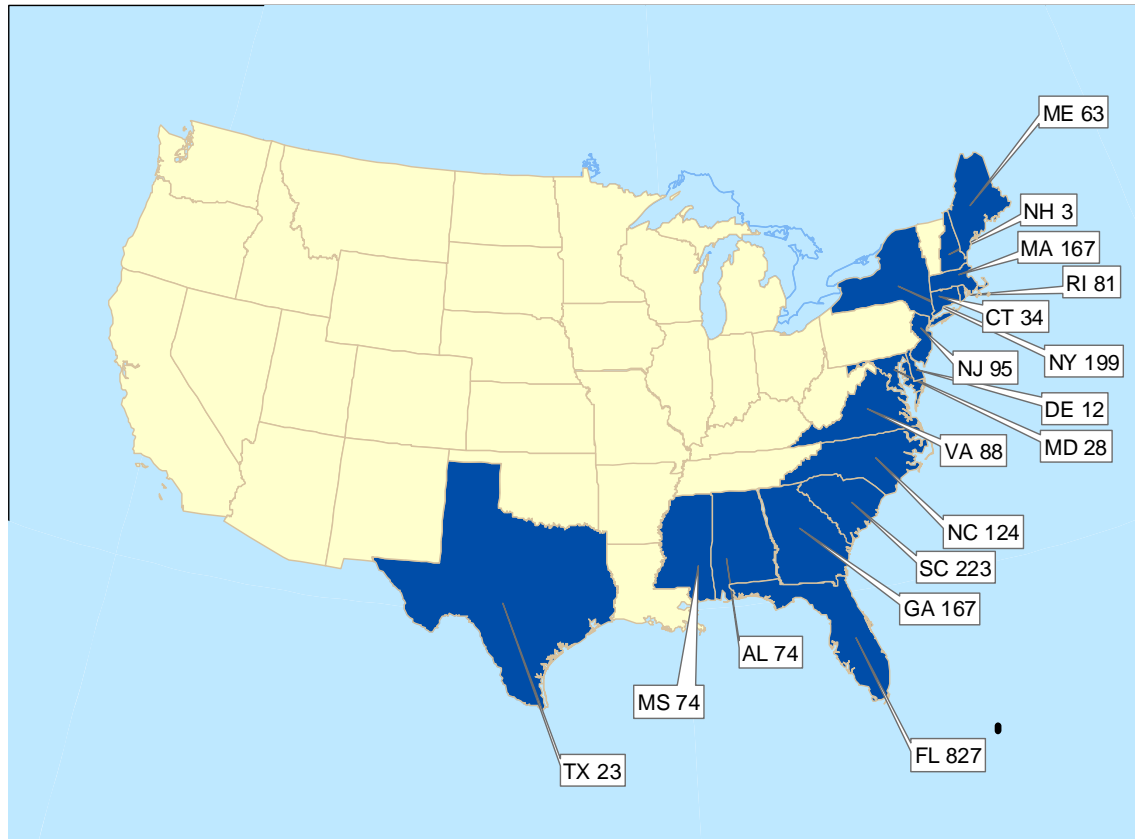

Figure B.2. Estimates of road mileage in 100-year floodplain "V-zones".

Table B.2. Atlantic and Gulf coastal county mileage in 100-year floodplains and v-zones.

State	County (100-year flood zone miles; v-zone miles)
Alabama	Baldwin (341;49) Mobile (419;25)
Connecticut	Fairfield (324; 11), Middlesex (133; 3), New Haven (267; 10), New London (162; 10)
Delaware	Kent (150; 1), New Castle (154; 0), Sussex (459; 11)
Florida	Bay (309; 5), Brevard (735; 3), Broward (4,688; 7), Charlotte (1,313; 19), Collier (859; 17), Dixie (967; 106), Duval (305; 14), Escambia (243; 16), Flagler (238; 0), Franklin (1,201; 63), Gulf (665; 15), Hernando (201; 45), Hillsborough (1,249; 17), Indian River (647; 2), Lee (1,881; 37), Levy (1,104; 118), Manatee (525; 16), Martin (139; 2), Miami-Dade (4,803; 23), Monroe (965; 94), Nassau (261; 8), Okaloosa (133; 7), Palm Beach (1,167; 22), Pasco (888; 18), Pinellas (1,253; 53), St. Lucie (203; 7), Santa Rosa (241; 8), Sarasota (667; 12), St. Johns (353; 0), Wakulla (524; 70), Walton (191; 3), Volusia (875; 0)
Georgia	Bryan (311;13), Camden (349;11), Chatham (710;48), Glynn (710;23), Liberty (294;29), McIntosh (263;43)
Louisiana	Cameron (944), Iberia (327), Jefferson (1,177), La Fourche (878), Orleans (1,222), Plaquemines (387), Saint Bernard (139), Saint Mary (753), Saint Tammany (1,090), Terrabonne (531), Vermillion (994)
Maine	Cumberland (123;10), Hancock (145;29), Penobscot (186;0), Sagadahoc (40;1), Waldo (65;4), Washington (121;15), York (134;4)
Maryland	Ann Arundel (127;2), Baltimore (156;0), Baltimore City (57;4), Calvert (18;1), Cecil (57;0), Dorchester (535;0), Harford (78;0), Prince Georges (90;0), Queen Anne (85;3), Saint Mary's (296;0), Somerset (63;3), Talbot (106;2), Wicomico (88;1), Worcester (353;12)
Massachusetts	Barnstable (350;59), Bristol (189;27), Dukes (64;11), Essex (222;10), Middlesex (224;0), Nantucket (40;9), Norfolk (180;3), Plymouth (362; 48)
Mississippi	Hancock (409;30), Harrison (340;22), Jackson (397;22)
New Hampshire	Rockingham (169;3)
New Jersey	Atlantic (1,053;10), Bergen (430;0), Burlington (895;0), Cape May (722;30), Cumberland (468;0), Monmouth (589;22), Ocean (1,313;33), Salem (396;0)
New York	Nassau (330;20), New York (475;23), Suffolk (701;152), Westchester (166;4)
North Carolina	Beaufort (649;0), Brunswick (743;69), Camden (132;0), Carteret (698;15), Currituck (242;2), Dare (842;20), Hyde (848;7), New Hanover (160;1), Onslow (161;7), Pamlico (370;2), Pender (409;1)
Rhode Island	Kent (99;17), Newport (79;28), Providence (86;7), Washington (158;29)
South Carolina	Beaufort (1,139;12), Berkeley (327;3), Charleston (1,523;157), Colleton (570;13), Georgetown (509;21), Horry (422;17), Jasper (352;0)
Texas	Aransas (182), Brazoria (1,135), Calhoun (361), Cameron (840), Chambers (610), Galveston (884), Jackson (323), Jefferson (742), Kenedy (23;23), Kleberg (292), Matagorda (520), Neuces (435), San Patricio (208), Willacy (107)
Virginia	Accomack(399;27), Gloucester (133;9), Hampton City (159;8), Lancaster (56;2), Matthews (189;7), Middlesex (30;2), Newport News City (32;1), Norfolk City (115;2), Northampton (69;10), Northumberland (29;1), Portsmouth City (59;0), Prince William (41;0), Poquoson City (51;1), Richmond (13;0), Virginia Beach City (233;16), Westmoreland (20;1), York (34;1)

Table B.3. Pacific and Great Lake States coastal county mileage in 100-year floodplains.

State	County (100-year flood zone miles)
California	Alameda (156), Contra Costa (327), Del Norte (80), Humboldt (1,855), Los Angeles (879), Marin (356), Mendocino (270), Monterey (503), Napa (89), Orange (1,105), San Mateo (129), San Luis Obispo (851), Santa Barbara (264), Santa Cruz (97), Sonoma (146), Ventura (387)
Illinois	Cook (550), Lake (214)
Michigan	Alpena (8), Arenac (98), Bay (233), Berrien (61), Chippewa (101), Delta (88), Huron (44), Iosco (20), Keweenaw (10), Mackinac (36), Macomb (149), Manistee (21), Menominee (33), Monroe (167), Muskegon (27), St. Clair (94), Wayne (252)
Minnesota	St. Louis (178)
Ohio	Cuyahoga (86), Erie (66), Lake (50), Ottawa (178)
Oregon	Clatsop (137), Coos (268), Douglass (294), Lane (660), Lincoln (190), Tillamook (146)
Pennsylvania	Erie (58)
Washington	Clallam (164), Grays Harbor (404), Jefferson (107), Pacific (125), San Juan (93), Whatcom (221)
Wisconsin	Bayfield (65), Brown (147), Manitowoc (45), Marinette (133), Milwaukee (76), Ozaukee (65), Racine (57)

Figure B.3 shows the estimated mileage of coastal highways in each state. The difference between the values in Figure B.1 and Figure B.3 is a result of the “reduction factor” applied to each State. Finally, Table B.4 presents a summary of these coastal, road results and includes the “reduction factors” used for each State.

#### **B.4 Study Caveats**

There are a number of shortcomings with the methodology outlined above that contribute to uncertainty and error in the estimate. The most obvious shortcoming is the very low results for some Great Lakes and Pacific coast states as shown in Figure B.3 and Table B.4. Some of those values, such as Ohio’s four miles, are clearly much too low. The primary issue was the lack of available flood mapping data in many coastal counties. Most of the missing counties are in the Great Lakes region but there are some in almost every coastal state.

The methodology also relies on the accuracy of the FEMA Q3 digital flood maps as obtained in the 1998-1999 timeframe. More recent updates are not included and all errors in those data are included. Another shortcoming is that the geography of some of the coastal states such as the Pacific or Great Lakes means that some highways that run along the tops of bluffs are not in the floodplain but might have protective coastal revetments. Another shortcoming is the subjective “reduction factor” approach discussed previously. Another shortcoming is that the definition of a coastal county is somewhat problematic.

In spite of these shortcomings, this result is the best available estimate of the nationwide extent of coastal highways. This is probably a low estimate. An improved estimate of the extent of coastal highways could be developed by the individual state DOTs.



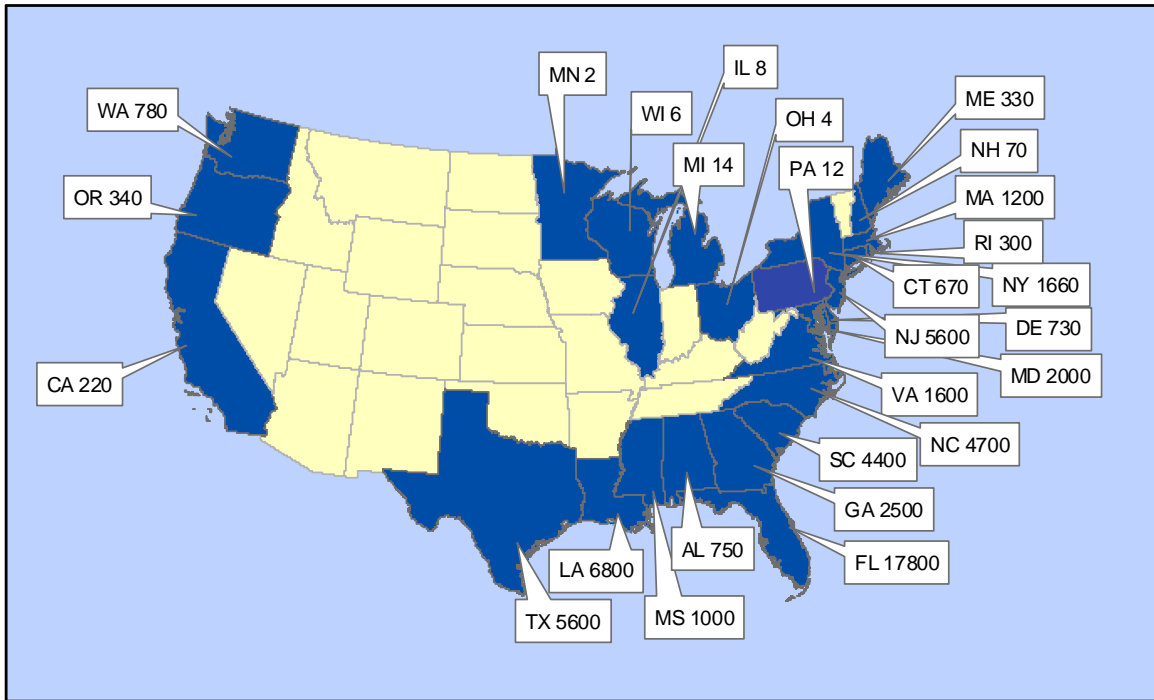

Figure B.3. Estimates of coastal highway mileage per State.

Table B.4. Summary of state coastal road miles and “reduction factors.”

State	“reduction factor”	Coastal Road Miles
Alabama	0.99	752
California	0.03	225
Connecticut	0.75	665
Delaware	0.95	725
Florida	0.60	17875
Georgia	0.95	2505
Illinois	0.01	8
Louisiana	0.80	6754
Maine	0.40	326
Maryland	0.95	2004
Massachusetts	0.75	1223
Michigan	0.01	14
Minnesota	0.01	2
Mississippi	0.95	1089
New Hampshire	0.40	68
New Jersey	0.95	5573
New York	0.99	1655
North Carolina	0.90	4729
Ohio	0.01	4
Oregon	0.20	339
Pennsylvania	0.20	11
Rhode Island	0.70	295
South Carolina	0.99	4445
Texas	0.85	5572
Virginia	0.99	1645
Washington	0.70	780
Wisconsin	0.01	6
Nationwide totals		59,287

## Appendix C – Estimation of Wave Height and Period

This Appendix describes a methodology and computer program for estimating wave heights and wave periods in coastal bays and lakes and other situations where the fetch is limited. The equations used were originally published in the Shore Protection Manual (USACE 1984). Subsequently, an algorithm, called WAVGEN, for the practical solution of the equations was reported by Weggel and Douglass (1985). The algorithm provides reasonable estimates of wave conditions when used to forecast for construction operations in shallow water (Douglass, et al. 1992). The practical solution algorithm can be programmed into a spreadsheet (Weggel 2005). This spreadsheet was used to generate Figure 4.14.

The USACE (1984) methodology uses parametric equations to estimate wave height and period in terms of the “parameters” of fetch (F), windspeed ( $U_a$ ), and an average, constant water depth (d). The equation for dimensionless wave height ( $H'$ ) is:

$$H' = c_1 \tanh(c_2 d'^{\frac{3}{4}}) \tanh\left[\frac{c_3 F'^{\frac{1}{2}}}{\tanh(c_2 d'^{\frac{3}{4}})}\right] \quad (C.1)$$

where:

- $c_1$  = coefficient equal to 0.283
- $c_2$  = coefficient equal to 0.530
- $c_3$  = coefficient equal to 0.00565
- $d'$  = dimensionless water depth, expressed by equation C.5 below
- $F'$  = dimensionless fetch, expressed by equation C.6 below

The dimensionless wave period ( $T'$ ) can be described as:

$$T' = c_4 \tanh(c_5 d'^{\frac{3}{8}}) \tanh\left[\frac{c_6 F'^{\frac{1}{3}}}{\tanh(c_5 d'^{\frac{3}{8}})}\right] \quad (C.2)$$

where:

- $c_4$  = coefficient equal to 7.540
- $c_5$  = coefficient equal to 0.833
- $c_6$  = coefficient equal to 0.0379

The duration (dimensionless) required to reach the fully arisen conditions implicit in Equations C.2 and C.3 ( $t'$ ) is:

$$t' = c_7 T'^{\frac{7}{3}} \quad (C.3)$$

where:

- $c_7$  = coefficient equal to 537

The dimensionless variables used above are defined as:

$$H' = \text{dimensionless wave height} = \frac{g H_{m_0}}{U_a^2} \quad (\text{C.4})$$

where:

$$\begin{aligned} g &= \text{Acceleration of gravity} \\ H_{m_0} &= \text{spectral-based significant wave height} \\ U_a &= \text{adjusted windspeed} \end{aligned}$$

$$d' = \text{dimensionless water depth} = \frac{g d}{U_a^2} \quad (\text{C.5})$$

where:

$$d = \text{water depth}$$

$$F' = \text{dimensionless fetch} = \frac{g F}{U_a^2} \quad (\text{C.6})$$

where:

$$F = \text{fetch length}$$

$$T' = \text{dimensionless wave period} = \frac{g T}{U_a} \quad (\text{C.7})$$

where:

$$T = \text{wave period corresponding to the peak of the energy density spectrum}$$

$$t' = \text{dimensionless time required for fully-arisen conditions} = \frac{g t}{U_a} \quad (\text{C.8})$$

where:

$$t = \text{duration of wind}$$

The adjusted windspeed ( $U_a$ ) in the above equations is the measured or forecast windspeed adjusted to include the effects of possible elevation differences from 33 feet (10 meters) above the surface, duration, a correction for whether the measurement is over land or water, non-constant coefficient of drag, and air-sea temperature differences. These adjustments and corrections follow the Shore Protection Manual recommendations and are based in large part on the investigation of wind boundary layer on the Great Lakes by Resio & Vincent (1977).

Observed windspeed depends upon the height at which the measurement is taken. To make an adjustment due to elevation, a common base height for the data is taken at 33 feet (10 meters) above the surface. To obtain the correction, the following equation is used:

$$U_{(10)} = U_{(z)} \left[ \frac{10}{z} \right]^{\frac{1}{7}} \quad (\text{C.9})$$

where:

- $U_{(10)}$  = windspeed 10 meters above the surface
- $U_{(z)}$  = windspeed z meters above the surface
- $z$  = height above the ground at which the wind measurement was made

Windspeed is not steady, so the reported windspeed is generally an average taken over a time span. The adjustment for duration converts a windspeed to an equivalent windspeed of a different averaging time period. This is achieved by converting windspeeds over any time period to another averaging time by first converting the observation to a one-hour averaging time. To obtain the correction, the following equations are used:

$$\frac{U_t}{U_{3600}} = 1.277 + 0.296 \tanh \left[ 0.9 \log \frac{45}{t} \right] \quad (\text{for } 1 \text{ sec} < t < 3600 \text{ sec}) \quad (\text{C.10})$$

$$\frac{U_t}{U_{3600}} = -0.15 \log(t) + 1.5334 \quad (\text{for } 3600 \text{ sec} < t < 36000 \text{ sec}) \quad (\text{C.11})$$

where:

- $t$  = duration of interest in seconds
- $U_t$  = equivalent windspeed of duration  $t$
- $U_{3600}$  = average one-hour windspeed

An adjustment is also necessary for overland measurement, due to increased surface area when passing over land than when compared to over water. Generally, overland measurements are obtained when data over water is not available, and wind data is taken from a nearby site, such as an airport. The correction equations are:

$$U_w = 2.4(U_l) \left[ \frac{U_l}{1.689} \right]^{(-0.2737)} \quad (\text{C.12})$$

where:

- $U_w$  = Windspeed over water (in ft/sec)
- $U_l$  = Windspeed over land (in ft/sec)

Wave generation is a function of the drag or stress of the wind on the water. Wind stress is not linearly related to wind speed. Windspeed is adjusted for this non-constant coefficient of drag by the equation:

$$U_a = 0.864 \left[ \frac{U_w}{1.4667} \right]^{1.23} \quad (\text{C.13})$$

where:

- $U_a$  = Windspeed adjusted for non-constant coefficient of drag (in ft/sec)

## Appendix C

$U_w$  = Windspeed over water (in ft/sec)

The difference in the temperatures of the air and the sea influences the effectiveness of the wind in generating waves. To adjust for this difference, the following equation is used:

$$U' = (1 + 0.06878 \times |T_w - T_a|) \times (0.3881) \times (\text{sign}[T_w - T_a]) \times U \quad (\text{C.14})$$

where:

$U'$  = windspeed adjusted for air-sea temperature difference (in ft/sec)  
 $T_w$  = water temperature (in degrees Celsius)  
 $T_a$  = air temperature (in degrees Celsius)  
 $U$  = windspeed not adjusted for air-sea temperature difference  
 $\text{sign}[T_w - T_a]$  = +1 when  $[T_w - T_a] > 0$   
= -1 when  $[T_w - T_a] < 0$   
= +1 when  $[T_w - T_a] = 0$

The averaging time for the windspeed measurement should match the time to reach the fully-arisen wave conditions. This requires a procedure which iterates between Equation C.8 and Equations C.10 or C.11. In other words the averaging time and corresponding windspeed is adjusted until the minimum duration required to meet the fully-developed wave conditions is obtained for that fetch and depth.

## Appendix D – Scour Policy, Guidance, and Research

### ***D.1 Coastal Scour Policy, Guidance, and Research***

Significant resources have been devoted to the bridge scour problem resulting in development of a body of knowledge. The discussion below provides a brief synopsis of key documents used in scour policy and guidance, including scour estimation and potential countermeasures. This discussion also provides a brief summary of some relevant coastal scour research efforts.

#### **D.1.1 Technical Advisory T 5140.23 – Evaluating Scour at Bridges**

In 1991, FHWA issued Technical Advisory T 5140.23 “Evaluating Scour at Bridges” (TA 5140.23) which makes specific recommendations to reduce future flood damage to bridges<sup>8</sup> (FHWA 1991). These recommendations address both new bridges and existing bridges.

TA 5140.23 specifically mentions tidal waterways. However, the TA’s call for interdisciplinary teams for evaluating scour only mentions the specialty areas of “hydraulic, geotechnical and structural engineers” and does not include coastal engineers. In coastal and tidally-influenced settings, a trained, experienced coastal engineer would be a valuable addition to such a team because of the significant differences between riverine and coastal hydraulics.

#### **D.1.2 Highway Engineer Circular 18 – Evaluating Scour at Bridges**

HEC-18 “Evaluating Scour at Bridges” (fourth edition) provides guidelines for designing new bridges to resist scour, evaluating existing bridges for vulnerability to scour, inspecting bridges for scour, and improving the state-of-practice of estimating scour at bridges (Richardson and Davis 2001).

HEC-18 has a chapter entitled “Scour Analysis for Tidal Waterways” that presents a three level approach to developing the hydraulic analyses required to apply the same scour equations that are used in riverine situations. The first level is qualitative, the second level includes an estimate of the maximum discharge under the bridge based on tidal prism, and the third level is based on numerical (or physical) models of coastal hydrodynamics.

The results of the hydraulic analyses, primarily maximum discharge, are then entered into scour estimation equations developed for riverine scour. There is a recognition that “using these riverine scour equations, which are for steady state equilibrium conditions for unsteady, dynamic tidal flow may result in estimating deeper scour depths than will actually occur (conservative estimate), but this represents the state of knowledge at this time for this level of analysis” (Richardson and Davis 2001).

#### **D.1.3 Bridge Scour Countermeasures**

Design of bridge scour countermeasures in the coastal environment should apply approaches and techniques described in HEC-23, “Bridge Scour and Stream Instability Countermeasures (second edition)” (Lagasse, 2001). Such guidance should be supplemented by the methods and approaches contained with this document.

---

<sup>8</sup> <http://www.fhwa.dot.gov/legsregs/directives>

## **D.2 Coastal Scour Research and Studies**

### **D.2.1 American Society of Civil Engineer efforts**

Richardson and Lagasse (1999) provide a compendium of scour and stream stability related papers and abstracts that were published and presented at the American Society of Civil Engineers' Hydraulics Division annual conference meetings between 1991 and 1998. It contains 24 abstracts and 11 papers on "Bridge Scour in Tidal Waters."

### **D.2.2 Pooled Fund Study**

From 1992 through 2002, twelve State DOTs and FHWA contributed to a "pooled fund" study of coastal hydraulics related to bridge scour. These states extended from Maine to Louisiana with South Carolina DOT taking the lead. The results of these studies are summarized in Richardson, et al. (1994), Zevenbergen, et al. (1997), Zevenbergen, et al. (2002a), Zevenbergen et al. (2002b), and Zevenbergen, et al. (2004). These studies make numerous recommendations for analyzing the hydraulics in the tidal bridge situation.

One recommendation was for Coastal State DOTs to reassess how they conducted hydraulic design studies in the coastal environment. As 95% of bridges in the United States cross rivers, it is not surprising that State DOT drainage manuals described river-oriented techniques and modeling approaches. This included using the practice of using steady flow assumptions (i.e., peak flow and no temporal variation of water surface elevation). The study recommended adopting unsteady flow or "storm hydrograph" approaches to reflect the reality of tides and storm surges on the coast.

Another recommendation was the use of a synthetic coastal storm surge hydrograph (SWL variation through time) as boundary conditions to evaluate maximum discharge for scour estimation. Several different synthetic unit hydrographs have been proposed in the literature (Cialone, et al. 1993; Zevenbergen, et al. 2002a).

Applying these recommendations means using unsteady flow models to simulate the more complex coastal hydrodynamics. The study also recognized that coastal waterways likely require two-dimensional models to more accurately simulate the bathymetric conditions in coastal waterways.

A related recommendation was the use of a set of estimates of the 100-year and 500-year storm surge magnitudes at some specific locations in the twelve states. These surge estimates were developed by the USACE using simulations of historic storms in the north Atlantic and Gulf of Mexico with the ADCIRC hydrodynamic model.

A final recommendation was to continue to research coastal waterway scour formation mechanisms (including the time dependency described earlier). Scour researchers have long understood that the problematic nature of applying riverine derived scour procedures to the coastal waterway.

Many of the "pooled fund" study analyses and procedures were eventually incorporated in the 1<sup>st</sup> edition of the HEC-25 document.

### **D.2.3 Florida DOT Sponsored Research**

As described elsewhere in this document, the Florida DOT (FDOT) has long engaged in scour research, suitable to the coastal environment and other places.

This effort began in mid-1980s, when FDOT began an intensive research effort to develop equations for estimating pier scour. Their efforts were not Florida-specific or initially focused on



the tidal environment, but rather targeting the fundamental mechanisms of pier scour. The FDOT exercised care in assessing credibility of available pier scour research data and in carrying out further experimentation. This provided FDOT with a real understanding of the applicability and risks associated with their research. After review and approval by the FHWA, the equations, policies, and manuals became current guidance for predicting bridge scour in the State of Florida (from FDOT, 2008).

For general bridge pier scour, FDOT adopted Sheppard's equations that targets three dimensionless hydraulic and sediment transport parameter groups to predict scour at simple piers (Sheppard, 2003; from FDOT, 2008). The equation is applicable to both riverine and tidal flows, applies to sediment sizes typical within the continental US, and gives good results for both narrow and wide piers (from FDOT, 2008). Additionally, FDOT uses scour equations suitable for complex pier configurations.

The University of Florida has conducted research and developed time dependent scour equations (Gosselin and Sheppard, 1998; Miller, 2003). The Florida equations require a time-marching solution for the depth of scour adjacent to bridge piers. Input requires time-varying estimates of depth-averaged storm surge velocities at the bridge based on numerical modeling of the hydrodynamics. The Florida equations include calibration coefficients which are primarily based on laboratory investigations. Miller (2003) discusses how the equations can be used to estimate scour at prototype coastal bridges.

To better understand and apply boundary conditions for scour and other coastal hydraulics, FDOT engaged Sheppard and Miller (2003) to evaluate available storm surge estimates along the Florida coast, including those from the "pooled fund" study. They recommend that the FDOT use the storm surge estimates from other available sources instead of using the estimates developed during the "pooled fund" study. The recommended storm surge estimates for FDOT were primarily from a study funded by the state coastal resource agency, the Florida Department of Environmental Protection. Some of the recommended values were from FEMA flood frequency analyses.

The FDOT continues to sponsor and conducted research in this area. Further information may be found on the FDOT website: <http://www.dot.state.fl.us/rddesign/dr/Bridgescour/Bridge-Scour-Policy-Guidance.htm> .

Because of the thoroughness of the research, and the clear and acknowledged understanding of the risks and uncertainties associated with the methods, the FHWA allows FDOT to apply these methods in lieu of HEC-18 approaches.

#### D.2.4 University of South Alabama Studies

As part of a FHWA affiliated research contract, the University of South Alabama (USA) is beginning a project to identify the salient mechanisms related to wave-induced scour. Identified threats related to wave-induced scour will be used to quantify potential damages or losses to infrastructure susceptible to coastal scour processes. This evaluation will generate a rubric, or norm-referenced set of criteria that may be applied to evaluate scour potential at various sites – even those that have not been, or are not, monitored for scour.

USA researchers will conduct qualitative, physical experiments on wave-induced scour to verify the salient mechanisms and processes controlling the phenomenon. These physical experiments will be performed in the USA wave basin. Physical measurements of scour holes at a number of bridges will also be obtained, as well as some limited monitoring if feasible.

Additionally, adapting a research model developed by the principal investigator, USA will perform numerical simulations of wave-induced scour. The results of these physical and

## Appendix D

numerical experiments will be used to identify appropriate methodologies and tools, to be utilized by DOT officials and engineers, for evaluating wave-induced scour potential at various sites.

## Appendix E – A Method for Estimating Wave Forces on Bridges

This Appendix presents a method for estimating wave loads on typical US bridge spans. This method was originally suggested in Douglass, et al. (2006) as interim guidance until a more appropriate methodology can be developed based on quantitative laboratory tests with realistic bridge models and properly scaled waves. The notation shown below is slightly different than the notation used in Douglass, et al. (2006). Subsequently available laboratory test results with realistic bridge models confirm that this approach provides reasonable, conservative estimates (Cruz-Castro, et al 2006, Douglass, et al. 2007).

This method is intended to be simple to apply, consistent with the available technical knowledge, and such that it can be applied conservatively. It is also intended to be an approach that can be tested and improved upon relatively easily in the future as laboratory and prototype experimental data become available. The method does a good job of explaining the recent damage to bridges.

The method is based on the basic concept that the peak wave-induced loads can be expressed in terms of an “apparent hydrostatic load” or “reference load.” This is not meant to imply that the wave loads are static. They are clearly extremely dynamically applied to the bridge superstructure by individual waves. However, a number of investigators have found that wave-induced loads can be expressed as some multiple of  $\gamma(\Delta z)A$ , which is similar to the hydrostatic load equation from hydraulic engineering. The vertical distance,  $\Delta z$ , is the level of submergence. For the wave-induced uplift load case, the level of submergence is defined below from the crest of the largest wave in the design sea state to either the bottom of the bridge deck or the bottom of the diaphragms under the deck.

The method assumes a wave-induced load signal that is similar to that shown in Figure 9.16 with two distinct portions to the load: a “varying” load and an “impact” load.

### E.1 Wave-Induced “Varying” Loads

The wave-induced varying loads imparted on elevated highway bridge decks by waves are estimated in terms of their vertical and horizontal components (see Figure E.1) as:

$$(F_v)_{\max} = c_{va-v} F_v^* \quad (E.1)$$

and

$$(F_h)_{\max} = [1 + c_r (N - 1)] c_{va-h} F_h^* \quad (E.2)$$

where:

- $(F_v)_{\max}$  = maximum of the vertical wave-induced load
- $(F_h)_{\max}$  = maximum of the horizontal wave-induced load
- $F_v^*$  = a “reference” vertical load defined by Equation D.3
- $F_h^*$  = a “reference” horizontal load defined by Equation D.4
- $c_{va-v}$  = an empirical coefficient for the vertical “varying” load
- $c_{va-h}$  = an empirical coefficient for the horizontal “varying” load

Appendix E

- $c_r$  = a reduction coefficient for reduced horizontal load on the internal (i.e. not the wave ward-most) girders (recommended value is  $c_r = 0.4$ )
- $N$  = the number of girders supporting the bridge span deck

$$F_v^* = \gamma (\Delta Z_v) A_v \quad (E.3)$$

where:

- $A_v$  = the area the bridge contributing to vertical uplift, i.e. the projection of the bridge deck onto the horizontal plane
- $\Delta Z_v$  = difference between the elevation of the crest of the maximum wave and the elevation of the underside of the bridge deck (see Figure E.2 for definition sketch or Figure E.3 for an alternative definition sketch)
- $\gamma$  = unit weight of water (64 lb/ft<sup>3</sup> for saltwater)

$$F_h^* = \gamma (\Delta Z_h) A_h \quad (E.4)$$

where:

- $A_h$  = the area of the projection of the bridge deck onto the vertical plane
- $\Delta Z_h$  = difference between the elevation of the crest of the maximum wave and the elevation of the centroid of  $A_h$  (see Figure E.2 for definition sketch).
- $\gamma$  = unit weight of water (64 lb/ft<sup>3</sup> for saltwater)

When the wave crest elevation does not exceed the top of the bridge, a reduced area and lowered centroid corresponding to the area below the wave crest elevation can be used in Equation E.4.

The wave crest elevation used in  $\Delta Z_v$  and  $\Delta Z_h$  should be that corresponding to a very large wave height estimated in the design sea state,  $\eta_{\max}$ .

Given a design sea state with a significant wave height ( $H_s$ ), this elevation can be estimated as:

$$\eta_{\max} \approx (0.8)(1.67)H_s = 1.3H_s \quad (E.5)$$

The design sea state is measured from the design storm surge elevation (see Figure E.2). The recommended value of each of the empirical coefficients is one (i.e.,  $c_{va-v} = 1$  and  $c_{va-h} = 1$ ). These recommended values are discussed below in and are not intended to be conservative. Thus, they should be increased for conservative design values. Given the uncertainties involved in the application of the available methods for estimating wave loads on US highway bridges, doubling these loads (i.e. factor-of-safety = 2) is recommended for conservative design.

When the coefficient is set to one, Equation E.1 is identical to the method for estimating uplift loads on horizontal waves presented by NAVFAC Design Memorandum 26.2 (1982).

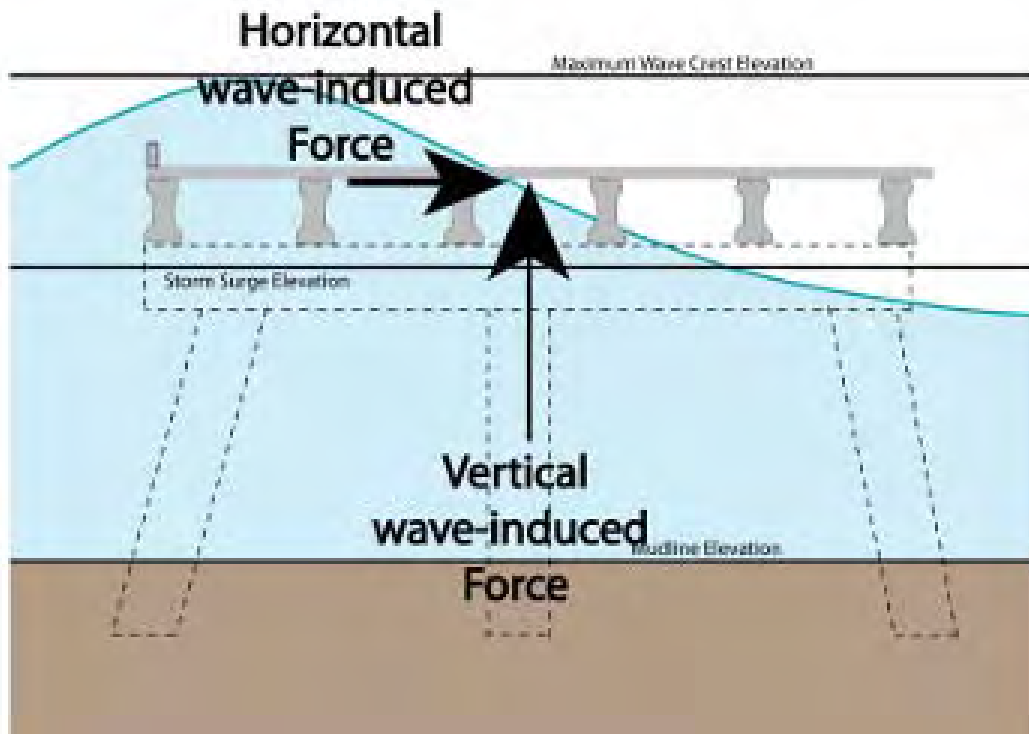
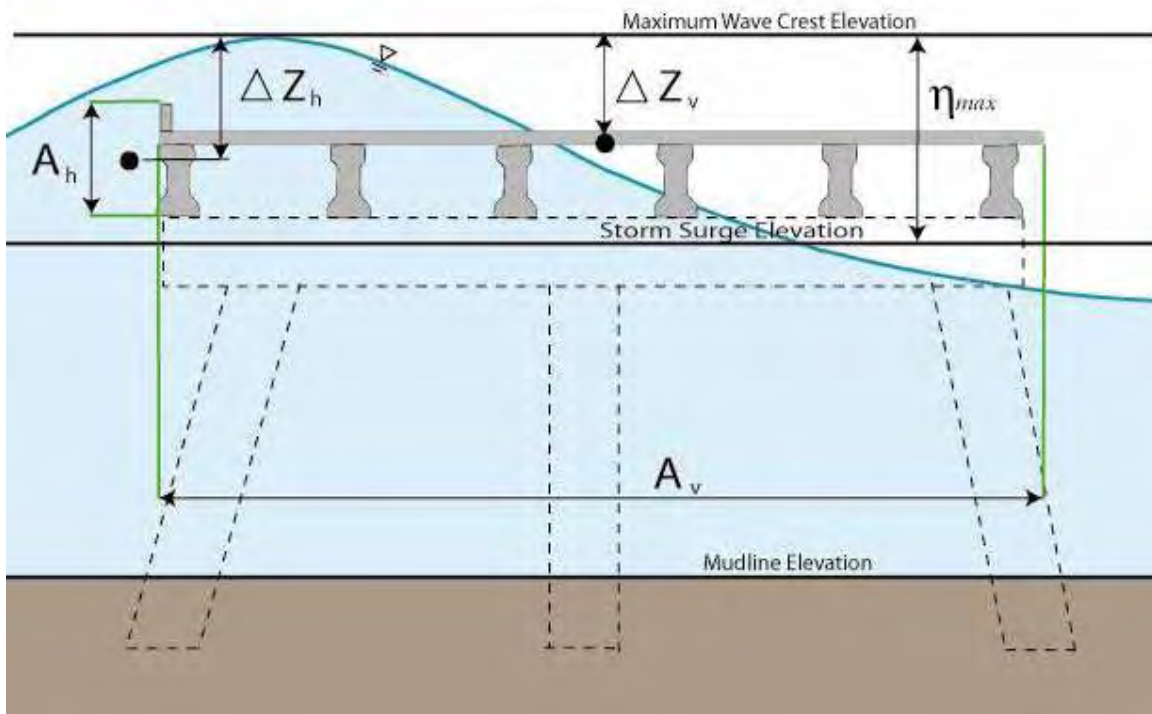

Figure E.1. Horizontal and vertical wave-induced loads on bridge decks

Figure E.2. Definition sketch for  $\Delta Z_h$ ,  $\Delta Z_v$ ,  $A_h$ ,  $A_v$ , and  $\eta_{max}$  used for estimating wave loads on elevated bridge decks

The method assumes, for the purposes of this recommended interim guidance, that the two components (horizontal and vertical) of the wave-induced loads given above act in phase. Thus, a maximum resultant load can be resolved as usual from the two components. The two components will likely not be completely in phase, i.e. at their maximums at the same instant, but this is a reasonable, conservative first approximation. Recent laboratory experiments show that the assumption of concurrent maximums for both components is reasonable for many conditions (Douglass, et al. 2007).

The resultant load, based on the two, horizontal and vertical, components can be assumed to be acting through the centroid of the cross-section. However, this approach ignores moments due to differences in wave-induced loads from the front to the back of the bridge deck cross-section. Such moments have been measured by Denson (1980) and in initial exploratory laboratory tests (Douglass, et al. 2006). It is possible that these moments may ultimately prove to be the most important part of the wave-induced loads on bridge decks. The loads from these equations can be applied at other locations on the bridge deck to estimate moments.

Equations E.1 and E.2 are only for the peak of the slowly “varying” loads. They do not include the magnitude of the peak of the impact load. It may be possible that the impact loads can be ignored by structural engineers due to their extremely short duration relative to the response of the structure. However, if the design engineer is concerned that any aspect of the design (connections, members, geotechnical) will respond to these impact loads, then higher maximum loads that include impact loads can be estimated as follows.

## **E.2 Impact Loads**

If the design engineer is concerned with the short-duration impact loads, then Equations E.1 and E.2 can be extended to include them as,

$$(F_v)_{\max} = \{c_{va-v} + c_{im-v}\} F_v^* \quad (E.6)$$

and

$$(F_h)_{\max} = \{[1 + c_r (N-1)]c_{va-h} + c_{im-h}\} F_h^* \quad (E.7)$$

where:

$c_{im-v}$  = an empirical coefficient for the vertical “impact” load (recommended value of three, i.e.,  $c_{im-v} = 3$ )

$c_{im-h}$  = an empirical coefficient for the horizontal “impact” load (recommended value of six, i.e.,  $c_{im-h} = 6$ )

The recommendations for vertical “impact” coefficient equaling three (i.e.,  $c_{im-v} = 3$ ) and horizontal “impact” coefficient equaling six (i.e.,  $c_{im-h} = 6$ ) should only be considered as interim estimates until more research is available. The high values are selected, in part, because of the recognition that the shape of the seaward face of many bridge decks is conducive to trapping pockets of air and thus potentially experiencing very high impact loads.

The two types of loads, “impact” and slowly “varying” will be additive but not necessarily in phase, i.e. they won’t both be at their peak at the same moment in time. However, given the uncertainties inherent in this recommended interim guidance, adding the two together is reasonable when the short-duration impact loads are deemed to be important. If the bridge engineer determines that the bridge deck will respond to the higher, shorter duration “impact” loads (i.e. bolts will fail or concrete will fail), then both coefficients should be used as in

Equations E.6 and E.7. The duration of the “impact” and the magnitude of the peak “impact” force are inversely proportional for this type of wave load (Weggel 1997).

### ***E.3 Example Application of Wave Load Equations***

Application of the methodology recommended for interim guidance is demonstrated using the US 90 bridge across Biloxi Bay, Mississippi as a case study. For the purposes of this example, a specific span has been selected as representative. This span is roughly in the middle of the western side of the bridge (see Figure 2.5). The low-chord elevation of the span (bottom of girders) was about +13 feet NGVD with the top of the bridge deck at +16.5 feet, and the bottom of the deck at +16 feet. In this portion of the bay, the depth is fairly shallow and it is assumed here that the bottom, mud-line elevation was about -4 feet NGVD.

Storm surge and wave hindcast modeling results (Douglass, et al. 2006) indicate that at 8:00 a.m. CDT on August 29, 2005, the mean water level had risen to an elevation of  $\bar{\eta} = 11.9$  feet and there was a significant wave height at the bridge location of  $H_s = 6.2$  feet. Thus, the waves were beginning to hit the span by that time in the storm.

The wave loads on the deck at that time are estimated as follows using the above equations:

$$\text{elevation of maximum wave crest} = \bar{\eta} + \eta_{\max} = 11.9 + 1.3(6.2) = 19.96 \text{ ft,}$$

$$\Delta Z_v = (\text{elevation maximum crest}) - (\text{elevation bottom deck}) = 19.96 - 16.0 = 3.96 \text{ ft}$$

$$(F_v)_{\max} = c_{va-v} F_v^* = c_{va-v} \gamma (\Delta Z_v) A_v = 1(64 \text{ lb/ft}^3)(3.96 \text{ ft})[(52)(33.4)\text{ft}^2] = 440 \text{ kips}$$

$$\Delta Z_h = (\text{elevation maximum crest}) - (\text{elevation centroid of } A_h) = 19.96 - 15.7 = 4.26 \text{ ft}$$

$$(F_h)_{\max} = [1+c_r(N-1)] c_{va-h} F_h^* = [1+0.4(6-1)] (1)(64 \text{ lb/ft}^3)(4.26 \text{ ft})(286 \text{ ft}^2) = 230 \text{ kips}$$

In this example,  $A_h$  has been estimated as 286 ft<sup>2</sup> with a centroid elevation of +15.7 feet (this value is obtained by accounting for the design of the rail) and there are six girders based on engineering plans obtained from Mississippi DOT for the Biloxi bridge.

So in summary, at 8:00 a.m. the wave-induced loads on this span are estimated as being cyclical with maximum “varying” loads of 440 kips of vertical uplift and 230 kips of horizontal landward force. It should be noted that these decks weighed about 340 kips and there was essentially no resistance to uplift provided by any connections. Thus, the implication of these calculations is that the uplift from some of the largest waves in the sea state at this time was enough to exceed the weight of the bridge span at the same time it was experiencing large lateral loads. Thus, these spans were probably beginning to get bumped, by individual large waves, up and over on the pile caps at about this time in the storm. Such behavior is consistent with the evidence. Katrina’s storm surge (and wave heights) continued to increase to a peak SWL of about +21.5 feet at around 10:30 a.m.

### ***E.4 Discussion of Recommended Method***

The approach outlined above is relatively simple to apply, can be applied in a conservative manner, is consistent with the available literature, and can be used to provide first estimates of wave loads on bridge decks.

Equations E.1 and E.2 explain the prototype damage that occurred in Hurricanes Ivan and Katrina reasonably well. The estimated loads differentiate the spans that broke their connections and moved from those at higher elevations that did not move at three bridges: the I-10 Escambia Bay, Florida bridge; the I-10 on ramp near Mobile, Alabama; and the US 90 bridge across Biloxi Bay (Douglass, et al., 2006).

Required input for the approach outlined above includes the basic bridge deck cross-section and elevation information and estimates of storm surge elevation and wave height.

This approach is not necessarily conservative. However, it can be conservatively applied through an appropriate factor of safety. A factor of safety can be applied for design by doubling the two coefficients in Equations E.1 and E.2 to two (i.e.,  $c_{va-v} = 2$  and  $c_{va-h} = 2$ ). This is justified based on the complexities of the process, the uncertainties in estimating design wave conditions, the limited available lab-scale load data, the lack of bridge-specific lab results, and the relatively small scales of the available lab data. A similar load factor of two (2) has been adopted in ASCE Standard No. 7: Minimum Design Loads for Buildings and Other Structures for wave loads on buildings for similar reasons (ASCE/SEI 2005).

The approach only provides an estimate of the total overall load without information concerning where that load is applied on the structure. Essentially, it thus implicitly assumes the load is applied through centroid of the cross-sectional area of the bridge. This is not particularly realistic. Also not considered are the details of wave phase and the fact that the down-wave width of bridge decks will likely cause spatially-varying loads, particularly uplift, that will impart a moment. These moments may be the most critical aspects of bridge deck response.

The approach outlined above should be used primarily for the case where storm surge elevation is roughly near the bridge deck elevation. Analyses indicate that this was the critical case during Hurricanes Ivan and Katrina. However, there are two other situational cases for bridge decks:

- The deck is much higher than the storm surge such that only the crests of a very few waves in the storm sea state hit the girders. Equations E.1 and E.2 are not conservative for this case (Douglass, et al. 2006). However, the loads are of a lower magnitude for this case.
- The surge is so high that the bridge deck is completely inundated.

There is little guidance in the literature that suggests appropriate coefficients for bridge deck geometries. Recent laboratory experiments (Douglass, et al. 2007) found that the method outlined above is appropriate for the geometry typical of US highway bridges (girder and deck with closed diaphragms under the deck); that the method also is conservative, but not excessively conservative, for levels of complete inundation; and the uplift loads can approach 3 times the weight of the prototype bridge decks. Those laboratory experiments also found the uplift loads doubled when diaphragms and end caps were added to the bridge deck for situations where the SWL was near the bottom of the diaphragms. The diaphragms essentially form a honeycomb with the only opening facing down toward the water surface and the water surface of the wave is likely trapping a pocket of air under the bridge deck. The trapping of air is consistent with higher peak wave loads on decks and vertical walls in the literature. Because of this sensitivity to the presence of the diaphragms, an alternative definition of the level of submergence is shown in Figure E.3. Use of this definition sketch is more conservative for design.



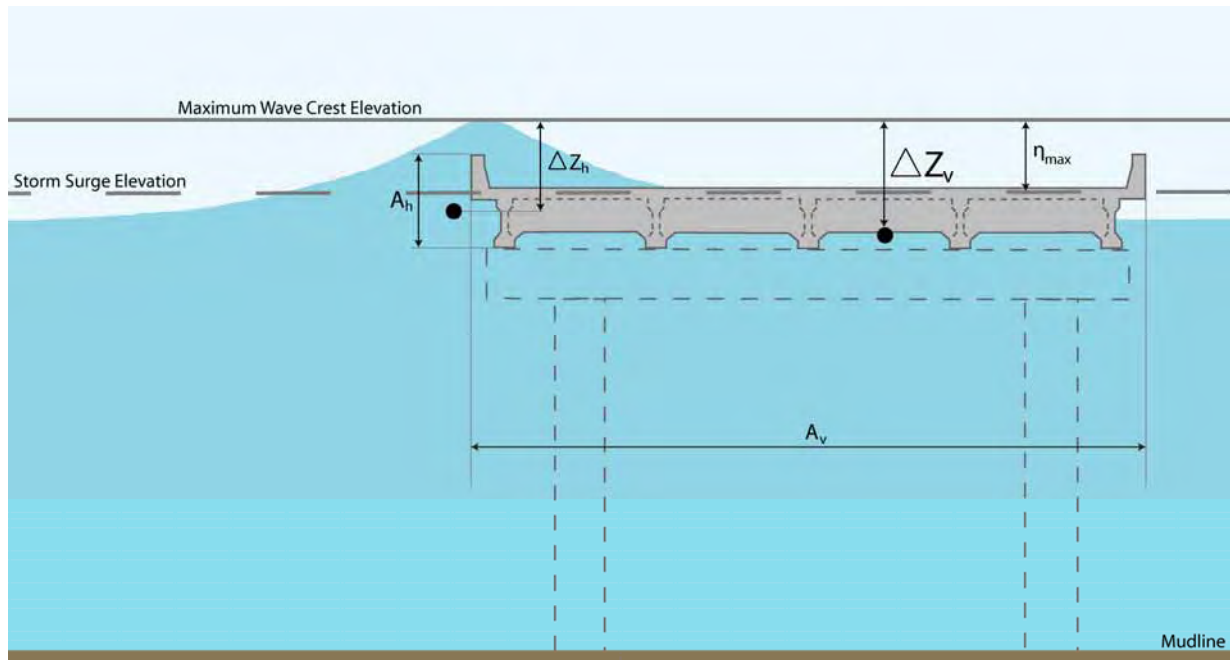

Figure E.3. Alternative definition sketch for  $\Delta z_v$ .

More, focused research on this issue is justified by the magnitudes of the estimated wave loads, the seriousness of the implications of them for design, the significant uncertainty in the available methods for estimating the loads, and the likelihood that the uncertainty can be reduced with more research. This research need includes quantitative laboratory force measurements for the cross-sectional geometry typical of simple-span bridge decks used in US highways across coastal waters for different levels of relative inundation.

*Page Intentionally Left Blank*