



# D Hurricane Ike Recovery Advisories

FEMA has prepared a series of Recovery Advisories that present guidance for design, construction, and restoration of buildings in areas subject to coastal flooding and high winds from Hurricane Ike. To date, eight advisories have been prepared and are included in this appendix:

- Attachment of Brick Veneer in High-Wind Regions ([December, 2005]; revised 2009)
- Design and Construction in Coastal A Zones ([December, 2005]; revised 2009)
- Designing for Flood Levels above the BFE ([July, 2006]; revised 2009)
- Enclosures and Breakaway Walls
- Erosion, Scour, and Foundation Design
- Minimizing Water Intrusion Through Roof Vents in High-Wind Regions
- Metal Roof Systems in High-Wind Regions
- Siding Installation in High-Wind Regions

These Advisories are also available online at <http://www.fema.gov/library/viewRecord.do?id=3539> where future Advisories will also be posted.



# Attachment of Brick Veneer in High-Wind Regions



FEMA  
<http://www.fema.gov>

## HURRICANE IKE RECOVERY ADVISORY

**Purpose:** To recommend practices for installing brick veneer that will enhance wind resistance in high-wind areas (i.e., greater than 90-mph gust design wind speed).

### Key Issues

- Brick veneer is frequently blown off walls of residential and non-residential buildings during hurricanes (Figure 1). When brick veneer fails, wind-driven water can enter and damage buildings, and building occupants can be vulnerable to injury from windborne debris (particularly if walls are sheathed with plastic foam insulation or wood fiberboard in lieu of wood panels). Pedestrians in the vicinity of damaged walls can also be vulnerable to injury from falling veneer (Figure 2).
- Common failure modes include tie (anchor) corrosion (Figure 3), tie fastener pull-out (Figure 4), failure of masons to embed ties into the mortar (Figure 5), and poor bonding between ties and mortar and mortar of poor quality (Figure 6).
- Ties are often installed before brick laying begins. When this is done, ties are often improperly placed above or below the mortar joints. When misaligned, the ties must be angled up or down in order for the ties to be embedded into the mortar joints (Figure 7). Misalignment not only reduces embedment depth, but also reduces the effectiveness of the ties because wind forces do not act parallel to the ties themselves.
- Corrugated ties typically used in residential veneer construction provide little resistance to compressive loads. Use of compression struts would likely be beneficial, but off-the-shelf devices do not currently exist. Two-piece adjustable ties (Figure 8) provide significantly greater compressive strength than corrugated ties and are, therefore, recommended. However, if corrugated ties are used, it is recommended that they be installed as shown in Figures 9 and 10 in order to enhance their wind performance.



**Figure 3.** Significant tie corrosion caused the brick at a fire station to fail, even though the building is not near the coast. Note that metal is missing for half of width of the tie at two locations (red arrows). The left end of the tie was still embedded into a concrete masonry unit back-up wall. The right end is where the tie failed in tension, thus leaving a portion of the tie embedded in the collapsed brick.



**Figure 1.** Failed brick veneer over plywood. Many of the ties are still attached to the substrate, but several of the tie fasteners pulled out of the substrate and the ties are embedded in the collapsed veneer. Estimated wind speed: 107 miles per hour (peak gust, Exposure C, at 33 feet).



**Figure 2.** The upper portion of the brick veneer at this apartment building collapsed. Pedestrian and vehicular traffic in the vicinity of the damaged wall are vulnerable to injury and damage if remaining portions of the wall were to collapse during subsequent storms.

- Buildings that experience veneer damage typically do not comply with current building codes. Building code requirements for brick veneer have changed over the years. Model codes prior to 1995 permitted brick veneer in any location, with no wind speed restrictions. Also, some older model codes allowed brick veneers to be anchored with fewer ties than what is required by today's standards.

The American Concrete Institute's (ACI's) 530/American Society of Civil Engineers (ASCE) 5/The Masonry Society (TMS) 402 (ACI 530) *Building Code Requirements for Masonry Structures* is the current masonry standard referenced by model building codes. The 2006 International Building Code® (IBC®) and the 2006 International Residential Code® (IRC®) both reference the 2005 edition of ACI 530. The latest ACI 530 is the 2008 edition.

ACI 530 addresses brick veneer in two manners: rational design and a prescriptive approach. Nearly all brick veneer in residential and low-rise construction follows the prescriptive approach. The first edition of ACI 530 limited the use of prescriptive design to areas with a basic wind speed of 110 mph or less. The 2005 and the 2008 editions of ACI 530 extend the prescriptive requirements to include a basic wind speed of 130 mph, but limit the amount of brick that can be anchored with veneer ties to 70 percent of that allowed in lower wind speed regions. Both the 2005 and the 2008 editions require rational design approaches in locations where the basic wind speeds exceed 130 mph.

Some noteworthy distinctions exist in the requirements for anchored brick veneer between the 2005 and the 2008 editions of ACI 530. For lower wind speed regions (110 mph and below), ACI 530-05 limited the vertical spacing of ties to 18"; the 2008 edition allows vertical ties to be spaced up to 25", provided the amount of veneer anchored per tie does not exceed 2.7 square feet. In ACI's high-wind regions (over 110 mph and up to 130 mph), both editions of the code limit vertical spacing to 18". ACI 530-08 also limits the space between veneer anchored with corrugated ties and the wall sheathing to 1". This is to avoid compression failures in the corrugated ties when they are exposed to positive pressures.



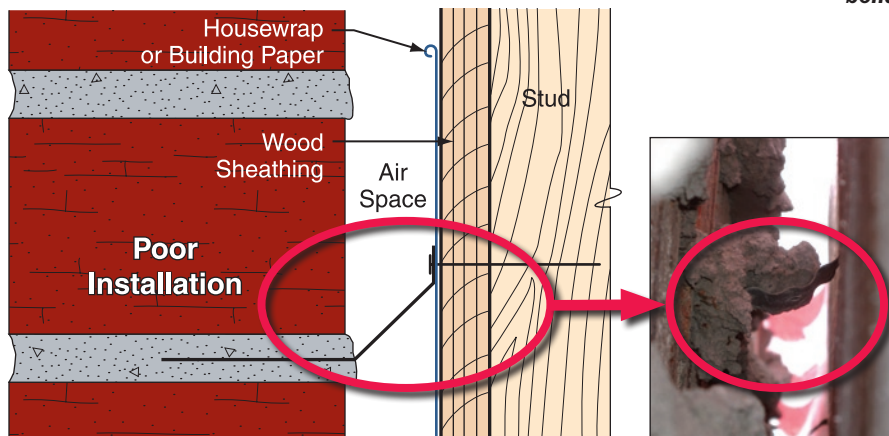
**Figure 4.** This tie remained embedded in the mortar joint while the smooth-shank nail pulled out from the stud.



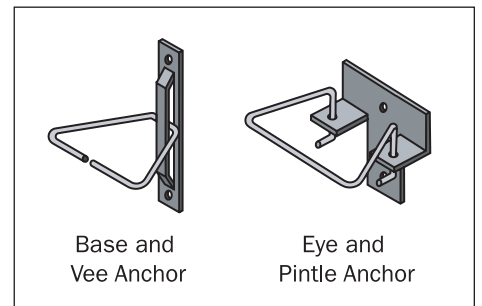
**Figure 5.** These four ties were never embedded into the mortar joint.



**Figure 6.** This tie was embedded in the mortar, but the bond was poor.



**Figure 7.** Misalignment of the tie reduces the embedment and promotes veneer failure.



**Figure 8.** Examples of two-piece adjustable ties.

- The following Brick Industry Association (BIA) Technical Notes provide guidance on brick veneer: Technical Notes 28 – Anchored Brick Veneer, Wood Frame Construction; Technical Notes 28B – Brick Veneer/Steel Stud Walls; and Technical Notes 44B – Wall Ties (available online at <http://www.bia.org>). These Technical Notes provide attachment recommendations, but the recommendations are not specific for high-wind regions and are, therefore, inadequate.

## Sustainability

Brick veneer can offer a very long service life, provided the ties are not weakened by corrosion. To help ensure that brick veneer achieves its long life potential, in addition to properly designing and installing the ties, stainless steel ties are recommended.

## Construction Guidance

The brick veneer wall system is complex in its behavior. There are limited test data on which to draw. The following guidance is based on professional judgment, wind loads specified in ASCE 7-05, *Minimum Design Loads for Buildings and Other Structures*, fastener strengths specified in the American Forest and Paper Association's (AF&PA's) National Design Specification (NDS) for Wood Construction, and brick veneer standards contained in ACI 530-05. In addition to the general guidance given in BIA Technical Notes 28 and 28B, the following are recommended:

Note: In areas that are also susceptible to high seismic loads, brick veneer should be evaluated by an engineer to ensure it can resist seismic and wind design loads.

**Stud Spacing:** For new construction, space studs 16" on center, so that ties can be anchored at this spacing.

**Tie Fasteners:** Ring-shank nails are recommended in lieu of smooth-shank nails. A minimum embedment of 2" into framing is suggested.

**Ties:** For use with wood studs, two-piece adjustable ties are recommended. However, where corrugated steel ties are used, use 22-gauge minimum, 7/8" wide by 6" long, complying with American Society for Testing and Materials (ASTM) A 366 with a zinc coating complying with ASTM A 153 Class B2. For ties for use with steel studs, see BIA Technical Notes 28B – Brick Veneer/Steel Stud Walls. Stainless steel ties should be used in areas within 3,000 feet of the coast.

## Tie Installation

- Install ties as the brick is laid so that the ties are properly aligned with the mortar joints.
- Install brick ties spaced per Table 1. Studs should be installed at 16" spacing. Veneer tie locations for 24" stud spacing are included for repairing damaged veneer on existing buildings with the wider stud spacing. In areas where the 2006 Editions of the IBC/IRC are adopted, install brick veneer ties spaced no more than 18" vertically to satisfy the requirements of ACI 530-05.
- Locate ties within 8" of door and window openings and within 12" of the top of veneer sections.
- Bend the ties at a 90-degree angle at the nail head in order to minimize tie flexing when the ties are loaded in tension or compression (Figure 9).
- Embed ties in joints so that mortar completely encapsulates the ties. Embed a minimum of 1 1/2" into the bed joint, with a minimum mortar cover of 5/8" to the outside face of the wall (Figure 10).

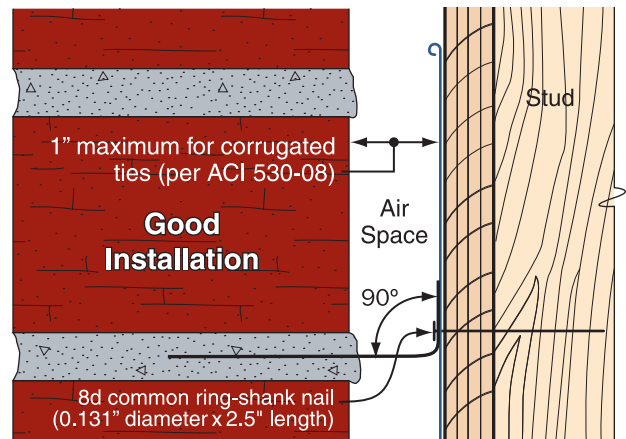


Figure 9. Bend ties at nail heads.

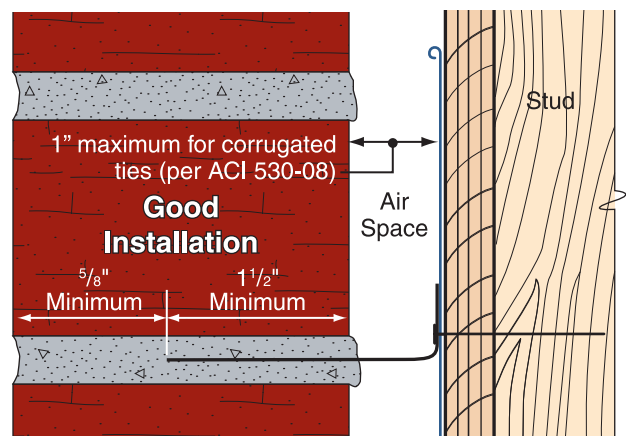


Figure 10. Tie embedment.

**Table 1. Brick Veneer Tie Spacing**

Wind Speed (mph) (3-Second Peak Gust)	Wind Pressure (psf)	Maximum Vertical Spacing for Ties (inches)	
		16" stud spacing	24" stud spacing
90	-19.5	24 <sup>a,b</sup>	16 <sup>a</sup>
100	-24.1	24 <sup>a,b</sup>	16 <sup>a</sup>
110	-29.1	20½ <sup>b</sup>	13½
120	-34.7	17	NA <sup>c</sup>
130	-40.7	15	NA <sup>c</sup>
140	-47.2	13	NA <sup>c</sup>
150	-54.2	11	NA <sup>c</sup>

**Notes:**

- The tie spacing is based on wind loads derived from Method 1 of ASCE 7-05, for the corner area of buildings up to 30' high, located in Exposure B with an importance factor (I) of 1.0 and no topographic influence. For other heights, exposures, or importance factors, engineered designs are recommended.
- Spacing is for 2½" long 8d common (0.131" diameter) ring-shank fasteners embedded 2" into framing. Fastener strength is for wall framing with a Specific Gravity G=0.55 with moisture contents less than 19 percent and the following adjustment factors, C<sub>t</sub>=0.8; and C<sub>D</sub>, C<sub>M</sub>, C<sub>eg</sub>, and C<sub>in</sub>=1.0. Factored withdrawal strength W'=65.6#.
- The brick veneer tie spacing table is based on fastener loads only and does not take into account the adequacy of wall framing, sheathing, and other building elements to resist wind pressures and control deflections from a high-wind event. Prior to repairing damaged brick veneer, the adequacy of wall framing, wall sheathing, and connections should be verified by an engineer.
  - Maximum spacing allowed by ACI 530-08.
  - In locales that have adopted the 2006 IBC/IRC, the maximum vertical spacing allowed by ACI 530-05 is 18".
  - 24" stud spacing exceeds the maximum horizontal tie spacing of ACI 530-08 prescribed for wind speeds over 110 mph.

# Design and Construction in Coastal A Zones



**FEMA**  
http://www.fema.gov

## HURRICANE IKE RECOVERY ADVISORY

**Purpose:** To recommend design and construction practices in coastal areas where wave and flood conditions during the base flood will be less severe than in V zones, but still cause significant damage to typical light-frame construction.

### Key Issues

- Recent post-storm investigations have shown that typical A-zone construction techniques (e.g., wood-frame, light gauge steel, or masonry walls on shallow footings or slabs, etc.) are subject to damage or destruction when exposed to less than 3' waves, which is the current threshold for V-zone conditions.
- Coastal A-zone buildings that employ typical residential and light commercial walls to elevate and support habitable space above the flood level will be susceptible to flood damage (Figure 1). Laboratory tests and recent field investigations confirm that breaking wave heights as small as 1.5' will cause failure of these types of walls (Figure 2).
- Other flood hazards associated with coastal waves (e.g., floating debris, high velocity flow, erosion and scour) also damage A-zone type construction in coastal areas (Figure 3).
- National Flood Insurance Program (NFIP) flood hazard mapping is generally divided into two categories, V and A zones. In coastal areas, the A-zone category could be subdivided into "Coastal A zone" and "A



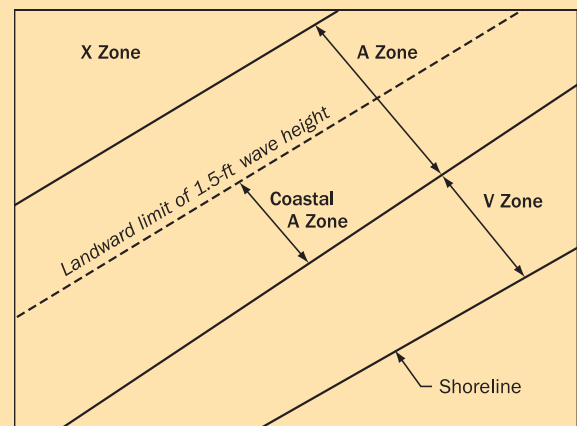
**Figure 1. Failure of wood-frame walls used to support a coastal building, which was subjected to shallow flooding, small waves, and floating debris (Fort Walton Beach, FL, Hurricane Opal).**

The Hurricane Ike Mitigation Assessment Team (MAT) observed small wave damage consistent with Coastal A-zone conditions throughout the area affected by Ike, including portions of west Galveston Island (Figure 4), communities situated along portions of Galveston Bay (Figure 5), Orange County (Figure 6), and portions of coastal Louisiana (Figure 7).

### Coastal A Zone, Defined

**Coastal A Zone:** area landward of a V zone, or landward of an open coast without mapped V zones. In a Coastal A zone, the principal source of flooding will be astronomical tides, storm surges, seiches or tsunamis, not riverine flooding. During base flood conditions, the potential for wave heights between 1.5 and 3.0' will exist. At least 2 to 4' of stillwater depth is necessary to support these wave heights.

Coastal A-zone design and construction practices described herein are not mandated by the NFIP, but are recommended for communities that wish to adopt higher floodplain management standards. Community Rating System (CRS) credits are available for doing so. Note that some Coastal A-zone practices may be required by the International Building Code®, through its reference to ASCE 24, *Standard for Flood Resistant Design and Construction*.



**Plan view showing a Coastal A zone landward of a V zone (source: ASCE 24-05).**

zone.” Base flood conditions in the Coastal A zone will be similar to, but less severe than, those in the V zone; base flood conditions in the A zone will be similar to those in riverine or lake floodplains.

- The Coastal A zone is not shown on the Flood Insurance Rate Maps (FIRMs) presently adopted by communities. Communities, designers, and owners will have to determine whether a site lies within a Coastal A zone, either by wave height estimation or by consultation with FEMA regarding the LiMWA (see text box).
- **In general, V-zone design and construction standards are recommended in Coastal A zones subject to erosion, high velocity flow, and/or wave heights greater than 1.5'.**

Flood insurance studies produced after Hurricane Katrina may include an advisory line indicating the limit of the 1.5' wave height during the base flood. This line is known as the Limit of Moderate Wave Action (LiMWA), and the area between this line and the VE zone boundary is the Coastal A zone.



**Figure 2.** Failure of wood-frame wall, brick veneer, and windows as a result of 4' of stillwater flooding and small waves (Bay St. Louis, MS, Hurricane Katrina).






**Figure 3.** Failure of A-zone type foundation in coastal area, not subject to V-zone conditions (Topsail Island, NC, Hurricane Fran).



**Figure 4.** Coastal A-zone flood conditions are sufficient to cause failure of solid breakaway walls and garage doors (west Galveston Island, TX, Hurricane Ike).



**Figure 5.** Damage to brick veneer walls due to shallow flooding, floating debris, and small waves. The damaged home was on a sheltered bay shoreline (Baytown, TX, Hurricane Ike).

<b>A Zones in Coastal Areas</b>		
 <b>V Zone</b>	 <b>Coastal A</b>	 <b>A</b>
Areas With Potential for Damaging Waves and Erosion During Base Flood	Areas With Shallow Flooding Only, Where Potential for Damaging Waves and Erosion Is Low	





**Figure 6.** Damage attributed to small waves and approximately 5' of stillwater depth (Bridge City, TX, Hurricane Ike).



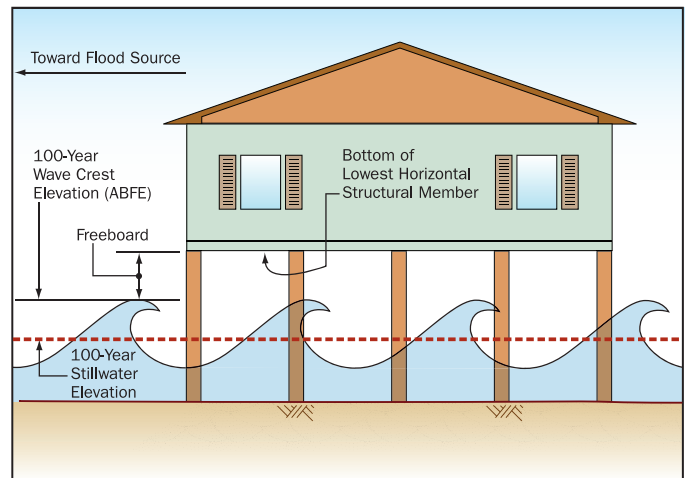
**Figure 7.** Damage believed to have resulted from Coastal A-zone conditions (Johnson Bayou, LA, Hurricane Ike).

## Coastal A-Zone Construction Guidance

Because of the presence of damaging waves, V-zone design, construction, and certification practices are recommended for Coastal A zones.

Coastal A-zone construction should include:

- Use of open foundations (pile or pier) designed to resist all base flood conditions, including small waves, high velocity flow, erosion and scour, and floodborne debris (see Table 1).
- Elevation of the bottom of the lowest horizontal structural member supporting the lowest floor above the base flood wave crest elevation (Figure 8). Since waves and debris will be impacting on the floor joists and other foundation elements during the base flood, do not follow current NFIP minimum requirements that allow the lowest floor's walking surface to be set at the wave crest elevation in Zone A. **The 2009 International Residential Code® (IRC®) will require 1' of freeboard in V zones and Coastal A zones.**
- Use of flood-resistant materials above the level of the walking surface of the lowest floor (in the event that future flooding exceeds the lowest floor level and any freeboard incorporated into the building design).
- Specification of connections between the foundation and the elevated building that are capable of withstanding simultaneous wind and flood forces. Post-hurricane investigations typically find many foundation-to-building connections that are deficient.
- Use of space below the lowest horizontal structural member for parking, access, or storage only. Adding sufficient freeboard to allow parking beneath the building will not only reduce future flood damages, but will also lower flood insurance premiums.



**Figure 8.** Recommended post-Katrina building standards in Coastal A zones.

- Use of screen, lattice, louvers, or solid breakaway walls if space below the elevated floor is enclosed (see Hurricane Ike Recovery Advisory, *Enclosures and Breakaway Walls*). Note: unless flood regulations are changed, solid breakaway walls in Coastal A zones must be equipped with flood openings.

Additional guidance for design and construction in Coastal A zones can be found in FEMA 499, *Home Builder's Guide to Coastal Construction* (<http://www.fema.gov/library/viewRecord.do?id=1570>). The publication is a series of 31 fact sheets that provide recommended design and construction practices for foundations, connections, building envelope, etc. Fact Sheet 2 summarizes recommended practices for Coastal A zones, and references other fact sheets that provide more details.

**Table 1. Foundation Recommendations for Coastal A Zones** (Users should read across from a foundation type to see under what soil and base flood conditions that foundation is acceptable. A foundation must be capable of resisting all base flood conditions likely to exist at the site, or it should not be used. For example, a properly constructed pier on a shallow footing will generally withstand 1.5 to 3.0' wave heights, but should not be used where soils are erodible, and where high velocity flow is possible.)

Foundation Type	Base Flood Condition Present	
	Wave Heights Between 1.5 and 3.0 Feet*	Velocity Flow, Erodeable Soils
Fill	no	no
Slab on grade	no	no
Crawlspace, shallow footing	no	no
Foundation walls, shallow footing	no	no
Stem wall**	no	no
Pier, shallow footing	yes	no
Pier, deep footing***	yes	yes
Post, shallow embedment	no	no
Pile/Column, deep embedment***	yes	yes

\* Wave heights greater than 3.0' mapped as V zone: fill, slab, crawlspace, wall foundations not permitted.

\*\* Typical stem wall foundations are vulnerable to damage from small waves or undermining and are, therefore, not recommended for use in Coastal A zones.

\*\*\* Deep means sufficiently deep to withstand erosion and scour, including that induced by the presence of the foundation itself.

## Identifying Coastal A Zones

Coastal A zones are not shown on present day FIRMs or mentioned in a community's Flood Insurance Study (FIS) Report. Those maps and studies show Zones VE, AE, and X (or older designations V1-30, A1-30, B, and C). Therefore, until Coastal A-zone designations or wave height contours are incorporated into FISs, the community official, designer, or owner will have to determine whether or not a site will be subject to Coastal A-zone conditions during the base flood.

In order for a Coastal A zone to be designated, two conditions are required:

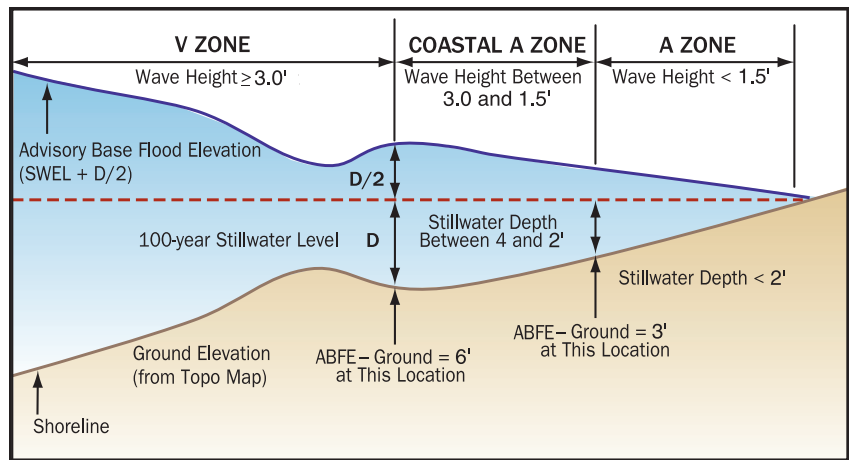
- 1) a water depth sufficient to support waves between 1.5 and 3.0' high, and
- 2) the actual presence of wave heights between 1.5 and 3.0'.

Condition 1 requires stillwater depths (vertical distance between the 100-year stillwater elevation and the ground elevation) of at least 2 to 4' at the site.

Condition 2 requires wave heights at the shoreline greater than 1.5 to 3.0' (under the 100-year flood conditions), sufficient water depth between the shoreline and the site and few, if any obstructions (buildings, dense tree stands, etc.) that may block or dampen the waves, between the shoreline and the site.

Figure 9 illustrates the procedure that was used following Hurricane Katrina to estimate Advisory Base Flood Elevations (ABFEs) and corresponding Coastal A zones, knowing only the ground elevation and the 1-percent annual chance stillwater level.

Communities, designers, and owners can obtain the information necessary to make a post-Ike Coastal A-zone determination by observing the site and its surroundings, knowing site ground elevations, and using 1-percent annual chance stillwater elevations (from the FIS report or as determined by a government agency). Figure 10 shows how site and surrounding conditions would influence a Coastal-A zone determination.



**Figure 9. Post-Katrina Coastal A-zone methodology cross-section showing 1 percent annual chance stillwater elevation, stillwater depth and ABFE, and inland limits of an V zone and a Coastal A zone.**



**Figure 10. The site on the left is mapped Zone AE, and lies directly along the Gulf of Mexico shoreline. Limited obstructions to waves indicate the site could be classified as a Coastal A zone. The site on the right is over 1/2 mile from the Gulf shoreline, is mapped as Zone AE, and has a base flood stillwater level sufficient to support  $>1.5'$  wave heights – but obstructions to waves (e.g., trees and other buildings between the site and the shoreline) and distance from the source of flooding would indicate the area is not a Coastal A zone.**

## References

- ASCE. 2005. *Standard for Flood Resistant Design and Construction*, ASCE 24-05.
- FEMA. 2005. *Home Builder's Guide to Coastal Construction*, FEMA 499.
- FEMA. 2009. *Hurricane Ike Recovery Advisory, Enclosures and Breakaway Walls*.
- ICC 2006. *International Building Code*. 2006.
- ICC 2009. *International Residential Code*. 2009.



# Designing for Flood Levels Above the BFE



**FEMA**  
<http://www.fema.gov>

## HURRICANE IKE RECOVERY ADVISORY

**Purpose:** To recommend design and construction practices that reduce the likelihood of flood damage in the event that flood levels exceed the Base Flood Elevation (BFE).

### Key Issues

- BFEs are established at a flood level, including wave effects, that has a 1-percent chance of being equaled or exceeded in any given year, also known as the 100-year flood or base flood. Floods more severe and less frequent than the 1-percent flood can occur in any year.
- Flood levels during some recent storms have exceeded BFEs depicted on the Flood Insurance Rate Maps (FIRMs), sometimes by several feet. In many communities, flooding extended inland, well beyond the 100-year floodplain (Special Flood Hazard Area (SFHA)) shown on the FIRM (see Figure 1).
- Flood damage increases rapidly once the elevation of the flood extends above the lowest floor of a building, especially in areas subject to coastal waves. In a V zone, a coastal flood with a wave crest 3 to 4' above the bottom of the floor beam (approximately 1 to 2 feet above the walking surface of the floor) will be sufficient to substantially damage or destroy most light-framed residential and commercial construction (see Figure 2).
- There are design and construction practices that can eliminate or minimize damage to buildings when flood levels exceed the BFE. The most common approach is to add freeboard to the design (i.e., to elevate the building higher than required by the FIRM).
- There are other benefits of designing for flood levels above the BFE: reduced building damage and maintenance; longer building life; reduced flood insurance premiums; reduced displacement and dislocation of building occupants after floods (and need for temporary shelter and assistance); reduced job loss; and increased retention of tax base.
- The cost of adding freeboard at the time of home construction is modest, and reduced flood insurance premiums will recover the freeboard cost in a few years time.



**Figure 1.** Bridge City, TX, homes were flooded during Ike, even though they were constructed outside the SFHA and in Zone B. The flood level was approximately 4' above the closest BFE.



**Figure 2.** Bolivar Peninsula, TX, V-zone house constructed with the lowest floor (bottom of floor beam) at the BFE (dashed line). The estimated wave crest level during Ike (solid line) was 3 to 4' above the BFE at this location.

### How High Above the BFE Should a Building be Elevated?

Ultimately, the building elevation will depend on several factors, all of which must be considered before a final determination is made:

- **The accuracy of the BFE shown on the FIRM:** If the BFE is suspect, it is probably best to elevate several feet above the BFE; if the BFE is deemed accurate, it may only be necessary to elevate a couple of feet above the BFE.
- **Availability of Advisory Base Flood Elevations (ABFEs):** ABFEs have been produced for coastal areas following Hurricanes Ivan, Katrina, and Rita. These elevations are intended to be interim recommendations until new FISs can be completed.
- **Availability of Preliminary Digital Flood Insurance Rate Maps (DFIRMS):** As new Flood Insurance Studies (FISs) are completed for Louisiana and Texas communities, preliminary DFIRMs will be produced and available for use, even before they are officially adopted by those communities.
- **Future conditions:** Since the FIRM reflects conditions at the time of the FIS, some owners or jurisdictions may wish to consider future conditions (such as sea level rise, subsidence, wetland loss, shoreline erosion, increased storm frequency/intensity, and levee settlement/failure) when they decide how high to elevate.
- **State or local requirements:** The State or local jurisdiction may require a minimum freeboard through its floodplain management requirements or building code.
- **Building code requirements:** The International Building Code® (IBC®) requires buildings be designed and constructed in accordance with American Society of Civil Engineers (ASCE) 24 (*Standard for Flood Resistant Design and Construction*). ASCE 24 requires between 0 and 2' of freeboard, depending on the building importance and the edition of ASCE 24 referenced.<sup>1</sup> The 2009 IRC will require 1 foot of freeboard in V and Coastal A zones.
- **Critical and essential facilities:** Given the importance of these facilities, some of which must remain operational during a hurricane, they should be elevated higher than commercial and residential buildings.
- **Building owner tolerance for damage, displacement, and downtime:** Some building owners may wish to avoid building damage and disruption, and may choose to elevate far above the BFE.

The Hurricane Ike MAT report recommends that critical and essential facilities be elevated to the 500-year flood elevation or to the requirements of ASCE 24-05, whichever is higher. This recommendation may also be appropriate for residential and commercial structures, as well.

The 500-year wave crest elevation can be approximated as 1.5 times the 500-year stillwater depth (500-year stillwater elevation minus the ground elevation) added to the ground elevation. This procedure is similar to the procedure used to calculate ABFEs, but with a different stillwater level.

If the 500-year stillwater elevation (feet North American Vertical Datum of 1988 [NAVD] or feet National Geodetic Vertical Datum of 1929 [NGVD]) is not available, a rule of thumb can be used to approximate it as 1.25 times the 100-year stillwater elevation (feet NAVD or feet NGVD).

#### **MAT Elevation Recommendation**

The Hurricane Ike MAT recommends new and reconstructed residential and commercial buildings be elevated above the effective BFEs with freeboard equal to that specified in ASCE 24-05, plus 3 feet. Once new DFIRMs are available and adopted, the MAT recommends new and reconstructed residential and commercial buildings be elevated to or above the freeboard elevation specified by ASCE 24-05. Critical and essential facilities should be elevated higher than residential and commercial buildings.

## **Flood Insurance Rate Maps and Flood Risk**

Hurricanes Ivan (2004), Katrina (2005), Rita (2005), and Ike (2008) have demonstrated that constructing a building to the minimum National Flood Insurance Program (NFIP) requirements – or constructing a building outside the SFHA shown on the FIRMs – is no guarantee that the building will not be damaged by flooding. This is due to two factors: 1) flooding more severe than the base flood occurs, and 2) some FIRMs, particularly older FIRMs, may no longer depict the true base flood level and SFHA boundary.

Even if the FIRM predicted flood levels perfectly, buildings constructed to the elevations shown on the FIRM will offer protection only against the 1-percent annual chance flood level (BFE). Some coastal storms will result in

<sup>1</sup> The 1998 edition of ASCE 24 is referenced by the 2003 edition of the IBC, and requires between 0 and 1' of freeboard. The 2005 edition of ASCE 24 is referenced by the 2006 edition of the IBC, and requires between 0 and 2' of freeboard.

flood levels that exceed the BFE, and buildings constructed to the minimum elevation could sustain flood damage. The black dashed line in Figure 3 shows the probability that the level of the flood will exceed the 100-year flood level during time periods between 1 year and 100 years; there is an 18-percent chance that the 100-year flood level will be exceeded in 20 years, a 39-percent chance it will be exceeded in 50 years, and a 51-percent chance it will be exceeded in 70 years. As the time period increases, the likelihood that the 100-year flood will be exceeded also increases.

Figure 3 also shows the probabilities that floods of other severities will be exceeded. For example, taking a 30-year time period where there is a 26-percent chance that the 100-year flood level will be exceeded, there is an 18-percent chance that the 150-year flood will be exceeded, a 14-percent chance that the 200-year flood will be exceeded, and a 6-percent chance that a flood more severe than the 500-year flood will occur.

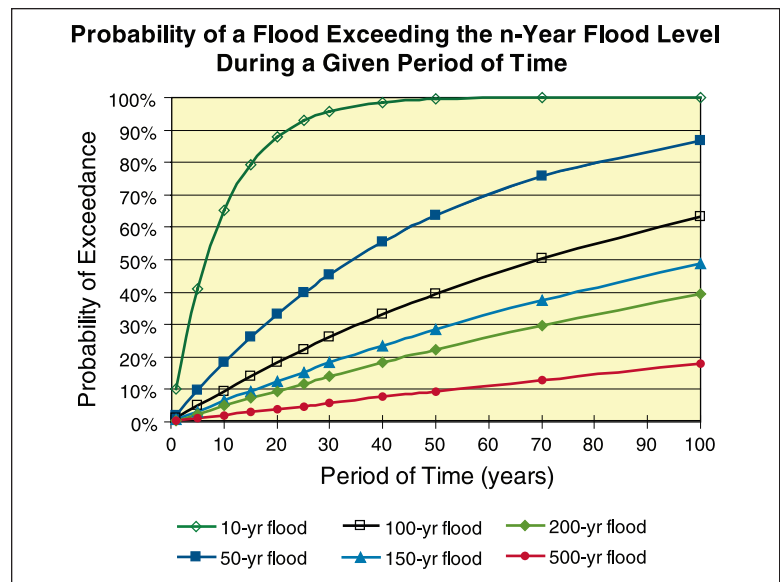
FIRMs depict the limits of flooding, flood elevations, and flood hazard zones during the base flood. As seen in Figure 3, buildings elevated only to the BFEs shown on the FIRMs have a significant chance of being flooded over a period of decades. Users should also be aware that the flood limits, flood elevations, and flood hazard zones shown on the FIRM reflect ground elevations, development, and flood conditions at the time of the FIS.<sup>2</sup>

## Consequences of Flood Levels Exceeding the BFE

Buildings are designed to **resist** most environmental hazards (e.g., wind, seismic, snow, etc.), but are generally designed to **avoid** flooding by elevating the building above the anticipated flood elevation. The difference in design approach is a result of the sudden onset of damage when a flood exceeds the lowest floor elevation of a building. Unlike wind – where exposure to a wind speed slightly above the design speed does not generally lead to severe building damage – occurrence of a flood level even a few inches above the lowest floor elevation generally leads to significant flood damage, therefore, the recommendation to add freeboard.

This is especially true in cases where waves accompany coastal flooding. Figure 4 illustrates the expected flood damage (expressed as a percent of a building's pre-damage market value) versus flood depth above the bottom of the lowest horizontal structural member supporting the lowest floor (e.g., bottom of the floor beam), for a V-zone building and for a riverine A-zone building.<sup>3</sup>

One striking difference between the two curves is that a V-zone flood depth (wave crest elevation) 3 to 4' above the bottom of the floor beam (or approximately 1 to 2' above the top of the floor) is sufficient to cause substantial (>50 percent) damage to a building. In contrast, A zone riverine flooding (without waves and high velocity) can submerge a structure without causing substantial damage. This difference in building damage is a direct result of the energy contained in coastal waves striking buildings – something obvious to those who saw the wave damage that Hurricane Ike caused in Texas and Louisiana (see Figure 5).



**Figure 3. Probability that a flood will exceed the n-year flood level over a given period of time. (Note: this analysis assumes no shoreline erosion, and no increase in sea level or storm frequency/severity over time.)**

### FIRMs do not account for the following:

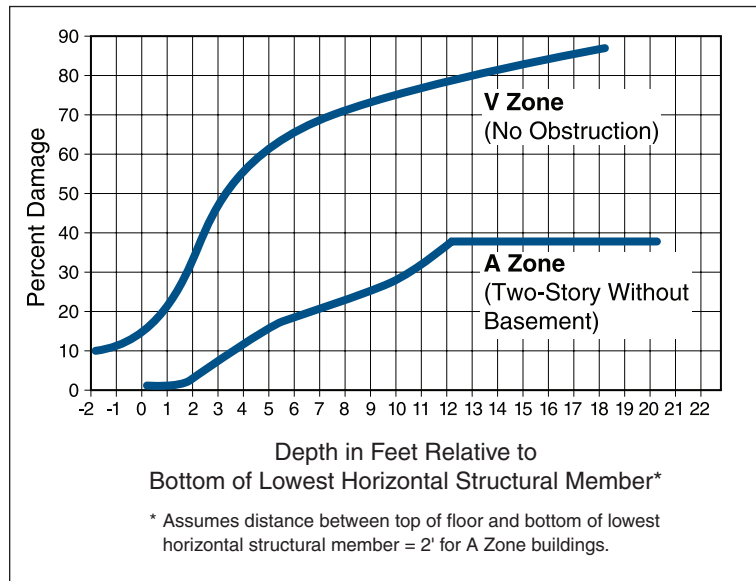
- Shoreline erosion, wetland loss, subsidence, and relative sea level rise
- Upland development or topographic changes
- Degradation or settlement of levees and floodwalls
- Changes in storm climatology (frequency and severity)
- The effects of multiple storm events

Thus, what was once an accurate depiction of the 100-year floodplain and flood elevations may no longer be so.

<sup>2</sup> Sections 7.8.1.3 and 7.9 of FEMA's *Coastal Construction Manual* (FEMA 55, 2000 edition) provide guidance on evaluating a FIRM to determine whether it still provides an accurate depiction of base flood conditions, or whether it is obsolete.

<sup>3</sup> Since the normal floor reference for A-zone buildings is the top of the lowest floor, the A-zone curve was shifted for comparison with the V-zone curve.

In cases where buildings are situated behind levees, a levee failure can result in rapid flooding of the area. Buildings near a levee breach may be exposed to high velocity flows, and damages to those buildings will likely be characterized by the V-zone damage curve in Figure 4. Damages to buildings farther away from the breach will be a result of inundation by floodwaters, and will likely resemble the A-zone curve in Figure 4.



**Figure 4. Flood depth versus building damage curves for V zones and riverine A zones (Source: FEMA 55, Coastal Construction Manual).**



**Figure 5. Hurricane Ike damage to buildings. The upper left and upper right photos are of buildings that were close to the Gulf of Mexico shoreline and subjected to storm surge and large waves above the lowest floor. The lower left photo is of a building close to Galveston Bay shoreline and subjected to storm surge and small waves. The lower right photo is of a Cameron Parish, Louisiana, school that was approximately 1.3 miles from the Gulf shoreline, but subjected to storm surge and small waves.**



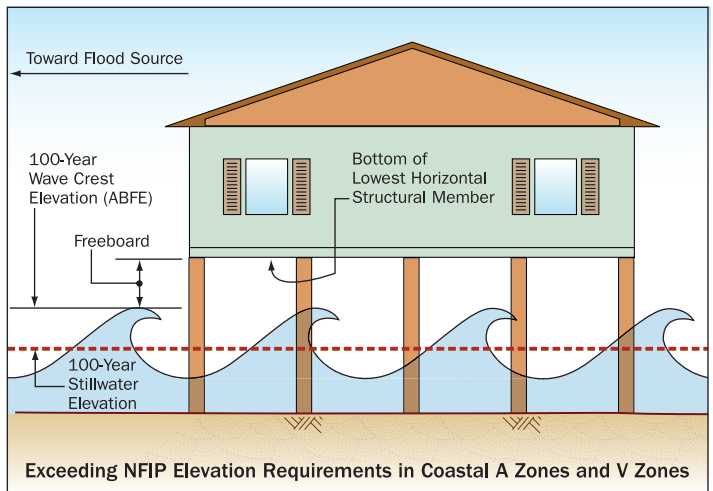
## General Recommendations

The goal of this Advisory is to provide methods to minimize damage to buildings in the event that coastal flood levels rise above the BFE. Achieving this goal will require adherence to one or more of the following general recommendations:

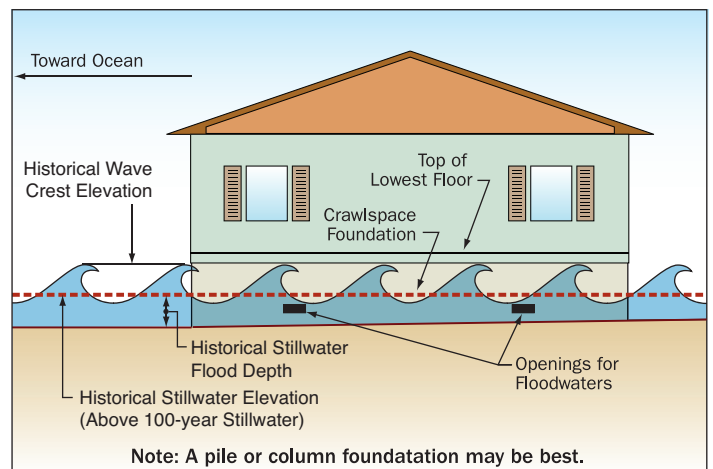
- In all areas where flooding is a concern, inside and outside the SFHA, elevate the lowest floor so that the bottom of the lowest horizontal structural member is at or above the Design Flood Elevation (DFE). Do not place the top of the lowest floor at the DFE, since this guarantees flood damage to wood floor systems, wood floors, floor coverings, and lower walls during the design flood, and may lead to mold/contamination damage (see Figure 6).
- In flood Zones V and A, use a DFE that results in freeboard (elevate the lowest floor above the BFE) (see Figure 7).
- In flood Zones V and A, calculate design loads and conditions (hydrostatic loads, hydrodynamic loads, wave loads, floating debris loads, and erosion and scour) under the assumption that the flood level will exceed the BFE.
- In an A zone subject to moderate waves (1.5 to 2.9 ft high) and/or erosion (i.e., a Coastal A zone), use a pile or column foundation (see Figure 7). See the Hurricane Ike Recovery Advisory at <http://www.fema.gov/library/viewRecord.do?id=3539> for details on Coastal A zones.
- Outside the SFHA (in flood Zones B, C, and X), adopt flood-resistant design and construction practices if historical evidence or a review of the available flood data shows the building could be damaged by a flood more severe than the base flood (see Figure 8).
- Design and construct buildings using the latest model building code, ASCE 7-05, *Minimum Design Loads for Buildings and Other Structures* and ASCE 24-05, *Standard for Flood Resistant Design and Construction*.
- Follow the recommendations in FEMA 499, *Home Builder's Guide to Coastal Construction Technical Fact Sheets Series* (available at: [http://www.fema.gov/rebuild/mat/mat\\_fema499.shtm](http://www.fema.gov/rebuild/mat/mat_fema499.shtm)).
- Use the pre-engineered foundations shown in FEMA 550, *Recommended Residential Construction for the Gulf Coast: Building on Strong and Safe Foundations* (available at: <http://www.fema.gov/library/viewRecord.do?id=1853>).
- Use strong connections between the foundation and the elevated building to prevent the building from floating or washing off the foundation, in the event that flood levels do rise above the lowest floor.



**Figure 6.** Other concerns when flood levels rise above the lowest floor are mold and biological/chemical contamination. These may render an otherwise repairable building unrepairable, or will at least make the cleanup, restoration, and repairs much more expensive and time-consuming.

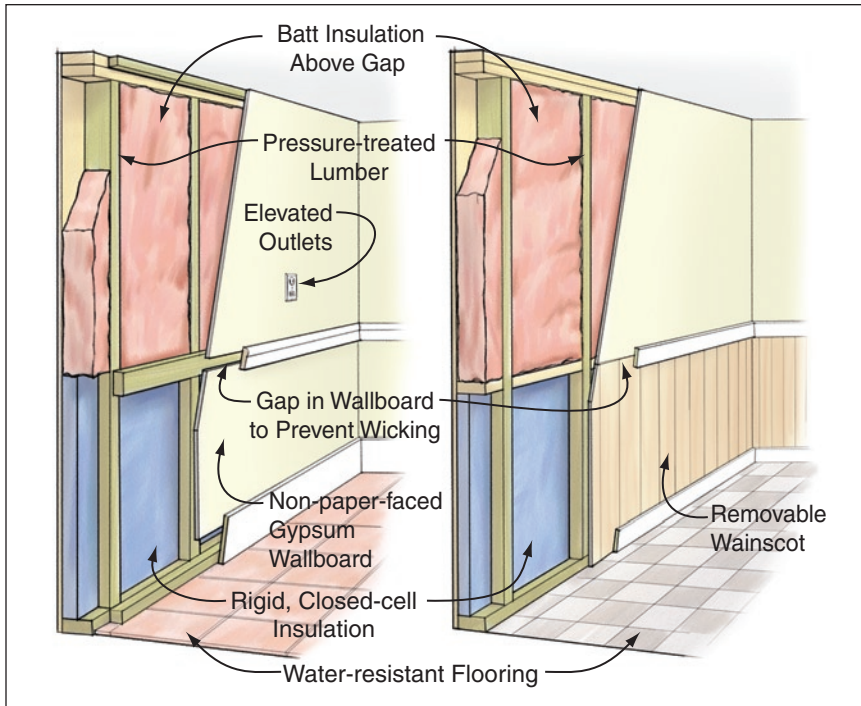


**Figure 7.** Recommended construction in Coastal A zones and V zones.

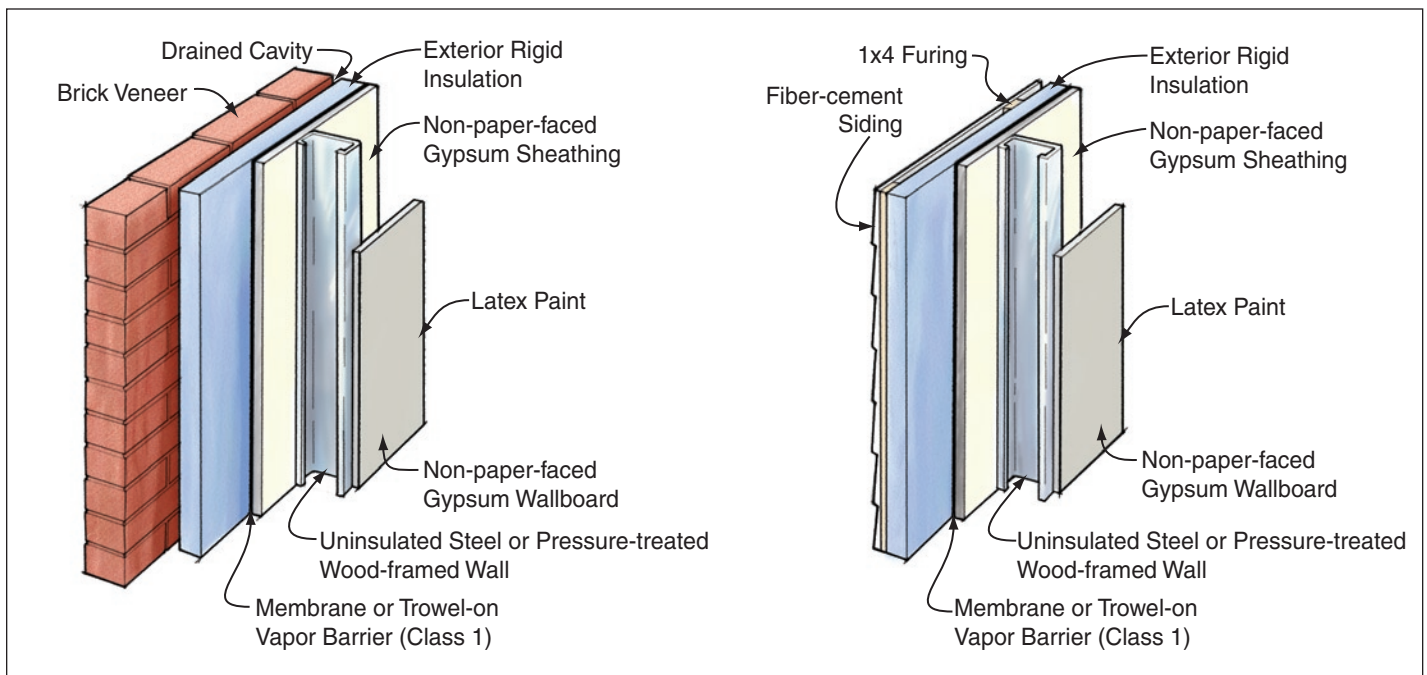


**Figure 8.** Recommended construction in Zones B, C, and X.

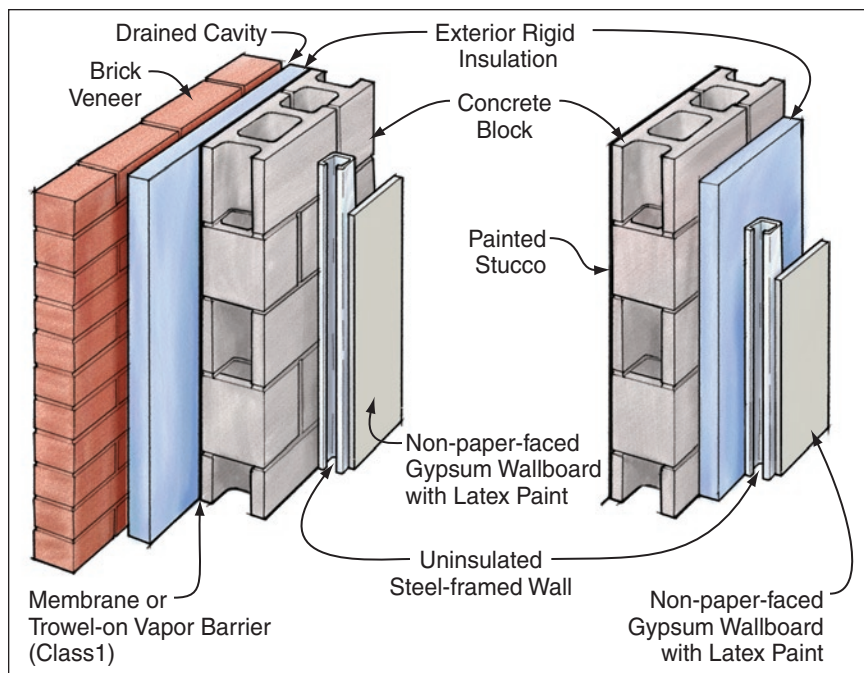
- Use **flood damage-resistant building materials and methods** above the lowest floor. For example, consider using drainable, dryable interior wall assemblies (see Figure 9). This allows interior walls to be opened up and dried after a flood above the lowest floor, minimizing damage to the structure. For cavity and mass wall assemblies, the methods and materials in Figures 10 and 11 are recommended.



**Figure 9. Recommended wet floodproofing techniques for interior wall construction. The following flood damage-resistant materials and methods will prevent wicking and limit flood damage: 1) construct walls with horizontal gaps in wallboard; 2) use non-paper-faced gypsum wallboard below gap, painted with latex paint; 3) use rigid, closed-cell insulation in lower portion of walls; 4) use water-resistant flooring with waterproof adhesive; and 5) use pressure treated wood framing (Source: LSU AgCenter and Coastal Contractor Magazine).**



**Figure 10. Recommended flood-resistant exterior cavity wall construction. The following materials and methods will limit flood damage to exterior cavity walls: 1) use brick veneer or fiber-cement siding, with non-paper-faced gypsum sheathing (vinyl siding is also flood-resistant but is less resistant to wind damage); 2) provide cavity for drainage; 3) use rigid, closed-cell insulation; 4) use steel or pressure-treated wood studs and framing; and 5) use non-paper-faced gypsum wallboard painted with latex paint (Source: Coastal Contractor Magazine and Building Science Corporation).**



**Figure 11. Recommended flood-resistant exterior mass wall construction. The following materials and methods will limit flood damage to exterior mass walls: 1) use concrete masonry with stucco or brick veneer (provide drainage cavity if brick veneer is used); 2) use rigid, closed-cell insulation; 3) use steel framing; and 4) use non-paper-faced gypsum wallboard painted with latex paint (Source: Coastal Contractor Magazine and Building Science Corporation).**

- New and replacement manufactured homes should be installed in accordance with the provisions of the 2009 edition of the National Fire Protection Association (NFPA) 225, *Model Manufactured Home Installation Standard* ([http://www.nfpa.org/aboutthecodes/AboutTheCodes.asp?DocNum=225&cookie\\_test=1](http://www.nfpa.org/aboutthecodes/AboutTheCodes.asp?DocNum=225&cookie_test=1)). The standard provides flood, wind, and seismic-resistant installation procedures. It also calls for elevating A-zone manufactured homes with the bottom of the main chassis frame beam at or above the BFE, not with the top of the floor at the BFE.

## Other Considerations

As previously stated, in addition to reduced building damage, there are other reasons to design for flood levels above the BFE:

- Reduced building maintenance and longer building life
- Reduced flood insurance premiums
- Reduced displacement and dislocation of building occupants after floods (and need for temporary shelter and assistance)
- Reduced job loss
- Increased retention of tax base

Until flooded, many homeowners and communities don't think about these benefits. However, one of the most persuasive (to homeowners) arguments for elevating homes above the BFE is the reduction in annual flood insurance premiums. In most cases, flood premiums can be cut in half by elevating a home 2 feet above the BFE, saving several hundred dollars per year in A zones, and \$2,000 or more per year in V zones. In V zones, savings increase with added freeboard.

A comprehensive study of freeboard (American Institutes for Research, 2006) demonstrated that adding freeboard at the time of house construction is cost-effective. Reduced flood damage yields a benefit/cost ratio greater than 1 over a wide range of scenarios, and flood insurance premium reductions make adding freeboard even more beneficial to the homeowner. **Reduced flood insurance premiums will pay for the cost of incorporating freeboard in a Zone V house in 1 to 3 years; for a Zone A house, the payback period is approximately 6 years.**

## Flood Insurance Premium Reductions Can Be Significant

<b>Example 1:</b> V-zone building, supported on piles or piers, no below-BFE enclosure or obstruction. \$250,000 building coverage, \$100,000 contents coverage.		<b>Example 2:</b> A-zone building, slab or crawlspace foundation (no basement). \$200,000 building coverage, \$75,000 contents coverage.	
Floor Elevation Above BFE	Reduction in Annual Flood Premium*	Floor Elevation Above BFE	Reduction in Annual Flood Premium*
1 foot	25%	1 foot	39%
2 feet	50%	2 feet	48%
3 feet	62%	3 feet	48%
4 feet	67%	4 feet	48%

\* Compared to flood premium with lowest floor at BFE

### References

ASCE. 2005. *Minimum Design Loads for Buildings and Other Structures*. ASCE 7-05.

ASCE. 2005. *Standard for Flood Resistant Design and Construction*. ASCE 24-05.

Building Science Corporation. 2006. (relevant articles and publications available at: <http://www.buildingscience.com>).

Coastal Contractor magazine. July 2006. *Low Country Rx: Wet Floodproofing. Drainable, dryable assemblies made with water-tolerant materials help speed recovery from deeper than-expected floods*, by Ted Cushman. (available at: <http://www.coastalcontractor.net/cgi-bin/issue.pl?issue=9>)

FEMA. 2000. *Coastal Construction Manual*. FEMA 55. (ordering information at: [http://www.fema.gov/pdf/plan/prevent/nhp/nhp\\_fema55.pdf](http://www.fema.gov/pdf/plan/prevent/nhp/nhp_fema55.pdf))

FEMA. 2005. *Home Builder's Guide to Coastal Construction Fact Sheets Series*. FEMA 499. (available at: [http://www.fema.gov/rebuild/mat/mat\\_fema499.shtm](http://www.fema.gov/rebuild/mat/mat_fema499.shtm))

FEMA. 2006. *Recommended Residential Construction for the Gulf Coast, Building on Strong and Safe Foundations*. FEMA-550. (available at: <http://www.fema.gov/library/viewRecord.do?id=1853>)

FEMA. 2009. *Mitigation Assessment Team Report, Hurricane Ike in Texas and Louisiana: Building Performance Observations, Recommendations, and Technical Guidance*. FEMA P-757.

LSU AgCenter. 1999. *Wet Floodproofing. Reducing Damage from Floods*. Publication 2771. (available at: <http://www.lsuagcenter.com/NR/rdonlyres/B2B6CDEC-2BSB-472E-BBD9-OBDEB0B29C4A/26120/pub2771Wet6.pdf>)

NFPA. 2009. *Model Manufactured Home Installation Standard*. NFPA 225. (available at: [http://www.nfpa.org/aboutthecodes/AboutTheCodes.asp?DocNum=225&cookie\\_test=1](http://www.nfpa.org/aboutthecodes/AboutTheCodes.asp?DocNum=225&cookie_test=1))

# Enclosures and Breakaway Walls



**FEMA**  
<http://www.fema.gov>

## HURRICANE IKE RECOVERY ADVISORY

**Purpose:** To discuss requirements and recommendations for enclosures and breakaway walls below the Base Flood Elevation (BFE).

### Key Issues

- Spaces below elevated buildings can be used only for building access, parking, and storage.
- Areas enclosed by solid walls below the BFE (“enclosures”) are subject to strict regulation under the National Flood Insurance Program (NFIP). Note that some local jurisdictions enforce stricter regulations for enclosures.
- Enclosures in V-zone buildings must be breakaway (non-breakaway enclosures are prohibited). Breakaway enclosures in V zones must be built with flood-resistant materials, meet specific design requirements, and be certified by a registered design professional.
- Enclosures (breakaway and non-breakaway) in A-zone buildings must be built with flood-resistant materials and equipped with flood openings that allow water levels inside and outside to equalize.
- Breakaway enclosure walls should be considered expendable, and the building owner could incur significant costs when the walls are replaced. Breakaway wall replacement is not covered by the flood insurance policy.
- For V zones, breakaway wall enclosures below an elevated building will result in higher flood insurance premiums; however, surrounding below-BFE space with insect screening, open lattice, slats, or shutters (louvers) can result in much lower flood insurance premiums (Figure 1). Use of these materials will allow floodwaters to pass into and out of the enclosed space and minimize damage to the enclosure “walls.” Although not required by the NFIP, installation of flood openings in breakaway walls may also reduce damage to the walls.

### Space Below the BFE – What Can It Be Used For?

NFIP regulations state that the area below an elevated building can be used only for parking, building access,



#### WARNING

Designers and owners should realize that: (1) enclosures and items within them are likely to be destroyed even during minor flood events; (2) enclosures, and most items within them, are not covered by flood insurance and can result in significant costs to the building owner; and (3) even the presence of properly constructed breakaway wall enclosures will increase flood insurance premiums for the entire building (the premium rate will increase as the enclosed area increases). Including enclosures in a building design can have significant cost implications.

The Hurricane Ike Mitigation Assessment Team (MAT) observed some breakaway walls in excess of 11' high. While FEMA promotes elevating homes above the BFE (i.e., adding freeboard), one of the unintended consequences appears to be the increasing size of floodborne debris elements due to taller breakaway walls.



**Figure 1.** Wood louvers installed beneath an elevated house in a V zone are a good alternative to solid breakaway walls.

and storage. These areas must not be finished or used for recreational or habitable purposes. No mechanical, electrical, or plumbing equipment is to be installed below the BFE.

## What is an Enclosure?

An “**enclosure**” is formed when any space below the BFE is enclosed on all sides by walls or partitions. Enclosures can be divided into two types, breakaway and non-breakaway.

- **Breakaway** enclosures are designed to fail under base flood conditions without jeopardizing the elevated building (Figure 2) – **any below-BFE enclosure in a V zone must be breakaway**. Breakaway enclosures are permitted in A zones, but must be equipped with flood openings.
- **Non-breakaway** enclosures can be constructed in an A zone. They may be used to provide structural support to the elevated building. All A-zone enclosures must be equipped with flood openings to allow the automatic entry and exit of floodwaters. **This Recovery Advisory recommends their use only in A-zone areas subject to shallow, slow-moving floodwaters without breaking waves.**

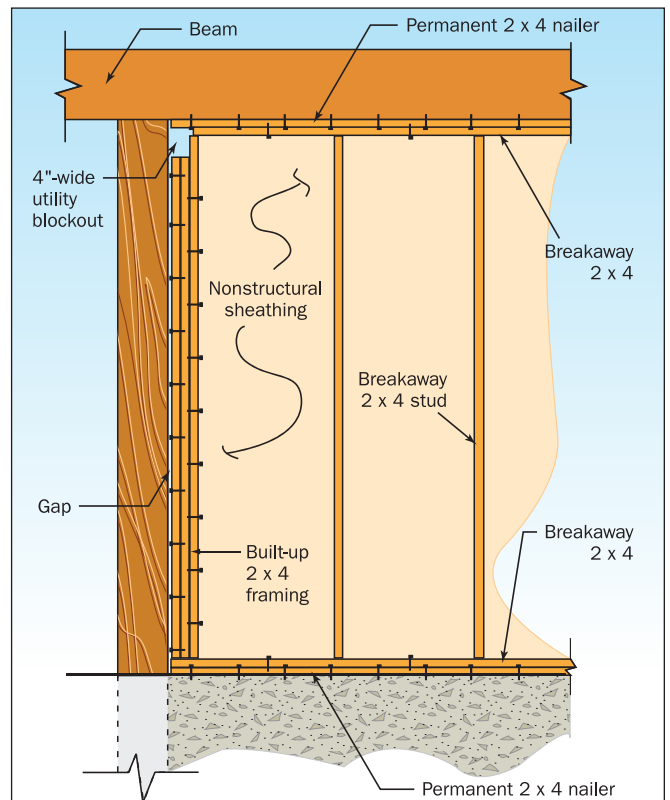
## Breakaway Walls

Breakaway walls must be designed to break free under the larger of: 1) the design wind load, 2) the design seismic load, or 3) 10 pounds per square foot (psf), acting perpendicular to the plane of the wall (see Figure 3 for an example of a compliant breakaway wall). If the loading at which the breakaway wall is intended to collapse exceeds 20 psf, **the breakaway wall design must be certified**. When certification is required, a registered engineer or architect must certify that the walls will collapse under a water load associated with the base flood and that the elevated portion of the building and its foundation will not be subject to collapse, displacement, or lateral movement under simultaneous wind and water loads. **Breakaway walls must break away cleanly and must not damage the elevated building when they do so** (Figure 4). **Utilities should not be attached to or pass through breakaway walls**. See FEMA (2008a) Technical Bulletin 9, Design and Construction Guidance for Breakaway Walls for more information.

**Figure 4. Building siding extended down and over the breakaway wall. Lack of a clean separation allowed damage to spread upward as the breakaway wall failed.**



**Figure 2. Breakaway walls beneath this building failed as intended under the flood forces of Hurricane Ike.**



**Figure 3. NFIP-compliant breakaway wall construction.**



## Obstruction Considerations

A V-zone building, elevated on an open foundation without an enclosure or other obstructions below the BFE, is said to be free of obstructions, and enjoys favorable flood insurance premiums (see FEMA (2008b) Technical Bulletin 5, *Free-of-Obstruction Requirements* for more information).

The following building scenarios are also classified by the NFIP as free of obstructions:

- Below BFE space is surrounded by insect screening and/or by wooden or plastic lattice, slats, or shutters (louvers), if at least 40 percent of the lattice and louver area is open. Lattice can be no thicker than ½"; slats or louvers can be no thicker than 1".
- Below BFE space is surrounded by a combination of one solid breakaway wall (or garage door), and all other sides of the enclosure are insect screening, or wooden or plastic lattice, slats, or louvers.

The following building scenarios are classified by the NFIP as with obstructions:

- Below BFE space is fully enclosed by solid breakaway walls.
- Below BFE space is enclosed by a combination of two or more solid breakaway walls, with the remaining sides of insect screening, or wooden or plastic lattice, slats, or louvers.

## Flood Openings

Foundation walls and other enclosure walls of A-zone buildings (including Coastal A-zone buildings) must be equipped with openings that allow the **automatic entry and exit of floodwaters** (Figure 5).

A-zone opening requirements are as follows:

- Flood openings must be provided in **at least two of the walls** forming the enclosure.
- **The bottom of each flood opening must be no more than 1' above the higher of the interior or exterior adjacent grade.**
- **Louvers, screens, or covers** may be installed over flood openings as long as they do not interfere with the operation of the openings during a flood.
- Flood openings may be **sized** according to either a prescriptive method (1 square inch of flood opening per square foot of enclosed area) or an engineering method (which must be certified by a registered engineer or architect).

Details concerning flood openings can be found in FEMA (2008c) Technical Bulletin 1, *Openings in Foundation Walls and Walls of Enclosures*.

## Other Considerations

Enclosures are strictly regulated because, if not constructed properly, they can transfer flood forces to the main structure (possibly leading to structural collapse). There are other considerations as well:

- Owners may be tempted to convert enclosed areas below the BFE into habitable space, leading to life-safety concerns and uninsured losses. Construction without enclosures should be encouraged. Contractors **should not stub out utilities in enclosures** (utility stub-outs make it easier for owners to finish and occupy the space).
- Siding used on the elevated portions of a building should not extend down over breakaway walls. Instead, a clean separation should be provided so that any siding installed on breakaway walls is structurally independent of siding elsewhere on the building. Without such a separation, the failure of breakaway walls can result in damage to siding elsewhere on the building (see Figure 4).
- Solid breakaway wall enclosures in V zones will result in **significantly higher flood insurance premiums** (especially where the enclosed area is 300 square feet or greater). Insect screening or lattice, slats, or louvers are recommended instead.



Figure 5. Flood opening in a below-BFE enclosure wall.

- If enclosures are constructed in **Coastal A zones** (see the Hurricane Ike Recovery Advisory, *Design and Construction in Coastal A Zones*), **open foundations with breakaway enclosures are recommended** in lieu of foundation walls or crawlspaces. If solid breakaway walls are used, they must be equipped with flood openings that allow floodwaters to enter and exit the enclosure. Use of breakaway enclosures in Coastal A zones (or any A zone) will not lead to higher flood insurance premiums.

This Recovery Advisory recommends the use of insect screening, or open wood or plastic lattice, slats, or louvers, instead of solid breakaway walls beneath elevated residential buildings.

- Garage doors installed in below-BFE enclosures of V-zone buildings – even reinforced and high-wind-resistant doors – must meet the performance requirement discussed in the *Breakaway Walls* section of this Recovery Advisory. Specifically, the doors must be designed to break free under the larger of the design wind load, the design seismic load, or 10 psf, acting perpendicular to the plane of the door. If the loading at which the door is intended to collapse is greater than 20 psf, **the door must be designed and certified to collapse under base flood conditions.**

This Recovery Advisory recommends that flood openings be considered for solid breakaway walls in V zones, even though they are not required by the NFIP. The presence of flood openings may relieve flood forces against the solid breakaway walls and reduce damage to the walls.

See the *Breakaway Walls* section for information about certification requirements.

## References

FEMA. 2008a. *Design and Construction Requirements for Breakaway Walls*. Technical Bulletin 9, available at: <http://www.fema.gov/library/viewRecord.do?id=1722>.

FEMA. 2008b. *Free-of-Obstruction Requirements*. Technical Bulletin 5, available at: <http://www.fema.gov/library/viewRecord.do?id=1718>.

FEMA. 2008c. *Openings in Foundation Walls and Walls of Enclosures*. Technical Bulletin 1, available at: <http://www.fema.gov/library/viewRecord.do?id=1579>.

FEMA. 2009. Hurricane Ike Recovery Advisory, *Design and Construction in Coastal A Zones*.



# Erosion, Scour, and Foundation Design



**FEMA**  
<http://www.fema.gov>

## HURRICANE IKE RECOVERY ADVISORY

**Purpose:** To discuss how any lowering of the ground surface can affect the ability of a building foundation to resist design loads, and to provide additional guidance for coastal foundation design.

### Key Issues

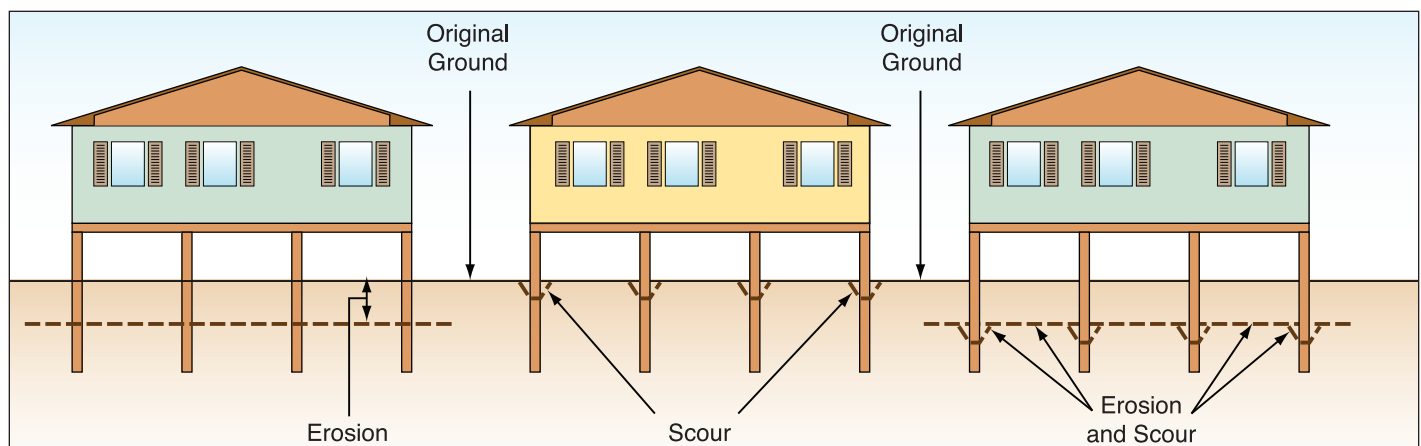
- Coastal buildings are often subject to flood loads and conditions that do not affect inland buildings. These include waves, high velocity storm surge flow, floodborne debris, and **erosion** and **scour**. This Recovery Advisory will focus on erosion and scour. See FEMA 499, *Home Builder's Guide to Coastal Construction* (2005), Fact Sheets 11 through 15 at: <http://www.fema.gov/library/viewRecord.do?id=1570>, and FEMA 55, *Coastal Construction Manual* (2000) at: <http://www.fema.gov/library/viewRecord.do?id=1671> for discussion of other foundation issues.
- Foundations must transfer all loads imposed on the building into the ground. If the foundation is not strong enough or deep enough to do this, the building will be destroyed. If the foundation embedment into the ground is not sufficient to account for erosion and scour that may occur over the life of the building, the building is vulnerable to collapse under design flood and wind conditions.
- Predicting the incidence, location, and magnitude of coastal erosion and scour is difficult, and present-day building codes and standards do not prescribe clear-cut solutions for designers. Therefore, designers should be conservative with their foundation designs. This means foundations may need to be stronger, deeper, and higher than what has historically been used. Lessons learned from Hurricane Ike and other recent coastal storm events should be incorporated into foundation designs.

**Erosion** refers to a general lowering of the ground surface over a wide area.

**Scour** refers to a localized loss of soil, often around a foundation element.

### Erosion and Scour Basics

**Erosion** is defined by the International Building Code® (ICC, 2006) as the “wearing away of the ground surface as a result of the movement of wind, water or ice.” Section 7.5 of FEMA’s *Coastal Construction Manual* describes erosion as “the wearing or washing away of coastal lands.” Since the exact configuration of the soil loss is important for foundation design purposes, a more specific definition is used in this Recovery Advisory (see text box and Figure 1).



**Figure 1. Distinguishing between coastal erosion and scour. A building may be subject to either or both, depending on the building location, soil characteristics, and flood conditions.**

**Erosion** can occur across a wide range of timeframes – it can be gradual, occurring over a long period of time (many years); more rapid, occurring over a relatively short period of time (weeks or months); or episodic, occurring during a single coastal storm event over a short period of time (hours or days). Figure 2 shows the result of erosion occurring over a long timeframe – buildings that were formerly on upland property, but now stand on the active beach. Figure 3 shows episodic erosion that occurred during Hurricane Ike. In both cases, the recession of the shoreline resulted in a horizontal translation of the beach profile and a lowering of the ground elevation under and near the affected buildings. The closer a building is to the shoreline, the more likely erosion will occur and the greater the erosion depth will be.

**Scour** occurs when floodwater passes around obstructions in the water column. As the water flows around an object, it must change direction and accelerate. Soil can be loosened and suspended by this process or by waves striking the object, and be carried away. Pilings, pile caps, columns, walls, footings, slabs, and other objects found under a coastal building can lead to localized scour. Scour effects increase with increasing flow velocity and turbulence, and with increasing soil erodibility.

Scour effects are generally **localized**, ranging from small, shallow conical depressions in the sand around individual piles (Figure 4) to larger and deeper depressions around individual piles (Figure 5), to a building-sized shallow depression around a group of piles (Figure 6), to a large and deep depression around a building foundation (Figure 7). Scour depressions like that shown in Figure 7 were observed frequently following Hurricane Ike, and many of these reportedly were 6 to 10' deep and required hundreds of cubic yards of soil to fill. The presence of large, non-frangible concrete slabs and deep grade beams under the buildings may be a contributing factor to the large local scour depressions observed.

In some cases, buildings may settle due to inadequate pile embedment, coupled with some combination of erosion, scour, and soil liquefaction that leads to loss of bearing. This type of failure was observed by the Hurricane Ike FEMA Mitigation Assessment Team (MAT) at Surfside Beach, TX (Figure 8) and Holly Beach, LA.



**Figure 2. Long-term erosion has caused the shoreline to retreat and has left homes standing on the beach (Surfside Beach, TX). July 2007 Texas General Land Office photo.**



**Figure 3. Storm-induced erosion beneath an elevated coastal building (Galveston Island, TX, Hurricane Ike).**



**Figure 4. Local scour around foundation piles (Pensacola Beach, FL, Hurricane Ivan).**



**Figure 5. Local scour around foundation piles (Holly Beach, LA, Hurricane Ike).**



**Figure 6. Local scour around a 3rd row house's pile foundation (Bolivar Peninsula, TX, Hurricane Ike).**



**Figure 7. Extreme local scour around a Gulf-front pile foundation (Bolivar Peninsula, TX, Hurricane Ike).**



**Figure 8. Differential settlement of buildings thought to be a result of inadequate foundation embedment coupled with erosion, scour, and/or soil liquefaction (Surfside Beach, TX, Hurricane Ike).**



**Figure 9. Linear scour and erosion patterns aligning with canals and roads (Bolivar Peninsula, TX, Hurricane Ike).**

There is one other erosion and scour scenario to consider in foundation design – the loss of soil around or under a building as a result of storm surge flow being channeled or directed across a building site. This process usually takes place where storm surge flow is constrained between large buildings or gaps in shore protection, or when return flow to the sea follows paths of least resistance, such as along canals and roads (Figure 9).

## **Erosion and Scour – Impacts on Foundations**

Erosion and scour have several adverse impacts on coastal foundations:

- Erosion and scour reduce the embedment of the foundation into the soil, causing shallow foundations to collapse and making buildings on deep foundations more susceptible to settlement, lateral movement, or overturning from lateral loads.
- Erosion and scour increase the unbraced length of pile foundations, increase the bending moment to which they are subjected, and can overstress piles.
- Erosion over a large area between a foundation and a flood source exposes the foundation to increased lateral flood loads (i.e., greater stillwater depths, possible higher wave heights, and higher flow velocities).
- Local scour around individual piles or a building foundation will not generally expose foundations to greater flood loads, but linear scour across a building site may do so.

Resisting *higher bending moments* brought about by erosion and scour may necessitate a larger pile cross-section or decreased pile spacing (i.e., more piles) or, in some cases, use of a different pile material (e.g., concrete or steel instead of wood). Resisting increased lateral flood loads brought about by erosion (and possibly by linear scour) would necessitate a similar approach. However, designers must remember that increasing the number of piles or increasing the pile diameter will, in turn, also increase lateral flood loads on the foundation.

Resisting *increased unbraced lengths* brought about by erosion and scour will require additional embedment of the foundation into the ground.

To illustrate these points, calculations were made to examine the effects of erosion and scour on foundation design for a simple case – a 32' x 32', two-story house (10' story height), situated away from the shoreline and elevated 8' above grade on 25 square timber piles (spaced 8' apart), on medium dense sand. The house was subjected to a design wind event with a 130-mph (3-second gust) wind speed and a 4' stillwater depth above the uneroded grade, with storm surge and broken waves passing under the elevated building. Lateral wind and flood loads were calculated in accordance with ASCE/SEI 7-05 *Minimum Design Loads for Buildings and Other Structures* (model codes and related prescriptive standards, such as the International Building Code (IBC), the International Residential Code® (IRC®), and ICC-600 *Standard for Residential Construction in High Wind Areas*, are based on ASCE 7 loads). For this illustration, the piles were analyzed under lateral wind and flood loads only; dead, live and wind uplift loads were neglected. If these neglected loads are included in the analysis, deeper pile embedment and possibly larger piles may be needed.

Three different timber pile sizes (8" square, 10" square, and 12" square) were evaluated using pre-storm embedment depths of 10', 15', and 20', and five different erosion and scour conditions (Erosion = 0' or 1'; Scour ranges from 2.0 times the pile diameter to 4.0 times the pile diameter). The results of the analysis are shown in Table 1. A shaded cell indicates the combination of pile size, pre-storm embedment, and erosion/scour does not provide the bending resistance and/or embedment required to resist lateral loads. The reason(s) for a foundation failure is indicated in each shaded cell, using "P" for failure due to bending and overstress within the pile and "E" for an embedment failure from the pile/soil interaction. An unshaded cell with "OK" indicates bending and foundation embedment criteria are both satisfied by the particular pile size/pile embedment/erosion-scour combination.

**Table 1. Example foundation adequacy calculations for a two-story house supported on square timber piles and situated away from the shoreline, storm surge and broken waves passing under the building, 130-mph wind zone, soil = medium dense sand. Shaded cells indicate the foundation fails to meet bending (P) and/or embedment (E) requirements.**

Pile Embedment Before Erosion and Scour	Erosion and Scour Conditions	Pile Diameter, a		
		8 inch	10 inch	12 inch
10 feet	Erosion = 0, Scour = 0	P, E	E	OK
	Erosion = 1 foot, Scour = 2.0 a	P, E	E	E
	Erosion = 1 foot, Scour = 2.5 a	P, E	E	E
	Erosion = 1 foot, Scour = 3.0 a	P, E	E	E
	Erosion = 1 foot, Scour = 4.0 a	P, E	P, E	E
15 feet	Erosion = 0, Scour = 0	P	OK	OK
	Erosion = 1 foot, Scour = 2.0 a	P	OK	OK
	Erosion = 1 foot, Scour = 2.5 a	P	OK	OK
	Erosion = 1 foot, Scour = 3.0 a	P	OK	OK
	Erosion = 1 foot, Scour = 4.0 a	P, E	P, E	E
20 feet	Erosion = 0, Scour = 0	P	OK	OK
	Erosion = 1 foot, Scour = 2.0 a	P	OK	OK
	Erosion = 1 foot, Scour = 2.5 a	P	OK	OK
	Erosion = 1 foot, Scour = 3.0 a	P	OK	OK
	Erosion = 1 foot, Scour = 4.0 a	P	P	OK

Review of the table shows several key points:

- Increasing pile embedment will not offset foundation inadequacy (bending failure) resulting from too small a pile cross-section or too weak a pile material.
- Increasing pile cross-section (or material strength) will not compensate for inadequate pile embedment
- Given the building and foundation configuration used in the example, the 8" square pile is not strong enough to resist the lateral loads resulting from the 130-mph design wind speed under any of the erosion and scour conditions evaluated, even if there is no erosion or scour. Homes supported by 8" square timber piles, with embedment depths of 10' or less, will likely fail in large numbers when subjected to design or near-design loads and conditions. Homes supported by deeper 8" piles may still be lost during a design event due to pile (bending) failures
- The 10" square pile is strong enough to resist bending under all but the most severe erosion and scour conditions analyzed.
- The 12" pile is the only pile size evaluated that satisfies bending requirements under all erosion and scour conditions analyzed. The 12" pile works with 10' of embedment under the no erosion and scour condition. However, introducing as little as 1' of erosion, and scour equal to twice the pile diameter, was enough to render the foundation too shallow.
- 15' of pile embedment is adequate for both 10" and 12" piles subject to 1' of erosion and scour up to three times the pile diameter. However, when the scour is increased to four times the pile diameter (frequently observed following Hurricane Ike), 15' of embedment is inadequate for both piles. In general terms, approximately 11' of embedment is required in this example house to resist the loads and conditions after erosion and scour are imposed.
- The 12" pile with 20' of embedment was the only foundation that worked under all erosion and scour conditions analyzed. This pile design may be justified for the sample house analyzed when expected erosion and scour conditions are unknown or uncertain.



#### WARNING

**The results in Table 1 should not be used in lieu of building- and site-specific engineering analyses and foundation design. The table is for illustrative purposes only and is based upon certain assumptions and simplifications, and for the combinations of building characteristics, soil conditions, and wind and flood conditions described above. Registered design professionals should be consulted for foundations designs.**

## NFIP and Building Code Requirements

One of the requirements of **Section 60.3(a)(3)** of the NFIP regulations that applies to all flood hazard zones (V, VE, V1-30, A, AE, A1-30, AO, AH, etc.) within the Special Flood Hazard Area (SFHA) is:

“If a proposed building site is in a flood-prone area, all new construction and substantial improvements shall be designed (or modified) and adequately anchored to prevent flotation, collapse, or lateral movement of the structure resulting from hydrodynamic and hydrostatic loads, including the effects of buoyancy.”

A requirement in **Section 60.3(e)(4)** states that all new construction and substantial improvements in V zones must be elevated on pilings and columns so that:

“(i) the bottom of the lowest horizontal structural member of the lowest floor (excluding the pilings or columns) is elevated to or above the base flood level; and

(ii) the pile or column foundation and structure attached thereto is anchored to resist flotation, collapse and lateral movement due to the effects of wind and water loads acting simultaneously on all building components.

Water loading values used shall be those associated with the base flood. Wind loading values used shall be those required by applicable State or local building standards. A registered professional engineer or architect shall develop or review the structural design, specifications and plans for the construction, and shall certify that the design and methods of construction to be used are in accordance with accepted standards of practice for meeting the provisions of paragraphs (e)(4)(i) and (ii) of this section.”

The International Residential Code (2006) has similar requirements:

**“R324.1.1 [Flood Resistant Construction] Structural systems.** All structural systems of all buildings and structures shall be designed, connected and anchored to resist flotation, collapse or permanent lateral movement due to structural loads and stresses from flooding equal to the design flood elevation.

**R324.3.3 [Coastal high-hazard areas] Foundations.** All buildings and structures erected in coastal high-hazard areas shall be supported on pilings or columns and shall be adequately anchored to such pilings or columns. Pilings shall have adequate soil penetration to resist the combined wave and wind loads (lateral and uplift). Water loading values used shall be those associated with the design flood. Wind loading values used shall be those required by this code. Pile embedment shall include consideration of decreased resistance capacity caused by scour of soil strata surrounding the piling. Pile systems design and installation shall be certified in accordance with Section R324.3.6. Mat, raft or other foundations that support columns shall not be permitted where soils investigations that are required in accordance with Section R401.4 indicate that soil material under the mat, raft or other foundation is subject to scour or erosion from wave-velocity flow conditions.

Buildings and structures, and all parts thereof, shall be constructed to support safely all loads, including dead loads, live loads, roof loads, flood loads, snow loads, wind loads and seismic loads as prescribed in this code. The construction of buildings and structures shall result in a system that provides a complete load path capable of transferring all loads from their point of origin through the load-resisting elements of the foundation.”

Thus, designers are responsible for ensuring that a foundation for a building in any flood hazard area must be adequate to support a building under applicable design loads and load combinations. Designers must consider the effects of erosion and scour when foundations are designed. Designers must certify the foundations.

There may also be other (State or local) foundation design and certification requirements.

## Erosion and Scour Design Guidance

Given that the design requirements listed above are performance requirements, designers must translate those into practice. This can be difficult with respect to estimating erosion and scour conditions at a particular site, since definitive guidance for estimating coastal erosion and scour is not present in building codes and standards.

FEMA’s *Coastal Construction Manual* (FEMA, 2000) provides some information and guidance, but even this should be considered preliminary and subject to improvement as we learn more from post-storm investigations. The pertinent CCM sections and guidance are summarized below:

CCM Section 7.5: this section summarizes the causes of erosion, its impacts on coastal lands and buildings, and how it is measured. Section 7.5.2.5 discusses local scour. One key point is a procedure outlined in the note on page 7-28 and illustrated in CCM Figure 7-66 – three steps that a designer should use to estimate future ground elevations and flood conditions at a site:

Step 1: determine the most landward shoreline location expected during the life of the building

Step 2: define the lowest expected ground elevation during the life of the building

Step 3: define the highest expected BFE during the life of the building

Designers in Texas and Louisiana can obtain erosion data and other related information from various state agencies (see References).

CCM Section 7.8.1.4 discusses FEMA’s current procedures for estimating storm-induced erosion.

CCM Section 7.9.2 discusses how designers can update an obsolete flood hazard description for a site by accounting for long-term (Step 1 above) and storm-induced erosion (Step 2 above). CCM Figure 7-67 (Figure 10) provides an example, illustrating the use of published long-term erosion information and simple storm erosion calculations to estimate future ground elevations at a building site.

CCM Section 11.6.11 discusses local scour and presents a simple method for calculating erosion around a single pile. The method predicts the depth of a scour depression below the eroded ground elevation

is equal to 2.0 times the pile diameter, unless non-erodible soil lies beneath the ground surface (Figure 11).

Designers should use the CCM scour depth relationship ( $S_{max} = 2.0 a$ ) with caution. Observations after Hurricane Ike showed scour exceeded twice the pile diameter at many locations. This could have been due to deeper scour depths around entire pile foundations (Figures 6 and 7), or to the presence of concrete slabs and deep grade beams that channeled flow between the bottom of the slab and the soil, or to other factors. Given the uncertainty over the exact cause of local scour during Hurricane Ike, foundation designs for reconstruction along the Gulf shoreline should be very conservative, and an assumed scour depth of 6 to 8' would not be unreasonable. Designers should investigate local soils and Hurricane Ike-induced scour at nearby locations before selecting a scour depth. Post-hurricane aerial photographs, such as those obtained after Hurricane Ike by NOAA and USGS (see References) will provide a good source of data for designers.

The CCM mentions linear scour channels occurring between large buildings or in-line with roads, canals, and drainage features (see CCM Section 8.3.2), but does not provide design guidance for estimating linear scour depths. As was the case with local scour, designers should utilize post-hurricane data when they estimate linear scour likelihood and depth.

## Existing Homes: Are the Pile Foundations Adequate?

The owner of an existing home may wonder whether the pile foundation is adequate to withstand erosion and scour during a design event. The builder or building official may have permit records, building plans, or foundation design information for the house, or may be able to provide information about typical design requirements, construction practices, and probable pile embedment depths for houses of the same age. A licensed engineer can perform an inspection of the foundation, provide information about non-destructive testing methods to determine pile embedment depth, review available foundation data, and analyze the foundation.

## References

- ASCE. 2005. *Minimum Design Loads for Buildings and Other Structures*. ASCE/SEI 7-05.
- FEMA. 2000. *Coastal Construction Manual*, 3rd ed. FEMA 55.
- FEMA. 2005. *Home Builder's Guide to Coastal Construction*. FEMA 499. See <http://www.fema.gov/library/viewRecord.do?id=1570>
- ICC 2006. *International Building Code*.
- ICC 2006. *International Residential Code with 2007 Supplement*.
- ICC 2008. *Standard for Residential Construction in High Wind Areas*. ICC 600.
- Louisiana Department of Natural Resources. 2008. *Coastal Restoration and Management data and reports*. See <http://dnr.louisiana.gov/crm/>

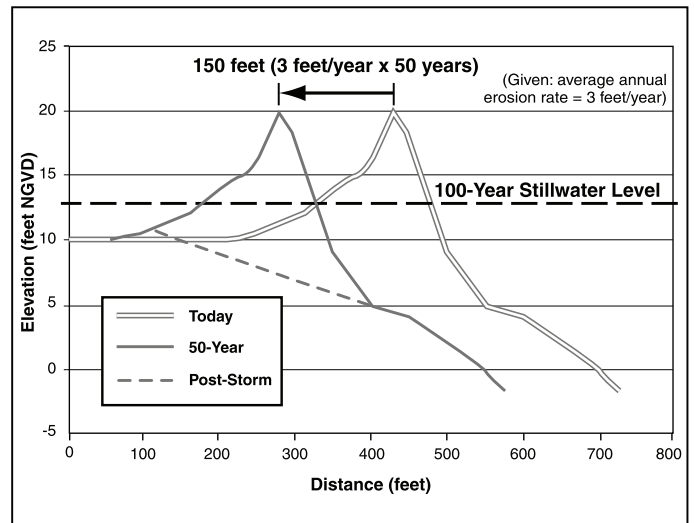


Figure 10. CCM Figure 7-67 illustrating a simple procedure to account for long-term erosion and storm erosion.

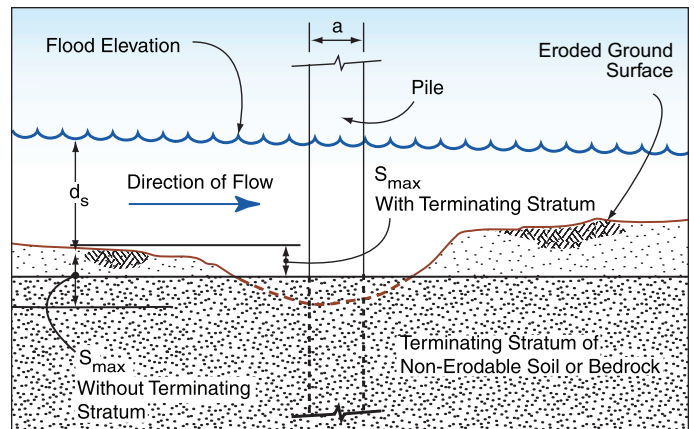


Figure 11. CCM Figure 11-12 illustrating scour estimate around a single pile - Hurricane Ike showed this method may underestimate local scour.

NOAA. 2008. Post-Ike aerial photographs. See <http://ngs.woc.noaa.gov/ike/index.html>

Texas Bureau of Economic Geology. 2008. Coastal Studies Program data and reports. See <http://www.beg.utexas.edu/coastal/coastal01.htm>

USGS. 2008. Post-Ike aerial photographs and data. See <http://coastal.er.usgs.gov/hurricanes/ike/>



# Minimizing Water Intrusion Through Roof Vents in High-Wind Regions



**FEMA**  
<http://www.fema.gov>

## HURRICANE IKE RECOVERY ADVISORY

**Purpose:** To recommend practices for minimizing water intrusion through roof vent systems that can lead to interior damage and mold growth in high-wind regions (i.e., greater than 90-miles per hour [mph] gust design wind speed).

### Key Issues

- Hurricane winds can drive large amounts of water through attic ventilation openings. The accumulating water soaks insulation, which can lead to mold growth and, in some cases, to the collapse of ceilings.
- Attic ventilation can be provided by a number of devices, most of which have been observed to allow water intrusion under certain conditions and some of which have been observed to blow off. These devices include:
  - Soffit vents
  - Ridge vents
  - Gable end vents
  - Off-ridge vents
  - Gable rake vents
  - Turbines
- Adequate ventilation of attics is generally required to promote the health of wood structural members and sheathing in the attic.
- Attic ventilation can reduce the temperatures of roof coverings, which will typically prolong the life of the roof covering. However, roof color can have more of an impact on roof covering temperature than the amount of ventilation that is or is not provided.
- An unventilated attic can be an effective way to prevent water intrusion and this type of attic is gaining popularity for energy efficiency reasons, provided the air conditioning system is sized appropriately. However, an unventilated attic is best accomplished when it is specifically designed into the house and all of the appropriate details are handled properly. On an existing house, any attempt to change to an unventilated attic configuration needs to be done very carefully with the advice of knowledgeable experts. There are a number of changes that have to be made to produce a successful transition from a ventilated to an unventilated attic. One side effect of going to an unventilated attic may be to void the warranty for the roof covering.
- The following information is intended to help minimize water intrusion through new and existing attic ventilation systems, not to change from a ventilated to an unventilated system. With the exception of the plugging of gable rake vents, all other shuttering of openings or plugging of vents should be done on a temporary basis and removed once the storm threat is over so that the attic is once again properly ventilated.

#### The Unventilated Attic

The most conservative approach to preventing wind-driven rain from entering the attic is to eliminate attic ventilation, but unventilated attics are controversial. Although allowed by the International Residential Code® (IRC®), provided the Code's criteria are met, unventilated attics may not comply with local building codes.

However, when unventilated attics are allowed by the building code or code compliance is not an issue, and when climatic and interior humidity conditions (e.g., no indoor swimming pools) are conducive to an unventilated design, an unventilated attic is a reliable way to prevent wind-driven rain from entering the attic.

*Air barrier: Refer to the Siding Installation in High-Wind Regions, Hurricane Ike Recovery Advisory for recommendations regarding attic air barriers.*

## Mitigation Guidance

### Soffit Vents

#### Key Issues

- First and foremost, it is important to keep the soffit material in place. While some water can be blown into the attic through almost any type of soffit vent, the amount of water intrusion increases dramatically when the soffit material is missing (Figure 1).
- Plywood or wood soffits are generally adequately anchored to wood framing attached to the roof structure and/or the walls. However, it has been common practice for vinyl and aluminum soffit panels to be installed in tracks that are frequently very poorly connected to the walls and fascia at the edge of the roof overhang. When these poorly anchored soffits are blown off, water intrusion increases significantly. Properly installed vinyl and aluminum soffit panels are fastened to the building structure or to nailing strips placed at intervals specified by the manufacturer.



Figure 1. Missing soffit material.

#### Proper Installation

The details of proper installation of vinyl and aluminum soffits depend on the type of eave to which they are attached. The key elements are illustrated in Figure 2.

A. Roof truss or rafter framing should extend across the bottom of the eaves, or be added to create a structural support for the soffit. As an alternative, soffits can be attached directly to the undersides of the angled rafters.

B. Nailing strips should be provided, if necessary, to allow attachment of the soffit at the ends. Intermediate nailing strips may be needed, depending on the maximum span permitted for the soffit. If this is not known, the span between attachment points should not exceed 12" in high-wind regions.

C. A J-channel (illustrated), F-channel, or other receiver as specified by the manufacturer should cover the ends of the soffit panels. Fasteners should be those specified by the manufacturer. Fasteners should be used through the nailing strip of each panel and at any other points (such as in the "valleys" of the soffit) if specified.

D. The overall span (eave depth) of the soffit should not exceed any limits specified by the manufacturer, and any required intermediate attachment points should be used.

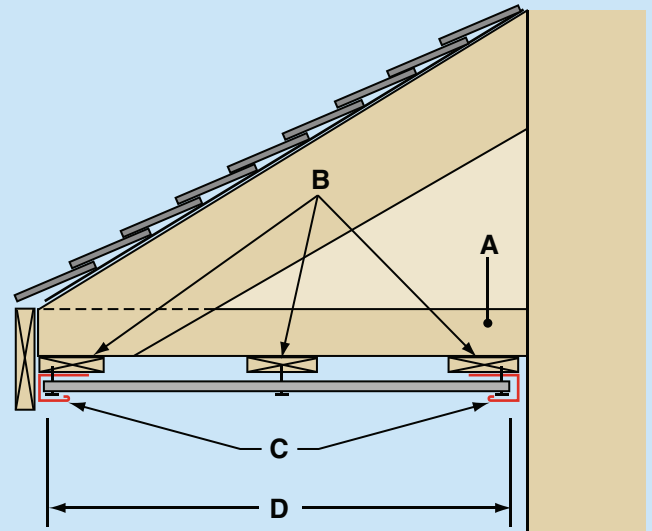


Figure 2. Key soffit installation points.

#### Checking Soffit Material Installation

As noted above, the most critical soffit installations to check are those where vinyl or aluminum soffit panels are used. Soffits should be fastened to the eave structure; they should not be loose in the channels. Pushing up on the soffit material and the channels used to support the material can be revealing. If it moves

Soffits can receive positive and negative (suction) loads; therefore, soffits need to be designed and installed to resist loads that push up and pull down on the soffit.

readily or is easy to deform, it probably is not attached very well. Similarly, if the width of the overhang is greater than 12", there should be an intermediate support running along the middle of the soffit and the panels should be attached to this support in addition to the supports at the ends of the panels. If you are concerned about the installation but can't be sure, there are a couple of tools with a viewing screen connected to a small camera lens and light mounted at the end of a flexible tube that can be used to observe the connections. These devices allow inspection through a small hole that is drilled in an inconspicuous location that can be later filled with sealant. In order to ensure that you have a strong connection at the wall, there should be wood blocking running along the wall above the track where the soffit channel is attached and the channel should be fastened to that blocking. If you do not find wood blocking and either see no vertical nailing surface on the channel or see occasional tabs that have been cut and bent up to allow fastening to the wall, strengthening of the anchorage of the soffit material is clearly indicated.

### Remedial Measures

If the inspection indicates a poorly attached soffit, the best way to ensure that the soffit material is adequately anchored in place is to remove it and install adequate wood blocking to allow solid anchorage of the soffit material. In some cases, it may be possible to remove the soffit material and reinstall it. However, it is also likely that some or all of the material will need to be replaced, so make sure that it can be matched before it is removed. Short of removing and properly reinstalling the soffit material, testing has shown that the anchorage can be greatly improved by applying a bead of sealant (Figure 3) along the bottom edge of the wall channel to adhere it to the wall surface below followed by applying large dabs of sealant in indentations between the soffit panels and the wall channel at one end (Figure 4) and the fascia flashing at the other end. Surfaces receiving sealant should be cleaned in order to facilitate bonding. Extra resistance can be gained by installing screws that mechanically tie the soffit panels to both the fascia flashing and to the wall channel (Figure 5). Note that use of sealant is a remedial measure only and is not a substitute for proper installation and fastening of soffits in a new installation.

**Wind-driven rain penetration:** Currently there is no adequate standard test method to evaluate the potential for wind-driven rain to enter attics through soffit vent openings, such as those shown in Figure 6. To avoid water entry at soffit vents, options include eliminating soffit vents and providing an alternate method for air to enter the attic, or design for an unventilated attic. Another approach is to place filter fabric (like that used for heating, ventilation, or cooling



**Figure 3. Applying a bead of sealant. (Note: Black sealant was used so that it would be visible in the photograph. Normally a matching sealant color would be used.)**



**Figure 4. Applying dabs of sealant.**



**Figure 5. Screws through wall channel.**

Rain screen wall venting: In lieu of providing soffit vents, another method to provide attic air intake is through a pressure-equalized rain screen wall system as discussed in *Siding Installation in High-Wind Regions*, Hurricane Ike Recovery Advisory. This alternative approach eliminates soffit vents and their susceptibility to wind-driven rain entry.

[HVAC] system filters) above the vent openings; however, such an approach needs to be custom designed.

**Fascia cover:** Field investigations after Hurricane Ike showed many cases where the aluminum fascia cover (fascia cap) from the fascia board was blown off (Figure 7). The fascia cover normally covers the ends of vinyl and aluminum soffits. When the fascia cover is blown off, the ends of the soffit panels are exposed to wind and wind-driven rain.

The IRC currently has no guidelines for the installation of fascia covers. Aluminum fascia covers are typically tucked under the roof drip edge and face-nailed every few feet. More frequent nailing would help secure the fascia cover, but would also inhibit normal thermal movement, which can cause unattractive warping and dimpling of the cover. Vinyl fascia covers are available, which are attached to a continuous strip of utility trim placed underneath the drip edge. This provides a somewhat more secure, continuous attachment and allows for thermal movement. Aluminum fascia covers can also be field-notched and installed with utility trim.



**Figure 7.** Loss of fascia cover exposes ends of vinyl soffit to direct entry of wind-driven rain.



**Figure 8.** This metal ridge vent was attached with widely spaced roofing nails.



**Figure 6.** Fiber cement soffit with ventilation slots (red arrow).

## Ridge Vents

### Key Issues

- Ridge vents are frequently fastened down using ordinary roofing nails since these are normally handy. It is pretty common to find ridge vents dislodged or blown off during a hurricane (Figure 8). Even a partially dislodged ridge vent can begin to act like a scoop that collects wind-driven rain and directs it into the attic.
- Most roofing manufacturers now make ridge vents that have passed wind-driven water tests. They are identified as having passed Florida Building Code's Product Approvals or Testing Application Standard (TAS) 100(A). Typically, they include a baffle in front of the vent tubes that provide the passageway for hot attic gasses to escape. This baffle is intended to trip any flow of wind and water blowing up the surface of the roof and deflect it over the top of the roof ridge.

### Slotting the Deck

When ridge venting is being added to a roof that previously did not have it, it is necessary to cut a slot through the decking. When doing so, it is important to set the depth of the saw blade so that it only slightly projects below the bottom of the decking. At the residence shown in Figure 8, the saw blade cut approximately 1½" into the trusses and cut a portion of the truss plate (red arrow).

## Checking Ridge Vents and Their Installation

When they are used, ridge vents are the last part of the roof to be installed. Consequently, the connection is readily accessible and frequently visible without having to pry up the edge of the vent cover top. Check the type and condition of the fasteners. If the fasteners are nails, replacement of the fasteners is in order. If the vent has clear holes or slots without any baffle or trip next to the edge of the vent channels, the vent is probably not one that is resistant to water intrusion and you should consider replacing the ridge vent with one that has passed the wind-driven water intrusion tests.

### Remedial Measures

Replace nails with gasketed stainless steel wood screws that are slightly larger than the existing nails and, if possible, try to add fasteners at locations where they will be embedded in the roof structure below and not just into the roof sheathing. Close spacing of fasteners is recommended (e.g., in the range of 3 to 6" on center, commensurate with the design wind loads). If the ridge vents are damaged or are one of the older types that are not resistant to water intrusion, they should be replaced with vents that have passed the wind-driven water intrusion tests.

## Gable End Vents

### Key Issues

- Virtually all gable end vents (Figure 9) will leak when the wall they are mounted on faces into the wind-driven rain. The pressures developed between the outside surface of the wall and the inside of the attic are sufficient to drive water uphill for a number of inches and, if there is much wind flow through the vent, water carried by the wind will be blown considerable distances into the attic.

### Remedial Measures

If it is practical and possible to shutter gable end vents from the outside of the house, this is the preferable way to minimize water intrusion through gable end vents (Figure 10). Install permanent anchors in the wood structure around the gable vent and pre-cut, pre-drill, and label plywood or other suitable shutter materials so that they are ready for installation by a qualified person just before a storm approaches. If installation of shutters from the outside is difficult because of the height or other considerations, but there is access through the attic, the gable vent opening can be shuttered from the inside. However, careful attention needs to be paid to sealing around the shutter and making sure that any water that accumulates in the cavity can drain to the outside of the house and not into the wall below.

## Off-ridge Vents

### Key Issues

- Poorly anchored off-ridge vents can flip up and become scoops that direct large amounts of wind-driven rain into the attic (Figure 11).



Figure 9. Gable end vent.

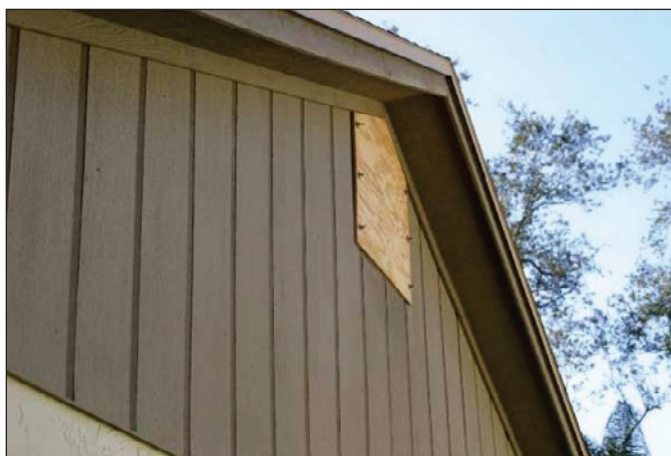


Figure 10. Shuttered gable end vent.



Figure 11. Two off-ridge vents are shown in this photograph. The vent that is covered with roofing felt flipped up and allowed a substantial amount of water to enter the residence. Carpeting, kitchen cabinets, and a large amount of gypsum board had to be replaced because of the water intrusion.

- Some vents are also prone to leaking when winds blow from certain directions. This will depend on the location of the vent on the roof surface and the geometry of the roof, as well as the geometry of the particular vent.

### Checking Off-ridge Vent Installations

Off-ridge vents typically have a flange that lies against the top surface of the roof sheathing and is used to anchor the vent to the roof sheathing. Frequently, roofing nails are used to attach the flange to the roof sheathing. The off-ridge vents should be checked to make sure that they are well anchored to the roof sheathing. If they seem loose, or there are not many fasteners holding them down, it could be a weak link in preventing water intrusion when a storm occurs. Since the flange and fasteners are hidden below the roof covering, it is not possible to simply add nails or screws to improve the anchorage as these will create holes through the roof covering.

### Remedial Measures

If the off-ridge vent is attached to the roof sheathing with long, thin nails, it may be possible to improve the anchorage by cinching the nails (bending them over against the underside of the roof sheathing). However, if they are short and/or thick, trying to bend them over may cause more harm than good. Some homeowners have had covers made that can be installed from the inside of the attic over the hole where the off-ridge vent is installed. This will be easiest if the vent is larger than the hole and the cover can be attached to the sheathing in an area where the fasteners can't be driven through the roof covering. Otherwise, it will be important to ensure that the fasteners are short enough that they won't extend through the roof sheathing and damage the roof cover. If the edge of the hole in the roof deck is flush with the inside edge of the vent, it may be possible to install metal straps that are screwed into the walls of the vent and attached with short screws to the bottom surface of the roof sheathing. Again, it is critical to use screws that are short enough that they won't extend through the roof sheathing and damage the roof covering. The strapping should be connected to the walls of the vent with short stainless steel sheet metal screws.

## Gable Rake Vents

### Key Issues

- Gable rake vents are formed when porous soffit panels or screen vents are installed on the bottom surface of the roof overhang at the gable end and there is a clear path for wind to blow into the attic. This usually happens when the gable overhang is supported by what are called outriggers. Outriggers are typically used when gable overhangs exceed 12". In these cases, the last roof truss or rafter (the gable end truss or rafter) is smaller than the trusses or rafters at the next location inside the attic. Outriggers (2x4s) are installed over top of the last gable truss or rafter, one end is anchored to the second truss or rafter back from the gable end, and the other end sticks out past the gable end wall to support the roof sheathing on the overhang.

### Finding Out if You Have Gable Rake Vents and Whether You Still Need Them

The easiest way to tell if your roof has gable rake vents is to look in the attic on a cool sunny day and see if light is visible in gaps just below the sheathing at the gable end. The presence of the outriggers (2x4s running perpendicular to the gable truss and disappearing into the gable overhang) should also be visible. If you also have a gable end vent or a ridge vent, then you probably don't need the gable rake vent in order to provide adequate venting for your attic.

### Remedial Measures

The best solution if you don't actually need the venting provided by the gable rake vents is to simply plug them up with metal flashing (Figure 12) or pieces of wood that are cut and anchored so that they are well attached and completely seal as many of the openings as possible and particularly those near the gable peak. Sealant can be used to seal around the edges of the metal or wood plugs.



**Figure 12. Metal plugs (red arrows) in gable rake vents.**

## Turbines

### Key Issues

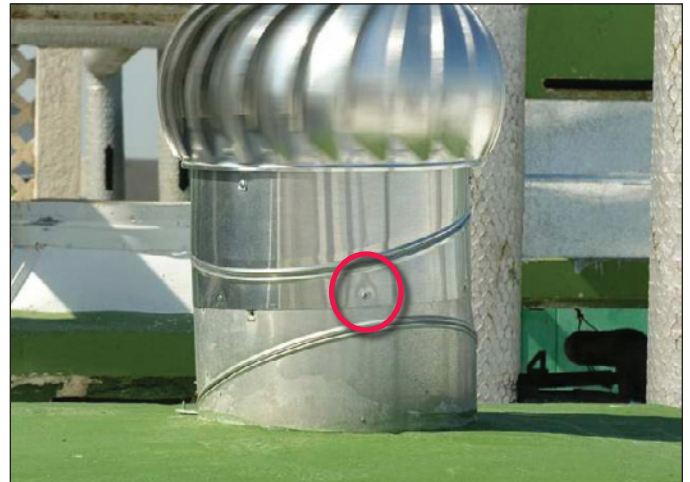
- The rotating top portion of many turbines is not designed to withstand high-wind conditions and they are frequently installed with just a friction fit to the short standpipe that provides the venting of the attic. It is possible to find high-wind rated turbines on store shelves in hurricane-prone regions but, in hurricane winds, the turbines will be rotating at tremendous speeds and can be easily damaged by windborne debris.
- The flange on the standpipe that provides the connection of the pipe to the roof sheathing may also be poorly anchored to the roof sheathing.

### Checking Turbines and Their Installation

Check any turbines to make sure that the stand pipes are not loose and that the turbine head is anchored to the stand pipe by sheet metal screws and not simply by a friction fit (Figure 13).

### Remedial Measures

Loose standpipes should be securely anchored to the roof sheathing. If the standpipe is attached to the roof sheathing with long, thin nails, it may be possible to improve the anchorage by cinching the nails (bending them over against the underside of the roof sheathing). However, if they are short and/or thick, trying to bend them over may cause more harm than good. Some homeowners have had covers made that can be installed from the inside of the attic over the hole where the standpipe is installed. This will be easiest if the standpipe is larger than the hole and the cover can be attached to the sheathing in an area where the fasteners can't be driven through the roof cover. Otherwise, it will be important to ensure that the fasteners are short enough that they won't extend through the roof sheathing and damage the roof cover. If the edge of the hole in the roof deck is flush with the inside edge of the standpipe, it may be possible to install metal straps that are screwed into the walls of the standpipe and attached with short screws to the bottom surface of the roof sheathing. Again, it is critical to use screws that are short enough that they won't extend through the roof sheathing and damage the roof cover. The strapping should be connected to the walls of the standpipe with short stainless steel sheet metal screws. Beyond any remedial measures taken to anchor the standpipe to the roof sheathing or to plug the hole from the attic side, it is also important to try and seal the standpipe from the outside so that water doesn't build up in the pipe and leak into the roof sheathing around the hole. The best approach is to have a qualified person remove the top active portion of the turbine vent before the storm and plug the hole at the top of the standpipe. A wooden plug can be used that covers the entire hole and has blocks that rest against the walls of the standpipe where screws can be installed to anchor the plug to the standpipe. Some homeowners have had the entire turbine wrapped in plastic to keep water out during a storm (Figure 14). This can work as long as the turbine or wrapping doesn't get dislodged. The smaller area provided by removing the turbine top and plugging the hole is considered preferable.



**Figure 13.** This turbine head is attached to the standpipe with dimple punches. Sheet metal screws should be added to strengthen the connection.



**Figure 14.** Plastic wrapped turbine.





# Metal Roof Systems in High-Wind Regions



**FEMA**  
<http://www.fema.gov>

## HURRICANE IKE RECOVERY ADVISORY

**Purpose:** To recommend practices for designing and installing metal roof systems that will enhance wind resistance in high-wind regions (i.e., greater than 90-miles per hour [mph] gust design wind speed). This Advisory is applicable to residential and commercial/industrial buildings and critical facilities.

### Metal Roofing Options

A variety of metal panel systems (including composite foam panels) are available for low-slope (i.e., 3:12 or less) and steep-slope (i.e., greater than 3:12) roofs. Metal shingles are also available for steep-slope roofs. Common metal roofing options are:

#### **Standing-Seam Hydrostatic (i.e., water-barrier)**

**Systems:** These panel systems are designed to resist water infiltration under hydrostatic pressure. They have standing seams, which raise the joint between panels above the water line. The seam is sealed with sealant tape or sealant in case it becomes inundated with water backed up by an ice dam or driven by high wind.

Most hydrostatic systems are structural systems (i.e., the roof panel has sufficient strength to span between purlins or nailers). A hydrostatic architectural panel (which cannot span between supports) may be specified, however, if continuous or closely spaced decking is provided.

An advantage of exposed fastener panels (versus panels with concealed clips) is that, after installation, it is easy to verify that the correct number of fasteners was installed. If fastening was not sufficient, adding exposed fasteners is easy and economical.

For attachment of corrugated metal panels, see FEMA 55, *Coastal Construction Manual*, Appendix K, available online at: <http://www.fema.gov/library/viewRecord.do?id=1671>.

#### **Hydrokinetic (i.e., water-shedding) panels:**

These panel systems are not designed to resist water infiltration under hydrostatic pressure and therefore require a relatively steep slope (typically greater than 3:12) and the use of an underlayment to provide secondary protection against water that infiltrates past the panels. Most hydrokinetic panels are architectural systems, thus requiring continuous or closely spaced decking to provide support for gravity loads.

This Recovery Advisory addresses wind and wind-driven rain issues. For general information on other aspects of metal roof system design and construction (including seam types, metal types, and finishes), see:

**Architectural Sheet Metal Manual** (Sheet Metal and Air Conditioning Contractors National Association, 2003: <http://www.smacna.org/bookstore>)

**Copper and Common Sense:** <http://www.reverecopper.com/candcs.html>

**Copper Development Association:** [http://www.copper.org/publications/pub\\_list/architecture.html](http://www.copper.org/publications/pub_list/architecture.html)

**Metal Construction Association:** <http://www.metalconstruction.org/pubs>

**Metal Roofing Systems Design Manual** (Metal Building Manufacturers Association, 2000, <http://www.mbma.com/display.cfm?p=44&pp6&i=47>)

**National Institute of Building Sciences, Whole Building Design Guide:**  
[http://www.wbdg.org/design/env\\_roofing.php](http://www.wbdg.org/design/env_roofing.php)

**The NRCA Roofing Manual:** Metal Panel and SPF Roof Systems (National Roofing Contractors Association, 2008, <http://www.nrca.net/rp/technical/manual/default.aspx>)

Some hydrokinetic panels have standing ribs and concealed clips (Figure 1), while others (such as 5V-crimp panels, R-panels [box-rib] and corrugated panels) are through-fastened (i.e., attached with exposed fasteners). Panels are available that simulate the appearance of tile.

**Metal Shingles:** Metal shingles are hydrokinetic products and therefore also require a relatively steep-slope and the use of an underlayment. Metal shingles are available that simulate the appearance of wood shakes and tiles.

## Key Issues

Damage investigations have revealed that some metal roofing systems have sufficient strength to resist extremely high winds (Figure 2), while other systems have blown off during winds that were well below design wind speeds given in ASCE 7. When metal roofing (or hip, ridge, or rake flashings) blow off during hurricanes, water may enter the building at displaced roofing; blown-off roofing can damage buildings and injure people. Guidance for achieving successful wind performance is presented below:

1. Always follow manufacturer's installation instructions and local building code requirements.
2. Calculate loads on the roof assembly in accordance with ASCE 7 or the local building code, whichever procedure results in the highest loads.
3. Specify/purchase a metal roof system that has sufficient uplift resist resistance to meet the design uplift loads.

- For standing seam and through-fastened metal panel systems, the International Building Code® (IBC®) requires test methods UL 580 or ASTM E 1592. For standing seam systems, it is recommended that design professionals specify E 1592 testing, because it gives a better representation of the system's uplift performance capability.

For safety factor determination, refer to Chapter F in standard NAS-01, published by the American Iron and Steel Institute (available online at: <http://www.professionalroofing.net/article.aspx?id=266>).

- For through-fastened steel panel systems, the IBC allows uplift resistance to be evaluated by testing or by calculations in accordance with standard NAS-01.
- For architectural panels with concealed clips, test method UL 580 is commonly used. However, it is recommended that design professionals specify E 1592 because it gives a better representation of the system's uplift performance capability. When testing architectural panel systems via E 1592, the deck joints need to be unsealed in order to allow air flow to the underside of the metal panels. Therefore, underlayment should be eliminated from the test specimen, and a



**Figure 1.** This architectural panel system has concealed clips. The panels unlatched from the clips. The first row of clips (just above the red line) was several inches from the end of the panels. The first row of clips should have been closer to the eave.



**Figure 2.** This structural standing seam roof system survived Hurricane Andrew (Florida, 1992), but some hip flashings were blown off. The estimated wind speed was 170 mph (peak gust, Exposure C at 33 feet).

For observations of metal roofing performance during Hurricanes Charley (2004, Florida), Ivan (2004, Alabama and Florida), and Katrina (Alabama, Louisiana, and Mississippi, 2005), respectively; see Chapter 5 in FEMA MAT reports 488, 489, and 549, available on-line at:

FEMA 488: <http://www.fema.gov/library/viewRecord.do?id=1444>

FEMA 489: <http://www.fema.gov/library/viewRecord.do?id=1569>

FEMA 549: <http://www.fema.gov/library/viewRecord.do?id=1857>

1/8" minimum gap between deck panel side and end joints should be specified.

For safety factor determination, refer to Chapter F in standard NAS-01.

- For copper roofing testing, see "NRCA analyzes and tests metal," Professional Roofing, May 2003 (available online at: <http://www.professionalroofing.net/article.aspx?id=266>).
  - For metal shingles, it is recommended that uplift resistance be based on test method UL 580 or 1897.
  - Specify the design uplift loads for field, perimeter, and corners of the roof. Also specify the dimension of the width of the perimeter. (Note: For small roof areas, the corner load can be used throughout the entire roof area.)
4. Suitably design the roof system components (see the construction guidance below).
  5. Obtain the services of a professional roofing contractor to install the roof system.

## Construction Guidance

- Consult the local building code and manufacturer's literature for specific installation requirements. Requirements may vary locally.
- Underlayment: If a robust underlayment system is installed, it can serve as a secondary water barrier if the metal roof panels or shingles are blown off (Figures 1 and 3). For enhanced underlayment recommendations, see Technical Fact Sheet No. 19 in FEMA 499, *Home Builder's Guide to Coastal Construction Technical Fact Sheet Series* (available online at: <http://www.fema.gov/library/viewRecord.do?id=1570>). Fact Sheet 19 pertains to underlayment options for asphalt shingle roofs. For metal panels and tiles, where Fact Sheet 19 recommends a Type I (#15) felt, use a Type II (#30) felt because the heavier felt provides greater resistance to puncture by the panels during application. Also, if a self-adhering modified bitumen underlayment is used, specify/purchase a product that is intended for use underneath metal (such products are more resistant to bitumen flow under high temperature).
- Where the basic (design) wind speed is 110 mph or greater, it is recommended that two clips be used along the eaves, ridges, and hips. Place the first eave clip within 2 to 3" of the eave, and place the second clip approximately 3 to 4" from the first clip. Figures 1 and 4 illustrate ramifications of clips being too far from the eave.
- For copper panel roofs in areas with a basic wind speed greater than 90 mph, it is recommended that Type 316 stainless steel clips and stainless steel screws be used in lieu of the much more malleable copper clips.



**Figure 3.** These architectural panel system have snap-lock seams. One side of the seam is attached with a concealed fastener. Although a large number of panels blew away, the underlayment did not.



**Figure 4.** These eave clips were too far from the panel ends. The clip at the left was 13" from the edge of the deck. The other clip was 17" from the edge. It would have been prudent to install double clips along the eave.



**Figure 5.** The panels blew off the upper roof and landed on the lower roof of this house. The upper asphalt shingle roof shown had been re-covered with 5V-Crimp panels that were screwed to nailers. The failure was caused by inadequate attachment of the nailers (which had widely-spaced nails) to the sheathing. Note that the hip flashing on the lower roof blew off.

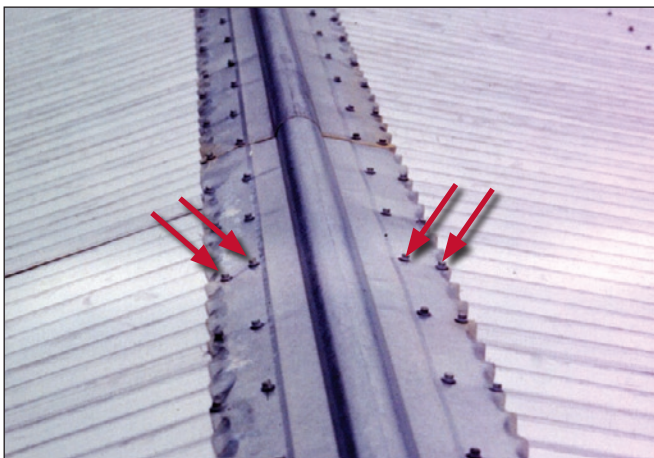


**Figure 6. Blow-off of nailers caused these panels to progressively fail. The nailers were installed directly over the trusses. In an assembly such as this where there is no decking, there is no opportunity to incorporate an underlayment. With loss of the panels, rainwater was free to enter the building.**



**Figure 7. This residence had metal shingles that simulated the appearance of tile. The shingles typically blew off the battens, but some of the battens were also blown away.**

- When clip or panel fasteners are attached to nailers (Figures 5, 6, and 7), detail the connection of the nailer to the nailer support (including the detail of where nailers are spliced over a support).
- When clip or panel fasteners are loaded in withdrawal (tension), screws are recommended in lieu of nails.
- For roofs located within 3,000' of the ocean line, stainless steel clips and fasteners are recommended.
- For concealed clips over a solid substrate, it is recommended that chalk lines be specified so that the clips are correctly spaced.
- Hip, ridge, and rake flashings: Because exposed fasteners are more reliable than cleat attachment, it is recommended that hip, ridge, and rake flashings be attached with exposed fasteners. Two rows of fasteners are recommended on either side of the hip/ridge line. Close spacing of fasteners is recommended (e.g., spacing in the range of 3 to 6" on center, commensurate with the design wind loads), as shown in Figure 8 in order to avoid flashing blow-off as shown in Figure 9.



**Figure 8. The ridge flashing on these corrugated metal panels had two rows of fasteners on each side of the ridge line.**



**Figure 9. The ridge flashing fasteners were placed too far apart. A significant amount of water leakage can occur when ridge flashings are blown away.**

### Critical Facilities

For metal roofs on critical facilities in hurricane-prone regions (as defined in ASCE 7), see the recommendations in FEMA 543, Section 3.4.3.4 (available online at <http://www.fema.gov/library/viewRecord.do?id=2441>). (For facilities located outside of hurricane-prone regions, see Section 3.3.3.4.) For load calculation recommendations, see Section 3.3.1.2.

For metal roofs on hospitals in hurricane-prone regions, see the recommendations in FEMA 577, Section 4.3.3.8 (available online at <http://www.fema.gov/library/viewRecord.do?id=2739>). (For hospitals located outside of hurricane-prone regions, see Section 4.3.3.7.) For load calculation recommendations, see Section 4.3.1.2.

### Sustainable Design

**Cool Roofs:** Use metal roofs with a solar reflectance Index (SRI) equal to or greater than 78 for low-slope and 29 for steep-sloped roofs. The higher solar reflectance will reduce the heat-island effect (thermal gradient differences between developed and undeveloped areas), minimizing the impact buildings have on microclimate and human and wildlife habitat. Heat islands can affect communities by increasing summertime peak energy demand, air conditioning costs, greenhouse gas emissions and air pollution, heat-related illness and mortality, and water quality (<http://www.EPA.gov/heatisland>).

**Recycled Content:** Use metal roof systems with recycled content. Many roofing products have recycled scrap content generated both from consumer and industrial users. Recycled content is defined in the International Organization of Standards (ISO) document, ISO 14021 ([http://www.iso.org/iso/catalogue\\_detail?csnumber=23146](http://www.iso.org/iso/catalogue_detail?csnumber=23146)). Using recycled products reduces impacts from extraction and processing of new materials.

For further information pertaining to sustainable design aspects of metal roofing, see: <http://www.metalconstruction.org/design>.



# Siding Installation in High-Wind Regions



**FEMA**  
<http://www.fema.gov>

## HURRICANE IKE RECOVERY ADVISORY

**Purpose:** To provide basic design and installation tips for various types of siding that will enhance wind resistance in high-wind regions (i.e., greater than 90-mph gust design wind speed).

### Key Issues

- Siding is frequently blown off walls of residential and non-residential buildings during hurricanes. Also, wind-driven rain is frequently blown into wall cavities (even when the siding itself is not blown off). Guidance for achieving successful wind performance is presented below.
- To avoid wind-driven rain penetration into wall cavities, an effective moisture barrier (housewrap or building paper) is needed. For further information on moisture barriers, see Technical Fact Sheet No. 9 in FEMA 499, *Home Builder's Guide to Coastal Construction*, Technical Fact Sheet Series (available online at: <http://www.fema.gov/library/viewRecord.do?id=1570>). For further information on housewrap, see Technical Fact Sheet No. 23.
- Always follow manufacturer's installation instructions and local building code requirements.
- Use products that are suitable for a coastal environment. Many manufacturers do not rate their products in a way that makes it easy to determine whether the product will be adequate for the coastal environment. Use only siding products where the supplier can provide specific information on product performance in coastal or high-wind environments.
- For buildings located within 3,000' of the ocean line, stainless steel fasteners are recommended.
- Avoid using dissimilar metals together.
- The installation details for starting the first (lowest) course of lap siding can be critical. Loss of siding often begins at the lowest course and proceeds up the wall (Figures 4 and 12). This is particularly important for elevated buildings, where the wind blows under the building as well as against the sides.
- When applying new siding over existing siding, use shims or install a solid backing to create a uniform, flat surface on which to apply the siding, and avoid creating gaps or projections that could catch the wind.
- Coastal buildings require more maintenance than inland buildings. This maintenance requirement needs to be considered in both the selection and installation of siding.

**Moisture barrier** (also known as a water-resistive barrier): In the context of residential walls, the moisture barrier is either housewrap or building paper (felt). The moisture barrier occurs between the wall sheathing and the siding. It is a dual-purpose layer that sheds water that gets through the siding and limits air flow through the wall. When properly sealed, housewrap is considered an air barrier. Although building paper provides some resistance to air flow, it is not considered an air barrier. Moisture barriers shed water, but they allow water vapor to pass through them.

For further guidance on principles, materials, and procedures for the design and construction of walls to make them resistant to water intrusion, see American Society for Testing and Materials (ASTM) E 2266, *Standard Guide for Design and Construction of Low-Rise Frame Building Wall Systems to Resist Water Intrusion*.

### Vinyl Siding

Vinyl siding can be used successfully in a coastal environment if properly designed and installed.

- Windload resistance:

- Vinyl siding is required by the International Building Code® (IBC®) and the International Residential Code® (IRC®) to comply with ASTM D 3679, *Standard Specification for Rigid Poly(Vinyl Chloride) (PVC) Siding*, which requires the siding to withstand wind pressures equivalent to 110 mph on a building up to 30' in height in Exposure B. Most vinyl siding has also been tested for higher wind pressures, and can be used in locations with a higher basic wind speed, greater building height, more open exposure, or some combination of those. The design wind pressure or wind speed for which these products are rated is available from product literature, installation instructions, or listings of agencies such as the International Code Council® (ICC®) Evaluation Service.
- For design wind speeds greater than 110 mph, or building heights greater than 30', or Exposure C, choose a model of siding rated for those conditions or higher. The manufacturer's product literature or installation instructions should specify the fastener type, size and spacing, and any other installation details needed to achieve this rating.

## Definition of Wind Exposure Zones

**Exposure B:** Urban, suburban, wooded areas.

**Exposure C:** Open terrain, flat open country, grasslands, all water surfaces in hurricane-prone regions.

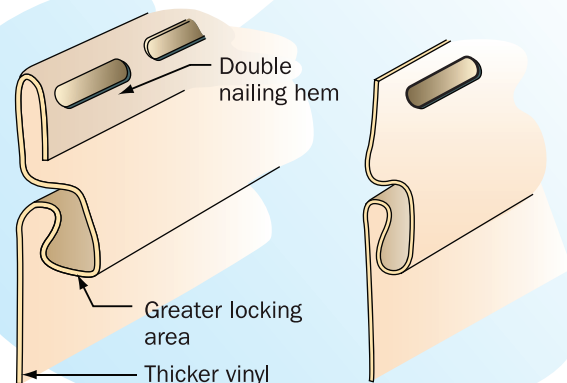
- Products that have been rated for high winds typically have an enhanced nailing hem and are sometimes made from thicker vinyl (Figure 1). Thick, rigid panels provide greater wind resistance, withstand dents, and lie flatter and straighter against the wall. Optimum panel thickness should be 0.040 to 0.048", depending on style and design. Thinner gauge vinyl works well for stable climates; thicker gauge vinyl is recommended for areas with high winds and high temperature changes.

- Position nails in the center of the nailing slot (Figure 2).
- To allow for thermal movement of the siding, do not drive the head of the nail tight against the nail hem (unless the hem has been specifically designed for this). Allow approximately 1/32" (which is about the thickness of a dime) clearance between the fastener head and the siding panel (Figure 3).

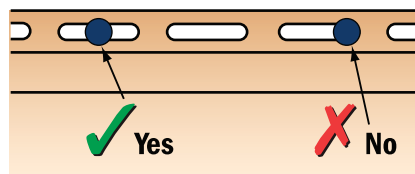
- Drive nails straight and level to prevent distortion and buckling in the panel.
- Do not caulk the panels where they meet the receiver of inside corners, outside corners, or J-trim. Do not caulk the overlap joints.
- Do not face-nail or staple through the siding.
- Use aluminum, galvanized steel, or other corrosion-resistant nails when installing vinyl siding. Aluminum trim pieces require aluminum or stainless steel fasteners.
- Nail heads should be 5/16" minimum in diameter. Shank should be 1/8" in diameter.

- Use the manufacturer-specified starter strip to lock in the first course; do not substitute other accessories such as a J-channel or utility trim (Figure 4) unless specified by the manufacturer. If the manufacturer specifies a particular strip for high-wind applications, use it. Make sure that the starter strip is designed to positively lock the panel, rather than just hooking over a bulge in the strip; field test the interlock before proceeding with the installation.

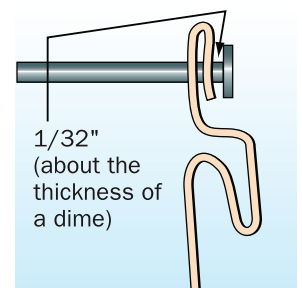
### High-wind siding      Standard siding



**Figure 1. Features of typical high-wind siding and standard siding.**



**Figure 2. Proper and improper fastener locations.**



**Figure 3. Allow 1/32" clearance between the fastener head and the siding panel.**



- Make sure that every course of siding is positively locked into the previous course (Figure 5). Push the panel up into the lock from the bottom before nailing rather than pulling from the top. Do not attempt to align siding courses with adjacent walls by installing some courses loosely.
- Make sure that adjacent panels overlap properly, about half the length of the notch at the end of the panel, or approximately 1". Make sure the overlap is not cupped or gapped, which is caused by pulling up or pushing down on the siding while nailing. Reinstall any panels that have this problem.
- Use utility trim under windows or anywhere the top nail hem needs to be cut from siding to fit around an obstacle. Be sure to punch snap-locks into the siding to lock into the utility trim. Do not overlap siding panels directly beneath a window (Figure 6).
- At gable end walls, it is recommended that vinyl siding be installed over wood sheathing rather than over plastic foam sheathing, as was done at the house shown in Figure 7.
- Install vinyl siding in accordance with manufacturer's installation instructions and local building code requirements.
- It is recommended that vinyl siding installers be certified under the VSI Certified Installer Program sponsored by the Vinyl Siding Institute. For more information, go to <http://www.vinylsiding.org/aboutsiding/installation/certinstaller>.



**Figure 4. Utility trim was substituted for the starter strip and the bottom lock was cut off the siding. Siding was able to pull loose under wind pressure.**



**Figure 5. The siding panel was not properly locked into the panel below.**



**Figure 6. Proper detailing around windows and other obstacles is important. Use utility trim, punch snap-locks into siding, and don't overlap directly beneath a window.**



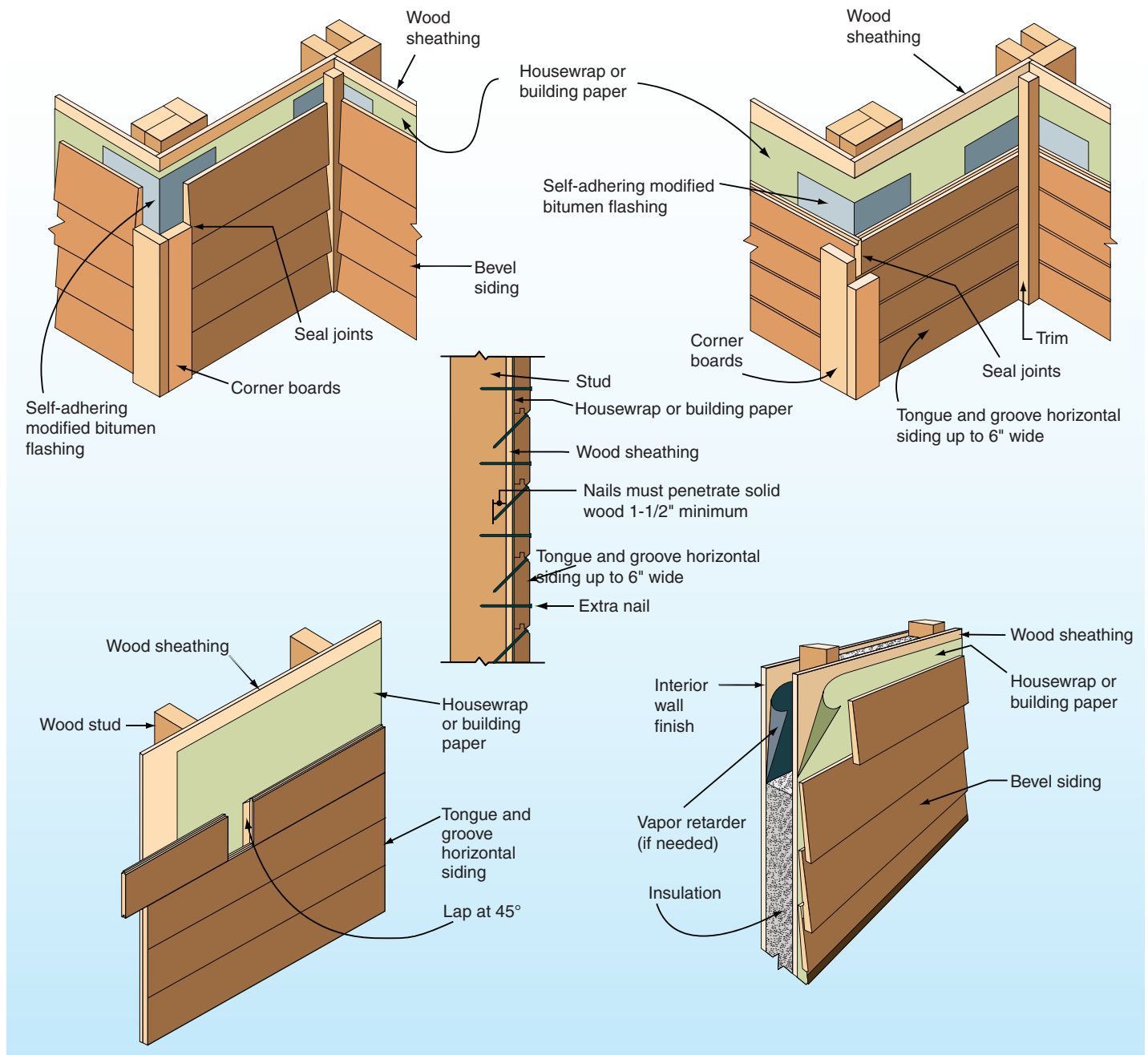
**Figure 7. The vinyl siding at this gable was installed over plastic foam insulation. Without wood sheathing, the wind pressures on the vinyl are increased. Also, if the siding blows away, the foam insulation is very vulnerable to blow-off. With loss of the foam insulation, wind-driven rain can freely enter the attic, saturate the ceiling insulation, and cause collapse of the ceiling.**

## Wood Siding

- Use decay-resistant wood such as redwood, cedar, or cypress. See the Sustainable Design section regarding certified wood.
- To improve longevity of paint, back-prime wood siding before installation.
- Carefully follow manufacturer's detailing instructions to prevent excessive water intrusion behind the siding.
- For attachment recommendations, see *Natural Wood Siding: Selection, Installation and Finishing*, published by the Western Wood Products Association (<http://www.wwpa.org>).

This publication recommends an air gap between the moisture barrier and the backside of the siding to promote drainage and ventilation. Such a wall configuration is referred to as a rain screen wall. See the text box on page 5.

- Follow the installation details shown in Figure 8. (Note: Although these details do not show a rain screen, inclusion of vertical furring strips to create a rain screen is recommended.)



**Figure 8. Wood siding installation details.**

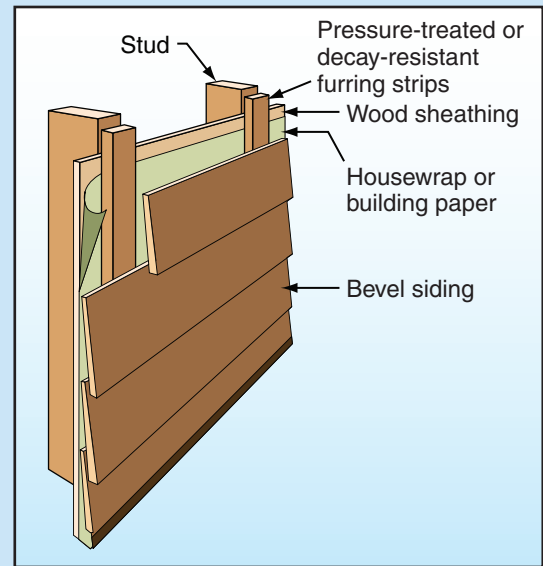
## Pressure-equalized rain screen wall system

In areas that experience frequent wind-driven rain and areas susceptible to high winds, it is recommended that a rain screen design be considered when specifying wood or fiber cement siding. (Typical vinyl siding products inherently provide air cavities behind the siding that facilitate drainage. Therefore, incorporation of vertical furring strips is normally not applicable to this type of wall covering.) A rain screen design is accomplished by installing suitable vertical furring strips between the moisture barrier and siding material (see Figure 9). The cavity facilitates drainage of water from the space between the moisture barrier and backside of the siding and it facilitates drying of the siding and moisture barrier.

**Furring strip attachment:** For 1" x 2" furring strips, tack strips in place and use siding nails that are  $\frac{3}{4}$ " longer than would be required if there were no strips (thereby maintaining the minimally required siding nail penetration into the studs). For thicker furring strips, an engineered attachment is recommended.

At the bottom of the wall, the cavity should be open to allow water drainage. However, the opening should be screened to avoid insect entry.

At the wall/soffit juncture, the top of the cavity can open into the attic space to provide inlet air ventilation, thereby eliminating soffit vents and their susceptibility to wind-driven rain entry. If the rain screen cavity vent path is used in lieu of soffit vents, the depth of the cavity needs to be engineered to ensure that it provides sufficient air flow to ventilate the attic.



**Figure 9. Pressure-equalized rain screen system.**

## Fiber Cement Siding

Installation procedures are similar to those for wood siding, but require specialized cutting blades and safety precautions because of the dust produced during cutting with power tools. Manufacturer's installation recommendations should be strictly adhered to, and particular attention paid to the painting and finishing recommendations for a high-quality installation.

- Always seal field-cut ends according to the manufacturer's instructions. Properly gap the intersection between siding edges and other building components and fill the gap with sealant.
- Always consult and follow the manufacturer's installation requirements for the needed wind speed rating or design pressure (refer to the manufacturer's building code compliance evaluation report). Observe the manufacturer's fastener specifications, including fastener type and size, spacing, and penetration requirements. Do not over drive or under drive.
- At gable end walls, it is recommended that fiber cement siding be installed over wood sheathing rather than over plastic foam sheathing.
- Keep blind nails between  $\frac{3}{4}$ " and 1" from the top edge of the panel (Figure 10). Be sure to drive nails at least  $\frac{3}{8}$ " from butt ends, or use manufacturer-specified joiners.
- Face nailing (Figure 11) instead of blind nailing is recommended where the basic (design) wind speed is 100 miles per hour or greater. If the local building code or manufacturer specifies face nailing at a lower wind speed, install accordingly.
- Do not leave the underside of the first course exposed or extending beyond the underlying material (Figure 12). Consider the use of a trim board to close off the underside of the first course.

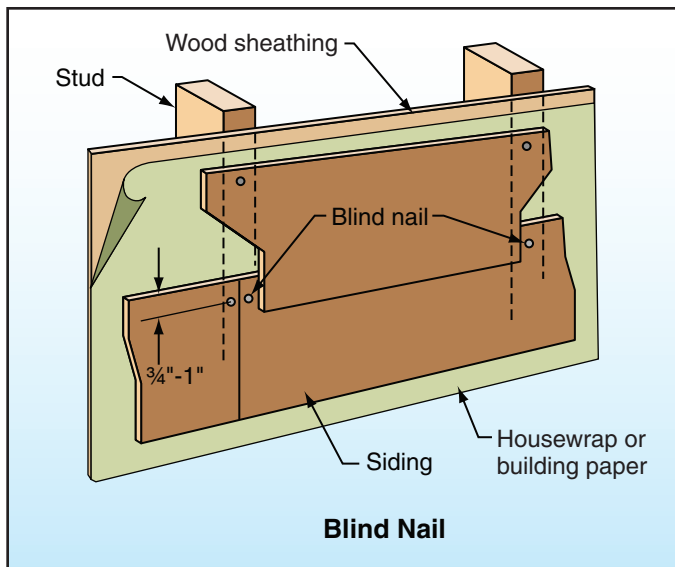


Figure 10. Blind nailing.

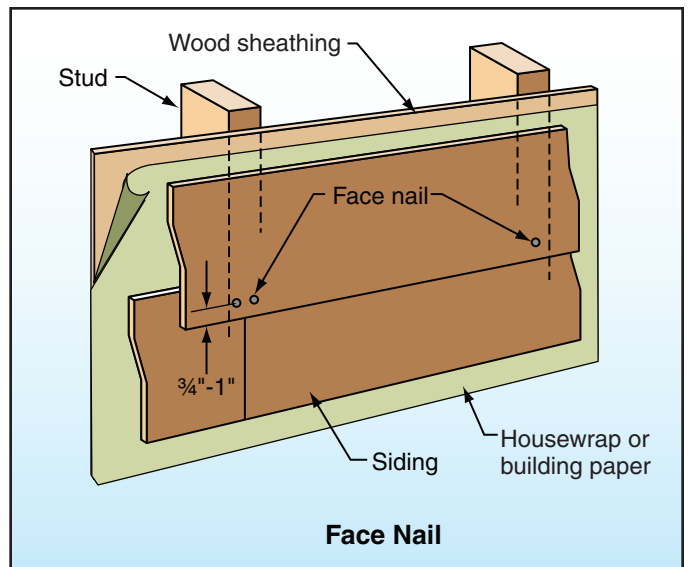


Figure 11. Face nailing.

## Sustainable Design

### Material selection for sustainable sources and durability

For wood products, select a Forest Stewardship Council (FSC) certified product. The FSC seeks to ensure that wood is harvested in a more responsible fashion, including protecting forest ecosystems, and avoids the use of chemicals and genetic engineering. While redwood, cedar, and cypress are decay-resistant and recommended for durability, they are generally cut from old growth timber. You can determine if the manufacturer is FSC certified by going to <http://www.fsc-info.org>.

For other siding products, consider long-term life spans for coastal environments, recycled content, and post-consumer use.

The following publications discuss sustainable aspects of vinyl siding:

*A Dozen Things You Might Not Know That Make Vinyl Siding Green* (available online at [http://www.vinylsiding.org/aboutsiding/greenpaper/080919\\_VSI\\_Green\\_Paper\\_for\\_web.pdf](http://www.vinylsiding.org/aboutsiding/greenpaper/080919_VSI_Green_Paper_for_web.pdf)).

*Siding with the Environment* (available online at [http://www.vinylsiding.org/publications/final\\_Enviro\\_single\\_pg.pdf](http://www.vinylsiding.org/publications/final_Enviro_single_pg.pdf)).

**Energy Conservation and Air Barriers:** Uncontrolled air leakage through the building envelope is often overlooked. The U.S. Department of Energy estimates that 40 percent of the cost of heating or cooling the average American home is lost to uncontrolled air leakage. In warmer climates, it is a lower percentage of loss. An air barrier system can reduce the heating, ventilation, and cooling (HVAC) system size, resulting in reduced energy use and demand.

Uncontrolled air leakage can also contribute to premature deterioration of building materials, mold and moisture problems, poor indoor air quality, and compromised occupant comfort. When uncontrolled air flows through the building envelope, water vapor moves with it. Controlling the movement of moisture by air infiltration requires controlling the air pathways and/or the driving force.

To effectively control air leakage through the building envelope, an effective air barrier is required. To be effective, it needs to be continuous; therefore, air barrier joints need to be sealed and the barrier needs to be sealed at penetrations through it. The Air Barrier Association of America recommends that materials used



Figure 12. Blind nailed siding installed with exposed gap at bottom (red circle) is vulnerable to failure.

as a component of a building envelope air barrier be tested to have an air infiltration rate of less than 0.004 cfm/square foot, assemblies of materials that form the air barrier be tested to have an air infiltration rate of less than 0.04 cubic feet per minute (cfm)/square foot, and the whole building exterior enclosure have an air infiltration rate of less than 0.4 cfm/square foot.

#### **Air barrier systems installed behind siding:**

Housewrap is the most common air barrier material for residential walls. To be effective, it is critical that the joints between sheets of housewrap be sealed as recommended by the manufacturer, and penetrations (other than fasteners) should also be sealed. At transitions between the housewrap and door and window frame, use of self-adhering modified bitumen flashing tape is recommended.

An air barrier should be installed over a rigid material, or it will not function properly. It also needs to be restrained from pulling off of the wall under negative wind pressures. For walls, wood sheathing serves as a suitable substrate, and the siding (or furring strips in a rain screen wall system) provide sufficient restraint for the air barrier.

At the base of the wall, the wall air barrier should be sealed to the foundation wall. If the house is elevated on piles, the wall barrier should be sealed to an air barrier installed at the plane of the floor.

If the building has a ventilated attic, at the top of the wall, the wall air barrier should be sealed to an air barrier that is installed at the plane of the ceiling.

If the building has an unventilated attic or no attic, at the top of the wall, the wall air barrier should be sealed to an air barrier that is installed at the plane of the roof (the roof air barrier may be the roof membrane itself, or a separate air barrier element).

#### **Siding maintenance:**

For all siding products, it is very important to periodically inspect and maintain the product especially in a coastal environment. This includes recoating on a scheduled maintenance plan that is necessary according to the manufacturer's instructions and a periodic check of the sealant to ensure its durability. Check the sealant for its proper resiliency and that it is still in place. Sealant should be replaced before it reaches the end of its service life.

**Air barrier:** A component installed to provide a continuous barrier to the movement of air through the building envelope. Housewrap is a common air barrier material for residential walls. Although very resistant to airflow, housewrap is very vapor permeable and therefore is not suitable for use as a vapor retarder.

**Vapor retarder:** A component installed to resist diffusion of water vapor and provide a continuous barrier to movement of air through the building envelope. Polyethylene is a common vapor retarder material for residential walls. To determine whether or not a vapor retarder is needed, refer to the Moisture Control section of the *NRCA Roofing and Waterproofing Manual*, published by the National Roofing Contractors Association (NRCA) (<http://www.nrca.net>).

*ASTM E 1677, Standard Specification for an Air Retarder (AR) Material or System for Low-Rise Framed Building Walls:* This specification covers the minimum performance and acceptance criteria for an air barrier material or system for framed walls of low-rise buildings with the service life of the building wall in mind. The provisions contained in this specification are intended to allow the user to design the wall performance criteria and increase air barrier specifications to accommodate a particular climate location, function, or design of the intended building.

