



NEHRP Recommended Seismic Provisions for New Buildings and Other Structures

Volume I: Part 1 Provisions, Part 2 Commentary

FEMA P-1050-1/2015 Edition



FEMA



Cover Photograph: Willard Marriott Library located on the campus of the University of Utah.
Credit: Kelly Petersen. Used with permission.

NEHRP (National Earthquake Hazards Reduction Program)

Recommended Seismic Provisions

for New Buildings and Other Structures (FEMA P-1050-1)

2015 Edition

Volume I: Part 1 Provisions, Part 2 Commentary

Prepared for the Federal Emergency Management Agency of the
U.S. Department of Homeland Security
By the Building Seismic Safety Council of the
National Institute of Building Sciences

BUILDING SEISMIC SAFETY COUNCIL
A council of the National Institute of Building Sciences
Washington, D.C.
2015

NOTICE: Any opinions, findings, conclusions, or recommendations expressed in this publication do not necessarily reflect the views of the Federal Emergency Management Agency. Additionally, neither FEMA nor any of its employees make any warranty, expressed or implied, nor assume any legal liability or responsibility for the accuracy, completeness, or usefulness of any information, product, or process included in this publication.

The **Building Seismic Safety Council** (BSSC) was established in 1979 under the auspices of the National Institute of Building Sciences as a forum-based mechanism for dealing with the complex regulatory, technical, social, and economic issues involved in developing and promulgating building earthquake hazard mitigation regulatory provisions that are national in scope. By bringing together in the BSSC all of the needed expertise and all relevant public and private interests, it was believed that issues related to the seismic safety of the built environment could be resolved and jurisdictional problems overcome through authoritative guidance and assistance backed by a broad consensus.

The BSSC is an independent, voluntary membership body representing a wide variety of building community interests. Its fundamental purpose is to enhance public safety by providing a national forum that fosters improved seismic safety provisions for use by the building community in the planning, design, construction, regulation, and utilization of buildings.

This report was prepared under Contract HSFEHQ-09-D-0417 between the Federal Emergency Management Agency and the National Institute of Building Sciences.

For further information on Building Seismic Safety Council activities and products, see the Council's website (www.bssconline.org) or contact the Building Seismic Safety Council, National Institute of Building Sciences, 1090 Vermont Avenue, N.W., Suite 700, Washington, D.C. 20005; phone 202-289-7800; fax 202-289-1092; e-mail bssc@nibs.org.

Copies of this report on CD Rom may be obtained from the FEMA Publication Distribution Facility at 1-800-480-2520. Limited paper copies also will be available. The report can also be downloaded in pdf form from the BSSC website at www.bssconline.org.

The National Institute of Building Sciences and its Building Seismic Safety Council caution users of this Provisions document to be alert to patent and copyright concerns especially when applying prescriptive requirements.

FOREWORD

The Federal Emergency Management Agency (FEMA) has committed under the National Earthquake Hazard Reduction Program (NEHRP) to support implementation of new knowledge and research results for improving seismic design and building practices in the nation. One of the effective ways to fulfill this commitment is the ongoing update of a key resource document – the *NEHRP Recommended Provisions for New Buildings and Other Structures* - with the Building Seismic Safety Council (BSSC) of National Institute of Building Sciences (NIBS). The 2015 *NEHRP Provisions* marks the ninth edition of this technical resource document since its first publication in 1985. FEMA is proud to sponsor this cycle of the *NEHRP Provisions* update, and to publish the new edition for use by national codes and standards organizations and the general public.

The 2015 *NEHRP Provisions* are a new knowledge-based resource document intended to translate research results into engineering design practice. Similar to the previous edition, the new *Provisions* have adopted by reference the American Structural Engineers Association (ASCE) / Structural Engineering Institute (SEI) standard *ASCE/SEI 7-10: Minimum Design Loads for New Buildings and Other Structures* as the baseline. Following an updated chapter describing the Provisions' intent, Part I of the *Provisions* includes recommended new changes and modifications to the adopted *ASCE/SEI 7-10*. Part II provides a full commentary for Part I, consisting of new commentaries integrated with the *ASCE/SEI 7-10* commentary. Part III contains resource papers covering new concepts and methods for trial use and other supporting materials for design professionals. The new changes in the 2015 *NEHRP Provisions* have incorporated extensive results and findings from recent research projects, problem-focused studies, and post-earthquake investigation reports conducted by various professional organizations, research institutes, universities, material industries and the NEHRP agencies.

The 2015 cycle of the *NEHRP Provisions* update started in 2010. Over the past five years, the twenty one members of the Provisions Update Committee (PUC), over eighty members of the eleven issue teams and study groups devoted tremendous amount of volunteer time into the development process. Their efforts have not only produced the valuable and widely recognized new *NEHRP Provisions*, but also made a significant impact to the next edition of the national standards and codes. All the recommended new changes in Part I of the 2015 *Provisions* have been further developed and adopted into the upcoming *ASCE/SEI 7-16*, which is expected to be adopted by reference in the 2018 edition of the International Building Code (IBC).

FEMA wishes to express its deepest gratitude to the large number of volunteer experts, the BSSC member organizations, the BSSC Board of Direction and staff who made the 2015 *NEHRP Provisions* document possible. Americans unfortunate enough to experience the earthquakes that will inevitably occur in this country in the future will owe much, perhaps even their very lives, to the contributions and dedication of these individuals to the seismic safety of buildings. Without the dedication and hard work of these men and women, this document and all it represents with respect to earthquake risk mitigation would not have been possible.

Federal Emergency Management Agency

Page intentionally left blank.

PREFACE and ACKNOWLEDGEMENTS

Since its creation in 1979, the National Earthquake Hazard Reduction Program (NEHRP) has provided a framework for efforts to reduce the risk from earthquakes. The Building Seismic Safety Council (BSSC) is extremely proud to have been selected by the Federal Emergency Management Agency (FEMA) once again to play a role under NEHRP in improving the seismic resistance of the built environment. The BSSC is especially pleased to mark the delivery to FEMA of the consensus-approved 2015 *NEHRP Recommended Seismic Provisions for New Buildings and Other Structures*. This landmark publication is ninth in a series of editions delivered in 1985, 1988, 1991, 1994, 1997, 2000, 2003 and 2009. The *Provisions* has evolved over the past three decades into a widely available, trusted, state-of-the-art seismic design resource document with requirements that have been adapted for use in the nation's model building codes and standards.

Work on the 2015 *Provisions* began in October 2009 when the National Institute of Building Sciences, the BSSC's parent organization, entered into a contract with FEMA for initiation of the 2015 *Provisions* update effort. Based on input from the BSSC Member Organizations, the 15-member BSSC Board of Direction, the Chair of the 2009 Provisions Update Committee, and FEMA, 21 subject matter experts were selected to serve on the 2015 Provisions Update Committee (PUC). The PUC identified Issue Teams for developing proposals for the 2015 *Provisions*. Between March 2011 and February 2015 the Issue Teams developed proposals that were reviewed by the PUC in seven ballots, and subsequently 47 proposals were reviewed by the Membership Organization representatives in four ballots. Proposals from these four ballots were approved by the BSSC Board of Direction for incorporation into the 2015 *Provisions*. It is the collective efforts and expertise of the national experts serving on these groups that is reflected in the 2015 *Provisions*.

In recognition of the fact that the codes and standards arena now operates differently than it did during previous editions of the *Provisions*, the format of the 2015 *Provisions* has completed a transition to a knowledge base for new technologies and procedures. Following an approach started with the 2009 *Provisions*, the national consensus design loads standard ASCE/SEI 7-10, *Minimum Design Loads for Buildings and Other Structures*, Chapters 11-23, including Supplement No. 1 and the Expanded Commentary, has been adopted as the primary reference standard of the *Provisions*. Areas of the standard in need of modification that passed BSSC's review and approval process appear in Part 1 of this document and, together with ASCE/SEI 7-10 and the references cited therein, constitute the 2015 *Provisions*. Representing a significant change, the recommended modifications affect half of the sections in ASCE/SEI 7-10, including replacing four entire chapters. All of the proposals for modification have been submitted to the ASCE ballot process for potential inclusion in ASCE/SEI 7-16.

A major effort was previously made to rewrite the commentary to the 2009 *Provisions*. This Commentary was subsequently adopted in ASCE/SEI 7-10. In the 2015 *Provisions* this commentary has been reproduced in Part 2 with recommended revisions, replacements and additions to explain the development and application of both the existing requirements and recommended modifications in Part 1.

Part 3 of this volume is a collection of resource papers. Included are substantive proposals on topics that require further consideration by the seismic design community before they become *Provisions* requirements in Part 1 as well as papers that clarify some aspects of the *Provisions* requirements in Part 2.

As in the past, the 2015 *Provisions* would not have been possible without the expertise, dedication, and countless hours of effort of the more than 100 dedicated volunteers who participated in the update process. The American people benefit immeasurably from their commitment to improving the seismic-resistance of the nation's buildings and affording protection of lives.

As Chair of the BSSC Board of Direction, it is my pleasure to express heartfelt appreciation for the efforts of the BSSC Provisions Update Committee, the Issue Teams, the representatives of the BSSC member organizations, the U.S. Geological Survey and National Institute of Standards and Technology and FEMA representatives, and the National Institute of Building Sciences staff. A list of all those who participated in the 2015 *Provisions* update project is included as the Appendix of this volume, but a number of individuals deserve special recognition for their efforts:

- David Bonneville, Chair of the PUC
- Curt Haselton for rewriting the chapter on seismic response history procedures
- Satyendra K. Ghosh and Kelly Cobeen for a new diaphragm design force procedure
- Robert Pekelnicky for rewriting the chapter on soil structure interaction for seismic design
- Martin Johnson for updated requirements for strength design for foundations
- Ronald Mayes for rewriting the chapters on seismic design requirements for isolated structures and structures with damping systems
- John Hooper, Curt Haselton and William Holmes for a new chapter of alternative seismic design requirements for seismic design category B buildings
- James Harris for rewriting the intent of the *NEHRP Provision*
- Ronald Hamburger for adoption of qualification methodologies for new seismic-force-resisting systems and substitute components
- Robert Bachman for requirements for structural foundations on liquefiable sites
- Nicolas Luco, Charles (C.B.) Crouse and Charles Kircher for updates to design ground motion maps, site soil factors, and related site-specific procedure requirements
- James Malley and Finley Charney for updates to the modal response analysis procedure
- Dominic Kelly for an alternative design procedure for rigid-wall and flexible-diaphragm buildings

Finally, I wish to thank the members of the BSSC Board of Direction, who recognize the importance of this effort and provided sage advice throughout the update, and FEMA Project Officer Mai Tong, FEMA Subject Matter Expert and Technical Advisor Robert Hanson, and BSSC Executive Director Philip Schneider for the project oversight and management.

We are all proud of the 2015 *NEHRP Recommended Seismic Provisions* and it is my pleasure to introduce them.

Jimmy W. Sealy, FAIA
Chair, BSSC Board of Direction

CONTENTS

FOREWORD	III
PREFACE AND ACKNOWLEDGEMENTS	V
INTRODUCTION	XXXI
INTENT	1
1.1 INTENT	1
1.1.1 Structure Collapse	1
1.1.2 Nonstructural Damage	2
1.1.3 Hazardous Materials.....	3
1.1.4 Preservation of Egress.....	3
1.1.5 Functionality of Critical or Essential Facilities	3
1.1.6 Repair Costs	3
1.1.7 Reference Document	3
2.1 COMMENTARY TO THE INTENT	4
2.1.1 Structure Collapse	4
2.1.2 Nonstructural Damage	6
2.1.3 Hazardous Materials.....	6
2.1.4 Preservation of Egress.....	6
2.1.5 Functionality of Critical or Essential Facilities	6
2.1.6 Repair Costs	7
PART 1, PROVISIONS	9
CHAPTER 1, GENERAL	11
SECTION 1.2.1	11
1.2.1 Definitions.....	11
CHAPTER 11, SEISMIC DESIGN CRITERIA	13
SECTION 11.2.....	13
11.2 DEFINITIONS	13
SECTION 11.3.....	13
11.3 SYMBOLS	13
SECTION 11.4.2.....	14
11.4.2 Site Class.....	14
SECTION 11.4.3.....	14
11.4.3 Site Coefficients and Risk-Targeted Maximum Considered Earthquake (MCER) Spectral Response Acceleration Parameters	14
SECTION 11.4.7.....	15
11.4.7 Site-Specific Ground Motion Procedures.....	15
SECTION 11.5 AND 11.6	16
11.5 IMPORTANCE FACTOR AND RISK CATEGORY	16
11.5.1 Importance Factor	16
11.5.2 Protected Access for Risk Category IV.....	16
11.6 SEISMIC DESIGN CATEGORY	16

SECTION 11.8.3.....	17
11.8.3 Additional Geotechnical Investigation Report Requirements for Seismic Design Categories D through F	17
CHAPTER 12, SEISMIC DESIGN REQUIREMENTS FOR BUILDING STRUCTURES	19
SECTION 12.1.5.....	19
12.1.5 Foundation Design	19
SECTION 12.2.....	19
12.2 STRUCTURAL SYSTEM SELECTION.....	19
12.2.1 Selection and Limitations.....	19
12.2.1.1 Alternative Seismic Force-Resisting Systems	19
12.2.1.2 Substitute Elements	20
SECTION 12.3.1.3.....	20
12.3.1.3 Calculated Flexible Diaphragm Condition	20
SECTION 12.4.2.2.....	21
12.4.2.2 Vertical Seismic Load Effect.....	21
SECTION 12.8.1.3.....	22
12.8.1.3 Maximum S_{DS} Value in Determination of C_s and E_v	22
SECTION 12.8.4.2.....	22
12.8.4.2 Accidental Torsion.....	22
SECTION 12.9.....	23
SECTION 12.9.1.1.....	23
12.9.1.1 Number of Modes	23
SECTION 12.9.1.4.....	24
12.9.1.4 Scaling Design Values of Combined Response.....	24
12.9.1.4.1 Scaling of Forces.....	24
12.9.1.4.2 Scaling of Drifts.....	24
SECTION 12.9.1.8.....	24
12.9.1.8 Structural Modeling	24
SECTION 12.9.2.....	24
12.9.2 Linear Response History Analysis	24
12.9.2.1 General Requirements.....	24
12.9.2.2 General Modeling Requirements	25
12.9.2.2.1 P-Delta Effects	25
12.9.2.2.2 Accidental Torsion.....	25
12.9.2.2.3 Foundation Modeling.....	25
12.9.2.2.4 Number of Modes to Include in Response History Analysis.....	25
12.9.2.2.5 Damping.....	25
12.9.2.3 Ground Motion Selection and Scaling	25
12.9.2.3.1 Procedure for Spectrum Matching	25
12.9.2.4 Application of Ground Acceleration Histories	25
12.9.2.5 Modification of Response for Inelastic Behavior	26
12.9.2.5.1 Determination of Maximum Elastic Base Shear	26
12.9.2.5.2 Determination of Maximum Inelastic Base Shear.....	26
12.9.2.5.3 Determination of Base Shear Scale Factor	26
12.9.2.5.4 Determination of Combined Force Response.....	26
12.9.2.5.5 Determination of Combined Displacement Response.....	26
12.9.2.6 Enveloping of Force Response Quantities	27
12.9.2.7 Enveloping of Displacement Response Quantities	27

SECTION 12.10.....	27
12.10 DIAPHRAGMS, CHORDS, AND COLLECTORS	27
SECTION 12.10.1.1.....	27
12.10.1.1 Diaphragm Design Forces.....	27
SECTION 12.10.3.....	27
12.10.3 Alternative Provisions for Diaphragms Including Chords and Collectors	28
12.10.3.1 Design.....	28
12.10.3.2 Seismic Design Forces for Diaphragms including Chords and Collectors.....	28
12.10.3.2.1 Design acceleration coefficients C_{p0} and C_{pn}	28
12.10.3.3 Transfer Diaphragms	29
12.10.3.4 Collectors - Seismic Design Categories C through F	29
12.10.3.5 Diaphragm Design Force Reduction Factor.....	30
SECTION 12.13.....	30
12.13 FOUNDATION DESIGN	30
12.13.1 Design Basis.....	30
12.13.2 Materials of Construction.....	30
12.13.3 Foundation Load-Deformation Characteristics	30
12.13.4 Reduction of Foundation Overturning	30
SECTION 12.13.5.....	31
12.13.5 Strength Design for Nominal Foundation Geotechnical Capacity	31
12.13.5.1 Nominal Strength.....	31
12.13.5.2 Resistance Factors	31
12.13.5.3 Acceptance Criteria	32
SECTION 12.13.5 AND 12.13.6.....	32
12.13.6 5 Requirements for Structures Assigned to Seismic Design Category C.....	32
12.13.7 6 Requirements for Structures Assigned to Seismic Design Category D through F	32
SECTION 12.13.8.....	32
12.13.8 Requirements for Structure Foundations on Liquefiable Sites.....	32
12.13.8.1 Foundation Design.....	32
12.13.8.2 Shallow Foundations	32
12.13.8.2.1 Shallow Foundation Detailing.....	33
12.13.8.3 Deep Foundations	34
12.13.8.3.1 Downdrag.....	34
12.13.8.3.2 Lateral Resistance	34
12.13.8.3.3 Concrete Deep Foundation Detailing	34
12.13.8.3.4 Lateral Spreading	35
12.13.8.3.5 Foundation Ties	35
SECTION 12.14.1.1.....	35
12.14.1.1 Simplified Design Procedure.....	35
CHAPTER 14, MATERIAL SPECIFIC SEISMIC DESIGN AND DETAILING REQUIREMENTS	37
SECTION 14.2.2.1.....	37
14.2.2.1 Definitions	37
SECTION 14.2.4.....	37
14.2.4 Additional Design and Detailing Requirements for Precast Concrete Diaphragms	37
14.2.4.1 Diaphragm Seismic Demand Levels.....	37
14.2.4.1.1 Diaphragm Span.....	38
14.2.4.1.2 Diaphragm Aspect Ratio	38
14.2.4.1.3 Diaphragm Shear Amplification Factor	38

14.2.4.2	Diaphragm Design Options	38
14.2.4.2.1	Elastic Design Option	38
14.2.3.2.2	Basic Design Option	39
14.2.3.2.3	Reduced Design Option	39
14.2.4.3	Diaphragm Connector or Joint Reinforcement Deformability.....	39
14.2.4.3.1	Low Deformability Element (LDE).....	39
14.2.4.3.2	Moderate Deformability Element (MDE).....	39
14.2.4.3.3	High Deformability Element (HDE).....	39
14.2.4.3.4	Connector/ Joint Reinforcement Classification.....	39
14.2.4.3.5	Special Inspection.....	39
14.2.4.4	Precast Concrete Diaphragm Connector and Joint Reinforcement Qualification Procedure.....	39
14.2.4.4.1	Test Modules.....	40
14.2.4.4.2	Number of Tests.....	40
14.2.4.4.3	Test Configuration	40
14.2.4.4.4	Instrumentation	40
14.2.4.4.5	Loading Protocols	40
14.2.4.4.6	Measurement Indices, Test Observations and Acquisition of Data	41
14.2.4.4.7	Response Properties	42
14.2.4.4.8	Test Report.....	42
14.2.4.4.9	Deformed Bar Reinforcement	43
CHAPTER 15, SEISMIC DESIGN REQUIREMENTS FOR NONBUILDING STRUCTURES.....		45
SECTION 15.4.1.....		45
15.4.1	Design Basis.....	45
CHAPTER 16, SEISMIC RESPONSE HISTORY PROCEDURES		47
16.1	GENERAL REQUIREMENTS	47
16.1.1	Design	47
16.1.2	Documentation	47
16.2	GROUND MOTIONS	48
16.2.1	Level of Ground Motion.....	48
16.2.2	Development of the Target Response Spectrum	48
16.2.2.1	Method 1.....	48
16.2.2.2	Method 2.....	48
16.2.3	Ground Motions Selection	48
16.2.3.1	Minimum Number of Ground Motions.....	48
16.2.3.2	Components of Ground Motion.....	48
16.2.3.3	Selection of Ground Motions.....	49
16.2.4	Ground Motion Scaling.....	49
16.2.4.1	Period Range for Scaling	49
16.2.4.2	Scaling of Ground Motions.....	49
16.2.4.3	Spectral Matching of Ground Motions	49
16.2.5	Application of Ground Motions to the Structural Model	49
16.2.5.1	Orientation of Ground Motions	50
16.2.5.2	Application of Input Ground Motion over Subterranean Levels	50
16.3	MODELING AND ANALYSIS	50
16.3.1	System Modeling	50
16.3.2	Gravity Load	50
16.3.3	P-delta Effects	50
16.3.4	Seismic Mass.....	50
16.3.5	Diaphragm Modeling	50
16.3.6	Torsion	50

16.3.7	Stiffness of Elements Modeled with Elastic Properties.....	51
16.3.8	Nonlinear Modeling	51
16.3.9	Damping	51
16.3.10	Soil-Structure Interaction (SSI).....	51
16.4	ANALYSIS RESULTS AND ACCEPTANCE CRITERIA	51
16.4.1	Global Acceptance Criteria	51
16.4.1.1	Unacceptable Response	51
16.4.1.2	Story Drift	52
16.4.2	Element-Level Acceptance Criteria	52
16.4.2.1	Force-Controlled Actions	52
16.4.2.2	Deformation-Controlled Actions	52
16.4.2.3	Components of the Gravity System	53
16.5	DESIGN REVIEW	53
16.5.1	Reviewer Qualifications	53
16.5.2	Review Scope.....	53

CHAPTER 17, SEISMIC DESIGN REQUIREMENTS FOR SEISMICALLY ISOLATED STRUCTURES. 55

17.1	GENERAL.....	55
17.1.2	Definitions.....	55
17.1.3	Notation.....	55
17.2	GENERAL DESIGN REQUIREMENTS	58
17.2.1	Importance Factor	58
17.2.2	Configuration	58
17.2.3	Redundancy.....	58
17.2.4	Isolation System.....	58
17.2.4.1	Environmental Conditions	58
17.2.4.2	Wind Forces.....	58
17.2.4.3	Fire Resistance.....	58
17.2.4.4	Lateral Restoring Force	59
17.2.4.5	Displacement Restraint	59
17.2.4.6	Vertical-Load Stability	59
17.2.4.7	Overturning.....	59
17.2.4.8	Inspection and Replacement	59
17.2.4.9	Quality Control	60
17.2.5	Structural System	60
17.2.5.1	Horizontal Distribution of Force.....	60
17.2.5.2	Minimum Building Separations.....	60
17.2.5.3	Nonbuilding Structures	60
17.2.5.4	Steel Ordinary Concentrically Braced Frames.....	60
17.2.5.5	Steel Grid Frames	60
17.2.6	Elements of Structures and Nonstructural Components.....	60
17.2.6.1	Components at or above the Isolation Interface.....	60
17.2.6.2	Components Crossing the Isolation Interface	61
17.2.6.3	Components below the Isolation Interface.....	61
17.2.7	Seismic Load Effects and Load Combinations	61
17.2.7.1	Isolator Unit Vertical Load Combinations.....	61
17.2.8	Isolation System Properties	61
17.2.8.1	Isolation System Component Types	61
17.2.8.2	Isolator Unit Nominal Properties	61
17.2.8.3	Bounding Properties of Isolation System Components	61
17.2.8.4	Property Modification Factors	62
17.2.8.5	Upper-Bound and Lower-Bound Force-Deflection Behavior of Isolation System Components	63
17.2.8.6	Isolation System Properties at Maximum Displacements.....	63

17.3	SEISMIC GROUND MOTION CRITERIA	63
17.3.1	Site-Specific Seismic Hazard	63
17.3.2	MCE _R Response Spectra and Spectral Response Acceleration Parameters, S_{MS} , S_{M1} ...	64
17.3.4	MCE _R Ground Motion Records	64
17.4	ANALYSIS PROCEDURE SELECTION	64
17.4.1	Equivalent Lateral Force Procedure	64
17.4.2	Dynamic Procedures	65
17.4.2.1	Response Spectrum Analysis Procedure.....	65
17.4.2.2	Response History Analysis Procedure	65
17.5	EQUIVALENT LATERAL FORCE PROCEDURE	65
17.5.1	General	65
17.5.2	Deformation Characteristics of the Isolation System	65
17.5.3	Minimum Lateral Displacements Required for Design.....	66
17.5.3.1	Maximum Displacement.....	66
17.5.3.2	Effective Period at the Maximum Displacement	66
17.5.3.3	Total Maximum Displacement	67
17.5.4	Minimum Lateral Forces Required for Design	67
17.5.4.1	Isolation System and Structural Elements below the Base Level	67
17.5.4.2	Structural Elements above the Base Level.....	68
17.5.4.3	Limits on V_s	69
17.5.5	Vertical Distribution of Force	69
17.5.6	Drift Limits	70
17.6	DYNAMIC ANALYSIS PROCEDURES	70
17.6.1	General	70
17.6.2	Modeling	70
17.6.2.1	Isolation System.....	70
17.6.2.2	Isolated Structure	70
17.6.3	Description of Procedures	71
17.6.3.1	General.....	71
17.6.3.2	MCE _R Ground Motions	71
17.6.3.3	Response-Spectrum Analysis Procedure	71
17.6.3.4	Response-History Analysis Procedure.....	71
17.6.3.4.1	Accidental Mass Eccentricity.....	71
17.6.4	Minimum Lateral Displacements and Forces.....	72
17.6.4.1	Isolation System and Structural Elements below the Base Level	72
17.6.4.2	Structural Elements above the Base Level.....	72
17.6.4.3	Scaling of Results	72
17.6.4.4	Drift Limits	73
17.7	DESIGN REVIEW	73
17.8	TESTING.....	73
17.8.1	General	73
17.8.1.2	Qualification Tests.....	73
17.8.2	Prototype Tests.....	74
17.8.2.1	Record.....	74
17.8.2.2	Sequence and Cycles	74
17.8.2.3	Dynamic Testing.....	74
17.8.2.4	Units Dependent on Bilateral Load.....	75
17.8.2.5	Maximum and Minimum Vertical Load	75
17.8.2.6	Sacrificial Wind-Restraint Systems	75
17.8.2.7	Testing Similar Units	75
17.8.3	Determination of Force-Deflection Characteristics.....	76
17.8.4	Test Specimen Adequacy	77
17.8.5	Production Tests.....	78

CHAPTER 18, SEISMIC DESIGN REQUIREMENTS FOR STRUCTURES WITH DAMPING SYSTEMS	79
18.1 GENERAL	79
18.1.1 Scope	79
18.1.2 Definitions	79
18.1.3 Notation	79
18.2 GENERAL DESIGN REQUIREMENTS	83
18.2.1 System Requirements	83
18.2.1.1 Seismic Force-Resisting System	84
18.2.1.2 Damping System	84
18.2.2 Seismic Ground Motion Criteria	84
18.2.2.1 Design Earthquake and MCE_R Response Spectra	84
18.2.2.2 Design Earthquake and MCE_R Ground Motion Records	85
18.2.3 Procedure Selection	85
18.2.3.1 Response-Spectrum Procedure	85
18.2.3.2 Equivalent Lateral Force Procedure	86
18.2.4 Damping System	86
18.2.4.1 Device Design	86
18.2.4.2 Multiaxis Movement	86
18.2.4.3 Inspection and Periodic Testing	86
18.2.4.4 Nominal Design Properties	87
18.2.4.5 Maximum and Minimum Damper Properties	87
18.2.4.6 Damping System Redundancy	88
18.3 NONLINEAR RESPONSE-HISTORY PROCEDURE	88
18.3.1 Damping Device Modeling	88
18.3.2 Accidental Mass Eccentricity	89
18.3.3 Response Parameters	89
18.4 SEISMIC LOAD CONDITIONS AND ACCEPTANCE CRITERIA FOR NONLINEAR RESPONSE-HISTORY PROCEDURE	89
18.4.1 Seismic Force-Resisting System	89
18.4.2 Damping System	89
18.4.3 Combination of Load Effects	89
18.4.4 Acceptance Criteria for the Response Parameters of Interest	90
18.5 DESIGN REVIEW	90
18.6 TESTING	90
18.6.1 Prototype Tests	90
18.6.1.1 Data Recording	91
18.6.1.2 Sequence and Cycles of Testing	91
18.6.1.3 Testing Similar Devices	92
18.6.1.4 Determination of Force-Velocity-Displacement Characteristics	92
18.6.1.5 Device Adequacy	92
18.6.1.5.1 Displacement-Dependent Damping Devices	93
18.6.1.5.2 Velocity-Dependent Damping Devices	93
18.6.2 Production Tests	94
18.7 ALTERNATE PROCEDURES AND CORRESPONDING ACCEPTANCE CRITERIA	94
18.7.1 Response Spectrum Procedure	94
18.7.1.1 Modeling	94
18.7.1.2 Seismic Force-Resisting System	95
18.7.1.2.1 Seismic Base Shear	95
18.7.1.2.2 Modal Base Shear	95
18.7.1.2.3 Modal Participation Factor	95
18.7.1.2.4 Fundamental Mode Seismic Response Coefficient	95

	18.7.1.2.5	Effective Fundamental Mode Period Determination.....	96
	18.7.1.2.6	Higher Mode Seismic Response Coefficient.....	96
	18.7.1.2.7	Design Lateral Force.....	96
	18.7.1.3	Damping System.....	96
	18.7.1.3.1	Design Earthquake Floor Deflection.....	97
	18.7.1.3.2	Design Earthquake Roof Displacement.....	97
	18.7.1.3.3	Design Earthquake Story Drift.....	97
	18.7.1.3.4	Design Earthquake Story Velocity.....	97
	18.7.1.3.5	MCE _R Response.....	98
18.7.2		Equivalent Lateral Force Procedure.....	98
	18.7.2.1	Modeling.....	98
	18.7.2.2	Seismic Force-Resisting System.....	99
	18.7.2.2.1	Seismic Base Shear.....	99
	18.7.2.2.2	Fundamental Mode Base Shear.....	99
	18.7.2.2.3	Fundamental Mode Properties.....	99
	18.7.2.2.4	Fundamental Mode Seismic Response Coefficient.....	100
	18.7.2.2.5	Effective Fundamental Mode Period Determination.....	100
	18.7.2.2.6	Residual Mode Base Shear.....	100
	18.7.2.2.7	Residual Mode Properties.....	101
	18.7.2.2.8	Residual Mode Seismic Response Coefficient.....	101
	18.7.2.2.9	Design Lateral Force.....	101
	18.7.2.3	Damping System.....	101
	18.7.2.3.1	Design Earthquake Floor Deflection.....	102
	18.7.2.3.2	Design Earthquake Roof Displacement.....	102
	18.7.2.3.3	Design Earthquake Story Drift.....	102
	18.7.2.3.4	Design Earthquake Story Velocity.....	102
	18.7.2.3.5	MCE _R Response.....	103
18.7.3		Damped Response Modification.....	103
	18.7.3.1	Damping Coefficient.....	103
	18.7.3.2	Effective Damping.....	104
	18.7.3.2.1	Inherent Damping.....	105
	18.7.3.2.2	Hysteretic Damping.....	105
	18.7.3.2.3	Viscous Damping.....	105
	18.7.3.3	Effective Ductility Demand.....	106
	18.7.3.4	Maximum Effective Ductility Demand.....	107
18.7.4		Seismic Load Conditions and Acceptance Criteria for RSA and ELF Procedures.....	107
	18.7.4.1	Seismic Force-Resisting System.....	107
	18.7.4.2	Damping System.....	108
	18.7.4.3	Combination of Load Effects.....	108
	18.7.4.4	Modal Damping System Design Forces.....	108
	18.7.4.5	Seismic Load Conditions and Combination of Modal Responses.....	108
	18.7.4.6	Inelastic Response Limits.....	110

CHAPTER 19, SOIL STRUCTURE INTERACTION FOR SEISMIC DESIGN..... 111

19.1	GENERAL.....	111
	19.1.1 Scope.....	111
	19.1.2 Definitions.....	111
	19.1.2 Notation.....	111
19.2	SSI ADJUSTED STRUCTURAL DEMANDS.....	112
	19.2.1 Equivalent Lateral Force Procedure.....	112
	19.2.2 Modal Response Spectrum Analysis.....	113
	19.2.2.1 SSI Modified General Design Response Spectrum.....	114
	19.2.2.2 SSI Site Specific Response Spectrum.....	114
	19.2.3 Response History Procedure.....	114
19.3	FOUNDATION DAMPING EFFECTS.....	115

19.3.1	Foundation Damping Requirements.....	115
19.3.2	Effective Damping Ratio.....	115
19.3.3	Radiation Damping for Rectangular Foundations.....	116
19.3.4	Radiation Damping for Circular Foundations.....	118
19.3.5	Soil Damping.....	118
19.4	KINEMATIC INTERACTION EFFECTS.....	119
19.4.1	Base Slab Averaging.....	119
19.4.2	Embedment.....	120
CHAPTER 21, SITE SPECIFIC GROUND MOTION PROCEDURES FOR SEISMIC DESIGN		123
SECTION 21.4.....		123
21.4	Design Acceleration Parameters.....	123
CHAPTER 22, SEISMIC GROUND MOTION, LONG-PERIOD TRANSITION AND RISK COEFFICIENT MAPS.....		125
INTRODUCTION.....		125
FIGURE 22-1	S_S Risk-Targeted Maximum Considered Earthquake (MCE_R) Ground Motion Parameter for the Conterminous United States for 0.2 s Spectral Response Acceleration (5% of Critical Damping), Site Class B.....	127
FIGURE 22-1 (continued)	S_S Risk-Targeted Maximum Considered Earthquake (MCE_R) Ground Motion Parameter for the Conterminous United States for 0.2 s Spectral Response Acceleration (5% of Critical Damping), Site Class B.....	128
FIGURE 22-2	S_I Risk-Targeted Maximum Considered Earthquake (MCE_R) Ground Motion Parameter for the Conterminous United States for 1.0 s Spectral Response Acceleration (5% of Critical Damping), Site Class B.....	129
FIGURE 22-2 (continued)	S_I Risk-Targeted Maximum Considered Earthquake (MCE_R) Ground Motion Parameter for the Conterminous United States for 1.0 s Spectral Response Acceleration (5% of Critical Damping), Site Class B.....	130
FIGURE 22-3	S_S Risk-Targeted Maximum Considered Earthquake (MCE_R) Ground Motion Parameter for Alaska for 0.2 s Spectral Response Acceleration (5% of Critical Damping), Site Class B.....	131
FIGURE 22-4	S_I Risk-Targeted Maximum Considered Earthquake (MCE_R) Ground Motion Parameter for Alaska for 1.0 s Spectral Response Acceleration (5% of Critical Damping), Site Class B.....	132
FIGURE 22-5	S_S and S_I Risk-Targeted Maximum Considered Earthquake (MCE_R) Ground Motion Parameter for Hawaii for 0.2 and 1.0 s Spectral Response Acceleration (5% of Critical Damping), Site Class B.....	133
FIGURE 22-6	S_S and S_I Risk-Targeted Maximum Considered Earthquake (MCE_R) Ground Motion Parameter for Puerto Rico and the Unites States Virgin Islands for 0.2 and 1.0 s Spectral Response Acceleration (5% of Critical Damping), Site Class B.....	134
FIGURE 22-7	S_S and S_I Risk-Targeted Maximum Considered Earthquake (MCE_R) Ground Motion Parameter for Guam and the Northern Mariana Islands for 0.2 and 1.0 s Spectral Response Acceleration (5% of Critical Damping), Site Class B.....	135
FIGURE 22-8	S_S and S_I Risk-Targeted Maximum Considered Earthquake (MCE_R) Ground Motion Parameter for American Samoa for 0.2 and 1.0 s Spectral Response Acceleration (5% of Critical Damping), Site Class B.....	136
FIGURE 22-9	Maximum Considered Earthquake Geometric Mean (MCE_G) PGA, %g, Site Class B for the Conterminous United States.....	137
FIGURE 22-9 (continued)	Maximum Considered Earthquake Geometric Mean (MCE_G) PGA, %g, Site Class B for the Conterminous United States.....	138
FIGURE 22-10	Maximum Considered Earthquake Geometric Mean (MCE_G) PGA, %g, Site Class B for Alaska.....	139
FIGURE 22-11	Maximum Considered Earthquake Geometric Mean (MCE_G) PGA, %g, Site Class B for Hawaii.....	139

FIGURE 22-12 Maximum Considered Earthquake Geometric Mean (MCE_G) PGA, %g, Site Class B for Puerto Rico and the United States Virgin Islands	140
FIGURE 22-13 Maximum Considered Earthquake Geometric Mean (MCE_G) PGA, %g, Site Class B for Guam and the Northern Mariana Islands and for American Samoa	141
FIGURE 22-14 Mapped Long-Period Transition Period, T_L (s), for the Conterminous United States	142
FIGURE 22-14 (continued) Mapped Long-Period Transition Period, T_L (s), for the Conterminous United States	143
FIGURE 22-15 Mapped Long-Period Transition Period, T_L (s), for Alaska	144
FIGURE 22-16 Mapped Long-Period Transition Period, T_L (s), for Hawaii	144
FIGURE 22-17 Mapped Long-Period Transition Period, T_L (s), for Puerto Rico and the United States Virgin Islands	145
FIGURE 22-18 Mapped Risk Coefficient at 0.2 s Spectral Response Period, C_{RS}	146
FIGURE 22-18 (continued) Mapped Risk Coefficient at 0.2 s Spectral Response Period, C_{RS}	147
FIGURE 22-18 (continued) Mapped Risk Coefficient at 0.2 s Spectral Response Period, C_{RS}	148
FIGURE 22-19 Mapped Risk Coefficient at 1.0 s Spectral Response Period, C_{RI}	149
FIGURE 22-19 (continued) Mapped Risk Coefficient at 1.0 s Spectral Response Period, C_{RI}	150
FIGURE 22-19 (continued) Mapped Risk Coefficient at 1.0 s Spectral Response Period, C_{RI}	151

CHAPTER 23A, VERTICAL GROUND MOTIONS FOR SEISMIC DESIGN..... 153

23.1 DESIGN VERTICAL RESPONSE SPECTRUM.....	153
23.2 MCE_R VERTICAL RESPONSE SPECTRUM	154

CHAPTER 24, ALTERNATIVE SEISMIC DESIGN REQUIREMENTS FOR SEISMIC DESIGN CATEGORY B BUILDINGS 155

24.1 GENERAL.....	155
24.1.1 Scope and Applicability	155
24.2 STRUCTURAL DESIGN BASIS	155
24.2.1 Basic Requirements.....	155
24.2.2 Member Design, Connection Design, and Deformation Limit.....	155
24.2.3 Continuous Load Path and Interconnection	155
24.2.4 Connection to Supports	156
24.2.5 Foundation Design	156
24.2.6 Material Design and Detailing Requirements	156
24.3 STRUCTURAL SYSTEM SELECTION.....	156
24.3.1 Selection and Limitations.....	156
24.3.2 Combinations of Framing Systems in Different Directions	156
24.3.3 Combinations of Framing Systems in the Same Direction.....	157
24.3.3.1 R, C_d , and Ω_0 Values for Vertical Combinations.....	157
24.3.3.2 Two Stage Analysis Procedure	157
24.3.3.3 R, C_d , and Ω_0 Values for Horizontal Combinations	157
24.3.4 Combination Framing Detailing Requirements.....	158
24.3.5 System Specific Requirements.....	158
24.3.5.1 Dual System.....	158
24.3.5.2 Cantilever Column Systems.....	158
24.3.5.3 Inverted Pendulum-Type Structures	158
24.3.5.4 Shear Wall-Frame Interactive Systems.....	158
24.4 DIAPHRAGM FLEXIBILITY AND CONFIGURATION IRREGULARITIES	158
24.4.1 Diaphragm Flexibility	158
24.4.1.1 Flexible Diaphragm Condition	158
24.4.1.2 Rigid Diaphragm Condition.....	159
24.4.1.3 Calculated Flexible Diaphragm Condition	159
24.4.2 Irregular and Regular Classification.....	159

	24.4.2.1	Horizontal Irregularity	159
	24.4.2.2	Vertical Irregularity	159
24.4.3		Limitations and Additional Requirements for Systems with Structural Irregularities	159
	24.4.3.1	Extreme Weak Stories	159
	24.4.3.2	Elements Supporting Discontinuous Walls or Frames.....	159
24.5		SEISMIC LOAD EFFECTS AND COMBINATIONS	160
	24.5.1	Applicability.....	160
	24.5.2	Seismic Load Effect	160
	24.5.2.1	Seismic Load Combinations	160
	24.5.3	Seismic Load Effect Including Overstrength Factor	160
	24.5.3.1	Load Combinations with Overstrength Factor.....	161
	24.5.3.2	Allowable Stress Increase for Load Combinations with Overstrength ..	161
24.6		DIRECTION OF LOADING	161
24.7		ANALYSIS PROCEDURE SELECTION	161
24.8		MODELING CRITERIA.....	162
	24.8.1	Foundation Modeling.....	162
	24.8.2	Effective Seismic Weight.....	162
	24.8.3	Structural Modeling	162
	24.8.4	Interaction Effects	162
24.9		EQUIVALENT LATERAL FORCE PROCEDURE.....	163
	24.9.1	Seismic Base Shear	163
	24.9.2	Period Determination	163
	24.9.2.1	Approximate Fundamental Period	163
	24.9.3	Vertical Distribution of Seismic Forces	164
	24.9.4	Horizontal Distribution of Forces.....	164
	24.9.4.1	Inherent Torsion.....	164
	24.9.4.2	Accidental Torsion.....	165
	24.9.5	Overturning	165
	24.9.6	Story Drift Determination	165
	24.9.6.1	Minimum Base Shear for Computing Drift	165
	24.9.6.2	Period for Computing Drift.....	165
	24.9.7	P-Delta Effects	165
24.10		MODAL RESPONSE SPECTRUM ANALYSIS.....	166
	24.10.1	Number of Modes	166
	24.10.2	Modal Response Parameters	166
	24.10.3	Combined Response Parameters	166
	24.10.4	Scaling Design Values of Combined Response	167
	24.10.4.1	Scaling of Forces	167
	24.10.5	Horizontal Shear Distribution	167
	24.10.6	P-Delta Effects	167
24.11		DIAPHRAGMS, CHORDS, AND COLLECTORS	167
	24.11.1	Diaphragm Design	167
	24.11.1.1	Diaphragm Design Forces	167
	24.11.2	Collector Elements	168
24.12		STRUCTURAL WALLS AND THEIR ANCHORAGE.....	168
	24.12.1	Design for Out-of-Plane Forces	168
	24.12.2	Anchorage of Structural Walls.....	168
24.13		DRIFT AND DEFORMATION	169
	24.13.1	Story Drift Limit	169
	24.13.2	Diaphragm Deflection.....	169
	24.13.3	Structural Separation.....	169

24.13.4	Members Spanning between Structures	169
24.14	FOUNDATION DESIGN	170
24.14.1	Design Basis.....	170
24.14.2	Materials of Construction.....	170
24.14.3	Foundation Load-Deformation Characteristics	170
24.14.4	Reduction of Foundation Overturning	170
24.15	SEISMIC DESIGN REQUIREMENTS FOR EGRESS STAIRWAYS AND PARAPETS	170
24.15.1	Scope.....	170
24.15.2	General Design Requirements.....	170
24.15.2.1	Submittal Requirements.....	170
24.15.2.2	Construction Documents.....	171
24.15.3	Seismic Design Force.....	171
24.15.4	Design of Egress Stairways for Seismic Relative Displacements	171
24.15.4.1	Displacements within Structures.....	172
24.15.4.2	Displacements between Structures	172
24.15.5	Out-of-Plane Bending	173
24.15.6	Anchorage	173
24.15.6.1	Design Force in the Attachment	173
24.15.6.2	Anchors in Concrete or Masonry.....	173
24.15.6.3	Installation Conditions.....	173
24.15.6.4	Multiple Attachments	173
24.15.6.5	Power Actuated Fasteners.....	173
	FIGURES AND TABLES	175
PART 2, COMMENTARY		179
COMMENTARY TO CHAPTER 11, SEISMIC DESIGN CRITERIA.....		181
C11.1	GENERAL.....	181
C11.1.1	Purpose.....	182
C11.1.2	Scope.....	182
C11.1.3	Applicability.....	183
C11.1.4	Alternate Materials and Methods of Construction	183
C11.2	DEFINITIONS	183
C11.3	SYMBOLS	189
C11.4	SEISMIC GROUND MOTION VALUES.....	189
C11.4.1	Mapped Acceleration Parameters.....	190
C11.4.2	Site Class.....	190
C11.4.3	Site Coefficients and Risk-Targeted Maximum Considered Earthquake (MCER) Spectral Response Acceleration Parameters	190
C11.4.4	Design Spectral Acceleration Parameters	193
C11.4.5	Design Response Spectrum.....	193
C11.4.7	Site-Specific Ground Motion Procedures.....	194
C11.5	IMPORTANCE FACTOR AND RISK CATEGORY	198
C11.5.1	Importance Factor	199
C11.5.2	Protected Access for Risk Category IV.....	199
C11.6	SEISMIC DESIGN CATEGORY	199
C11.7	DESIGN REQUIREMENTS FOR SEISMIC DESIGN CATEGORY A.....	202
C11.8	GEOLOGIC HAZARDS AND GEOTECHNICAL INVESTIGATION.....	202
C11.8.1	Site Limitation for Seismic Design Categories E and F.....	203

C11.8.2	Geotechnical Investigation Report Requirements for Seismic Design Categories C through F	203
C11.8.3	Additional Geotechnical Investigation Report Requirements for Seismic Design Categories D through F	203
REFERENCES.....		206

COMMENTARY TO CHAPTER 12, SEISMIC DESIGN REQUIREMENTS FOR BUILDING STRUCTURES..... 207

C12.1	STRUCTURAL DESIGN BASIS	207
C12.1.1	Basic Requirements.....	207
C12.1.2	Member Design, Connection Design, and Deformation Limit.....	211
C12.1.3	Continuous Load Path and Interconnection	211
C12.1.4	Connection to Supports	211
C12.1.5	Foundation Design	211
C12.1.6	Material Design and Detailing Requirements	212
C12.2	STRUCTURAL SYSTEM SELECTION.....	212
C12.2.1	Selection and Limitations.....	212
C12.2.1.1	Alternative Structural Systems	213
C12.2.1.2	Substitute Elements	214
C12.2.2	Combinations of Framing Systems in Different Directions	214
C12.2.3	Combinations of Framing Systems in the Same Direction.....	215
C12.2.3.1	R , C_d , and Ω_0 Values for Vertical Combinations	215
C12.2.3.2	Two-Stage Analysis Procedure.....	215
C12.2.3.3	R , C_d , and Ω_0 Values for Horizontal Combinations	215
C12.2.4	Combination Framing Detailing Requirements.....	215
C12.2.5	System-Specific Requirements	215
C12.2.5.1	Dual System.....	215
C12.2.5.2	Cantilever Column Systems.....	216
C12.2.5.3	Inverted Pendulum-Type Structures	216
C12.2.5.4	Increased Structural Height Limit for Steel Eccentrically Braced Frames, Steel Special Concentrically Braced Frames, Steel Buckling-Restrained Braced Frames, Steel Special Plate Shear Walls, and Special Reinforced Concrete Shear Walls	216
C12.2.5.5	Special Moment Frames in Structures Assigned to Seismic Design Categories D through F.....	216
C12.2.5.6	Steel Ordinary Moment Frames.....	217
C12.2.5.6.1	Seismic Design Category D or E.....	217
C12.2.5.6.2	Seismic Design Category F.....	218
C12.2.5.7	Steel Intermediate Moment Frames	218
C12.2.5.7.1	Seismic Design Category D	219
C12.2.5.7.2	Seismic Design Category E.....	219
C12.2.5.7.3	Seismic Design Category F.....	219
C12.2.5.8	Shear Wall–Frame Interactive Systems	219
C12.3	DIAPHRAGM FLEXIBILITY, CONFIGURATION IRREGULARITIES, AND REDUNDANCY	219
C12.3.1	Diaphragm Flexibility	219
C12.3.1.1	Flexible Diaphragm Condition	220
C12.3.1.2	Rigid Diaphragm Condition.....	220
C12.3.1.3	Calculated Flexible Diaphragm Condition	220
C12.3.2	Irregular and Regular Classification.....	220
C12.3.2.1	Horizontal Irregularity	221
C12.3.2.2	Vertical Irregularity	222
C12.3.3	Limitations and Additional Requirements for Systems with Structural Irregularities.....	223

	C12.3.3.1	Prohibited Horizontal and Vertical Irregularities for Seismic Design Categories D through F.....	223
	C12.3.3.2	Extreme Weak Stories	224
	C12.3.3.3	Elements Supporting Discontinuous Walls or Frames.....	224
	C12.3.3.4	Increase in Forces Because of Irregularities for Seismic Design Categories D through F.....	225
	C12.3.4	Redundancy.....	225
	C12.3.4.1	Conditions Where Value of ρ is 1.0.....	226
	C12.3.4.2	Redundancy Factor, ρ , for Seismic Design Categories D through F	226
C12.4		SEISMIC LOAD EFFECTS AND COMBINATIONS	228
	C12.4.1	Applicability.....	228
	C12.4.2	Seismic Load Effect	228
	C12.4.2.1	Horizontal Seismic Load Effect.....	229
	C12.4.2.2	Vertical Seismic Load Effect.....	229
	C12.4.2.3	Seismic Load Combinations	229
	C12.4.3	Seismic Load Effect Including Overstrength Factor	229
	C12.4.3.1	Horizontal Seismic Load Effect with Overstrength Factor	229
	C12.4.3.2	Load Combinations with Overstrength Factor.....	230
	C12.4.3.3	Allowable Stress Increase for Load Combinations with Overstrength ..	230
	C12.4.4	Minimum Upward Force for Horizontal Cantilevers for Seismic Design Categories D through F	230
C12.5		DIRECTION OF LOADING	230
	C12.5.1	Direction of Loading Criteria.....	230
	C12.5.2	Seismic Design Category B.....	230
	C12.5.3	Seismic Design Category C.....	231
	C12.5.4	Seismic Design Categories D through F	232
C12.6		ANALYSIS PROCEDURE SELECTION	232
C12.7		MODELING CRITERIA.....	233
	C12.7.1	Foundation Modeling	233
	C12.7.2	Effective Seismic Weight.....	234
	C12.7.3	Structural Modeling	234
	C12.7.4	Interaction Effects	235
C12.8		EQUIVALENT LATERAL FORCE PROCEDURE.....	235
	C12.8.1	Seismic Base Shear	236
	C12.8.1.1	Calculation of Seismic Response Coefficient.....	236
	C12.8.1.2	Soil–Structure Interaction Reduction.....	237
	C12.8.1.3	Maximum S_s Value in Determination of C_s	237
	C12.8.2	Period Determination	237
	C12.8.2.1	Approximate Fundamental Period	239
	C12.8.3	Vertical Distribution of Seismic Forces	240
	C12.8.4	Horizontal Distribution of Forces.....	241
	C12.8.4.1	Inherent Torsion.....	241
	C12.8.4.2	Accidental Torsion.....	242
	C12.8.4.3	Amplification of Accidental Torsional Moment.....	243
	C12.8.5	Overturning	244
	C12.8.6	Story Drift Determination	244
	C12.8.6.1	Minimum Base Shear for Computing Drift	246
	C12.8.6.2	Period for Computing Drift.....	246
	C12.8.7	P-Delta Effects	246
C12.9		MODAL RESPONSE SPECTRUM ANALYSIS AND LINEAR RESPONSE HISTORY ANALYSIS.....	250
	C12.9.1	Modal Response Spectrum Analysis.....	250
	C12.9.1.1	Number of Modes	251

C12.9.1.2	Modal Response Parameters	251
C12.9.1.3	Combined Response Parameters	251
C12.9.1.4	Scaling Design Values of Combined Response	252
C12.9.1.4.1	Scaling of Forces	252
C12.9.1.4.2	Scaling of Drifts	252
C12.9.1.5	Horizontal Shear Distribution	252
C12.9.1.6	P-Delta Effects	253
C12.9.1.7	Soil–Structure Interaction Reduction	253
C12.9.1.8	Structural Modeling	253
C12.9.2	Linear Response History Analysis	254
C12.9.2.1	General Requirements	254
12.9.2.2	General Modeling Requirements	254
C12.9.2.2.1	P-Delta Effects	254
C12.9.2.2.2	Accidental Torsion	255
C12.9.2.2.3	Foundation Modeling	255
C12.9.2.2.4	Number of Modes to Include in Response History Analysis	255
C12.9.2.2.5	Damping	255
C12.9.2.3	Ground Motion Selection and Scaling	256
C12.9.2.3.1	Procedure for Spectrum Matching	256
C12.9.2.4	Application of Ground Acceleration Histories	257
C12.9.2.5	Modification of Response for Inelastic Behavior	257
C12.9.2.6	Enveloping of Force Response Quantities	257
C12.10	DIAPHRAGMS, CHORDS, AND COLLECTORS	258
C12.10.1	Diaphragm Design	258
C12.10.1.1	Diaphragm Design Forces	259
C12.10.2.1	Collector Elements Requiring Load Combinations with Overstrength Factor for Seismic Design Categories C through F	259
C12.10.3	Diaphragms Including Chords and Collectors	259
C12.10.3.1	Diaphragm Design	260
C12.10.3.2	Seismic Design Forces for Diaphragms including Chords and Collectors	260
C12.10.3.3	Transfer Diaphragms	264
C12.10.3.4	Collectors	265
C12.10.3.5	Diaphragm Design Force Reduction Factor	265
C12.11	STRUCTURAL WALLS AND THEIR ANCHORAGE	271
C12.11.1	Design for Out-of-Plane Forces	271
C12.11.2	Anchorage of Structural Walls and Transfer of Design Forces into Diaphragms	271
C12.11.2.1	Wall Anchorage Forces	272
C12.11.2.2	Additional Requirements for Diaphragms in Structures Assigned to Seismic Design Categories C through F	272
C12.11.2.2.1	Transfer of Anchorage Forces into Diaphragm	272
C12.11.2.2.2	Steel Elements of Structural Wall Anchorage System	272
C12.11.2.2.3	Wood Diaphragms	272
C12.11.2.2.4	Metal Deck Diaphragms	273
C12.11.2.2.5	Embedded Straps	273
C12.11.2.2.6	Eccentrically Loaded Anchorage System	274
C12.11.2.2.7	Walls with Pilasters	274
C12.12	DRIFT AND DEFORMATION	275
C12.12.3	Structural Separation	276
C12.12.4	Members Spanning between Structures	276
C12.12.5	Deformation Compatibility for Seismic Design Categories D through F	277
C12.13	FOUNDATION DESIGN	277
C12.13.1	Design Basis	277
C12.13.3	Foundation Load-Deformation Characteristics	278

C12.13.4	Reduction of Foundation Overturning	279
C12.13.5	Strength Design of Nominal Foundation Geotechnical Capacity.....	279
	C12.13.5.1 Nominal Strength.....	279
	C12.13.5.2 Resistance Factors	280
	C12.13.5.3 Acceptance Criteria	280
C12.13.6	Requirements for Structures Assigned to Seismic Design Category C.....	281
	C12.13.6.1 Pole-Type Structures	281
	C12.13.6.2 Foundation Ties	281
	C12.13.6.3 Pile Anchorage Requirements	281
C12.13.7	Requirements for Structures Assigned to Seismic Design Categories D through F....	281
	C12.13.7.1 Pole-Type Structures	281
	C12.13.7.2 Foundation Ties	281
	C12.13.7.3 General Pile Design Requirement.....	281
	C12.13.7.4 Batter Piles.....	282
	C12.13.7.5 Pile Anchorage Requirements	282
	C12.13.7.6 Splices of Pile Segments.....	282
	C12.13.7.7 Pile–Soil Interaction	282
	C12.13.7.8 Pile Group Effects.....	283
C12.13.8	Requirements for Structure Foundations on Liquefiable Sites.....	283
	C12.13.8.1 Foundation Design.....	285
	C12.13.8.2 Shallow Foundation	285
	C12.13.8.3 Deep Foundations	286
C12.14	SIMPLIFIED ALTERNATIVE STRUCTURAL DESIGN CRITERIA FOR SIMPLE BEARING WALL OR BUILDING FRAME SYSTEMS	288
	C12.14.1 General	288
	C12.14.1.1 Simplified Design Procedure	288
	C12.14.3 Seismic Load Effects and Combinations.....	289
	C12.14.7 Design and Detailing Requirements.....	290
	C12.14.8 Simplified Lateral Force Analysis Procedure.....	290
	C12.14.8.1 Seismic Base Shear.....	290
	C12.14.8.2 Vertical Distribution	290
	C12.14.8.5 Drift Limits and Building Separation	290
	REFERENCES.....	290

COMMENTARY TO CHAPTER 13, SEISMIC DESIGN REQUIREMENTS FOR NONSTRUCTURAL COMPONENTS 295

C13.1	GENERAL.....	295
	C13.1.1 Scope.....	297
	C13.1.2 Seismic Design Category	298
	C13.1.3 Component Importance Factor.....	298
	C13.1.4 Exemptions.....	299
	C13.1.5 Application of Nonstructural Component Requirements to Nonbuilding Structures..	300
	C13.1.6 Reference Documents	300
	C13.1.7 Reference Documents Using Allowable Stress Design.....	301
C13.2	GENERAL DESIGN REQUIREMENTS	301
	C13.2.1 Applicable Requirements for Architectural, Mechanical, and Electrical Components, Supports, and Attachments.....	301
	C13.2.2 Special Certification Requirements for Designated Seismic Systems.....	302
	C13.2.3 Consequential Damage.....	303
	C13.2.4 Flexibility	303
	C13.2.5 Testing Alternative for Seismic Capacity Determination.....	304
	C13.2.6 Experience Data Alternative for Seismic Capacity Determination	305
	C13.2.7 Construction Documents	306

C13.3	SEISMIC DEMANDS ON NONSTRUCTURAL COMPONENTS	306
C13.3.1	Seismic Design Force.....	306
C13.3.2	Seismic Relative Displacements	308
C13.3.2.1	Displacements within Structures.....	309
C13.3.2.2	Displacements between Structures	310
C13.4	NONSTRUCTURAL COMPONENT ANCHORAGE	310
C13.4.1	Design Force in the Attachment.....	311
C13.4.2	Anchors in Concrete or Masonry	311
C13.4.3	Installation Conditions	312
C13.4.4	Multiple Attachments.....	312
C13.4.5	Power-Actuated Fasteners.....	313
C13.4.6	Friction Clips.....	313
C13.5	ARCHITECTURAL COMPONENTS	314
C13.5.1	General	314
C13.5.2	Forces and Displacements.....	314
C13.5.3	Exterior Nonstructural Wall Elements and Connections.....	315
C13.5.5	Out-of-Plane Bending	316
C13.5.6	Suspended Ceilings	316
C13.5.6.1	Seismic Forces.....	317
C13.5.6.2	Industry Standard Construction for Acoustical Tile or Lay-In Panel Ceilings.....	317
C13.5.6.2.1	Seismic Design Category C.....	319
C13.5.6.2.2	Seismic Design Categories D through F	319
C13.5.6.3	Integral Construction	320
C13.5.7	Access Floors	320
C13.5.7.1	General.....	320
C13.5.7.2	Special Access Floors	320
C13.5.8	Partitions	320
C13.5.9	Glass in Glazed Curtain Walls, Glazed Storefronts, and Glazed Partitions	321
C13.5.9.1	General.....	321
C13.5.9.2	Seismic Drift Limits for Glass Components	321
C13.6	MECHANICAL AND ELECTRICAL COMPONENTS	321
C13.6.1	General	322
C13.6.2	Component Period.....	323
C13.6.3	Mechanical Components and C13.6.4 Electrical Components	323
C13.6.5	Component Supports.....	324
C13.6.5.1	Design Basis	324
C13.6.5.2	Design for Relative Displacement	324
C13.6.5.3	Support Attachment to Component	324
C13.6.5.5	Additional Requirements	325
C13.6.5.6	Conduit, Cable Tray, and Other Electrical Distribution Systems (Raceways)	325
C13.6.6	Utility and Service Lines.....	326
C13.6.7	Ductwork.....	326
C13.6.8	Piping Systems	326
C13.6.8.1	ASME Pressure Piping Systems	328
C13.6.8.2	Fire Protection Sprinkler Piping Systems	328
C13.6.8.3	Exceptions	329
C13.6.9	Boilers and Pressure Vessels.....	329
C13.6.10	Elevator and Escalator Design Requirements	329
C13.6.10.3	Seismic Controls for Elevators	329
C13.6.10.4	Retainer Plates	330
C13.6.11	Other Mechanical and Electrical Components	330
REFERENCES.....		330

COMMENTARY TO CHAPTER 14, MATERIAL-SPECIFIC SEISMIC DESIGN AND DETAILING REQUIREMENTS	333
C14.0 SCOPE	333
C14.1 STEEL	333
C14.1.1 Reference Documents	333
C14.1.2 Structural Steel	333
C14.1.2.1 General.....	333
C14.1.2.2 Seismic Requirements for Structural Steel Structures	333
C14.1.2.2.1 Seismic Design Categories B and C.....	333
C14.1.2.2.2 Seismic Design Categories D through F	334
C14.1.3 Cold-Formed Steel	334
C14.1.3.1 General.....	334
C14.1.3.2 Seismic Requirements for Cold-Formed Steel Structures	334
C14.1.4 Cold-Formed Steel Light-Frame Construction.....	334
C14.1.4.1 General.....	334
C14.1.4.2 Seismic Requirements for Cold-Formed Steel Light-Frame Construction.....	335
C14.1.4.3 Prescriptive Cold-Formed Steel Light-Frame Construction	335
C14.1.5 Steel Deck Diaphragms.....	335
C14.1.6 Steel Cables.....	336
C14.1.7 Additional Detailing Requirements for Steel Piles in Seismic Design Categories D through F	336
C14.2 CONCRETE	336
C14.2.2.1 Definitions	336
C14.2.2.2 ACI 318, Section 7.10	336
C14.2.2.3 Scope	336
C14.2.2.4 Intermediate Precast Structural Walls.....	336
C14.2.2.6 Foundations	337
C14.2.2.7 Detailed Plain Concrete Shear Walls.....	337
C14.2.3 Additional Detailing Requirements for Concrete Piles	337
C14.2.3.1.2 Reinforcement for Uncased Concrete Piles (SDC C).....	337
C14.2.3.1.5 Reinforcement for Precast Nonprestressed Concrete Piles (SDC C)	337
C14.2.3.1.6 Reinforcement for Precast Prestressed Piles (SDC C).....	338
C14.2.3.2.3 Reinforcement for Uncased Concrete Piles (SDC D through F) 338	
C14.2.3.2.5 Reinforcement for Precast Concrete Piles (SDC D through F) ..	338
C14.2.3.2.6 Reinforcement for Precast Prestressed Piles (SDC D through F)338	
C14.2.4 Additional Detailing Requirements for Precast Concrete Diaphragms	338
C14.2.4.1 Diaphragm Seismic Demand Levels.....	339
C14.2.4.2 Diaphragm Design Options	341
C14.2.4.3 Diaphragm Connector or Reinforcement Deformability	343
C14.2.4.3.5 Special Inspection	344
C14.2.4.4 Precast Concrete Diaphragm Joint Connector and Reinforcement Qualification Procedure	344
C14.2.4.4.1 Test Modules.....	345
C14.2.4.4.3 Test Configuration	345
C14.2.4.4.4 Instrumentation	345
C14.2.4.4.5 Loading Protocols	346
C14.2.4.4.6 Measurement Indices	347
C14.2.4.4.7 Response Properties	347
C14.2.4.4.8 Test Report.....	348
C14.2.4.4.9 Deformed Bar Reinforcement	348
C14.3 COMPOSITE STEEL AND CONCRETE STRUCTURES	348
C14.3.1 Reference Documents	348

C14.3.4	Metal-Cased Concrete Piles	348
C14.4	MASONRY	348
C14.5	WOOD	349
C14.5.1	Reference Documents	349
REFERENCES	349

COMMENTARY TO CHAPTER 15, SEISMIC DESIGN REQUIREMENTS FOR NONBUILDING STRUCTURES..... 353

C15.1	GENERAL.....	353
C15.1.1	Nonbuilding Structures	353
C15.1.2	Design	353
C15.1.3	Structural Analysis Procedure Selection	353
C15.2	REFERENCE DOCUMENTS.....	356
C15.3	NONBUILDING STRUCTURES SUPPORTED BY OTHER STRUCTURES	357
C15.3.1	Less than 25% Combined Weight Condition	357
C15.3.2	Greater Than or Equal to 25% Combined Weight Condition.....	358
C15.4	STRUCTURAL DESIGN REQUIREMENTS.....	358
C15.4.1	Design Basis.....	359
C15.4.1.1	Importance Factor	360
C15.4.2	Rigid Nonbuilding Structures.....	360
C15.4.3	Loads.....	361
C15.4.4	Fundamental Period	361
C15.4.8	Site-Specific Response Spectra.....	361
C15.4.9	Anchors in Concrete or Masonry	361
C15.5	NONBUILDING STRUCTURES SIMILAR TO BUILDINGS	361
C15.5.1	General	361
C15.5.2	Pipe Racks.....	361
C15.5.3	Steel Storage Racks.....	362
C15.5.4	Electrical Power Generating Facilities	362
C15.5.5	Structural Towers for Tanks and Vessels.....	362
C15.5.6	Piers and Wharves.....	362
C15.6	GENERAL REQUIREMENTS FOR NONBUILDING STRUCTURES NOT SIMILAR TO BUILDINGS	364
C15.6.1	Earth-Retaining Structures	364
C15.6.2	Stacks and Chimneys	364
C15.6.4	Special Hydraulic Structures.....	364
C15.6.5	Secondary Containment Systems	364
C15.6.5.1	Freeboard.....	365
C15.6.6	Telecommunication Towers	365
C15.7	TANKS AND VESSELS	365
C15.7.1	General	365
C15.7.2	Design Basis.....	366
C15.7.3	Strength and Ductility	367
C15.7.4	Flexibility of Piping Attachments	368
C15.7.5	Anchorage	368
C15.7.6	Ground-Supported Storage Tanks for Liquids	368
C15.7.6.1	General.....	368
C15.7.6.1.4	Internal Elements	370
C15.7.6.1.5	Sliding Resistance.....	370
C15.7.6.1.6	Local Shear Transfer.....	371
C15.7.6.1.7	Pressure Stability.....	371

	C15.7.6.1.8	Shell Support.....	371
	C15.7.6.1.9	Repair, Alteration, or Reconstruction.....	371
C15.7.7		Water Storage and Water Treatment Tanks and Vessels	371
	C15.7.7.3	Reinforced and Prestressed Concrete.....	371
C15.7.8		Petrochemical and Industrial Tanks and Vessels Storing Liquids.....	372
	C15.7.8.1	Welded Steel.....	372
	C15.7.8.2	Bolted Steel.....	372
C15.7.9		Ground-Supported Storage Tanks for Granular Materials	372
	C15.7.9.1	General.....	372
	C15.7.9.2	Lateral Force Determination.....	373
	C15.7.9.3	Force Distribution to Shell and Foundation.....	373
		C15.7.9.3.1 Increased Lateral Pressure.....	373
		C15.7.9.3.2 Effective Mass	373
		C15.7.9.3.3 Effective Density.....	373
		C15.7.9.3.4 Lateral Sliding.....	373
		C15.7.9.3.5 Combined Anchorage Systems	374
C15.7.10		Elevated Tanks and Vessels for Liquids and Granular Materials.....	374
	C15.7.10.1	General.....	374
	C15.7.10.4	Transfer of Lateral Forces into Support Tower	374
	C15.7.10.5	Evaluation of Structures Sensitive to Buckling Failure	374
	C15.7.10.7	Concrete Pedestal (Composite) Tanks	378
C15.7.11		Boilers and Pressure Vessels.....	378
C15.7.12		Liquid and Gas Spheres	378
C15.7.13		Refrigerated Gas Liquid Storage Tanks and Vessels	378
C15.7.14		Horizontal, Saddle-Supported Vessels for Liquid or Vapor Storage.....	381
		REFERENCES.....	381

COMMENTARY TO CHAPTER 16, SEISMIC RESPONSE HISTORY PROCEDURES..... 383

C16.1		GENERAL REQUIREMENTS	383
	C16.1.1	Overview	383
	C16.1.2	Collapse Safety Goals and Approaches to Demonstrate Appropriate Collapse Safety	383
	C16.1.3	Framework of the Chapter 16 Response-History Procedure	383
	C16.1.4	Treatment of Minimum Base Shear	384
	C16.1.5	Applicability.....	384
C16.2		GROUND MOTIONS	384
	C16.2.1	Level of Ground Motion	385
	C16.2.2	Definition of the Target Response Spectrum	385
		C16.2.2.1 Method 1.....	386
		C16.2.2.2 Method 2.....	386
	C16.2.3	Ground Motions Selection	387
		C16.2.3.1 Minimum Number of Ground Motions.....	387
		C16.2.3.2 Components of Ground Motion.....	387
		C16.2.3.3 Selection of Ground Motions.....	387
	C16.2.4	Ground Motion Scaling.....	389
		C16.2.4.1 Period Range for Scaling.....	390
		C16.2.4.2 Scaling of Ground Motions.....	390
		C16.2.4.3 Spectral Matching of Ground Motions	391
	C16.2.5	Application of Ground Motions to the Structural Model	391
		C16.2.5.1 Orientation of Ground Motions	391
		C16.2.5.2 Application of Input Ground Motion over Subterranean Levels	392
C16.3		MODELING AND ANALYSIS	393
	C16.3.1	System Modeling	393
	C16.3.2	Gravity Load	394

C16.3.3	P-Delta Effects	394
C16.3.4	Seismic Mass.....	394
C16.3.5	Diaphragm Modeling	395
C16.3.6	Torsion	395
C16.3.7	Stiffness of Elements Modeled with Elastic Properties.....	396
C16.3.8	Nonlinear Modeling	396
C16.3.9	Damping.....	397
C16.3.10	Soil-Structure Interaction	397
C16.4	ANALYSIS RESULTS AND ACCEPTANCE CRITERIA	398
C16.4.1	Global Acceptance Criteria	398
C16.4.1.1	Unacceptable Responses.....	398
C16.4.1.2	Story Drift.....	403
C16.4.2	Element-Level Acceptance Criteria	403
C16.4.2.1	Force-Controlled Actions	405
C16.4.2.2	Deformation-Controlled Actions	410
C16.4.2.3	Components of the Gravity System	413
C16.5	DESIGN REVIEW	413
	REFERENCES.....	413

COMMENTARY TO CHAPTER 17, SEISMIC DESIGN REQUIREMENTS FOR SEISMICALLY ISOLATED STRUCTURES 415

C17.1	GENERAL.....	415
C17.2	GENERAL DESIGN REQUIREMENTS	417
C17.2.4	Isolation System	418
C17.2.4.1	Environmental Conditions	418
C17.2.4.2	Wind Forces.....	418
C17.2.4.3	Fire Resistance.....	418
C17.2.4.4	Lateral Restoring Force	418
C17.2.4.5	Displacement Restraint	418
C17.2.4.6	Vertical Load Stability.....	418
C17.2.4.7	Overturning.....	419
C17.2.4.8	Inspection and Replacement	419
C17.2.4.9	Quality Control	419
C17.2.5	Structural System	419
C17.2.5.2	Building Separations.....	419
C17.2.5.4	Steel Ordinary Concentrically Braced Frames.....	419
C17.2.6	Elements of Structures and Nonstructural Components.....	420
C17.2.8	Isolation System Properties.....	423
C17.2.8.2	Isolator Unit Nominal Properties	423
C17.2.8.3	Bounding Properties of Isolation System Components	424
C17.2.8.4	Property Modification (λ) Factors	425
C17.2.8.5	Upper-Bound and Lower Bound Lateral Force-Displacement Behavior of Isolation System Components	427
C17.3	GROUND MOTION FOR ISOLATED SYSTEMS	428
C17.3.1	Site-Specific Seismic Hazard	428
C17.3.2	MCE _R Spectral Response Acceleration Parameters, S_{MS} , S_{M1}	428
C17.3.3	MCE _R Response Spectrum.....	428
C17.3.4	MCE _R Ground Motion Records	428
C17.4	ANALYSIS PROCEDURE SELECTION	428
C17.5	EQUIVALENT LATERAL FORCE PROCEDURE.....	429
C17.5.3	Minimum Lateral Displacements	430
C17.5.3.1	Maximum MCE _R Displacements.....	430

	C17.5.3.2	Effective Period at the Maximum MCE_R Displacement	430
	C17.5.3.5	Total Maximum MCE_R Displacement	430
C17.5.4		Minimum Lateral Forces	431
	C17.5.4.1	Isolation System and Structural Elements below the Base Level	433
	C17.5.4.2	Structural Elements above the Base Level	433
	C17.5.4.3	Limits on V_s	434
C17.5.5		Vertical Distribution of Force	434
C17.5.6		Drift Limits	437
C17.6		DYNAMIC ANALYSIS PROCEDURES	437
C17.7		DESIGN REVIEW	439
C17.8		TESTING	439
	C17.8.2.2	Sequence and Cycles	439
	C17.8.2.3	Units Dependent on Loading Rates	440
	C17.8.2.4	Units Dependent on Bilateral Load	441
	C17.8.2.5	Maximum and Minimum Vertical Load	441
	C17.8.2.7	Testing Similar Units	441
C17.8.3		Determination of Force-Deflection Characteristics	442
C17.8.4		Determination of Isolator Unit Test Properties for Design	443
C17.8.6		Production Tests	444
		REFERENCES	444

COMMENTARY TO CHAPTER 18, SEISMIC DESIGN REQUIREMENTS FOR STRUCTURES WITH DAMPING SYSTEMS **447**

C18.1		GENERAL	447
C18.2		GENERAL DESIGN REQUIREMENTS	447
	C18.2.1	System Requirements	447
		C18.2.1.2 Damping System	448
	C18.2.2	Seismic Ground Motion Criteria	448
	C18.2.3	Procedure Selection	448
		C18.2.4.1 Device Design	449
		C18.2.4.4 Nominal Design Properties	451
		C18.2.4.5 Maximum and Minimum Damper Properties	451
		C18.2.4.6 Damping System Redundancy	453
C18.3		NONLINEAR PROCEDURES	454
	C18.3.2	Accidental Mass Eccentricity	454
C18.4		SEISMIC LOAD CONDITIONS AND ACCEPTANCE CRITERIA FOR NONLINEAR RESPONSE-HISTORY PROCEDURE	455
	C18.4.1	Seismic Force Resisting System	455
C18.5		DESIGN REVIEW	456
C18.6		TESTING	456
		C18.6.1.2 Sequence and Cycles of Testing	456
		C18.6.1.3 Testing Similar Devices	456
	C18.6.2	Production Testing	456
C18.7		ALTERNATE PROCEDURES AND CORRESPONDING ACCEPTANCE CRITERIA	457
	C18.7.1	Response-Spectrum Procedure and C18.7.2 Equivalent Lateral Force Procedure	457
	C18.7.3	Damped Response Modification	459
		C18.7.3.1 Damping Coefficient	459
		C18.7.3.2 Effective Damping	460
		C18.7.4.5 Seismic Load Conditions and Combination of Modal Responses	460
		REFERENCES	460

COMMENTARY TO CHAPTER 19, SOIL-STRUCTURE INTERACTION FOR SEISMIC DESIGN	463
C19.1 GENERAL.....	463
C19.2 SSI ADJUSTED STRUCTURAL DEMANDS	464
C19.3 FOUNDATION DAMPING	466
C19.4 KINEMATIC INTERACTION EFFECTS	469
C19.4.1 Base Slab Averaging	469
C19.4.2 Embedment	470
REFERENCES.....	470
COMMENTARY TO CHAPTER 20, SITE CLASSIFICATION PROCEDURE FOR SEISMIC DESIGN .	473
C20.1 SITE CLASSIFICATION	473
C20.3 SITE CLASS DEFINITIONS.....	473
C20.3.1 Site Class F.....	473
C20.4 DEFINITIONS OF SITE CLASS PARAMETERS	474
COMMENTARY TO CHAPTER 21, SITE-SPECIFIC GROUND MOTION PROCEDURES FOR SEISMIC DESIGN.....	475
C21.0 GENERAL.....	475
C21.1 SITE RESPONSE ANALYSIS	476
C21.1.1 Base Ground Motions	476
C21.1.2 Site Condition Modeling	476
C21.1.3 Site Response Analysis and Computed Results	477
C21.2 RISK-TARGETED MAXIMUM CONSIDERED EARTHQUAKE (MCE _R) GROUND MOTION HAZARD ANALYSIS.....	477
C21.2.1 Probabilistic (MCE _R) Ground Motions	477
C21.2.1.1 Method 1.....	478
C21.2.1.2 Method 2.....	478
C21.2.2 Deterministic (MCE _R) Ground Motions.....	478
C21.2.3 Site-Specific MCE _R	478
C21.3 DESIGN RESPONSE SPECTRUM.....	478
C21.4 DESIGN ACCELERATION PARAMETERS.....	479
C21.5 MAXIMUM CONSIDERED EARTHQUAKE GEOMETRIC MEAN (MCE _G) PEAK GROUND ACCELERATION.....	479
REFERENCES.....	480
COMMENTARY TO CHAPTER 22, SEISMIC GROUND MOTION, LONG-PERIOD TRANSITION AND RISK COEFFICIENT MAPS	483
RISK-TARGETED MAXIMUM CONSIDERED EARTHQUAKE (MCE _R) GROUND MOTION MAPS	491
MAXIMUM CONSIDERED EARTHQUAKE GEOMETRIC MEAN (MCE _G) PGA MAPS	492
LONG-PERIOD TRANSITION MAPS	492
RISK COEFFICIENT MAPS	493
GROUND MOTIONS WEB TOOL.....	494
UNIFORM-HAZARD AND DETERMINISTIC GROUND MOTION MAPS.....	494

REFERENCES.....	494
COMMENTARY TO CHAPTER 23A, VERTICAL GROUND MOTIONS FOR SEISMIC DESIGN	497
C23.1 DESIGN VERTICAL RESPONSE SPECTRUM.....	497
C23.1.1 General.....	497
C23.1.2 General Design Procedure.....	497
C23.1.3 Detailed Design Procedure.....	498
C23.1.4 Limits Imposed on S_{av}	499
REFERENCES.....	499
COMMENTARY TO CHAPTER 24, ALTERNATIVE SEISMIC DESIGN REQUIREMENTS FOR SEISMIC DESIGN CATEGORY B BUILDINGS.....	501
C24.1 GENERAL.....	501
C24.2 STRUCTURAL DESIGN BASIS	501
C24.3 STRUCTURAL SYSTEM SELECTION.....	501
C24.4 DIAPHRAGM FLEXIBILITY AND CONFIGURATION IRREGULARITIES	502
C24.5 SEISMIC LOAD EFFECTS AND COMBINATIONS	502
C24.6 DIRECTION OF LOADING	502
C24.7 ANALYSIS PROCEDURE SELECTION	502
C24.8 MODELING CRITERIA.....	502
C24.9 EQUIVALENT LATERAL FORCE PROCEDURE.....	503
C24.9.1 Seismic Base Shear	503
C24.9.2 Period Determination	503
C24.9.4.2 Accidental Torsion.....	503
C24.10 MODAL RESPONSE SPECTRUM ANALYSIS.....	503
C24.11 DIAPHRAGMS, CHORDS AND COLLECTORS	503
C24.13 DRIFT AND DEFORMATION	504
C24.14 FOUNDATION DESIGN	504
C24.15 SEISMIC DESIGN REQUIREMENTS FOR EGRESS STAIRWAYS AND PARAPETS	504
C24.15.2 General Design Requirements.....	504
C24.15.3 Seismic Design Force.....	504
C24.15.4 Design of Egress Stairways for Seismic Relative Displacements	504
REFERENCES.....	504
APPENDIX 2015 NEHRP RECOMMENDED SEISMIC PROVISIONS PROJECT PARTICIPANTS.....	505

INTRODUCTION

The 2015 edition of the *NEHRP Recommended Seismic Provisions for New Buildings and Other Structures* is a new knowledge-based resource of technologies and procedures for improving seismic design and building practices in the nation. Starting with the 2009 edition, the Provisions began to focus on serving as a resource document aimed at translating research into practice. In this process, the earlier practice of containing a full set of seismic design requirements was eliminated. This approach is continued with the 2015 Provisions. The new changes in the 2015 NEHRP Provisions are based on extensive results and findings from research projects, problem-focused studies, and post-earthquake investigation reports conducted by various professional organizations, research institutes, universities, material industries and NEHRP agencies.

Consistent with the approach used in the 2009 edition, the national standard ASCE/SEI 7-10, Minimum Design Loads for Buildings and Other Structures, Chapters 11-23, including Supplement No. 1 and the Expanded Commentary, has been adopted by reference for the Provisions. Modifications and additions to the Standard that passed BSSC's evaluation and consensus approval process appear in Part 1 of the Provisions. These recommended changes are intended for consideration and adoption in the next edition of ASCE/SEI 7. Each proposed Part 1 change is accompanied by a corresponding change to the ASCE 7-10 Commentary, which is contained in Part 2 of the Provisions. Parts 1 and 2 together with the adopted chapters of ASCE/SEI 7-10 and the references cited therein constitute Volume 1 the 2015 Provisions. Part 3 of the Provisions presents Resource Papers in a separate Volume 2.

Work on the 2015 Provisions began in October 2009 when the National Institute of Building Sciences, the BSSC's parent organization, entered into a contract with FEMA for initiation of the 2015 Provisions update effort. In consideration of balancing geographical and design practices, providing expertise in a broad range of subject areas, focusing on key areas of code improvement, and collaborating with national standards and building codes, 21 individual experts were selected to serve on the 2015 Provisions Update Committee (PUC). The PUC, with input from the earthquake engineering community, identified technical issues considered most critical for improvement of the U.S. seismic design practice, and formed Issue Teams for developing change proposals to the ASCE Standard. The following topics were investigated in the 2015 Provisions cycle: incorporation of P-695/P-795 methodologies for qualification of new systems and components; evaluation of performance objectives for seismic design and re-evaluation of seismic design categories; anchorage to concrete based on ACI 318 Appendix D; nonlinear response history analysis; diaphragm issues; foundations on liquefiable soil and other site-related issues; soil amplification factors; triggers for site-specific spectra, design mapping issues based on the U.S. Geological Survey's 2014 national seismic hazard maps; base isolation, energy dissipation systems; soil-structure interaction, and modal response spectrum analysis.

Between March 2010 and February 2015, the Issue Teams, members of the PUC, and the BSSC's Simplified Seismic Design Project developed 47 change proposals that were evaluated by the PUC in seven ballots, and subsequently evaluated by the Membership Organization representatives in four ballots. The consensus approved proposals from these four ballots were accepted by the BSSC Board of Direction for incorporation into the 2015 Provisions. The 2015 Provisions include extensive new changes, affecting significant parts of the seismic design sections in ASCE 7-10, including replacing four entire chapters.

All changes in Parts 1 and 2 of the Provisions are submitted to the ASCE/SEI 7 Standard committee for consideration of adoption. With some further improvements on the code language, most of these new changes are expected to be accepted in ASCE/SEI 7-16. The Standard is expected to be adopted by reference in International Building Codes (IBC) 2018.

The 2015 Provisions are divided into two volumes. For readers who are not familiar with the format and contents of the new Provisions in Volume 1, a short summary on the composition of each volume is provided below. In particular, for Part 1 of the Provisions in Volume 1, its Table of Contents lists only those sections and subsections of ASCE/SEI 7-10 that have been changed by approved proposals of the Provisions. For information on specific changes in Part 1 of the Provisions, the table below provides the topics of the approved change proposals along with their relevant section numbers and commentary section numbers.

Topics of change proposals	Related or new sections of ASCE/SEI 7	Related commentary sections
Intent of the Provisions	Section 1.1 (this applies to the 2015 Provisions only)	2.1
Adoption of ASCE/SEI 7-10 Chapters 11-23, Supplement No. 1 and the Expanded Commentary for the 2015 Provisions	All sections of Chapters 11-23 in ASCE/SEI 7-10 without exception	All sections of C11-C22
Revised site coefficients F_a , F_v , and F_{PGA} for MCE_R spectral response and maximum considered geo-mean peak ground acceleration PGA_M	Sections 11.4.2, 11.4.3, and 11.8.3	C11.4, C11.4.2, C11.4.3 C11.8
Site-specific ground motion procedures for certain structures on site classes D and E	Sections 11.4.7, and 21.4	C11.4.7 C21.4
Limit S_{M5} not less than S_{M1}	Section 11.4.3	C11.4.3
Adoption of FEMA P-695 methodology for qualification of alternative new seismic resistant systems	Section 12.2.1, 12.2.1.1	C12.2.1.1
Adoption of FEMA P-795 methodology for equivalence of substitute components	Section 12.2.1.2	C12.2.1.2
Strength-based design of foundations	Sections 1.2, 12.1.5, 12.7, and 12.13.1-7	C12.13.1, 5-7
Requirements for using maximum S_s value in determination of C_s	Sections 12.8.1.3	C12.8.1.3
Accidental Torsion	Section 12.8.4.2	C12.8.4.2
Modal analysis procedure in scaling design values of combined response, 3D structural modeling and linear modal response history analysis	Section 12.9.1 Section 12.9.4 Section 12.9.8 Section 12.9.2	C12.9.1 C12.9.3 C12.9.4 C12.9.8 C12.9.2
Requirements for structure foundations on liquefiable sites	Section 12.13.8	C12.13.8
Revision to section 12.14 Simplified Alternative Seismic Design Criteria	Section 12.14.1	C12.14.1
A new alternative diaphragm design procedure and diaphragm design force reduction factor R_s	Sections 11.2, 11.3, 12.3.1.3, 12.10, and 12.10.3	C11.2, C11.3, C12.3.1.3, C12.10, and C12.10.3
Diaphragm design procedure mandatory for pre-cast concrete diaphragm in SDC D, E and F, optional for other concrete and wood sheathing diaphragms	Sections 11.3, 14.2.2.1, and 14.2.4,	C14.2.2.1, C14.2.4
Adoption of ASCE/SEI 7-10 Supplement No. 2, deletion of the line item on tanks and vessels supported on other structures or towers in Table 15.4	Section 15.4.1	C15.4.1
Chapter 16 Seismic Response History Procedure	Sections All listed sections of Chapter 16, 11.4.7, and 12.4.2.2	C16, C11.4.7
Chapter 17 Seismic Design Requirements for Seismically Isolated Structures	All listed sections of Chapter 17	C17

Topics of change proposals	Related or new sections of ASCE/SEI 7	Related commentary sections
Steel ordinary concentrically braced frames (OCBF) used in isolated structures in SDC D, E and F	Section 17.2.5.4	C17.2.5.4
Steel grid frames at base level of isolated structures	Section 17.2.4.9	
Chapter 18 Seismic Design Requirements for Structures with Damping Systems	All listed sections of Chapter 18	C18
Chapter 19 Soil-Structure Interaction for Seismic Design	All listed sections of Chapter 19	C19
Seismic design ground motion maps for Guam and America Samoa	Chapter 22 Introduction and Figures 22-7, 22-8 and 22-13	
Seismic design ground motion maps based-on the 2014 USGS seismic hazard maps	Chapter 22 Figures 22-1, 22-2, 22-9, 22-18, 22-19	C22
Chapter 23, Vertical Ground Motions for Seismic Design (retained from 2009 NEHRP Provisions)	All sections of Chapter 23A	C23A
New Chapter 24 Alternative Seismic Design Requirements for SDC B Buildings	All sections of new Chapter 24	All sections of C24

For Part 2 in Volume 1 and Part 3 in Volume 2, the Table of Contents lists all chapters and up-to the fourth level of subsection headings.

A separate companion Provisions CD includes proposed maps for ASCE/SEI 7-16, IBC 2018 and IRC 2018 and issues and research recommendations for developing the 2020 Provisions.

The composition of each volume of the 2015 Provisions chapters and the appendix is described below.

Volume 1:

Intent

This chapter on the Intent of the 2015 Provisions, including a commentary on the intent, describes the expected seismic performance that is judged to be inherent in the seismic requirements in Parts 1 and 2.

Part 1, Provisions – Modifications to ASCE/SEI 7-10, Chapters 11 - 22

For ASCE/SEI 7-10, this part of the 2015 *NEHRP Recommended Seismic Provisions* consists of:

- Revisions, replacements and additions to Chapters 11, 12, 14, 15, 21 and 22.
- Complete replacement of Chapters 16, 17, 18 and 19.
- A minor modification to Chapter 1.

Part 1 also contains:

- Chapter 23A, a reprint of Chapter 23 from the 2009 Provisions.
- The addition of Chapter 24.

ASCE 7-10 Chapter 11 Sections 11.5 Importance Factor and Risk Category and 11.6 Seismic Design Category are included without modification. These two sections with the revised soil factors and seismic ground motions in Section 11.4 Seismic Ground Motion Values and the complete set of existing and modified Chapter 22 maps are intended to assist nontechnical users of the Provisions (state and local government earthquake program managers, planners and policy makers, students and educators, insurance industry and risk management professionals etc.) in determining the Seismic Design Category for a building based on the new ground motion values and soil factors adopted by the *Provisions*.

Chapter 23A follows Chapter 23 of ASCE/SEI 7-10, which is not addressed in Part 1. Any reference to Chapter 23 in Part 1 of the 2015 Provisions directs the reader to Chapter 23 of ASCE 7-10.

Part 2, Commentary - ASCE/SEI 7-10, Chapters C11 - C22 with Modifications

For the 2015 Provisions, the commentary in Part 2 explains the development and application of both the existing requirements in ASCE 7-10 and recommended modifications in Part 1. In the 2009 Provisions a major effort was made to rewrite a commentary that was subsequently adopted in ASCE/SEI 7-10. The 2009 Provisions Part 1 changes appended their own commentaries. In Part 2 of the 2015 Provisions the ASCE/SEI 7-10 commentary (the final version developed after the 3rd Printing) is reproduced in its entirety with recommended revisions, replacements and additions indicated by a vertical line in the right hand margin. Specifically, Part 2 includes:

- Revisions, replacements and additions to Chapters C11, C12, C14, C15, C21 and C22.
- Complete replacement of Chapters C16, C17, C18 and C19.

The Part 2 Commentary also contains:

- Unedited Chapters 13 and 20 of the ASCE/SEI 7-10 Commentary.
- Chapter C23A, a reprint of Chapter 23 from the 2009 Provisions.
- The addition of Chapter C24.

This amended commentary is intended primarily for design professionals and members of the codes and standards development community. However, an understanding of the basis for the seismic regulations contained in the nation's building codes and standards is important to many outside this technical community, including elected officials and other decision makers responsible for aspects of the built environment, the financial and insurance communities, and individual business owners and other citizens. These individuals and others who do not have in-depth technical knowledge may find of interest a complementary report that presents a brief overview that was developed for the 2009 Provisions. This overview is published as FEMA P-749, *Concepts of Seismic Design: An Introduction to the NEHRP Recommended Seismic Provisions for New Buildings and Other Structures*.

Appendix, 2015 NEHRP Recommended Seismic Provisions Project Participants

The Appendix lists project participants that supported the development of the 2015 *Provisions* including the members of the BSSC Board of Direction, the Member Organizations and their representatives, the Provisions Update Committee members, the Issue Teams and Study Work Groups and their members, NEHRP liaison, FEMA, NIST, USGS representatives and BSSC staff support.

Volume 2:

Part 3, Resource Papers (RP) on Special Topics on Seismic Design

In a separate volume, Part 3 of the 2015 NEHRP Recommended Seismic Provisions is a collection of resource papers that introduce new procedures or provisions not currently contained in the referenced standards for consideration and experimental use by the design community, researchers, and standards- and code-development organizations. Part 3 also represents Issue Team efforts on substantive proposals for topics that require further consideration by the seismic design community and additional research before being submitted to the BSSC membership for consensus approval for Parts 1 and 2 in the 2020 Provisions. Part 3 provides useful guidance on the application of Part 1 requirements, either as a discussion of an overall approach or as a detailed procedure and clarify some aspects of the Provisions requirements in Part 2. Part 3 consists of the following resource papers:

- Resource Paper 1, New Performance Basis for the Provisions
- Resource Paper 2, Diaphragm Design Force Level
- Resource Paper 3, Diaphragm Design: Current Practice, Past Performance and Future Improvements

- Resource Paper 4, Updated Maximum-Response Scale Factors
- Resource Paper 5, One-Story, Flexible Diaphragm Buildings with Stiff Vertical Elements

Specifically, the five resource papers include:

- Proposals for code and standard changes reflecting new and innovative concepts or technologies that are judged, at the time of publication of this edition of the Provisions, to require additional exposure to those who use codes and standards, and to possibly require systematic trial use. Some of these potential future changes are formatted for direct adoption while others discuss only the thrust of the proposed change.
- Discussions of topics that historically have been difficult to adequately codify. These papers provide background information intended to stimulate further discussion and research and, eventually, code change proposals.

Resource Papers 2, 3 and 4 also contain further proposed modifications to Parts 1 and 2 of the Provisions.

Feedback on the resource papers is encouraged. Comments and questions about the topics treated in these Part 3 resource papers should be addressed to:

Building Seismic Safety Council
National Institute of Building Sciences
1090 Vermont Avenue, N.W., Suite 700
Washington, D.C. 20005
Tel: (202) 289-7800, Fax: (202) 289-1092, E-mail: bssc@nibs.org

Page intentionally left blank.

2015 NEHRP RECOMMENDED SEISMIC PROVISIONS FOR NEW BUILDINGS AND OTHER STRUCTURES:

INTENT

This chapter on the Intent of the 2015 Provisions describes the expected seismic performance that is judged to be inherent in the seismic requirements in Parts 1 and 2.

1.1 INTENT

The *NEHRP Recommended Seismic Provisions for New Buildings and Other Structures* presents the minimum recommended requirements necessary for the design and construction of new buildings and other structures to resist earthquake ground motions throughout the United States. The objectives of these provisions are to provide reasonable assurance of seismic performance that will:

1. Avoid serious injury and life loss due to
 - a. Structure collapse
 - b. Failure of nonstructural components or systems
 - c. Release of hazardous materials
2. Preserve means of egress
3. Avoid loss of function in critical facilities, and
4. Reduce structural and nonstructural repair costs where practicable.

These performance objectives do not all have the same likelihood of being achieved. Additional detail on the objectives is provided in section 1.1.1 through 1.1.6.

The degree to which these objectives can be achieved depends on a number of factors including structural framing type, building configuration, structural and nonstructural materials and details, and overall quality of design and construction. In addition, large uncertainties as to the intensity and duration of shaking and the possibility of unfavorable response of a small subset of buildings or other structures may prevent full realization of these objectives.

1.1.1 Structure Collapse

For objective 1.a the *Provisions* target performance such that the probability of collapse of a significant portion or all of an ordinary use (Risk Category II¹) structure due to earthquake ground shaking does not exceed 10% given the occurrence of a very rare ground motion. For nearly all of the country the very rare ground motion is computed such that for structures that have the typical collapse fragility when subjected to various seismic ground motions, there is an overall 1% chance of collapse in 50 years due to earthquake ground shaking. The combination of these two probabilities defines the “Risk Targeted Maximum Considered Earthquake Ground Motion (MCE_R).” There are areas near faults that produce frequent, large

¹ Where the Risk Category is defined in Section 1.5 of ASCE/SEI 7-10

earthquakes where the MCE_R ground shaking is not computed on the basis of the 1% in 50 year target, because that probabilistic computation produces extremely large ground motions. In such areas the MCE_R ground shaking is determined by assuming that a characteristic earthquake for that fault does occur and then computing the ground motion attenuation from the fault to the site at the 84th percentile level.

Objective 1.a is adjusted, using importance factors, to target a higher reliability against collapse for structures in higher Risk Categories¹, such as those housing a function essential to the response of a community following a disastrous event, large or less capable populations, or hazardous materials. There are additional performance goals for some of these types of structures, addressed in the following sections, and those other goals may govern the design. Roughly, these adjustments in the risk target reduce by half the probability of collapse for each incremental increase in the Risk Category. This adjustment applies to the conditional probability of collapse given the occurrence of the MCE_R ground motion. The probabilities of collapse in 50 years also change in a similar fashion, but there will be some difference from site to site based upon the nature of the seismic ground motion hazard. Thus the probabilities of collapse for the four risk categories are targeted as follows:

Risk Category ¹	Probability of Collapse	
	Given MCE_R Shaking	In 50 years*
I	**	**
II	10%	1%
III	5%	less than 1%
IV	2.5%	less than 1%

*The probability of collapse in 50 years is larger in areas where the MCE_R ground motion is computed from a deterministic assumption of earthquake occurrence.

**Most Risk Category I structures are designed for the same requirement as Risk Category II, while some are exempted from any seismic design requirement.

The basic recommendation for Risk Category II structures is based upon acceptance of substantial damage at the MCE_R ground motion and lesser damage at lesser ground motions.

The *Provisions* employ a system of Seismic Design Categories to apply various requirements for more rigorous design methods, construction details, and limitations on materials and systems. The category depends on the MCE_R ground motion at the specific site and the Risk Category of the structure. The MCE_R ground motion is defined to include modifications for ground conditions at the specific site.

Seismic Design Category A is the lowest category. No seismic design requirements are applied for Category A. It is defined to be those sites where the MCE_R ground motion is less than half that associated with structural damage in historical earthquakes, regardless of Risk Category.

1.1.2 Nonstructural Damage

For objective 1.b the *Provisions* recommend that structures and selected nonstructural components be designed and built to prevent failures of nonstructural components or systems, where such failures would endanger life. The criterion is based on less severe and more frequent ground shaking than used for protection against structure collapse. Based on historic precedent, this level of ground motion is taken as two-thirds of the MCE_R ground motion. It is termed the design earthquake ground motion, or DE ground motion.

For components that pose a life safety threat due to their weight and position, the fundamental requirement is to maintain the position of the component through anchorage, bracing, and strength. Observations of damage to some unbraced and unanchored components in past earthquakes suggest that life threatening damage is unlikely under moderate ground motions, while other components such as parapets and other appendages still pose a significant risk. Thus the scope of components to consider is substantially less in the seismic design categories where the ground shaking demand is moderate. Through the use of a component importance factor to require greater strength and displacement capacity, the probability of

failure given the DE ground motion is reduced for components that are necessary for life safety immediately following a strong earthquake, such as fire suppression systems and egress stairways. In addition to requirements for bracing and anchorage, equipment assigned the high component importance factor must be qualified through testing, experience data, or analysis to assure continuous operation when subject to the DE ground motion. Performance of nonstructural components is also influenced by the requirements for a minimum lateral stiffness (drift limits) for structural systems and requirements that nonstructural systems accommodate the anticipated structural drift; the stiffness requirement is more restrictive for higher Risk Categories.

1.1.3 Hazardous Materials

For objective 1.c the *Provisions* target structures to be designed and built to prevent failure of structural or nonstructural components or systems that would release unacceptable quantities of hazardous materials. For buildings and nonbuilding structures the performance target is adjusted for the Risk Category just as it is for the collapse objective (1.1.1). For nonstructural components, the performance target is adjusted with component importance factors, and the basis is the DE. For Risk Categories III and IV the objective is to provide a likelihood of major release of hazardous materials that is very low at the DE ground motion and thus low at the MCE_R ground motion. For nonstructural components the amount of inelastic behavior permitted at strong ground motions is adjusted with the component importance factor. For nonbuilding structures the protection from major releases may include secondary containment.

1.1.4 Preservation of Egress

For Objective 2 the *Provisions* intend that stairs be designed and built to be functional following the DE ground motion. The component importance factor is intended to provide a low likelihood that stairs lose support due to seismic displacements.

1.1.5 Functionality of Critical or Essential Facilities

For Objective 3 the *Provisions* intend to avoid earthquake-induced loss of functionality for Risk Category IV structures and some nonbuilding Risk Category III structures. In addition the *Provisions* include some requirements to increase the likelihood that function be maintained for nonstructural components and systems at the DE ground motion. To help achieve these goals, permissible story drifts are reduced to control damage to nonstructural components connected to multiple floor levels. Nonstructural system performance is enhanced by strengthening the anchorage and bracing requirements for components necessary for functionality of the facility, and by requiring that important equipment and associated systems be shown to be functional after being shaken. The expectation is that functionality will usually be maintained at ground motions comparable to the motion used for design of nonstructural elements (the DE ground motion); however, given the state of knowledge for predicting such performance, the probability of meeting that expectation is not specified.

1.1.6 Repair Costs

Objective 4 is primarily aimed at those nonstructural elements for which seismic anchorage and bracing are both low cost and effective in reducing economic losses in ground motions that are smaller and more frequent than the motions used for life safety. There are also provisions in various material design standards that aim to provide additional resistance for certain structural failure states that are not particularly threatening to life, but are very expensive to repair.

1.1.7 Reference Document

Design for seismic resistance of structural elements including foundation elements and nonstructural components shall conform to the requirements of ASCE/SEI 7-10, *Minimum Design Loads for Buildings*

and Other Structures, including Supplement No. 1 (referred to hereinafter as ASCE/SEI 7-10), as modified herein.

2.1 COMMENTARY TO THE INTENT

The primary intent of the *NEHRP Recommended Seismic Provisions for New Buildings and Other Structures* is to prevent, for ordinary buildings and structures, serious injury and life loss caused by damage from earthquake ground shaking and ground failure. Most earthquake injuries and deaths are caused by structural collapse; therefore, the major thrust of the Provisions is to prevent collapse for very rare, intense ground motion, termed the risk targeted maximum considered earthquake (MCE_R) ground motion. Additional objectives to preserve means of egress, maintain functionality of critical or essential facilities following major earthquakes, and to reduce damage costs, where practicable, are addressed as corollaries to the primary intent.

The *Provisions* requirements are not intended to prevent damage due to landslides (such as those that occurred in Anchorage, Alaska) or tsunami (such as occurred in Hilo, Hawaii, the Indian Ocean, and Japan). They provide only for required resistance to earthquake ground shaking and movements due to liquefaction without significant slides, subsidence, or faulting in the immediate vicinity of the structure. In most cases, practical engineering solutions are available to resist other potential earthquake hazards, but they must be developed on a case-by-case basis. The *Provisions* do require geotechnical investigations for sites where such instabilities are possible, and the geotechnical reports must recommend appropriate mitigation.

Although the *Provisions* sets the minimum performance goals described in Section 1.1, earthquake performance of buildings and other structures is highly variable. The characteristics of the shaking itself are highly uncertain and even different ground motion records defined to qualify as maximum considered earthquake ground motions for the same target spectrum can result in significantly different responses. Additional uncertainty is created by the wide variety of systems and configurations allowed under the regulations as well as by the various interpretations and implementation practices of individual designers. Thus, a small percentage of buildings designed to the requirements of the *Provisions* may not meet the performance intent when exposed to earthquake ground motions. The commentary of the *Tentative Provisions for the Development of Seismic Regulations for Buildings* (Applied Technology Council, 1978), upon which the first edition of the *NEHRP Recommended Provisions* (1985) was based, suggested a less than 1 percent chance of collapse in a 50-year period for a building designed using the tentative requirements. More recent studies (e.g., *Quantification of Building Seismic Performance Factors*, FEMA P-695, 2009) suggest a 10 percent chance of collapse with shaking at the maximum considered earthquake level, which is roughly equivalent to the 1978 estimations.

In the future it is possible that the risk targeting concepts implemented for the structural collapse objective may be applied to other objectives, using methods such as described in *Tentative Framework for Advanced Seismic Design Criteria for New Buildings*². More knowledge of seismic performance of constructed systems is needed to accomplish this.

2.1.1 Structure Collapse

The primary objective regarding collapse has remained the same since the 1997 edition of the Provisions; however, the quantification was not added until the 2009 edition when the prevention of collapse was redefined in terms of risk-targeted maximum considered earthquake (MCE_R) ground motions. A building deemed to have higher importance due to hazardous contents or critical occupancy is assigned to a higher

² *Tentative Framework for Development of Advanced Seismic Design Criteria for New Buildings*, NEHRP Consultants Joint Venture, NIST GCR 12-917-20, National Institute of Standards and Technology, Gaithersburg, MD 20899, 2012

Risk Category (see ASCE/SEI 7-10 Table 1.5-1). The damage level in such buildings is intended to be reduced by decreasing nonlinear demand using an importance factor, I , to reduce the response modification coefficient, R . The resulting increased strength will reduce structural damage, and increase reliability of acceptable performance, for a given level of shaking. Some authorities having jurisdiction subject the design and construction of such buildings to a higher level of scrutiny to reduce uncertainties associated with design or construction error.

The amplitude of the MCE_R shaking, except where the deterministic limit applies, generally is somewhat less than a ground motion hazard having a probability of 2% of being exceeded in 50 years. The deterministic limit is imposed on the MCE_R ground motion, because the large uncertainty in our ability to predict ground motion at a site, given an earthquake of known magnitude at a known location, drives the probabilistic computation to predict very large ground motions where the return period of the characteristic earthquake is only a small fraction of the return period of interest for failure. The alternative calculation effectively places a bound on that uncertainty in ground motion while preserving the occurrence of a rare and large earthquake at a known location with some conservatism in the prediction of ground motion for that event as the design basis. Compared to less seismically active regions where earthquake records are rare, there is much more data available on the likely magnitude of earthquakes that active faults in such regions are capable of generating. It is also true that very large ground motions make some types of construction economically impractical, and there is insufficient experience to validate that design for such extreme ground motions without the deterministic limit is necessary.

The risk target of a 1% chance of collapse in 50 years is roughly an order of magnitude higher than the chance of failure of structural elements subject to combinations of conventional loads without earthquake, in large part because the cost of providing seismic protection is substantial in high hazard locations. These probabilities are meaningful when computed with the carefully constrained methodologies³ used in developing the probabilities cited here and are not intended to imply that the actual failure rates will be that large or that such failure rates would be considered acceptable. It is believed the real rates are lower because

1. historical damage statistics would support better performance
2. the beneficial effect of the gravity load framing is ignored in establishing the seismic response modification factor (the R factor),
3. conservative assumptions on uncertainties are included in the analysis of the seismic hazard and the structural performance, and
4. on the average, structures are not actually designed at the limit of the design criterion

The constraints are intended to permit rational comparison of differing probabilities for differing circumstances.

The ground motion level below which seismic design is not required is established at a conservatively low level in part to recognize the lower confidence of knowledge of seismic hazards in such areas, but also to address this discrepancy in risk under other loadings in an approximate fashion. In other words, given the variation in ground shaking hazard with probability of exceedance in the pertinent range of probabilities, the risk of collapse due to seismic action should be well under the 1% in 50 years target near the transition in hazard level from Seismic Design Category A to B. The transition in risk of collapse to the target of 1% in 50 years where the MCE_R motions are higher is not yet well understood.

³ FEMA P695 *Quantification of Building Seismic Performance Factors*, Applied Technology Council, Federal Emergency Management Agency, Washington, DC, June 2009, and Luco, N., et al., "Risk-targeted versus current seismic design maps for the coterminous United States," Proceedings, SEAOC 76th Annual Convention, Structural Engineers Association of California, Sacramento, CA, 2007

2.1.2 Nonstructural Damage

Falling exterior walls and cladding and falling interior ceilings, light fixtures, pipes, equipment, and other nonstructural components also cause deaths and injuries, as well as loss of function. The *Provisions* minimizes this risk using requirements for anchoring and bracing nonstructural components. In the future it may be possible to target this objective to a specific risk, but at this time the level of protection is set at two-thirds of the MCE_R ground motion in part because that level is roughly the same as the level used for design in Coastal California before the criterion for structure collapse was defined at the MCE_R ground motion. The level of ground motion of two-thirds of the MCE_R ground motion is referred to as the Design Earthquake ground motion; the probability of that level of ground motion occurring varies with location. Another complicating factor in understanding the level of risk surrounding nonstructural failures is that the demand on nonstructural components would vary with the amount of actual yielding in the structural response to ground shaking, but it is currently not possible to provide for that in any design procedure based upon linear response analysis methods.

The component importance factor is used to reduce the probability of failure of nonstructural components or systems that create a risk to life stemming from loss of their function immediately following the earthquake, such as the failure of the fire suppression system, rather than risks posed by the component from its weight and position. The uncertainty in performance would be similar to the uncertainty in structural collapse, because the overall uncertainty is dominated by variations in ground motion and dynamic response of both the structure and the component, therefore the risk of failure of such components is likely reduced but the degree cannot be stated at this time.

2.1.3 Hazardous Materials

Hazardous materials can be released by a structural and nonstructural failure, however such failures can occur short of collapse. The expectation is that the probability of catastrophic release of such materials across a facility boundary would be similar to the probability of structure collapse for ordinary structures, although more study will be needed to validate that any target is indeed met by the recommended provisions. Release within a facility where relatively fewer lives are at risk would be less rare, although no specific target exists at this time. There is a lack of data, especially regarding the performance of nonstructural systems under strong ground shaking that makes quantification of the objective impossible without further study. Refer to the commentary for Section 1.5.3 of ASCE/SEI 7-10 for the quantitative definition of toxic, highly toxic, and explosive categories of hazardous materials.

2.1.4 Preservation of Egress

In the 2015 *Provisions* preservation of egress was identified as a distinct objective. At this time the specific requirements are focused on deformation compatibility of stairs and ramps.

2.1.5 Functionality of Critical or Essential Facilities

It is important to realize that functionality does not imply an absence of damage, or even function as it would be under ordinary circumstances. Experience has shown that extensive workaround solutions are made to respond to damage in essential facilities so that some level of function is maintained, however such solutions are not the goal of the *Provisions*. More work is necessary to improve standards so that functional performance is achieved when desired. The functionality objective for Risk Category IV and some Risk Category III structures will often control the structural design over the collapse objective. The performance of critical occupancy structures in past earthquakes indicates that the increase in the importance factor, in combination with strict regulation of design, testing, and inspection, reduces structural damage in moderate shaking. Experience data show that some nonstructural components will remain functional if they stay in position, but other components will require testing to show that they will function following strong shaking. The emphasis to date has been on the seismic qualification of individual components and analysis of individual systems. However, the nonstructural systems of many buildings are, in reality, complex networks

that can be shut down by a single failure. For example, a break in a pressurized pipe can flood a critical area of the facility, or if not quickly isolated, all of a building, forcing it to close, and failure of the anchorage (or internal workings) of a battery, day tank, fuel lines, muffler, or main engine can shut down an emergency generator. Therefore, the special regulations for seismic protection of nonstructural systems represent a rational approach to achieving performance appropriate for the various occupancies, but experience data to confirm their adequacy are lacking.

2.1.6 Repair Costs

The requirements for anchoring and bracing of nonstructural components and systems coupled with reasonable limitations on differential movement between floors (i.e., story drift limits) may serve to control damage that may be costly to repair or that would result in lengthy building closures, particularly for moderate shaking levels. This level of economic protection will vary across different types of structural and nonstructural systems, and no specific target has been established, nor is there a consensus among stakeholders as to the appropriate levels of protection. Nonstructural designs for story drift that focus on limiting damage to the component or system rather than only preventing catastrophic failure are much more effective at reducing economic losses.

Stricter story drift limits can further limit damage to components connected to more than one floor (e.g., walls, cladding and stairways) but, at the same time, can create higher acceleration levels in the building that could increase damage to nonstructural components braced or anchored to a single floor (e.g., ceilings, light fixtures, and pipes). Achieving an optimum balance between the cost and performance of the structural system and the effect of structural stiffness on performance of the nonstructural systems is not accomplished using the prescriptive rules of a building code, particularly given the variety of structural systems used in the United States.

Examples of provisions with a primary focus of damage control, rather than life safety, include bracing of lightweight ceiling systems, limitations on punching shear in concrete flat slabs (in the design standard for concrete structures), and limitations on interstory drift for masonry walls.

Page intentionally left blank.

2015 NEHRP RECOMMENDED SEISMIC PROVISIONS FOR NEW BUILDINGS AND OTHER STRUCTURES:

PART 1, PROVISIONS

MODIFICATIONS TO ASCE/SEI 7-10, CHAPTERS 11 – 22, AND ADDITIONAL CHAPTERS 23A AND 24

The 2015 edition of the *NEHRP Recommended Seismic Provisions for New Buildings and Other Structures* is a new knowledge-based resource of technologies and procedures for improving seismic design and building practices in the nation. Starting with the 2009 edition, the Provisions began to focus on serving as a resource document aimed at translating research into practice. In this process, the earlier practice of containing a full set of seismic design requirements was eliminated. This approach is continued with the 2015 Provisions. The new changes in the 2015 NEHRP Provisions are based on extensive results and findings from research projects, problem-focused studies, and post-earthquake investigation reports conducted by various professional organizations, research institutes, universities, material industries and NEHRP agencies.

Consistent with the approach used in the 2009 edition, the national standard ASCE/SEI 7-10, Minimum Design Loads for Buildings and Other Structures, Chapters 11-23, including Supplement No. 1 and the Expanded Commentary, has been adopted by reference for the Provisions. Modifications and additions to the Standard that passed BSSC's evaluation and consensus approval process appear in Part 1 of the Provisions. These recommended changes are intended for consideration and adoption in the next edition of ASCE/SEI 7. Each proposed Part 1 change is accompanied by a corresponding change to the ASCE 7-10 Commentary, which is contained in Part 2 of the Provisions. Parts 1 and 2 together with the adopted chapters of ASCE/SEI 7-10 and the references cited therein constitute Volume 1 the 2015 Provisions. Part 3 of the Provisions presents Resource Papers in a separate Volume 2.

Work on the 2015 Provisions began in October 2009 when the National Institute of Building Sciences, the BSSC's parent organization, entered into a contract with FEMA for initiation of the 2015 Provisions update effort. In consideration of balancing geographical and design practices, providing expertise in a broad range of subject areas, focusing on key areas of code improvement, and collaborating with national standards and building codes, 21 individual experts were selected to serve on the 2015 Provisions Update Committee (PUC). The PUC, with input from the earthquake engineering community, identified technical issues considered most critical for improvement of the U.S. seismic design practice, and formed Issue Teams for developing change proposals to the ASCE Standard. The following topics were investigated in the 2015 Provisions cycle: incorporation of P-695/P-795 methodologies for qualification of new systems and components; evaluation of performance objectives for seismic design and re-evaluation of seismic design categories; anchorage to concrete based on ACI 318 Appendix D; nonlinear response history analysis; diaphragm issues; foundations on liquefiable soil and other site-related issues; soil amplification factors; triggers for site-specific spectra, design mapping issues based on the U.S. Geological Survey's 2014

national seismic hazard maps; base isolation, energy dissipation systems; soil-structure interaction, and modal response spectrum analysis.

Between March 2010 and February 2015, the Issue Teams, members of the PUC, and the BSSC's Simplified Seismic Design Project developed 47 change proposals that were evaluated by the PUC in seven ballots, and subsequently evaluated by the Membership Organization representatives in four ballots. The consensus approved proposals from these four ballots were accepted by the BSSC Board of Direction for incorporation into the 2015 Provisions. The 2015 Provisions include extensive new changes, affecting significant parts of the seismic design sections in ASCE 7-10, including replacing four entire chapters.

All changes in Parts 1 and 2 of the Provisions are submitted to the ASCE/SEI 7 Standard committee for consideration of adoption. With some further improvements on the code language, most of these new changes are expected to be accepted in ASCE/SEI 7-16. The Standard is expected to be adopted by reference in International Building Codes (IBC) 2018.

The 2015 Provisions are divided into two volumes. For Part 1 of the Provisions in Volume 1, its Table of Contents lists only those sections and subsections of ASCE/SEI 7-10 that have been changed by approved proposals of the Provisions. For Part 2 in Volume 1 and Part 3 in Volume 2, the Table of Contents lists all chapters and up-to the fourth level of subsection headings.

A separate companion Provisions CD includes proposed maps for ASCE/SEI 7-16, IBC 2018 and IRC 2018 and issues and research recommendations for developing the 2020 Provisions.

Part 1 consists of:

- Revisions, replacements and additions to Chapters 11, 12, 14, 15, 21 and 22.
- Complete replacement of Chapters 16, 17, 18 and 19.
- A minor modification to Chapter 1.

Part 1 also contains:

- Chapter 23A, a reprint of Chapter 23 from the 2009 Provisions.
- The addition of Chapter 24.

ASCE 7-10 Chapter 11 Sections 11.5 Importance Factor and Risk Category and 11.6 Seismic Design Category are included without modification. These two sections with the revised soil factors and seismic ground motions in Section 11.4 Seismic Ground Motion Values and the complete set of existing and modified Chapter 22 maps are intended to assist nontechnical users of the Provisions (state and local government earthquake program managers, planners and policy makers, students and educators, insurance industry and risk management professionals etc.) in determining the Seismic Design Category for a building based on the new ground motion values and soil factors adopted by the *Provisions*.

Chapter 23A follows Chapter 23 of ASCE 7-10, which is not addressed in Part 1. Any reference to Chapter 23 in Part 1 of the 2015 Provisions directs the reader to Chapter 23 of ASCE 7-10.

CHAPTER 1, GENERAL

(Modifications)

SECTION 1.2.1

1.2.1 Definitions

In Section 1.2.1 Definitions, add the following:

FOUNDATION GEOTECHNICAL CAPACITY: The maximum allowable stress or strength design capacity of a foundation based upon the supporting soil, rock or controlled low-strength material.

FOUNDATION STRUCTURAL CAPACITY: The design strength of foundations or foundation components as determined in accordance with adopted material standards and as altered by the requirements of this Standard.

Page intentionally left blank.

CHAPTER 11, SEISMIC DESIGN CRITERIA (Modifications)

SECTION 11.2

11.2 DEFINITIONS

In Section 11.2 DEFINITIONS, replace the definition of “DIAPHRAGM” with the following:

DIAPHRAGM: Roof, floor, or other membrane or bracing system acting to transfer the lateral forces to the vertical resisting elements.

FLEXURE-CONTROLLED DIAPHRAGM: Diaphragm with a well-defined flexural yielding mechanism, which limits the force that develops in the diaphragm.

SHEAR-CONTROLLED DIAPHRAGM: Diaphragm that does not meet the requirements of a flexure-controlled diaphragm.

TRANSFER DIAPHRAGM: A diaphragm that transfers seismic forces from the vertical resisting elements above the diaphragm to other vertical resisting elements below the diaphragm due to offsets in the placement of the elements or to changes in relative lateral stiffnesses of the vertical elements.

In Section 11.2 DEFINITIONS, add the following definition:

PRECAST CONCRETE DIAPHRAGM DESIGN OPTIONS: (a) Basic Design Option (BDO) targets elastic diaphragm response in the design earthquake, (b) Elastic Design Option (EDO) targets elastic diaphragm response in the maximum considered earthquake, and (c) Reduced Design Option (RDO) permits limited diaphragm yielding in the design earthquake. These options are implemented in precast diaphragm design in accordance with Section 14.2.4. [Note: A new Section 14.2.4 has been added to Part 1 of the Provisions.]

SECTION 11.3

In Section 11.3 SYMBOLS, add the following symbols:

11.3 SYMBOLS

- C_{dX} = Deflection amplification factor in the X direction (Section 12.9.2.5.5)
- C_{dY} = Deflection amplification factor in the Y direction (Section 12.9.2.5.5)
- C_{p0} = diaphragm design acceleration coefficient at the structure base, Section 12.10.3.2.1
- C_{pn} = diaphragm design acceleration coefficient at the structural height, h_n , Section 12.10.3.2.1
- C_{px} = diaphragm design acceleration coefficient at Level x , Section 12.10.3.2.1
- C_{s2} = higher mode seismic response coefficient, Section 12.10.3.2.1
- F_{px} = diaphragm seismic design force at Level x
- R_s = diaphragm design force reduction factor, Section 12.10.3.5
- R_X = Response modification factor in the X direction (Section 12.9.2.5.2)
- R_Y = Response modification factor in the Y direction (Section 12.9.2.5.2)
- T_{Lower} = Period of vibration at which 90% of the actual mass has been recovered in each of the two orthogonal directions of response (Section 12.9.2.2.4). The mathematical model used to compute T_{Lower} shall not include accidental torsion

- T_{Upper} = The larger of the two orthogonal fundamental periods of vibration (Section 12.9.2.2.4). The mathematical model used to compute T_{Upper} shall not include accidental torsion
- V_{EX} = Maximum absolute value of Elastic Base Shear computed in the X direction among all three analyses performed in that direction (Section 12.9.2.5.1)
- V_{EY} = Maximum absolute value of Elastic Base Shear computed in the Y direction among all three analyses performed in that direction (Section 12.9.2.5.1)
- V_{IX} = Inelastic base shear in the X direction (Section 12.9.2.5.2)
- V_{IY} = Inelastic Base Shear in the Y direction (Section 12.9.2.5.2)
- V_X = ELF base shear for the X direction (Section 12.9.2.5.3)
- V_Y = ELF base shear in the Y direction (Section 12.9.2.5.3)
- w_{px} = weight tributary to the diaphragm at Level x
- z_s = mode shape factor, Section 12.10.3.2.1
- Δ_{ADVE} = average drift of adjoining vertical elements of the seismic force-resisting system over the story below the diaphragm under consideration, under tributary lateral load equivalent to that used in the computation of δ_{MDD} , Fig. 12.3-1 (in. or mm)
- δ_{MDD} = computed maximum in-plane deflection of the diaphragm under lateral load, Fig. 12.3-1 (in. or mm)
- Γ_{m1}, Γ_{m2} = first and higher modal contribution factors, respectively, Section 12.10.3.2.1
- η_X = Force scale factor in the X direction (Section 12.9.2.5.4)
- η_Y = Force scale factor in the Y direction (Section 12.9.2.5.4)
- Ω_v = diaphragm shear overstrength factor; see Section 14.2.4.1

SECTION 11.4.2

Replace Section 11.4.2 with the following:

11.4.2 Site Class

Based on the site soil properties, the site shall be classified as Site Class A, B, C, D, E, or F in accordance with Chapter 20. Where the soil properties are not known in sufficient detail to determine the site class, Site Class D, subject to the requirements of Section 11.4.3, shall be used unless the authority having jurisdiction or geotechnical data determines Site Class E or F soils are present at the site.

For situations in which site investigations, performed in accordance with Chapter 20, reveal competent rock conditions consistent with Site Class B, but site-specific velocity measurements are not made, the site coefficients F_a and F_v shall be taken as unity (1.0).

SECTION 11.4.3

Replace Section 11.4.3 with the following:

11.4.3 Site Coefficients and Risk-Targeted Maximum Considered Earthquake (MCE_R) Spectral Response Acceleration Parameters

The MCE_R spectral response acceleration parameters for short periods (S_{MS}), and at 1 s (S_{M1}), and, adjusted for Site Class effects, shall be determined by Eqs. 11.4-1 and 11.4-2, respectively.

$$S_{MS} = F_a S_S \quad (11.4-1)$$

$$S_{M1} = F_v S_I \quad (11.4-2)$$

but S_{MS} shall not be taken less than S_{M1} except when determining Seismic Design Category in accordance with Section 11.6

where

S_S = the mapped MCE_R spectral response acceleration parameter at short periods as determined in accordance with Section 11.4.1, and

S_I = the mapped MCE_R spectral response acceleration parameter at a period of 1 s as determined in accordance with Section 11.4.1

where site coefficients F_a and F_v are defined in Tables 11.4-1 and 11.4-2, respectively. Where Site Class D is selected as the default site class per Section 11.4.2, the value of F_a shall not be less than 1.2. Where the simplified design procedure of Section 12.14 is used, the value of F_a shall be determined in accordance with Section 12.14.8.1, and the values for F_v , S_{MS} , and S_{M1} need not be determined.

Table 11.4-1 Short-Period Site Coefficient, F_a
Mapped Risk-Targeted Maximum Considered Earthquake (MCE_R) Spectral Response Acceleration Parameter at Short Period

Site Class	$S_S \leq 0.25$	$S_S = 0.5$	$S_S = 0.75$	$S_S = 1.0$	$S_S = 1.25$	$S_S \geq 1.5$
A	0.8	0.8	0.8	0.8	0.8	0.8
B	0.9	0.9	0.9	0.9	0.9	0.9
C	1.3	1.3	1.2	1.2	1.2	1.2
D	1.6	1.4	1.2	1.1	1.0	1.0
E	2.4	1.7	1.3	See Section 11.4.7	See Section 11.4.7	See Section 11.4.7
F	See Section 11.4.7	See Section 11.4.7	See Section 11.4.7	See Section 11.4.7	See Section 11.4.7	See Section 11.4.7

Note: Use straight-line interpolation for intermediate values of S_I .

Table 11.4-2 Long-Period Site Coefficient, F_v
Mapped Risk-Targeted Maximum Considered Earthquake (MCE_R) Spectral Response Acceleration Parameter at 1-s Period

Site Class	$S_I \leq 0.1$	$S_I = 0.2$	$S_I = 0.3$	$S_I = 0.4$	$S_I = 0.5$	$S_I \geq 0.6$
A	0.8	0.8	0.8	0.8	0.8	0.8
B	0.8	0.8	0.8	0.8	0.8	0.8
C	1.5	1.5	1.5	1.5	1.5	1.4
D	2.4	2.2 ¹	2.0 ¹	1.9 ¹	1.8 ¹	1.7 ¹
E	4.2	3.3 ¹	2.8 ¹	2.4 ¹	2.2 ¹	2.0 ¹
F	See Section 11.4.7	See Section 11.4.7	See Section 11.4.7	See Section 11.4.7	See Section 11.4.7	See Section 11.4.7

Note: ¹Also, see requirements for site-specific ground motions in Section 11.4.7.

Note: Use straight-line interpolation for intermediate values of S_I .

SECTION 11.4.7

Replace Section 11.4.7 with the following:

11.4.7 Site-Specific Ground Motion Procedures

It shall be permitted to perform a site response analysis in accordance with Section 21.1 and/or a ground motion hazard analysis in accordance with Section 21.2 to determine ground motions for any structure.

When the procedures of either Section 21.1 or Section 21.2 are used, the design response spectrum shall be determined in accordance with Section 21.3, the design acceleration parameters shall be determined in accordance with Section 21.4 and, if required, the MCE_G peak ground acceleration parameter shall be determined in accordance with Section 21.5.

A site response analysis shall be performed in accordance with Section 21.1 for structures on Site Class F sites, unless exempted in accordance with Section 20.3.1.

A ground motion hazard analysis shall be performed in accordance with Section 21.2 for the following:

1. seismically isolated structures, for structures with damping systems and for structures designed using the response history procedure of Chapter 16, on sites with S_1 greater than or equal to 0.6.
2. structures on Site Class E sites with S_S greater than or equal to 1.0.
3. structures on Site Class D and E sites with S_I greater than or equal to 0.2.

EXCEPTION:

A ground motion hazard analysis is not required for the following cases:

4. Structures on Site Class E sites with S_S greater than or equal to 1.0, provided the site coefficient F_a is taken as equal to that of Site Class C.
5. Structures on Site Class D sites with S_I greater than or equal to 0.2, provided that the value of the seismic response coefficient C_s is determined by Eq. 12.8-2 for values of $T \leq 1.5T_s$ and taken as equal to 1.5 times the value computed in accordance with either Eq. 12.8-3 for $T_L \geq T > 1.5T_s$ or Eq. 12.8-4 for $T > T_L$.
6. Structures on Site Class E sites with S_I greater than or equal to 0.2, provided that T is less than or equal to T_s and the equivalent static force procedure is used for design.

The above exceptions do not apply to seismically isolated structures, structures with damping systems or structures designed using the response history procedures of Chapter 16.

SECTION 11.5 AND 11.6

The following two sections, 11.5 and 11.6, are provided without modification for reference:

11.5 IMPORTANCE FACTOR AND RISK CATEGORY

11.5.1 Importance Factor

An importance factor, I_e , shall be assigned to each structure in accordance with Table 1.5-2.

11.5.2 Protected Access for Risk Category IV

Where operational access to a Risk Category IV structure is required through an adjacent structure, the adjacent structure shall conform to the requirements for Risk Category IV structures. Where operational access is less than 10 ft. from an interior lot line or another structure on the same lot, protection from potential falling debris from adjacent structures shall be provided by the owner of the Risk Category IV structure.

11.6 SEISMIC DESIGN CATEGORY

Structures shall be assigned a Seismic Design Category in accordance with this section.

Risk Category I, II, or III structures located where the mapped spectral response acceleration parameter at 1-s period, S_1 , is greater than or equal to 0.75 shall be assigned to Seismic Design Category E. Risk Category IV structures located where the mapped spectral response acceleration parameter at 1-s period, S_1 , is greater than or equal to 0.75 shall be assigned to Seismic Design Category F. All other structures shall

be assigned to a seismic design category based on their risk category and the design spectral response acceleration parameters, S_{DS} and S_{D1} , determined in accordance with Section 11.4.4. Each building and structure shall be assigned to the more severe seismic design category in accordance with Table 11.6-1 or 11.6-2, irrespective of the fundamental period of vibration of the structure, T .

Where S_1 is less than 0.75, the seismic design category is permitted to be determined from Table 11.6-1 alone where all of the following apply:

1. In each of the two orthogonal directions, the approximate fundamental period of the structure, T_a , determined in accordance with Section 12.8.2.1 is less than $0.8T_s$, where T_s is determined in accordance with Section 11.4.5.

Table 11.6-1 Seismic Design Category Based on Short Period Response Acceleration Parameter

Value of S_{DS}	Risk Category - I or II or III	Risk Category - IV
$S_{DS} < 0.167$	A	A
$0.167 \leq S_{DS} < 0.33$	B	C
$0.33 \leq S_{DS} < 0.50$	C	D
$0.50 \leq S_{DS}$	D	D

Table 11.6-2 Seismic Design Category Based on 1-S Period Response Acceleration Parameter

Value of S_{D1}	Risk Category - I or II or III	Risk Category - IV
$S_{D1} < 0.067$	A	A
$0.067 \leq S_{D1} < 0.133$	B	C
$0.133 \leq S_{D1} < 0.20$	C	D
$0.20 \leq S_{D1}$	D	D

2. In each of two orthogonal directions, the fundamental period of the structure used to calculate the story drift is less than T_s .
3. Eq. 12.8-2 is used to determine the seismic response coefficient C_s .
4. The diaphragms are rigid as defined in Section 12.3.1 or for diaphragms that are flexible, the distance between vertical elements of the seismic force-resisting system does not exceed 40 ft.

Where the alternate simplified design procedure of Section 12.14 is used, the seismic design category is permitted to be determined from Table 11.6-1 alone, using the value of S_{DS} determined in Section 12.14.8.1.

SECTION 11.8.3

Replace Section 11.8.3, Item 2. with the following:

11.8.3 Additional Geotechnical Investigation Report Requirements for Seismic Design Categories D through F

2. The potential for liquefaction and soil strength loss evaluated for site peak ground acceleration, earthquake magnitude, and source characteristics consistent with the MCE_G peak ground acceleration. Peak ground acceleration shall be determined based on either (1) a site-specific study taking into account soil amplification effects as specified in Section 11.4.7 or (2) the peak ground acceleration PGA_M , from Eq. 11.8-1.

$$PGA_M = F_{PGA} PGA \quad (\text{Eq. 11.8-1})$$

where

PGA_M = MCE_G peak ground acceleration adjusted for Site Class effects

PGA = Mapped MCE_G peak ground acceleration shown in Figs. 22-6 through 22-10

F_{PGA} = Site coefficient from Table 11.8-1

Where the soil properties are not known in sufficient detail to determine the site class, Site Class D and $F_{PGA} \geq 1.2$ shall be used unless the authority having jurisdiction or geotechnical data determines Site Class E or F soils are present at the site.

Table 11.8-1 Site Coefficient F_{PGA}
Mapped Maximum Considered Geometric Mean (MCE_G) Peak Ground Acceleration, PGA

Site Class	PGA ≤ 0.1	PGA = 0.2	PGA = 0.3	PGA = 0.4	PGA = 0.5	PGA ≥ 0.6
A	0.8	0.8	0.8	0.8	0.8	0.8
B	0.9	0.9	0.9	0.9	0.9	0.9
C	1.3	1.2	1.2	1.2	1.2	1.2
D	1.6	1.4	1.3	1.2	1.1	1.1
E	2.4	1.9	1.6	1.4	1.2	1.1
F	See Section 11.4.7	See Section 11.4.7	See Section 11.4.7	See Section 11.4.7	See Section 11.4.7	See Section 11.4.7

Note: Use straight-line interpolation for intermediate values of PGA.

CHAPTER 12, SEISMIC DESIGN REQUIREMENTS FOR BUILDING STRUCTURES

(Modifications)

SECTION 12.1.5

Replace Section 12.1.5 with the following:

12.1.5 Foundation Design

The foundation shall be designed to resist the forces developed and accommodate the movements imparted to the structure by the design ground motions. The dynamic nature of the forces, the expected ground motion, the design basis for strength and energy dissipation capacity of the structure, and the dynamic properties of the soil shall be included in the determination of the foundations design criteria. The design and construction of foundations shall comply with Section 12.13.

When calculating load combinations using either the load combinations specified in Sections 2.3 or 2.4, the weights of foundations shall be considered dead loads in accordance with Section 3.1.2. The dead loads are permitted to include overlying fill and paving materials.

SECTION 12.2

Replace Section 12.2 with the following:

12.2 STRUCTURAL SYSTEM SELECTION

12.2.1 Selection and Limitations

Except as noted in Section 12.2.1.1, the basic lateral and vertical seismic force-resisting system shall conform to one of the systems indicated in Table 12.2-1 or a combination of systems as permitted in Sections 12.2.2, 12.2.3, and 12.2.4. Each system is subdivided by the types of vertical elements used to resist lateral seismic forces. The structural systems used shall be in accordance with the structural system limitations and the limits on structural height, h_n , contained in Table 12.2-1. The appropriate response modification coefficient, R , overstrength factor, Ω_o , and deflection amplification factor, C_d , indicated in Table 12.2-1 shall be used in determining the base shear, element design forces, and design story drift.

Each selected seismic force-resisting system shall be designed and detailed in accordance with the specific requirements for the system as set forth in the applicable reference document listed in Table 12.2-1 and the additional requirements set forth in Chapter 14.

Nothing contained in this Section shall prohibit the use of alternative procedures for the design of individual structures that demonstrate acceptable performance in accordance with the requirements of Section 1.3.1.3 of this Standard.

12.2.1.1 Alternative Seismic Force-Resisting Systems

Use of seismic force-resisting systems not contained in Table 12.2-1 shall be permitted contingent on submittal to and approval by the authority having jurisdiction of an accompanying set of design criteria, substantiating analytical and test data and the results of an independent design review. The design criteria shall include the following: any limitations on system use, including Seismic Design Category and height; required procedures for designing the system's members and connections; required detailing; and the values of the seismic design parameters including: the response modification coefficient, R , overstrength factor, Ω_o , and deflection amplification factor, C_d . The submitted data shall establish the system's nonlinear

dynamic characteristics and demonstrate that the design criteria results in a probability of collapse conditioned on the occurrence of MCE_R shaking not greater than 10% for Risk Category II structures. The conditional probability of collapse shall be determined for a suite of archetypes representing the range of structural configurations to which the system is applicable based on nonlinear analytical evaluation of the system and shall account for sources of uncertainty in quality of the design criteria, modeling fidelity, laboratory test data and ground motions. The testing, analysis, and resulting design criteria shall be subject to an independent structural design review, which shall conform to the criteria of Section 16.5 and shall include not less than 3 individual reviewers.

12.2.1.2 Substitute Elements

Elements of seismic force-resisting systems, including members and their connections, shall conform to the requirements for those systems contained in the Standards referenced in Table 12.2-1. Substitute elements shall be permitted contingent on submittal to and approval by the authority having jurisdiction of all of the following:

- a. In depth description of, or reference to published documentation of the equivalency methodology used to evaluate equivalency of the substitute element for the seismic force resisting system of interest.
- b. Justification of the applicability of the equivalency methodology, including but not limited to, consideration of the similarity of the forces transferred across the boundary between the substitute and conforming elements and the balance of the seismic force resisting system, and the similarity between the substitute and conforming elements on the distribution of forces and displacements in the balance of the structure.
- c. A design procedure for the substitute elements, including procedures to determine design strength, stiffness, detailing, connections, and limitations to applicability and use.
- d. Requirements for the manufacturing, installation, testing, inspection and maintenance of the substitute elements
- e. Experimental evidence demonstrating that the hysteretic characteristics of the conforming and substitute elements are sufficiently similar through deformation levels anticipated in response to MCE_R shaking. The evaluation of experimental evidence shall include assessment of the ratio of the measured maximum strength; to design strength; the ratio of the measured initial stiffness to design stiffness; the ultimate deformation capacity; and the cyclic strength and stiffness deterioration characteristics of the conforming and substitute elements.

Independent structural design review or review by a third party acceptable to the authority having jurisdiction.

SECTION 12.3.1.3

Replace Section 12.3.1.3 with the following:

12.3.1.3 Calculated Flexible Diaphragm Condition

Diaphragms not satisfying the conditions of Sections 12.3.1.1 or 12.3.1.2 are permitted to be idealized as flexible provided:

$$\frac{\delta_{MDD}}{\Delta_{ADVE}} > 2 \quad (12.3-1)$$

where δ_{MDD} and Δ_{ADVE} are as shown in Fig. 12.3-1.

Replace Figure 12.3-1 with the following:

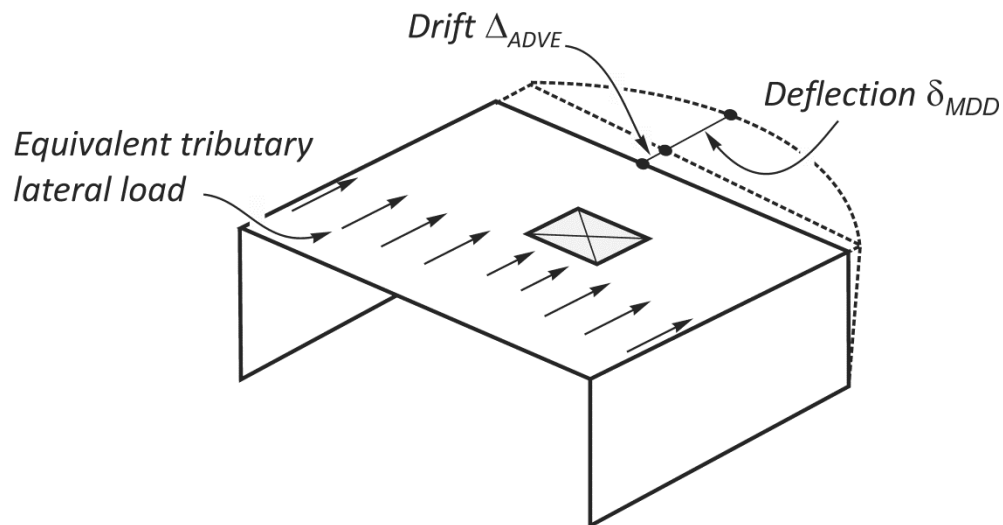

FIGURE 12.3-1 Flexible Diaphragm

SECTION 12.4.2.2

Replace Section 12.4.2.2 with the following:

12.4.2.2 Vertical Seismic Load Effect

The vertical seismic load effect, E_v , shall be determined in accordance with Eq. 12.4-4 as follows:

$$E_v = 0.2S_{DS}D \quad (12.4-4)$$

where

- S_{DS} = design spectral response acceleration parameter at short periods obtained from Section 11.4.4
- D = effect of dead load

EXCEPTION: The vertical seismic load effect, E_v , is permitted to be taken as zero for either of the following conditions:

3. In Eqs. 12.4-1, 12.4-2, 12.4-5, and 12.4-6 for structures assigned to Seismic Design Category B.
4. In Eq. 12.4-2 where determining demands on the soil-structure interface of foundations.

Replace Table 12.6-1 with the following:

Table 12.6-1 Permitted Analytical Procedures

Seismic Design Category	Structural Characteristics	Equivalent Lateral Force Analysis, Section 12.8 ^a	Modal Response Spectrum Analysis, Section 12.9, and Modal Response History Analysis, Section 12.10 ^a	Seismic Response History Procedures, Chapter 16 ^a
B, C	All structures	P	P	P
D, E, F	Risk Category I or II buildings not exceeding 2 stories above the base	P	P	P
D, E, F	Structures of light frame construction	P	P	P
D, E, F	Structures with no structural irregularities and not exceeding 160 ft. in structural height	P	P	P
D, E, F	Structures exceeding 160 ft. in structural height with no structural irregularities and with $T < 3.5T_s$	P	P	P
D, E, F	Structures not exceeding 160 ft. in structural height and having only horizontal irregularities of Type 2, 3, 4, or 5 in Table 12.3-1 or vertical irregularities of Type 4, 5a, or 5b in Table 12.3-2	P	P	P
D, E, F	All other structures	NP	P	P

^aP: Permitted; NP: Not Permitted; $T_s = S_D/S_{DS}$.

SECTION 12.8.1.3

Replace Section 12.8.1.3 with the following:

12.8.1.3 Maximum S_{DS} Value in Determination of C_s and E_v

The value of C_s and E_v are permitted to be calculated using a value of S_{DS} equal to 1.0, but not less than 70% of S_{DS} as defined in Section 11.4.4 for structures that meet all of the following criteria:

1. None of the irregularities defined in Section 12.3.2 apply.
2. Not exceeding five stories above the base as defined in Section 11.2.
3. Having a fundamental period, T , determined using Section 12.8.2, not exceeding 0.5 s.
4. Meeting the requirements necessary for the redundancy factor, ρ , to be permitted to be taken as 1.0 per Section 12.3.4.2.
5. Not be located where the site soil properties are classified as Site Class E or F as defined in Section 11.4.2.
6. Classified as Risk Category I or II as defined in Section 1.5.1.

SECTION 12.8.4.2

Replace Section 12.8.4.2 with the following:

12.8.4.2 Accidental Torsion

Where diaphragms are not flexible, the design shall include the inherent torsional moment (M_t) resulting from the location of the structure masses plus the accidental torsional moments (M_{ta}) caused by assumed displacement of the center of mass each way from its actual location by a distance equal to 5 percent of the dimension of the structure perpendicular to the direction of the applied forces.

Where earthquake forces are applied concurrently in two orthogonal directions, the required 5 percent displacement of the center of mass need not be applied in both of the orthogonal directions at the same time, but shall be applied in the direction that produces the greater effect. The accidental torsional moment shall also be included in the determination of possible horizontal structural irregularities in Table 12.3-1.

EXCEPTION: For structures assigned to Seismic Design Category B, the accidental torsional moments (M_{ta}) need not be included in design of buildings that do not have a Type 1b horizontal structural

irregularity. For structures assigned to Seismic Design Category C, D, E, or F, the accidental torsional moments (M_{ta}) need not be included in design of buildings that do not have a Type 1a or 1b horizontal structural irregularity.

SECTION 12.9

Revise Section 12.9 titles and numbering as follows:

12.9 Modal Response Spectrum Analysis and Linear Response History

Analysis 12.9.1 Modal Response Spectrum Analysis

12.9.1.1 Number of Modes

12.9.1.2 Modal Response Parameters

12.9.1.3 Combined Response Parameters

12.9.1.4 Scaling Design Values of Combined Response

12.9.1.4.1 Scaling of Forces

12.9.1.4.2 Scaling of Drifts

12.9.1.5 Horizontal Shear Distribution

12.9.1.6 P-Delta Effects

12.9.1.7 Soil Structure Interaction Reduction

The Section 12.9 titles and numbering in ASCE 7-10 affected by the above revision are listed below:

12.9 Modal Response Spectrum Analysis

12.9.1 Number of Modes

12.9.2 Modal Response Parameters

12.9.3 Combined Response Parameters

12.9.4 Scaling Design Values of Combined Response

12.9.4.1 Scaling of Forces

12.9.4.2 Scaling of Drifts

12.9.5 Horizontal Shear Distribution

12.9.6 P-Delta Effects

12.9.7 Soil Structure Interaction Reduction

SECTION 12.9.1.1

Replace Section 12.9.1.1 with the following:

12.9.1.1 Number of Modes

An analysis shall be conducted to determine the modes of vibration for the structure. The analysis shall include sufficient modes to capture participation of 100% of the structures mass. For this purpose, it shall be permitted to represent all modes with periods less than 0.05 seconds in a single rigid body mode having a period of 0.05 seconds.

EXCEPTION: Alternatively, the analysis shall be permitted to include a sufficient number of modes to obtain a combined modal mass participating of at least 90 percent of the actual mass in each orthogonal horizontal direction of response considered in the model.

SECTION 12.9.1.4

Replace Section 12.9.1.4 with the following:

12.9.1.4 Scaling Design Values of Combined Response.

A base shear (V) shall be calculated in each of the two orthogonal horizontal directions using the calculated fundamental period of the structure T in each direction and the procedures of Section 12.8.

12.9.1.4.1 Scaling of Forces

Where the calculated fundamental period exceeds $C_u T_a$ in a given direction, $C_u T_a$ shall be used in lieu of T in that direction. Where the combined response for the modal base shear (V_t) is less than 100 percent of the calculated base shear (V) using the equivalent lateral force procedure, the forces shall be multiplied by V/V_t :

where

V = the equivalent lateral force procedure base shear, calculated in accordance with this section and Section 12.8

V_t = the base shear from the required modal combination

12.9.1.4.2 Scaling of Drifts

Where the combined response for the modal base shear (V_t) is less than $C_s W$, and where C_s is determined in accordance with Eq. 12.8-6, drifts shall be multiplied by $C_s W/V_t$.

SECTION 12.9.1.8

Add Section 12.9.1.8:

12.9.1.8 Structural Modeling

A mathematical model of the structure shall be constructed in accordance with Section 12.7.3, except that all structures designed in accordance with this Section shall be analyzed using a 3-D representation. Where the diaphragms have not been classified as rigid in accordance with Section 12.3.1, the model shall include representation of the diaphragm's stiffness characteristics and additional dynamic degrees of freedom as required to account for the participation of the diaphragm in the structure's dynamic response.

SECTION 12.9.2

Add Section 12.9.2:

12.9.2 Linear Response History Analysis

12.9.2.1 General Requirements

Response history analysis shall consist of an analysis of a linear mathematical model of the structure to determine its response through methods of numerical integration, to suites of spectrally matched acceleration histories compatible with the design response spectrum for the site. The analysis shall be performed in accordance with the requirements of this section.

12.9.2.2 General Modeling Requirements

Three-dimensional models of the structure shall be required. Modeling the distribution of stiffness and mass throughout the structure's lateral load resisting system and diaphragms shall be in accordance with Section 12.7.3.

12.9.2.2.1 P-Delta Effects

The mathematical model shall include P-Delta effects. Limits on the story stability coefficient (θ) shall be satisfied in accordance with Section 12.8.7.

12.9.2.2.2 Accidental Torsion

Accidental torsion shall be included by offsetting the center of mass each way (i.e. plus or minus) from its expected location by a distance equal to 5 percent of the horizontal dimension of the structure at the given floor measured parallel to the direction of mass offset. Amplification of accidental torsion in accordance with Section 12.8.4.3 is not required.

12.9.2.2.3 Foundation Modeling

Where foundation flexibility is included in the analysis, modeling of the foundation shall be in accordance with Section 12.13.3.

12.9.2.2.4 Number of Modes to Include in Response History Analysis

The analysis shall include a sufficient number of modes to capture participation of 100% of the structure's mass. Where modal response history analysis is used it shall be permitted to represent all modes with periods less than 0.05 seconds in a single rigid body mode having a period of 0.05 seconds.

EXCEPTION: Alternatively, when modal response history analysis is used, it shall be permitted to include all modes with periods greater than or equal to T_{Lower} and less than or equal to T_{Upper} .

12.9.2.2.5 Damping

Viscous damping shall not exceed 5% critical for any mode with a vibration period greater than or equal to T_{Lower} .

12.9.2.3 Ground Motion Selection and Scaling

Ground acceleration histories used for analysis shall consist three sets of spectral matched orthogonal components derived from artificial or recorded ground motion events. The target response spectrum for each spectral matched component of each set shall be developed in accordance with Sections 11.4.5 or 21.3, as applicable.

12.9.2.3.1 Procedure for Spectrum Matching

Each component of ground motion from each set shall be spectral matched over the period range $0.8T_{Lower}$ to $1.2T_{Upper}$. Over the same period range the average of the 5% damped response spectra computed using the spectrum matched records shall not fall below the target spectrum by more than ten percent in each direction of response.

12.9.2.4 Application of Ground Acceleration Histories

Two orthogonal directions of response, designated as X and Y, shall be selected and used for all response history analysis. Ground motions shall be applied independently in the X and Y directions.

12.9.2.5 Modification of Response for Inelastic Behavior

The linear elastic response histories computed for each ground motion shall be modified for inelastic response in accordance with the requirements of this section.

12.9.2.5.1 Determination of Maximum Elastic Base Shear

For each direction of response, a Maximum Elastic Base Shear, designated as V_{EX} and V_{EY} in the X and Y directions, respectively, shall be determined for each ground motion used in the analysis. The mathematical model used for computing dynamic base shear shall not include accidental torsion.

12.9.2.5.2 Determination of Maximum Inelastic Base Shear

For each direction analyzed a Maximum Inelastic Base Shear shall be determined as follows:

$$V_{IX} = \frac{V_{EX} I_e}{R_X} \quad (12.9-1)$$

$$V_{IY} = \frac{V_{EY} I_e}{R_Y} \quad (12.9-2)$$

where I_e is the importance factor and R_X and R_Y are the response modifications factors for the X and Y directions, respectively.

12.9.2.5.3 Determination of Base Shear Scale Factor

Static base shears, V_X , and V_Y , shall be computed in the X and Y directions, respectively, in accordance with Section 12.8.1. *Base Shear Scale Factors* in each direction of response shall be computed as follows:

$$\eta_X = \frac{V_X}{V_{IX}} \geq 1.0 \quad (12.9-3)$$

$$\eta_Y = \frac{V_Y}{V_{IY}} \geq 1.0 \quad (12.9-4)$$

12.9.2.5.4 Determination of Combined Force Response

For each direction of response and for each ground motion analyzed the *Combined Force Response* shall be determined as follows:

- The Combined Force Response* in the X direction shall be determined as $I_e \eta_X / R_X$ times the computed elastic response in the X direction using the mathematical model with accidental torsion, plus $I_e \eta_Y / R_Y$ times the computed elastic response in the Y direction using the mathematical model without accidental torsion.
- The Combined Force Response* in the Y direction shall be determined as $I_e \eta_Y / R_Y$ times the computed elastic response in the Y direction using the mathematical model with accidental torsion, plus $I_e \eta_X / R_X$ times the computed elastic response in the X direction using the mathematical model without accidental torsion.

12.9.2.5.5 Determination of Combined Displacement Response

Response Modification Factors C_{dX} and C_{dY} shall be assigned in the X and Y directions, respectively. For each direction of response and for each ground motion analyzed the *Combined Displacement Responses* shall be determined as follows:

- a. *The Combined Displacement Response* in the X direction shall be determined as C_{dx}/R_x times the computed elastic response in the X direction using the mathematical model with accidental torsion, plus C_{dy}/R_y times the computed elastic response in the Y direction using the mathematical model without accidental torsion.
- b. *The Combined Displacement Response* in the Y direction shall be determined as C_{dy}/R_y times the computed elastic response in the Y direction using the mathematical model with accidental torsion, plus C_{dx}/R_x times the computed elastic response in the X direction using the mathematical model without accidental torsion.

12.9.2.6 Enveloping of Force Response Quantities

Design force response quantities shall be taken as the envelope of the Combined Force Response quantities computed in both orthogonal directions and for all ground motions considered. Where force interaction effects are considered, demand to capacity ratios may be enveloped in lieu of individual force quantities.

12.9.2.7 Enveloping of Displacement Response Quantities

Story drift quantities shall be determined for each ground motion analyzed and in each direction of response using the Combined Displacement Responses defined in Section 12.9.2.5.5. For the purpose of complying with the drift limits specified in Section 12.12, the envelope of story drifts computed in both orthogonal directions and for all ground motions analyzed shall be used.

SECTION 12.10

12.10 DIAPHRAGMS, CHORDS, AND COLLECTORS

Add the following as the 1st Paragraph in Section 12.10:

Diaphragms, chords, and collectors shall be designed in accordance with Sections 12.10.1 and 12.10.2.

EXCEPTIONS:

1. Precast concrete diaphragms including chords and collectors in structures assigned to SDC C, D, E or F shall be designed in accordance with Section 12.10.3.
2. Precast concrete diaphragms in SDC B, cast-in-place concrete diaphragms, and wood-sheathed diaphragms supported by wood diaphragm framing are permitted to be designed in accordance with Section 12.10.3.

SECTION 12.10.1.1

12.10.1.1 Diaphragm Design Forces

Replace Section 12.10.1.1, 4th (and last) Paragraph with the following:

A transfer diaphragm shall be designed for the force obtained from the lateral load analysis in accordance with Section 12.8 or 12.9, amplified by Ω_0 for the lateral force-resisting system of the building, added to the force determined from Eq. 12.10-1 through 12.10-3 for the level of the transfer diaphragm. For transfer diaphragms in structures assigned to Seismic Design Category B, the Ω_0 multiplier is permitted to be replaced with 1.0. For structures having horizontal or vertical structural irregularities of the types indicated in Section 12.3.3.4, the requirements of that section shall also apply.

SECTION 12.10.3

Add Section 12.10.3:

12.10.3 Alternative Provisions for Diaphragms Including Chords and Collectors

In accordance with Section 12.10, diaphragms including chords and collectors shall be designed using the provisions in Section 12.10.3.1 through 12.10.3.5 and the following:

1. Delete footnote g to Table 12.2-1.
2. Delete Section 12.3.3.4.
3. Replace Section 12.3.4.1 Item 5 with the following: “Design of diaphragms including chords, collectors and their connections to the vertical elements.”
4. Delete Section 12.3.4.1, Item 7.

12.10.3.1 Design

Diaphragms including chords, collectors and their connections to the vertical elements shall be designed in two orthogonal directions to resist the in-plane design seismic forces determined in Section 12.10.3.2. Collectors shall be provided that are capable of transferring the seismic forces originating in other portions of the structure to the vertical elements providing the resistance to those forces. Design shall provide for transfer of forces at diaphragm discontinuities, such as openings and reentrant corners.

12.10.3.2 Seismic Design Forces for Diaphragms including Chords and Collectors

Diaphragms including chords, collectors and their connections to the vertical elements shall be designed to resist in-plane seismic design forces given by Eq. 12.10-4

$$F_{px} = \frac{C_{px}}{R_s} w_{px} \quad (12.10-4)$$

The force F_{px} determined from Eq. 12.10-4 shall not be less than:

$$F_{px} = 0.2S_{DS} I_e w_{px} \quad (12.10-5)$$

where C_{px} is calculated from C_{p0} and C_{pn} as given in Section 12.10.3.2.1. For structures three stories or more in height, C_{px} is equal to C_{p0} up to 80 percent of h_n above the base and is to be linearly interpolated between C_{p0} and C_{pn} from 80 percent of h_n to h_n , as illustrated in Figure 12.10-2. For structures up to two stories in height, C_{px} is to be linearly interpolated between C_{p0} and C_{pn} from base to h_n .

12.10.3.2.1 Design acceleration coefficients C_{p0} and C_{pn}

Design acceleration coefficients C_{p0} and C_{pn} shall be calculated by Eqs. 12.10-6 and 12.10-7:

$$C_{p0} = 0.4S_{DS} I_e \quad (12.10-6)$$

and

$$C_{pn} = \sqrt{(\Gamma_{m1} \Omega_o C_s)^2 + (\Gamma_{m2} C_{s2})^2} \quad (12.10-7)$$

where Ω_o is the overstrength factor given in Table 12.2-1, C_s is determined in accordance with Section 12.8 or 12.9, and C_{s2} shall be the smallest of values calculated from Eqs. 12.10-8, 12.10-9 and 12.10-10:

$$C_{s2} = (0.15n + 0.25) I_e S_{DS} \quad (12.10-8)$$

$$C_{s2} = I_e S_{DS} \quad (12.10-9)$$

$$C_{s2} = \frac{I_e S_{DI}}{0.03(n-1)} \quad \text{For } n \geq 2 \quad (12.10-10a)$$

$$C_{s2} = 0 \text{ For } n = 1 \quad (12.10-10b)$$

The modal contribution factors Γ_{m1} and Γ_{m2} in Eq. 12.10-7 shall be calculated from Eqs. 12.10-11 and 12.10-12:

$$\Gamma_{m1} = 1 + \frac{z_s}{2} \left(1 - \frac{1}{n} \right) \quad (12.10-11)$$

and

$$\Gamma_{m2} = 0.9 z_s \left(1 - \frac{1}{n} \right)^2 \quad (12.10-12)$$

where the mode shape factor z_s is to be taken as:

0.3 for buildings designed with Buckling Restrained Braced Frame systems defined in Table 12.2-1, or

0.7 for buildings designed with Moment-Resisting Frame systems defined in Table 12.2-1, or

0.85 for buildings designed with Dual Systems defined in Table 12.2-1 with Special or Intermediate Moment Frames capable of resisting at least 25% of the prescribed seismic forces, or

1.0 for buildings designed with all other seismic force-resisting systems.

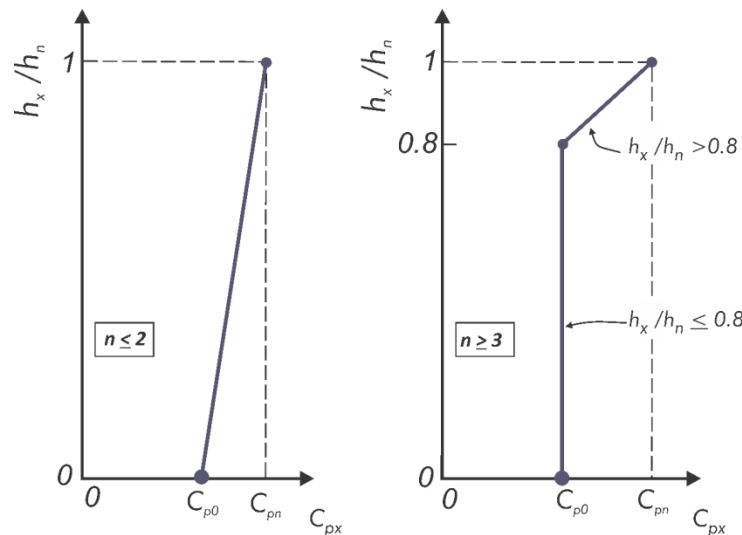

FIGURE 12.10-2 Calculating the Design Acceleration Coefficient C_{px} in Buildings with $n \leq 2$ and in Buildings with $n \geq 3$

12.10.3.3 Transfer Diaphragms

Transfer diaphragms including chords and collectors shall be designed for the forces obtained from the lateral load analysis in accordance with Section 12.8 or 12.9, amplified by Ω_0 for the lateral force-resisting system of the structure, added to the forces determined from Eqs. 12.10-4 and 12.10-5 for the level of the transfer diaphragm. For transfer diaphragms in structures assigned to Seismic Design Category B, the Ω_0 multiplier is permitted to be replaced with 1.0.

12.10.3.4 Collectors - Seismic Design Categories C through F

In structures assigned to Seismic Design Category C, D, E, or F, collectors and their connections including connections to vertical elements shall be designed to resist 1.5 times the diaphragm seismic design forces

from Section 12.10.3.2. Collectors of transfer diaphragms and their connections in structures assigned to Seismic Design Category C, D, E or F shall be designed to resist 1.5 times the design forces prescribed in Section 12.10.3.3.

EXCEPTION: In structures or portions thereof braced entirely by light-frame shear walls, collector elements and their connections including connections to vertical elements need only be designed to resist the diaphragm seismic design forces without the 1.5 multiplier.

12.10.3.5 Diaphragm Design Force Reduction Factor

The diaphragm design force reduction factor, R_s , shall be determined in accordance with Table 12.10-1. Where flexure-controlled diaphragms are used, the diaphragms shall be designed such that the factored shear resistance is greater than the shear corresponding to flexural yielding.

Table 12.10-1 Diaphragm Design Force Reduction Factor, R_s

Diaphragm System	Shear-Controlled	Flexure-Controlled
Cast-in-place concrete designed in accordance with ACI 318	1.5	2
Precast concrete designed in accordance with Section 14.2.4 and ACI 318, EDO	0.7	0.7
Precast concrete designed in accordance with Section 14.2.4 and ACI 318, BDO	1.0	1.0
Precast concrete designed in accordance with Section 14.2.4 and ACI 318, RDO	1.4	1.4
Wood sheathed designed in accordance with AF&PA (now AWC) Special Design Provisions for Wind and Seismic	3.0	NA

SECTION 12.13

Replace the following sections in Section 12.13:

12.13 FOUNDATION DESIGN

12.13.1 Design Basis

The design basis for foundations shall be as set forth in Section 12.1.5.

12.13.2 Materials of Construction

Materials used for the design and construction of foundations shall comply with the requirements of Chapter 14. Design and detailing of steel piles shall comply with Section 14.1.7. Design and detailing of concrete piles shall comply with Section 14.2.3.

12.13.3 Foundation Load-Deformation Characteristics

Where foundation flexibility is included in analysis conducted in accordance with Chapter 12, the load-deformation characteristics of the foundation-soil system shall be modeled in accordance with the requirements of this section. The linear load-deformation behavior of foundations shall be represented by an equivalent linear stiffness using soil properties that are compatible with the soil strain levels associated with the design earthquake motion. The strain-compatible shear modulus, G , and the associated strain-compatible shear wave velocity, v_s , needed for the evaluation of equivalent linear stiffness shall be determined using the criteria in Section 19.3 or based on a site-specific study. A 50 percent increase and decrease in stiffness shall be incorporated in dynamic analysis unless smaller variations can be justified based on field measurements of dynamic soil properties or direct measurements of dynamic foundation stiffness. The largest values of response shall be used in design.

12.13.4 Reduction of Foundation Overturning

Overturning effects at the soil–foundation interface are permitted to be reduced by 25 percent for foundations of structures that satisfy both of the following conditions:

- a. The structure is designed in accordance with the Equivalent Lateral Force Analysis as set forth in Section 12.8.
- b. The structure is not an inverted pendulum or cantilevered column type structure.

Overtopping effects at the soil–foundation interface are permitted to be reduced by 10 percent for foundations of structures designed in accordance with the modal analysis requirements of Section 12.9.

SECTION 12.13.5

Add section 12.13.5:

12.13.5 Strength Design for Nominal Foundation Geotechnical Capacity

Where basic combinations for strength design listed in Section 12.4 are used, the following sections shall apply for determination of the applicable nominal strengths and resistance factors at the soil–foundation interface.

12.13.5.1 Nominal Strength

The nominal foundation geotechnical capacity, Q_{ns} , shall be determined by a registered design professional based on site specific geotechnical investigations that include field exploration and laboratory testing to determine soil classification and soil strength parameters, or in-situ testing of prototype foundations. For competent soils that do not undergo strength degradation under seismic loading, strength parameters associated with static loading conditions shall be used to compute nominal foundation geotechnical capacities for seismic design unless increased seismic strength parameters derived from geotechnical investigations are provided by a registered design professional. For sensitive cohesive soils or saturated cohesionless soils, the potential for earthquake induced strength degradation shall be considered. Nominal foundation geotechnical capacities for vertical, lateral, and rocking loading shall be determined using accepted foundation design procedures and principles of plastic analysis, and shall be best-estimate values using soil properties that are representative average values for individual foundations.

Total resistance to lateral loads is permitted to be determined by taking the sum of the values derived from lateral bearing pressure plus horizontal sliding resistance (from either friction or cohesion).

1. Horizontal friction sliding resistance shall be limited to sand, silty sand, clayey sand, silty gravel and clayey gravel soils (SW, SP, SM, SC, GM and GC). Horizontal friction resistance shall be calculated as the most unfavorable dead load factor multiplied by dead load and multiplied by a coefficient of friction.
2. Horizontal cohesion sliding resistance shall be limited to clay, sandy clay, clayey silt, silt and sandy silt (CL, ML, MH and CH). Horizontal cohesion resistance shall be calculated as the contact area multiplied by the cohesion.

Where presumptive load bearing values for supporting soils are permitted to be used to determine nominal soil strengths, mud, organic silt, organic clays, peat or unprepared fill shall not be assumed to have a presumptive load capacity, unless data to substantiate the use of strength values is submitted to and approved by the Authority Having Jurisdiction.

12.13.5.2 Resistance Factors

The resistance factors prescribed in this section shall be used for vertical, lateral, and rocking resistance of all foundation types. Nominal foundation geotechnical capacities, Q_{ns} , shall be multiplied by the resistance factors (ϕ) in Table 12.13-1 to reflect uncertainties in site conditions and in the reliability of analysis methods.

Table 12.13-1 Resistance Factors for Strength Design of Soil-Foundation Interface

Direction and Type of Resistance	Resistance Factors, ϕ
Vertical Resistance: Compression (Bearing) Strength	0.45
Vertical Resistance: Pile Friction (either upward or downwards)	0.45
Horizontal Resistance: Lateral Bearing Pressure	0.5
Horizontal Resistance: Sliding (by either Friction or Cohesion)	0.85

12.13.5.3 Acceptance Criteria

For linear seismic analysis procedures in accordance with Sections 12.8, 12.9, and 16.1, factored loads shall not exceed foundation design strengths, ϕQ_{ns} .

SECTION 12.13.5 AND 12.13.6

Revise Section 12.13.5 and 12.13.6 titles and numbering as follows:

12.13.6 5 Requirements for Structures Assigned to Seismic Design Category C

(Remaining parts of this Section are renumbered)

12.13.7 6 Requirements for Structures Assigned to Seismic Design Category D through F

(Remaining parts of this Section are renumbered)

SECTION 12.13.8

Add Section 12.13.8:

12.13.8 Requirements for Structure Foundations on Liquefiable Sites

Where the geotechnical investigation report required in Section 11.8 identifies the potential for soil strength loss due to liquefaction in MCE_G earthquake motions, structures shall be designed to accommodate the effects of liquefaction in accordance with the requirements of Sections 12.13.8.1 through 12.13.8.3. Such structures shall also be designed to resist the seismic load effects of Section 12.4, presuming liquefaction does not occur.

EXCEPTION: Structures need not be designed for liquefaction effects where the geotechnical investigation report indicates that there is negligible risk of lateral spreading, no bearing capacity loss and differential settlements of site soils or improved site soils do not exceed $\frac{1}{4}$ of the permissible limits of Table 12.13-3.

Where the geotechnical investigation report indicates the potential for lateral flow or flow failure, the provisions of Section 12.13.8 are not applicable.

12.13.8.1 Foundation Design

Foundations shall be designed to support gravity and Design Earthquake loads, as indicated in the load combinations of Section 12.4, using the reduced soil bearing capacity, as indicated in the geotechnical investigation report, considering the effects of liquefaction due to MCE_G earthquake motions. The foundation capacity shall be permitted to include the mitigating effects of any planned ground improvements for the site.

12.13.8.2 Shallow Foundations

Building structures shall be permitted to be supported on shallow foundations provided that the foundations are detailed in accordance with Section 12.13.8.2.1 and the conditions provided in items 'a' and 'b' of Section 12.13.8.2 are met.

Nonbuilding structures similar to buildings shall be permitted to be supported on shallow foundations provided that the foundations are detailed in accordance with Section 12.13.8.2.1 and the conditions provided in items ‘a’ and ‘b’ of Section 12.13.8.2 are met. Nonbuilding structures not similar to buildings shall be permitted to be supported on shallow foundations at liquefiable sites only if it can be demonstrated that the structure’s foundation, superstructure and connecting systems can be designed to accommodate the lateral spreading and differential settlements induced by MCE_G earthquake ground motions indicated in the geotechnical investigation report.

- a. The geotechnical investigation report indicates that permanent horizontal ground displacement induced by lateral spreading associated with MCE_G earthquake motions will not exceed the value in Table 12.13-2.
- b. The foundation and superstructure are designed to accommodate differential settlements due to liquefaction without loss of the ability to support gravity loads. For structures assigned to Risk Category II or III, residual strength of members and connections shall not be less than 67 percent of the nominal strength, considering the nonlinear behavior of the structure. For structures assigned to Risk Category IV, demands on members and connections shall not exceed the element’s nominal strength when subjected to differential settlements.

Table 12.13-2 Lateral Spreading Horizontal Ground Displacement Permissible Limit for Shallow Foundations

Risk Category I	Risk Category II	Risk Category III	Risk Category IV
18 in.	18 in.	12 in.	4 in.

EXCEPTION: Where the geotechnical investigation report indicates that the differential settlements do not exceed the limits specified in Table 12.13.3, explicit design beyond the detailing requirements of Section 12.13.8.2.1 to accommodate differential settlements is not required.

Table 12.13-3 Differential Settlement Permissible Limit for Shallow Foundations Depending on Structure Type, δ_v/L^a

Structure Type	Risk Category I	Risk Category II	Risk Category III	Risk Category IV
Single-story concrete or masonry wall systems.	0.0075	0.0075	0.005	0.002
Other single-story structures.	0.015	0.015	0.010	0.002
Multi-story structures with concrete or masonry wall systems.	0.005	0.005	0.003	0.002
Other multi-story structures.	0.010	0.010	0.006	0.002

Note: ^a δ_v is the differential settlement between two points, as indicated in the geotechnical report
 Note: L is the horizontal distance between the indicated two points

12.13.8.2.1 Shallow Foundation Detailing

Shallow foundations shall satisfy the design and detailing requirements of Sections 12.13.8.2.1.1 or 12.13.8.2.1.2 as required.

12.13.8.2.1.1 Foundation Ties

Individual footings shall be interconnected by ties in accordance with Section 12.13.7.2 and the additional requirements of this Section. The ties shall be designed to accommodate the differential settlements between adjacent footings. Reinforced concrete sections shall be detailed in accordance with Sections 21.5.2.1 and 21.5.3 of ACI 318-11. Where the geotechnical investigation report indicates permanent ground displacement induced by lateral spreading exceeding 3 inches will occur in MCE_G earthquake motions, both of the following requirements shall be met:

1. Ties between individual footings on the same column or wall line shall, in lieu of the force requirements of Section 12.13.7.2, have a design strength in tension and compression at least equal

to F_{tie} , as indicated in Eq. 12.13-1. These effects shall be combined with the load effects from Design Earthquake lateral loads.

$$F_{tie} = 0.5\mu P_u \quad (12.13-1)$$

where

F_{tie} = the design tie force

μ = the coefficient of friction between the bottom of the footing and the soil, as indicated in the geotechnical report, or taken as 0.5 in the absence of other information

P_u = the total of the supported gravity loads of all footings along the same column or wall line, determined in accordance with Load Combination 5 in Section 2.3.2

- Individual footings shall be integral with or connected to a reinforced concrete slab-on-grade, at least 5 inches thick and reinforced in each horizontal direction with a minimum reinforcing ratio of 0.0025, or a post-tensioned concrete slab-on-grade, designed according to PTI DC10.1.

EXCEPTION: A system of diagonal reinforced concrete ties may be employed, if the system of ties provides equivalent lateral shear strength and stiffness to a slab-on-grade as defined above.

12.13.8.2.1.2 Mat Foundations

Mat foundations shall be designed to accommodate the expected vertical differential settlements indicated in the geotechnical investigation report. Mat foundations shall have longitudinal reinforcement in both directions top and bottom. Mat foundations shall be detailed in accordance with the requirements of Section 21.5.2.1 of ACI 318-11, or shall be explicitly designed to accommodate the differential settlements.

12.13.8.3 Deep Foundations

Deep foundations shall be designed to support vertical loads as indicated in the load combinations of Section 12.4, in combination with the moments and shears caused by lateral deep foundation deformation that is due to lateral inertial loads. Axial deep foundation capacity and lateral soil resistance shall be reduced to account for the effects of liquefaction. Deep foundations shall satisfy the design and detailing requirements of Sections 12.13.8.3.1 through Section 12.13.8.3.5.

12.13.8.3.1 Downdrag

Design of piles shall incorporate the effects of downdrag due to liquefaction. For geotechnical design, the liquefaction induced downdrag shall be determined as the downward skin friction on the pile within and above the liquefied zone(s). The net geotechnical ultimate capacity of the pile shall be the ultimate geotechnical capacity of the pile reduced by the downdrag load. For structural design, downdrag load induced by liquefaction shall be treated as a seismic load and factored accordingly.

12.13.8.3.2 Lateral Resistance

Passive pressure and friction mobilized against walls, pile caps and grade beams, when reduced for the effects of liquefaction, shall be permitted to transfer lateral inertial loads in combination with piles. Resistance provided by the combination of piles, passive pressure and friction shall be determined based on compatible lateral deformations.

12.13.8.3.3 Concrete Deep Foundation Detailing

Concrete piles including cast-in-place and precast piles shall be detailed to comply with Sections 21.6.4.2 through 21.6.4.4 of ACI 318-11 from the top of the pile to a depth exceeding that of the deepest liquefiable soil by at least 7 times the pile diameter.

12.13.8.3.4 Lateral Spreading

Where the geotechnical investigation report indicates permanent ground displacement induced by lateral spreading will occur in the event of MCE_G earthquake motions, pile design shall be based on a detailed analysis incorporating the expected lateral deformation, the depths over which the deformation is expected to occur, and the nonlinear behavior of the piles. Where nonlinear behavior of piles occurs due to permanent ground displacement induced by lateral spreading, the pile deformations shall not exceed a value that results in loss of the pile's ability to carry gravity loads or in deterioration of the pile's lateral strength to less than 67 percent of the nominal strength. In addition, the following requirements shall be satisfied.

1. Structural steel H-piles shall satisfy the width-thickness limits for highly ductile H-piles members in AISC 341.
2. Unfilled structural steel pipe piles shall satisfy the width-thickness limits for highly ductile round HSS elements in AISC 341.
3. Concrete piles shall be detailed to comply with Sections 21.6.4.2 through 21.6.4.4 of ACI 318-11 from the top of the pile to a depth exceeding that of the deepest liquefiable soil by at least 7 times the pile diameter. Nominal shear strength shall exceed the maximum forces that can be generated due to pile deformations determined in the detailed analysis.

12.13.8.3.5 Foundation Ties

Individual pile caps shall be interconnected by ties in accordance with Section 12.13.6.2. Where the geotechnical investigation report indicates permanent ground displacement induced by lateral spreading, the design forces for ties shall include the additional pressures applied to foundation elements due to the lateral displacement in accordance with the recommendations of the geotechnical investigation report. These effects shall be combined with the load effects from Design Earthquake lateral loads.

SECTION 12.14.1.1

Replace Section 12.14.1.1 with the following:

12.14.1.1 Simplified Design Procedure

The procedures of this section are permitted to be used in lieu of other analytical procedures in Chapter 12 for the analysis and design of simple buildings with bearing wall or building frame systems, subject to all of the limitations listed in this section. Where these procedures are used, the seismic design category shall be determined from Table 11.6-1 using the value of S_{DS} from Section 12.14.8.1. The simplified design procedure is permitted to be used if the following limitations are met:

1. The structure shall qualify for Risk Category I or II in accordance with Table 1.5-1.
2. The site class, defined in Chapter 20, shall not be class E or F.
3. The structure shall not exceed three stories above grade plane.
4. The seismic force-resisting system shall be either a bearing wall system or building frame system, as indicated in Table 12.14-1.
5. The structure shall have at least two lines of lateral resistance in each of two major axis directions.
6. The center of weight in each story shall be located not further from the geometric centroid of the diaphragm than 10% of the length of the diaphragm parallel to the eccentricity.
7. For structures with cast-in-place concrete diaphragms, overhangs beyond the outside line of shear walls or braced frames shall satisfy the following:

$$a \leq d/3 \quad (12.14-1)$$

where

a = the distance perpendicular to the forces being considered from the extreme edge of the diaphragm to the line of vertical resistance closest to that edge

d = the depth of the diaphragm parallel to the forces being considered at the line of vertical resistance closest to the edge

For all other diaphragm overhangs beyond the outside line of shear walls or braced frames shall satisfy the following:

$$a \leq d/5 \quad (12.14-2)$$

8. For buildings with a diaphragm that is not flexible, design by 12.14 is permitted if the forces are apportioned to the vertical elements as if the diaphragm was flexible and the following additional requirements are satisfied:
 - a. For structures with two lines of resistance in a given direction, the distance between the two lines is at least 50% of the length of the diaphragm perpendicular to the lines;
 - b. For structures with more than two lines of resistance in a given direction, the distance between the two most extreme lines of resistance in that direction is at least 60% of the length of the diaphragm perpendicular to the lines;
 - c. Where two or more lines of resistance are closer together than one-half the horizontal length of the longer of the walls or braced frames, it shall be permitted to replace those lines by a single line at the centroid of the group for the initial distribution of forces and the resultant force to the group shall then be distributed to the members of the group based upon their relative stiffnesses.
9. Lines of resistance of the seismic force-resisting system shall be oriented at angles of no more than 15° from alignment with the major orthogonal horizontal axes of the building.
10. The simplified design procedure shall be used for each major orthogonal horizontal axis direction of the building.
11. System irregularities caused by in-plane or out-of-plane offsets of lateral force-resisting elements shall not be permitted.

EXCEPTION: Out-of-plane and in-plane offsets of shear walls are permitted in two-story buildings of light-frame construction provided that the framing supporting the upper wall is designed for seismic force effects from overturning of the wall amplified by a factor of 2.5.

12. The lateral load resistance of any story shall not be less than 80 percent of the story above.

CHAPTER 14, MATERIAL SPECIFIC SEISMIC DESIGN AND DETAILING REQUIREMENTS

(Modifications)

SECTION 14.2.2.1

Replace Section 14.2.2.1 with the following:

14.2.2.1 Definitions

Add the following definitions to Section 2.2

CONNECTION: A region that joins two or more members. For precast concrete diaphragm design, a connection also refers to an assembly of connectors with the linking parts, welds and anchorage to concrete which forms a load path across a joint between members, at least one of which is a precast concrete member.

CONNECTOR: fabricated part embedded in concrete for anchorage and intended to provide a load path across a precast joint.

DETAILED PLAIN CONCRETE STRUCTURAL WALL: A wall complying with the requirements of Chapter 22 of ACI 318.

ORDINARY PRECAST STRUCTURAL WALL: A precast wall complying with the requirements of Chapter 18 of ACI 318.

PRECAST CONCRETE DIAPHRAGM DESIGN OPTIONS: (a) Basic Design Option (BDO) targets elastic diaphragm response in the design earthquake, (b) Elastic Design Option (EDO) targets elastic diaphragm response in the maximum considered earthquake, and (c) Reduced Design Option (RDO) permits limited diaphragm yielding in the design earthquake. These options are implemented in precast diaphragm design in accordance with Section 14.2.4.

SECTION 14.2.4

Add Section 14.2.4 as follows:

14.2.4 Additional Design and Detailing Requirements for Precast Concrete Diaphragms

In addition to the requirements for reinforced concrete set forth in this standard and Section 21.11 of ACI 318, design, detailing and construction of diaphragms constructed with precast concrete components in Seismic Design Categories C, D, E, and F shall conform to the requirements of this section.

14.2.4.1 Diaphragm Seismic Demand Levels

A seismic demand level for each precast concrete diaphragm shall be determined in each direction, based on Seismic Design Category (SDC), number of stories, n , diaphragm span, L , as defined in Section 14.2.4.1.1, and diaphragm aspect ratio, AR , as defined in Section 14.2.4.1.2. For structures assigned to SDC C, the seismic demand level is low. For structures assigned to SDC D, E or F, the seismic demand level shall be determined in accordance with Figure 14.2.4-1.

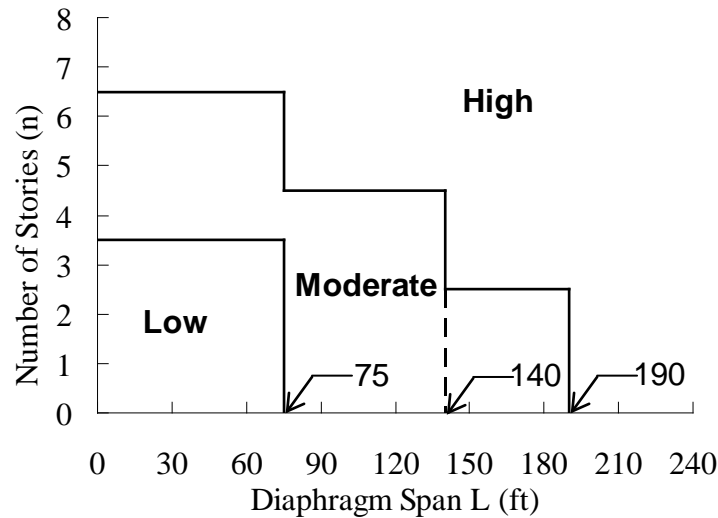

FIGURE 14.2.4-1 Diaphragm Seismic Demand Level

1. If AR is greater than 2.5 and the diaphragm seismic demand is *Low* according to Figure 14.2.4-1, the diaphragm seismic demand level shall be changed from *Low* to *Moderate*.
2. If AR is less than 1.5 and the diaphragm seismic demand is *High* according to Figure 14.2.4-1, the diaphragm seismic demand level shall be changed from *High* to *Moderate*.

14.2.4.1.1 Diaphragm Span

Diaphragm span of a structure, L , shall be the maximum diaphragm span on any floor in the structure in any direction. The diaphragm span in a particular direction on a particular floor level shall be the larger of the maximum distance between two LFRS elements and twice the exterior distance between the outer LFRS element and the free diaphragm edge.

14.2.4.1.2 Diaphragm Aspect Ratio

The diaphragm aspect ratio, AR , shall be the diaphragm span-to-depth ratio using the diaphragm span, L , defined in 14.2.4.1.1. The diaphragm depth shall be the diaphragm dimensions perpendicular to the diaphragm span between the chord lines for the diaphragm or portion of diaphragm.

14.2.4.1.3 Diaphragm Shear Amplification Factor

The required shear strength for diaphragm shall be amplified by the diaphragm shear overstrength factor, Ω_v , which shall be taken equal to $1.4R_v$.

14.2.4.2 Diaphragm Design Options

A diaphragm design option, as defined in Section 14.2.2.1, shall be assigned based on the lowest classification of connector or joint reinforcement deformability used.

14.2.4.2.1 Elastic Design Option

Any classification of connector or joint reinforcement deformability is permitted to be used with the Elastic Design Option, which in turn is permitted for:

1. Low Seismic Demand Level

2. Moderate Seismic Demand Level, provided the diaphragm design force is increased 15%

14.2.3.2.2 Basic Design Option

Either Moderate Deformability Elements (MDE) or High Deformability Elements (HDE) are required to be used with the Basic Design Option, which is permitted for:

1. Low Seismic Demand Level
2. Moderate Seismic Demand Level
3. High Seismic Demand Level, provided the diaphragm design force is increased 15%

14.2.3.2.3 Reduced Design Option

High Deformability Elements (HDE) are required to be used with the Reduced Design Option, which is permitted to be used for all Seismic Demand Levels.

14.2.4.3 Diaphragm Connector or Joint Reinforcement Deformability

Precast concrete diaphragm connectors or joint reinforcement shall be classified as follows:

14.2.4.3.1 Low Deformability Element (LDE).

Connectors or joint reinforcement used in precast concrete diaphragms with tension deformation capacity, as defined in Section 14.2.4.4.7, less than 0.3 in. (7.5mm) are classified as low deformability elements.

14.2.4.3.2 Moderate Deformability Element (MDE)

Connectors or joint reinforcement used in precast concrete diaphragms with tension deformation capacity, as defined in Section 14.2.4.4.7, greater than or equal to 0.3 in. (7.5mm) but less than 0.6 in. (15 mm) are classified as moderate deformability elements.

14.2.4.3.3 High Deformability Element (HDE)

Connectors or joint reinforcement used in precast concrete diaphragms with tension deformation capacity, as defined in Section 14.2.4.4.7, greater than or equal to 0.6 in. (15 mm) are classified as high deformability elements.

14.2.4.3.4 Connector/ Joint Reinforcement Classification

Classification of precast concrete diaphragm reinforcement or connector elements shall be determined by testing of individual elements following the cyclic testing protocols defined in Section 14.2.4.4.

14.2.4.3.5 Special Inspection

For precast concrete joint reinforcement or connector classified as a High Deformability Element (HDE), installation of the embedded parts and completion of the reinforcement or connection in the field shall be subject to continuous special inspection performed by qualified inspectors under the supervision of a licensed design professional.

14.2.4.4 Precast Concrete Diaphragm Connector and Joint Reinforcement Qualification Procedure

Precast concrete diaphragm connectors and joint reinforcement shall be assigned to a deformability classification based on tests as required by 14.2.4.3.4. The testing shall establish the strength, stiffness, and deformation capacity of the element. As a minimum, in-plane shear tests and in-plane tension tests shall be conducted. The following procedure is deemed to satisfy the test requirements.

14.2.4.4.1 Test Modules

A test module shall consist of two concrete elements connected by joint reinforcement or a connector or connectors. A separate full scale test module and a minimum number of tests shall be used for each characteristic of interest. Modules shall be fabricated at full scale. Test modules shall include a minimum edge distance of 2 ft. (0.6 m) from each connector centerline. Additional reinforcement shall be used to prevent premature failure of the test module. The additional reinforcement shall not be placed in a way that would alter the performance of the connector. The geometry, reinforcing details, fabrication procedures and material properties of the connections and connected concrete elements shall be representative of those to be used in the prototype structure.

14.2.4.4.2 Number of Tests

Evaluation of test results shall be made on the basis of the values obtained from not less than 3 tests, provided that the deviation of any value obtained from any single test does not vary from the average value for all tests by more than 15%. If such deviation from the average value for any test exceeds 15%, then additional tests shall be performed until the deviation of any test from the average value does not exceed 15% or a minimum of 6 tests has been performed. No test shall be eliminated unless a rationale for its exclusion is given.

14.2.4.4.3 Test Configuration

For each connection test, a multi-directional test fixture shall be used to allow for the simultaneous control of shear, axial, and potential bending deformations at the test module joint. Demand shall be applied through displacement control of up to three actuators. The test module shall be connected to restraint beams along each edge parallel to the joint; slip between the test module and beams shall be minimized. One support beam shall be fastened to the laboratory floor, providing a fixed edge, while the other beam shall rest on a low-friction movable support. Vertical movement of the panel shall be restricted.

14.2.4.4.4 Instrumentation

At a minimum, instrumentation shall consist of displacement and force transducers. Force shall be measured in line with each actuator to quantify shear and axial demands on the connection. To accommodate displacement control of the actuators, feedback transducers shall be incorporated into each actuator. Connection deformation shall be measured directly on the test module. A minimum of two axial transducers shall be used to determine the average axial opening and closing at the connection. Shear deformation shall be determined from measurements taken at the location of the connection. Transducer supports shall be placed on the test module at adequate distances from the connection, to minimize damage to the transducer supports during the test.

14.2.4.4.5 Loading Protocols

Connections shall be loaded in in-plane shear and tension In accordance with the following:

1. Monotonic and cyclic tests shall be conducted under displacement control, using rates less than 0.05 in./sec (1.25 mm/sec). Each module shall be tested until its strength decreases to 15% of the maximum load.
2. A monotonic test shall be performed to determine the reference deformation, as defined in Section 14.2.4.4.6 Item 2, of the connector or reinforcement, if a reference deformation is not available. The test module shall be loaded under a monotonically increasing displacement until its strength decreases to 15% of the maximum load.
3. In-plane cyclic shear tests, with a constant 0.1 in. (2.5 mm) axial opening, shall be conducted to determine stiffness, strength and deformation under shear loading. The test module shall be subject to increasing shear displacement amplitudes. Three fully reversed cycles shall be applied at each displacement amplitude. Starting from zero displacement, there shall be four increments of

displacement amplitude equal to one-quarter of the reference displacement. This shall be followed by two increments, each equal to one-half the reference displacement. Then there shall be two more increments, each equal to the reference displacement. This shall be followed by increments equal to twice the reference displacement, until the strength decreases to 15% of the maximum load.

4. In-plane cyclic tension/compression tests shall be conducted to determine stiffness, strength and deformation. Starting from zero displacement, there shall be four increments of tension displacement amplitudes equal to one-quarter of the reference displacement. This shall be followed by two increments, each equal to one-half the reference displacement. Then there shall be two more increments, each equal to the reference displacement. This shall be followed by increments equal to twice the reference displacement, until the tensile strength decreases to 15% of the maximum load. There shall be three cycles of loading at each displacement amplitude. The compression portion of each cycle shall be force-limited. Each compression half cycle shall consist of an increasing compressive deformation until a force limit is reached. The force limit for each cycle shall be equal to the maximum force of the preceding tension half cycle. The shear deformation along the joint shall not be restrained during a tension/compression test.

14.2.4.4.6 Measurement Indices, Test Observations and Acquisition of Data

The applied shear and tension/compression deformations and all resulting forces shall be recorded at least once every second.

1. Reference Deformation. The reference deformation, Δ_1 , corresponding to Point 1, defined in Item 2 below, represents the effective yield deformation of the connector or reinforcement. It shall be permitted to make an analytical determination of the reference deformation as an alternative to determination based on monotonic testing.
2. Backbone Qualification Envelope. The measured cyclic response shall be processed in accordance with the procedure below.

An envelope of the cyclic force deformation response shall be constructed from the force corresponding to the peak displacement applied during the first cycle of each increment of deformation. The envelope shall be simplified to a backbone curve consisting of four segments in accordance with Figure 14.2.4-2.

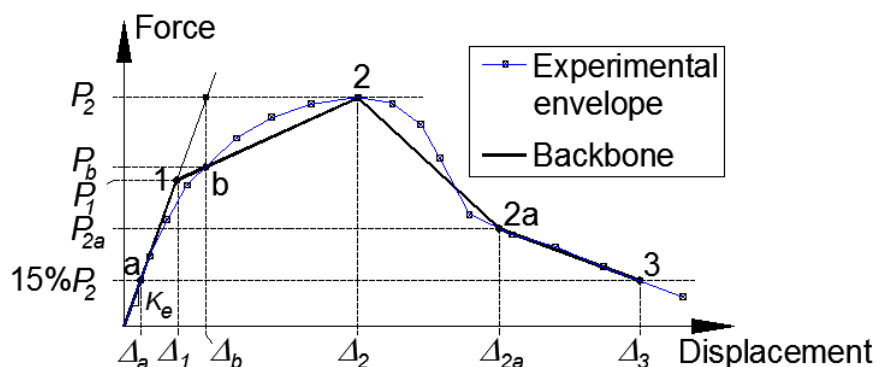

FIGURE 14.2.4-2 Backbone Qualification Curve

Point 2 represents the peak envelope load. Point 'a' is defined as the point on the backbone curve where the strength first equals 15% of peak load. Initial elastic stiffness, K_e , is calculated as the slope of the secant of the strength-displacement relationship from origin to Point 'a'. Point 'b' is the point on the envelope curve at a displacement Δ_b . The displacement Δ_b is at the intersection of a horizontal line from the peak envelope load and the initial elastic stiffness line through 15% of the peak load. Point 1 represents the occurrence of yield, which is defined by drawing a line from Point '2' to 'b' and extending it to intersect the initial elastic

stiffness line through 15% of the peak load. Point '3' is defined as the point where the strength has decreased to 15% of the peak load. Point '2a' is defined as the point where the deformation is 50% of the summation of deformations at Point '2' and '3'.

The backbone curve shall be classified as one of the types indicated in Figure 14.2.4-3. Deformation controlled elements shall conform to Type 1 or Type 2, but not Type 2 Alternate response, with $\Delta_2 \geq 2\Delta_1$. All other responses shall be classified as force-controlled.

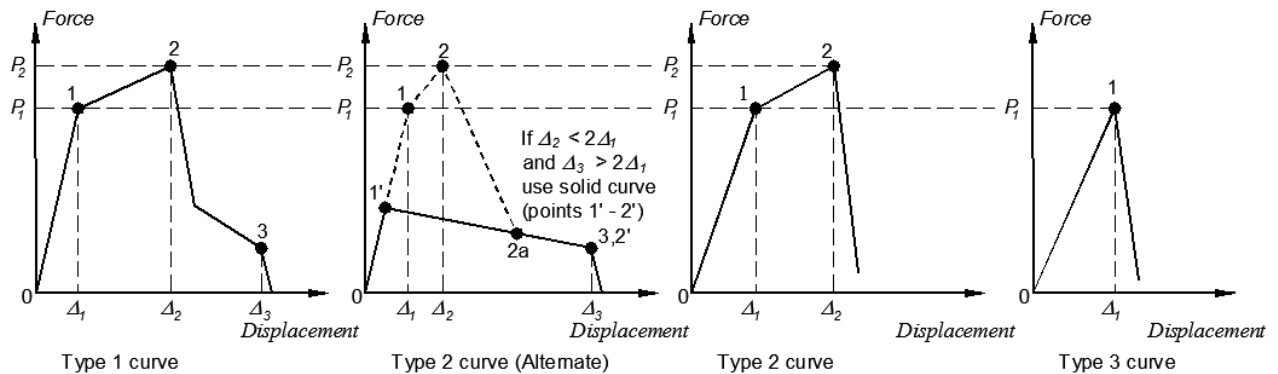

FIGURE 14.2.4-3 Deformation Curve Types

14.2.4.4.7 Response Properties

The following performance characteristics of the connector or joint reinforcement shall be quantified from the backbone response: The effective yield (reference) deformation, the tension deformation capacity, the tensile strength, and the shear strength shall be the average of values obtained from the number of tests required by Section 14.2.4.4.2. The tension deformation capacity is defined as corresponding to Point 2, for deformation controlled connections (see definition in Section 14.2.4.4.6, Item 2). It is defined as corresponding to Point 1 for force-controlled connections, except that for force-controlled connections exhibiting Type 2 Alternate response, tension deformation capacity shall correspond to Point 1'.

Deformation Category. The connector or joint reinforcement shall be classified as a Low Deformability Element (LDE), a Moderate Deformability Element (MDE), or a High Deformability Element (HDE) based on its deformation capacity in tension. The tension deformation capacity ranges given in 14.2.4.3 shall be used to determine the deformation category of the connector or reinforcement.

Tensile Strength. The tensile strength of the connector or joint reinforcement is defined as the force corresponding to Point 1.

Shear Strength. If the shear deformation Δ_1 is less than 0.25 in. (6.4mm), the shear strength shall be taken as the force at Point 1. If the shear deformation Δ_1 is greater than 0.25 in. (6.4 mm), the shear strength shall be taken as the force at 0.25 in. of shear deformation. This shear strength is equal to the stiffness, K_e , multiplied by 0.25 in.

14.2.4.4.8 Test Report

The test report shall be sufficiently complete and self-contained for a qualified expert to be satisfied that the tests have been designed and carried out in accordance with the criteria previously described. The test report shall contain sufficient information for an independent evaluation of the performance of the test module. As a minimum, all of the following information shall be provided:

- Details of test module design and construction, including engineering drawings.
- Specified material properties used for design, and actual material properties obtained by testing.

- Description of test setup, including diagrams and photographs.
- Description of instrumentation, location, and purpose.
- Description and graphical presentation of applied loading protocol.
- Material properties of the concrete measured in accordance with ASTM C39. The average of a minimum of three tests shall be used. The compression tests shall be conducted within 7 days of the connection tests or shall be interpolated from compression tests conducted before and after the connection test series.
- Material properties of the connector, slug, and weld metal based on material testing or mill certification. As a minimum, the yield stress, tensile stress, and the ultimate strain shall be reported.
- Description of observed performance, including photographic documentation, of test-module condition at key deformation cycles.
- Graphical presentation of force versus deformation response.
- The envelope and backbone of the load-deformation response.
- Yield strength, peak strength, yield deformation, tension deformation capacity, and connection category.
- Test data, report data, name of testing agency, report author(s), supervising professional engineer, and test sponsor.

14.2.4.4.9 Deformed Bar Reinforcement

Deformed bar reinforcement (ASTM A615 or ASTM A706) placed in cast-in-place concrete topping or cast-in-place concrete pour strips and satisfying the cover, lap, and development requirements of ACI 318 shall be deemed to qualify as High Deformability Elements (HDE).

Page intentionally left blank.

CHAPTER 15, SEISMIC DESIGN REQUIREMENTS FOR NONBUILDING STRUCTURES

(Modifications)

SECTION 15.4.1

Revise Section 15.4.1 as follows:

15.4.1 Design Basis

[...]

7. The base shear is permitted to be reduced in accordance with Section 19.2 to account for the effects of foundation damping from soil-structure interaction. In no case shall the reduced base shear be less than $0.7V$.

Delete the following text from Table 15.4-2:

Nonbuilding Structure Type	Detailing Requirements ^c	R	Ω_0	C_d	B	C	D	E	F
Tanks or vessels supported on structural towers similar to buildings	15.5.5	Use values for the appropriate structure type in the categories for building frame systems and moment resisting frame systems listed in Table 12.2-1 or Table 15.4-1.							

Page intentionally left blank.

CHAPTER 16, SEISMIC RESPONSE HISTORY PROCEDURES

(Replacement)

16.1 GENERAL REQUIREMENTS

16.1.1 Design

A response-history analysis, consisting of determination of the response of a mathematical model of the structure to suites of ground motion acceleration histories, shall be performed in accordance with the requirements and acceptance criteria of this chapter.

The design of the structure shall also meet the strength design requirements of the equivalent lateral force procedure or modal response spectrum analysis procedure, in accordance with Chapter 12, with the Chapter 12 requirements modified as follows:

1. For Risk Category I, II, and III structures, the drift limits of Section 12.12.1 do not apply.
2. For Risk Category IV structures, the drift limits shall be 125 percent of the drift limits specified in Section 12.12.1.
3. The overstrength factor, Ω_0 , is permitted to equal 1.0 for the seismic load effects of Section 12.4.3.
4. The redundancy factor, ρ , is permitted to equal 1.0.

Design review shall be provided in accordance with Section 16.5.

16.1.2 Documentation

The procedure utilized in the structural design shall be documented. The project-specific design criteria and other associated project documentation shall include the following:

1. Anticipated structural system and procedure utilized in the structural design.
2. Geotechnical investigation report(s) including soil characteristics (soil shear strength, stiffness, and damping characteristics), recommended foundation types and design parameters, seismic hazard evaluation, target spectra, and selection and scaling of ground motions.
3. Loading on the structure, including gravity loading and seismic loading.
4. Analytical modeling summary including all key assumptions, modeling approach and software, definition of mass, identification of force-controlled versus deformation-controlled components (in accordance with Section 16.4.2) and description of which component actions are modeled elastically and inelastically, expected material properties, basis for hysteretic component modeling (including assumptions or test data), component initial stiffness assumptions, joint stiffness assumptions, diaphragm modeling, damping, and soil modeling (if employed).
5. Summaries of laboratory test data and other applicable data used to justify the hysteretic component modeling or used to justify acceptable structural performance.
6. Specific acceptance criteria values used for evaluating the performance (in accordance with Section 16.4); associated documentation shall also include which component failures are deemed to lead to global collapse, local collapse, or no collapse (in accordance with Section 16.4.2); documentation will also include the specific criteria used for components of the gravity system (in accordance with Section 16.4.2.3).
7. Overall building dynamic behavior including natural frequencies, mode shapes, modal mass participation, and the period range computed in accordance with Section 16.2.4.1.
8. Key structural response parameter results and comparisons with the acceptance criteria of Section 16.4.
9. Detailing of critical elements.

16.2 GROUND MOTIONS

16.2.1 Level of Ground Motion

The analysis shall be based on the risk-targeted Maximum Considered Earthquake (MCE_R) ground motion level determined in accordance with Section 11.4.

16.2.2 Development of the Target Response Spectrum

The target response spectrum, or target response spectra, shall be developed by either Method 1 of Section 16.2.2.1 or Method 2 of Section 16.2.2.2.

16.2.2.1 Method 1

A single target response spectrum shall be developed, based on the requirements of either Section 11.4.6 or Section 11.4.7.

16.2.2.2 Method 2

Two or more site-specific target response spectra shall be developed and a ground motion suite shall be developed for each target response spectrum. When this method is used, the following requirements shall be fulfilled, in addition to the other requirements of this chapter:

1. Two or more periods shall be selected, corresponding to those periods of vibration that significantly contribute to the inelastic dynamic response of the building. In the selection of periods, lengthening of the elastic periods of the model shall be considered.
2. For each selected period, a target spectrum shall be created that either matches or exceeds the MCE_R value at that period. When developing the target spectrum (1) site-specific disaggregation shall be performed to identify earthquake events that contributed most to the MCE_R ground motion at the selected period and (2) the target spectrum shall be developed to capture one or more spectral shapes for dominant magnitude and distance combinations revealed by the disaggregation.
3. The envelope of the target spectra shall not be less than 75% of the spectral values computed using Method 1 of Section 16.2.2.1, for all periods in the range specified in Section 16.2.4.1.
4. For each target response spectrum, a ground motion suite for response history analyses shall be developed and utilized in accordance with Sections 16.2.3 through Section 16.2.5. The acceptance criteria requirements of Section 16.4 shall be fulfilled for each of the ground motion suites.

Variations on the procedures described in this section are permitted to be used when approved by the design review.

16.2.3 Ground Motions Selection

16.2.3.1 Minimum Number of Ground Motions

Each suite shall be comprised of not less than eleven ground motions.

16.2.3.2 Components of Ground Motion

Ground motions shall consist of pairs of horizontal ground motion components, and, if required, a vertical ground motion component.

Vertical ground motion shall not be required except in cases where the structure's configuration makes it sensitive to failure modes induced by vertical ground motion. In such cases, the ground motions shall include a vertical ground motion component and the structural model shall be capable of capturing the responses of elements that are sensitive to vertical ground motion.

16.2.3.3 Selection of Ground Motions

Ground motions shall be selected from events within the same general tectonic regime and having generally consistent magnitudes and fault distances as those controlling the maximum considered earthquake level of ground motion. The ground motion spectral shapes shall also be comparable to the target response spectrum of Section 16.2.2. Where the required number of recorded ground motions is not available, it shall be permitted to use appropriately simulated ground motions to make up the total number required.

When the MCE_R ground motion level is controlled by events for which near-fault effects are expected, the site shall be identified as a near-fault site and a suitable number of the ground motions shall include near-fault and directivity effects including direction of fault rupture and velocity pulses as appropriate.

16.2.4 Ground Motion Scaling

Ground motions shall be scaled based on the requirements of this section. Where vertical ground motion components are utilized, the vertical component shall be scaled by the same factor as the horizontal ground motion component(s).

16.2.4.1 Period Range for Scaling

For the purpose of ground motion scaling, a period range shall be determined, corresponding to the vibration periods that significantly contribute to the building's dynamic response. This period range shall have an upper bound greater than or equal to twice the largest first-mode period in the orthogonal horizontal directions of response, unless a lower value is justified by dynamic analysis under MCE_R ground motions. In no case shall the upper bound be less than 1.5 times the largest first-mode period in the orthogonal horizontal directions of response. The lower-bound period shall be established such that the period range includes at least the number of elastic modes necessary to achieve 90% mass participation in each orthogonal horizontal direction. The lower-bound period shall not exceed 20% of the smallest first-mode period for the two orthogonal horizontal directions of response.

16.2.4.2 Scaling of Ground Motions

For each ground motion, a maximum-direction spectrum shall be constructed from the two horizontal ground motion components. Each ground motion shall be scaled (with an identical scale factor applied to both horizontal components) such that the average of the maximum-direction spectra from all ground motions matches the target response spectrum defined in Section 16.2.2, on average, over the period range defined in Section 16.2.4.1. Additionally, the average of the maximum-direction spectra from all the ground motions shall not fall below 90% of the target response spectrum for any period within the same period range.

16.2.4.3 Spectral Matching of Ground Motions

If spectral matching of ground motions is utilized, each ground motion component shall be scaled such that the average of the spectra from all ground motion components, in each horizontal direction for which ground motions are applied, shall not be less than the target response spectrum defined in Section 16.2.2, over the period range defined in Section 16.2.4.1.

For sites identified as near-fault in Section 16.2.3.3, spectral matching shall not be utilized unless the pulse characteristics of the ground motions are retained after the matching process has been completed.

16.2.5 Application of Ground Motions to the Structural Model

Ground motions shall be applied to the structural model based on the requirements of this section.

16.2.5.1 Orientation of Ground Motions

For sites identified as near-fault in Section 16.2.3.3, each pair of horizontal ground motion components shall be rotated to the fault-normal and fault-parallel directions of the causative fault and applied to the building in such orientation.

At all other sites, each pair of horizontal ground motion components shall be applied to the building at arbitrary orientation angles.

For either type of site, individual pairs of horizontal ground motion components need not be applied in multiple orientations.

16.2.5.2 Application of Input Ground Motion over Subterranean Levels

When subterranean levels are included in the structural model, ground motions shall be applied at the foundation level of the model, in accordance with the requirements of Section 16.3.10.

16.3 MODELING AND ANALYSIS

Mathematical models shall conform to the requirements of Section 12.7 and the requirements of this section.

16.3.1 System Modeling

The model of the structural system shall be three-dimensional and shall represent all components that significantly affect the seismic response when subjected to MCE_R ground motions defined in Section 16.2. Component models shall incorporate expected material properties.

16.3.2 Gravity Load

The modeling of and demands on elements in the analysis model shall be determined considering earthquake effects acting in the presence of expected gravity loads. Expected gravity loads shall be taken as $1.0D + 0.5L$, where L is a reduced design live load. L shall be taken as $0.8L_0$ for live loads that exceed 100 lb/ft^2 (4.79 kN/m^2) and $0.4L_0$ for all other live loads, where L_0 is the unreduced design live load (see Table 4-1).

16.3.3 P-delta Effects

P-delta effects shall be included in the analysis using the gravity loads defined in Section 16.3.2 above.

16.3.4 Seismic Mass

Masses used in the analytical model shall represent the effective seismic weight per Section 12.7.2.

16.3.5 Diaphragm Modeling

Analysis models shall be capable of representing the flexibility of floor diaphragms where this is significant to the structure's response. Diaphragms at horizontal and vertical discontinuities in lateral resistance shall be explicitly modeled in a manner that permits capture of the force transfers and resulting deformations.

16.3.6 Torsion

The analysis model shall capture torsional behavior of the structure. Inherent eccentricities resulting from the distribution of mass and stiffness shall be included. Accidental torsion need not be considered in the analysis.

16.3.7 Stiffness of Elements Modeled with Elastic Properties

Linear properties, consistent with the requirements of Section 12.7.3, are permitted to be used for those elements demonstrated by the analysis to remain essentially elastic. To the extent that such effects are anticipated to be significant, element properties shall account for the following:

1. Stiffness properties of reinforced concrete and reinforced masonry shall account for cracking and other phenomena that affect effective initial stiffness including strain penetration, bond slip, and tension shift associated with shear cracking.
2. Stiffness properties of steel or other connected elements shall account for connection stiffness and, for moment frames, the effect of panel zone (beam-column joint) deformations.

16.3.8 Nonlinear Modeling

The mathematical model shall directly account for the nonlinear hysteretic behavior of all members and connections undergoing inelastic behavior, in a manner consistent with applicable laboratory test data. Test data shall not be extrapolated beyond tested deformation levels. If the analysis results for any ground motion indicate that component inelastic deformations are large enough to cause degradation in element strength or stiffness, the hysteretic models shall include these effects.

16.3.9 Damping

Hysteretic energy dissipation of structural members shall be modeled directly with inelastic elements. Additional inherent damping not associated with inelastic behavior of elements shall be modeled appropriate to the structure type and shall not exceed 3% equivalent viscous damping in the significant modes of response, unless supplemental damping is provided in accordance with Chapter 18.

16.3.10 Soil-Structure Interaction (SSI)

For structures having subterranean levels, the structural model shall extend to the foundation level and ground motions shall be input at the foundation level. Foundation level motions shall be taken as those defined in Section 16.2.2 or, as an alternative, the motions are permitted to be reduced from those in Section 16.2.2 to account for kinematic interaction effects. When soil spring and/or dashpot elements are included in the structural model, input motions shall be applied to the ends of the soil elements rather than being applied to the foundation directly.

16.4 ANALYSIS RESULTS AND ACCEPTANCE CRITERIA

Structures shall be demonstrated to meet the global acceptance criteria of Section 16.4.1 and the element-level acceptance criteria of Section 16.4.2.

16.4.1 Global Acceptance Criteria

16.4.1.1 Unacceptable Response

For Risk Categories I and II, and when spectral matching of ground motions is not utilized, not more than one motion of the eleven shall produce an unacceptable response. Any of the following shall be designated as an unacceptable response: a dynamic instability, a non-convergent analysis, a response that exceeds the valid range of modeling of a deformation controlled component, or a force demand that exceeds the average strength of a critical force-controlled component. In the case that an unacceptable response occurs, the average response estimates shall be taken as the counted median response multiplied by 1.2, but not less than the average response from the remaining motions.

For Risk Categories I and II, when spectral matching of ground motions is utilized, no motions shall produce an unacceptable response.

For Risk Categories III and IV, no motions shall produce an unacceptable response.

16.4.1.2 Story Drift

The average story drift ratio for each story shall not exceed two times the limits of Table 12.12-1. For masonry shear wall structures, the masonry limits of Table 12.12-1 shall not apply and these structures shall instead comply with the limits as for all other structures.

16.4.2 Element-Level Acceptance Criteria

All element actions shall be evaluated either as force-controlled or deformation-controlled. Element actions for which reliable inelastic deformation capacity is achievable without critical strength decay shall be deemed as deformation-controlled. Element actions for which inelastic deformation capacity cannot be assured shall be deemed as force-controlled. Any element actions modeled with linear properties shall be deemed to be force-controlled.

All element actions shall also be categorized as critical, ordinary, or non-critical. Critical element actions are those in which failure would result in the collapse of multiple bays of multiple stories of the building or would result in a significant reduction of the seismic resistance of the structure. Ordinary element actions are those in which failure would result in only local collapse, comprising not more than one bay in a single story, and would not result in a significant reduction of the seismic resistance of the structure. Non-critical element actions are those in which failure would not result in either collapse or substantive loss of the seismic resistance of the structure.

16.4.2.1 Force-Controlled Actions

For element actions deemed to be force-controlled, the required element strength shall be determined in accordance with this section.

Critical force-controlled actions shall satisfy:

$$2.0 I_e F_u \leq F_e \quad (16.4-1)$$

where I_e is the importance factor as prescribed in Section 11.5.1, F_u is the average demand for the response parameter of interest, and F_e is the expected strength of the component.

Ordinary force-controlled actions shall satisfy:

$$1.5 I_e F_u \leq F_e \quad (16.4-2)$$

Non-critical force-controlled actions shall satisfy:

$$1.0 I_e F_u \leq F_e \quad (16.4-3)$$

EXCEPTION: For actions other than shear in structural walls and columns, the force demand need not exceed the maximum force that can develop in the element as determined by plastic mechanism analysis, where the analysis is based on expected material properties. When designing components for such force demand, nominal component strengths shall be used instead of expected strengths and appropriate strength reduction factors shall be used.

16.4.2.2 Deformation-Controlled Actions

For element actions deemed to be deformation-controlled, the inelastic deformation limit shall be determined in accordance with this section.

For critical deformation-controlled actions, the average inelastic deformation shall not exceed $0.3/I_e$ multiplied by the inelastic deformation that would result in the loss of ability of the component to carry gravity loads. For ordinary deformation-controlled actions, the average inelastic deformation shall not exceed $0.5/I_e$ multiplied by the inelastic deformation that would result in the loss of ability of the component to carry gravity loads. For non-critical deformation-controlled actions, the inelastic

deformation is only limited by Section 16.4.1.1 requirement that deformations not exceed the valid range of modeling.

EXCEPTION: Where it can be shown that an alternate load path exists that allows gravity load redistribution and prevents an immediate consequence of element failure, the average inelastic deformation limit is permitted to be as follows: For critical deformation-controlled actions, the limit shall be $0.5/I_e$ multiplied by the inelastic deformation that would result in the loss of ability of the component to carry gravity loads. For ordinary deformation-controlled actions, the limit shall be $0.7/I_e$ multiplied by the inelastic deformation that would result in the loss of ability of the component to carry gravity loads. The inelastic deformation that would result in the loss of ability of the component to carry gravity loads shall be taken as the average value observed from test data.

16.4.2.3 Components of the Gravity System

Elements that are not part of the seismic force-resisting system shall comply with the Section 12.12.5 deformation-compatibility requirement of this standard using the average building displacements from response history analysis for MCE_R ground motions.

16.5 DESIGN REVIEW

When the seismic response history procedure is utilized to demonstrate compliance with the requirements of this standard, structural design review shall be performed in accordance with the requirements of this section. Upon completion of the review, and prior to the issuance of the final permit, the reviewer(s) shall provide the authority having jurisdiction and the registered design professional a letter of completion attesting to:

1. Scope of review performed.
2. Concurrence with the analysis and its applicability to the design.
3. Items relating to the design or analysis that require resolution.

16.5.1 Reviewer Qualifications

Reviewer(s) shall consist of one or more individuals providing knowledge of the following items, with a minimum of one reviewer being a registered design professional:

1. The requirements of this standard and the standards referenced herein, as they pertain to design of the type of structure under consideration.
2. Selection and scaling of ground motions for use in nonlinear response history analysis.
3. Analytical structural modeling for use in nonlinear response history analysis, including use of laboratory tests in the creation and calibration of the structural analysis models, and including knowledge of soil-structure interaction (if used in the analysis or the treatment of ground motions).
4. Behavior of structural systems, of the type under consideration, when subjected to earthquake loading.

16.5.2 Review Scope

The scope of Review shall include the project-specific design criteria in Section 16.1.2 as well as the associated project documentation that demonstrate conformance to the design criteria.

Page intentionally left blank

CHAPTER 17, SEISMIC DESIGN REQUIREMENTS FOR SEISMICALLY ISOLATED STRUCTURES

(Replacement)

17.1 GENERAL

Every seismically isolated structure and every portion thereof shall be designed and constructed in accordance with the requirements of this section and the applicable requirements of this standard.

17.1.2 Definitions

BASE LEVEL: The first level of the isolated structure above the isolation interface.

MAXIMUM DISPLACEMENT: The maximum lateral displacement, excluding additional displacement due to actual and accidental torsion, required for design of the isolation system. The Maximum Displacement is to be computed separately using upper bound and lower bound properties.

TOTAL MAXIMUM DISPLACEMENT: The total maximum lateral displacement, including additional displacement due to actual and accidental torsion, required for verification of the stability of the isolation system or elements thereof, design of structure separations, and vertical load testing of isolator unit prototypes. . The Total Maximum Displacement is to be computed separately using upper bound and lower bound properties.

DISPLACEMENT RESTRAINT SYSTEM: A collection of structural elements that limits lateral displacement of seismically isolated structures due to the maximum considered earthquake.

EFFECTIVE DAMPING: The value of equivalent viscous damping corresponding to energy dissipated during cyclic response of the isolation system.

EFFECTIVE STIFFNESS: The value of the lateral force in the isolation system, or an element thereof, divided by the corresponding lateral displacement.

ISOLATION INTERFACE: The boundary between the upper portion of the structure, which is isolated, and the lower portion of the structure, which moves rigidly with the ground.

ISOLATION SYSTEM: The collection of structural elements that includes all individual isolator units, all structural elements that transfer force between elements of the isolation system, and all connections to other structural elements. The isolation system also includes the wind-restraint system, energy-dissipation devices, and/or the displacement restraint system if such systems and devices are used to meet the design requirements of this chapter.

ISOLATOR UNIT: A horizontally flexible and vertically stiff structural element of the isolation system that permits large lateral deformations under design seismic load. An isolator unit is permitted to be used either as part of, or in addition to, the weight-supporting system of the structure.

SCRAGGING: Cyclic loading or working of rubber products, including elastomeric isolators, to effect a reduction in stiffness properties, a portion of which will be recovered over time.

WIND-RESTRAINT SYSTEM: The collection of structural elements that provides restraint of the seismic-isolated structure for wind loads. The wind-restraint system is permitted to be either an integral part of isolator units or a separate device.

17.1.3 Notation

B_M = numerical coefficient as set forth in Table 17.5-1 for effective damping equal to β_M

- b = shortest plan dimension of the structure, in ft. (mm) measured perpendicular to d
- C_{vX} = Vertical distribution factor
- D_M = maximum displacement, in in. (mm), at the center of rigidity of the isolation system in the direction under consideration, as prescribed by Eq. 17.5-1
- D'_M = maximum displacement, in in. (mm), at the center of rigidity of the isolation system in the direction under consideration, as prescribed by Eq. 17.6-1
- D_{TM} = total maximum displacement, in in. (mm), of an element of the isolation system including both translational displacement at the center of rigidity and the component of torsional displacement in the direction under consideration, as prescribed by Eq. 17.5-3
- d = longest plan dimension of the structure, in ft. (mm) measured perpendicular to b
- E_{loop} = energy dissipated in kips-in. (kN-mm), in an isolator unit during a full cycle of reversible load over a test displacement range from Δ^+ to Δ^- , as measured by the area enclosed by the loop of the force-deflection curve
- e = actual eccentricity, in ft. (mm), measured in plan between the center of mass of the structure above the isolation interface and the center of rigidity of the isolation system, plus accidental eccentricity, in ft. (mm), taken as 5 percent of the maximum building dimension perpendicular to the direction of force under consideration
- F^- = minimum negative force in an isolator unit during a single cycle of prototype testing at a displacement amplitude of Δ^-
- F^+ = maximum positive force in kips (kN) in an isolator unit during a single cycle of prototype testing at a displacement amplitude of Δ^+
- F_x = lateral seismic force, in kips (kN), at Level x as prescribed by Eq. 17.5-9
- h_i, h_1, h_x = height above the isolation interface of Level $i, 1,$ or x
- h_{sx} = height of story below Level x
- k_M = effective stiffness, in kips/in. (kN/mm), of the isolation system in the horizontal direction under consideration, as prescribed by Eq. 17.8-5
- k_{eff} = effective stiffness of an isolator unit, as prescribed by Eq. 17.8-1
- L = effect of live load in Chapter 17
- N = number of isolator units
- P_T = ratio of the effective translational period of the isolation system to the effective torsional period of the isolation system, as prescribed by Eq. 17.5-6A, but need not be taken as less than 1.0
- r_I = radius of gyration of the isolation system in ft. (mm), equal to $(b^2 + d^2)^{1/2}/12$ for isolation systems of rectangular plan dimension, $b \times d$
- R_I = numerical coefficient related to the type of seismic force-resisting system above the isolation system
- S_{DS} = the MCE_R , 5 percent damped, spectral response acceleration parameter at short periods adjusted for site class effects, as defined in Section 11.4.4
- S_{MI} = the MCE_R , 5 percent damped, spectral response acceleration parameter at a period of 1 s adjusted for site class effects, as defined in Section 11.4.3
- S_{MS} = the MCE_R , 5 percent damped, spectral response acceleration parameter at short periods adjusted for site class effects, as defined in Section 11.4.3
- T_M = effective period, in s, of the seismically isolated structure at the displacement D_M in the direction under consideration, as prescribed by Eq. 17.5-2

- T_{fb} = the fundamental period, in s, of the structure above the isolation interface determined using a modal analysis assuming fixed-base conditions
- V_b = total lateral seismic design force or shear on elements of the isolation system or elements below isolation system, in kips (kN), as prescribed by Eq. 17.5-7 or Eq. 17.5-7A
- V_s = total lateral seismic design force or shear on elements above the base level, in kips (kN), as prescribed by Eq. 17.5-8 and the limits of Section 17.5.4.3
- V_{st} = total unreduced lateral seismic design force or shear on elements above the base level, in kips (kN), as prescribed by Eq. 17.5-8A
- y = distance, in ft. (mm), between the center of rigidity of the isolation system rigidity and the element of interest measured perpendicular to the direction of seismic loading under consideration
- W = effective seismic weight, in kips (kN), of the structure above the isolation interface, as defined by Section 12.7.2
- W_s = effective seismic weight, in kips (kN), of the structure above the isolation interface, as defined by Section 12.7.2, excluding the effective seismic weight, in kips (kN), of the base level
- w_i, w_l, w_x = portion of W that is located at or assigned to Level i , 1, or x
- x_i, y_i = horizontal distances in ft. (mm) from the center of mass to the i^{th} isolator unit in the two horizontal axes of the isolation system
- β_M = effective damping of the isolation system at the displacement D_M , as prescribed by Eq. 17.2-4
- β_{eff} = effective damping of the isolation system, as prescribed by Eq. 17.8-2
- Δ^+ = maximum positive displacement of an isolator unit during each cycle of prototype testing
- Δ^- = minimum negative displacement of an isolator unit during each cycle of prototype testing
- λ_{max} = property modification factor for calculation of the maximum value of the isolator property of interest, used to account for all sources of isolator property variability, as defined in Section 17.2.8.4
- λ_{min} = property modification factor for calculation of the minimum value of the isolator property of interest, used to account for all sources of isolator property variability, as defined in Section 17.2.8.4
- $\lambda_{(\text{ae}, \text{max})}$ = property modification factor for calculation of the maximum value of the isolator property of interest, used to account for aging effects and environmental conditions as defined in Section 17.2.8.4
- $\lambda_{(\text{ae}, \text{min})}$ = property modification factor used to calculate the minimum value of the isolator property of interest, used to account for aging effects and environmental conditions as defined in Section 17.2.8.4
- $\lambda_{(\text{test}, \text{max})}$ = property modification factor used to calculate the maximum value of the isolator property of interest, used to account for heating, rate of loading, and scragging as defined in Section 17.2.8.4
- $\lambda_{(\text{test}, \text{min})}$ = property modification factor used to calculate the minimum value of the isolator property of interest, used to account for heating, rate of loading, and scragging as defined in Section 17.2.8.4
- $\lambda_{(\text{spec}, \text{max})}$ = property modification factor used to calculate the maximum value of the isolator property of interest, used to account for permissible manufacturing variation on the average properties of a group of same sized isolators as defined in Section 17.2.8.4

$\lambda_{(\text{spec, min})}$ = property modification factor used to calculate the minimum value of the isolator property of interest, used to account for permissible manufacturing variation on the average properties of a group of same sized isolators as defined in Section 17.2.8.4

ΣE_M = total energy dissipated, in kips-in. (kN-mm), in the isolation system during a full cycle of response at displacement D_M

ΣF_M^+ = sum, for all isolator units, of the maximum absolute value of force, in kips (kN), at a positive displacement equal to D_M

ΣF_M^- = sum, for all isolator units, of the maximum absolute value of force, in kips (kN), at a negative displacement equal to D_M

17.2 GENERAL DESIGN REQUIREMENTS

17.2.1 Importance Factor

All portions of the structure, including the structure above the isolation system, shall be assigned a risk category in accordance with Table 1.5-1. The importance factor, I_e , shall be taken as 1.0 for a seismically isolated structure, regardless of its risk category assignment.

17.2.2 Configuration

Each isolated structure shall be designated as having a structural irregularity if the structural configuration above the isolation system has a Type 1b horizontal structural irregularity, as defined in Table 12.3-1, or Type 1a, 1b, 5a, 5b vertical irregularity, as defined in Table 12.3-2.

17.2.3 Redundancy

A redundancy factor, ρ , shall be assigned to the structure above the isolation system based on requirements of Section 12.3.4. The value of redundancy factor, ρ , is permitted to be equal to 1.0 for isolated structures that do not have a structural irregularity, as defined in Section 17.2.2.

17.2.4 Isolation System

17.2.4.1 Environmental Conditions

In addition to the requirements for vertical and lateral loads induced by wind and earthquake, the isolation system shall provide for other environmental conditions including aging effects, creep, fatigue, operating temperature, and exposure to moisture or damaging substances.

17.2.4.2 Wind Forces

Isolated structures shall resist design wind loads at all levels above the isolation interface. At the isolation interface, a wind-restraint system shall be provided to limit lateral displacement in the isolation system to a value equal to that required between floors of the structure above the isolation interface in accordance with Section 17.5.6.

17.2.4.3 Fire Resistance

Fire resistance for the isolation system shall be provided to at least the be the same degree as the fire resistance required for the columns, walls, or other such gravity-bearing elements in the same region of the structure.

17.2.4.4 Lateral Restoring Force

The isolation system shall be configured, for both upper bound and lower bound isolation system properties, to produce a restoring force such that the lateral force at the corresponding maximum displacement is at least $0.025W$ greater than the lateral force at 50 percent of the corresponding maximum displacement.

17.2.4.5 Displacement Restraint

The isolation system shall not be configured to include a displacement restraint that limits lateral displacement due to MCE_R ground motions to less than the total maximum displacement, D_{TM} , unless the seismically isolated structure is designed in accordance with all of the following criteria:

1. MCE_R response is calculated in accordance with the dynamic analysis requirements of Section 17.6, explicitly considering the nonlinear characteristics of the isolation system and the structure above the isolation system.
2. The ultimate capacity of the isolation system and structural elements below the isolation system shall exceed the strength and displacement demands of the MCE_R response.
3. The structure above the isolation system is checked for stability and ductility demand of the MCE_R response.
4. The displacement restraint does not become effective at a displacement less than 0.6 times the total maximum displacement.

17.2.4.6 Vertical-Load Stability

Each element of the isolation system shall be designed to be stable under the design vertical load where subjected to a horizontal displacement equal to the total maximum displacement. The design vertical load shall be computed using load combination (2) of Section 17.2.7.1 for the maximum vertical load and load combination (3) of Section 17.2.7.1 for the minimum vertical load.

17.2.4.7 Overturning

The factor of safety against global structural overturning at the isolation interface shall not be less than 1.0 for required load combinations. All gravity and seismic loading conditions shall be investigated. Seismic forces for overturning calculations shall be based on MCE_R ground motions, and W shall be used for the vertical restoring force.

Local uplift of individual elements shall not be allowed unless the resulting deflections do not cause overstress or instability of the isolator units or other structure elements.

17.2.4.8 Inspection and Replacement

All of the following items shall be addressed as part of the long term inspection and replacement program:

1. Access for inspection and replacement of all components of the isolation system shall be provided.
2. A registered design professional shall complete a final series of observations of structure separation areas and components that cross the isolation interface prior to the issuance of the certificate of occupancy for the seismically isolated structure. Such observations shall verify that conditions allow free and unhindered displacement of the structure up to the total maximum displacement, and that components that cross the isolation interface have been constructed to accommodate the total maximum displacement.
3. Seismically isolated structures shall have a monitoring, inspection, and maintenance plan for the isolation system established by the registered design professional responsible for the design of the isolation system.
4. Remodeling, repair, or retrofitting at the isolation system interface, including that of components that cross the isolation interface, shall be performed under the direction of a registered design professional.

17.2.4.9 Quality Control

A quality control testing program for isolator units shall be established by the registered design professional responsible for the structural design, incorporating the production testing requirements of Section 17.8.6.

17.2.5 Structural System

17.2.5.1 Horizontal Distribution of Force

A horizontal diaphragm or other structural elements shall provide continuity above the isolation interface and shall have adequate strength and ductility to transmit forces from one part of the structure to another.

17.2.5.2 Minimum Building Separations

Minimum separations between the isolated structure and surrounding retaining walls or other fixed obstructions shall not be less than the total maximum displacement.

17.2.5.3 Nonbuilding Structures

Nonbuilding structures shall be designed and constructed in accordance with the requirements of Chapter 15 using design displacements and forces calculated in accordance with Sections 17.5 or 17.6.

17.2.5.4 Steel Ordinary Concentrically Braced Frames

Steel Ordinary Concentrically Braced Frames are permitted as the Seismic Force Resisting System in seismically isolated structures assigned to SDC D, E and F and are permitted to a height of 160 feet or less provided that all of the following design requirements are satisfied.

1. The value of R_I as defined in Section 17.5.4. is 1.0.
2. The total maximum MCE_R displacement (D_{TM}) as defined in Equation 17.5-3 shall be increased by a factor of 1.20.
3. The additional seismic detailing requirements of Section F1.7 of AISC 341-10 are met.

17.2.5.5 Steel Grid Frames

Moment-resisting connections of structural steel elements of the seismic isolation system and of column bases joined to the seismic isolation system shall be permitted to conform to the requirements for Ordinary Steel Moment Frames of AISC 341 E1.6a through b.

17.2.6 Elements of Structures and Nonstructural Components

Parts or portions of an isolated structure, permanent nonstructural components and the attachments to them, and the attachments for permanent equipment supported by a structure shall be designed to resist seismic forces and displacements as prescribed by this section and the applicable requirements of Chapter 13.

17.2.6.1 Components at or above the Isolation Interface

Elements of seismically isolated structures and nonstructural components, or portions thereof that are at or above the isolation interface shall be designed to resist a total lateral seismic force equal to the maximum dynamic response of the element or component under consideration determined using a response history analysis.

EXCEPTION: Elements of seismically isolated structures and nonstructural components or portions designed to resist seismic forces and displacements as prescribed in Chapter 12 or 13 as appropriate are not required to meet this provision.

17.2.6.2 Components Crossing the Isolation Interface

Elements of seismically isolated structures and nonstructural components, or portions thereof that cross the isolation interface shall be designed to withstand the total maximum displacement and to accommodate on a long term basis any permanent residual displacement.

17.2.6.3 Components below the Isolation Interface

Elements of seismically isolated structures and nonstructural components, or portions thereof, that are below the isolation interface shall be designed and constructed in accordance with the requirements of Section 12.1 and Chapter 13.

17.2.7 Seismic Load Effects and Load Combinations

All members of the isolated structure, including those not part of the seismic force-resisting system, shall be designed using the seismic load effects of Section 12.4 and the additional load combinations of Section 17.2.7.1 for design of the isolation system and for testing of prototype isolator units.

17.2.7.1 Isolator Unit Vertical Load Combinations

The average, minimum and maximum vertical load on each isolator unit type shall be computed from application of horizontal seismic forces, Q_E , due to MCE_R ground motions and the following applicable vertical load combinations:

1. Average vertical load: load corresponding to 1.0 dead load plus 0.5 live load.
2. Maximum vertical load: load combination 5 of Section 2.3.2, where E is given by Eq. 12.4-1 and S_{DS} is replaced by S_{MS} in Eq. (12.4-4).
3. Minimum vertical load: load combination 7 of Section 2.3.2, where E is given by Eq. 12.4-2 and S_{DS} is replaced by S_{MS} in Eq. (12.4-4).

17.2.8 Isolation System Properties

17.2.8.1 Isolation System Component Types

All components of the isolation system shall be categorized and grouped in terms of common type and size of isolator unit and common type and size of supplementary damping device, if such devices are also components of the isolation system.

17.2.8.2 Isolator Unit Nominal Properties

Isolator unit type nominal design properties shall be based on average properties over the three cycles of prototype testing, specified by Item 2 of Section 17.8.2.2. Variation in isolator unit properties with vertical load are permitted to be established based on a single representative deformation cycle by averaging the properties determined using the three vertical load combinations specified in Section 17.2.7.1, at each displacement level, where required to be considered by Section 17.8.2.2.

EXCEPTION: If the measured values of isolator unit effective stiffness and effective damping for vertical load 1 of Section 17.2.7.1 differ by less than 15% from the those based on the average of measured values for the three vertical load combinations of Section 17.3.2, then nominal design properties are permitted to be computed only for load combination 1 of Section 17.2.7.1

17.2.8.3 Bounding Properties of Isolation System Components

Bounding properties of isolation system components shall be developed for each isolation system component type. Bounding properties shall include variation in all of the following component properties:

1. measured by prototype testing, Item 2 of Section 17.8.2.2, considering variation in prototype isolator unit properties due to required variation in vertical test load, rate of test loading or velocity effects, effects of heating during cyclic motion, history of loading, scragging (temporary degradation of mechanical properties with repeated cycling) and other potential sources of variation measured by prototype testing,
2. permitted by manufacturing specification tolerances used to determine acceptability of production isolator units, as required by Section 17.8.6, and
3. due to aging and environmental effects including creep, fatigue, contamination, operating temperature and duration of exposure to that temperature, and wear over the life of the structure.

17.2.8.4 Property Modification Factors

Maximum and minimum property modification (λ) factors shall be used to account for variation of the nominal design parameters of each isolator unit type for the effects of heating due to cyclic dynamic motion, loading rate, scragging and recovery, variability in production bearing properties, temperature, aging, environmental exposure and contamination. When manufacturer-specific qualification test data in accordance with 17.8.1.2 has been approved by the registered design professional, these data may be used to develop the property modification factors and the maximum and minimum limits of Eqs. 17.2-1 and 17.2-2 need not apply. When qualification test data in accordance with 17.8.1.2 have not been approved by the registered design professional, the maximum and minimum limits of Eqs. 17.2-1 and 17.2-2 shall apply.

Property modification factors (λ) shall be developed for each isolator unit type and when applied to the nominal design parameters shall envelope the hysteretic response for the range of demands from $\pm 0.5D_M$ up to and including the maximum displacement, $\pm D_M$. Property modification factors for environmental conditions are permitted to be developed from data that need not satisfy the similarity requirements of Section 17.8.2.7

For each isolator unit type, the maximum property modification factor, λ_{max} , and the minimum property modification factor, λ_{min} , shall be established from contributing property modification factors in accordance with Eq. 17.2-1 and Eq. 17.2-2, respectively:

$$\lambda_{max} = (1 + (0.75 * (\lambda_{(ae, max)} - 1))) * \lambda_{(test, max)} * \lambda_{(spec, max)} \geq 1.8 \quad (17.2-1)$$

$$\lambda_{min} = (1 - (0.75 * (1 - \lambda_{(ae, min)}))) * \lambda_{(test, min)} * \lambda_{(spec, min)} \leq 0.80 \quad (17.2-2)$$

where

- $\lambda_{(ae, max)}$ = property modification factor for calculation of the maximum value of the isolator property of interest, used to account for aging effects and environmental conditions
- $\lambda_{(ae, min)}$ = property modification factor used to calculate the minimum value of the isolator property of interest, used to account for aging effects and environmental conditions
- $\lambda_{(test, max)}$ = property modification factor used to calculate the maximum value of the isolator property of interest, used to account for heating, rate of loading, and scragging
- $\lambda_{(test, min)}$ = property modification factor used to calculate the minimum value of the isolator property of interest, used to account for heating, rate of loading, and scragging
- $\lambda_{(spec, max)}$ = property modification factor used to calculate the maximum value of the isolator property of interest, used to account for permissible manufacturing variation on the average properties of a group of same sized isolators
- $\lambda_{(spec, min)}$ = property modification factor used to calculate the minimum value of the isolator property of interest, used to account for permissible manufacturing variation on the average properties of a group of same sized isolators

17.2.8.5 Upper-Bound and Lower-Bound Force-Deflection Behavior of Isolation System Components

A mathematical model of upper-bound force-deflection (loop) behavior of each type of isolation system component shall be developed. Upper-bound force-deflection behavior of isolation system components that are essentially hysteretic devices (e.g., isolator units) shall be modeled using the maximum values of isolator properties calculated using the property modification factors of Section 17.2.8.4. Upper-bound force-deflection behavior of isolation system components that are essentially viscous devices (e.g., supplementary viscous dampers), shall be modeled in accordance with the requirements of Chapter 18 for such devices.

A mathematical model of lower-bound force-deflection (loop) behavior of each type of isolation system component shall be developed. Lower-bound force-deflection behavior of isolation system components that are essentially hysteretic devices (e.g., isolator units) shall be modeled using the minimum values of isolator properties calculated using the property modification factors of Section 17.2.8.4. Lower-bound force-deflection behavior of isolation system components that are essentially viscous devices (e.g., supplementary viscous dampers), shall be modeled in accordance with the requirements of Chapter 18 for such devices.

17.2.8.6 Isolation System Properties at Maximum Displacements

The effective stiffness, k_M , of the isolation system at the maximum displacement, D_M , shall be computed using both upper-bound and lower-bound force-deflection behavior of individual isolator units, in accordance with Eq. 17.2-3:

$$k_M = \frac{\sum |F_M^+| + \sum |F_M^-|}{2D_M} \quad (17.2-3)$$

The effective damping, β_M , of the isolation system at the maximum displacement, D_M , in inches (mm) shall be computed using both upper-bound and lower-bound force-deflection behavior of individual isolator units, in accordance with Eq. 17.2-4:

$$\beta_M = \frac{\sum E_M}{2\pi k_M D_M^2} \quad (17.2-4)$$

where

- $\sum E_M$ = total energy dissipated, in kips-in. (kN-mm), in the isolation system during a full cycle of response at the displacement D_M
- $\sum F_M^+$ = sum, for all isolator units, of the absolute value of force, in kips (kN), at a positive displacement equal to D_M
- $\sum F_M^-$ = sum, for all isolator units, of the absolute value of force, in kips (kN), at a negative displacement equal to D_M

17.3 SEISMIC GROUND MOTION CRITERIA

17.3.1 Site-Specific Seismic Hazard

The MCE_R response spectrum requirements of Section 11.4.5 and 11.4.6 are permitted to be used to determine the MCE_R response spectrum for the site of interest. The site-specific ground motion procedures set forth in Chapter 21 are also permitted to be used to determine ground motions for any isolated structure. For isolated structures on Site Class F sites, site response analysis shall be performed in accordance with Section 21.1.

17.3.2 MCE_R Response Spectra and Spectral Response Acceleration Parameters, S_{MS} , S_{M1}

The MCE_R response spectrum shall be the MCE_R response spectrum of 11.4.5, 11.4.6 or 11.4.7. The MCE_R response spectral acceleration parameters S_{MS} and S_{M1} shall be determined in accordance with Section 11.4.3, 11.4.5, 11.4.6, or 11.4.7.

17.3.4 MCE_R Ground Motion Records

Where response history analysis procedures are used, MCE_R ground motions shall consist of not less than seven pairs of horizontal acceleration components selected and scaled from individual recorded events having magnitudes, fault distance and source mechanisms that are consistent with those that control the maximum considered earthquake (MCE_R). Amplitude or spectral matching is permitted to scale the ground motions. Where the required number of recorded ground motion pairs is not available, simulated ground motion pairs are permitted to make up the total number required.

For each pair of horizontal ground motion components, a square root of the sum of the squares (SRSS) spectrum shall be constructed by taking the SRSS of the 5 percent-damped response spectra for the scaled components (when amplitude scaling is used an identical scale factor is applied to both components of a pair). Each pair of motions shall be scaled such that in the period range from $0.75 T_M$, determined using upper bound isolation system properties, to $1.25 T_M$, determined using lower bound isolation system properties, the average of the SRSS spectral from all horizontal component pairs does not fall below the corresponding ordinate of the response spectrum used in the design (MCE_R), determined in accordance with Section 11.4.6 or 11.4.7.

For records that are spectrally matched each pair of motions shall be scaled such that in the period range from $0.2 T_M$, determined using upper bound properties, to $1.25 T_M$, determined using lower bound properties, the response spectrum of one component of the pair is at least 90% of the corresponding ordinate of the response spectrum used in the design determined in accordance with Section 11.4.6 or 11.4.7.

For sites within 3 miles (5 km) of the active fault that controls the hazard, spectral matching shall not be utilized unless the pulse characteristics of the near field ground motions are included in the site specific response spectra, and pulse characteristics when present in individual ground motions are retained after the matching process has been completed.

At sites within 3 miles (5 km) of the active fault that controls the hazard, each pair of components shall be rotated to the fault-normal and fault-parallel directions of the causative fault and shall be scaled so that the average spectrum of the fault normal components is not less than the MCE_R spectrum and the average spectrum of the fault-parallel components is not less than 50% of the MCE_R response spectrum for the period range $0.2 T_M$, determined using upper bound properties, to $1.25 T_M$, determined using lower bound properties.

17.4 ANALYSIS PROCEDURE SELECTION

Seismically isolated structures except those defined in Section 17.4.1 shall be designed using the dynamic procedures of Section 17.6.

17.4.1 Equivalent Lateral Force Procedure

The equivalent lateral force procedure of Section 17.5 is permitted to be used for design of a seismically isolated structure and where applicable the following requirements shall be evaluated separately for upper-bound and lower-bound isolation system properties and the more restrictive requirement shall govern. All of the following items shall be satisfied for use of the equivalent lateral force procedure.

1. The structure is located on a Site Class A, B, C and D.

2. The effective period of the isolated structure at the maximum displacement, D_M , is less than or equal to 5.0s.
3. The effective damping of the isolation system at the maximum displacement, D_M , is less than or equal to 30%.
4. The effective period of the isolated structure T_M is greater than three times the elastic, fixed-base period of the structure above the isolation system determined using a rational modal analysis.
5. The structure above the isolation system does not have a structural irregularity, as defined in Section 17.2.2.
6. The isolation system meets all of the following criteria:
 - a. The effective stiffness of the isolation system at the maximum displacement is greater than one-third of the effective stiffness at 20 percent of the maximum displacement.
 - b. The isolation system is capable of producing a restoring force as specified in Section 17.2.4.4.
 - c. The isolation system does not limit maximum earthquake displacement to less than the total maximum displacement, D_{TM} .

17.4.2 Dynamic Procedures

The dynamic procedures of Section 17.6 are permitted to be used as specified in this section.

17.4.2.1 Response Spectrum Analysis Procedure

Response spectrum analysis procedure shall not be used for design of a seismically isolated structure unless the structure and isolation system meet the criteria of Section 17.4.1 Items 1, 2, 3, 4 and 6.

17.4.2.2 Response History Analysis Procedure

The response history analysis procedure is permitted to be used for design of any seismically isolated structure and shall be used for design of all seismically isolated structures not meeting the criteria of Section 17.4.2.1.

17.5 EQUIVALENT LATERAL FORCE PROCEDURE

17.5.1 General

Where the equivalent lateral force procedure is used to design seismically isolated structures, the requirements of this section shall apply.

17.5.2 Deformation Characteristics of the Isolation System

Minimum lateral earthquake design displacements and forces on seismically isolated structures shall be based on the deformation characteristics of the isolation system. The deformation characteristics of the isolation system includes the effects of the wind-restraint system if such a system is used to meet the design requirements of this standard. The deformation characteristics of the isolation system shall be based on properly substantiated prototype tests performed in accordance with Section 17.8 and incorporate property modification factors in accordance with Section 17.2.8.

The analysis of the isolation system and structure shall be performed separately for upper-bound and lower-bound properties, and the governing case for each response parameter of interest shall be used for design.

17.5.3 Minimum Lateral Displacements Required for Design

17.5.3.1 Maximum Displacement

The isolation system shall be designed and constructed to withstand, as a minimum, the maximum displacement, D_M , determined using upper-bound and lower-bound properties, in the most critical direction of horizontal response, calculated using Eq. 17.5-1:

$$D_M = \frac{g S_{M1} T_M}{4\pi^2 B_M} \quad (17.5-1)$$

where

- g = acceleration due to gravity, in units of in./s² (mm/s²) if the units of the displacement D_M are in in. (mm)
- S_{M1} = MCE_R 5-percent damped spectral acceleration parameter at 1-s period in units of g -sec., as determined in Section 11.4.5
- T_M = effective period of the seismically isolated structure in seconds at the displacement D_M in the direction under consideration, as prescribed by Eq. 17.5-2
- B_M = numerical coefficient as set forth in Table 17.5-1 for the effective damping of the isolation system β_M , at the displacement D_M

Table 17.5-1 Damping Coefficient, B_d or B_m

Effective Damping, β_D or β_M (percentage of critical) ^{a,b}	B_D or B_M Factor
≤ 2	0.8
5	1.0
10	1.2
20	1.5
30	1.7
40	1.9
≥ 50	2.0

^aThe damping coefficient shall be based on the effective damping of the isolation system determined in accordance with the requirements of Section 17.2.8.6.

^bThe damping coefficient shall be based on linear interpolation for effective damping values other than those given.

17.5.3.2 Effective Period at the Maximum Displacement

The effective period of the isolated structure, T_M , at the maximum displacement, D_M , shall be determined using upper-bound and lower-bound deformational characteristics of the isolation system and Eq. 17.5-2:

$$T_M = 2\pi \sqrt{\frac{W}{k_M g}} \quad (17.5-2)$$

where

- W = effective seismic weight of the structure above the isolation interface as defined in Section 12.7.2
- k_M = effective stiffness in kips/in. (kN/mm) of the isolation system at the maximum displacement, D_M , as prescribed by Eq. 17.2-3
- g = acceleration due to gravity, in units of in./s² (mm/s²) if the units of k_M are in kips/in. (kN/mm)

17.5.3.3 Total Maximum Displacement

The total maximum displacement, D_{TM} , of elements of the isolation system shall include additional displacement due to actual and accidental torsion calculated from the spatial distribution of the lateral stiffness of the isolation system and the most disadvantageous location of eccentric mass. The total maximum displacement, D_{TM} , of elements of an isolation system shall not be taken as less than that prescribed by Eq. 17.5-3:

$$D_{TM} = D_M \left[1 + \left(\frac{y}{P_T} \right) \frac{12e}{b^2 + d^2} \right] \quad (17.5-3)$$

where

D_M = displacement at the center of rigidity of the isolation system in the direction under consideration as prescribed by Eq. 17.5-1

y = the distance in in. (mm) between the centers of rigidity of the isolation system and the element of interest measured perpendicular to the direction of seismic loading under consideration

e = the actual eccentricity measured in plan between the center of mass of the structure above the isolation interface and the center of rigidity of the isolation system, plus accidental eccentricity, in ft. (mm), taken as 5 percent of the longest plan dimension of the structure perpendicular to the direction of force under consideration

b = the shortest plan dimension of the structure in ft. (mm) measured perpendicular to d

d = the longest plan dimension of the structure in ft. (mm) measured perpendicular to b

P_T = ratio of the effective translational period of the isolation system to the effective torsional period of the isolation system, as calculated by dynamic analysis or as prescribed by Eq. 17.5-4, but need not be taken as less than 1.0

$$P_T = \frac{1}{r_l} \sqrt{\frac{\sum_{i=1}^N (x_i^2 + y_i^2)}{N}} \quad (17.5-4)$$

where:

x_i, y_i = horizontal distances in ft. (mm) from the center of mass to the i^{th} isolator unit in the two horizontal axes of the isolation system

N = number of isolator units

r_l = radius of gyration of the isolation system in ft. (mm), which is equal to $(b^2 + d^2)^{1/2}/12$ for isolation systems of rectangular plan dimension, $b \times d$

b = the shortest plan dimension of the structure in ft. (mm) measured perpendicular to d

d = the longest plan dimension of the structure in ft. (mm) measured perpendicular to b

The total maximum displacement, D_{TM} , shall not be taken as less than 1.1 times D_M .

17.5.4 Minimum Lateral Forces Required for Design

17.5.4.1 Isolation System and Structural Elements below the Base Level

The isolation system, the foundation, and all structural elements below the base level shall be designed and constructed to withstand a minimum lateral seismic force, V_b , using all of the applicable requirements for

a non-isolated structure and as prescribed by the value of Eq. 17.5-5, determined using both upper-bound and lower-bound isolation system properties:

$$V_b = k_M D_M \quad (17.5-5)$$

where

k_M = effective stiffness, in kips/in. (kN/mm), of the isolation system at the displacement D_M , as prescribed by Eq. 17.2-3

D_M = maximum displacement, in in. (mm), at the center of rigidity of the isolation system in the direction under consideration, as prescribed by Eq. 17.5-3

V_b shall not be taken as less than the maximum force in the isolation system at any displacement up to and including the maximum displacement D_M , as defined in Section 17.5.3.

Overturning loads on elements of the isolation system, the foundation, and structural elements below the base level due to lateral seismic force V_b shall be based on the vertical distribution of force of Section 17.5.5, except that the unreduced lateral seismic design force V_{st} shall be used in lieu of V_s in Eq. 17.5-9.

17.5.4.2 Structural Elements above the Base Level

The structure above the base level shall be designed and constructed using all of the applicable requirements for a non-isolated structure for a minimum shear force, V_s , determined using upper-bound and lower-bound isolation system properties, as prescribed by Eq. 17.5-6:

$$V_s = \frac{V_{st}}{R_I} \quad (17.5-6)$$

where

R_I = numerical coefficient related to the type of seismic force-resisting system above the isolation system

V_{st} = total unreduced lateral seismic design force or shear on elements above the base level, as prescribed by Eq. 17.5-7

The R_I factor shall be based on the type of seismic force-resisting system used for the structure above the base level in the direction of interest and shall be three-eighths of the value of R given in Table 12.2-1, with a maximum value not greater than 2.0 and a minimum value not less than 1.0.

EXCEPTION: The value of R_I is permitted to be taken greater than 2.0, provided the strength of structure above the base level in the direction of interest, as determined by nonlinear static analysis at a roof displacement corresponding to a maximum story drift the lesser of the MCE design drift or $0.015 h_{sx}$, is not less than 1.1 times V_b .

The total unreduced lateral seismic force or shear on elements above the base level shall be determined using upper-bound and lower-bound isolation system properties, as prescribed by Eq. 17.5-7:

$$V_{st} = V_b \left(\frac{W_s}{W} \right)^{(1-2.5\beta_M)} \quad (17.5-7)$$

where

W = effective seismic weight, in kips (kN) of the structure above the isolation interface as defined in Section 12.7.2, in kip (kN)

W_s = effective seismic weight, in kips (kN) of the structure above the isolation interface as defined in Section 12.7.2, in kips (kN), excluding the effective seismic weight, in kips (kN), of the base level

The effective seismic weight W_s in Equation 17.5.7 shall be taken as equal to W when the average distance from top of isolator to the underside of base level floor framing above the isolators exceeds 3 feet.

EXCEPTION: For isolation systems whose hysteretic behavior is characterized by an abrupt transition from pre-yield to post-yield or pre-slip to post-slip behavior, the exponent term $(1-2.5\beta_M)$ in equation (17.5-7) shall be replaced by $(1-3.5\beta_M)$.

17.5.4.3 Limits on V_s

The value of V_s shall not be taken as less than each of the following:

1. The lateral seismic force required by Section 12.8 for a fixed-base structure of the same effective seismic weight, W_s , and a period equal to the period of the isolation system using the upper bound properties T_M .
2. The base shear corresponding to the factored design wind load.
3. The lateral seismic force, V_{st} , calculated using Eq. 17.5-7, and with V_b set equal to the force required to fully activate the isolation system utilizing the greater of the upper bound properties, or
 - a. 1.5 times the nominal properties, for the yield level of a softening system,
 - b. the ultimate capacity of a sacrificial wind-restraint system,
 - c. the break-away friction force of a sliding system, or
 - d. the force at zero displacement of a sliding system following a complete dynamic cycle of motion at D_M .

17.5.5 Vertical Distribution of Force

The lateral seismic force V_s shall be distributed over the height of the structure above the base level, using upper-bound and lower-bound isolation system properties, using the following equations:

$$F_1 = (V_b - V_{st}) / R_I \quad (17.5-8)$$

and

$$F_x = C_{vx} V_s \quad (17.5-9)$$

$$C_{vx} = \frac{w_x h_x^k}{\sum_{i=2}^n w_i h_i^k} \quad (17.5-10)$$

and

$$k = 14\beta_M T_{fb} \quad (17.5-11)$$

and

where

F_1 = lateral seismic force, in kips (or kN) induced at Level 1, the base level

F_x = lateral seismic force, in kips (or kN) induced at Level x , $x > 1$

C_{vx} = vertical distribution factor

V_s = total lateral seismic design force or shear on elements above the base level as prescribed by Eq. 17.5-6 and the limits of Section 17.5.4.3

w_x = portion of W_s that is located at or assigned to Level i or x

h_x = height above the isolation interface of Level i or x

T_{fb} = the fundamental period, in s, of the structure above the isolation interface determined using a rational modal analysis assuming fixed-base conditions

EXCEPTION: In lieu of Equation (17.5-7 and 17.5-9), the lateral seismic force F_x is permitted to be calculated as the average value of the force at Level x in the direction of interest using the results of a simplified stick model of the building and a lumped representation of the isolation system using response history analysis scaled to V_b/R_I at the base level.

17.5.6 Drift Limits

The maximum story drift of the structure above the isolation system shall not exceed $0.015h_{sx}$. The drift shall be calculated by Eq. 12.8-15 with C_d for the isolated structure equal to R_I as defined in Section 17.5.4.2.

17.6 DYNAMIC ANALYSIS PROCEDURES

17.6.1 General

Where dynamic analysis is used to design seismically isolated structures, the requirements of this section shall apply.

17.6.2 Modeling

The mathematical models of the isolated structure including the isolation system, the seismic force-resisting system, and other structural elements shall conform to Section 12.7.3 and to the requirements of Sections 17.6.2.1 and 17.6.2.2.

17.6.2.1 Isolation System

The isolation system shall be modeled using deformational characteristics developed in accordance with Section 17.2.8. The lateral displacements and forces shall be computed separately for upper-bound and lower-bound isolation system properties as defined in Section 17.2.8.5. The isolation system shall be modeled with sufficient detail to capture all of the following:

1. Spatial distribution of isolator units.
2. Translation, in both horizontal directions, and torsion of the structure above the isolation interface considering the most disadvantageous location of eccentric mass.
3. Overturning/uplift forces on individual isolator units.
4. Effects of vertical load, bilateral load, and/or the rate of loading if the force-deflection properties of the isolation system are dependent on one or more of these attributes.

The total maximum displacement, D_{TM} , across the isolation system shall be calculated using a model of the isolated structure that incorporates the force-deflection characteristics of nonlinear elements of the isolation system and the seismic force-resisting system.

17.6.2.2 Isolated Structure

The maximum displacement of each floor and design forces and displacements in elements of the seismic force-resisting system are permitted to be calculated using a linear elastic model of the isolated structure provided that all elements of the seismic force-resisting system of the structure above the isolation system remain essentially elastic.

Seismic force-resisting systems with essentially elastic elements include, but are not limited to, regular structural systems designed for a lateral force not less than 100 percent of V_s determined in accordance with Sections 17.5.4.2 and 17.5.4.3.

The analysis of the isolation system and structure shall be performed separately for upper-bound and lower-bound properties, and the governing case for each response parameter of interest shall be used for design.

17.6.3 Description of Procedures

17.6.3.1 General

Response-spectrum analysis shall be performed in accordance with Section 12.9 and the requirements of Section 17.6.3.3. Response history analysis shall be performed in accordance with the requirements of Section 17.6.3.4.

17.6.3.2 MCE_R Ground Motions

The MCE_R ground motions of Section 17.3 shall be used to calculate the lateral forces and displacements in the isolated structure, the total maximum displacement of the isolation system, and the forces in the isolator units, isolator unit connections, and supporting framing immediately above and below the isolators used to resist isolator $P-\Delta$ demands.

17.6.3.3 Response-Spectrum Analysis Procedure

Response-spectrum analysis shall be performed using a modal damping value for the fundamental mode in the direction of interest not greater than the effective damping of the isolation system or 30 percent of critical, whichever is less. Modal damping values for higher modes shall be selected consistent with those that would be appropriate for response-spectrum analysis of the structure above the isolation system assuming a fixed base.

Response-spectrum analysis used to determine the total maximum displacement shall include simultaneous excitation of the model by 100 percent of the ground motion in the critical direction and 30 percent of the ground motion in the perpendicular, horizontal direction. The maximum displacement of the isolation system shall be calculated as the vector sum of the two orthogonal displacements.

17.6.3.4 Response-History Analysis Procedure

Response-history analysis shall be performed for a set of ground motion pairs selected and scaled in accordance with Section 17.3.2. Each pair of ground motion components shall be applied simultaneously to the model considering the most disadvantageous location of eccentric mass. The maximum displacement of the isolation system shall be calculated from the vectorial sum of the two orthogonal displacements at each time step.

The parameters of interest shall be calculated for each ground motion used for the response-history analysis and the average value of the response parameter of interest shall be used for design.

For sites identified as near fault each pair of horizontal ground motion components shall be rotated to the fault-normal and fault-parallel directions of the causative faults and applied to the building in such orientation.

For all other sites, individual pairs of horizontal ground motion components need not be applied in multiple orientations.

17.6.3.4.1 Accidental Mass Eccentricity

Torsional response resulting from lack of symmetry in mass and stiffness shall be accounted for in the analysis. In addition, accidental eccentricity consisting of displacement of the center-of-mass from the computed location by an amount equal to 5% of the diaphragm dimension, separately in each of two orthogonal directions at the level under consideration.

The effects of accidental eccentricity are permitted to be accounted for by amplifying forces, drifts and deformations determined from an analysis using only the computed center-of-mass, provided that factors used to amplify forces, drifts and deformations of the center-of-mass analysis are shown to produce results that bound all the mass-eccentric cases.

17.6.4 Minimum Lateral Displacements and Forces

17.6.4.1 Isolation System and Structural Elements below the Base Level

The isolation system, foundation, and all structural elements below the base level shall be designed using all of the applicable requirements for a non-isolated structure and the forces obtained from the dynamic analysis without reduction, but the design lateral force shall not be taken as less than 90 percent of V_b determined by Eq. 17.5-5.

The total maximum displacement of the isolation system shall not be taken as less than 80 percent of D_{TM} as prescribed by Section 17.5.3.3 except that D'_M is permitted to be used in lieu of D_M where:

$$D'_M = \frac{D_M}{\sqrt{1 + (T/T_M)^2}} \quad (17.6-1)$$

and

D_M = maximum displacement in in. (mm), at the center of rigidity of the isolation system in the direction under consideration, as prescribed by Eq. 17.5-1

T = elastic, fixed-base period, in s, of the structure above the isolation system as determined by Section 12.8.2, and including the coefficient C_u , if the approximate period formulas are used to calculate the fundamental period

T_M = effective period, in s, of the seismically isolated structure, at the displacement D_M in the direction under consideration, as prescribed by Eq. 17.5-2

17.6.4.2 Structural Elements above the Base Level

Subject to the procedure-specific limits of this section, structural elements above the base level shall be designed using the applicable requirements for a non-isolated structure and the forces obtained from the dynamic analysis reduced by a factor of R_I as determined in accordance with Section 17.5.4.2.

For response spectrum analysis, the design shear at any story shall not be less than the story shear resulting from application of the forces calculated using Eq. 17.5-9 and a value of V_b equal to the base shear obtained from the response-spectrum analysis in the direction of interest.

For response history analysis of regular structures, the value of V_b shall not be taken as less than 80 percent of that determined in accordance with 17.5.4.1, and the value V_s shall not be taken as less than 100 percent of the limits specified by Section 17.5.4.3.

For response history analysis of irregular structures, the value of V_b shall not be taken as less than 100 percent of that determined in accordance with 17.5.4.1, and the value V_s shall not be taken as less than 100 percent of the limits specified by Section 17.5.4.3.

17.6.4.3 Scaling of Results

Where the factored lateral shear force on structural elements, determined using either response-spectrum or response-history procedure, is less than the minimum values prescribed by Sections 17.6.4.1 and 17.6.4.2, all design parameters shall be adjusted upward proportionally.

17.6.4.4 Drift Limits

Maximum story drift corresponding to the design lateral force including displacement due to vertical deformation of the isolation system shall comply with either of the following limits:

1. Where response spectra analysis is used the maximum story drift of the structure above the isolation system shall not exceed $0.015h_{sx}$.
2. Where response history analysis based on the force-deflection characteristics of nonlinear elements of the seismic force-resisting system is used the maximum story drift of the structure above the isolation system shall not exceed $0.020h_{sx}$.

Drift shall be calculated using Eq. 12.8-15 with the C_d of the isolated structure equal to R_I as defined in Section 17.5.4.2.

The secondary effects of the maximum lateral displacement of the structure above the isolation system combined with gravity forces shall be investigated if the story drift ratio exceeds $0.010/R_I$.

17.7 DESIGN REVIEW

An independent design review of the isolation system and related test programs shall be performed by one or more individuals possessing knowledge of the following items with a minimum of one reviewer being a registered design professional. Isolation system design review shall include, but not be limited to, all of the following:

1. Project design criteria including site-specific spectra and ground motion histories.
2. Preliminary design including the selection of the devices, determination of the total design displacement, the total maximum displacement, and the lateral force level.
3. Review of qualification data and appropriate property modification factors for the manufacturer and device selected.
4. Prototype testing program (Section 17.8).
5. Final design of the entire structural system and all supporting analyses including modelling of isolators for response history analysis if performed.
6. Isolator production testing program (Section 17.8.5).

17.8 TESTING

17.8.1 General

The deformation characteristics and damping values of the isolation system used in the design and analysis of seismically isolated structures shall be based on tests of a selected sample of the components prior to construction as described in this section. The isolation system components to be tested shall include the wind-restraint system if such a system is used in the design.

The tests specified in this section are for establishing and validating the isolator unit and isolation system test properties which are used to determine design properties of the isolation system in accordance Section 17.2.8.

17.8.1.2 Qualification Tests

Isolation device manufacturers shall submit for approval by the registered design professional the results of qualification tests, analysis of test data and supporting scientific studies that may be used to quantify the effects of heating due to cyclic dynamic motion, loading rate, scragging, variability and uncertainty in production bearing properties, temperature, aging, environmental exposure, and contamination. The qualification testing shall be applicable to the component types, models, materials and sizes to be used in the construction. The qualification testing shall have been performed on components manufactured by the same manufacturer supplying the components to be used in the construction. When scaled specimens are

used in the qualification testing, principles of scaling and similarity shall be used in the interpretation of the data.

17.8.2 Prototype Tests

Prototype tests shall be performed separately on two full-size specimens (or sets of specimens, as appropriate) of each predominant type and size of isolator unit of the isolation system. The test specimens shall include the wind-restraint system if such a system is used in the design. Specimens tested shall not be used for construction unless accepted by the registered design professional responsible for the design of the structure.

17.8.2.1 Record

For each cycle of each test, the force-deflection behavior of the test specimen shall be recorded.

17.8.2.2 Sequence and Cycles

Each of The following sequence of tests shall be performed for the prescribed number of cycles at a vertical load equal to the average dead load plus one-half the effects due to live load on all isolator units of a common type and size:

1. Twenty fully reversed cycles of loading at a lateral force corresponding to the wind design force.
2. The sequence of either item (a) or item (b) below shall be performed:
 - a. Three fully reversed cycles of loading at each of the following increments of the displacement — $0.25D_M$, $0.5D_M$, $0.67D_M$, and $1.0D_M$ where D_M is determined in Section 17.5.3.1 or Section 17.6, as appropriate.
 - b. The following sequence, performed dynamically at the effective period, T_M : continuous loading of one fully-reversed cycle at each of the following increments of the total maximum displacement $1.0 D_M$, $0.67 D_M$, $0.5 D_M$ and $0.25 D_M$ followed by continuous loading of one fully-reversed cycle at $0.25 D_M$, $0.5 D_M$, $0.67 D_M$, and $1.0 D_M$. A rest interval is permitted between these two sequences.
3. Three fully reversed cycles of loading at the maximum displacement, $1.0D_M$.
4. The sequence of either item (a) or item (b) below shall be performed:
 - a. $30S_{MI}/(S_{MS}B_M)$, but not less than 10, continuous fully reversed cycles of loading at 0.75 times the total maximum displacement, $0.75D_M$.
 - b. The test of 17.8.2.2.4. (a), performed dynamically at the effective period, T_M . This test may comprise separate sets of multiple cycles of loading, with each set consisting of not less than five continuous cycles.

If an isolator unit is also a vertical-load-carrying element, then item 2 of the sequence of cyclic tests specified in the preceding text shall be performed for two additional vertical load cases specified in Section 17.2.7.1. The load increment due to earthquake overturning, Q_E , shall be equal to or greater than the peak earthquake vertical force response corresponding to the test displacement being evaluated. In these tests, the combined vertical load shall be taken as the typical or average downward force on all isolator units of a common type and size. Axial load and displacement values for each test shall be the greater of those determined by analysis using upper-bound and lower-bound values of isolation system properties determined in accordance with Section 17.2.8.5. The effective period T_M shall be the lower of those determined by analysis using upper-bound and lower-bound values.

17.8.2.3 Dynamic Testing

Tests specified in Section 17.8.2.2 shall be performed dynamically at the lower of the effective periods, T_M , determined using upper-bound and lower-bound properties.

Dynamic testing shall not be required if the prototype testing has been performed dynamically on similar sized isolators meeting the requirements of Section 17.8.2.7, and the testing was conducted at similar loads and accounted for the effects of velocity, amplitude of displacement, and heating affects.

Only if full scale testing is not possible reduced-scale prototype specimens can be used to quantify rate-dependent properties of isolators. The reduced-scale prototype specimens shall be of the same type and material and be manufactured with the same processes and quality as full-scale prototypes and shall be tested at a frequency that represents full-scale prototype loading rates

17.8.2.4 Units Dependent on Bilateral Load

If the force-deflection properties of the isolator units exhibit bilateral load dependence, the tests specified in Sections 17.8.2.2 and 17.8.2.3 shall be augmented to include bilateral load at the following increments of the total design displacement, D_M : 0.25 and 1.0, 0.5 and 1.0, 0.67 and 1.0, and 1.0 and 1.0.

If reduced-scale specimens are used to quantify bilateral-load-dependent properties they shall meet the requirements of Section 17.8.2.7. The reduced-scale specimens shall be of the same type and material and manufactured with the same processes and quality as full-scale prototypes.

The force-deflection properties of an isolator unit shall be considered to be dependent on bilateral load if the effective stiffness where subjected to bilateral loading is different from the effective stiffness where subjected to unilateral loading, by more than 15 percent.

17.8.2.5 Maximum and Minimum Vertical Load

Isolator units that carry vertical load shall be subjected to one fully reversed cycle of loading at the total maximum displacement, D_{TM} , and at each of the vertical loads corresponding to the maximum and minimum downward vertical loads as specified in Section 17.2.7.1 on any one isolator of a common type and size. Axial load and displacement values for each test shall be the greater of those determined by analysis using the upper-bound and lower-bound values of isolation system properties determined in accordance with Section 17.2.8.5.

EXCEPTION: In lieu of envelope values for a single test, it shall be acceptable to perform two tests, one each for the combination of vertical load and horizontal displacement obtained from analysis using the upper-bound and lower-bound values of isolation system properties, respectively, determined in accordance with Section 17.2.8.5.

17.8.2.6 Sacrificial Wind-Restraint Systems

If a sacrificial wind-restraint system is to be utilized, its ultimate capacity shall be established by test.

17.8.2.7 Testing Similar Units

Prototype tests need not be performed if an isolator unit when compared to another tested unit, complies with all of the following criteria:

1. The isolator design is not more than 15% larger nor more than 30% smaller than the previously tested prototype, in terms of governing device dimensions; and
2. Is of the same type and materials; and
3. Has an energy dissipated per cycle, E_{loop} , that is not less than 85% of the previously tested unit, and
4. Is fabricated by the same manufacturer using the same or more stringent documented manufacturing and quality control procedures.
5. For elastomeric type isolators, the design shall not be subject to a greater shear strain nor greater vertical stress than that of the previously tested prototype.

6. For sliding type isolators, the design shall not be subject to a greater vertical stress or sliding velocity than that of the previously tested prototype using the same sliding material.

The prototype testing exemption above shall be approved by independent design review, as specified in Section 17.7.

17.8.3 Determination of Force-Deflection Characteristics

The force-deflection characteristics of an isolator unit shall be based on the cyclic load tests of prototype isolators specified in Section 17.8.2.

As required, the effective stiffness of an isolator unit, k_{eff} , shall be calculated for each cycle of loading as prescribed by Eq. 17.8-1:

$$k_{\text{eff}} = \frac{|F^+| + |F^-|}{|\Delta^+| + |\Delta^-|} \quad (17.8-1)$$

where F^+ and F^- are the positive and negative forces, at the maximum positive and minimum negative displacements Δ^+ and Δ^- , respectively.

As required, the effective damping, β_{eff} , of an isolator unit shall be calculated for each cycle of loading by Eq. 17.8-2:

$$\beta_{\text{eff}} = \frac{2}{\pi} \frac{E_{\text{loop}}}{k_{\text{eff}} (|\Delta^+| + |\Delta^-|)^2} \quad (17.8-2)$$

where the energy dissipated per cycle of loading, E_{loop} , and the effective stiffness, k_{eff} , shall be based on peak test displacements of Δ^+ and Δ^- .

As required, the post-yield stiffness, k_d , of each isolator unit shall be calculated for each cycle of loading using the following assumptions:

1. A test loop shall be assumed to have a bilinear hysteretic characteristics with values of k_l , k_d , F_o , F_y , k_{eff} , and E_{loop} as shown in Figure 17.8.3-1
2. The computed loop shall have the same values of effective stiffness, k_{eff} , and energy dissipated per cycle of loading, E_{loop} , as the test loop.
3. The assumed value of k_l shall be a visual fit to the elastic stiffness of the isolator unit during unloading immediately after D_M .

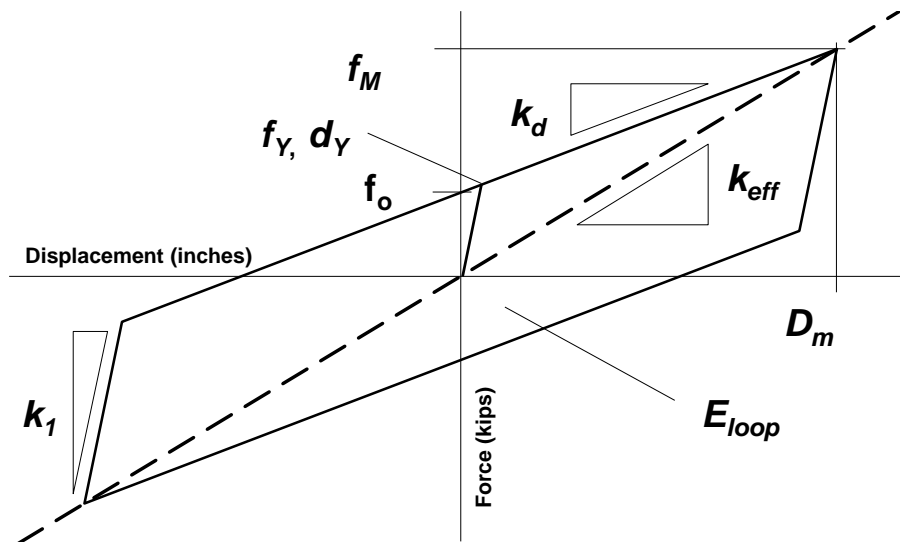

FIGURE 17.8.3-1 Nominal Properties of the Isolator Bilinear Force-Deflection Model

It is permitted to use different methods for fitting the loop, such as a straight-line fit of k_d directly to the hysteresis curve and then determining k_1 to match E_{loop} , or defining D_y and F_y by visual fit and then determining k_d to match E_{loop} .

17.8.4 Test Specimen Adequacy

The performance of the test specimens shall be deemed adequate if all of the following conditions are satisfied:

1. The force-deflection plots for all tests specified in Section 17.8.2 have a positive incremental force-resisting capacity.
2. The average post-yield stiffness, k_d , and energy dissipated per cycle, E_{loop} , for the three cycles of test specified in Section 17.8.2.2(3) for the vertical load equal to the average dead load plus one-half the effects due to live load, including the effects of heating and rate of loading in accordance with Section 17.2.8.3, shall fall within the range of the nominal design values defined by the permissible individual isolator range which are typically $\pm 5\%$ greater than the $\lambda_{(spec, min)}$ and $\lambda_{(spec, max)}$ range for the average of all isolators.
3. For each increment of test displacement specified in item 2 and item 3 of Section 17.8.2.2 and for each vertical load case specified in Section 17.8.2.2,
4. For each test specimen the value of the post-yield stiffness, k_d , at each of the cycles of test at a common displacement shall fall within the range defined by $\lambda_{(test, min)}$ and $\lambda_{(test, max)}$ multiplied by the nominal value of post-yield stiffness.
5. For each cycle of test, the difference between post-yield stiffness, k_d , effective stiffness of the two test specimens of a common type and size of the isolator unit and the average effective stiffness is no greater than 15 percent.
6. For each specimen there is no greater than a 20 percent change in the initial effective stiffness over the cycles of test specified in item 4 of Section 17.8.2.2.
7. For each test specimen the value of the post-yield stiffness, k_d , and energy dissipated per cycle, E_{loop} , for any cycle of each set of five cycles of test 17.8.2.2.4 shall fall within the range of the nominal design values defined by $\lambda_{(test, min)}$ and $\lambda_{(test, max)}$.

8. For each specimen there is no greater than a 20 percent decrease in the initial effective damping over the cycles of test specified in item 4 of Section 17.8.2.2.
9. All specimens of vertical-load-carrying elements of the isolation system remain stable where tested in accordance with Section 17.8.2.5.

Effective Damping, β_M (percentage of critical)	BM Factor
≤ 2	0.8
5	1.0
10	1.2
20	1.5
30	1.7
40	1.9
≥ 50	2.0

EXCEPTION: The registered design professional is permitted to adjust the limits of items 2, 3 and 4 to account for the property variation factors of Section 17.2.8 used for design of the isolation system.

17.8.5 Production Tests

A test program for the isolator units used in the construction shall be established by the registered design professional. The test program shall evaluate the consistency of measured values of nominal isolator unit properties by testing 100% of the isolators in combined compression and shear at not less than two-thirds of the maximum displacement, D_M , determined using lower bound properties.

The mean results of all tests shall fall within the range of values defined by the $\lambda_{(\text{spec, max})}$ and $\lambda_{(\text{spec, min})}$ values established in Section 17.2.8.4. A different range of values is permitted to be used for individual isolator units and for the average value across all isolators of a given unit type provided that differences in the ranges of values are accounted for in the design of the each element of the isolation system, as prescribed in Section 17.2.8.4.

CHAPTER 18, SEISMIC DESIGN REQUIREMENTS FOR STRUCTURES WITH DAMPING SYSTEMS

(Replacement)

18.1 GENERAL

18.1.1 Scope

Every structure with a damping system and every portion thereof shall be designed and constructed in accordance with the requirements of this standard as modified by this Chapter. Where damping devices are used across the isolation interface of a seismically isolated structure, displacements, velocities, and accelerations shall be determined in accordance with Chapter 17.

18.1.2 Definitions

The following definitions apply to the provisions of Chapter 18:

DAMPING DEVICE: A flexible structural element of the damping system that dissipates energy due to relative motion of each end of the device. Damping devices include all pins, bolts, gusset plates, brace extensions, and other components required to connect damping devices to the other elements of the structure. Damping devices is permitted to be classified as either displacement-dependent or velocity-dependent, or a combination thereof, and is permitted to be configured to act in either a linear or nonlinear manner.

DAMPING SYSTEM: The collection of structural elements that includes all the individual damping devices, all structural elements or bracing required to transfer forces from damping devices to the base of the structure, and the structural elements required to transfer forces from damping devices to the seismic force-resisting system.

DISPLACEMENT-DEPENDENT DAMPING DEVICE: The force response of a displacement-dependent damping device is primarily a function of the relative displacement between each end of the device. The response is substantially independent of the relative velocity between each of the devices and/or the excitation frequency.

FORCE-CONTROLLED ELEMENTS: Element actions for which reliable inelastic deformation capacity is not achievable without critical strength decay.

VELOCITY-DEPENDENT DAMPING DEVICE: The force-displacement relation for a velocity-dependent damping device is primarily a function of the relative velocity between each end of the device and could also be a function of the relative displacement between each end of the device.

18.1.3 Notation

The following notations apply to the provisions of this chapter:

B_{1D} = numerical coefficient as set forth in Table 18.7-1 for effective damping equal to β_{m1} ($m = 1$) and period of structure equal to T_{1D}

B_{1E} = numerical coefficient as set forth in Table 18.7-1 for the effective damping equal to $\beta_I + \beta_{V1}$ and period equal to T_1

B_{1M} = numerical coefficient as set forth in Table 18.7-1 for effective damping equal to β_{mM} ($m = 1$) and period of structure equal to T_{1M}

B_{mD} = numerical coefficient as set forth in Table 18.7-1 for effective damping equal to β_{ml} and period of structure equal to T_m

- B_{mM} = numerical coefficient as set forth in Table 18.7-1 for effective damping equal to β_{mM} and period of structure equal to T_m
- B_R = numerical coefficient as set forth in Table 18.7-1 for effective damping equal to β_R and period of structure equal to T_R
- B_{V+I} = numerical coefficient as set forth in Table 18.7-1 for effective damping equal to the sum of viscous damping in the fundamental mode of vibration of the structure in the direction of interest, β_{vm} ($m = 1$), plus inherent damping, β_I , and period of structure equal to T_I
- C_{mFD} = force coefficient as set forth in Table 18.7-2
- C_{mFV} = force coefficient as set forth in Table 18.7-3
- C_{S1} = seismic response coefficient of the fundamental mode of vibration of the structure in the direction of interest, Section 18.7.1.2.4 or 18.7.2.2.4 ($m = 1$)
- C_{Sm} = seismic response coefficient of the m^{th} mode of vibration of the structure in the direction of interest, Section 18.7.1.2.4.4 ($m = 1$) or Section 18.7.1.2.6 ($m > 1$)
- C_{SR} = seismic response coefficient of the residual mode of vibration of the structure in the direction of interest, Section 18.7.2.2.8
- D_{1D} = fundamental mode design displacement at the center of rigidity of the roof level of the structure in the direction under consideration, Section 18.7.2.3.2
- D_{1M} = fundamental mode MCE_R displacement at the center of rigidity of the roof level of the structure in the direction under consideration, Section 18.7.2.3.5
- D_{mD} = design displacement at the center of rigidity of the roof level of the structure due to the m^{th} mode of vibration in the direction under consideration, Section 18.7.1.3.2
- D_{mM} = MCE_R displacement at the center of rigidity of the roof level of the structure due to the m^{th} mode of vibration in the direction under consideration, Section 18.7.1.3.5
- D_{RD} = residual mode design displacement at the center of rigidity of the roof level of the structure in the direction under consideration, Section 18.7.2.3.2
- D_{RM} = residual mode MCE_R displacement at the center of rigidity of the roof level of the structure in the direction under consideration, Section 18.7.2.3.5
- D_Y = displacement at the center of rigidity of the roof level of the structure at the effective yield point of the seismic force-resisting system, Section 18.7.3.3
- E_{loop} = area of one load-displacement hysteresis loop, Section 18.6.1.5.1
- f_i = lateral force at Level i of the structure distributed approximately in accordance with Section 12.8.3, Section 18.7.2.2.3
- F_{i1} = inertial force at Level i (or mass point i) in the fundamental mode of vibration of the structure in the direction of interest, Section 18.7.2.2.9
- F_{im} = inertial force at Level i (or mass point i) in the m^{th} mode of vibration of the structure in the direction of interest, Section 18.7.1.2.7
- F_{iR} = inertial force at Level i (or mass point i) in the residual mode of vibration of the structure in the direction of interest, Section 18.7.2.2.9
- h_i = the height above the base to Level i , Section 18.7.2.2.3
- h_n = the structural height, Section 18.7.2.2.3
- q_H = hysteresis loop adjustment factor as determined in Section 18.7.3.2.2.1
- Q_{DSD} = force in an element of the damping system required to resist design seismic forces of displacement-dependent damping devices, Section 18.7.4.5
- Q_E = seismic design force in each element of the damping system, Section 18.7.4.5

- Q_{mDSV} = force in an element of the damping system required to resist design seismic forces of velocity-dependent damping devices due to the m^{th} mode of vibration of the structure in the direction of interest, Section 18.7.4.5
- Q_{mSFRS} = force in an element of the damping system equal to the design seismic force of the m^{th} mode of vibration of the structure in the direction of interest, Section 18.7.4.5
- T_1 = the fundamental period of the structure in the direction under consideration
- T_{1D} = effective period, in seconds, of the fundamental mode of vibration of the structure at the design displacement in the direction under consideration, as prescribed by Section 18.7.1.2.5 or 18.7.2.2.5
- T_{1M} = effective period, in seconds, of the fundamental mode of vibration of the structure at the MCE_R displacement in the direction under consideration, as prescribed by Section 18.7.1.2.5 or 18.7.2.2.5
- T_m = period, in seconds, of the m^{th} mode of vibration of the structure in the direction under consideration, Section 18.7.1.2.6
- T_R = period, in seconds, of the residual mode of vibration of the structure in the direction under consideration, Section 18.7.2.2.7
- V_I = design value of the seismic base shear of the fundamental mode in a given direction of response, as determined in Section 18.7.2.2.2, Section 18.7.2.2.1
- V_m = design value of the seismic base shear of the m^{th} mode of vibration of the structure in the direction of interest, Section 18.7.1.2.2
- V_{\min} = minimum allowable value of base shear permitted for design of the seismic force-resisting system of the structure in the direction of interest, Section 18.2.1.1
- V_R = design value of the seismic base shear of the residual mode of vibration of the structure in a given direction, as determined in Section 18.7.2.2.6
- w_i = effective seismic weight of the i^{th} floor of the structure, Section 18.7.1.2.2
- \bar{W}_1 = effective fundamental mode seismic weight determined in accordance with Eq. 18.7-2b for $m = 1$
- \bar{W}_m = effective seismic weight of the m^{th} mode of vibration of the structure, Section 18.7.1.2.2
- W_m = maximum strain energy in the m^{th} mode of vibration of the structure in the direction of interest at modal displacements, δ_{im} , Section 18.7.3.2.2.1
- W_{mj} = work done by j^{th} damping device in one complete cycle of dynamic response corresponding to the m^{th} mode of vibration of the structure in the direction of interest at modal displacements, δ_{im} , Section 18.7.3.2.2.1
- \bar{W}_R = effective residual mode seismic weight determined in accordance with Eq. 18.7-30
- α = velocity exponent relating damping device force to damping device velocity
- β_{mD} = total effective damping of the m^{th} mode of vibration of the structure in the direction of interest at the design displacement, Section 18.7.3.2
- β_{mM} = total effective damping of the m^{th} mode of vibration of the structure in the direction of interest at the MCE_R displacement, Section 18.7.3.2
- β_{HD} = component of effective damping of the structure in the direction of interest due to post-yield hysteretic behavior of the seismic force-resisting system and elements of the damping system at effective ductility demand μ_D , Section 18.7.3.2.2

- β_{HM} = component of effective damping of the structure in the direction of interest due to post-yield hysteretic behavior of the seismic force-resisting system and elements of the damping system at effective ductility demand, μ_M , Section 18.7.3.2.2
- β_I = component of effective damping of the structure due to the inherent dissipation of energy by elements of the structure, at or just below the effective yield displacement of the seismic force-resisting system, Section 18.7.3.2.1
- β_R = total effective damping in the residual mode of vibration of the structure in the direction of interest, calculated in accordance with Section 18.7.3.2 (using $\mu_D = 1.0$ and $\mu_M = 1.0$)
- β_{vm} = component of effective damping of the m^{th} mode of vibration of the structure in the direction of interest due to viscous dissipation of energy by the damping system, at or just below the effective yield displacement of the seismic force-resisting system, Section 18.7.3.2.3
- δ_i = elastic deflection of Level i of the structure due to applied lateral force, f_i , Section 18.7.2.2.3
- δ_{i1D} = fundamental mode design deflection of Level i at the center of rigidity of the structure in the direction under consideration, Section 18.7.2.3.1
- δ_{iD} = total design deflection of Level i at the center of rigidity of the structure in the direction under consideration, Section 18.7.2.3
- δ_{iM} = total MCE_R deflection of Level i at the center of rigidity of the structure in the direction under consideration, Section 18.7.2.3
- δ_{iRD} = residual mode design deflection of Level i at the center of rigidity of the structure in the direction under consideration, Section 18.7.2.3.1
- δ_{im} = deflection of Level i in the m^{th} mode of vibration at the center of rigidity of the structure in the direction under consideration, Section 18.7.3.2.3
- δ_{imD} = design deflection of Level i in the m^{th} mode of vibration at the center of rigidity of the structure in the direction under consideration, Section 18.7.1.3.1
- Δ_{1D} = design story drift due to the fundamental mode of vibration of the structure in the direction of interest, Section 18.7.2.3.3
- Δ_D = total design story drift of the structure in the direction of interest, Section 18.7.2.3.3
- Δ_M = total MCE_R story drift of the structure in the direction of interest, Section 18.7.2.3
- Δ_{mD} = design story drift due to the m^{th} mode of vibration of the structure in the direction of interest, Section 18.7.1.3.3
- Δ_{RD} = design story drift due to the residual mode of vibration of the structure in the direction of interest, Section 18.7.2.3.3
- μ = effective ductility demand on the seismic force-resisting system in the direction of interest
- μ_D = effective ductility demand on the seismic force-resisting system in the direction of interest due to the design earthquake ground motions, Section 18.7.3.3
- μ_M = effective ductility demand on the seismic force-resisting system in the direction of interest due to the MCE_R ground motions, Section 18.7.3.3
- μ_{max} = maximum allowable effective ductility demand on the seismic force-resisting system due to the design earthquake ground motions, Section 18.7.3.4
- ϕ_{i1} = displacement amplitude at Level i of the fundamental mode of vibration of the structure in the direction of interest, normalized to unity at the roof level, Section 18.7.2.2.3
- ϕ_{im} = displacement amplitude at Level i of the m^{th} mode of vibration of the structure in the direction of interest, normalized to unity at the roof level, Section 18.7.1.2.2

- ϕ_{iR} = displacement amplitude at Level i of the residual mode of vibration of the structure in the direction of interest normalized to unity at the roof level, Section 18.7.2.2.7
- Γ_1 = participation factor of the fundamental mode of vibration of the structure in the direction of interest, Section 18.7.1.2.3 or 18.7.2.2.3 ($m = 1$)
- Γ_m = participation factor in the m^{th} mode of vibration of the structure in the direction of interest, Section 18.7.1.2.3
- Γ_R = participation factor of the residual mode of vibration of the structure in the direction of interest, Section 18.7.2.2.7
- $\lambda_{(ae,max)}$ = factor to represent possible variation in damper properties above the tested values due to aging and environmental effects – this is a multiple of all the individual aging and environmental effects, Section 18.2.4.5
- $\lambda_{(ae,min)}$ = factor to represent possible variation in damper properties below the tested values due to aging and environmental effects - this is a multiple of all the individual aging and environmental effects, Section 18.2.4.5
- $\lambda_{(test,max)}$ = factor to represent possible variations in damper properties above the nominal values obtained from the prototype tests - this is a multiple of all the testing effects, Section 18.2.4.5
- $\lambda_{(test,min)}$ = factor to represent possible variations in damper properties below the nominal values obtained from the prototype tests - this is a multiple of all the testing effects, Section 18.2.4.5
- λ_{max} = factor to represent possible total variation in damper properties above the nominal properties, Section 18.2.4.5
- λ_{min} = factor to represent possible total variation in damper properties below the nominal properties, Section 18.2.4.5
- $\lambda_{(spec,max)}$ = factor to represent permissible variation in production damper nominal properties above those assumed in design, Section 18.2.4.5
- $\lambda_{(spec,min)}$ = factor to represent permissible variation in production damper nominal properties below those assumed in design, Section 18.2.4.5
- ∇_D = total design story velocity of the structure in the direction of interest, Section 18.7.1.3.4
- ∇_{1D} = design story velocity due to the fundamental mode of vibration of the structure in the direction of interest, Section 18.7.2.3.4
- ∇_M = total MCE_R story velocity of the structure in the direction of interest, Section 18.7.2.3
- ∇_{mD} = design story velocity due to the m^{th} mode of vibration of the structure in the direction of interest, Section 18.7.1.3.4
- ∇_{RD} = design story velocity due to the residual mode of vibration of the structure in the direction of interest, Section 18.7.2.3.4

18.2 GENERAL DESIGN REQUIREMENTS

18.2.1 System Requirements

Design of the structure shall consider the basic requirements for the seismic force-resisting system and the damping system as defined in the following sections. The seismic force-resisting system shall have the required strength to meet the forces defined in Section 18.2.2.1. The combination of the seismic force-resisting system and the damping system is permitted to be used to meet the drift requirement.

18.2.1.1 Seismic Force-Resisting System

Structures that contain a damping system shall have a seismic force-resisting system that, in each lateral direction, conforms to one of the types indicated in Table 12.2-1.

The design of the seismic force-resisting system in each direction shall satisfy minimum base shear requirements as listed in this section and the requirements of Section 18.4 for all methods of analysis including the Nonlinear Response History Procedure of Section 18.3 is used, and Section 18.7.4 if either the Response Spectrum Procedure of Section 18.7.1 or the Equivalent Lateral Force procedure of Section 18.7.2 is used.

The seismic base shear used for design of the seismic force-resisting system shall not be less than V_{\min} , where V_{\min} is determined as the greater of the values computed using Eqs. 18.2-1 and 18.2-2:

$$V_{\min} = \frac{V}{B_{V+I}} \quad (18.2-1)$$

$$V_{\min} = 0.75V \quad (18.2-2)$$

where

V = seismic base shear in the direction of interest, determined in accordance with Section 12.8

B_{V+I} = numerical coefficient as set forth in Table 18.7-1 for effective damping equal to the sum of viscous damping in the fundamental mode of vibration of the structure in the direction of interest, β_{Vm} ($m = 1$), plus inherent damping, β_I , and period of structure equal to T_1

EXCEPTION: The seismic base shear used for design of the seismic force-resisting system shall not be taken as less than $1.0V$, if either of the following conditions apply:

1. In the direction of interest, the damping system has less than two damping devices on each floor level, configured to resist torsion.
2. The seismic force-resisting system has horizontal irregularity Type 1b (Table 12.3-1) or vertical irregularity Type 1b (Table 12.3-2).

18.2.1.2 Damping System

Damping devices and all other components required to connect damping devices to the other elements of the structure shall be designed to remain elastic for MCE_R loads. Other elements of the damping system are permitted to have inelastic response at MCE_R if it is shown by analysis or test that inelastic response of these elements would not adversely affect damping system function. If either the Response Spectrum Procedure of Section 18.7.1 or the Equivalent Lateral Force procedure of Section 18.7.2 is used, the inelastic response shall be limited in accordance with the requirements of Section 18.7.4.6.

Force-controlled elements of the damping system shall be designed for seismic forces that are increased by 20% from those corresponding to average MCE_R response.

18.2.2 Seismic Ground Motion Criteria

18.2.2.1 Design Earthquake and MCE_R Response Spectra

The response spectrum requirements of Sections 11.4.5 and 11.4.6 are permitted to be used to determine the design earthquake and MCE_R response spectra for the site of interest. The site-specific ground motion procedures set forth in Chapter 21 are also permitted to be used to determine ground motions for any structure with a damping system.

For any structure with a damping system located on a Site Class F site, site response analysis shall be performed in accordance with Section 21.1.

18.2.2.2 Design Earthquake and MCE_R Ground Motion Records

Where nonlinear response-history analysis procedures are used, design earthquake and MCE_R ground motion suites shall each consist of not less than seven pairs of horizontal acceleration components. Selected and scaled from individual recorded events having magnitudes, fault distance and source mechanisms that are consistent with those that control the design earthquake and MCE_R events. Amplitude or spectral matching is permitted to scale the ground motions. Where the required number of recorded ground motion pairs is not available, simulated ground motion pairs are permitted to make up the total number required.

For each pair of horizontal ground motion components, a square root of the sum of the squares (SRSS) spectrum shall be constructed by taking the SRSS of the 5 percent-damped response spectra for the scaled components (when amplitude scaling is used an identical scale factor is applied to both components of a pair). For both the design earthquake and the MCE_R suites, each pair of motions shall be scaled such that in the period range from $0.2T_{ID}$ to $1.25T_{IM}$, the average of the SRSS spectra from all horizontal component pairs does not fall below the corresponding ordinate of the response spectra used in the design, determined in accordance with Section 18.2.2.1.

For records that are spectrally matched, for both the design earthquake and the MCE_R , each pair of motions shall be scaled such that in the period range from $0.2T_{ID}$ to $1.25T_{IM}$, the response spectrum of one component of the pair is at least 90% of the corresponding ordinate of the response spectrum used in the design, determined in accordance with Section 18.2.2.1.

For sites within 3 miles (5 km) of the active fault that controls the hazard, spectral matching shall not be utilized unless the pulse characteristics of the near field ground motions are included in the site specific response spectra, and pulse characteristics, when present in individual ground motions, are retained after the matching process has been completed.

At sites within 3 miles (5 km) of the active fault that controls the hazard, for both the design earthquake and the MCE_R suites, each pair of components shall be rotated to the fault-normal and fault-parallel directions of the causative fault and shall be scaled so that the average spectrum of the fault-normal components is not less than the design or MCE_R response spectrum, as appropriate, and the average spectrum of the fault-parallel components is not less than 50% of the design or MCE_R response spectrum, as appropriate, for the period range from $0.2T_{ID}$ to $1.25T_{IM}$.

18.2.3 Procedure Selection

Structures with a damping system provided for seismic resistance shall be analyzed and designed using the nonlinear response history procedure of Section 18.3.

EXCEPTION: It shall be permitted to analyze and design the structure using the response spectrum procedure of 18.7.1 subject to the limits of 18.2.3.1 or the equivalent lateral force procedure of Section 18.7.2 subject to the limits of Section 18.2.3.2.

18.2.3.1 Response-Spectrum Procedure

The response-spectrum procedure of Section 18.7.1 is permitted to be used for analysis and design provided that all of the following conditions apply:

1. In each principal direction, the damping system has at least two damping devices in each story, configured to resist torsion.
2. The total effective damping of the fundamental mode, β_{mD} ($m = 1$), of the structure in the direction of interest is not greater than 35 percent of critical.
3. The S_1 value for the site is less than 0.6.

18.2.3.2 Equivalent Lateral Force Procedure

The equivalent lateral force procedure of Section 18.7.2 is permitted to be used for analysis and design provided that all of the following conditions apply:

1. In each principal direction, the damping system has at least two damping devices in each story, configured to resist torsion.
2. The total effective damping of the fundamental mode, β_{mD} ($m = 1$), of the structure in the direction of interest is not greater than 35 percent of critical.
3. The seismic force-resisting system does not have horizontal irregularity Type 1a or 1b (Table 12.3-1) or vertical irregularity Type 1a, 1b, 2, or 3 (Table 12.3-2).
4. Floor diaphragms are rigid as defined in Section 12.3.1.
5. The height of the structure above the base does not exceed 100 ft. (30 m).
6. The S_1 value for the site is less than 0.6.

18.2.4 Damping System

18.2.4.1 Device Design

The design, construction, and installation of damping devices shall be based on response to MCE_R ground motions and consideration of the all of the following:

1. Low-cycle, large-displacement degradation due to seismic loads.
2. High-cycle, small-displacement degradation due to wind, thermal, or other cyclic loads.
3. Forces or displacements due to gravity loads.
4. Adhesion of device parts due to corrosion or abrasion, biodegradation, moisture, or chemical exposure.
5. Exposure to environmental conditions, including, but not limited to, temperature, humidity, moisture, radiation (e.g., ultraviolet light), and reactive or corrosive substances (e.g., salt water).

Devices utilizing bi-metallic interfaces subject to cold welding of the sliding interface shall be prohibited from use in a damping system.

Damping devices subject to failure by low-cycle fatigue shall resist wind forces without slip, movement, or inelastic cycling.

The design of damping devices shall incorporate the range of thermal conditions, device wear, manufacturing tolerances, and other effects that cause device properties to vary during the design life of the device in accordance with Section 18.2.4.4. Ambient temperature shall be the normal in-service temperature of the damping device. The design temperature range shall cover the annual minimum and maximum in-service temperatures of the damping device.

18.2.4.2 Multiaxis Movement

Connection points of damping devices shall provide sufficient articulation to accommodate simultaneous longitudinal, lateral, and vertical displacements of the damping system.

18.2.4.3 Inspection and Periodic Testing

Means of access for inspection and removal of all damping devices shall be provided.

The registered design professional responsible for design of the structure shall establish an inspection, maintenance and testing schedule for each type of damping device to ensure that the devices respond in a dependable manner throughout their design life. The degree of inspection and testing shall reflect the established in-service history of the damping devices and the likelihood of change in properties over the design life of the devices.

18.2.4.4 Nominal Design Properties

Nominal design properties for energy dissipation devices shall be established from either project specific prototype test data or prior prototype tests on devices of similar type and size. The nominal design properties shall be based on data from prototype tests specified in Section 18.6.1.2 (2) and determined by Section 18.6.1.4 (2). These nominal design properties shall be modified by property variation or lambda (λ) factors as specified in Section 18.2.4.5.

18.2.4.5 Maximum and Minimum Damper Properties

Maximum and minimum property modification (λ) factors shall be established in accordance with Eqs 18.2-3a and 18.2-3b for each device by the registered design professional and used in analysis and design to account for the variation from nominal properties.

$$\lambda_{\max} = (1 + (0.75 * (\lambda_{(ae, \max)} - 1))) * \lambda_{(test, \max)} * \lambda_{(spec, \max)} \geq 1.2 \quad (18.2-3a)$$

$$\lambda_{\min} = (1 - (0.75 * (1 - \lambda_{(ae, \min)}))) * \lambda_{(test, \min)} * \lambda_{(spec, \min)} \leq 0.85 \quad (18.2-3b)$$

where:

$\lambda_{(ae, \max)}$ = factor to represent possible variation in damper properties above the nominal values due to aging and environmental effects - this is a multiple of all the individual aging and environmental effects

$\lambda_{(ae, \min)}$ = factor to represent possible variation in damper properties below the nominal values due to aging and environmental effects - this is a multiple of all the individual aging and environmental effects

$\lambda_{(test, \max)}$ = factor to represent possible variations in damper properties above the nominal values obtained from the prototype tests - this is a multiple of all the testing effects

$\lambda_{(test, \min)}$ = factor to represent possible variations in damper properties below the nominal values obtained from the prototype tests - this is a multiple of all the testing effects

$\lambda_{(spec, \max)}$ = factor established by the registered design professional to represent permissible variation in production damper properties above the nominal values

$\lambda_{(spec, \min)}$ = factor established by the registered design professional to represent permissible variation in production damper properties below the nominal values

EXCEPTION: With test data reviewed by the registered design professional and accepted by Peer Review, it is permitted to use λ_{\max} less than 1.2 and λ_{\min} greater than 0.85.

Maximum and minimum analysis and design properties for each device shall be determined in accordance with Eqs 18.2-4a and 18.2-4b for each modeling parameter as follows:

$$\text{Maximum Design Property} = \text{Nominal Design Property} * \lambda_{\max} \quad (18.2-4a)$$

$$\text{Minimum Design Property} = \text{Nominal Design Property} * \lambda_{\min} \quad (18.2-4b)$$

A maximum and minimum analysis and design property shall be established for each modeling parameter as necessary for the selected method of analysis. Maximum velocity coefficients, stiffness, strength and energy dissipation shall be considered together as the maximum analysis and design case, and minimum velocity coefficients, strength, stiffness and energy dissipation shall be considered together as the minimum analysis and design case.

Separate maximum and minimum properties shall be established for loads and displacements corresponding to the design level conditions and the MCE_R conditions.

18.2.4.6 Damping System Redundancy

If fewer than four energy dissipation devices are provided in any story of a building in either principal direction, or fewer than two devices are located on each side of the center of stiffness of any story in either principal direction, all energy dissipation devices shall be capable of sustaining displacements equal to 130% of the maximum calculated displacement in the device under MCE_R . A velocity-dependent device shall be capable of sustaining the force and displacement associated with a velocity equal to 130% of the maximum calculated velocity for that device under MCE_R .

18.3 NONLINEAR RESPONSE-HISTORY PROCEDURE

The stiffness and damping properties of the damping devices used in the models shall be based on or verified by testing of the damping devices as specified in Section 18.6. The nonlinear force-velocity-displacement characteristics of damping devices shall be modeled, as required, to explicitly account for device dependence on frequency, amplitude, and duration of seismic loading.

A nonlinear response-history analysis shall utilize a mathematical model of the seismic force-resisting system and the damping system as provided in this section. The model shall directly account for the nonlinear hysteretic behavior of all members and connections undergoing inelastic behavior, in a manner consistent with applicable laboratory test data. Test data shall not be extrapolated beyond tested deformation levels. If the analysis results indicate that degradation in element strength or stiffness can occur, the hysteretic models shall include these effects.

EXCEPTION: If the calculated force in an element of the seismic force-resisting system or the damping system does not exceed 1.5 times its expected strength using strength reduction factor $\phi=1$, that element is permitted to be modeled as linear.

For sites identified as near-fault, each pair of horizontal ground motion components shall be rotated to the fault-normal and fault-parallel directions of the causative faults and applied to the mathematical model in such orientation.

For all other sites, individual pairs of horizontal ground motion components need not be applied to the mathematical model in multiple orientations.

Inherent damping of the structure shall not be taken as greater than 3 percent of critical unless test data consistent with levels of deformation at or just below the effective yield displacement of the seismic force-resisting system support higher values.

Analysis shall be performed at both the design earthquake and at the MCE_R earthquake levels. The design earthquake analysis need not include the effects of accidental eccentricity. Results from the design earthquake analysis shall be used to design the seismic force-resisting system. Results from the MCE_R analysis shall be used to design the damping system.

18.3.1 Damping Device Modeling

Mathematical models of displacement-dependent damping devices shall include the hysteretic behavior of the devices consistent with test data and accounting for all significant changes in strength, stiffness, and hysteretic loop shape. Mathematical models of velocity-dependent damping devices shall include the velocity coefficient consistent with test data. If damping device properties change with time and/or temperature, such behavior shall be modeled explicitly. The flexible elements of damping devices connecting damper units to the structure shall be included in the model.

EXCEPTION: If the properties of the damping devices are expected to change during the duration of the response-history analysis, the dynamic response is permitted to be enveloped by the maximum and minimum device properties from Section 18.2.4.5. All these limit cases for variable device properties shall satisfy the same conditions as if the time-dependent behavior of the devices were explicitly modeled.

18.3.2 Accidental Mass Eccentricity

Inherent eccentricity resulting from lack of symmetry in mass and stiffness shall be accounted for in the MCE_R analysis. In addition, accidental eccentricity consisting of displacement of the center-of-mass from the computed location by an amount equal to 5% of the diaphragm dimension separately in each of two orthogonal directions at each diaphragm level shall be accounted for in the analysis.

EXCEPTION: It is permitted to account for the effects of accidental eccentricity through the establishment of amplification factors on forces, drifts and deformations that permit results determined from an analysis using only the computed center-of-mass configuration to be scaled to bound the results of all the mass-eccentric cases.

18.3.3 Response Parameters

Maximum values of each response parameter of interest shall be calculated for each ground motion used for the response-history analysis. Response parameters shall include the forces, displacements and velocities (in the case of velocity-dependent devices) in each discrete damping device. The average value of a response parameter of interest across the suite of design earthquake or MCE_R motions is permitted to be used for design.

18.4 SEISMIC LOAD CONDITIONS AND ACCEPTANCE CRITERIA FOR NONLINEAR RESPONSE-HISTORY PROCEDURE

For the nonlinear response-history procedure of Section 18.3, the seismic force-resisting system, damping system, loading conditions, and acceptance criteria for response parameters of interest shall conform with the requirements of the following subsections.

18.4.1 Seismic Force-Resisting System

The seismic force-resisting system shall satisfy the strength requirements of Section 12.2.1 using both:

1. The seismic base shear, V_{min} , as given by Section 18.2.1.1.
2. The demands from the design earthquake nonlinear response history analysis.

The story drifts shall be determined using the MCE_R ground motions with the combined model of the seismic force resisting system and the damping system. Accidental eccentricity shall be included.

The maximum drift at MCE_R shall not exceed 3% nor the drift limits specified in Table 12.12-1 times smaller of $1.5 R/C_d$ and 1.9. C_d and R shall be taken from Table 12.2-1 for the building framing under consideration.

18.4.2 Damping System

The damping devices and their connections shall be sized to resist the forces, displacements, and velocities from the MCE_R ground motions. Force-controlled elements of the damping system shall be designed for seismic forces that are increased by 20% from those corresponding to average MCE_R response.

18.4.3 Combination of Load Effects

The effects on the damping system due to gravity loads and seismic forces shall be combined in accordance with Section 12.4 using the effect of horizontal seismic forces, Q_E , except that Q_E shall be determined in accordance with the MCE_R analysis. When load combinations are used that include live loading, it is permitted to use a factor of 25% for live load as permitted by Section 16.2.3 for non-linear response history analysis. The redundancy factor, ρ , shall be taken equal to 1.0 in all cases, and the seismic load effect with overstrength factor of Section 12.4.3 need not apply to the design of the damping system.

18.4.4 Acceptance Criteria for the Response Parameters of Interest

The damping system components shall be evaluated by the strength design criteria of this standard using the seismic forces and seismic loading conditions determined from the MCE_R nonlinear response-history analyses and strength reduction factor $\varphi = 1.0$.

18.5 DESIGN REVIEW

An independent design review of the damping system and related test programs shall be performed by one or more individuals possessing knowledge of the following items with a minimum of one reviewer being a registered design professional. Damping system design review shall include, but need not be limited to, all of the following:

1. Project design criteria including site-specific spectra and ground motion histories.
2. Preliminary design of the seismic force-resisting system and the damping system, including selection of the devices and their design parameters.
3. Review of manufacturer test data and property modification factors for the manufacturer and device selected.
4. Prototype testing program (Section 18.6.1).
5. Final design of the entire structural system and supporting analyses including modelling of the damping devices for response history analysis if performed.
6. Damping device production testing program (Section 18.6.2).

18.6 TESTING

The force-velocity-displacement relationships and damping properties assumed as the damping device nominal design properties in Section 18.2.4.4 shall be confirmed by the tests conducted in accordance with Section 18.6.1, or shall be based on prior tests of devices meeting the similarity requirements of Section 18.6.1.3.

The prototype tests specified in Section 18.6.1 shall be conducted to confirm the force-velocity-displacement properties of the damping devices assumed for analysis and design, and to demonstrate the robustness of individual devices under seismic excitation. These tests shall be conducted prior to production of devices for construction.

The production testing requirements are specified in Section 18.6.2.

Device nominal properties determined from the prototype testing shall meet the acceptance criteria established using $\lambda_{(spec,max)}$ and $\lambda_{(spec,min)}$ from Section 18.2.4.5. These criteria shall account for likely variations in material properties.

Device nominal properties determined from the production testing of Section 18.6.2 shall meet the acceptance criteria established using $\lambda_{(spec,max)}$ and $\lambda_{(spec,min)}$ from Section 18.2.4.5.

The fabrication and quality control procedures used for all prototype and production devices shall be identical. These procedures shall be approved by the registered design professional prior to the fabrication of prototype devices.

18.6.1 Prototype Tests

The following tests shall be performed separately on two full-size damping devices of each type and size used in the design, in the order listed as follows.

Representative sizes of each type of device are permitted to be used for prototype testing, provided both of the following conditions are met:

1. Fabrication and quality control procedures are identical for each type and size of device used in the structure.
2. Prototype testing of representative sizes is approved by the registered design professional responsible for design of the structure.

Test specimens shall not be used for construction, unless they are approved by the registered design professional responsible for design of the structure and meet the requirements for prototype and production tests.

18.6.1.1 Data Recording

The force-deflection relationship for each cycle of each test shall be recorded electronically.

18.6.1.2 Sequence and Cycles of Testing

For all of the following test sequences, each damping device shall be subjected to gravity load effects and thermal environments representative of the installed condition. For seismic testing, the displacement in the devices calculated for the MCE_R ground motions, termed herein as the maximum device displacement, shall be used.

1. A production test in accordance with Section 18.6.2 shall be performed and data from this test shall be used as the base line for comparison with subsequent prototype tests.
2. Each damping device shall be subjected to the number of cycles expected in the design windstorm, but not less than 2,000 continuous fully reversed cycles of wind load. Wind load shall be at amplitudes expected in the design windstorm and shall be applied at a frequency equal to the inverse of the fundamental period of the structure, $1/T_1$.

It is permitted to use alternate loading protocols, representative of the design wind storm, that apportion the total wind displacement into its expected static, pseudo-static and dynamic components.

EXCEPTION: Damping devices need not be subjected to these tests if they are not subject to wind-induced forces or displacements or if the design wind force is less than the device yield or slip force.

3. Each damping device shall be brought to ambient temperature and loaded with the following sequence of fully reversed, sinusoidal cycles at a frequency equal to $1/(1.5T_1)$.
 - a. Ten fully reversed cycles at the displacement in the energy dissipation device corresponding to 0.33 times the MCE_R device displacement.
 - b. Five fully reversed cycles at the displacement in the energy dissipation device corresponding to 0.67 times the MCE_R device displacement.
 - c. Three fully reversed cycles at the displacement in the energy dissipation device corresponding to 1.0 times the MCE_R device displacement.
 - d. Where test (c) produces a force in the energy dissipation device that is less than the MCE_R force in the device from analysis, test (c) shall be repeated at a frequency that produces a force equal to or greater than the MCE_R force from analysis.
4. Where the damping device characteristics vary with operating temperature, the tests of 18.6.1.2.2, (a) to (d) shall be conducted on at least one device, at a minimum of two additional temperatures (minimum and maximum), that bracket the design temperature range.

EXCEPTION: Damping devices are permitted to be tested by alternative methods provided all of the following conditions are met:

- a. Alternative methods of testing are equivalent to the cyclic testing requirements of this section.
- b. Alternative methods capture the dependence of the damping device response on ambient temperature, frequency of loading, and temperature rise during testing.

- c. Alternative methods are approved by the registered design professional responsible for the design of the structure.
5. If the force-deformation properties of the damping device at any displacement less than or equal to the maximum device displacement change by more than 15 percent for changes in testing frequency from $1/(1.5T_1)$ to $2.5/T_1$, then the preceding tests (2(a) through 2(c)) shall also be performed at frequencies equal to $1/T_1$ and $2.5/T_1$.

EXCEPTION: When full-scale dynamic testing is not possible due to test machine limitations, it is permitted to use reduced-scale prototypes to qualify the rate-dependent properties of damping devices provided that scaling principles and similitude are used in the design of the reduced-scale devices and the test protocol.

18.6.1.3 Testing Similar Devices

Prototype tests need not be performed on a particular damping device if there exist a previously prototype-tested unit that meets all of the following conditions:

1. Is of similar dimensional characteristics, internal construction, and static and dynamic internal pressures (if any) to the subject damping device; and
2. Is of the same type and materials as the subject damping device; and
3. Was fabricated using identical documented manufacturing and quality control procedures that govern the subject damping device; and
4. Was tested under similar maximum strokes and forces to those required of the subject damping device.

18.6.1.4 Determination of Force-Velocity-Displacement Characteristics

The force-velocity-displacement characteristics of the prototype damping device shall be based on the cyclic displacement tests specified in Section 18.6.1.2 and all of the following requirements:

1. The maximum force and minimum force at zero displacement, the maximum force and minimum force at maximum device displacement, and the area of hysteresis loop (E_{loop}) shall be calculated for each cycle of deformation. Where required, the effective stiffness of a damping device shall be calculated for each cycle of deformation using Eq. 17.8-1.
2. Damping device nominal test properties for analysis and design shall be based on the average value for the first three cycles of test at a given displacement. For each cycle of each test, corresponding lambda factors (λ_{test}) for cyclic effects shall be established by comparison of nominal and per-cycle properties. When damping devices have first cycle test properties that differ significantly from the average properties of the first three cycles, it is permitted to obtain the, average values from second through fourth cycle, provided that the effect of first cycle properties are explicitly addressed.
3. Lambda (λ) factors for velocity and temperature shall be determined simultaneously with those for cyclic effects where full scale prototype test data is available. Where these or similar effects are determined from separate tests, lambda factors shall be established by comparison of properties determined under prototype test conditions with corresponding properties determined under the range of test conditions applicable to the property variation parameter.

18.6.1.5 Device Adequacy

The performance of a prototype damping device shall be deemed adequate if all of the conditions listed below are satisfied. The 15 percent limits specified in the following text are permitted to be increased by the registered design professional responsible for the design of the structure provided that the increased limit has been demonstrated by analysis not to have a deleterious effect on the response of the structure.

18.6.1.5.1 Displacement-Dependent Damping Devices

The performance of the prototype displacement-dependent damping devices shall be deemed adequate if all of the following conditions, based on tests specified in Section 18.6.1.2, are satisfied:

1. For Test 1, no signs of damage including leakage, yielding, or breakage.
2. For Tests 2, 3 and 4, the maximum force and minimum force at zero displacement for a damping device for any one cycle does not differ by more than 15 percent from the average maximum and minimum forces at zero displacement as calculated from all cycles in that test at a specific frequency and temperature.
3. For Tests 2, 3 and 4, the maximum force and minimum force at maximum device displacement for a damping device for any one cycle does not differ by more than 15 percent from the average maximum and minimum forces at the maximum device displacement as calculated from all cycles in that test at a specific frequency and temperature.
4. For Tests 2, 3 and 4, the area of hysteresis loop (E_{loop}) of a damping device for any one cycle does not differ by more than 15 percent from the average area of the hysteresis loop as calculated from all cycles in that test at a specific frequency and temperature.
5. The average maximum and minimum forces at zero displacement and maximum displacement, and the average area of the hysteresis loop (E_{loop}), calculated for each test in the sequence of Tests 2, 3 and 4, shall not differ by more than 15 percent from the target values specified by the registered design professional responsible for the design of the structure.
6. The average maximum and minimum forces at zero displacement and the maximum displacement, and the average area of the hysteresis loop (E_{loop}), calculated for Test 2.(c) shall fall within the limits specified by the registered design professional, as described by the nominal properties and the lambda factor for specification tolerance ($\lambda_{(spec, max)}$ and $\lambda_{(spec, min)}$) from Section 18.2.4.5.
7. The test lambda factors for damping units, determined in accordance with Section 18.6.1.4, shall not exceed the values specified by the registered design professional in accordance with Section 18.2.4.5.

18.6.1.5.2 Velocity-Dependent Damping Devices

The performance of the prototype velocity-dependent damping devices shall be deemed adequate if all of the following conditions, based on tests specified in Section 18.6.1.2, are satisfied:

1. For Test 1, no signs of damage including leakage, yielding, or breakage.
2. For velocity-dependent damping devices with stiffness, the effective stiffness of a damping device in any one cycle of Tests 2, 3 and 4 does not differ by more than 15 percent from the average effective stiffness as calculated from all cycles in that test at a specific frequency and temperature.
3. For Tests 2, 3 and 4, the maximum force and minimum force at zero displacement for a damping device for any one cycle does not differ by more than 15 percent from the average maximum and minimum forces at zero displacement as calculated from all cycles in that test at a specific frequency and temperature.
4. For Tests 2, 3 and 4, the area of hysteresis loop (E_{loop}) of a damping device for any one cycle does not differ by more than 15 percent from the average area of the hysteresis loop as calculated from all cycles in that test at a specific frequency and temperature.
5. The average maximum and minimum forces at zero displacement, effective stiffness (for damping devices with stiffness only), and average area of the hysteresis loop (E_{loop}), calculated for Test 2.(c), shall fall within the limits specified by the registered design professional, as described by the nominal properties and the lambda factor for specification tolerance ($\lambda_{(spec, max)}$ and $\lambda_{(spec, min)}$) from Section 18.2.4.5. 6. The test lambda factors for damping units determined in accordance with Section 18.6.1.4 shall not exceed the values specified by the registered design professional in accordance with Section 18.2.4.5.

18.6.2 Production Tests

Prior to installation in a building, damping devices shall be tested in accordance with the requirements of this section.

A test program for the production damping devices shall be established by the registered design professional. The test program shall validate the nominal properties by testing 100% of the devices for three cycles at 0.67 times the MCE_R stroke at a frequency equal to $1/(1.5T_1)$. The measured values of the nominal properties shall fall within the limits provided in the project specifications. These limits shall agree with the specification tolerances on nominal design properties established in Section 18.2.4.5.

EXCEPTION: Production damping devices need not be subjected to this test program if it can be shown by other means that their properties meet the requirements of the project specifications. In such cases, the registered design professional shall establish an alternative program to assure the quality of the installed damping devices. This alternative program shall include production testing of at least one device of each type and size, unless project-specific prototype tests have been conducted on that identical device type and size. Devices that undergo inelastic action or are otherwise damaged during this test shall not be used in construction.

18.7 ALTERNATE PROCEDURES AND CORRESPONDING ACCEPTANCE CRITERIA

Structures analyzed by the response-spectrum procedure shall meet the requirements of Sections 18.7.1, 18.7.3 and 18.7.4. Structures analyzed by the equivalent lateral force procedure shall meet the requirements of Sections 18.7.2, 18.7.3 and 18.7.4.

18.7.1 Response Spectrum Procedure

Where the response-spectrum procedure is used to analyze a structure with a damping system, the requirements of this section shall apply.

18.7.1.1 Modeling

A mathematical model of the seismic force-resisting system and damping system shall be constructed that represents the spatial distribution of mass, stiffness, and damping throughout the structure. The model and analysis shall comply with the requirements of Section 12.9 for the seismic force-resisting system and to the requirements of this section for the damping system. The stiffness and damping properties of the damping devices used in the models shall be based on or verified by testing of the damping devices as specified in Section 18.6.

The elastic stiffness of elements of the damping system other than damping devices shall be explicitly modeled. Stiffness of damping devices shall be modeled depending on damping device type as follows:

1. For displacement-dependent damping devices: Displacement-dependent damping devices shall be modeled with an effective stiffness that represents damping device force at the response displacement of interest (e.g., design story drift). Alternatively, the stiffness of hysteretic and friction damping devices is permitted to be excluded from response spectrum analysis provided design forces in displacement-dependent damping devices, QDSD, are applied to the model as external loads (Section 18.7.4.5).
2. For velocity-dependent damping devices: Velocity-dependent damping devices that have a stiffness component (e.g., viscoelastic damping devices) shall be modeled with an effective stiffness corresponding to the amplitude and frequency of interest.

18.7.1.2 Seismic Force-Resisting System

18.7.1.2.1 Seismic Base Shear

The seismic base shear, V , of the structure in a given direction shall be determined as the combination of modal components, V_m , subject to the limits of Eq. 18.7-1:

$$V \geq V_{\min} \quad (18.7-1)$$

The seismic base shear, V , of the structure shall be determined by the square root of the sum of the squares method (SRSS) or complete quadratic combination of modal base shear components, V_m .

18.7.1.2.2 Modal Base Shear

Modal base shear of the m^{th} mode of vibration, V_m , of the structure in the direction of interest shall be determined in accordance with Eqs. 18.7-2:

$$V_m = C_{Sm} \bar{W}_m \quad (18.7-2a)$$

$$\bar{W}_m = \frac{\left(\sum_{i=1}^n w_i \phi_{im} \right)^2}{\sum_{i=1}^n w_i \phi_{im}^2} \quad (18.7-2b)$$

where

C_{Sm} = seismic response coefficient of the m^{th} mode of vibration of the structure in the direction of interest as determined from Section 18.7.1.2.4 ($m = 1$) or Section 18.7.1.2.6 ($m > 1$)

\bar{W}_m = effective seismic weight of the m^{th} mode of vibration of the structure

ϕ_{im} = displacement amplitude at the i^{th} level of the structure in the m^{th} mode of vibration in the direction of interest, normalized to unity at the roof level

18.7.1.2.3 Modal Participation Factor

The modal participation factor of the m^{th} mode of vibration, Γ_m , of the structure in the direction of interest shall be determined in accordance with Eq. 18.7-3:

$$\Gamma_m = \frac{\bar{W}_m}{\sum_{i=1}^n w_i \phi_{im}} \quad (18.7-3)$$

18.7.1.2.4 Fundamental Mode Seismic Response Coefficient

The fundamental mode ($m = 1$) seismic response coefficient, C_{S1} , in the direction of interest shall be determined in accordance with Eqs. 18.7-4 and 18.7-5:

For $T_{1D} < T_S$,

$$C_{S1} = \left(\frac{R}{C_d} \right) \frac{S_{DS}}{\Omega_0 B_{1D}} \quad (18.7-4)$$

For $T_{1D} \geq T_S$,

$$C_{S1} = \left(\frac{R}{C_d} \right) \frac{S_{D1}}{T_{1D} (\Omega_0 B_{1D})} \quad (18.7-5)$$

18.7.1.2.5 Effective Fundamental Mode Period Determination

The effective fundamental mode ($m = 1$) period at the design earthquake ground motion, T_{1D} , and at the MCE_R ground motion, T_{1M} , shall be based on either explicit consideration of the post-yield force deflection characteristics of the structure or determined in accordance with Eqs. 18.7-6 and 18.7-7:

$$T_{1D} = T_1 \sqrt{\mu_D} \quad (18.7-6)$$

$$T_{1M} = T_1 \sqrt{\mu_M} \quad (18.7-7)$$

18.7.1.2.6 Higher Mode Seismic Response Coefficient

Higher mode ($m > 1$) seismic response coefficient, C_{Sm} , of the m^{th} mode of vibration ($m > 1$) of the structure in the direction of interest shall be determined in accordance with Eqs. 18.7-8 and 18.7-9:

For $T_m < T_s$,

$$C_{Sm} = \left(\frac{R}{C_d} \right) \frac{S_{D1}}{\Omega_0 B_{mD}} \quad (18.7-8)$$

For $T_m \geq T_s$,

$$C_{Sm} = \left(\frac{R}{C_d} \right) \frac{S_{D1}}{T_m (\Omega_0 B_{mD})} \quad (18.7-9)$$

where

T_m = period, in seconds, of the m^{th} mode of vibration of the structure in the direction under consideration

B_{mD} = numerical coefficient as set forth in Table 18.7-1 for effective damping equal to β_{mD} and period of the structure equal to T_m

18.7.1.2.7 Design Lateral Force

Design lateral force at Level i due to the m^{th} mode of vibration, F_{im} , of the structure in the direction of interest shall be determined in accordance with Eq. 18.7-10:

$$F_{im} = w_i \phi_{im} \frac{\Gamma_m}{W_m} V_m \quad (18.7-10)$$

Design forces in elements of the seismic force-resisting system shall be determined by the SRSS or complete quadratic combination of modal design forces.

18.7.1.3 Damping System

Design forces in damping devices and other elements of the damping system shall be determined on the basis of the floor deflection, story drift, and story velocity response parameters described in the following sections.

Displacements and velocities used to determine maximum forces in damping devices at each story shall account for the angle of orientation of each device from the horizontal and consider the effects of increased response due to torsion required for design of the seismic force-resisting system.

Floor deflections at Level i , δ_{iD} and δ_{iM} , story drifts, Δ_D and Δ_M , and story velocities, ∇_D and ∇_M , shall be calculated for both the design earthquake ground motions and the MCE_R ground motions, respectively, in accordance with this section.

18.7.1.3.1 Design Earthquake Floor Deflection

The deflection of structure due to the design earthquake ground motions at Level i in the m^{th} mode of vibration, δ_{imD} , of the structure in the direction of interest shall be determined in accordance with Eq. 18.7-11:

$$\delta_{imD} = D_{mD}\phi_{im} \quad (18.7-11)$$

The total design deflection at each floor of the structure shall be calculated by the SRSS or complete quadratic combination of modal design earthquake deflections.

18.7.1.3.2 Design Earthquake Roof Displacement

Fundamental ($m = 1$) and higher mode ($m > 1$) roof displacements due to the design earthquake ground motions, D_{1D} and D_{mD} , of the structure in the direction of interest shall be determined in accordance with Eqs. 18.7-12 and to 18.7-13:

For $m = 1$,

$$D_{1D} = \left(\frac{g}{4\pi^2} \right) \Gamma_1 \frac{S_{DS} T_{1D}^2}{B_{1D}} \geq \left(\frac{g}{4\pi^2} \right) \Gamma_1 \frac{S_{DS} T_1^2}{B_{1E}}, T_{1D} < T_S \quad (18.7-12a)$$

$$D_{1D} = \left(\frac{g}{4\pi^2} \right) \Gamma_1 \frac{S_{D1} T_{1D}}{B_{1D}} \geq \left(\frac{g}{4\pi^2} \right) \Gamma_1 \frac{S_{D1} T_1}{B_{1E}}, T_{1D} \geq T_S \quad (18.7-12b)$$

For $m > 1$,

$$D_{mD} = \left(\frac{g}{4\pi^2} \right) \Gamma^m \frac{S_{D1} T_m}{B_{mD}} \leq \left(\frac{g}{4\pi^2} \right) \Gamma^m \frac{S_{DS} T_m^2}{B_{mD}} \quad (18.7-13)$$

18.7.1.3.3 Design Earthquake Story Drift

Design story drift in the fundamental mode, Δ_{1D} , and higher modes, Δ_{mD} ($m > 1$), of the structure in the direction of interest shall be calculated in accordance with Section 12.8.6 using modal roof displacements of Section 18.7.1.3.2.

Total design story drift, Δ_D , shall be determined by the SRSS or complete quadratic combination of modal design earthquake drifts.

18.7.1.3.4 Design Earthquake Story Velocity

Design story velocity in the fundamental mode, ∇_{1D} , and higher modes, ∇_{mD} ($m > 1$), of the structure in the direction of interest shall be calculated in accordance with Eqs. 18.7-14 and 18.7-15:

$$\text{For } m = 1, \nabla_{1D} = 2\pi \frac{\Delta_{1D}}{T_{1D}} \quad (18.7-14)$$

$$\text{For } m > 1, \nabla_{mD} = 2\pi \frac{\Delta_{mD}}{T_m} \quad (18.7-15)$$

Total design story velocity, D_D , shall be determined by the SRSS or complete quadratic combination of modal design velocities.

18.7.1.3.5 MCE_R Response

Total modal maximum floor deflection at Level i , MCE_R story drift values, and MCE_R story velocity values shall be based on Sections 18.7.1.3.1, 18.7.1.3.3, and 18.7.1.3.4, respectively, except design roof displacement shall be replaced by MCE_R roof displacement. MCE_R roof displacement of the structure in the direction of interest shall be calculated in accordance with Eqs. 18.7-16 and to 18.7-17:

For $m = 1$,

$$D_{1M} = \left(\frac{g}{4\pi^2} \right) \Gamma_1 \frac{S_{MS} T_{1M}^2}{B_{1M}} \geq \left(\frac{g}{4\pi^2} \right) \Gamma_1 \frac{S_{MS} T_1^2}{B_{1E}}, T_{1M} < T_S \quad (18.7-16a)$$

$$D_{1M} = \left(\frac{g}{4\pi^2} \right) \Gamma_1 \frac{S_{M1} T_{1M}}{B_{1M}} \geq \left(\frac{g}{4\pi^2} \right) \Gamma_1 \frac{S_{M1} T_1}{B_{1E}}, T_{1M} \geq T_S \quad (18.7-16b)$$

For $m > 1$,

$$D_{mM} = \left(\frac{g}{4\pi^2} \right) \Gamma_m \frac{S_{M1} T_m}{B_{mM}} \leq \left(\frac{g}{4\pi^2} \right) \Gamma_m \frac{S_{MS} T_m^2}{B_{mM}} \quad (18.7-17)$$

where

B_{mM} = numerical coefficient as set forth in Table 18.7-1 for effective damping equal to β_{mM} and period of the structure equal to T_m

18.7.2 Equivalent Lateral Force Procedure

Where the equivalent lateral force procedure is used to design a structure with a damping system, the requirements of this section shall apply.

18.7.2.1 Modeling

Elements of the seismic force-resisting system shall be modeled in a manner consistent with the requirements of Section 12.8. For purposes of analysis, the structure shall be considered to be fixed at the base.

Elements of the damping system shall be modeled as required to determine design forces transferred from damping devices to both the ground and the seismic force-resisting system. The effective stiffness of velocity-dependent damping devices shall be modeled.

Damping devices need not be explicitly modeled provided effective damping is calculated in accordance with the procedures of Section 18.7.4 and used to modify response as required in Sections 18.7.2.2 and 18.7.2.3.

The stiffness and damping properties of the damping devices used in the models shall be based on or verified by testing of the damping devices as specified in Section 18.6.

18.7.2.2 Seismic Force-Resisting System

18.7.2.2.1 Seismic Base Shear

The seismic base shear, V , of the seismic force-resisting system in a given direction shall be determined as the combination of the two modal components, V_1 and V_R , in accordance with Eq. 18.7-18:

$$V = \sqrt{V_1^2 + V_R^2} \geq V_{\min} \quad (18.7-18)$$

where

V_1 = design value of the seismic base shear of the fundamental mode in a given direction of response, as determined in Section 18.7.2.2.2

V_R = design value of the seismic base shear of the residual mode in a given direction, as determined in Section 18.7.2.2.6

V_{\min} = minimum allowable value of base shear permitted for design of the seismic force-resisting system of the structure in direction of the interest, as determined in Section 18.2.1.1

18.7.2.2.2 Fundamental Mode Base Shear

The fundamental mode base shear, V_1 , shall be determined in accordance with Eq. 18.7-19:

$$V_1 = C_{S1} \overline{W}_1 \quad (18.7-19)$$

where

C_{S1} = the fundamental mode seismic response coefficient, as determined in Section 18.7.2.2.4

\overline{W}_1 = the effective fundamental mode seismic weight including portions of the live load as defined by Eq. 18.7-2b for $m = 1$

18.7.2.2.3 Fundamental Mode Properties

The fundamental mode shape, ϕ_{i1} , and participation factor, Γ_1 , shall be determined by either dynamic analysis using the elastic structural properties and deformational characteristics of the resisting elements or using Eqs. 18.7-20 and 18.7-21:

$$\phi_{i1} = \frac{h_i}{h_n} \quad (18.7-20)$$

$$\Gamma_1 = \frac{\overline{W}_1}{\sum_{i=1}^n w_i \phi_{i1}} \quad (18.7-21)$$

where

h_i = the height above the base to Level i

h_n = the structural height as defined in Section 11.2

w_i = the portion of the total effective seismic weight, W , located at or assigned to Level i

The fundamental period, T_1 , shall be determined either by dynamic analysis using the elastic structural properties and deformational characteristics of the resisting elements, or using Eq. 18.7-22 as follows:

$$T_1 = 2\pi \sqrt{\frac{\sum_{i=1}^n w_i \delta_i^2}{g \sum_{i=1}^n f_i \delta_i}} \quad (18.7-22)$$

where

f_i = lateral force at Level i of the structure distributed in accordance with Section 12.8.3

δ_i = elastic deflection at Level i of the structure due to applied lateral forces f_i

18.7.2.2.4 Fundamental Mode Seismic Response Coefficient

The fundamental mode seismic response coefficient, C_{S1} , shall be determined using Eq. 18.7-23 or 18.7-24:

For $T_{1D} < T_S$,

$$C_{S1} = \left(\frac{R}{C_d} \right) \frac{S_{D1}}{\Omega_0 B_{1D}} \quad (18.7-23)$$

For $T_{1D} \geq T_S$,

$$C_{S1} = \left(\frac{R}{C_d} \right) \frac{S_{D1}}{T_{1D} (\Omega_0 B_{1D})} \quad (18.7-24)$$

where

S_{DS} = the design spectral response acceleration parameter in the short period range

S_{D1} = the design spectral response acceleration parameter at a period of 1 s

B_{1D} = numerical coefficient as set forth in Table 18.7-1 for effective damping equal to β_{mD} ($m = 1$) and period of the structure equal to T_{1D}

18.7.2.2.5 Effective Fundamental Mode Period Determination

The effective fundamental mode period at the design earthquake, T_{1D} , and at the MCE_R, T_{1M} , shall be based on explicit consideration of the post-yield force deflection characteristics of the structure or shall be calculated using Eqs. 18.7-25 and 18.7-26:

$$T_{1D} = T_1 \sqrt{\mu_D} \quad (18.7-25)$$

$$T_{1M} = T_1 \sqrt{\mu_M} \quad (18.7-26)$$

18.7.2.2.6 Residual Mode Base Shear

Residual mode base shear, V_R , shall be determined in accordance with Eq. 18.7-27:

$$V_R = C_{SR} \overline{W}_R \quad (18.7-27)$$

where

C_{SR} = the residual mode seismic response coefficient as determined in Section 18.7.2.2.8

\overline{W}_R = the effective residual mode effective weight of the structure determined using Eq. 18.7-30

18.7.2.2.7 Residual Mode Properties

Residual mode shape, ϕ_{iR} , participation factor, Γ_R , effective residual mode seismic weight of the structure, \overline{W}_R , and effective period, T_R , shall be determined using Eqs. 18.7-28 through 18.7-31:

$$\phi_{iR} = \frac{1 - \Gamma_1 \phi_{i1}}{1 - \Gamma_1} \quad (18.7-28)$$

$$\Gamma_R = 1 - \Gamma_1 \quad (18.7-29)$$

$$\overline{W}_R = W - \overline{W}_1 \quad (18.7-30)$$

$$T_R = 0.4T_1 \quad (18.7-31)$$

18.7.2.2.8 Residual Mode Seismic Response Coefficient

The residual mode seismic response coefficient, C_{SR} , shall be determined in accordance with Eq. 18.7-32:

$$C_{SR} = \left(\frac{R}{C_d} \right) \frac{S_{DS}}{\Omega_0 B_R} \quad (18.7-32)$$

where

B_R = numerical coefficient as set forth in Table 18.7-1 for effective damping equal to β_R , and period of the structure equal to T_R

18.7.2.2.9 Design Lateral Force

The design lateral force in elements of the seismic force-resisting system at Level i due to fundamental mode response, F_{i1} , and residual mode response, F_{iR} , of the structure in the direction of interest shall be determined in accordance with Eqs. 18.7-33 and 18.7-34:

$$F_{i1} = w_i \phi_{i1} \frac{\Gamma_1}{\overline{W}_1} V_1 \quad (18.7-33)$$

$$F_{iR} = w_i \phi_{iR} \frac{\Gamma_R}{\overline{W}_R} V_R \quad (18.7-34)$$

Design forces in elements of the seismic force-resisting system shall be determined by taking the SRSS of the forces due to fundamental and residual modes.

18.7.2.3 Damping System

Design forces in damping devices and other elements of the damping system shall be determined on the basis of the floor deflection, story drift, and story velocity response parameters described in the following sections.

Displacements and velocities used to determine maximum forces in damping devices at each story shall account for the angle of orientation of each device from the horizontal and consider the effects of increased response due to torsion required for design of the seismic force-resisting system.

Floor deflections at Level i , δ_{iD} and δ_{iM} , story drifts, Δ_D and Δ_M , and story velocities, ∇_D and ∇_M , shall be calculated for both the design earthquake ground motions and the MCE_R ground motions, respectively, in accordance with the following sections.

18.7.2.3.1 Design Earthquake Floor Deflection

The total design deflection at each floor of the structure in the direction of interest shall be calculated as the SRSS of the fundamental and residual mode floor deflections. The fundamental and residual mode deflections due to the design earthquake ground motions, δ_{i1D} and δ_{iRD} , at the center of rigidity of Level i of the structure in the direction of interest shall be determined using Eqs. 18.7-35 and 18.7-36:

$$\delta_{i1D} = D_{1D}\phi_{i1} \quad (18.7-35)$$

$$\delta_{iRD} = D_{RD}\phi_{iR} \quad (18.7-36)$$

where

D_{1D} = fundamental mode design displacement at the center of rigidity of the roof level of the structure in the direction under consideration, Section 18.7.2.3.2

D_{RD} = residual mode design displacement at the center of rigidity of the roof level of the structure in the direction under consideration, Section 18.7.2.3.2

18.7.2.3.2 Design Earthquake Roof Displacement

Fundamental and residual mode displacements due to the design earthquake ground motions, D_{1D} and D_{1R} , at the center of rigidity of the roof level of the structure in the direction of interest shall be determined using Eqs. 18.7-37 and 18.7-38:

$$D_{1D} = \left(\frac{g}{4\pi^2} \right) \Gamma_1 \frac{S_{DS} T_{1D}^2}{B_{1D}} \geq \left(\frac{g}{4\pi^2} \right) \Gamma_1 \frac{S_{DS} T_1^2}{B_{1D}}, T_{1D} < T_S \quad (18.7-37a)$$

$$D_{1D} = \left(\frac{g}{4\pi^2} \right) \Gamma_1 \frac{S_{D1} T_{1D}}{B_{1D}} \geq \left(\frac{g}{4\pi^2} \right) \Gamma_1 \frac{S_{D1} T_1}{B_{1E}}, T_{1D} \geq T_S \quad (18.7-37b)$$

$$D_{RD} = \left(\frac{g}{4\pi^2} \right) \Gamma_R \frac{S_{D1} T_R}{B_R} \leq \left(\frac{g}{4\pi^2} \right) \Gamma_R \frac{S_{DS} T_R^2}{B_R} \quad (18.7-38)$$

18.7.2.3.3 Design Earthquake Story Drift

Design story drifts, Δ_D , in the direction of interest shall be calculated using Eq. 18.7-39:

$$\Delta_D = \sqrt{\Delta_{1D}^2 + \Delta_{RD}^2} \quad (18.7-39)$$

where

Δ_{1D} = design story drift due to the fundamental mode of vibration of the structure in the direction of interest

Δ_{RD} = design story drift due to the residual mode of vibration of the structure in the direction of interest

Modal design story drifts, Δ_{1D} and Δ_{RD} , shall be determined as the difference of the deflections at the top and bottom of the story under consideration using the floor deflections of Section 18.7.2.3.1.

18.7.2.3.4 Design Earthquake Story Velocity

Design story velocities, ∇_D , in the direction of interest shall be calculated in accordance with Eqs. 18.7-40 through 18.7-42:

$$\nabla_D = \sqrt{\nabla_{1D}^2 + \nabla_{RD}^2} \quad (18.7-40)$$

$$\nabla_{1D} = 2\pi \frac{\Delta_{1D}}{T_{1D}} \quad (18.7-41)$$

$$\nabla_{RD} = 2\pi \frac{\Delta_{RD}}{T_R} \quad (18.7-42)$$

where

∇_{1D} = design story velocity due to the fundamental mode of vibration of the structure in the direction of interest

∇_{RD} = design story velocity due to the residual mode of vibration of the structure in the direction of interest

18.7.2.3.5 MCE_R Response

Total modal MCE_R floor deflections at Level *i*, maximum story drifts, and maximum story velocities shall be based on the equations in Sections 18.7.2.3.1, 18.7.2.3.3, and 18.7.2.3.4, respectively, except that design roof displacements shall be replaced by MCE_R roof displacements. MCE_R roof displacements shall be calculated in accordance with Eqs. 18.7-43 and 18.7-44:

$$D_{1M} = \left(\frac{g}{4\pi^2} \right) \Gamma_1 \frac{S_{MS} T_{1M}^2}{B_{1M}} \geq \left(\frac{g}{4\pi^2} \right) \Gamma_1 \frac{S_{MS} T_1^2}{B_{1E}}, T_{1M} < T_S \quad (18.7-43a)$$

$$D_{1M} = \left(\frac{g}{4\pi^2} \right) \Gamma_1 \frac{S_{M1} T_{1M}}{B_{1M}} \geq \left(\frac{g}{4\pi^2} \right) \Gamma_1 \frac{S_{M1} T_1}{B_{1E}}, T_{1M} \geq T_S \quad (18.7-43b)$$

$$D_{RM} = \left(\frac{g}{4\pi^2} \right) \Gamma_R \frac{S_{M1} T_R}{B_R} \leq \left(\frac{g}{4\pi^2} \right) \Gamma_R \frac{S_{MS} T_R^2}{B_R} \quad (18.7-44)$$

where

S_{M1} = the MCE_R, 5 percent damped, spectral response acceleration parameter at a period of 1 s adjusted for site class effects as defined in Section 11.4.3

S_{MS} = the MCE_R, 5 percent damped, spectral response acceleration parameter at short periods adjusted for site class effects as defined in Section 11.4.3

B_{1M} = numerical coefficient as set forth in Table 18.7-1 for effective damping equal to β_{mM} ($m = 1$) and period of structure equal to T_{1M}

18.7.3 Damped Response Modification

As required in Sections 18.7.1 and 18.7.2, response of the structure shall be modified for the effects of the damping system.

18.7.3.1 Damping Coefficient

Where the period of the structure is greater than or equal to T_0 , the damping coefficient shall be as prescribed in Table 18.7-1. Where the period of the structure is less than T_0 , the damping coefficient shall be linearly

interpolated between a value of 1.0 at a 0-second period for all values of effective damping and the value at period T_0 as indicated in Table 18.7-1.

Table 18.7-1 Damping Coefficient, B_{V+I} , B_{1D} , B_{1E} , B_R , B_{1M} , B_{mD} , B_{mM} (Where Period of the Structure $\geq T_0$)

Effective Damping, β (percentage of critical)	B_{V+I} , B_{1D} , B_{1E} , B_R , B_{1M} , B_{mD} , B_{mM} (where period of the structure $\geq T_0$)
≤ 2	0.8
5	1.0
10	1.2
20	1.5
30	1.8
40	2.1
50	2.4
60	2.7
70	3.0
80	3.3
90	3.6
≥ 100	4.0

18.7.3.2 Effective Damping

The effective damping at the design displacement, β_{mD} , and at the MCE_R displacement, β_{mM} , of the m^{th} mode of vibration of the structure in the direction under consideration shall be calculated using Eqs. 18.7-45 and 18.7-46:

$$\beta_{mD} = \beta_I + \beta_{Vm} \sqrt{\mu_D} + \beta_{HD} \quad (18.7-45)$$

$$\beta_{mM} = \beta_I + \beta_{Vm} \sqrt{\mu_M} + \beta_{HM} \quad (18.7-46)$$

where

β_{HD} = component of effective damping of the structure in the direction of interest due to post-yield hysteretic behavior of the seismic force-resisting system and elements of the damping system at effective ductility demand, μ_D

β_{HM} = component of effective damping of the structure in the direction of interest due to post-yield hysteretic behavior of the seismic force-resisting system and elements of the damping system at effective ductility demand, μ_M

β_I = component of effective damping of the structure due to the inherent dissipation of energy by elements of the structure, at or just below the effective yield displacement of the seismic force-resisting system

β_{Vm} = component of effective damping of the m^{th} mode of vibration of the structure in the direction of interest due to viscous dissipation of energy by the damping system, at or just below the effective yield displacement of the seismic force-resisting system

μ_D = effective ductility demand on the seismic force-resisting system in the direction of interest due to the design earthquake ground motions

μ_M = effective ductility demand on the seismic force-resisting system in the direction of interest due to the MCE_R ground motions

Unless analysis or test data supports other values, the effective ductility demand of higher modes of vibration in the direction of interest shall be taken as 1.0.

18.7.3.2.1 Inherent Damping

Inherent damping, β_i , shall be based on the material type, configuration, and behavior of the structure and nonstructural components responding dynamically at or just below yield of the seismic force-resisting system. Unless analysis or test data supports other values, inherent damping shall be taken as not greater than 3 percent of critical for all modes of vibration.

18.7.3.2.2 Hysteretic Damping

Hysteretic damping of the seismic force-resisting system and elements of the damping system shall be based either on test or analysis or shall be calculated using Eqs. 18.7-47 and 18.7-48:

$$\beta_{HD} = q_H (0.64 - \beta_I) \left(1 - \frac{1}{\mu_D} \right) \quad (18.7-47)$$

$$\beta_{HM} = q_H (0.64 - \beta_I) \left(1 - \frac{1}{\mu_M} \right) \quad (18.7-48)$$

where

q_H = hysteresis loop adjustment factor, as defined in Section 18.7.3.2.2.1

μ_D = effective ductility demand on the seismic force-resisting system in the direction of interest due to the design earthquake ground motions

μ_M = effective ductility demand on the seismic force-resisting system in the direction of interest due to the MCE_R ground motions

Unless analysis or test data supports other values, the hysteretic damping of higher modes of vibration in the direction of interest shall be taken as zero.

18.7.3.2.2.1 Hysteresis Loop Adjustment Factor

The calculation of hysteretic damping of the seismic force-resisting system and elements of the damping system shall consider pinching and other effects that reduce the area of the hysteresis loop during repeated cycles of earthquake demand. Unless analysis or test data support other values, the fraction of full hysteretic loop area of the seismic force-resisting system used for design shall be taken as equal to the factor, q_H , calculated using Eq. 18.7-49:

$$q_H = 0.67 \frac{T_S}{T_1} \quad (18.7-49)$$

where

T_S = period defined by the ratio, S_{D1}/S_{DS}

T_1 = period of the fundamental mode of vibration of the structure in the direction of the interest

The value of q_H shall not be taken as greater than 1.0 and need not be taken as less than 0.5.

18.7.3.2.3 Viscous Damping

Viscous damping of the m^{th} mode of vibration of the structure, β_{vm} , shall be calculated using Eqs. 18.7-50 and 18.7-51:

$$\beta_{vm} = \frac{\sum_j W_{mj}}{4\pi W_m} \quad (18.7-50)$$

$$W_m = \frac{1}{2} \sum_j F_{im} \delta_{im} \quad (18.7-51)$$

where

W_{mj} = work done by j^{th} damping device in one complete cycle of dynamic response corresponding to the m^{th} mode of vibration of the structure in the direction of interest at modal displacements, δ_{im}

W_m = maximum strain energy in the m^{th} mode of vibration of the structure in the direction of interest at modal displacements, δ_{im}

F_{im} = m^{th} mode inertial force at Level i

δ_{im} = deflection of Level i in the m^{th} mode of vibration at the center of rigidity of the structure in the direction under consideration

Viscous modal damping of displacement-dependent damping devices shall be based on a response amplitude equal to the effective yield displacement of the structure.

The calculation of the work done by individual damping devices shall consider orientation and participation of each device with respect to the mode of vibration of interest. The work done by individual damping devices shall be reduced as required to account for the flexibility of elements, including pins, bolts, gusset plates, brace extensions, and other components that connect damping devices to other elements of the structure.

18.7.3.3 Effective Ductility Demand

The effective ductility demand on the seismic force-resisting system due to the design earthquake ground motions, μ_D , and due to the MCE_R ground motions, μ_M , shall be calculated using Eqs. 18.7-52, 18.7-53, and 18.7-54:

$$\mu_D = \frac{D_{1D}}{D_Y} \geq 1.0 \quad (18.7-52)$$

$$\mu_M = \frac{D_{1M}}{D_Y} \geq 1.0 \quad (18.7-53)$$

$$D_Y = \left(\frac{g}{4\pi^2} \right) \left(\frac{\Omega_0 C_d}{R} \right) \Gamma_1 C_{s1} T_1^2 \quad (18.7-54)$$

where

D_{1D} = fundamental mode design displacement at the center of rigidity of the roof level of the structure in the direction under consideration, Section 18.7.1.3.2 or 18.7.2.3.2

D_{1M} = fundamental mode maximum displacement at the center of rigidity of the roof level of the structure in the direction under consideration, Section 18.7.1.3.5 or 18.7.2.3.5

D_Y = displacement at the center of rigidity of the roof level of the structure at the effective yield point of the seismic force-resisting system

- R = response modification coefficient from Table 12.2-1
 C_d = deflection amplification factor from Table 12.2-1
 Ω_0 = overstrength factor from Table 12.2-1
 Γ_1 = participation factor of the fundamental mode of vibration of the structure in the direction of interest, Section 18.7.1.2.3 or 18.7.2.2.3 ($m = 1$)
 C_{S1} = seismic response coefficient of the fundamental mode of vibration of the structure in the direction of interest, Section 18.7.1.2.4 or 18.7.2.2.4 ($m = 1$)
 T_1 = period of the fundamental mode of vibration of the structure in the direction of interest

The design ductility demand, μ_D , shall not exceed the maximum value of effective ductility demand, μ_{\max} , given in Section 18.7.3.4.

EXCEPTION: It is permitted to use nonlinear modeling as described in Section 18.3, to develop a force-displacement (pushover) curve of the seismic force resisting system. It is permitted to use this curve in lieu of the effective yield displacement, D_Y , of Eq. 18.7-54 to calculate the effective ductility demand due to the design earthquake ground motions, μ_D , and due to the MCE_R ground motions, μ_M , in Eqs. 18.7-52 and 18.7-53, respectively. In this case, the value of (R/C_d) shall be taken as 1.0 in Eqs. 18.7-4, 18.7-5, 18.7-8 and 18.7-9.

18.7.3.4 Maximum Effective Ductility Demand

For determination of the hysteresis loop adjustment factor, hysteretic damping, and other parameters, the maximum value of effective ductility demand, μ_{\max} , shall be calculated using Eqs. 18.7-55 and 18.7-56:

For $T_{1D} \leq T_S$,

$$\mu_{\max} = 0.5[(R/(\Omega_0 I_e))^2 + 1] \quad (18.7-55)$$

For $T_1 \geq T_S$,

$$\mu_{\max} = R/(\Omega_0 I_e) \quad (18.7-56)$$

where

I_e = the importance factor determined in accordance with Section 11.5.1

T_{1D} = effective period of the fundamental mode of vibration of the structure at the design displacement in the direction under consideration

For $T_1 < T_S < T_{1D}$, μ_{\max} shall be determined by linear interpolation between the values of Eqs. 18.7-55 and 18.7-56.

18.7.4 Seismic Load Conditions and Acceptance Criteria for RSA and ELF Procedures

Design forces and displacements determined in accordance with the response spectrum procedure of Section 18.7.1 or the equivalent lateral force procedure of Section 18.7.2 shall be checked using the strength design criteria of this standard and the seismic loading conditions of Section 18.7.4.3.

The seismic force-resisting system, damping system, seismic loading conditions, and acceptance criteria shall conform to the following subsections.

18.7.4.1 Seismic Force-Resisting System

The seismic force-resisting system shall satisfy the requirements of Section 12.2.1 using seismic base shear and design forces determined in accordance with Section 18.7.1.2 or 18.7.2.2.

The design story drift, Δ_D , as determined in either Section 18.7.1.3.3 or 18.7.2.3.3 shall not exceed (R/C_d) times the allowable story drift, as obtained from Table 12.12-1, considering the effects of torsion as required in Section 12.12.1.

18.7.4.2 Damping System

The damping system shall satisfy the requirements of Section 12.2.1 for seismic design forces and seismic loading conditions determined in accordance with Section 18.7.4.3. Force-controlled elements of the damping system shall be designed for seismic forces that are increased by 20% from those corresponding to average MCE_R response.

18.7.4.3 Combination of Load Effects

The effects on the damping system and its components due to gravity loads and seismic forces shall be combined in accordance with Section 12.4 using the effect of horizontal seismic forces, Q_E , determined in accordance with Section 18.7.4.5. The redundancy factor, ρ , shall be taken equal to 1.0 in all cases, and the seismic load effect with overstrength factor of Section 12.4.3 need not apply to the design of the damping system.

18.7.4.4 Modal Damping System Design Forces

Modal damping system design forces shall be calculated on the basis of the type of damping devices and the modal design story displacements and velocities determined in accordance with either Section 18.7.1.3 or 18.7.2.3.

Modal design story displacements and velocities shall be increased as required to envelop the total design story displacements and velocities determined in accordance with Section 18.3 where peak response is required to be confirmed by response-history analysis.

For displacement-dependent damping devices: Design seismic force in displacement-dependent damping devices shall be based on the maximum force in the device at displacements up to and including the design story drift, Δ_D .

For velocity-dependent damping devices: Design seismic force in each mode of vibration in velocity-dependent damping devices shall be based on the maximum force in the device at velocities up to and including the design story velocity for the mode of interest.

Displacements and velocities used to determine design forces in damping devices at each story shall account for the angle of orientation of the damping device from the horizontal and consider the effects of increased floor response due to torsional motions.

18.7.4.5 Seismic Load Conditions and Combination of Modal Responses

Seismic design force, Q_E , in each element of the damping system shall be taken as the maximum force of the following three loading conditions:

1. Stage of maximum displacement: Seismic design force at the stage of maximum displacement shall be calculated in accordance with Eq. 18.7-57:

$$Q_E = \Omega_0 \sqrt{\sum_m (Q_{mSFRS})^2} \pm Q_{DSD} \quad (18.7-57)$$

where

Q_{mSFRS} = force in an element of the damping system equal to the design seismic force of the m^{th} mode of vibration of the structure in the direction of interest

Q_{DSD} = force in an element of the damping system required to resist design seismic forces of displacement-dependent damping devices

Seismic forces in elements of the damping system, Q_{DSD} , shall be calculated by imposing design forces of displacement-dependent damping devices on the damping system as pseudostatic forces. Design seismic forces of displacement-dependent damping devices shall be applied in both positive and negative directions at peak displacement of the structure.

2. Stage of maximum velocity: Seismic design force at the stage of maximum velocity shall be calculated in accordance with Eq. 18.7-58:

$$Q_E = \sqrt{\sum_m (Q_{mDSV})^2} \quad (18.7-58)$$

where

Q_{mDSV} = force in an element of the damping system required to resist design seismic forces of velocity-dependent damping devices due to the m^{th} mode of vibration of the structure in the direction of interest. Modal seismic design forces in elements of the damping system, Q_{mDSV} , shall be calculated by imposing modal design forces of velocity-dependent devices on the nondeformed damping system as pseudostatic forces. Modal seismic design forces shall be applied in directions consistent with the deformed shape of the mode of interest. Horizontal restraint forces shall be applied at each floor Level i of the nondeformed damping system concurrent with the design forces in velocity-dependent damping devices such that the horizontal displacement at each level of the structure is zero. At each floor Level i , restraint forces shall be proportional to and applied at the location of each mass point

3. Stage of maximum acceleration: Seismic design force at the stage of maximum acceleration shall be calculated in accordance with Eq. 18.7-59:

$$Q_E = \sqrt{\sum_m (C_{mFD} Q_0 Q_{mSFRS} + C_{mFV} Q_{mDSV})^2} \pm Q_{DSD} \quad (18.7-59)$$

The force coefficients, C_{mFD} and C_{mFV} , shall be determined from Tables 18.7-2 and 18.7-3, respectively, using values of effective damping determined in accordance with the following requirements:

For fundamental-mode response ($m = 1$) in the direction of interest, the coefficients, C_{1FD} and C_{1FV} , shall be based on the velocity exponent, α , that relates device force to damping device velocity. The effective fundamental-mode damping shall be taken as equal to the total effective damping of the fundamental mode less the hysteretic component of damping ($\beta_{1D} - \beta_{HD}$ or $\beta_{1M} - \beta_{HM}$) at the response level of interest ($\mu = \mu_D$ or $\mu = \mu_M$).

For higher-mode ($m > 1$) or residual-mode response in the direction of interest, the coefficients, C_{mFD} and C_{mFV} , shall be based on a value of α equal to 1.0. The effective modal damping shall be taken as equal to the total effective damping of the mode of interest (β_{mD} or β_{mM}). For determination of the coefficient C_{mFD} , the ductility demand shall be taken as equal to that of the fundamental mode ($\mu = \mu_D$ or $\mu = \mu_M$).

Table 18.7-2 Force Coefficient, $C_{mFD}^{a,b}$

Effective Damping	$\mu \leq 1.0$ $\alpha \leq 0.25$	$\mu \leq 1.0$ $\alpha = 0.5$	$\mu \leq 1.0$ $\alpha = 0.75$	$\mu \leq 1.0$ $\alpha \geq 1.0$	$C_{mFD} = 1.0^c$
≤ 0.05	1.00	1.00	1.00	1.00	$\mu \geq 1.0$
0.1	1.00	1.00	1.00	1.00	$\mu \geq 1.0$
0.2	1.00	0.95	0.94	0.93	$\mu \geq 1.1$
0.3	1.00	0.92	0.88	0.86	$\mu \geq 1.2$
0.4	1.00	0.88	0.81	0.78	$\mu \geq 1.3$
0.5	1.00	0.84	0.73	0.71	$\mu \geq 1.4$
0.6	1.00	0.79	0.64	0.64	$\mu \geq 1.6$
0.7	1.00	0.75	0.55	0.58	$\mu \geq 1.7$
0.8	1.00	0.70	0.50	0.53	$\mu \geq 1.9$
0.9	1.00	0.66	0.50	0.50	$\mu \geq 2.1$
≥ 1.0	1.00	0.62	0.50	0.50	$\mu \geq 2.2$

^aUnless analysis or test data support other values, the force coefficient C_{mFD} for viscoelastic systems shall be taken as 1.0.

^bInterpolation shall be used for intermediate values of velocity exponent, α , and ductility demand, μ .

^c C_{mFD} shall be taken as equal to 1.0 for values of ductility demand, μ , greater than or equal to the values shown.

Table 18.7-3 Force Coefficient, $C_{mFV}^{a,b}$

Effective Damping	$\alpha \leq 0.25$	$\alpha = 0.5$	$\alpha = 0.75$	$\alpha \geq 1.0$
≤ 0.05	1.00	0.35	0.20	0.10
0.1	1.00	0.44	0.31	0.20
0.2	1.00	0.56	0.46	0.37
0.3	1.00	0.64	0.58	0.51
0.4	1.00	0.70	0.69	0.62
0.5	1.00	0.75	0.77	0.71
0.6	1.00	0.80	0.84	0.77
0.7	1.00	0.83	0.90	0.81
0.8	1.00	0.90	0.94	0.90
0.9	1.00	1.00	1.00	1.00
≥ 1.0	1.00	1.00	1.00	1.00

^aUnless analysis or test data support other values, the force coefficient C_{mFD} for viscoelastic systems shall be taken as 1.0.

^bInterpolation shall be used for intermediate values of velocity exponent, α .

18.7.4.6 Inelastic Response Limits

Elements of the damping system are permitted to exceed strength limits for design loads provided it is shown by analysis or test that each of the following conditions are satisfied:

1. Inelastic response does not adversely affect damping system function.
2. Element forces calculated in accordance with Section 18.7.4.5, using a value of Ω_0 taken as equal to 1.0, do not exceed the strength required to satisfy the load combinations of Section 12.4.

CHAPTER 19, SOIL STRUCTURE INTERACTION FOR SEISMIC DESIGN

(Replacement)

19.1 GENERAL

19.1.1 Scope

Determination of the design earthquake forces and the corresponding displacements of the structure shall be permitted to consider the effects of soil-structure interaction (SSI) in accordance with this Section. SSI may be used in conjunction with the Equivalent Lateral Force Procedure per Section 19.2.1, Modal Analysis Procedure per Section 19.2.2, or the Response History Procedure per Chapter 16. When soil-structure interaction effects are considered, the analytical model of the structure shall directly incorporate horizontal, vertical, and rotational foundation and soil flexibility. For the purpose of this section both upper and lower bound estimates for the foundation and soil stiffnesses per Section 12.13.3 shall be considered. The case that results in the lesser reduction or greater amplification in response parameters shall be used for design.

If the provisions of this chapter are used, then Section 12.8.1.3 shall not apply.

19.1.2 Definitions

The following definitions apply to the provisions of Chapter 19:

FREE-FIELD MOTION: Motion at ground surface in absence of structure and its foundation.

FOUNDATION INPUT MOTION: Motion that effectively excites the structure and its foundation.

INERTIAL SSI: The dynamic interaction between the structure, its foundation, and the surrounding soil due to the foundation input motion.

KINEMATIC SSI: The modification of free field ground motion due to non-vertical incident seismic waves and spatial incoherence; the modification yields the foundation input motion.

BASE SLAB AVERAGING: Kinematic SSI of a shallow (non-embedded) foundation due to wave incongruence over a rigid base area.

SOIL DAMPING: The hysteretic (material) damping of the soil.

RADIATION DAMPING: The damping in the soil-structure system due to the generation and propagation of waves away from the foundation due to dynamic displacements of the foundation relative to the free field displacements.

19.1.2 Notation

The following notations apply to the provisions of Chapter 19:

B = Half the smaller dimension of the base of the structure

B_{SSI} = the factor to adjust the general response spectrum for damping ratios other than 0.05

\tilde{C}_s = the seismic response coefficient determined in accordance with Section 12.8.1.1 assuming a flexible structural base at the foundation-soil interface per Section 19.1

D_s = the depth of a soft layer overlaying a stiff layer, (Eq. 19.3-4)

G = effective shear modulus derived or approximated based on G_0 and Table 19.3-2

G_0 = the average shear modulus for the soils beneath the foundation at small strain levels

- K_y, K_r = translational foundational stiffness (Eqs. 19.3-6 & 19.3-16)
 K_{xx}, K_{rr} = rotational foundation stiffness (Eqs. 19.3-7 & 19.3-17)
 L = Half the larger dimension of the base of the structure
 M^* = effective modal mass for the fundamental mode of vibration in the direction under consideration
 r_f = radius of the circular foundation (Eqs. 19.3-18, 19.3-19, 19.3-20, 19.3-21 and 19.3-22)
 RRS_{bsa} = site-specific response spectral modification factor for base-slab averaging
 RRS_e = site-specific response spectral modification factor for foundation embedment
 \tilde{S}_a = response spectral acceleration including the effects of SSI
 \tilde{T} = fundamental period of the structure using a model with a flexible base
 T_y, T_r = fundamental translational period of SSI system (Eqs. 19.3-4 & 19.3-14)
 T_{xx}, T_{rr} = fundamental translational period of SSI system (Eq. 19.3-5 & 19.3-15)
 \tilde{V} = base shear adjusted for soil-structure interaction
 \tilde{V}_r = base shear adjusted for soil-structure interaction determined through modal response spectrum analysis
 \bar{W} = weight due to the modal mass in the fundamental mode, which alternatively shall be taken as the effective seismic weight per Section 12.7.2
 a_o = dimensionless frequency (Eqs. 19.3-9 & 19.3-19)
 b_e = effective foundation size
 h^* = effective structure height
 v_s = the average effective shear wave velocity over a depth of B below the base of the structure determined using v_{so} and Table 19.3-1
 v_{so} = the average shear wave velocity over a depth of B below the base of the structure
 Ψ = dimensionless factor, function of Poisson's ratio (Eqs. 19.3-11 & 19.3-21)
 α_{xx}, α_{rr} = dimensionless factor, function of dimensionless frequency, a_o (Eqs. 19.3-12 & 19.3-22)
 β_f = effective viscous damping ratio relating to foundation-soil interaction
 β_r = Radiation damping ratio determined in accordance with Section 19.3.2 or Section 19.3.3
 β_s = Soil hysteretic damping ratio determined in accordance with Section 19.3.4
 β_{xx}, β_{rr} = rotational foundation damping coefficient (Eqs. 19.3-10 & 19.3-20)
 β_y, β_r = translational foundation damping coefficient (Eqs. 19.3-8 & 19.3-18)
 β = effective viscous damping ratio of the structure, taken as 5% unless otherwise justified by analysis
 β_0 is the effective viscous damping ratio of the soil-structure system, per Section 19.3
 μ = expected ductility demand
 γ = the average unit weight of the soils over a depth of B below the base of the structure
 ν = Poisson's ratio; it shall be permitted to use 0.3 for sand and 0.45 for clay soils

19.2 SSI ADJUSTED STRUCTURAL DEMANDS

19.2.1 Equivalent Lateral Force Procedure

To account for the effects of SSI using a linear static procedure, the base shear, (V), determined from Eq. 12.8-1 shall be permitted to be modified as follows:

$$\tilde{V} = V - \Delta V \geq \alpha V \quad (19.2-1)$$

$$\Delta V = \left(C_s - \frac{\tilde{C}_s}{B_{SSI}} \right) \bar{W} \quad (19.2-2)$$

$$\alpha = \begin{cases} 0.7 & \text{for } R \leq 3 \\ 0.5 + R/15 & \text{for } 3 < R < 6 \\ 0.9 & \text{for } R \geq 6 \end{cases} \quad (19.2-3)$$

$$B_{SSI} = 4 / [5.6 - \ln(100\beta_0)] \quad (19.2-4)$$

where

\tilde{V} = base shear adjusted for SSI

V = the fixed-base structure base shear computed in accordance with 12.8-1

R = the response modification factor in Table 12.2-1

C_s = the seismic response coefficient determined in accordance with Section 12.8.1.1 assuming a fixed structural base at the foundation-soil interface

\tilde{C}_s = the seismic response coefficient determined in accordance with Section 12.8.1.1 assuming flexibility of the structural base at the foundation-soil interface per Section 19.1, using \tilde{T} as the fundamental period of the structure in lieu of the fundamental period of the structure, T , as determined by 12.8.2

\tilde{T} = fundamental period of the structure using a model with a flexible base per Section 19.1 without the limitation of $C_u T_a$ in Section 12.8.2

\bar{W} = weight due to the effective modal mass in the fundamental mode, alternatively shall be taken as the effective seismic weight per Section 12.7.2

β_0 is the effective viscous damping ratio of the soil-structure system, per Section 19.3.

The inclusion of Kinematic Interaction Effects per Section 19.4 is not permitted with the Equivalent Lateral Force Procedure.

19.2.2 Modal Response Spectrum Analysis

To account for the effects of SSI, a modal analysis shall be permitted to be performed per Section 12.9 using either the SSI modified general response spectrum per Section 19.2.2.1 or a SSI modified site specific response spectrum per Section 19.2.2.2 for spectral response acceleration, \tilde{S}_a , versus structural period, T . The resulting response spectral acceleration shall be divided by $R/(I_e)$. The mathematic model used for the modal analysis shall include flexibility of the foundation and underlying soil per Section 19.1.

The inclusion of Kinematic Interaction Effects per Section 19.4 is not permitted with the Modal Analysis Procedure.

Scaling of the lateral forces from the modal response analysis shall be per Section 12.9.4 with calculated base shear, V , being replaced with SSI adjusted base shear, \tilde{V} , per Eq. 19.2-1 and the modal base shear, V_t , being replaced by the modal base shear calculated with the effects of SSI, \tilde{V}_t .

The modal base shear calculated with the effects of SSI, \tilde{V}_t , shall not be less than αV_t , where α is defined in Eq. 19.2-3.

19.2.2.1 SSI Modified General Design Response Spectrum

The general design response spectrum which includes the effects of SSI to be used with the modal analysis procedure in Section 19.2.2 shall be developed as follows:

$$\tilde{S}_a = \left[\left(\frac{5}{B_{SSI}} - 2 \right) \times \frac{T}{T_s} + 0.4 \right] \times S_{DS} \quad (19.2-5)$$

for $0 < T < T_0$, and

$$\tilde{S}_a = S_{DS}/B_{SSI} \text{ for } T_0 \leq T \leq T_s, \text{ and} \quad (19.2-6)$$

$$\tilde{S}_a = S_{D1} / (B_{SSI}T), \text{ for } T_s < T \leq T_L, \text{ and} \quad (19.2-7)$$

$$\tilde{S}_a = S_{D1} T_L / (B_{SSI}T^2), \text{ for } T > T_L, \quad (19.2-8)$$

where S_{DS} and S_{D1} are defined in Section 11.4.4; T_s , T_0 , and T_L are as defined in Section 11.4.5; T is the period at the response spectrum ordinate; and B_{SSI} is defined in Eq. 19.2-2.

19.2.2.2 SSI Site Specific Response Spectrum

A site specific response spectrum, which incorporates modifications due to SSI, shall be permitted to be developed in accordance with the requirements of Chapter 21. The spectrum shall be permitted to be adjusted for the effective viscous damping ratio of β_0 , of the soil-structure system, as defined in Section 19.3, in the development of the site specific spectrum.

19.2.3 Response History Procedure

To account for the effects of SSI, a response history analysis shall be performed per Chapter 16 using acceleration histories scaled to a site specific response spectrum modified for kinematic interaction per Section 19.4 or other approved methods. The mathematic model used for the analysis shall include foundation and soil flexibility per Section 19.1 and explicitly incorporate the effects of foundation damping per Section 19.3 or by other approved methods. If SSI effects are considered, then the strength design requirements of Section 16.1.1 shall use the base shear calculated per Section 19.2.1 or Section 19.2.2 using a site specific response spectrum. Kinematic interaction effects per Section 19.4 shall be permitted to be included in the determination of the site specific response spectrum.

The site specific response spectrum shall be developed per the requirements of Chapter 21 with the following additional requirements:

1. The spectrum shall be permitted to be adjusted for Kinematic SSI effects by multiplying the spectral acceleration ordinate at each period by the corresponding response spectrum ratios for either base slab averaging or embedment or both base-slab averaging and embedment ($RRS_{bsa} \times RRS_e$) per Section 19.4 or by directly incorporating one or both of these effects into the development of the spectrum.
2. For structures embedded in the ground, the site specific response spectrum may be developed at the depth of the embedded base level in lieu of at grade. For this case, the response spectrum ratio for embedment effects (RRS_e) shall be taken as 1.0.
3. The site specific response spectrum modified for kinematic interaction shall not be taken as less than 80 percent of S_a as determined from a site-specific response spectrum in accordance with Section 21.3, unless the site specific response spectrum considering SSI is subjected to peer review and approved by the authority having jurisdiction.
4. The site specific response spectrum modified for kinematic interaction shall not be taken as less than 70 percent of S_a as determined from the general response spectrum in accordance with Section 11.4.5, unless the site specific response spectrum considering SSI is subjected to peer review and approved by the authority having jurisdiction.

5. In no case shall the site specific response spectrum modified for kinematic interaction be taken as less than 60 percent of S_a as determined from the general response spectrum in accordance with Section 11.4.5

19.3 FOUNDATION DAMPING EFFECTS

19.3.1 Foundation Damping Requirements

Foundation damping effects shall be permitted to be considered through direct incorporation of soil hysteretic damping and radiation damping in the mathematical model of the structure.

The procedures of this section shall not be used for the following cases:

1. A foundation system consisting of discrete footings that are not interconnected and that are spaced less than the larger dimension of the supported lateral force-resisting element in the direction under consideration.
2. A foundation system consisting of, or including, deep foundations such as piles or piers.
3. A foundation system consisting of structural mats or interconnected by concrete slabs that are characterized as flexible in accordance with Section 12.3.1.3 or that are not continuously connected to grade beams or other foundation elements.

19.3.2 Effective Damping Ratio

The effects of foundation damping shall be represented by the effective damping ratio of the soil-structure system, β_o , determined in accordance with Eq. 19.3-1.

$$\beta_o = \beta_f + \frac{\beta}{\left(\tilde{T}/T\right)_{eff}^2} \leq 0.20 \quad (19.3-1)$$

where

β_f = effective viscous damping ratio relating to foundation-soil interaction

β = effective viscous damping ratio of the structure, taken as 5% unless otherwise justified by analysis; and

$\left(\tilde{T}/T\right)_{eff}$ = effective period lengthening ratio defined in Eq. 19.3-2

The effective period lengthening ratio shall be determined in accordance with Eq. 19.3-2

$$\left(\frac{\tilde{T}}{T}\right)_{eff} = \left\{ 1 + \frac{1}{\mu} \left[\left(\frac{\tilde{T}}{T}\right)^2 - 1 \right] \right\}^{0.5} \quad (19.3-2)$$

where

μ = expected ductility demand. For Equivalent Lateral Force or Modal Response Spectrum Analysis procedures, μ is the maximum base shear divided by the elastic base shear capacity, or μ shall be permitted to be taken as R/Ω_o , where R and Ω_o , are per Table 12.2-1. For the Response History Analysis procedures, μ is the maximum displacement divided by the yield displacement of the structure measured at the highest point above grade.

\tilde{T} = fundamental period of the structure using a model with a flexible base per Section 19.1. The upper-bound limitation of $C_u T_a$ on the fundamental period from Section 12.8.2 shall not apply and the approximate structural period, T_a , shall not be used

T = fundamental period of the structure determined in accordance with Section 12.8.2 based on a mathematical model with a fixed base condition. The upper-bound limitation of $C_u T_a$ on the fundamental period from Section 12.8.2 shall not apply and the approximate structural period, T_a , shall not be used

The foundation damping ratio due to soil hysteretic damping and radiation damping, β_f , shall be permitted to be determined in accordance with Eq. 19.3-2 or by other approved methods.

$$\beta_f = \left[\frac{(\bar{T}/T)^2 - 1}{(\bar{T}/T)^2} \right] \beta_s + \beta_r \quad (19.3-3)$$

where

β_s = Soil hysteretic damping ratio determined in accordance with Section 19.3.4

β_r = Radiation damping ratio determined in accordance with Section 19.3.2 or Section 19.3.3

If a site over a depth B or r_f below the base of the building consists of a relatively uniform layer of depth, D_s overlaying a very stiff layer with a shear wave velocity more than twice that of the surface layer and $\frac{4D_s}{v_s \bar{T}} < 1$, then the damping values, β_r , in Eq. 19.3-3 shall be replaced by β'_s per Eq. 19.3-4.

$$\beta'_s = \left(\frac{4D_s}{v_s \bar{T}} \right)^4 \beta_s \quad (19.3-4)$$

19.3.3 Radiation Damping for Rectangular Foundations

The effects of radiation damping for structures with a rectangular foundation plan shall be represented by the effective damping ratio of the soil-structure system, β_r , determined in accordance with Eq. 19.3-3.

$$\beta_r = \frac{1}{(\bar{T}/T_y)^2} \beta_y + \frac{1}{(\bar{T}/T_{xx})^2} \beta_{xx} \quad (19.3-5)$$

$$T_y = 2\pi \sqrt{\frac{M^*}{K_y}} \quad (19.3-6)$$

$$T_{xx} = 2\pi \sqrt{\frac{M^*(h^*)^2}{\alpha_{xx} K_{xx}}} \quad (19.3-7)$$

$$K_y = \frac{GB}{2-\nu} \left[6.8 \left(\frac{L}{B} \right)^{0.65} + 0.8 \left(\frac{L}{B} \right) + 1.6 \right] \quad (19.3-8)$$

$$K_{xx} = \frac{GB^3}{1-\nu} \left[3.2 \left(\frac{L}{B} \right) + 0.8 \right] \quad (19.3-9)$$

$$\beta_y = \left[\frac{4(L/B)}{(K_y/GB)} \right] \left[\frac{a_0}{2} \right] \quad (19.3-10)$$

$$a_0 = \frac{2\pi B}{\bar{T} v_s} \quad (19.3-11)$$

$$\beta_{xx} = \left[\frac{(4\psi/3)(L/B)a_0^2}{\left(\frac{K_{xx}}{GB^3}\right)\left[2.2 - \frac{0.4}{(L/B)^3} + a_0^2\right]} \right] \left[\frac{a_0}{2\alpha_{xx}} \right] \quad (19.3-12)$$

$$\psi = \sqrt{\frac{2(1-\nu)}{1-2\nu}} \leq 2.5 \quad (19.3-13)$$

$$\alpha_{xx} = 1.0 - \left[\frac{(0.55 + 0.01\sqrt{(L/B)-1})a_0^2}{\left(2.4 - \frac{0.4}{(L/B)^3} + a_0^2\right)} \right] \quad (19.3-14)$$

where

M^* = effective modal mass for the fundamental mode of vibration in the direction under consideration

h^* = effective structure height taken as the vertical distance from the foundation to the centroid of the first mode shape for multistory structures per Eq. 19.3-6. Alternatively, h^* shall be permitted to be approximated as 70% of the total structure height for multistory structures or as the full height of the structure for one-story structures

L = Half the larger dimension of the base of the structure

B = Half the smaller dimension of the base of the structure

v_s = the average effective shear wave velocity over a depth of B below the base of the structure determined using v_{so} and Table 19.3-1

v_{so} = the average shear wave velocity over a depth of B below the base of the structure

G = effective shear modulus derived or approximated based on G_0 and Table 19.3-2

$G_0 = \gamma v_{so}/g$ = the average shear modulus for the soils beneath the foundation at small strain levels

γ = the average unit weight of the soils over a depth of B below the base of the structure

ν = Poisson's ratio; it shall be permitted to use 0.3 for sandy and 0.45 for clayey soils

Table 19.3-1 Effective Shearwave Velocity Ratio (v_s/v_{so}) in terms of Effective Peak Acceleration, $S_{DS}/2.5^1$

Site Class	$S_{DS}/2.5 = 0$	$S_{DS}/2.5 = 0.1$	$S_{DS}/2.5 = 0.4$	$S_{DS}/2.5 = 0.8$
A	1.00	1.00	1.00	1.00
B	1.00	1.00	0.97	0.95
C	1.00	0.97	0.87	0.77
D	1.00	0.95	0.71	0.32
E	1.00	0.77	0.22	*
F	*	*	*	*

¹Use straight-line interpolation for intermediate values of $S_{DS}/2.5$.

*Site-specific geotechnical investigation and dynamic site response analyses shall be performed.

Table 19.3-2 Effective Shear Modulus Ratio (G/G_0) in terms of Effective Peak Acceleration, $S_{DS}/2.5^1$

Site Class	$S_{DS}/2.5 = 0$	$S_{DS}/2.5 = 0.1$	$S_{DS}/2.5 = 0.4$	$S_{DS}/2.5 = 0.8$
A	1.00	1.00	1.00	1.00
B	1.00	1.00	0.95	0.90
C	1.00	0.95	0.75	0.60
D	1.00	0.90	0.50	0.10

E	1.00	0.60	0.05	*
F	*	*	*	*

¹Use straight-line interpolation for intermediate values of $S_{DS}/2.5$.

*Site-specific geotechnical investigation and dynamic site response analyses shall be performed.

19.3.4 Radiation Damping for Circular Foundations

The effects of radiation damping for structures with a circular foundation plan shall be represented by the effective damping ratio of the soil-structure system, β_r , determined in accordance with Eq. 19.3-13.

$$\beta_r = \frac{1}{(\bar{T}/T_r)^2} \beta_r + \frac{1}{(\bar{T}/T_{rr})^2} \beta_{rr} \quad (19.3-15)$$

$$T_r = 2\pi \sqrt{\frac{M^*}{K_r}} \quad (19.3-16)$$

$$T_{rr} = 2\pi \sqrt{\frac{M^*(h^*)^2}{\alpha_{rr} K_{rr}}} \quad (19.3-17)$$

$$K_r = \frac{8Gr_f}{2-\nu} \quad (19.3-18)$$

$$K_{rr} = \frac{8Gr_f^3}{3(1-\nu)} \quad (19.3-19)$$

$$\beta_r = \left[\frac{\pi}{(K_r/Gr_f)} \right] \left[\frac{a_0}{2} \right] \quad (19.3-20)$$

$$a_0 = \left[\frac{2\pi r_f}{\bar{T}v_s} \right] \quad (19.3-21)$$

$$\beta_{rr} = \left[\frac{(\pi\psi/4)a_0^2}{\left(\frac{K_{rr}}{Gr_f^3} \right) [2+a_0^2]} \right] \left[\frac{a_0}{2\alpha_{rr}} \right] \quad (19.3-22)$$

$$\psi = \sqrt{\frac{2(1-\nu)}{(1-2\nu)}} \leq 2.5 \quad (19.3-23)$$

$$\alpha_{rr} = 1.0 - \left[\frac{0.35a_0^2}{1.0 + a_0^2} \right] \quad (19.3-24)$$

where

r_f = radius of the circular foundation

v_s = the average effective shear wave velocity over a depth of r_f below the base of the structure determined using v_{so} and Table 19.3-1

v_{so} = the average shear wave velocity over a depth of r_f below the base of the structure

γ = the average unit weight of the soils over a depth of r_f below the base of the structure

19.3.5 Soil Damping

The effects of soil damping for structures shall be represented by the effective damping ratio of the soil-structure system, β_s determined based on a site specific study. Alternatively, it shall be permitted to determine β_s in accordance with Table 19.3-3.

Table 19.3-3 Soil Damping Ratio in terms of Effective Peak Acceleration, $S_{DS}/2.5$ ¹

Site Class	$S_{DS}/2.5 = 0$	$S_{DS}/2.5 = 0.1$	$S_{DS}/2.5 = 0.4$	$S_{DS}/2.5 = 0.8$
A	0.01	0.01	0.01	0.01
B	0.01	0.01	0.01	0.02
C	0.01	0.01	0.03	0.05
D	0.01	0.02	0.07	0.15
E	0.01	0.05	0.20	*
F	*	*	*	*

¹Use straight-line interpolation for intermediate values of $S_{DS}/2.5$.

*Site-specific geotechnical investigation and dynamic site response analyses shall be performed.

19.4 KINEMATIC INTERACTION EFFECTS

Kinematic interaction effects shall be permitted to be represented by response spectra factors RRS_{bsa} for base slab averaging and RRS_e for embedment, which are multiplied by the spectral acceleration ordinates on the response spectrum at each period. The response spectra factors are calculated in accordance with Sections 19.4.1 and 19.4.2. Modification of the response spectrum for kinematic interaction effects shall be permitted only for use with the response history analysis provisions of Chapter 16. Such modification shall be performed using site specific response spectrum developed in accordance with Chapter 21 and subject to the limitations in Sections 19.2.3, 19.4.1 and 19.4.2.

The product of $RRS_{bsa} \times RRS_e$, shall not be less than 0.6.

19.4.1 Base Slab Averaging

Consideration of the effects of base slab averaging shall be permitted. Such effects shall be accounted for through the development of site specific transfer functions that represent the kinematic interaction effects expected at the site for a given foundation configuration.

Alternatively, modifications for base slab averaging using the procedures of this section shall be permitted for the following cases:

1. All structures located on Site Class C, D, or E; and
2. Structures that have structural mats or foundation elements interconnected with concrete slabs or that are continuously connected with grade beams or other foundation elements of sufficient lateral stiffness so as not to be characterized as flexible under the requirements of Section 12.3.1.3

The RRS factor for base slab averaging, RRS_{bsa} , shall be determined using Eq. 19.4-1 for each period required for analysis.

$$RRS_{bsa} = 0.25 + 0.75 \times \left\{ \frac{1}{b_0^2} \left[1 - \left(\exp(-2b_0^2) \right) \right] \times B_{bsa} \right\}^{1/2} \quad (19.4-1)$$

where

$$B_{bsa} = \begin{cases} 1 + b_0^2 + b_0^4 + \frac{b_0^6}{2} + \frac{b_0^8}{4} + \frac{b_0^{10}}{12} & b_0 \leq 1 \\ \left[\exp(2b_0^2) \right] \times \left[\frac{1}{\sqrt{\pi}b_0} \left(1 - \frac{1}{16b_0^2} \right) \right] & b_0 > 1 \end{cases} \quad (19.4-2)$$

$$b_0 = 0.00071 \times \left(\frac{b_e}{T} \right) \quad (19.4-3)$$

b_e = effective foundation size (ft.);

$$b_e = \sqrt{A_{base}} \leq 260 \text{ ft.}; \quad (19.4-4)$$

$$650 \leq v_s \leq 1650$$

(v_s in ft./s)

In SI

$$b_0 = 0.0023 \times \left(\frac{b_e}{T} \right) \quad (19.4-3M)$$

b_e = effective foundation size (m);

$$b_e = \sqrt{A_{base}} \leq 80 \text{ m}; \quad (19.4-4M)$$

$$200 \leq v_s \leq 500$$

(v_s in m/s)

T = response spectra ordinate period, which shall not be taken as less than 0.20 s when used in Eq. 19.4-3

A_{base} = area of the base of the structure, (ft² or m²); and

19.4.2 Embedment

The response spectrum shall be developed based on a site specific study at the depth of the base of the structure. Alternatively, modifications for embedment shall be permitted using the procedures of this section.

The RRS factor for embedment, RRS_e , shall be determined using Eq. 19.4-6 for each period required for analysis.

$$RRS_e = 0.25 + 0.75 \times \cos\left(\frac{2\pi e}{Tv_s}\right) \geq 0.50 \quad (19.4-6)$$

where

e = foundation embedment depth (ft.), not greater than 20 feet. A minimum of 75% of the foundation footprint shall be present at the embedment depth. For structures located on sloping sites, the shallowest embedment shall be taken as the foundation embedment;

v_s = shear wave velocity for site soil conditions. This velocity shall be taken as the average value of velocity over the embedment depth of the foundation per Table 19.3-1 and shall not be less than 650 ft./s (200 m/s);

T = response spectra ordinate period, which shall not be taken as less than 0.20 s when used in Eq. 19.4-6;

$n = \sqrt{G/G_0}$ shear wave velocity reduction factor or per table 19.3-2;

G = effective shear modulus ratio for the soils beneath the foundation or approximated using Table 19.3-2 and G_0

$G_0 = \gamma(v_{so})^2/g$ = the average shear modulus for the soils beneath the foundation at small strain levels

γ = the average unit weight of the soils

v_{so} = the average shear wave velocity for the soils beneath the foundation at small strain levels (10⁻³ percent or less) over a depth of B or r_f below the base of the foundation. B and r_f are defined in Section 19.3

Page intentionally left blank.

CHAPTER 21, SITE SPECIFIC GROUND MOTION PROCEDURES FOR SEISMIC DESIGN

(Modifications)

SECTION 21.4

21.4 Design Acceleration Parameters

Revise the first paragraph of Section 21.4 as follows:

Where the site-specific procedure is used to determine the design ground motion in accordance with Section 21.3, the parameter S_{DS} shall be taken as 90 percent of the maximum spectral acceleration, S_a , obtained from the site specific spectrum, at any period within the range from 0.2 s to 5 s, inclusive. The parameter S_{D1} shall be taken as the maximum value of the product, TS_a , for periods from 1 s to 2 s for sites with $v_{s,30} > 1,200$ ft./s and for periods from 1 s to 5 s for sites with $v_{s,30} \leq 1,200$ ft./s. The parameters S_{MS} and S_{M1} shall be taken as 1.5 times S_{DS} and S_{D1} , respectively. The values so obtained shall not be less than 80 percent of the values determined in accordance with Section 11.4.3 for S_{MS} and S_{M1} and Section 11.4.4 for S_{DS} and S_{D1} .

Page intentionally left blank.

CHAPTER 22, SEISMIC GROUND MOTION, LONG-PERIOD TRANSITION AND RISK COEFFICIENT MAPS

(Modifications)

INTRODUCTION

Replace the chapter introduction with the following:

Contained in this chapter are Figs. 22-1 through 22-8, which provide the risk-targeted maximum considered earthquake (MCE_R) ground motion parameters S_S and S_I ; Figs. 22-9 through 22-13, which provide the maximum considered earthquake geometric mean (MCE_G) peak ground accelerations as a percentage of g for Site Class B; Figs. 22-14 through 22-17, which provide the long-period transition periods T_L for use in applying the seismic provisions of this standard; and Figs. 22-18 and 22-19, which provide the risk coefficients C_{RS} and C_{RI} . S_S is the mapped MCE_R , 5 percent damped, spectral response acceleration parameter at short periods as defined in Section 11.4.1. S_I is the mapped MCE_R , 5 percent damped, spectral response acceleration parameter at a period of 1 s as defined in Section 11.4.1. C_{RS} is the mapped risk coefficient at short periods used in Section 21.2.1.1. C_{RI} is the mapped risk coefficient at a period of 1 s used in Section 21.2.1.1. T_L is the mapped long-period transition period used in Section 11.4.5.

These maps were prepared by the United States Geological Survey (USGS) in collaboration with the Building Seismic Safety Council (BSSC) Provisions Update Committee and the American Society of Civil Engineers (ASCE) 7 Seismic Subcommittee. The following maps have been updated from the maps contained in ASCE 7-10: Figures 22-1, 22-2, 22-7, 22-8, 22-9, 22-13, 22-18 and 22-19.

Maps of the long-period transition periods, T_L , for Guam and the Northern Mariana Islands and for American Samoa are not provided because parameters have not yet been developed for those islands via the same deaggregation computations done for the other U.S. regions. Therefore, as in previous editions of this standard, the parameter T_L shall be 12 seconds for those islands.

The following is a list of figures contained in this chapter:

FIGURE 22-1 S_S Risk-Targeted Maximum Considered Earthquake (MCE_R) Ground Motion Parameter for the Conterminous United States for 0.2 s Spectral Response Acceleration (5% of Critical Damping), Site Class B.

FIGURE 22-2 S_I Risk-Targeted Maximum Considered Earthquake (MCE_R) Ground Motion Parameter for the Conterminous United States for 1.0 s Spectral Response Acceleration (5% of Critical Damping), Site Class B.

FIGURE 22-3 S_S Risk-Targeted Maximum Considered Earthquake (MCE_R) Ground Motion Parameter for Alaska for 0.2 s Spectral Response Acceleration (5% of Critical Damping), Site Class B.

FIGURE 22-4 S_I Risk-Targeted Maximum Considered Earthquake (MCE_R) Ground Motion Parameter for Alaska for 1.0 s Spectral Response Acceleration (5% of Critical Damping), Site Class B.

FIGURE 22-5 S_S and S_I Risk-Targeted Maximum Considered Earthquake (MCE_R) Ground Motion Parameter for Hawaii for 0.2 and 1.0 s Spectral Response Acceleration (5% of Critical Damping), Site Class B.

FIGURE 22-6 S_S and S_I Risk-Targeted Maximum Considered Earthquake (MCE_R) Ground Motion Parameter for Puerto Rico and the United States Virgin Islands for 0.2 and 1.0 s Spectral Response Acceleration (5% of Critical Damping), Site Class B.

FIGURE 22-7 S_S and S_I Risk-Targeted Maximum Considered Earthquake (MCE_R) Ground Motion Parameter for Guam and the Northern Mariana Islands for 0.2 and 1.0 s Spectral Response Acceleration (5% of Critical Damping), Site Class B.

FIGURE 22-8 S_S and S_I Risk-Targeted Maximum Considered Earthquake (MCE_R) Ground Motion Parameter for American Samoa for 0.2 and 1.0 s Spectral Response Acceleration (5% of Critical Damping), Site Class B.

FIGURE 22-9 Maximum Considered Earthquake Geometric Mean (MCE_G) PGA, %g, Site Class B for the Conterminous United States.

FIGURE 22-10 Maximum Considered Earthquake Geometric Mean (MCE_G) PGA, %g, Site Class B for Alaska.

FIGURE 22-11 Maximum Considered Earthquake Geometric Mean (MCE_G) PGA, %g, Site Class B for Hawaii.

FIGURE 22-12 Maximum Considered Earthquake Geometric Mean (MCE_G) PGA, %g, Site Class B for Puerto Rico and the United States Virgin Islands.

FIGURE 22-13 Maximum Considered Earthquake Geometric Mean (MCE_G) PGA, %g, Site Class B for Guam and the Northern Mariana Islands and for American Samoa.

FIGURE 22-14 Mapped Long-Period Transition Period, T_L (s), for the Conterminous United States.

FIGURE 22-15 Mapped Long-Period Transition Period, T_L (s), for Alaska.

FIGURE 22-16 Mapped Long-Period Transition Period, T_L (s), for Hawaii.

FIGURE 22-17 Mapped Long-Period Transition Period, T_L (s), for Puerto Rico and the United States Virgin Islands.

FIGURE 22-18 Mapped Risk Coefficient at 0.2 s Spectral Response Period, C_{RS} .

FIGURE 22-19 Mapped Risk Coefficient at 1.0 s Spectral Response Period, C_{RI} .

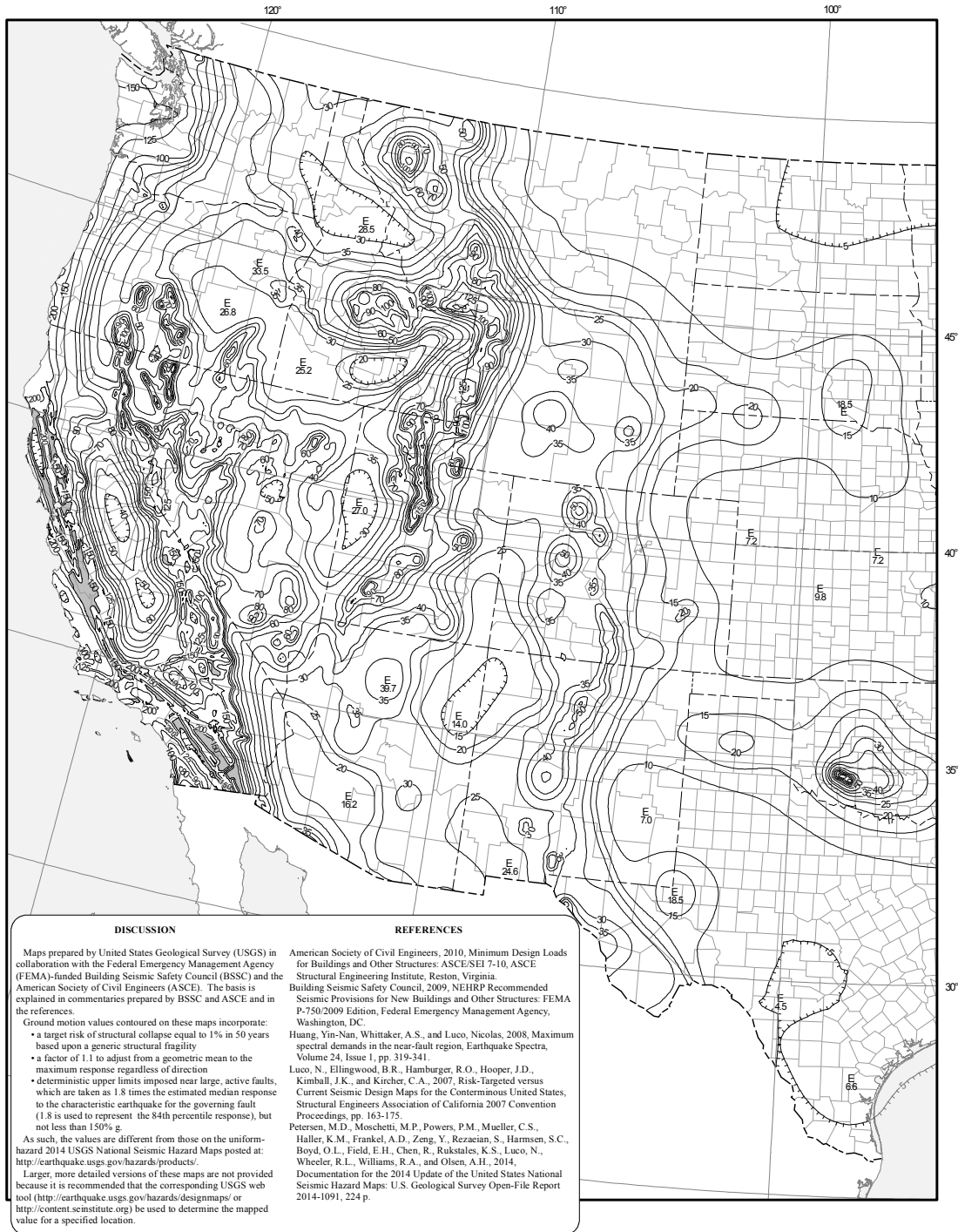

FIGURE 22-1 S_s Risk-Targeted Maximum Considered Earthquake (MCE_R) Ground Motion Parameter for the Conterminous United States for 0.2 s Spectral Response Acceleration (5% of Critical Damping), Site Class B

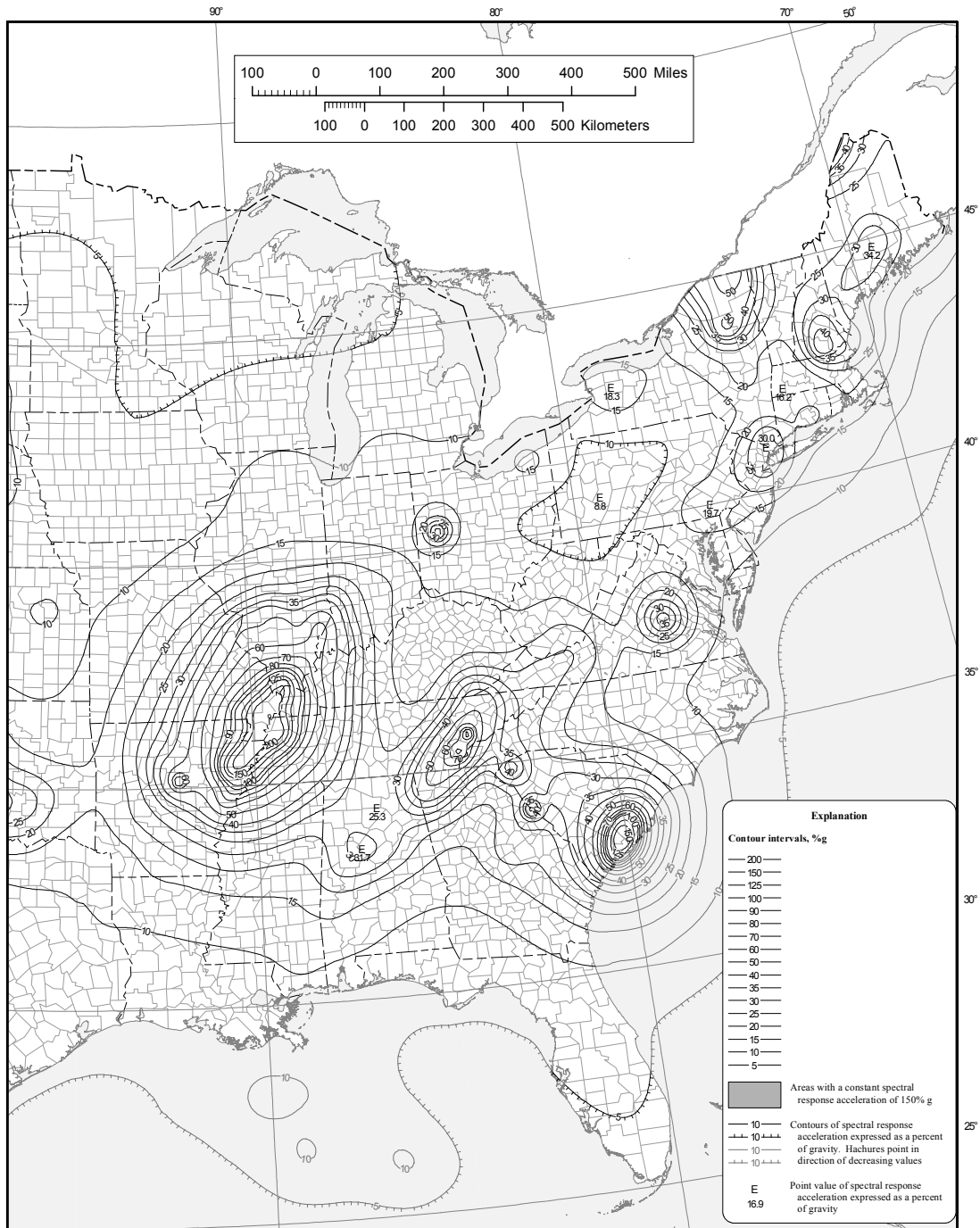

FIGURE 22-1 (continued) S_s Risk-Targeted Maximum Considered Earthquake (MCE_R) Ground Motion Parameter for the Conterminous United States for 0.2 s Spectral Response Acceleration (5% of Critical Damping), Site Class B

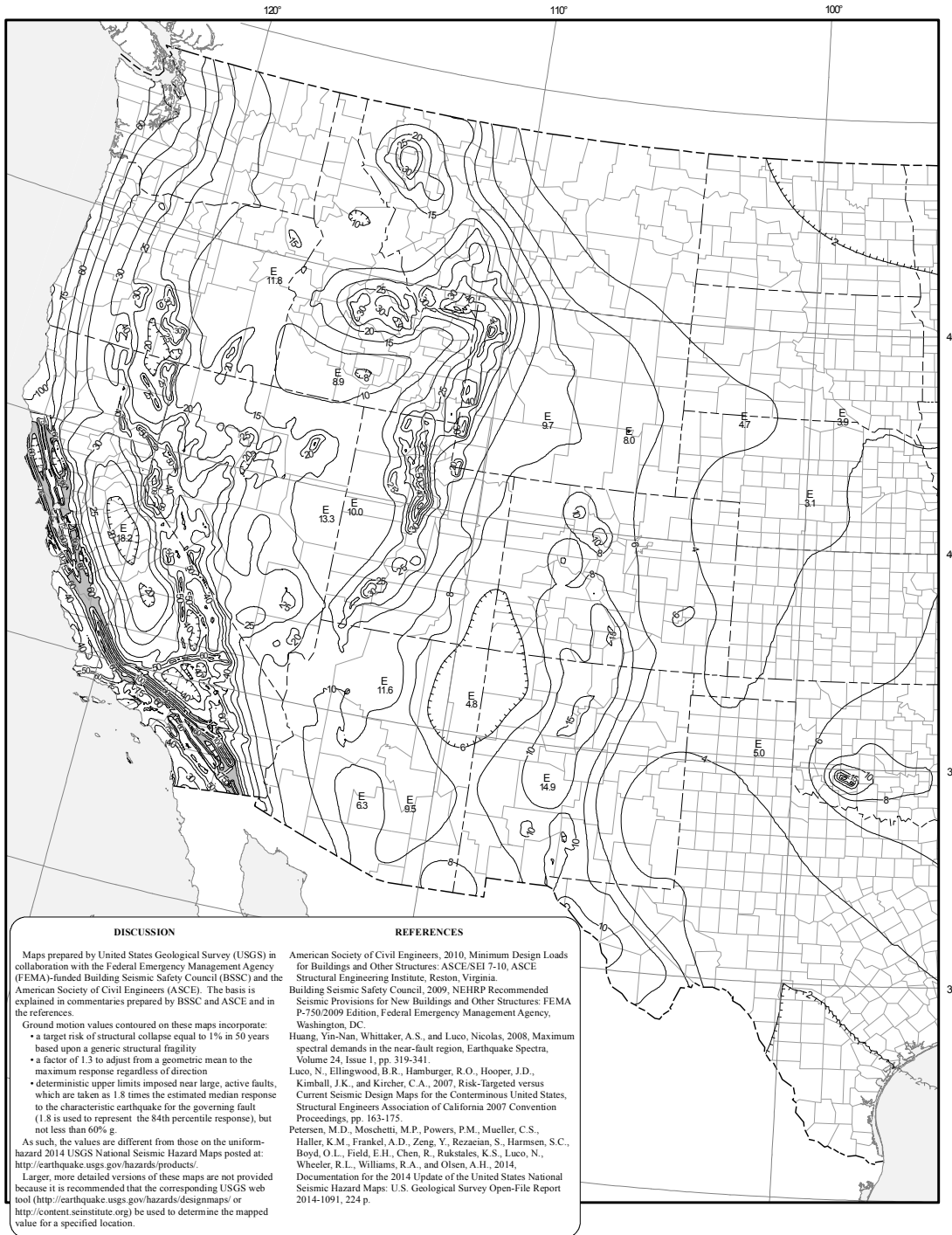

FIGURE 22-2 S₁ Risk-Targeted Maximum Considered Earthquake (MCE_R) Ground Motion Parameter for the Conterminous United States for 1.0 s Spectral Response Acceleration (5% of Critical Damping), Site Class B

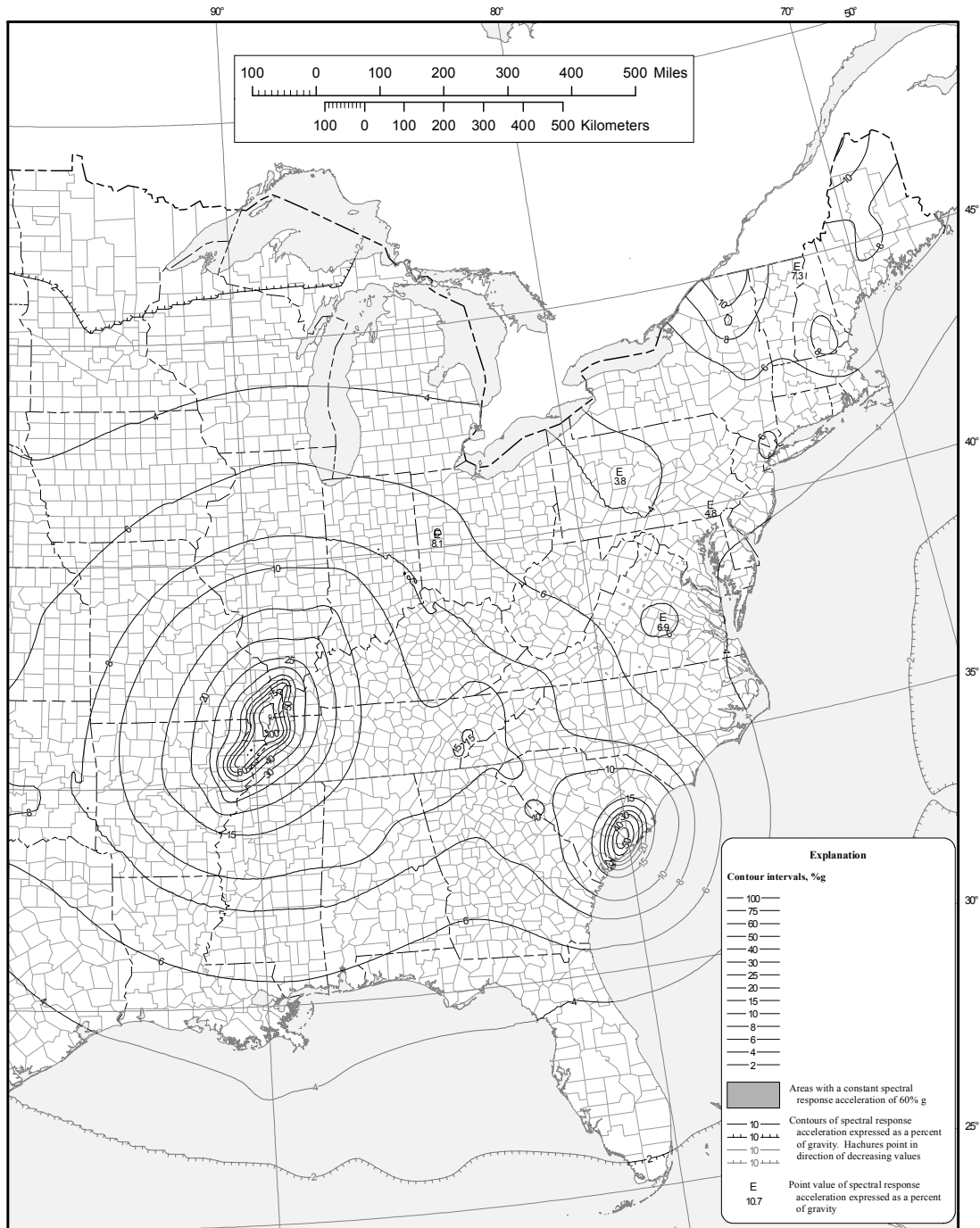

FIGURE 22-2 (continued) S_1 Risk-Targeted Maximum Considered Earthquake (MCE_R) Ground Motion Parameter for the Conterminous United States for 1.0 s Spectral Response Acceleration (5% of Critical Damping), Site Class B

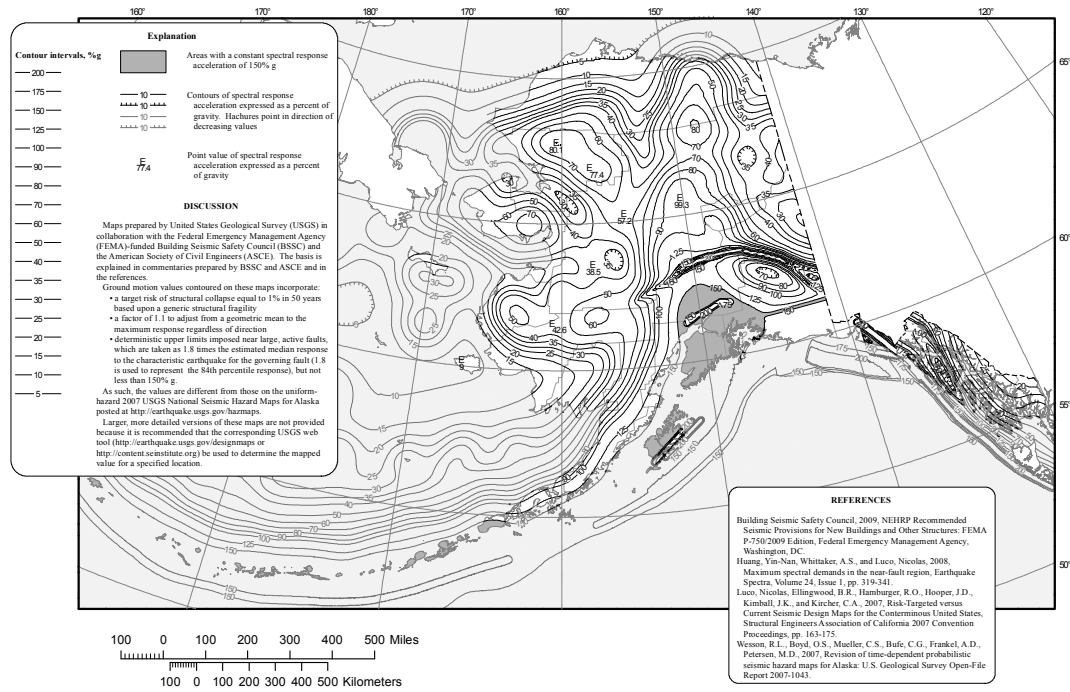

FIGURE 22-3 S₅ Risk-Targeted Maximum Considered Earthquake (MCE_R) Ground Motion Parameter for Alaska for 0.2 s Spectral Response Acceleration (5% of Critical Damping), Site Class B

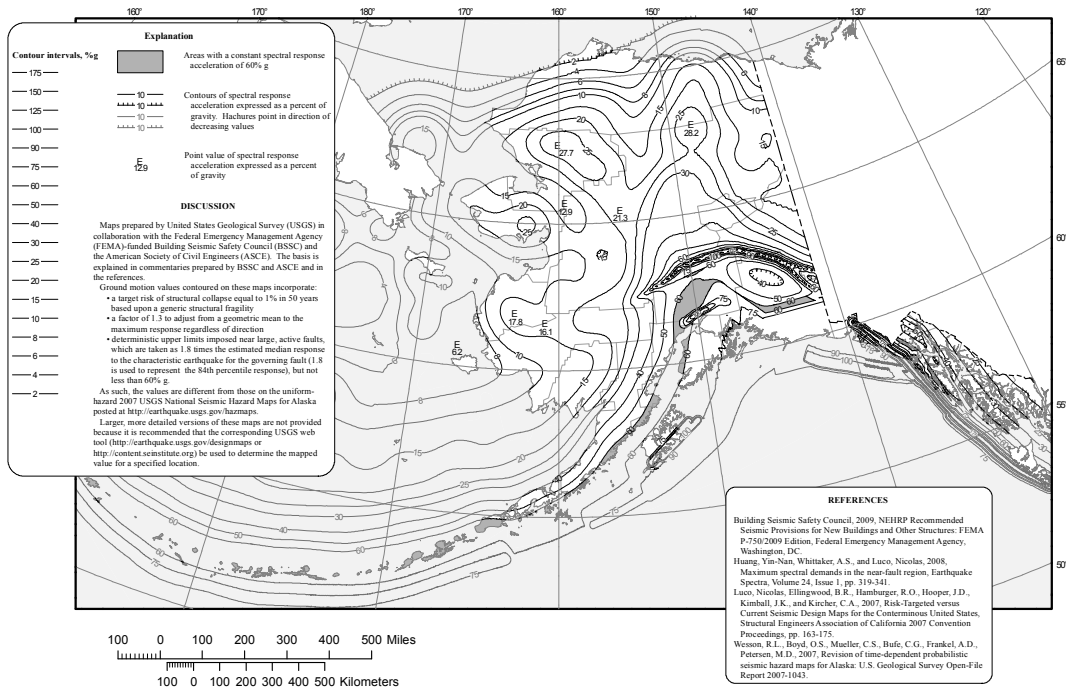
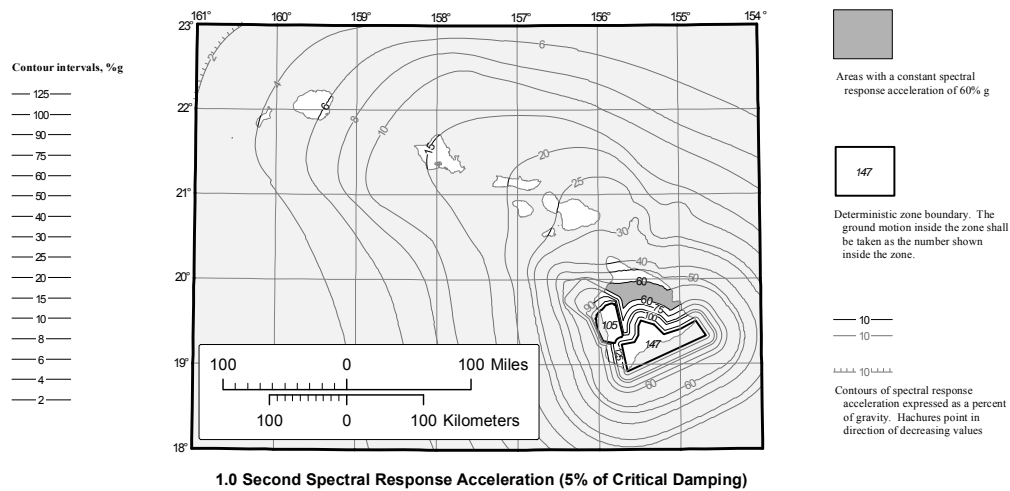
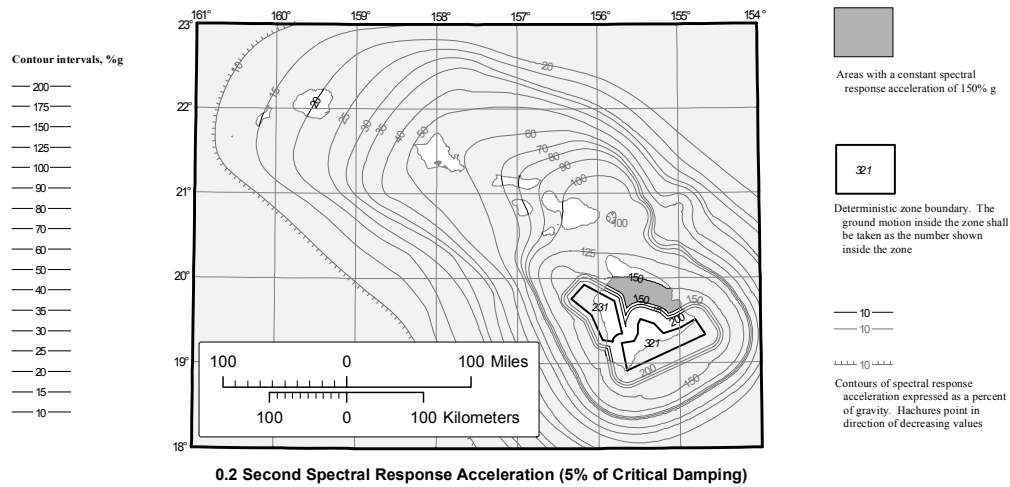

FIGURE 22-4 S₇ Risk-Targeted Maximum Considered Earthquake (MCE_R) Ground Motion Parameter for Alaska for 1.0 s Spectral Response Acceleration (5% of Critical Damping), Site Class B



DISCUSSION	REFERENCES
<p>Maps prepared by United States Geological Survey (USGS) in collaboration with the Federal Emergency Management Agency (FEMA)-funded Building Seismic Safety Council (BSSC) and the American Society of Civil Engineers (ASCE). The basis is explained in commentaries prepared by BSSC and ASCE and in the references.</p> <p>Ground motion values contoured on these maps incorporate:</p> <ul style="list-style-type: none"> • a target risk of structural collapse equal to 1% in 50 years based upon a generic structural fragility • deterministic upper limits imposed near large, active faults, which are taken as 1.8 times the estimated median response to the characteristic earthquake for the governing fault (1.8 is used to represent the 84th percentile response), but not less than 150% and 60% g for 0.2 and 1.0 sec., respectively. <p>As such, the values are different from those on the uniform-hazard 1998 USGS National Seismic Hazard Maps for Hawaii posted at http://earthquake.usgs.gov/hazmaps.</p> <p>Larger, more detailed versions of these maps are not provided because it is recommended that the corresponding USGS web tool (http://earthquake.usgs.gov/designmaps or http://content.seisintstitute.org) be used to determine the mapped value for a specified location.</p>	<p>Building Seismic Safety Council, 2009, NEHRP Recommended Seismic Provisions for New Buildings and Other Structures, FEMA P-750/2009 Edition, Federal Emergency Management Agency, Washington, DC.</p> <p>Huang, Yin-Nan, Whittaker, A.S., and Luo, Nicolas, 2008, Maximum spectral demands in the near-fault region, <i>Earthquake Spectra</i>, Volume 24, Issue 1, pp. 319-341.</p> <p>Klein, F., Frankel, A.D., Mueller, C.S., Wesson, R.L., and Okubo, P., 2001, Seismic hazard in Hawaii: high rate of large earthquakes and probabilistic ground-motion maps, <i>Bulletin of the Seismological Society of America</i>, Volume 91, pp. 479-498.</p> <p>Luo, Nicolas, Ellingwood, B.R., Hamburger, R.O., Hooper, J.D., Kimball, J.K., and Kircher, C.A., 2007, Risk-Targeted versus Current Seismic Design Maps for the Conterminous United States, <i>Structural Engineers Association of California 2007 Convention Proceedings</i>, pp. 163-175.</p>

FIGURE 22-5 S_S and S_I Risk-Targeted Maximum Considered Earthquake (MCE_R) Ground Motion Parameter for Hawaii for 0.2 and 1.0 s Spectral Response Acceleration (5% of Critical Damping), Site Class B

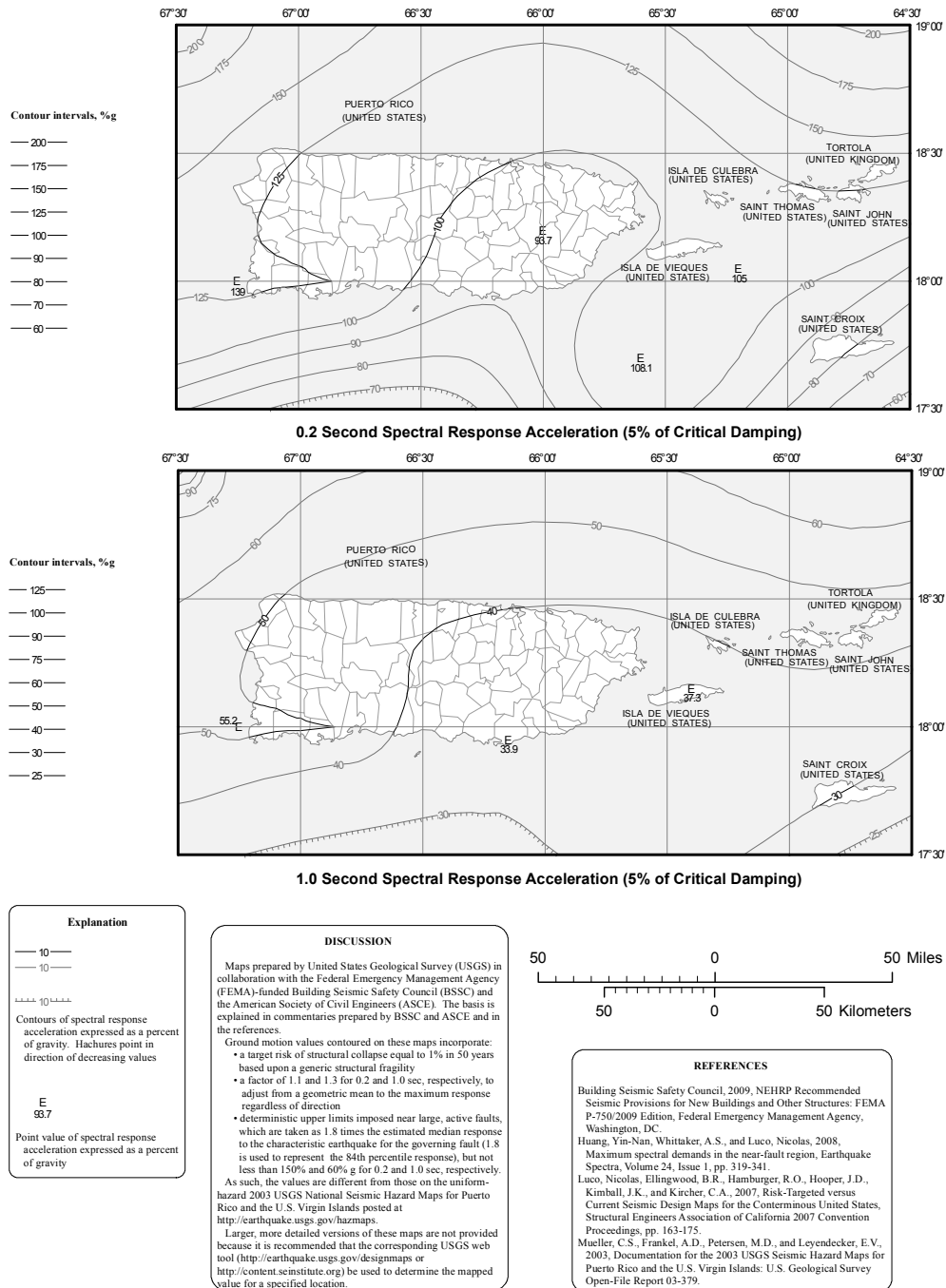
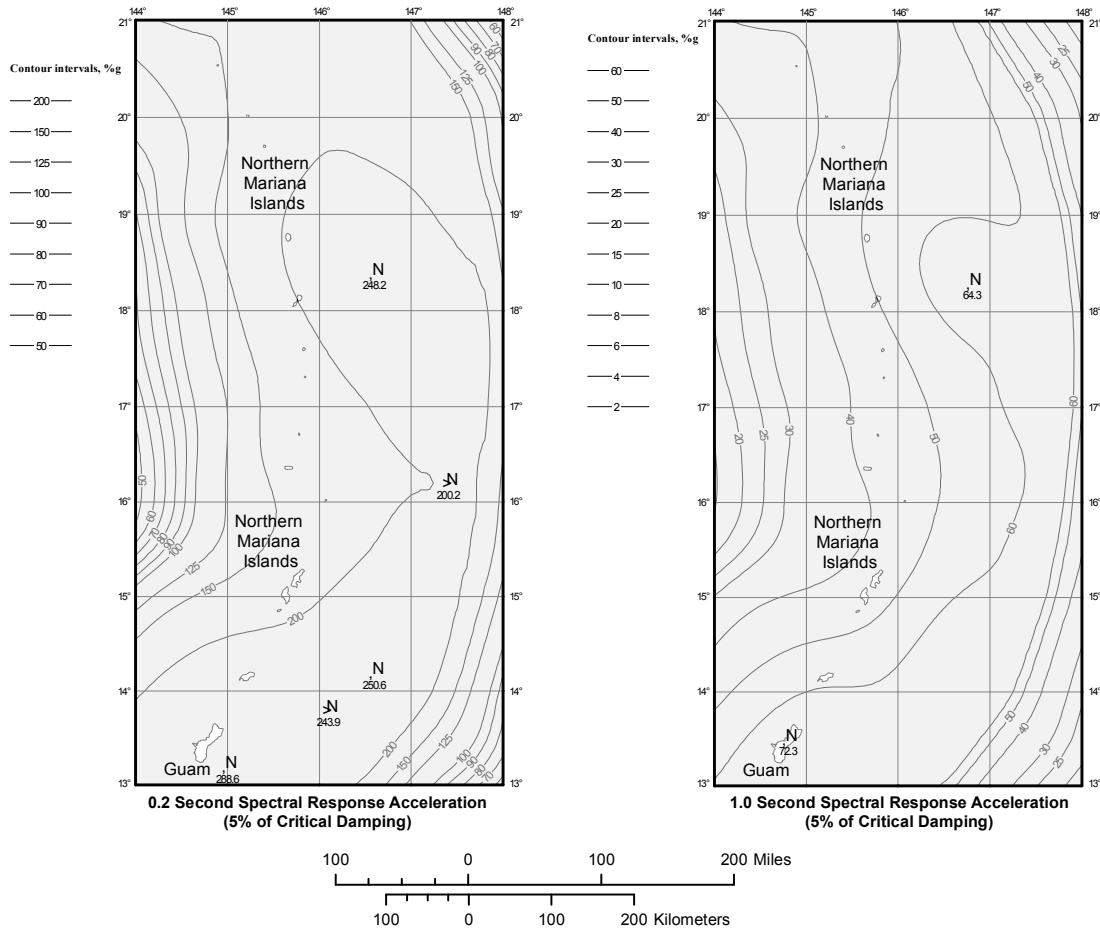

FIGURE 22-6 S_0 and S_1 Risk-Targeted Maximum Considered Earthquake (MCE_R) Ground Motion Parameter for Puerto Rico and the United States Virgin Islands for 0.2 and 1.0 s Spectral Response Acceleration (5% of Critical Damping), Site Class B



Explanation

Contours of spectral response acceleration expressed as a percent of gravity.

— 10 —
— 10 —

Point values of spectral response acceleration expressed as a percent of gravity.

> 200.2 Local minimum
N 250.6 Local maximum
N 243.9 Saddle point

DISCUSSION

Maps prepared by United States Geological Survey (USGS) in collaboration with the Federal Emergency Management Agency (FEMA)-funded Building Seismic Safety Council (BSSC). The basis is explained in commentary prepared by BSSC and in the references.

Ground motion values contoured on these maps incorporate:

- a target risk of structural collapse equal to 1% in 50 years based upon a generic structural fragility
- a factor of 1.1 and 1.3 for 0.2 and 1.0 sec, respectively, to adjust from a geometric mean to the maximum response regardless of direction
- deterministic upper limits imposed near large, active faults, which are taken as 1.8 times the estimated median response to the characteristic earthquake for the governing fault (1.8 is used to represent the 84th percentile response), but not less than 150% and 60% g for 0.2 and 1.0 sec, respectively.

As such, the values are different from those on the uniform-hazard 2012 USGS National Seismic Hazard Maps for Guam and the Northern Mariana Islands posted at <http://earthquake.usgs.gov/hazmaps>.

Larger, more detailed versions of these maps are not provided because it is recommended that the corresponding USGS web tool (<http://earthquake.usgs.gov/designmaps>) be used to determine the mapped value for a specified location.

REFERENCES

American Society of Civil Engineers, 2010, Minimum Design Loads for Buildings and Other Structures: ASCE/SEI 7-10, ASCE Structural Engineering Institute, Reston, Virginia.

Building Seismic Safety Council, 2009, NEHRP Recommended Seismic Provisions for New Buildings and Other Structures: FEMA P-750/2009 Edition, Federal Emergency Management Agency, Washington, DC.

Huang, Yin-Nan, Whitaker, A.S., and Luco, Nicolas, 2008, Maximum spectral demands in the near-fault region, Earthquake Spectra, Volume 24, Issue 1, pp. 319-341.

Luco, Nicolas, Ellingwood, B.R., Hamburger, R.O., Hooper, J.D., Kimball, J.K., and Kircher, C.A., 2007, Risk-Targeted versus Current Seismic Design Maps for the Conterminous United States, Structural Engineers Association of California 2007 Convention Proceedings, pp. 163-175.

Mueller, C.S., Haller, K.M., Luco, Nicolas, Petersen, M.D., and Frankel, A.D., 2012, Seismic Hazard Assessment for Guam and the Northern Mariana Islands: U.S. Geological Survey Open-File Report 2012-1015.

FIGURE 22-7 S_0 and S_1 Risk-Targeted Maximum Considered Earthquake (MCE_R) Ground Motion Parameter for Guam and the Northern Mariana Islands for 0.2 and 1.0 s Spectral Response Acceleration (5% of Critical Damping), Site Class B

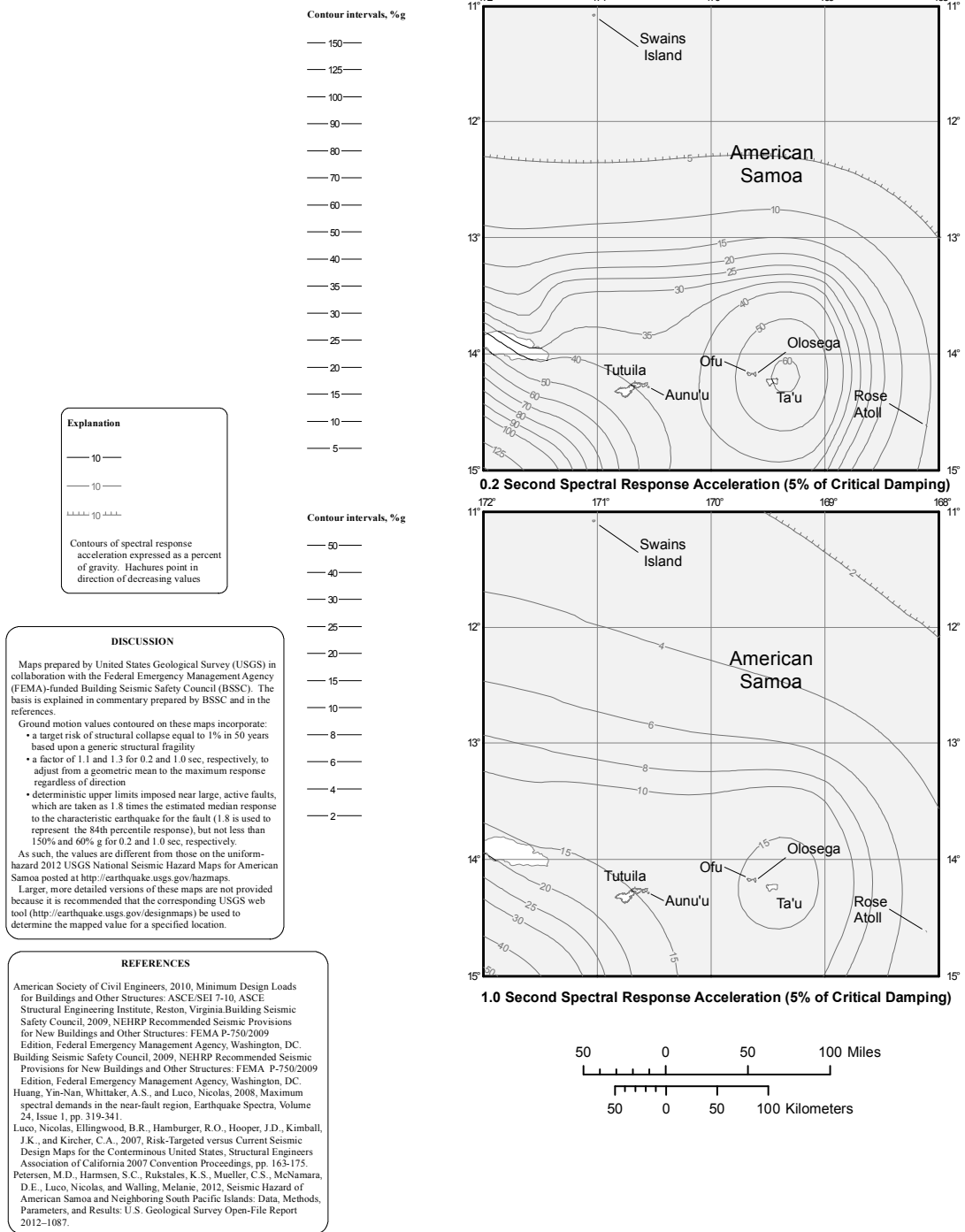

FIGURE 22-8 S_S and S_1 Risk-Targeted Maximum Considered Earthquake (MCE_R) Ground Motion Parameter for American Samoa for 0.2 and 1.0 s Spectral Response Acceleration (5% of Critical Damping), Site Class B

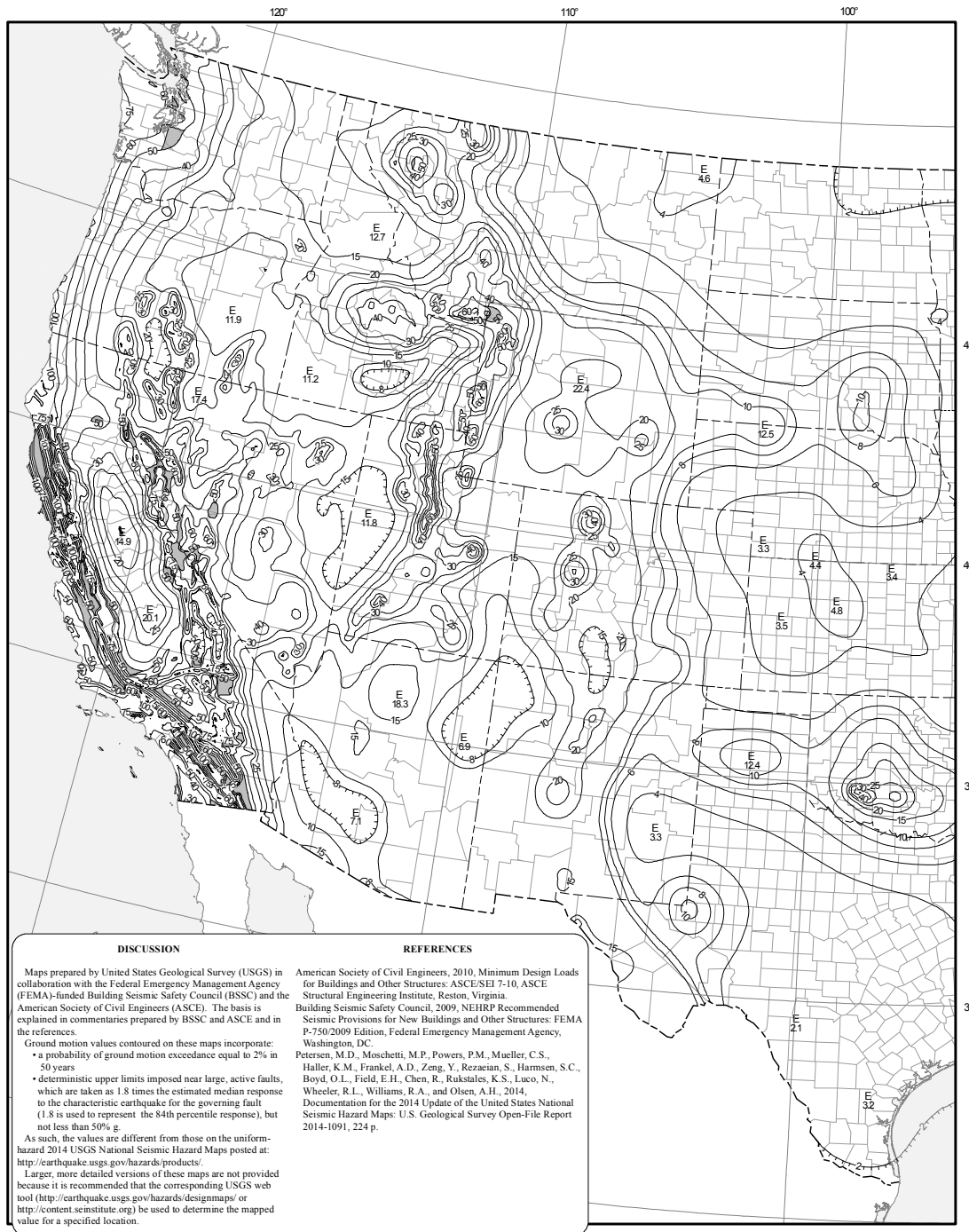

FIGURE 22-9 Maximum Considered Earthquake Geometric Mean (MCE_G) PGA, %g, Site Class B for the Conterminous United States

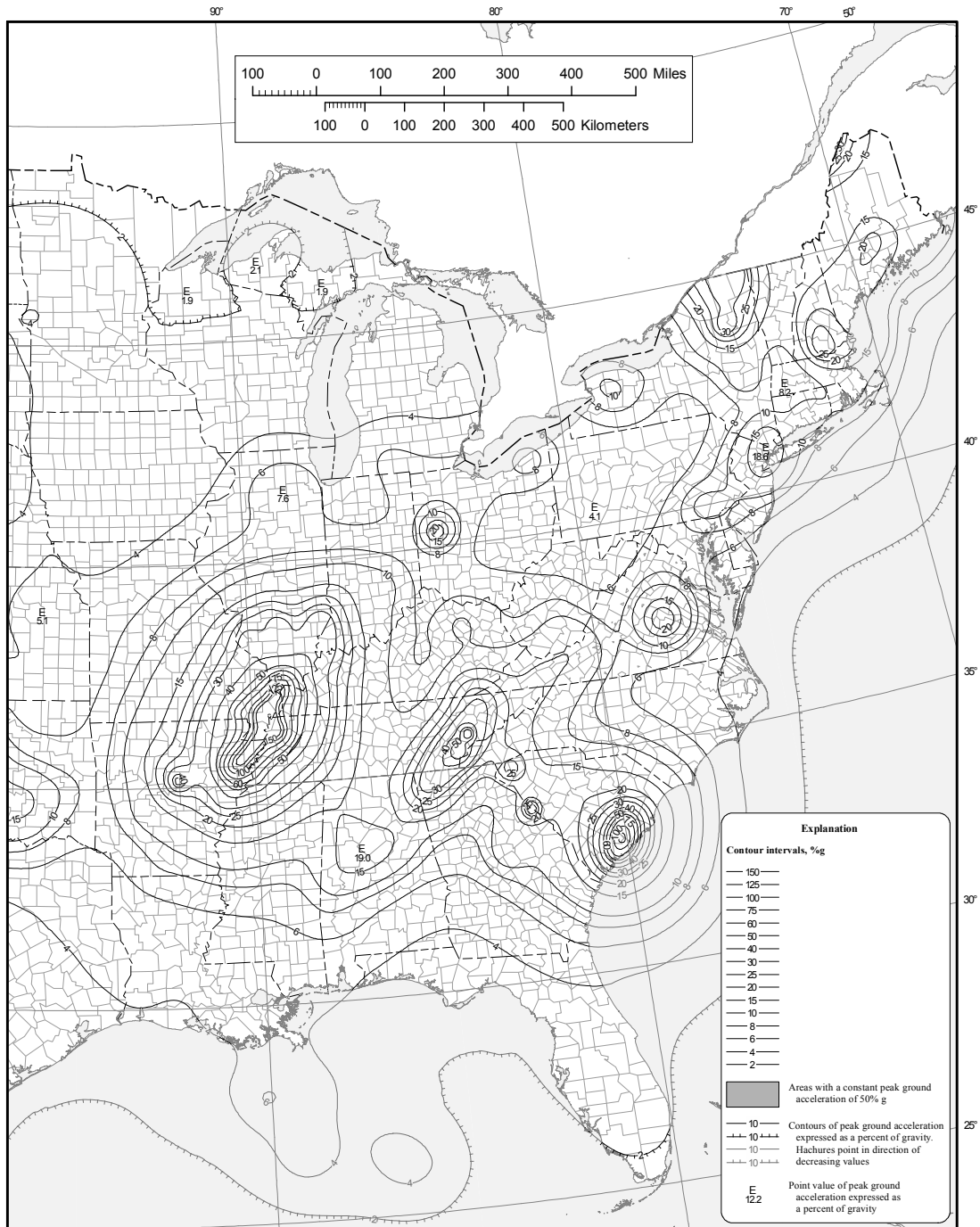

FIGURE 22-9 (continued) Maximum Considered Earthquake Geometric Mean (MCE_G) PGA, %g, Site Class B for the Conterminous United States

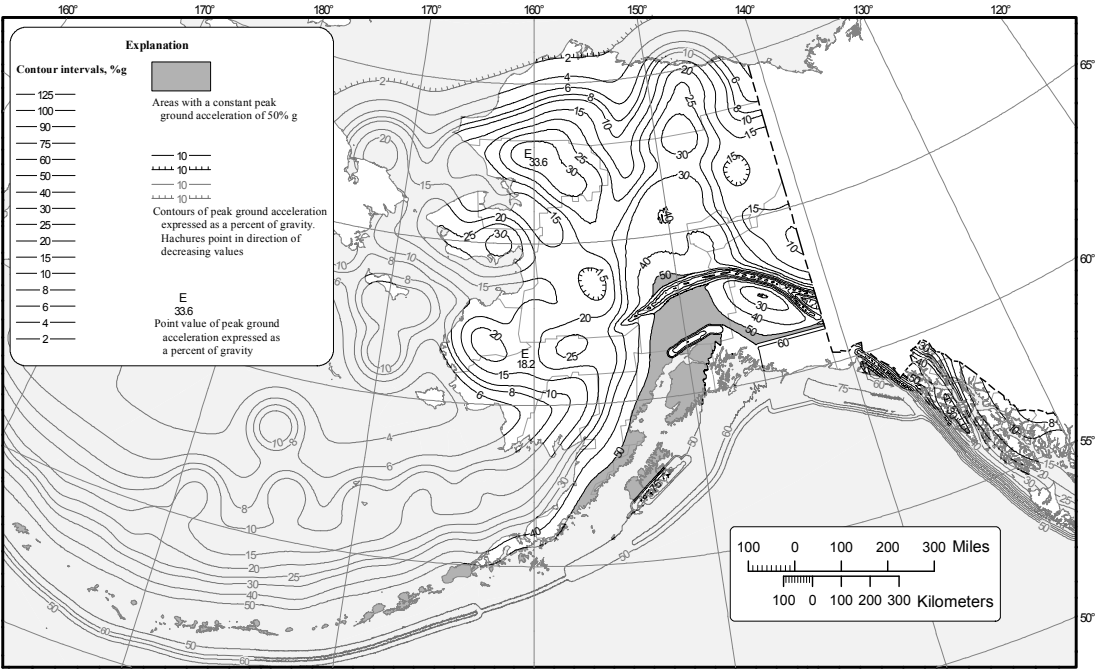

FIGURE 22-10 Maximum Considered Earthquake Geometric Mean (MCE_G) PGA, %g, Site Class B for Alaska

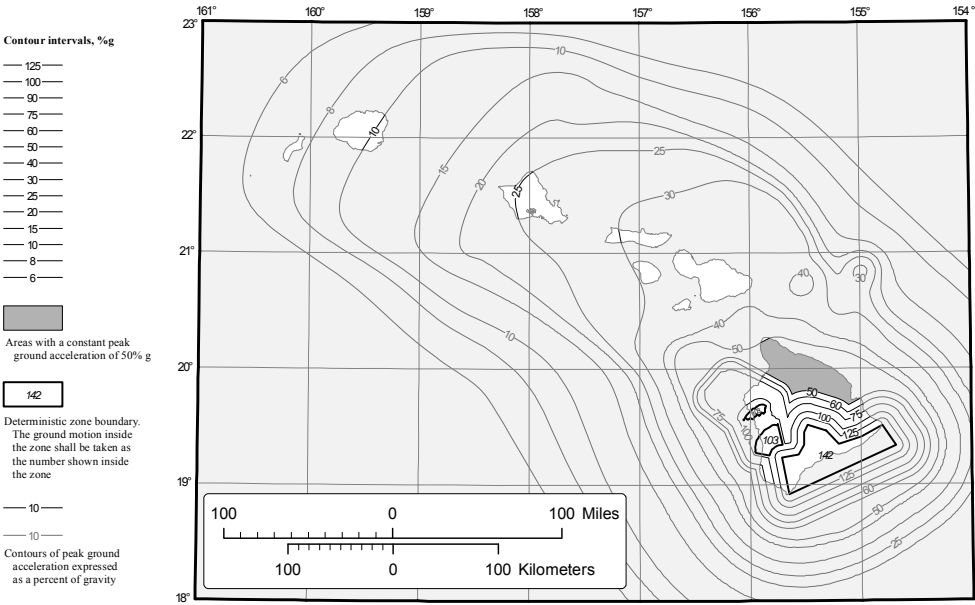

FIGURE 22-11 Maximum Considered Earthquake Geometric Mean (MCE_G) PGA, %g, Site Class B for Hawaii

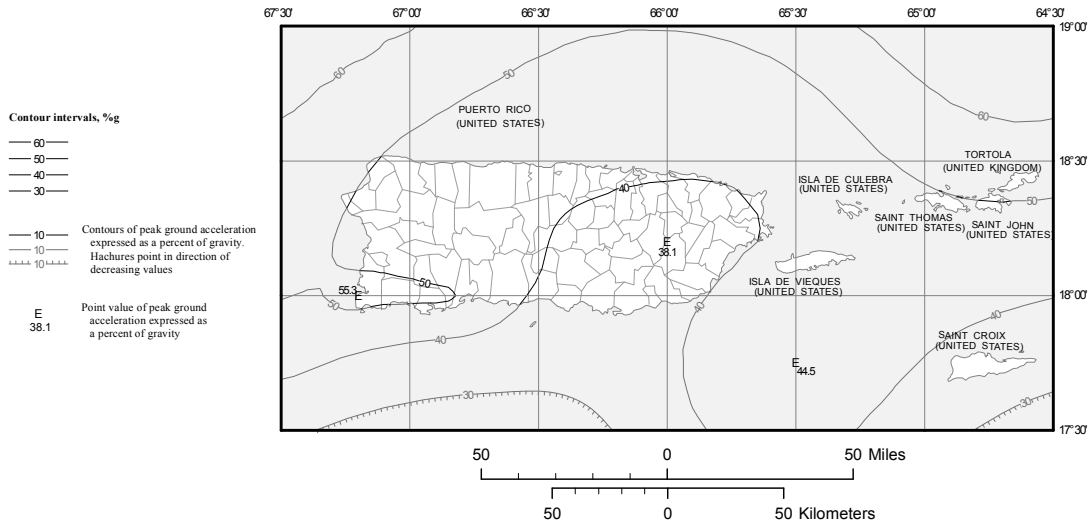

FIGURE 22-12 Maximum Considered Earthquake Geometric Mean (MCE_G) PGA, %g, Site Class B for Puerto Rico and the United States Virgin Islands

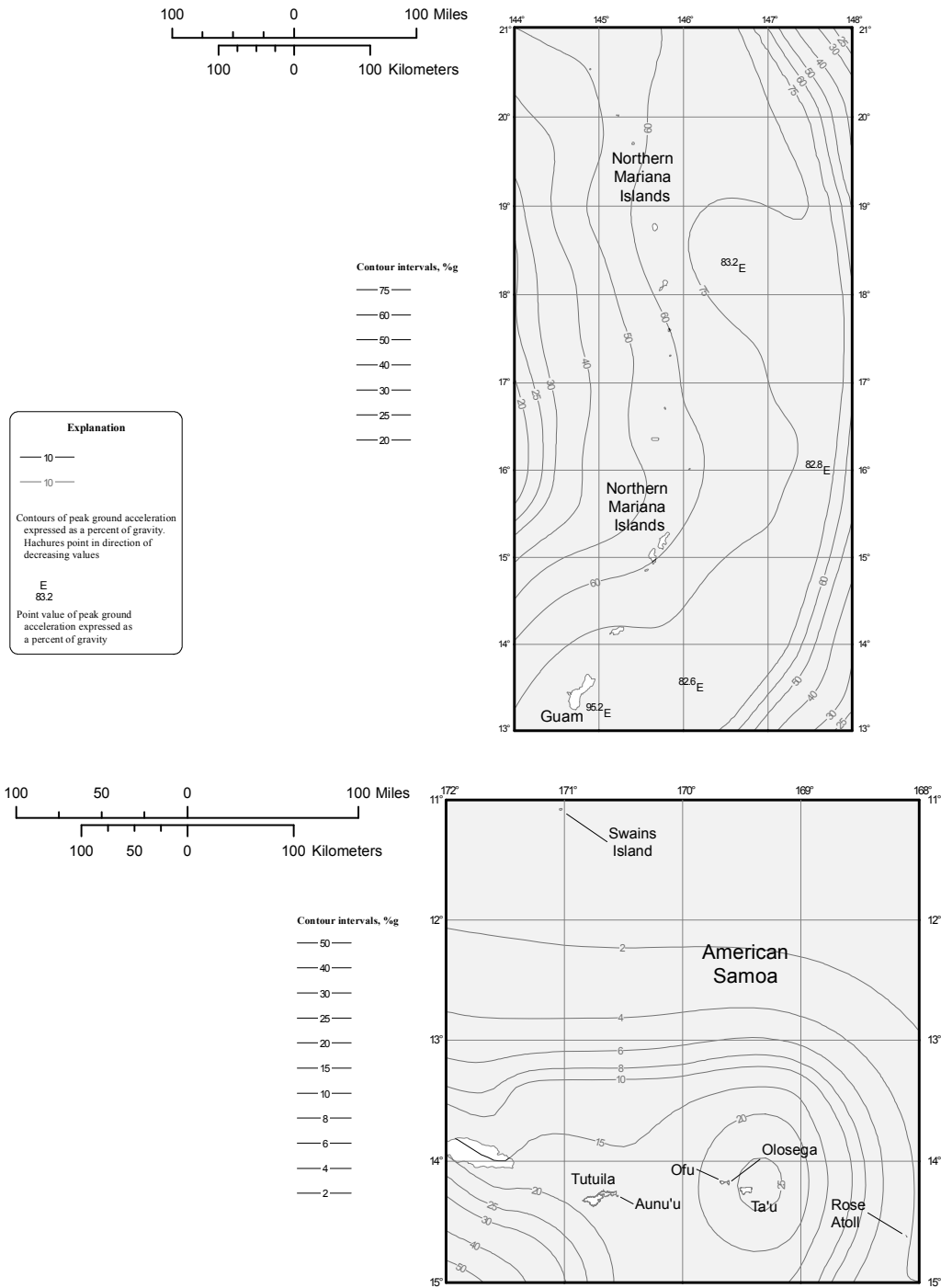

FIGURE 22-13 Maximum Considered Earthquake Geometric Mean (MCE_G) PGA, %g, Site Class B for Guam and the Northern Mariana Islands and for American Samoa

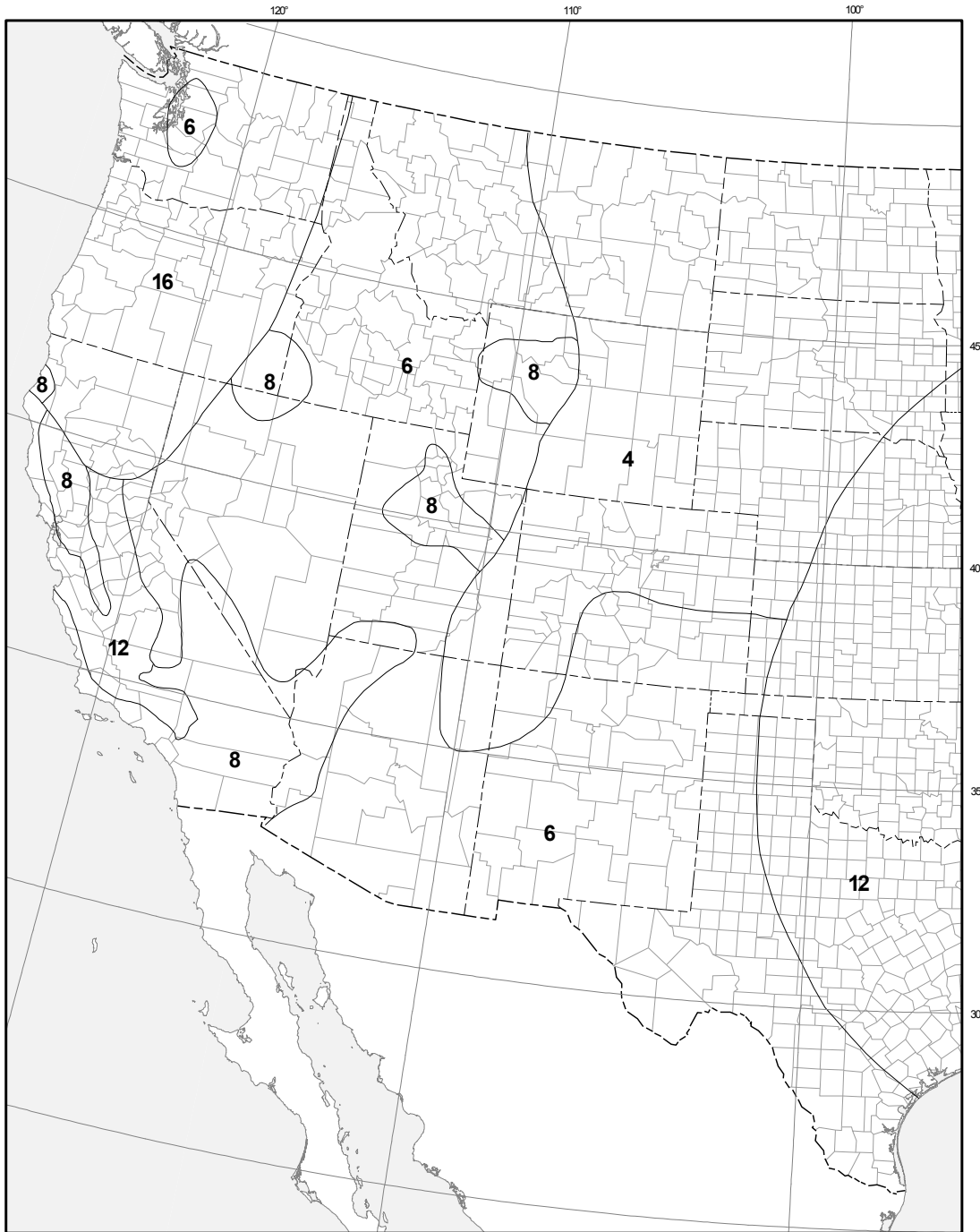

FIGURE 22-14 Mapped Long-Period Transition Period, T_L (s), for the Conterminous United States

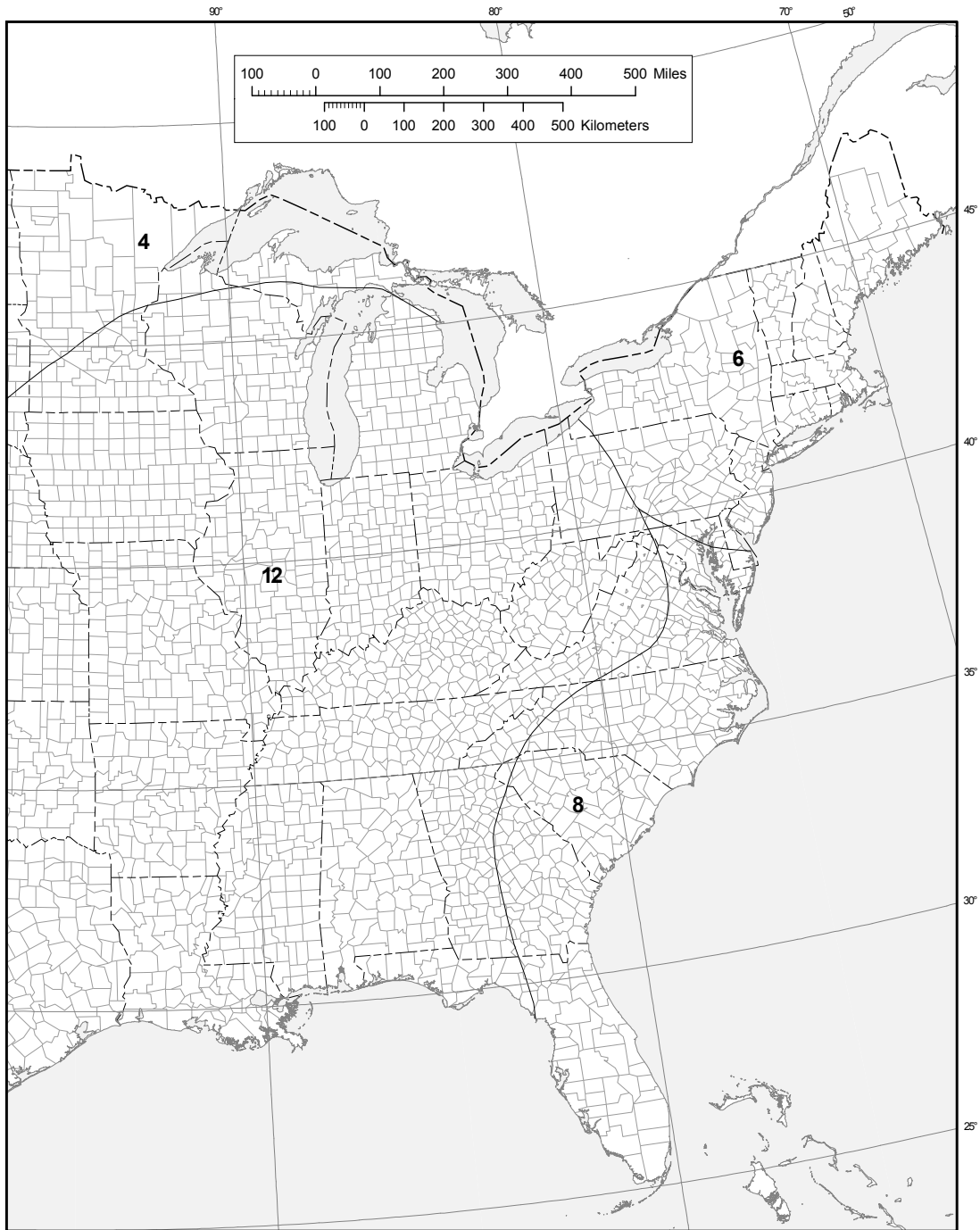

FIGURE 22-14 (continued) Mapped Long-Period Transition Period, T_L (s), for the Conterminous United States

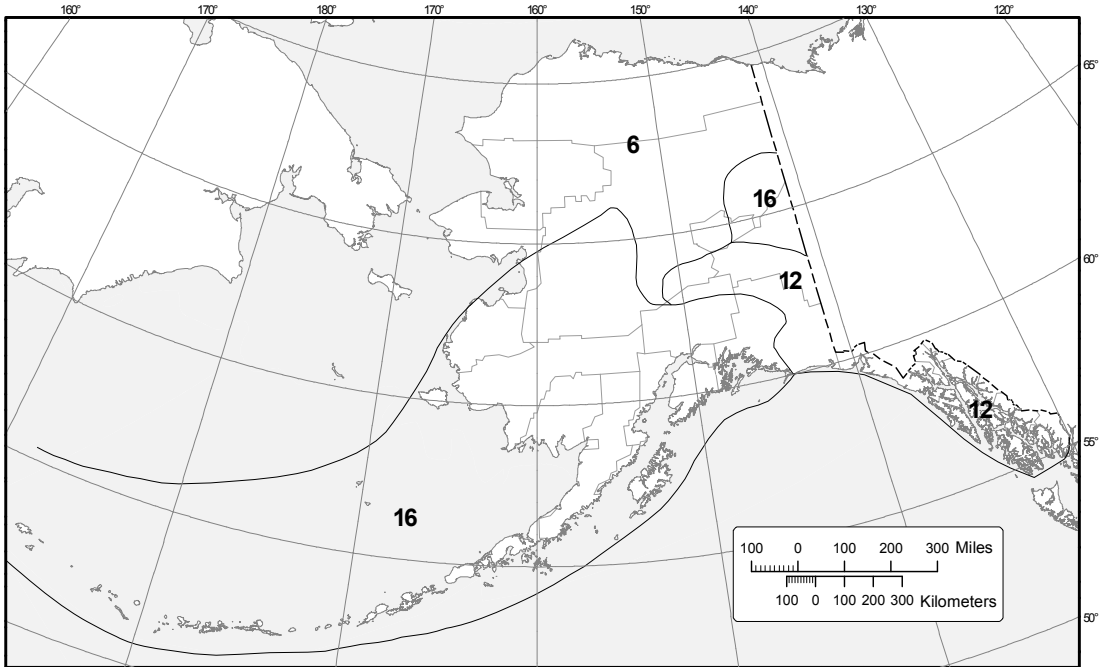

FIGURE 22-15 Mapped Long-Period Transition Period, T_L (s), for Alaska

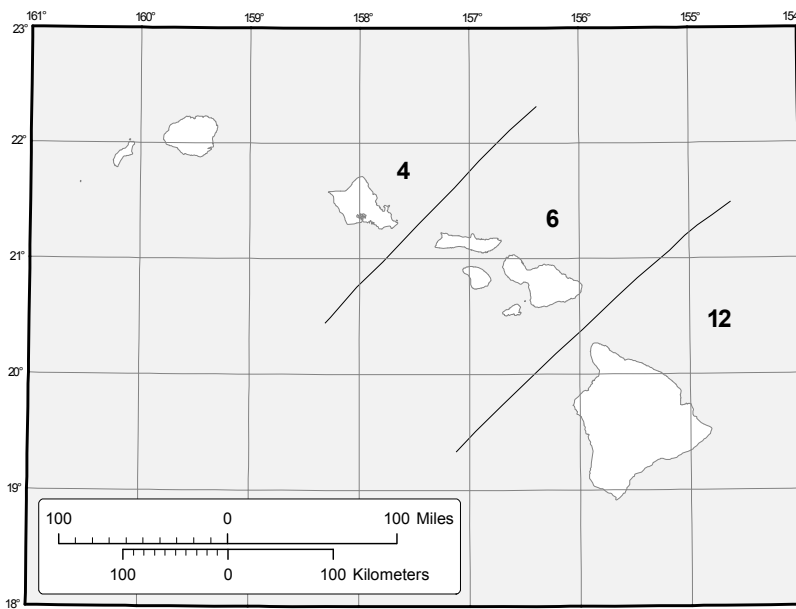

FIGURE 22-16 Mapped Long-Period Transition Period, T_L (s), for Hawaii

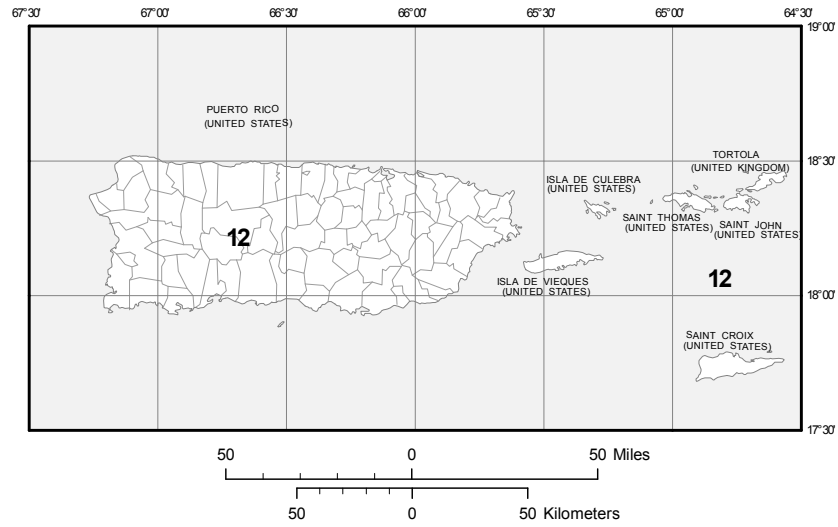

FIGURE 22-17 Mapped Long-Period Transition Period, T_L (s), for Puerto Rico and the United States Virgin Islands

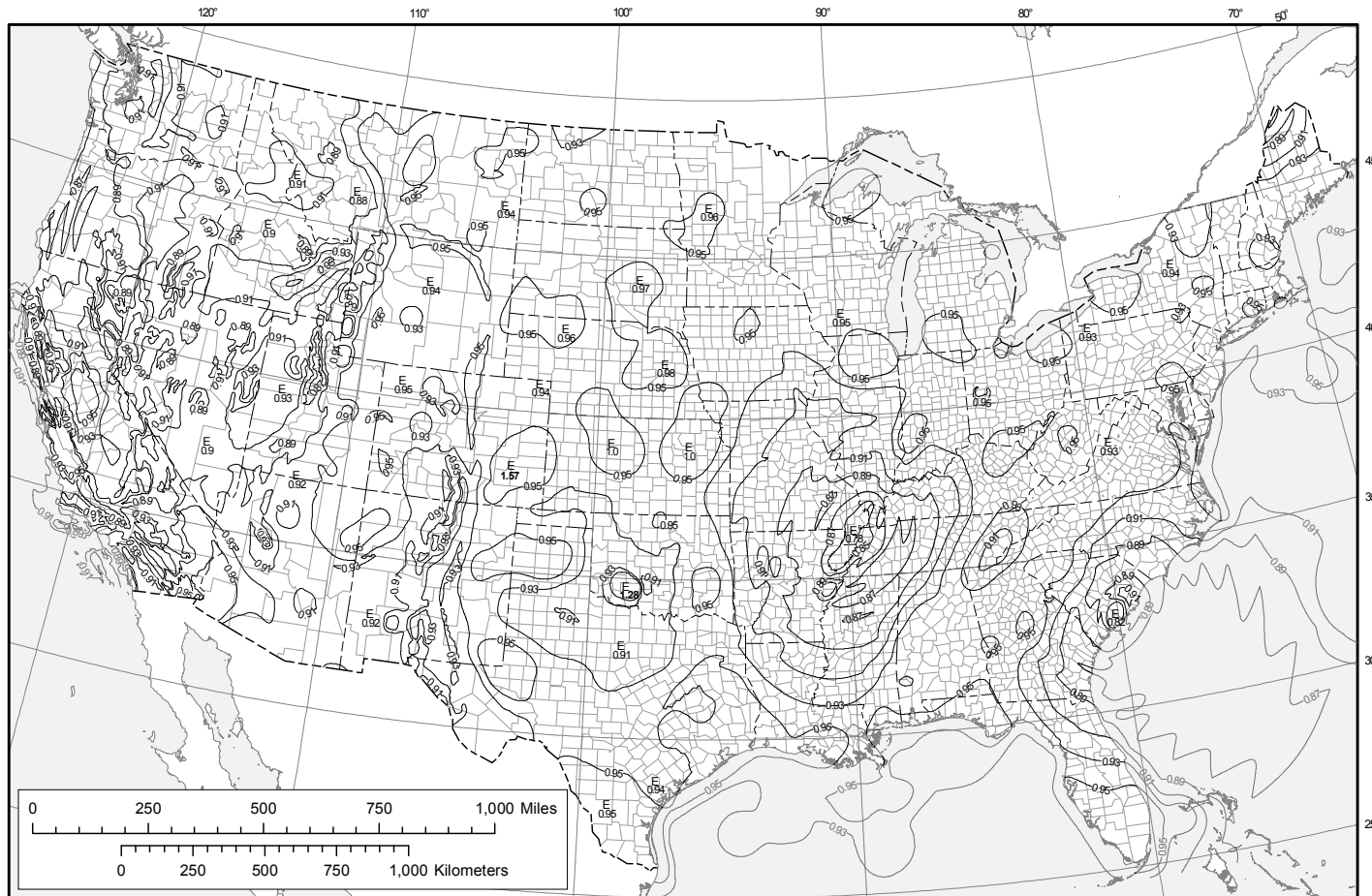
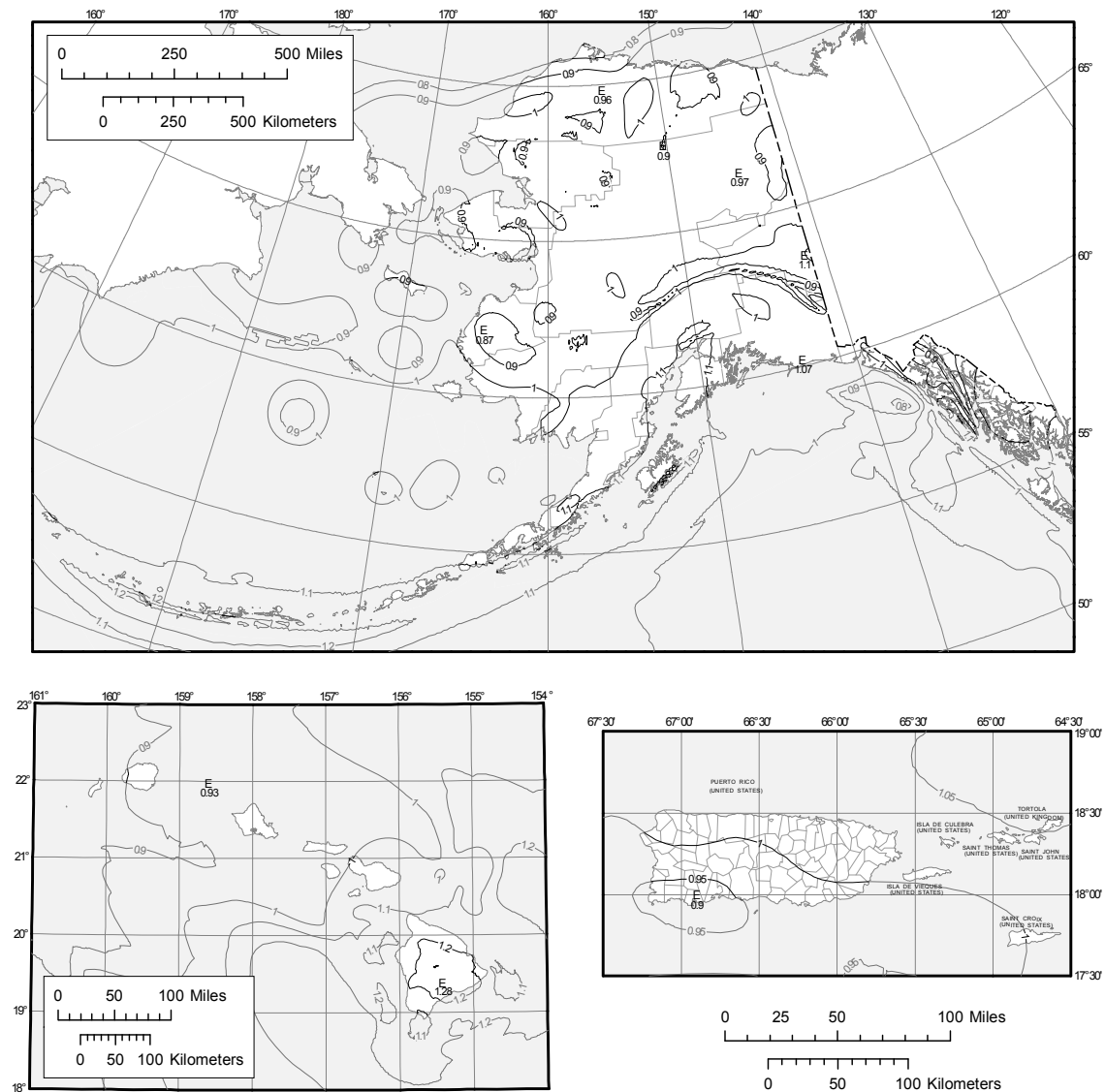

FIGURE 22-18 Mapped Risk Coefficient at 0.2 s Spectral Response Period, C_{RS}



Notes:

- Maps prepared by United States Geological Survey (USGS).
- Larger, more detailed versions of these maps are not included because it is recommended that the corresponding USGS web tool (<http://earthquake.usgs.gov/designmaps/>) be used to determine the mapped value for a specified location.

FIGURE 22-18 (continued) Mapped Risk Coefficient at 0.2 s Spectral Response Period, C_{RS}

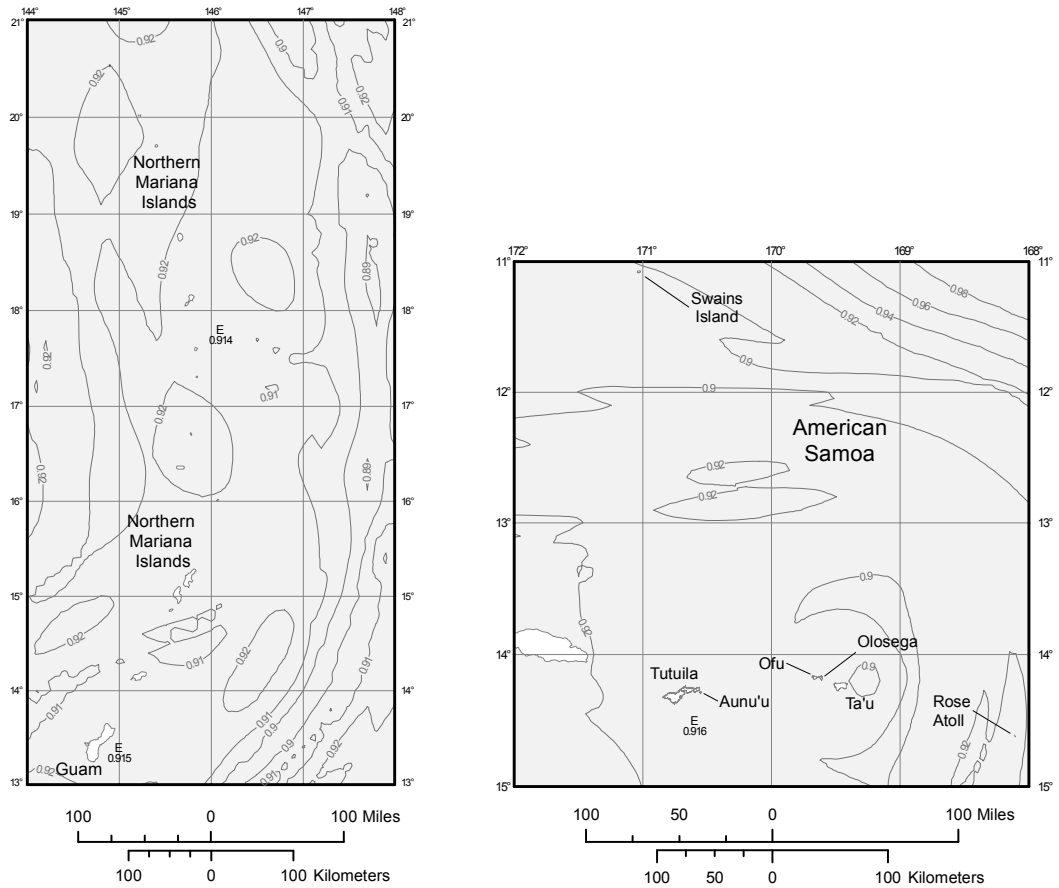

Notes:

- Maps prepared by United States Geological Survey (USGS).
- Larger, more detailed versions of these maps are not included because it is recommended that the corresponding USGS web tool (<http://earthquake.usgs.gov/designmaps/>) be used to determine the mapped value for a specified location.

FIGURE 22-18 (continued) Mapped Risk Coefficient at 0.2 s Spectral Response Period, C_{RS}

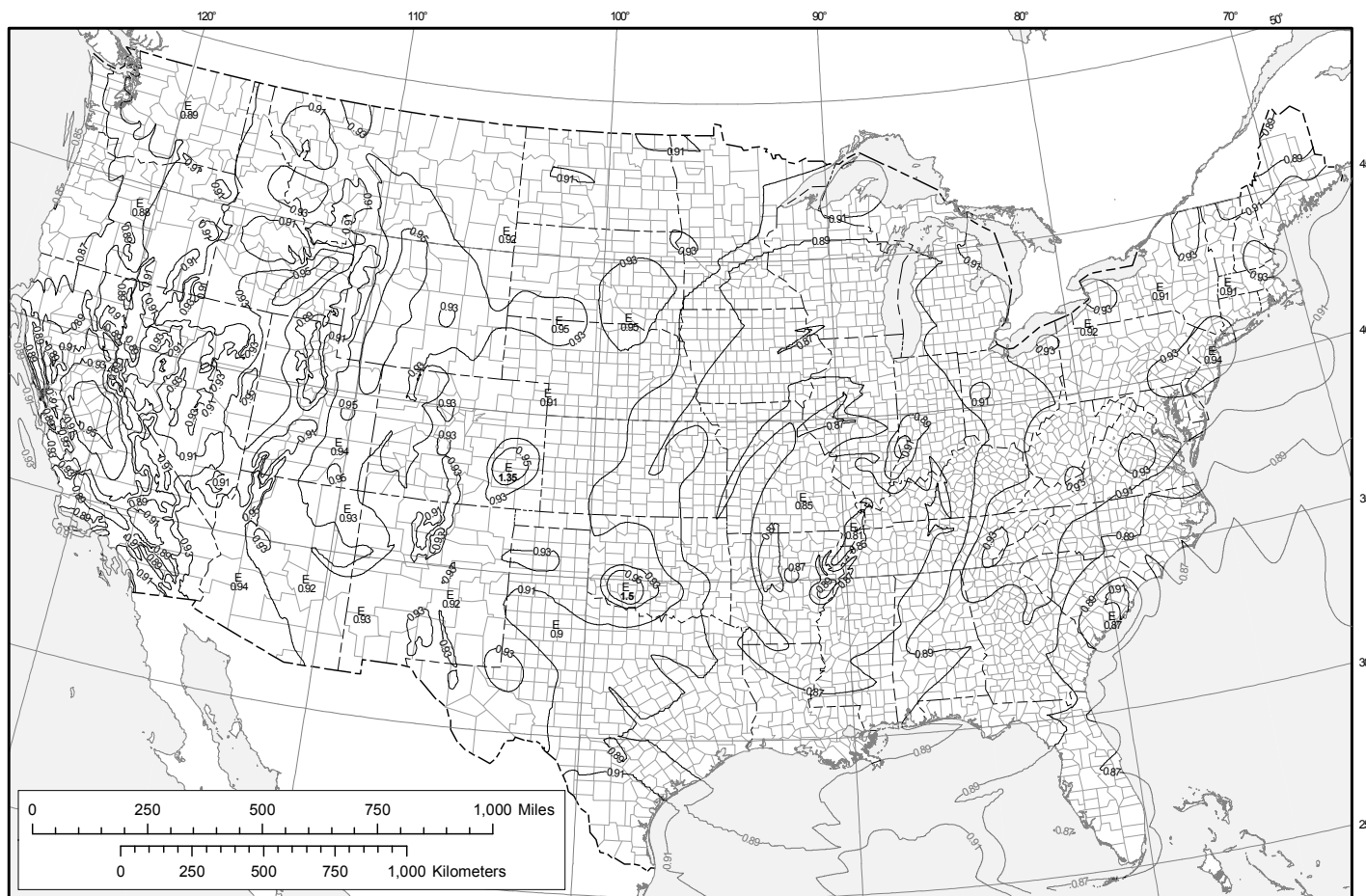
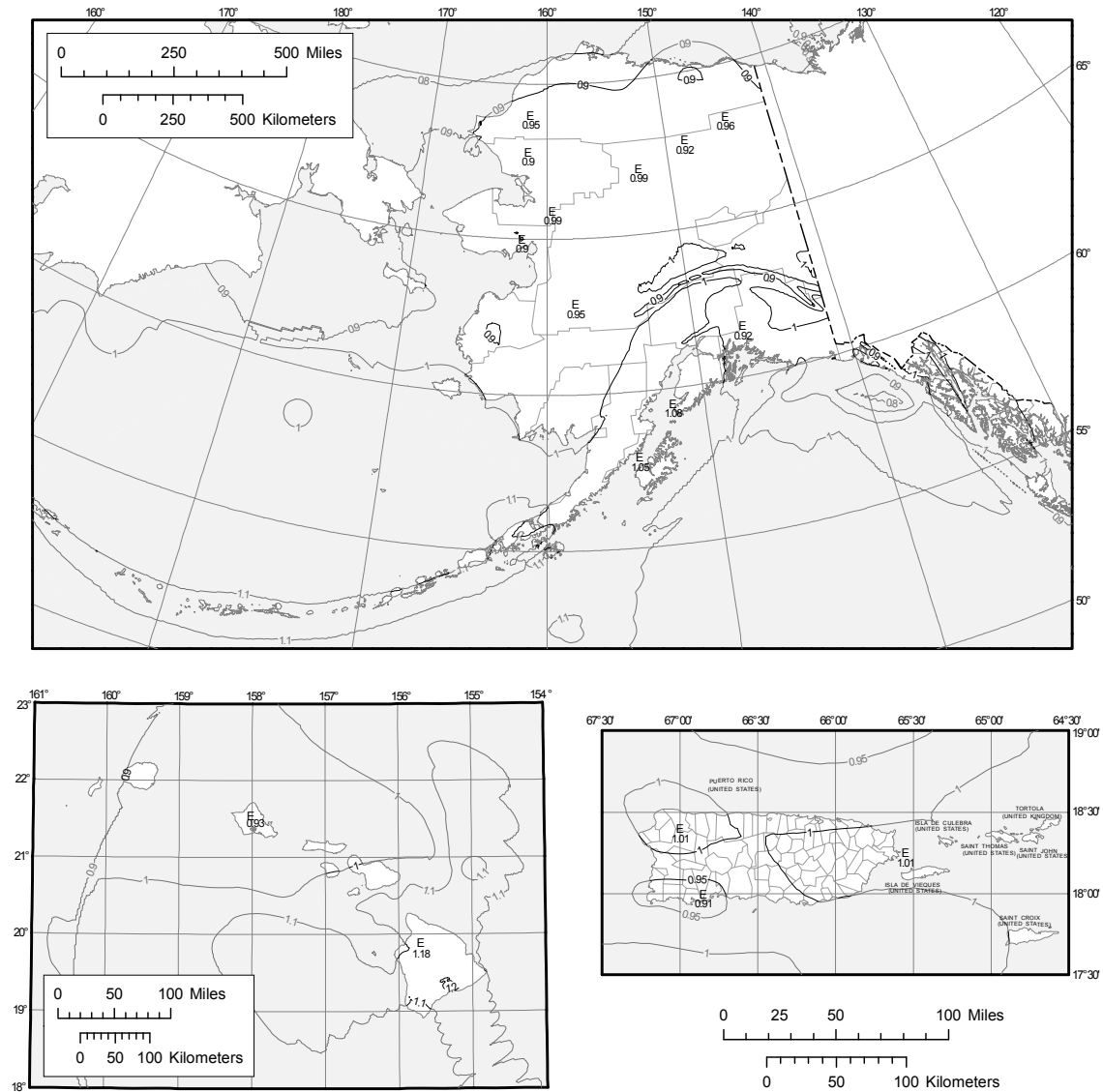

FIGURE 22-19 Mapped Risk Coefficient at 1.0 s Spectral Response Period, C_{R1}



Notes:

- Maps prepared by United States Geological Survey (USGS).
- Larger, more detailed versions of these maps are not included because it is recommended that the corresponding USGS web tool (<http://earthquake.usgs.gov/designmaps/>) be used to determine the mapped value for a specified location.

FIGURE 22-19 (continued) Mapped Risk Coefficient at 1.0 s Spectral Response Period, C_{R1}

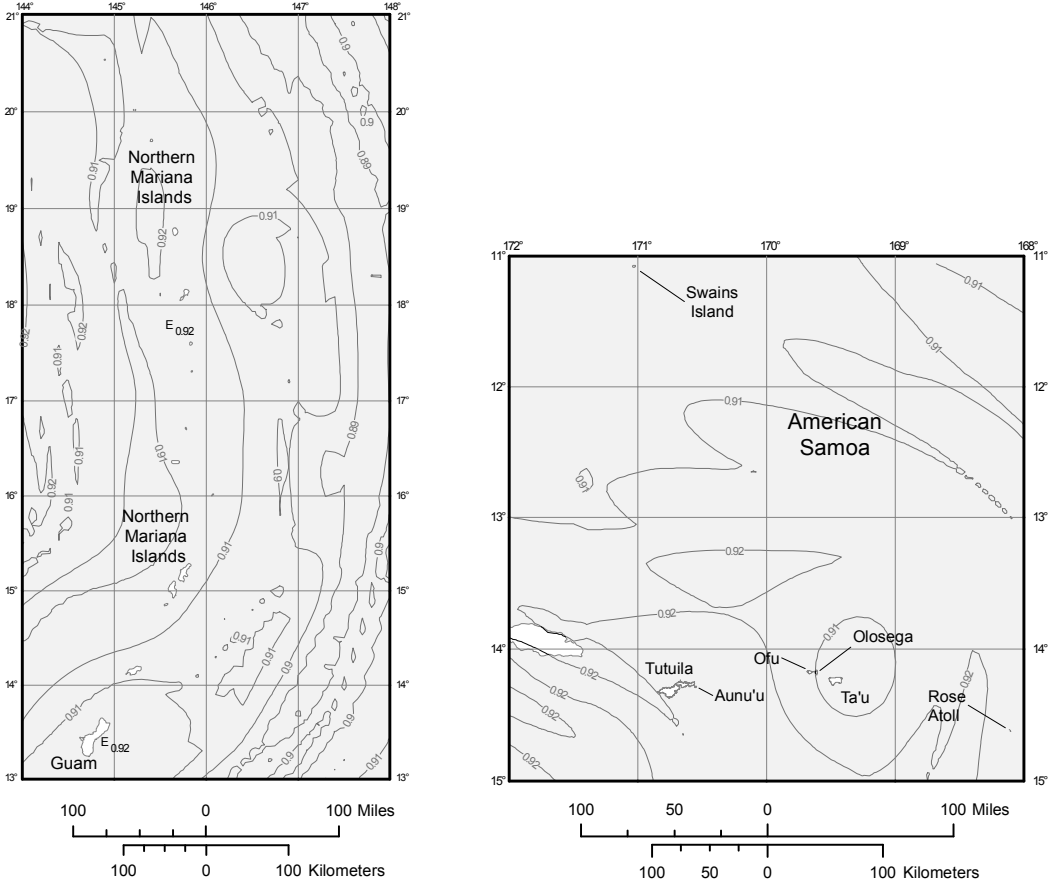

Notes:

- Maps prepared by United States Geological Survey (USGS).
- Larger, more detailed versions of these maps are not included because it is recommended that the corresponding USGS web tool (<http://earthquake.usgs.gov/designmaps/>) be used to determine the mapped value for a specified location.

FIGURE 22-19 (continued) Mapped Risk Coefficient at 1.0 s Spectral Response Period, C_{R1}

Page intentionally left blank

CHAPTER 23A, VERTICAL GROUND MOTIONS FOR SEISMIC DESIGN

(Retained from the 2009 NEHRP Provisions)

23.1 DESIGN VERTICAL RESPONSE SPECTRUM

Where a design vertical response spectrum is required by these *Provisions* and site-specific procedures are not used, the design vertical response spectral acceleration, S_{av} , (in g – gravity unit) shall be developed as follows:

1. For vertical periods less than or equal to 0.025 second, S_{av} shall be determined in accordance with Equation 23.1-1 as follows:

$$S_{av} = 0.3C_V S_{DS} \quad (23.1-1)$$

2. For vertical periods greater than 0.025 second and less than or equal to 0.05 second, S_{av} shall be determined in accordance with Equation 23.1-2 as follows:

$$S_{av} = 20C_V S_{DS}(T_V - 0.025) + 0.3C_V S_{DS} \quad (23.1-2)$$

3. For vertical periods greater than 0.05 second and less than or equal to 0.15 second, S_{av} shall be determined in accordance with Equation 23.1-3 as follows:

$$S_{av} = 0.8C_V S_{DS} \quad (23.1-3)$$

4. For vertical periods greater than 0.15 second and less than or equal to 2.0 seconds, S_{av} shall be determined in accordance with Equation 23.1-4 as follows:

$$S_{av} = 0.8C_V S_{DS} \left(\frac{0.15}{T_V} \right)^{0.75} \quad (23.1-4)$$

where C_V is defined in terms of S_S in Table 23.1-1, S_{DS} = the design spectral response acceleration parameter at short periods, and T_V = the vertical period of vibration.

Table 23.1-1 Values of Vertical Coefficient C_V

MCE _R Spectral Response Parameter at Short Periods ^a	Site Class A, B	Site Class C	Site Class D, E, F
$S_S \geq 2.0$	0.9	1.3	1.5
$S_S = 1.0$	0.9	1.1	1.3
$S_S = 0.6$	0.9	1.0	1.1
$S_S = 0.3$	0.8	0.8	0.9
$S_S \leq 0.2$	0.7	0.7	0.7

^a Use straight-line interpolation for intermediate values of S_S .

S_{av} shall not be less than one-half (1/2) of the corresponding S_a for horizontal components determined in accordance with the general or site-specific procedures of Section 11.4 or Chapter 21, respectively.

For vertical periods greater than 2.0 seconds, S_{av} shall be developed from a site-specific procedure; however, the resulting ordinate of S_{av} shall not be less than one-half (1/2) of the corresponding S_a for horizontal components determined in accordance with the general or site-specific procedures of Section 11.4 or Chapter 21, respectively.

In lieu of using the above procedure, a site-specific study may be performed to obtain S_{av} at vertical periods less than or equal to 2.0 seconds, but the value so determined shall not be less than 80 percent of the S_{av} value determined from Equations 23.1-1 through 23.1-4.

23.2 MCE_R VERTICAL RESPONSE SPECTRUM

The MCE_R vertical response spectral acceleration shall be 150 percent of the S_{av} determined in Section 23.1.

Page intentionally left blank

CHAPTER 24, ALTERNATIVE SEISMIC DESIGN REQUIREMENTS FOR SEISMIC DESIGN CATEGORY B BUILDINGS

(Added New Chapter)

24.1 GENERAL

24.1.1 Scope and Applicability

The seismic analysis and design requirements in this chapter are permitted to be used in lieu of the requirements in Chapter 12 and Chapter 13 for the seismic analysis and design of structures assigned to Seismic Design Category B and for the design of parapets and egress stairways attached to those structures. Nonbuilding structures as defined in Chapter 15 and below, seismically isolated structures as defined in Chapter 17, and structures with damping systems as defined in Chapter 18, are not permitted to be designed by the procedures in this chapter.

Where the weight of a nonstructural component is greater than or equal to 25 percent of the effective seismic weight, W , of the structure as defined in Section 12.7.2, the component shall be classified as a nonbuilding structure and is not permitted to be designed in accordance with Chapter 24.

24.2 STRUCTURAL DESIGN BASIS

24.2.1 Basic Requirements

The building structure shall include complete lateral and vertical force-resisting systems capable of providing adequate strength, stiffness, and energy dissipation capacity to withstand the design ground motions within the prescribed limits of deformation and strength demand. The design ground motions shall be assumed to occur along any horizontal direction of a building structure. The adequacy of the structural systems shall be demonstrated through the construction of a mathematical model and evaluation of this model for the effects of design ground motions. The design seismic forces, and their distribution over the height of the building structure, shall be established in accordance with one of the applicable procedures indicated in Section 24.7 and the corresponding internal forces and deformations in the members of the structure shall be determined. An approved alternative procedure shall not be used to establish the seismic forces and their distribution unless the corresponding internal forces and deformations in the members are determined using a model consistent with the procedure adopted.

24.2.2 Member Design, Connection Design, and Deformation Limit

Individual members, including those not part of the seismic force-resisting system, shall be provided with adequate strength to resist the shears, axial forces, and moments determined in accordance with this standard, and connections shall develop the strength of the connected members or the forces indicated in Section 24.2.1. The deformation of the structure shall not exceed the prescribed limits where the structure is subjected to the design seismic forces.

24.2.3 Continuous Load Path and Interconnection

A continuous load path, or paths, with adequate strength and stiffness shall be provided to transfer all forces from the point of application to the final point of resistance. All parts of the structure between separation joints shall be interconnected to form a continuous path to the seismic force-resisting system, and the connections shall be capable of transmitting the seismic force (F_p) induced by the parts being connected. Any smaller portion of the structure shall be tied to the remainder of the structure with elements having a design strength capable of transmitting a seismic force of 5 percent of the weight of the smaller portion.

This connection force does not apply to the overall design of the seismic force-resisting system. Connection design forces need not exceed the maximum forces that the structural system can deliver to the connection.

24.2.4 Connection to Supports

A positive connection for resisting a horizontal force acting parallel to the member shall be provided for each beam, girder, or truss either directly to its supporting elements, or to slabs designed to act as diaphragms. Where the connection is through a diaphragm, then the member's supporting element must also be connected to the diaphragm. The connection shall have a minimum design strength of 5 percent of the dead plus live load reaction.

24.2.5 Foundation Design

The foundation shall be designed to resist the forces developed and accommodate the movements imparted to the structure by the design ground motions. The dynamic nature of the forces, the expected ground motion, the design basis for strength and energy dissipation capacity of the structure, and the dynamic properties of the soil shall be included in the determination of the foundation design criteria. The design and construction of foundations shall comply with Section 24.14.

24.2.6 Material Design and Detailing Requirements

Structural elements including foundation elements shall conform to the material design and detailing requirements set forth in Chapter 14.

24.3 STRUCTURAL SYSTEM SELECTION

24.3.1 Selection and Limitations

The basic lateral and vertical seismic force-resisting system shall conform to one of the types indicated in Table 24.3-1 or a combination of systems as permitted in Sections 24.3.2, 24.3.3, and 24.3.4. Each type is subdivided by the types of vertical elements used to resist lateral seismic forces. The structural system used shall be in accordance with the structural system limitations and the limits on structural height, h_n , contained in Table 24.3-1. The appropriate response modification coefficient, R , overstrength factor, Ω_0 , and the deflection amplification factor, C_d , indicated in Table 24.3-1 shall be used in determining the base shear, element design forces, and design story drift.

Each selected seismic force-resisting system shall be designed and detailed in accordance with the specific requirements for the system as set forth in the applicable reference document listed in Table 24.3-1 and the additional requirements set forth in Chapter 14.

Seismic force-resisting systems not contained in Table 24.3-1 are permitted provided analytical and test data are submitted to the authority having jurisdiction for approval that establish their dynamic characteristics and demonstrate their lateral force resistance and energy dissipation capacity to be equivalent to the structural systems listed in Table 24.3-1 for equivalent values of response modification coefficient, R , overstrength factor, Ω_0 , and deflection amplification factor, C_d .

24.3.2 Combinations of Framing Systems in Different Directions

Different seismic force-resisting systems are permitted to be used to resist seismic forces along each of the two orthogonal axes of the structure. Where different systems are used, the respective R , C_d , and Ω_0 coefficients shall apply to each system, including the structural system limitations contained in Table 24.3-1.

24.3.3 Combinations of Framing Systems in the Same Direction

Where different seismic force-resisting systems are used in combination to resist seismic forces in the same direction, other than those combinations considered as dual systems, the most stringent applicable structural system limitations contained in Table 24.3-1 shall apply and the design shall comply with the requirements of this section.

24.3.3.1 R, C_d , and Ω_0 Values for Vertical Combinations

Where a structure has a vertical combination in the same direction, the following requirements shall apply:

1. Where the lower system has a lower Response Modification Coefficient, R , the design coefficients (R , Ω_0 , and C_d) for the upper system are permitted to be used to calculate the forces and drifts of the upper system. For the design of the lower system, the design coefficients (R , Ω_0 , and C_d) for the lower system shall be used. Forces transferred from the upper system to the lower system shall be increased by multiplying by the ratio of the higher response modification coefficient to the lower response modification coefficient.
2. Where the upper system has a lower Response Modification Coefficient, the Design Coefficients (R , Ω_0 , and C_d) for the upper system shall be used for both systems.

EXCEPTIONS:

1. Rooftop structures not exceeding two stories in height and 10 percent of the total structure weight.
2. Other supported structural systems with a weight equal to or less than 10 percent of the weight of the structure.
3. Detached one- and two-family dwellings of light-frame construction.

24.3.3.2 Two Stage Analysis Procedure

A two-stage equivalent lateral force procedure is permitted to be used for structures having a flexible upper portion above a rigid lower portion, provided the design of the structure complies with all of the following:

- The stiffness of the lower portion shall be at least 10 times the stiffness of the upper portion.
- The period of the entire structure shall not be greater than 1.1 times the period of the upper portion considered as a separate structure supported at the transition from the upper to the lower portion.
- The upper portion shall be designed as a separate structure using the appropriate value of R .
- The lower portion shall be designed as a separate structure using the appropriate value of R . The reactions from the upper portion shall be those determined from the analysis of the upper portion amplified by the ratio of R of the upper portion over R of the lower portion. This ratio shall not be less than 1.0.
- The upper portion is analyzed with the equivalent lateral force or modal response spectrum procedure, and the lower portion is analyzed with the equivalent lateral force procedure.

24.3.3.3 R, C_d , and Ω_0 Values for Horizontal Combinations

The value of the response modification coefficient, R , used for design in the direction under consideration shall not be greater than the least value of R for any of the systems utilized in that direction. The deflection amplification factor, C_d , and the overstrength factor, Ω_0 , shall be consistent with R required in that direction.

EXCEPTION: Resisting elements are permitted to be designed using the least value of R for the different structural systems found in each independent line of resistance if the following three conditions are met: (1) Risk Category I or II building, (2) two stories or less above grade plane, and (3) use of light-frame construction or flexible diaphragms. The value of R used for design of diaphragms in such structures shall not be greater than the least value of R for any of the systems utilized in that same direction.

24.3.4 Combination Framing Detailing Requirements

Structural members common to different framing systems used to resist seismic forces in any direction shall be designed using the detailing requirements of this chapter required by the highest response modification coefficient, R , of the connected framing systems.

24.3.5 System Specific Requirements

The structural framing system shall also comply with the following system specific requirements of this section.

24.3.5.1 Dual System

For a dual system, the moment frames shall be capable of resisting at least 25 percent of the design seismic forces. The total seismic force resistance is to be provided by the combination of the moment frames and the shear walls or braced frames in proportion to their rigidities.

24.3.5.2 Cantilever Column Systems

Cantilever column systems are permitted as indicated in Table 24.3-1 and as follows. The required axial strength of individual cantilever column elements, considering only the load combinations that include seismic load effects, shall not exceed 15 percent of the available axial strength, including slenderness effects.

Foundation and other elements used to provide overturning resistance at the base of cantilever column elements shall be designed to resist the seismic load effects including overstrength factor of Section 24.5.3.

24.3.5.3 Inverted Pendulum-Type Structures

Regardless of the structural system selected, inverted pendulums as defined in Section 11.2, shall comply with this section. Supporting columns or piers of inverted pendulum-type structures shall be designed for the bending moment calculated at the base determined using the procedures given in Section 24.9 and varying uniformly to a moment at the top equal to one-half the calculated bending moment at the base.

24.3.5.4 Shear Wall-Frame Interactive Systems

The shear strength of the shear walls of the shear wall-frame interactive system shall be at least 75 percent of the design story shear at each story. The frames of the shear wall-frame interactive system shall be capable of resisting at least 25 percent of the design story shear in every story.

24.4 DIAPHRAGM FLEXIBILITY AND CONFIGURATION IRREGULARITIES

24.4.1 Diaphragm Flexibility

The structural analysis shall consider the relative stiffnesses of diaphragms and the vertical elements of the seismic force-resisting system. Unless a diaphragm can be idealized as either flexible or rigid in accordance with Sections 24.4.1.1, 24.4.1.2, or 24.4.1.3, the structural analysis shall explicitly include consideration of the stiffness of the diaphragm (i.e., semi-rigid modeling assumption).

24.4.1.1 Flexible Diaphragm Condition

Diaphragms constructed of untopped steel decking or wood structural panels are permitted to be idealized as flexible if any of the following conditions exist:

1. In structures where the vertical elements are steel braced frames, steel and concrete composite braced frames or concrete, masonry, steel, or steel and concrete composite shear walls.
2. In one- and two-family dwellings.
3. In structures of light-frame construction where all of the following conditions are met:

- a. Topping of concrete or similar materials is not placed over wood structural panel diaphragms except for nonstructural topping no greater than 1 1/2 in. (38 mm) thick.
- b. Each line of vertical elements of the seismic force-resisting system complies with the allowable story drift of Table 24.13-1.

24.4.1.2 Rigid Diaphragm Condition

Diaphragms of concrete slabs or concrete filled metal deck with span-to-depth ratios of 3 or less in structures that have no horizontal irregularities are permitted to be idealized as rigid.

24.4.1.3 Calculated Flexible Diaphragm Condition

Diaphragms not satisfying the conditions of Sections 24.4.1.1 or 24.4.1.2 are permitted to be idealized as flexible where the computed maximum in-plane deflection of the diaphragm under lateral load is more than two times the average story drift of adjoining vertical elements of the seismic force-resisting system of the associated story under equivalent tributary lateral load as shown in Fig. 24.4-1. The loadings used for this calculation shall be those prescribed by Section 24.9.

24.4.2 Irregular and Regular Classification

Structures shall be classified as having a structural irregularity based upon the criteria in this section. Such classification shall be based on their structural configurations.

24.4.2.1 Horizontal Irregularity

Structures having one or more of the irregularity types listed in Table 24.4-1 shall be designated as having a horizontal structural irregularity. Such structures shall comply with the requirements in the sections referenced in that table.

24.4.2.2 Vertical Irregularity

Structures having one or more of the irregularity types listed in Table 24.4-2 shall be designated as having a vertical structural irregularity. Such structures shall comply with the requirements in the sections referenced in that table.

24.4.3 Limitations and Additional Requirements for Systems with Structural Irregularities

24.4.3.1 Extreme Weak Stories

Structures with a vertical irregularity Type 5b as defined in Table 24.4-2, shall not be over two stories or 30 ft. (9 m) in structural height, h_n .

EXCEPTION: The limit does not apply where the “weak” story is capable of resisting a total seismic force equal to Ω_0 times the design force prescribed in Section 24.9.

24.4.3.2 Elements Supporting Discontinuous Walls or Frames

Columns, beams, trusses, or slabs supporting discontinuous walls or frames of structures having horizontal irregularity Type 4 of Table 24.4-1 or vertical irregularity Type 4 of Table 24.4-2 shall be designed to resist the seismic load effects including overstrength factor of Section 24.5.3. The connections of such discontinuous elements to the supporting members shall be adequate to transmit the forces for which the discontinuous elements were required to be designed.

24.5 SEISMIC LOAD EFFECTS AND COMBINATIONS

24.5.1 Applicability

All members of the structure, including those not part of the seismic force-resisting system, shall be designed using the seismic load effects of Section 24.5 unless otherwise exempted by this chapter. Seismic load effects are the axial, shear, and flexural member forces resulting from application of horizontal and vertical seismic forces as set forth in Section 24.5.2. Where specifically required, seismic load effects shall be modified to account for overstrength, as set forth in Section 24.5.3.

24.5.2 Seismic Load Effect

The seismic load effect, E , shall be determined, based only on horizontal seismic forces, in accordance with Eq. 24.5-1 as follows:

$$E = Q_E \quad (24.5-1)$$

where

E = seismic load effect

Q_E = effects of horizontal seismic forces from V or F_p

24.5.2.1 Seismic Load Combinations

Where the prescribed seismic load effect, E , defined in Section 24.5.2 is combined with the effects of other loads as set forth in Chapter 2, the following seismic load combinations for structures not subject to flood or atmospheric ice loads shall be used in lieu of the seismic load combinations in either Section 2.3.2 or 2.4.1:

Basic Combinations for Strength Design (see Sections 2.3.2 and 2.2 for notation).

1. $1.2D + Q_E + L + 0.2S$
2. $0.9D + Q_E + 1.6H$

NOTES:

1. The load factor on L in combination 5 is permitted to equal 0.5 for all occupancies in which L_o in Table 4-1 is less than or equal to 100 psf (4.79 kN/m²), with the exception of garages or areas occupied as places of public assembly.
2. The load factor on H shall be set equal to zero in combination 7 if the structural action due to H counteracts that due to E . Where lateral earth pressure provides resistance to structural actions from other forces, it shall not be included in H but shall be included in the design resistance.

Basic Combinations for Allowable Stress Design (see Sections 2.4.1 and 2.2 for notation).

3. $1.0D + H + F + 0.7Q_E$
4. $1.0D + H + F + 0.525Q_E + 0.75L + 0.75(L_r \text{ or } S \text{ or } R)$
5. $0.6D + 0.7Q_E + H$

24.5.3 Seismic Load Effect Including Overstrength Factor

Where specifically required, conditions requiring overstrength factor applications shall be determined based only on horizontal seismic forces in accordance with the following:

$$E_m = \Omega_0 Q_E \quad (24.5-2)$$

where

E_m = seismic load effect including overstrength factor

Q_E = effects of horizontal seismic forces from V , F_{px} , or F_p as specified in Sections 24.9.1, 24.11, or 24.15.3.1

Ω_0 = overstrength factor

24.5.3.1 Load Combinations with Overstrength Factor

Where the seismic load effect with overstrength factor, E_m , defined in Section 24.5.3, is combined with the effects of other loads as set forth in Chapter 2, the following seismic load combination for structures not subject to flood or atmospheric ice loads shall be used in lieu of the seismic load combinations in either Section 2.3.2 or 2.4.1:

Basic Combinations for Strength Design with Overstrength Factor (see Sections 2.3.2 and 2.2 for notation).

1. $1.2D + \Omega_0 Q_E + L + 0.2S$
2. $0.9D + \Omega_0 Q_E + 1.6H$

NOTES:

1. The load factor on L in combination 5 is permitted to equal 0.5 for all occupancies in which L_o in Table 4-1 is less than or equal to 100 psf (4.79 kN/m²), with the exception of garages or areas occupied as places of public assembly.
2. The load factor on H shall be set equal to zero in combination 7 if the structural action due to H counteracts that due to E . Where lateral earth pressure provides resistance to structural actions from other forces, it shall not be included in H but shall be included in the design resistance.

Basic Combinations for Allowable Stress Design with Overstrength Factor (see Sections 2.4.1 and 2.2 for notation).

3. $1.0D + H + F + 0.7 \Omega_0 Q_E$
4. $1.0D + H + F + 0.525 \Omega_0 Q_E + 0.75L + 0.75(L_r \text{ or } S \text{ or } R)$
5. $0.6D + 0.7 \Omega_0 Q_E + H$

24.5.3.2 Allowable Stress Increase for Load Combinations with Overstrength

Where allowable stress design methodologies are used with the seismic load effect defined in Section 24.5.3 applied in load combinations 5, 6, or 8 of Section 2.4.1, allowable stresses are permitted to be determined using an allowable stress increase of 1.2. This increase shall not be combined with increases in allowable stresses or load combination reductions otherwise permitted by this standard or the material reference document except for increases due to adjustment factors in accordance with AF&PA NDS.

24.6 DIRECTION OF LOADING

The directions of application of seismic forces used in the design shall be those which will produce the most critical load effects. To satisfy this requirement, the design seismic forces are permitted to be applied independently in each of two orthogonal directions and orthogonal interaction effects are permitted to be neglected.

24.7 ANALYSIS PROCEDURE SELECTION

The structural analysis required by this chapter shall consist of either the Equivalent Lateral Force Analysis procedure (Section 24.9) or the Modal Response Spectrum Analysis procedure (Section 24.10).

24.8 MODELING CRITERIA

24.8.1 Foundation Modeling

For purposes of determining seismic loads, it is permitted to consider the structure to be fixed at the base. Alternatively, where foundation flexibility is considered, it shall be in accordance with Section 24.14.3.

24.8.2 Effective Seismic Weight

The effective seismic weight, W , of a structure shall include the dead load, as defined in Section 3.1, above the base and other loads above the base as listed below:

1. In areas used for storage, a minimum of 25 percent of the floor live load shall be included.

EXCEPTIONS:

- a. Where the inclusion of storage loads adds no more than 5% to the effective seismic weight at that level, it need not be included in the effective seismic weight.
 - b. Floor live load in public garages and open parking structures need not be included.
2. Where provision for partitions is required by Section 4.2.2 in the floor load design, the actual partition weight or a minimum weight of 10 psf (0.48 kN/m²) of floor area, whichever is greater.
 3. Total operating weight of permanent equipment.
 4. Where the flat roof snow load, P_f , exceeds 30 psf (1.44 kN/m²), 20 percent of the uniform design snow load, regardless of actual roof slope.
 5. Weight of landscaping and other materials at roof gardens and similar areas.

24.8.3 Structural Modeling

A mathematical model of the structure shall be constructed for the purpose of determining member forces and structure displacements resulting from applied loads and any imposed displacements or P-delta effects. The model shall include the stiffness and strength of elements that are significant to the distribution of forces and deformations in the structure and represent the spatial distribution of mass and stiffness throughout the structure.

In addition, the model shall comply with the following:

- a. Stiffness properties of concrete and masonry elements shall consider the effects of cracked sections.
- b. For steel moment frame systems, the contribution of panel zone deformations to overall story drift shall be included.

Structures that have horizontal structural irregularity Type 1a, 1b, 4, or 5 of Table 24.4-1 shall be analyzed using a 3-D representation. Where a 3-D model is used, a minimum of three dynamic degrees of freedom consisting of translation in two orthogonal plan directions and rotation about the vertical axis shall be included at each level of the structure. Where the diaphragms have not been classified as rigid or flexible in accordance with Section 24.4.1, the model shall include representation of the diaphragm's stiffness characteristics and such additional dynamic degrees of freedom as are required to account for the participation of the diaphragm in the structure's dynamic response.

EXCEPTION: Analysis using a 3-D representation is not required for structures with flexible diaphragms that have Type 4 horizontal structural irregularities.

24.8.4 Interaction Effects

Moment-resisting frames that are enclosed or adjoined by elements that are more rigid and not considered to be part of the seismic force-resisting system shall be designed so that the action or failure of those elements will not impair the vertical load and seismic force-resisting capability of the frame. The design

shall provide for the effect of these rigid elements on the structural system at structural deformations corresponding to the design story drift (Δ) as determined in Section 24.9.6. In addition, the effects of these elements shall be considered where determining whether a structure has one or more of the irregularities defined in Section 24.4.2.

24.9 EQUIVALENT LATERAL FORCE PROCEDURE

24.9.1 Seismic Base Shear

The seismic base shear, V , in a given direction shall be determined in accordance with the following equation:

$$V = C_s W \quad (24.9-1)$$

where

C_s = the seismic response coefficient determined in accordance with this section

W = the effective seismic weight per Section 24.8.2

The seismic response coefficient, C_s , shall be determined in accordance with Eq. 24.9-2

$$C_s = S_{DS} / (R/I_e) \quad (24.9-2)$$

where

S_{DS} = the design spectral response acceleration parameter in the short period range as determined from Section 11.4.4 or 11.4.7

R = the response modification factor in Table 24.3-1

I_e = the importance factor determined in accordance with Table 1.5-2 Section 11.5.1

The value of C_s computed in accordance with Eq. 24.9-2 need not exceed the following:

$$C_s = S_{D1} / T(R/I_e) \quad (24.9-3)$$

C_s shall not be less than

$$C_s = 0.044 S_{DS} I_e \geq 0.01 \quad (24.9-4)$$

where I_e and R are as defined in Section 24.9.1 and

S_{D1} = the design spectral response acceleration parameter at a period of 1.0 s, as determined from Section 11.4.4 or 11.4.7

T = the fundamental period of the structure(s) determined in Section 24.9.2

S_1 = the mapped maximum considered earthquake spectral response acceleration parameter determined in accordance with Section 11.4.1 or 11.4.7

24.9.2 Period Determination

The fundamental period of the structure, T , in the direction under consideration shall be established using the structural properties and deformational characteristics of the resisting elements in a properly substantiated analysis. The fundamental period, T , shall not exceed $1.6T_a$, where T_a is determined in accordance with Section 24.9.2.1. As an alternative to performing an analysis to determine the fundamental period, T , it is permitted to use the approximate building period, T_a , calculated in accordance with Section 24.9.2.1, directly.

24.9.2.1 Approximate Fundamental Period

The approximate fundamental period (T_a), in s, shall be determined from the following equation:

$$T_a = C_t h_n^x \quad (24.9-5)$$

where h_n is the structural height as defined in Section 11.2 and the coefficients C_t and x are determined from Table 24.9-1.

24.9.3 Vertical Distribution of Seismic Forces

The lateral seismic force (F_x) (kip or kN) induced at any level shall be determined from the following equations:

$$F_x = C_{vx} V \quad (24.9-6)$$

and

$$C_{vx} = \frac{w_x h_x^k}{\sum_{i=1}^n w_i h_i^k} \quad (24.9-7)$$

where

C_{vx} = vertical distribution factor

V = total design lateral force or shear at the base of the structure (kip or kN)

w_i and w_x = the portion of the total effective seismic weight of the structure (W) located or assigned to Level i or x

h_i and h_x = the height (ft. or m) from the base to Level i or x

k = an exponent related to the structure period as follows:

for structures having a period of 0.5 s or less, $k = 1$

for structures having a period of 2.5 s or more, $k = 2$

for structures having a period between 0.5 and 2.5 s, k shall be 2 or shall be determined by linear interpolation between 1 and 2

24.9.4 Horizontal Distribution of Forces

The seismic design story shear in any story (V_x) (kip or kN) shall be determined from the following equation:

$$V_x = \sum_{i=x}^n F_i \quad (24.9-8)$$

where F_i = the portion of the seismic base shear (V) (kip or kN) induced at Level i .

The seismic design story shear (V_x) (kip or kN) shall be distributed to the various vertical elements of the seismic force-resisting system in the story under consideration based on the relative lateral stiffness of the vertical resisting elements and the diaphragm.

24.9.4.1 Inherent Torsion

For diaphragms that are not flexible, the distribution of lateral forces at each level shall consider the effect of the inherent torsional moment, M_t , resulting from eccentricity between the locations of the center of mass and the center of rigidity. For flexible diaphragms, the distribution of forces to the vertical elements shall account for the position and distribution of the masses supported.

24.9.4.2 Accidental Torsion

Where diaphragms are not flexible, the design shall include the inherent torsional moment (M_t) resulting from the location of the structure masses plus the accidental torsional moments (M_{ta}) caused by assumed displacement of the center of mass each way from its actual location by a distance equal to 5 percent of the dimension of the structure perpendicular to the direction of the applied forces. The accidental torsional moment shall also be included in the determination of possible horizontal structural irregularities in Table 24.4-1.

EXCEPTION: The accidental torsional moments (M_{ta}) need not be included in design of buildings that do not have a Type 1b horizontal structural irregularity.

24.9.5 Overturning

The structure shall be designed to resist overturning effects caused by the seismic forces determined in Section 24.12.3.

24.9.6 Story Drift Determination

The design story drift (Δ) shall be computed as the difference of the deflections at the centers of mass at the top and bottom of the story under consideration. See Fig. 24.9-1. Where centers of mass do not align vertically, it is permitted to compute the deflection at the bottom of the story based on the vertical projection of the center of mass at the top of the story. Where allowable stress design is used, Δ shall be computed using the strength level seismic forces specified in Section 24.9 without reduction for allowable stress design.

The deflection at Level x (δ_x) (in. or mm) used to compute the design story drift, Δ , shall be determined in accordance with the following equation:

$$\delta_x = \frac{C_d \delta_{xe}}{I_e} \quad (24.9-9)$$

where

C_d = the deflection amplification factor in Table 24.3-1

δ_{xe} = the deflection at the location required by this section determined by an elastic analysis

I_e = the importance factor determined in accordance with Section 11.5.1

24.9.6.1 Minimum Base Shear for Computing Drift

The elastic analysis of the seismic force-resisting system for computing drift shall be made using the prescribed seismic design forces of Section 24.9.

EXCEPTION: Eq. 24.9-4 need not be considered for computing drift.

24.9.6.2 Period for Computing Drift

For determining compliance with the story drift limits of Section 24.13.1, it is permitted to determine the elastic drifts, (δ_{xe}), using seismic design forces based on the computed fundamental period of the structure without the upper limit ($C_u T_a$) specified in Section 24.9.2.

24.9.7 P-Delta Effects

P-delta effects on story shears and moments, the resulting member forces and moments, and the story drifts induced by these effects are not required to be considered where the stability coefficient (θ) as determined by the following equation is equal to or less than 0.10:

$$\theta = \frac{P_x \Delta I_e}{V_x h_{sx} C_d} \quad (24.9-10)$$

where

P_x = the total vertical design load at and above Level x (kip or kN); where computing P_x , no individual load factor need exceed 1.0

Δ = the design story drift as defined in Section 24.9.6 occurring simultaneously with V_x (in. or mm)

I_e = the importance factor determined in accordance with Section 11.5.1

V_x = the seismic shear force acting between Levels x and $x - 1$ (kip or kN)

h_{sx} = the story height below Level x (in. or mm)

C_d = the deflection amplification factor in Table 24.3-1

The stability coefficient (θ) shall not exceed θ_{max} determined as follows:

$$\theta_{max} = \frac{0.5}{\beta C_d} \leq 0.25 \quad (24.9-11)$$

where β is the ratio of shear demand to shear capacity for the story between Levels x and $x - 1$. This ratio is permitted to be conservatively taken as 1.0.

Where the stability coefficient (θ) is greater than 0.10 but less than or equal to θ_{max} , the incremental factor related to P-delta effects on displacements and member forces shall be determined by rational analysis. Alternatively, it is permitted to multiply displacements and member forces by $1.0/(1 - \theta)$.

Where θ is greater than θ_{max} , the structure is potentially unstable and shall be redesigned.

Where the P-delta effect is included in an automated analysis, Eq. 24.9-11 shall still be satisfied, however, the value of θ computed from Eq. 24.9-10 using the results of the P-delta analysis is permitted to be divided by $(1 + \theta)$ before checking Eq. 24.9-11.

24.10 MODAL RESPONSE SPECTRUM ANALYSIS

24.10.1 Number of Modes

An analysis shall be conducted to determine the natural modes of vibration for the structure. The analysis shall include a sufficient number of modes to obtain a combined modal mass participation of at least 90 percent of the actual mass in each of the orthogonal horizontal directions of response considered by the model.

24.10.2 Modal Response Parameters

The value for each force-related design parameter of interest, including story drifts, support forces, and individual member forces for each mode of response shall be computed using the properties of each mode and the response spectra defined in either Section 11.4.5 or 21.2 divided by the quantity R/I_e . The value for displacement and drift quantities shall be multiplied by the quantity C_d/I_e .

24.10.3 Combined Response Parameters

The value for each parameter of interest calculated for the various modes shall be combined using the square root of the sum of the squares (SRSS) method, the complete quadratic combination (CQC) method, the complete quadratic combination method as modified by ASCE 4 (CQC-4), or an approved equivalent

approach. The CQC or the CQC-4 method shall be used for each of the modal values where closely spaced modes have significant cross-correlation of translational and torsional response.

24.10.4 Scaling Design Values of Combined Response

A base shear (V) shall be calculated in each of the two orthogonal horizontal directions using the calculated fundamental period of the structure T in each direction and the procedures of Section 24.9.

24.10.4.1 Scaling of Forces

Where the calculated fundamental period exceeds $1.6T_a$ in a given direction, $1.6T_a$ shall be used in lieu of T in that direction. Where the combined response for the modal base shear (V_i) is less than 85 percent of the calculated base shear (V) using the equivalent lateral force procedure, the forces shall be multiplied by

$$0.85 \frac{V}{V_i}$$

where

V = the equivalent lateral force procedure base shear, calculated in accordance with this section and Section 24.9

V_i = the base shear from the required modal combination

24.10.5 Horizontal Shear Distribution

The distribution of horizontal shear shall be in accordance with Section 24.9.4.

24.10.6 P-Delta Effects

The P-delta effects shall be determined in accordance with Section 24.9.7. The base shear used to determine the story shears and the story drifts shall be determined in accordance with Section 24.9.6.

24.11 DIAPHRAGMS, CHORDS, AND COLLECTORS

24.11.1 Diaphragm Design

Diaphragms shall be designed for both the shear and bending stresses resulting from design forces. At diaphragm discontinuities, such as openings and reentrant corners, the design shall assure that the dissipation or transfer of edge (chord) forces combined with other forces in the diaphragm is within shear and tension capacity of the diaphragm.

24.11.1.1 Diaphragm Design Forces

Floor and roof diaphragms shall be designed to resist design seismic forces from the structural analysis, but shall not be less than that determined in accordance with Eq. 24.11-1 as follows:

$$F_{px} = \frac{\sum_{i=x}^n F_i}{\sum_{i=x}^n w_i} w_{px} \quad (24.11-1)$$

where

F_{px} = the diaphragm design force

F_i = the design force applied to Level i

w_i = the weight tributary to Level i

w_{px} = the weight tributary to the diaphragm at Level x

The force determined from Eq. 24.11-1 shall not be less than

$$F_{px} = 0.2S_{DS}I_eW_{px} \quad (24.11-2)$$

The force determined from Eq. 24.11-1 need not exceed

$$F_{px} = 0.4S_{DS}I_eW_{px} \quad (24.11-3)$$

Where the diaphragm is required to transfer design seismic force from the vertical resisting elements above the diaphragm to other vertical resisting elements below the diaphragm due to offsets in the placement of the elements or to changes in relative lateral stiffness in the vertical elements, these forces shall be added to those determined from Eq. 24.11-1.

24.11.2 Collector Elements

Collector elements shall be provided that are capable of transferring the seismic forces originating in other portions of the structure to the element providing the resistance to those forces.

24.12 STRUCTURAL WALLS AND THEIR ANCHORAGE

24.12.1 Design for Out-of-Plane Forces

Structural walls and their anchorage shall be designed for a force normal to the surface equal to $F_p = 0.4S_{DS}I_e$ times the weight of the structural wall with a minimum force of 10 percent of the weight of the structural wall. Interconnection of structural wall elements and connections to supporting framing systems shall have sufficient ductility, rotational capacity, or sufficient strength to resist shrinkage, thermal changes, and differential foundation settlement when combined with seismic forces.

24.12.2 Anchorage of Structural Walls

The anchorage of structural walls to supporting construction shall provide a direct connection capable of resisting the following force:

$$F_p = 0.2k_aI_eW_p \quad (24.12-1)$$

$$k_a = 1.0 + L_f/100 \quad (24.12-2)$$

k_a need not be taken larger than 2.0.

where

F_p = the design force in the individual anchors

I_e = the importance factor determined in accordance with Section 11.5.1

k_a = amplification factor for diaphragm flexibility

L_f = the span, in feet, of a flexible diaphragm that provides the lateral support for the wall; the span is measured between vertical elements that provide lateral support to the diaphragm in the direction considered; use zero for rigid diaphragms

W_p = the weight of the wall tributary to the anchor

Where the anchorage is not located at the roof and all diaphragms are not flexible, the value from Eq. 24.12-1 is permitted to be multiplied by the factor $(1 + 2z/h)/3$, where z is the height of the anchor above the base of the structure and h is the height of the roof above the base.

Structural walls shall be designed to resist bending between anchors where the anchor spacing exceeds 4 ft. (1,219 mm).

24.13 DRIFT AND DEFORMATION

24.13.1 Story Drift Limit

The design story drift (Δ) as determined in Sections 24.9.6 or 24.10.2, shall not exceed the allowable story drift (Δ_a) as obtained from Table 24.13-1 for any story.

24.13.2 Diaphragm Deflection

The deflection in the plane of the diaphragm, as determined by engineering analysis, shall not exceed the permissible deflection of the attached elements. Permissible deflection shall be that deflection that will permit the attached element to maintain its structural integrity under the individual loading and continue to support the prescribed loads.

24.13.3 Structural Separation

All portions of the structure shall be designed and constructed to act as an integral unit in resisting seismic forces unless separated structurally by a distance sufficient to avoid damaging contact as set forth in this section.

Separations shall allow for the maximum inelastic response displacement (δ_M). δ_M shall be determined at critical locations with consideration for translational and torsional displacements of the structure using the following equation:

$$\delta_M = \frac{C_d \delta_{max}}{I_e} \quad (24.13-1)$$

where δ_{max} = maximum elastic displacement at the critical location.

Adjacent structures on the same property shall be separated by at least δ_{MT} , determined as follows:

$$\delta_{MT} = \sqrt{(\delta_{M1})^2 + (\delta_{M2})^2} \quad (24.13-2)$$

where δ_{M1} and δ_{M2} are the maximum inelastic response displacements of the adjacent structures at their adjacent edges.

Where a structure adjoins a property line not common to a public way, the structure shall be set back from the property line by at least the displacement δ_M of that structure.

EXCEPTION: Smaller separations or property line setbacks are permitted where justified by rational analysis based on inelastic response to design ground motions.

24.13.4 Members Spanning between Structures

Gravity connections or supports for members spanning between structures or seismically separate portions of structures shall be designed for the maximum anticipated relative displacements. These displacements shall be calculated:

1. Using the deflection calculated at the locations of support, per Eq. 24.9-9 multiplied by $1.5R/C_d$, and
2. Considering additional deflection due to diaphragm rotation, and
3. Considering diaphragm deformations, and
4. Assuming the two structures are moving in opposite directions and using the absolute sum of the displacements.

24.14 FOUNDATION DESIGN

24.14.1 Design Basis

The design basis for foundations shall be as set forth in Section 24.2.5.

24.14.2 Materials of Construction

Materials used for the design and construction of foundations shall comply with the requirements of Chapter 14. Design and detailing of steel piles shall comply with Section 14.1.7 Design and detailing of concrete piles shall comply with Section 14.2.3.

24.14.3 Foundation Load-Deformation Characteristics

Where foundation flexibility is included for the linear analysis procedures in this chapter, the load-deformation characteristics of the foundation–soil system (foundation stiffness) shall be modeled in accordance with the requirements of this section. The linear load-deformation behavior of foundations shall be represented by an equivalent linear stiffness using soil properties that are compatible with the soil strain levels associated with the design earthquake motion. The strain-compatible shear modulus, G , and the associated strain-compatible shear wave velocity, v_s , needed for the evaluation of equivalent linear stiffness shall be determined using the criteria in Section 19.2.1.1 or based on a site-specific study. A 50 percent increase and decrease in stiffness shall be incorporated in dynamic analyses unless smaller variations can be justified based on field measurements of dynamic soil properties or direct measurements of dynamic foundation stiffness. The largest values of response shall be used in design.

24.14.4 Reduction of Foundation Overturning

Overturning effects at the soil–foundation interface are permitted to be reduced by 25 percent for foundations of structures that satisfy both of the following conditions:

- a. The structure is designed in accordance with the Equivalent Lateral Force Analysis as set forth in Section 24.9.
- b. The structure is not an inverted pendulum or cantilevered column type structure.

Overturning effects at the soil–foundation interface are permitted to be reduced by 10 percent for foundations of structures designed in accordance with the modal analysis requirements of Section 24.10.

24.15 SEISMIC DESIGN REQUIREMENTS FOR EGRESS STAIRWAYS AND PARAPETS

24.15.1 Scope

This section establishes minimum design criteria for parapets and egress stairways and their supports and attachments in Seismic Design Category B. All other nonstructural components and their supports and attachments are exempt from the requirements of Section 24.15.

24.15.2 General Design Requirements

24.15.2.1 Submittal Requirements

Evidence demonstrating compliance with the requirements of this section shall be submitted for approval to the authority having jurisdiction after review and acceptance by a registered design professional. Parapets and egress stairways may also be seismically qualified by analysis, testing, or experience data in accordance with Section 13.2.1.

24.15.2.2 Construction Documents

The design of parapets and egress stairways, and their supports and attachments, shall be shown in construction documents prepared by a registered design professional for use by the owner, authorities having jurisdiction, contractors, and inspectors.

24.15.3 Seismic Design Force

Parapets and egress stairways, and their supports and attachments, shall be designed for the seismic forces defined in this section. Where non-seismic loads on nonstructural components exceed F_p , such loads shall govern the strength design, but the limitations prescribed in this chapter shall apply.

The horizontal seismic design force (F_p) shall be applied at the component's center of gravity and distributed relative to the component's mass distribution and shall be determined in accordance with Eq. 24.15-1:

$$F_p = \frac{0.4a_p S_{DS} W_p}{\left(\frac{R_p}{I_p}\right)} \left(1 + 2\frac{z}{h}\right) \quad (24.15-1)$$

and F_p shall not be taken as less than

$$F_p = 0.3S_{DS}I_pW_p \quad (24.15-2)$$

where

F_p = horizontal seismic design force applied to the parapet or egress stairway

S_{DS} = spectral acceleration, short period, as determined from Section 11.4.4

a_p = component amplification factor. a_p shall be taken as 2.5 for parapets that are unbraced or braced to the structural frame below the center of mass, 1.0 for parapets braced above the center of mass, and 1.0 for egress stairways

I_p = component importance factor. I_p shall be taken as 1.0 for parapets and 1.5 for egress stairways

W_p = weight of the parapet or egress stairway

R_p = component response modification factor. R_p shall be taken as 2.5

z = height in structure of point of attachment of parapet or egress stairway with respect to the base of the structure. For items at or below the base, z shall be taken as 0. The value of z/h need not exceed 1.0

h = average roof height of structure with respect to the base of the structure

The force (F_p) shall be applied independently in at least two orthogonal horizontal directions in combination with service loads associated with the component, as appropriate. For vertically cantilevered systems, however, the force F_p shall be assumed to act in any horizontal direction. The overstrength factor, Ω_0 , does not apply.

24.15.4 Design of Egress Stairways for Seismic Relative Displacements

Egress stairways, and their supports and attachments, shall be designed to accommodate the seismic relative displacement requirements of this section. Egress stairways shall be designed considering vertical deflection due to joint rotation of cantilever structural members.

The effects of seismic relative displacements shall be considered in combination with displacements caused by other loads as appropriate. Seismic relative displacements, D_{pl} , shall be determined in accordance with Eq. 24.15-3 as:

$$D_{pl} = D_p I_e \quad (24.15-3)$$

where

I_e = the importance factor in Section 11.5.1

D_p = displacement determined in accordance with the equations set forth in Sections 24.15.4.1 and 24.15.4.2

24.15.4.1 Displacements within Structures

For two connection points on the same Structure A or the same structural system, one at a height h_x and the other at a height h_y , D_p shall be determined as

$$D_p = \delta_{xA} - \delta_{yA} \quad (24.15-4)$$

Alternatively, D_p is permitted to be determined using modal procedures described in Section 24.10, using the difference in story deflections calculated for each mode and then combined using appropriate modal combination procedures. D_p is not required to be taken as greater than

$$D_p = \frac{(h_x - h_y) \Delta_{aA}}{h_{sx}} \quad (24.15-5)$$

24.15.4.2 Displacements between Structures

For two connection points on separate Structures A and B or separate structural systems, one at a height h_x and the other at a height h_y , D_p shall be determined as

$$D_p = |\delta_{xA}| + |\delta_{yB}| \quad (24.15-6)$$

D_p is not required to be taken as greater than

$$D_p = \frac{h_x \Delta_{aA}}{h_{sx}} + \frac{h_y \Delta_{aB}}{h_{sy}} \quad (24.15-7)$$

where

D_p = relative seismic displacement that the component must be designed to accommodate

δ_{xA} = deflection at building Level x of Structure A, determined in accordance with Eq. (24.9-9)

δ_{yA} = deflection at building Level y of Structure A, determined in accordance with Eq. (24.9-9)

δ_{yB} = deflection at building Level y of Structure B, determined in accordance with Eq. (24.9-9)

h_x = height of Level x to which upper connection point is attached

h_y = height of Level y to which lower connection point is attached

Δ_{aA} = allowable story drift for Structure A as defined in Table 24.13-1

Δ_{aB} = allowable story drift for Structure B as defined in Table 24.13-1

h_{sx} = story height used in the definition of the allowable drift Δ_a in Table 24.13-1. Note that Δ_a/h_{sx} = the drift index

The effects of seismic relative displacements shall be considered in combination with displacements caused by other loads as appropriate.

24.15.5 Out-of-Plane Bending

Transverse or out-of-plane bending or deformation of a parapet or egress stairway subjected to forces as determined in Section 24.15.3, or displacements as determined in Section 24.15.4, shall not exceed the deflection capability of the parapet or egress stairway.

24.15.6 Anchorage

Parapet and egress stairways, and their supports, shall be attached (or anchored) to the structure in accordance with the requirements of this section and the attachment shall satisfy the requirements for the parent material as set forth elsewhere in this standard.

Parapets and egress stairways, and their supports, shall be bolted, welded, or otherwise positively fastened without consideration of frictional resistance produced by the effects of gravity. A continuous load path of sufficient strength and stiffness shall be provided between the parapet or egress stairway and the supporting structure. Local elements of the structure including connections shall be designed and constructed for the forces in the attachment where they control the design of the elements or their connections. The design documents shall include sufficient information relating to the attachments to verify compliance with the requirements of this section.

24.15.6.1 Design Force in the Attachment

The force in the attachment shall be determined based on the prescribed forces and displacements for the parapet or egress stairway as determined in Sections 24.15.3 and 24.15.4.

24.15.6.2 Anchors in Concrete or Masonry

Anchors in concrete shall be designed in accordance with Appendix D of ACI 318.

Anchors in masonry shall be designed in accordance with TMS 402/ACI 503/ASCE 5. Anchors shall be designed to be governed by the tensile or shear strength of a ductile steel element.

EXCEPTION: Anchors in masonry shall be permitted to be designed so that the support that the anchor is connecting to the structure undergoes ductile yielding at a load level corresponding to anchor forces not greater than their design strength, or the minimum design strength of the anchors shall be at least 2.5 times the factored forces transmitted by the parapet or egress stairway.

Post-installed anchors in concrete shall be prequalified for seismic applications in accordance with ACI 355.2, ACI 355.4 or other approved qualification procedures. Post-installed anchors in masonry shall be prequalified for seismic applications in accordance with approved qualification procedures.

24.15.6.3 Installation Conditions

Determination of forces in attachments shall take into account the expected conditions of installation including eccentricities and prying effects.

24.15.6.4 Multiple Attachments

Determination of force distribution of multiple attachments at one location shall take into account the stiffness and ductility of the component, component supports, attachments, and structure and the ability to redistribute loads to other attachments in the group. Designs of anchorage in concrete in accordance with Appendix D of ACI 318 shall be considered to satisfy this requirement.

24.15.6.5 Power Actuated Fasteners

Power actuated fasteners in concrete or steel shall not be used for sustained tension loads. Power actuated fasteners in masonry are not permitted unless approved for seismic loading.

EXCEPTION 1: Power actuated fasteners in concrete used for support of acoustical tile or lay-in panel suspended ceiling applications and distributed systems where the service load on any individual fastener does not exceed 90 lb (400 N). Power actuated fasteners in steel where the service load on any individual fastener does not exceed 250 lb (1,112 N).

EXCEPTION 2: Power actuated fasteners in steel where the service load on any individual fastener does not exceed 250 lb (1,112 N).

FIGURES AND TABLES

Table 24.3-1 Design Coefficients and Factors for Seismic Force-Resisting Systems

System	Seismic Force-Resisting System	ASCE 7 Section Where Detailing Requirements Are Specified	Response Modification Coefficient, R^a	Overstrength Factor, Ω_o^c	Deflection Amplification Factor, C_d^b
Bearing Wall	2. Ordinary reinforced concrete shear walls ^d	14.2	4	2½	4
Bearing Wall	5. Intermediate precast shear walls ^d	14.2	4	2½	4
Bearing Wall	6. Ordinary precast shear walls ^d	14.2	3	2½	3
Bearing Wall	8. Intermediate reinforced masonry shear walls	14.4	3½	2½	2¼
Bearing Wall	9. Ordinary reinforced masonry shear walls	14.4	2	2½	1¾
Bearing Wall	13. Ordinary reinforced AAC masonry shear walls	14.4	2	2½	2
Bearing Wall	14. Ordinary plain AAC masonry shear walls	14.4	1½	2½	1½
Bearing Wall	15. Light-frame (wood) walls sheathed with wood structural panels rated for shear resistance	14.1 and 14.5	6½	3	4
Bearing Wall	16. Light-frame (cold-formed steel) walls sheathed with wood structural panels rated for shear resistance or steel sheets	14.1	6½	3	4
Bearing Wall	17. Light-frame walls with shear panels of all other materials	14.1 and 14.5	2	2½	2
Bearing Wall	18. Light-frame (cold-formed steel) wall systems using flat strap bracing	14.1	4	2	3½
Building Frame	3. Steel ordinary concentrically braced frames	14.1	3¼	2	3¼
Building Frame	5. Ordinary reinforced concrete shear walls ^d	14.2	5	2½	4½
Building Frame	8. Intermediate precast shear walls ^d	14.2	5	2½	4½
Building Frame	9. Ordinary precast shear walls ^d	14.2	4	2½	4
Building Frame	17. Intermediate reinforced masonry shear walls	14.4	4	2½	4
Building Frame	18. Ordinary reinforced masonry shear walls	14.4	2	2½	2
Building Frame	22. Light-frame (wood) walls sheathed with wood structural panels rated for shear resistance	14.5	7	2½	4½
Building Frame	23. Light-frame (cold-formed steel) walls sheathed with wood structural panels rated for shear resistance or steel sheets	14.1	7	2½	4½
Building Frame	24. Light-frame walls with shear panels of all other materials	14.1 and 14.5	2½	2½	2½
Moment-Resisting Frame	3. Steel intermediate moment frames	14.1	4½	3	4
Moment-Resisting Frame	4. Steel ordinary moment frames	14.1	3½	3	3
Moment-Resisting Frame	6. Intermediate reinforced concrete moment frames	14.2	5	3	4½
Moment-Resisting Frame	7. Ordinary reinforced concrete moment frames	14.2	3	3	2½
Moment-Resisting Frame	9. Steel and concrete composite intermediate moment frames	14.3	5	3	4½
Moment-Resisting Frame	10. Steel and concrete composite partially restrained moment frames [System is limited to a structural height, h_n , of 160 ft. (48.8 m)]	14.3	6	3	5½
Moment-Resisting Frame	11. Steel and concrete composite ordinary moment frames	14.3	3	3	2½
Dual Systems with Intermediate Moment Frames Capable of Resisting at Least 25% of Prescribed Seismic Forces	3. Ordinary reinforced masonry shear walls	24.3.5.1 and 14.4	3	3	2½
Dual Systems with Intermediate Moment Frames Capable of Resisting at Least 25% of Prescribed Seismic Forces	4. Intermediate reinforced masonry shear walls	24.3.5.1 and 14.4	3½	3	3
Dual Systems with Intermediate Moment Frames Capable of Resisting at Least 25% of	6. Steel and concrete composite ordinary braced frames	24.3.5.1 and 14.3	3½	2½	3

System	Seismic Force-Resisting System	ASCE 7 Section Where Detailing Requirements Are Specified	Response Modification Coefficient, R^a	Overstrength Factor, Ω_o^c	Deflection Amplification Factor, C_d^b
Prescribed Seismic Forces					
Dual Systems with Intermediate Moment Frames Capable of Resisting at Least 25% of Prescribed Seismic Forces	7. Steel and concrete composite ordinary shear walls	24.3.5.1 and 14.3	5	3	4½
Dual Systems with Intermediate Moment Frames Capable of Resisting at Least 25% of Prescribed Seismic Forces	8. Ordinary reinforced concrete shear walls ^d	24.3.5.1 and 14.2	5½	2½	4½
Shear Wall-Frame Interactive	With Ordinary Reinforced Concrete Moment Frames And Ordinary Reinforced Concrete Shear Walls ^d	24.3.5.4 and 14.2	4½	2½	4
Cantilevered Column Systems Detailed to Conform to the Requirements for [System is limited to a structural height, h_n , of 35 ft (10.7 m)]	2. Steel ordinary cantilever column systems	24.3.5.2 and 14.1	1¼	1¼	1¼
Cantilevered Column Systems Detailed to Conform to the Requirements for [System is limited to a structural height, h_n , of 35 ft (10.7 m)]	4. Intermediate reinforced concrete moment frames	24.3.5.2 and 14.2	1½	1¼	1½
Cantilevered Column Systems Detailed to Conform to the Requirements for [System is limited to a structural height, h_n , of 35 ft (10.7 m)]	5. Ordinary reinforced concrete moment frames	24.3.5.2 and 14.2	1	1¼	1
Cantilevered Column Systems Detailed to Conform to the Requirements for [System is limited to a structural height, h_n , of 35 ft (10.7 m)]	6. Timber frames	24.3.5.2 and 14.5	1½	1½	1½
Steel Systems	Not specifically detailed for seismic resistance, excluding cantilever column systems	14.1	3	3	3

^aResponse modification coefficient, R , for use throughout the standard. Note R reduces forces to a strength level, not an allowable stress level.

^bDeflection amplification factor, C_d , for use in Sections 24.9.6, 24.9.7, and 24.10.2.

^cWhere the tabulated value of the overstrength factor, Ω_o , is greater than or equal to 2½, Ω_o is permitted to be reduced by subtracting the value of 1/2 for structures with flexible diaphragms.

^dIn Section 2.2 of ACI 318. A shear wall is defined as a structural wall.

FIGURE 24.4-1 Flexible Diaphragm => FIGURE 12.3-1 Flexible Diaphragm

Table 24.4-1 Horizontal Structural Irregularities

Type	Description	Reference Section
1a.	Torsional Irregularity: Torsional irregularity is defined to exist where the maximum story drift, computed including accidental torsion with $A_x = 1.0$, at one end of the structure transverse to an axis is more than 1.2 times the average of the story drifts at the two ends of the structure. Torsional irregularity requirements in the reference sections apply only to structures in which the diaphragms are rigid or semirigid.	24.8.3
1b.	Extreme Torsional Irregularity: Extreme torsional irregularity is defined to exist where the maximum story drift, computed including accidental torsion with $A_x = 1.0$, at one end of the structure transverse to an axis is more than 1.4 times the average of the story drifts at the two ends of the structure. Extreme torsional irregularity requirements in the reference sections apply only to structures in which the diaphragms are rigid or semirigid.	24.8.3 24.9.4.2
4.	Out-of-Plane Offset Irregularity: Out-of-plane offset irregularity is defined to exist where there is a discontinuity in a lateral force-resistance path, such as an out-of-plane offset of at least one of the vertical elements.	24.4.3.2 24.8.3
5.	Nonparallel System Irregularity: Nonparallel system irregularity is defined to exist where vertical lateral force-resisting elements are not parallel to the major orthogonal axes of the seismic force-resisting system.	24.8.3

Table 24.4-2 Vertical Structural Irregularities

Type	Description	Reference Section
4.	In-Plane Discontinuity in Vertical Lateral Force-Resisting Element Irregularity: In-plane discontinuity in vertical lateral force-resisting elements irregularity is defined to exist where there is an in-plane offset of a vertical seismic force-resisting element resulting in overturning demands on a supporting beam, column, truss, or slab.	24.4.3.2
5b.	Discontinuity in Lateral Strength—Extreme Weak Story Irregularity: Discontinuity in lateral strength—extreme weak story irregularity is defined to exist where the story lateral strength is less than 65% of that in the story above. The story strength is the total strength of all seismic-resisting elements sharing the story shear for the direction under consideration.	24.4.3.1

Table 24.9-1 Values of Approximate Period Parameters C_t and x

Structure Type	C_t	x
Moment-resisting frame systems in which the frames resist 100% of the required seismic force and are not enclosed or adjoined by components that are more rigid and will prevent the frames from deflecting where subjected to seismic forces:		
Steel moment-resisting frames	0.028 (0.0724) ^a	0.8
Concrete moment-resisting frames	0.016 (0.0466) ^a	0.9
All other structural systems	0.02 (0.0488) ^a	0.75

^aMetric equivalents are shown in parentheses.

FIGURE 24.9-1 Story Drift Determination => FIGURE 12.8-2 Story Drift Determination

FIGURE 24.11-1 Collectors => FIGURE 12.10-1 Collectors

Table 24.13-1 Allowable Story Drift, Δ_a ^a

Structure	Risk Category I or II	Risk Category III
Structures, other than masonry shear wall structures, 4 stories or less above the base as defined in Section 11.2, with interior walls, partitions, ceilings, and exterior wall systems that have been designed to accommodate the story drifts.	$0.025h_{sx}$ ^b	$0.020h_{sx}$
Masonry cantilever shear wall structures ^c	$0.010h_{sx}$	$0.010h_{sx}$
Other masonry shear wall structures	$0.007h_{sx}$	$0.007h_{sx}$
All other structures	$0.020h_{sx}$	$0.015h_{sx}$

^a h_{sx} is the story height below Level x .

^bThere shall be no drift limit for single-story structures with interior walls, partitions, ceilings, and exterior wall systems that have been designed to accommodate the story drifts. The structure separation requirement of Section 24.13.3 is not waived.

^cStructures in which the basic structural system consists of masonry shear walls designed as vertical elements cantilevered from their base or foundation support which are so constructed that moment transfer between shear walls (coupling) is negligible.

Page intentionally left blank

2015 NEHRP RECOMMENDED SEISMIC PROVISIONS FOR NEW BUILDINGS AND OTHER STRUCTURES:

PART 2, COMMENTARY

ASCE/SEI 7-10 (updated version of the third Print), CHAPTERS C11 - C22 WITH MODIFICATIONS AND ADDITIONAL CHAPTERS 23A AND 24

The 2015 edition of the *NEHRP Recommended Seismic Provisions for New Buildings and Other Structures* is a new knowledge-based resource of technologies and procedures for improving seismic design and building practices in the nation. Starting with the 2009 edition, the Provisions began to focus on serving as a resource document aimed at translating research into practice. In this process, the earlier practice of containing a full set of seismic design requirements was eliminated. This approach is continued with the 2015 Provisions. The new changes in the 2015 NEHRP Provisions are based-on extensive results and findings from research projects, problem-focused studies, and post-earthquake investigation reports conducted by various professional organizations, research institutes, universities, material industries and NEHRP agencies.

Consistent with the approach used in the 2009 edition, the national standard ASCE/SEI 7-10, Minimum Design Loads for Buildings and Other Structures, Chapters 11-23, including Supplement No. 1 and the Expanded Commentary, has been adopted by reference for the Provisions. Modifications and additions to the Standard that passed BSSC's evaluation and consensus approval process appear in Part 1 of the Provisions. These recommended changes are intended for consideration and adoption in the next edition of ASCE/SEI 7. Each proposed Part 1 change is accompanied by a corresponding change to the ASCE 7-10 Commentary, which is contained in Part 2 of the Provisions. Parts 1 and 2 together with the adopted chapters of ASCE/SEI 7-10 and the references cited therein constitute Volume 1 the 2015 Provisions. Part 3 of the Provisions presents Resource Papers in a separate Volume 2.

Work on the 2015 Provisions began in October 2009 when the National Institute of Building Sciences, the BSSC's parent organization, entered into a contract with FEMA for initiation of the 2015 Provisions update effort. In consideration of balancing geographical and design practices, providing expertise in a broad range of subject areas, focusing on key areas of code improvement, and collaborating with national standards and building codes, 21 individual experts were selected to serve on the 2015 Provisions Update Committee (PUC). The PUC, with input from the earthquake engineering community, identified technical issues considered most critical for improvement of the U.S. seismic design practice, and formed Issue Teams for developing change proposals to the ASCE Standard. The following topics were investigated in the 2015 Provisions cycle: incorporation of P-695/P-795 methodologies for qualification of new systems and components; evaluation of performance objectives for seismic design and re-evaluation of seismic design categories; anchorage to concrete based-on ACI 318 Appendix D; nonlinear response history analysis; diaphragm issues; foundations on liquefiable soil and other site-related issues; soil amplification factors; triggers for site-specific spectra, design mapping issues based-on the U.S. Geological Survey's 2014

national seismic hazard maps; base isolation, energy dissipation systems; soil-structure interaction, and modal response spectrum analysis.

Between March 2010 and February 2015, the Issue Teams, members of the PUC, and the BSSC's Simplified Seismic Design Project developed 47 change proposals that were evaluated by the PUC in seven ballots, and subsequently evaluated by the Membership Organization representatives in four ballots. The consensus approved proposals from these four ballots were accepted by the BSSC Board of Direction for incorporation into the 2015 Provisions. The 2015 Provisions include extensive new changes, affecting significant parts of the seismic design sections in ASCE 7-10, including replacing four entire chapters.

All changes in Parts 1 and 2 of the Provisions are submitted to the ASCE/SEI 7 Standard committee for consideration of adoption. With some further improvements on the code language, most of these new changes are expected to be accepted in ASCE/SEI 7-16. The Standard is expected to be adopted by reference in International Building Codes (IBC) 2018.

The 2015 Provisions are divided into two volumes. For Part 1 of the Provisions in Volume 1, its Table of Contents lists only those sections and subsections of ASCE/SEI 7-10 that have been changed by approved proposals of the Provisions. For Part 2 in Volume 1 and Part 3 in Volume 2, the Table of Contents lists all chapters and up-to the fourth level of subsection headings.

A separate companion Provisions CD includes proposed maps for ASCE/SEI 7-16, IBC 2018 and IRC 2018 and issues and research recommendations for developing the 2020 Provisions.

The commentary in Part 2 explains the development and application of both the existing requirements in ASCE 7-10 and recommended modifications in Part 1. In the 2009 Provisions a major effort was made to rewrite a commentary that was subsequently adopted in ASCE/SEI 7-10. The 2009 Provisions Part 1 changes appended their own commentaries. In Part 2 of the 2015 Provisions the ASCE/SEI 7-10 commentary (the final edition developed after the 3rd Edition) is reproduced in its entirety with recommended revisions, replacements and additions indicated by a vertical line in the right hand margin. Specifically, Part 2 includes:

- Revisions, replacements and additions to Chapters C11, C12, C14, C15, C21 and C22.
- Complete replacement of Chapters C16, C17, C18 and C19.

The Part 2 Commentary also contains:

- Unedited Chapters 13 and 20 of the ASCE/SEI 7-10 Commentary.
- Chapter C23A, a reprint of Chapter 23 from the 2009 Provisions.
- The addition of Chapter C24.

This amended commentary is intended primarily for design professionals and members of the codes and standards development community. However, an understanding of the basis for the seismic regulations contained in the nation's building codes and standards is important to many outside this technical community, including elected officials and other decision makers responsible for aspects of the built environment, the financial and insurance communities, and individual business owners and other citizens. These individuals and others who do not have in-depth technical knowledge may find of interest a complementary report that presents a brief overview that was developed for the 2009 Provisions. This overview is published as FEMA P-749, *Concepts of Seismic Design: An Introduction to the NEHRP Recommended Seismic Provisions for New Buildings and Other Structures*.

COMMENTARY TO CHAPTER 11, SEISMIC DESIGN CRITERIA

C11.1 GENERAL

Many of the technical changes made to the seismic provisions of the 2010 edition of this standard are primarily based on Part 1 of the 2009 edition of the *NEHRP Recommended Seismic Provisions for New Buildings and Other Structures*, which was prepared by the Building Seismic Safety Council (BSSC) under sponsorship of the Federal Emergency Management Agency (FEMA) as part of its contribution to the National Earthquake Hazards Reduction Program (NEHRP). The National Institute of Standards and Technology (NIST) is the lead agency for NEHRP, the federal government's long-term program to reduce the risks to life and property posed by earthquakes in the United States. Since 1985, the NEHRP provisions have been updated every three to five years. The efforts by BSSC to produce the NEHRP provisions were preceded by work performed by the Applied Technology Council (ATC) under sponsorship of the National Bureau of Standards (NBS)—now NIST—which originated after the 1971 San Fernando Valley earthquake. These early efforts demonstrated the design rules of that time for seismic resistance but had some serious shortcomings. Each subsequent major earthquake has taught new lessons. The NEHRP agencies (FEMA, NIST, the National Science Foundation [NSF], and the U.S. Geological Survey [USGS]), ATC, BSSC, ASCE, and others have endeavored to work individually and collectively to improve each succeeding document to provide state-of-the-art earthquake engineering design and construction provisions and to ensure that the provisions have nationwide applicability.

Content of Commentary. The enhanced commentary to ASCE/SEI 7-10 is based substantially on Part 2, Commentary, of the *NEHRP Recommended Seismic Provisions for New Buildings and Other Structures* (FEMA P-750, 2009), Building Seismic Safety Council, Federal Emergency Management Agency, 2009 edition. For additional background on the earthquake provisions contained in Chapters 11 through 23 of ASCE/SEI 7-10, the reader is referred to *Recommended Lateral Force Requirements and Commentary*, Seismology Committee, Structural Engineers Association of California, 1999.

Nature of Earthquake “Loads.” Earthquakes load structures indirectly through ground motion. As the ground shakes, a structure responds. The response vibration produces structural deformations with associated strains and stresses. The computation of dynamic response to earthquake ground shaking is complex. The design forces prescribed in this standard are intended only as approximations to generate internal forces suitable for proportioning the strength and stiffness of structural elements and for estimating the deformations (when multiplied by the deflection amplification factor, C_d) that would occur in the same structure in the event of the design-level earthquake ground motion (not MCE_R).

The basic methods of analysis in the standard use the common simplification of a response spectrum. A response spectrum for a specific earthquake ground motion provides the maximum value of response for elastic single-degree-of-freedom oscillators as a function of period without the need to reflect the total response history for every period of interest. The design response spectrum specified in Section 11.4 and used in the basic methods of analysis in Chapter 12 is a smoothed and normalized approximation for many different recorded ground motions.

The design limit state for resistance to an earthquake is unlike that for any other load within the scope of ASCE/SEI 7. The earthquake limit state is based upon system performance, not member performance, and considerable energy dissipation through repeated cycles of inelastic straining is assumed. The reason is the large demand exerted by the earthquake and the associated high cost of providing enough strength to maintain linear elastic response in ordinary buildings. This unusual limit state means that several conveniences of elastic behavior, such as the principle of superposition, are not applicable and makes it difficult to separate design provisions for loads from those for resistance. This difficulty is the reason Chapter 14 of the standard contains so many provisions that modify customary requirements for proportioning and detailing structural members and systems. It is also the reason for the construction quality assurance requirements.

Use of Allowable Stress Design Standards. The conventional design of almost all masonry structures and many wood and steel structures has been accomplished using allowable stress design (ASD). Although the fundamental basis for the earthquake loads in Chapters 11 through 23 is a strength limit state beyond the first yield of the structure, the provisions are written such that conventional ASD methods can be used by the design engineer. Conventional ASD methods may be used in one of two ways:

1. The earthquake load as defined in Chapters 11 through 23 may be used directly in allowable stress load combinations of Section 2.4, and the resulting stresses may be compared directly with conventional allowable stresses.
2. The earthquake load may be used in strength design load combinations, and resulting stresses may be compared with amplified allowable stresses (for those materials for which the design standard gives the amplified allowable stresses, e.g., masonry).

Federal Government Construction. The Interagency Committee on Seismic Safety in Construction has prepared an order executed by the president (Executive Order 12699) that all federally owned or leased building construction, as well as federally regulated and assisted construction, should be constructed to mitigate seismic hazards and that the NEHRP provisions are deemed to be the suitable standard. It is expected that this standard would be deemed equivalent, but the reader should bear in mind that there are certain differences.

C11.1.1 Purpose

The purpose of Section 11.1.1 is to clarify that the detailing requirements and limitations prescribed in this section and referenced standards are still required even when the design load combinations involving the wind forces of Chapters 26 through 29 produce greater effects than the design load combinations involving the earthquake forces of Chapters 11 through 23. This detailing is required so that the structure resists, in a ductile manner, potential seismic loads in excess of the prescribed wind loads. A proper, continuous load path is an obvious design requirement, but experience has shown that it is often overlooked and that significant damage and collapse can result. The basis for this design requirement is twofold:

1. To ensure that the design has fully identified the seismic force-resisting system and its appropriate design level and
2. To ensure that the design basis is fully identified for the purpose of future modifications or changes in the structure.

Detailed requirements for analyzing and designing this load path are given in the appropriate design and materials chapters.

C11.1.2 Scope

Certain structures are exempt for the following reasons:

Exemption 1—Detached wood frame dwellings not exceeding two stories above grade plane constructed in accordance with the prescriptive provisions of the International Residential Code (IRC) for light-frame wood construction, including all applicable IRC seismic provisions and limitations are deemed capable of resisting the anticipated seismic forces. Detached one- and two-story wood frame dwellings generally have performed well even in regions of higher seismicity. Therefore, within its scope, the IRC adequately provides the level of safety required for buildings. The structures that do not meet the prescriptive limitations of the IRC are required to be designed and constructed in accordance with the International Building Code (IBC) and the ASCE/SEI 7 provisions adopted therein.

Exemption 2—Agricultural storage structures generally are exempt from most code requirements because such structures are intended only for incidental human occupancy and represent an exceptionally low risk to human life.

Exemption 3—Bridges, transmission towers, nuclear reactors, and other structures with special configurations and uses are not covered. The regulations for buildings and building-like structures presented in this document do not adequately address the design and performance of such special structures.

ASCE/SEI 7-10 is not retroactive and usually applies to existing structures only when there is an addition, change of use, or alteration. Minimum acceptable seismic resistance of existing buildings is a policy issue normally set by the authority having jurisdiction. Appendix 11B of the standard contains rules of application for basic conditions. ASCE/SEI 31, *Seismic Evaluation of Existing Buildings*, and ASCE/SEI 41, *Seismic Rehabilitation of Existing Buildings*, provide technical guidance but do not contain policy recommendations. A chapter in the *International Building Code (IBC)* applies to alteration, repair, addition, and change of occupancy of existing buildings, and the International Code Council maintains the International Existing Building Code (IEBC) and associated commentary.

C11.1.3 Applicability

Industrial buildings may be classified as nonbuilding structures in certain situations for the purposes of determining seismic design coefficients and factors, system limitations, height limits, and associated detailing requirements. Many industrial building structures have geometries and/or framing systems that are different from the broader class of occupied structures addressed by Chapter 12, and the limited nature of the occupancy associated with these buildings reduces the hazard associated with their performance in earthquakes. Therefore, when the occupancy is limited primarily to maintenance and monitoring operations, these structures may be designed in accordance with the provisions of Section 15.5 for nonbuilding structures similar to buildings. Examples of such structures include, but are not limited to, boiler buildings, aircraft hangars, steel mills, aluminum smelting facilities, and other automated manufacturing facilities, whereby the occupancy restrictions for such facilities should be uniquely reviewed in each case. These structures may be clad or open structures.

C11.1.4 Alternate Materials and Methods of Construction

It is not possible for a design standard to provide criteria for the use of all possible materials and their combinations and methods of construction, either existing or anticipated. This section serves to emphasize that the evaluation and approval of alternate materials and methods require a recognized and accepted approval system. The requirements for materials and methods of construction contained within the document represent the judgment of the best use of the materials and methods based on well-established expertise and historical seismic performance. It is important that any replacement or substitute be evaluated with an understanding of all the ramifications of performance, strength, and durability implied by the standard.

Until needed standards and agencies are created, authorities that have jurisdiction need to operate on the basis of the best evidence available to substantiate any application for alternates. If accepted standards are lacking, applications for alternative materials or methods should be supported by test data obtained from test data requirements in Section 1.3.1.2. The tests should simulate expected load and deformation conditions to which the system, component, or assembly may be subjected during the service life of the structure. These conditions, when applicable, should include several cycles of full reversals of loads and deformations in the inelastic range.

C11.2 DEFINITIONS

ATTACHMENTS, COMPONENTS, AND SUPPORTS: The distinction among attachments, components, and supports is necessary to the understanding of the requirements for nonstructural components and nonbuilding structures. Common cases associated with nonstructural elements are illustrated in Fig. C11-1. The definitions of components, supports, and attachments are generally applicable to components with a defined envelope in the as-manufactured condition and for which additional supports and attachments are required to provide support in the as-built condition. This distinction may not always

be clear, particularly when the component is equipped with prefabricated supports; therefore, judgment must be used in the assignment of forces to specific elements in accordance with the provisions of Chapter 13.

BASE: The following factors affect the location of the seismic base:

- location of the grade relative to floor levels,
- soil conditions adjacent to the building,
- openings in the basement walls,
- location and stiffness of vertical elements of the seismic force-resisting system,
- location and extent of seismic separations,
- depth of basement,
- manner in which basement walls are supported,
- proximity to adjacent buildings, and
- slope of grade.

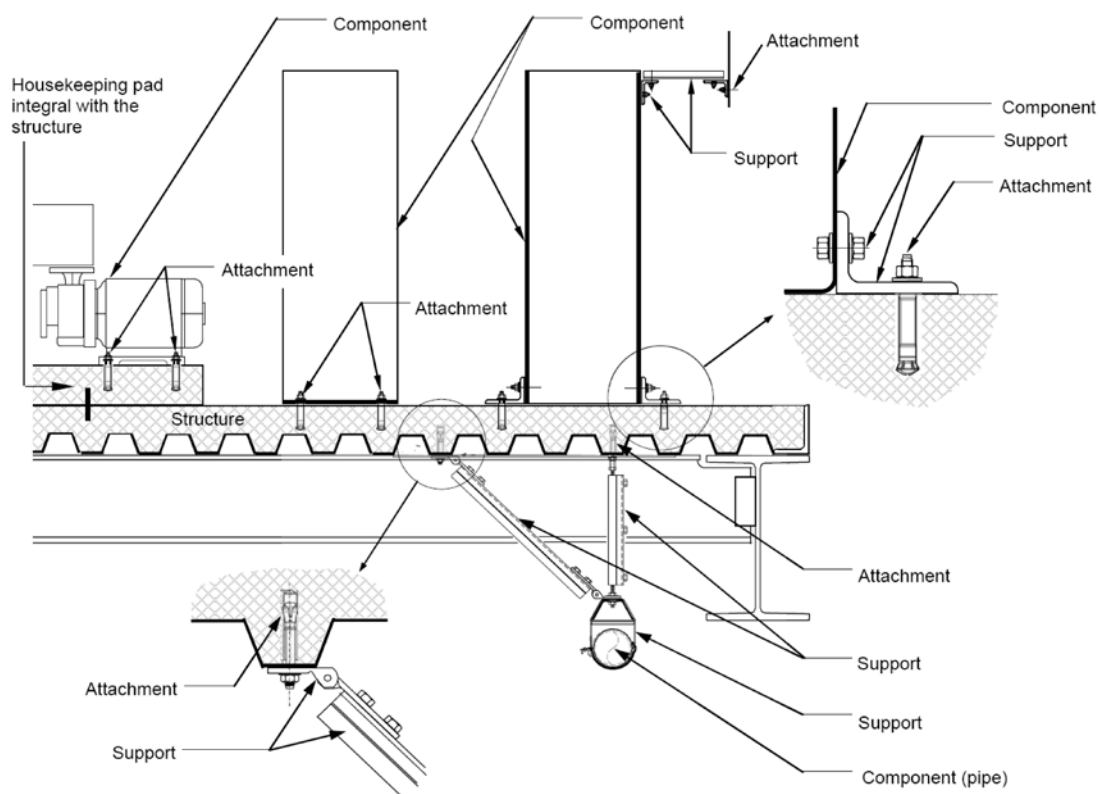

FIGURE C11-1 Examples of Components, Supports, and Attachments

For typical buildings on level sites with competent soils, the base is generally close to the grade plane. For a building without a basement, the base is generally established near the ground-level slab elevation, as shown in Fig. C11-2. Where the vertical elements of the seismic force-resisting system are supported on interior footings or pile caps, the base is the top of these elements. Where the vertical elements of the seismic force-resisting system are supported on top of perimeter foundation walls, the base is typically established at the top of the foundation walls. Often vertical elements are supported at various elevations on the top of footings, pile caps, and perimeter foundation walls. Where this occurs, the base is generally established as the lowest elevation of the tops of elements supporting the vertical elements of the seismic force-resisting system.

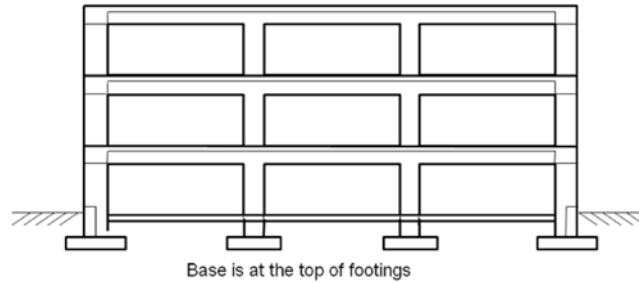

FIGURE C11-2 Base for a Level Site

For a building with a basement located on a level site, it is often appropriate to locate the base at the floor closest to grade, as shown in Fig. C11-3. If the base is to be established at the level located closest to grade, the soil profile over the depth of the basement should not be liquefiable in the MCE_G ground motion. The soil profile over the depth of the basement also should not include quick and highly sensitive clays or weakly cemented soils prone to collapse in the MCE_G ground motion. Where liquefiable soils or soils susceptible to failure or collapse in an MCE_G ground motion are located within the depth of the basement, the base may need to be located below these soils rather than close to grade. Stiff soils are required over the depth of the basement because seismic forces are transmitted to and from the building at this level and over the height of the basement walls. The engineer of record is responsible for establishing whether the soils are stiff enough to transmit seismic forces near grade. For tall or heavy buildings or where soft soils are present within the depth of the basement, the soils may compress laterally too much during an earthquake to transmit seismic forces near grade. For these cases, the base should be located at a level below grade.



FIGURE C11-3 Base at Ground Floor Level

In some cases, the base may be at a floor level above grade. For the base to be located at a floor level above grade, stiff foundation walls on all sides of the building should extend to the underside of the elevated level considered the base. Locating the base above grade is based on the principles for the two-stage equivalent lateral force procedure for a flexible upper portion of a building with one-tenth the stiffness of the lower portion of the building, as permitted in Sec. 12.2.3.2. For a floor level above grade to be considered the base, it generally should not be above grade more than one-half the height of the basement story, as shown in Fig. C11-4. Fig. C11-4 illustrates the concept of the base level located at the top of a floor level above grade, which also includes light-frame floor systems that rest on top of stiff basement walls or stiff crawl space stem walls of concrete or masonry construction.

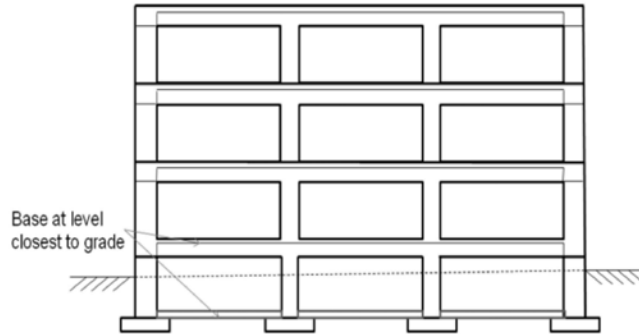

FIGURE C11-4 Base at Level Closest to Grade Elevation

A condition where the basement walls that extend above grade on a level site may not provide adequate stiffness is where the basement walls have many openings for items such as light wells, areaways, windows, and doors, as shown in Fig. C11-5. Where the basement wall stiffness is inadequate, the base should be taken as the level close to but below grade. If all of the vertical elements of the seismic force-resisting system are located on top of basement walls and there are many openings in the basement walls, it may be appropriate to establish the base at the bottom of the openings. Another condition where the basement walls may not be stiff enough is where the vertical elements of the seismic force-resisting system are long concrete shear walls extending over the full height and length of the building, as shown in Fig. C11-6. For this case, the appropriate location for the base is the foundation level of the basement walls.

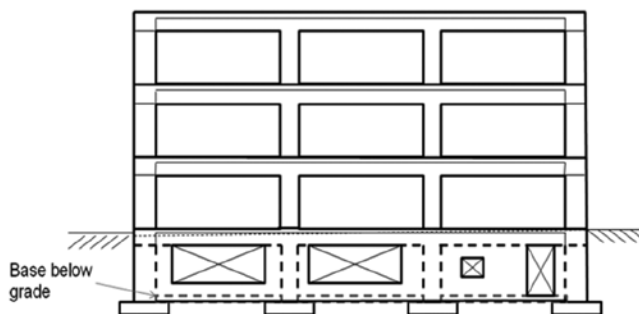

FIGURE C11-5 Base Below Substantial Openings in Basement Wall

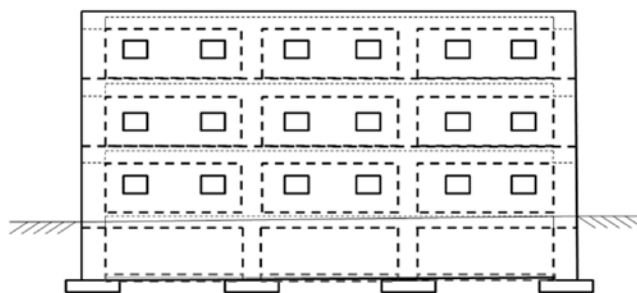

FIGURE C11-6 Base at Foundation Level Where There Are Full-Length Exterior Shear Walls

Where the base is established below grade, the weight of the portion of the story above the base that is partially above and below grade must be included as part of the effective seismic weight. If the equivalent lateral force procedure is used, this procedure can result in disproportionately high forces in upper levels because of a large mass at this lowest level above the base. The magnitude of these forces can often be mitigated by using the two-stage equivalent lateral force procedure where it is allowed or by using dynamic

analysis to determine force distribution over the height of the building. If dynamic analysis is used, it may be necessary to include multiple modes to capture the required mass participation, unless soil springs are incorporated into the model. Incorporation of soil springs into the model generally reduces seismic forces in the upper levels. With one or more stiff stories below more flexible stories, the dynamic behavior of the structure may result in the portion of the base shear from the first mode being less than the portion of base shear from higher modes.

Other conditions may also necessitate establishing the base below grade for a building with a basement that is located on a level site. Such conditions include those where seismic separations extend through all floors, including those located close to and below grade; those where the floor diaphragms close to and below grade are not tied to the foundation wall; those where the floor diaphragms, including the diaphragm for the floor close to grade, are flexible; and those where other buildings are located nearby.

For a building with seismic separations extending through the height of the building including levels close to and below grade, the separate structures are not supported by the soil against a basement wall on all sides in all directions. If there is only one joint through the building, assigning the base to the level close to grade may still be appropriate if the soils over the depth of the basement walls are stiff and the diaphragm is rigid. Stiff soils are required so that the seismic forces can be transferred between the soils and basement walls in both bearing and side friction. If the soils are not stiff, adequate side friction may not develop for movement in the direction perpendicular to the joint.

For large footprint buildings, seismic separation joints may extend through the building in two directions and there may be multiple parallel joints in a given direction. For individual structures within these buildings, substantial differences in the location of the center of rigidity for the levels below grade relative to levels above grade can lead to torsional response. For such buildings, the base should usually be at the foundation elements below the basement or the highest basement slab level where the separations are no longer provided.

Where floor levels are not tied to foundation walls, the base may need to be located well below grade at the foundation level. An example is a building with tie-back walls and posttensioned floor slabs. For such a structure, the slabs may not be tied to the wall to allow relative movement between them. In other cases a soft joint may be provided. If shear forces cannot be transferred between the wall and a ground level or basement floor, the location of the base depends on whether forces can be transferred through bearings between the floor diaphragm and basement wall and between the basement wall and the surrounding soils. Floor diaphragms bearing against the basement walls must resist the compressive stress from earthquake forces without buckling. If a seismic or expansion joint is provided in one of these buildings, the base almost certainly needs to be located at the foundation level or a level below grade where the joint no longer exists.

If the diaphragm at grade is flexible and does not have substantial compressive strength, the base of the building may need to be located below grade. This condition is more common with existing buildings. Newer buildings with flexible diaphragms should be designed for compression to avoid the damage that can otherwise occur.

Proximity to other structures can also affect where the base should be located. If other buildings with basements are located adjacent to one or more sides of a building, it may be appropriate to locate the base at the bottom of the basement. The closer the adjacent building is to the building, the more likely it is that the base should be below grade.

For sites with sloping grade, many of the same considerations for a level site are applicable. For example, on steeply sloped sites, the earth may be retained by a tie-back wall so that the building does not have to resist the lateral soil pressures. For such a case, the building is independent of the wall, so the base should be located at a level close to the elevation of grade on the side of the building where it is lowest, as shown in Fig. C11-7. Where the building's vertical elements of the seismic force-resisting system also resist lateral soil pressures, as shown in Fig. C11-8, the base should also be located at a level close to the elevation of

grade on the side of the building where grade is low. For these buildings, the seismic force-resisting system below highest grade is often much stiffer than the system used above it, as shown in Fig. C11-9, and the seismic weights for levels close to and below highest grade are greater than for levels above highest grade. Use of a two-stage equivalent lateral force procedure can be useful for these buildings.

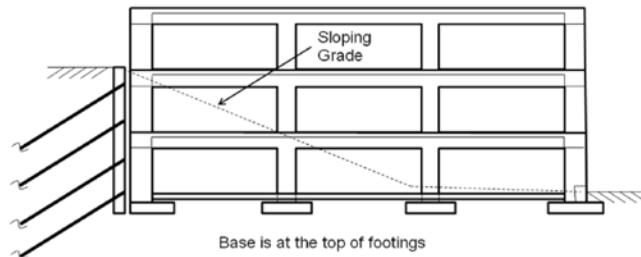

FIGURE C11-7 Building with Tie-Back or Cantilevered Retaining Wall That Is Separate from the Building

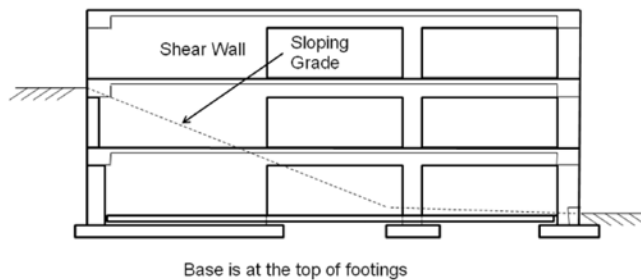

FIGURE C11-8 Building with Vertical Elements of the Seismic Force-Resisting System Supporting Lateral Earth Pressures

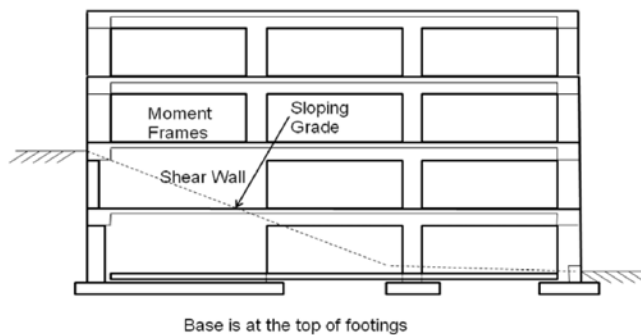

FIGURE C11-9 Building with Vertical Elements of the Seismic Force-Resisting System Supporting Lateral Earth Pressures

Where the site is moderately sloped such that it does not vary in height by more than a story, stiff walls often extend to the underside of the level close to the elevation of high grade, and the seismic force-resisting system above grade is much more flexible above grade than it is below grade. If the stiff walls extend to the underside of the level close to high grade on all sides of the building, locating the base at the level closest to high grade may be appropriate. If the stiff lower walls do not extend to the underside of the level located closest to high grade on all sides of the building, the base should be assigned to the level closest to low grade. If there is doubt as to where to locate the base, it should conservatively be taken at the lower elevation.

Flexure-Controlled Diaphragm. An example of a flexure-controlled diaphragm is a cast-in-place concrete diaphragm, where the flexural yielding mechanism would typically be yielding of the chord tension reinforcement.

Shear-Controlled Diaphragm. Shear-controlled diaphragms fall into two main categories. The first category is diaphragms that cannot develop a flexural mechanism because of aspect ratio, chord member strength, or other constraints. The second category is diaphragms that are intended to yield in shear rather than in flexure. Wood sheathed diaphragms, for example, typically fall in the second category.

Story Above Grade Plane. Fig. C11-10 illustrates this definition.

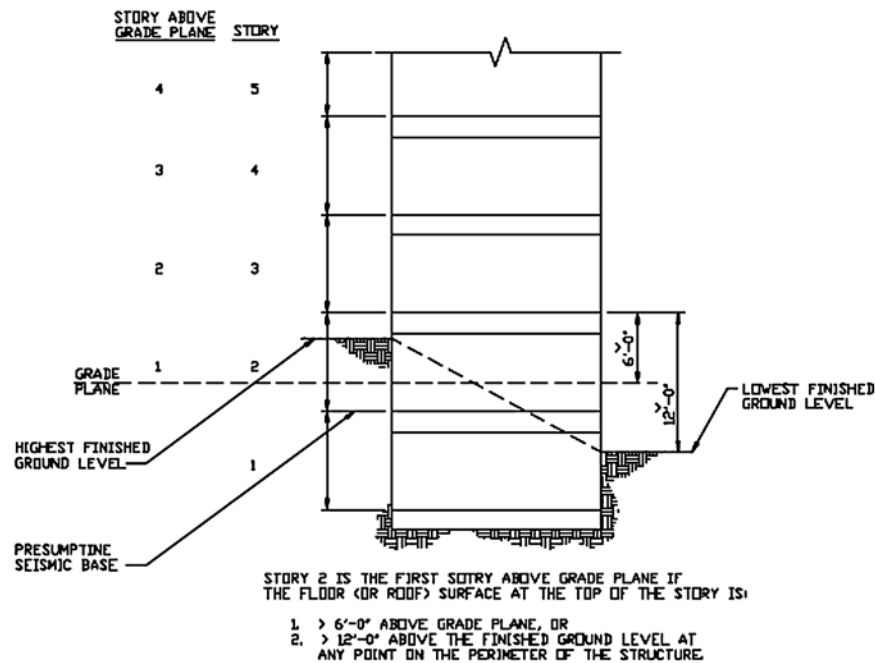

FIGURE C11-10 Illustration of Definition of Story above Grade Plane

C11.3 SYMBOLS

δ_{MDD} refers to in-plane diaphragm deflection, and therefore designated with a lower case delta. Note that the definition for δ_{MDD} refers to “lateral load” without any qualification, and the definition for Δ_{ADVE} refers to “tributary lateral load equivalent to that used in the computation of δ_{MDD} .” This equivalency is an important concept that was part of the 1997 UBC definition for a flexible diaphragm.

The provisions for precast concrete diaphragm design are intended to ensure that yielding, when it occurs, is ductile. Since yielding in shear will generally be brittle at precast concrete connections, an additional overstrength factor, Ω_v , has been introduced; the required shear strength for a precast diaphragm is required to be amplified by this factor. This term is added to the symbols.

As indicated in Section 14.2.4.1.3, $\Omega_v = 1.4R_s$. For the Elastic Design Option (EDO), which requires the entire diaphragm to remain elastic for the maximum considered earthquake, Ω_v is 1.0. For the Basic Design Option (BDO) and Reduced Design Option (RDO), Ω_v will be 1.4 and 2.0, respectively.

C11.4 SEISMIC GROUND MOTION VALUES

The basis for the mapped values of the MCE_R ground motions in ASCE 7-16 is identical to that in ASCE 7-10. Both of these are significantly different from mapped values of MCE ground motions in earlier editions of ASCE 7. These differences include use of (1) probabilistic ground motions that are based on

uniform risk, rather than uniform hazard, (2) deterministic ground motions that are based on the 84th percentile (approximately 1.8 times median), rather than 1.5 times median response spectral acceleration for sites near active faults, and (3) ground motion intensity that is based on maximum rather than the average (geometric mean), response spectral acceleration in the horizontal plane. These differences are explained in detail in the Commentary of the 2009 *NEHRP Recommended Provisions*. Except for determining the MCE_G PGA values in Chapters 11 and 21, the mapped values are given as MCE_R spectral values.

C11.4.1 Mapped Acceleration Parameters

Mapped response spectral accelerations (5% damping) are provided on USGS maps for short periods, S_S , and at 1 sec, S_I , for sites at the boundary of Site Classes B and C, which is $\bar{v}_s = 760$ m/s (2500 ft/s). The USGS maps have been applicable to this site condition since 1996 (Frankel et al., 1996), but now are more clearly marked as being applicable to the reference value of \bar{v}_s . USGS ground motion maps are available at: <http://earthquake.usgs.gov/hazards/designmaps/>.

C11.4.2 Site Class

The new site coefficients, F_a and F_v , necessitated a revision to the default site class when the site is known to be soil not classified as Site Class E or F. The F_a and F_v values for Site Class D in ASCE 7-10 were always equal to or greater than F_a and F_v values for Site Class C. Thus, specifying the Site Class D as the default site class ensured that the response spectral accelerations would not be underestimated. However, the F_a values for Site Class C are greater than those for Site Class D for $S_S \geq 1.0$. Thus, a minor modification, consisting of adding “and $F_a \geq 1.2$ ” after “Site Class D”, was required in the second sentence of the first paragraph to ensure that the larger of the site coefficients for Site Classes C and D would be selected when the soil properties are not sufficiently known to determine the site class, and the authority having jurisdiction or geotechnical data have determined that Site Class E or F soils are not present.

Because the site coefficients, F_a and F_v , are less than unity (1.0) for Site Class B, a new paragraph was added to this section that requires the measurement of shear-wave velocity to demonstrate that the site is Site Class B according to the definition in Section 20.3. Furthermore, when $S_I \geq 1.0$, the values of F_a for Site Class C are now greater than those for Site Class D.

C11.4.3 Site Coefficients and Risk-Targeted Maximum Considered Earthquake (MCER) Spectral Response Acceleration Parameters

Acceleration response parameters obtained from the maps (figures) cited in Section 11.4.1 are applicable for sites having $\bar{v}_s = 760$ m/s (2500 ft/s). For other site conditions, the S_S and S_I values are computed as indicated in Section 11.4.3. This section has been revised from ASCE 7-10 to adjust the site factors to a reference site condition of $\bar{v}_s = 760$ m/s (2500 ft/s) (instead of Site Class B) and to reflect more recent knowledge and data pertaining to site response.

The site coefficients, F_a and F_v , presented respectively in Tables 11.4-1 and 11.4-2 for the various site classes are based on analysis of strong motion data and on numerical simulations of nonlinear site response. The development of the factors that were in place from the 1994 *NEHRP Provisions* through ASCE 7-10 is described in Dobry et al. (2000) and the references therein. Motivation for the revisions to these site factors includes (Seyhan and Stewart, 2012): (1) updating the reference site condition used for the factors to match the condition on the national maps, which is $\bar{v}_s = 760$ m/s (2500 ft/s); (2) incorporating into the factors the substantial knowledge gains (stemming in large part from an enormous increase in available data) on site response over the past two decades.

The work undertaken to develop the revised factors is described in two PEER reports (Boore et al., 2013; Stewart and Seyhan, 2013). They develop a semi-empirical site amplification model for shallow crustal

regions with two components: (1) a component to account for the change in ground motion with \bar{v}_s for weak shaking conditions (referred to as the \bar{v}_s -scaling component); and (2) a component accounting for the effect of nonlinearity. The \bar{v}_s -scaling component was derived from strong ground motion data compiled and analyzed as part of the NGA-West 2 project (<http://peer.berkeley.edu/ngawest2/>). Whereas Stewart and Seyhan (2013) describe some regional variations in \bar{v}_s -scaling, such variations were not judged to be sufficiently robust for inclusion in the model and therefore the model's \bar{v}_s -scaling reflects the average of the full international data set. The nonlinear component of the model is designed to jointly capture nonlinear effects revealed by strong motion data analysis and the results of numerical simulations by Kamai et al. (2013).

The complete model (incorporating both \bar{v}_s -scaling and nonlinearity) is used to derive the recommended values of F_a and F_v for Site Classes B-D. The reference velocity used in the computations was 760 m/s (2500 ft/s). The values of \bar{v}_s used to compute the tabulated factors for Classes B, C, and D were 913 m/s, 489 m/s, and 266 m/s, respectively. These are average values of \bar{v}_s for sites in the respective classes based on the NGA-West 2 data set. For Site Class E, median estimates of site amplification were computed using the complete model (applied at 155 m/s) as with the other classes. However, the recommended factors for Site Class E are increased above the median by $\frac{1}{2}$ of the within-event standard deviation derived from the data, which increases site factors by approximately a factor of 1.3-1.4. This introduces a conservative bias to the Class E factors that is considered desirable due to the relatively modest amount of data for this site condition. A conservative bias was applied in the original site factors for Class E as well.

Figure C11.4-0 shows the recommended site factors as a function of \bar{v}_s for the levels of excitation (specified as values of S_S and S_I) given in Tables 11.4-1 and 11.4-2. The revised site factors for Site Class B (Rock) are smaller than prior values due to the change in reference velocity from 1050 to 760 m/s. The revised values for soil sites are generally similar to the prior values. However, for stronger shaking levels and Site Class C and D soils, the revised site factors are the same or greater than the prior values because of reduced levels of nonlinearity, especially at long period (i.e., in the F_v parameter). For Class E, the relative levels of revised and prior site factors are strongly influenced by the amount of conservative bias adopted in their selection. Whereas the overall levels of Class E site amplification remains about the same, the degree of nonlinearity has been reduced somewhat for F_a and increased somewhat for F_v .

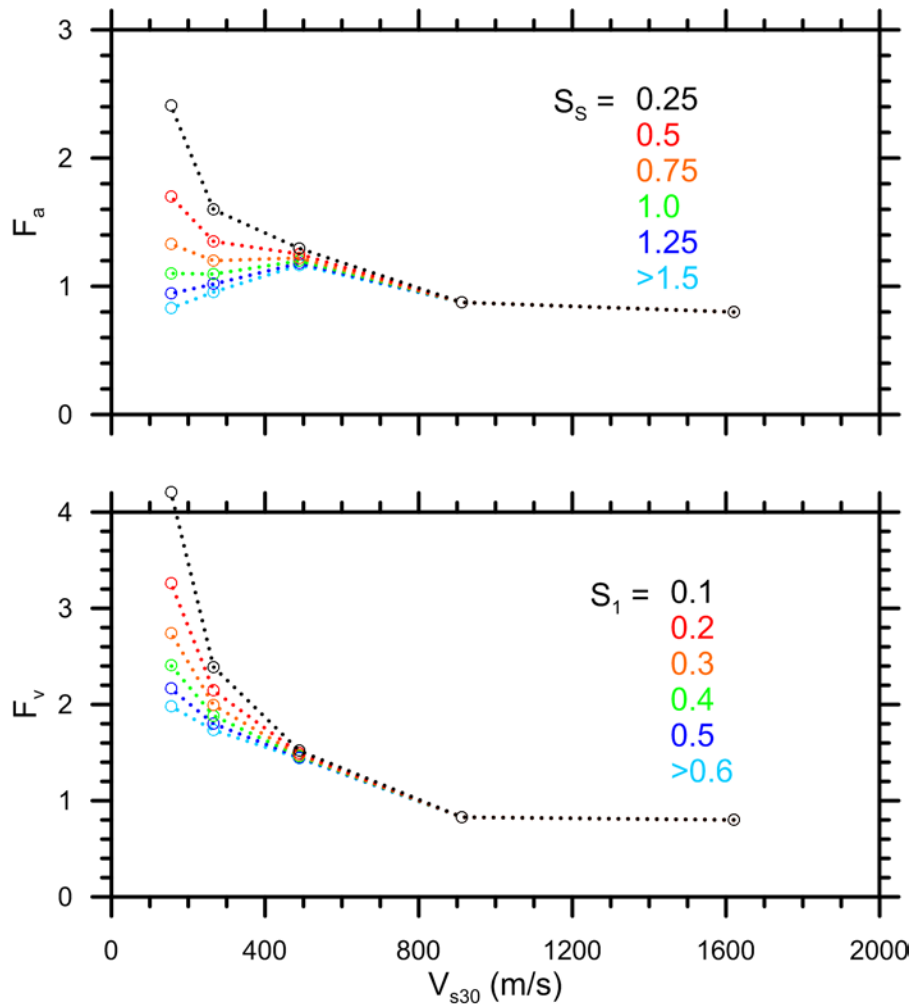

Figure C11.4-0. Site factors F_a and F_v as function of \bar{v}_s (shown as V_{s30} in figure) for various amplitudes of reference rock shaking (from Stewart and Seyhan, 2013).

Note: In the top frame of Figure C11.4-0, the values of F_a for $V_{s30} = 155$ m/s (Site Class E) are 1.1, 1.0, and 0.8 for $S_s = 1.0$, 1.25, and > 1.5 , respectively. These values were originally approved by the Provisions Update Committee but were later replaced by the note, “See Sec. 11.4.7”, which was necessitated by the results of more recent research. See C11.4.7 for details.

The revised factors are applicable for average site conditions in tectonically active regions (e.g., west coast of United States). Because of different average site conditions in stable continental regions (such as the central and eastern US), differences in average site response relative to the factors in Tables 11.4-1 and 11.4-2 should be anticipated for such regions. This can be addressed through site-specific analysis performed in accordance with Section 11.4.7.

For Site Classes B-D, site coefficients F_a and F_v may be computed from the following equations in lieu of using the site factors in Tables 11.4-1 and 11.4-2:

$$F_a = \exp \left[-0.727 \ln \left(\frac{V_{s30}}{760} \right) - 0.2298 \left[\frac{\exp \{ -0.00638 (\min(V_{s30}, 760) - 360) \}}{\exp \{ -0.00638 \times 400 \}} \right] - \ln \left(\frac{(S_s / 2.3) + 0.1}{0.1} \right) \right] \quad (C11.4-1)$$

$$F_v = \exp \left[-1.03 \ln \left(\frac{V_{s30}}{760} \right) - 0.118 \left[\frac{\exp \{ -0.00756 (\min(V_{s30}, 760) - 360) \}}{\exp \{ -0.00756 \times 400 \}} \right] - \ln \left(\frac{(S_I / 0.7) + 0.1}{0.1} \right) \right] \quad (C11.4-2)$$

In equations (C11.4-1) and (C11.4-2), \bar{v}_s (shown as V_{s30} in the equations) is in units of m/s and S_s and S_I are in units of g. The equations are considered useful for $\bar{v}_s = 150$ to 1000 m/s, $S_s = 0$ to 1.8 g, and $S_I = 0$ to 0.6 g. To obtain the F_a and F_v for $\bar{v}_s < 180$ m/s, the $+1/2$ standard-deviation correction for Site Class E described earlier in this section would need to be applied to the natural logarithm of F_a and F_v resulting from both equations. The standard deviations are 0.67 for F_a and 0.58 for F_v . One half of these standard deviations are to be added to the natural logarithms of F_a and F_v ; the anti logs of the resulting values yield F_a and F_v for Site Class E. Equations applicable for specific periods, and that allow use of $\bar{v}_s > 1000$ m/s, are given in Boore et al. (2013). Velocities measured in ft/s can be converted to m/s by multiplying by 0.3048 m/ft.

There are locations in high seismic areas and on Site Class E soils in the US where $S_{M1} > S_{MS}$. The present procedure for constructing the design response spectrum in Sect. 11.4.5 was modified for this case, and this modification preserves the basic shape of the design response spectrum in Figure 11.4-1. Generally, in those locations where $S_{M1} > S_{MS}$, the ratio, S_{M1}/S_{MS} , is typically less than 1.1, so setting $S_{MS} = S_{M1}$ is not overly conservative for $T_s < 1.0$ sec. This solution was judged preferable to alternatives, such as retaining the constant spectral acceleration portion as S_{MS} , but extending it past 1.0 sec to $T_s = S_{M1}/S_{MS}$.

C11.4.4 Design Spectral Acceleration Parameters

As described in Section C11.4, structural design in ASCE/SEI 7-10 is performed for earthquake demands that are 2/3 of the MCE_R response spectra. As set forth in Section 11.4.4, two additional parameters, S_{DS} and S_{D1} , are used to define the acceleration response spectrum for this design level event. These parameters are 2/3 of the respective S_{MS} and S_{M1} values and define a design response spectrum for sites of any characteristics and for natural periods of vibration less than the transition period, T_L . Values of S_{MS} , S_{M1} , S_{DS} , and S_{D1} can also be obtained from the USGS website cited previously.

C11.4.5 Design Response Spectrum

The design response spectrum (Fig. 11.4-1) consists of several segments. The constant-acceleration segment covers the period band from T_0 to T_s ; response accelerations in this band are constant and equal to S_{DS} . The constant-velocity segment covers the period band from T_s to T_L , and the response accelerations in this band are proportional to $1/T$ with the response acceleration at a 1-s period equal to S_{D1} . The long-period portion of the design response spectrum is defined on the basis of the parameter, T_L , the period that marks the transition from the constant-velocity segment to the constant-displacement segment of the design response spectrum. Response accelerations in the constant-displacement segment, where $T \geq T_L$, are proportional to $1/T^2$. Values of T_L are provided on maps in Figs. 22-12 through 22-16.

The T_L maps were prepared following a two-step procedure. First, a correlation between earthquake magnitude and T_L was established. Then, the modal magnitude from deaggregation of the ground-motion

seismic hazard at a 2-s period (a 1-s period for Hawaii) was mapped. Details of the procedure and the rationale for it are found in Crouse et al. (2006).

C11.4.7 Site-Specific Ground Motion Procedures

Site-specific ground motion procedures are permitted for any structure, and have traditionally been required for design of certain structures incorporating either seismic isolation or energy dissipation technology. This requirement has been contained in the building code requirements for many years and was originally developed when design ground motions were tied to seismic zones which covered broad swaths of the country. It was felt that the coarse approximation of design ground motion obtained from parameters tied to seismic zones was not consistent with the higher reliability often sought for structures incorporating these technologies. Since the adoption by the Standard of contour maps to represent seismic hazard, design ground motions derived using the maps is considerably improved relative to the old seismic zones and in many cases is as accurate as motions obtained from site-specific study, particularly for structures of moderate fundamental period (two seconds or less) located on sites with firm soil profiles or rock, and which are not located close to a known active fault.

On sites located close to major active faults, or with unstable or soft soil conditions, the two-parameter (S_1 , S_s) spectrum obtained using the ground motion maps in combination with site factors (F_a , F_v) does not provide a good estimate of the spectral shape of design ground motions, particularly at longer periods. Studies of site-specific seismic hazards and site response can significantly improve the shape and amplitude of the design spectrum on such sites, and is therefore required for these structures.

As noted earlier, the site-specific procedures of Chapter 21 are the same as those used by the USGS to develop the mapped values of MCE_R ground motions shown in Figures 22-1 through 22-6 of Chapter 22. Unless significant differences in local seismic and site conditions are determined by a site-specific analysis of earthquake hazard, site-specific ground motions would not be expected to differ significantly from those of the mapped values of MCE_R ground motions prepared by the USGS.

Site-specific ground motions are required for design of structures at softer soil sites and stronger ground motion intensities for which the two domains of constant acceleration and constant velocity (e.g., of the design response spectrum) do not adequately characterize site response and MCE_R response spectral acceleration can not be reliably calculated using procedures and formulas of Section 11.4. Softer soil sites requiring site-specific ground motions were identified by a study that investigated and developed solutions to potential short-comings in ELF (and MSRA) design procedures (Kircher & Associates 2015). The impetus for the ELF study came from a PUC effort (late in the 2015 cycle) to define seismic design forces at additional response periods beyond 1.0s; a first step toward ultimately basing seismic design forces on multi-period MCE_R response spectra.

Multi-period MCE_R response spectra would eliminate potential short-comings associated with the use of seismic forces based on only two response periods by directly providing reliable values of seismic demand at all design periods of interest. Unfortunately, multi-period hazard and associated design methods are not yet mature enough for incorporation in seismic codes and the site-specific requirements of Section 11.4.7 for softer sites and stronger ground motions provide a short-term solution to a problem that will ultimately be resolved by adoption of design methods based on multi-period response spectra.

The value of parameter S_{MS} is based on response at a period of 0.2 s and the value of the parameter S_{M1} is based on response at a period of 1 s. The domain of constant acceleration defined by the parameter (S_{MS}) and the domain of constant velocity (S_{M1}/T) are crude approximations to the actual shape of response spectral accelerations of MCE_R ground motions, such as those calculated using the site-specific procedures of Chapter 21 for a number of different periods of response (so-called multi-period MCE_R response spectra).

Although approximate, the two domains of constant acceleration and velocity provide reasonably accurate and conservative representation of the frequency content of design ground motions when peak response spectral acceleration occurs at or near $T = 0.2$ s, the period used to define S_{MS} , and peak response spectral

velocity (i.e., peak response spectral acceleration divided by response period) occurs at or near $T = 1.0$ s, the period used to define S_{MI} . Such is the case for response at stiffer sites governed by smaller magnitude earthquakes, but generally inaccurate and potentially unconservative at softer sites (e.g., Site Classes D and E), in particular sites for which seismic hazard is dominated by large magnitude earthquakes. In the latter case, values of S_{MS} and S_{MI} would be more accurately calculated if based on response at periods that better represent peak response spectral acceleration and peak response spectral velocity and hence the frequency content, of MCE_R ground motions of the site of interest.

The site-specific requirements of Section 21.4 of ASCE 7-10 recognized that periods of peak response are not always at 0.2s and 1.0s and require that S_{DI} be taken as equal to 2 x response spectral acceleration at 2 seconds when greater than 1-second response spectral acceleration, and that S_{DS} be taken as equal to 0.2-second response spectral acceleration, but not less than 90 percent of response at any period to better represent the frequency content of site-specific ground motions. For softer sites governed by large magnitude events, the peak value of response spectral velocity can occur at a period beyond 2 seconds and ASCE 7-16 extends the S_{DI} criteria of Section 21.4 to a period range of 1 s to 5 s for Site Class D and E sites i.e., ($v_{s,30} \leq 1,200$ ft/s).

Potential short-comings in ELF seismic design forces are illustrated in Figures C11.4-1, C11.4-2 and C11.4-3 each of which show plots of a multi-period MCE_R response spectrum for Site Class BC, multi-period MCE_R and design response spectra for the site class of interest (Site Class C, D, or E), and the two-domain ELF design spectrum, defined by the product $C_s \times (R/I_e)$. In these figures, the MCE_R ground motions represent a magnitude M7.0, earthquake at $R_x = 6.75$ km which has values of the parameters $S_S = 1.5$ g and $S_I = 0.6$ g for Site Class BC conditions ($v_{s,30} = 2,500$ ft/s). The ELF design spectrum is based on these values of S_S and S_I and values of the site coefficients F_a and F_v for the site class of interest. For example, the domain of constant acceleration is defined by value of the parameter $S_{DS} = 2/3 \times 0.8 \times 1.5$ g = 0.8 g and the domain of constant velocity is defined by the value of the parameter $S_{DI} = 2/3 \times 2.0 \times 0.6$ g = 0.8 g for the ELF design spectrum shown in Figure C11.4-3 for Site Class E conditions.

Comparisons of multi-period and ELF design spectra in Figures C11.4-1, C11.4-2 and C11.4-3 show varying degrees of similarity. For Site Class C (Figure C11.4-1) the ELF design spectrum is similar to the multi-period design spectrum. The ELF domain of constant acceleration matches the peak of the multi-period design spectrum at period of 0.25 s and the ELF domain of constant velocity ($1/T$) matches the multi-period design spectrum at periods of 1 s and greater. For Site Class D (Figure C11.4-2), the ELF design spectrum is moderately unconservative at most periods (e.g., by about 20 percent at a period of 1 s to 2 s) and for Site Class E (Figure C11.4-3) the design spectrum is significantly unconservative at all periods (e.g., by about a factor of 1.65 at periods of 2 s to 3 s). These figures are based on multi-period response spectra whose shape corresponds to a magnitude M7.0 earthquake. Spectral shape is a function of magnitude and smaller magnitude events would show greater similarity between the multi-period design spectrum and ELF spectrum of site class of interest, while larger magnitude events would show more significant differences.

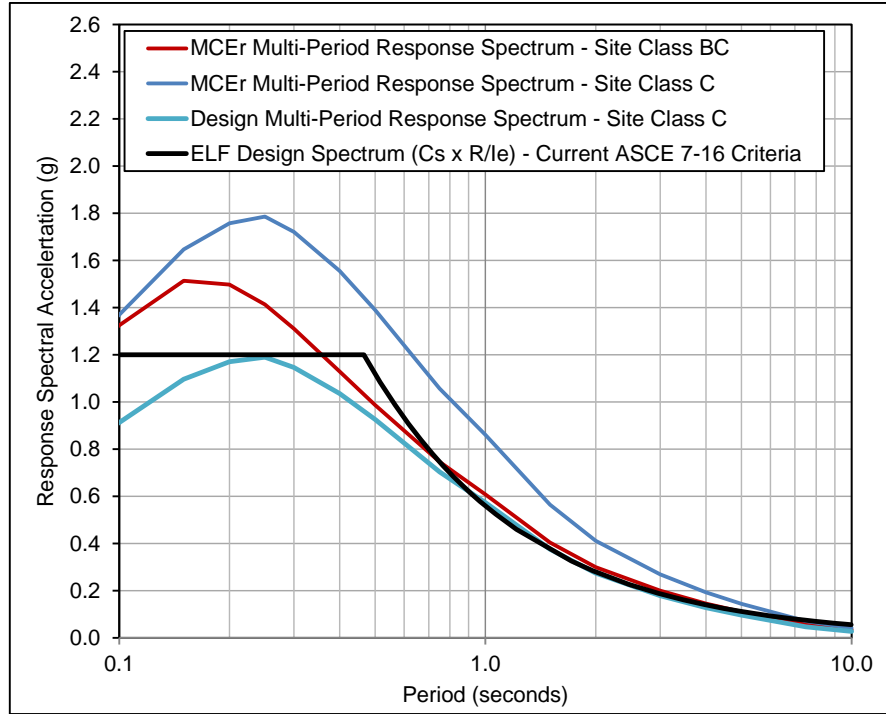

FIGURE C11.4-1 Comparison of ELF and Multi-Period Design Spectra – Site Class C Ground Motions ($v_{s,30} = 1,600$ ft/s)

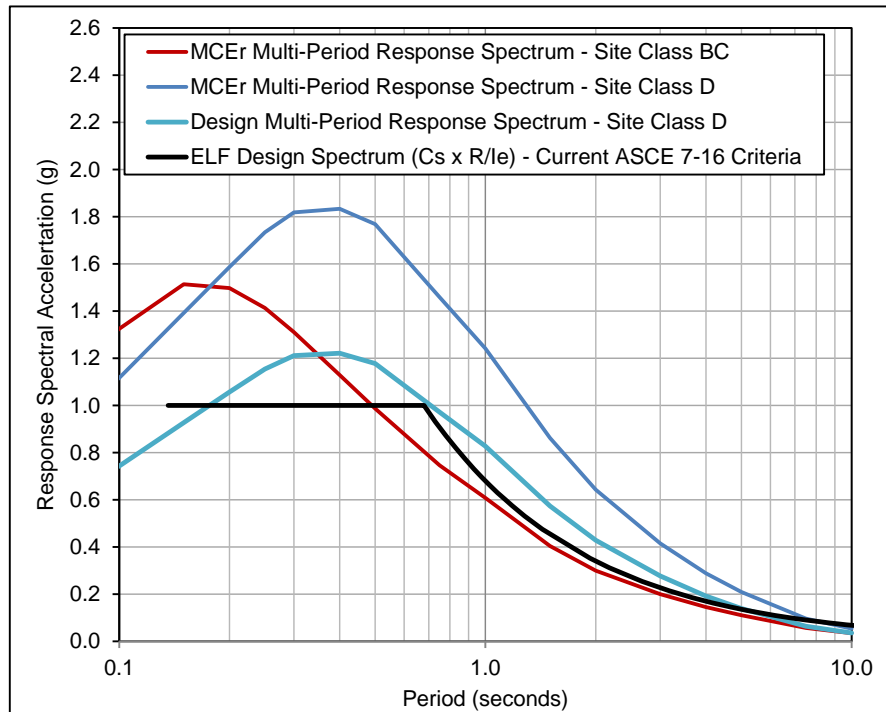

FIGURE C11.4-2 Comparison of ELF and Multi-Period Design Spectra – Site Class D Ground Motions ($v_{s,30} = 870$ ft/s)

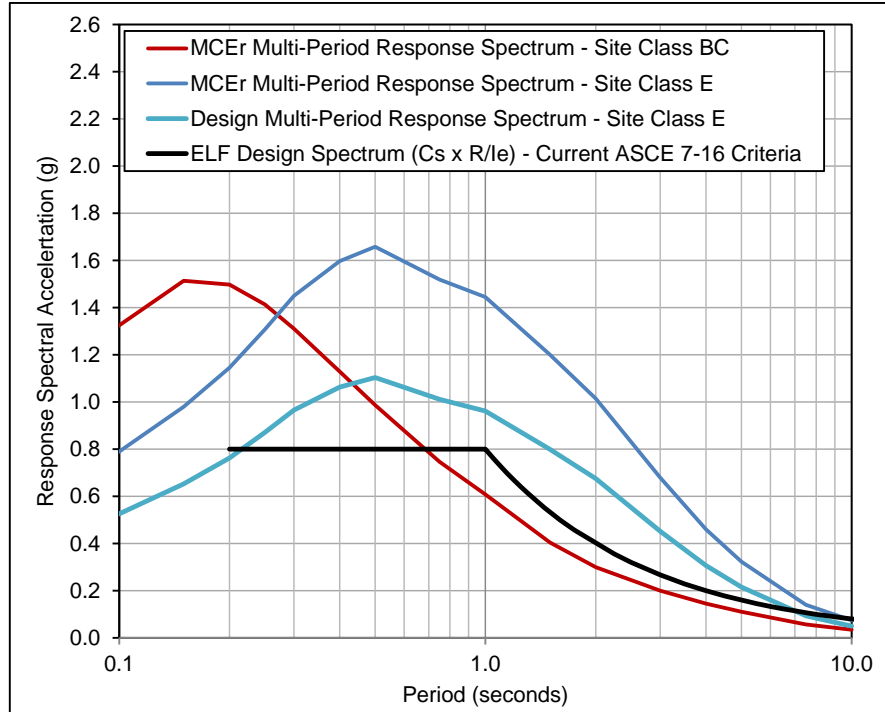

FIGURE C11.4-3 Comparison of ELF and Multi-Period Design Spectra – Site Class E Ground Motions ($v_{s,30} = 510$ ft/s)

In general, Section 11.4.7 requires site-specific hazard analysis for structures on Site Class E with values of S_S greater than or equal to 1.0 g, and for structures on Site Class D or Site Class E for values of S_I greater than or equal to 0.2 g. These requirements significantly limit the use of practical ELF and MSRA design methods, which is particularly significant for Site Class D sites which are quite common. To lessen the impact of these requirements on design practice, three exceptions permit the use of conservative values of design parameters for certain conditions for which conservative values of design were identified by the ELF study. These exceptions do not apply to seismically isolated structures and structures with damping systems for which site-specific analysis is required in all cases at sites with S_I greater than or equal to 0.6.

The first exception permits use of the value of the site coefficient F_a of Site Class C ($F_a = 1.2$) for Site Class E sites (for values of S_S greater than or equal to 1.0 g) in lieu of site-specific hazard analysis. The ELF study found that while values of the site coefficient F_a tend to decrease with intensity for softer sites, values of spectrum shape adjustment factor C_a tend to increase such that the net effect is approximately the same intensity of MCE_R ground motions for Site Classes C, D and E when MCE_R ground motion intensity is strong (i.e., $S_{MS} \geq 1.0$). Site Class C was found to not require spectrum shape adjustment and the value of site coefficient F_a for Site Class C ($F_a = 1.2$) is large enough to represent both site class and spectrum shape effects for Site Class E (and Site Class D).

The second exception permits both ELF and MRSA design of structures at Site Class D sites for values of S_I greater than or equal to 0.2 g, provided that the value of the seismic response coefficient C_s is conservatively calculated using Eq. 12.8-2 for $T \leq 1.5T_s$ and using 1.5 times the value computed in accordance with either Eq. 12.8-3 for $T_L \geq T > 1.5T_s$ or Eq. 12.8-4 for $T > T_L$. This exception recognizes that structures are conservatively designed for the response spectral acceleration defined by the domain of constant acceleration (S_{DS}) or by a 50 percent increase in the value of seismic response coefficient C_s for structures with longer periods ($T \geq 1.5T_s$). The underlying presumption of this exception for MRSA design of structures is that the shape of the design response spectrum (Figure 11.4-1) is sufficiently representative of the frequency content of Site Class D ground motions to permit use of MRSA and that the potential

underestimation of fundamental-mode response using the design response spectrum shape of Figure 11.4-1 is accounted for by scaling MRSA design values (Section 12.9.4) with a conservative value of the seismic response coefficient C_s . In general, this exception effectively limits the requirements for site-specific hazard analysis to very tall and or flexible structures at Site Class D sites ($S_I \geq 0.2g$).

The third exception permits ELF design of short-period structures ($T \leq T_s$) at Site Class E sites for values of S_S greater than or equal to 0.2 g. This exception recognizes that short-period structures are conservatively designed using the ELF procedure for values of seismic response coefficient C_s based on the domain of constant acceleration (S_{DS}) which is, in all case, greater than or equal to response spectral accelerations of the domain of constant velocity, and therefore need not consider the effects of spectrum shape at periods $T > T_s$. In general, the shape of the design response spectrum (Figure 11.4-1) is not representative of the frequency content of Site Class E ground motions and MRSA is not permitted for design unless the design spectrum is calculated using the site-specific procedures if Section 21.2.

C11.5 IMPORTANCE FACTOR AND RISK CATEGORY

Large earthquakes are rare events that include severe ground motions. Such events are expected to result in damage to structures even if they were designed and built in accordance with the minimum requirements of the standard. The consequence of structural damage or failure is not the same for the various types of structures located within a given community. Serious damage to certain classes of structures, such as critical facilities (e.g., hospitals), disproportionately affects a community. The fundamental purpose of this section and of subsequent requirements that depend on this section is to improve the ability of a community to recover from a damaging earthquake by tailoring the seismic protection requirements to the relative importance of a structure. That purpose is achieved by requiring improved performance for structures that

1. Are necessary to response and recovery efforts immediately after an earthquake,
2. Present the potential for catastrophic loss in the event of an earthquake, or
3. House a large number of occupants or occupants less able to care for themselves than the average.

The first basis for seismic design in the standard is that structures should have a suitably low likelihood of collapse in the rare events defined as the maximum considered earthquake (MCE) ground motion. A second basis is that life-threatening damage, primarily from failure of nonstructural components in and on structures, is unlikely in a design earthquake ground motion (defined as two-thirds of the MCE). Given the occurrence of ground motion equivalent to the MCE, a population of structures built to meet these design objectives probably still experiences substantial damage in many structures, rendering these structures unfit for occupancy or use. Experience in past earthquakes around the world has demonstrated that there is an immediate need to treat injured people, to extinguish fires and prevent conflagration, to rescue people from severely damaged or collapsed structures, and to provide shelter and sustenance to a population deprived of its normal means. These needs are best met when structures essential to response and recovery activities remain functional.

The standard addresses these objectives by requiring that each structure be assigned to one of the four risk categories presented in Chapter 1 and by assigning an importance factor, I_e , to the structure based on that risk category. (The two lowest categories, I and II, are combined for all purposes within the seismic provisions.) The risk category is then used as one of two components in determining the Seismic Design Category (see Section C11.6) and is a primary factor in setting drift limits for building structures under the design earthquake ground motion (see Section C12.12).

Fig. C11-11 shows the combined intent of these requirements for design. The vertical scale is the likelihood of the ground motion with the MCE being the rarest considered. The horizontal scale is the level of performance intended for the structure and attached nonstructural components, which range from collapse to operational. The basic objective of collapse prevention at the MCE for ordinary structures (Risk Category II) is shown at the lower right by the solid triangle; protection from life-threatening damage at the design earthquake ground motion (defined by the standard as two-thirds of the MCE) is shown by the open triangle.

The performance implied for higher risk categories III and IV is shown by squares and circles, respectively. The performance anticipated for less severe ground motion is shown by dotted symbols.

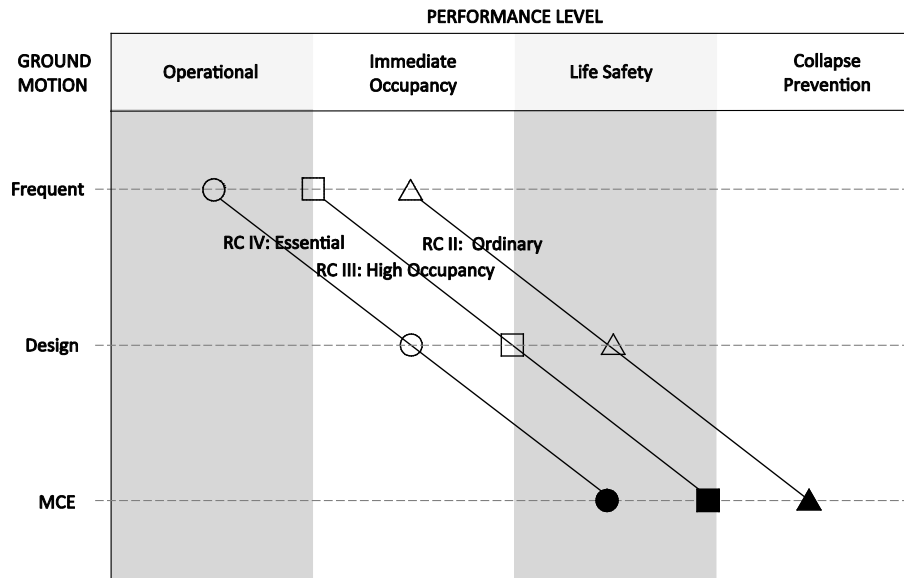

FIGURE C11-11 Expected Performance as Related to Risk Category and Level of Ground Motion

C11.5.1 Importance Factor

The importance factor, I_e , is used throughout the standard in quantitative criteria for strength. In most of those quantitative criteria, the importance factor is shown as a divisor on the factor R or R_p to reduce damage for important structures in addition to preventing collapse in larger ground motions. The R and R_p factors adjust the computed linear elastic response to a value appropriate for design; in many structures, the largest component of that adjustment is ductility (the ability of the structure to undergo repeated cycles of inelastic strain in opposing directions). For a given strength demand, reducing the effective R factor (by means of the importance factor) increases the required yield strength, thus reducing ductility demand and related damage.

C11.5.2 Protected Access for Risk Category IV

Those structures considered essential facilities for response and recovery efforts must be accessible to carry out their purpose. For example, if the collapse of a simple canopy at a hospital could block ambulances from the emergency room admittance area, then the canopy must meet the same structural standard as the hospital. The protected access requirement must be considered in the siting of essential facilities in densely built urban areas.

C11.6 SEISMIC DESIGN CATEGORY

Seismic Design Categories (SDCs) provide a means to step progressively from simple, easily performed design and construction procedures and minimums to more sophisticated, detailed, and costly requirements as both the level of seismic hazard and the consequence of failure escalate. The SDCs are used to trigger requirements that are not scalable; such requirements are either on or off. For example, the basic amplitude of ground motion for design is scalable—the quantity simply increases in a continuous fashion as one moves from a low hazard area to a high hazard area. However, a requirement to avoid weak stories is not particularly scalable. Requirements such as this create step functions. There are many such requirements in the standard, and the SDCs are used systematically to group these step functions. (Further examples include

whether seismic anchorage of nonstructural components is required or not, whether particular inspections will be required or not, and structural height limits applied to various seismic force-resisting systems.)

In this regard, SDCs perform one of the functions of the seismic zones used in earlier U.S. building. However, SDCs also depend on a building's occupancy and, therefore, its desired performance. Furthermore, unlike the traditional implementation of seismic zones, the ground motions used to define the SDCs include the effects of individual site conditions on probable ground-shaking intensity.

In developing the ground-motion limits and design requirements for the various Seismic Design Categories, the equivalent modified Mercalli intensity (MMI) scale was considered. There are now correlations of the qualitative MMI scale with quantitative characterizations of ground motions. The reader is encouraged to consult any of a great many sources that describe the MMIs. The following list is a coarse generalization:

MMI V	No real damage
MMI VI	Light nonstructural damage
MMI VII	Hazardous nonstructural damage
MMI VIII	Hazardous damage to susceptible structures
MMI IX	Hazardous damage to robust structures

When the current design philosophy was adopted (the 1997 edition of the NEHRP Recommended Provisions for Seismic Regulations for New Buildings and Other Structures, FEMA 302, and NEHRP Recommended Provisions for Seismic Regulations for New Buildings and Other Structures, Part 2, Commentary, FEMA 303), the upper limit for SDC A was set at roughly one-half of the lower threshold for MMI VII, and the lower limit for SDC D was set at roughly the lower threshold for MMI VIII. However, the lower limit for SDC D was more consciously established by equating that design value (two-thirds of the MCE) to one-half of what had been the maximum design value in building codes over the period of 1975 to 1995. As more correlations between MMI and numerical representations of ground motion have been created, it is reasonable to make the following correlation between the MMI at MCE ground motion and the Seismic Design Category (all this discussion is for ordinary occupancies):

MMI V	SDC A
MMI VI	SDC B
MMI VII	SDC C
MMI VIII	SDC D
MMI IX	SDC E

An important change was made to the determination of SDC when the current design philosophy was adopted. Earlier editions of the *NEHRP Provisions* used the peak velocity-related acceleration, A_v , to determine a building's seismic performance category. However, this coefficient does not adequately represent the damage potential of earthquakes on sites with soil conditions other than rock. Consequently, the 1997 NEHRP provisions adopted the use of response spectral acceleration parameters S_{DS} and S_{D1} , which include site soil effects for this purpose.

Except for the lowest level of hazard (SDC A), the SDC also depends on the risk categories. For a given level of ground motion, the SDC is one category higher for Risk Category IV structures than for lower-risk structures. This rating has the effect of increasing the confidence that the design and construction requirements can deliver the intended performance in the extreme event.

Note that the tables in the standard are at the design level, defined as two-thirds of the MCE level. Also recall that the MMIs are qualitative by their nature and that the above correlation will be more or less valid, depending on which numerical correlation for MMI is used. The numerical correlations for MMI roughly

double with each step, so correlation between design earthquake ground motion and MMI is not as simple or convenient.

In sum, at the MCE level, SDC A structures should not see motions that are normally destructive to structural systems, whereas the MCE level motions for SDC D structures can destroy vulnerable structures. The grouping of step function requirements by SDC is such that there are a few basic structural integrity requirements imposed at SDC A, graduating to a suite of requirements at SDC D based on observed performance in past earthquakes, analysis, and laboratory research.

The nature of ground motions within a few kilometers of a fault can be different from more distant motions. For example, some near-fault motions have strong velocity pulses, associated with forward rupture directivity, that tend to be highly destructive to irregular structures, even if they are well detailed. For ordinary occupancies, the boundary between SDCs D and E is set to define sites likely to be close enough to a fault that these unusual ground motions may be present. Note that this boundary is defined in terms of mapped bedrock outcrop motions affecting response at 1 s, not site-adjusted values, to better discriminate between sites near and far from faults. Short-period response is not normally as affected as the longer period response. The additional design criteria imposed on structures in SDCs E and F specifically are intended to provide acceptable performance under these very intense near-fault ground motions.

For most buildings, the SDC is determined without consideration of the building's period. Structures are assigned to an SDC based on the more severe condition determined from 1 s acceleration and short-period acceleration. This assigning is done for several reasons. Perhaps the most important of these is that it is often difficult to estimate precisely the period of a structure using default procedures contained in the standard. Consider, for example, the case of rigid wall–flexible diaphragm buildings, including low-rise reinforced masonry and concrete tilt-up buildings with either untopped metal deck or wood diaphragms. The formula in the standard for determining the period of vibration of such buildings is based solely on the structural height, h_n , and the length of wall present. These formulas typically indicate very short periods for such structures, often on the order of 0.2 s or less. However, the actual dynamic behavior of these buildings often is dominated by the flexibility of the diaphragm—a factor neglected by the formula for approximate fundamental period. Large buildings of this type can have actual periods on the order of 1 s or more. To avoid misclassifying a building's SDC by inaccurately estimating the fundamental period, the standard generally requires that the more severe SDC determined on the basis of short- and long-period shaking be used.

Another reason for this requirement is a desire to simplify building regulation by requiring all buildings on a given soil profile in a particular region to be assigned to the same SDC, regardless of the structural type. This assignment has the advantage of permitting uniform regulation in the selection of seismic force-resisting systems, inspection and testing requirements, seismic design requirements for nonstructural components, and similar aspects of the design process regulated on the basis of SDC, within a community.

Notwithstanding the above, it is recognized that classification of a building as SDC C instead of B or D can have a significant impact on the cost of construction. Therefore, the standard includes an exception permitting the classification of buildings that can reliably be classified as having short structural periods on the basis of short-period shaking alone.

Local or regional jurisdictions enforcing building regulations may desire to consider the effect of the maps, typical soil conditions, and seismic design categories on the practices in their jurisdictional areas. For reasons of uniformity of practice or reduction of potential errors, adopting ordinances could stipulate particular values of ground motion, particular site classes, or particular Seismic Design Categories for all or part of the area of their jurisdiction. For example,

1. An area with a historical practice of high seismic zone detailing might mandate a minimum SDC of D regardless of ground motion or site class.

2. A jurisdiction with low variation in ground motion across the area might stipulate particular values of ground motion rather than requiring the use of maps.
3. An area with unusual soils might require use of a particular site class unless a geotechnical investigation proves a better site class.

C11.7 DESIGN REQUIREMENTS FOR SEISMIC DESIGN CATEGORY A

The 2002 edition of the standard included a new provision of minimum lateral force for Seismic Design Category A structures. The minimum load is a structural integrity issue related to the load path. It is intended to specify design forces in excess of wind loads in heavy low-rise construction. The design calculation in Sec. 1.4.3 of the standard is simple and easily done to ascertain if the seismic load or the wind load governs. This provision requires a minimum lateral force of 1% of the total gravity load assigned to a story to ensure general structural integrity.

Seismic Design Category A is assigned when the MCE ground motions are below those normally associated with hazardous damage. Damaging earthquakes are not unknown or impossible in such regions, however, and ground motions close to such events may be large enough to produce serious damage. Providing a minimum level of resistance reduces both the radius over which the ground motion exceeds structural capacities and resulting damage in such rare events. There are reasons beyond seismic risk for minimum levels of structural integrity.

The requirements for SDC A in Sec. 1.4 are all minimum strengths for structural elements stated as forces at the level appropriate for direct use in the strength design load combinations of Sec. 2.3. The two fundamental requirements are a minimum strength for a structural system to resist lateral forces (Sec. 1.4.3) and a minimum strength for connections of structural members (Sec. 1.4.4).

For many buildings, the wind force controls the strength of the lateral-force-resisting system, but for low-rise buildings of heavy construction with large plan aspect ratios, the minimum lateral force specified in Sec. 1.4.3 may control. Note that the requirement is for strength and not for toughness, energy dissipation capacity, or some measure of ductility. The force level is not tied to any postulated seismic ground motion. The boundary between SDCs A and B is based on a spectral response acceleration of 25% of gravity (MCE level) for short-period structures; clearly the 1% acceleration level (from Eq. (1.4-1)) is far smaller. For ground motions below the A/B boundary, the spectral displacements generally are on the order of a few inches or less depending on period. Experience has shown that even a minimal strength is beneficial in providing resistance to small ground motions, and it is an easy provision to implement in design. The low probability of motions greater than the MCE is a factor in taking the simple approach without requiring details that would produce a ductile response. Another factor is that larger design forces are specified in Section 1.4.4 for connections between main elements of the lateral force load path.

The minimum connection force is specified in three ways: a general minimum horizontal capacity for all connections; a special minimum for horizontal restraint of in-line beams and trusses, which also includes the live load on the member; and a special minimum for horizontal restraint of concrete and masonry walls perpendicular to their plane (Section 1.4.5). The 5% coefficient used for the first two is a simple and convenient value that provides some margin over the minimum strength of the system as a whole.

C11.8 GEOLOGIC HAZARDS AND GEOTECHNICAL INVESTIGATION

In addition to this commentary, Part 3 of the 2009 NEHRP recommended provisions includes additional and more detailed discussion and guidance on evaluation of geologic hazards and determination of seismic lateral pressures.

C11.8.1 Site Limitation for Seismic Design Categories E and F

Because of the difficulty of designing a structure for the direct shearing displacement of fault rupture and the relatively high seismic activity of SDCs E and F, locating a structure on an active fault that has the potential to cause rupture of the ground surface at the structure is prohibited.

C11.8.2 Geotechnical Investigation Report Requirements for Seismic Design Categories C through F

Earthquake motion is only one factor in assessing potential for geologic and seismic hazards. All of the listed hazards can lead to surface ground displacements with potential adverse consequences to structures. Finally, hazard identification alone has little value unless mitigation options are also identified.

C11.8.3 Additional Geotechnical Investigation Report Requirements for Seismic Design Categories D through F

New provisions for computing peak ground acceleration for soil liquefaction and stability evaluations have been introduced in this section. Of particular note in this section is the explicitly-stated requirement that liquefaction must now be evaluated for the MCE_G ground motion. These provisions include maps of the Maximum Considered Earthquake geometric mean (MCE_G) peak ground acceleration for Site Class B bedrock (PGA), plus a site-coefficient (F_{PGA}) table to convert the PGA value to one adjusted for Site Class effects (PGA_M). A requirement, similar to the one in Section 11.4.3, has been added to the provisions to take the larger of the F_{PGA} for Site Classes C and D to conservatively account for the amplification when the site is known to consist of soil that is not in Site Class E or F.

The equation used to derive the F_{PGA} values is similar to Equations C11.4-1 and C11.4-2 for F_a and F_v ; it is as follows:

$$F_{PGA} = \exp \left[-0.600 \ln \left(\frac{\bar{v}_s}{760} \right) - 0.150 \left[\frac{\exp\{-0.00701(\min(\bar{v}_s, 760) - 360)\} - 1}{\exp\{-0.00701 \times 400\} - 1} \right] \ln \left(\frac{PGA+0.1}{0.1} \right) \right] \quad (C11.8-1)$$

In equation (C11.8-1), \bar{v}_s is in units of m/s and PGA is in units of g. Velocities measured in ft/s can be converted to m/s by multiplying by 0.3048 m/ft. To obtain the F_{PGA} for $\bar{v}_s < 180$ m/s, the $+1/2$ standard-deviation correction described for Site Class E in C11.4.3 would need to be applied to the natural logarithm of F_{PGA} . The standard deviation is 0.70.

PGA Provisions. Paragraph 2 of Section 11.8.3 states that peak ground acceleration shall be determined based on either a site-specific study taking into account soil amplification effects or using Eq. 11.8-1 for which MCE_G peak ground acceleration is obtained from national maps of peak ground acceleration for bedrock Site Class B (PGA) multiplied by a site coefficient (F_{PGA}) to obtain peak ground acceleration for other site classes (PGA_M). This methodology for determining peak ground acceleration for liquefaction evaluations improves the methodology in ASCE 7-05 by using mapped PGA rather than the approximation for PGA by the ratio $S_s/2.5$. Furthermore, in the Central and Eastern U.S. (CEUS), the ratio $S_s/2.5$ tends to underestimate PGA. $S_s/2.5$ is applicable for bedrock Site Class B and thus could be used as input at depth to a site response analysis under the provisions of ASCE 7-05. The use of Eq. 11.8-1 provides an alternative to conducting site response analysis using rock PGA by providing a site-adjusted ground surface acceleration (PGA_M) that can directly be applied in the widely-used empirical correlations for assessing liquefaction potential. Correlations for evaluating liquefaction potential are elaborated on in Resource Paper RP 12, Evaluation of Geologic Hazards and Determination of Seismic Lateral Earth Pressures, published in the 2009 NEHRP Provisions.

Maps of MCE_G PGA for Site Class B bedrock, similar to maps of S_s and S_1 , are shown in Figures 22-7 to 22-11 in Chapter 22. Similar to adjustments for the bedrock spectral response accelerations for site response through the F_a and F_v coefficients, bedrock motions for PGA are adjusted for these same site effects using a site coefficient, F_{PGA} , that depends on the level of ground shaking in terms of PGA and the stiffness of the

soil, typically defined in terms of the shear-wave velocity in the upper 30 meters of geologic profile, V_{s30} . Values of F_{PGA} are presented in Table 11.8-1, and the adjustment is made through Equation 11.8-1, i.e., $PGA_M = F_{PGA} PGA$, where PGA_M is peak ground acceleration adjusted for site class. The method of determining Site Class, used in the determination of F_a and F_v , is also identical to that in the present and previous ASCE 7 documents.

There is an important difference in the derivation of the PGA maps and the maps of S_s and S_1 in ASCE 7-10. Unlike previous editions of ASCE 7, the S_s and S_1 maps in ASCE 7-10 have been derived for the “maximum direction shaking” and are now risk-based rather than hazard-based. On the other hand, the PGA maps have been derived based on the geometric mean of the two horizontal components of motion. The geomean was used in the PGA maps rather than the PGA for the maximum direction shaking to assure that there is consistency between the determination of PGA and the basis of the simplified empirical field procedure for estimating liquefaction potential based on results of Standard Penetration Tests (SPT), cone penetrometer tests (CPT), and other similar field investigative methods. When these correlations were originally derived, the geomean (or similar metric) of peak ground acceleration at the ground surface was used to identify the cyclic stress ratio for sites with or without liquefaction. The resulting envelopes of data define the liquefaction cyclic resistance ratio (CRR). Rather than re-evaluating these case histories for the “maximum direction shaking”, it was decided to develop maps of the geomean PGA and continue using the existing empirical methods.

Liquefaction Evaluation Requirements. Beginning with ASCE 7-02, it has been the intent that liquefaction potential be evaluated at MCE ground motion levels. There was ambiguity in the previous requirement in ASCE 7-05 as to whether liquefaction potential should be evaluated for the MCE or the design earthquake. Paragraph 2 of Section 11.8.3 of ASCE 7-05 stated that liquefaction potential be evaluated for the design earthquake, while also stating that in the absence of a site specific study, peak ground acceleration shall be assumed equal to $S_s/2.5$ (S_s being the MCE short-period response spectral acceleration on Site Class B rock). There has also been a difference in provisions between ASCE 7-05 and the 2006 edition of the IBC in which Section 1802.2.7 stated that liquefaction shall be evaluated for the design earthquake ground motions and the default value of peak ground acceleration in the absence of a site specific study was given as $S_{DS}/2.5$ (S_{DS} being the short-period site-adjusted design response spectral acceleration). ASCE 7-10, Paragraph 2 of Section 11.8.3 and Equation 11.8-1 now require explicitly that liquefaction potential be evaluated based upon the MCE_G peak ground acceleration.

The explicit requirement in ASCE-7-10 to evaluate liquefaction for MCE ground motion rather than design earthquake ground motion assures that the full potential for liquefaction is addressed during the evaluation of structure stability, rather than a lesser level when the design earthquake is used. This change also assures that, for the MCE ground motion, the performance of the structure is considered under a consistent hazard level for the effects of liquefaction, such as collapse prevention or life safety, depending on the Risk Category for the structure (see Figure C11-11). By evaluating liquefaction for the MCE rather than the design earthquake peak ground acceleration, the ground motion for the liquefaction assessment increases by a factor of 1.5. This increase in peak ground acceleration to the MCE level means that sites that previously were nonliquefiable could now be liquefiable, and sites where liquefaction occurred to a limited extent under the design earthquake could undergo more liquefaction, in terms of depth and lateral extent. Some mechanisms that are directly related to the development of liquefaction, such as lateral spreading and flow or ground settlement, could also increase in severity.

This change in peak ground acceleration level for the liquefaction evaluation addressed an issue that has existed and periodically been discussed since the design earthquake concept was first suggested in the 1990s. The design earthquake ground motion was obtained by multiplying the MCE ground motion by a factor of $2/3$ to account for a margin in capacity in most buildings. Various calibration studies at the time of code development concluded that for the design earthquake most buildings had a reserve capacity of over 1.5 relative to collapse. This reserve capacity allowed the spectral accelerations for the MCE to be reduced using a factor of $2/3$, while still achieving safety from collapse. On the other hand, liquefaction

potential is evaluated at the selected MCE_G peak ground acceleration and typically determined to be acceptable if the factor of safety is greater than 1.0, meaning that there is no implicit safety margin on liquefaction potential. By multiplying peak ground acceleration by a factor of 2/3, liquefaction would be assessed at an effective return period or probability of exceedance different than that for the MCE. However, ASCE 7-10 now requires that liquefaction be evaluated for the MCE.

Paragraph 3 of Section 11.8.3 of the ASCE 7-10 Standard states the various potential consequences of liquefaction that must be assessed; soil downdrag and loss in lateral soil reaction for pile foundations are additional consequences that have been included in this paragraph. This section of the new provisions, as in previous editions, does not present specific seismic criteria for the design of the foundation or substructure, but Paragraph 4 does state that the geotechnical report must include discussion of possible measures to mitigate these consequences.

A liquefaction resource document has been prepared in support of these revisions to Section 11.8.3. The resource document, *Evaluation of Geologic Hazards and Determination of Seismic Lateral Earth Pressures*, includes a summary of methods that are currently being used to evaluate liquefaction potential, and the limitations of these methods. This summary appears as Resource Paper, RP-12, in the 2009 NEHRP Provisions. The resource document summarizes alternatives for evaluating liquefaction potential, methods for evaluating the possible consequences of liquefaction (e.g., loss of ground support, increased lateral earth pressures, etc.) and methods of mitigating the liquefaction hazard. The resource document also identifies alternate methods of evaluating liquefaction hazards, such as analytical and physical modeling. Reference is made to the use of non-linear effective stress methods for modeling the build-up in pore water pressure during seismic events at liquefiable sites.

Evaluation of Dynamic Seismic Lateral Earth Pressures. The dynamic lateral earth pressure on basement and retaining walls during earthquake ground shaking is considered to be an earthquake load, E, for use in design load combinations. This dynamic earth pressure is superimposed on the pre-existing static lateral earth pressure during ground shaking. The pre-existing static lateral earth pressure is considered to be an H load.

REFERENCES

- Borcherdt, R. D. (2002). "Empirical Evidence for Site Coefficients in Building-code Provisions," *Earthquake Spectra*, 18(2):189-217.
- Boore D.M., Stewart J.P., Seyhan E., Atkinson G.M. (2013). "NGA-West 2 Equations for Predicting Response Spectral Accelerations for Shallow Crustal Earthquakes, *PEER Report 2013/05*", Pacific Earthquake Engineering Research Center, University of California, Berkeley, CA.
- Crouse, C. B., and J. W. McGuire. (1996). "Site Response Studies for Purposes of Revising NEHRP Seismic Provisions," *Earthquake Spectra*, 12(3).
- Crouse, C. B., E. V. Leyendecker, P. G. Somerville, M. Power, and W. J. Silva. (2006). "Development of Seismic Ground-Motion Criteria for the ASCE/SEI 7 Standard," Paper 533 in *Proceedings 8th U.S. National Conference on Earthquake Engineering*, April 18-22, 2006, San Francisco, California.
- Dobry, R., R. Ramos, and M. S. Power. (1999). *Site Factors and Site Categories in Seismic Codes*, Technical Report MCEER-99-0010. Multidisciplinary Center for Earthquake Engineering Research.
- Dobry, R., R. Borcherdt, C. B. Crouse, I. M. Idriss, W. B. Joyner, G. R. Martin, M. S. Power, E. E. Rinne, and R. B. Seed. (2000). "New Site Coefficients and Site Classifications System Used in Recent Building Seismic Code Provisions," *Earthquake Spectra*, 16(1):41-67.
- Field, E. H. (2000). "A Modified Ground Motion Attenuation Relationship for Southern California that Accounts for Detailed Site Classification and a Basin Depth Effect," *Bulletin of the Seismological Society of America*, 90:S209-S221.
- Frankel, A., Mueller, C., Barnhard, T., Perkins, D., Leyendecker, E.V., Dickman, N., Hanson, S., and Hopper, M. (1996). "National Seismic Hazard Maps." Documentation June 1996, *Open File Report 96-532*, US Geological Survey, Denver, CO.
- Harmsen, S.C. (1997). "Determination of Site Amplification in the Los Angeles Urban Area from Inversion of Strong Motion Records," *Bulletin of the Seismological Society of America*, 87:866-887.
- Huang, Yin-Nan ; Whittaker, Andrew S.; Luco, Nicolas (2008) *Orientation of Maximum Spectral Demand in the Near-Fault Region*. *Earthquake Spectra*, 24: 319 – 341.
- Joyner, W. B., and D. M. Boore. (2000). "Recent Developments in Earthquake Ground Motion Estimation in Proceeding of the 6th International Conference on Seismic Zonation, Palm Springs, California.
- Kamai R., Abrahamson N.A., Silva W.J. (2013). "Nonlinear Horizontal Site Response for the NGA-West 2 Project, *PEER Report 2013/12*," Pacific Earthquake Engineering Research Center, Berkeley, CA.
- Kircher & Associates (2015). "Investigation of an identified short-coming in the seismic design procedures of ASCE 7-10 and development of recommended improvements for ASCE 7-16," prepared for Building Seismic Safety Council, National Institute of Building Sciences, Washington, D.C., prepared by Kircher & Associates, Consulting Engineers, Palo Alto, CA, March 15, 2015.
- Luco, N., B. R. Ellingwood, R. O. Hamburger, J. D. Hooper, J. K. Kimball and C. A. Kircher, (2007). "Risk-Targeted versus Current Seismic Design Maps for the Conterminous United States," *Proceedings, SEAOC 76th Annual Convention*, (Structural Engineers Association of California, Sacramento, California).
- Petersen, M.D., Frankel, A.D., Harmsen, S.C., Mueller, C.S., Haller, K.M., Wheeler, R.L., Wesson, R.L., Zeng, Y., Boyd, O.S., Perkins, D.M., Luco, N., Field, E.H., Wills, C.J., and Rukstales, K.S. (2008), "Documentation for the 2008 Update of the United States National Seismic Hazard Maps," USGS Open File Report 2008-1128.
- Rodriguez-Marek, A., J. D. Bray, and N. Abrahamson. (2001). "An Empirical Geotechnical Site Response Procedure," *Earthquake Spectra*, 17(1):65-87.
- Seyhan, E. (2014). Weighted Average of 2014 NGA West-2 GMPEs, Excel file: NGAW2_GMPE_Spreadsheets_v5.6_070514, Pacific Earthquake Engineering Center, <http://peer.berkeley.edu/ngawest2/databases/>
- Seyhan, E. and Stewart, J.P. (2012). "Site Response in NEHRP Provisions and NGA Models, in Geotechnical Engineering State of the Art and Practice: Volume of Keynote Lectures from GeoCongress 2012," Oakland, CA, *ASCE Geotechnical Special Publication No. 226*, K Rollins and D Zekkos (eds.), 359-379.
- Silva, W., R. Darragh, N. Gregor, G. Martin, N. Abrahamson, and C. Kircher. (2000). Reassessment of Site Coefficients and Near-fault Factors for Building Code Provisions, Program Element II, Report 98-HQ-GR-1010 to the U.S. Geological Survey.
- Stewart, J. P, A. H. Liu, and Y. Choi. (2003). "Amplification Factors for Spectral Acceleration in Tectonically Active Regions," *Bulletin of the Seismological Society of America*, 93(1):332-352.
- Stewart, J.P. and Seyhan, E. (2013). "Semi-empirical Nonlinear Site Amplification and its Application in NEHRP Site Factors, *PEER Report 2013/13*," Pacific Earthquake Engineering Research Center, University of California, Berkeley, CA.
- Steidl, J. H. (2000). "Site Response in Southern California for Probabilistic Seismic Hazard Analysis, *Bulletin of the Seismological Society of America*, 90:S149-S169.

COMMENTARY TO CHAPTER 12, SEISMIC DESIGN REQUIREMENTS FOR BUILDING STRUCTURES

C12.1 STRUCTURAL DESIGN BASIS

The performance expectations for structures designed in accordance with ASCE/SEI 7-10 are described in Sections C11.1 and C11.5. Structures designed in accordance with the standard are likely to have a low probability of collapse but may suffer serious structural damage if subjected to the maximum considered earthquake (MCE) or stronger ground motion.

Although the seismic requirements of the standard are stated in terms of forces and loads, there are no external forces applied to the structure during an earthquake as, for example, is the case during a wind storm. The design forces are intended only as approximations to generate internal forces suitable for proportioning the strength and stiffness of structural elements and for estimating the deformations (when multiplied by the deflection amplification factor, C_d) that would occur in the same structure in the event of design earthquake (not MCE_R) ground motion.

C12.1.1 Basic Requirements

Chapter 12 of the standard sets forth a set of coordinated requirements that must be used together. The basic steps in structural design of a building structure for acceptable seismic performance are as follows:

1. Select gravity- and seismic force-resisting systems appropriate to the anticipated intensity of ground shaking. Section 12.2 sets forth limitations depending on the Seismic Design Category.
2. Configure these systems to produce a continuous, regular, and redundant load path so that the structure acts as an integral unit in responding to ground shaking. Section 12.3 addresses configuration and redundancy issues.
3. Analyze a mathematical model of the structure subjected to lateral seismic motions and gravity forces. Sections 12.6 and 12.7 set forth requirements for the method of analysis and for construction of the mathematical model. Sections 12.5, 12.8, and 12.9 set forth requirements for conducting a structural analysis to obtain internal forces and displacements.
4. Proportion members and connections to have adequate lateral and vertical strength and stiffness. Section 12.4 specifies how the effects of gravity and seismic loads are to be combined to establish required strengths, and Section 12.12 specifies deformation limits for the structure.

One- to three-story structures with shear wall or braced frame systems of simple configuration may be eligible for design under the simplified alternative procedure contained in Section 12.14. Any other deviations from the requirements of Chapter 12 are subject to approval by the authority having jurisdiction (AHJ) and must be rigorously justified, as specified in Section 11.1.4.

The baseline seismic forces used for proportioning structural elements (individual members, connections, and supports) are static horizontal forces derived from an elastic response spectrum procedure. A basic requirement is that horizontal motion can come from any direction relative to the structure, with detailed requirements for evaluating the response of the structure provided in Section 12.5. For most structures, the effect of vertical ground motions is not analyzed explicitly; it is implicitly included by adjusting the load factors (up and down) for permanent dead loads, as specified in Section 12.4. Certain conditions requiring more detailed analysis of vertical response are defined in Chapters 13 and 15 for nonstructural components and nonbuilding structures, respectively.

The basic seismic analysis procedure uses response spectra that are representative of, but substantially reduced from, the anticipated ground motions. As a result, at the MCE_R level of ground shaking, structural elements are expected to yield, buckle, or otherwise behave inelastically. This approach has substantial historical precedent. In past earthquakes, structures with appropriately ductile, regular, and continuous systems that were designed using *reduced* design forces have performed acceptably. In the standard, such

design forces are computed by dividing the forces that would be generated in a structure behaving elastically when subjected to the design earthquake ground motion by the response modification coefficient, R , and this design ground motion is taken as two-thirds of the MCE_R ground motion.

The intent of R is to reduce the demand determined, assuming that the structure remains elastic at the design earthquake, to target the development of the first significant yield. This reduction accounts for the displacement ductility demand, R_d , required by the system and the inherent overstrength, Ω , of the seismic force-resisting system (SFRS) (Fig. C12.1-1). Significant yield is the point where complete plastification of a critical region of the SFRS first occurs (e.g., formation of the first plastic hinge in a moment frame), and the stiffness of the SFRS to further increases in lateral forces decreases as continued inelastic behavior spreads within the SFRS. This approach is consistent with member-level ultimate strength design practices. As such, first significant yield should not be misinterpreted as the point where first yield occurs in any member (e.g., 0.7 times the yield moment of a steel beam or either initial cracking or initiation of yielding in a reinforcing bar in a reinforced concrete beam or wall).

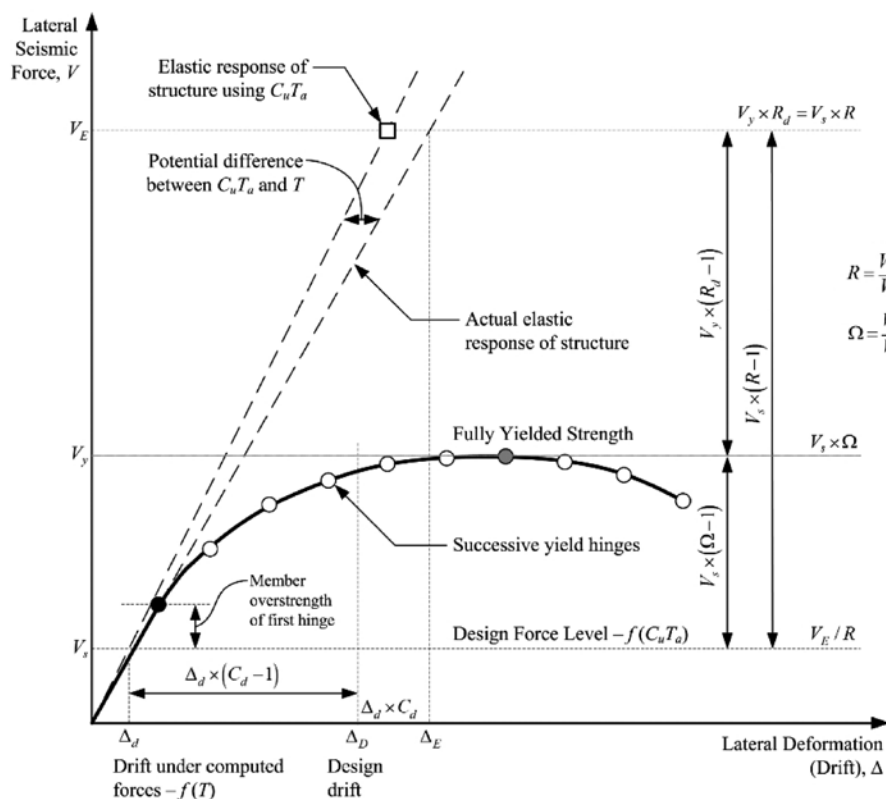

FIGURE C12.1-1 Inelastic Force–Deformation Curve

Fig. C12.1-1 shows the lateral force versus deformation relation for an archetypal moment frame used as an SFRS. First significant yield is shown as the lowest plastic hinge on the force–deformation diagram. Because of particular design rules and limits, including material strengths in excess of nominal or project-specific design requirements, structural elements are stronger by some degree than the strength required by analysis. The SFRS is therefore expected to reach first significant yield for forces in excess of design forces. With increased lateral loading, additional plastic hinges form and the resistance increases at a reduced rate (following the solid curve) until the maximum strength is reached, representing a fully yielded system. The maximum strength developed along the curve is substantially higher than that at first significant yield, and this margin is referred to as the system overstrength capacity. The ratio of these strengths is denoted as Ω . Furthermore, the figure illustrates the potential variation that can exist between the actual elastic response of a system and that considered using the limits on the fundamental period

(assuming 100% mass participation in the fundamental mode—see Section C12.8.6). Although not a concern for strength design, this variation can have an effect on the expected drifts.

The system overstrength described above is the direct result of overstrength of the elements that form the SFRS, and to a lesser extent the lateral force distribution used to evaluate the inelastic force-deformation curve. These two effects interact with applied gravity loads to produce sequential plastic hinges as illustrated in the figure. This member overstrength is the consequence of several sources. First, material overstrength (i.e., actual material strengths higher than the nominal material strengths specified in the design) may increase the member overstrength significantly. For example, a recent survey shows that the mean yield strength of ASTM A36 steel is about 30 to 40% higher than the specified yield strength used in design calculations. Second, member design strengths usually incorporate a strength reduction or resistance factor, ϕ , to produce a low probability of failure under design loading. It is common to not include this factor in the member load-deformation relation when evaluating the seismic response of a structure in a nonlinear structural analysis. Third, designers can introduce additional strength by selecting sections or specifying reinforcing patterns that exceed those required by the computations. Similar situations occur where prescriptive minimums of the standard, or of the referenced design standards, control the design. Finally, the design of many flexible structural systems (e.g., moment-resisting frames) can be controlled by the drift rather than strength, with sections selected to control lateral deformations rather than to provide the specified strength.

The result is that structures typically have a much higher lateral strength than that specified as the minimum by the standard, and the first significant yielding of structures may occur at lateral load levels that are 30 to 100% higher than the prescribed design seismic forces. If provided with adequate ductile detailing, redundancy, and regularity, full yielding of structures may occur at load levels that are two to four times the prescribed design force levels.

Most structural systems have some elements whose action cannot provide reliable inelastic response or energy dissipation. Similarly, some elements are required to remain essentially elastic to maintain the structural integrity of the structure (e.g., columns supporting a discontinuous SFRS). Such elements and actions must be protected from undesirable behavior by considering that the actual forces within the structure can be significantly larger than those at first significant yield. The standard specifies an overstrength factor, Ω_0 , to amplify the prescribed seismic forces for use in design of such elements and for such actions. This approach is a simplification to determining the maximum forces that could be developed in a system and the distribution of these forces within the structure. Thus, this specified overstrength factor is neither an upper nor a lower bound; it is simply an approximation specified to provide a nominal degree of protection against undesirable behavior.

The elastic deformations calculated under these reduced forces (*see* Section C12.8.6) are multiplied by the deflection amplification factor, C_d , to estimate the deformations likely to result from the design earthquake ground motion. This factor was first introduced in ATC 3-06 (ATC 1984). For a vast majority of systems, C_d is less than R , with a few notable exceptions where inelastic drift is strongly coupled with an increased risk of collapse (e.g., reinforced concrete bearing walls). Research over the past 30 years has illustrated that inelastic displacements may be significantly greater than Δ_E for many structures and less than Δ_E for others. Where C_d is substantially less than R , the system is considered to have damping greater than the nominal 5% of critical damping. As set forth in Section 12.12 and Chapter 13, the amplified deformations are used to assess story drifts and to determine seismic demands on elements of the structure that are not part of the seismic force-resisting system and on nonstructural components within structures.

Fig. C12.1-1 illustrates the significance of seismic design parameters contained in the standard, including the response modification coefficient, R ; the deflection amplification factor, C_d ; and the overstrength factor, Ω_0 . The values of these parameters, provided in Table 12.2-1, as well as the criteria for story drift and P-delta effects, have been established considering the characteristics of typical properly designed structures. The provisions of the standard anticipate an SFRS with redundant characteristics wherein significant system

strength above the level of first significant yield can be obtained by plastification at other critical locations in the structure before the formation of a collapse mechanism. If excessive “optimization” of a structural design is performed with lateral resistance provided by only a few elements, the successive yield hinge behavior depicted in Fig. C12.1-1 is not able to form, the actual overstrength (Ω) is small, and use of the seismic design parameters in the standard may not provide the intended seismic performance.

The response modification coefficient, R , represents the ratio of the forces that would develop under the specified ground motion if the structure had an entirely linear-elastic response to the prescribed design forces (Fig. C12.1-1). The structure must be designed so that the level of significant yield exceeds the prescribed design force. The ratio R_d , expressed as $R_d = V_E/V_S$, where V_E is the elastic seismic force demand and V_S is the prescribed seismic force demand, is always larger than 1.0; thus, all structures are designed for forces smaller than those the design ground motion would produce in a structure with a completely linear-elastic response. This reduction is possible for a number of reasons. As the structure begins to yield and deform inelastically, the effective period of response of the structure lengthens, which results in a reduction in strength demand for most structures. Furthermore, the inelastic action results in a significant amount of energy dissipation (hysteretic damping) in addition to other sources of damping present below significant yield. The combined effect, which is known as the ductility reduction, explains why a properly designed structure with a fully yielded strength (V_y in Fig. C12.1-1) that is significantly lower than V_E can be capable of providing satisfactory performance under the design ground motion excitations.

The energy dissipation resulting from hysteretic behavior can be measured as the area enclosed by the force–deformation curve of the structure as it experiences several cycles of excitation. Some structures have far more energy dissipation capacity than others. The extent of energy dissipation capacity available depends largely on the amount of stiffness and strength degradation the structure undergoes as it experiences repeated cycles of inelastic deformation. Fig. C12.1-2 shows representative load deformation curves for two simple substructures, such as a beam–column assembly in a frame. Hysteretic curve (a) in the figure represents the behavior of substructures that have been detailed for ductile behavior. The substructure can maintain almost all of its strength and stiffness over several large cycles of inelastic deformation. The resulting force–deformation “loops” are quite wide and open, resulting in a large amount of energy dissipation. Hysteretic curve (b) represents the behavior of a substructure that has much less energy dissipation than that for the substructure (a) but has a greater change in response period. The structural response is determined by a combination of energy dissipation and period modification.

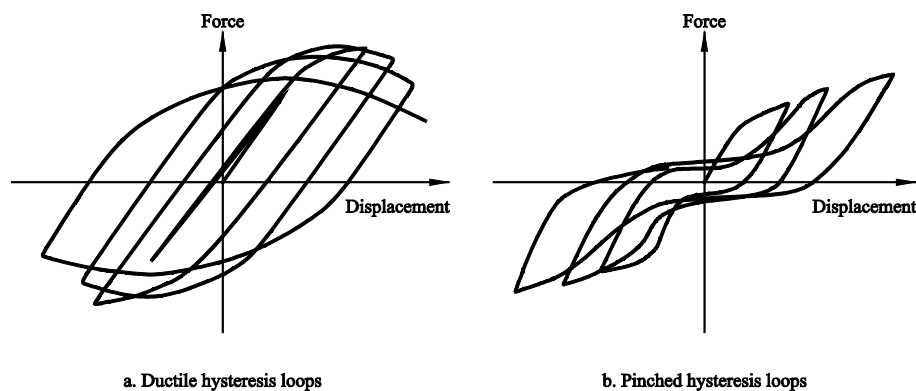

FIGURE C12.1-2 Typical Hysteretic Curves

The principles of this section outline the conceptual intent behind the seismic design parameters used by the standard. However, these parameters are based largely on engineering judgment of the various materials and performance of structural systems in past earthquakes and cannot be directly computed using the relationships presented in Fig. C12.1-1. The seismic design parameters chosen for a specific project or

system should be chosen with care. For example, lower values should be used for structures possessing a low degree of redundancy wherein all the plastic hinges required for the formation of a mechanism may be formed essentially simultaneously and at a force level close to the specified design strength. This situation can result in considerably more detrimental P-delta effects. Because it is difficult for individual designers to judge the extent to which the value of R should be adjusted based on the inherent redundancy of their designs, Section 12.3.4 provides the redundancy factor, ρ , that is typically determined by being based on the removal of individual seismic force-resisting elements.

Higher-order seismic analyses are permitted for any structure and are required for some structures (*see* Section 12.6); lower limits based on the equivalent lateral force procedure may, however, still apply.

C12.1.2 Member Design, Connection Design, and Deformation Limit

Given that key elements of the seismic force-resisting system are likely to yield in response to ground motions, as discussed in Section C12.1.1, it might be expected that structural connections would be required to develop the strength of connected members. Although that is a logical procedure, it is not a general requirement. The actual requirement varies by system and generally is specified in the standards for design of the various structural materials cited by reference in Chapter 14. Good seismic design requires careful consideration of this issue.

C12.1.3 Continuous Load Path and Interconnection

In effect, Section 12.1.3 calls for the seismic design to be complete and in accordance with the principles of structural mechanics. The loads must be transferred rationally from their point of origin to the final point of resistance. This requirement should be obvious, but it often is overlooked by those inexperienced in earthquake engineering. Design consideration should be given to potentially adverse effects where there is a lack of redundancy. Given the many unknowns and uncertainties in the magnitude and characteristics of earthquake loading, in the materials and systems of construction for resisting earthquake loadings, and in the methods of analysis, good earthquake engineering practice has been to provide as much redundancy as possible in the seismic force-resisting system of buildings. Redundancy plays an important role in determining the ability of the building to resist earthquake forces. In a structural system without redundant elements, every element must remain operative to preserve the integrity of the building structure. However, in a highly redundant system, one or more redundant elements may fail and still leave a structural system that retains its integrity and can continue to resist lateral forces, albeit with diminished effectiveness.

Although a redundancy requirement is included in Section 12.3.4, overall system redundancy can be improved by making all joints of the vertical load-carrying frame moment resisting and incorporating them into the seismic force-resisting system. These multiple points of resistance can prevent a catastrophic collapse caused by distress or failure of a member or joint. (The overstrength characteristics of this type of frame are discussed in Section C12.1.1.)

The minimum connection forces are not intended to be applied simultaneously to the entire seismic force-resisting system.

C12.1.4 Connection to Supports

The requirement is similar to that given in Section 1.4 on connections to supports for general structural integrity. *See* Section C1.4.

C12.1.5 Foundation Design

Most foundation design criteria are still stated in terms of allowable stresses, and the forces computed in the standard are all based on the strength level of response. When developing strength-based criteria for foundations, all the factors cited in Section 12.1.5 require careful consideration. Section C12.13 provides specific guidance.

C12.1.6 Material Design and Detailing Requirements

The design limit state for resistance to an earthquake is unlike that for any other load within the scope of the standard. The earthquake limit state is based on overall system performance, not member performance, where repeated cycles of inelastic straining are accepted as an energy-dissipating mechanism. Provisions that modify customary requirements for proportioning and detailing structural members and systems are provided to produce the desired performance.

C12.2 STRUCTURAL SYSTEM SELECTION

C12.2.1 Selection and Limitations

For the purpose of seismic analysis and design requirements, seismic force-resisting systems are grouped into categories as shown in Table 12.2-1. These categories are subdivided further for various types of vertical elements used to resist seismic forces. In addition, the sections for detailing requirements are specified.

Specification of response modification coefficients, R , requires considerable judgment based on knowledge of actual earthquake performance and research studies. The coefficients and factors in Table 12.2-1 continue to be reviewed in light of recent research results. The values of R for the various systems were selected considering observed performance during past earthquakes, the toughness (ability to dissipate energy without serious degradation) of the system, and the amount of damping typically present in the system when it undergoes inelastic response. FEMA P-695 (2009b) has been developed with the purpose of establishing and documenting a methodology for quantifying seismic force-resisting system performance and response parameters for use in seismic design. Whereas R is a key parameter being addressed, related design parameters such as the overstrength factor, Ω_0 , and the deflection amplification factor, C_d , also are addressed. Collectively, these terms are referred to as “seismic design coefficients (or factors).” Future systems are likely to derive their seismic design coefficients (or factors) using this methodology, and existing system coefficients (or factors) also may be reviewed in light of this new procedure.

Height limits have been specified in codes and standards for more than 50 years. The structural system limitations and limits on structural height, h_n , specified in Table 12.2-1, evolved from these initial limitations and were further modified by the collective expert judgment of the NEHRP Provisions Update Committee (PUC) and the ATC-3 project team (the forerunners of the PUC). They have continued to evolve over the past 30 years based on observations and testing, but the specific values are based on subjective judgment.

In a bearing wall system, major load-carrying columns are omitted and the walls carry a major portion of the gravity (dead and live) loads. The walls supply in-plane lateral stiffness and strength to resist wind and earthquake loads and other lateral loads. In some cases, vertical trusses are used to augment lateral stiffness. In general, lack of redundancy for support of vertical and horizontal loads causes values of R to be lower for this system compared with R values of other systems.

In a building frame system, gravity loads are carried primarily by a frame supported on columns rather than by bearing walls. Some portions of the gravity load may be carried on bearing walls, but the amount carried should represent a relatively small percentage of the floor or roof area. Lateral resistance is provided by shear walls or braced frames. Light-framed walls with shear panels are intended for use only with wood and steel building frames. Although gravity load-resisting systems are not required to provide lateral resistance, most of them do. To the extent that the gravity load-resisting system provides additional lateral resistance, it enhances the building’s seismic performance capability, so long as it is capable of resisting the resulting stresses and undergoing the associated deformations.

In a moment-resisting frame system, moment-resisting connections between the columns and beams provide lateral resistance. In Table 12.2-1, such frames are classified as ordinary, intermediate, or special. In high seismic design categories, the anticipated ground motions are expected to produce large inelastic

demands, so special moment frames designed and detailed for ductile response in accordance with Chapter 14 are required. In low Seismic Design Categories, the inherent overstrength in typical structural designs is such that the anticipated inelastic demands are somewhat reduced, and less ductile systems may be used safely. Because these less ductile ordinary framing systems do not possess as much toughness, lower values of R are specified.

The values for R , Ω_0 , and C_d at the composite systems in Table 12.2-1 are similar to those for comparable systems of structural steel and reinforced concrete. Use of the tabulated values is allowed only when the design and detailing requirements in Section 14.3 are followed.

In a dual system, a three-dimensional space frame made up of columns and beams provides primary support for gravity loads. Primary lateral resistance is supplied by shear walls or braced frames, and secondary lateral resistance is provided by a moment frame complying with the requirements of Chapter 14.

Where a beam-column frame or slab-column frame lacks special detailing, it cannot act as an effective backup to a shear wall subsystem, so there are no dual systems with ordinary moment frames. Instead, Table 12.2-1 permits the use of a shear wall-frame interactive system with ordinary reinforced concrete moment frames and ordinary reinforced concrete shear walls. Use of this defined system, which requires compliance with Section 12.2.5.8, offers a significant advantage over a simple combination of the two constituent ordinary reinforced concrete systems. Where those systems are simply combined, Section 12.2.3.3 would require use of seismic design parameters for an ordinary reinforced concrete moment frame.

In a cantilevered column system, stability of mass at the top is provided by one or more columns with base fixity acting as a single-degree-of-freedom system.

Cantilever column systems are essentially a special class of moment-resisting frame, except that they do not possess the redundancy and overstrength that most moment-resisting frames derive from sequential formation of yield or plastic hinges. Where a typical moment-resisting frame must form multiple plastic hinges in members to develop a yield mechanism, a cantilever column system develops hinges only at the base of the columns to form a mechanism. As a result, their overstrength is limited to that provided by material overstrength and by design conservatism.

It is permitted to construct cantilever column structures using any of the systems that can be used to develop moment frames, including ordinary and special steel; ordinary, intermediate, and special concrete; and timber frames. The system limitations for cantilever column systems reflect the type of moment frame detailing provided but with a limit on structural height, h_n , of 35 ft.

The value of R for cantilever column systems is derived from moment-resisting frame values where R is divided by Ω_0 but is not taken as less than 1 or greater than 2 1/2. This range accounts for the lack of sequential yielding in such systems. C_d is taken as equal to R , recognizing that damping is quite low in these systems and inelastic displacement of these systems is not less than the elastic displacement.

C12.2.1.1 Alternative Structural Systems

Historically, this Standard has permitted the use of alternative seismic force resisting systems subject to satisfactory demonstration that the proposed systems' lateral force resistance and energy dissipation capacity is equivalent to structural systems listed in Table 12.2-1, for equivalent values of the response modification coefficient, R , overstrength factor, Ω_o , and deflection amplification coefficient, C_d . These design factors were established based on limited analytical and laboratory data and the engineering judgment of the developers of the standard.

Under funding from the Federal Emergency Management Agency, the Applied Technology Council developed a rational methodology for validation of design criteria for seismic force-resisting systems under its ATC-63 project. Published as *FEMA P-695*, this methodology recognizes that the fundamental goal of seismic design rules contained in the Standard is to limit collapse probability to acceptable levels. The *FEMA P-695* methodology uses nonlinear response history analysis to predict an adjusted collapse margin

ratio (ACMR) for a suite of archetypical structures designed in accordance with a proposed set of system-specific design criteria and subjected to a standard series of ground motion accelerograms. The suite of archetypical structures is intended to represent the typical types and sizes of structures that are likely to incorporate the system. The ACMR relates to the conditional probability of collapse given MCE_R shaking and considers uncertainties associated with the record to record variability of ground motions, the quality of the design procedure, the comprehensiveness and quality of the laboratory data upon which the analytical modeling is based; and uncertainties associated with the analytical modeling. Subsequent studies have been used to benchmark this methodology against selected systems contained in Table 12.2-1 and have demonstrated that the methodology provides rational results consistent with past engineering judgment for many systems. The *FEMA P-695* methodology is therefore deemed to constitute the preferred procedure for demonstrating adequate collapse resistance for new structural systems not presently contained in Table 12.2-1.

Under the *FEMA P-695* methodology, the archetypes used to evaluate seismic force-resisting systems are designed using the criteria for Risk Categories II structures and evaluated to demonstrate that the conditional probability of collapse of such structures conforms to the 10% probability of collapse goal stated in this Section and also described in Section C.1.3.1 of the Commentary to this Standard. It is assumed that application of the seismic importance factors and more restrictive drift limits associated with the design requirements for structures assigned to Risk Categories III and IV will provide such structures with the improved resistance to collapse described in Section C.1.3.1 for those Risk Categories.

In addition to providing a basis for establishment of design criteria for structural systems that can be used for design of a wide range of structures, the *FEMA P-695* methodology also contains a building-specific methodology intended for application to individual structures. The rigor associated with application of the *FEMA P-695* methodology may not be appropriate to the design of individual structures that conform with limited and clearly defined exceptions, to the criteria contained in the Standard for a defined structural system. Nothing contained in this section is intended to require the use of *FEMA P-695* or similar methodologies for such cases.

C12.2.1.2 Substitute Elements

This standard and its referenced standards specify design and detailing criteria for members and their connections (elements) of seismic force-resisting systems defined in Table 12.2.1. Substitute elements replace portions of the defined seismic force-resisting systems. Examples include proprietary products comprising special steel moment resisting connections or proprietary shear walls for use in light frame construction. Requirements for qualification of substitute elements of seismic force-resisting systems are intended to ensure equivalent seismic performance of the element and the system as a whole. The evaluation of suitability for substitution is based on comparison of key performance parameters of the code-defined (conforming) element and the substitute element.

FEMA P-795, Quantification of Building Seismic Performance Factors Component Equivalency Methodology is an acceptable methodology to demonstrate equivalence of substitute elements and their connections, that provides methods for component testing, calculation of parameter statistics from test data and acceptance criteria for evaluating equivalency. Key performance parameters include: strength ratio, stiffness ratio, deformation capacity and cyclic strength and stiffness characteristics.

C12.2.2 Combinations of Framing Systems in Different Directions

Different seismic force-resisting systems can be used along each of the two orthogonal axes of the structure, as long as the respective values of R , Ω_0 , and C_d are used. Depending on the combination selected, it is possible that one of the two systems may limit the extent of the overall system with regard to structural system limitations or structural height, h_n ; the more restrictive of these would govern.

C12.2.3 Combinations of Framing Systems in the Same Direction

The intent of the provision requiring use of the most stringent seismic design parameters (R , Ω_0 , and C_d) is to prevent mixed seismic force-resisting systems that could concentrate inelastic behavior in the lower stories.

C12.2.3.1 R , C_d , and Ω_0 Values for Vertical Combinations

This section expands upon Section 12.2.3 by specifying the requirements specific to the cases where (a) the value of R for the lower seismic force-resisting system is lower than that for the upper system, and (b) the value of R for the upper seismic force-resisting system is lower than that for the lower system.

The two cases are intended to account for all possibilities of vertical combinations of seismic force-resisting systems in the same direction. For a structure with a vertical combination of three or more seismic force-resisting systems in the same direction, Section 12.2.3.1 must be applied to the adjoining pairs of systems until the vertical combinations meet the requirements therein.

There are also exceptions to these requirements for conditions that do not affect the dynamic characteristics of the structure or that do not result in concentration of inelastic demand in critical areas.

C12.2.3.2 Two-Stage Analysis Procedure

A two-stage equivalent lateral force procedure is permitted where the lower portion of the structure has a minimum of 10 times the stiffness of the upper portion of the structure. In addition, the period of the entire structure is not permitted to be greater than 1.1 times the period of the upper portion considered as a separate structure supported at the transition from the upper to the lower portion. An example would be a concrete podium under a wood- or steel-framed upper portion of a structure. The upper portion may be analyzed for seismic forces and drifts using the values of R , Ω_0 , and C_d for the upper portion as a separate structure. The seismic forces (e.g., shear and overturning) at the base of the upper portion are applied to the top of the lower portion and scaled up by the ratio of $(R/\rho)_{\text{upper}}$ to $(R/\rho)_{\text{lower}}$. The lower portion, which now includes the seismic forces from the upper portion, may then be analyzed using the values of R , Ω_0 , and C_d for the lower portion of the structure.

C12.2.3.3 R , C_d , and Ω_0 Values for Horizontal Combinations

For almost all conditions, the least value of R of different seismic force-resisting systems in the same direction must be used in design. This requirement reflects the expectation that the entire system will undergo the same deformation with its behavior controlled by the least ductile system. However, for light-frame construction or flexible diaphragms meeting the listed conditions, the value of R for each independent line of resistance can be used. This exceptional condition is consistent with light-frame construction that uses the ground for parking with residential use above.

C12.2.4 Combination Framing Detailing Requirements

This requirement is provided so that the seismic force-resisting system with the highest value of R has the necessary ductile detailing throughout. The intent is that details common to both systems be designed to remain functional throughout the response to earthquake load effects to preserve the integrity of the seismic force-resisting system.

C12.2.5 System-Specific Requirements

C12.2.5.1 Dual System

The moment frame of a dual system must be capable of resisting at least 25% of the design seismic forces; this percentage is based on judgment. The purpose of the 25% frame is to provide a secondary seismic force-resisting system with higher degrees of redundancy and ductility to improve the ability of the building

to support the service loads (or at least the effect of gravity loads) after strong earthquake shaking. The primary system (walls or bracing) acting together with the moment frame must be capable of resisting all of the design seismic forces. The following analyses are required for dual systems:

1. The moment frame and shear walls or braced frames must resist the design seismic forces, considering fully the force and deformation interaction of the walls or braced frames and the moment frames as a single system. This analysis must be made in accordance with the principles of structural mechanics that consider the relative rigidities of the elements and torsion in the system. Deformations imposed upon members of the moment frame by their interaction with the shear walls or braced frames must be considered in this analysis.
2. The moment frame must be designed with sufficient strength to resist at least 25% of the design seismic forces.

C12.2.5.2 Cantilever Column Systems

Cantilever column systems are singled out for special consideration because of their unique characteristics. These structures often have limited redundancy and overstrength and concentrate inelastic behavior at their bases. As a result, they have substantially less energy dissipation capacity than other systems. A number of apartment buildings incorporating this system experienced severe damage and, in some cases, collapsed in the 1994 Northridge (California) earthquake. Because the ductility of columns that have large axial stress is limited, cantilever column systems may not be used where individual column axial demands from seismic load effects exceed 15% of their available axial strength, including slenderness effects.

Elements providing restraint at the base of cantilever columns must be designed for seismic load effects, including overstrength, so that the strength of the cantilever columns is developed.

C12.2.5.3 Inverted Pendulum-Type Structures

Inverted pendulum-type structures do not have a unique entry in Table 12.2-1 because they can be formed from many structural systems. Inverted pendulum-type structures have more than half of their mass concentrated near the top (producing one degree of freedom in horizontal translation) and rotational compatibility of the mass with the column (producing vertical accelerations acting in opposite directions). Dynamic response amplifies this rotation; hence, the bending moment induced at the top of the column can exceed that computed using the procedures of Section 12.8. The requirement to design for a top moment that is one-half of the base moment calculated in accordance with Section 12.8 is based on analyses of inverted pendulums covering a wide range of practical conditions.

C12.2.5.4 Increased Structural Height Limit for Steel Eccentrically Braced Frames, Steel Special Concentrically Braced Frames, Steel Buckling-Restrained Braced Frames, Steel Special Plate Shear Walls, and Special Reinforced Concrete Shear Walls

The first criterion for an increased limit on structural height, h_n , precludes extreme torsional irregularity because premature failure of one of the shear walls or braced frames could lead to excessive inelastic torsional response. The second criterion, which is similar to the redundancy requirements, is to limit the structural height of systems that are too strongly dependent on any single line of shear walls or braced frames. The inherent torsion resulting from the distance between the center of mass and the center of rigidity must be included, but accidental torsional effects are neglected for ease of implementation.

C12.2.5.5 Special Moment Frames in Structures Assigned to Seismic Design Categories D through F

Special moment frames, either alone or as part of a dual system, are required to be used in Seismic Design Categories D through F where the structural height, h_n , exceeds 160 ft (or 240 ft for buildings that meet the provisions of Section 12.2.5.4) as indicated in Table 12.2-1. In shorter buildings where special moment

frames are not required to be used, the special moment frames may be discontinued and supported on less ductile systems as long as the requirements of Section 12.2.3 for framing system combinations are followed.

For the situation where special moment frames are required, they should be continuous to the foundation. In cases where the foundation is located below the building's base, provisions for discontinuing the moment frames can be made as long as the seismic forces are properly accounted for and transferred to the supporting structure.

C12.2.5.6 Steel Ordinary Moment Frames

Steel ordinary moment frames (OMFs) are less ductile than steel special moment frames; consequently, their use is prohibited in structures assigned to Seismic Design Categories D, E, and F (Table 12.2-1). Structures with steel OMFs, however, have exhibited acceptable behavior in past earthquakes where the structures were sufficiently limited in their structural height, number of stories, and seismic mass. The provisions in the standard reflect these observations. The exception is discussed separately below. Table C12.2.5.6-C12.2.5.7 summarizes the provisions.

Table C12.2.5.6-C12.2.5.7 Summary of Conditions for OMFs and IMFs in Structures Assigned to Seismic Design Category D, E, or F (Refer to the Standard for Additional Requirements)

Section	Frame	SDC	Max. Number Stories	Light-Frame Construction	Max. h_n	Max. roof/floor DL (lb/ft ²)	Exterior Wall DL Max. lb/ft ²	Exterior Wall ^a Height (ft)
12.2.5.6.1(a)	OMF	D, E	1	Not Applicable	65'0"	20	20	35'0"
12.2.5.6.1(a)-Exc	OMF	D, E	1	Not Applicable	No Limit	20	20	35'0"
12.2.5.6.1(b)	OMF	D, E	No Limit	Required	35'0"	35	20	0'0"
12.2.5.6.2	OMF	F	1	Not Applicable	65'0"	20	20	0'0"
12.2.5.7.1(a)	IMF	D	1	Not Applicable	65'0"	20	20	35'0"
12.2.5.7.1(a)-Exc	IMF	D	1	Not Applicable	No Limit	20	20	35'0"
12.2.5.7.1(b)	IMF	D	No Limit	Not Applicable	35'0"	No Limit	No Limit	Not Applicable
12.2.5.7.2(a)	IMF	E	1	Not Applicable	65'0"	20	20	35'0"
12.2.5.7.2(a)-Exc	IMF	E	1	Not Applicable	No Limit	20	20	35'0"
12.2.5.7.2(b)	IMF	E	No Limit	Not Applicable	35'0"	35	20	0'0"
12.2.5.7.3(a)	IMF	F	1	Not Applicable	65'0"	20	20	0'0"
12.2.5.7.3(b)	IMF	F	No Limit	Required	35'0"	35	20	0'0"

Note: ^aApplies to portion of wall above listed wall height.

C12.2.5.6.1 Seismic Design Category D or E

Single-story steel OMFs are permitted, provided that (a) the structural height, h_n , is a maximum of 65 ft (20 m), (b) the dead load supported by and tributary to the roof is a maximum of 20 lb/ft² (0.96 kN/m²), and (c) the dead load of the exterior walls more than 35 ft (10.6 m) above the seismic base tributary to the moment frames is a maximum of 20 lb/ft² (0.96 kN/m²).

In structures of light-frame construction, multistory steel OMFs are permitted, provided that (a) the structural height, h_n , is a maximum of 35 ft (10.6 m), (b) the dead load of the roof and each floor above the

seismic base supported by and tributary to the moment frames are each a maximum of 35 lb/ft² (1.68 kN/m²), and (c) the dead load of the exterior walls tributary to the moment frames is a maximum of 20 lb/ft² (0.96 kN/m²).

EXCEPTION: Industrial structures, such as aircraft maintenance hangars and assembly buildings, with steel OMFs have performed well in past earthquakes with strong ground motions (EQE Inc. 1983, 1985, 1986a, 1986b, 1986c, and 1987); the exception permits single-story steel OMFs to be unlimited in height provided that (a) the structure is limited to the enclosure of equipment or machinery; (b) its occupants are limited to maintaining and monitoring the equipment, machinery, and their associated processes; (c) the sum of the dead load and equipment loads supported by and tributary to the roof is a maximum of 20 lb/ft² (0.96 kN/m²); and (d) the dead load of the exterior wall system, including exterior columns more than 35 ft (10.6 m) above the seismic base is a maximum of 20 lb/ft² (0.96 kN/m²). Though the latter two load limits (items c and d) are similar to those described in Section C12.2.5.6.1, there are meaningful differences.

The exception further recognizes that these facilities often require large equipment or machinery, and associated systems, not supported by or considered tributary to the roof, that support the intended operational functions of the structure, such as top running bridge cranes, jib cranes, and liquid storage containment and distribution systems. To limit the seismic interaction between the seismic force-resisting systems and these components, the exception requires the weight of equipment or machinery that is not self-supporting (i.e., not freestanding) for all loads (e.g., dead, live, or seismic) to be included when determining compliance with the roof or exterior wall load limits. This *equivalent* equipment load shall be in addition to the loads listed above.

To determine the equivalent equipment load, the exception requires the weight to be considered fully (100%) tributary to an area not exceeding 600 ft² (55.8 m²). This limiting area can be taken either to an adjacent exterior wall for cases where the weight is supported by an exterior column (which may also span to the first interior column) or to the adjacent roof for cases where the weight is supported entirely by an interior column or columns, but not both; nor can a fraction of the weight be allocated to each zone. Equipment loads within overlapping tributary areas should be combined in the same limiting area. Other provisions in the standard, as well as in past editions, require satisfying wall load limits tributary to the moment frame, but this requirement is not included in the exception in that it is based on a component-level approach that does not consider the interaction between systems in the structure. As such, the limiting area is considered to be a reasonable approximation of the tributary area of a moment frame segment for the purpose of this conversion. Although this weight allocation procedure may not represent an accurate physical distribution, it is considered to be a reasonable method for verifying compliance with the specified load limits to limit seismic interactions. The engineer must still be attentive to actual mass distributions when computing seismic loads. Further information is discussed in Section C11.1.3.

C12.2.5.6.2 Seismic Design Category F

Single-story steel OMFs are permitted, provided that they meet conditions (a) and (b) described in Section C12.2.5.6.1 for single-story frames and (c) the dead load of the exterior walls tributary to the moment frames is a maximum of 20 lb/ft² (0.96 kN/m²).

C12.2.5.7 Steel Intermediate Moment Frames

Steel intermediate moment frames (IMFs) are more ductile than steel ordinary moment frames (OMFs) but less ductile than steel special moment frames; consequently, restrictions are placed on their use in structures assigned to Seismic Design Category D and their use is prohibited in structures assigned to Seismic Design Categories E and F (Table 12.2-1). As with steel OMFs, steel IMFs have also exhibited acceptable behavior in past earthquakes where the structures were sufficiently limited in their structural height, number of stories, and seismic mass. The provisions in the standard reflect these observations. The exceptions are discussed separately (below). Table C12.2.5.6-C12.2.5.7 summarizes the provisions.

C12.2.5.7.1 Seismic Design Category D

Single-story steel IMFs are permitted without limitations on dead load of the roof and exterior walls, provided that the structural height, h_n , is a maximum of 35 ft (10.6 m). An increase to 65 ft (20 m) is permitted for h_n , provided that (a) the dead load supported by and tributary to the roof is a maximum of 20 lb/ft² (0.96 kN/m²), and (b) the dead load of the exterior walls more than 35 ft (10.6 m) above the seismic base tributary to the moment frames is a maximum of 20 lb/ft² (0.96 kN/m²).

The exception permits single-story steel IMFs to be unlimited in height, provided that they meet all of the conditions described in the exception to Section C12.2.5.6.1 for the same structures.

C12.2.5.7.2 Seismic Design Category E

Single-story steel IMFs are permitted, provided that they meet all of the conditions described in Section C12.2.5.6.1 for single-story OMFs.

The exception permits single-story steel IMFs to be unlimited in height, provided that they meet all of the conditions described in Section C12.2.5.6.1 for the same structures.

Multistory steel IMFs are permitted, provided that they meet all of the conditions described in Section C12.2.5.6.1 for multistory OMFs, except that the structure is not required to be of light-frame construction.

C12.2.5.7.3 Seismic Design Category F

Single-story steel IMFs are permitted, provided that (a) the structural height, h_n , is a maximum of 65 ft (20 m), (b) the dead load supported by and tributary to the roof is a maximum of 20 lb/ft² (0.96 kN/m²), and (c) the dead load of the exterior walls tributary to the moment frames is a maximum of 20 lb/ft² (0.96 kN/m²).

Multistory steel IMFs are permitted, provided that they meet all of the conditions described in the exception to Section C12.2.5.6.1 for multistory OMFs in structures of light-frame construction.

C12.2.5.8 Shear Wall–Frame Interactive Systems

For structures assigned to Seismic Design Category A or B (where seismic hazard is low), it is usual practice to design shear walls and frames of a shear wall-frame structure to resist lateral forces in proportion to their relative rigidities, considering interaction between the two subsystems at all levels. As discussed in Section C12.2.1, this typical approach would require use of a lower response modification coefficient, R , than that defined for shear wall-frame interactive systems. Where the special requirements of this section are satisfied, more reliable performance is expected, justifying a higher value of R .

C12.3 DIAPHRAGM FLEXIBILITY, CONFIGURATION IRREGULARITIES, AND REDUNDANCY**C12.3.1 Diaphragm Flexibility**

Most seismic force-resisting systems have two distinct parts: the horizontal system that distributes lateral forces to the vertical elements and the vertical system that transmits lateral forces between the floor levels and the base of the structure.

The horizontal system may consist of diaphragms or a horizontal bracing system. For the majority of buildings, diaphragms offer the most economical and positive method of resisting and distributing seismic forces in the horizontal plane. Typically, diaphragms consist of a metal deck (with or without concrete), concrete slabs, and wood sheathing and/or decking. Although most diaphragms are flat, consisting of the floors of buildings, they also may be inclined, curved, warped, or folded configurations, and most diaphragms have openings.

The diaphragm stiffness relative to the stiffness of the supporting vertical seismic force-resisting system ranges from flexible to rigid and is important to define. Provisions defining diaphragm flexibility are given in Sections 12.3.1.1 through 12.3.1.3. If a diaphragm cannot be idealized as either flexible or rigid, explicit consideration of its stiffness must be included in the analysis.

The diaphragms in most buildings braced by wood light-frame shear walls are semirigid. Because semirigid diaphragm modeling is beyond the capability of available software for wood light-frame buildings, it is anticipated that this requirement will be met by evaluating force distribution using both rigid and flexible diaphragm models and taking the worse case of the two. Although this procedure is in conflict with common design practice, which typically includes only flexible diaphragm force distribution for wood light-frame buildings, it is one method of capturing the effect of the diaphragm stiffness.

C12.3.1.1 Flexible Diaphragm Condition

Section 12.3.1.1 defines broad categories of diaphragms that may be idealized as flexible, regardless of whether the diaphragm meets the calculated conditions of Section 12.3.1.3. These categories include the following:

- a. Construction with relatively stiff vertical framing elements, such as steel-braced frames and concrete or masonry shear walls;
- b. One-and two-family dwellings; and
- c. Light-frame construction (e.g., construction consisting of light-frame walls and diaphragms) with or without nonstructural toppings of limited stiffness.

For item c above, compliance with story drift limits along each line of shear walls is intended as an indicator that the shear walls are substantial enough to share load on a tributary area basis and not require torsional force redistribution.

C12.3.1.2 Rigid Diaphragm Condition

Span-to-depth ratio limits are included in the deemed-to-comply condition as an indirect measure of the flexural contribution to diaphragm stiffness.

C12.3.1.3 Calculated Flexible Diaphragm Condition

A diaphragm is permitted to be idealized as flexible if the calculated diaphragm deflection (typically at midspan) between supports (lines of vertical elements) is greater than two times the average story drift of the vertical lateral force-resisting elements located at the supports of the diaphragm span.

Figure 12.3-1 depicts a distributed load, conveying the intent that the tributary lateral load be used to compute δ_{MDD} , consistent with the Section 11.3 symbols. A diaphragm opening is illustrated and the shorter-length arrows in the portion of the diaphragm with the opening indicate lower load intensity because of lower tributary seismic mass.

C12.3.2 Irregular and Regular Classification

The configuration of a structure can significantly affect its performance during a strong earthquake that produces the ground motion contemplated in the standard. Structural configuration can be divided into two aspects: horizontal and vertical. Most seismic design provisions were derived for buildings that have regular configurations, but earthquakes have shown repeatedly that buildings that have irregular configurations suffer greater damage. This situation prevails even with good design and construction.

There are several reasons for the poor behavior of irregular structures. In a regular structure, the inelastic response, including energy dissipation and damage, produced by strong ground shaking tends to be well distributed throughout the structure. However, in irregular structures, inelastic behavior can be concentrated by irregularities and can result in rapid failure of structural elements in these areas. In

addition, some irregularities introduce unanticipated demands into the structure, which designers frequently overlook when detailing the structural system. Finally, the elastic analysis methods typically used in the design of structures often cannot predict the distribution of earthquake demands in an irregular structure very well, leading to inadequate design in the areas associated with the irregularity. For these reasons, the standard encourages regular structural configurations and prohibits gross irregularity in buildings located on sites close to major active faults, where very strong ground motion and extreme inelastic demands are anticipated. The termination of seismic force-resisting elements at the foundation, however, is not considered to be a discontinuity.

C12.3.2.1 Horizontal Irregularity

A building may have a symmetric geometric shape without reentrant corners or wings but still be classified as irregular in plan because of its distribution of mass or vertical seismic force-resisting elements. Torsional effects in earthquakes can occur even where the centers of mass and rigidity coincide. For example, ground motion waves acting on a skew with respect to the building axis can cause torsion. Cracking or yielding in an asymmetric fashion also can cause torsion. These effects also can magnify the torsion caused by eccentricity between the centers of mass and rigidity. Torsional structural irregularities (Types 1a and 1b) are defined to address this concern.

A square or rectangular building with minor reentrant corners would still be considered regular, but large reentrant corners creating a crucifix form would produce an irregular structural configuration (Type 2). The response of the wings of this type of building generally differs from the response of the building as a whole, and this difference produces higher local forces than would be determined by application of the standard without modification. Other winged plan configurations (e.g., H-shapes) are classified as irregular even if they are symmetric because of the response of the wings.

Significant differences in stiffness between portions of a diaphragm at a level are classified as Type 3 structural irregularities because they may cause a change in the distribution of seismic forces to the vertical components and may create torsional forces not accounted for in the distribution normally considered for a regular building.

Where there are discontinuities in the path of lateral force resistance, the structure cannot be considered regular. The most critical discontinuity defined is the out-of-plane offset of vertical elements of the seismic force-resisting system (Type 4). Such offsets impose vertical and lateral load effects on horizontal elements that are difficult to provide for adequately.

Where vertical lateral force-resisting elements are not parallel to the major orthogonal axes of the seismic force-resisting system, the equivalent lateral force procedure of the standard cannot be applied appropriately, so the structure is considered to have an irregular structural configuration (Type 5).

Fig. C12.3-1 illustrates horizontal structural irregularities.

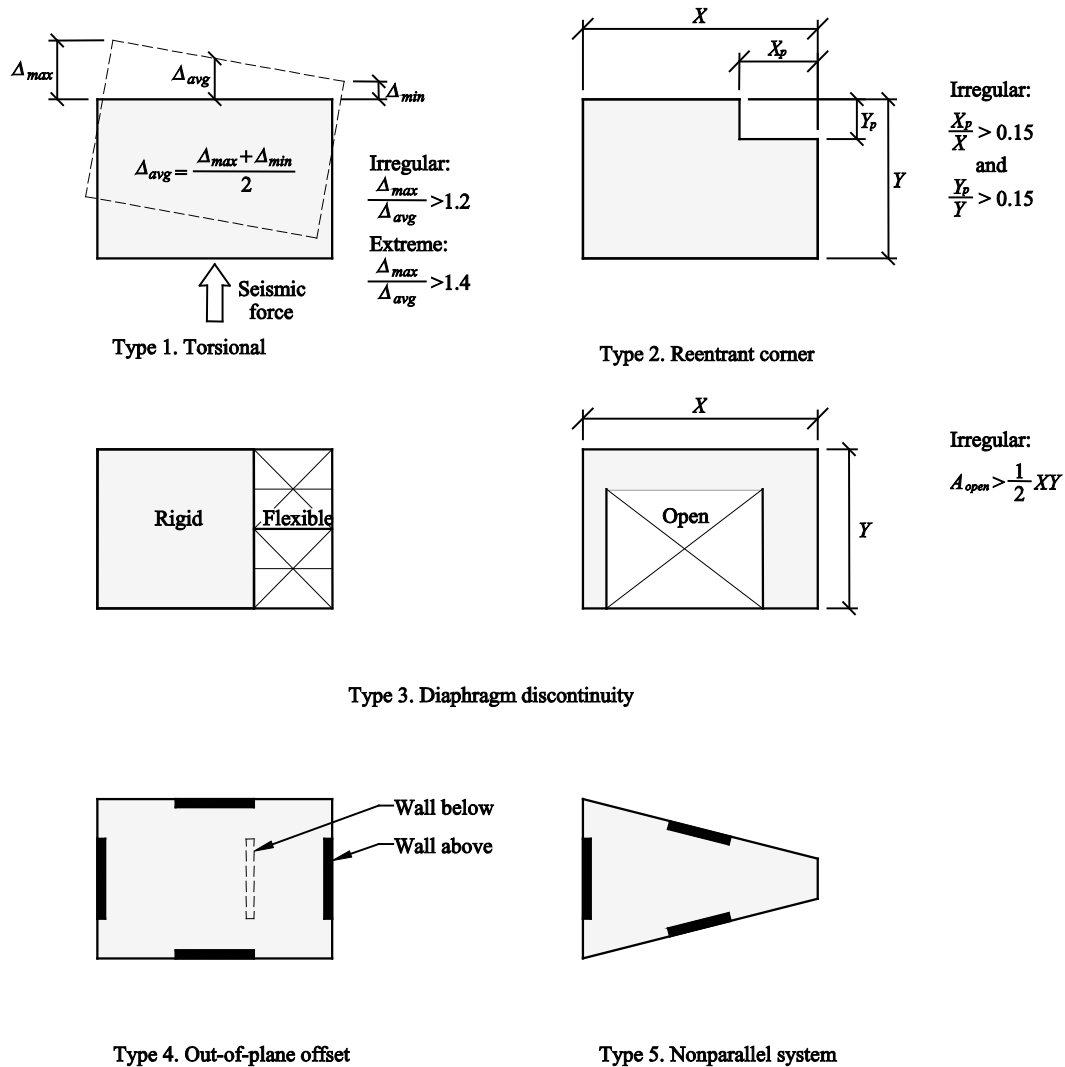

FIGURE C12.3-1 Horizontal Structural Irregularity Examples

C12.3.2.2 Vertical Irregularity

Vertical irregularities in structural configuration affect the responses at various levels and induce loads at these levels that differ significantly from the distribution assumed in the equivalent lateral force procedure given in Section 12.8.

A moment-resisting frame building might be classified as having a soft story irregularity (Type 1a or 1b) if one story is much taller than the adjoining stories and the design did not compensate for the resulting decrease in stiffness that normally would occur.

A building is classified as having a weight (mass) irregularity (Type 2) where the ratio of mass to stiffness in adjacent stories differs significantly. This difference typically occurs where a heavy mass (e.g., an interstitial mechanical floor) is placed on one level.

A vertical geometric irregularity (Type 3) applies regardless of whether the larger dimension is above or below the smaller one.

Vertical lateral force-resisting elements at adjoining stories that are offset from each other in the vertical plane of the elements and impose overturning demands on supporting structural elements, such as beams, columns, trusses, walls, or slabs, are classified as in-plane discontinuity irregularities (Type 4).

Buildings with a weak-story irregularity (Type 5a or 5b) tend to develop all of their inelastic behavior and consequent damage at the weak story, possibly leading to collapse.

Fig. C12.3-2 illustrates examples of vertical structural irregularities.

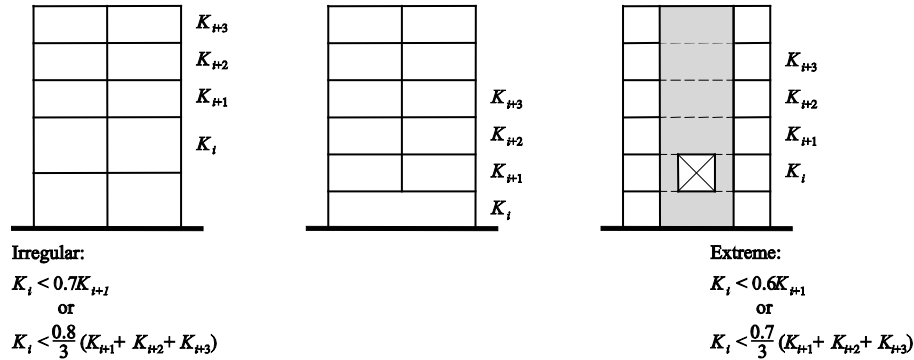

Type 1. Stiffness — Soft Story

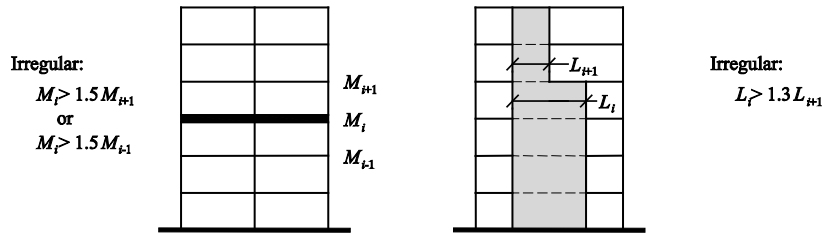

Type 2. Weight (Mass)

Type 3. Geometric

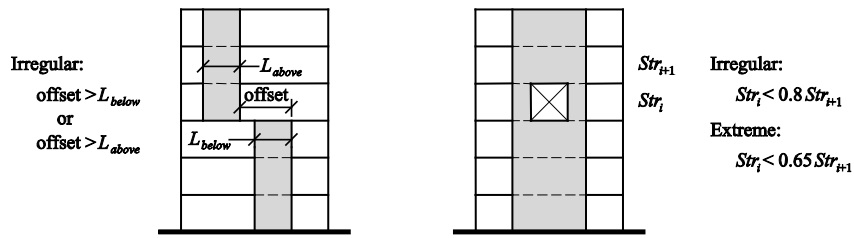

Type 4. In-Plane Discontinuity Type 5. Lateral Strength — Weak Story

FIGURE C12.3-2 Vertical Structural Irregularities

C12.3.3 Limitations and Additional Requirements for Systems with Structural Irregularities

C12.3.3.1 Prohibited Horizontal and Vertical Irregularities for Seismic Design Categories D through F

The prohibitions and limits caused by structural irregularities in this section stem from poor performance in past earthquakes and the potential to concentrate large inelastic demands in certain portions of the structure. Even where such irregularities are permitted, they should be avoided whenever possible in all structures.

C12.3.3.2 Extreme Weak Stories

Because extreme weak story irregularities are prohibited in Section 12.3.3.1 for buildings located in Seismic Design Categories D, E, and F, the limitations and exceptions in this section apply only to buildings assigned to Seismic Design Category B or C. Weak stories of structures assigned to Seismic Design Category B or C that are designed for seismic forces amplified by the overstrength factor, Ω_0 , are exempted because reliable inelastic response is expected.

C12.3.3.3 Elements Supporting Discontinuous Walls or Frames

The purpose of requiring elements (e.g., beams, columns, trusses, slabs, and walls) that support discontinuous walls or frames to be designed to resist seismic load effects, including overstrength factor, is to protect the gravity load-carrying system against possible overloads caused by overstrength of the seismic force-resisting system. Either columns or beams may be subject to such failure; therefore, both should include this design requirement. Beams may be subject to failure caused by overloads in either the downward or upward directions of force. Examples include reinforced concrete beams, the weaker top laminations of glued laminated beams, or unbraced flanges of steel beams or trusses. Hence, the provision has not been limited simply to downward force, but instead to the larger context of “vertical load.” Additionally, walls that support isolated point loads from frame columns or discontinuous perpendicular walls or walls with significant vertical offsets, as shown in Figs. C12.3-3 and C12.3-4, can be subject to the same type of failure caused by overload.

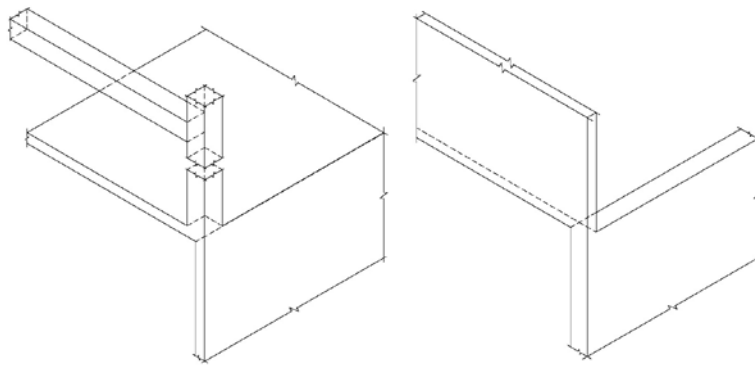

FIGURE C12.3-3 Vertical In-Plane-Discontinuity Irregularity from Columns or Perpendicular Walls (Type 4)

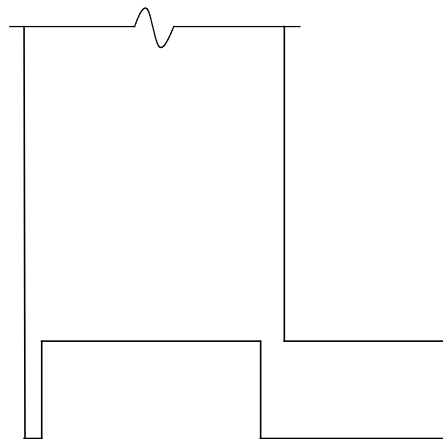

FIGURE C12.3-4 Vertical In-Plane-Discontinuity Irregularity from Walls with Significant Offsets (Type 4)

The connection between the discontinuous element and the supporting member must be adequate to transmit the forces required for the design of the discontinuous element. For example, where the discontinuous element is required to comply with the seismic load effects, including overstrength factor in Section 12.4.3, as is the case for a steel column in a braced frame or a moment frame, its connection to the supporting member is required to be designed to transmit the same forces. These same seismic load effects are not required for shear walls, and, thus the connection between the shear wall and the supporting member would only need to be designed to transmit the loads associated with the shear wall.

For wood light-frame shear wall construction, the final sentence of Section 12.3.3.3 results in the shear and overturning connections at the base of a discontinued shear wall (i.e., shear fasteners and tie-downs) being designed using the load combinations of Section 2.3 or 2.4 rather than the load combinations with overstrength factor of Section 12.4.3 (Fig. C12.3-5). The intent of the first sentence of Section 12.3.3.3 is to protect the system providing resistance to forces transferred from the shear wall by designing the system for amplified seismic load effects; strengthening of the shear wall anchorage to this system is not required to meet this intent.

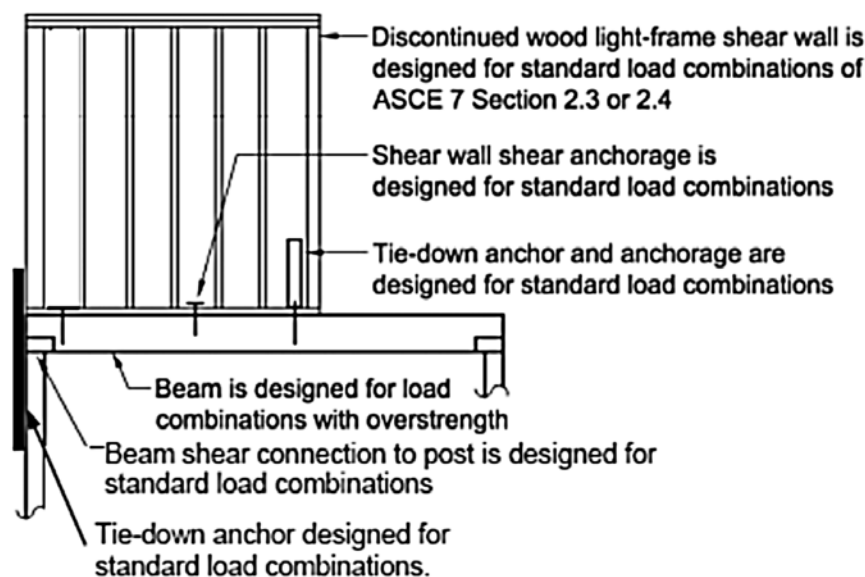

FIGURE C12.3-5 Discontinued Wood Light-Frame Shear Wall

C12.3.3.4 Increase in Forces Because of Irregularities for Seismic Design Categories D through F

The listed irregularities may result in loads that are distributed differently than those assumed in the equivalent lateral force procedure of Section 12.8, especially as related to the interconnection of the diaphragm with vertical elements of the seismic force-resisting system. The 25% increase in force is intended to account for this difference. Where the force is calculated using the seismic load effects including overstrength factor, no further increase is warranted.

C12.3.4 Redundancy

The standard introduces a revised redundancy factor, ρ , for structures assigned to Seismic Design Category D, E, or F to quantify redundancy. The value of this factor is either 1.0 or 1.3. This factor has the effect of reducing the response modification coefficient, R , for less redundant structures, thereby increasing the seismic demand. The factor is specified in recognition of the need to address the issue of redundancy in the design.

The desirability of redundancy, or multiple lateral force-resisting load paths, has long been recognized. The redundancy provisions of this section reflect the belief that an excessive loss of story shear strength or development of an extreme torsional irregularity (Type 1b) may lead to structural failure. The value of ρ determined for each direction may differ.

C12.3.4.1 Conditions Where Value of ρ is 1.0

This section provides a convenient list of conditions where ρ is 1.0.

C12.3.4.2 Redundancy Factor, ρ , for Seismic Design Categories D through F

There are two approaches to establishing a redundancy factor, ρ , of 1.0. Where neither condition is satisfied, ρ is taken as equal to 1.3. It is permitted to take ρ equal to 1.3 without checking either condition. A reduction in the value of ρ from 1.3 is not permitted for structures assigned to Seismic Design Category D that have an extreme torsional irregularity (Type 1b). Seismic Design Categories E and F are not also specified because extreme torsional irregularities are prohibited (see Section 12.3.3.1).

The first approach is a check of the elements outlined in Table 12.3-3 for cases where the seismic design story shear exceeds 35% of the base shear. Parametric studies (conducted by Building Seismic Safety Council Technical Subcommittee 2 but unpublished) were used to select the 35% value. Those studies indicated that stories with story shears of at least 35% of the base shear include all stories of low-rise buildings (buildings up to five to six stories) and about 87% of the stories of tall buildings. The intent of this limit is to exclude penthouses of most buildings and the uppermost stories of tall buildings from the redundancy requirements.

This approach requires the removal (or loss of moment resistance) of an individual lateral force-resisting element to determine its effect on the remaining structure. If the removal of elements, one by one, does not result in more than a 33% reduction in story strength or an extreme torsional irregularity, ρ may be taken as 1.0. For this evaluation, the determination of story strength requires an in-depth calculation. The intent of the check is to use a simple measure (elastic or plastic) to determine whether an individual member has a significant effect on the overall system. If the original structure has an extreme torsional irregularity to begin with, the resulting ρ is 1.3. Fig. C12.3-6 presents a flowchart for implementing the redundancy requirements.

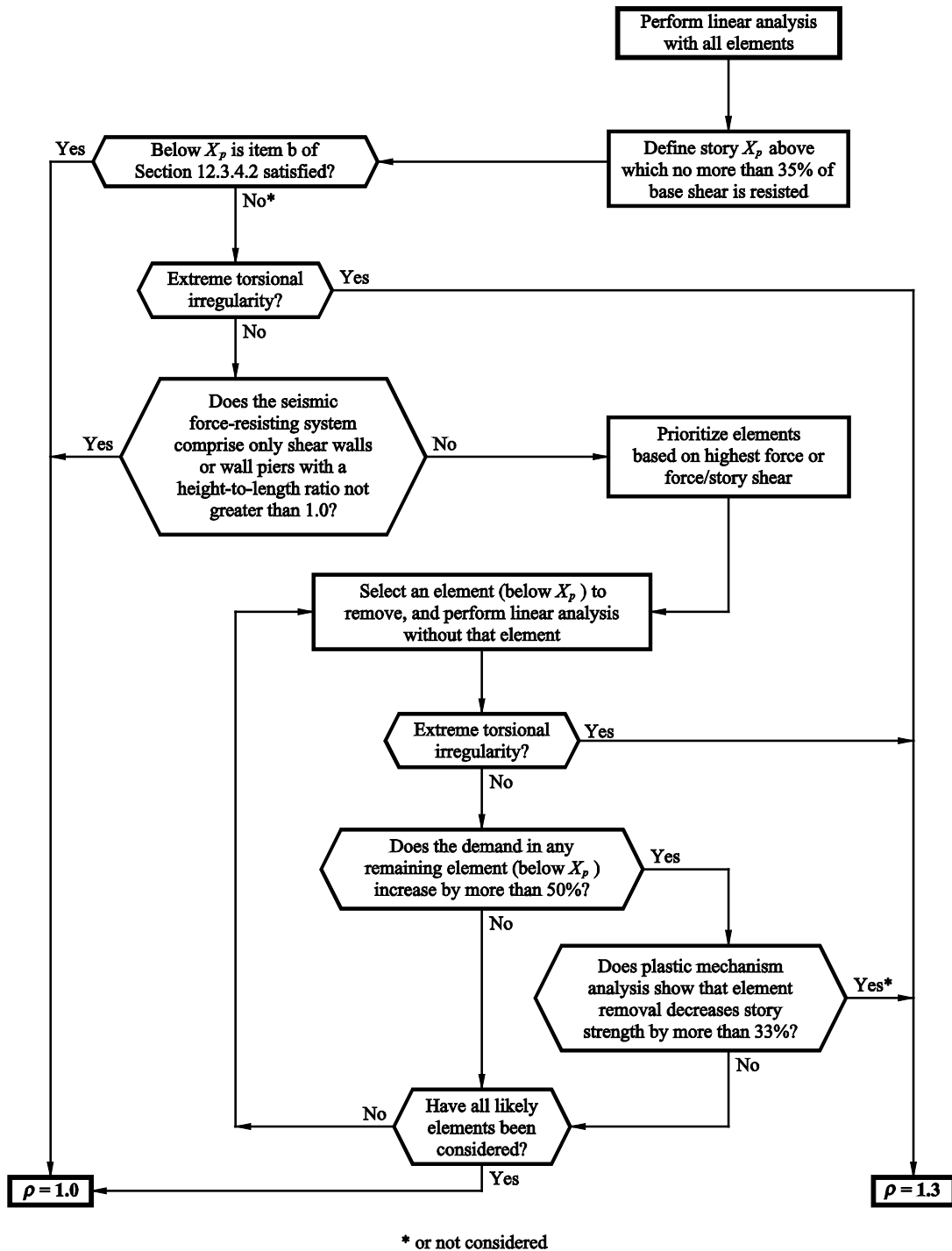

FIGURE C12.3-6 Calculation of the Redundancy Factor, ρ

As indicated in Table 12.3-3, braced frame, moment frame, shear wall, and cantilever column systems must conform to redundancy requirements. Dual systems also are included but, in most cases, are inherently redundant. Shear walls or wall piers with a height-to-length aspect ratio greater than 1.0 within any story have been included; however, the required design of collector elements and their connections for Ω_0 times the design force may address the key issues. To satisfy the collector force requirements, a reasonable number of shear walls usually is required. Regardless, shear wall systems are addressed in this section so

that either an adequate number of wall elements is included or the proper redundancy factor is applied. For wall piers, the height is taken as the height of the adjacent opening and generally is less than the story height.

The second approach is a deemed-to-comply condition wherein the structure is regular and has a specified arrangement of seismic force-resisting elements to qualify for a ρ of 1.0. As part of the parametric study, simplified braced frame and moment frame systems were investigated to determine their sensitivity to the analytical redundancy criteria. This simple deemed-to-comply condition is consistent with the results of the study.

C12.4 SEISMIC LOAD EFFECTS AND COMBINATIONS

C12.4.1 Applicability

Structural elements designated by the engineer as part of the seismic force-resisting system typically are designed directly for seismic load effects. None of the seismic forces associated with the design base shear are formally assigned to structural elements that are not designated as part of the seismic force-resisting system, but such elements must be designed using the load conditions of Section 12.4 and must accommodate the deformations resulting from application of seismic loads.

C12.4.2 Seismic Load Effect

Section 12.4 presents the required combinations of seismic forces with other loads. The load combinations are taken from the basic load combinations of Chapter 2 of the standard with further elaboration of the seismic load effect, E . The seismic load effect includes horizontal and vertical components. The horizontal seismic load effects, E_h , are caused by the response of the structure to horizontal seismic ground motions, whereas the vertical seismic load effects are caused by the response of the structure to vertical seismic ground motions. The basic load combinations in Chapter 2 were duplicated and reformulated in Section 12.4 to clarify the intent of the provisions for the vertical seismic load effect term, E_v .

The concept of using an equivalent static load coefficient applied to the dead load to represent vertical seismic load effects was first introduced in ATC 3-06 (1978), where it was defined as simply $\pm 0.2D$. The load combinations where the vertical seismic load coefficient was to be applied assumed strength design load combinations. Neither ATC 3-06 (1978) nor the early versions of the NEHRP provisions (FEMA 2009a) clearly explained how the values of 0.2 were determined, but it is reasonable to assume that it was based on the judgment of the writers of those documents. It is accepted by the writers of this standard that vertical ground motions do occur and that the value of $\pm 0.2S_{DS}$ was determined based on consensus judgment. Many issues enter into the development of the vertical coefficient, including phasing of vertical ground motion and appropriate R factors, which make determination of a more precise value difficult. Although no specific rationale or logic is provided in editions of the NEHRP provisions (FEMA 2009a) on how the value of $0.2S_{DS}$ was determined, one possible way to rationalize the selection of the $0.2S_{DS}$ value is to recognize that it is equivalent to $(2/3)(0.3)S_{DS}$, where the $2/3$ factor represents the often-assumed ratio between the vertical and horizontal components of motion, and the 0.3 factor represents the 30% in the 100% to 30% orthogonal load combination rule used for horizontal motions.

Although details regarding defining vertical ground motion spectra are currently well known, the committee elected not to define a vertical ground motion spectra in this standard because the approach provided by the equivalent static coefficient $0.2S_{DS}$ is adequate. For situations where one wishes to explicitly include the vertical component of ground motion in design analysis, one may use the vertical ground motion spectra definition that is provided in the “New Chapter 23, Vertical Ground Motions for Seismic Design” in the 2009 edition of the NEHRP provisions (FEMA 2009a).

C12.4.2.1 Horizontal Seismic Load Effect

Horizontal seismic load effects, E_h , are determined in accordance with Eq. (12.4-3) as $E_h = \rho Q_E$. Q_E is the seismic load effect of horizontal seismic forces from V or F_p . The purpose of E_h is to approximate the horizontal seismic load effect from the design basis earthquake to be used in load combinations including E for the design of lateral force-resisting elements including diaphragms, vertical elements of seismic force-resisting systems as defined in Table 12.2-1, the design and anchorage of elements such as structural walls, and the design of nonstructural components.

C12.4.2.2 Vertical Seismic Load Effect

The vertical seismic load effect, E_v , is determined with Eq. (12.4-4) as $E_v = 0.2S_{DS}D$. E_v is permitted to be taken as zero in Eqs. (12.4-1), (12.4-2), (12.4-5), and (12.4-6) if S_{DS} is equal to or less than 0.125 and in Eq. (12.4-2) for determining demands on the soil–structure interface of foundations. E_v increases the load on beams and columns supporting seismic elements and increases the axial load in the P–M interaction of walls resisting seismic load effects.

C12.4.2.3 Seismic Load Combinations

The seismic load effect, E , is combined with the effects of other loads as set forth in Chapter 2 of the standard. For strength design, the load combinations in Section 2.3.2 that include E are modified in Section 12.4.2.3 to include the horizontal and vertical seismic load effects of Sections 12.4.2.1 and 12.4.2.2, respectively. Similarly, the basic load combinations for allowable stress design in Section 2.4.1 that include E are also modified in Section 12.4.2.3 to include the same seismic load effects.

For structures subject to the effects of flood loads or ice loads, Chapter 2 of the standard requires the consideration of additional load combinations and should be consulted to determine which combinations include E .

C12.4.3 Seismic Load Effect Including Overstrength Factor

Some elements of properly detailed structures are not capable of safely resisting ground-shaking demands through inelastic behavior. To ensure safety, these elements must be designed with sufficient strength to remain elastic. The overstrength factor, Ω_0 , approximates the inherent overstrength in typical structures that have different seismic force-resisting systems.

C12.4.3.1 Horizontal Seismic Load Effect with Overstrength Factor

Horizontal seismic load effects with overstrength factor, E_{mh} , are determined in accordance with Eq. (12.4-7) as $E_{mh} = \Omega_0 Q_E$. Q_E is the effect of horizontal seismic forces from V , F_{px} , or F_p . The purpose for E_{mh} is to approximate the maximum seismic load for the design of critical elements, including discontinuous systems, transfer beams and columns supporting discontinuous systems, and collectors.

EXCEPTION: Seismic load effects, E , multiplied by Ω_0 , are an approximation of the maximum force these elements are ever likely to experience. The standard permits the seismic load effects, including overstrength factor, to be taken as less than the amount computed by applying Ω_0 to the design seismic forces where it can be determined that yielding of other elements in the structure limits the amount of load that can be delivered to the element and, therefore, the amount of force that can develop in the element.

As an example, the axial load in a column of a moment-resisting frame results from the shear forces in the beams that connect to this column. The axial loads caused by seismic load effects need never be taken as greater than the sum of the shears in these beams at the development of a full structural mechanism, considering the probable strength of the materials and strain-hardening effects. For frames controlled by beam hinge-type mechanisms, this load would typically be $2M_{pb}/L$ for steel frames where M_{pb} is the nominal plastic flexural strength of the beam as defined in AISC 341-10 (2010), and M_{pr}/l_n for concrete frames

where M_{pr} is the probable flexural strength of the beam and l_n is the clear span length as defined in ACI 318-08 (2008).

In this context, the capacity of the element is its expected or median anticipated strength, considering potential variation in material yield strength and strain-hardening effects. When calculating the capacity of elements for this purpose, material strengths should not be reduced by strength reduction or resistance factors, ϕ .

C12.4.3.2 Load Combinations with Overstrength Factor

The seismic load effect including overstrength factor, E_m , is combined with other loads as set forth in Chapter 2 using the load combinations as set forth in Section 12.4.3.2. The purpose for load combinations with overstrength factor is to approximate the maximum seismic load combination for the design of critical elements including discontinuous systems, transfer beams and columns supporting discontinuous systems, and collectors.

C12.4.3.3 Allowable Stress Increase for Load Combinations with Overstrength

The allowable stress increase for load combinations with overstrength is to provide compatibility with past practice.

C12.4.4 Minimum Upward Force for Horizontal Cantilevers for Seismic Design Categories D through F

In Seismic Design Categories D, E, and F, horizontal cantilevers are designed for an upward force that results from an effective vertical acceleration of 1.2 times gravity. This design requirement is meant to provide some minimum strength in the upward direction and to account for possible dynamic amplification of vertical ground motions resulting from the vertical flexibility of the cantilever. The requirement is not applied to downward forces on cantilevers, for which the typical load combinations are used.

C12.5 DIRECTION OF LOADING

Seismic forces are delivered to a building through ground accelerations that may approach from any direction relative to the orthogonal directions of the building; therefore, seismic effects are expected to develop in both directions simultaneously. The standard requires structures to be designed for the most critical loading effects from seismic forces applied in any direction. The procedures outlined in this section are deemed to satisfy this requirement.

For horizontal structural elements such as beams and slabs, orthogonal effects may be minimal; however, design of vertical elements of the seismic force-resisting system that participate in both orthogonal directions is likely to be governed by these effects.

C12.5.1 Direction of Loading Criteria

For structures with orthogonal seismic force-resisting systems, the most critical load effects can typically be computed using a pair of orthogonal directions that coincide with the principal axes of the structure. Structures with nonparallel or nonorthogonal systems may require a set of orthogonal direction pairs to determine the most critical load effects. If a three-dimensional mathematical model is used, the analyst must be attentive to the orientation of the global axes in the model in relation to the principal axes of the structure.

C12.5.2 Seismic Design Category B

Recognizing that design of structures assigned to Seismic Design Category (SDC) B is often controlled by nonseismic load effects and, therefore, is not sensitive to orthogonal loadings regardless of any horizontal structural irregularities, it is permitted to determine the most critical load effects by considering that the

maximum response can occur in any single direction; simultaneous application of response in the orthogonal direction is not required. Typically, the two directions used for analysis coincide with the principle axes of the structure.

C12.5.3 Seismic Design Category C

Design of structures assigned to SDC C often parallels the design of structures assigned to SDC B and, therefore, as a minimum conforms to Section 12.5.2. Although it is not likely that design of the seismic force-resisting systems in regular structures assigned to SDC C would be sensitive to orthogonal loadings, special consideration must be given to structures with nonparallel or nonorthogonal systems (Type 5 horizontal structural irregularity) to avoid overstressing by different directional loadings. In this case, the standard provides two methods to approximate simultaneous orthogonal loadings and requires a three-dimensional mathematical model of the structure for analysis in accordance with Section 12.7.3.

The orthogonal combination procedure in item (a) of Section 12.5.3 combines the effects from 100% of the seismic load applied in one direction with 30% of the seismic load applied in the perpendicular direction. This general approximation—the “30% rule”—was introduced by Rosenblueth and Contreras (1977) based on earlier work by A. S. Veletsos and also N. M. Newmark (cited in Rosenblueth and Contreras 1977) as an alternative to performing the more rational, yet computationally demanding, response history analysis, and is applicable to any elastic structure. Combining effects for seismic loads in each direction, and accidental torsion in accordance with Sections 12.8.4.2 and 12.8.4.3, results in the following 16 load combinations:

- $Q_E = +/- Q_{E_{X+AT}} +/- 0.3Q_{E_Y}$ where Q_{E_Y} = effect of Y -direction load at the center of mass (Section 12.8.4.2);
- $Q_E = +/- Q_{E_{X-AT}} +/- 0.3Q_{E_Y}$ where Q_{E_X} = effect of X -direction load at the center of mass (Section 12.8.4.2);
- $Q_E = +/- Q_{E_{Y+AT}} +/- 0.3Q_{E_X}$ where AT = accidental torsion computed in accordance with Sections 12.8.4.2 and 12.8.4.3; and
- $Q_E = +/- Q_{E_{Y-AT}} +/- 0.3Q_{E_X}$.

Though the standard permits combining effects from forces applied independently in any pair of orthogonal directions (to approximate the effects of concurrent loading), accidental torsion need not be considered in the direction that produces the lesser effect, per Section 12.8.4.2. This provision is sometimes disregarded when using a mathematical model for three-dimensional analysis that can automatically include accidental torsion, which then results in 32 load combinations.

The maximum effect of seismic forces, Q_E , from orthogonal load combinations is modified by the redundancy factor, ρ , or the overstrength factor, Ω_0 , where required, and the effects of vertical seismic forces, E_v , are considered in accordance with Section 12.4, to obtain the seismic load effect, E .

These orthogonal combinations should not be confused with uniaxial modal combination rules, such as the square root of the sum of the squares (SRSS) or the complete quadratic combination (CQC) method. In past standards, an acceptable alternative to the above was to use the SRSS method to combine effects of the two orthogonal directions, where each term computed is assigned the sign that resulted in the most conservative result. This method is no longer in common use. Although both approaches described for considering orthogonal effects are approximations, it is important to note that they were developed with consideration of results for a square building.

Orthogonal effects can alternatively be considered by performing three-dimensional response history analyses (see Chapter 16) with application of orthogonal ground motion pairs applied simultaneously in any two orthogonal directions. If the structure is located within 3 mi (5 km) of an active fault, the ground motion pair should be rotated to the fault-normal and fault-parallel directions of the causative fault.

C12.5.4 Seismic Design Categories D through F

The direction of loading for structures assigned to SDCs D, E, or F conforms to Section 12.5.3 for structures assigned to SDC C. If a Type 5 horizontal structural irregularity exists, then orthogonal effects are similarly included in design. Recognizing the higher seismic risk associated with structures assigned to SDCs D, E, or F, the standard provides additional requirements for vertical members coupled between intersecting seismic force-resisting systems.

C12.6 ANALYSIS PROCEDURE SELECTION

Table 12.6-1 provides the permitted analysis procedures for all Seismic Design Categories. The table is applicable only to buildings without seismic isolation (Chapter 17) or passive energy devices (Chapter 18) for which there are additional requirements in Sections 17.4 and 18.2.4, respectively.

The four basic procedures provided in Table 12.6-1 are the equivalent lateral force (ELF, Section 12.8), the modal response spectrum (MRS, Section 12.9), the linear response history (LRH, Section 16.1), and the nonlinear response history (NRH, Section 16.2) analysis procedures. Nonlinear static pushover analysis is not provided as an “approved” analysis procedure in the standard.

The ELF procedure is allowed for all buildings assigned to Seismic Design Category B or C and for all buildings assigned to Seismic Design Category D, E, or F, except for the following:

- Structures with structural height, h_n , > 160 ft (48.8 m) and $T > 3.5T_s$;
- Structures with structural height, h_n , > 160 ft (48.8 m) and $T \leq 3.5T_s$ but with one or more of the structural irregularities in Table 12.3-1 or 12.3-2; and
- Structures with structural height, h_n , < 160 ft (48.8 m) and with one or more of the following structural irregularities: torsion or extreme torsion (Table 12.3-1); or soft story, extreme soft story, weight (mass), or vertical geometric (Table 12.3-2).

$T_s = S_{D1}/S_{DS}$ is the period at which the horizontal and descending parts of the design response spectrum intersect (Fig. 11.4-1). The value of T_s depends on the site class because S_{DS} and S_{D1} include such effects. Where the ELF procedure is not allowed, the analysis must be performed using modal response spectrum or response history analysis.

The use of the ELF procedure is limited to buildings with the listed structural irregularities because the procedure is based on an assumption of a gradually varying distribution of mass and stiffness along the height and negligible torsional response. The basis for the $3.5T_s$ limitation is that the higher modes become more dominant in taller buildings (Lopez and Cruz 1996, Chopra 2007), and as a result, the ELF procedure may underestimate the seismic base shear and may not correctly predict the vertical distribution of seismic forces in taller buildings.

As Table C12.6-1 demonstrates, the value of $3.5T_s$ generally increases as ground motion intensity increases and as soils become softer. Assuming a fundamental period of approximately 0.1 times the number of stories, the maximum structural height, h_n , for which the ELF procedure applies ranges from about 10 stories for low seismic hazard sites with firm soil to 30 stories for high seismic hazard sites with soft soil. Because this trend was not intended, the 160-ft (48.8-m) height limit is introduced.

Table C12.6-1 Values of $3.5T_s$ for Various Cities and Site Classes

Location	S_s (g)	S_1 (g)	$3.5 T_s$ (s) for Site Class A & B	$3.5 T_s$ (s) for Site Class C	$3.5 T_s$ (s) for Site Class D	$3.5 T_s$ (s) for Site Class E
Denver	0.219	0.057	0.91	1.29	1.37	1.07
Boston	0.275	0.067	0.85	1.21	1.30	1.03
New York City	0.359	0.070	0.68	0.97	1.08	0.93
Las Vegas	0.582	0.179	1.08	1.50	1.68	1.89
St. Louis	0.590	0.169	1.00	1.40	1.60	1.81
San Diego	1.128	0.479	1.31	1.73	1.99	2.91
Memphis	1.341	0.368	0.96	1.38	1.59	2.25
Charleston	1.414	0.348	0.86	1.25	1.47	2.08
Seattle	1.448	0.489	1.18	1.55	1.78	2.63
San Jose	1.500	0.600	1.40	1.82	2.10	2.12
Salt Lake City	1.672	0.665	1.39	1.81	2.09	3.10

C12.7 MODELING CRITERIA

C12.7.1 Foundation Modeling

Structural systems consist of three interacting subsystems: the structural framing (girders, columns, walls, and diaphragms), the foundation (footings, piles, and caissons), and the supporting soil. The ground motion that a structure experiences, as well as the response to that ground motion, depends on the complex interaction among these subsystems.

Those aspects of ground motion that are affected by site characteristics are assumed to be independent of the structure–foundation system because these effects would occur in the free field in the absence of the structure. Hence, site effects are considered separately (Sections 11.4.2 through 11.4.4 and Chapters 20 and 21).

Given a site-specific ground motion or response spectrum, the dynamic response of the structure depends on the foundation system and on the characteristics of the soil that support the system. The dependence of the response on the structure–foundation–soil system is referred to as soil–structure interaction (SSI). Such interactions usually, but not always, result in a reduction of seismic base shear. This reduction is caused by the flexibility of the foundation–soil system and an associated lengthening of the fundamental period of vibration of the structure. In addition, the soil system may provide an additional source of damping. However, that total displacement typically increases with soil–structure interaction.

If the foundation is considered to be rigid, the computed base shears are usually conservative, and it is for this reason that rigid foundation analysis is permitted. The designer may neglect soil–structure interaction or may consider it explicitly in accordance with Section 12.13.3 or implicitly in accordance with Chapter 19.

As an example, consider a moment-frame building without a basement and with moment-frame columns supported on footings designed to support shear and axial loads, i.e., pinned column bases. If foundation flexibility is not considered, the columns should be restrained horizontally and vertically, but not rotationally. Consider a moment-frame building with a basement. For this building, horizontal restraint may be provided at the level closest to grade, as long as the diaphragm is designed to transfer the shear out of the moment frame. Because the columns extend through the basement, they may also be restrained rotationally and vertically at this level. However, it is often preferable to extend the model through the basement and provide the vertical and rotational restraints at the foundation elements, which is more consistent with the actual building geometry.

C12.7.2 Effective Seismic Weight

During an earthquake, the structure accelerates laterally, and these accelerations of the structural mass produce inertial forces. These inertial forces, accumulated over the height of the structure, produce the seismic base shear.

When a building vibrates during an earthquake, only that portion of the mass or weight that is physically tied to the structure needs to be considered as effective. Hence, live loads (e.g., loose furniture, loose equipment, and human occupants) need not be included. However, certain types of live loads, such as storage loads, may develop inertial forces, particularly where they are densely packed.

Also considered as contributing to effective seismic weight are the following:

1. All permanent equipment (e.g., air conditioners, elevator equipment, and mechanical systems);
2. Partitions to be erected or rearranged as specified in Section 4.3.2 (greater of actual partition weight and 10 lb/ft² of floor area);
3. 20% of significant snow load ($p_f > 30$ lb/ft²); and
4. The weight of landscaping and similar materials.

The full snow load need not be considered because maximum snow load and maximum earthquake load are unlikely to occur simultaneously and loose snow does not move with the roof.

C12.7.3 Structural Modeling

The development of a mathematical model of a structure is always required because the story drifts and the design forces in the structural members cannot be determined without such a model. In some cases, the mathematical model can be as simple as a free-body diagram as long as the model can appropriately capture the strength and stiffness of the structure.

The most realistic analytical model is three-dimensional, includes all sources of stiffness in the structure and the soil–foundation system as well as P-delta effects, and allows for nonlinear inelastic behavior in all parts of the structure–foundation–soil system. Development of such an analytical model is time consuming, and such analysis is rarely warranted for typical building designs performed in accordance with the standard. Instead of performing a nonlinear analysis, inelastic effects are accounted for indirectly in the linear analysis methods by means of the response modification coefficient, R , and the deflection amplification factor, C_d .

Using modern software, it often is more difficult to decompose a structure into planar models than it is to develop a full three-dimensional model, so three-dimensional models are now commonplace. Increased computational efficiency also allows efficient modeling of diaphragm flexibility. Three-dimensional models are required where the structure has horizontal torsional (Type 1), out-of-plane offset (Type 4), or nonparallel system (Type 5) irregularities.

Analysis using a three-dimensional model is not required for structures with flexible diaphragms that have horizontal out-of-plane offset irregularities. It is not required because the irregularity imposes seismic load effects in a direction other than the direction under consideration (orthogonal effects) because of eccentricity in the vertical load path caused by horizontal offsets of the vertical lateral force-resisting elements from story to story. This situation is not likely to occur, however, with flexible diaphragms to an extent that warrants such modeling. The eccentricity in the vertical load path causes a redistribution of seismic design forces from the vertical elements in the story above to the vertical elements in the story below in essentially the same direction. The effect on the vertical elements in the orthogonal direction in the story below is minimal. Three-dimensional modeling may still be required for structures with flexible diaphragms caused by other types of horizontal irregularities (e.g., nonparallel system).

In general, the same three-dimensional model may be used for the equivalent lateral force, the modal response spectrum, and the linear response history analysis procedures. Modal response spectrum and

linear response history analyses require a realistic modeling of structural mass; the response history method also requires an explicit representation of inherent damping. Five percent of critical damping is automatically included in the modal response spectrum approach. Chapter 16 and the related commentary have additional information on linear and nonlinear response history analysis procedures.

It is well known that deformations in the panel zones of the beam–column joints of steel moment frames are a significant source of flexibility. Two different mechanical models for including such deformations are summarized in Charney and Marshall (2006). These methods apply to both elastic and inelastic systems. For elastic structures, centerline analysis provides reasonable, but not always conservative, estimates of frame flexibility. Fully rigid end zones should not be used because this method always results in an overestimation of lateral stiffness in steel moment-resisting frames. Partially rigid end zones may be justified in certain cases, such as where doubler plates are used to reinforce the panel zone.

Including the effect of composite slabs in the stiffness of beams and girders may be warranted in some circumstances. Where composite behavior is included, due consideration should be paid to the reduction in effective composite stiffness for portions of the slab in tension (Schaffhausen and Wegmuller 1977 and Liew et al. 2001).

For reinforced concrete buildings, it is important to address the effects of axial, flexural, and shear cracking in modeling the effective stiffness of the structural elements. Determining appropriate effective stiffness of the structural elements should take into consideration the anticipated demands on the elements, their geometry, and the complexity of the model. Recommendations for computing cracked section properties may be found in Paulay and Priestley (1992) and similar texts.

C12.7.4 Interaction Effects

The interaction requirements are intended to prevent unexpected failures in members of moment-resisting frames. Fig. C12.7-1 illustrates a typical situation where masonry infill is used and this masonry is fitted tightly against reinforced concrete columns. Because the masonry is much stiffer than the columns, hinges in a column form at the top of the column and at the top of the masonry rather than at the top and bottom of the column. If the column flexural capacity is M_p , the shear in the columns increases by the factor H/h , and this increase may cause an unexpected nonductile shear failure in the columns. Many building collapses have been attributed to this effect.

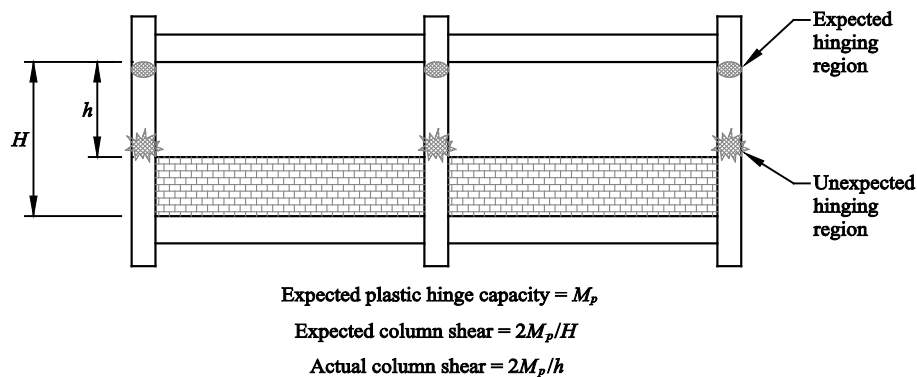

FIGURE C12.7-1 Undesired Interaction Effects

C12.8 EQUIVALENT LATERAL FORCE PROCEDURE

The equivalent lateral force (ELF) procedure provides a simple way to incorporate the effects of inelastic dynamic response into a linear static analysis. This procedure is useful in preliminary design of all structures and is allowed for final design of the vast majority of structures. The procedure is valid only for structures without significant discontinuities in mass and stiffness along the height, where the dominant response to ground motions is in the horizontal direction without significant torsion.

The ELF procedure has three basic steps:

1. Determine the seismic base shear, V ;
2. Distribute V vertically along the height of the structure; and
3. Distribute V horizontally across the width and breadth of the structure.

Each of these steps is based on a number of simplifying assumptions. A broader understanding of these assumptions may be obtained from any structural dynamics textbook that emphasizes seismic applications.

C12.8.1 Seismic Base Shear

Treating the structure as a single-degree-of-freedom system with 100% mass participation in the fundamental mode, Eq. (12.8-1) simply expresses V as the product of the effective seismic weight, W , and the seismic response coefficient, C_s , which is a period-dependent, spectral pseudoacceleration, in g units. C_s is modified by the response modification coefficient, R , and the importance factor, I_e , as appropriate, to account for inelastic behavior and to provide for improved performance for high-occupancy or essential structures.

C12.8.1.1 Calculation of Seismic Response Coefficient

The standard prescribes five equations for determining C_s . Eqs. (12.8-2), (12.8-3), and (12.8-4) are illustrated in Fig. C12.8-1.

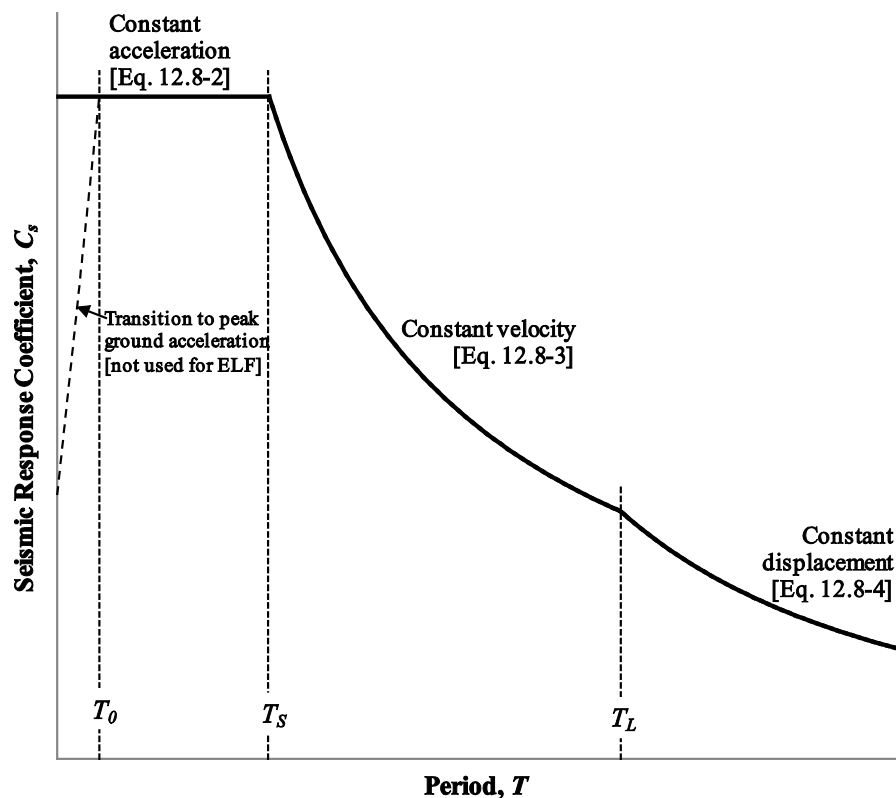

FIGURE C12.8-1 Seismic Response Coefficient Versus Period

Eq. (12.8-2) controls where $0.0 < T < T_s$ and represents the constant acceleration part of the design response spectrum (Section 11.4.5). In this region, C_s is independent of period. Although the theoretical design response spectrum shown in Fig. 11.4-1 illustrates a transition in pseudoacceleration to the peak ground acceleration as the fundamental period, T , approaches zero from T_0 , this transition is not used in the ELF

procedure. One reason is that simple reduction of the response spectrum by $(1/R)$ in the short period region would exaggerate inelastic effects.

Eq. (12.8-3), representing the constant velocity part of the spectrum, controls where $T_s < T < T_L$. In this region, the seismic response coefficient is inversely proportional to period, and the pseudovelocity (pseudoacceleration divided by circular frequency, ω , assuming steady-state response) is constant. T_L , the long-period transition period, represents the transition to constant displacement and is provided in Figs. 22-12 through 22-16. T_L ranges from 4 s in the north-central conterminous states and western Hawaii to 16 s in the Pacific Northwest and in western Alaska.

Eq. (12.8-4), representing the constant displacement part of the spectrum, controls where $T > T_L$. Given the current mapped values of T_L , this equation only affects long-period structures. The transition period has recently received increased attention because displacement response spectra from the 2010 magnitude 8.8 Chilean earthquake indicate that a considerably lower transition period is possible in locations controlled by subduction zone earthquakes.

The final two equations represent minimum base shear levels for design. Eq. (12.8-5) is the minimum base shear and primarily affects sites in the far field. This equation provides an allowable strength of approximately 3% of the weight of the structure. This minimum base shear was originally enacted in 1933 by the state of California (Riley Act). Based on research conducted in the ATC-63 project (FEMA 2009b), it was determined that this equation provides an adequate level of collapse resistance for long-period structures when used in conjunction with other provisions of the standard.

Eq. (12.8-6) applies to sites near major active faults (as reflected by values of S_1) where pulse-type effects can increase long-period demands.

C12.8.1.2 Soil–Structure Interaction Reduction

Soil–structure interaction, which can significantly influence the dynamic response of a structure during an earthquake, is addressed in Chapter 19.

C12.8.1.3 Maximum S_D Value in Determination of C_s

The maximum value of S_{DS} was created during the update from the 1994 UBC to the 1997 UBC. At that time near source factors were introduced which increased the design force for building in Zone 4, which is similar to Seismic Design Categories D through F in this standard. The near source factor was based on observations of instrument recording during the 1994 Northridge earthquake and new ground motion science. The cap on S_{DS} reflected engineering judgment about performance of code-complying structures in past earthquakes. In the 1997 UBC, the maximum reduction the cap provided was 30%. That is why this provision provides for a maximum reduction in design force of 30%.

Regular, low rise structures possessing well distributed seismic force resisting systems have been observed to perform well in historic earthquakes with respect to the intended performance of preventing collapse and significant loss of life, when the building is one of the permitted systems, so the structural height, period, redundancy, and regularity conditions required for use of the limit are very important qualifiers. Because the observations of acceptable performance have been with respect to collapse and life safety, not damage control or preservation of function, this cap on the design force is meant to only apply to Risk Category I and II structures. Also, because past earthquake experience has indicated that buildings on very soft soils, Site Classes E and F, have performed noticeably poorer than buildings on more competent ground, this cap cannot be used on those sites.

C12.8.2 Period Determination

The fundamental period, T , for an elastic structure is used to determine the design base shear, V , as well as the exponent, k , that establishes the distribution of V along the height of the structure (see Section 12.8.3). T may be computed using a mathematical model of the structure that incorporates the requirements of

Section 12.7 in a properly substantiated analysis. Generally, this type of analysis is performed using a computer program that incorporates all deformational effects (e.g., flexural, shear, and axial) and accounts for the effect of gravity load on the stiffness of the structure. For many structures, however, the sizes of the primary structural members are not known at the outset of design. For preliminary design, as well as instances where a substantiated analysis is not used, the standard provides formulas to compute an approximate fundamental period, T_a (see Section 12.8.2.1). These periods represent lower-bound estimates of T for different structure types. Period determination is typically computed for a mathematical model that is fixed at the base. That is, the base where seismic effects are imparted into the structure is globally restrained (e.g., horizontally, vertically, and rotationally). Column base modeling (i.e., pinned or fixed) for frame-type seismic force-resisting systems is a function of frame mechanics, detailing, and foundation (soil) rigidity; attention should be given to the adopted assumption. However, this conceptual restraint is not the same for the structure as is stated above. Soil flexibility may be considered for computing T (typically assuming a rigid foundation element). The engineer should be attentive to the equivalent linear soil-spring stiffness used to represent the deformational characteristics of the soil at the base (see Section 12.13.3). Similarly, pinned column bases in frame-type structures are sometimes used to conservatively account for soil flexibility under an assumed rigid foundation element. Period shifting of a fixed-base model of a structure caused by soil–structure interaction is permitted in accordance with Chapter 19.

The fundamental mode of a structure with a geometrically complex arrangement of seismic force-resisting systems determined with a three-dimensional model may be associated with the torsional mode of response of the system, with mass participating in both horizontal directions (orthogonal) concurrently. The analyst must be attentive to this mass participation and recognize that the period used to compute the design base shear should be associated to the mode with the largest mass participation in the direction being considered. Often in this situation, these periods are close to each other. Significant separation between the torsional mode period (when fundamental) and the shortest translational mode period may be an indicator of an ill-conceived structural system or potential modeling error. The standard requires that the fundamental period, T , used to determine the design base shear, V , does not exceed the approximate fundamental period, T_a , times the upper limit coefficient, C_u , provided in Table 12.8-1. This period limit prevents the use of an unusually low base shear for design of a structure that is, analytically, overly flexible because of mass and stiffness inaccuracies in the analytical model. C_u has two effects on T_a . First, recognizing that project-specific design requirements and design assumptions can influence T , C_u lessens the conservatism inherent in the empirical formulas for T_a to more closely follow the mean curve (Fig. C12.8-2). Second, the values for C_u recognize that the formulas for T_a are targeted to structures in high seismic hazard locations. The stiffness of a structure is most likely to decrease in areas of lower seismicity, and this decrease is accounted for in the values of C_u . The response modification coefficient, R , typically decreases to account for reduced ductility demands, and the relative wind effects increase in lower seismic hazard locations. The design engineer must therefore be attentive to the value used for design of seismic force-resisting systems in structures that are controlled by wind effects. Although the value for C_u is most likely to be independent of the governing design forces in high wind areas, project-specific serviceability requirements may add considerable stiffness to a structure and decrease the value of C_u from considering seismic effects alone. This effect should be assessed where design forces for seismic and wind effects are almost equal. Lastly, if T from a properly substantiated analysis (Section 12.8.2) is less than $C_u T_a$, then the lower value of T and $C_u T_a$ should be used for the design of the structure.

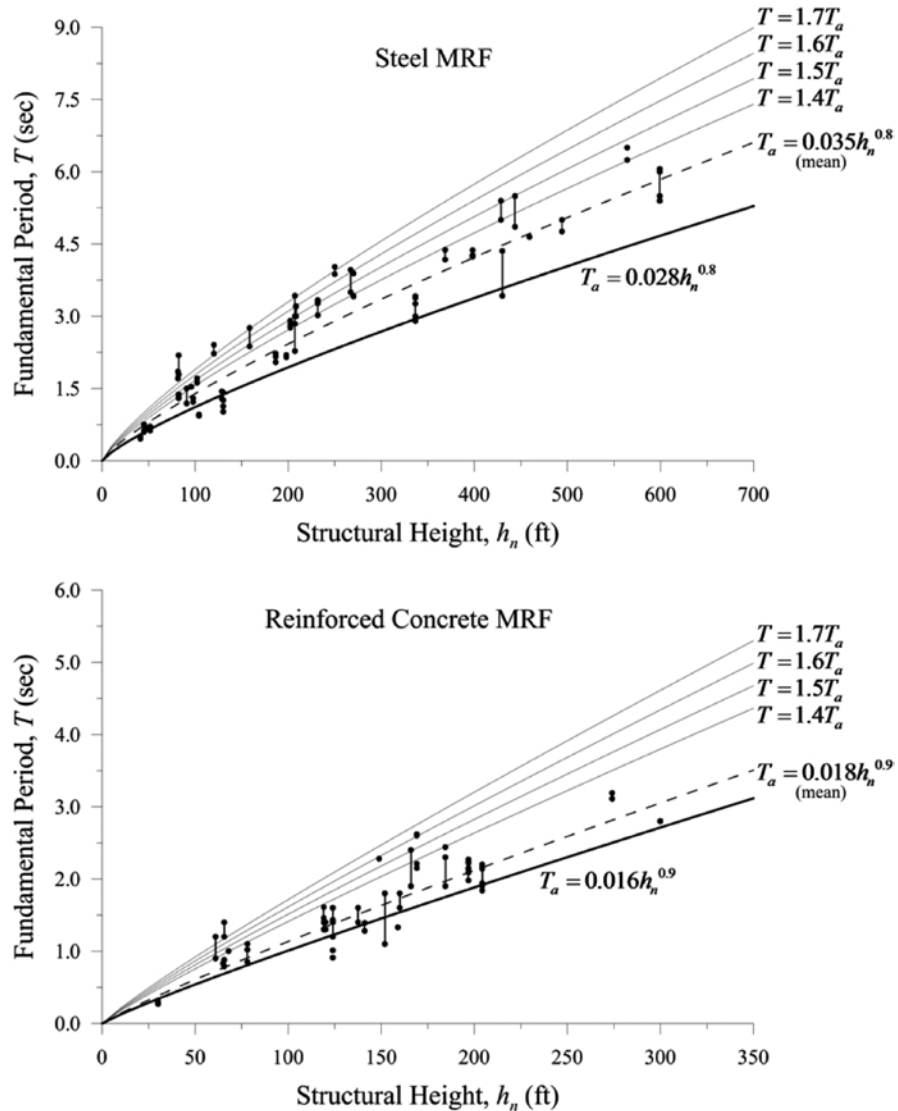

FIGURE C12.8-2 Variation of Fundamental Period with Structural Height

C12.8.2.1 Approximate Fundamental Period

Eq. (12.8-7) is an empirical relationship determined through statistical analysis of the measured response of building structures in small- to moderate-sized earthquakes, including response to wind effects (Goel and Chopra 1997 and 1998). Fig. C12.8-2 illustrates such data for various building structures with steel and reinforced concrete moment-resisting frames. Historically, the exponent, x , in Eq. (12.8-7) has been taken as 0.75 and was based on the assumption of a linearly varying mode shape while using Rayleigh's method. The exponents provided in the standard, however, are based on actual response data from building structures, thus more accurately reflecting the influence of mode shape on the exponent. Because the empirical expression is based on the lower bound of the data, it produces a lower bound estimate of the period for a building structure of a given height. This lower bound period, when used in Eqs. (12.8-3) and (12.8-4) to compute the seismic response coefficient, C_s , provides a conservative estimate of the seismic base shear, V .

C12.8.3 Vertical Distribution of Seismic Forces

Eq. (12.8-12) is based on the simplified first mode shape shown in Fig. C12.8-3. In the figure, F_x is the inertial force at level x , which is simply the absolute acceleration at level x times the mass at level x . The base shear is the sum of these inertial forces, and Eq. (12.8-11) simply gives the ratio of the lateral seismic force at level x , F_x , to the total design lateral force or shear at the base, V .

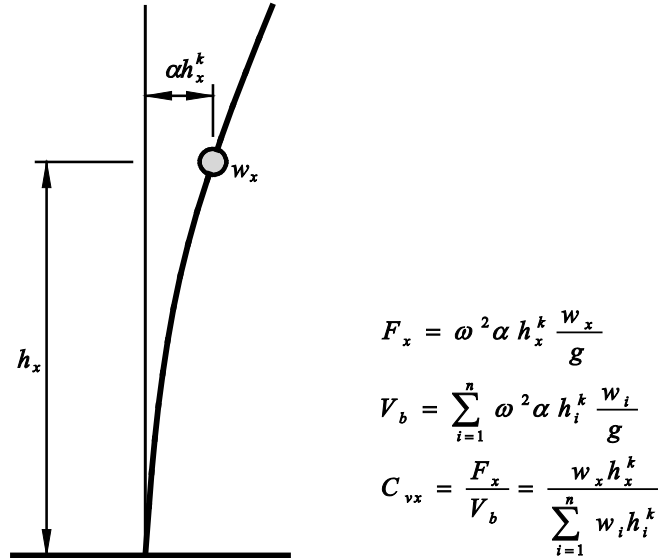

FIGURE C12.8-3 Basis of Eq. (12.8-12)

The deformed shape of the structure in Fig. C12.8-3 is a function of the exponent k , which is related to the fundamental period of the structure, T . The variation of k with T is illustrated in Fig. C12.8-4. The exponent k is intended to approximate the effect of higher modes, which are generally more dominant in structures with a longer fundamental period of vibration. Lopez and Cruz (1996) discuss the factors that influence higher modes of response. Although the actual first mode shape for a structure is also a function of the type of seismic force-resisting system, that effect is not reflected in these equations. Also, because T is limited to $C_u T_a$ for design, this mode shape may differ from that corresponding to the statistically based empirical formula for the approximate fundamental period, T_a . A drift analysis in accordance with Section 12.8.6 can be conducted using the actual period (see Section C12.8.6). As such, k changes to account for the variation between T and the actual period.

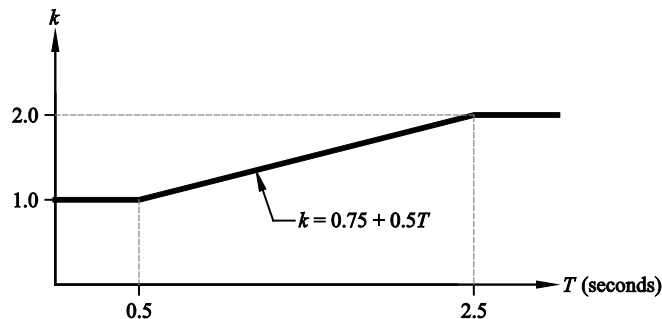

FIGURE C12.8-4 Variation of Exponent k with Period T

The horizontal forces computed using Eq. (12.8-11) do not reflect the actual inertial forces imparted on a structure at any particular point in time. Instead, they are intended to provide lateral seismic forces at

individual levels that are consistent with enveloped results from more accurate analyses (Chopra and Newmark 1980).

C12.8.4 Horizontal Distribution of Forces

Within the context of an ELF analysis, the horizontal distribution of lateral forces in a given story to various seismic force-resisting elements in that story depends on the type, geometric arrangement, and vertical extents of the structural elements and on the shape and flexibility of the floor or roof diaphragm. Because some elements of the seismic force-resisting system are expected to respond inelastically to the design ground motion, the distribution of forces to the various structural elements and other systems also depends on the strength of the yielding elements and their sequence of yielding (see Section C12.1.1). Such effects cannot be captured accurately by a linear elastic static analysis (Paulay 1997), and a nonlinear dynamic analysis is too computationally cumbersome to be applied to the design of most buildings. As such, approximate methods are used to account for uncertainties in horizontal distribution in an elastic static analysis, and to a lesser extent in elastic dynamic analysis.

Of particular concern in regard to the horizontal distribution of lateral forces is the torsional response of the structure during the earthquake. The standard requires that the inherent torsional moment be evaluated for every structure with diaphragms that are not flexible (see Section C12.8.4.1). Although primarily a factor for torsionally irregular structures, this mode of response has also been observed in structures that are designed to be symmetric in plan and layout of seismic force-resisting systems (De La Llera and Chopra 1994). This torsional response in the case of a torsionally regular structure is caused by a variety of “accidental” torsional moments caused by increased eccentricities between the centers of rigidity and mass that exist because of uncertainties in quantifying the mass and stiffness distribution of the structure, as well as torsional components of earthquake ground motion that are not included explicitly in code-based designs (Newmark and Rosenblueth 1971). Consequently, the accidental torsional moment can affect any structure, and potentially more so for a torsionally irregular structure. The standard requires that the accidental torsional moment be considered for every structure (see Section C12.8.4.2) as well as the amplification of this torsion for structures with torsional irregularity (see Section C12.8.4.3).

C12.8.4.1 Inherent Torsion

Where a rigid diaphragm is in the analytical model, the mass tributary to that floor or roof can be idealized as a lumped mass located at the resultant location on the floor or roof—termed the center of mass (CoM). This point represents the resultant of the inertial forces on the floor or roof. This diaphragm model simplifies structural analysis by reducing what would be many degrees of freedom in the two principal directions of a structure to three degrees of freedom (two horizontal and one rotational about the vertical axis). Similarly, the resultant stiffness of the structural members providing lateral stiffness to the structure tributary to a given floor or roof can be idealized as the center of rigidity (CoR).

It is difficult to accurately determine the center of rigidity for a multistory building because the center of rigidity for a particular story depends on the configuration of the seismic force-resisting elements above and below that story and may be load dependent (Chopra and Goel 1991). Furthermore, the location of the CoR is more sensitive to inelastic behavior than the CoM. If the CoM of a given floor or roof does not coincide with the CoR of that floor or roof, an inherent torsional moment, M_i , is created by the eccentricity between the resultant seismic force and the CoR. In addition to this *idealized* inherent torsional moment, the standard requires that an accidental torsional moment, M_{ta} , be considered (see Section C12.8.4.2).

Similar principles can be applied to models of semirigid diaphragms that explicitly model the in-plane stiffness of the diaphragm, except that the deformation of the diaphragm needs to be included in computing the distribution of the resultant seismic force and inherent torsional moment to the seismic force-resisting system.

This inherent torsion is included automatically when performing a three-dimensional analysis using either a rigid or semirigid diaphragm. If a two-dimensional planar analysis is used, where permitted, the CoR and CoM for each story must be determined explicitly and the applied seismic forces must be adjusted accordingly.

For structures with flexible diaphragms (as defined in Section 12.3), vertical elements of the seismic force-resisting system are assumed to resist inertial forces from the mass that is tributary to the elements with no explicitly computed torsion. No diaphragm is perfectly flexible; therefore some torsional forces develop even when they are neglected.

C12.8.4.2 Accidental Torsion

The locations of the centers of mass and rigidity for a given floor or roof typically cannot be established with a high degree of accuracy because of mass and stiffness uncertainty and deviations in design, construction, and loading from the idealized case. To account for this inaccuracy, the standard requires the consideration of a minimum eccentricity of 5% of the width of a structure perpendicular to the direction being considered to any static eccentricity computed using idealized locations of the centers of mass and rigidity. Where a structure has a geometrically complex or nonrectangular floor plan, the eccentricity is computed using the diaphragm extents perpendicular to the direction of loading (see Section C12.5).

One approach to account for this variation in eccentricity is to shift the CoM each way from its calculated location and apply the seismic lateral force at each shifted location as separate seismic load cases. It is typically conservative to assume that the CoM offsets at all floors and roof occur simultaneously and in the same direction. This offset produces an “accidental” static torsional moment, M_{ta} , at each story. Most computer programs can automate this offset for three-dimensional analysis by automatically applying these static moments in the autogenerated seismic load case (along the global coordinate axes used in the computer model—see Section C12.5). Alternatively, user-defined torsional moments can be applied as separate load cases and then added to the seismic lateral force load case. For two-dimensional analysis, the accidental torsional moment is distributed to each seismic force-resisting system as an applied static lateral force in proportion to its relative elastic lateral stiffness and distance from the CoR.

Shifting the CoM is a static approximation and thus does not affect the dynamic characteristics of the structure, as would be the case were the CoM to be physically moved by, for example, altering the horizontal mass distribution and mass moment of inertia. Although this “dynamic” approach can be used to adjust the eccentricity, it can be too computationally cumbersome for static analysis and therefore is reserved for dynamic analysis (see Section C12.9.5).

The previous discussion is applicable only to a rigid diaphragm model. A similar approach can be used for a semirigid diaphragm model except that the accidental torsional moment is decoupled into nodal moments or forces that are placed throughout the diaphragm. The amount of nodal action depends on how sensitive the diaphragm is to in-plane deformation. As the in-plane stiffness of the diaphragm decreases, tending toward a flexible diaphragm, the nodal inputs decrease proportionally.

The physical significance of this mass eccentricity should not be confused with the physical meaning of the eccentricity required for representing nonuniform wind pressures acting on a structure. However, this accidental torsion also incorporates to a lesser extent the potential torsional motion input into structures with large footprints from differences in ground motion within the footprint of the structure.

Torsionally irregular structures whose fundamental mode is potentially dominated by the torsional mode of response can be more sensitive to dynamic amplification of this accidental torsional moment. Consequently, the 5% minimum can underestimate the accidental torsional moment. In these cases, the standard requires the amplification of this moment for design when using an elastic static analysis procedure, including satisfying the drift limitations (see Section C12.8.4.3).

Accidental torsion results in forces that are combined with those obtained from the application of the seismic design story shears, V_x , including inherent torsional moments. All elements are designed for the maximum effects determined, considering positive accidental torsion, negative accidental torsion, and no accidental torsion (see Section C12.5). Where consideration of earthquake forces applied concurrently in any two orthogonal directions is required by the standard, it is permitted to apply the 5% eccentricity of the center of mass along the single orthogonal direction that produces the greater effect, but it need not be applied simultaneously in the orthogonal direction.

The exception in this section provides relief from accidental torsion requirements for buildings that are deemed to be relatively insensitive to torsion. It is supported by research (Debock et al., 2014) that compared the collapse probability (using nonlinear dynamic response-history analysis) of building designed with and without accidental torsion requirements. The research indicated that, while accidental torsion requirements are important for most torsionally-sensitive buildings (i.e., those with plan torsional irregularities arising from torsional flexibility or irregular plan layout), and especially for buildings in Seismic Design Category D, E or F, the implementation of accidental torsion provisions has little impact on collapse probability for Seismic Design Category B buildings without Type 1b horizontal structural irregularity and for Seismic Design Category D buildings without Type 1a or 1b irregularity.

The exception is included such that unnecessary accidental torsion requirements are not imposed for buildings that are insensitive to torsion. This exception is supported by research (Debock et al. 2014) that utilized nonlinear dynamic time history analysis to compare the collapse safety of buildings designed with and without the accidental torsion requirements. This study showed that accidental torsion requirements are important for most torsionally sensitive buildings (i.e. those with plan torsional irregularities, either due to being torsionally flexible or irregular due to plan layout) and especially important for buildings in Seismic Design Category D and above. This study also showed that accidental torsion requirements had little impact on collapse safety, and therefore are unnecessary, for Seismic Design Category B buildings without a Type 1b horizontal structural irregularity and Seismic Design Category D buildings without a Type 1a (or 1b) irregularity.

C12.8.4.3 Amplification of Accidental Torsional Moment

For structures with torsional or extreme torsional irregularity (Type 1a or 1b horizontal structural irregularity) analyzed using the equivalent lateral force procedure, the standard requires amplification of the accidental torsional moment to account for increases in the torsional moment caused by potential yielding of the perimeter seismic force-resisting systems (i.e., shifting of the center of rigidity), as well as other factors potentially leading to dynamic torsional instability. For verifying torsional irregularity requirements in Table 12.3-1, story drifts resulting from the applied loads, which include both the inherent and accidental torsional moments, are used with no amplification of the accidental torsional moment ($A_x = 1$). The same process is used when computing the amplification factor, A_x , except that displacements (relative to the base) at the level being evaluated are used in lieu of story drifts. Displacements are used here to indicate that amplification of the accidental torsional moment is primarily a system-level phenomenon, proportional to the increase in acceleration at the extreme edge of the structure, and not explicitly related to an individual story and the components of the seismic force-resisting system contained therein.

Eq. (12.8-14) was developed by the SEAOC Seismology Committee to encourage engineers to design buildings with good torsional stiffness; it was first introduced in the UBC-88 (ICBO 1988). Fig. C12.8-5 illustrates the effect of Eq. (12.8-14) for a symmetric rectangular building with various aspect ratios (L/B) where the seismic force-resisting elements are positioned at a variable distance (defined by α) from the center of mass in each direction. Each element is assumed to have the same stiffness. The structure is loaded parallel to the short direction with an eccentricity of $0.05L$.

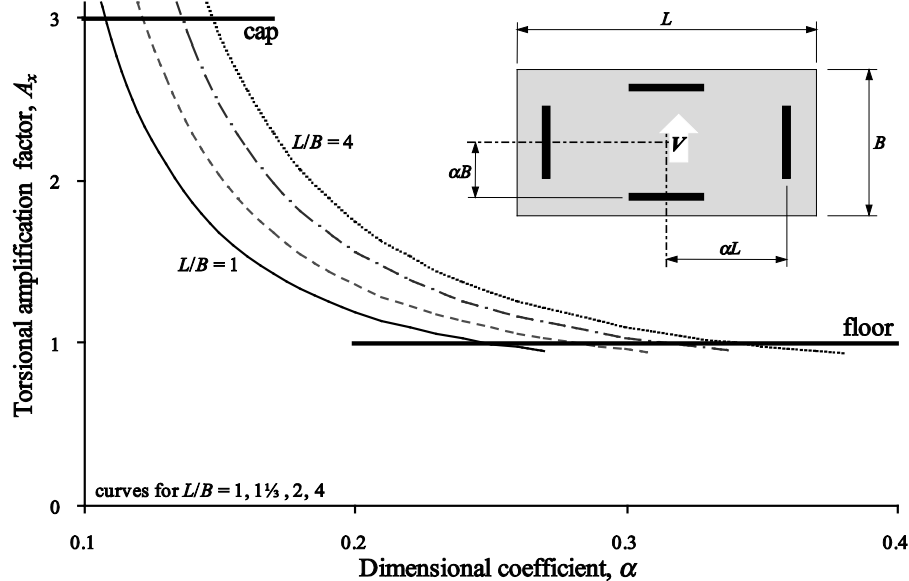

FIGURE C12.8-5 Torsional Amplification Factor for Symmetric Rectangular Buildings

For α equal to 0.5, these elements are at the perimeter of the building, and for α equal to 0.0, they are at the center (providing no torsional resistance). For a square building ($L/B = 1.00$), A_x is greater than 1.0 where α is less than 0.25 and increases to its maximum value of 3.0 where α is equal to 0.11. For a rectangular building with L/B equal to 4.00, A_x is greater than 1.0 where α is less than 0.34 and increases to its maximum value of 3.0 where α is equal to 0.15.

C12.8.5 Overturning

The overturning effect on a vertical lateral force-resisting element is computed based on the calculation of lateral seismic force, F_x , times the height from the base to the level of the horizontal lateral force-resisting element that transfers F_x to the vertical element, summed over each story. Each vertical lateral force-resisting element resists its portion of overturning based on its relative stiffness with respect to all vertical lateral force-resisting elements in a building or structure. The seismic forces used are those from the equivalent lateral force procedure determined in Section 12.8.3 or based on a dynamic analysis of the building or structure. The overturning forces may be resisted by dead loads and can be combined with dead and live loads or other loads, in accordance with the load combinations of Section 12.4.2.3.

C12.8.6 Story Drift Determination

Eq. (12.8-15) is used to estimate inelastic deflections (δ_x), which are then used to calculate design story drifts, Δ . These story drifts must be less than the allowable story drifts, Δ_a , of Table 12.12-1. For structures without torsional irregularity, computations are performed using deflections of the centers of mass of the floors bounding the story. If the eccentricity between the centers of mass of two adjacent floors, or a floor and a roof, is more than 5% of the width of the diaphragm extents, it is permitted to compute the deflection for the bottom of the story at the point on the floor that is vertically aligned with the location of the center of mass of the top floor or roof. This situation can arise where a building has story offsets and the diaphragm extents of the top of the story are smaller than the extents of the bottom of the story. For structures assigned to Seismic Design Category C, D, E, or F that are torsionally irregular, the standard requires that deflections be computed along the edges of the diaphragm extents using two vertically aligned points.

Fig. C12.8-6 illustrates the force-displacement relationships between elastic response, response to reduced design-level forces, and the expected inelastic response. If the structure remained elastic during an earthquake, the force developed would be V_E , and the corresponding displacement would be δ_E . V_E does

not include R , which accounts primarily for ductility and system overstrength. According to the equal displacement approximation rule of seismic response, the maximum displacement of an inelastic system is approximately equal to that of an elastic system with the same initial stiffness. This condition has been observed for structures idealized with bilinear inelastic response and a fundamental period, T , greater than T_s (see Section 11.4.5). For shorter period structures, peak displacement of an inelastic system tends to exceed that of the corresponding elastic system. Because the forces are reduced by R , the resulting displacements are representative of an elastic system and need to be amplified to account for inelastic response.

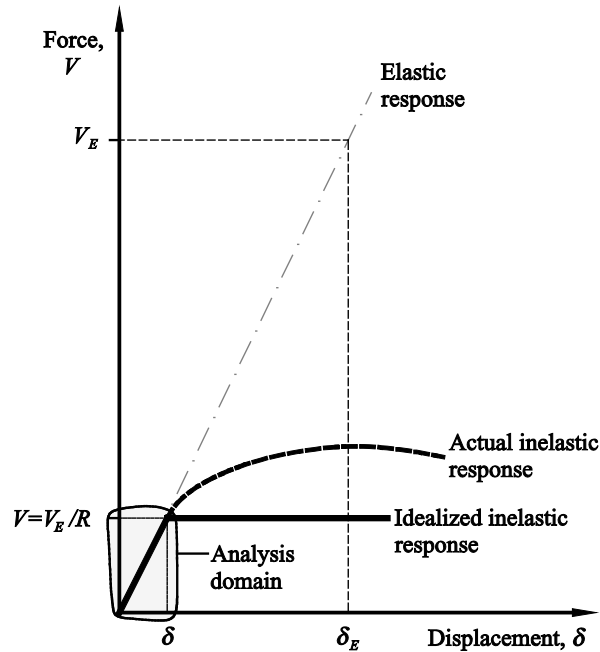

FIGURE C12.8-6 Displacements Used to Compute Drift

The deflection amplification factor, C_d , in Eq. (12.8-15) amplifies the displacements computed from an elastic analysis using prescribed forces to represent the expected inelastic displacement for the design-level earthquake and is typically less than R (Section C12.1.1). It is important to note that C_d is a story-level amplification factor and does not represent displacement amplification of the elastic response of a structure, either modeled as an *effective* single-degree-of-freedom structure (fundamental mode) or a constant amplification to represent the deflected shape of a multiple-degree-of-freedom structure, in effect, implying that the mode shapes do not change during inelastic response. Furthermore, drift-level forces are different than design-level forces used for strength compliance of the structural elements. Drift forces are typically lower because the computed fundamental period can be used to compute the base shear (see Section C12.8.6.2).

When conducting a drift analysis, the analyst should be attentive to the applied gravity loads used in combination with the strength-level earthquake forces so that consistency between the forces used in the drift analysis and those used for stability verification (P- Δ) in Section 12.8.7 is maintained, including consistency in computing the fundamental period if a second-order analysis is used. Further discussion is provided in Section C12.8.7.

The design forces used to compute the elastic deflection (δ_{ve}) include the importance factor, I_e , so Eq. (12.8-15) includes I_e in the denominator. This inclusion is appropriate because the allowable story drifts (except for masonry shear wall structures) in Table 12.12-1 are more stringent for higher risk categories.

C12.8.6.1 Minimum Base Shear for Computing Drift

Except for period limits (as described in Section C12.8.6.2), all of the requirements of Section 12.8 must be satisfied when computing drift for an ELF analysis, except that the minimum base shear determined from applying Eq. (12.8-5) does not need to be considered. This equation represents a minimum strength that needs to be provided to a system (see Section C12.8.1.1). Eq. (12.8-6) needs to be considered, when triggered, because it represents the increase in the response spectrum in the long-period range from near-fault effects.

C12.8.6.2 Period for Computing Drift

Where the design response spectrum of Section 11.4.5 or the corresponding equations of Section 12.8.1 are used and the fundamental period of the structure, T , is less than the long-period transition period, T_L , displacements increase with increasing period (even though forces may decrease). Section 12.8.2 applies an upper limit on T so that design forces are not underestimated, but if the lateral forces used to compute drifts are inconsistent with the forces corresponding to T , then displacements can be overestimated. To account for this variation in dynamic response, the standard allows the determination of displacements using forces that are consistent with the computed fundamental period of the structure without the upper limit of Section 12.8.2.

The analyst must still be attentive to the period used to compute drift forces. The same analytical representation (see Section C12.7.3) of the structure used for strength design must also be used for computing displacements. Similarly, the same analysis method (Table 12.6-1) used to compute design forces must also be used to compute drift forces. It is generally appropriate to use 85% of the computed fundamental period to account for mass and stiffness inaccuracies as a precaution against overly flexible structures, but it need not be taken as less than that used for strength design. The more flexible the structure, the more likely it is that P-delta effects ultimately control the design (see Section C12.8.7). Computed values of T that are significantly greater than (perhaps more than 1.5 times in high seismic areas) $C_u T_a$ may indicate a modeling error. Similar to the discussion in Section C12.8.2, the analyst should assess the value of C_u used where serviceability constraints from wind effects add significant stiffness to the structure.

C12.8.7 P-Delta Effects

Fig. C12.8-7 shows an idealized static force-displacement response for a simple one-story structure (e.g., idealized as an inverted pendulum-type structure). As the top of the structure displaces laterally, the gravity load, P , supported by the structure acts through that displacement and produces an increase in overturning moment by P times the story drift, Δ , that must be resisted by the structure—the so-called “P-delta (P- Δ) effect.” This effect also influences the lateral displacement response of the structure from an applied lateral force, F .

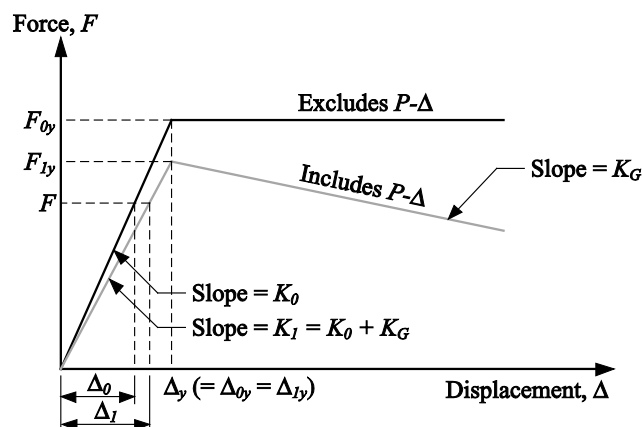

FIGURE C12.8-7 Idealized Response of a One-Story Structure with and without P- Δ

The response of the structure not considering the P- Δ effect is depicted by Condition 0 in the figure with a slope of K_0 and lateral first-order yield force F_{0y} . This condition characterizes the first-order response of the structure (the response of the structure from an analysis not including P-delta effects). Where the P- Δ effect is included (depicted by Condition 1 in the figure), the related quantities are K_1 and F_{1y} . This condition characterizes the second-order response of the structure (the response of the structure from an analysis including P-delta effects).

The geometric stiffness of the structure, K_G , in this example is equal to the gravity load, P , divided by the story height, h_{sx} . K_G is used to represent the change in lateral response by analytically reducing the elastic stiffness, K_0 . K_G is negative where gravity loads cause compression in the structure. Because the two response conditions in the figure are for the same structure, the inherent yield displacement of the structure is the same ($\Delta_{0y} = \Delta_{1y} = \Delta_y$).

Two consequential points taken from the figure are (1) the increase in required strength and stiffness of the seismic force-resisting system where the P- Δ effect influences the lateral response of the structure must be accounted for in design, and (2) the P- Δ effect can create a negative stiffness condition during postyield response, which could initiate instability of the structure. Where the postyield stiffness of the structure may become negative, dynamic displacement demands can increase significantly (Gupta and Krawinkler 2000).

One approach that can be used to assess the influence of the P- Δ effect on the lateral response of a structure is to compare the first-order response to the second-order response, which can be done using an elastic stability coefficient, θ , defined as the absolute value of K_G divided by K_0 .

$$\theta = \frac{|K_G|}{K_0} = \left| \frac{P\Delta_{0y}}{F_{0y}h_{sx}} \right| \quad (\text{C12.8-1})$$

Given the above, and the geometric relationships shown in Fig. C12.8-7, it can be shown that the force producing yield in condition 1 (with P- Δ effects) is

$$F_{1y} = F_{0y}(1 - \theta) \quad (\text{C12.8-2})$$

and that for a force, F , less than or equal to F_{1y}

$$\Delta_1 = \frac{\Delta_0}{1 - \theta} \quad (\text{C12.8-3})$$

Therefore, the stiffness ratio, K_0/K_1 , is

$$\frac{K_0}{K_1} = \frac{1}{1 - \theta} \quad (\text{C12.8-4})$$

In the previous equations,

F_{0y} = the lateral first-order yield force;

F_{1y} = the lateral second-order yield force;

h_{sx} = the story height (or structure height in this example);

K_G = the geometric stiffness;

K_0 = the elastic first-order stiffness;

K_1 = the elastic second-order stiffness;

P = the total gravity load supported by the structure;

Δ_0 = the lateral first-order drift;

Δ_{0y} = the lateral first-order yield drift;

Δ_1 = the lateral second-order drift;

Δ_{1y} = the lateral second-order yield drift; and

θ = the elastic stability coefficient

A physical interpretation of this effect is that to achieve the second-order response depicted in the figure, the seismic force-resisting system must be designed to have the increased stiffness and strength depicted by the first-order response. As θ approaches unity, Δ_1 approaches infinity and F_1 approaches zero, defining a state of static instability.

The intent of Section 12.8.7 is to determine whether P- Δ effects are significant when considering the first-order response of a structure and, if so, to increase the strength and stiffness of the structure to account for P- Δ effects. Some material-specific design standards require P- Δ effects to always be included in the elastic analysis of a structure and strength design of its members. The amplification of first-order member forces in accordance with Section 12.8.7 should not be misinterpreted to mean that these other requirements can be disregarded; nor should they be applied concurrently. Therefore, Section 12.8.7 is primarily used to verify compliance with the allowable drifts and check against potential postearthquake instability of the structure, while provisions in material-specific design standards are used to increase member forces for design, if provided. In so doing, the analyst should be attentive to the stiffness of each member used in the mathematical model so that synergy between standards is maintained.

Eq. (12.8-16) is used to determine the elastic stability coefficient, θ , of each story of a structure.

$$\theta = \frac{P\Delta_0}{F_0 h_{sx}} = \frac{P\Delta_e}{V_x h_{sx} C_d} \quad (C12.8-5)$$

where h_{sx} , I_e , and V_x are the same as defined in the standard and

F_0 = the force in a story causing $\Delta_0 = \sum F_x = V_x$;

Δ_0 = the elastic lateral story drift = $\Delta I_e / C_d$;

Δ = the inelastic story drift determined in accordance with Section 12.8.6; and

P = the total point-in-time gravity load supported by the structure

Structures with θ less than 0.10 generally are expected to have a positive monotonic postyield stiffness. Where θ for any story exceeds 0.10, P- Δ effects must be considered for the entire structure using one of the two approaches in the standard. Either first-order displacements and member forces are multiplied by $1/(1 - \theta)$ or the P- Δ effect is explicitly included in the structural analysis and the resulting θ is multiplied by $1/(1 + \theta)$ to verify compliance with the first-order stability limit. Most commercial computer programs can perform second-order analysis. The analyst must therefore be attentive to the algorithm incorporated in the software and cognizant of any limitations, including suitability of iterative and noniterative methods, inclusion of second-order effects (P- Δ and P- δ) in automated modal analyses, and appropriateness of superposition of design forces.

Gravity load drives the increase in lateral displacements from the equivalent lateral forces. The standard requires the total vertical design load, and the largest vertical design load for combination with earthquake loads is given by combination 5 from Section 2.3.2, which is transformed in Section 12.4.2.3 to be

$$(1.2 + 0.2S_{DS})D + 1.0L + 0.2S + 1.0E$$

where the 1.0 factor on L is actually 0.5 for many common occupancies. The provision of Section 12.8.7 allows the factor on dead load D to be reduced to 1.0 for the purpose of P-delta analysis under seismic loads. The vertical seismic component need not be considered for checking θ_{max} .

As explained in the commentary for Chapter 2, the 0.5 and 0.2 factors on L and S , respectively, are intended to capture the arbitrary point-in-time values of those loads. The factor 1.0 results in the dead load effect being fairly close to best estimates of the arbitrary point-in-time value for dead load. L is defined in Chapter 4 of the standard to include the reduction in live load based on floor area. Many commercially available computer programs do not include live load reduction in the basic structural analysis. In such programs,

live reduction is applied only in the checking of design criteria; this difference results in a conservative calculation with regard to the requirement of the standard.

The seismic story shear, V_x (in accordance with Section 12.8.4), used to compute θ includes the importance factor, I_e . Furthermore, the design story drift, Δ (in accordance with Section 12.8.6), does not include this factor. Therefore, I_e has been added to Eq. (12.8-16) to correct an apparent omission in previous editions of the standard. Nevertheless, the standard has always required V_x and Δ used in this equation to be those occurring simultaneously.

Eq. (12.8-17) establishes the maximum stability coefficient, θ_{\max} , permitted. The intent of this requirement is to protect structures from the possibility of instability triggered by postearthquake residual deformation. The danger of such failures is real and may not be eliminated by apparently available overstrength. This problem is particularly true of structures designed in regions of lower seismicity.

For the idealized system shown in Fig. C12.8-7, assume that the maximum displacement is $C_d\Delta_0$. Assuming that the unloading stiffness, K_u , is equal to the elastic stiffness, K_0 , the residual displacement is

$$\left(C_d - \frac{1}{\beta}\right)\Delta_0 \quad (C12.8-6)$$

Additionally, assume that there is a factor of safety, FS , of 2 against instability at the maximum residual drift, $\Delta_{r,\max}$. Evaluating the overturning and resisting moments ($F_0 = V_0$ in this example),

$$P\Delta_{r,\max} \leq \frac{V_0}{\beta FS}h \quad \text{where} \quad \beta = \frac{V_0}{V_{0y}} \leq 1.0 \quad (C12.8-7)$$

Therefore,

$$\frac{P[\Delta_0(\beta C_d - 1)]}{V_0h} \leq 0.5 \rightarrow \theta_{\max}(\beta C_d - 1) = 0.5 \rightarrow \theta_{\max} = \frac{0.5}{\beta C_d - 1}$$

Conservatively assume that $\beta C_d - 1 \approx \beta C_d$

$$\theta_{\max} = \frac{0.5}{\beta C_d} \leq 0.25 \quad (C12.8-9)$$

In the previous equations,

- C_d = the displacement amplification factor;
- FS = the factor of safety;
- h_{sx} = the story height (or height of the structure in this example);
- P = the total point-in-time gravity load supported by the structure;
- V_0 = the first-order story shear demand;
- V_{0y} = the first-order yield strength of the story;
- β = the ratio of shear demand to shear capacity;
- Δ_0 = the elastic lateral story drift;
- $\Delta_{r,\max}$ = the maximum residual drift at $V_0 = 0$; and
- θ_{\max} = the maximum elastic stability coefficient

The standard requires that the computed stability coefficient, θ , not exceed 0.25 or $0.5/\beta C_d$, where βC_d is an adjusted ductility demand that takes into account the variation between the story strength demand and the story strength supplied. The story strength demand is simply V_x . The story strength supplied may be computed as the shear in the story that occurs simultaneously with the attainment of the development of first significant yield of the overall structure. To compute first significant yield, the structure should be

loaded with a seismic force pattern similar to that used to compute story strength demand and iteratively increased until first yield. Alternatively, a simple and conservative procedure is to compute the ratio of demand to strength for each member of the seismic force-resisting system in a particular story and then use the largest such ratio as β .

The principal reason for inclusion of β is to allow for a more equitable analysis of those structures in which substantial extra strength is provided, whether as a result of added stiffness for drift control, code-required wind resistance, or simply a feature of other aspects of the design. Some structures inherently possess more strength than required, but instability is not typically a concern. For many flexible structures, the proportions of the structural members are controlled by drift requirements rather than strength requirements; consequently, β is less than 1.0 because the members provided are larger and stronger than required. This method has the effect of reducing the inelastic component of total seismic drift, and thus, β is placed as a factor on C_d .

Accurate evaluation of β would require consideration of all pertinent load combinations to find the maximum ratio of demand to capacity caused by seismic load effects in each member. A conservative simplification is to divide the total demand with seismic load effects included by the total capacity; this simplification covers all load combinations in which dead and live load effects add to seismic load effects. If a member is controlled by a load combination where dead load counteracts seismic load effects, to be correctly computed, β must be based only on the seismic component, not the total. The gravity load, P , in the P- Δ computation would be less in such a circumstance and, therefore, θ would be less. The importance of the counteracting load combination does have to be considered, but it rarely controls instability.

Although the P- Δ procedure in the standard reflects a simple static idealization as shown in Fig. C12.8-7, the real issue is one of dynamic stability. To adequately evaluate second-order effects during an earthquake, a nonlinear response history analysis should be performed that reflects variability of ground motions and system properties, including initial stiffness, strain hardening stiffness, initial strength, hysteretic behavior, and magnitude of point-in-time gravity load, P . Unfortunately, the dynamic response of structures is highly sensitive to such parameters, causing considerable dispersion to appear in the results (Vamvatsikos 2002). This dispersion, which increases dramatically with stability coefficient θ , is caused primarily by the incrementally increasing residual deformations (ratcheting) that occur during the response. Residual deformations may be controlled by increasing either the initial strength or the secondary stiffness. Gupta and Krawinkler (2000) give additional information.

C12.9 MODAL RESPONSE SPECTRUM ANALYSIS AND LINEAR RESPONSE HISTORY ANALYSIS

C12.9.1 Modal Response Spectrum Analysis

In the modal response spectrum analysis method, the structure is decomposed into a number of single-degree-of-freedom systems, each having its own mode shape and natural period of vibration. The number of modes available is equal to the number of mass degrees of freedom of the structure, so the number of modes can be reduced by eliminating mass degrees of freedom. For example, rigid diaphragm constraints may be used to reduce the number of mass degrees of freedom to one per story for planar models and to three per story (two translations and rotation about the vertical axis) for three-dimensional structures. However, where the vertical elements of the seismic force-resisting system have significant differences in lateral stiffness, rigid diaphragm models should be used with caution because relatively small in-plane diaphragm deformations can have a significant effect on the distribution of forces.

For a given direction of loading, the displacement in each mode is determined from the corresponding spectral acceleration, modal participation, and mode shape. Because the sign (positive or negative) and the time of occurrence of the maximum acceleration are lost in creating a response spectrum, there is no way to recombine modal responses exactly. However, statistical combination of modal responses produces reasonably accurate estimates of displacements and component forces. The loss of signs for computed

quantities leads to problems in interpreting force results where seismic effects are combined with gravity effects, produce forces that are not in equilibrium, and make it impossible to plot deflected shapes of the structure.

C12.9.1.1 Number of Modes

In general, the provisions require modal analysis to determine all individual modes of vibration, but permit modes with periods less than or equal to 0.05 seconds to be collectively treated as a single, rigid mode of response with an assumed period of 0.05 seconds. In general, structural modes of interest to building design have periods greater than 0.05 seconds (frequencies greater than 20 Hz.), and earthquake records tend to have little, if any, energy, at frequencies greater than 20 Hz. Thus, only “rigid” response is expected for modes with frequencies above 20 Hz. Although not responding dynamically, the “residual mass” of modes with frequencies greater than 20 Hz. should be included in the analysis to avoid underestimation of earthquake design forces.

Section 4.3 of ASCE 4-14 provides formulas which may be used to calculate the modal properties of the residual-mass mode. When using the formulas of ASCE 4-14 to calculate residual-mass mode properties, the “cut-off” frequency should be taken as 20 Hz. and response spectral acceleration at 20 Hz. (0.05 seconds) should be assumed to govern response of the residual-mass mode. It may be noted that the properties of residual-mass mode are derived from the properties of modes with frequencies less than or equal to 20 Hz., such that modal analysis need only determine properties of modes of vibration with periods greater than 0.05 seconds (when the residual-mass mode is included in the modal analysis). The design response spectral acceleration at 0.05 seconds (20 Hz) should be determined using Equation 11.4-5 of this *Standard* where the Design Response Spectrum shown in Figure 11.4-1 is being used for the design analysis. Substituting 0.05 seconds for T and $0.2 T_s$ for T_o in equation 11.4-5, one obtains the residual-mode response spectral acceleration as $S_a = S_{DS} [0.4 + 0.15/T_s]$. Most general purpose linear structural analysis software has the capacity to consider residual mass modes in order to meet the existing requirements of ASCE 4.

The exception permits excluding modes of vibration when such would result in a modal mass in each orthogonal direction of at least 90 per cent of the actual mass. This approach has been included in ASCE 7 for many years and is still considered adequate for most building structures that typically do not have significant modal mass in the very short period range.

C12.9.1.2 Modal Response Parameters

The design response spectrum (whether the general spectrum from Section 11.4.5 or a site-specific spectrum determined in accordance with Section 21.2) is representative of linear elastic structures. Division of the spectral ordinates by the response modification coefficient, R , accounts for inelastic behavior, and multiplication of spectral ordinates by the importance factor, I_e , provides the additional strength needed to improve the performance of important structures. The displacements that are computed using the response spectrum that has been modified by R and I_e (for strength) must be amplified by C_d and reduced by I_e to produce the expected inelastic displacements (see Section C12.8.6.)

C12.9.1.3 Combined Response Parameters

Most computer programs provide for either the SRSS or the CQC method (Wilson et al. 1981) of modal combination. The two methods are identical where applied to planar structures, or where zero damping is specified for the computation of the cross-modal coefficients in the CQC method. The modal damping specified in each mode for the CQC method should be equal to the damping level that was used in the development of the design response spectrum. For the spectrum in Section 11.4.5, the damping ratio is 0.05.

The SRSS or CQC method is applied to loading in one direction at a time. Where Section 12.5 requires explicit consideration of orthogonal loading effects, the results from one direction of loading may be added

to 30% of the results from loading in an orthogonal direction. Wilson (2000) suggests that a more accurate approach is to use the SRSS method to combine 100% of the results from each of two orthogonal directions where the individual directional results have been combined by SRSS or CQC, as appropriate.

The CQC-4 method (as modified by ASCE 4 (1999)) is also specified and is an alternative to the required use of the CQC method where there are closely spaced modes with significant cross-correlation of translational and torsional response. The CQC-4 method varies slightly from the CQC method through the use of a parameter that forces a correlation in modal responses where they are partially or completely in phase with the input motion. This difference primarily affects structures with short fundamental periods, T , that have significant components of response that are in phase with the ground motion. In these cases, using the CQC method can be nonconservative. A general overview of the various modal response combination methods can be found in U.S Nuclear Regulatory Commission (2012).

The SRSS or CQC method is applied to loading in one direction at a time. Where Section 12.5 requires explicit consideration of orthogonal loading effects, the results from one direction of loading may be added to 30 percent of the results from loading in an orthogonal direction. Wilson et al. (1995) suggests that a more accurate approach is to use the SRSS method to combine 100 percent of the results from each of two orthogonal directions where the individual directional results have been combined by SRSS or CQC, as appropriate. Menun and Der Kiureghian (1998) propose an alternate method, referred to as CQC3, that provides the critical orientation of the earthquake relative to the structure. Wilson (2000) now endorses the CQC3 method for combining the results from multiple component analyses.

C12.9.1.4 Scaling Design Values of Combined Response

The modal base shear, V_i , may be less than the ELF base shear, V , because: (a) the calculated fundamental period, T , may be longer than that used in computing V , (b) the response is not characterized by a single mode, or (c) the ELF base shear assumes 100 percent mass participation in the first mode, which is always an overestimate.

C12.9.1.4.1 Scaling of Forces

The scaling required by Section 12.9.4.1 provides, in effect, a minimum base shear for design. This minimum base shear is provided because the computed fundamental period may be the result of an overly flexible (incorrect) analytical model. Recent studies of building collapse performance such as those of FEMA P-695 (the ATC-63 Project), NIST GCR 10-917-8 (the ATC-76 Project) and NIST GCR 12-917-20 (the ATC-84 Project) show that designs based on the ELF procedure generally result in better collapse performance than those based on MRSA with the 15% reduction in base shear included. In addition, many of the designs using MRSA did not achieve the targeted 10% probability of collapse given MCE ground shaking. While scaling to 100% of the ELF base shear and to 100% of the drifts associated with Eq. 12.8-6 does not necessarily achieve the intended collapse performance, it does result in performance that is closer to the stated goals of this Standard. This change also corrects the misleading implication from the previous scaling criteria that MRSA achieves improved collapse performance relative to the ELF procedure.

C12.9.1.4.2 Scaling of Drifts

Displacements from the modal response spectrum are only scaled to the ELF base shear where V_i is less than $C_s W$ and C_s is determined based on Eq. 12.8-6. For all other situations, the displacements need not be scaled because the use of an overly flexible model will result in conservative estimates of displacement that need not be further scaled. The reason for requiring scaling when Eq. 12.8-6 controls the minimum based shear is to be consistent with the requirements for designs based on the ELF procedure.

C12.9.1.5 Horizontal Shear Distribution

Torsion effects in accordance with Section 12.8.4 must be included in the modal response spectrum analysis (MRSA) as specified in Section 12.9 by requiring use of the procedures in Section 12.8 for the

determination of the seismic base shear, V . There are two basic approaches for consideration of accidental torsion.

The first approach follows the static procedure discussed in Section C12.8.4.2, where the total seismic lateral forces obtained from the MRSA—using the computed locations of the centers of mass and rigidity—are statically applied at an artificial point offset from the center of mass to compute the accidental torsional moments. Most computer programs can automate this procedure for three-dimensional analysis. Alternatively, the torsional moments can be statically applied as separate load cases and added to the results obtained from the MRSA.

Because this approach is a static approximation, amplification of the accidental torsion in accordance with Section 12.8.4.3 is required. MRSA results in a single, positive response, thus inhibiting direct assessment of torsional response. One method to circumvent this problem is to determine the maximum and average displacements for each mode participating in the direction being considered and then apply modal combination rules (primarily the CQC method) to obtain the total displacements used to check torsional irregularity and compute the amplification factor, A_x . The analyst should be attentive about how accidental torsion is included for individual modal responses.

The second approach, which applies primarily to three-dimensional analysis, is to modify the dynamic characteristics of the structure so that dynamic amplification of the accidental torsion is directly considered. This modification can be done, for example, by either reassigning the lumped mass for each floor and roof (rigid diaphragm) to alternate points offset from the initially calculated center of mass and modifying the mass moment of inertia, or physically relocating the initially calculated center of mass on each floor and roof by modifying the horizontal mass distribution (typically presumed to be uniformly distributed). This approach increases the computational demand significantly because all possible configurations would have to be analyzed, primarily two additional analyses for each principal axis of the structure. The advantage of this approach is that the dynamic effects of direct loading and accidental torsion are assessed automatically. Practical disadvantages are the increased bookkeeping required to track multiple analyses and the cumbersome calculations of the mass properties.

Where this “dynamic” approach is used, amplification of the accidental torsion in accordance with Section 12.8.4.3 is not required because repositioning the center of mass increases the coupling between the torsional and lateral modal responses, directly capturing the amplification of the accidental torsion.

Most computer programs that include accidental torsion in a MRSA do so statically (first approach discussed above) and do not physically shift the center of mass. The designer should be aware of the methodology used for consideration of accidental torsion in the selected computer program.

C12.9.1.6 P-Delta Effects

The requirements of Section 12.8.7, including the stability coefficient limit, θ_{\max} , apply to modal response spectrum analysis.

C12.9.1.7 Soil–Structure Interaction Reduction

The standard permits including soil–structure interaction (SSI) effects in a modal response spectrum analysis in accordance with Chapter 19. The increased use of modal analysis for design stems from computer analysis programs automatically performing such an analysis. However, common commercial programs do not give analysts the ability to customize modal response parameters. This problem hinders the ability to include SSI effects in an automated modal analysis.

C12.9.1.8 Structural Modeling

Using modern software, it often is more difficult to decompose a structure into planar models than it is to develop a full three-dimensional model. As a result, three-dimensional models are now commonplace. Increased computational efficiency also allows efficient modeling of diaphragm flexibility. As a result,

when modal response spectrum analysis is used, a three-dimensional model is required for all structures, including those with diaphragms that can be designated as flexible.

C12.9.2 Linear Response History Analysis

C12.9.2.1 General Requirements

The Linear Response History (LRH) analysis method provided in this section is intended as an alternate to the Modal Response Spectrum (MRS) method. The principal motivation for providing the LRH method is that signs (positive-negative bending moments, tension-compression brace forces) are preserved, whereas they are lost in forming the SRSS and CQC combination in MRS analysis.

It is important to note that, like the ELF method and the MRS method, the LRH method is used as a basis for structural design, and not to predict how the structure will respond to a given ground motion. Thus, in the method provided in this section, spectrum matched ground motions are used in lieu of amplitude scaled motions. The analysis may be performed using modal superposition, or by direct analysis of the fully coupled equations of motion.

As discussed in Section 12.10.3, the LRH method requires the use of three sets of ground motions, with two orthogonal components in each set. These motions are then modified such that the response spectra of the modified motions closely match the shape of the target response spectrum. Thus, the maximum computed response in each mode will be virtually identical to the value obtained from the target response spectrum. The only difference between the MRS method and the LRH method (as developed in this section using the spectral matched ground motions) is that in the MRS method the system response is computed by statistical combination (SRSS or CQC) of the modal responses and in the LRH method the system response is obtained by direct addition of modal responses or by simultaneous solution of the full set of equations of motion.

12.9.2.2 General Modeling Requirements

Three-dimensional modeling is required for conformance with the inherent and accidental torsion requirements of Section 12.9.2.2.2.

C12.9.2.2.1 P-Delta Effects

A static analysis is required to determine the story stability coefficients using Equation 12.8-17. Typically the mathematical model used to compute the quantity Δ in Equation 12.8-16 does not directly include P-Delta effects. However, Section 12.8.7 provides a methodology for checking compliance with the θ_{max} limit where P-Delta effects are directly included in the model. For dynamic analysis, a post-facto modification of results from an analysis that does not include P-Delta effects to one that does (approximately) include such effects is not rational.

Given that virtually all software that performs response history analysis has the capability to directly include P-Delta effects, it is required that P-Delta effects be included in all analysis, even when the maximum stability ratio at any level is less than 0.1. The inclusion of such effects will cause a lengthening of the period of vibration of the structure, and this period should be used for establishing the range of periods for spectrum matching (Section 12.10.3.1) and for selecting the number of modes to include in the response (Section 12.9.2.2.4).

While the P-Delta effect is essentially a nonlinear phenomenon (stiffness depends on displacements and displacements depend on stiffness), such effects are often "linearized" by forming a constant geometric stiffness matrix that is created from member forces generated from an initial gravity load analysis (Wilson and Habibullah, 1987; Wilson, 2004). This approach works for both the modal superposition method and the direct analysis method. It is noted, however, that there are some approximations in this method, principally the way the global torsional component of P-Delta effects is handled. The method is of sufficient

accuracy in analysis for which materials remain elastic. Where direct integration is used, a more accurate response can be computed by iteratively updating the geometric stiffness at each time step or by iteratively satisfying equilibrium about the deformed configuration. In either case the analysis is in fact "nonlinear", but it is considered as a linear analysis in Section 12.9 because material properties remain linear.

C12.9.2.2.2 Accidental Torsion

The required 5 percent offset of the center of mass need not be applied in both orthogonal directions at the same time. Direct modeling of accidental torsion by offsetting the center of mass is required to retain the signs (positive-negative bending moments, tension-compression forces in braces). In addition to the four mathematical models with mass offsets, a fifth model without accidental torsion (including only inherent torsion) must also be prepared. The model without accidental torsion is needed as the basis for scaling results as required in Section 12.9.2.5. While not a requirement of the LRH method, the analyst may also compare the modal characteristics (periods, mode shapes) to the systems with and without accidental mass eccentricity to gauge the sensitivity of the structure to accidental torsional response.

C12.9.2.2.3 Foundation Modeling

Foundation flexibility may be included in the analysis. Where such modeling is used, the requirements of Section 12.13.3 should be satisfied. Additional guidance on modeling foundation effects may be found in (NIST, 2010).

C12.9.2.2.4 Number of Modes to Include in Response History Analysis

Where modal response history analysis is used it is common to analyze only a subset of the modes. In the past, the number of modes to analyze has been determined such that a minimum of 90% of the effective mass in each direction is captured in the response. An alternate procedure that produces participation of 100% of the effective mass is to represent all modes with periods less than 0.05 seconds in a single rigid body mode having a period of 0.05 seconds. In direct analysis the question of the number of modes to include does not arise because the system response is computed without modal decomposition.

An example of a situation where it would be difficult to obtain 90% of the mass in a reasonable number of modes is reported in Chapter 4 of FEMA P-751 (2013), which presents the dynamic analysis of a 12-story building over a 1-story basement. When the basement walls and grade level diaphragm were excluded from the model, 12 modes were sufficient to capture 90% of the effective mass. When the basement was modeled as a stiff first story, it took more than 120 modes to capture 90% percent of the total mass (including the basement and the ground level diaphragm). It is noted in the Chapter 4 discussion that when the full structure was modeled and only 12 modes were used, the member forces and system deformations obtained were virtually identical to those obtained when 12 modes were used for the fixed-base system (modeled without the podium).

If modal response history analysis is used and it is desired to use a mathematical model that includes a stiff podium, it might be beneficial to use Ritz vectors in lieu of eigenvectors (Wilson, 2004). Another approach is the use of the "Static Correction Method" in which the responses of the higher modes are determined by a static analysis instead of a dynamic analysis (Chopra 2008). The requirement in Section 12.10.2.4 of including all modes with periods of less than 0.05 seconds as a rigid body mode is in fact an implementation of the static correction method.

C12.9.2.2.5 Damping

Where modal superposition analysis is used five percent damping should be specified for each mode because it is equal to the damping used in the development of the response spectrum specified in Section 11.4.5 and in Section 21.1.3. Where direct analysis is used it is possible, but not common to form a damping matrix that provides uniform damping across all modes (Wilson and Penzien, 1972). It is more common to use a mass and stiffness proportional damping matrix (i.e. Rayleigh Damping), but when this is done the

damping ratio may be specified at only two periods. Damping ratios at other periods depend on the mass and stiffness proportionality constants. At periods associated with higher modes, the damping ratios may become excessive, effectively damping out important modes of response. To control this, Section 12.9.2.2.5 requires the damping in all included modes (with periods as low as T_{Lower}) be less than or equal to 5% critical.

C12.9.2.3 Ground Motion Selection and Scaling

Response spectrum matching (also called spectral matching) is the non-uniform scaling of an actual or artificial ground motion such that its pseudoacceleration response spectrum closely matches a target spectrum. In most cases the target spectrum is the same spectrum used for scaling actual recorded ground motions (i.e. the ASCE 7 design spectrum). Spectral matching can be contrasted with amplitude scaling, in which a uniform scale factor is applied to the ground motion. The principal advantage of spectral matching is that fewer ground motions, compared to amplitude scaling, can be used to arrive at an acceptable estimate of the mean response (NIST 2011). Figure C12.9-1(a) shows the response spectra of two ground motions that have been spectral matched and Figure C12.9-1(b) shows the response spectra of the original ground motions. In both cases the ground motions are normalized to match the target response spectrum at a period of 1.10 sec. Clearly, the two amplitude scaled records will result in significantly different responses, whereas analysis using the spectrum matched records will be very similar. As described later however, there is enough variation in the response using spectrum matched records to require the use of more than one record in the response history analysis.

A variety of methods are available for spectrum matching, and the reader is referred to Hancock, et al. (2006) for details. Additional information on use of spectrum matched ground motions in response history analysis is provided by Grant and Diaferia (2012).

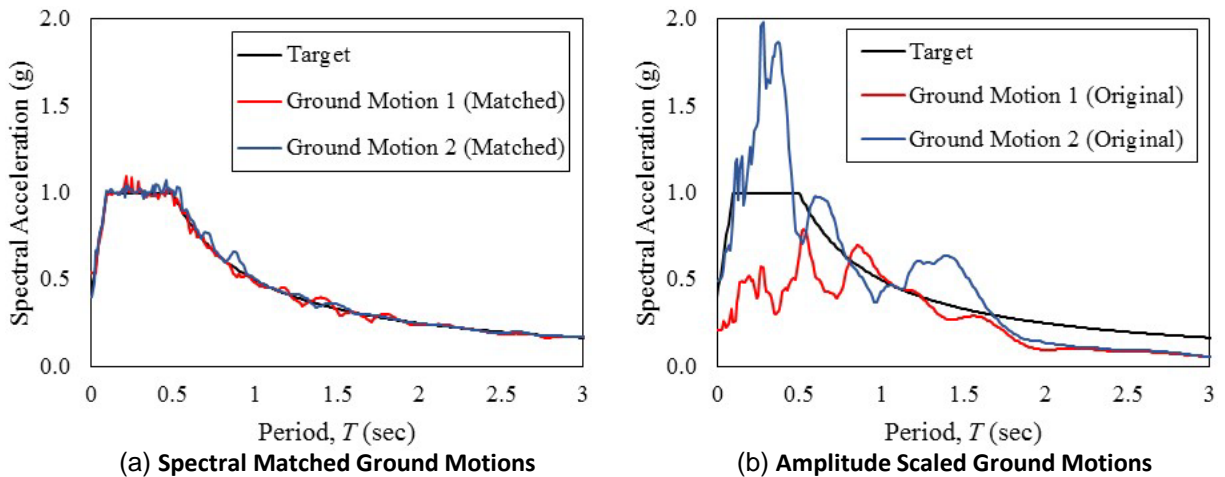

FIGURE C12.9-1 Spectral Matching vs. Amplitude Scaled Response Spectra

C12.9.2.3.1 Procedure for Spectrum Matching

Experience with spectrum matching has indicated that it is easier to get a good match when the matching period extends beyond the period range of interest. It is for this reason that spectrum matching is required over the range $0.8 T_{Lower}$ to $1.2 T_{Upper}$. For the purposes of this section, a good match is defined when the ordinates of the average (arithmetic mean) of the computed acceleration spectrum from the matched records in each direction does not fall below the target spectrum by more than 10 percent over the period range of interest.

C12.9.2.4 Application of Ground Acceleration Histories

One of the advantages of linear response history analysis is that analyses for gravity loads and for ground shaking may be computed separately and then combined in accordance with Section 12.4.2. Where linear response history analysis is performed in accordance with Section 12.10, it is required that each direction of response for each ground motion be computed independently. This requirement is based on the need to apply different scaling factors in the two orthogonal directions. It will be required to run analyses with and without accidental torsion for each ground motion. Thus, the total number of response histories that need to be computed is 18. (For each ground motion one analysis is needed in each direction without mass eccentricity, and two analyses are needed in each direction to account for accidental torsion. These six cases times three ground motions gives 18 required analyses.)

As specified in Section 12.9.2.7, envelope values are used to determine the seismic deformations and displacements used in design. One advantage of this approach is that the three motions in each direction may be applied in one dynamic analysis, with the records placed end to end. Where this approach is used, it is recommended that some dead time (with ground acceleration of zero) be placed between the individual records to allow the response for one motion to effectively damp out before the next motion arrives. Dead times of approximately 10 times the fundamental period of vibration are recommended. Where the records are applied in the manner, the total required number of response history analyses required for the LRH procedure reduces to six.

C12.9.2.5 Modification of Response for Inelastic Behavior

The dynamic responses computed using spectrum matched motions are elastic responses, and must be modified for inelastic behavior.

For force based quantities the design base shear computed from the dynamic analysis must not be less than the base shear computed using the equivalent lateral force method. The factors η_x and η_y , computed in section 12.9.2.5.3, serve that purpose. Next, the force responses must be multiplied by I_e and divided by R . This modification, together with the application of the ELF scale factors, is accomplished in Section 12.9.2.5.4.

For displacement base quantities it is not required to normalize to ELF, and computed response history quantities need be multiplied only by the appropriate C_d/R in the direction of interest. This is accomplished in Section 12.9.2.5.5.

While accidental torsion is not required for determining the maximum elastic base shear, which is used only for determining the required base shear scaling, it is required for all analyses that are used to determine design displacements and member forces.

C12.9.2.6 Enveloping of Force Response Quantities

Forces used in design are the envelope of forces computed from all analyses. Thus, for a brace, the maximum tension and the maximum compression forces are obtained. For a beam-column, envelope values of axial force and envelope values of bending moment are obtained, but these actions do not likely occur at the same time, and using these values in checking member capacity is not rational. The preferred approach is to record the histories of axial forces and bending moments, and to plot their traces together with the interaction diagram of the member. If all points of the force trace fall inside the interaction diagram, for all ground motions analyzed, the design is sufficient. An alternate is to record member demand to capacity ratio histories (also called usage ratio histories), and to base the design check on the envelope of these values.

C12.10 DIAPHRAGMS, CHORDS, AND COLLECTORS

This section permits choice of diaphragm design in accordance with either the provisions in Sections 12.10.1 and 12.10.2 or the new provisions of Section 12.10.3 for all diaphragms except precast diaphragms in SDC C through F. Use of the Section 12.10.3 provisions is required for precast diaphragm systems in SDC C through F based on recent research that indicates that enhanced earthquake performance can thus be attained. Although the provisions of Section 12.10.3 present a more rational approach to diaphragm design than those of Sections 12.10.1 and 12.10.2, many conventional diaphragm systems designed in accordance with Sections 12.10.1 and 12.10.2 have performed adequately. In the future, once engineers have become familiar and comfortable with the provisions of Section 12.10.3, consideration may be given to removal of the provisions in Sections 12.10.1 and 12.10.2.

C12.10.1 Diaphragm Design

Diaphragms are generally treated as horizontal deep beams or trusses that distribute lateral forces to the vertical elements of the seismic force-resisting system. As deep beams, diaphragms must be designed to resist the resultant shear and bending stresses. Diaphragms are commonly compared to girders, with the roof or floor deck analogous to the girder web in resisting shear, and the boundary elements (chords) analogous to the flanges of the girder in resisting flexural tension and compression. As in girder design, the chord members (flanges) must be sufficiently connected to the body of the diaphragm (web) to prevent separation and to force the diaphragm to work as a single unit.

Diaphragms may be considered flexible, semirigid, or rigid. The flexibility or rigidity of the diaphragm determines how lateral forces are distributed to the vertical elements of the seismic force-resisting system (see Section C12.3.1). Once the distribution of lateral forces is determined, shear and moment diagrams are used to compute the diaphragm shear and chord forces. Where diaphragms are not flexible, inherent and accidental torsion must be considered in accordance with Section 12.8.4.

Diaphragm openings may require additional localized reinforcement (subchords and collectors) to resist the subdiaphragm chord forces above and below the opening and to collect shear forces where the diaphragm depth is reduced (Fig. C12.10-1). Collectors on each side of the opening drag shear into the subdiaphragms above and below the opening. The subchord and collector reinforcement must extend far enough into the adjacent diaphragm to develop the axial force through shear transfer. The required development length is determined by dividing the axial force in the subchord by the shear capacity (in force/unit length) of the main diaphragm.

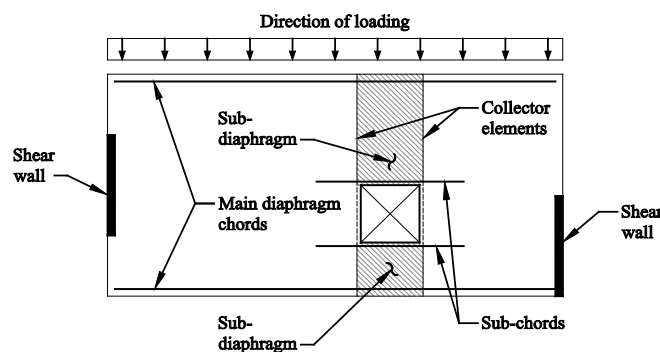

FIGURE C12.10-1 Diaphragm with an Opening

Chord reinforcement at reentrant corners must extend far enough into the main diaphragm to develop the chord force through shear transfer (Fig. C12.10-2). Continuity of the chord members also must be considered where the depth of the diaphragm is not constant.

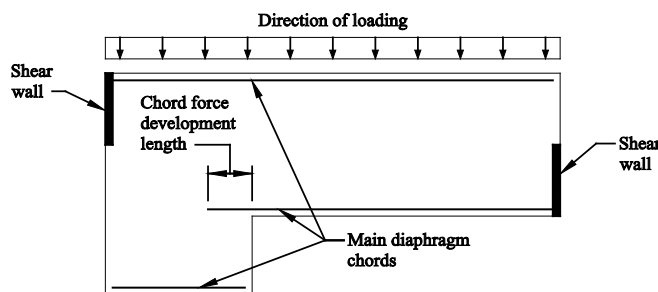

FIGURE C12.10-2 Diaphragm with a Reentrant Corner

In wood and metal deck diaphragm design, framing members are often used as continuity elements, serving as subchords and collector elements at discontinuities. These continuity members also are often used to transfer wall out-of-plane forces to the main diaphragm, where the diaphragm itself does not have the capacity to resist the anchorage force directly. For additional discussion, see Sections C12.11.2.2.3 and C12.11.2.2.4.

C12.10.1.1 Diaphragm Design Forces

Diaphragms must be designed to resist inertial forces, as specified in Eq. (12.10-1) and to transfer design seismic forces caused by horizontal offsets or changes in stiffness of the vertical resisting elements. Inertial forces are those seismic forces that originate at the specified diaphragm level, whereas the transfer forces originate above the specified diaphragm level. The redundancy factor, ρ , used for design of the seismic force-resisting elements also applies to diaphragm transfer forces, thus completing the load path.

C12.10.2.1 Collector Elements Requiring Load Combinations with Overstrength Factor for Seismic Design Categories C through F

The overstrength requirement of this section is intended to keep inelastic behavior in the ductile elements of the seismic force-resisting system (consistent with the response modification coefficient, R) rather than in collector elements.

C12.10.3 Diaphragms Including Chords and Collectors

The provisions of Section 12.10.3 are being mandated for precast concrete diaphragms in buildings assigned to SDC C, D, E, or F and are being offered as an alternative to those of Sections 12.10.1 and 12.10.2 for other precast concrete diaphragms, cast-in-place concrete diaphragms, and wood-sheathed diaphragms supported by wood framing. Diaphragms designed by Sections 12.10.1 and 12.10.2 have generally performed adequately in past earthquakes. The level of diaphragm design force from Sections 12.10.1 and 12.10.2 may not ensure, however, that diaphragms have sufficient strength and ductility to mobilize the inelastic behavior of vertical elements of the seismic force-resisting system. Analytical and experimental results show that actual diaphragm forces over much of the height of a structure during the design-level earthquake may be significantly greater than those from Sections 12.10.1 and 12.10.2, particularly when diaphragm response is near-elastic. There are material-specific factors that are related to overstrength and deformation capacity that may account for the adequate diaphragm performance in past earthquakes. The provisions of Section 12.10.3 consider both the significantly greater forces observed in near-elastic diaphragms and the anticipated overstrength and deformation capacity of diaphragms, resulting in an improved distribution of diaphragm strength over the height of buildings and among buildings with different types of seismic force resisting systems.

Based on experimental and analytical data and observations of building performance in past earthquakes, changes are warranted to the procedures of Sections 12.10.1 and 12.10.2 for some types of diaphragms and

for some locations within structures. Examples are the large diaphragms in some parking garages and transfer diaphragms connecting dissimilar lateral force-resisting systems within a building.

Section 12.10.3, Item 1: Footnote g to Table 12.2-1 permits reduction in the value of Ω_0 for structures with flexible diaphragms. The lowered Ω_0 results in lower diaphragm forces, which is not consistent with experimental and analytical observations. Justification for footnote g is not apparent; therefore, to avoid the inconsistency, the reduction is eliminated when using the Section 12.10.3 design provisions.

Section 12.10.3, Item 2: The ASCE 7-10 Section 12.3.3.4 provision requiring a 25% increase in design forces for certain diaphragm elements in building with several listed irregularities is eliminated when using the Section 12.10.3 design provisions because the diaphragm design force level in this alternative proposal is based on realistic assessment of anticipated diaphragm behavior. Under the Sections 12.10.1 and 12.10.2 design provisions, the 25% increase is invariably superseded by the requirement to amplify seismic design forces for certain diaphragm elements by Ω_0 , the only exception being wood diaphragms, which are exempt from the Ω_0 multiplier.

Section 12.10.3, Items 3 and 4: Section 12.10.3.2 of these provisions provides realistic seismic design forces for diaphragms. Section 12.10.3.4 requires that diaphragm collectors be designed for 1.5 times the force level used for diaphragm in-plane shear and flexure. Based on these forces, the use of a ρ factor greater than one for collector design is not necessary and would overly penalize designs. Section 12.10.3 retains the unit value of the redundancy factor for diaphragms designed by the force level given in that section. This is reflected in the deletion of Item 7 and the addition of diaphragms to Item 5. For transfer diaphragms, see Section 12.10.3.3

C12.10.3.1 Diaphragm Design

This provision is a re-write of ASCE 7-10 Section 12.10.1. The phrase “diaphragms including chords, collectors and their connections to the vertical elements” is used consistently throughout Section 12.10.3 to emphasize that its provisions apply to all portions of a diaphragm. It is also emphasized that the diaphragm is to be designed in two orthogonal directions.

C12.10.3.2 Seismic Design Forces for Diaphragms including Chords and Collectors

Eq. 12.10-4 makes the diaphragms seismic design force equal to the weight tributary to the diaphragm, w_{px} , times a diaphragm design acceleration coefficient, C_{px} , divided by a diaphragm design force reduction factor, R_s , which is material-dependent and whose background is given in C12.10.3.5. The background to the diaphragm design acceleration coefficient, C_{px} , is given below.

The diaphragm design acceleration coefficient at any height of the building can be determined from linear interpolation as indicated in Fig. 12.10-2.

The diaphragm design acceleration coefficient at the building base, C_{p0} , equals the peak ground acceleration consistent with the design response spectrum in ASCE 7-10 Section 11.4.5, times the importance factor I_e . Note that the term $0.4S_{DS}$ can be calculated from Eq. 11.4-5 by making $T = 0$.

At the structural height, h_n , the diaphragm design acceleration coefficient, C_{pn} , given by Eq. 12.10-7, reflects the influence of the first mode, amplified by system overstrength, and of the higher modes without amplification on the floor acceleration at this height. The individual terms are combined using the square root of the sum of the squares. The overstrength amplification of the first mode recognizes that the occurrence of an inelastic mechanism in the first mode is an anticipated event under the design earthquake, whereas inelastic mechanisms due to higher mode behavior are not anticipated. The higher mode seismic response coefficient, C_{s2} , is computed as the smallest of the values given by Eqs. 12.10-8, 12.10-9 and 12.10-10. These three equations consider that the periods of the higher modes contributing to the floor acceleration can lie on the ascending, constant or first descending branch of the design response spectrum shown in ASCE 7-10 Fig.11.4-1. Users are warned against extracting higher modes from their modal

analysis of buildings and using them in lieu of the procedure presented in Section 12.10.3.2.1, as the higher mode contribution to floor accelerations can come from a number of modes, particularly when there is torsional-lateral coupling of the modes.

Note that Eq. 12.10-7 makes use of the modal contribution factor defined here as the mode shape ordinate at the building height times the modal participation factor, and is uniquely defined for each mode of response (Chopra, 1995). A building database was compiled to obtain approximate equations for the first mode and higher mode contribution factors. The first and second translational modes, as understood in the context of two-dimensional modal analysis, were extracted from the mode shapes obtained from three-dimensional modal analysis by considering modal ordinates at the center of mass. These buildings had diverse lateral systems, and the number of stories ranged from 3 to 23. Equations 12.10-11 and 12.10-12 were empirically calibrated from simple two-dimensional models of realistic frame-type and wall-type buildings, and then compared with data extracted from the database, see Figure 12.10-3.

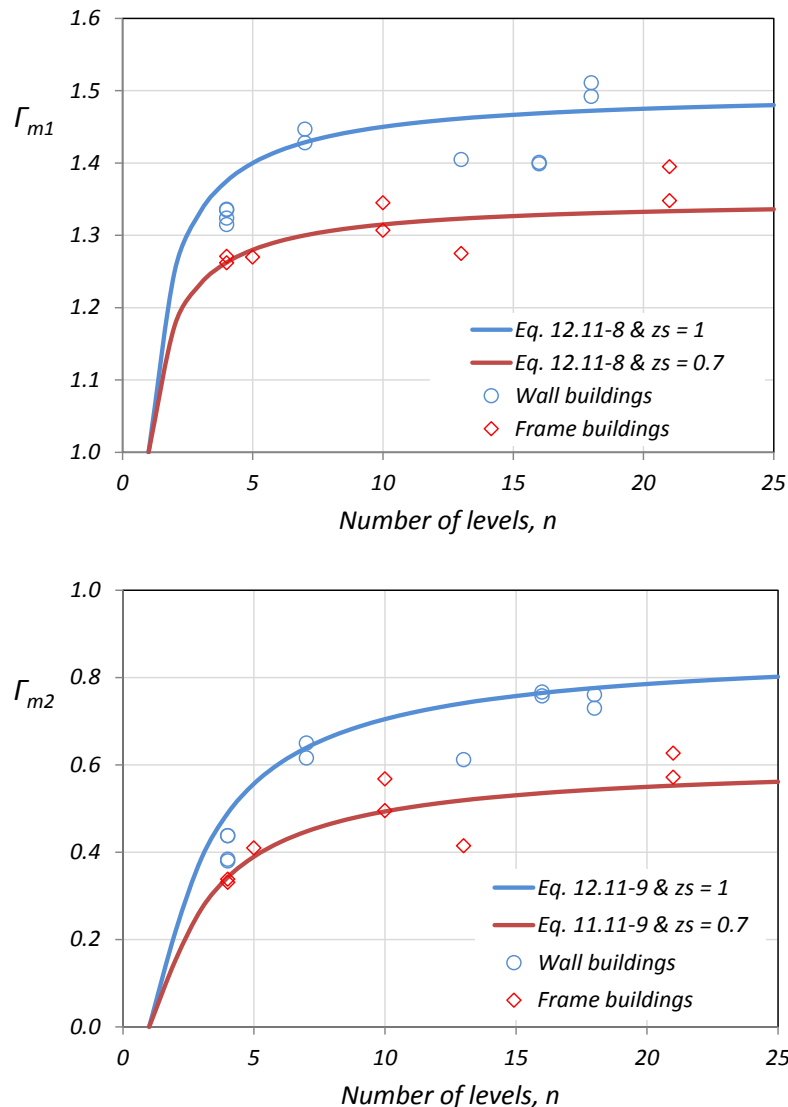

FIGURE 12.10-3 Comparison of Factors Γ_{m1} and Γ_{m2} Obtained from Analytical Models and Actual Structures with Those Predicted by Eqs. 12.10-11 and 12.10-12

To validate Eq. 12.10-4, coefficients C_{px} were calculated for various buildings tested on a shake table. Figures 12.10-4 and 12.10-5 plot the floor acceleration envelopes and the floor accelerations predicted from Eq. 12.10-4 with $R_s = 1$ for two buildings built at full-scale and tested on a shake table (Panagiotou et al., 2011; Chen et al., 2013), with C_{p0} defined as the diaphragm design acceleration coefficient at the structure base, and C_{px} defined as the diaphragm design acceleration coefficient at Level x . Measured floor accelerations are reasonably predicted by Eq. 12.10-4. Research work by Choi et al. (2008) concluded that buckling-restrained braced frames are very effective in limiting floor accelerations in buildings arising from higher-mode effects. This finding is reflected in this proposal, where the mode shape factor z_s has been made the smallest for buckling-restrained braced frame systems. Figure C 12.10-6 compares average floor accelerations obtained from the nonlinear time-history analysis of four buildings (two steel buckling-restrained braced frame systems and two steel special moment frame systems) when subjected to an ensemble of spectrum-compatible earthquakes with floor accelerations computed from Eqs. 12.10-4 and 12.10-5. The proposed design equations predict the accelerations in the uppermost part of the building and in the lowest levels reasonably well.

The significant difference between a low- z_s system such as the BRBF and a high- z_s system such as a bearing wall system is that inelastic deformations are distributed throughout the height of the structure in a low- z_s system, whereas they are concentrated at the base of the structure in a high- z_s system. If rational analysis can be performed to demonstrate that inelastic deformations are in fact distributed along the height of the structure, as is often the case with eccentrically braced frame or coupled shear wall systems, then the use of a low z_s value, as has been assigned to the BRBF, for such a system would be justified.

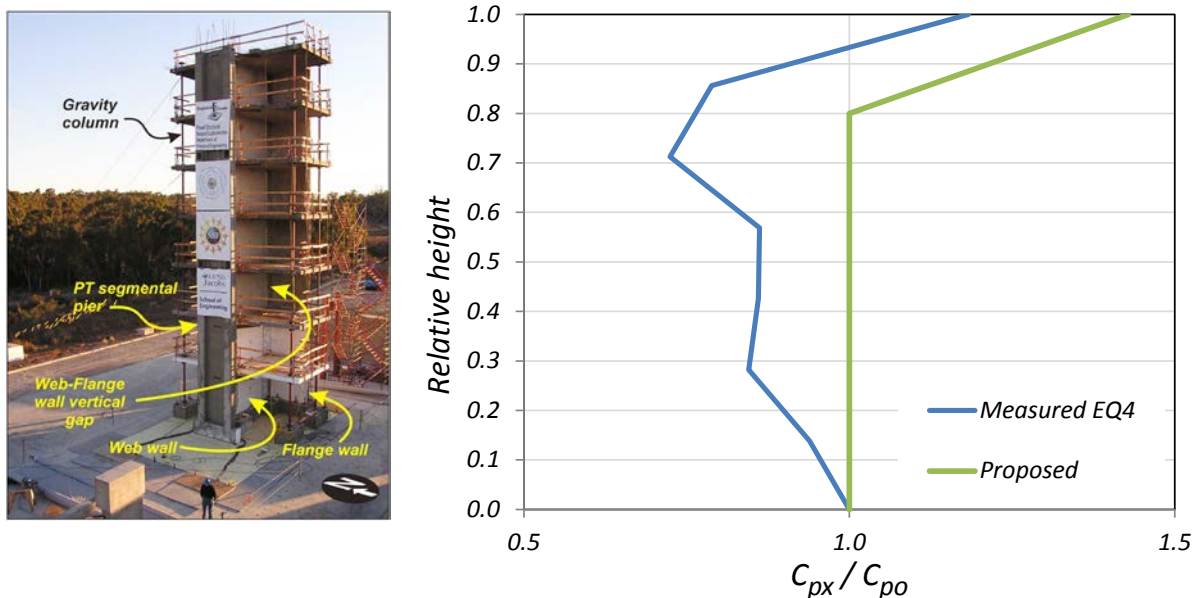

FIGURE 12.10-4 Comparison of Measured Floor Accelerations and Accelerations Predicted by Eq. 12.10-4 for a 7-Story Bearing Wall Building (Panagiotou et al., 2011)

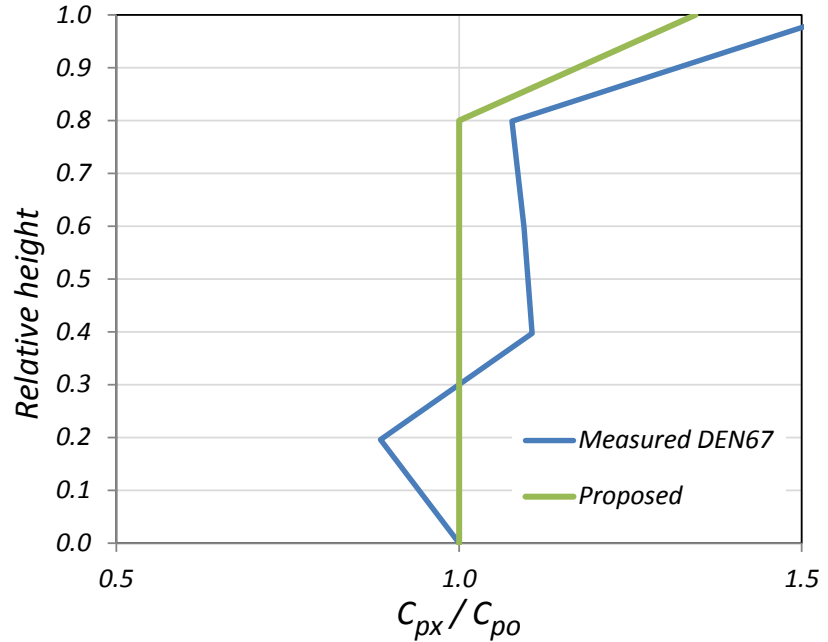

FIGURE 12.10-5 Comparison of Measured Floor Accelerations and Accelerations Predicted by Eq. 12.10-4 for a 5-Story Special MRF Building (Chen et al., 2013)

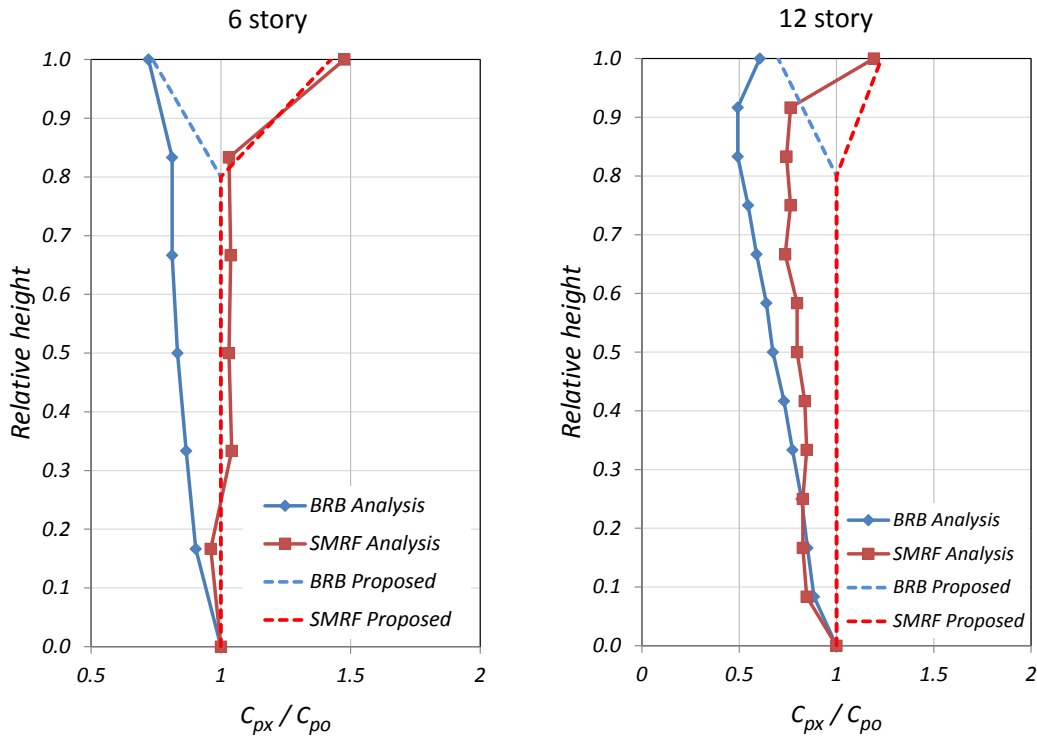

FIGURE 12.10-6 Comparison of Measured Floor Accelerations with Proposed Eqs. 12.10-4 and 12.10-5 for Steel BRBF and Special MRF Buildings (Adapted from Choi et al. 2008)

During the calibration of the design procedure leading to Eq. 12.10-4, it was found that at intermediate levels in lateral systems designed using large response modification coefficients; diaphragm design forces given by this equation could be rather low. There was consensus within the Issue Team that diaphragm design forces should not be taken less than the minimum force currently prescribed by ASCE 7-10, hence Eq. 12.10-5.

The procedure presented in Section 12.10.3 is based on consideration of buildings and structures whose mass distribution is reasonably uniform along the building height. Buildings or structures with tapered mass distribution along their height or with set-backs in their upper levels may experience diaphragm forces in the upper levels that are greater than those derived from Eq. 12.10-4. In such buildings and structures, it is preferable to define an effective building height, h_{ne} , and a corresponding level, n_e , the level to which the structural effective height is measured. The effective number of levels in a building, n_e , is defined as Level x where ratio $\sum_{i=1}^x w_i / \sum_{i=1}^n w_i$ first exceeds 0.95. Level 1 is defined as the first level above the base. The effective structural height, h_{ne} , is the height of the building measured from the base to Level n_e . In buildings with tapered mass distribution or setbacks, the diaphragm design acceleration coefficient, C_{pn} , is calculated by interpolation and extrapolation as shown in Fig. C12.10-6, with n replaced by n_e in Eqs. 12.10-8 through 12.10-12.

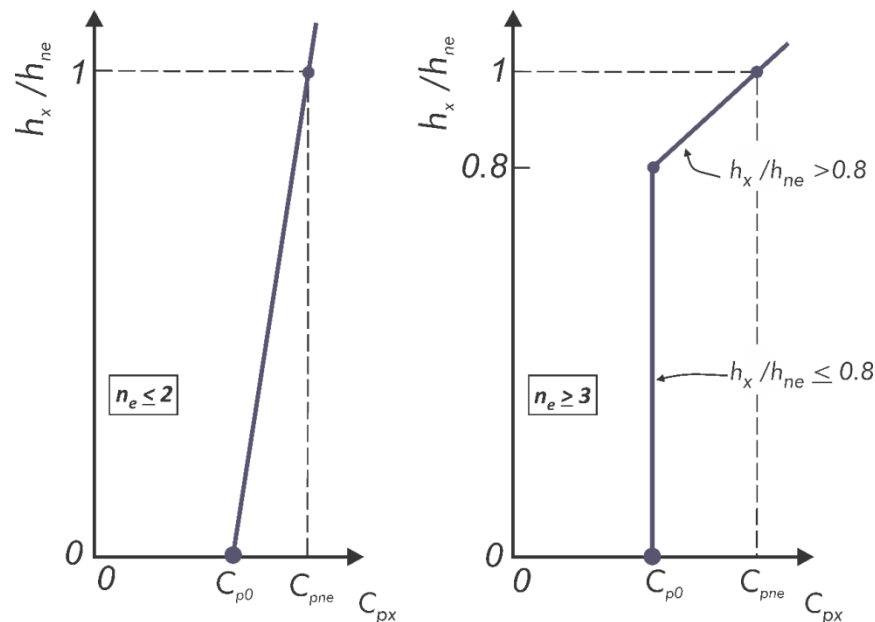

FIGURE 12.10-7 Diaphragm Design Acceleration Coefficient C_{px} for Buildings with Non-Uniform Mass Distribution

C12.10.3.3 Transfer Diaphragms

All diaphragms are subject to inertial forces due to the weight tributary to the diaphragm. Where the relative lateral stiffnesses of vertical resisting elements vary from story to story, or the vertical resisting elements have out-of-plane offsets, lateral forces in the vertical elements need to be transferred through the diaphragms as part of the load path between vertical elements above and below the diaphragm. These transfer forces are in addition to the inertial forces and can at times be quite large.

The magnitude of the transfer forces is dependent upon the overstrength in the vertical elements of the seismic force-resisting system. Therefore the design of the transfer diaphragm is required to be for the transfer force, amplified by the overstrength factor, Ω_0 , of the seismic force-resisting system, plus the inertial force.

Transfer forces can develop in many diaphragms, even within regular buildings. The wording of Section 12.10.3.3 is intended to capture instances where there is significant, rather than just minor, redistribution.

C12.10.3.4 Collectors

For structures in Seismic Design Categories C through F, ASCE 7-10 Section 12.10.2.1 specifies the use of forces including the overstrength factor, Ω_0 , for design of diaphragm collectors and their connections to vertical elements of the seismic force-resisting system. The intent of this requirement is to increase collector forces in order to help ensure that collectors will not be the weak links in the seismic force-resisting system. Because this proposal specifically includes Ω_0 in the diaphragm design forces, the collector force is instead differentiated by using a single multiplier of 1.5. This is a smaller multiplier than has been used in the past, but is justified because the diaphragm forces are more accurately identified by Eq. 12.10-4.

C12.10.3.5 Diaphragm Design Force Reduction Factor

Despite the fact that analytical and shake table studies indicate higher diaphragm accelerations than currently used in diaphragm design, many commonly used diaphragm systems, including diaphragms designed under a number of U.S. building codes and editions, have a history of excellent earthquake performance. With limited exceptions, diaphragms have not been reported to have performed below the life-safety intent of building code seismic design provisions in past earthquakes. Based on this history, it is felt that, for many diaphragm systems, no broad revision is required to the balance between demand and capacity used for design of diaphragms under current ASCE 7 provisions. In view of this observation, it was recognized that the analytical studies and diaphragm testing from which the higher accelerations and design forces were being estimated used diaphragms that were elastic or near-elastic in their response. Commonly used diaphragm systems are recognized to have a wide range of overstrength, and inelastic displacement capacity (ductility). It was recognized that the effect of the varying diaphragm systems on seismic demand required evaluation and incorporation into the proposed diaphragm design forces. Equation 12.10-4 incorporates the diaphragm overstrength and inelastic displacement capacity through the use of the diaphragm force reduction factor, R_s . This factor is most directly based on the global ductility capacity of the diaphragm system; however, the derivation of the global ductility capacity inherently also captures the effect of diaphragm overstrength.

For diaphragm systems with inelastic deformation capacity sufficient to permit inelastic response under the design earthquake, the diaphragm design force reduction factor, R_s , is typically greater than 1.0, so that the design force demand, F_{px} , is reduced relative to the force demand for a diaphragm that remains linear elastic under the design earthquake. For diaphragm systems that do not have sufficient inelastic deformation capacity, R_s should be less than 1.0, or even 0.7, so that linear-elastic force-deformation response can be expected under the maximum considered earthquake (MCE).

Diaphragms with R_s values greater than 1.0 shall have the following characteristics: (1) a well-defined, specified yield mechanism, (2) global ductility capacity for the specified yield mechanism, which exceeds anticipated ductility demand for the maximum considered earthquake, and (3) sufficient local ductility capacity to provide for the intended global ductility capacity, considering that the specified yield mechanism may require concentrated local inelastic deformations to occur. The following discussion addresses these characteristics and the development of R_s -factors in detail.

A diaphragm system with an R_s value greater than 1.0 should have a specified, well-defined yield mechanism, for which both the global strength and the global deformation capacity can be estimated. For some diaphragm systems, a shear-yield mechanism may be appropriate, while for other diaphragm systems, a flexural-yield mechanism may be appropriate.

Figure 12.10-8(a) shows schematically the force-deformation ($F_{dia} - \Delta_{dia}$) response of a diaphragm with significant inelastic deformation capacity. The figure illustrates the response of a diaphragm system, such as a wood diaphragm or a steel deck diaphragm, which is not expected to exhibit a distinct yield point, so

that an effective yield point (F_{Y-eff} and Δ_{Y-eff}) needs to be defined. For wood diaphragms and steel deck diaphragms the figure illustrates one way to define the effective yield point. The stiffness of a test specimen is defined by the secant stiffness through a point corresponding to 40% of the peak strength (F_{peak}). The effective yield point (F_{Y-eff} and Δ_{Y-eff}) for a diaphragm is defined by the secant stiffness through $0.4F_{peak}$ and the nominal diaphragm strength reduced by a strength reduction factor (ϕF_n), as shown in the figure. The $F_{dia} - \Delta_{dia}$ response is then idealized with a bilinear model, using the effective yield point (F_{Y-eff} and Δ_{Y-eff}) and F_{peak} and the corresponding deformation Δ_{peak} as shown in the figure.

Figure 12.10-8(b) shows schematically the force-deformation ($F_{dia} - \Delta_{dia}$) response of a diaphragm with significant inelastic deformation capacity, which is expected to have nearly linear $F_{dia} - \Delta_{dia}$ response up to a distinct yield point, such as a cast-in-place reinforced concrete diaphragm. For this type of a diaphragm system, the effective yield point can be taken as the actual yield point ($F_{Y-actual}$ and $\Delta_{Y-actual}$) of the diaphragm (accounting for diaphragm material overstrength and not including a strength reduction factor (ϕ)).

The global (or system) deformation capacity of a diaphragm system (Δ_{cap}) should be estimated from analyses of test data. The force-deformation ($F_{dia} - \Delta_{dia}$) response shown schematically in Figures 12.10-8(a) and 12.10-8(b) is the global force-deformation behavior.

In some cases, tests provide directly the global deformation capacity, but more often, tests provide only the local response, including the strength and deformation capacity, of diaphragm components and connections. When tests provide only the local deformation capacity, analyses of typical diaphragms should be made to estimate the global deformation capacity of these diaphragms. These analyses should consider: (1) the specified yield mechanism, (2) the local force-deformation response data from tests, (3) the typical distributions of design strength and internal force demands across the diaphragm, and (4) any other factors which may require concentrated local inelastic deformation to occur when the intended yield mechanism forms.

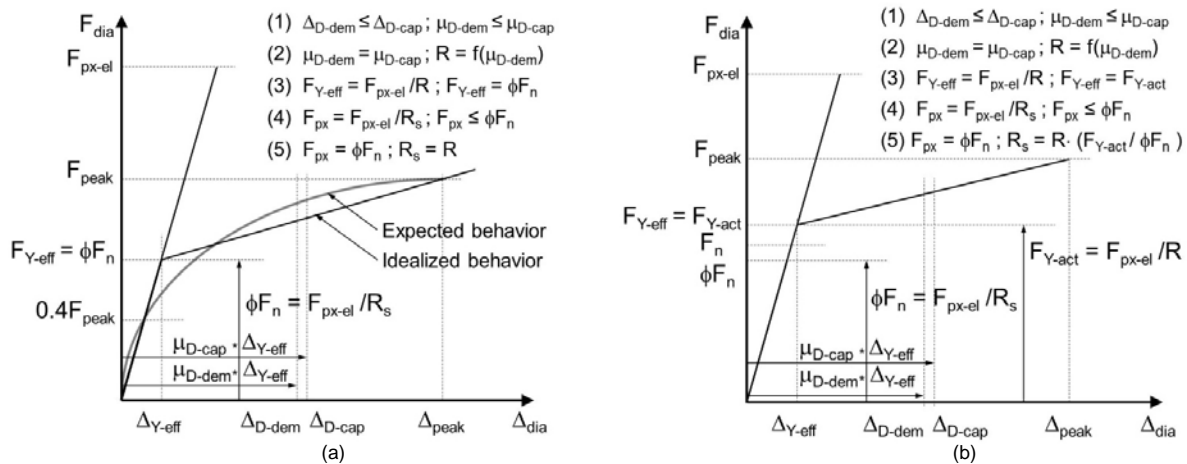

FIGURE 12.10-8 Diaphragm Inelastic Response Models for (a) a Diaphragm System that is not Expected to Exhibit a Distinct Yield Point and (b) a Diaphragm System that does Exhibit a Distinct Yield Point

After the global force-deformation ($F_{dia} - \Delta_{dia}$) response of a diaphragm has been estimated, the global deformation capacity (Δ_{cap}) can be determined. In Figure 12.10-8(a), for example, Δ_{cap} can be taken as Δ_{peak} which is the deformation corresponding to the strength (F_{peak}). For some diaphragm systems, it may be acceptable to take the deformation corresponding to 80% of F_{peak} (i.e., post-peak) as Δ_{cap} .

Only a selected portion of the deformation capacity of a diaphragm (Δ_{cap}) should be utilized under the design earthquake in recognition of two major concerns: (1) the diaphragm must perform adequately under the MCE, which has a design spectrum 50% more intense than the design earthquake design spectrum, (2)

significant inelastic deformation under the design earthquake may result in undesirable damage to the diaphragm. As a rough estimate, the diaphragm deformation capacity under the design earthquake (Δ_{D-cap}) should be limited to approximately one-half to two-thirds of the deformation capacity Δ_{cap} .

To develop the diaphragm force reduction factor, R_s , the diaphragm global deformation capacity should be expressed as a global ductility capacity (Δ_{cap}) which equals the deformation capacity (Δ_{cap}) divided by the effective yield deformation (Δ_{Y-eff}). The corresponding diaphragm design ductility capacity (Δ_{D-cap}) equals $\Delta_{D-cap}/\Delta_{Y-eff}$.

From the diaphragm global deformation capacity and corresponding ductility capacity, an appropriate R_s -factor can be estimated. Use of the estimated R_s -factor in design should result in diaphragm ductility demands which do not exceed the ductility capacity that was used to estimate R_s . The force reduction factor is ideally derived from system-specific studies. Where such studies are unavailable, however, some guidance on the conversion from global ductility to force reduction is available from past studies.

Expressions that provide the force reduction factor, R , for the seismic force-resisting system of a building corresponding to an expected ductility demand (μ_{dem}) have been proposed by numerous research teams. Numerous factors, including vibration period, inherent damping, deformation hardening (stiffness after the effective yield point), and hysteretic energy dissipation under cyclic loading have been considered in developing these expressions. Two such expressions, which are based on elasto-plastic force-deformation response under cyclic loading (Newmark & Hall, 1982), are as follows: (1) $R = (2\mu_{dem} - 1)^{0.5}$ applicable to short-period systems, and (2) $R = \mu_{dem}$, applicable to systems with longer periods. The first function, known as the equal energy rule, will give a smaller value of R for a given value of μ_{dem} ; the second function, known as the equal displacement rule, is also widely used.

Figures 12.10-8(a) and 12.10-8(b) summarize an approach to estimating R_s as follows:

1. For the selected value of R_s , the diaphragm deformation demand under the design earthquake (Δ_{D-dem}) should not exceed the diaphragm design deformation capacity (Δ_{D-cap}). This design constraint, expressed in terms of diaphragm ductility, requires that the diaphragm ductility demand under the design earthquake (μ_{D-dem}) should not exceed the diaphragm design ductility capacity (μ_{D-cap}).
2. The largest value of R which can be justified for a given diaphragm design deformation capacity is obtained by setting the ductility demand (μ_{D-dem}) equal to the design ductility capacity (μ_{D-cap}), and determining R from a function that provides R for a given μ_{dem} . For example, if $\mu_{D-cap} = 2.5$, then μ_{D-dem} is set equal to 2.5 and the corresponding $R = 2$ from the equal energy rule or $R = 2.5$ from the equal displacement rule.
3. R from step (2) is the ratio of the force demand for a linear elastic diaphragm (F_{px-el}) to the effective yield strength of the diaphragm (F_{Y-eff}). For a diaphragm system which is not expected to exhibit a distinct yield point (Figure C12.10-8a), F_{Y-eff} equals the factored nominal diaphragm strength (ϕF_n). For a diaphragm system that is expected to exhibit a distinct yield point (Figure C12.10-8b), F_{Y-eff} equals the actual yield strength ($F_{Y-actual}$), accounting for diaphragm material overstrength and not including the strength reduction factor (ϕ).
4. R_s is, however, defined as the ratio of the force demand for a linear elastic diaphragm (F_{px-el}) to the design force demand (F_{px}). The diaphragm must be designed such that the design force demand (F_{px}) is less than or equal to the factored nominal diaphragm strength (ϕF_n).
5. For a diaphragm system without a distinct yield point (Figure 12.10-8a) which has the minimum strength ($F_{px} = \phi F_n$), R_s equals R from step (2). For a diaphragm system with a distinct yield point (Figure 12.10-8b) which has the minimum strength ($F_{px} = \phi F_n$), R_s equals R from step (2) multiplied by the ratio $F_{Y-eff}/\phi F_n$.

Diaphragm force reduction factors, R_s , have been developed for some commonly used diaphragm systems. The derivation of factors for each of these systems is explained in detail in the following commentary sections. For each, the specific design standard considered in the development of the R_s -factor is specified.

The resulting R_s -factors are specifically tied to the design and detailing requirements of the noted standard, as these play a significant role in setting the ductility and overstrength of the diaphragm system. For this reason, the applicability of the R_s -factor to diaphragms designed using other standards must be specifically considered and justified.

CAST-IN-PLACE CONCRETE DIAPHRAGMS

The R_s values in Table 12.10-1 address cast-in-place concrete diaphragms designed in accordance with ACI 318 (ACI, 2011).

Intended Mechanism. Flexural yielding is the intended yield mechanism for a reinforced concrete diaphragm. Where this can be achieved, designation as a flexure-controlled diaphragm and use of the corresponding R_s -factor in Table 12.10-1 is appropriate. There are many circumstances, however, where the development of a well-defined yielding mechanism is not possible due to diaphragm geometry (aspect ratio or complex diaphragm configuration), in which case, designation as a shear-controlled diaphragm and use of the lower R_s -factor is required.

Derivation of Diaphragm Force Reduction Factor. Test results for reinforced concrete diaphragms are not available in the literature. Test results for shear walls under cyclic lateral loading were considered. The critical regions of shear wall test specimens usually have high levels of shear force, moment, and flexural deformation demands; high levels of shear force are known to degrade the flexural ductility capacity. The flexural ductility capacity of shear wall test specimens under cyclic lateral loading was used to estimate the flexural ductility capacity of reinforced concrete diaphragms, using the previously described method based on Newmark and Hall.

Based on shear wall test results, the estimated global flexural ductility capacity of a reinforced concrete diaphragm is 3, based on the actual yield displacement ($\Delta_{Y-actual}$) of the test specimens. The design ductility capacity is taken as 2/3 of the ductility capacity; the design ductility capacity (μ_{D-cap}) is 2.

Setting the ductility demand (μ_{dem}) equal to the design ductility capacity (μ_{D-cap}) and using the equal energy rule, the force reduction factor R is: $R = (2\mu_{dem} - 1)^{0.5} = 1.73$.

R_s equals R multiplied by the ratio $F_{Y-eff}/\phi F_n$. F_{Y-eff} is taken equal to $F_{Y-actual}$ which is assumed to be $1.1F_n$ and ϕ equals 0.9. Therefore $R_s = 2.11$, which is rounded to 2.

Due to the geometric characteristics of a building or other factors, such as minimum reinforcement requirements, it will not be possible to design some reinforced concrete diaphragms to yield in flexure. Such diaphragms are termed as “shear controlled” to indicate that they are expected to yield in shear. Shear-controlled reinforced concrete diaphragms should be designed to remain essentially elastic under the design earthquake, with their available global ductility held in reserve for safety under the MCE.

Based on the following considerations, R_s is specified as 1.5 for shear-controlled reinforced concrete diaphragms: Reinforced-concrete diaphragms have performed well in past earthquakes. ACI-318 specifies ϕ of 0.75 or 0.6 for diaphragm shear strength and limits the concrete contribution to the shear strength to only $2(f'_c)^{0.5}$. In addition, reinforced concrete floor slabs often have gravity load reinforcement that is not considered in determining the diaphragm shear strength. Therefore, shear-controlled reinforced concrete diaphragms are expected to have significant overstrength. The ratio $F_{Y-eff}/\phi F_n$ for a reinforced concrete diaphragm, where F_{Y-eff} is taken equal to $F_{Y-actual}$, is expected to exceed 1.5, which is the rationale for $R_s = 1.5$, even though μ_{dem} is assumed to be 1 for the design earthquake.

Precast Concrete Diaphragms

The R_s values in Table 12.10-1 address precast concrete diaphragms designed in accordance with ACI 318 (ACI, 2011).

Derivation of Diaphragm Force Reduction Factors. The diaphragm force reduction factors, R_s , in Table 12.10-1 for precast concrete diaphragms were established based on the results of analytical earthquake simulation studies conducted within a multi-university project: Development of a Seismic Design Methodology (DSDM) for Precast Concrete Diaphragms (Fleischman et al. 2012). In this research effort, diaphragm design force levels have been aligned with the diaphragm deformation capacities specifically for precast concrete diaphragms. Three different design options were proposed according to different design performance targets, as indicated in Table C12.10-1. The relationships between diaphragm design force levels and diaphragm local/global ductility demands have been established in the DSDM research project. These relationships have been used to derive the R_s for precast concrete diaphragms in Table 12.10-1.

Table C12.10-1 Diaphragm Design Performance Targets

Options	Flexure DBE	Flexure MCE	Shear DBE&MCE
EDO	Elastic	Elastic	Elastic
BDO	Elastic	Inelastic	Elastic
RDO	Inelastic	Inelastic	Elastic

Diaphragm R_{dia} - μ_{global} - μ_{local} Relationships. Extensive analytical studies have been performed (Fleischman et al. 2012) to develop the relationship of R_{dia} - μ_{global} - μ_{local} . R_{dia} is the diaphragm force reduction factor (similar to the R_s in Table 12.10-1) measured from the required elastic diaphragm design force at MCE level. μ_{global} is the diaphragm global ductility demand and μ_{local} is the diaphragm local connector ductility demand measured at MCE level. Figure C12.10-9 shows the μ_{global} - μ_{local} and R_{dia} - μ_{global} analytical results for different diaphragm aspect ratios (AR) and proposed linear equations derived from the data.

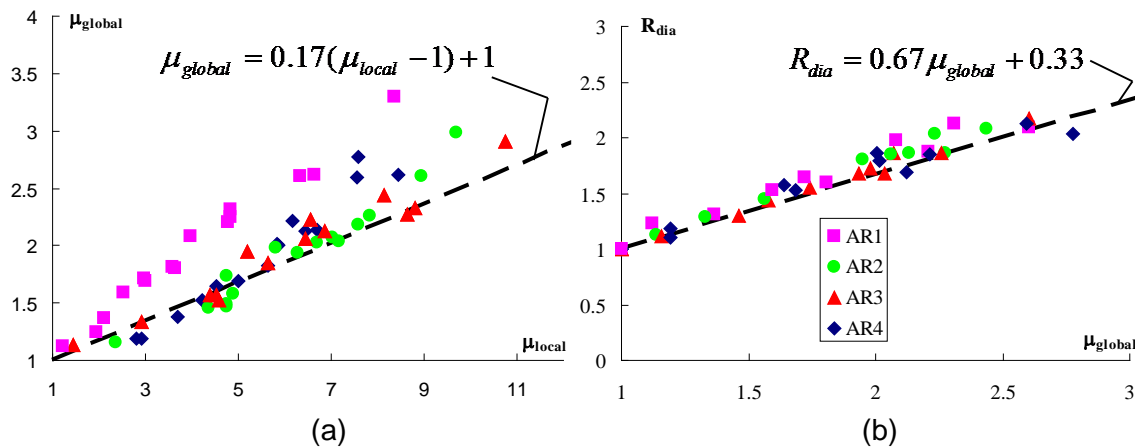

FIGURE C12.10-9 Relationships: (a) μ_{global} - μ_{local} and (b) R_{dia} - μ_{global}

Diaphragm Force Reduction Factor (R_s). Using the equations in Fig. C12.10-9, the R_s can be calculated for different diaphragm design options provided the diaphragm local reinforcement ductility capacity is known. In the DSDM research, precast diaphragm connectors have been extensively tested (Fleischman et al. 2012) and have been qualified into three categories: High-deformability elements (HDE), moderate-deformability elements (MDE), and low-deformability elements (LDE), which are required as a minimum

for designs employing the reduced design objective (RDO), the basic design objective (BDO), and the elastic design objective (EDO), respectively. The local deformation and ductility capacities for diaphragm connector categories are shown in Table C12.10-2. Considering that the proposed diaphragm design force level (Eq. 12.10-4) targets elastic diaphragm response at the design earthquake, which is equivalent to design employing BDO where $\mu_{local}=3.5$ at MCE (see Table C12.10-2), the available diaphragm global ductility capacity has to be reduced from Fig. 12.10-9(a), acknowledging more severe demands in the MCE,

$$\mu_{global, red} = 0.17(\mu_{local} - 3.5) + 1 \tag{Eq. C12.10-1}$$

Accordingly, the R_s -factor can be modified from Fig. C-12.10-9(b) (see Table C12.10-2):

$$R_s = 0.67\mu_{global, red} + 0.33 \tag{Eq. C12.10-2}$$

Table C12.10-2 Diaphragm Force Reduction Factors

Options	Diaphragm Connector Category	δ_{local} (in)	μ_{local}	μ_{global}	$\mu_{global, red}$	R_s
EDO	LDE	0.06	1.0	1.0	0.58	0.7
BDO	MDE	0.2	3.5	1.4	1.0	1.0
RDO	HDE	0.4	7.0	2.0	1.6	1.4

Diaphragm Shear Overstrength Factor. Precast diaphragms typically exhibit ductile flexural response but brittle shear response. In order to avoid brittle shear failure, elastic shear response targets are required for both flexure-controlled and shear-controlled systems at design earthquake and MCE levels. Thus, a shear overstrength factor, Ω_v , is required for diaphragm shear design. For EDO design, since the diaphragm is expected to remain elastic under the MCE, no shear overstrength is needed. Figure C12.10-10 shows the analytical results for required shear overstrength factors for BDO and RDO (shown as marks). A simplified conservative equation is proposed as (see black lines in Fig. C12.10-10):

$$\Omega_v = 1.4R_s \tag{Eq. C12.10-3}$$

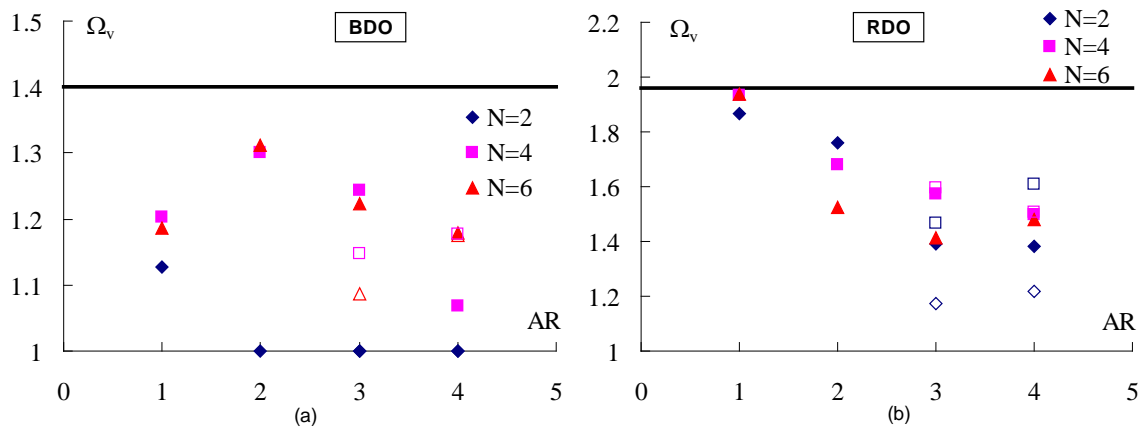

FIGURE C12.10-10 Diaphragm Shear Overstrength Factor: (a) BDO; (b) RDO (Fleischman et al., 2012)

WOOD SHEATHED DIAPHRAGMS

The R_s values given in Table 12.10-1 are for wood-sheathed diaphragms designed in accordance with AWC Special Design Provisions for Wind and Seismic (AWC, 2008).

Intended mechanism. Wood-sheathed diaphragms are shear-controlled, with design strength determined in accordance with SDPWS and the shear behavior based on the sheathing-to-framing connections. Wood diaphragm chord members are unlikely to form flexural mechanisms (ductile or otherwise), due to the overstrength inherent in axially loaded members designed in accordance with applicable standards.

Derivation of Diaphragm Design Force Reduction Factor. An R_s -factor of 3 is assigned in Table 12.10-1, based on diaphragm test data (APA, 1966; APA, 2000; DFPA, 1954; DFPA, 1963) and analytical studies. The available testing includes diaphragm spans (loaded as simple-span beams) ranging from 24 to 48 ft, aspect ratios ranging between 1 and 3.3, and diaphragm construction covering a range of construction types including blocked and unblocked construction, and regular and high-load diaphragms. The loading was applied with a series of point loads at varying spacing; however, the loading was reasonably close to uniform. While available diaphragm testing was monotonic; based on shear wall loading protocol studies (Gatto & Uang, 2002), it is believed that the monotonic load-deflection behavior is reasonably representative of the cyclic load-deflection envelope, suggesting that it is appropriate to use monotonic load-deflection behavior in the estimation of overstrength, ductility, and displacement capacity.

Analytical studies using nonlinear response history analysis evaluated the relationship between global ductility and diaphragm force reduction factor for a model wood building. The analysis identified the resulting diaphragm force reduction factor as ranging from just below three to significantly in excess of five. A force reduction factor of three was selected so that diaphragm design force levels would generally not be less than determined in accordance with provisions of Sections 12.10.1 and 12.10.2.

The calibration approach for selection of R_s of 3 was considered appropriate to limit conditions where diaphragm force levels would drop below those determined in accordance with Sections 12.10.1 and 12.10.2. This was due in part to historical experience of good diaphragm performance across a range of wood diaphragm types, even though test data showed varying levels of ductility and deformation capacity. Tests of nailed wood diaphragms showed significant but varying levels of overstrength. It is recognized that even further variation of overstrength will result from:

- Presence of floor coverings or toppings and their attachment or bond to diaphragm sheathing,
- Presence of wall to floor framing nailing through diaphragm sheathing, and
- Presence of adhesives in combination with required sheathing nailing (commonly used for purposes of mitigating floor vibration, increasing floor stiffness for gravity loading, and reducing the potential for squeaking)

These sources of overstrength are not considered to be detrimental to overall diaphragm performance.

C12.11 STRUCTURAL WALLS AND THEIR ANCHORAGE

As discussed in Section C1.4, structural integrity is important not only in earthquake-resistant design but also in resisting high winds, floods, explosion, progressive failure, and even such ordinary hazards as foundation settlement. The detailed requirements of this section address wall-to-diaphragm integrity.

C12.11.1 Design for Out-of-Plane Forces

Because they are often subjected to local deformations caused by material shrinkage, temperature changes, and foundation movements, wall connections require some degree of ductility to accommodate slight movements while providing the required strength.

Although nonstructural walls are not subject to this requirement, they must be designed in accordance with Chapter 13.

C12.11.2 Anchorage of Structural Walls and Transfer of Design Forces into Diaphragms

There are numerous instances in U.S. earthquakes of tall, single-story, and heavy walls becoming detached from supporting roofs, resulting in collapse of walls and supported bays of roof framing (Hamburger and

McCormick 2004). The response involves dynamic amplification of ground motion by response of vertical system and further dynamic amplification from flexible diaphragms. The design forces for Seismic Design Category D and higher have been developed over the years in response to studies of specific failures. It is generally accepted that the rigid diaphragm value is reasonable for structures subjected to high ground motions. For a simple idealization of the dynamic response, these values imply that the combined effects of inelastic action in the main framing system supporting the wall, the wall (acting out of plane), and the anchor itself correspond to a reduction factor of 4.5 from elastic response to an MCE motion, and therefore the value of the response modification coefficient, R , associated with nonlinear action in the wall or the anchor itself is 3.0. Such reduction is generally not achievable in the anchorage itself, thus it must come from yielding elsewhere in the structure, for example, the vertical elements of the seismic force-resisting system, the diaphragm, or walls acting out of plane. The minimum forces are based on the concept that less yielding occurs with smaller ground motions and less yielding is achievable for systems with smaller values of R , which are permitted in structures assigned to Seismic Design Categories B and C. The minimum value of R in structures assigned to Seismic Design Category D, except cantilever column systems and light-frame walls sheathed with materials other than wood structural panels, is 3.25, whereas the minimum values of R for Categories B and C are 1.5 and 2.0, respectively.

Where the roof framing is not perpendicular to anchored walls, provision needs to be made to transfer both the tension and sliding components of the anchorage force into the roof diaphragm. Where a wall cantilevers above its highest attachment to, or near, a higher level of the structure, the reduction factor based on the height within the structure, $(1 + 2z/h)/3$, may result in a lower anchorage force than appropriate. In such an instance, using a value of 1.0 for the reduction factor may be more appropriate.

C12.11.2.1 Wall Anchorage Forces

Diaphragm flexibility can amplify out-of-plane accelerations so that the wall anchorage forces in this condition are twice those defined in Section 12.11.1.

C12.11.2.2 Additional Requirements for Diaphragms in Structures Assigned to Seismic Design Categories C through F

C12.11.2.2.1 Transfer of Anchorage Forces into Diaphragm

This requirement, which aims to prevent the diaphragm from tearing apart during strong shaking by requiring transfer of anchorage forces across the complete depth of the diaphragm, was prompted by failures of connections between tilt-up concrete walls and wood panelized roof systems in the 1971 San Fernando earthquake.

Depending on diaphragm shape and member spacing, numerous suitable combinations of subdiaphragms and continuous tie elements and smaller sub-subdiaphragms connecting to larger subdiaphragms and continuous tie elements are possible. The configuration of each subdiaphragm (or sub-subdiaphragm) provided must comply with the simple 2.5-to-1 length-to-width ratio, and the continuous ties must have adequate member and connection strength to carry the accumulated wall anchorage forces.

C12.11.2.2.2 Steel Elements of Structural Wall Anchorage System

A multiplier of 1.4 has been specified for strength design of steel elements to obtain a fracture strength of almost 2 times the specified design force (where ϕ_t is 0.75 for tensile rupture).

C12.11.2.2.3 Wood Diaphragms

Material standards for wood structural panel diaphragms permit the sheathing to resist shear forces only; use of diaphragm sheathing to resist direct tension or compression forces is not permitted. Therefore, seismic out-of-plane anchorage forces from structural walls must be transferred into framing members (such as beams, purlins, or subpurlins) using suitable straps or anchors. For wood diaphragms, it is common to

use local framing and sheathing elements as subdiaphragms to transfer the anchorage forces into more concentrated lines of drag or continuity framing that carry the forces across the diaphragm and hold the building together. Fig. C12.11-1 shows a schematic plan of typical roof framing using subdiaphragms.

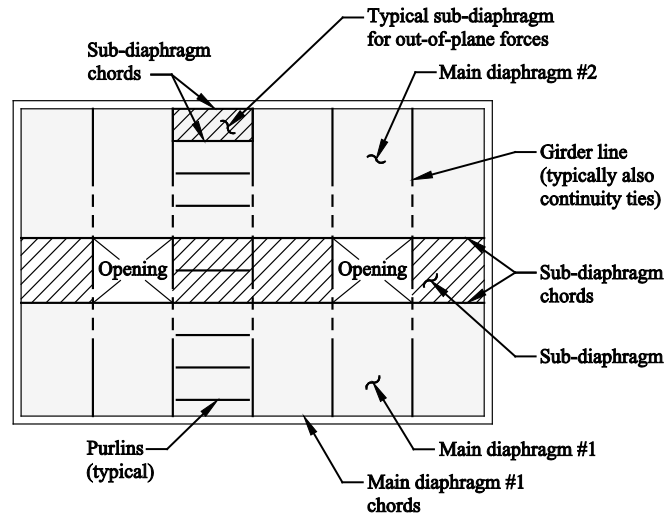

FIGURE C12.11-1 Typical Subdiaphragm Framing

Fasteners that attach wood ledgers to structural walls are intended to resist shear forces from diaphragm sheathing attached to the ledger that act longitudinally along the length of the ledger but not shear forces that act transversely to the ledger, which tend to induce splitting in the ledger caused by cross-grain bending. Separate straps or anchors generally are provided to transfer out-of-plane wall forces into perpendicular framing members.

C12.11.2.2.4 Metal Deck Diaphragms

In addition to transferring shear forces, metal deck diaphragms often can resist direct axial forces in at least one direction. However, corrugated metal decks cannot transfer axial forces in the direction perpendicular to the corrugations and are prone to buckling if the unbraced length of the deck as a compression element is large. To manage diaphragm forces perpendicular to the deck corrugations, it is common for metal decks to be supported at 8- to 10-ft intervals by joists that are connected to walls in a manner suitable to resist the full wall anchorage design force and to carry that force across the diaphragm. In the direction parallel to the deck corrugations, subdiaphragm systems are considered near the walls; if the compression forces in the deck become large relative to the joist spacing, small compression reinforcing elements are provided to transfer the forces into the subdiaphragms.

C12.11.2.2.5 Embedded Straps

Steel straps may be used in systems where heavy structural walls are connected to wood or steel diaphragms as the wall-to-diaphragm connection system. In systems where steel straps are embedded in concrete or masonry walls, the straps are required to be bent around reinforcing bars in the walls, which improve their ductile performance in resisting earthquake load effects (e.g., the straps pull the bars out of the wall before the straps fail by pulling out without pulling the reinforcing bars out). Consideration should be given to the probability that light steel straps have been used in past earthquakes and have developed cracks or fractures at the wall-to-diaphragm framing interface because of gaps in the framing adjacent to the walls.

C12.11.2.2.6 Eccentrically Loaded Anchorage System

Wall anchors often are loaded eccentrically, either because the anchorage mechanism allows eccentricity, or because of anchor bolt or strap misalignment. This eccentricity reduces the anchorage connection capacity and hence must be considered explicitly in design of the anchorage. Fig. C12.11-2 shows a one-sided roof-to-wall anchor that is subjected to severe eccentricity because of a misplaced anchor rod. If the detail were designed as a concentric two-sided connection, this condition would be easier to correct.

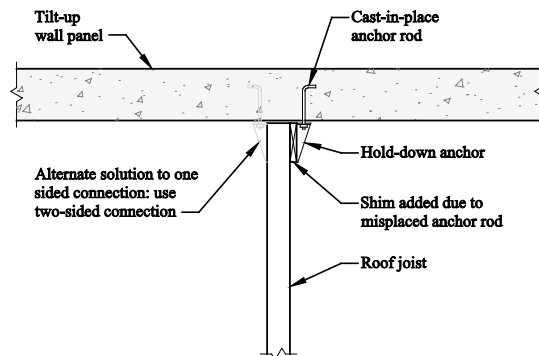

FIGURE C12.11-2 Plan View of Wall Anchor with Misplaced Anchor Rod

C12.11.2.2.7 Walls with Pilasters

The anchorage force at pilasters must be calculated considering two-way bending in wall panels. It is customary to anchor the walls to the diaphragms assuming one-way bending and simple supports at the top and bottom of the wall. However, where pilasters are present in the walls, their stiffening effect must be taken into account. The panels between pilasters are typically supported along all panel edges. Where this support occurs, the reaction at the top of the pilaster is the result of two-way action of the panel and is applied directly to the anchorage supporting the top of the pilaster. The anchor load at the pilaster generally is larger than the typical uniformly distributed anchor load between pilasters. Fig. C12.11-3 shows the tributary area typically used to determine the anchorage force for a pilaster.

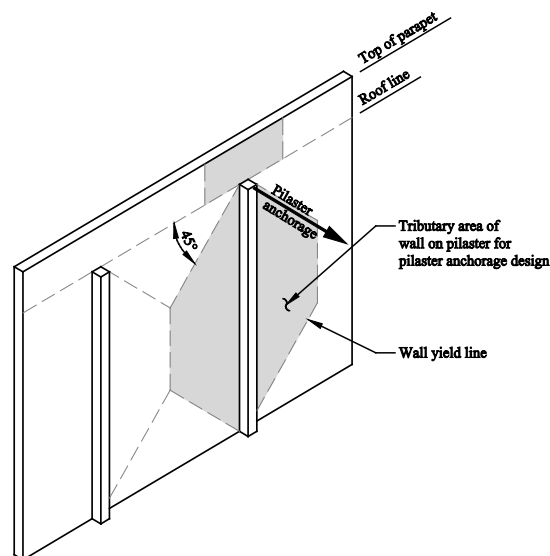

FIGURE C12.11-3 Tributary Area Used to Determine Anchorage Force at Pilaster

Anchor points adjacent to the pilaster must be designed for the full tributary loading, conservatively ignoring the effect of the adjacent pilaster.

C12.12 DRIFT AND DEFORMATION

As used in the standard, deflection is the absolute lateral displacement of any point in a structure relative to its base, and design story drift, Δ , is the difference in deflection along the height of a story (i.e., the deflection of a floor relative to that of the floor below). The drift, Δ , is calculated according to the procedures of Section 12.8.6. (Sections 12.9.2 and 16.1 give procedures for calculating displacements for modal response spectrum and linear response history analysis procedures, respectively; the definition of Δ in Section 11.3 should be used).

Calculated story drifts generally include torsional contributions to deflection (i.e., additional deflection at locations of the center of rigidity at other than the center of mass caused by diaphragm rotation in the horizontal plane). The provisions allow these contributions to be neglected where they are not significant, such as in cases where the calculated drifts are much less than the allowable story drifts, Δ_a , no torsional irregularities exist, and more precise calculations are not required for structural separations (see Sections C12.12.3 and C12.12.4).

The deflections and design story drifts are calculated using for the design earthquake ground motion, which is two-thirds of the risk-targeted maximum considered earthquake (MCE_R) ground motion. The resulting drifts are therefore likely to be underestimated.

The design base shear, V , used to calculate Δ is reduced by the response modification coefficient, R . Multiplying displacements by the deflection amplification factor, C_d , is intended to correct for this reduction and approximate inelastic drifts corresponding to the design response spectrum unreduced by R . However, it is recognized that use of values of C_d less than R underestimates deflections (Uang and Maarouf 1994). Also Sections C12.8.6.2 and C12.9.4 deal with the appropriate base shear for computing displacements.

For these reasons, the displacements calculated may not correspond well to MCE_R ground motions. However, they are appropriate for use in evaluating the structure's compliance with the story drift limits put forth in Table 12.12-1 of the standard.

There are many reasons to limit drift; the most significant are to address the structural performance of member inelastic strain and system stability and to limit damage to nonstructural components, which can be life-threatening. Drifts provide a direct but imprecise measure of member strain and structural stability. Under small lateral deformations, secondary stresses caused by the P-delta effect are normally within tolerable limits (see Section C12.8.7). The drift limits provide indirect control of structural performance.

Buildings subjected to earthquakes need drift control to limit damage to partitions, shaft and stair enclosures, glass, and other fragile nonstructural components. The drift limits have been established without regard to economic considerations such as a comparison of present worth of future repairs with additional structural costs to limit drift. These are matters for building owners and designers to address.

The allowable story drifts, Δ_a , of Table 12.12-1 reflect the consensus opinion of the ASCE 7 Committee taking into account the life-safety and damage control objectives described in the aforementioned. Because the displacements induced in a structure include inelastic effects, structural damage as the result of a design-level earthquake is likely. This notion may be seen from the values of Δ_a stated in Table 12.12-1. For other structures assigned to Risk Category I or II, the value of Δ_a is $0.02 h_{sx}$, which is about 10 times the drift ordinarily allowed under wind loads. If deformations well in excess of Δ_a were to occur repeatedly, structural elements of the seismic force-resisting system could lose so much stiffness or strength that they would compromise the safety and stability of the structure.

To provide better performance for structures assigned to Risk Category III or IV, their allowable story drifts, Δ_a , generally are more stringent than for those assigned to Risk Category I or II. However, those limits are still greater than the damage thresholds for most nonstructural components. Therefore, though the performance of structures assigned to Risk Category III or IV should be improved, there may be considerable damage from a design-level earthquake.

The allowable story drifts, Δ_a , for structures a maximum of four stories above the base are relaxed somewhat, provided that the interior walls, partitions, ceilings, and exterior wall systems have been designed to accommodate story drifts. The type of structure envisioned by footnote d in Table 12.12-1 would be similar to a prefabricated steel structure with metal skin.

The values of Δ_a set forth in Table 12.12-1 apply to each story. For some structures, satisfying strength requirements may produce a system with adequate drift control. However, the design of moment-resisting frames and of tall, narrow shear walls or braced frames often is governed by drift considerations. Where design spectral response accelerations are large, seismic drift considerations are expected to control the design of midrise buildings.

C12.12.3 Structural Separation

This section addresses the potential for impact from adjacent structures during an earthquake. Such conditions may arise because of construction on or near a property line or because of the introduction of separations within a structure (typically called “seismic joints”) for the purpose of permitting their independent response to earthquake ground motion. Such joints may effectively eliminate irregularities and large force transfers between portions of the building with different dynamic properties.

The standard requires the distance to be “sufficient to avoid damaging contact under total deflection.” It is recommended that the distance be computed using the square root of the sum of the squares of the lateral deflections. Such a combination method treats the deformations as linearly independent variables. The deflections used are the expected displacements (e.g., the anticipated maximum inelastic deflections including the effects of torsion and diaphragm deformation). Just as these displacements increase with height, so does the required separation. If the effects of impact can be shown not to be detrimental, the required separation distances can be reduced.

For rigid shear wall structures with rigid diaphragms whose lateral deflections cannot be reasonably estimated, the NEHRP provisions (FEMA 2009a) suggest that older code requirements for structural separations of at least 1 in. (25 mm) plus 1/2 in. (13 mm) for each 10 ft (3 m) of height above 20 ft (6 m) be followed.

C12.12.4 Members Spanning between Structures

Where a portion of the structure is seismically separated from its support, the design of the support requires attention to ensure that support is maintained as the two portions move independently during earthquake ground motions. To prevent loss of gravity support for members that bridge between the two portions, the relative displacement must not be underestimated. Displacements computed for verifying compliance with drift limits (Eq. (12.8-15)) and structural separations (Eq. (12.12-1)) may be insufficient for this purpose.

The provision gives four requirements to ensure that displacement is not underestimated:

1. The deflections calculated using Eq. (12.8-15) are multiplied by $1.5R/C_d$ to correct for likely underestimation of displacement by the equation. The factor of 1.5 corrects for the 2/3 factor that is used in the calculation of seismic base shear, V , by reducing the base shear from the value based on the MCE_R ground motion (Section 11.4.4). Multiplying by R/C_d corrects for the fact that values of C_d less than R underestimate deflections (Uang and Maarouf 1994).
2. The deflections are calculated for torsional effects, including amplification factors. Diaphragm rotation can add significantly to the center-of-mass displacements calculated using Eq. (12.8-15).
3. Displacement caused by diaphragm deformations are required to be calculated, as in some types of construction where the deformation during earthquake ground motions of the diaphragm can be considerable.
4. The absolute sum of displacements of the two portions is used instead of a modal combination, such as with Eq. (12.12-2), which would represent a probable value.

It is recognized that displacements so calculated are likely to be conservative. However, the consequences of loss of gravity support are likely to be severe and some conservatism is deemed appropriate.

C12.12.5 Deformation Compatibility for Seismic Design Categories D through F

In regions of high seismicity, many designers apply ductile detailing requirements to elements that are intended to resist seismic forces but neglect such practices for nonstructural components, or for structural components that are designed to resist only gravity forces but must undergo the same lateral deformations as the designated seismic force-resisting system. Even where elements of the structure are not intended to resist seismic forces and are not detailed for such resistance, they can participate in the response and may suffer severe damage as a result. This provision requires the designer to provide a level of ductile detailing or proportioning to all elements of the structure appropriate to the calculated deformation demands at the design story drift, Δ . This provision may be accomplished by applying details in gravity members similar to that used in members of the seismic force-resisting system or by providing sufficient *strength in those members, or by providing sufficient stiffness in the overall structure to preclude ductility demands in those members.*

In the 1994 Northridge earthquake, such participation was a cause of several failures. A preliminary reconnaissance report of that earthquake (EERI 1994) states:

Of much significance is the observation that six of the seven partial collapses (in modern precast concrete parking structures) seem to have been precipitated by damage to the gravity load system. Possibly, the combination of large lateral deformation and vertical load caused crushing in poorly confined columns that were not detailed to be part of the lateral load resisting system. Punching shear failures were observed in some structures at slab-to-column connections, such as at the Four Seasons building in Sherman Oaks. The primary lateral load resisting system was a perimeter ductile frame that performed quite well. However, the interior slab-column system was incapable of undergoing the same lateral deflections and experienced punching failures.

This section addresses such concerns. Rather than relying on designers to assume appropriate levels of stiffness, this section explicitly requires that the stiffening effects of adjoining rigid structural and nonstructural elements be considered and that a rational value of member and restraint stiffness be used for the design of structural components that are not part of the seismic force-resisting system.

This section also includes a requirement to address shears that can be induced in structural components that are not part of the seismic force-resisting system because sudden shear failures have been catastrophic in past earthquakes.

The exception is intended to encourage the use of intermediate or special detailing in beams and columns that are not part of the seismic force-resisting system. In return for better detailing, such beams and columns are permitted to be designed to resist moments and shears from unamplified deflections. This design approach reflects observations and experimental evidence that well-detailed structural components can accommodate large drifts by responding inelastically without losing significant vertical load-carrying capacity.

C12.13 FOUNDATION DESIGN

C12.13.1 Design Basis

In traditional geotechnical engineering practice, foundation design is based on allowable stresses, with allowable foundation load capacities, Q_{as} , for dead plus live loads based on limiting static settlements, which provides a large factor of safety against exceeding ultimate capacities. In this practice, allowable soil stresses for dead plus live loads often are increased arbitrarily by one-third for load combinations that include wind or seismic forces. That approach is overly conservative and not entirely consistent with the design basis prescribed in Section 12.1.5, since it is not based on explicit consideration of the expected

strength and dynamic properties of the site soils. Strength design of foundations in accordance with Section 12.13.5 facilitates more direct satisfaction of the design basis.

Section 12.13.1.1 provides horizontal load effect, E_h values that are used in Section 12.4.2 to determine foundation load combinations that include seismic effects. Vertical seismic load effects are still determined in accordance with Section 12.4.2.2.

Foundation horizontal seismic load effect values specified in Section 12.13.1.1 are intended to be used with horizontal seismic forces, Q_E defined in Section 12.4.2.1.

C12.13.3 Foundation Load-Deformation Characteristics

For linear static and dynamic analysis methods, where foundation flexibility is included in the analysis, the load-deformation behavior of the supporting soil should be represented by an equivalent elastic stiffness using soil properties that are compatible with the soil strain levels associated with the design earthquake motion. The strain-compatible shear modulus, G , and the associated strain-compatible shear wave velocity, v_s , needed for the evaluation of equivalent elastic stiffness are specified in Chapter 19 of the standard or can be based on a site-specific study. Although inclusion of soil flexibility tends to lengthen the fundamental period of the structure, it should not change the maximum period limitations applied when calculating the required base shear of a structure.

A mathematical model incorporating a combined superstructure and foundation system is necessary to assess the effect of foundation and soil deformations on the superstructure elements. Typically, frequency-independent linear springs are included in the mathematical model to represent the load-deformation characteristics of the soil, and the foundation components are either explicitly modeled (e.g., mat foundation supporting a configuration of structural walls) or are assumed to be rigid (e.g., spread footing supporting a column). In specific cases, a spring may be used to model both the soil and the foundation component (e.g., grade beams or individual piles).

For dynamic analysis, the standard requires a parametric evaluation with upper and lower bound soil parameters to account for the uncertainty in as-modeled soil stiffness and in situ soil variability and to evaluate the sensitivity of these variations on the superstructure. Sources of uncertainty include variability in the rate of loading, including the cyclic nature of building response, level of strain associated with loading at the design earthquake (or stronger), idealization of potentially nonlinear soil properties as elastic, and variability in the estimated soil properties. To a lesser extent, this variation accounts for variability in the performance of the foundation components, primarily when a rigid foundation is assumed or distribution of cracking of concrete elements is not explicitly modeled.

Commonly used analysis procedures tend to segregate the “structural” components of the foundation (e.g., footing, grade beam, pile, and pile cap) from the supporting (e.g., soil) components. The “structural” components are typically analyzed using standard strength design load combinations and methodologies, whereas the adjacent soil components are analyzed using allowable stress design (ASD) practices, in which earthquake forces (that have been reduced by R) are considered using ASD load combinations, to make comparisons of design forces versus allowable capacities. These “allowable” soil capacities are typically based on expected strength divided by a factor of safety, for a given level of potential deformations.

When design of the superstructure and foundation components is performed using strength-level load combinations, this traditional practice of using allowable stress design to verify soil compliance can become problematic for assessing the behavior of foundation components. The 2009 NEHRP provisions (FEMA 2009a) contain two resource papers (RP 4 and RP 8) that provide guidance on the application of ultimate strength design procedures in the geotechnical design of foundations and the development of foundation load-deformation characterizations for both linear and nonlinear analysis methods. Additional guidance on these topics is contained in ASCE/SEI 41-06 (2007).

C12.13.4 Reduction of Foundation Overturning

Overturning effects at the soil–foundation interface are permitted to be reduced by 25% for foundations of structures that satisfy both of the following conditions:

- a. The structure is designed in accordance with the equivalent lateral force analysis as set forth in Section 12.8.
- b. The structure is not an inverted pendulum or cantilevered column-type structure.

Overturning effects at the soil–foundation interface may be reduced by 10% for foundations of structures designed in accordance with the modal analysis requirements of Section 12.9.

C12.13.5 Strength Design of Nominal Foundation Geotechnical Capacity

This section provides guidance for determination of nominal strengths, resistance factors, and acceptance criteria, when the strength design load combinations of Section 12.4.2 are used, instead of allowable stress load combinations, to check stresses at the soil–foundation interface.

C12.13.5.1 Nominal Strength

If soils are saturated or anticipated to become so, undrained soil properties might be used for transient seismic loading, even though drained strengths may have been used for static or more sustained loading. For competent soils that are not expected to degrade in strength during seismic loading (e.g., due to partial or total liquefaction of cohesionless soils or strength reduction of sensitive clays), use of static soil strengths is recommended for determining the nominal foundation geotechnical capacity, Q_{ns} , of foundations. Use of static strengths is somewhat conservative for such soils because rate-of-loading effects tend to increase soil strengths for transient loading. Such rate effects are neglected because they may not result in significant strength increase for some soil types and are difficult to estimate confidently without special dynamic testing programs. The assessment of the potential for soil liquefaction or other mechanisms for reducing soil strengths is critical, because these effects may reduce soil strengths greatly below static strengths for susceptible soils.

The best-estimated nominal strength of footings, Q_{ns} , should be determined using accepted foundation engineering practice. In the absence of moment loading, the ultimate vertical load capacity of a rectangular footing of width B and length L may be written as $Q_{ns} = q_c (BL)$, where q_c = ultimate soil bearing pressure.

For rigid footings subject to moment and vertical load, contact stresses become concentrated at footing edges, particularly as footing uplift occurs. Although the nonlinear behavior of soils will cause the actual soil pressure beneath a footing to become nonlinear, resulting in an ultimate foundation strength that is slightly greater than the strength that is determined by assuming a simplified trapezoidal or triangular soil pressure distribution with a maximum soil pressure equal to the expected ultimate soil pressure, q_c , the difference between the expected ultimate foundation strength and the effective ultimate strength calculated using these simplified assumptions is not significant.

The lateral foundation geotechnical capacity of a footing may be assumed equal to the sum of the best-estimated soil passive resistance against the vertical face of the footing plus the best-estimated soil friction force on the footing base. The determination of passive resistance should consider the potential contribution of friction on the vertical face.

For piles, the best-estimated vertical strength (for both axial compression and axial tensile loading) should be determined using accepted foundation engineering practice. The moment capacity of a pile group should be determined assuming a rigid pile cap, leading to an initial triangular distribution of axial pile loading from applied overturning moments. However, the full expected axial capacity of piles may be mobilized when computing moment capacity, in a manner analogous to that described for a footing. The strength provided in pile caps and intermediate connections should be capable of transmitting the best-estimated pile

forces to the supported structure. When evaluating axial tensile strength, consideration should be given to the capability of pile cap and splice connections to resist the factored tensile loads.

The lateral foundation geotechnical capacity of a pile group may be assumed equal to the best-estimated passive resistance acting against the face of the pile cap plus the additional resistance provided by piles.

C12.13.5.2 Resistance Factors

Resistance factors, ϕ , are provided to reduce nominal foundation geotechnical capacities, Q_{ns} , to design foundation geotechnical capacities, ϕQ_{ns} , to verify foundation acceptance criteria. The values of ϕ recommended here are simplified values that have been based on the values presented in the AASHTO LRFD Bridge Design Specifications.

C12.13.5.3 Acceptance Criteria

The design foundation geotechnical capacity, ϕQ_{ns} , is used to assess acceptability for the linear analysis procedures. The mobilization of ultimate capacity in nonlinear analysis procedures does not necessarily lead to unacceptable performance as structural deformations due to foundation displacements may be tolerable, as discussed by Martin and Lam (2000). For the nonlinear analysis procedures, Section 12.13.3 also requires evaluation of structural behavior utilizing parametric variation of foundation strength to identify potential changes in structural ductility demands.

In order to coordinate the strength design methodology defined in Section 12.13.5 with existing foundation requirements found in the IBC, modifications to the IBC are also recommended. Recommended modifications to 2012 IBC are:

CHAPTER 18, SOILS AND FOUNDATIONS

(Sections 1801 through 1805.4.3 are unchanged)

SECTION 1806 - PRESUMPTIVE LOAD-BEARING VALUES OF SOILS

1806.1 Load Combinations

The presumptive load-bearing values provided in Table 1806.2 shall be used with the *allowable stress design* load combinations specified in Section 1605.3. The values of vertical foundation pressure and lateral bearing pressure given in Table 1806.2 shall be permitted to be increased by one-third where used with the alternative basic load combinations of Section 1605.3.2 that include wind or earthquake loads.

The presumptive load-bearing values of vertical foundation pressure and lateral bearing pressure provided in Table 1806.2 shall be permitted to be multiplied by 3.0 when used with the *strength design* load combinations specified in Section 1605.2. No additional increases to the resulting values of vertical foundation pressure or lateral bearing pressure shall be permitted where used with the basic load combinations of Section 1605.2 that include wind or earthquake loads.

1806.2 Presumptive Load-Bearing Values

The load-bearing values used in design for supporting soils near the surface shall not exceed the values specified in Table 1806.2 unless data to substantiate the use of higher values are submitted and *approved*. Where the *building official* has reason to doubt the classification, strength or compressibility of the soil, the requirements of Section 1803.5.2 shall be satisfied.

(remainder of this section is unchanged)

COMMENTARY FOR MODIFICATIONS TO 2012 IBC

C1806 Presumptive Load-Bearing Values Of Soils

For many smaller structures, the presumptive load-bearing values presented in Section 1806 have long been used in order to avoid extensive soils testing. Even when project-specific geotechnical reports with foundation design recommendations are provided, the “standard” presumptive load-bearing values often have been used as a benchmark for comparison. Because these values were developed for use with traditional ASD design practices, some clarification of intent and usage is needed for application to strength design. The value of the multiplier for strength design was selected to result in approximate parity with comparative ASD load and strength values.

C12.13.6 Requirements for Structures Assigned to Seismic Design Category C

C12.13.6.1 Pole-Type Structures

The high contact pressures that develop between an embedded pole and soil as a result of lateral loads make pole-type structures sensitive to earthquake motions. Pole-bending strength and stiffness, the soil lateral bearing capacity, and the permissible deformation at grade level are key considerations in the design. For further discussion of pole–soil interaction, see Section C12.13.7.7.

C12.13.6.2 Foundation Ties

One important aspect of adequate seismic performance is that the foundation system acts as an integral unit, not permitting one column or wall to move appreciably to another. To attain this performance, the standard requires that pile caps be tied together. This requirement is especially important where the use of deep foundations is driven by the existence of soft surface soils.

Multistory buildings often have major columns that run the full height of the building adjacent to smaller columns that support only one level; the calculated tie force should be based on the heavier column load.

The standard permits alternate methods of tying foundations together when appropriate. Relying on lateral soil pressure on pile caps to provide the required restraint is not a recommended method because ground motions are highly dynamic and may occasionally vary between structure support points during a design-level seismic event.

C12.13.6.3 Pile Anchorage Requirements

The pile anchorage requirements are intended to prevent brittle failures of the connection to the pile cap under moderate ground motions. Moderate ground motions can result in pile tension forces or bending moments that could compromise shallow anchorage embedment. Loss of pile anchorage could result in increased structural displacements from rocking, overturning instability, and loss of shearing resistance at the ground surface. A concrete bond to a bare steel pile section usually is unreliable, but connection by means of deformed bars properly developed from the pile cap into concrete confined by a circular pile section is permitted.

C12.13.7 Requirements for Structures Assigned to Seismic Design Categories D through F

C12.13.7.1 Pole-Type Structures

See Section C12.13.6.1.

C12.13.7.2 Foundation Ties

See Section C12.13.6.2. For Seismic Design Categories D through F, the requirement is extended to spread footings on soft soils (Site Class E or F).

C12.13.7.3 General Pile Design Requirement

Design of piles is based on the same response modification coefficient, R , used in design of the superstructure; because inelastic behavior results, piles should be designed with ductility similar to that of

the superstructure. When strong ground motions occur, inertial pile–soil interaction may produce plastic hinging in piles near the bottom of the pile cap, and kinematic soil–pile interaction results in bending moments and shearing forces throughout the length of the pile, being higher at interfaces between stiff and soft soil strata. These effects are particularly severe in soft soils and liquefiable soils, so Section 14.2.3.2.1 requires special detailing in areas of concern.

The shears and curvatures in piles caused by inertial and kinematic interaction may exceed the bending capacity of conventionally designed piles, resulting in severe damage. Analysis techniques to evaluate pile bending are discussed by Margason and Holloway (1977) and Mylonakis (2001), and these effects on concrete piles are further discussed by Sheppard (1983). For homogeneous, elastic media and assuming that the pile follows the soil, the free-field curvature (soil strains without a pile present) can be estimated by dividing the peak ground acceleration by the square of the shear wave velocity of the soil. Considerable judgment is necessary in using this simple relationship for a layered, inelastic profile with pile–soil interaction effects. Norris (1994) discusses methods to assess pile–soil interaction.

Where determining the extent of special detailing, the designer must consider variation in soil conditions and driven pile lengths, so that adequate ductility is provided at potentially high curvature interfaces. Confinement of concrete piles to provide ductility and maintain functionality of the confined core pile during and after the earthquake may be obtained by use of heavy spiral reinforcement or exterior steel liners.

C12.13.7.4 Batter Piles

Partially embedded batter piles have a history of poor performance in strong ground shaking, as shown by Gerwick and Fotinos (1992). Failure of battered piles has been attributed to design that neglects loading on the piles from ground deformation or assumes that lateral loads are resisted by axial response of piles without regard to moments induced in the pile at the pile cap (Lam and Bertero 1990). Because batter piles are considered to have limited ductility, they must be designed using the load combinations with overstrength factor. Moment-resisting connections between pile and pile cap must resolve the eccentricities inherent in batter pile configurations. This concept is illustrated clearly by EQE Engineering (1991).

C12.13.7.5 Pile Anchorage Requirements

Piles should be anchored to the pile cap to permit energy-dissipating mechanisms, such as pile slip at the pile–soil interface, while maintaining a competent connection. This section of the standard sets forth a capacity design approach to achieve that objective. Anchorages occurring at pile cap corners and edges should be reinforced to preclude local failure of plain concrete sections caused by pile shears, axial loads, and moments.

C12.13.7.6 Splices of Pile Segments

A capacity design approach, similar to that for pile anchorage, is applied to pile splices.

C12.13.7.7 Pile–Soil Interaction

Short piles and long slender piles embedded in the earth behave differently when subjected to lateral forces and displacements. The response of a long slender pile depends on its interaction with the soil considering the nonlinear response of the soil. Numerous design aid curves and computer programs are available for this type of analysis, which is necessary to obtain realistic pile moments, forces, and deflections and is common in practice (Ensoft 2004b). More sophisticated models, which also consider inelastic behavior of the pile itself, can be analyzed using general-purpose nonlinear analysis computer programs or closely approximated using the pile–soil limit state methodology and procedure given by Song et al. (2005).

Short piles (with length-to-diameter ratios no more than 6) can be treated as a rigid body, simplifying the analysis. A method assuming a rigid body and linear soil response for lateral bearing is given in the current

building codes. A more accurate and comprehensive approach using this method is given in a study by Czerniak (1957).

C12.13.7.8 Pile Group Effects

The effects of groups of piles, where closely spaced, must be taken into account for vertical and horizontal response. As groups of closely spaced piles move laterally, failure zones for individual piles overlap and horizontal strength and stiffness response of the pile–soil system is reduced. Reduction factors or “*p*-multipliers” are used to account for these groups of closely spaced piles. For a pile center-to-center spacing of three pile diameters, reduction factors of 0.6 for the leading pile row and 0.4 for the trailing pile rows are recommended by Rollins et al. (1999). Computer programs are available to analyze group effects assuming nonlinear soil and elastic piles (Ensoft 2004a).

C12.13.8 Requirements for Structure Foundations on Liquefiable Sites

This new section provides requirements for foundations of structures that are located on sites that have been determined to have the potential to liquefy when subjected to Geo-mean Maximum Considered Earthquake ground motions. This section complements the requirements of Section 11.8 which provides requirements for geotechnical investigations in areas with significant seismic ground motion hazard with specific requirements for additional geotechnical information and recommendations for sites that have the potential to liquefy when subjected to the Geo-mean Maximum Considered Earthquake ground motion.

Prior to the 2010 edition of ASCE 7 (which was based on the *2009 NEHRP Recommended Seismic Provisions for Buildings and Other Structures*), the governing building code requirements for foundations where potentially liquefiable soil conditions were present was Chapter 18 of the International Building Code (IBC). Chapter 18 of the IBC 2009 specified the use of the Design Earthquake (DE) ground motions for all structural and geotechnical evaluations for buildings. Chapter 18 of the IBC 2012 references the ASCE 7 – 2010 Standard for liquefaction-related evaluations (ASCE, 2010) and deletes reference to the DE. Chapter 11 of the ASCE 7-2010 has new requirements that specify that clearly states that Maximum Considered Earthquake (MCE) rather than the DE ground motions be used for geotechnical (liquefaction-related) evaluations that are specified in the IBC 2009.

The reason that the change to MCE ground motions for liquefaction evaluations were made in ASCE 7-2010 was to make the ground motions used in the evaluations consistent with the ground motions used as the basis for the design of structures. Starting with the 2000 IBC, the ground motion maps provided in the Code for seismic design were MCE mapped values and not DE values. While design values for structures in the IBC are based on DE ground motions which are two-thirds of the MCE, studies (FEMA P-695) have indicated that structures designed for DE motions had a low probability of collapse at MCE level motions. However these studies presumed non-liquefiable soil conditions. It should also be noted that most essential structures such as hospitals are required to be explicitly designed for MCE motions. While ASCE 7-10 has specific requirements for MCE-level liquefaction evaluations, it has no specific requirements for foundation design when these conditions exist. This lack of clear direction was the primary reason for the development of this new Section.

The requirements of this section along with the seismic requirements of this standard are intended to result in structure foundation systems that satisfy the performance goals stated in Section 1.1 of the *2009 NEHRP Recommended Seismic Provisions for Buildings and Other Structures* for structure sites that have been determined to be liquefiable per Section 11.8. They require mitigation of significant liquefaction induced risks, either through ground improvement or structural measures, aimed at preventing liquefaction-induced building collapse and permitting the structure and its nonstructural system to satisfy the Section 1.1 performance goals. With the exception of Risk Category IV "Essential Facilities", the provisions do not seek to control non-life-threatening damage to buildings that may occur as a result of liquefaction-induced settlement. For Risk Category IV Essential Facilities", the provisions seek to limit damage attributable to

liquefaction to levels that would permit post-earthquake use. For example, settlement is controlled to levels that would be expected to allow for continued operation of doors.

There is nothing in these provisions that is intended to preclude local authorities from enacting more stringent planning regulations for building on sites susceptible to potential geologic hazards, in recognition of losses that may occur in the event of an earthquake that triggers liquefaction.

In the first paragraph of Section 12.13.8, it is stated that the foundation must also be designed to resist the effects of Design Earthquake seismic load effects assuming liquefaction does not occur. This additional requirement is imposed since maximum seismic loads on a foundation during an earthquake can occur prior to liquefaction. This additional requirement provides assurance that the foundation will be adequate regardless of when liquefaction occurs during the seismic event.

Observed Liquefaction related Structural Damage in Past Earthquakes

Damage to structures from liquefaction-related settlement, punching failure of footings and lateral spreading has been common in past earthquakes. Whereas total post liquefaction settlement values have varied from several inches to several feet (depending on the relative density and thickness of saturated sand deposits), differential settlements depend on the uniformity of site conditions and the depth of liquefied strata. For example, in the 1995 Kobe, Japan, earthquake, total settlements of 1.5 to 2.5 ft. were observed but with relatively small differential settlements.

In the 1989 Loma Prieta, California, earthquake, settlements of as much as 2 feet and lateral spreading that ranged between 0.25 feet and 5 feet were observed on the Moss Landing spit. The Monterey Bay Aquarium Research Institute's (MBARI's) Technology building was supported on shallow foundation with ties and located some 30 feet away from the edge of the Moss Landing South Harbor. While 0.25 feet of lateral spreading was measured at the edge of the harbor across the street from the MBARI building, the building suffered only minor cracks. On the other hand, the Moss Landing Marine Lab (MLML) building was located on a different part of the spit and over 30 feet from the edge of the same river channel, constituting the harbor. Between 4 and 5 feet of lateral spreading was measured at the edge of the channel in this part of the spit. The MLML building, which was supported on shallow foundations without ties, collapsed as the building footings were pulled apart. The MBARI research pier, located at the harbor, across the street from the Technology Building, suffered no damage except for minor spalling at the underside of the concrete deck, where the 16-inch diameter cylindrical driven piles for the pier interfaced with the overlying concrete deck.

The 1999 Kocaeli, Turkey earthquake provided numerous examples of the relationship between liquefaction-induced soil deformations and building and foundation damage in the City of Adapazari. Examples include a 5-story reinforced concrete frame building on a mat foundation that settled about 0.5 ft. at one corner and 5 ft. at the opposite corner with related tilting associated with rigid body motion. Essentially no foundation or structural damage was observed. In contrast, several buildings on mat foundations underwent bearing capacity failures and overturned. The foundation soil strength loss, evidenced by bulging around the building perimeter, initiated the failures, as opposed to differential settlement caused by post liquefaction volume change in the former case history. In addition, lateral movements of building foundations were also observed. Movements were essentially rigid body for buildings on stiff mat foundations, and led to no significant building damage. For example, a 5-story building experienced about 1.5 ft. of settlement and 3ft. of lateral displacement.

In the 2011 and 2012 Christchurch, New Zealand, earthquakes, significant differential settlement occurred for several buildings on spread footings. Values of differential settlement of 1 to 1.5 ft. were measured for 3- to 5-story buildings, resulting in building tilt of 2 to 3 degrees. Structural damage was less for cases where relatively strong reinforced concrete ties between footings were used to minimize differential settlement. Footing punching failures also occurred leading to significant damage. For taller buildings on

relatively rigid raft foundations, differential ground settlement resulted in building tilt, but less structural damage. In contrast, structures on pile foundations performed relatively well.

C12.13.8.1 Foundation Design

Foundations are not allowed to lose the strength capacity to support vertical reactions following liquefaction. This requirement is intended to prevent bearing capacity failure of shallow foundations and axial load failure of deep foundations. Settlement in the event of such failures cannot be accurately estimated and has potentially catastrophic consequences. Such failures can be prevented by using ground improvement or adequately designed deep foundations.

Liquefaction-induced differential settlement can result from variations in the thickness, relative density, or fines content of potentially liquefiable layers that occur across the footprint of the structure. When planning a field exploration program for a potentially liquefiable site, where it is anticipated that shallow foundations may be employed, the Geotechnical Engineer must have information on the proposed layout of the building(s) on the site. This information is essential to properly locating and spacing exploratory holes to obtain an appropriate estimate of anticipated differential settlement. One acceptable method for dealing with unacceptable liquefaction-induced settlements is by performing ground improvement. There are many acceptable methods for ground improvement.

C12.13.8.2 Shallow Foundation

Shallow foundations are permitted where individual footings are tied together so they have the same horizontal displacements and differential settlements are limited or where the expected differential settlements can be accommodated by the structure and the foundation system. The lateral spreading limits provided in Table 12.13-2 are based on engineering judgment and are the judged upper limits of lateral spreading displacements that can be tolerated while still achieving the desired performance for each Risk Category presuming the foundation is well tied together. Differential settlement is defined as δ_v / L , where δ_v and L are illustrated for an example structure in Figure C12.13.8-1 below. The differential settlement limits specified in Table 12.13-3 are intended to provide collapse resistance for Risk Category II and III structures.

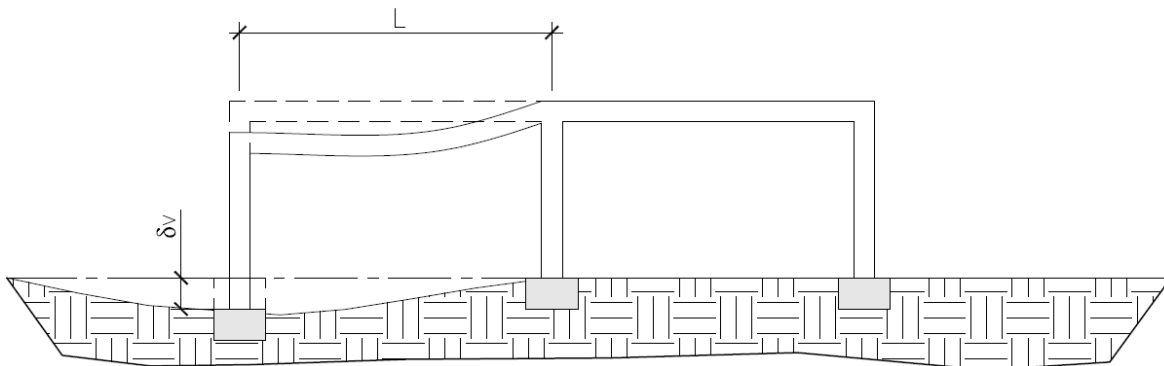

FIGURE C12.13.8-1 Example Showing Differential Settlement Terms δ_v and L

The limit for one-story Risk Category II structures with concrete or masonry structural walls is consistent with the drift limit in ASCE 41 for concrete shear walls to maintain Collapse Prevention. The limit for taller structures is more restrictive, due to the effects that the tilt would have on the floors of upper levels. This more restrictive limit is consistent with the “moderate to severe damage” for multi-story masonry structures as indicated in Boscardin and Cording (1989).

The limits for structures without concrete or masonry structural walls are less restrictive and are consistent with the drift limits in ASCE 41 for high-ductility concrete frames to maintain Collapse Prevention. Note that frames of lower ductility are not permitted in seismic design categories C and above, which are the only categories where liquefaction hazards need to be assessed.

The limits for Risk Category III structures are two-thirds of those specified for Risk Category II.

The limits for Risk Category IV are intended to maintain differential settlements less than the distortion that will cause doors to jam in the Design Earthquake. The numerical value is based on the median value of drift (0.0023) at the onset of the damage state for jammed doors developed for the ATC-58 project, multiplied by 1.5 to account for the dispersion and scaled to account for the higher level of shaking in the MCE relative to the DE.

Shallow foundations are required to be interconnected by ties, regardless of the effects of liquefaction. The additional detailing requirements in this section are intended to provide moderate ductility in the behavior of the ties, as the adjacent foundations may settle differentially. The tie force required to accommodate lateral ground displacement is intended to be a conservative assessment to overcome the maximum frictional resistance that could occur between footings along each column or wall line. The tie force assumes that the lateral spreading displacement occurs abruptly midway along the column or wall line. The coefficient of friction between the footings and underlying soils may be taken conservatively as 0.50. This requirement is intended to maintain continuity throughout the substructure in the event of lateral ground displacement affecting a portion of the structure. The required tie force should be added to the force determined from the lateral loads for the Design Earthquake in accordance with either Sections 12.8, 12.9, 12.14 or Chapter 16.

C12.13.8.3 Deep Foundations

Pile foundations are intended to remain elastic under axial loadings, including those from gravity, seismic and downdrag loads. Since geotechnical design is most frequently performed using allowable-stress (ASD) methods, and liquefaction-induced downdrag is assessed at an ultimate level, the requirements state that the downdrag is considered as a reduction in the ultimate capacity. Since structural design is most frequently performed using load and resistance factor design (LRFD) methods, and the downdrag is considered as a load for the pile structure to resist, the requirements clarify that the downdrag is considered as a seismic axial load, to which a factor of 1.0 would be applied for design.

The ultimate geotechnical capacity of the pile should be determined using only the contribution from the soil below the liquefiable layer. The net ultimate capacity is the ultimate capacity reduced by the downdrag load. See Figure C12.13.7-2 below.

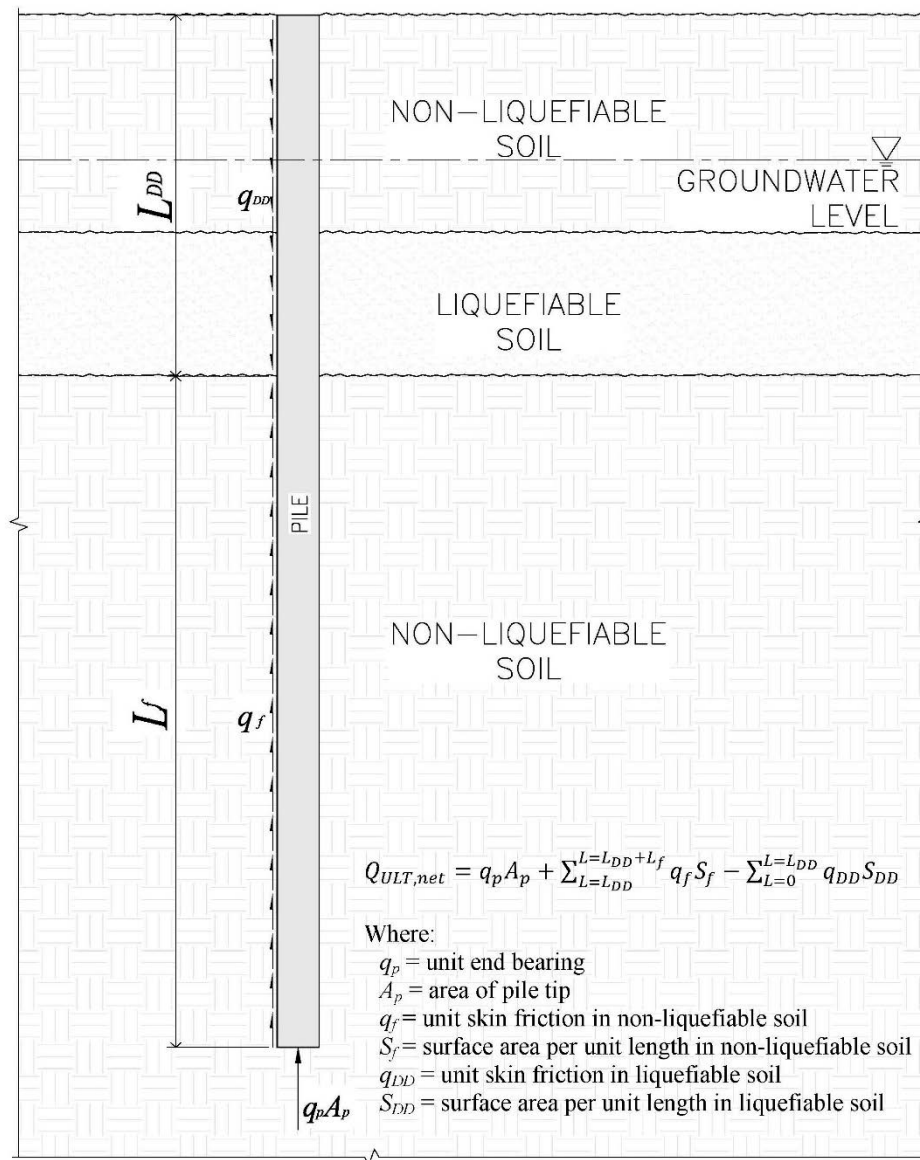

FIGURE C12.13.8-2 Determination of Ultimate Pile Capacity in Liquefiable Soils

Lateral resistance of the foundation system includes resistance of the piles as well as passive pressure acting on walls, pile caps, and grade beams. Analysis of the lateral resistance provided by these disparate elements is usually accomplished separately. In order for these analyses to be applicable, the displacements employed must be compatible. Lateral pile analyses commonly employ nonlinear soil properties. Geotechnical recommendations for passive pressure should include the displacement at which the pressure is applicable, or should provide a nonlinear mobilization curve. Liquefaction occurring in near-surface layers may substantially reduce the ability to transfer lateral inertial forces from foundations to the subgrade, potentially resulting in damaging lateral deformations to piles. Ground improvement of surface soils may be considered for pile supported structures to provide additional passive resistance to be mobilized on the sides of embedded pile caps and grade beams, as well as to increase the lateral resistance of piles. Otherwise the check for transfer of lateral inertial forces is the same as for structures on non-liquefiable sites.

IBC Section 1810.2.1 requires that deep foundation elements in fluid (liquefied) soil be considered unsupported for lateral resistance until a point 5 feet into stiff soil or 10 feet into soft soil unless otherwise approved by the authority having jurisdiction on the basis of a geotechnical investigation by a registered design professional. Where liquefaction is predicted to occur, the geotechnical engineer should provide the dimensions (depth and length) of the unsupported length of the pile or should indicate if the liquefied soil will provide adequate resistance such that the length is considered laterally supported in this soil. The geotechnical engineer should develop these dimensions by performing a p-y analysis.

Concrete pile detailing includes transverse reinforcing requirements for columns in ACI 318-11. This is intended to provide ductility within the pile similar to that required for columns.

Where permanent ground displacement is indicated, piles are not required to remain elastic when subjected to this displacement. The provisions are intended to provide ductility and maintain vertical capacity, including flexure-critical behavior of concrete piles.

The required tie force specified in Section C12.13.8.3.5 should be added to the force determined from the lateral loads for the Design Earthquake in accordance with either Sections 12.8, 12.9, 12.14 or Chapter 16.

C12.14 SIMPLIFIED ALTERNATIVE STRUCTURAL DESIGN CRITERIA FOR SIMPLE BEARING WALL OR BUILDING FRAME SYSTEMS

C12.14.1 General

In recent years, engineers and building officials have become concerned that the seismic design requirements in codes and standards, while intended to make structures perform more reliably, have become so complex and difficult to understand and implement that they may be counterproductive. Since the response of buildings to earthquake ground shaking is very complex (especially for irregular structural systems), realistically accounting for these effects can lead to complex requirements. There is a concern that the typical designers of small, simple buildings, which may represent more than 90 percent of construction in the United States, have difficulty understanding and applying the general seismic requirements of the standard.

The simplified procedure presented in this section of the standard applies to low-rise, stiff buildings. The procedure, which was refined and tested over a five-year period, was developed to be used for a defined set of buildings deemed to be sufficiently regular in structural configuration to allow a reduction of prescriptive requirements. Further study of torsional response of buildings with rigid diaphragms resulted in additional simplifications (BSSC, 2015). For some design elements, such as foundations and anchorage of nonstructural components, other sections of the standard must be followed, as referenced within Section 12.14.

C12.14.1.1 Simplified Design Procedure

Reasons for the limitations of the simplified design procedure of Section 12.14 are as follows:

1. The procedure was developed to address adequate seismic performance for standard occupancies. Since it was not developed for higher levels of performance associated with structures assigned to Risk Category III and IV, no importance factor (I_e) is employed.
2. Site Class E and F soils require specialized procedures that are beyond the scope of the procedure.
3. The procedure was developed for stiff, low-rise buildings, where higher-mode effects are negligible.
4. Only stiff systems where drift is not a controlling design criterion may employ the procedure. Because of this limitation, drifts are not computed. The response modification coefficient, R , and the associated system limitations are consistent with those found in the general Chapter 12 requirements.

5. In order to achieve a balanced design and a reasonable level of redundancy, two lines of resistance are required in each of the two major axis directions. Because of this stipulation, no redundancy factor (ρ) is applied.
6. When combined with the requirements in items 7 and 8, this requirement reduces the potential for dominant torsional response.
7. Although cast-in-place concrete diaphragms may be designed for even larger overhangs, the torsional response of the system as a show would be inconsistent with the behavior assumed in development of Section 12.14. Large overhangs for flexible diaphragm buildings can also produce a response that is inconsistent with the assumptions associated with the procedure.
8. Linear analysis shows a significant difference in response between flexible and rigid diaphragm behavior. However, nonlinear response history analysis of systems with the level of ductility present in the systems permitted in Table 12.14-1 for the higher seismic design categories has shown that a system that satisfies these layout and proportioning requirements provides essentially the same probability of collapse as a system with the same layout but proportioned based upon rigid diaphragm behavior (BSSC, 2015). This procedure avoids the need to check for torsional irregularity, and calculation of accidental torsional moments is not required. Figure C12.14-1 shows a plan with closely spaced walls in which the method permitted in subparagraph c) should be implemented. In that circumstance the flexible diaphragm analysis would first be performed as if there were one wall at the location of the centroid of walls 4 and 5, then the force computed for that group would be distributed to walls 4 and 5 based upon a reasonable assessment of their relative stiffnesses.

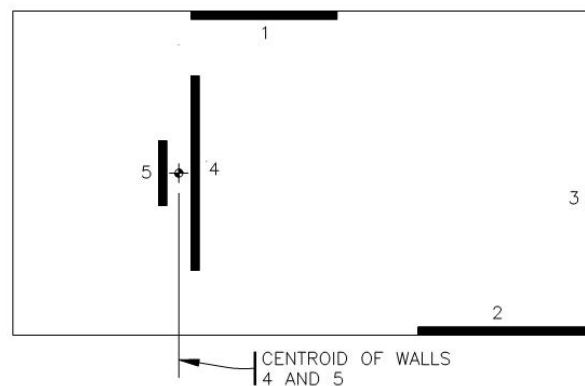

FIGURE C12.14-1 Treatment of Closely Spaced Walls

9. An essentially orthogonal orientation of lines of resistance effectively uncouples response along the two major axis directions, so orthogonal effects may be neglected.
10. Where the simplified design procedure is chosen, it must be used for the entire design, in both major axis directions.
11. Since in-plane and out-of-plane offsets generally create large demands on diaphragms, collectors, and discontinuous elements, which are not addressed by the procedure, these irregularities are prohibited.
12. Buildings that exhibit weak-story behavior violate the assumptions used to develop the procedure.

C12.14.3 Seismic Load Effects and Combinations

The equations for seismic load effects and load combinations in the simplified design procedure are consistent with those for the general procedure, with one notable exception: the overstrength factor (corresponding to Ω_0 in the general procedure) is set at 2.5 for all systems as indicated in Section

12.14.3.2.1. Given the limited systems that can use the simplified design procedure, specifying unique overstrength factors was deemed unnecessary.

C12.14.7 Design and Detailing Requirements

The design and detailing requirements outlined in this section are similar to those for the general procedure. The few differences include the following:

1. Forces used to connect smaller portions of a structure to the remainder of the structures are taken as 0.20 times the short-period design spectral response acceleration, S_{DS} , rather than the general procedure value of 0.133 (Section 12.14.7.1).
2. Anchorage forces for concrete or masonry structural walls for structures with diaphragms that are not flexible are computed using the requirements for nonstructural walls (Section 12.14.7.5).

C12.14.8 Simplified Lateral Force Analysis Procedure

C12.14.8.1 Seismic Base Shear

The seismic base shear in the simplified design procedure, as given by Eq. (12.14-11), is a function of the short-period design spectral response acceleration, S_{DS} . The value for F in the base shear equation addresses changes in dynamic response for buildings that are two or three stories above grade plane (see Section 11.2 for definitions of “grade plane” and “story above grade plane”). As in the general procedure (Section 12.8.1.3), S_{DS} may be computed for short, regular structures with S_S taken as no greater than 1.5.

C12.14.8.2 Vertical Distribution

The seismic forces for multistory buildings are distributed vertically in proportion to the weight of the respective floor. Given the slightly amplified base shear for multistory buildings, this assumption, along with the limit of three stories above grade plane for use of the procedure, produces results consistent with the more traditional triangular distribution without introducing that more sophisticated approach.

C12.14.8.5 Drift Limits and Building Separation

For the simplified design procedure, which is restricted to stiff shear wall and braced frame buildings, drift need not be calculated. Where drifts are required (such as for structural separations and cladding design) a conservative drift value of 1% is specified.

REFERENCES

- AASHTO *LRFD Bridge Design Specifications*, 2010
- American Concrete Institute (ACI). (2008). “Building code requirements for structural concrete and commentary.” *ACI 318-08*, Farmington Hills, Mich.
- American Institute of Steel Construction. 2005. *Seismic Provisions for Structural Steel Buildings*, AISC 341-05.
- American Institute of Steel Construction (AISC). (2010). “Seismic provisions for structural steel buildings.” *AISC 341-10*, Chicago.
- American Society of Civil Engineers (ASCE). (2000). “Seismic analysis of safety-related nuclear structures and commentary.” *ASCE 4-98*, Reston, Va.
- American Society of Civil Engineers/Structural Engineering Institute (ASCE/SEI). (2007). “Seismic rehabilitation of existing buildings.” *ASCE/SEI 41-06*. ASCE, Reston, Va.
- APA, 1966. *1966 Horizontal Plywood Diaphragm Tests* (Laboratory Report 106), American Plywood Association, Tacoma, WA.
- APA, 2000. *Plywood Diaphragms* (Research Report 138), American Plywood Association, Tacoma, WA.
- Applied Technology Council (ATC). (1978) (Amended 1984). “Tentative provisions for the development of seismic regulations for buildings.” *ATC 3-06*. ATC, Redwood City, Calif.
- Applied Technology Council. 1996. *Seismic Evaluation and Retrofit of Concrete Buildings*, ATC 40, 2 volumes. Prepared for the Seismic Safety Commission of the State of California. ATC, Redwood City, California.
- AWC, 2008. *Special Design Provisions for Wind and Seismic* (AWC SDPWS-2008), American Wood Council, Leesburg, VA.

- Boscardin, M. D. and Cording, E. J. (1989). "Building Response to Excavation-Induced Settlement," *Journal of Geotechnical Engineering*, ASCE, Vol. 115, No. 1, pp. 1-21.
- BSSC (Building Seismic Safety Council) (2015), "Development of Simplified Seismic Design Provisions, Working Group 1 Report: Simplifying Section 12.14", National Institute of Building Sciences, Washington, DC.
- Building Seismic Safety Council. 1997a and b. National Earthquake Hazard Reduction Program Guidelines and Commentary for the Seismic Rehabilitation of Buildings, FEMA 273 and 274. Federal Emergency Management Agency, Washington, D.C.
- Charney, F. A., and Marshall, J. (2006). "A comparison of the Krawinkler and scissors models for including beam-column joint deformations in the analysis of moment-resisting frames." *AISC Engrg. J.*, 43(1), 31–48.
- Chen, M., Pantoli E., Astroza R., Ebrahimian H., Mintz S., Wang X., Hutchinson T., Conte J., Restrepo J., Meacham B., Kim J., and Park H., 2013 (Draft). *Full-scale structural and nonstructural building system performance during earthquakes and post-earthquake fire: Specimen design, construction and test protocol*. Structural Systems Research Project Report Series. University of California San Diego, San Diego, CA.
- Choi, H., Erochko, J., Christopoulos, C and Tremblay, R., 2008. *Comparison of the Seismic Response of Steel Buildings Incorporating Self-Centering Energy-Dissipative Braces, Buckling Restrained Braces and Moment-Resisting Frames*, Research Report 05-2008, University of Toronto, Canada.
- Chopra, 1995. *Structural Dynamics*, Anil K. Chopra, Prentice Hall, New York NY.
- Chopra, A.K., 2007. *Dynamics of Structures*, Prentice Hall, Upper Saddle River, New Jersey.
- Chopra, A. K. (2007). *Structural Dynamics*, Prentice Hall, Upper Saddle River, N.J.
- Chopra, A. K., and Goel, R. K. (1991). "Evaluation of torsional provisions in seismic codes." *J. Struct. Engrg.*, 117(12), 3762–3782.
- Chopra, A. K., and Newmark, N. M. (1980). "Analysis." Chapter 2, *Design of Earthquake Resistant Structures*, E. Rosenblueth, ed., John Wiley and Sons, New York.
- City of Newport Beach "Minimum Liquefaction Mitigation Measures" April 24, 2012.
- Czerniak, E. (1957). "Resistance to overturning of single, short piles." *J. Struct. Div.*, 83(2), 1–25.
- De La Llera, J. C., and Chopra, A. K. (1994). "Evaluation of code accidental-torsion provisions from building records." *J. Struct. Engrg.*, 120(2), 597–616.
- DFPA, 1963. *Lateral tests on Plywood Sheathed Diaphragms* (Laboratory Report 55), Douglas Fir Plywood Association, Tacoma, WA.
- DFPA, 1954. *Horizontal Plywood Diaphragm Tests* (Laboratory Report 63a), Douglas Fir Plywood Association, Tacoma, WA.
- Earthquake Engineering Research Institute (EERI). (1994). "Northridge Earthquake, January 17, 1994: Preliminary Reconnaissance Report," John F. Hall, ed., EERI, Oakland, Calif., 56–57.
- Ensoft, Inc. (2004a). Computer Program GROUP, Version 6.0, A Program for the Analysis of a Group of Piles Subjected to Axial and Lateral Loading, User's Manual and Technical Manual. Ensoft, Austin, Tex.
- Ensoft, Inc. (2004b). Computer Program LPILE Plus Version 5.0, A Program for the Analysis of Piles and Drilled Shafts under Lateral Loads, User's Manual and Technical Manual. Ensoft, Austin, Tex.
- EQE Engineering. (1991). *Structural Concepts and Details for Seismic Design*, UCRL-CR-106554. Department of Energy, Washington, D.C.
- EQE Incorporated. (1983). "The effects of the May 2, 1983, Coalinga, California earthquake on industrial facilities." EQE Inc.
- EQE Incorporated. (1985). "Summary of the September 19, 1985, Mexico earthquake." EQE Inc.
- EQE Incorporated. (1986a). "Summary of the March 3, 1985, Chile earthquake." EQE Inc.
- EQE Incorporated. (1986b). "The effects of the March 3, 1985, Chile earthquake on power and industrial facilities." EQE Inc.
- EQE Incorporated. (1986c). "Power and industrial facilities in the epicentral area of the 1985 Mexico earthquake." EQE Inc.
- EQE Incorporated. (1987). "Summary of the 1987 Bay of Plenty, New Zealand, earthquake." EQE Inc.
- Federal Emergency Management Agency (FEMA). (2009a). "NEHRP recommended seismic provisions for new buildings and other structures." *FEMA P-750*, Building Seismic Safety Council, Federal Emergency Management Agency, Washington, D.C.
- Federal Emergency Management Agency (FEMA). (2009b). "Quantification of building seismic performance factors." *FEMA P-695*, Applied Technology Council, Federal Emergency Management Agency, Washington, D.C.
- FEMA (2013). 2009 NEHRP Recommended Provisions: Design Examples, Federal Emergency Management Agency, Washington, D.C.
- Fleischman R.B., Restrepo J.I, Naito C.J., Sause R., Zhang D. and Schoettler M., 2013. "Integrated Analytical and Experimental Research to Develop a New Seismic Design Methodology for Precast Concrete Diaphragms," *ASCE J. Struct. Engrg.*, 139(7), 1192-1204.

- Gatto & Uang, 2002. *Cyclic Response of Woodframe Shearwalls: Loading Protocol and Rate of Loading Effects*, Consortium of Universities for Research in Earthquake Engineering, Richmond, CA.
- Gazetas, G. 1991. "Foundation Vibrations," *Foundation Engineering Handbook*, 2nd Edition, Van Nostrand Reinhold, Edited by Hsai-Yang Fang.
- Gerwick, B., Jr., and Fotinos, G. (1992). "Drilled piers and driven piles for foundations in areas of high seismicity." SEAONC Fall Seminar, October 29, San Francisco, Calif.
- Goel, R. K., and Chopra, A.K. (1997). "Period formulas for moment-resisting frame buildings." *J. Struct. Engrg.*, 123(11), 1454–1461.
- Goel, R. K., and Chopra, A. K. (1998). "Period formulas for concrete shear wall buildings." *J. Struct. Engrg.*, 124(4), 426–433.
- Grant, D., and Diaferia, R. (2012). "Assessing Adequacy of Spectrum Matched Ground Motions for Response History Analysis", *Earthquake Engineering and Structural Dynamics*, 42(9), 1265-1280.
- Gupta, A., and Krawinkler, H. (2000). "Dynamic P-delta effects for flexible inelastic steel structures." *J. Struct. Engrg.*, 126(1), 145–154.
- Hamburger, R. O., and McCormick, D. L. (2004). "Implications of the January 17, 1994, Northridge earthquake on tilt-up and masonry buildings with wood roofs." *Proceedings, 63rd Annual Convention*, Structural Engineers Association of California, Lake Tahoe, Calif., 243–255.
- Hancock, J., J. Watson-Lamprey, N. A. Abrahamson, J. J. Bommer, A. Markatis, E. McCoy, and R. Mendis, 2006. "An improved method of matching response spectra of recorded earthquake ground motion using wavelets," *Journal of Earthquake Engineering*, 10(1), 67-89.
- International Conference of Building Officials (ICBO). (1988). *Uniform Building Code*, UBC-88.
- International Code Council. 2012. *International Building Code*.
- Lam, I., and Bertero, V. (1990). "A seismic design of pile foundations for port facilities." *Proceedings of the POLA Seismic Workshop on Seismic Engineering*, March 21–23, San Pedro, Calif., Port of Los Angeles.
- Liew, J. Y. R., Chen, H., and Shanmugam, N. E. (2001). "Inelastic analysis of steel frames with composite beams." *J. Struct. Engrg.*, 127(2), 194–202.
- Lopez, O. A., and Cruz, M. (1996). "Number of modes for the seismic design of buildings." *Earthquake Engrg. and Struct. Dyn.*, 25(8), 837–856.
- Margason, E., and Holloway, M. (1977). "Pile bending during earthquakes." *Proceedings of the 6th World Conference on Earthquake Engineering*, New Delhi.
- Martin, G. R., and I. P. Lam. 2000. "Earthquake Resistant Design of Foundations: Retrofit of Existing Foundations," in *GeoEng 2000*, proceedings of the International Conference on Geological and Geotechnical Engineering, Melbourne, Australia, November.
- Menun, Charles, and Der Kiureghian, A. (1998). "A Replacement for the 30%, 40%, and SRSS Rules for Multicomponent Seismic Analysis", *Earthquake Spectra*, V14, No1.
- Mylonakis, G. (2001). "Seismic pile bending at soil–layer interfaces." *Soils and Found.*, 41(4), 47–58.
- Newmark, N. M., and Rosenblueth, E. (1971). *Fundamentals of Earthquake Engineering*, Prentice Hall, Englewood Cliff, N.J.
- Newmark, N.M., Hall, W.J., 1982. *Earthquake Spectra and Design*, EERI Monograph Series, Earthquake Engineering Research Institute, Oakland, CA.
- NIST (2010). *Nonlinear Structural Analysis for Seismic Design, A Guide for Practicing Structural Engineers*, Report Number NIST GCR 10-917-5, National Institute of Standards and Technology, Gaithersburg, MD.
- NIST (2011). *Selecting and Scaling Earthquake Ground Motions for Performing Response-History Analyses*, NIST GCR 11-918-15. Prepared by the NEHRP Consultants Joint Venture for the National Institute of Standards and Technology Gaithersburg, MD.
- Norris, G. M. (1994). "Seismic bridge pile foundation behavior." *Proceedings, International Conference on Design and Construction of Deep Foundations*, Federal Highway Administration, Vol. 1.
- Panagiotou, M, Restrepo, J, and Conte J.P., 2011. "Shake-Table Test of a Full-Scale 7-Story Building Slice. Phase I: Rectangular Wall", *ASCE J. Struct. Engrg.*, 137(6), 691-704.
- Paulay, T. (1997). "Are existing seismic torsion provisions achieving design aims?" *Earthquake Spectra*, 13(2), 259–280.
- Paulay, T., and Priestley, M. J. N. (1992). *Seismic Design of Reinforced Concrete and Masonry Structures*. John Wiley and Sons, New York.
- Rollins, K. M., Peterson, K. T., Weaver, T. J., and Sparks, A. E. (1999). "Static and dynamic lateral load behavior on a full-scale pile group in clay." Brigham Young University, Provo, Utah, and the Utah Department of Transportation, Salt Lake City, June 23.

- Rosenblueth, E., and Contreras, H. (1977). "Approximate design for multicomponent earthquakes." *J. Engrg. Mech. Div.*, 103(5), 881–893.
- Schaffhausen, R., and Wegmuller, A. (1977). "Multistory rigid frames with composite girders under gravity and lateral forces." *AISC Engrg. J.*, 2nd Quarter.
- Sheppard, D. A. (1983). "Seismic design of prestressed concrete piling." *PCI J.*, 28(2), 20–49.
- Song, S. T., Chai, Y. H., and Hale, T. H. (2005). "Analytical model for ductility assessment of fixed-head concrete piles." *J. Struct. Engrg.*, 131(7), 1051–1059.
- Special Publication SP 117A – Guidelines for Evaluation and Mitigation of Seismic Hazards in California – California Geological Survey, 2008.
- Structural Engineers Association of California, Seismology Committee, Ad Hoc Foundations Committee. 2001.
- Task Force Report – Geotechnical Guidelines for Buildings on Liquefiable Sites in Accordance with the NBC 2005 for Greater Vancouver – May 8, 2007.
- "USD/LRFD/Limit State Approach to Foundation Design," in Proceedings of the 70th Annual SEAOC Convention, San Diego, California.
- U.S. Nuclear Regulatory Commission (2012). "Combining modal responses and spatial components in seismic response analysis", Regulatory Guide 1.92".
- Uang, C.-M., and Maarouf, A. (1994). "Deflection amplification factor for seismic design provisions." *J. Struct. Engrg.*, 120(8), 2423–2436.
- Vamvatsikos, D. (2002). "Seismic performance, capacity and reliability of structures as seen through incremental dynamic analysis." Ph.D. Dissertation, Department of Civil and Environmental Engineering, Stanford University, Palo Alto, Calif.
- Wilson, E. L. (2000). "Three-dimensional static and dynamic analysis of structures." Computers and Structures, Inc., Berkeley, Calif.
- Wilson, E. L. (2004). *Static and Dynamic Analysis of Structures*, Computers and Structures, Berkeley, CA.
- Wilson, E.L., and Habibullah, A. (1987). "Static and Dynamic Analysis of Multi-Story Buildings, Including P-Delta Effects", *Earthquake Spectra* 3(2), 289-298.
- Wilson, E. L., Der Kiureghian, A., and Bayo, E. P. (1981). "A replacement for the SRSS method in seismic analysis." *Earthquake Engrg. and Struct. Dyn.*, 9(2), 187–194.
- Wilson, E.L., and Penzien, J. (1972). "Evaluation of Orthogonal Damping Matrices", *International Journal of Numerical Methods*, Vol. 4, 5-10.
- Wilson, E.L., Suhawardy, I., and Habibullah, A. (1995). "A Clarification of the Orthogonal Effects in a Three Dimensional Seismic Analysis", *Earthquake Spectra*, V11, No 4.
- OTHER REFERENCES (NOT CITED)**
- Bernal, D. (1987). "Amplification factors for inelastic dynamic P-delta effects in earthquake analysis." *Earthquake Engrg. and Struct. Dyn.*, 18, 635–681.
- Charney, F. A. (1990). "Wind drift serviceability limit state design of multistory buildings." *J. Wind Engrg. and Industrial Aerodynamics*, 36, 203–212.
- Degenkolb, H. J. (1987). "A study of the P-delta effect." *Earthquake Spectra*, 3(1).
- Griffis, L. (1993). "Serviceability limit states under wind load." *Engrg. J., Am. Inst. Steel Construction*, First Quarter.
- Newmark, N. M., and Hall, W. J. (1978). *Development of Criteria for Seismic Review of Selected Nuclear Power Plants*, NUREG/CR-0098, U.S. Nuclear Regulatory Commission.

Page intentionally left blank.

COMMENTARY TO CHAPTER 13, SEISMIC DESIGN REQUIREMENTS FOR NONSTRUCTURAL COMPONENTS

C13.1 GENERAL

Chapter 13 defines minimum design criteria for architectural, mechanical, electrical, and other nonstructural systems and components, recognizing structure use, occupant load, the need for operational continuity, and the interrelation of structural, architectural, mechanical, electrical, and other nonstructural components. Nonstructural components are designed for design earthquake ground motions as defined in Section 11.2 and determined in Section 11.4.4 of the standard. In contrast to structures, which are implicitly designed for a low probability of collapse when subjected to the maximum considered earthquake (MCE) ground motions, there are no implicit performance goals associated with the MCE for nonstructural components. Performance goals associated with the design earthquake are discussed in Section C13.1.3.

Suspended or attached nonstructural components that could detach either in full or in part from the structure during an earthquake are referred to as falling hazards and may represent a serious threat to property and life safety. Critical attributes that influence the hazards posed by these components include their weight, their attachment to the structure, their failure or breakage characteristics (e.g., nonshatterproof glass), and their location relative to occupied areas (e.g., over an entry or exit, a public walkway, an atrium, or a lower adjacent structure). Architectural components that pose potential falling hazards include parapets, cornices, canopies, marquees, glass, large ornamental elements (e.g., chandeliers), and building cladding. In addition, suspended mechanical and electrical components (e.g., mixing boxes, piping, and ductwork) may represent serious falling hazards. Figs. C13.1-1 through C13.1-4 show damage to nonstructural components in past earthquakes.



FIGURE C13.1-1 Hospital Imaging Equipment That Fell from Overhead Mounts



FIGURE C13.1-2 Collapsed Light Fixtures



FIGURE C13.1-3 Collapsed Duct and HVAC Diffuser



FIGURE C13.1-4 Damaged Ceiling System

Components whose collapse during an earthquake could result in blockage of the means of egress deserve special consideration. The term “means of egress” is used commonly in building codes with respect to fire hazard. Egress paths may include intervening aisles, doors, doorways, gates, corridors, exterior exit balconies, ramps, stairways, pressurized enclosures, horizontal exits, exit passageways, exit courts, and yards. Items whose failure could jeopardize the means of egress include walls around stairs and corridors,

veneers, cornices, canopies, heavy partition systems, ceilings, architectural soffits, light fixtures, and other ornaments above building exits or near fire escapes. Examples of components that generally do not pose a significant falling hazard include fabric awnings and canopies. Architectural, mechanical, and electrical components that, if separated from the structure, fall in areas that are not accessible to the public (e.g., into a mechanical shaft or light well) also pose little risk to egress routes.

For some architectural components, such as exterior cladding elements, wind design forces may exceed the calculated seismic design forces. Nevertheless, seismic detailing requirements may still govern the overall structural design. Where this is a possibility, it must be investigated early in the structural design process.

The seismic design of nonstructural components may involve consideration of nonseismic requirements that are affected by seismic bracing. For example, accommodation of thermal expansion in pressure piping systems often is a critical design consideration, and seismic bracing for these systems must be arranged in a manner that accommodates thermal movements. Particularly in the case of mechanical and electrical systems, the design for seismic loads should not compromise the functionality, durability, or safety of the overall design; this method requires collaboration among the various disciplines of the design and construction team.

For various reasons (e.g., business continuity), it may be desirable to consider higher performance than that required by the building code. For example, to achieve continued operability of a piping system, it is necessary to prevent unintended operation of valves or other inline components in addition to preventing collapse and providing leak tightness. Higher performance also is required for components containing substantial quantities of hazardous contents (as defined in Section 11.2). These components must be designed to prevent uncontrolled release of those materials.

The requirements of Chapter 13 are intended to apply to new construction and tenant improvements installed at any time during the life of the structure, provided that they are listed in Table 13.5-1 or 13.6-1. Furthermore, they are intended to reduce (not eliminate) the risk to occupants and to improve the likelihood that essential facilities remain functional. Although property protection (in the sense of investment preservation) is a possible consequence of implementation of the standard, it is not currently a stated or implied goal; a higher level of protection may be advisable if such protection is desired or required.

C13.1.1 Scope

The requirements for seismic design of nonstructural components apply to the nonstructural component and to its supports and attachments to the main structure. In some cases, as defined in Section 13.2, it is necessary to consider explicitly the performance characteristics of the component. The requirements are intended to apply only to permanently attached components, not to furniture, temporary items, or mobile units. Furniture, such as tables, chairs, and desks, may shift during strong ground shaking but generally poses minimal hazards provided that it does not obstruct emergency egress routes. Storage cabinets, tall bookshelves, and other items of significant mass do not fall into this category and should be anchored or braced in accordance with this chapter.

Temporary items are those that remain in place for short periods of time (months, not years). Components that are expected to remain in place for periods of a year or longer, even if they are designed to be movable, should be considered permanent for the purposes of this section. Modular office systems are considered permanent because they ordinarily remain in place for long periods. In addition, they often include storage units that have significant capacity and may topple in an earthquake. They are subject to the provisions of Section 13.5.8 for partitions if they exceed 6 ft. high. Mobile units include components that are moved from one point in the structure to another during ordinary use. Examples include desktop computers, office equipment, and other components that are not permanently attached to the building utility systems (Fig. C13.1-5). Components that are mounted on wheels to facilitate periodic maintenance or cleaning but that otherwise remain in the same location (e.g., server racks) are not considered movable for the purposes of

anchorage and bracing. Likewise, skid-mounted components (as shown in Fig. C13.1-6), as well as the skids themselves, are considered permanent equipment.



FIGURE C13.1-5 Toppled Storage Cabinets



FIGURE C13.1-6 Skid-Mounted Components

In all cases, equipment must be anchored if it is permanently attached to utility services (electricity, gas, and water). For the purposes of this requirement, “permanently attached” should be understood to include all electrical connections except NEMA 5-15 and 5-20 straight-blade connectors (duplex receptacles).

C13.1.2 Seismic Design Category

The requirements for nonstructural components are based in part on the Seismic Design Category (SDC) to which they are assigned. As the SDC is established considering factors not unique to specific nonstructural components, all nonstructural components occupying or attached to a structure are assigned to the same SDC as the structure.

C13.1.3 Component Importance Factor

Performance expectations for nonstructural components often are defined in terms of the functional requirements of the structure to which the components are attached. Although specific performance goals for nonstructural components have yet to be defined in building codes, the component importance factor

(I_p) implies performance levels for specific cases. For noncritical nonstructural components (those with an importance factor, I_p , of 1.0), the following behaviors are anticipated for shaking of different levels of intensity:

1. Minor earthquake ground motions—minimal damage; not likely to affect functionality;
2. Moderate earthquake ground motions—some damage that may affect functionality; and
3. Design earthquake ground motions—major damage but significant falling hazards are avoided; likely loss of functionality.

Components with importance factors greater than 1.0 are expected to remain in place, sustain limited damage, and when necessary, function after an earthquake (see Section C13.2.2). These components can be located in structures that are not assigned to Risk Category IV. For example, fire sprinkler piping systems have an importance factor, I_p , of 1.5 in all structures because these essential systems should function after an earthquake. Egress stairways are assigned an I_p of 1.5 as well, although in many cases the design of these stairways is dictated by differential displacements, not inertial force demands.

The component importance factor is intended to represent the greater of the life-safety importance of the component and the hazard-exposure importance of the structure. It indirectly influences the survivability of the component via required design forces and displacement levels, as well as component attachments and detailing. Although this approach provides some degree of confidence in the seismic performance of a component, it may not be sufficient in all cases. For example, individual ceiling tiles may fall from a ceiling grid that has been designed for larger forces. This problem may not represent a serious falling hazard if the ceiling tiles are made of lightweight materials, but it may lead to blockage of critical egress paths or disruption of the facility function. When higher levels of confidence in performance are required, the component is classified as a designated seismic system (Section 11.2), and in certain cases, seismic qualification of the component or system is necessary. Seismic qualification approaches are provided in Sections 13.2.5 and 13.2.6. In addition, seismic qualification approaches presently in use by the Department of Energy (DOE) can be applied.

Risk Category IV structures are intended to be functional after a design earthquake; critical nonstructural components and equipment in such structures are designed with I_p equal to 1.5. This requirement applies to most components and equipment because damage to vulnerable unbraced systems or equipment may disrupt operations after an earthquake even if they are not directly classified as essential to life safety. The nonessential and nonhazardous components are themselves not affected by this requirement. Instead, requirements focus on the supports and attachments. UFC 3-310-04 (DOD 2007) has additional guidance for improved performance.

C13.1.4 Exemptions

Several classes of nonstructural components are exempted from the requirements of Chapter 13. The exemptions are made on the assumption that, either because of their inherent strength and stability or the lower level of earthquake demand (accelerations and relative displacements), or both, these nonstructural components and systems can achieve the performance goals described earlier in this commentary without explicitly satisfying the requirements of this chapter.

The requirements are intended to apply only to permanent components, not furniture and temporary or mobile equipment. Furniture (with the exception of more massive elements like storage cabinets) may shift during strong ground shaking but poses minimal hazards. Equipment must be anchored if it is permanently attached to the structure utility services, such as electricity, gas, or water. For the purposes of this requirement, “permanently attached” includes all electrical connections except plugs for duplex receptacles. See Section 13.1.1 for a discussion of temporary components.

Mobile units include components that are moved from one point in the structure to another during ordinary use. Examples include desktop computers, office equipment, and other components that are not permanently attached to the building utility systems. Components mounted on wheels to facilitate periodic

maintenance or cleaning but that otherwise remain in the same location are not considered movable for the purposes of anchorage and bracing.

Furniture resting on floors, such as tables, chairs, and desks, may shift during strong ground shaking, but they generally pose minimal hazards, provided that they do not obstruct emergency egress routes. Examples also include desktop computers, office equipment, and other components that are not permanently attached to the building utility systems.

With the exception of parapets supported by bearing walls or shear walls, all components in Seismic Design Categories A and B are exempt because of the low levels of ground shaking expected. Parapets are not exempt because experience has shown that these items can fail and pose a significant falling hazard, even at low-level shaking levels.

The exemption for mechanical and electrical components in Seismic Design Categories D, E, or F based on weight and location of the center of mass is particularly applicable to vertical equipment racks and similar components. Where detailed information regarding the center of mass of the intended installation is unavailable, a conservative estimate based on potential equipment configurations should be used.

Although the exemptions listed in Section 13.1.4 are intended to waive bracing requirements for nonstructural components that are judged to pose negligible life-safety hazard, in some cases it may nevertheless be advisable to consider bracing (in consultation with the owner) for exempted components to minimize repair costs and/or disproportionate loss (e.g., art works of high value).

C13.1.5 Application of Nonstructural Component Requirements to Nonbuilding Structures

At times, a nonstructural component should be treated as a nonbuilding structure. When the physical characteristics associated with a given class of nonstructural components vary widely, judgment is needed to select the appropriate design procedure and coefficients. For example, cooling towers vary from small packaged units with an operating weight of 2,000 lb. or less to structures the size of buildings. Consequently, design coefficients for the design of “cooling towers” are found both in Tables 13.6-1 and 15.4-2. Small cooling towers are best designed as nonstructural components using the provisions of Chapter 13, whereas large ones are clearly nonbuilding structures that are more appropriately designed using the provisions of Chapter 15. Similar issues arise for other classes of nonstructural component (e.g., boilers and bins). Guidance on determining whether an item should be treated as a nonbuilding structure or nonstructural component for the purpose of seismic design is provided in Bachman and Dowty (2008).

Premanufactured modular mechanical units are considered nonbuilding structures supporting nonstructural components. The entire system (all modules assembled) can be shake-table qualified or qualified separately as subsystems. Modular mechanical units house various nonstructural components that are subject to all the design requirements of Chapter 13.

The specified weight limit for nonstructural components (25% relative to the combined weight of the structure and component) relates to the condition at which dynamic interaction between the component and the supporting structural system is potentially significant. Section 15.3.2 contains requirements for addressing this interaction in design.

C13.1.6 Reference Documents

Professional and trade organizations have developed nationally recognized codes and standards for the design and construction of specific mechanical and electrical components. These documents provide design guidance for normal and upset (abnormal) operating conditions and for various environmental conditions. Some of these documents include earthquake design requirements in the context of the overall mechanical or electrical design. It is the intent of the standard that seismic requirements in referenced documents be used. The developers of these documents are familiar with the expected performance and failure modes of the components; however, the documents may be based on design considerations not immediately obvious

to a structural design professional. For example, in the design of industrial piping, stresses caused by seismic inertia forces typically are not added to those caused by thermal expansion.

Where reference documents have been adopted specifically by this standard as meeting the force and displacement requirements of this chapter with or without modification, they are considered to be a part of the standard.

There is a potential for misunderstanding and misapplication of reference documents for the design of mechanical and electrical systems. A registered design professional familiar with both the standard and the reference documents used should be involved in the review and acceptance of the seismic design.

Even when reference documents for nonstructural components lack specific earthquake design requirements, mechanical and electrical equipment constructed in accordance with industry-standard reference documents have performed well historically when properly anchored. Nevertheless, manufacturers of mechanical and electrical equipment are expected to consider seismic loads in the design of the equipment itself, even when such consideration is not explicitly required by this chapter.

Although some reference documents provide requirements for seismic capacity appropriate to the component being designed, the seismic demands used in design may not be less than those specified in the standard.

Specific guidance for selected mechanical and electrical components and conditions is provided in Section 13.6.

Unless exempted in Section 13.1.4, components should be anchored to the structure and to promote coordination required supports and attachments should be detailed in the construction documents. Reference documents may contain explicit instruction for anchorage of nonstructural components. The anchorage requirements of Section 13.4 must be satisfied in all cases, however, to ensure a consistent level of robustness in the attachments to the structure.

C13.1.7 Reference Documents Using Allowable Stress Design

Many nonstructural components are designed using specifically developed reference documents that are based on allowable stress loads and load combinations and generally permit increases in allowable stresses for seismic loading. Although Section 2.4.1 of the standard does not permit increases in allowable stresses, Section 13.1.7 explicitly defines the conditions for stress increases in the design of nonstructural components where reference documents provide a basis for earthquake-resistant design.

C13.2 GENERAL DESIGN REQUIREMENTS

C13.2.1 Applicable Requirements for Architectural, Mechanical, and Electrical Components, Supports, and Attachments

Compliance with the requirements of Chapter 13 may be accomplished by project-specific design or by a manufacturer's certification of seismic qualification of a system or component. When compliance is by manufacturer's certification, the items must be installed in accordance with the manufacturer's requirements. Evidence of compliance may be provided in the form of a signed statement from a representative of the manufacturer or from the registered design professional indicating that the component or system is seismically qualified. One or more of the following options for evidence of compliance may be applicable:

1. An analysis (e.g., of a distributed system such as piping) that includes derivation of the forces used for the design of the system, the derivation of displacements and reactions, and the design of the supports and anchorages;
2. A test report, including the testing configuration and boundary conditions used (where testing is intended to address a class of components, the range of items covered by the testing performed

should also include the justification of similarities of the items that make this certification valid);
and/or

3. An experience data report.

Components addressed by the standard include individual simple units and assemblies of simple units for which reference documents establish seismic analysis or qualification requirements. Also addressed by the standard are complex architectural, mechanical, and electrical systems for which reference documents either do not exist or exist for only elements of the system. In the design and analysis of both simple components and complex systems, the concepts of flexibility and ruggedness often can assist the designer in determining the necessity for analysis and, when analysis is necessary, the extent and methods by which seismic adequacy may be determined. These concepts are discussed in Section C13.6.1.

C13.2.2 Special Certification Requirements for Designated Seismic Systems

This section addresses the qualification of active designated seismic equipment, its supports, and attachments with the goals of improving survivability and achieving a high level of confidence that a facility will be functional after a design earthquake. Where components are interconnected, the qualification should provide the permissible forces (e.g., nozzle loads) and, as applicable, anticipated displacements of the component at the connection points to facilitate assessment for consequential damage, in accordance with Section 13.2.3. Active equipment has parts that rotate, move mechanically, or are energized during operation. Active designated seismic equipment constitutes a limited subset of designated seismic systems. Failure of active designated seismic equipment itself may pose a significant hazard. For active designated seismic equipment, failure of structural integrity and loss of function are to be avoided.

Examples of active designated seismic equipment include mechanical (HVAC and refrigeration) or electrical (power supply distribution) equipment, medical equipment, fire pump equipment, and uninterruptible power supplies for hospitals.

There are practical limits on the size of a component that can be qualified via shake-table testing. Components too large to be qualified by shake-table testing need to be qualified by a combination of structural analysis and qualification testing or empirical evaluation through a subsystem approach. Subsystems of large, complex components (e.g., large chillers or skid-mounted equipment assemblies) can be qualified individually, and the overall structural frame of the component can be evaluated by structural analysis.

Evaluating post-earthquake operational performance for active equipment by analysis generally involves sophisticated modeling with experimental validation and may not be reliable. Therefore, the use of analysis for active or energized components is not permitted unless a comparison can be made to components that have been otherwise deemed as rugged. As an example, a transformer is energized but contains components that can be shown to remain linearly elastic and are inherently rugged. However, switch equipment that contains fragile components is similarly energized but not inherently rugged, and it therefore cannot be certified solely by analysis. For complex components, testing or experience may therefore be the only practical way to ensure that the equipment will be operable after a design earthquake. Past earthquake experience has shown that most active equipment is inherently rugged. Therefore, evaluation of experience data, together with analysis of anchorage, is adequate to demonstrate compliance of active equipment such as pumps, compressors, and electric motors. In other cases, such as for motor control centers and switching equipment, shake-table testing may be required.

With some exceptions (e.g., elevator motors), experience indicates that active mechanical and electrical components that contains electric motors of more than 10 hp or that have a thermal exchange capacity greater than 200 MBH are unlikely to merit the exemption from shake-table testing on the basis of inherent ruggedness. Components with lesser motor horsepower and thermal exchange capacity are generally considered to be small active components and are deemed rugged. Exceptions to this rule may be appropriate for specific cases, such as elevator motors that have higher horsepower but have been shown

by experience to be rugged. Analysis is still required to ensure the structural integrity of the nonactive components. For example, a 15-ton condenser would require analysis of the load path between the condenser fan and the coil to the building structure attachment.

C13.2.3 Consequential Damage

Although the components identified in Tables 13.5-1 and 13.6-1 are listed separately, significant interrelationships exist and must be considered. Consequential damage occurs because of interaction between components and systems. Even “braced” components displace, and the displacement between lateral supports can be significant in the case of distributed systems such as piping systems, cable and conduit systems, and other linear systems. It is the intent of the standard that the seismic displacements considered include both relative displacement between multiple points of support (addressed in Section 13.3.2) and, for mechanical and electrical components, displacement within the component assemblies. Impact of components must be avoided, unless the components are fabricated of ductile materials that have been shown to be capable of accommodating the expected impact loads. With protective coverings, ductile mechanical and electrical components and many more fragile components are expected to survive all but the most severe impact loads. Flexibility and ductility of the connections between distribution systems and the equipment to which they attach is essential to the seismic performance of the system.

The determination of the displacements that generate these interactions are not addressed explicitly in Section 13.3.2.1. That section concerns relative displacement of support points. Consequential damage may occur because of displacement of components and systems between support points. For example, in older suspended ceiling installations, excessive lateral displacement of a ceiling system may fracture sprinkler heads that project through the ceiling. A similar situation may arise if sprinkler heads projecting from a small-diameter branch line pass through a rigid ceiling system. Although the branch line may be properly restrained, it may still displace sufficiently between lateral support points to affect other components or systems. Similar interactions occur where a relatively flexible distributed system connects to a braced or rigid component.

The potential for impact between components that are in contact with or close to other structural or nonstructural components must be considered. However, where considering these potential interactions, the designer must determine if the potential interaction is both credible and significant. For example, the fall of a ceiling panel located above a motor control center is a credible interaction because the falling panel in older suspended ceiling installations can reach and impact the motor control center. An interaction is significant if it can result in damage to the target. Impact of a ceiling panel on a motor control center may not be significant because of the light weight of the ceiling panel. Special design consideration is appropriate where the failure of a nonstructural element could adversely influence the performance of an adjacent critical nonstructural component, such as an emergency generator.

C13.2.4 Flexibility

In many cases, flexibility is more important than strength in the performance of distributed systems, such as piping and ductwork. A good understanding of the displacement demand on the system, as well as its displacement capacity, is required. Components or their supports and attachments must be flexible enough to accommodate the full range of expected differential movements; some localized inelasticity is permitted in accommodating the movements. Relative movements in all directions must be considered. For example, even a braced branch line of a piping system may displace, so it needs to be connected to other braced or rigid components in a manner that accommodates the displacements without failure (Fig. C13.2-1). A further example is provided by cladding units (such as precast concrete wall units). Often very rigid in plane, cladding units require connections capable of accommodating story drift if attached at more than one level. (See Fig. C13.3-3 for an illustration.)

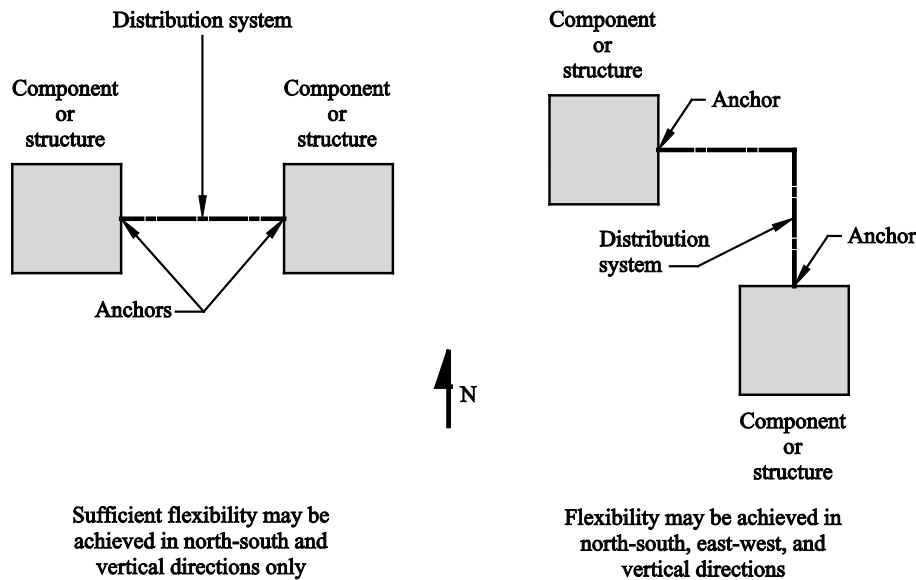

FIGURE C13.2-1 Schematic Plans Illustrating Branch Line Flexibility

If component analysis assumes rigid anchors or supports, the predicted loads and local stresses can be unrealistically large, so it may be necessary to consider anchor and/or support stiffness.

C13.2.5 Testing Alternative for Seismic Capacity Determination

Testing is a well-established alternative method of seismic qualification for small- to medium-size equipment. Several national reference documents have testing requirements adaptable for seismic qualification. One such reference document (ICC-ES AC156) (2010) is a shake-table testing protocol that has been adopted by the International Code Council Evaluation Service. It was developed specifically to be consistent with acceleration demands (that is, force requirements) of the standard.

The development or selection of testing and qualification protocols should at a minimum include the following:

1. Description of how the protocol meets the intent for the project-specific requirements and relevant interpretations of the standard;
2. Definition of a test input motion with a response spectrum that meets or exceeds the design earthquake spectrum for the site;
3. Accounting for dynamic amplification caused by above-grade equipment installations (consideration of the actual dynamic characteristics of the primary support structure is permitted, but not required);
4. Definition of how shake-table input demands were derived;
5. Definition and establishment of a verifiable pass/fail acceptance criterion for the seismic qualification based on the equipment importance factor and consistent with the building code and project-specific design intent; and
6. Development of criteria that can be used to rationalize test unit configuration requirements for highly variable equipment product lines.

To aid the design professional in assessing the adequacy of the manufacturer's certificate of compliance, it is recommended that certificates of compliance include the following:

1. Product family or group covered;
2. Building code(s) and standard(s) for which compliance was evaluated;
3. Testing standard used;

4. Performance objective and corresponding importance factor ($I_p = 1.0$ or $I_p = 1.5$);
5. Seismic demand for which the component is certified, including code and/or standard design parameters used to calculate seismic demand (such as values used for a_p , R_p , and site class); and
6. Installation restrictions, if any (grade, floor, or roof level).

Without a test protocol recognized by the building code, qualification testing is inconsistent and difficult to verify. The use of ICC-ES AC156 (2010) simplifies the task of compliance verification because it was developed to address directly the testing alternative for nonstructural components, as specified in the standard. It also sets forth minimum test plan and report deliverables.

Use of other standards or ad hoc protocols to verify compliance of nonstructural components with the requirement of the standard should be considered carefully and used only where project-specific requirements cannot be met otherwise.

Where other qualification test standards are used, in whole or in part, it is necessary to verify compliance with this standard. For example, IEEE 693 (2005) indicates that it is to be used for the sole purpose of qualifying electrical equipment (specifically listed in the standard) for use in utility substations. Where equipment testing has been conducted to other standards (for instance, testing done in compliance with IEEE 693), a straightforward approach would be to permit evaluation, by the manufacturer, of the test plan and data to validate compliance with the requirements of ICC-ES AC156 (2010) because it was developed specifically to comply with the seismic demands of this standard.

The qualification of mechanical and electrical components for seismic loads alone may not be sufficient to achieve high-performance objectives. Establishing a high confidence that performance goals will be met requires consideration of the performance of structures, systems (e.g., fluid, mechanical, electrical, and instrumentation), and their interactions (e.g., interaction of seismic and other loads), as well as compliance with installation requirements.

C13.2.6 Experience Data Alternative for Seismic Capacity Determination

An established method of seismic qualification for certain types of nonstructural components is the assessment of data for the performance of similar components in past earthquakes. The seismic capacity of the component in question is extrapolated based on estimates of the demands (e.g., force or displacement) to which the components in the database were subjected. Procedures for such qualification have been developed for use in nuclear facility applications by the Seismic Qualification Utility Group (SQUG) of the Electric Power Research Institute.

The SQUG rules for implementing the use of experience data are described in a proprietary Generic Implementation Procedure database. It is a collection of findings from detailed engineering studies by experts for equipment from a variety of utility and industrial facilities.

Valid use of experience data requires satisfaction of rules that address physical characteristics; manufacturer's classification and standards; and findings from testing, analysis, and expert consensus opinion.

Four criteria are used to establish seismic qualification by experience, as follows:

1. Seismic capacity versus demand (a comparison with a bounding spectrum);
2. Earthquake experience database cautions and inclusion rules;
3. Evaluation of anchorage; and
4. Evaluation of seismic interaction.

Experience data should be used with care because the design and manufacture of components may have changed considerably in the intervening years. The use of this procedure is also limited by the relative rarity of strong-motion instrument records associated with corresponding equipment experience data.

C13.2.7 Construction Documents

Where the standard requires seismic design of components or their supports and attachments, appropriate construction documents defining the required construction and installation must be prepared. These documents facilitate the special inspection and testing needed to provide a reasonable level of quality assurance. Of particular concern are large nonstructural components (such as rooftop chillers) whose manufacture and installation involve multiple trades and suppliers and which impose significant loads on the supporting structure. In these cases, it is important that the construction documents used by the various trades and suppliers be prepared by a registered design professional to satisfy the seismic design requirements.

The information required to prepare construction documents for component installation includes the dimensions of the component, the locations of attachment points, the operating weight, and the location of the center of mass. For instance, if an anchorage angle is attached to the side of a metal chassis, the gauge and material of the chassis must be known so that the number and size of required fasteners can be determined. Or when a piece of equipment has a base plate that is anchored to a concrete slab with expansion anchors, the drawings must show the base plate's material and thickness, the diameter of the bolt holes in the plate, and the size and depth of embedment of the anchor bolts. If the plate is elevated above the slab for leveling, the construction documents must also show the maximum gap permitted between the plate and the slab.

C13.3 SEISMIC DEMANDS ON NONSTRUCTURAL COMPONENTS

The seismic demands on nonstructural components, as defined in this section, are acceleration demands and relative displacement demands. Acceleration demands are represented by equivalent static forces. Relative displacement demands are provided directly and are based on either the actual displacements computed for the structure or the maximum allowable drifts that are permitted for the structure.

C13.3.1 Seismic Design Force

The seismic design force for a component depends on the weight of the component, the component importance factor, the component response modification factor, the component amplification factor, and the component acceleration at a point of attachment to the structure. The forces prescribed in this section of the standard reflect the dynamic and structural characteristics of nonstructural components. As a result of these characteristics, forces used for verification of component integrity and design of connections to the supporting structure typically are larger than those used for design of the overall seismic force-resisting system.

Certain nonstructural components lack the desirable attributes of structures (such as ductility, toughness, and redundancy) that permit the use of greatly reduced lateral design forces. Thus values for the response modification factor, R_p , in Tables 13.5-1 and 13.6-1 generally are smaller than R values for structures. These R_p values, used to represent the energy absorption capability of a component and its attachments, depend on both overstrength and deformability. At present, these potentially separate considerations are combined in a single factor. The tabulated values are based on the collective judgment of the responsible committee.

Beginning with the 2005 edition of ASCE 7, significant adjustments have been made to tabulated R_p values for certain mechanical and electrical systems. For example, the value of R_p for welded steel piping systems is increased from 3.5 to 9. The a_p value increased from 1.0 to 2.5, so although it might appear that forces on such piping systems have been reduced greatly, the net change is negligible because R_p/a_p changes from 3.5 to 3.6. The minimum seismic design force of Eq. (13.3-3), which governs in many cases, is unchanged.

The component amplification factor (a_p) represents the dynamic amplification of component responses as a function of the fundamental periods of the structure (T) and component (T_p). When components are designed or selected, the structural fundamental period is not always defined or readily available. The component fundamental period (T_p) is usually only accurately obtained by shake-table or pull-back tests

and is not available for the majority of components. Tabulated a_p values are based on component behavior that is assumed to be either rigid or flexible. Where the fundamental period of the component is less than 0.06 s, dynamic amplification is not expected and the component is considered rigid. The tabulation of assumed a_p values is not meant to preclude more precise determination of the component amplification factor where the fundamental periods of both structure and component are available. The National Center for Earthquake Engineering Research formulation shown in Fig. C13.3-1 may be used to compute a_p as a function of T_p/T .

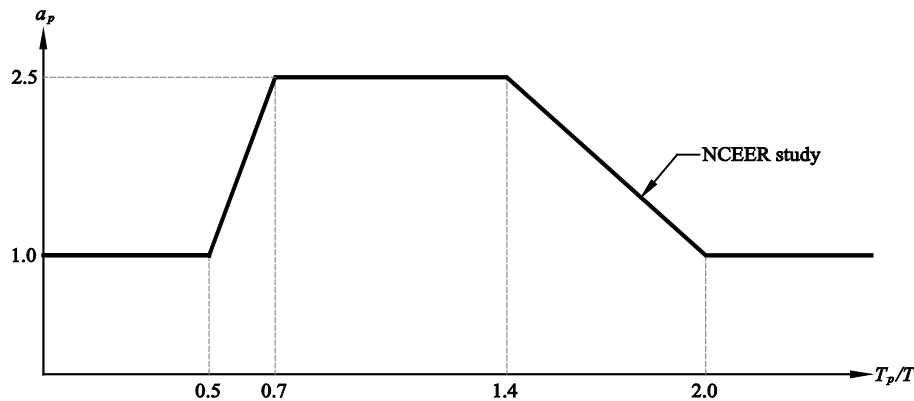

FIGURE C13.3-1 NCEER Formulation for a_p as Function of Structural and Component Periods

Dynamic amplification occurs where the period of a nonstructural component closely matches that of any mode of the supporting structure, although this effect may not be significant depending on the ground motion. For most buildings, the primary mode of vibration in each direction has the most influence on the dynamic amplification for nonstructural components. For long-period structures (such as tall buildings), where the period of vibration of the fundamental mode is greater than 3.5 times T_s , higher modes of vibration may have periods that more closely match the period of nonstructural components. For this case, it is recommended that amplification be considered using such higher mode periods in lieu of the higher fundamental period. This approach may be generalized by computing floor response spectra for various levels that reflect the dynamic characteristics of the supporting structure to determine how amplification varies as a function of component period. Calculation of floor response spectra can be complex, but simplified procedures are presented in Kehoe and Hachem (2003). Consideration of nonlinear behavior of the structure greatly complicates the analysis.

Eq. (13.3-1) represents a trapezoidal distribution of floor accelerations within a structure, varying linearly from the acceleration at the ground (taken as $0.4S_{DS}$) to the acceleration at the roof (taken as $1.2S_{DS}$). The ground acceleration ($0.4S_{DS}$) is intended to be the same acceleration used as design input for the structure itself, including site effects. The roof acceleration is established as three times the input ground acceleration based on examination of recorded in-structure acceleration data for short and moderate height structures in response to large California earthquakes. Work by Miranda and Singh suggests that, for taller structures, the amplification with height may vary significantly because of higher mode effects. Where more information is available, Eq. (13.3-4) permits an alternate determination of the component design forces based on the dynamic properties of the structure.

Eq. (13.3-3) establishes a minimum seismic design force, F_p , that is consistent with current practice. Eq. (13.3-2) provides a simple maximum value of F_p that prevents multiplication of the individual factors from producing a design force that would be unreasonably high, considering the expected nonlinear response of support and component. Fig. C13.3-2 illustrates the distribution of the specified lateral design forces.

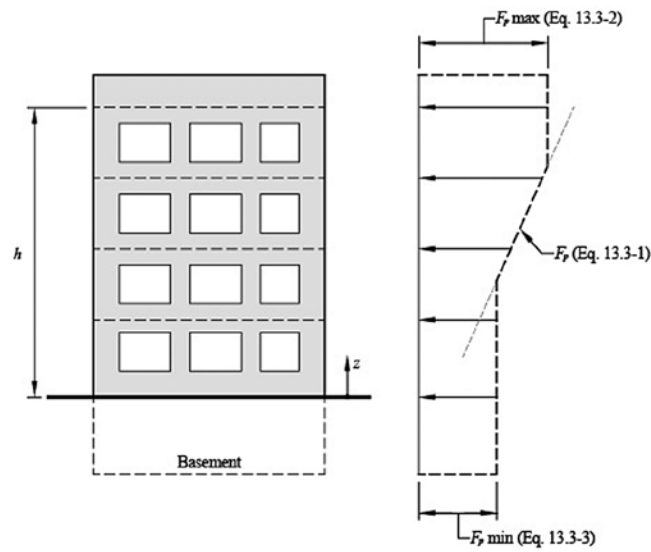

FIGURE C13.3-2 Lateral Force Magnitude over Height

For elements with points of attachment at more than one height, it is recommended that design be based on the average of values of F_p determined individually at each point of attachment (but with the entire component weight, W_p) using Eqs. (13.3-1) through (13.3-3).

Alternatively, for each point of attachment, a force F_p may be determined using Eqs. (13.3-1) through (13.3-3), with the portion of the component weight, W_p , tributary to the point of attachment. For design of the component, the attachment force F_p must be distributed relative to the component's mass distribution over the area used to establish the tributary weight. To illustrate these options, consider a solid exterior nonstructural wall panel, supported top and bottom, for a one-story building with a rigid diaphragm. The values of F_p computed, respectively, for the top and bottom attachments using Eqs. (13.3-1) through (13.3-3) are $0.48S_{DS}I_pW_p$ and $0.30S_{DS}I_pW_p$. In the recommended method, a uniform load is applied to the entire panel based on $0.39S_{DS}I_pW_p$. In the alternative method, a trapezoidal load varying from $0.48S_{DS}I_pW_p$ at the top to $0.30S_{DS}I_pW_p$ at the bottom is applied. Each anchorage force is then determined considering static equilibrium of the complete component subject to all the distributed loads.

Cantilever parapets that are part of a continuous element should be checked separately for parapet forces. The seismic force on any component must be applied at the center of gravity of the component and must be assumed to act in any horizontal direction. Vertical forces on nonstructural components equal to $\pm 0.2S_{DS}W_p$ are specified in Section 13.3.1 and are intended to be applied to all nonstructural components and not just cantilevered elements. Nonstructural concrete or masonry walls laterally supported by flexible diaphragms must be anchored out of plane in accordance with Section 12.11.2.

C13.3.2 Seismic Relative Displacements

The equations of this section are for use in design of cladding, stairways, windows, piping systems, sprinkler components, and other components connected to one structure at multiple levels or to multiple structures. Two equations are given for each situation. Eqs. (13.3-6) and (13.3-8) produce structural displacements as determined by elastic analysis, unreduced by the structural response modification factor (R). Because the actual displacements may not be known when a component is designed or procured, Eqs. (13.3-7) and (13.3-9) provide upper-bound displacements based on structural drift limits. Use of upper-bound equations may facilitate timely design and procurement of components but may also result in costly added conservatism.

The value of seismic relative displacements is taken as the calculated displacement, D_p , times the importance factor, I_e , because the elastic displacement calculated in accordance with Eq. (12.8-15) to establish δ_x (and thus D_p) is adjusted for I_e in keeping with the philosophy of displacement demand for the structure. For component design, the unreduced elastic displacement is appropriate.

The standard does not provide explicit acceptance criteria for the effects of seismic relative displacements, except for glazing. Damage to nonstructural components caused by relative displacement is acceptable, provided that the performance goals defined elsewhere in the chapter are achieved.

The design of some nonstructural components that span vertically in the structure can be complicated when supports for the element do not occur at horizontal diaphragms. The language in Section 13.3.2 was previously amended to clarify that story drift must be accommodated in the elements that actually distort. For example, a glazing system supported by precast concrete spandrels must be designed to accommodate the full story drift, even though the height of the glazing system is only a fraction of the floor-to-floor height. This condition arises because the precast spandrels behave as rigid bodies relative to the glazing system and therefore all the drift must be accommodated by anchorage of the glazing unit, the joint between the precast spandrel and the glazing unit, or some combination of the two.

C13.3.2.1 Displacements within Structures

Seismic relative displacements can subject components or systems to unacceptable stresses. The potential for interaction resulting from component displacements (in particular for distributed systems) and the resulting impact effects should also be considered (see Section 13.2.3).

These interrelationships may govern the clearance requirements between components or between components and the surrounding structure. Where sufficient clearance cannot be provided, consideration should be given to the ductility and strength of the components and associated supports and attachments to accommodate the potential impact.

Where nonstructural components are supported between, rather than at, structural levels, as frequently occurs for glazing systems, partitions, stairs, veneers, and mechanical and electrical distributed systems, the height over which the displacement demand, D_p , must be accommodated may be less than the story height, h_{sx} , and should be considered carefully. For example, consider the glazing system supported by rigid precast concrete spandrels shown in Fig. C13.3-3. The glazing system may be subjected to full story drift, D_p , although its height ($h_x - h_y$) is only a fraction of the story height. The design drift must be accommodated by anchorage of the glazing unit, the joint between the precast spandrel and the glazing unit, or some combination of the two. Similar displacement demands arise where pipes, ducts, or conduit that are braced to the floor or roof above are connected to the top of a tall, rigid, floor-mounted component.

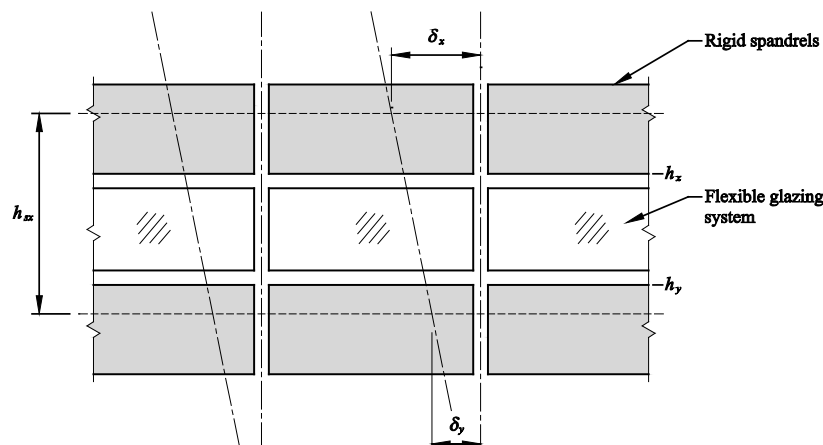

FIGURE C13.3-3 Displacements over Less than Story Height

For ductile components, such as steel piping fabricated with welded connections, the relative seismic displacements between support points can be more significant than inertial forces. Ductile piping can accommodate relative displacements by local yielding with strain accumulations well below failure levels. However, for components fabricated using less ductile materials, where local yielding must be avoided to prevent unacceptable failure consequences, relative displacements must be accommodated by flexible connections.

C13.3.2.2 Displacements between Structures

A component or system connected to two structures must accommodate horizontal movements in any direction, as illustrated in Fig. C13.3-4

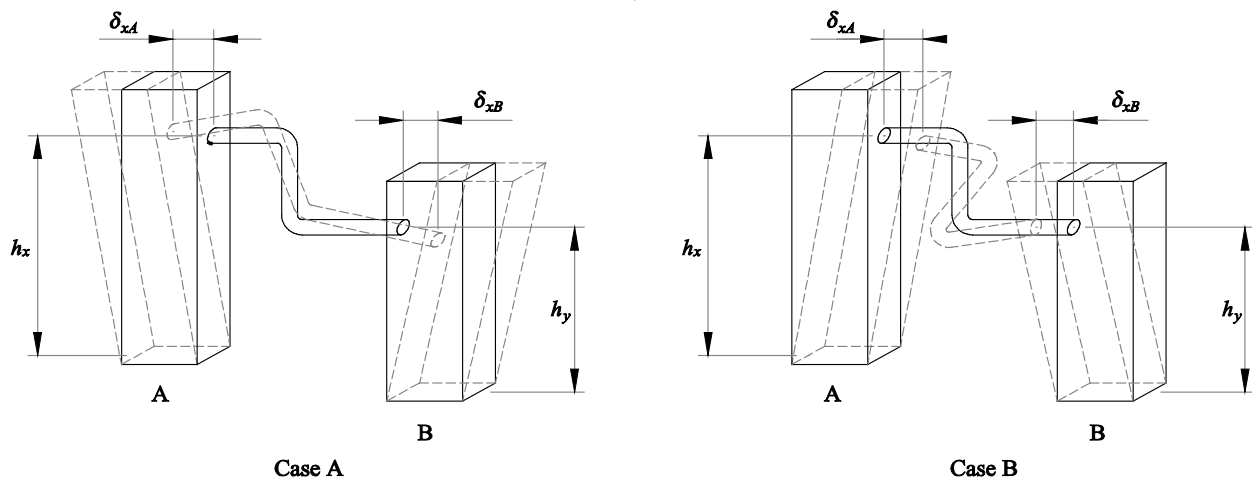

FIGURE C13.3-4 Displacements between Structures

C13.4 NONSTRUCTURAL COMPONENT ANCHORAGE

Unless exempted in Section 13.1.4, components must be anchored to the structure, and all required supports and attachments must be detailed in the construction documents. To satisfy the load path requirement of this section, the detailed information described in Section C13.2.7 must be communicated during the design phase to the registered design professional responsible for the design of the supporting structure. The load path includes housekeeping slabs and curbs, which must be adequately reinforced and positively fastened to the supporting structure. Because the exact magnitude and location of the loads imposed on the structure may not be known until nonstructural components are ordered, the initial design of supporting structural elements should be based on conservative assumptions. The design of the supporting structural elements must be verified once the final magnitude and location of the design loads have been established.

Design documents should provide details with sufficient information so that compliance with these provisions can be verified. Parameters such as a_p , R_p , I_p , S_{DS} , and W_p should be noted. Attachment details may include, as appropriate, dimensions and material properties of the connecting material, weld sizes, bolt sizes and material types for steel-to-steel connections, post installed anchor types, diameters, embedments, installation requirements, sheet metal screw diameters and material thicknesses of the connected parts, wood fastener types, and minimum requirements for specific gravity of the base materials.

Seismic design forces are determined using the provisions of Section 13.3.1. Specific reference standards should be consulted for additional adjustments to loads or strengths. Refer, for example, to the anchor design provisions of ACI 318 (2011b), *Building Code Requirements for Structural Concrete and Commentary*, Appendix D, for specific provisions related to seismic design of anchors in concrete.

Unanchored components often rock or slide when subjected to earthquake motions. Because this behavior may have serious consequences, is difficult to predict, and is exacerbated by vertical ground motions, positive restraint must be provided for each component.

The effective seismic weight used in design of the seismic force-resisting system must include the weight of supported components. To satisfy the load path requirements of this section, localized component demand must also be considered. This satisfaction may be accomplished by checking the capacity of the first structural element in the load path (for example, a floor beam directly under a component) for combined dead, live, operating, and seismic loads, using the horizontal and vertical loads from Section 13.3.1 for the seismic demand, and repeating this procedure for each structural element or connection in the load path until the load case, including horizontal and vertical loads from Section 13.3.1, no longer governs design of the element. The load path includes housekeeping slabs and curbs, which must be adequately reinforced and positively fastened to the supporting structure.

Because the exact magnitude and location of loads imposed on the structure may not be known until nonstructural components are ordered, the initial design of supporting structural elements should be based on conservative assumptions. The design of the supporting structural elements may need to be verified once the final magnitude and location of the design loads have been established.

Tests have shown that there are consistent shear ductility variations between bolts installed in drilled or punched plates with nuts and connections using welded shear studs. The need for reductions in allowable loads for particular anchor types to account for loss of stiffness and strength may be determined through appropriate dynamic testing. Although comprehensive design recommendations are not available at present, this issue should be considered for critical connections subject to dynamic or seismic loading.

C13.4.1 Design Force in the Attachment

Previous editions of ASCE/SEI 7 included provisions for the amplification of forces to design the component anchorage. These provisions were intended to ensure that the anchorage either (a) would respond to overload in a ductile manner or (b) would be designed so that the anchorage would not be the weakest link in the load path.

Because of the difficulties associated with the application of the anchorage provisions in Section 13.4 in conjunction with anchorage provisions in other reference standards, the provisions for anchorage in ASCE/SEI 7-10 are substantially simplified. Adjustments on the R_p value used for the anchorage calculation have been eliminated, with the exception of the upper limit on R_p of 6, which is intended primarily to address the anchorage of ductile piping systems that are assigned higher R_p values. These higher component response modification factors reflect the inherent ductility and overstrength of ductile piping but may result in an under-prediction of the forces on the anchorage.

C13.4.2 Anchors in Concrete or Masonry

Design capacity for anchors in concrete must be determined in accordance with ACI 318 (2011b), Appendix D. Design capacity for anchors in masonry is determined in accordance with ACI 530 (2011a). Anchors must be designed to have ductile behavior or to provide a specified degree of excess strength. Depending on the specifics of the design condition, ductile design of anchors in concrete may satisfy one or more of the following objectives:

1. Adequate load redistribution between anchors in a group;
2. Allowance for anchor overload without brittle failure; or
3. Energy dissipation.

Achieving deformable, energy-absorbing behavior in the anchor itself is often difficult. Unless the design specifically addresses the conditions influencing desirable hysteretic response (e.g., adequate gauge length, anchor spacing, edge distance, and steel properties), anchors cannot be relied on for energy dissipation.

Simple geometric rules, such as restrictions on the ratio of anchor embedment length to depth, may not be adequate to produce reliable ductile behavior. For example, a single anchor with sufficient embedment to force ductile tension failure in the steel body of the anchor bolt may still experience concrete fracture (a nonductile failure mode) if the edge distance is small, the anchor is placed in a group of tension-loaded anchors with reduced spacing, or the anchor is loaded in shear instead of tension. In the common case where anchors are subject primarily to shear, response governed by the steel element may be nonductile if the deformation of the anchor is constrained by rigid elements on either side of the joint. Designing the attachment so that its response is governed by a deformable link in the load path to the anchor is encouraged. This approach provides ductility and overstrength in the connection while protecting the anchor from overload. Ductile bolts should only be relied on as the primary ductile mechanism of a system if the bolts are designed to have adequate gauge length (using the unbonded strained length of the bolt) to accommodate the anticipated nonlinear displacements of the system at the design earthquake. Guidance for determining the gauge length can be found in Part 3 of the 2009 NEHRP provisions.

Anchors used to support towers, masts, and equipment are often provided with double nuts for leveling during installation. Where base-plate grout is specified at anchors with double nuts, it should not be relied on to carry loads because it can shrink and crack or be omitted altogether. The design should include the corresponding tension, compression, shear, and flexure loads.

Post-installed anchors in concrete and masonry should be qualified for seismic loading through appropriate testing. The requisite tests for expansion and undercut anchors in concrete are given in ACI 355.2-07, *Qualification of Post-Installed Mechanical Anchors in Concrete and Commentary* (2007). Testing and assessment procedures based on the ACI standard that address expansion, undercut, screw, and adhesive anchors are incorporated in ICC-ES acceptance criteria. AC193, *Acceptance Criteria for Mechanical Anchors in Concrete Elements* (2012c), and AC308, *Acceptance Criteria for Post-Installed Adhesive Anchors in Concrete Elements* (2012d), refer to ACI 355.4-11, *Qualification of Post-Installed Adhesive Anchors in Concrete and Commentary* (2011c). These criteria, which include specific provisions for screw anchors and adhesive anchors, also reference ACI qualification standards for anchors. For post installed anchors in masonry, seismic prequalification procedures are contained in ICC-ES AC01, *Acceptance Criteria for Expansion Anchors in Masonry Elements* (2012b), AC58, *Acceptance Criteria for Adhesive Anchors in Masonry Elements* (2012a), and AC106, *Acceptance Criteria for Predrilled Fasteners (Screw Anchors) in Masonry Elements* (2012b).

Other references to adhesives (such as in Section 13.5.7.2) apply not to adhesive anchors but to steel plates and other structural elements bonded or glued to the surface of another structural component with adhesive; such connections are generally nonductile.

C13.4.3 Installation Conditions

Prying forces on anchors, which result from a lack of rotational stiffness in the connected part, can be critical for anchor design and must be considered explicitly.

For anchorage configurations that do not provide a direct mechanism to transfer compression loads (for example, a base plate that does not bear directly on a slab or deck but is supported on a threaded rod), the design for overturning must reflect the actual stiffness of base plates, equipment, housing, and other elements in the load path when computing the location of the compression centroid and the distribution of uplift loads to the anchors.

C13.4.4 Multiple Attachments

Although the standard does not prohibit the use of single anchor connections, it is good practice to use at least two anchors in any load-carrying connection whose failure might lead to collapse, partial collapse, or disruption of a critical load path.

C13.4.5 Power-Actuated Fasteners

Restrictions on the use power-actuated fasteners are based on observations of failures of sprinkler pipe runs in the 1994 Northridge earthquake. Although it is unclear from the record to what degree the failures occurred because of poor installation, product deficiency, overload, or consequential damage, the capacity of power-actuated fasteners in concrete often varies more than that of drilled post installed anchors. The shallow embedment, small diameter, and friction mechanism of these fasteners make them particularly susceptible to the effects of concrete cracking. The suitability of power-actuated fasteners to resist tension in concrete should be demonstrated by simulated seismic testing in cracked concrete.

Where properly installed in steel, power-actuated fasteners typically exhibit reliable cyclic performance. Nevertheless, they should not be used singly to support suspended elements. Where used to attach cladding and metal decking, subassembly testing may be used to establish design capacities because the interaction among the decking, the subframe, and the fastener can only be estimated crudely by currently available analysis methods.

The exception permits the use of power-actuated fasteners for specific light-duty applications with upper limits on the load that can be resisted in these cases. All fasteners must have adequate capacity for the calculated loads, including prying forces.

The exception allows for the continued use of power-actuated fasteners in concrete for the vertical support of suspended acoustical tile or lay-in panel ceilings and for other light distributed systems such as small-diameter conduit held to the concrete surface with C-clips. Experience indicates that these applications have performed satisfactorily because of the high degree of redundancy and light loading. Other than ceilings, hung systems should not be included in this exception because of the potential for bending in the fasteners.

The exception for power-actuated fasteners in steel provides a conservative limit on loading. Currently, no accepted procedure exists for the qualification of power-actuated fasteners to resist earthquake loads.

C13.4.6 Friction Clips

The term *friction clip* is defined in Section 11.2 in a general way to encompass C-type beam clamps, as well as cold-formed metal channel (strut) connections. Friction clips are suitable to resist seismic forces provided that they are properly designed and installed, but under no circumstances should they be relied on to resist sustained gravity loads. C-type clamps must be provided with restraining straps, as shown in Fig. C13.4-1.

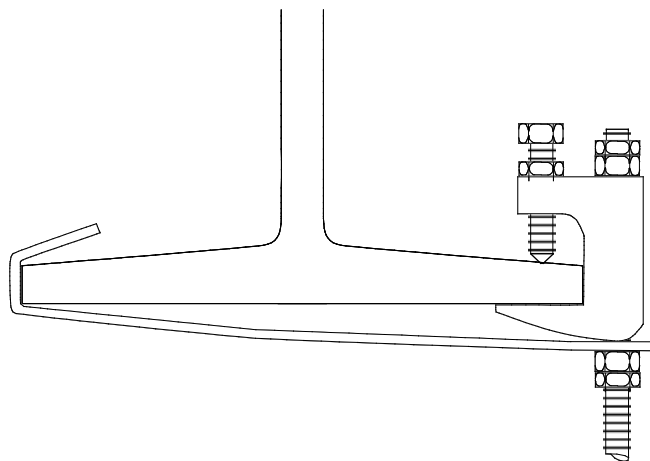

FIGURE C13.4-1 C-Type Beam Clamp Equipped with a Restraining Strap

C13.5 ARCHITECTURAL COMPONENTS

For structures in Risk Categories I through III, the requirements of Section 13.5 are intended to reduce property damage and life-safety hazards posed by architectural components and caused by loss of stability or integrity. When subjected to seismic motion, components may pose a direct falling hazard to building occupants or to people outside the building (as in the case of parapets, exterior cladding, and glazing). Failure or displacement of interior components (such as partitions and ceiling systems in exits and stairwells) may block egress.

For structures in Risk Category IV, the potential disruption of essential function caused by component failure must also be considered.

Architectural component failures in earthquakes can be caused by deficient design or construction of the component, interrelationship with another component that fails, interaction with the structure, or inadequate attachment or anchorage. For architectural components, attachment and anchorage are typically the most critical concerns related to their seismic performance. Concerns regarding loss of function are most often associated with mechanical and electrical components. Architectural damage, unless severe, can be accommodated temporarily. Severe architectural damage is often accompanied by significant structural damage.

C13.5.1 General

Suspended architectural components are not required to satisfy the force and displacement requirements of Chapter 13, where prescriptive requirements are met. The requirements were relaxed in the 2005 edition of the standard to better reflect the consequences of the expected behavior. For example, impact of a suspended architectural ornament with a sheet metal duct may only dent the duct without causing a credible danger (assuming that the ornament remains intact). The reference to Section 13.2.3 allows the designer to consider such consequences in establishing the design approach.

Nonstructural components supported by chains or otherwise suspended from the structure are exempt from lateral bracing requirements, provided that they are designed not to inflict damage to themselves or any other component when subject to seismic motion. However, for the 2005 edition, it was determined that clarifications were needed on the type of nonstructural components allowed by these exceptions and the acceptable consequences of interaction between components. In ASCE/SEI 7-02, certain nonstructural components that could represent a fire hazard after an earthquake were exempted from meeting the Section 9.6.1 requirements. For example, gas-fired space heaters clearly pose a fire hazard after an earthquake but were permitted to be exempted from the Section 9.6.1 requirements. The fire hazard after the seismic event must be given the same level of consideration as the structural failure hazard when considering components to be covered by this exception. In addition, the ASCE/SEI 7-02 language was sometimes overly restrictive because it did not distinguish between credible seismic interactions and incidental interactions. In ASCE/SEI 7-02, if a suspended lighting fixture could hit and dent a sheet metal duct, it would have to be braced, although no credible danger is created by the impact. The new reference in Section 13.2.3 of ASCE/SEI 7-05 allowed the designer to consider whether the failures of the component and/or the adjacent components are likely to occur if contact is made. These provisions have been brought into ASCE/SEI 7-10.

C13.5.2 Forces and Displacements

Partitions and interior and exterior glazing must accommodate story drift without failure that will cause a life-safety hazard. Design judgment must be used to assess potential life-safety hazards and the likelihood of life-threatening damage. Special detailing to accommodate drift for typical gypsum board or demountable partitions is unlikely to be cost-effective, and damage to these components poses a low hazard to life safety. Damage in these partitions occurs at low drift levels but is inexpensive to repair.

If they must remain intact after strong ground motion, nonstructural fire-resistant enclosures and fire-rated partitions require special detailing that provides isolation from the adjacent or enclosing structure for deformation equivalent to the calculated drift (relative displacement). In-plane differential movement between structure and wall is permitted. Provision must be made for out-of-plane restraint. These requirements are particularly important in steel or concrete moment-frame structures, which experience larger drifts. The problem is less likely to be encountered in stiff structures, such as those with shear walls.

Differential vertical movement between horizontal cantilevers in adjacent stories (such as cantilevered floor slabs) has occurred in past earthquakes. The possibility of such effects should be considered in the design of exterior walls.

C13.5.3 Exterior Nonstructural Wall Elements and Connections

Nonbearing wall panels that are attached to and enclose the structure must be designed to resist seismic (inertial) forces, wind forces, and gravity forces and to accommodate movements of the structure resulting from lateral forces and temperature change. The connections must allow wall panel movements caused by thermal and moisture changes and must be designed to prevent the loss of load-carrying capacity in the event of significant yielding. Where wind loads govern, common practice is to design connectors and panels to allow for not less than two times the story drift caused by wind loads determined, using a return period appropriate to the site location.

Design to accommodate seismic relative displacements often presents a greater challenge than design for strength. Story drifts can amount to 2 in. (50 mm) or more. Separations between adjacent panels are intended to limit contact and resulting panel misalignment or damage under all but extreme building response. Section 13.5.3, item 1, calls for a minimum separation of 1/2 in. (13 mm). For practical joint detailing and acceptable appearance, separations typically are limited to about 3/4 in. (19 mm). Manufacturing and construction tolerances for both wall elements and the supporting structure must be considered in establishing design joint dimensions and connection details.

Cladding elements, which are often stiff in-plane, must be isolated so that they do not restrain and are not loaded by drift of the supporting structure. Slotted connections can provide isolation, but connections with long rods that flex achieve the desired behavior without requiring precise installation. Such rods must be designed to resist tension and compression in addition to induced flexural stresses, brittle, low-cycle fatigue failure.

Full-story wall panels are usually rigidly attached to and move with the floor structure nearest the panel bottom and isolated at the upper attachments. Panels also can be vertically supported at the top connections with isolation connections at the bottom. An advantage of this configuration is that failure of an isolation connection is less likely to result in complete detachment of the panel because it tends to rotate into the structure rather than away from it.

To minimize the effects of thermal movements and shrinkage on architectural cladding panels, connection systems are generally detailed to be statically determinate. Because the resulting support systems often lack redundancy, exacerbating the consequences of a single connection failure, fasteners must be designed for amplified forces and connecting members must be ductile. The intent is to keep inelastic behavior in the connecting members while the more brittle fasteners remain essentially elastic. To achieve this intent, the tabulated a_p and R_p values produce fastener design forces that are about three times those for the connecting members.

Limited deformability curtain walls, such as aluminum systems, are generally light and can undergo large deformations without separating from the structure. However, care must be taken in design of these elements so that low deformability components (as defined in Section 11.2) that may be part of the system, such as glazing panels, are detailed to accommodate the expected deformations without failure.

In Table 13.5-1, veneers are classified as either limited or low deformability elements. Veneers with limited deformability, such as vinyl siding, pose little risk. Veneers with low deformability, such as brick and ceramic tile, are highly sensitive to the performance of the supporting substrate. Significant distortion of the substrate results in veneer damage, possibly including separation from the structure. The resulting risk depends on the size and weight of fragments likely to be dislodged and on the height from which the fragments would fall. Detachment of large portions of the veneer can pose a significant risk to life. Such damage can be reduced by isolating veneer from displacements of the supporting structure. For structures with flexible lateral force-resisting systems, such as moment frames and buckling-restrained braced frames, approaches used to design nonbearing wall panels to accommodate story drift should be applied to veneers.

C13.5.5 Out-of-Plane Bending

The effects of out-of-plane application of seismic forces (defined in Section 13.3.1) on nonstructural walls, including the resulting deformations, must be considered. Where weak or brittle materials are used, conventional deflection limits are expressed as a proportion of the span. The intent is to preclude out-of-plane failure of heavy materials (such as brick or block) or applied finishes (such as stone or tile).

C13.5.6 Suspended Ceilings

Suspended ceiling systems are fabricated using a wide range of building materials with differing characteristics. Some systems (such as gypsum board, screwed or nailed to suspended members) are fairly homogeneous and should be designed as light-frame diaphragm assemblies, using the forces of Section 13.3 and the applicable material-specific design provisions of Chapter 14. Others are composed of discrete elements laid into a suspension system and are the subject of this section.

Seismic performance of ceiling systems with lay-in or acoustical panels depends on support of the grid and individual panels at walls and expansion joints, integrity of the grid and panel assembly, interaction with other systems (such as fire sprinklers), and support for other nonstructural components (such as light fixtures and HVAC systems). Observed performance problems include dislodgement of tiles because of impact with walls and water damage (sometimes leading to loss of occupancy) because of interaction with fire sprinklers.

Suspended lath and plaster ceilings are not exempted from the requirements of this section because of their more significant mass and the greater potential for harm associated with their failure. However, the prescriptive seismic provisions of Section 13.5.6.2 and ASTM E580 (2006) for acoustical tile and lay-in panel ceilings, including the use of compression posts, are not directly applicable to these systems primarily because of their behavior as a continuous diaphragm and greater mass. As such, they require more attention to design and detailing, in particular for the attachment of the hanger wires to the structure and main carriers, the attachment of the cross-furring channels to main carriers, and the attachment of lath to cross-furring channels. Attention should also be given to the attachment of light fixtures and diffusers to the ceiling structure. Bracing should consider both horizontal and vertical movement of the ceiling, as well as discontinuities and offsets. The seismic design and detailing of lath and plaster ceilings should use rational engineering methods to transfer seismic design ceiling forces to the building structural elements.

The performance of ceiling systems is affected by the placement of seismic bracing and the layout of light fixtures and other supported loads. Dynamic testing has demonstrated that splayed wires, even with vertical compression struts, may not adequately limit lateral motion of the ceiling system caused by straightening of the end loops. Construction problems include slack installation or omission of bracing wires caused by obstructions. Other testing has shown that unbraced systems may perform well where the system can accommodate the expected displacements, by providing both sufficient clearance at penetrations and wide closure members, which are now required by the standard.

With reference to the exceptions in Section 13.5.6,

- The first exemption is based on the presumption that lateral support is accomplished by the surrounding walls for areas equal to or less than 144 ft² (e.g., a 12-ft by 12-ft room). The 144-ft² limit corresponds historically to an assumed connection strength of 180 lb and forces associated with requirements for suspended ceilings that first appeared in the 1976 Uniform Building Code.
- The second exemption assumes that planar, horizontal drywall ceilings behave as diaphragms (i.e., develop in-plane strength). This assumption is supported by the performance of drywall ceilings in past earthquakes.

C13.5.6.1 Seismic Forces

Where the weight of the ceiling system is distributed non-uniformly, that condition should be considered in the design because the typical T-bar ceiling grid has limited ability to redistribute lateral loads.

C13.5.6.2 Industry Standard Construction for Acoustical Tile or Lay-In Panel Ceilings

The key to good seismic performance is sufficiently wide closure angles at the perimeter to accommodate relative ceiling motion and adequate clearance at penetrating components (such as columns and piping) to avoid concentrating restraining loads on the ceiling system.

Table C13.5-1 provides an overview of the combined requirements of ASCE/SEI 7 and ASTM E580 (2010). Careful review of both documents is required to determine the actual requirements.

Table C13.5-1 Summary of Requirements for Acoustical Tile or Lay-in Panel Ceilings

Item	Seismic Design Category C	Seismic Design Categories D, E, & F
Up to 144 ft²		
NA	No requirements.	No requirements.
Greater than 144 ft² but less than or equal to 1,000 ft²		
Duty Rating	Only Intermediate or Heavy Duty Load Rated grid as defined by ASTM C635 (2004a) may be used for commercial ceilings. (ASTM C635 sections 4.1.3.1, 4.1.3.2, & 4.1.3.3)	Heavy Duty Load Rating as defined in ASTM C635 is required. (§5.1.1)
Grid Connections	Minimum main tee connection and cross tee intersection strength of 60 lb. (§4.1.2)	Minimum main tee connection and cross tee intersection strength of 180 lb. (§5.1.2)
Vertical Suspension Wires	Vertical hanger wires must be a minimum of 12 gauge. (§4.3.1) Vertical hanger wires maximum 4 ft on center. (§4.3.1) Vertical hanger wires must be sharply bent and wrapped with three turns in 3 in. or less. (§4.3.2) All vertical hanger wires may not be more than 1 in 6 out of plumb without having additional wires countersplayed. (§4.3.3) Wires may not attach to or bend around interfering equipment without the use of trapezes. (§4.3.4)	Vertical hanger wire must be a minimum of 12 gauge. (§5.2.7.1) Vertical hanger wires maximum 4 ft on center. (§5.2.7.1) Vertical hanger wires must be sharply bent and wrapped with three turns in 3 in. or less. (§5.2.7.2) All vertical hanger wires may not be more than 1 in 6 out of plumb without having additional wires countersplayed. (§5.2.7.3) Any connection device from the vertical hanger wire to the structure above must sustain a minimum load of 100 lb. (§5.2.7.2) Wires may not attach to or bend around interfering equipment without the use of trapezes. (§5.2.7.4)
Lateral Bracing	Lateral bracing is not permitted. Ceiling is intended to “float” relative to balance of structure. Tee connections may be insufficient to maintain integrity if braces were included. (§4.2.6, NOTE 1)	Not required under 1,000 ft ² . For ceiling areas under 1,000 ft ² , perimeter and tee connections are presumed to be sufficiently strong to maintain integrity whether bracing is installed or not. (§5.2.8)
Perimeter	Perimeter closure (molding) width must be a minimum of 7/8 in. (§4.2.2) Perimeter closures with a support ledge of less than 7/8-in. shall be supported by perimeter vertical hanger wires not more than 8 in. from the wall. (§4.2.3) A minimum clearance of 3/8 in. must be maintained on all four sides. (§4.2.4) Grid ends on all four walls must be free to move. (§4.2.6) Proprietary solutions may use approved attachment devices on some walls and varying closure widths.	Perimeter closure (molding) width must be a minimum of 2 in. (§5.2.2) Proprietary solutions using approved perimeter clips may use perimeter closures less than 2 in. (ASCE 7-10, para. 13.5.6.2.2.a) Two adjacent sides must be connected to the wall or perimeter closure. (§5.2.3) A minimum clearance of 3/4 in. must be maintained on the other two adjacent sides. (§5.2.3) Perimeter tees must be supported by vertical hanger wires not more than 8 in. from the wall. (§5.2.6)

Item	Seismic Design Category C	Seismic Design Categories D, E, & F
	Perimeter tee ends must be tied together to prevent spreading. (§4.2.5)	Perimeter tee ends must be tied together not more than 8 in. from the wall to prevent spreading. (§5.2.4)
Light Fixtures	<p>Light fixtures must be positively attached to the grid by at least two connections, each capable of supporting the weight of the lighting fixture. (§4.4.1 and NEC)</p> <p>Surface-mounted light fixtures shall be positively clamped to the grid. (§4.4.2)</p> <p>Clamping devices for surface-mounted light fixtures shall have safety wires to the grid or to the structure above. (§4.4.2)</p> <p>Light fixtures and attachments weighing 10 lb or less require number 12 gauge (minimum) hanger wire connected to the housing (e.g., canister light fixture). This wire may be slack. (§4.4.3)</p> <p>Light fixtures that weigh 10–56 lb require two number 12 gauge (minimum) hanger wires at diagonal corners. These wires may be slack. (§4.4.4)</p> <p>Light fixtures that weigh more than 56 lb require independent support from the structure. (§4.4.5)</p> <p>Pendent-hung light fixtures shall be supported by a minimum 9-gauge wire or other approved alternate. (§4.4.6)</p> <p>Rigid conduit is not permitted for the attachment of fixtures. (§4.4.7)</p>	<p>Light fixtures must be positively attached to the grid by at least two connections, each capable of supporting the weight of the lighting fixture. (NEC, para. 5.3.1)</p> <p>Surface-mounted light fixtures shall be positively clamped to the grid. (§5.3.2)</p> <p>Clamping devices for surface-mounted light fixtures shall have safety wires to the grid or to the structure above. (§5.3.2)</p> <p>When cross tees with a load-carrying capacity of less than 16 lb/ft are used, supplementary hanger wires are required. (§5.3.3)</p> <p>Light fixtures and attachments weighing 10 lb or less require one 12-gauge minimum hanger wire connected to the housing (e.g., canister light fixture) and connected to the structure above. This wire may be slack. (§5.3.4)</p> <p>Light fixtures that weigh 10–56 lb require two number 12 gauge minimum hanger wires attached to the fixture housing and connected to the structure above. These wires may be slack. (§5.3.5)</p> <p>Light fixtures that weigh more than 56 lb require independent support from the structure by approved hangers. (§5.3.6)</p> <p>Pendent-hung light fixtures shall be supported by a minimum 9-gauge wire or other approved alternate. (§5.3.7)</p> <p>Rigid conduit is not permitted for the attachment of fixtures. (§5.3.8)</p>
Mechanical Services	<p>Flexibly mounted mechanical services weighing less than 20 lb must be positively attached to main runners or cross runners with the same load-carrying capacity as the main runners. (§4.5.1)</p> <p>Flexibly mounted mechanical services weighing more than 20 lb but less than 56 lb require two 12-gauge (minimum) hanger wires. These wires may be slack. (§4.5.2)</p> <p>Flexibly mounted mechanical services greater than 56 lb require direct support from the structure. (§4.5.3)</p>	<p>Flexibly mounted mechanical services weighing less than 20 lb must be positively attached to main runners or cross runners with the same load-carrying capacity as the main runners. (§5.4.1)</p> <p>Flexibly mounted mechanical services weighing more than 20 lb but less than or equal to 56 lb require two 12-gauge (minimum) hanger wires. These wires may be slack. (§5.4.2)</p> <p>Flexibly mounted mechanical services greater than 56 lb require direct support from the structure. (§5.4.3)</p>
Supplemental Requirements	All ceiling penetrations must have a minimum of 3/8 in. clearance on all sides. (§4.2.4)	<p>Direct concealed systems must have stabilizer bars a maximum of 60 in. on center with stabilizer bars within 24 in. of the perimeter. (§5.2.5)</p> <p>Bracing is required for ceiling plane elevation changes. (§5.2.8.6)</p> <p>Cable trays and electrical conduits shall be supported independently of the ceiling. (§5.2.8.7)</p> <p>Seismic separation joints or full-height partitions are required for ceiling areas greater than 2,500 ft². (§5.2.9.1)</p>
		<p>All ceiling penetrations and independently supported fixtures or services must have closures that allow for a 1-in. movement. (§5.2.8.5)</p> <p>An integral ceiling sprinkler system may be designed by the licensed design professional to eliminate the required spacing of penetrations. (§5.2.8.8)</p> <p>A licensed design professional must review the interaction of nonessential ceiling components with essential ceiling components to prevent the failure of the essential components. (§5.7.1)</p>
Partitions	<p>The ceiling may not provide lateral support to partitions. (§4.6.1)</p> <p>Partitions attached to the ceiling must use flexible connections to avoid transferring force to the ceiling. (§4.6.1)</p>	Partition bracing must be independent of the ceiling. (§5.5.1)
Exceptions	The ceiling weight must be less than 2.5 lb/ft ² , otherwise the prescribed construction for Seismic Design Categories D, E, and F must be used. (§4.1.1)	None.
Greater than 1,000 ft² but less than or equal to 2500 ft²		
Lateral Bracing	No additional requirements.	Lateral force bracing (splay wires or rigid bracing) is required within 2 in. of main tee/cross tee intersection and splayed 90 deg apart in the plan view, at maximum 45-deg angle from the horizontal and located

Item	Seismic Design Category C	Seismic Design Categories D, E, & F
		12 ft on center in both directions, starting 6 ft from walls. (§5.2.8.1 & §5.2.8.2) Lateral force bracing must be spaced a minimum of 6 in. from unbraced horizontal piping or ductwork. (§5.2.8.3) Lateral force bracing connection strength must be a minimum of 250 lb. (§5.2.8.3) Unless rigid bracing is used or calculations have shown that lateral deflection is less than 1/4 in., sprinkler heads and other penetrations shall have a minimum of 1-in. clear space in all directions. (§5.2.8.5)
Greater than 2500 ft ²		
Special Considerations	No additional requirements.	Seismic separation joints with a minimum of 3/4-in. axial movement or full-height partitions with the usual 2-in. closure and other requirements. (§5.2.9.1)

Notes: There are no requirements for suspended ceilings located in structures assigned to Seismic Design Categories A and B. Unless otherwise noted, all section references in parentheses (§) refer to ASTM E580 (2009a).

C13.5.6.2.1 Seismic Design Category C

The prescribed method for SDC C is a floating ceiling. The design assumes a small displacement of the building structure caused by the earthquake at the ceiling and isolates the ceiling from the perimeter. The vertical hanger wires are not capable of transmitting significant movement or horizontal force into the ceiling system and therefore the ceiling does not experience significant force or displacement as long as the perimeter gap is not exceeded. All penetrations and services must be isolated from the building structure for this construction method to be effective. If this isolation is impractical or undesirable, the prescribed construction for SDCs D, E, and F may be used.

C13.5.6.2.2 Seismic Design Categories D through F

The industry standard construction addressed in this section relies on ceiling contact with the perimeter wall for restraint.

Typical splay wire lateral bracing allows for some movement before it effectively restrains the ceiling. The intent of the 2-in. perimeter closure wall angle is to permit back-and-forth motion of the ceiling during an earthquake without loss of support, and the width of the closure angle is important to good performance. This standard has been experimentally verified by large-scale testing conducted by ANCO Engineers, Inc., in 1983.

Extensive shake-table testing using the protocol contained in ICC-ES AC156 (2010) by major manufacturers of suspended ceilings has shown that perimeter clips can provide equivalent performance if they are designed to accommodate the same degree of movement as the closure angle while supporting the T ends.

The requirement for a 1-in. clearance around sprinkler drops found in Section 13.5.6.2.2 (e) of ASCE/SEI 7-05 is maintained and is contained in ASTM E580 (2006).

This seismic separation joint is intended to break the ceiling into isolated areas, preventing large-scale force transfer across the ceiling. The new requirement to accommodate 3/4-in. axial movement specifies the performance requirement for the separation joint.

The requirement for seismic separation joints to limit ceiling areas to 2,500 ft² is intended to prevent overload of the connections to the perimeter angle. Limiting the ratio of long to short dimensions to 4:1 prevents dividing the ceiling into long and narrow sections, which could defeat the purpose of the separation.

C13.5.6.3 Integral Construction

Ceiling systems that use integral construction are constructed of modular preengineered components that integrate lights, ventilation components, fire sprinklers, and seismic bracing into a complete system. They may include aluminum, steel, and PVC components and may be designed using integral construction of ceiling and wall. They often use rigid grid and bracing systems, which provide lateral support for all the ceiling components, including sprinkler drops. This bracing reduces the potential for adverse interactions among components and eliminates the need to provide clearances for differential movement.

C13.5.7 Access Floors

C13.5.7.1 General

In past earthquakes and in cyclic load tests, some typical raised access floor systems behaved in a brittle manner and exhibited little reserve capacity beyond initial yielding or failure of critical connections. Testing shows that unrestrained individual floor panels may pop out of the supporting grid unless they are mechanically fastened to supporting pedestals or stringers. This fault may be a concern, particularly in egress pathways.

For systems with floor stringers, it is accepted practice to calculate the seismic force, F_p , for the entire access floor system within a partitioned space and then distribute the total force to the individual braces or pedestals. For stringerless systems, the seismic load path should be established explicitly.

Overtuning effects subject individual pedestals to vertical loads well in excess of the weight, W_p , used in determining the seismic force, F_p . It is unconservative to use the design vertical load simultaneously with the design seismic force for design of anchor bolts, pedestal bending, and pedestal welds to base plates. “Slip on” heads that are not mechanically fastened to the pedestal shaft and thus cannot transfer tension are likely unable to transfer to the pedestal the overturning moments generated by equipment attached to adjacent floor panels.

To preclude brittle failure, each element in the seismic load path must have energy-absorbing capacity. Buckling failure modes should be prevented. Lower seismic force demands are allowed for special access floors that are designed to preclude brittle and buckling failure modes.

C13.5.7.2 Special Access Floors

An access floor can be a “special access floor” if the registered design professional opts to comply with the requirements of Section 13.5.7.2. Special access floors include construction features that improve the performance and reliability of the floor system under seismic loading. The provisions focus on providing an engineered load path for seismic shear and overturning forces. Special access floors are designed for smaller lateral forces, and their use is encouraged at facilities with higher nonstructural performance objectives.

C13.5.8 Partitions

Partitions subject to these requirements must have independent lateral support bracing from the top of the partition to the building structure or to a substructure attached to the building structure. Some partitions are designed to span vertically from the floor to a suspended ceiling system. The ceiling system must be designed to provide lateral support for the top of the partition. An exception to this condition is provided to exempt bracing of light (gypsum board) partitions where the load does not exceed the minimum partition lateral load. Experience has shown that partitions subjected to the minimum load can be braced to the ceiling without failure.

C13.5.9 Glass in Glazed Curtain Walls, Glazed Storefronts, and Glazed Partitions

The performance of glass in earthquakes falls into one of four categories:

1. The glass remains unbroken in its frame or anchorage.
2. The glass cracks but remains in its frame or anchorage while continuing to provide a weather barrier and to be otherwise serviceable.
3. The glass shatters but remains in its frame or anchorage in a precarious condition, likely to fall out at any time.
4. The glass falls out of its frame or anchorage, either in shards or as whole panels.

Categories 1 and 2 satisfy both immediate-occupancy and life-safety performance objectives. Although the glass is cracked in Category 2, immediate replacement is not required. Categories 3 and 4 cannot provide for immediate occupancy, and their provision of life safety depends on the post breakage characteristics of the glass and the height from which it can fall. Tempered glass shatters into multiple, pebble-size fragments that fall from the frame or anchorage in clusters. These broken glass clusters are relatively harmless to humans when they fall from limited heights, but they could be harmful when they fall from greater heights.

C13.5.9.1 General

Eq. (13.5-1) is derived from Sheet Glass Association of Japan (1982) and is similar to an equation in Bouwkamp and Meehan (1960) that permits calculation of the story drift required to cause glass-to-frame contact in a given rectangular window frame. Both calculations are based on the principle that a rectangular window frame (specifically, one that is anchored mechanically to adjacent stories of a structure) becomes a parallelogram as a result of story drift, and that glass-to-frame contact occurs when the length of the shorter diagonal of the parallelogram is equal to the diagonal of the glass panel itself. The value Δ_{fallout} represents the displacement capacity of the system, and D_p represents the displacement demand.

The 1.25 factor in the requirements described above reflects uncertainties associated with calculated inelastic seismic displacements of building structures. Wright (1989) states that post-elastic deformations, calculated using the structural analysis process may well underestimate the actual building deformation by up to 30 percent. It would therefore be reasonable to require the curtain wall glazing system to withstand 1.25 times the computed maximum inter-story displacement to verify adequate performance.

The reason for the second exception to Eq. (13.5-1) is that the tempered glass, if shattered, would not produce an overhead falling hazard to adjacent pedestrians, although some pieces of glass may fall out of the frame.

C13.5.9.2 Seismic Drift Limits for Glass Components

As an alternative to the prescriptive approach of Section 13.5.9.1, the deformation capacity of glazed curtain wall systems may be established by test.

C13.6 MECHANICAL AND ELECTRICAL COMPONENTS

These requirements, focused on design of supports and attachments, are intended to reduce the hazard to life posed by loss of component structural stability or integrity. The requirements increase the reliability of component operation but do not address functionality directly. For critical components where operability is vital, Section 13.2.2 provides methods for seismically qualifying the component.

Traditionally, mechanical components (such as tanks and heat exchangers) without rotating or reciprocating components are directly anchored to the structure. Mechanical and electrical equipment components with rotating or reciprocating elements are often isolated from the structure by vibration isolators (using rubber acting in shear, springs, or air cushions). Heavy mechanical equipment (such as large boilers) may not be restrained at all, and electrical equipment other than generators, which are normally isolated to dampen vibrations, usually is rigidly anchored (for example, switch gear and motor control centers).

Two distinct levels of earthquake safety are considered in the design of mechanical and electrical components. At the usual safety level, failure of the mechanical or electrical component itself because of seismic effects poses no significant hazard. In this case, design of the supports and attachments to the structure is required to avoid a life-safety hazard. At the higher safety level, the component must continue to function acceptably after the design earthquake. Such components are defined as designated seismic systems in Section 11.2 and may be required to meet the special certification requirements of Section 13.2.2.

Not all equipment or parts of equipment need to be designed for seismic forces. Where I_p is specified to be 1.0, damage to, or even failure of, a piece or part of a component does not violate these requirements as long as a life-safety hazard is not created. The restraint or containment of a falling, breaking, or toppling component (or its parts) by means of bumpers, braces, guys, wedges, shims, tethers, or gapped restraints to satisfy these requirements often is acceptable, although the component itself may suffer damage.

Judgment is required to fulfill the intent of these requirements; the key consideration is the threat to life safety. For example, a nonessential air handler package unit that is less than 4 ft (1.2 m) tall bolted to a mechanical room floor is not a threat to life as long as it is prevented from significant displacement by having adequate anchorage. In this case, seismic design of the air handler itself is unnecessary. However, a 10-ft (3.0-m) tall tank on 6-ft (1.8-m) long angles used as legs, mounted on a roof near a building exit does pose a hazard. The intent of these requirements is that the supports and attachments (tank legs, connections between the roof and the legs, and connections between the legs and the tank), and possibly even the tank itself be designed to resist seismic forces. Alternatively, restraint of the tank by guys or bracing could be acceptable.

It is not the intent of the standard to require the seismic design of shafts, buckets, cranks, pistons, plungers, impellers, rotors, stators, bearings, switches, gears, nonpressure retaining casings and castings, or similar items. Where the potential for a hazard to life exists, the design effort should focus on equipment supports, including base plates, anchorages, support lugs, legs, feet, saddles, skirts, hangers, braces, and ties.

Many mechanical and electrical components consist of complex assemblies of parts that are manufactured in an industrial process that produces similar or identical items. Such equipment may include manufacturer's catalog items and often are designed by empirical (trial-and-error) means for functional and transportation loadings. A characteristic of such equipment is that it may be inherently rugged. The term "rugged" refers to an amplexness of construction that provides such equipment with the ability to survive strong motions without significant loss of function. By examining such equipment, an experienced design professional usually should be able to confirm such ruggedness. The results of an assessment of equipment ruggedness may be used in determining an appropriate method and extent of seismic design or qualification effort.

The revisions to Table 13-3 in ASCE/SEI 07-10 are the result of work done in recent years to better understand the performance of mechanical and electrical components and their attachment to the structure. The primary concepts of flexible and rigid equipment and ductile and rugged behavior are drawn from SEAOC (1999), Commentary Section C107.1.7. Material on HVAC is based on ASHRAE (2000). Other material on industrial piping, boilers, and pressure vessels is based on the American Society of Mechanical Engineers codes and standards publications.

C13.6.1 General

The exception allowing unbraced suspended components has been clarified, addressing concerns about the type of nonstructural components allowed by these exceptions, as well as the acceptable consequences of interaction between components. In previous editions of the standard, certain nonstructural components that could represent a fire hazard after an earthquake were exempt from lateral bracing requirements. In the revised exception, reference to Section 13.2.3 addresses such concerns while distinguishing between credible seismic interactions and incidental interactions.

The seismic demand requirements are based on component structural attributes of flexibility (or rigidity) and ruggedness. Table 13.6-1 provides seismic coefficients based on judgments of the component flexibility, expressed in the a_p term, and ruggedness, expressed in the R_p term. It may also be necessary to consider the flexibility and ductility of the attachment system that provides seismic restraint.

Entries for components and systems in Table 13.6-1 are grouped and described to improve clarity of application. Components are divided into three broad groups, within which they are further classified depending on the type of construction or expected seismic behavior. For example, mechanical components include “air-side” components (such as fans and air handlers) that experience dynamic amplification but are light and deformable; “wet-side” components that generally contain liquids (such as boilers and chillers) that are more rigid and somewhat ductile; and rugged components (such as engines, turbines, and pumps) that are of massive construction because of demanding operating loads and that generally perform well in earthquakes, if adequately anchored.

A distinction is made between components isolated using neoprene and those that are spring isolated. Spring-isolated components are assigned a lower R_p value because they tend to have less effective damping. Internally isolated components are classified explicitly to avoid confusion.

C13.6.2 Component Period

Component period is used to clarify components as rigid ($T \leq 0.06$ s) or flexible ($T > 0.06$ s). Determination of the fundamental period of a mechanical or electrical component using analytical or test methods can become involved. If not properly performed, the fundamental period may be underestimated, producing unconservative results. The flexibility of the component’s supports and attachments typically dominates response and thus fundamental component period. Therefore, analytical determinations of component period must consider those sources of flexibility. Where determined by testing, the dominant mode of vibration of concern for seismic evaluation must be excited and captured by the test setup. This dominant mode of vibration cannot be discovered through in situ tests that measure only ambient vibrations. To excite the mode of vibration with the highest fundamental period by in situ tests, relatively significant input levels of motion are required (that is, the flexibility of the base and attachment must be exercised). A resonant frequency search procedure, such as that given in ICC-ES AC156 (2010), may be used to identify the dominant modes of vibration of a component.

Many types of mechanical components have fundamental periods below 0.06 s and may be considered rigid. Examples include horizontal pumps, engine generators, motor generators, air compressors, and motor-driven centrifugal blowers. Other types of mechanical equipment are stiff but may have fundamental periods up to about 0.125 s. Examples include vertical immersion and deep well pumps, belt-driven and vane axial fans, heaters, air handlers, chillers, boilers, heat exchangers, filters, and evaporators. These fundamental period estimates do not apply where the equipment is mounted on vibration isolators.

Electrical equipment cabinets can have fundamental periods of about 0.06 to 0.3 s, depending on the supported weight and its distribution, the stiffness of the enclosure assembly, the flexibility of the enclosure base, and the load path through to the attachment points. Tall, narrow motor control centers and switchboards lie at the upper end of this period range. Low- and medium-voltage switch gear, transformers, battery chargers, inverters, instrumentation cabinets, and instrumentation racks usually have fundamental periods ranging from 0.1 to 0.2 s. Braced battery racks, stiffened vertical control panels, bench boards, electrical cabinets with top bracing, and wall-mounted panel boards have fundamental periods ranging from 0.06 to 0.1 s.

C13.6.3 Mechanical Components and C13.6.4 Electrical Components

Most mechanical and electrical equipment is inherently rugged and, where properly attached to the structure, has performed well in past earthquakes. Because the operational and transportation loads for which the equipment is designed typically are larger than those caused by earthquakes, these requirements

focus primarily on equipment anchorage and attachments. However, designated seismic systems, which are required to function after an earthquake or which must maintain containment of flammable or hazardous materials, must themselves be designed for seismic forces or be qualified for seismic loading in accordance with Section 13.2.2.

The likelihood of post-earthquake operability can be increased where the following measures are taken:

1. Internal assemblies, subassemblies, and electrical contacts are attached sufficiently to prevent their being subjected to differential movement or impact with other internal assemblies or the equipment enclosure.
2. Operators, motors, generators, and other such components that are functionally attached to mechanical equipment by means of an operating shaft or mechanism are structurally connected or commonly supported with sufficient rigidity such that binding of the operating shaft is avoided.
3. Any ceramic or other nonductile components in the seismic load path are specifically evaluated.
4. Adjacent electrical cabinets are bolted together and cabinet lineups are prevented from impacting adjacent structural members.

Components that could be damaged, or could damage other components, and are fastened to multiple locations of a structure, must be designed to accommodate seismic relative displacements. Such components include bus ducts, cable trays, conduits, elevator guide rails, and piping systems. As discussed in Section C13.3.2.1, special design consideration is required where full story drift demands are concentrated in a fraction of the story height.

C13.6.5 Component Supports

The intent of this section is to require seismic design of all mechanical and electrical component supports to prevent sliding, falling, toppling, or other movement that could imperil life. Component supports are differentiated here from component attachments to emphasize that the supports themselves, as enumerated in the text, require seismic design even if they are fabricated by the mechanical or electrical component manufacturer. This need exists regardless of whether the mechanical or electrical component itself is designed for seismic loads.

C13.6.5.1 Design Basis

Standard supports are those developed in accordance with a reference document (Section 13.1.6). Where standard supports are not used, the seismic design forces and displacement demands of Chapter 13 are used with applicable material-specific design procedures of Chapter 14.

C13.6.5.2 Design for Relative Displacement

For some items, such as piping, seismic relative displacements between support points are of more significance than inertial forces. Components made of high-deformability materials such as steel or copper can accommodate relative displacements inelastically, provided that the connections also provide high deformability. Threaded and soldered connections exhibit poor ductility under inelastic displacements, even for ductile materials. Components made of less ductile materials can accommodate relative displacement effects only if appropriate flexibility or flexible connections are provided.

Detailing distribution systems that connect separate structures with bends and elbows makes them less prone to damage and less likely to fracture and fall, provided that the supports can accommodate the imposed loads.

C13.6.5.3 Support Attachment to Component

As used in this section, “integral” relates to the manufacturing process, not the location of installation. For example, both the legs of a cooling tower and the attachment of the legs to the body of the cooling tower must be designed, even if the legs are provided by the manufacturer and installed at the plant. Also, if the

cooling tower has an $I_p = 1.5$, the design must address not only the attachments (e.g., welds and bolts) of the legs to the component but also local stresses imposed on the body of the cooling tower by the support attachments.

C13.6.5.5 Additional Requirements

As reflected in this section of the standard and in the footnote to Table 13.6-1, vibration-isolated equipment with snubbers is subject to amplified loads as a result of dynamic impact.

Most sheet metal connection points for seismic anchorage do not exhibit the same mechanical properties as bolted connections with structural elements. The use of Belleville washers improves the seismic performance of connections to equipment enclosures fabricated from sheet metal 7 gauge (0.18 in.) or thinner by distributing the stress over a larger surface area of the sheet metal connection interface, allowing for bolted connections to be torqued to recommended values for proper preload while reducing the tendency for local sheet metal tearing or bending failures or loosening of the bolted connection (Fig. C13.6-1). The intrinsic spring loading capacity of the Belleville washer assists with long-term preload retention to maintain integrity of the seismic anchorage.

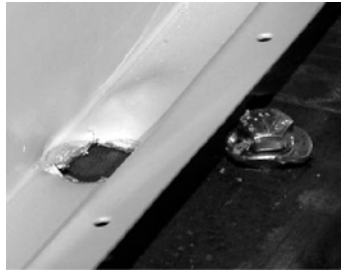

Failure of sheet metal base anchored with standard washer (With permission)

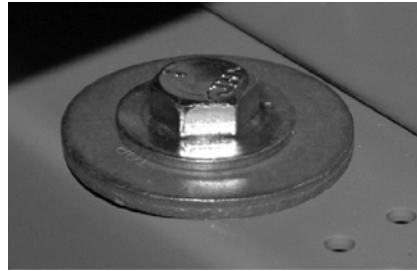

Anchorage equipped with Belleville washer (With permission)

FIGURE C13.6-1 Equipment Anchorage with Belleville Washers

Manufacturers test or design their equipment to handle seismic loads at the equipment “hard points” or anchor locations. The results of this design qualification effort are typically reflected in installation instructions provided by the manufacturer. It is imperative that the manufacturer’s installation instructions be followed. Where such guidance does not exist, the registered design professional should design appropriate reinforcement.

C13.6.5.6 Conduit, Cable Tray, and Other Electrical Distribution Systems (Raceways)

The term *raceway* is defined in several standards with somewhat varying language. As used here, it is intended to describe all electrical distribution systems including conduit, cable trays, and open and closed raceways. Experience indicates that a size limit of 2.5 in. can be established for the provision of flexible connections to accommodate seismic relative displacements that might occur between pieces of connected equipment because smaller conduit normally possesses the required flexibility to accommodate such displacements. The bracing exemption for hangers less than 12 in. (305 mm) long, presuming that the hangers have negligible bending strength and sufficient resistance to lateral seismic loads, is provided by the restoring force induced by pendulum displacement of the raceway. The short length of the hangers is also presumed to limit the amount of horizontal raceway displacement.

Short hangers fabricated from threaded rods resist lateral force primarily through bending and are prone to failure through cyclic fatigue. Providing a swivel at the connection between the threaded rod hanger and the structure eliminates the bending stress in the threaded rod. Where this swivel and braces are not provided, the rod hangers (and, where applicable, the anchors) must be designed for the resultant bending forces.

The exemption for short hangers is limited to the case where every hanger in the raceway run is less than 12 in. (305 mm) because of the need to carefully consider the seismic loads and compatible displacement limits for the portions of raceways with longer hanger supports.

C13.6.6 Utility and Service Lines

For essential facilities (Risk Category IV), auxiliary on-site mechanical and electrical utility sources are recommended.

Where utility lines pass through the interface of adjacent, independent structures, they must be detailed to accommodate differential displacement computed in accordance with Section 13.3.2 and including the C_d factor of Section 12.2.1.

As specified in Section 13.1.3, nonessential piping whose failure could damage essential utilities in the event of pipe rupture may be considered designated seismic systems.

C13.6.7 Ductwork

Experience in past earthquakes has shown that HVAC duct systems are rugged and perform well in strong ground shaking. Bracing in accordance with ANSI/SMACNA 001 (2000) has been effective in limiting damage to duct systems. Typical failures have affected only system function, and major damage or collapse has been uncommon. Therefore, industry standard practices should prove adequate for most installations. Expected earthquake damage is limited to opening of duct joints and tears in ducts. Connection details that are prone to brittle failures, especially hanger rods subject to large amplitude cycles of bending stress, should be avoided.

The amplification factor for ductwork has been increased from 1.0 to 2.5 because even braced duct systems are relatively flexible. The R_p values also have been increased so that the resulting seismic design forces are consistent with those determined previously.

Ductwork systems that carry hazardous materials or must remain operational during and after an earthquake are assigned a value of $I_p = 1.5$, and they require a detailed engineering analysis addressing leak-tightness.

Lighter inline components may be designed to resist the forces from Section 13.3 as part of the overall duct system design, whereby the duct attached to the inline component is explicitly designed for the forces generated by the component. Where inline components are more massive, the component must be supported and braced independently of the ductwork to avoid failure of the connections.

The requirements for flexible connections of unbraced piping to inline components such as reheat coils applies regardless of the component weight.

C13.6.8 Piping Systems

Because of the typical redundancy of piping system supports, documented cases of total collapse of piping systems in earthquakes are rare; however, pipe leakage resulting from excessive displacement or overstress often results in significant consequential damage and in some cases loss of facility operability. Loss of fluid containment (leakage) normally occurs at discontinuities such as threads, grooves, bolted connectors, geometric discontinuities, or locations where incipient cracks exist, such as at the toe or root of a weld or braze. Numerous building and industrial national standards and guidelines address a wide variety of piping systems materials and applications. Construction in accordance with the national standards referenced in these provisions is usually effective in limiting damage to piping systems and avoiding loss of fluid containment under earthquake conditions.

ASHRAE (2000) and MSS (2001) are derived in large part from the predecessors of SMACNA (2008). These documents may be appropriate references for use in the seismic design of piping systems. Because the SMACNA standard does not refer to pipe stresses in the determination of hanger and brace spacing, however, a supplementary check of pipe stresses may be necessary when this document is used. ASME

piping rules as given in the ASME (2010) and ASME B31 parts B31.1 (2001), B31.3 (2001), B31.5 (2010), B31.9 (2008), and B31.12 (2008) are normally used for high-pressure, high-temperature piping but can also conservatively be applied to other lower pressure, lower temperature piping systems. Code-compliant seismic design manuals prepared specifically for proprietary systems may also be appropriate references.

Table 13-3 entries for piping previously listed the amplification factor related to the response of piping systems as rigid ($a_p = 1.0$) and values for component response modification factors lower than in the current table. However, it was realized that most piping systems are flexible and that the amplification factor values should reflect this fact; thus, a_p was increased to 2.5 and the R_p values were adjusted accordingly such that a_p/R_p remains roughly consistent with earlier provisions.

Although seismic design in accordance with Section 13.6.8 generally ensures that effective seismic forces do not fail piping, seismic displacements may be underestimated such that impact with nearby structural, mechanical, or electrical components could occur. In marginal cases, it may be advisable to protect the pipe with wrapper plates where impacts could occur, including at gapped supports. Insulation may in some cases also serve to protect the pipe from impact damage. Piping systems are typically designed for pressure containment, and piping designed with a factor of safety of three or more against pressure failure (rupture) may be inherently robust enough to survive impact with nearby structures, equipment, and other piping, particularly if the piping is insulated. Piping that has less than standard weight wall thickness may require the evaluation of the effects of impact locally on the pipe wall and may necessitate means to protect the pipe wall.

It is usually preferable for piping to be detailed to accommodate seismic relative displacements between the first seismic support upstream or downstream from connections and other seismically supported components or headers. This accommodation is preferably achieved by means of pipe flexibility or, where pipe flexibility is not possible, flexible supports. Piping not otherwise detailed to accommodate such seismic relative displacements must be provided with connections that have sufficient flexibility in the connecting element or in the component or header to avoid failure of the piping. The option to use a flexible connecting element may be less desirable because of the need for greater maintenance efforts to ensure continued proper function of the flexible element.

Grooved couplings, ball joints, resilient gasket compression fittings, other articulating-type connections, bellows expansion joints, and flexible metal hose are used in many piping systems and can serve to increase the rotational and lateral deflection design capacity of the piping connections.

Grooved couplings are classified as either rigid or flexible. Flexible grooved couplings demonstrate limited free rotational capacity. The free rotational capacity is the maximum articulating angle where the connection behaves essentially as a pinned joint with limited or negligible stiffness. The remaining rotational capacity of the connection is associated with conventional joint behavior, and design force demands in the connection are determined by traditional means.

Rigid couplings are typically used for high-pressure applications and usually are assumed to be stiffer than the pipe. Alternatively, rigid coupling may exhibit bilinear rotational stiffness with the initial rotational stiffness affected by installation.

Coupling flexibilities vary significantly between manufacturers, particularly for rigid couplings. Manufacturer's data may be available. Industrywide procedures for the determination of coupling flexibility are not currently available; however, some guidance for couplings may be found in the provisions for fire sprinkler piping, where grooved couplings are classified as either rigid or flexible on the basis of specific requirements on angular movement. In Section 3.5.4 of NFPA (2007), flexible couplings are defined as follows:

A listed coupling or fitting that allows axial displacement, rotation, and at least 1 degree of angular movement of the pipe without inducing harm on the pipe. For pipe diameters of 8 in. (203.2 mm) and larger, the angular movement shall be permitted to be less than 1 degree but not less than 0.5 degrees.

Couplings determined to be flexible on this basis are listed either with FM Global (2007) or UL (2004).

Piping component testing suggests that the ductility capacity of carbon steel threaded and flexible grooved piping component joints ranges between 1.4 and 3.0, implying an effective stress intensification of approximately 2.5. These types of connections have been classified as having limited deformability, and piping systems with these connections have R_p values lower than piping with welded or brazed joints.

The allowable stresses for piping constructed with ductile materials assumed to be materials with high deformability, and not designed in accordance with an applicable standard or recognized design basis, are based on values consistent with industrial piping and structural steel standards for comparable piping materials.

The allowable stresses for piping constructed with low-deformability materials, and not designed in accordance with an applicable standard or recognized design basis, are derived from values consistent with ASME standards for comparable piping materials.

For typical piping materials, pipe stresses may not be the governing parameter in determining the hanger and other support spacing. Other considerations, such as the capacity of the hanger and other support connections to the structure, limits on the lateral displacements between hangers and other supports to avoid impacts, the need to limit pipe sag between hangers to avoid the pooling of condensing gases, and the loads on connected equipment may govern the design. Nevertheless, seismic span tables, based on limiting stresses and displacements in the pipe, can be a useful adjunct for establishing seismic support locations.

Piping systems' service loads of pressure and temperature also need to be considered in conjunction with seismic inertia loads. The potential for low ambient and lower than ambient operating temperatures should be considered in the designation of the piping system materials as having high or low deformability. High deformability may often be assumed for steels, particularly ASME listed materials operating at high temperatures, copper and copper alloys, and aluminum. Low deformability should be assumed for any piping material that exhibits brittle behavior, such as glass, ceramics, and many plastics.

Piping should be designed to accommodate relative displacements between the first rigid piping support and connections to equipment or piping headers often assumed to be anchors. Barring such design, the equipment or header connection could be designed to have sufficient flexibility to avoid failure. The specification of such flexible connections should consider the necessity of connection maintenance.

Where appropriate, a walkdown of the finally installed piping system by an experienced design professional familiar with seismic design is recommended, particularly for piping greater than 6-in. (152.4-mm) nominal pipe size, high-pressure piping, piping operating at higher than ambient temperatures, and piping containing hazardous materials. The need for a walkdown may also be related to the scope, function, and complexity of the piping system, as well as the expected performance of the facility. In addition to providing a review of seismic restraint location, orientation, and attachment to the structure, the walkdown verifies that the required separation exists between the piping and nearby structures, equipment, and other piping in the as-built condition.

C13.6.8.1 ASME Pressure Piping Systems

In Table 13-3, the increased R_p values listed for ASME B31-compliant piping systems are intended to reflect the more rigorous design, construction, and quality control requirements, as well as the intensified stresses associated with ASME B31 (2010) designs.

Materials meeting ASME toughness requirements may be considered high-deformability materials.

C13.6.8.2 Fire Protection Sprinkler Piping Systems

The lateral design procedures of NFPA (2007) have been revised for consistency with the ASCE/SEI 7 design approach while retaining traditional sprinkler system design concepts. Using conservative upper-

bound values of the various design parameters, a single lateral force coefficient, C_p , was developed. It is a function of the mapped short-period response parameter S_s . Stresses in the pipe and connections are controlled by limiting the maximum reaction at bracing points as a function of pipe diameter.

Other components of fire protection systems, e.g., pumps and control panels, are subject to the general requirements of ASCE/SEI 7.

C13.6.8.3 Exceptions

The conditions under which the force and displacement requirements of Section 13.3 may be waived are based on observed performance in past earthquakes. The 12-in. (305-mm) limit on the hanger or trapeze drop must be met by all the hangers or trapezes supporting the piping system.

C13.6.9 Boilers and Pressure Vessels

Experience in past earthquakes has shown that boilers and pressure vessels are rugged and perform well in strong ground motion. Construction in accordance with current requirements of the *ASME Boiler and Pressure Vessel Code* (ASME BPVC) has been shown to be effective in limiting damage to and avoiding loss of fluid containment in boilers and pressure vessels under earthquake conditions. It is, therefore, the intent of the standard that nationally recognized codes be used to design boilers and pressure vessels provided that the seismic force and displacement demands are equal to or exceed those outlined in Section 13.3. Where nationally recognized codes do not yet incorporate force and displacement requirements comparable to the requirements of Section 13.3, it is nonetheless the intent to use the design acceptance criteria and construction practices of those codes.

C13.6.10 Elevator and Escalator Design Requirements

The *ASME Safety Code for Elevators and Escalators* (ASME A17.1) (2007) has adopted many requirements to improve the seismic response of elevators; however, they do not apply to some regions covered by this chapter. These changes are to extend force requirements for elevators to be consistent with the standard.

C13.6.10.3 Seismic Controls for Elevators

ASME A17.1 (2007), Section 8.4.10.1.2, specifies the requirements for the location and sensitivity of seismic switches to achieve the following goals: (a) safe shutdown in the event of an earthquake severe enough to impair elevator operations, (b) rapid and safe reactivation of elevators after an earthquake, and (c) avoidance of unintended elevator shutdowns. This level of safety is achieved by requiring the switches to be in or near the elevator equipment room, by using switches located on or near building columns that respond to vertical accelerations that would result from P and S waves, and by setting the sensitivity of the switches at a level that avoids false shutdowns because of nonseismic sources of vibration. The trigger levels for switches with horizontal sensitivity (for cases where the switch cannot be located near a column) are based on the experience with California hospitals in the Northridge earthquake of 1994. Elevators in which the seismic switch and counterweight derail device have triggered should not be put back into service without a complete inspection. However, in the case where the loss of use of the elevator creates a life-safety hazard, an attempt to put the elevator back into service may be attempted. Operating the elevator before inspection may cause severe damage to the elevator or its components.

The building owner should have detailed written procedures in place defining for the elevator operator and/or maintenance personnel which elevators in the facility are necessary from a post-earthquake life-safety perspective. It is highly recommended that these procedures be in place, with appropriate personnel training, before an event occurs that is strong enough to trip the seismic switch.

C13.6.10.4 Retainer Plates

The use of retainer plates is a low-cost provision to improve the seismic response of elevators.

C13.6.11 Other Mechanical and Electrical Components

The material properties set forth in item 2 of this section are similar to those allowed in ASME BPVC (2010) and reflect the high factors of safety necessary for seismic, service, and environmental loads.

REFERENCES

- American Concrete Institute (ACI). (2007). "Qualification of post-installed mechanical anchors in concrete and commentary." *ACI 355.2*, Farmington Hills, Mich.
- American Concrete Institute (ACI). (2011a). "Building code requirements and specification for masonry structures and related commentaries." *ACI 530/530.1*, Farmington Hills, Mich.
- American Concrete Institute (ACI). (2011b). "Building code requirements for structural concrete and commentary." *ACI 318*, Farmington Hills, Mich.
- American Concrete Institute (ACI). (2011c). "Qualification of post-installed adhesive anchors in concrete and commentary." *ACI 355.4*, Farmington Hills, Mich.
- American National Standards Institute/Sheet Metal and Air-Conditioning Contractors National Association (ANSI/SMACNA). (2000). "Seismic restraint manual: Guidelines for mechanical systems." *ANSI/SMACNA 001*, Chantilly, Va.
- American Society of Heating, Refrigerating, and Air-Conditioning Engineers (ASHRAE). (2000). *Practical Guide to Seismic Restraint*, RP-812, American Society of Heating, Refrigerating, and Air-Conditioning Engineers, Atlanta, Ga.
- American Society of Mechanical Engineers (ASME). (2007). "Safety Code for Elevators and Escalators" *A17.1*, New York.
- American Society of Mechanical Engineers (ASME). (2010). "Boiler and Pressure Vessel Code" *BPVC*, New York.
- American Society of Mechanical Engineers (ASME). (2010). "Standard for the seismic design and retrofit of above-ground piping systems." *B31E*, New York.
- ANCO Engineers, Inc. (1983). "Seismic hazard assessment of non-structural components—Phase I." Final Report for the National Science Foundation from ANCO Engineers, Inc., Culver City, Calif., September.
- ASTM International. (2006). "Standard practice for application of ceiling suspension systems for acoustical tile and lay-in panels in areas requiring seismic restraint." *ASTM E580*, West Conshohocken, Penn.
- ASTM International. (2007). "Standard specification for the manufacture, performance, and testing of metal suspension systems for acoustical tile and lay-in panel ceilings." *ASTM C635/C635M*, West Conshohocken, Penn.
- ASTM International. (2008). "Standard practice for installation of metal ceiling suspension systems for acoustical tile and lay-in panels." *ASTM C636/C636M*, West Conshohocken, Penn.
- ASTM International. (2010). "Standard practice for installation of ceiling suspension systems for acoustical tile and lay-in panels for areas subject to earthquake ground motion." *ASTM E580/E580M*, West Conshohocken, Penn.
- Bachman, R. E., and Dowty, S. M. (2008). "Nonstructural component or nonbuilding structure?" *Building Safety Journal* (April–May).
- Bouwkamp, J. G., and Meehan, J. F. (1960). "Drift limitations imposed by glass." *Proceedings of the Second World Conference on Earthquake Engineering*, Tokyo, Japan, 1763–1778.
- Department of Defense (DOD). (2007). "Seismic design for buildings." *UFC 3-310-04*, U.S. Department of Defense, Unified Facilities Criteria, Washington, D.C.
- FM Global. (2007). Approved Standard for Pipe Couplings and Fittings for Aboveground Fire Protection Systems. <<http://www.fmglobal.com/assets/pdf/fmapprovals/1920.pdf>>.
- Institute of Electrical and Electronics Engineers, Inc. (IEEE). (2005). "IEEE recommended practices for seismic design of substations" *IEEE 693-2005*, Piscataway, NJ.
- International Code Council Evaluation Service (ICC-ES). (2010). "Seismic qualification by shake-table testing of nonstructural components and systems." *ICC-ES AC156*, Whittier, Calif.
- International Code Council Evaluation Service (ICC-ES). (2012a). "Acceptance criteria for adhesive anchors in masonry elements." *ICC-ES AC58*, Whittier, Calif.
- International Code Council Evaluation Service (ICC-ES). (2012b). "Acceptance criteria for expansion anchors in masonry elements." *ICC-ES AC01*, Whittier, Calif.
- International Code Council Evaluation Service (ICC-ES). (2012c). "Acceptance criteria for mechanical anchors in concrete elements." *ICC-ES AC193*, Whittier, Calif.

- International Code Council Evaluation Service (ICC-ES). (2012d). "Acceptance criteria for post-installed adhesive anchors in concrete elements." *ICC-ES AC308*, Whittier, Calif.
- International Code Council Evaluation Service (ICC-ES). (2012e). "Acceptance criteria for predrilled fasteners (screw anchors) in masonry." *ICC-ES AC106*, Whittier, Calif.
- Kehoe, B., and Hachem, M. (2003). "Procedures for estimating floor accelerations." ATC 29-2, *Proceedings of the Seminar on Seismic Design, Performance, and Retrofit of Nonstructural Components in Critical Facilities*, Newport Beach, Calif., 361–374.
- Manufacturers Standardization Society of the Valve and Fitting Industry (MSS). (2001). "Bracing for piping systems seismic–wind–dynamic design, selection, application." *MSS SP-127*, Vienna, Va.
- Miranda, E. and Taghavi, S. (2003). "Estimation of Seismic Demands on Acceleration-Sensitive Nonstructural Components in Critical Facilities," In *Proceedings of the Seminar on Seismic Design, Performance, and Retrofit of Nonstructural Components in Critical Facilities*, ATC 29-2. Newport Beach, CA, p. 347-360.
- National Earthquake Hazards Reduction Program (NEHRP). (2009). *NEHRP Recommended Provisions for Seismic Regulations for New Buildings and Other Structures*, National Earthquake Hazards Reduction Program, Washington, D.C.
- National Fire Protection Association (NFPA). (2007). "Standard for the installation of sprinkler systems." *NFPA 13*, Quincy, Mass.
- National Fire Protection Association (NFPA). (2011). "National electric code (NEC)." *NFPA 70*, Quincy, Mass.
- Sheet Glass Association of Japan. (1982). *Earthquake Safety Design of Windows*.
- Sheet Metal and Air-Conditioning Contractors National Association (SMACNA). (2008). *Seismic Restraint Manual: Guidelines for Mechanical Systems*, 3rd ed., Sheet Metal and Air-Conditioning Contractors National Association, Chantilly, Va.
- Singh et al. (2003)
- Structural Engineers Association of California (SEAOC). (1999). *Recommended Lateral Force Requirements and Commentary*, Structural Engineers Association of California, Sacramento, Calif.
- Underwriter Laboratories (UL). (2004). "Rubber gasketed fittings for fire-protection service." *UL 213*, Northbrook, Ill.
- Wright, P. D. (1989). *The Development of a Procedure and Rig for Testing the Racking Resistance of Curtain Wall Glazing*, BRANZ Study Report 17, Building Research Association of New Zealand (BRANZ), Porirua, New Zealand.

OTHER REFERENCES (NOT CITED)

- Bachman, R. E. and Drake, R. M. (1996). "A study to empirically validate the component response modification factors in the 1994 *NEHRP Provisions* design force equations for architectural, mechanical, and electrical components," letter report to the National Center for Earthquake Engineering Research, July.
- Bachman, R. E., Drake, R. M., and Richter, P. J. (1993). "1994 update to 1991 *NEHRP Provisions* for architectural, mechanical, and electrical components and systems," letter report to the National Center for Earthquake Engineering Research, February 22.
- Behr, R. A., and Belarbi, A. (1996). "Seismic test methods for architectural glazing systems." *Earthquake Spectra*, 12(1), 129–143.
- Behr, R. A., Belarbi, A., and Brown, A. T. (1995). "Seismic performance of architectural glass in a storefront wall system." *Earthquake Spectra*, 11(3), 367–391.
- Drake, R. M., and Bachman, R. E. (1994). "1994 *NEHRP Provisions* for architectural, mechanical, and electrical components." In *Proceedings of the 5th United States National Conference on Earthquake Engineering*.
- Drake, R. M., and Bachman, R. E. (1995). "Interpretation of instrumented building seismic data and implications for building codes." In *Proceedings of the 1995 SEAOC Annual Convention*.
- Drake, R. M., and Bachman, R. E. (1996). "NEHRP provisions for 1994 for nonstructural components." *J. Arch. Engrg.*, 2(1), 26–31.
- Gates, W. E., and McGavin, G. (1998). "Lessons learned from the 1994 Northridge earthquake on the vulnerability of nonstructural systems." In *Proceedings, Seminar on Seismic Design, Retrofit, and Performance of Nonstructural Components*, ATC-29-1, Applied Technology Council, Redwood City, Calif., 93–101.
- Haroun, M. A., and Housner, G. W. (1981). "Seismic design of liquid storage tanks." *J. Tech. Councils of ASCE*, 107(1), 191–207.
- Pantelides, C. P., Truman, K. Z., Behr, R. A., and Belarbi, A. (1996). "Development of a loading history for seismic testing of architectural glass in a shop-front wall system." *Engrg. Struct.*, 18(12), 917

Page intentionally left blank

COMMENTARY TO CHAPTER 14, MATERIAL-SPECIFIC SEISMIC DESIGN AND DETAILING REQUIREMENTS

Because seismic loading is expected to cause nonlinear behavior in structures, seismic design criteria require not only provisions to govern loading but also provisions to define the required configurations, connections, and detailing to produce material and system behavior consistent with the design assumptions. Thus, although ASCE/SEI 7-10 is primarily a loading standard, compliance with Chapter 14, which covers material-specific seismic design and detailing, is required. In general, Chapter 14 adopts material design and detailing standards developed by material standards organizations. These material standards organizations maintain complete commentaries covering their standards, and such material is not duplicated here.

C14.0 SCOPE

The scoping statement in this section clarifies that foundation elements are subject to all of the structural design requirements of the standard.

C14.1 STEEL

C14.1.1 Reference Documents

This section lists a series of structural standards published by the American Institute of Steel Construction (AISC), the American Iron and Steel Institute (AISI), the American Society of Civil Engineers (ASCE/SEI), and the Steel Joist Institute (SJI), which are to be applied in the seismic design of steel members and connections in conjunction with the requirements of ASCE/SEI 7. The AISC references are available free of charge in electronic format at www.aisc.org, and the SJI references are available as a free download at www.steeljoist.org.

C14.1.2 Structural Steel

C14.1.2.1 General

This section adopts ANSI/AISC 360 (2010b) by direct reference. The specification applies to the design of the structural steel system or systems with structural steel acting compositely with reinforced concrete. In particular, the document sets forth criteria for the design, fabrication, and erection of structural steel buildings and other structures, where other structures are defined as structures designed, fabricated, and erected in a manner similar to buildings, with building like vertical and lateral load-resisting elements. The document includes extensive commentary.

C14.1.2.2 Seismic Requirements for Structural Steel Structures

C14.1.2.2.1 Seismic Design Categories B and C

For the lower Seismic Design Categories (SDCs) B and C, a range of options are available in the design of a structural steel lateral force-resisting system. The first option is to design the structure to meet the design and detailing requirements in ANSI/AISC 341 (2010a) for structures assigned to higher SDCs, with the corresponding seismic design parameters (R , Ω_0 , and C_d). The second option, presented in the exception, is to use an R factor of 3 (resulting in an increased base shear), an Ω_0 of 3, and a C_d value of 3 but without the specific seismic design and detailing required in ANSI/AISC 341. The basic concept underlying this option is that design for a higher base shear force results in essentially elastic response that compensates for the limited ductility of the members and connections. The resulting performance is considered comparable to that of more ductile systems.

C14.1.2.2 Seismic Design Categories D through F

For the higher SDCs, the engineer must follow the seismic design provisions of ANSI/AISC 341 (2010a) using the seismic design parameters specified for the chosen structural system, except as permitted in Table 15.4-1. For systems other than those identified in Table 15.4-1, it is not considered appropriate to design structures without specific design and detailing for seismic response in these high SDCs.

C14.1.3 Cold-Formed Steel**C14.1.3.1 General**

This section adopts two standards by direct reference: ANSI/AISI S100 with S2-10 (2010), North American Specification for the Design of Cold-Formed Steel Structural Members, and ASCE/SEI 8 (2002), Specification for the Design of Cold Formed Stainless Steel Structural Members.

Both of the adopted reference documents have specific limits of applicability. ANSI/AISI S100 (2010) (Section A1.1) applies to the design of structural members that are cold-formed to shape from carbon or low-alloy steel sheet, strip, plate, or bar not more than 1 in. thick. ASCE/SEI 8 (Section 1.1.1) governs the design of structural members that are cold-formed to shape from annealed and cold-rolled sheet, strip, plate, or flat bar stainless steels. Both documents focus on load-carrying members in buildings; however, allowances are made for applications in nonbuilding structures, if dynamic effects are considered appropriately.

Within each document, there are requirements related to general provisions for the applicable types of steel; design of elements, members, structural assemblies, connections, and joints; and mandatory testing. In addition, ANSI/AISI S100 (2010) contains a chapter on the design of cold-formed steel structural members and connections undergoing cyclic loading. Both standards contain extensive commentaries.

C14.1.3.2 Seismic Requirements for Cold-Formed Steel Structures

This section adopts three standards by direct reference—ANSI/AISI S100 (2010), ASCE/SEI 8 (2002), and ANSI/AISI S110 with S1-09 (2009). Cold-formed steel and stainless steel members that are part of a seismic force-resisting system listed in Table 12.2-1 must be detailed in accordance with the appropriate standard: ANSI/AISI S100 (2010) or ASCE/SEI 8 (2002).

In addition, the section adopts a reference to ANSI/AISI S110 (2009), which provides design provisions for a specific seismic force-resisting system entitled “cold-formed steel—special bolted moment frame” or CFS-SBMF. Sato and Uang (2007) have shown that this system experiences inelastic deformation at the bolted connections because of slip and bearing during significant seismic events. To develop the designated mechanism, requirements based on capacity design principles are provided for the design of the beams, columns, and associated connections. The document has specific requirements for the application of quality assurance and quality control procedures.

C14.1.4 Cold-Formed Steel Light-Frame Construction**C14.1.4.1 General**

This subsection of cold-formed steel relates to light-frame construction, which is defined as a method of construction where the structural assemblies are formed primarily by a system of repetitive wood or cold-formed steel framing members or subassemblies of these members (Section 11.2 of this standard). It adopts Section D4 of ANSI/AISI S100 (2010), which directs the user to an additional suite of AISI standards, including AISI S200 (2007a), AISI S210 (2007b), AISI S211 (2007c), AISI S212 (2007d), AISI S213 (2007e), and AISI S214 (2007f).

In addition, all of these documents include commentaries to aid users in the correct application of their requirements.

C14.1.4.2 Seismic Requirements for Cold-Formed Steel Light-Frame Construction

Per AISI S213 (2007e), Sections C1.1 and D1.1, all cold-formed steel light-frame construction systems with R greater than 3 must be designed in accordance with AISI S213 (2007e) inclusive of Sections C5 and D3. In particular, this requirement includes all entries from Table 12.2-1 of this standard for “light-frame walls sheathed with wood structural panels . . . or steel sheets” and “light-frame wall systems using flat strap bracing.”

Per AISI S213 (2007e), Sections C1.1 and D1.1, cold-formed steel light-frame construction systems with R less than or equal to 3 are permitted to be designed and constructed exclusive of AISI S213, Sections C5 and D3 only—they must meet the other applicable requirements of AISI S213. This requirement includes entries from Table 12.2-1 of this standard for “light-frame walls with shear panels of all other materials” and “steel systems not specifically detailed for seismic resistance, excluding cantilever column systems.”

C14.1.4.3 Prescriptive Cold-Formed Steel Light-Frame Construction

This section adopts AISI S230 (2007g), *Standard for Cold-Formed Steel Framing—Prescriptive Method for One and Two Family Dwellings*, which applies to the construction of detached one- and two-family dwellings, townhouses, and other attached single-family dwellings not more than two stories in height using repetitive in-line framing practices (Section A1). This document adopts AISI S200 (2007a) by direct reference and includes a commentary to aid the user in the correct application of its requirements.

C14.1.5 Steel Deck Diaphragms

Design of steel deck diaphragms is to be based on recognized national standards or a specific testing program directed by a person experienced in testing procedures and steel deck. All fastener design values (welds, screws, power-actuated fasteners, and button punches) for attaching steel deck sheet to steel deck sheet or for attaching the steel deck to the building framing members must be per recognized national design standards or specific steel deck testing programs. All steel deck diaphragm and fastener design properties must be approved for use by the authorities in whose jurisdiction the construction project occurs. Steel deck diaphragm in-plane design forces (seismic, wind, or gravity) must be determined per ASCE/SEI 7, Section 12.10.1. Steel deck manufacturer test reports prepared in accordance with this provision can be used where adopted and approved by the authority having jurisdiction for the building project. The diaphragm design manual produced by the Steel Deck Institute (2004) is also a reference for design values.

Steel deck is assumed to have a corrugated profile consisting of alternating up and down flutes that are manufactured in various widths and heights. Use of flat sheet metal as the overall floor or roof diaphragm is permissible where designed by engineering principles, but it is beyond the scope of this section. Flat or bent sheet metal may be used as closure pieces for small gaps or penetrations or for shear transfer over short distances in the steel deck diaphragm where diaphragm design forces are considered.

Steel deck diaphragm analysis must include design of chord members at the perimeter of the diaphragm and around interior openings in the diaphragm. Chord members may be steel beams attached to the underside of the steel deck designed for a combination of axial loads and bending moments caused by acting gravity and lateral loads.

Where diaphragm design loads exceed the bare steel deck diaphragm design capacity, then either horizontal steel trusses or a structurally designed concrete topping slab placed over the steel deck must be provided to distribute lateral forces. Where horizontal steel trusses are used, the steel deck must be designed to transfer diaphragm forces to the steel trusses. Where a structural concrete topping over the steel deck is used as the diaphragm, the diaphragm chord members at the perimeter of the diaphragm and edges of interior openings must be either (a) designed flexural reinforcing steel placed in the structural concrete topping or (b) steel beams located under the steel deck with connectors (that provide a positive connection) as required to transfer design shear forces between the concrete topping and steel beams.

C14.1.6 Steel Cables

These provisions reference ASCE/SEI 19-96, *Structural Applications of Steel Cables for Buildings*, for the determination of the design strength of steel cables.

C14.1.7 Additional Detailing Requirements for Steel Piles in Seismic Design Categories D through F

Steel piles used in higher SDCs are expected to yield just under the pile cap or foundation because of combined bending and axial load. Design and detailing requirements of ANSI/AISC 341 (2010a) for H-piles are intended to produce stable plastic hinge formation in the piles. Because piles can be subjected to tension caused by overturning moment, mechanical means to transfer such tension must be designed for the required tension force, but not less than 10% of the pile compression capacity.

C14.2 CONCRETE

The section adopts by reference ACI 318-11 for structural concrete design and construction. In addition, modifications to ACI 318-11 (2011) are made that are needed to coordinate the provisions of that material design standard with the provisions of ASCE/SEI 7. Work is ongoing to better coordinate the provisions of the two documents (ACI 318 2011 and ASCE/SEI 7) such that the provisions in Section 14.2 will be significantly reduced in future editions of ASCE/SEI 7.

C14.2.2.1 Definitions

The first two definitions describe wall types for which definitions currently do not exist in ACI 318 (2011). These definitions are essential to the proper interpretation of the R and C_d factors for each wall type specified in Table 12.2-1.

A definition for *connector* has been added, which does not currently exist in ACI 318. Section 12.11 provides an alternative to the current diaphragm design procedure of Section 12.10. The alternative procedure is made mandatory for precast concrete diaphragms in structures assigned to SDC C, D, E, or F. The definition of *connector* is essential because the three design options (EDO, BDO, RDO) are closely related to the connector classification and the diaphragm design force reduction factor, R_s , depends on the design option.

The definition for *connection* in ACI 318 has also been supplemented, as it applies to Section 14.2.4l.

C14.2.2.2 ACI 318, Section 7.10

Section 7.10.5.7 of ACI 318 (2011) prescribes reinforcement details for ties in compression members. This modification prescribes additional details for ties around anchor bolts in structures assigned to SDCs C through F.

C14.2.2.3 Scope

This provision describes how the ACI 318 (2011) provisions should be interpreted for consistency with the ASCE/SEI 7-10 provisions.

C14.2.2.4 Intermediate Precast Structural Walls

Section 21.4 of ACI 318 (2011) imposes requirements on precast walls for moderate seismic risk applications. Ductile behavior is to be ensured by yielding of the steel elements or reinforcement between panels or between panels and foundations. This provision requires the designer to determine the deformation in the connection corresponding to the earthquake design displacement and then to check from experimental data that the connection type used can accommodate that deformation without significant strength degradation.

Several steel element connections have been tested under simulated seismic loading, and the adequacy of their load-deformation characteristics and strain capacity have been demonstrated (Schultz and Magana 1996). One such connection was used in the five-story building test that was part of the PRESSS Phase 3 research. The connection was used to provide damping and energy dissipation, and it demonstrated a very large strain capacity (Nakaki et al. 2001). Since then, several other steel element connections have been developed that can achieve similar results (Banks and Stanton 2005 and Nakaki et al. 2005). In view of these results, it is appropriate to allow yielding in steel elements that have been shown experimentally to have adequate strain capacity to maintain at least 80% of their yield force through the full design displacement of the structure.

C14.2.2.6 Foundations

The intention is that there should be no conflicts between the provisions of Section 21.12 of ACI 318 (2011) and Sections 12.1.5, 12.13, and 14.2 of ASCE/SEI 7-10. However, the additional detailing requirements for concrete piles of Section 14.2.3 can result in conflicts with ACI 318 provisions if the pile is not fully embedded in the soil.

C14.2.2.7 Detailed Plain Concrete Shear Walls

Design requirements for plain masonry walls have existed for many years, and the corresponding type of concrete construction is the plain concrete wall. To allow the use of such walls as the lateral force-resisting system in SDCs A and B, this provision requires such walls to contain at least the minimal reinforcement specified in Section 22.6.7.2.

C14.2.3 Additional Detailing Requirements for Concrete Piles

PCI (2004) provides detailed information on the structural design of piles and on pile-to-cap connections for precast prestressed concrete piles. ACI 318 (2011) does not contain provisions governing the design and installation of portions of concrete piles, drilled piers, and caissons embedded in ground except for SDC D, E, and F structures.

C14.2.3.1.2 Reinforcement for Uncased Concrete Piles (SDC C)

The transverse reinforcing requirements in the potential plastic hinge zones of uncased concrete piles in SDC C are a selective composite of two ACI 318 (2011) requirements. In the potential plastic hinge region of an intermediate moment-resisting concrete frame column, the transverse reinforcement spacing is restricted to the least of (1) eight times the diameter of the smallest longitudinal bar, (2) 24 times the diameter of the tie bar, (3) one-half the smallest cross-sectional dimension of the column, and (4) 12 in. Outside of the potential plastic hinge region of a special moment-resisting frame column, the transverse reinforcement spacing is restricted to the smaller of six times the diameter of the longitudinal column bars and 6 in.

C14.2.3.1.5 Reinforcement for Precast Nonprestressed Concrete Piles (SDC C)

Transverse reinforcement requirements inside and outside of the plastic hinge zone of precast nonprestressed piles are clarified. The transverse reinforcement requirement in the potential plastic hinge zone is a composite of two ACI 318 (2011) requirements (see Section C14.2.3.1.2). Outside of the potential plastic hinge region, the transverse reinforcement spacing is restricted to 16 times the longitudinal bar diameter. This restriction should permit the longitudinal bars to reach compression yield before buckling. The maximum 8-in. tie spacing comes from current building code provisions for precast concrete piles.

C14.2.3.1.6 Reinforcement for Precast Prestressed Piles (SDC C)

The transverse and longitudinal reinforcing requirements given in ACI 318 (2011), Chapter 21, were never intended for slender precast prestressed concrete elements and result in unbuildable piles. These requirements are based on PCI Committee on Prestressed Concrete Piling (1993).

Eq. (14.2-1), originally from ACI 318 (2011), has always been intended to be a lower-bound spiral reinforcement ratio for larger diameter columns. It is independent of the member section properties and can therefore be applied to large- or small-diameter piles. For cast-in-place concrete piles and precast prestressed concrete piles, the spiral reinforcing ratios resulting from this formula are considered to be sufficient to provide moderate ductility capacities (Fanous et al. 2007).

Full confinement per Eq. (14.2-1) is required for the upper 20 ft of the pile length where curvatures are large. The amount is relaxed by 50% outside of that length in view of lower curvatures and in consideration of confinement provided by the soil.

C14.2.3.2.3 Reinforcement for Uncased Concrete Piles (SDC D through F)

The reinforcement requirements for uncased concrete piles are taken from current building code requirements and are intended to provide ductility in the potential plastic hinge zones (Fanous et al. 2007).

C14.2.3.2.5 Reinforcement for Precast Concrete Piles (SDC D through F)

The transverse reinforcement requirements for precast nonprestressed concrete piles are taken from the IBC (ICC 2012) requirements and should be adequate to provide ductility in the potential plastic hinge zones (Fanous et al. 2007).

C14.2.3.2.6 Reinforcement for Precast Prestressed Piles (SDC D through F)

The reduced amounts of transverse reinforcement specified in this provision compared with those required for special moment frame columns in ACI 318 (2011) are justified by the results of the study by Fanous et al. (2007). The last paragraph provides minimum transverse reinforcement outside of the zone of prescribed ductile reinforcing.

C14.2.4 Additional Detailing Requirements for Precast Concrete Diaphragms

Section 12.11 introduces an alternative procedure for the calculation of diaphragm design forces, which is made mandatory for precast concrete diaphragms in structures assigned to SDC C, D, E, or F. The diaphragm design force reduction factors, R_s , in Table 12.11.5-1 for precast concrete diaphragms are specifically tied to design and detailing requirements, so that the ductility and overstrength necessary for expected diaphragm performance are achieved. Section 14.2.4 is based on the Diaphragm Seismic Design Methodology (DSDM), the product of a multi-university research project termed “The DSDM Project” (Pankow, 2014), and gives detailing requirements for diaphragms constructed of precast concrete units in SDC C, D, E, or F, consistent with the R_s factors. These detailing requirements are in addition to those of ACI 318, as modified by Section 14.2. The derivation of diaphragm design force reduction factors is described in Commentary Section C12.11.5.

Section C12.11.5 relates the global ductility required by the three design options defined in Section 11.2 to the local ductility of connectors measured at the MCE level. The jointed nature of precast systems results in the load paths and deformations being largely determined by the connections across the joints. The connections may consist of either reinforced concrete topping slabs or discrete mechanical connectors. Since the diaphragm strains are concentrated at the joints, the connectors or the reinforcement in the topping slab must accommodate some strain demand.

C14.2.4.1 Diaphragm Seismic Demand Levels

Figure 14.2.4-1 is used to determine diaphragm seismic demand level as a function of the diaphragm span and the diaphragm aspect ratio.

The diaphragm span defined in Section 14.2.4.1.1 is illustrated in Figure C14.2-1. Most precast diaphragms contain precast units running in only one direction, and typically the maximum span will be oriented perpendicular to the joints between the primary precast floor units. The connector or reinforcement deformability classifications and resulting R_s -factors are calibrated relative to joint opening between the precast floor units, and is thus based on the more typical orientation.

The diaphragm aspect ratio (AR) defined in Section 14.2.4.1.2 is also illustrated in Figure C14.2.4-1.

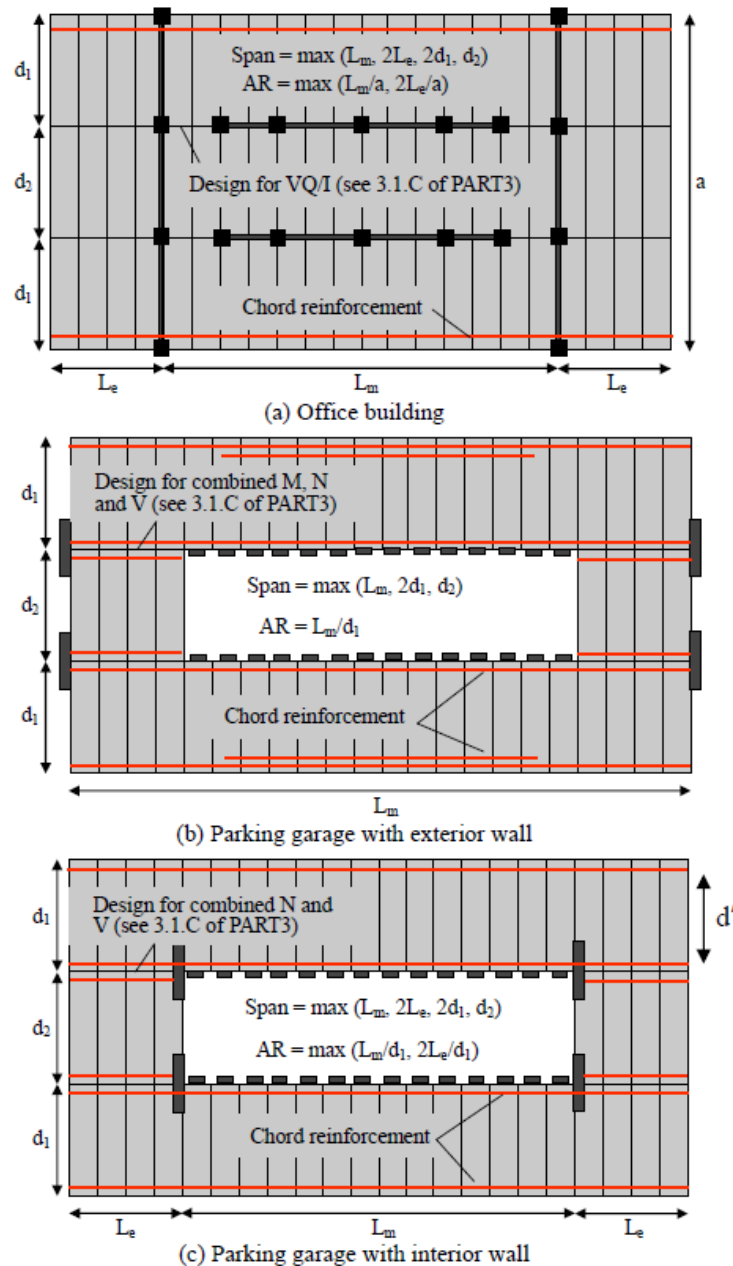

FIGURE C14.2.4-1 Diaphragm Dimensions

The following provide details of seismic demand level classifications, determined in accordance with Figure 14.2.4-1:

Low Seismic Demand Level:

1. Diaphragms in structures assigned to SDC C.
2. Diaphragms in structures assigned to SDC D, E, or F with diaphragm span ≤ 75 ft, number of stories ≤ 3 and diaphragm aspect ratio < 2.5 .

Moderate Seismic Demand Level:

1. Diaphragms in structures assigned to SDC D, E, or F with diaphragm span ≤ 75 ft, number of stories ≤ 6 but greater than 3, and diaphragm aspect ratio ≥ 2.5 .
2. Diaphragms in structures assigned to SDC D, E, or F with diaphragm span > 75 ft but ≤ 190 ft, number of stories ≤ 2 , and diaphragm aspect ratio < 1.5 .
3. Diaphragms in structures assigned to SDC D, E, or F with diaphragm span > 75 ft but ≤ 140 ft, number of stories > 2 but ≤ 5 and diaphragm aspect ratio < 1.5 .

High Seismic Demand Level:

1. Diaphragms in structures assigned to SDC D, E, or F with diaphragm span > 190 ft.
2. Diaphragms in structures assigned to SDC D, E, or F with diaphragm span > 140 ft and number of stories > 2 .
3. Diaphragms in structures assigned to SDC D, E, or F with diaphragm span > 75 ft and number of stories > 4 .
4. Diaphragms in structures assigned to SDC D, E, or F with number of stories > 6 .
5. Diaphragms in structures assigned to SDC D, E, or F with diaphragm aspect ratio greater 1.5.

Diaphragm Shear Overstrength Factor. The diaphragm shear overstrength factor, Ω_v , is applied to diaphragm shear reinforcement/connectors. The purpose of this factor is to keep the diaphragm shear response elastic while the diaphragm develops inelastic flexural action, as is anticipated for the BDO in the MCE, and for the RDO for both the design earthquake and the MCE. No inelastic diaphragm response is anticipated for the EDO.

The value of diaphragm shear overstrength factor is $\Omega_v = 1.4R_s$. The values of the diaphragm design force reduction factor, R_s , are 0.7, 1.0, and 1.4 for the EDO, BDO and RDO, respectively. This translates into diaphragm shear overstrength factors Ω_v of 1.0, 1.4 and 2.0 (rounded to one decimal place) for the EDO, BDO and RDO, respectively.

The diaphragm shear overstrength factor, Ω_v , is applied to the diaphragm design forces, and thus is a measure relative to the flexural strength of the diaphragm. As implied by the above-listed Ω_v values, the level of overstrength required relative to the diaphragm flexural strength varies with the design option. The RDO requires a higher overstrength than the BDO due to the larger anticipated inelastic action. For the EDO, no overstrength is required since the diaphragm design force itself targets elastic behavior in the MCE. It is noted that the absolute shear strength required in the design procedure is constant, regardless of design option, since the parameter R_s in the overstrength factor is cancelled out by the R_s in the denominator of the diaphragm design force expression.

The Ω_v values represent upper bound constant values (for each diaphragm design option) of parametric expressions developed for the required shear overstrength on the basis of detailed parametric studies performed using nonlinear dynamic time history analysis (NTHA) of analytical models of precast structures developed and calibrated on the basis of extensive large scale physical testing. These precast structures were subjected to spectrum compatible ground motions scaled to the MCE in order to determine the required shear overstrength factors.

Precast diaphragms can be designed and detailed for ductile flexural response. However, to achieve the desired mechanism, potentially non-ductile shear limit states have to be precluded. In order to prevent these

shear failures, elastic shear response is targeted in the design procedure for both flexure-controlled and shear-controlled systems. Thus, the shear overstrength factor, Ω_v , is applied in the diaphragm shear design.

The shear amplification factor values were obtained by bounding the maximum shear force V_{max} occurring in NTHA of the diaphragm at the critical shear joint as the diaphragm developed a flexural mechanism (in other regions of the floor) at MCE-level hazard, and scaling it by the design shear, V_u . Accordingly:

- Ω_E , the diaphragm shear amplification factor for the EDO, is taken as unity ($\Omega_E = 1.0 \approx 1.4R_s$, where $R_s=0.7$ for EDO) since elastic diaphragm response is expected in the MCE for EDO.
- Ω_D , the diaphragm shear amplification factor for the BDO, is taken as an upper bound on the V_{max}/V_u ratio for the BDO design under MCE-level hazard.
- Ω_R , the diaphragm shear amplification factor for the RDO, is taken as an upper bound on the V_{max}/V_u ratio for the RDO design under MCE-level hazard.

Figure C14.2.4-2 shows a scatter plot of the V_{max}/V_u ratios from NTHA for different numbers of stories (n) and diaphragm aspect ratios (AR) at the maximum considered earthquake. The data represent the mean of the maximum responses from 5 ground motions. The expression provided for Ω_v , $\Omega_v = 1.4R_s$, is plotted as a horizontal green line on each plot, indicating that the expression provides a constant upper bound for the anticipated required elastic shear forces for all design cases.

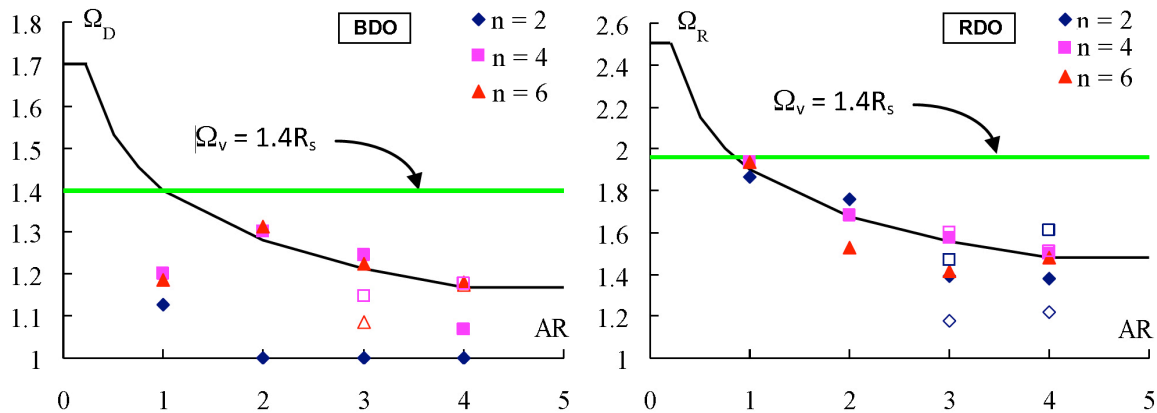

FIGURE C14.2.4-2 Diaphragm Shear Amplification Factor Results from NTHA at MCE: (a) BDO; (b) RDO

C14.2.4.2 Diaphragm Design Options

The intent of the design procedure is to provide the diaphragm with the proper combination of strength and deformation capacity in order to survive anticipated seismic events. Three different design options are provided to the designer to accomplish this objective, ranging from a fully elastic diaphragm design under the MCE to designs that permit significant inelastic deformations in the diaphragm under the design earthquake. The motivation for this approach is the recognition that, under certain conditions, a precast diaphragm designed to remain fully elastic up to the MCE may not be economical or reliable. Under other conditions, however, a diaphragm designed to remain elastic up to the MCE will be satisfactory and may be most desirable.

The methodology allows the designer three options related to deformation capacity:

1. An Elastic Design Option (EDO), where the diaphragm is designed to the highest force levels, calibrated to keep the diaphragm elastic not only for the design earthquake, but also in an MCE. In exchange for the higher design force, this option permits the designer to detail the diaphragm with the Low Deformability Element (LDE) connector or reinforcement that need not meet any specific deformation capacity requirements (tension deformation capacity less than 0.3 in.).

This option is limited in its use through the introduction of Diaphragm Seismic Demand Levels, which are based on building height, diaphragm geometry and seismic hazard level. The use of the EDO is not permitted if the diaphragm seismic demand level is high.

2. A Basic Design Option (BDO), in which the diaphragm is designed to a force level calibrated to keep the diaphragm elastic in the design earthquake, but not necessarily in the MCE. The design force level is lower than that required for the EDO, but this option requires Moderate Deformability Element (MDE) connectors or reinforcement to provide an inelastic deformation capacity sufficient to survive the anticipated deformation demands in an MCE. This option and the RDO require the use of a diaphragm shear overstrength factor, Ω_v , to assure that a non-ductile shear failure does not occur prior to the connectors or reinforcement reaching its intended inelastic deformation. Note that *inelastic deformation* is associated with joint *opening* due to diaphragm flexure, not joint sliding deformation due to shear.
3. A *Reduced Design Option (RDO)*, in which the diaphragm is designed for the lowest design force level.

Because the design force level is lower than in the BDO, some yielding in the diaphragm is anticipated in the design earthquake. The force levels have been calibrated to keep diaphragm inelastic deformation demands in an MCE within the allowable deformation capacity for the High Deformability Element (HDE), the highest classification of precast diaphragm connector or reinforcement (see Section 14.2.4.3).

Each design option can be used with its associated seismic demand level or a lower seismic demand level. A 15% diaphragm force increase penalty is applied when a diaphragm design option is used for a seismic demand level that is one higher than its associated seismic demand level. A design option cannot be used for a seismic demand level two higher than the associated seismic demand level, i.e. the Elastic Design Option cannot be used for the High Seismic Demand Level.

The BDO has two performance targets: (1) elastic diaphragm response in the design earthquake; and, (2) diaphragm connector/reinforcement deformation demands (i.e. joint opening) in the MCE within the allowable deformation capacity of connector/reinforcement in the Moderate Deformability Element (MDE) category, δ_a^{MD} . The diaphragm design force levels for the BDO are aligned to the former requirement. Thus, the attainment of the second performance target hinges on the selection of the value for δ_a^{MD} relative to the diaphragm inelastic deformation demands anticipated for the maximum considered earthquake. These anticipated deformation demands were established through nonlinear dynamic time history analysis (NTHA) of precast structures with diaphragms designed to the BDO force levels, and subjected to spectrum compatible ground motions scaled to the MCE.

It should be recognized that practical considerations also exist in the selection of δ_a^{MD} . The allowable deformation of High Deformability Elements (HDE), δ_a^{HD} , (as required for the RDO) was established based on the best performing existing precast diaphragm connectors. This performance resulted in an HDE allowable deformation capacity $\delta_a^{HD} = 0.4$ in. (Note that the allowable value is 2/3 of the qualification value, thus HDEs are required to have a demonstrated deformation capacity of 0.6 in. in qualification testing, as was achieved by the best performing existing connectors). Given that Low Deformability Elements (LDEs) do not have a deformation requirement, the MDE allowable deformation value should reside somewhere near half the HDE value, or $\delta_a^{MD} = 0.2$ in.

The NTHA results for the MCE are shown in Figure C14.2.4-3. These results show that $\delta_a^{MD} = 0.2$ in. was an appropriate and viable choice for the MDEs used in the BDO, provided the diaphragms were in the Moderate Seismic Demand Level (solid triangular markers in Figure C14.2.4-3), or in the Low Seismic Demand Level (solid circular markers in Figure C14.2.4-3). However, this value did not produce satisfactory designs for diaphragms in the High Seismic Demand Level (solid square markers in Figure C14.2.4-3), and thus some measure is required to bring the design procedure in conformance.

A choice exists in how to modify the design procedure to resolve this non-conformance to the design target: (a) The allowable deformation ranges for the diaphragm connectors/ reinforcement could be modified (i.e., a more stringent qualification deformation requirement for MDE, leading to an increase in δ_a^{MD}); (b) the diaphragm force levels could be increased across the board (i.e., change the design earthquake performance target for elastic diaphragm response from the diaphragm yield point itself to a lower value within the diaphragm elastic range); or (c) create a special requirement for the non-conforming diaphragm case (i.e. increase the diaphragm forces only for non-conforming cases). The first choice did not align well with the typical deformation capacities of existing connectors, and would not produce evenly-sized deformation ranges for the LDE, MDE and HDE classifications. The second choice not only produces overly conservative designs for many cases, but also blurs the clean BDO performance target of elastic diaphragm response in the design earthquake. For these reasons, the third choice was considered as most desirable.

Thus, rather than increase the value of δ_a^{MD} to accommodate the diaphragms in the High Seismic Demand Level, it was decided to keep $\delta_a^{MD} = 0.2$ in. and create a special requirement for conformance in the case of diaphragms in the High Seismic Demand Level. As each design option was developed with an associated diaphragm seismic demand level in mind, and the non-conformance did not occur at the associated level, i.e. the Moderate Seismic Demand Level, but instead at the High Seismic Demand Level, the special requirement can be considered as a measure for using a diaphragm design option with a more demanding seismic demand level.

The special requirement is an increase in the design force for the non-conforming case. The magnitude of the design force increase is 15%. The manner in which this value was established is also shown in Figure C14.2.4-3. As mentioned previously, the solid square markers indicate the maximum diaphragm connector/reinforcement deformation (joint opening demand) for the BDO for high diaphragm seismic demand levels and indicate demands greater than $\delta_a^{MD} = 0.2$ in. The hollow square markers indicate the maximum diaphragm connector/reinforcement deformation for these same cases with the 15% increase in diaphragm force. This design force increase is seen to bring the deformation demand within the allowable limit. The same design force increase is enforced in 14.2.4.2.1 for use of the EDO with the Moderate Seismic Demand Level, though this provision was not based on any quantitative analytical results.

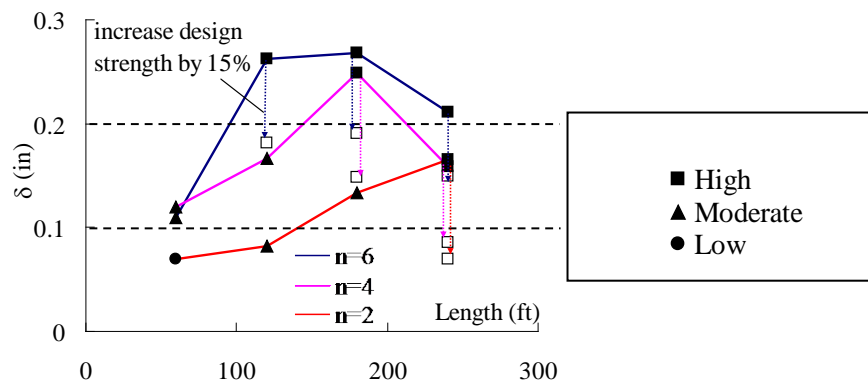

FIGURE C14.2.4-3 Diaphragm Maximum Joint Opening in NTHA for Basic Design Option Designs Under the MCE

C14.2.4.3 Diaphragm Connector or Reinforcement Deformability

The precast diaphragm seismic design methodology (DSDM) uses an approach that requires knowledge of the diaphragm connector or reinforcement stiffness, deformation capacity, and strength to effectively and efficiently design the diaphragm system for seismic forces. To meet this need, it is critical that the connector or reinforcement properties be determined in a repeatable, reproducible, and consistent manner so that

existing and new connections can be utilized effectively in the diaphragm system. The qualification protocol provides an experimental approach for the determination of connector or reinforcement properties.

Precast concrete diaphragms deform mostly by the strains that occur at the joints between the precast concrete units. The requirements for reinforcement or connector deformability come from the need for the connections to accommodate these strains at the joints. A connection is an assembly of connectors including the linking parts, welds, and anchorage to concrete. Mechanical connectors are identified as the primary parts that make the connection, but the deformation capacity identified with the connector represents the performance of the entire link across the joint. Qualification of the deformation capacity of the connector, then, is dependent on the details of the entire load path across the joint. The use in design of a connector qualified by testing is only valid when the design incorporates the complete connector detailing, as tested.

The diaphragm reinforcement classifications are High Deformability Elements (HDE), Moderate Deformability Elements (MDE), and Low Deformability Elements (LDE). The threshold values of tension deformation capacity for each connector or reinforcement class were selected by considering the range of the ultimate (cyclic tension opening) deformations exhibited by the various precast diaphragm connectors examined in the DSDM experimental program (Naito et al., 2006) (Naito et al., 2007). Based on these results, a threshold deformation of 0.6 in. was selected for HDE connector or reinforcement and 0.3 in. for MDE connector or reinforcement. There is no deformation requirement for LDE reinforcement.

A factor of safety of 1.5 was introduced into the design procedure by establishing the allowable maximum joint opening value at 2/3 of the connector's reliable and maximum joint opening deformation capacity. The 2/3 factor leads to maximum allowable deformations of 0.4 in. and 0.2 in. for the High Deformability Element (HDE) and the Moderate Deformability Element (MDE), respectively. No deformation capacity requirement is needed for the Low Deformability Element (LDE), since this classification of connector or reinforcement is used with designs that result in fully elastic diaphragm response up to the MCE. The allowable maximum joint openings were used as targets in the analytical parametric studies to calibrate the design factors.

A few further comments are given about the connector or reinforcement classification:

1. The diaphragm connector or reinforcement classification is based on inelastic deformation associated with joint opening due to diaphragm flexure, not joint sliding deformation due to shear.
2. The diaphragm connector or reinforcement classification applies to the chord reinforcement and shear reinforcement. Other reinforcement (collector/anchorage, secondary connections to spandrels, and similar) may have different requirements or characteristics.
3. In meeting the required maximum deformation capacity using the testing protocols in the Qualification Procedure, the required cumulative inelastic deformation capacity is also met.

C14.2.4.3.5 Special Inspection

The purpose of this requirement is to verify that the detailing required in High Deformability Elements is properly executed through inspection personnel who are qualified to inspect these elements. Qualifications of inspectors should be acceptable to the jurisdiction enforcing the general building code.

C14.2.4.4 Precast Concrete Diaphragm Joint Connector and Reinforcement Qualification Procedure

This section provides a qualification procedure using experimental methods to assess the in-plane strength, stiffness, and deformation capacity of precast concrete diaphragm connectors and reinforcement. The methodology was developed as part of the DSDM research program specifically for diaphragm flange-to-flange connections, and is intended to provide the required connector or reinforcement properties and classification for use in the seismic design procedure.

C14.2.4.4.1 Test Modules

Test modules are fabricated and tested to evaluate the performance of a precast concrete connection. Figure C14.2.4-2 illustrates an example test module. It is required that multiple tests be conducted to assess repeatability and consistency. The test module should represent the geometry and thickness of the precast concrete components that will be connected. All connectors and reinforcement should be installed and welded in accordance with the manufacturer's published installation instructions. The results or the data generated are limited to connections built to the specified requirements.

Reduced scale connectors with appropriate reductions in maximum aggregate size following laws of similitude can be used as research tools to gain knowledge but are not to be used for connector qualification.

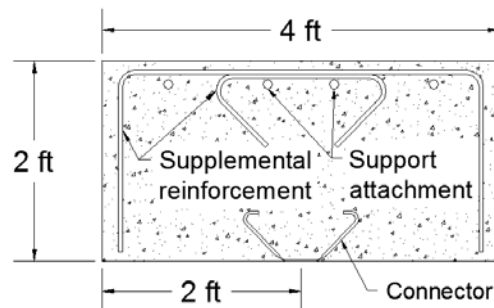

FIGURE C14.2.4-2 Test Module

C14.2.4.4.3 Test Configuration

A possible setup is illustrated in Figure C14.2.4-3. The fixture is composed of three independently controlled actuators, two providing axial displacement and one providing shear displacement to the connection.

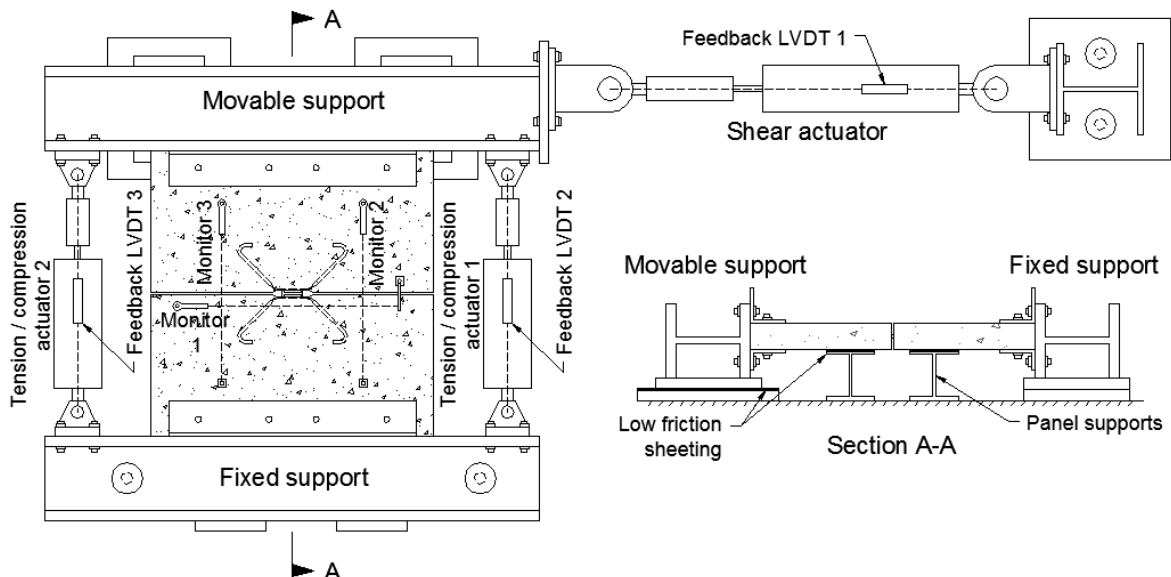

FIGURE C14.2.4-3 Possible Test Set-Up

C14.2.4.4.4 Instrumentation

Use of actuator transducers is not recommended due to potential slip in the test fixture.

C14.2.4.4.5 Loading Protocols

Figures C14.2.4-4 and C14.2.4-5 illustrate the shear and tension/compression loading protocols for use in testing.

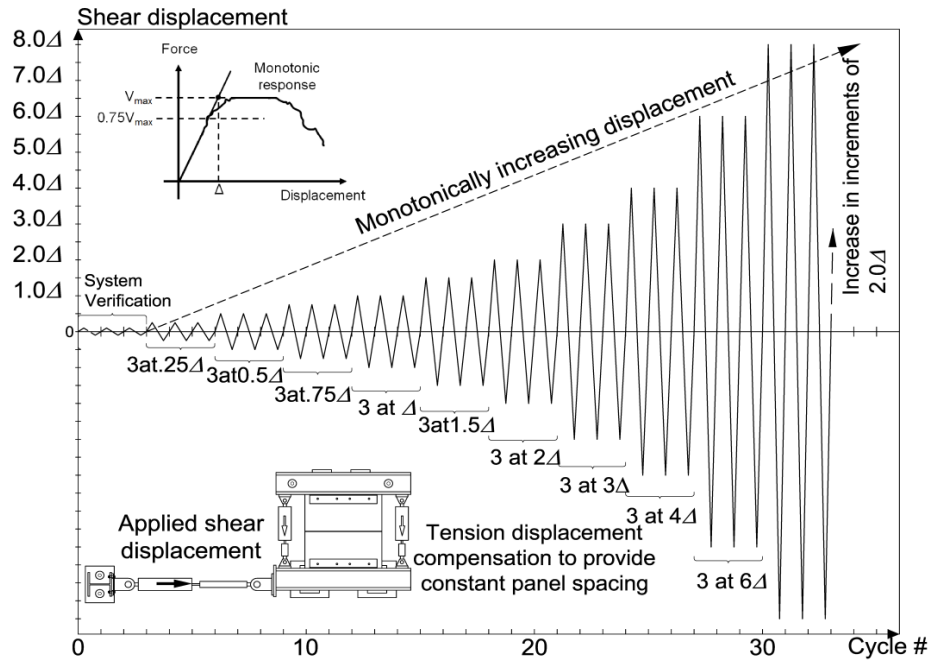

FIGURE C14.2.4-4 Shear Loading Protocol

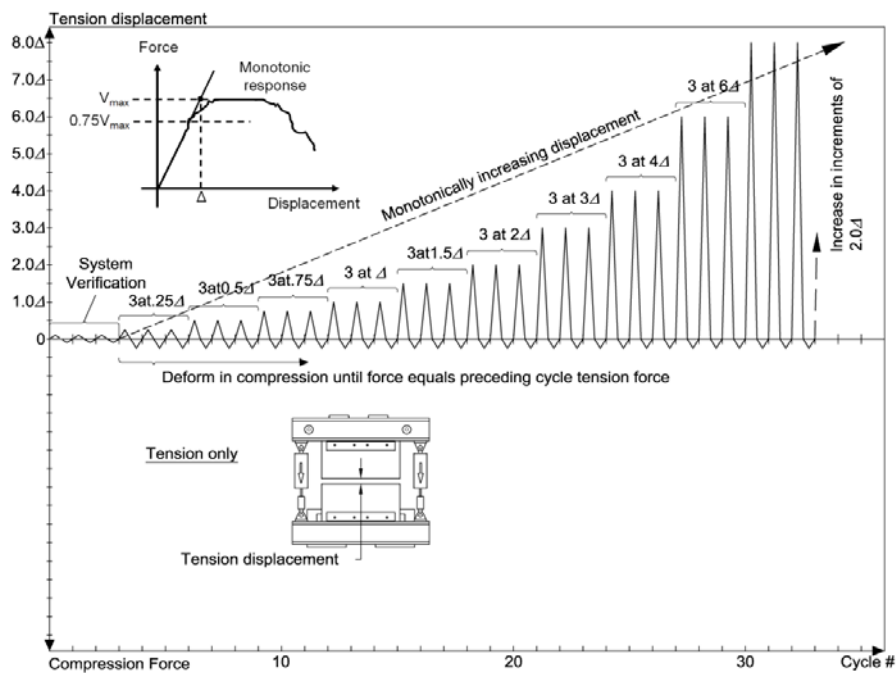

FIGURE C14.2.4-5 Tension/Compression Loading Protocol

C14.2.4.4.6 Measurement Indices

Quantitative data should be recorded from each test, such that interpretation can be made of the performance of the test module. For in-plane tests, the axial and shear force and deformations should be recorded. Photographs should be taken to illustrate the condition of the test module at the initiation and completion of testing as well as at points through the testing history. Ideally, photos should be taken at the end of each group of cycles. Test history photos taken at points of interest, such as cracking, yielding, and peak load, and post-test photos are adequate for most evaluations.

The backbone curve is adopted to represent a simple approximation of the load-deformation response of the connection. The points are defined in terms of the resistances P_a , P_1 , P_b , P_2 , P_{2a} and P_3 , and the displacements Δ_a , Δ_1 , Δ_b , Δ_2 , Δ_{2a} , and Δ_3 , respectively.

As depicted in Figure 14.2.4-3, the Type 1 curve is representative of ductile behavior where there is an elastic range (Point 0 to Point 1 on the curve) and an inelastic range (Point 1 to Point 3 on the curve), followed by loss of force-resisting capacity. The Type 2 curve is representative of ductile behavior where there is an elastic range (Point 0 to Point 1) and an inelastic range (Point 1 to Point 2 on the curve), followed by substantial loss of force-resisting capacity. Some connections may exhibit a small peak strength with limited ductility. For these cases the alternate type 2 curve is recommended. The Type 3 curve is representative of a brittle or non-ductile behavior where there is an elastic range (Point 0 to Point 1) followed by loss of strength. Deformation controlled elements conform to Type 1 or Type 2, but not Type 2 alternate, response with $\Delta_2 \geq 2\Delta_1$. All other responses are classified as force-controlled. An example of test data is included in (Ren and Naito, 2013).

C14.2.4.4.7 Response Properties

The reliable and stable maximum deformation capacity is defined for design code purposes as the connector deformation at peak load, Point 2 on the backbone curve, obtained in testing following the loading protocols defined here. All analytical calibrations were performed for a reliable and stable maximum deformation capacity corresponding to a deformation where the strength reduces to 80% of P_2 , which is similar to the beam-column connection deformation capacity definition for steel structures in AISC 341-10 (AISC, 2010). Thus, an added degree of conservatism is provided in the definition proposed for the design code.

Deformation Category. The category ranges were determined from finite element analysis of a database of diaphragm systems under a range of seismic demands. Alternate deformation limits can be used if supporting data are provided. It should be noted that the connector or joint reinforcement classification is based solely on tension deformation capacity (as stated in Section 14.2.4.3), while the qualification procedure, applies equally to, and requires both, tension and shear tests. In other words, while both tension and shear characterization is required to determine the needed strengths, the connector classification is based solely on the tension testing.

Tensile Strength. The design factors for flexural strength are calibrated to the yield point of the chord connectors, not to their peak strength. For instance, for the EDO, elastic response of the diaphragm under the MCE is being targeted, so this is aligned to the yield strength, not the peak strength. For consistency, the BDO and RDO factors are also calibrated to this same level, i.e. yield. So the nominal strength of the connectors is based on P_1 , not P_2 . Using P_2 creates a situation where yield should be anticipated in the diaphragm for the EDO, and larger inelastic deformations for the BDO and RDO.

Shear Strength. The intention is for the diaphragm system to remain elastic under shear demands. Consequently the inelastic shear force capacity of connections is not considered. Due to the existence of low stiffness connections, limits are placed on the allowable deformation at which the force P_1 can be determined.

C14.2.4.4.8 Test Report

The minimum information that must be included in a test report is spelled out.

C14.2.4.4.9 Deformed Bar Reinforcement

Deformed bar reinforcement can be considered to be High Deformability Elements (HDE), provided certain conditions are met.

C14.3 COMPOSITE STEEL AND CONCRETE STRUCTURES

This section provides guidance on the design of composite and hybrid steel–concrete structures. Composite structures are defined as those incorporating structural elements made of steel and concrete portions connected integrally throughout the structural element by mechanical connectors, bond, or both. Hybrid structures are defined as consisting of steel and concrete structural elements connected together at discrete points. Composite and hybrid structural systems mimic many of the existing steel (moment and braced frame) and reinforced concrete (moment frame and wall) configurations but are given their own design coefficients and factors in Table 12.2-1. Their design is based on ductility and energy dissipation concepts comparable to those used in conventional steel and reinforced concrete structures, but it requires special attention to the interaction of the two materials because it affects the stiffness, strength, and inelastic behavior of the members, connections, and systems.

C14.3.1 Reference Documents

Seismic design for composite structures assigned to SDCs D, E, or F is governed primarily by ANSI/AISC 341 (2010a). Composite design provisions in ANSI/AISC 341 are less prescriptive than those for structural steel and provide flexibility for designers to use analytical tools and results of research in their practice. Composite structures assigned to SDC A, B, or C may be designed according to principles outlined in ANSI/AISC 360 (2010b) and ACI 318 (2011). ANSI/AISC 360 and ACI 318 provide little guidance on connection design; therefore, designers are encouraged to review ANSI/AISC 341 for guidance on the design of joint areas. Differences between older AISC and ACI provisions for cross-sectional strength for composite beam–columns have been minimized by changes in the latest ANSI/AISC 360, and ANSI/AISC 360 refers to ACI 318 for much of the design of reinforced concrete components of composite structures. However, there is not uniform agreement between the provisions in ACI 318 and ANSI/AISC 360 regarding detailing, limits on material strengths, stability, and strength for composite beam–columns. The composite design provisions in ANSI/AISC 360 are considered to be current.

C14.3.4 Metal-Cased Concrete Piles

Design of metal-cased concrete piles, which are analogous to circular concrete filled tubes, is governed by Sections 14.2.3.1.3 and 14.2.3.2.4 of this standard. The intent of these provisions is to require metal-cased concrete piles to have confinement and protection against long-term deterioration comparable to that for uncased concrete piles.

C14.4 MASONRY

This section adopts by reference and then makes modifications to TMS 402/ACI 530/ASCE/SEI 5 (MSJC 2005a) and TMS 602/ACI 530.1/ASCE/SEI 6 (MSJC 2005b), which are commonly referred to as the “MSJC Standards (Code and Specification)” after the Masonry Standards Joint Committee (MSJC), which is charged with development and maintenance of these standards. In past editions of this standard, modifications to these referenced standards were made. During the development of the 2008 edition of the MSJC standards, each of these modifications was considered by the MSJC. Some were incorporated directly into the MSJC standards. These modifications have accordingly been removed from the modifications in this standard. Work is ongoing to better coordinate the provisions of the two documents

(MSJC and ASCE/SEI 7) so that the provisions in Section 14.4 are significantly reduced or eliminated in future editions.

C14.5 WOOD

C14.5.1 Reference Documents

Two national consensus standards are adopted for seismic design of engineered wood structures: the *National Design Specification* (AWC 2012), and the *Special Design Provisions for Wind and Seismic* (AWC 2008). Both of these standards are presented in dual allowable stress design (ASD) and load and resistance factor design (LRFD) formats. Both standards reference a number of secondary standards for related items such as wood materials and fasteners. AWC (2008) addresses general principles and specific detailing requirements for shear wall and diaphragm design and provides tabulated nominal unit shear capacities for shear wall and diaphragm sheathing and fastening. The balance of member and connection design is to be in accordance with the AWC (2012).

REFERENCES

- AISC, 2010. *Seismic Provisions for Structural Steel Buildings*, ANSI/AISC 341-10, American Institute of Steel Construction, Chicago, IL, 22 June.
- American Concrete Institute (ACI). (2008). "Building code requirements for structural concrete and commentary," *ACI 318*, Farmington Hills, Mich.
- American Concrete Institute (ACI). (2011). "Building code requirements for structural concrete and commentary," *ACI 318*, Farmington Hills, Mich.
- American Institute of Steel Construction (AISC). (2010a). "Seismic provisions for structural steel buildings." *ANSI/AISC 341*, Chicago.
- American Institute of Steel Construction (AISC). (2010b). "Specification for structural steel buildings. *ANSI/AISC 360*, Chicago.
- American Institute of Timber Construction. (2005). *Timber Construction Manual*, 5th Ed. John Wiley and Sons, New York.
- American Iron and Steel Institute (AISI). (2007a). "North American standard for cold-formed steel framing—General provisions." *S200*, Washington, D.C.
- American Iron and Steel Institute (AISI). (2007b). "North American standard for cold-formed steel framing—Floor and roof system design," *S210*, Washington, D.C.
- American Iron and Steel Institute (AISI). (2007c). "North American standard for cold-formed steel framing—Wall stud design." *S211*, Washington, D.C.
- American Iron and Steel Institute (AISI). (2007d). "North American standard for cold-formed steel framing—Header design." *S212*, Washington, D.C.
- American Iron and Steel Institute (AISI). (2007e). "North American standard for cold-formed steel framing—Lateral design." *S213*, Washington, D.C.
- American Iron and Steel Institute (AISI). (2007f). "North American standard for cold-formed steel framing—Supplement 2, truss design." *S214*, Washington, D.C.
- American Iron and Steel Institute (AISI). (2007g). "Standard for cold-formed steel framing—Prescriptive method for one and two family dwellings." *S230*, Washington, D.C.
- American Iron and Steel Institute (AISI). (2009). "Standard for seismic design of cold-formed steel structural systems—Special bolted moment frames." *ANSI/AISI S110 with S1-09*, 2007, with Supplement 1, Washington, D.C.
- American Iron and Steel Institute (AISI). (2010). "North American Specification for the design of cold-formed steel structural members." *ANSI/AISI S100 with S2-10*, 2007, with Supplement 2, Washington, D.C.
- American Society of Civil Engineers (ASCE). (2002). "Specification for the design of cold-formed stainless steel structural members." *ASCE/SEI 8-02*. Reston, Va.
- American Society of Civil Engineers (ASCE). (2010). "Structural applications of steel cables for buildings." *ASCE 19-10*, Reston, Va.
- American Society of Civil Engineers (ASCE). (2011). "Building code requirements and specifications for masonry structures." *TMS 402-11/ACI 530-11/ASCE 5-11*, Reston, Va.
- American Wood Council (AWC). (2008). "Special design provisions for wind and seismic (wind & seismic)." *ANSI/AWC SDPWS-2012*, Leesburg, Va.

- American Wood Council (AWC). (2012). "National Design Specification (NDS) for wood construction with commentary." *ANSI/AWC NDS-2012*, Leesburg, Va.
- APA, The Engineered Wood Association. (1994). "Northridge California earthquake." *T94-5*, Tacoma, Wash.
- APA, The Engineered Wood Association. (2004). "Diaphragms and shear walls design/construction guide." *L350*, Tacoma, Wash.
- Applied Technology Council. (1981). "Guidelines for the design of horizontal wood diaphragms." *ATC-7*, Redwood City, Calif.
- Banks, G., and Stanton, J. (2005). "Panel-to-panel connections for hollow-core shear walls subjected to seismic loading." In *Proceedings, 2005 PCI Convention*, Precast/Prestressed Concrete Institute, Chicago.
- Bora, C., Oliva, M. G., Nakaki, S. D., and Becker, R. (2007). "Development of a precast concrete shear-wall system requiring special code acceptance." *PCI J.*, 52(1), 122–135.
- Breyer et al. (2006). *Design of Wood Structures ASD/LRFD*, Sixth Ed., McGraw-Hill Book Company, New York.
- Canadian Wood Council. (1995). *Wood Reference Handbook*. Canadian Wood Council, Ottawa.
- Canadian Wood Council. (2005). *Wood Design Manual 2005*. Canadian Wood Council, Ottawa.
- Cobeen, K. (2004). "Recent developments in the seismic design and construction of woodframe buildings." Chapter 18, *Earthquake Engineering from Engineering Seismology to Performance-Based Engineering*, Yousef Bozorgia and Vitelmo Bertero, eds., CRC Press, Boca Raton, Fla.
- Consortium of Universities for Research in Earthquake Engineering (CUREE). (2004). *Recommendations for Earthquake Resistance in the Design and Construction of Woodframe Buildings*, CUREE W-30. CUREE, Richmond, Calif.
- Department of the Army, Navy, and Air Force. (1992). "Seismic design for buildings." *TM5-809-10 (Tri-Services Manual)*. U.S. Government Printing Office, Washington, D.C.
- Dolan, J. D. (2003). "Wood structures." Chapter 15, *Earthquake Engineering Handbook*, Wai-Fah Chen and Charles Scawthorn, eds., CRC Press, Boca Raton, Fla.
- Earthquake Engineering Research Institute (EERI). (1996). "Northridge earthquake reconnaissance report." *Earthquake Spectra*, Chapter 6 of Supplement C to Volume 11, EERI, Oakland, Calif.
- Faherty, K. F., and Williamson, T. G. (1989). *Wood Engineering and Construction Handbook*. McGraw-Hill, New York.
- Fanous, A., Sritharan, S., Suleiman, M., and Arulmoli, A. (2007). Minimum spiral reinforcement requirements and lateral displacement limits for prestressed concrete piles in high seismic regions, Department of Civil, Construction and Environmental Engineering, Iowa State University, Ames, ISU-ERI Ames Report.
- Federal Emergency Management Agency (FEMA). (2003). "NEHRP recommended provisions for seismic regulations for new buildings and other structures." *FEMA 450*, Federal Emergency Management Agency, Building Seismic Safety Council, Washington, D.C.
- Federal Emergency Management Agency (FEMA). (2005). *Coastal Construction Manual*, Third Ed., FEMA 55. FEMA, Washington, D.C.
- Forest Products Laboratory. (1986). *Wood: Engineering Design Concepts*. Materials Education Council, The Pennsylvania State University, University Park.
- Goetz, K. H., Hoor, D., Moehler, K., and Natterer, J. (1989). *Timber Design and Construction Source Book: A Comprehensive Guide to Methods and Practice*. McGraw-Hill, New York.
- Hoyle, R. J., and Woeste, F. E. (1989). *Wood Technology in the Design of Structures*. Iowa State University Press, Ames.
- International Code Council (ICC). (2006). "ICC standard on the design and construction of log structures," Third Draft. Country Club Hills, Ill.
- International Code Council (ICC). (2012). "International building code." *IBC*, Country Club Hills, IL.
- Ishizuka, T., and Hawkins, N. M. (1987). Effect of Bond Deterioration on the Seismic Response of Reinforced and Partially Prestressed Concrete Ductile Moment Resistant Frames, Report SM 87-2. Department of Civil Engineering, University of Washington, Seattle.
- Karacabeyli, E., and Popovsky, M. (2003). "Design for earthquake resistance." Chapter 15 of *Timber Engineering*, H. Larsen and S. Thelandersson, eds., John Wiley & Sons, New York.
- Keenan, F. J. (1986). *Limit States Design of Wood Structures*. Morrison Hershfield Limited, North York, Ont.
- Lee, N. H., Kim, K. S., Bang, C. J., and Park, K. R. (2007). "Tensile-headed anchors with large diameter and deep embedment in concrete." *ACI Struct. J.*, 104(4), 479–486.
- Lee, N. H., Park, K. R., and Suh, Y. P. (2010). "Shear behavior of headed anchors with large diameters and deep embedments." *ACI Struct. J.*, 107 (2), 146–156.
- Masonry Standards Joint Committee (MSJC). (1999). "Building code requirements for masonry structures." *ACI 530-99/ASCE 5-99/TMS 402-99*, "Specification for masonry structures." *ACI 530.1-99/ASCE 6-99/TMS 602-99*, "Commentary on building code requirements for masonry structures, commentary on specification for masonry structures," known as "MSJC Standards

- (Code and Specification),” The Masonry Society, Boulder, Colo., American Concrete Institute, Farmington Hills, Mich., American Society of Civil Engineers, Reston, Va.
- Masonry Standards Joint Committee (MSJC). (2005a). “Building code requirements for masonry structures.” *ACI 530-05/ASCE/SEI 5-05/TMS 402-5*, Farmington Hills, Mich.
- Masonry Standards Joint Committee (MSJC). (2005b). “Specification for masonry structures.” *ACI 530.1-05/ASCE/SEI 6-05/TMS 602-05*, Farmington Hills, Mich.
- Nakaki, S. D., Stanton, J. F., and Sritharan, S. (1999). “An overview of the PRESSS five-story precast test building.” *PCI J.*, 44(2), 26–39.
- Nakaki, S., Stanton, J. F., and Sritharan, S. (2001). “The PRESSS Five-Story Precast Concrete Test Building, University of California, San Diego, La Jolla, California,” *PCI Journal*, 46(5), 20–26.
- Nakaki, S., Becker, R., Oliva, M. G., and Paxson, D. (2005). “New connections for precast wall systems in high seismic regions.” In *Proceedings, 2005 PCI Convention*, Precast/Prestressed Concrete Institute, Chicago.
- Pankow Foundation, 2014. Seismic Design Methodology Document for Precast Concrete Diaphragms, Vancouver, Washington, 23 January.
- Park, R., and Thompson, K. J.. (1977). “Cyclic load tests on pretressed and partially prestressed beam–column joints.” *PCI J.*, 22(5), 84–110.
- PCI Committee on Prestressed Concrete Piling. (1993). “Recommended practice for design, manufacture and installation of prestressed concrete piling.” *PCI J.*, 38(2), 14–41.
- Precast/Prestressed Concrete Institute (PCI). (2004). “Precast prestressed concrete piles.” Chapter 20, *Bridge Design Manual*, BM-20-04. PCI, Chicago.
- Ren, R., and Naito, C. J., 2013. “Precast Concrete Diaphragm Connector Performance Database, *Journal of Structural Engineering*, ASCE, January.
- Sato, A., and Uang, C. M. (2007). “Development of a seismic design procedure for cold-formed steel bolted frames,” Report No. SSRP-07/16, University of California, San Diego.
- Schultz, A. E., and Magana, R. A. (1996). “Seismic behavior of connections in precast concrete walls.” *Proceedings, Mete A. Sozen Symposium*, SP-162, American Concrete Institute, Farmington Hills, Mich., 273–311.
- Sherwood, G. E., and Stroh, R. C. (1989). “Wood-frame house construction.” In *Agricultural Handbook 73*, U.S. Government Printing Office, Washington, D.C.
- Somayaji, Shan. (1992). *Structural Wood Design*. West Publishing Co., St. Paul, Minn.
- Stalnaker, J. J., and Harris, E. C. (1996). *Structural Design in Wood*, 2nd Ed., McGraw-Hill, New York.
- Steel Deck Institute. (2004). *Diaphragm Design Manual*, 3rd Ed., No. DDMO3. SDI, Fox River Grove, Ill.
- Structural Engineers Association of California (SEAOC). (1999). *Recommended Lateral Force Requirements and Commentary*. SEAOC, Sacramento, Calif.
- Structural Engineers Association of Northern California (SEAONC). (2005). Guidelines for Seismic Evaluation and Rehabilitation of Tilt-Up Buildings and Other Rigid Wall/Flexible Diaphragm Structures. SEAONC, Sacramento, Calif.
- U.S. Department of Agriculture, National Oceanic and Atmospheric Administration. (1971). *San Fernando, California, Earthquake of February 9, 1971*. NOAA, Washington, D.C.

Page intentionally left blank

COMMENTARY TO CHAPTER 15, SEISMIC DESIGN REQUIREMENTS FOR NONBUILDING STRUCTURES

C15.1 GENERAL

C15.1.1 Nonbuilding Structures

Building codes traditionally have been perceived as minimum standards for the design of nonbuilding structures, and building code compliance of these structures is required by building officials in many jurisdictions. However, requirements in the industry reference documents are often at odds with building code requirements. In some cases, the industry documents need to be altered, while in other cases, the building codes need to be modified. Registered design professionals are not always aware of the numerous accepted documents within an industry and may not know whether the accepted documents are adequate. One of the intents of Chapter 15 of the standard is to bridge the gap between building codes and existing industry reference documents.

Differences between the ASCE/SEI 7-10 design approaches for buildings and industry document requirements for steel multilegged water towers (Fig. C15.1-1) are representative of this inconsistency. Historically, such towers have performed well when properly designed in accordance with American Water Works Association (AWWA) standards and industry practices. Those standards and practices differ from the ASCE/SEI 7-10 treatment of buildings in that tension-only rods are allowed, upset rods are preloaded at the time of installation, and connection forces are not amplified.

Chapter 15 also provides an appropriate link so that the industry reference documents can be used with the seismic ground motions established in the standard. Some nonbuilding structures are similar to buildings and can be designed using sections of the standard directly, whereas other nonbuilding structures require special analysis unique to the particular type of nonbuilding structure.

Building structures, vehicular bridges, electrical transmission towers, hydraulic structures (e.g., dams), buried utility lines and their appurtenances, and nuclear reactors are excluded from the scope of the nonbuilding structure requirements, although industrial buildings are permitted per Chapter 11 to use the provisions in Chapter 15 for nonbuilding structures with structural systems similar to buildings, provided that specific conditions are met. The excluded structures are covered by other well-established design criteria (e.g., electrical transmission towers and vehicular bridges), are not under the jurisdiction of local building officials (e.g., nuclear reactors and dams), or require technical considerations beyond the scope of the standard (e.g., buried utility lines and their appurtenances).

C15.1.2 Design

Nonbuilding structures and building structures have much in common with respect to design intent and expected performance, but there are also important differences. Chapter 15 relies on other portions of the standard where possible and provides special notes where necessary.

There are two types of nonbuilding structures: those with structural systems similar to buildings and those with structural systems not similar to buildings. Specific requirements for these two cases appear in Sections 15.5 and 15.6.

C15.1.3 Structural Analysis Procedure Selection

Nonbuilding structures that are similar to buildings are subject to the same analysis procedure limitations as building structures. Nonbuilding structures that are not similar to buildings are subject to those limitations and are subject to procedure limitations prescribed in applicable specific reference documents.

For many nonbuilding structures supporting flexible system components, such as pipe racks (Fig. C15.1-2), the supported piping and platforms generally are not regarded as rigid enough to redistribute seismic forces to the supporting frames.

For nonbuilding structures supporting very stiff (i.e., rigid) system components, such as steam turbine generators (STGs) and heat recovery steam generators (HRSGs) (Fig. C15.1-3), the supported equipment, ductwork, and other components (depending on how they are attached to the structure) may be rigid enough to redistribute seismic forces to the supporting frames. Torsional effects may need to be considered in such situations.

Section 12.6 presents seismic analysis procedures for building structures based on the Seismic Design Category (SDC); the fundamental period, T ; and the presence of certain horizontal or vertical irregularities in the structural system. Where the fundamental period is greater than or equal to $3.5 T_s$ (where $T_s = S_{D1}/S_{DS}$), the use of the equivalent lateral force procedure is not permitted in SDCs D, E, and F. This requirement is based on the fact that, unlike the dominance of the first mode response in case of buildings with lower first mode period, higher vibration modes do contribute more significantly in situations when the first mode period is larger than $3.5 T_s$. For buildings that exhibit classic flexural deformation patterns (such as slender shear-wall or braced-frame systems), the second mode frequency is at least 3.5 times the first mode frequency, so where the fundamental period exceeds $3.5 T_s$, the higher modes have larger contributions to the total response because they occur near the peak of the design response spectrum.

It follows that dynamic analysis (modal response spectrum analysis or response-history analysis) may be necessary to properly evaluate buildinglike nonbuilding structures if the first mode period is larger than $3.5 T_s$ and the equivalent lateral force analysis is sufficient for nonbuilding structures that respond as single-degree-of-freedom systems.

The recommendations for nonbuilding structures provided in the following are intended to supplement the designer's judgment and experience. The designer is given considerable latitude in selecting a suitable analysis method for nonbuilding structures.

Buildinglike Nonbuilding Structures. Table 12.6-1 is used in selecting analysis methods for buildinglike nonbuilding structures, but, as illustrated in the following three conditions, the relevance of key behavior must be considered carefully:

1. Irregularities: Table 12.6-1 requires dynamic analysis for SDC D, E, and F structures that have certain horizontal or vertical irregularities. Some of these building irregularities (defined in Section 12.3.2) are relevant to nonbuilding structures. The weak- and soft-story vertical irregularities (Types 1a, 1b, 5a, and 5b of Table 12.3-2) are pertinent to the behavior of buildinglike nonbuilding structures. Other vertical and horizontal irregularities may or may not be relevant, as described below.
 - a. Horizontal irregularities: Horizontal irregularities of Types 1a and 1b affect the choice of analysis method, but these irregularities apply only where diaphragms are rigid or semirigid, and some buildinglike nonbuilding structures have either no diaphragms or flexible diaphragms.
 - b. Vertical irregularities: Vertical irregularity Type 2 is relevant where the various levels actually support significant loads. Where a buildinglike nonbuilding structure supports significant mass at a single level while other levels support small masses associated with stair landings, access platforms, and so forth, dynamic response is dominated by the first mode, so the equivalent lateral force procedure may be applied. Vertical irregularity Type 3 addresses large differences in the horizontal dimension of the seismic force-resisting system in adjacent stories because the resulting stiffness distribution can produce a fundamental mode shape unlike that assumed in the development of the equivalent lateral

force procedure. Because the concern relates to stiffness distribution, the horizontal dimension of the seismic force-resisting system, not of the overall structure, is important.

2. Arrangement of supported masses: Even where a nonbuilding structure has buildinglike appearance, it may not behave like a building, depending on how masses are attached. For example, the response of nonbuilding structures with suspended vessels and boilers cannot be determined reliably using the equivalent lateral force procedure because of the pendulum modes associated with the significant mass of the suspended components. The resulting pendulum modes, although potentially reducing story shears and base shear, may require large clearances to allow pendulum motion of the supported components and may produce excessive demands on attached piping. Dynamic analysis is highly recommended in such cases, with consideration for appropriate impact forces in the absence of adequate clearances.
3. Relative rigidity of beams: Even where a classic building model may seem appropriate, the equivalent lateral force procedure may underpredict the total response if the beams are flexible relative to the columns (of moment frames) or the braces (of braced frames). This underprediction occurs because higher modes associated with beam flexure may contribute more significantly to the total response (even if the first mode response is at a period less than $3.5 T_s$). This situation of flexible beams can be especially pronounced for nonbuilding structures because the “normal” floors common to buildings may be absent. Therefore, the dynamic analysis procedures are suggested for buildinglike nonbuilding structures with flexible beams.

Nonbuilding Structures Not Similar to Buildings. The (static) equivalent lateral force procedure is based on classic building dynamic behavior, which differs from the behavior of many nonbuilding structures not similar to buildings. As discussed below, several issues should be considered for selecting either an appropriate method of dynamic analysis or a suitable distribution of lateral forces for static analysis.

1. Structural geometry: The dynamic response of nonbuilding structures with a fixed base and a relatively uniform distribution of mass and stiffness, such as bottom-supported vertical vessels, stacks, and chimneys, can be represented adequately by a cantilever (shear building) model. For these structures, the equivalent lateral force procedure provided in the standard is suitable. This procedure treats the dynamic response as being dominated by the first mode. In such cases, it is necessary to identify the first mode shape (using, for instance, the Rayleigh–Ritz method or other classical methods from the literature) for distribution of the dynamic forces. For some structures, such as tanks with low height-to-diameter ratios storing granular solids, it is conservative to assume a uniform distribution of forces. Dynamic analysis is recommended for structures that have neither a uniform distribution of mass and stiffness nor an easily determined first mode shape.
2. Number of lateral supports: Cantilever models are obviously unsuitable for structures with multiple supports. Fig. C15.1-4 shows a nonbuilding braced frame structure that provides nonuniform horizontal support to a piece of equipment. In such cases, the analysis should include coupled model effects. For such structures, an application of the equivalent lateral force method could be used, depending on the number and locations of the supports. For example, most beam-type configurations lend themselves to application of the equivalent lateral force method.
3. Method of supporting dead weight: Certain nonbuilding structures (such as power boilers) are supported from the top. They may be idealized as pendulums with uniform mass distribution. In contrast, a suspended platform may be idealized as a classic pendulum with concentrated mass. In either case, these types of nonbuilding structures can be analyzed adequately using the equivalent lateral force method by calculating the appropriate frequency and mode shape. Fig. C15.1-5 shows a nonbuilding structure containing lug-supported equipment with W_P greater than $0.25(W_S + W_P)$. In such cases, the analysis should include a coupled system with the mass of the equipment and the local flexibility of the supports considered in the model. Where the support is located near the

- nonbuilding structure's vertical location of the center of mass, a dynamic analysis is recommended.
4. Mass irregularities: Just as in the case of buildinglike nonbuilding structures, the presence of significantly uneven mass distribution is a situation where the equivalent lateral force method is not likely to provide a very accurate and perhaps unconservative force distribution. The dynamic analysis methods are recommended in such situations. Fig. C15.1-6 illustrates two such situations. In part (a), a mass irregularity exists if W_1 is greater than $1.5 W_2$ or less than $0.67 W_2$. In part (b), a mass irregularity exists if W_3 is greater than either $1.5 W_2$ or $1.5 W_4$.
 5. Torsional irregularities: Structures in which the fundamental mode of response is torsional or in which modes with significant mass participation exhibit a prominent torsional component may also have inertial force distributions that are significantly different from those predicted by the equivalent lateral force method. In such cases, dynamic analyses should be considered. Fig. C15.1-7 illustrates one such case where a vertical vessel is attached to a secondary vessel with W_2 greater than about $0.25(W_1 + W_2)$.
 6. Stiffness and strength irregularities: Just as for buildinglike nonbuilding structures, abrupt changes in the distribution of stiffness or strength in a nonbuilding structure not similar to buildings can result in substantially different inertial forces from those indicated by the equivalent lateral force method. Fig. C15.1-8 represents one such case. For structures that have such configurations, consideration should be given to the use of dynamic analysis procedures. Even where dynamic analysis is required, the standard does not define in any detail the degree of modeling; an adequate model may have a few dynamic degrees of freedom or tens of thousands of dynamic degrees of freedom. The important point is that the model captures the significant dynamic response features so that the resulting lateral force distribution is valid for design. The designer is responsible for determining whether dynamic analysis is warranted and, if so, the degree of detail required to address adequately the seismic performance.
 7. Coupled response: Where the weight of the supported structure is large compared with the weight of the supporting structure, the combined response can be affected significantly by the flexibility of the supported nonbuilding structure. In that case, dynamic analysis of the coupled system is recommended. Examples of such structures are shown in Fig. C15.1-9. Part (a) shows a flexible nonbuilding structure with W_p greater than $0.25(W_s + W_p)$, supported by a relatively flexible structure; the flexibility of the supports and attachments should be considered. Part (b) shows flexible equipment connected by a large-diameter, thick-walled pipe and supported by a flexible structure; the structures should be modeled as a coupled system including the pipe.

C15.2 REFERENCE DOCUMENTS

Chapter 15 of the standard makes extensive use of reference documents in the design of nonbuilding structures for seismic forces. The documents referenced in Chapter 15 are industry documents commonly used to design specific types of nonbuilding structures. The vast majority of these reference documents contain seismic provisions that are based on the seismic ground motions of the 1997 UBC or earlier editions of the UBC. To use these reference documents, Chapter 15 modifies the seismic force provisions of these reference documents through the use of "bridging equations." The standard only modifies industry documents that specify seismic demand and capacity. The bridging equations are intended to be used directly with the other provisions of the specific reference documents. Unlike the other provisions of the standard, if the reference documents are written in terms of allowable stress design, then the bridging equations are shown in allowable stress design format. In addition, the detailing requirements referenced in Tables 15.4-1 and Table 15.4-2 are expected to be followed, as well as the general requirements found in Section 15.4.1. The usage of reference documents in conjunction with the requirements of Section 15.4.1 are summarized below in Table C15.2-1.

Table C15.2-1 Usage of Reference Documents in Conjunction with Section 15.4.1

Subject	Requirement
R , Ω_0 , and C_d values, detailing requirements, and height limits	Use values and limits in Tables 12.2-1, 15.4-1, or 15.4-2 as appropriate. Values from the reference document are not to be used.
Minimum base shear	Use the appropriate value from Eq. (15.4-1) or (15.4-2) for nonbuilding structures not similar to buildings. For structures containing liquids, gases, and granular solids supported at the base, the minimum seismic force cannot be less than that required by the reference document.
Importance factor	Use the value from Section 15.4.1.1 based on risk category. Importance factors from the reference document are not to be used unless they are greater than those provided in the standard.
Vertical distribution of lateral load	Use requirements of Section 12.8.3 or Section 12.9 or the applicable reference document.
Seismic provisions of reference documents	The seismic force provisions of reference documents may be used only if they have the same basis as Section 11.4 and the resulting values for total lateral force and total overturning moment are no less than 80% of the values obtained from the standard.
Load combinations	Load combinations specified in Section 2.3 (LRFD) or Section 15 (includes ASD load combinations of Section 2.4) must be used.

Currently, only four reference documents have been revised to meet the seismic requirements of the standard. AWWA D100-05 (2006); API 620, 11th Ed., Addendum 1 (2009); API 650, 11th Ed., Addendum 1 (2008) and ANSI/RMI MH 16.1 (2008) have been adopted by reference in the standard without modification, except that height limits are imposed on “elevated tanks on symmetrically braced legs (not similar to buildings)” in AWWA D100-05 and the anchorage requirements of Section 15.4.9 are imposed on steel storage racks in ANSI/RMI MH 16.1 (2008). Three of these reference documents apply to welded steel liquid storage tanks.

C15.3 NONBUILDING STRUCTURES SUPPORTED BY OTHER STRUCTURES

There are instances where nonbuilding structures not similar to buildings are supported by other structures or other nonbuilding structures. This section specifies how the seismic design loads for such structures are to be determined and the detailing requirements that are to be satisfied in the design.

C15.3.1 Less than 25% Combined Weight Condition

In many instances, the weight of the supported nonbuilding structure is relatively small compared with the weight of the supporting structure, such that the supported nonbuilding structure has a relatively small effect on the overall nonlinear earthquake response of the primary structure during design-level ground motions. It is permitted to treat such structures as nonstructural components and to use the requirements of Chapter 13 for their design. The ratio of secondary component weight to total weight of 25% at which this treatment is permitted is based on judgment and was introduced into code provisions in the 1988 *Uniform Building Code* by the SEAOC Seismology Committee. Analytical studies, typically based on linear elastic primary and secondary structures, indicate that the ratio should be lower, but the SEAOC Seismology Committee judged that the 25% ratio is appropriate where primary and secondary structures exhibit nonlinear behavior that tends to lessen the effects of resonance and interaction. In cases where a nonbuilding structure (or nonstructural component) is supported by another structure, it may be appropriate to analyze in a single model. In such cases, it is intended that seismic design loads and detailing requirements be determined following the procedures of Section 15.3.2. Where there are multiple large nonbuilding structures, such as vessels supported on a primary nonbuilding structure, and the weight of an individual supported nonbuilding structure does not exceed the 25% limit but the combined weight of the supported nonbuilding structures does, it is recommended that the combined analysis and design approach of Section 15.3.2 be used. It is also suggested that dynamic analysis be performed in such cases, because the equivalent lateral

force procedure may not capture some important response effects in some members of the supporting structure.

Where the weight of the supported nonbuilding structure does not exceed the 25% limit and a combined analysis is performed, the following procedure should be used to determine the F_p force of the supported nonbuilding structure based on Eq. (13.3-4):

1. A modal analysis should be performed in accordance with Section 12.9. The base shear of the combined structure and nonbuilding structure should be taken as no less than 85% of the equivalent lateral force procedure base shear.
2. For a component supported at level i , the acceleration at that level should be taken as a_i , the total shear just below level i divided by the seismic weight at and above level i .
3. The elastic value of the component shear force coefficient should next be determined as the shear force from the modal analysis at the point of attachment of the component to the structure divided by the weight of the component. This value is preliminarily taken as $a_i a_p$. Because a_p cannot be taken as less than 1.0, the value of a_p is taken as $a_i a_p / a_i$, except that the final value a_p need not be taken as greater than 2.5 and should not be taken as less than 1.0. The final value of $a_i a_p$ should be the final value of a_i determined in Step 2 multiplied by the final value of a_p determined earlier in this step.
4. The resulting value of $(a_i a_p)$ should be used in Eq. (13.3-4); the resulting value of F_p is subject to the maximum and minimum values of Eqs. (13.3-2) and (13.3-3), respectively.

C15.3.2 Greater Than or Equal to 25% Combined Weight Condition

Where the weight of the supported structure is relatively large compared with the weight of the supporting structure, the overall response can be affected significantly. The standard sets forth two analysis approaches, depending on the rigidity of the nonbuilding structure. The determination of what is deemed rigid or flexible is based on the same criteria used for nonstructural components.

Where the supported nonbuilding structure is rigid, it is acceptable to treat the supporting structure as a nonbuilding structure similar to a building and to determine its design loads and detailing using the requirements of Section 15.5. The design of the rigid nonbuilding structure and its anchorage is determined using the requirements of Chapter 13 with the amplification factor, a_p , taken as 1.0. However, this condition is relatively rare because the flexibility of any directly supporting members in the primary structure, such as floor beams, must be considered in determining the period of the component.

In the usual case, where the supported nonbuilding structure is flexible, a combined model of the supporting structure and the supported nonbuilding structure is used. The design loads and detailing are determined based on the lower R value of the supported nonbuilding structure or supporting structure.

Although not specifically mentioned in Section 15.3.2, another approach is permitted. A nonlinear response history analysis of the combined system can be performed in accordance with Section 16.2, and the results can be used for the design of both the supported and supporting nonbuilding structures. This option should be considered where standard static and dynamic elastic analysis approaches may be inadequate to evaluate the earthquake response (such as for suspended boilers). This option should be used with extreme caution because modeling and interpretation of results require considerable judgment. Because of this sensitivity, Section 16.2 requires independent design review.

C15.4 STRUCTURAL DESIGN REQUIREMENTS

This section specifies the basic coefficients and minimum design forces to be used to determine seismic design loads for nonbuilding structures. It also specifies height limits and restrictions. As with building structures, it presumes that the first step in establishing the design forces is to determine the design base shear for the structure.

There are two types of nonbuilding structures: those with structural systems similar to buildings and those with structural systems not similar to buildings. Specific requirements for these two cases appear in Sections 15.5 and 15.6.

Table 15.4-1 contains the response modification coefficient (R) for nonbuilding structures similar to buildings. Table 15.4-2 contains the response modification coefficient for nonbuilding structures not similar to buildings. Every response modification coefficient has associated design and detailing requirements to ensure the required ductility associated with that response modification coefficient value (e.g., AISC 341 2010). Some structures, such as pipe racks, do not resemble a traditional building in that they do not house people or have such things as walls and bathrooms. These structures have lateral force-resisting systems composed of braced frames and moment frames similar to a traditional building. Therefore, pipe racks are considered nonbuilding structures similar to buildings. The response modification coefficient for a pipe rack should be taken from Table 15.4-1 for the appropriate lateral force-resisting system used, and the braced frames and/or moment frames used must meet all of the design and detailing requirements associated with the R value selected (see Section 15.5.2, Pipe Racks).

Most major power distribution facility (power island) structures, such as HRSG support structures, steam turbine pedestals, coal boiler support structures, pipe racks, air inlet structures, and duct support structures, also resist lateral forces predominantly by use of buildinglike framing systems such as moment frames, braced frames, or cantilever column systems. Therefore, their response modification coefficient should be selected from Table 15.4-1, and they must meet all the design and detailing requirements associated with the response modification coefficient selected.

Many nonbuilding structures, such as flat-bottom tanks, silos, and stacks, do not use braced frames or moment frames similar to those found in buildings to resist seismic loads. Therefore, they have their own unique response modification coefficient, which can be found in Table 15.4-2.

For nonbuilding structures with lateral systems composed predominantly of buildinglike framing systems, such as moment frames, braced frames, or cantilever column systems, it would be inappropriate to extrapolate the descriptions in Table 15.4-2, resulting in inappropriately high response modification coefficients and the elimination of detailing requirements.

Once a response modification coefficient is selected from the tables, Section 15.4.1 provides additional guidance.

C15.4.1 Design Basis

Separate tables provided in this section identify the basic coefficients, associated detailing requirements, and height limits and restrictions for the two types of nonbuilding structures.

For nonbuilding structures similar to buildings, the design seismic loads are determined using the same procedures used for buildings as specified in Chapter 12, with two exceptions: fundamental periods are determined in accordance with Section 15.4.4, and Table 15.4-1 provides additional options for structural systems. Although only Section 12.8 (the equivalent lateral force procedure) is specifically mentioned in Section 15.4.1, Section 15.1.3 provides the analysis procedures that are permitted for nonbuilding structures.

In Table 15.4-1, seismic coefficients, system restrictions, and height limits are specified for a few nonbuilding structures similar to buildings. The values of R , Ω_0 , and C_d ; the detailing requirement references; and the structural system height limits are the same as those in Table 12.2-1 for the same systems, except for ordinary moment frames. In Chapter 12, increased height limits for ordinary moment frame structural systems apply to metal building systems, whereas in Chapter 15 they apply to pipe racks with end plate bolted moment connections. The seismic performance of pipe racks was judged to be similar to that of metal building structures with end plate bolted moment connections, so the height limits were made the same as those specified in previous editions.

Table 15.4-1 also provides lower R values with less restrictive height limits in SDCs D, E, and F based on good performance in past earthquakes. For some options, no seismic detailing is required if very low values of R (and corresponding high seismic design forces) are used. The concept of extending this approach to other structural systems is the subject of future research using the methodology developed by the ATC 63 project.

For nonbuilding structures not similar to buildings, the seismic design loads are determined as in Chapter 12 with three exceptions: the fundamental periods are determined in accordance with Section 15.4.4, the minima are those specified in Section 15.4.1.2, and the seismic coefficients are those specified in Table 15.4-2.

Some entries in Table 15.4-2 may seem to be conflicting or confusing. For example, the first major entry is for elevated tanks, vessels, bins, or hoppers. A subset of this entry is for tanks on braced or unbraced legs. This subentry is intended for structures where the supporting columns are integral with the shell (such as an elevated water tank). Tension-only bracing is allowed for such a structure. Where the tank or vessel is supported by building-like frames, the frames are to be designed in accordance with all of the restrictions normally applied to building frames. Section 15.3 includes provisions for nonbuilding structures supported by building-like frames. Beginning with the 2005 edition of ASCE 7, Table 15.4.2 contained an entry for “Tanks or vessels supported on structural towers similar to buildings”. Under certain circumstances, text provided with this table entry conflicted with the requirements of Section 15.3. If the weight of the nonbuilding structure is relatively small compared to the weight of the structure (less than 25% of the weight of the structure) or the nonbuilding structure is rigid, the supported nonbuilding structure can be treated as a nonstructural component and the values of the supporting structure seismic coefficients can be taken from Table 15.4-1. Under these circumstances, the deleted entry was correct. However, if the weight of the supported nonbuilding structure is not small and the nonbuilding structure is flexible (which is generally the case especially when the vertical and rocking flexibilities of supporting floor beams are considered), the seismic coefficients are determined as the more conservative values between the supported nonbuilding structure and the supporting structure. To correct this conflict, the entry was deleted from the standard in Supplement 2 of ASCE 7-10.

C15.4.1.1 Importance Factor

The importance factor for a nonbuilding structure is based on the risk category defined in Chapter 1 of the standard or the building code being used in conjunction with the standard. In some cases, reference standards provide a higher importance factor, in which case the higher importance factor is used.

If the importance factor is taken as 1.0 based on a hazard and operability (HAZOP) analysis performed in accordance with Chapter 1, the third paragraph of Section 1.5.3 requires careful consideration; worst-case scenarios (instantaneous release of a vessel or piping system) must be considered. HAZOP risk analysis consultants often do not make such assumptions, so the design professional should review the HAZOP analysis with the HAZOP consultant to confirm that such assumptions have been made to validate adjustment of the importance factor. Clients may not be aware that HAZOP consultants do not normally consider the worst-case scenario of instantaneous release but tend to focus on other more hypothetical limited-release scenarios, such as those associated with a 2-in.² hole in a tank or vessel.

C15.4.2 Rigid Nonbuilding Structures

The definition of rigid (having a natural period of less than 0.06 s) was selected judgmentally. Below that period, the energy content of seismic ground motion is generally believed to be very low, and therefore the building response is not likely to be excessively amplified. Also, it is unlikely that any building will have a first mode period as low as 0.06 s, and it is even unusual for a second mode period to be that low. Thus, the likelihood of either resonant behavior or excessive amplification becomes quite small for equipment that has periods below 0.06 s.

The analysis to determine the period of the nonbuilding structure should include the flexibility of the soil subgrade.

C15.4.3 Loads

As for buildings, the seismic weight must include the range of design operating weight of permanent equipment.

C15.4.4 Fundamental Period

A significant difference between building structures and nonbuilding structures is that the approximate period formulas and limits of Section 12.8.2.1 may not be used for nonbuilding structures. In lieu of calculating a specific period for a nonbuilding structure for determining seismic lateral forces, it is of course conservative to assume a period of $T = T_s$, which results in the largest lateral design forces. Computing the fundamental period is not considered a significant burden because most commonly used computer analysis programs can perform the required calculations.

C15.4.8 Site-Specific Response Spectra

Where site-specific response spectra are required, they should be developed in accordance with Chapter 21 of the standard. If determined for other recurrence intervals, Section 21.1 applies, but Sections 21.2 through 21.4 apply only to maximum considered earthquake (MCE) determinations. Where other recurrence intervals are used, it should be demonstrated that the requirements of Chapter 15 also are satisfied.

C15.4.9 Anchors in Concrete or Masonry

Many nonbuilding structures rely on the ductile behavior of anchor bolts to justify the response modification factor, R , assigned to the structure. Nonbuilding structures typically rely more heavily on anchorage to provide system ductility. The additional requirements of Section 15.4.9 provide additional anchorage strength and ductility to support the response modification factors assigned to these systems. The addition of Section 15.4.9 provides a consistent treatment of anchorage for nonbuilding structures.

C15.5 NONBUILDING STRUCTURES SIMILAR TO BUILDINGS

C15.5.1 General

Although certain nonbuilding structures exhibit behavior similar to that of building structures, their functions and occupancies are different. Section 15.5 of the standard addresses the differences.

C15.5.2 Pipe Racks

Free-standing pipe racks supported at or below grade with framing systems that are similar to building systems are designed in accordance with Section 12.8 or 12.9 and Section 15.4. Single-column pipe racks that resist lateral loads should be designed as inverted pendulums.

Based on good performance in past earthquakes, Table 15.4-1 sets forth the option of lower R values and less restrictive height limits for structural systems commonly used in pipe racks. The R value versus height limit trade-off recognizes that the size of some nonbuilding structures is determined by factors other than traditional loadings and results in structures that are much stronger than required for seismic loadings. Therefore, the ductility demand is generally much lower than that for a corresponding building. The intent is to obtain the same structural performance at the increased heights. This option proves to be economical in most situations because of the relative cost of materials and construction labor. The lower R values and increased height limits of Table 15.4-1 apply to nonbuilding structures similar to buildings; they cannot be applied to building structures. Table C15.5-1 illustrates the R values and height limits for a 70-ft-high steel ordinary moment frame (OMF) pipe rack.

C15.5.3 Steel Storage Racks

The two approaches to the design of steel storage racks set forth by the standard are intended to produce comparable results. The specific revisions to the RMI specification cited in earlier editions of this standard and the detailed requirements of the new ANSI/RMI MH 16.1 (2008) specification reflect the recommendations of FEMA 460 (2005), *Seismic Considerations for Steel Storage Racks Located in Areas Accessible to the Public*.

Although the ANSI/RMI MH 16.1 (2008) specification reflects the recommendations of FEMA 460 (2005), the anchorage provisions of the ANSI/RMI MH 16.1 specification are not in conformance with ASCE/SEI 7. Therefore, specific anchorage requirements were added in Sections 15.5.3.2 and 15.5.3.3.

These recommendations address the concern that storage racks in warehouse-type retail stores may pose a greater seismic risk to the general public than exists in low-occupancy warehouses or more conventional retail environments. Under normal conditions, retail stores have a far higher occupant load than an ordinary warehouse of a comparable size. Failure of a storage rack system in a retail environment is much more likely to cause personal injury than would a similar failure in a storage warehouse. To provide an appropriate level of additional safety in areas open to the public, an importance factor of 1.50 is specified. Storage rack contents, though beyond the scope of the standard, may pose a potentially serious threat to life should they fall from the shelves in an earthquake. It is recommended that restraints be provided, as shown in Fig. C15.5-1, to prevent the contents of rack shelving open to the general public from falling during strong ground shaking.

Table C15.5-1 R Value Selection Example for Steel OMF Pipe Racks

SDC	R	ASCE/SEI 7-10 Table	System	Seismic Detailing Requirements
C	3.5	12.2-1 or 15.4-1	Steel ordinary moment frame	AISC (2010a)
C	3	12.2-1	Structural steel systems not specifically detailed for seismic resistance	None
D or E	2.5	15.4-1	Steel OMF with permitted height increase	AISC (2010a)
D, E, or F	1	15.4-1	Steel OMF with unlimited height	AISC (2010b)

C15.5.4 Electrical Power Generating Facilities

Electrical power plants closely resemble building structures, and their performance in seismic events has been good. For reasons of mechanical performance, lateral drift of the structure must be limited. The lateral bracing system of choice has been the concentrically braced frame. In the past, the height limits on braced frames in particular have been an encumbrance to the design of large power generating facilities. Based on acceptable past performance, Table 15.4-1 permits the use of ordinary concentrically braced frames with both lower R values and less restrictive height limits. This option is particularly effective for boiler buildings, which generally are 300 ft or more high. A peculiarity of large boiler buildings is the general practice of suspending the boiler from the roof structures; this practice results in an unusual mass distribution, as discussed in Section C15.1.3.

C15.5.5 Structural Towers for Tanks and Vessels

The requirements of this section apply to structural towers that are not integral with the supported tank. Elevated water tanks designed in accordance with AWWA D100-05 (2006) are not subject to Section 15.5.5.

C15.5.6 Piers and Wharves

Current industry practice recognizes the distinct differences between the two categories of piers and wharves described in the standard. Piers and wharves with public occupancy, described in Section 15.5.6.2, are commonly treated as the “foundation” for buildings or buildinglike structures; design is performed using

the standard, likely under the jurisdiction of the local building official. Piers and wharves without occupancy by the general public are often treated differently and are outside the scope of the standard; in many cases, these structures do not fall under the jurisdiction of building officials, and design is performed using other industry-accepted approaches.

Design decisions associated with these structures often reflect economic considerations by both owners and local, regional, or state jurisdictional entities with interest in commercial development. Where building officials have jurisdiction but lack experience analyzing pier and wharf structures, reliance on other industry-accepted design approaches is common.

Where occupancy by the general public is not a consideration, seismic design of structures at major ports and marine terminals often uses a performance-based approach, with criteria and methods that are very different from those used for buildings, as provided in the standard. Design approaches most commonly used are generally consistent with the practices and criteria described in the following documents:

1. *Seismic Design Guidelines for Port Structures*. (2001). Working Group No. 34 of the Maritime Navigation Commission (PIANC/MarCom/WG34), A. A. Balkema, Lisse, Netherlands.
2. Ferritto, J., Dickenson, S., Priestley, N., Werner, S., Taylor, C., Burke, D., Seelig, W., and Kelly, S. (1999). *Seismic Criteria for California Marine Oil Terminals*, Vol. 1 and Vol. 2, Technical Report TR-2103-SHR, Naval Facilities Engineering Service Center, Port Hueneme, Calif.
3. Priestley, N. J. N., Siebel, F., and Calvi, G. M. (1996). *Seismic Design and Retrofit of Bridges*, New York.
4. Werner, S. D., ed. (1998). *Seismic Guidelines for Ports*, Monograph No. 12, ASCE, Reston, Va.
5. *Marine Oil Terminal Engineering and Maintenance Standards*. (2005). Title 24, Part 2, California Building Code, Chapter 31F.

These alternative approaches have been developed over a period of many years by working groups within the industry, and they reflect the historical experience and performance characteristics of these structures, which are different from those of building structures.

The main emphasis of the performance-based design approach is to provide criteria and methods that depend on the economic importance of a facility. Adherence to the performance criteria in the documents listed does not seek to provide uniform margins of collapse for all structures; their application is expected to provide at least as much inherent life-safety as for buildings designed using the standard. The reasons for the higher inherent level of life safety for these structures include the following:

1. These structures have relatively infrequent occupancy, with few working personnel and low density of personnel. Most of these structures consist primarily of open area, with no enclosed structures that can collapse onto personnel. Small control buildings on marine oil terminals or similar secondary structures are commonly designed in accordance with the local building code.
2. These pier or wharf structures typically are constructed of reinforced concrete, prestressed concrete, or steel and are highly redundant because of the large number of piles supporting a single wharf deck unit. Tests done at the University of California at San Diego for the Port of Los Angeles have shown that high ductilities (10 or more) can be achieved in the design of these structures using practices currently used in California ports.
3. Container cranes, loading arms, and other major structures or equipment on piers or wharves are specifically designed not to collapse in an earthquake. Typically, additional piles and structural members are incorporated into the wharf or pier specifically to support such items.
4. Experience has shown that seismic “failure” of wharf structures in zones of strong seismicity is indicated not by collapse but by economically irreparable deformations of the piles. The wharf deck generally remains level or slightly tilting but shifts out of position. Earthquake loading on properly maintained marine structures has never induced complete failure that could endanger life safety.

5. The performance-based criteria of the listed documents address reparability of the structure. These criteria are much more stringent than collapse prevention criteria and create a greater margin for life safety.

Lateral load design of these structures in low, or even moderate, seismic regions often is governed by other marine conditions.

C15.6 GENERAL REQUIREMENTS FOR NONBUILDING STRUCTURES NOT SIMILAR TO BUILDINGS

Nonbuilding structures not similar to buildings exhibit behavior markedly different from that of building structures. Most of these types of structures have reference documents that address their unique structural performance and behavior. The ground motion in the standard requires appropriate translation to allow use with industry standards.

C15.6.1 Earth-Retaining Structures

Section C11.8.3 presents commonly used approaches for the design of nonyielding walls and yielding walls for bending, overturning, and sliding, taking into account the varying soil types, importance, and site seismicity.

C15.6.2 Stacks and Chimneys

The design of stacks and chimneys to resist natural hazards generally is governed by wind design considerations. The exceptions to this general rule involve locations with high seismicity, stacks and chimneys with large elevated masses, and stacks and chimneys with unusual geometries. It is prudent to evaluate the effect of seismic loads in all but those areas with the lowest seismicity. Although not specifically required, it is recommended that the special seismic details required elsewhere in the standard be considered for application to stacks and chimneys.

Concrete chimneys typically possess low ductility, and their performance is especially critical in the regions around large (breach) openings because of reductions in strength and loss of confinement for vertical reinforcement in the jamb regions around the openings. Earthquake-induced chimney failures have occurred in recent history (in Turkey in 1999) and have been attributed to strength and detailing problems (Kilic and Sozen 2003). Therefore, the R value of 3 traditionally used in ASCE/SEI 7-05 for concrete stacks and chimneys is reduced to 2, and detailing requirements for breach openings are added in the 2010 edition of this standard.

Guyed steel stacks and chimneys generally are lightweight. As a result, the design loads caused by natural hazards generally are governed by wind. On occasion, large flares or other elevated masses located near the top may require in-depth seismic analysis. Although it does not specifically address seismic loading, Chapter 6 of Troitsky (1990) provides a methodology appropriate for resolution of the seismic forces defined in the standard.

C15.6.4 Special Hydraulic Structures

The most common special hydraulic structures are baffle walls and weirs that are used in water treatment and wastewater treatment plants. Because there are openings in the walls, during normal operations the fluid levels are equal on each side of the wall, exerting no net horizontal force. Sloshing during a seismic event can exert large forces on the wall, as illustrated in Fig. C15.6-1. The walls can fail unless they are designed properly to resist the dynamic fluid forces.

C15.6.5 Secondary Containment Systems

This section reflects the judgment that designing all impoundment dikes for the MCE ground motion when full and sizing all impoundment dikes for the sloshing wave is too conservative. Designing an impoundment

dike as full for the MCE assumes failure of the primary containment and occurrence of a significant aftershock. Such significant aftershocks (of the same magnitude as the MCE ground motion) are rare and do not occur in all locations. Although explicit design for aftershocks is not a requirement of the standard, secondary containment must be designed full for an aftershock to protect the general public. The use of two-thirds of the MCE ground motion as the magnitude of the design aftershock is supported by Bath's law, according to which the maximum expected aftershock magnitude may be estimated to be 1.2 scale units below the main shock magnitude.

The risk assessment and risk management plan described in Section 1.5.2 are used to determine where the secondary containment must be designed full for the MCE. The decision to design secondary containment for this more severe condition should be based on the likelihood of a significant aftershock occurring at the particular site, considering the risk posed to the general public by the release of hazardous material from the secondary containment.

Secondary containment systems must be designed to contain the sloshing wave where the release of liquid would place the general public at risk by exposing them to hazardous materials, by scouring of foundations of adjacent structures, or by causing other damage to adjacent structures.

C15.6.5.1 Freeboard

Eq. (15.6-1) was revised to return to the more exact theoretical formulation for sloshing wave height instead of the rounded value introduced in ASCE/SEI 7-05. The rounded value in part accounted for maximum direction of response effects. Because the ground motion definition in ASCE/SEI 7-10 is changed and the maximum direction of response is now directly accounted for, it is no longer necessary to account for these effects by rounding up the theoretical sloshing wave height factor in Eq. (15.6-1).

C15.6.6 Telecommunication Towers

Telecommunication towers support small masses, and their design generally is governed by wind forces. Although telecommunication towers have a history of experiencing seismic events without failure or significant damage, seismic design in accordance with the standard is required.

Typically bracing elements bolt directly (without gusset plates) to the tower legs, which consist of pipes or bent plates in a triangular plan configuration.

C15.7 TANKS AND VESSELS

C15.7.1 General

Methods for seismic design of tanks, currently adopted by a number of reference documents, have evolved from earlier analytical work by Jacobsen, Housner, Veletsos, Haroun, and others. The procedures used to design flat-bottom storage tanks and liquid containers are based on the work of Housner, Wozniak, and Mitchell. The reference documents for tanks and vessels have specific requirements to safeguard against catastrophic failure of the primary structure based on observed behavior in seismic events since the 1930s. Other methods of analysis, using flexible shell models, have been proposed but at present are beyond the scope of the standard.

The industry-accepted design methods use three basic steps:

1. Dynamic modeling of the structure and its contents. When a liquid-filled tank is subjected to ground acceleration, the lower portion of the contained liquid, identified as the impulsive component of mass, W_i , acts as if it were a solid mass rigidly attached to the tank wall. As this mass accelerates, it exerts a horizontal force, P_i , on the wall; this force is directly proportional to the maximum acceleration of the tank base. This force is superimposed on the inertia force of the accelerating wall itself, P_s . Under the influence of the same ground acceleration, the upper portion of the contained liquid responds as if it were a solid mass flexibly attached to the tank wall. This

portion, which oscillates at its own natural frequency, is identified as the convective component, W_c , and exerts a horizontal force, P_c , on the wall. The convective component oscillations are characterized by sloshing whereby the liquid surface rises above the static level on one side of the tank and drops below that level on the other side.

2. Determination of the period of vibration, T_i , of the tank structure and the impulsive component and determination of the natural period of oscillation (sloshing), T_c , of the convective component.
3. Selection of the design response spectrum. The response spectrum may be site specific, or it may be constructed on the basis of seismic coefficients given in national codes and standards. Once the design response spectrum is constructed, the spectral accelerations corresponding to T_i and T_c are obtained and are used to calculate the dynamic forces P_i , P_s , and P_c .

Detailed guidelines for the seismic design of circular tanks, incorporating these concepts to varying degrees, have been the province of at least four industry reference documents: AWWA D100 for welded steel tanks (since 1964); API 650 for petroleum storage tanks; AWWA D110 for prestressed, wire-wrapped tanks (since 1986); and AWWA D115 for prestressed concrete tanks stressed with tendons (since 1995). In addition, API 650 and API 620 contain provisions for petroleum, petrochemical, and cryogenic storage tanks. The detail and rigor of analysis prescribed in these documents have evolved from a semistatic approach in the early editions to a more rigorous approach at present, reflecting the need to include the dynamic properties of these structures.

The requirements in Section 15.7 are intended to link the latest procedures for determining design-level seismic loads with the allowable stress design procedures based on the methods in the standard. These requirements, which in many cases identify specific substitutions to be made in the design equations of the reference documents, assist users of the standard in making consistent interpretations.

ACI has published ACI 350.3-06 (2006), *Standard Practice for the Seismic Design of Liquid-Containing Concrete Structures*. This document, which addresses all types of concrete tanks (prestressed and nonprestressed, circular, and rectilinear), has provisions that are unfortunately not consistent with the seismic criteria of ASCE/SEI 7-10. However, the document, when combined with the modifications required in Section 15.7.7.3, serves as both a practical “how-to” loading reference and a guide to supplement application of ACI 318 (2011), Chapter 21.

C15.7.2 Design Basis

In the case of the seismic design of nonbuilding structures, standardization requires adjustments to industry reference documents to minimize existing inconsistencies among them, while recognizing that structures designed and built over the years in accordance with these documents have performed well in earthquakes of varying severity. Of the inconsistencies among reference documents, the ones most important to seismic design relate to the base shear equation. The traditional base shear takes the following form:

$$V = \frac{ZIS}{R_w} CW \quad (\text{C15.7-1})$$

An examination of those terms as used in the different references reveals the following:

1. Z, S : The seismic zone coefficient, Z , has been rather consistent among all the documents because it usually has been obtained from the seismic zone designations and maps in the model building codes. However, the soil profile coefficient, S , does vary from one document to another. In some documents, these two terms are combined.
2. I : The importance factor, I , has varied from one document to another, but this variation is unavoidable and understandable because of the multitude of uses and degrees of importance of tanks and vessels.
3. C : The coefficient C represents the dynamic amplification factor that defines the shape of the design response spectrum for any given ground acceleration. Because C is primarily a function of the frequency of vibration, inconsistencies in its derivation from one document to another stem

from at least two sources: differences in the equations for the determination of the natural frequency of vibration, and differences in the equation for the coefficient itself. (For example, for the shell/impulsive liquid component of lateral force, the steel tank documents use a constant design spectral acceleration [constant C] that is independent of the “impulsive” period, T .) In addition, the value of C varies depending on the damping ratio assumed for the vibrating structure (usually between 2% and 7% of critical).

4. Where a site-specific response spectrum is available, calculation of the coefficient C is not necessary except in the case of the convective component (coefficient C_c), which is assumed to oscillate with 0.5% of critical damping and whose period of oscillation is usually long (greater than 2.5 s). Because site-specific spectra are usually constructed for high damping values (3% to 7% of critical) and because the site-specific spectral profile may not be well-defined in the long-period range, an equation for C_c applicable to a 0.5% damping ratio is necessary to calculate the convective component of the seismic force.
5. R_w : The response modification factor, R_w , is perhaps the most difficult to quantify, for a number of reasons. Although R_w is a compound coefficient that is supposed to reflect the ductility, energy-dissipating capacity, and redundancy of the structure, it is also influenced by serviceability considerations, particularly in the case of liquid-containing structures.

In the standard, the base shear equation for most structures has been reduced to $V = C_s W$, where the seismic response coefficient, C_s , replaces the product ZSC/R_w . C_s is determined from the design spectral response acceleration parameters S_{DS} and S_{D1} (at short periods and at a period of 1, respectively), which in turn are obtained from the mapped MCE spectral accelerations S_s and S_1 . As in the case of the prevailing industry reference documents, where a site-specific response spectrum is available, C_s is replaced by the actual values of that spectrum.

The standard contains several bridging equations, each designed to allow proper application of the design criteria of a particular reference document in the context of the standard. These bridging equations associated with particular types of liquid-containing structures and the corresponding reference documents are discussed in the following. Calculation of the periods of vibration of the impulsive and convective components is in accordance with the reference documents, and the detailed resistance and allowable stresses for structural elements of each industry structure are unchanged, except where new information has led to additional requirements.

It is expected that the bridging equations of Sections 15.7.7.3 and 15.7.10.7 will be eliminated as the relevant reference documents are updated to conform to the standard. The bridging equations previously provided for AWWA D100-05 (2006) and API 650 already have been eliminated as a result of updates of these documents.

C15.7.3 Strength and Ductility

As is the case for building structures, ductility and redundancy in the lateral support systems for tanks and vessels are desirable and necessary for good seismic performance. Tanks and vessels are not highly redundant structural systems, and therefore ductile materials and well-designed connection details are needed to increase the capacity of the vessel to absorb more energy without failure. The critical performance of many tanks and vessels is governed by shell stability requirements rather than by yielding of the structural elements. For example, contrary to building structures, ductile stretching of anchor bolts is a desirable energy absorption component where tanks and vessels are anchored. The performance of cross-braced towers is highly dependent on the ability of the horizontal compression struts and connection details to develop fully the tension yielding in the rods. In such cases, it is also important to preclude both premature failure in the threaded portion of the connection and failure of the connection of the rod to the column before yielding of the rod.

The changes made to Section 15.7.3(a) are intended to ensure that anchors and anchor attachments are designed such that the anchor yields (stretches) before the anchor attachment to the structure fails. The

changes also clarify that the anchor rod embedment requirements are to be based on the requirements of Section 15.7.5 and not Section 15.7.3(a).

C15.7.4 Flexibility of Piping Attachments

Poor performance of piping connections (tank leakage and damage) caused by seismic deformations is a primary weakness observed in seismic events. Although commonly used piping connections can impart mechanical loads to the tank shell, proper design in seismic areas results in only negligible mechanical loads on tank connections subject to the displacements shown in Table 15.7-1. API 650 treats the values shown in Table 15.7-1 as allowable stress-based values and therefore requires that these values be multiplied by 1.4 where strength-based capacity values are required for design.

The displacements shown in Table 15.7-1 are based on movements observed during past seismic events. The vertical tank movements listed are caused by stretch of the mechanical anchors or steel tendons (in the case of a concrete tank) for mechanically anchored tanks or the deflection caused by bending of the bottom of self-anchored tanks. The horizontal movements listed are caused by the deformation of the tank at the base.

In addition, interconnected equipment, walkways, and bridging between multiple tanks must be designed to resist the loads and accommodate the displacements imposed by seismic forces. Unless connected tanks and vessels are founded on a common rigid foundation, the calculated differential movements must be assumed to be out of phase.

C15.7.5 Anchorage

Many steel tanks can be designed without anchors by using annular plate detailing in accordance with reference documents. Where tanks must be anchored because of overturning potential, proper anchorage design provides both a shell attachment and an embedment detail that allows the bolt to yield without tearing the shell or pulling the bolt out of the foundation. Properly designed anchored tanks have greater reserve strength to resist seismic overload than do unanchored tanks.

To ensure that the bolt yields (stretches) before failure of the anchor embedment, the anchor embedment must be designed in accordance with ACI 318 (2011), Appendix D, Eq. (D-3), and must be provided with a minimum gauge length of eight bolt diameters. Gauge length is the length of the bolt that is allowed to stretch. It may include part of the embedment length into the concrete that is not bonded to the bolt. A representation of gauge length is shown in Fig. C15.7-1.

It is also important that the bolt not be significantly oversized to ensure that the bolt stretches. The prohibition on using the load combinations with overstrength of Section 12.4.3 is intended to accomplish this goal.

Where anchor bolts and attachments are misaligned such that the anchor nut or washer does not bear evenly on the attachment, additional bending stresses in threaded areas may cause premature failure before anchor yielding.

C15.7.6 Ground-Supported Storage Tanks for Liquids

C15.7.6.1 General

The response of ground storage tanks to earthquakes is well documented by Housner, Mitchell and Wozniak, Veletsos, and others. Unlike building structures, the structural response of these tanks is influenced strongly by the fluid–structure interaction. Fluid–structure interaction forces are categorized as sloshing (convective) and rigid (impulsive) forces. The proportion of these forces depends on the geometry (height-to-diameter ratio) of the tank. API 650 (2011), API 620 (2010), AWWA D100-05 (2006), AWWA D110 (2004), AWWA D115 (2006), and ACI 350.3 (2006) provide the data necessary to determine the relative masses and moments for each of these contributions.

The standard requires that these structures be designed in accordance with the prevailing reference documents, except that the height of the sloshing wave, δ_s , must be calculated using Eq. (15.7-13). API 650 (2011) and AWWA D100-05 (2006) include this requirement in their latest editions.

Eqs. (15.7-10) and (15.7-11) provide the spectral acceleration of the sloshing liquid for the constant-velocity and constant-displacement regions of the response spectrum, respectively. The 1.5 factor in these equations is an adjustment for 0.5% damping. An exception in the use of Eq. (15.7-11) was added for the 2010 edition of this standard. The mapped values of T_L were judged to be unnecessarily conservative by the ASCE 7 Seismic Subcommittee in light of actual site-specific studies carried out since the introduction of the T_L requirements of ASCE/SEI 7-05. These studies indicate that the mapped values of T_L appear to be very conservative based on observations during recent large earthquakes, especially the 2010 M_w 8.8 Chilean earthquake, where the large amplifications at very long periods (6–10 s) were not evident either in the ground motion records or in the behavior of long-period structures (particularly sloshing in tanks). Because a revision of the T_L maps is a time-consuming task that would not be possible during the 2010 update cycle, an exception was added to allow the use of site-specific values that are less than the mapped values with a floor of 4 s or one-half the mapped value of T_L . The exception was added under Section 15.7.6 because, for nonbuilding structures, the overly conservative values for T_L are primarily an issue for tanks and vessels. Discussion of the site-specific procedures can be found in the Commentary for Chapter 22.

Small-diameter tanks and vessels are more susceptible to overturning and vertical buckling. As a general rule, a greater ratio of H/D produces lower resistance to vertical buckling. Where H/D is greater than 2, overturning approaches “rigid mass” behavior (the sloshing mass is small). Large-diameter tanks may be governed by additional hydrodynamic hoop stresses in the middle regions of the shell.

The impulsive period (the natural period of the tank components and the impulsive component of the liquid) is typically in the 0.25–0.6 s range. Many methods are available for calculating the impulsive period. The Veletsos flexible-shell method is commonly used by many tank designers. For example, see Veletos (1974) and Malhotra et al. (2000).

C15.7.6.1.1 Distribution of Hydrodynamic and Inertia Forces

Most of the reference documents for tanks define reaction loads at the base of the shell–foundation interface, without indicating the distribution of loads on the shell as a function of height. ACI 350.3 (2006) specifies the vertical and horizontal distribution of such loads.

The overturning moment at the base of the shell in the industry reference documents is only the portion of the moment that is transferred to the shell. The total overturning moment also includes the variation in bottom pressure, which is an important consideration for design of pile caps, slabs, or other support elements that must resist the total overturning moment. Wozniak and Mitchell (1978) and U.S. Department of Energy TID-7024 (1963) provide additional information.

C15.7.6.1.2 Sloshing

In past earthquakes, sloshing contents in ground storage tanks have caused both leakage and noncatastrophic damage to the roof and internal components. Even this limited damage and the associated costs and inconvenience can be significantly mitigated where the following items are considered:

1. Effective masses and hydrodynamic forces in the container;
2. Impulsive and pressure loads at
 - a. The sloshing zone (that is, the upper shell and edge of the roof system);
 - b. The internal supports (such as roof support columns and tray supports); and
 - c. The internal equipment (such as distribution rings, access tubes, pump wells, and risers); and
3. Freeboard (which depends on the sloshing wave height).

When no freeboard is required, a minimum freeboard of $0.7 \delta_s$ is recommended for economic considerations. Freeboard is always required for tanks assigned to Risk Category IV.

Tanks and vessels storing biologically or environmentally benign materials typically do not require freeboard to protect the public health and safety. However, providing freeboard in areas of frequent seismic occurrence for vessels normally operated at or near top capacity may lessen damage (and the cost of subsequent repairs) to the roof and upper container.

The sloshing wave height specified in Section 15.7.6.1.2 is based on the design earthquake defined in the standard. For economic reasons, freeboard for tanks assigned to Risk Category I, II, or III may be calculated using a fixed value of T_L equal to 4 s (as indicated in Section 15.7.6.1, note 4) but using the appropriate importance factor taken from Table 1.5-2. Because of life-safety concerns, freeboard for tanks assigned to Risk Category IV must be based on the mapped value of T_L . Because use of the mapped value of T_L results in the theoretical maximum value of freeboard, the calculation of freeboard in the case of Risk Category IV tanks is based on an importance factor equal to 1.0 (as indicated in Section 15.7.6.1, note 3).

If the freeboard provided is less than the computed sloshing height, δ_s , the sloshing liquid impinges on the roof in the vicinity of the roof-to-wall joint, subjecting it to a hydrodynamic force. This force may be approximated by considering the sloshing wave as a hypothetical static liquid column having a height, δ_s . The pressure exerted at any point along the roof at a distance y_s above the at-rest surface of the stored liquid may be assumed to be equal to the hydrostatic pressure exerted by the hypothetical liquid column at a distance $\delta_s - y_s$ from the top of that column. A better approximation of the pressure exerted on the roof is found in Malhotra (2005 and 2006).

Another effect of a less-than-full freeboard is that the restricted convective (sloshing) mass “converts” into an impulsive mass, thus increasing the impulsive forces. This effect should be taken into account in the tank design. A method for converting the restricted convective mass into an impulsive mass is found in Malhotra (2005 and 2006). It is recommended that sufficient freeboard to accommodate the full sloshing height be provided wherever possible.

Eq. (15.7-13) was revised to use the theoretical formulation for sloshing wave height instead of the rounded value introduced in ASCE/SEI 7-05. The rounded value of Eq. (15.6-1) increased the required freeboard by approximately 19%, thereby significantly increasing the cost of both secondary containment and large-diameter, ground-supported storage tanks. See Section C15.6.5.1 for additional commentary on freeboard.

C15.7.6.1.4 Internal Elements

Wozniak and Mitchell (1978) provide a recognized analysis method for determining the lateral loads on internal components caused by sloshing liquid.

C15.7.6.1.5 Sliding Resistance

Historically, steel ground-supported tanks full of product have not slid off foundations. A few unanchored, empty tanks or bulk storage tanks without steel bottoms have moved laterally during earthquake ground shaking. In most cases, these tanks may be returned to their proper locations. Resistance to sliding is obtained from the frictional resistance between the steel bottom and the sand cushion on which bottoms are placed. Because tank bottoms usually are crowned upward toward the tank center and are constructed of overlapping, fillet-welded, individual steel plates (resulting in a rough bottom), it is reasonably conservative to take the ultimate coefficient of friction on concrete as 0.70 (AISC 1986), and therefore a value of $\tan 30^\circ$ ($= 0.577$) for sand is used in design. The value of 30° represents the internal angle of friction of sand and is conservatively used in design. The vertical weight of the tank and contents, as reduced by the component of vertical acceleration, provides the net vertical load. An orthogonal combination of vertical and horizontal seismic forces, following the procedure in Section 12.5.3, may be used. In recent years, a significant issue has been the prevention of subsurface pollution caused by tank bottom corrosion and leakage. To prevent this problem, liners are often used with the tank foundation. When some of these liners are used, sliding of

the tank and/or foundation caused by the seismic base shear may be an issue. If the liner is completely contained within a concrete ring-wall foundation, the liner's surface is not the critical plane to check for sliding. If the liner is placed within an earthen foundation or is placed above or completely below a concrete foundation, it is imperative that sliding be evaluated. It is recommended that the sliding resistance factor of safety be at least 1.5.

C15.7.6.1.6 Local Shear Transfer

The transfer of seismic shear from the roof to the shell and from the shell to the base is accomplished by a combination of membrane shear and radial shear in the wall of the tank. For steel tanks, the radial (out-of-plane) seismic shear is very small and usually is neglected; thus, the shear is assumed to be resisted totally by membrane (in-plane) shear. For concrete walls and shells, which have a greater radial shear stiffness, the shear transfer may be shared. The ACI 350.3 (2006) commentary provides further discussion.

C15.7.6.1.7 Pressure Stability

Internal pressure may increase the critical buckling capacity of a shell. Provision to include pressure stability in determining the buckling resistance of the shell for overturning loads is included in AWWA D100-05 (2006). Recent testing on conical and cylindrical shells with internal pressure yielded a design methodology for resisting permanent loads in addition to temporary wind and seismic loads (Miller et al. 1997).

C15.7.6.1.8 Shell Support

Anchored steel tanks should be shimmed and grouted to provide proper support for the shell and to reduce impact on the anchor bolts under reversible loads. The high bearing pressures on the toe of the tank shell may cause inelastic deformations in compressible material (such as fiberboard), creating a gap between the anchor and the attachment. As the load reverses, the bolt is no longer snug and an impact of the attachment on the anchor can occur. Grout is a structural element and should be installed and inspected as an important part of the vertical and lateral force-resisting system.

C15.7.6.1.9 Repair, Alteration, or Reconstruction

During their service lives, storage tanks are frequently repaired, modified, or relocated. Repairs often are related to corrosion, improper operation, or overload from wind or seismic events. Modifications are made for changes in service, updates to safety equipment for changing regulations, or installation of additional process piping connections. It is imperative that these repairs and modifications be designed and implemented properly to maintain the structural integrity of the tank or vessel for seismic loads and the design operating loads.

The petroleum steel tank industry has developed specific guidelines in API 653 (2010) that are statutory requirements in some states. It is recommended that the provisions of API 653 also be applied to other liquid storage tanks (e.g., water, wastewater, and chemical) as it relates to repairs, modifications, or relocation that affect the pressure boundary or lateral force-resisting system of the tank or vessel.

C15.7.7 Water Storage and Water Treatment Tanks and Vessels

The AWWA design requirements for ground-supported steel water storage structures use allowable stress design procedures that conform to the requirements of the standard.

C15.7.7.3 Reinforced and Prestressed Concrete

A review of ACI 350.3-06 (2006), *Seismic Design of Liquid-Containing Concrete Structures and Commentary*, revealed that this document is not in general agreement with the seismic provisions of ASCE/SEI 7.

This section was clarified to note that the importance factor, I , and the response modification factor, R , are to be specified by ASCE/SEI 7 and not the reference document. The descriptions used in ACI 350.3-06 (2006) to determine the applicable values of the importance factor and response modification factor do not match those used in ASCE/SEI 7.

It was noted that the ground motions for determining the convective (sloshing) seismic forces specified in ACI 350.3-06 (2006) were not the same and are actually lower than those specified by ASCE/SEI 7. ACI 350.3 essentially redefines the long-period transition period, T_L . This alternate transition period allows large-diameter tanks to have significantly lower convective forces and lower seismic freeboard than those permitted by the provisions of ASCE/SEI 7. Therefore, Section 15.7.7.3 was revised to require that the convective acceleration be determined according to the procedure found in Section 15.7.6.1.

It was also noted that the vertical ground motions specified in ACI 350.3-06 (2006) were not the same as those specified by ASCE/SEI 7. Therefore, appropriate modifications to ACI 350.3, Section 9.4.3, were introduced.

C15.7.8 Petrochemical and Industrial Tanks and Vessels Storing Liquids

C15.7.8.1 Welded Steel

The American Petroleum Institute (API) uses an allowable stress design procedure that conforms to the requirements of the standard.

The most common damage to tanks observed during past earthquakes includes the following:

1. Buckling of the tank shell near the base because of excessive axial membrane forces. This buckling damage is usually evident as “elephant foot” buckles a short distance above the base or as diamond-shaped buckles in the lower ring. Buckling of the upper ring also has been observed.
2. Damage to the roof caused by impingement on the underside of the roof of sloshing liquid with insufficient freeboard.
3. Failure of piping or other attachments that are overly restrained.
4. Foundation failures.

Other than the above damage, the seismic performance of floating roofs during earthquakes has generally been good, with damage usually confined to the rim seals, gauge poles, and ladders. However, floating roofs have sunk in some earthquakes because of lack of adequate freeboard or the proper buoyancy and strength required by API 650 (2011). Similarly, the performance of open-top tanks with top wind girder stiffeners designed per API 650 has been generally good.

C15.7.8.2 Bolted Steel

Bolted steel tanks are often used for temporary functions. Where use is temporary, it may be acceptable to the jurisdictional authority to design bolted steel tanks for no seismic loads or for reduced seismic loads based on a reduced return period. For such reduced loads based on reduced exposure time, the owner should include a signed removal contract with the fixed removal date as part of the submittal to the authority having jurisdiction.

C15.7.9 Ground-Supported Storage Tanks for Granular Materials

C15.7.9.1 General

The response of a ground-supported storage tank storing granular materials to a seismic event is highly dependent on its height-to-diameter (H/D) ratio and the characteristics of the stored product. The effects of intergranular friction are described in more detail in Section C15.7.9.3.1 (increased lateral pressure), C15.7.9.3.2 (effective mass), and C15.7.9.3.3 (effective density).

Long-term increases in shell hoop tension because of temperature changes after the product has been compacted also must be included in the analysis of the shell; Anderson (1966) provides a suitable method.

C15.7.9.2 Lateral Force Determination

Seismic forces acting on ground-supported liquid storage tanks are divided between impulsive and convective (sloshing) components. However, in a ground-supported storage tank for granular materials, all seismic forces are of the impulsive type and relate to the period of the storage tank itself. Because of the relatively short period of a tank shell, the response is normally in the constant acceleration region of the response spectrum, which relates to S_{DS} . Therefore, the seismic base shear is calculated as follows:

$$V = \frac{S_{DS}}{\left(\frac{R}{I}\right)} W_{\text{Effective}} \quad (\text{C15.7-2})$$

where V , S_{DS} , I , and R have been previously defined, and $W_{\text{effective}}$ is the gross weight of the stored product multiplied by an effective mass factor and an effective density factor, as described in Sections C15.7.9.3.2 and C15.7.9.3.3, plus the dead weight of the tank. Unless substantiated by testing, it is recommended that the product of the effective mass factor and the effective density factor be taken as no less than 0.5 because of the limited test data and the highly variable properties of the stored product.

C15.7.9.3 Force Distribution to Shell and Foundation

C15.7.9.3.1 Increased Lateral Pressure

In a ground-supported tank storing granular materials, increased lateral pressures develop as a result of rigid body forces that are proportional to ground acceleration. Information concerning design for such pressure is scarce. Trahair et al. (1983) describe both a simple, conservative method and a difficult, analytical method using failure wedges based on the Mononobe–Okabe modifications of the classical Coulomb method.

C15.7.9.3.2 Effective Mass

For ground-supported tanks storing granular materials, much of the lateral seismic load can be transferred directly into the foundation, via intergranular shear, before it can reach the tank shell. The effective mass that loads the tank shell is highly dependent on the H/D ratio of the tank and the characteristics of the stored product. Quantitative information concerning this effect is scarce, but Trahair et al. (1983) describe a simple, conservative method to determine the effective mass. That method presents reductions in effective mass, which may be significant, for H/D ratios less than 2. This effect is absent for elevated tanks.

C15.7.9.3.3 Effective Density

Granular material stored in tanks (both ground-supported and elevated) does not behave as a solid mass. Energy loss through intergranular movement and grain-to-grain friction in the stored material effectively reduces the mass subject to horizontal acceleration. This effect may be quantified by an effective density factor less than 1.0.

Based on Chandrasekaran and Jain (1968) and on shake-table tests reported in Chandrasekaran et al. (1968), ACI 313 (1997) recommends an effective density factor of not less than 0.8 for most granular materials. According to Chandrasekaran and Jain (1968), an effective density factor of 0.9 is more appropriate for materials with high moduli of elasticity, such as aggregates and metal ores.

C15.7.9.3.4 Lateral Sliding

Most ground-supported steel storage tanks for granular materials rest on a base ring and do not have a steel bottom. To resist seismic base shear, a partial bottom or annular plate is used in combination with anchor bolts or a curb angle. An annular plate can be used alone to resist the seismic base shear through friction between the plate and the foundation, in which case the friction limits of Section 15.7.6.1.5 apply. The curb

angle detail serves to keep the base of the shell round while allowing it to move and flex under seismic load. Various base details are shown in Fig. 13 of Kaups and Lieb (1985).

C15.7.9.3.5 Combined Anchorage Systems

This section is intended to apply to combined anchorage systems that share loads based on their relative stiffnesses, and not to systems where sliding is resisted completely by one system (such as a steel annular plate) and overturning is resisted completely by another system (such as anchor bolts).

C15.7.10 Elevated Tanks and Vessels for Liquids and Granular Materials

C15.7.10.1 General

The three basic lateral load-resisting systems for elevated water tanks are defined by their support structure:

1. Multileg braced steel tanks (trussed towers, as shown in Fig. C15.7-2);
2. Small-diameter, single-pedestal steel tanks (cantilever columns, as shown in Fig. C15.7-3); and
3. Large-diameter, single-pedestal tanks of steel or concrete construction (load-bearing shear walls, as shown in Fig. C15.7-4).

Unbraced multileg tanks are uncommon. These types of tanks differ in their behavior, redundancy, and resistance to overload. Multileg and small-diameter pedestal tanks have longer fundamental periods (typically greater than 2 s) than the shear wall type tanks (typically less than 2 s). The lateral load failure mechanisms usually are brace failure for multileg tanks, compression buckling for small-diameter steel tanks, compression or shear buckling for large-diameter steel tanks, and shear failure for large-diameter concrete tanks. Connection, welding, and reinforcement details require careful attention to mobilize the full strength of these structures. To provide a greater margin of safety, R factors used with elevated tanks typically are less than those for other comparable lateral load-resisting systems.

C15.7.10.4 Transfer of Lateral Forces into Support Tower

The vertical loads and shears transferred at the base of a tank or vessel supported by grillage or beams typically vary around the base because of the relative stiffness of the supports, settlements, and variations in construction. Such variations must be considered in the design for vertical and horizontal loads.

C15.7.10.5 Evaluation of Structures Sensitive to Buckling Failure

Nonbuilding structures that are designed with limited structural redundancy for lateral loads may be susceptible to total failure when loaded beyond the design loads. This phenomenon is particularly true for shell-type structures that exhibit unstable postbuckling behavior, such as tanks and vessels supported on shell skirts or pedestals. Evaluation for this critical condition ensures stability of the nonbuilding structure for governing design loads.

The design spectral response acceleration, S_a , used in this evaluation includes site factors. The I/R coefficient is taken as 1.0 for this critical check. The structural capacity of the shell is taken as the critical buckling strength (that is, the factor of safety is 1.0). Vertical and orthogonal combinations need not be considered for this evaluation because the probability of peak values occurring simultaneously is very low.

The intent of Section 15.7.10.5 and Table 15.4-2 is that skirt-supported vessels must be checked for seismic loads based on $I_e/R = 1.0$ if the structure falls in Risk Category IV or if an R value of 3.0 is used in the design of the vessel. For the purposes of this section, a skirt is a thin-walled steel cylinder or cone used to support the vessel in compression. Skirt-supported vessels fail in buckling, which is not a ductile failure mode. Therefore, a more conservative design approach is required. The $I_e/R = 1.0$ check typically governs the design of the skirt over using loads determined with an R factor of 3 in a moderate to high area of seismic activity. The only benefit of using an R factor of 3 in this case is in the design of the foundation. The foundation is not required to be designed for the $I_e/R = 1.0$ load. Section 15.7.10.5, item b, states that

resistance of the structure shall be defined as the critical buckling resistance of the element for the $I_{e/R} = 1.0$ load. This stipulation means that the support skirt can be designed based on critical buckling (factor of safety of 1.0). The critical buckling strength of a skirt can be determined using a number of published sources. The two most common methods for determining the critical buckling strength of a skirt are the 2007 ASME BVPC, Section VIII, Division 2, 2008 Addenda, Paragraph 4.4, using a factor of safety of 1.0 and AWWA D100-05 (2006), Section 13.4.3.4. To use these methods, the radius, length, and thickness of the skirt, modulus of elasticity of the steel, and yield strength of the steel are required. These methods take into account both local buckling and slenderness effects of the skirt. Under no circumstance should the theoretical buckling strength of a cylinder, found in many engineering mechanics texts, be used to determine the critical buckling strength of the skirt. The theoretical value, based on a perfect cylinder, does not take into account imperfections built into real skirts. The theoretical buckling value is several times greater than the actual value measured in tests. The buckling values found in the suggested references above are based on actual tests.

Examples of applying the 2007 ASME BVPC, Section VIII, Division 2, 2008 Addenda, Paragraph 4.4, and AWWA D100-05 (2006), Section 13.4.3.4, buckling rules are shown in Fig. Ex-1.

**Example Problem 1. 2007 ASME BPVC, Section VIII, Division 2, 2008 Addenda, Paragraph 4.4
Vessel Period**

$$T = \frac{7.78 \left(\frac{H}{D}\right)^2}{10^6} \sqrt{\frac{12wD}{t}} = \frac{7.78 \left(\frac{100}{10}\right)^2}{10^6} \sqrt{\frac{12 \left(\frac{300,000}{100}\right) 10}{0.625}}$$

$$= 0.591 \text{ s}$$

Determine C_s per ASCE/SEI 7-10, Section 12.8.1.1, with $I/R = 1.0$

$$T_i \leq T_s \Rightarrow C_s = S_{DS} = 0.733$$

$$\text{Base shear, } V, = 0.733(300) = 219.9 \text{ kip}$$

$$\text{Per ASCE/SEI 7-10, Section 12.8.3, for } T = 0.591 \text{ s, } k = 1.045$$

$$\text{Centroid for a distributed mass cantilever structure} = [(k+1)/(k+2)]H = 67.16 \text{ ft}$$

$$\text{Overturning moment} = 219.9(67.16) = 14,768 \text{ ft-kip}$$

Determine Stresses at Base of Skirt

$$\text{Axial stress} = P/A = 300,000/(\pi(10)12(0.625)) = 1,274 \text{ lb/in.}^2$$

$$\text{Bending stress} = M/S = 14,768(1,000)12/[(0.625)\pi(10(12))^2/4] = 25,072 \text{ lb/in.}^2$$

Example Problem 2. AWWA D100-05, Section 13.4.3.4

Seismic Information

$$S_S = 0.162, S_1 = 0.077$$

$$\text{Site Class C, } F_a = 1.2, F_v = 1.7$$

$$S_{DS} = 0.130, S_{D1} = 0.087, T_L = 12 \text{ s}$$

Risk Category IV

$$T_s = 0.674 \text{ s}$$

Tank Information

Structure Period $T_i = 3.88$ s

Class 2 Material: A36 ($F_y = 36$ kip/in.²)

Skirt angle (from vertical) = 15 deg

Weight of tank and water, $W_w = 4,379$ kip

Weight of tank, tower, and water, $W_T = 4,502$ kip

$KL/r = 50$

Determine S_{ai} per AWWA D100-05, Section 13.2.7.2

$$T_s < T_i \leq T_L \Rightarrow S_{ai} = S_{D1}/T_i = 0.087/3.88 = 0.0225$$

Determine Critical Buckling Acceleration ($I_e/1.4 R_i = 1$)

Per Section 13.4.3.4, $A_i = S_{ai}$ for critical buckling check (A_i in AWWA D100-05 (2006) is the same as C_s in ASCE/SEI 7)

$$A_i = 0.0225$$

Lateral Displacement Caused by S_{ai} (P- Δ)

The final deflected position of the water centroid is an iterative process and must account for the additional moment applied to the structure because of the P- Δ effect. The deflection from the critical buckling deflection is equal to 3.89 in.

Check Skirt at Base of Tower

Seismic overturning moment at base of tower without P- Δ = 11,928 ft-kip (includes mass of tower).

Seismic overturning moment at base of tower with P- Δ = 11,928 ft-kip + 4,379 kip \times 3.89 in./12 in.
per ft

$$= 13,348 \text{ ft-kip}$$

$$\text{Area of skirt} = \pi(26 \times 12)(0.625) = 612.6 \text{ in.}^2$$

$$\text{Section modulus of skirt} = \pi(26 \times 12)^2/4 \times 0.625 = 47,784 \text{ in.}^3$$

$$\text{Skirt stress caused by axial load} = 4,502(1,000)/(612.6 \times \cos 15) = 7,608 \text{ lb/in.}^2$$

$$\text{Skirt stress caused by moment} = 13,348(12)(1000)/(47,784 \times \cos 15) = 3,470 \text{ lb/in.}^2$$

Input Data for ASME Section VIII, Div. 2 Buckling Checks (Paragraph 4.4)

Input Values		
COURSE =	Skirt	
t = thickness of vessel section =	0.625	in
H _T = top elevation of course =	120	in
H _B = bottom elevation of course =	0	in
D _o = outer diameter of vessel section =	120	in
E _y = material modulus of elasticity =	29000000	psi
S _y = material yield strength =	36000	psi
P _{ext} = external pressure =	0.000	psi
f _a = axial comp membrane stress from axial load =	1274	psi
f _b = axial comp membrane stress from bending =	25072	psi
V = net section shear force =	219900	lbs
V _{phi} = applied shear force angle =	90	deg.
C _m = coefficient =	1	0.85, 1.0, or 6.0 – 0.4 (M ₁ /M ₂)
K _u = effective length factor =	2.1	Free-fixed
L _u = maximum laterally unbraced length =	1200	in
L = design length vessel section for external pressure =	120	in
L = design length vessel section for axial compression =	120	in
FS = Input Factor of Safety =	1.0	
Calculated Values		
R _o = outer radius of shell section =	60	in
R = radius of centerline of shell =	59.6875	in
R _m = vessel mean radius =	59.6875	in
r = radius of gyration of cyl = (1/4)(D _o ² +D _i ²)0.5 =	42.2	in
A = Cross sectional area of cylinder =	234.4	in ²
f _q = axial compressive membrane stress = PπD _i ² /4A =	0.0	psi

Determine Critical Buckling Stress

$$R = 13 \times 12 / \cos 15 = 161.5 \text{ in.}$$

$$t/R = 0.625/161.5 = 0.0039$$

For Class 2 material, $KL/r = 50$, and $t/R = 0.0039$, determine allowable axial compressive stress, F_a , from Table 13 of AWWA D100-05 (2006).

$$F_a = 9,882 \text{ lb/in.}^2$$

Per AWWA D100-05, Section 13.4.3.4,

$$\text{Critical buckling stress} = 2F_a = 19,764 \text{ lb/in.}^2$$

For Class 2 material and $t/R = 0.0039$, determine allowable bending compressive stress, F_b , from Table 11 of AWWA D100-05.

$$F_b = F_L = 10,380 \text{ lb/in.}^2$$

Per AWWA D100-05, Section 13.4.3.4,

$$\text{Critical bending stress} = 2F_b = 20,760 \text{ lb/in.}^2$$

Check unity per AWWA D100-05, Section 3.3.1:

$$7,608/19,764 + 3,470/20,760 = 0.552 \leq 1.0 \text{ OK}$$

C15.7.10.7 Concrete Pedestal (Composite) Tanks

A composite elevated water-storage tank is composed of a welded steel tank for watertight containment, a single-pedestal concrete support structure, a foundation, and accessories. The lateral load-resisting system is a load-bearing concrete shear wall. Because the seismic provisions in ACI 371R (1998) are based on an older edition of ASCE/SEI 7, appropriate bridging equations are provided in Section 15.7.10.7.

C15.7.11 Boilers and Pressure Vessels

The support system for boilers and pressure vessels must be designed for the seismic forces and displacements presented in the standard. Such design must include consideration of the support, the attachment of the support to the vessel (even if “integral”), and the body of the vessel itself, which is subject to local stresses imposed by the support connection.

C15.7.12 Liquid and Gas Spheres

The commentary in Section C15.7.11 also applies to liquid and gas spheres.

C15.7.13 Refrigerated Gas Liquid Storage Tanks and Vessels

Even though some refrigerated storage tanks and vessels, such as those storing liquefied natural gas, are required to be designed for ground motions and performance goals in excess of those found in the standard, all such structures must also meet the requirements of this standard as a minimum. All welded steel refrigerated storage tanks and vessels must be designed in accordance with the requirements of the standard and the requirements of API 620.

4.4.12 Combined Loadings and Allowable Compressive Stresses (continued)

b) Axial Compressive Stress Acting Alone – The allowable axial compressive membrane stress of a cylinder subject to an axial compressive load acting alone, F_{xa} is computed by the following equations.

1) For $\lambda_{dc} \leq 0.15$ (Local Buckling)

$$F_{xa} = \min [F_{xa1}, F_{xa2}] \quad (4.4.61)$$

$$F_{xa1} = S_y/FS \quad \text{for } D_o/t \leq 135 \quad (4.4.62)$$

$$F_{xa1} = 466S_y/[(331 + D_o/t) FS] \quad \text{for } 135 < D_o/t < 600 \quad (4.4.63)$$

$$F_{xa1} = 0.5 S_y/FS \quad \text{for } D_o/t \geq 600 \quad (4.4.64)$$

$$F_{xa2} = F_{xe}/FS \quad (4.4.65)$$

where: $F_{xe} = C_x E_y t / D_o \quad (4.4.66)$

$$C_x = \min[409c/[389 + D_o/t], 0.9] \quad \text{for } D_o/t < 1247 \quad (4.4.67)$$

$$C_x = 0.25 c \quad \text{for } 1247 \leq D_o/t \leq 2000 \quad (4.4.68)$$

$$c = 2.64 \quad \text{for } M_x \leq 1.5 \quad (4.4.69)$$

$$c = 3.13/M_x^{0.42} \quad \text{for } 1.5 < M_x < 15 \quad (4.4.70)$$

$$c = 1.0 \quad \text{for } M_x \geq 15 \quad (4.4.71)$$

$$M_x = L/(R_o t)^{1/2} \quad (4.4.124)$$

where L is the design length of a vessel section between lines of support

$$D_o/t = 192.00 \quad 135 < D_o/t < 600$$

$$M_x = L/(R_o t)^{1/2} = 19.60 > 15 \quad C = 1.0000$$

$$D_o/t < 1247 \quad C_x = \min [409c/[389 + D_o/t], 0.9] = .7039587 \quad (4.4.67)$$

$$F_{xe} = C_x E_y t / D_o = 106,237 \text{ psi} \quad (4.4.66)$$

Calculate F_{xa1}

$$F_{ic} = 466 * S_y / (331 + D_o/t) = 32076 \text{ psi}$$

$$\text{Use Input FS} = 1.00$$

$$F_{xa1} = 466 * S_y / (331 + D_o/t * FS) = 32076 \text{ psi}$$

Calculate F_{xa2}

$$F_{ic} = 106,327 \text{ psi}$$

$$\text{Use Input FS} = 1.0$$

$$F_{xa2} = F_{xe} / FS = 106,327 \text{ psi} \quad (4.4.65)$$

Calculate F_{xa}

$$F_{xa} = \min [F_{xa1}, F_{xa2}] = 32,076 \text{ psi}$$

$$\lambda_{dc} = (K)(L_u)/[(\pi)(r_g)][(F_{xa})(FS)/E]^{0.5} = 0.6321 \quad 0.15 < \lambda < 1.147$$

2) For $\lambda_{dc} > 0.15$ and $K_u L_u / r_g < 200$ (Column Buckling)

$$F_{ca} = F_{xa} [1 - 0.74(\lambda_{dc} - 0.15)]^{0.3} \quad \text{for } 0.15 < \lambda_{dc} \leq 1.147 \quad (4.4.72)$$

$$F_{ca} = 0.88 F_{xa} / (\lambda_{dc})^2 \quad \text{for } \lambda_{dc} \geq 1.147 \quad (4.4.73)$$

$$K L_u / r_g = 59.7 < 200$$

$\lambda_{dc} > 0.15$ and $K L_u / r < 200$ therefore:

$$F_{ca} = F_{xa} [1 - 0.74(\lambda - 0.15)]^{0.3} = 28,100 \text{ psi}$$

4.4.12 Combined Loadings and Allowable Compressive Stresses (continued)

c) Compressive Bending Stress – The allowable axial compressive membrane stress of a cylindrical shell subject to a bending moment acting across the full circular section F_{ba} is computed using the following equations.

$$F_{ba} = F_{xa} \quad \text{for } 135 \leq D_o/t \leq 2000 \quad (4.4.74)$$

$$F_{ba} = 466S_y / [(331 + D_o/t)FS] \quad \text{for } 100 \leq D_o/t < 135 \quad (4.4.75)$$

$$F_{ba} = 1.081S_y/FS \quad \text{for } D_o/t < 100 \text{ and } y \geq 0.11 \quad (4.4.76)$$

$$F_{ba} = (1.4 - 2.9y)S_y/FS \quad \text{for } D_o/t < 100 \text{ and } y < 0.11 \quad (4.4.77)$$

$$\text{where: } y = S_y D_o / E_y t \quad (4.4.78)$$

$$D_o/t = 192$$

$$y = S_y D_o / E_y t = 0.2383$$

$$F_{ic} = F_{xa}$$

$$F_{ic} = 32.076 \text{ psi}$$

$D_o/t = 192.000 > 135$ (see sect 3.1.1) Use Input FS = 1.0

$$F_{ba} = F_{xa} = 32,076 \text{ psi}$$

d) Shear Stress – The allowable shear stress of cylindrical shell F_{va} is computed using the following equations.

$$F_{va} = n_v F_{ve} / FS \quad (4.4.79)$$

where: $F_{ve} = a_v C_v E t / D_o \quad (4.4.80)$

$$C_v = 4.454 \quad \text{for } M_x \leq 1.5 \quad (4.4.81)$$

$$C_v = (9.64/M_x^2)(1 + 0.0239M_x^3)^{1/2} \quad \text{for } 1.5 < M_x < 26 \quad (4.4.82)$$

$$C_v = 1.492/(M_x)^{1/2} \quad \text{for } 26 \leq M_x < 4.347D_o/t \quad (4.4.83)$$

$$C_v = 0.716(t/D_o)^{1/2} \quad \text{for } M_x \geq 4.347D_o/t \quad (4.4.84)$$

$$a_v = 0.8 \quad \text{for } D_o/t \leq 500 \quad (4.4.85)$$

$$a_v = 1.389 - 0.218 \log_{10}(D_o/t) \quad \text{for } D_o/t > 500 \quad (4.4.86)$$

$$n_v = 1.0 \quad \text{for } F_{ve}/S_y < 0.48 \quad (4.4.87)$$

$$n_v = 0.43S_y/F_{ve} + 0.1 \quad \text{for } 0.48 < F_{ve}/S_y < 1.7 \quad (4.4.88)$$

$$N_v = 0.6 S_y/F_{ve} \quad \text{for } F_{ve}/S_y > 1.7 \quad (4.4.89)$$

$$D_o/t = 192.00$$

$$M_x = L/(R_o t)^{0.5} = 19.596$$

$$1.5 < M_x < 26 \quad C_v = (9.64/M_x^2) * (1 + 0.0239 * M_x^3)^{0.5} = 0.3376$$

$$D_o/t < 500$$

$$F_{ve} = a_v C_v E t / D_o = 40,793 \text{ psi}$$

$$a_v = 0.8000$$

$$F_{ve}/S_y = 1.13$$

$$0.48 < F_{ve}/S_y < 1.7$$

$$N_v = 0.43S_y/F_{ve} + 0.1 = 0.4795$$

$$F_{ic} = 19,559 \text{ psi}$$

Use Input FS = 1.000

Use Input FS = 1.000

$$F_{va} = n_v F_{ve} / FS = 19,559 \text{ psi}$$

4.4.12 Combined Loadings and Allowable Compressive Stresses (continued)

i) Axial Compressive Stress, Compressive Bending Stress and Shear – the allowable compressive stress for the combination of uniform axial compression, axial compression due to bending, and shear in the absence of hoop compression.

$$\text{Let } K_s = 1 - (f_v/F_{va})^2 \quad (4.4.105)$$

$$\text{For } 0.15 < (\lambda_{dc}) < 1.2 \\ \lambda_{dc} = 0.63 \quad (\text{Section 3.2})$$

$$0.15 < \lambda < 1.2 \text{ OK}$$

$$\begin{aligned} f_a/(K_s F_{ca}) + (8/9) (\delta) f_b/(K_s F_{ba}) &\leq 1.0 & f_a/(K_s F_{ca}) &\geq 0.2 & (4.4.112) \\ f_a/(2K_s F_{ca}) + (\delta) f_b/(K_s F_{ba}) &\leq 1.0 & f_a/(K_s F_{ca}) &\geq 0.2 & (4.4.113) \end{aligned}$$

$$K_s = 1 - (f_v/F_{va})^2 = 0.9977$$

$$F_e = (\pi)^2 E / [K L_u / r]^2 = 80,287 \text{ psi}$$

$$\delta = C_m [1 - f_a F / F_e] = 1.0161$$

$$f_a / (K_s F_{ca}) = 0.45443 < 0.2$$

$$f_a / (2K_s F_{ca}) + (\delta) f_b / (K_s F_{ba}) = 0.82 < 1.0 \text{ OK!}$$

C15.7.14 Horizontal, Saddle-Supported Vessels for Liquid or Vapor Storage

Past practice has been to assume that a horizontal, saddle-supported vessel (including its contents) behaves as a rigid structure (with natural period, T , less than 0.06 s). For this situation, seismic forces would be determined using the requirements of Section 15.4.2. For large horizontal, saddle-supported vessels (length-to-diameter ratio of 6 or more), this assumption can be unconservative, so Section 15.7.14.3 requires that the natural period be determined assuming the vessel to be a simply supported beam.

REFERENCES

- American Concrete Institute (ACI). (2006). "Seismic design of liquid-containing concrete structures." *ACI 350.3-06* Farmington Hills, Mich.
- American Institute of Steel Construction (AISC). (1986). *Load and Resistance Factor Design Specification for Structural Steel Buildings*, Chicago.
- Anderson, P. F. (1966). "Temperature stresses in steel grain storage tanks." *Civil Engineering*, 36(1), 74.
- Chandrasekaran, A. R., and Jain, P. C. (1968). "Effective live load of storage materials under dynamic conditions." *Indian Concrete J.* (Bombay), 42(9), 364–365.
- Chandrasekaran, A. R., Saini, S. S., and Jhamb, I. C. (1968). "Live load effects on dynamic behavior of structures." *J. of the Institution of Engineers (India)*, 48, 850–859.
- Federal Emergency Management Agency (FEMA). (2005). "Seismic considerations for steel storage racks located in areas accessible to the public." *FEMA 460*, Building Seismic Safety Council, National Institute of Building Sciences, Washington, D.C.
- Kaups, T., and Lieb, J. M. (1985). *A Practical Guide for the Design of Quality Bulk Storage Bins and Silos*, Chicago Bridge & Iron Company, Plainfield, Ill.
- Kilic, S., and Sozen, M. (2003). "Evaluation of effect of August 17, 1999, Marmara earthquake on two tall reinforced concrete chimneys." *ACI Struct. J.*, 100(3).
- Malhotra, P. K. (2005). "Sloshing loads in liquid-storage tanks with insufficient freeboard." *Earthquake Spectra*, 21(4), 1185–1192.
- Malhotra, P. K. (2006). "Earthquake induced sloshing in cone and dome roof tanks with insufficient freeboard." *J. of Structural Engineering International*, IABSE, 16(3), 222–225.

- Malhotra, P. K., Wenk, T., and Wieland, M. (2000). "Simple procedure for seismic analysis of liquid-storage tanks." *J. of Structural Engineering International*, IABSE, 10(3), 197–201.
- Miller, C. D., Meier, S. W., and Czaska, W. J. (1997). "Effects of internal pressure on axial compressive strength of cylinders and cones," paper presented at Structural Stability Research Council Annual Technical Meeting, June.
- Trahair, M. S., Abel, A., Ansourian, P., Irvine, H. M., and Rotter, J. M. (1983). *Structural Design of Steel Bins for Bulk Solids*. Australian Institute of Steel Construction, Ltd., Sydney.
- Troitsky, M. S. (1990). *Tubular Steel Structures—Theory and Design*. The James F. Lincoln Arc Welding Foundation.
- U.S. Department of Energy. (1963). "Nuclear reactors and earthquakes." *TID-7024*, U.S. Atomic Energy Commission.
- Veletsos, A. S. (1974). "Seismic effects in flexible liquid-storage tanks." In *Proceedings of the Fifth World Conference on Earthquake Engineering*, Rome, 630–639.
- Wozniak, R. S., and Mitchell, W. W. (1978). "Basis of seismic design provisions for welded steel oil storage tanks." Presented at the Session on Advances in Storage Tank Design, American Petroleum Institute, Refining, 43rd Midyear Meeting, Toronto, Canada, May 9.

COMMENTARY TO CHAPTER 16, SEISMIC RESPONSE HISTORY PROCEDURES

C16.1 GENERAL REQUIREMENTS

C16.1.1 Overview

This commentary documents the rationale and logic behind the Chapter 16 requirements. Related additional documentation and literature review can also be found in the Haselton et al. (2013) and example applications can be found in Zimmerman et al. (2013).

C16.1.2 Collapse Safety Goals and Approaches to Demonstrate Appropriate Collapse Safety

The collapse performance goals given in Table C.1.3.1b are defined such that, when a building is subjected to Maximum Considered Earthquake (MCE_R) ground motion, a maximum 10% probability of collapse exists for Risk Category I and II structures. For Risk Category III and IV structures, these maximum collapse probabilities are reduced to 6% and 3%, respectively. The goal of a 1% in 50-year collapse risk is also implicit in the performance goals, but this is not strictly enforced in all regions (e.g. near fault regions and transition regions), so the 1% in 50-year collapse risk target was not explicitly used in the development of the Chapter 16 acceptance criteria.

There are also performance expectations for Risk Category III and IV structures that go beyond the collapse safety performance goals (e.g. limited damage for lower ground motion levels, etc.). These enhance performance goals are addressed in this chapter simply by enforcing an $I_e > 1.0$ in the linear design step (which is consistent with the approach taken in the other design methods of Chapter 12).

It is conceptually desirable to create a Chapter 16 response-history analysis (RHA) design process that explicitly evaluates the collapse probability and ensures that the performance goal is fulfilled. However, explicit evaluation of collapse safety is a difficult task requiring (a) a structural model that is able to directly simulate the collapse behavior, (b) use of hundreds of nonlinear response-history analyses, and (c) proper treatment of many types of uncertainties. This process is excessively complex and lengthy for practical use in design. Therefore, Chapter 16 maintains the simpler approach of *implicitly* demonstrating adequate performance through a prescribed set of analysis rules and acceptance criteria. Even so, this implicit approach does not preclude the use of more advanced procedures that explicitly demonstrate that a design fulfills the collapse safety goals. Such more advanced procedures are permitted by the Section 1.3.1.3 of this Standard, so this allowance of advanced methods is not reiterated in the Chapter 16. An example of an advanced explicit procedure is the building-specific collapse assessment methodology in Appendix F of FEMA P-695, *Quantification of Building Seismic Performance Factors* (FEMA 2009), which was developed by the Applied Technology Council.

C16.1.3 Framework of the Chapter 16 Response-History Procedure

The Chapter 16 response-history analysis procedure is based on the following framework:

1. Perform a code-level, or design-level, evaluation. This step can use either the Modal Response Spectrum Analysis (RSA) Procedure (Section 12.9) or the Equivalent Lateral Force (ELF) Procedure (Section 12.8). This step ensures that the building has equivalent or greater strength as compared with buildings designed using the basic Chapter 12 requirements. During this step, it is permissible to take the exemptions allowed in Section 16.1 to simplify this design-level evaluation.
2. A service-level evaluation (for a motion below the design-level) is not required because such ground motion level is not supported by the framework of Chapters 11 and 12 (which define only

- MCE_R-level and design-level motions). Nothing precludes a designer from performing an additional service-level evaluation, but it is not required as part of Chapter 16.
3. Perform an MCE_R-level evaluation. The goals of this step are (a) to demonstrate that the building has predictable and stable response at MCE_R ground shaking levels and (b) to determine forces for the design of force-controlled (usually brittle) components. This step, and fulfillment of the associated acceptance criteria, demonstrates that the building has equivalent or better durability and seismic resistance as compared with designs using the basic Chapter 12 requirements.
 4. Complete all of the above steps subject to design review approval. The above framework maintains the requirement for a code-level evaluation. While there would have been desirable outcomes of making this framework more flexible and more performance-based, the code-level evaluation (Step 1 above) was retained for two reasons. First, it was decided that a clear basis was needed for establishing minimum strength (including the enforcement of the minimum base shear requirement imposed in Chapter 12). This could have been accomplished through the addition of a service-level evaluation, but such an evaluation was not added in the RHA procedure, for the purpose of maintaining consistency with the ELF and RSA procedures in Chapter 12. Second, Step 2 addresses many of the detailed design safeguards that then do not need to be specifically incorporated into the MCE_R-level evaluation step, thereby simplifying the MCE_R-level evaluation. For example, the code-level evaluation includes provisions for accidental torsion, enforcement of multiple gravity load combinations, wind loads, redundancy requirements, in addition to many other requirements. These design safeguards being handled in the code-level evaluation allows them to not be required in the MCE_R-level RHA evaluation.

C16.1.4 Treatment of Minimum Base Shear

The minimum base shear requirements are enforced as part of the code-level evaluation step outlined above. This is important because no minimum base shear is imposed in the process of selecting and scaling ground motions for the MCE_R-level nonlinear RHA evaluation. This is crucial, in order to ensure that the building has at least equivalent strength as compared with buildings designed using the basic Chapter 12 requirements.

C16.1.5 Applicability

Following from Section 11.1.3 and Section 12.6, this chapter applies to the analysis and design of building structures. There are circumstances where this procedure will be used to validate a design that takes exception to provisions, e.g. height limits, as part of a performance-based design per Section 1.3.1.3. Nonstructural components are designed in accordance with Chapter 13, nonbuilding structures are designed in accordance with Chapter 15, seismically isolated structures are design in accordance with Chapter 17, and structures with damping systems are designed in accordance with Chapter 18.

C16.2 GROUND MOTIONS

This Standard defines the spectral acceleration values in terms of a maximum direction spectral acceleration. The structural performance assessment should ideally not depend on what type of spectral acceleration definition is being used to quantify the ground motion, provided that each step of the RHA process is completed in a manner that is consistent with the chosen spectral acceleration definition (i.e. selection, scaling, application to the structural model, and interpretation of response predictions). Given that the maximum direction spectral acceleration is explicitly required in this Standard, the steps in this Chapter 16 RHA procedure have been developed carefully so as to specifically account for this definition and to avoid undue conservatism that could come from this ground motion definition if the steps in the RHA were not completed properly (e.g., Stewart et al., 2011).

C16.2.1 Level of Ground Motion

In the Chapter 16 RHA procedure, the MCE_R -level evaluation is done at the MCE_R ground motion level, as the name implies, rather than the design ground motion level (which is $2/3$ of MCE_R). The MCE_R level is used because this is a more direct approach for evaluating adherence to the collapse safety goals of C.1.3.1b. This approach is also consistent with other recent guidelines for performance-based design procedures (LATBSDC, 2008; AB-083, 2008; PEER, 2010).

C16.2.2 Definition of the Target Response Spectrum

This section starts by defining the various target spectra used for structural performance assessments and then explains why two different options are included in the Chapter 16 RHA procedure. These two options are then explained in more detail.

Explanation of Various Target Spectra

Uniform Hazard Spectrum. The Uniform Hazard Spectrum (UHS) has been used as the target spectrum in design practice for the past two decades. The Uniform Hazard Spectrum is created for a given hazard level by enveloping the results of seismic hazard analysis for each period (for a given probability of exceedance). Accordingly, it will generally be a conservative target spectrum if used for ground motion selection and scaling, especially for large and rare ground motions, unless the structure exhibits only elastic first mode response. This inherent conservatism comes from the fact that the spectral values at each period are not likely to all occur in a single ground motion. This limitation of the Uniform Hazard Spectrum has been noted for many years (e.g., Bommer et al., 2000; Naeim and Lew, 1995; Reiter, 1990).

MCE_R Spectrum. The primary difference between the MCE_R spectrum and the 2% in 50 year UHS is that the MCE_R spectrum is modified with a risk coefficient to produce a 1% collapse risk in 50 years for sites that are not nearby an active fault (Luco et al. 2008). For sites near an active fault, the Section 21.2.2 deterministic ground motions control, and MCE_R motions result in a higher than 1% collapse risk in 50 years. This process of computing MCE_R motions results in typical return periods for MCE_R motions ranging from 1,500 to 3,000 years, depending on the site location.

Conditional Mean Spectra (CMS). The Conditional Mean Spectrum (CMS) is an alternative target spectrum to the Uniform Hazard or MCE_R spectra and can be used as a target for ground motion selection in performance-based engineering (e.g., Baker, 2006, 2011, Al Atik and Abrahamson 2010). To address the above-mentioned problem with the Uniform Hazard Spectrum as a target for ground motion selection and scaling, the Conditional Mean Spectrum instead conditions the spectrum calculation on a spectral acceleration at a single period, and then computes the mean (or distribution of) spectral acceleration values at other periods. This conditional calculation ensures that the resulting spectrum is reasonably likely to occur, and that ground motions selected to match the spectrum have an appropriate spectral shape consistent with naturally occurring ground motions at the site of interest. The calculation is no more difficult than the calculation of a Uniform Hazard Spectrum, and is arguably more appropriate for use as a ground motion selection target in risk assessment applications. The spectrum calculation requires disaggregation information, making it a site-specific calculation that cannot be generalized to other sites. It is also period-specific, in that the conditional response spectrum is conditioned on a spectral acceleration value at a specified period. The shape of the conditional spectrum also changes as the spectral amplitude changes (even when the site and period are fixed). FIGURE C16-1 provides examples of the Conditional Mean Spectrum for an example site in Palo Alto, California, anchored at four different candidate periods. The Uniform Hazard Spectrum for this example site is also provided for comparison. Note that FIGURE C16-1 shows four candidate periods, with the associated CMS target spectra, but typically only two of these periods and target spectra would be chosen for analysis using a CMS approach.

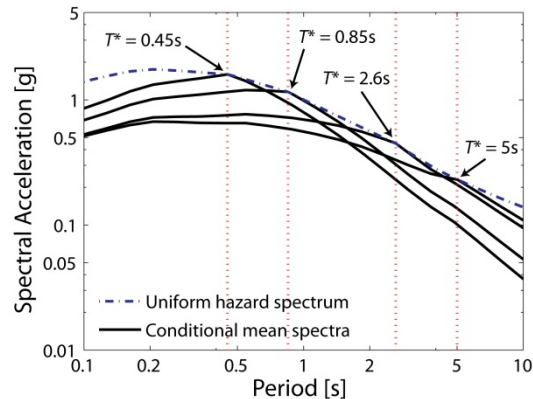

FIGURE C16-1 Example Conditional Mean Spectra for the Palo Alto Site Anchored for 2% in 50-year Motion at $T^* = 0.45s$, $0.85s$, $2.6s$, and $5s$. (NIST, 2011a)

Discussion of the Various Target Spectra

As discussed in the previous section, the UHS and MCE_R spectra are conservative target spectra for ground motion selection and the use of CMS target spectra is more appropriate for representing anticipated ground motions for a 2% in 50 year (or MCE_R) ground motion level at a specified period. A basic CMS-type approach was used in the analytical procedures of the ATC-63 (FEMA P695) project, the results of which provided the initial basis for establishing the 10% probability of collapse goal shown in Table C.1.3.1b. Therefore, the use of CMS target spectra in the Chapter 16 RHA design procedure is also internally consistent with how the collapse probability goals of Table C.1.3.1b were developed.

In this Chapter 16 RHA procedure, the MCE_R target spectrum is retained (as a simpler and more conservative option) and the CMS target spectra approach is also included as a new alternative (as a more appropriate approach for representing expected ground motions). These two alternative approaches are termed Method I and Method II, respectively, in the proposed Chapter 16 RHA procedure, as explained further below. To make the language more general, the CMS approach is referred to as the “Method 2” approach in the Chapter 16 code language; this less specific language is intended to provide the user with more flexibility for employing other types of scenario spectra formulations and not be limited to the currently published definitions of the CMS.

C16.2.2.1 Method 1

Method I is the traditional approach of using the MCE_R target spectrum. This approach is retained as an option because it is simpler and generally more conservative. This approach allows the MCE_R spectrum to be defined using the basic approach of Section 11.4.6 or the site-specific hazard analysis approach of Section 11.4.7.

C16.2.2.2 Method 2

Method II allows the use of multiple target spectra; this can be based on the CMS or similar approach. The Method II procedure includes the following steps for creating the site-specific target response spectra.

1. Select two or more periods that correspond to periods of vibration that significantly contribute to the inelastic dynamic response of the building. This will include a period near the fundamental mode periods of the building, or perhaps a slightly extended period to account for inelastic period lengthening (e.g. $1.5T_1$), and likely will also include a period near the translational second-mode periods. When selecting these significant periods of responses, the elastic periods of response should be considered (according to the level of mass participation for each of these periods) and

the amount of first-mode period elongation, due to inelastic response effects, should also be considered.

2. For each period selected above, create a target spectrum that matches or exceeds the MCE_R value at that period. When developing the target spectrum (a) perform site-specific disaggregation to identify earthquake events likely to result in MCE_R ground shaking and then (b) develop the target spectrum to capture one or more spectral shapes for dominant magnitude and distance combinations revealed by the disaggregation.
3. Enforce that the envelope of the target spectra not be less than 75 percent of the MCE_R spectrum (from Method I) for any period within the period range of interest (as defined in Section 16.2.4.1).

After the target spectra are created, each target response spectrum is then used in the remainder of the response history analyses process and the building must be shown to meet the acceptance criteria for each of the targets.

The primary purpose of the 75% floor value is to provide a basis for determining how many scenario spectra are needed for analysis. For small period ranges, fewer targets will be needed, while more target spectra will be needed for buildings where a wider range of periods are important to the structural response (e.g. taller buildings). When creating the target spectra, some spectral values can also be artificially increased to meet the requirements of this 75% floor (as more fully explained in the later examples). A secondary reason for the 75% floor is to enforce a reasonable lower-bound. The specific 75% threshold value was determined using several examples (some of which are included in the examples below), with the intention being that this 75% floor requirement will be fulfilled through the use of two target spectra, in most cases. From the perspective of collapse risk, the requirement of being within 75% of the MCE_R at all periods may introduce some conservatism, but the requirement adds robustness to the procedure by ensuring that the structural will be subjected to ground motions with near- MCE_R -level intensities at all potentially relevant periods. Additionally, this requirement ensures that demands unrelated to collapse safety, such as higher-mode-sensitive force demands, can be reasonably determined from the procedure.

C16.2.3 Ground Motions Selection

C16.2.3.1 Minimum Number of Ground Motions

The required number of ground motions was taken as eleven for the Chapter 16 RHA procedure, not on the basis of detailed statistical analyses, but rather as selected by judgment to balance the competing objectives of more reliable estimates of average structural responses (through use of more motions) against computational effort (reduced by using fewer motions). Overall, it is expected that the total level of effort in this Chapter 16 RHA procedure is actually lower than previous versions of Chapter 16, because the slightly increased number of motions is mitigated by the addition of explicit statements that additional analysis cases are not necessary for accidental torsion and that multiple orientations of ground motion are not required for analysis (these are discussed in later sections of this commentary).

C16.2.3.2 Components of Ground Motion

The framework of the Chapter 16 RHA procedure is such that a ground motion is typically comprised of two horizontal ground motion components, but the framework also includes the possibility of a vertical ground motion component for the cases that vertical dynamic responses are clearly important (as discussed in the later modeling section).

C16.2.3.3 Selection of Ground Motions

Definition of a Near-Fault Sites versus a Site that is not Near-Fault. A near-fault site is defined as having a reasonable probability of experiencing ground motions strongly influenced by rupture directivity effects. These effects can include pulse-type ground motions (e.g., Shahi and Baker, 2011) observable in velocity histories and polarization of ground motions such that the maximum direction of response tends to be in

the direction normal to the fault strike. The issue of pulse-type ground motions affects the manner by which individual ground motions are selected for the site, as described further below. The issue of ground motion polarization affects the way that horizontal ground motions are applied to the structure, as described further in Section 16.2.5.

As the name implies, a near-fault site is located in close proximity to the causative fault for an earthquake, as measured by site-source distance. To identify whether a site qualifies as near-fault, it is required to develop a site-specific MCE_R spectrum, followed by site-specific disaggregation at the periods of principal interest. If the controlling earthquakes identified through disaggregation are in close proximity to the site, the site should be considered as near-fault. From the standpoint of pulse-type characteristics, recent research suggests that such effects are reasonably probable up to 10-20 km from the site (Shahi and Baker, 2011). From the standpoint of ground motion polarization in the fault-normal direction, such effects extend to approximately 3-5 km (Watson-Lamprey and Boore, 2007).

Selection of Ground Motions for Sites that are not Near-Fault. The traditional approach has been to select (and/or simulate) ground motions having magnitudes, fault distances, source mechanisms, and site soil conditions that are roughly similar to those likely to cause the ground motion intensity level of interest (e.g., Stewart et al., 2001), and not to consider the spectral shape in the ground motion selection. In many cases, the response spectrum is the property of a ground motion most correlated with the structural response (PEER 2009), so the Chapter 16 language requires consideration of spectral shape when selecting ground motions. When spectral shape is considered in the ground motion selection, the allowable range of magnitudes, distances, and site conditions, can be relaxed so that a sufficient number of ground motions with appropriate spectral shapes are available.

The selection of recorded motions typically occurs in two steps, as explained in the following illustration. Step 1 involves pre-selecting the ground motion records in the database (e.g., PEER-NGA, 2012) having reasonable magnitude, fault distance, source mechanisms, site soil conditions, and range of useable frequencies. In completing this pre-selection, it is permissible to use relatively liberal ranges because Step 2 can involve selecting motions that provide good matches to a target spectrum of interest (and matching to a target spectrum tends to implicitly account for many of the above issues). Step 2 in the selection process is to select the final set of motions from those pre-selected in Step 1.

In the first step, the following criteria should be utilized to filter out ground motions that should not be considered as candidates in the final selection process:

- **Source Mechanism:** Ground motions from differing tectonic regimes (e.g., subduction versus active crustal regions) often have substantially differing spectral shapes and durations, so recordings from appropriate tectonic regimes should be used whenever possible.
- **Magnitude:** Earthquake magnitude is related to the duration of ground shaking, so using ground motions from earthquakes with appropriate magnitudes should already have approximately the appropriate durations. Earthquake magnitude is also related to the shape of the resulting ground motion's response spectrum, though spectral shape is considered explicitly in Step 2 of the process and so this is not a critical factor when identifying ground motions from appropriate magnitude earthquakes.
- **Site-to-Source Distance:** The distance is a lower-priority parameter to consider when selecting ground motions. Studies investigating this property have all found that response history analyses performed using ground motions from different source-to-site distances but otherwise equivalent properties will produce practically equivalent demands on structures.
- **Site Soil Conditions:** Site soil conditions (Site Class) exert a large influence on ground motions, but are already reflected in the spectral shape used in Step 2. For Step 1, reasonable limits on site soil conditions should be imposed but should not be too restrictive as to unnecessarily limit the number of candidate motions.

- **Useable Frequency of the Ground Motion:** Only processed ground motion records should be considered for RHA. Processed motions have a usable frequency range; in active regions, the most critical parameter is the lowest usable frequency. It is important to verify that the useable frequencies of the record (after filtering) accommodate the range of frequencies important to the building response; this frequency (or period) range is discussed in this next section on scaling.

Once the pre-selection process has been completed, Step 2 is undertaken to select the final set of ground motions according to the following criteria:

- **Spectral Shape:** The shape of the response spectrum is a primary consideration when selecting ground motions.
- **Scale Factor:** It is also traditional to select motions such that the necessary scale factor is limited; an allowable scale factor limit of approximately 0.25 to four is not uncommon.
- **Maximum Motions from a Single Event:** Many also think it important to limit the number of motions from a single seismic event, such that the ground motion set is not unduly influenced by the single event. This criterion is deemed less important than limiting the scale factor, but imposing a limit of only three or four motions from a single event would not be unreasonable for most cases.

Further discussion of ground motion selection is available in NIST GCR 11-917-15 (NIST 2012).

Selection of Ground Motions for a Near-Fault Site. As discussed previously, near-fault sites by definition have a certain probability of experiencing pulse-type ground motions. This probability is not unity, so only a certain fraction of selected ground motions should exhibit pulse-like characteristics, while the remainder can be non-pulse records selected according to the standard process described above. The probability of experiencing pulse-like characteristics is dependent principally on (1) distance of site from fault; (2) fault type (e.g., strike slip or reverse); and (3) location of hypocenter relative to site, such that rupture occurs towards or away from the site.

Criteria (1) and (2) above are available from conventional disaggregation of PSHA. Criteria (3) can be computed as well in principal, but is not generally provided in a conventional hazard analysis. However, for the long ground motion return periods associated with MCE_R spectra, it is conservative and reasonable to assume that the fault rupture will be towards the site for the purposes of evaluating pulse probabilities. Empirical relations for evaluating pulse probabilities in consideration of these criteria are given in the aforementioned ATC-82 report and in Shahi and Baker (2011).

Once the pulse probability is identified, the proper percentage of pulse-like records should be enforced in the ground motion selection. For example, if the pulse probability is 30% and 11 records are to be used, then 3 or 4 records in the set should exhibit pulse-like characteristics in at least one of the horizontal components. The PEER Ground Motion database can be used to identify records with pulse-type characteristics. The other criteria described in the previous section should also be considered to identify pulse-like records that are appropriate for a given target spectrum and set of disaggregation results.

C16.2.4 Ground Motion Scaling

This section explains the requirements related to ground motion scaling, including discussion of the period range for scaling, scaling of motions, and use of spectral matching.

When a vertical ground motion component is used, it should be scaled by the same factor as horizontal components, to ensure that vertical components are representative of observed ground motions. To ensure that the vertical ground motion components are not too small, it would be sensible to compare the scaled vertical components to a vertical acceleration target spectrum. However, this is intentionally not a firm requirement because broad consensus is not available regarding the appropriate target values for a vertical acceleration spectrum.

C16.2.4.1 Period Range for Scaling

The Chapter 16 RHA procedure uses the full MCE_R ground motion level (Section 16.2.1). Greater inelastic response is anticipated at this level as compared to the design spectrum, so the upper-bound period has accordingly been raised from $1.5T$ to $2.0T$, where T is redefined as the *maximum* fundamental period of the building (i.e. the maximum of the fundamental periods in both translational directions and the fundamental torsional period). This increase in the upper-bound period is also based on recent research that has shown that the $1.5T$ limit is too low for assessing ductile frame buildings subjected to MCE_R motions (Haselton and Baker, 2006). A smaller upper-bound period may be used if it can be shown that a period lower than $2.0T$ is appropriate for the building type when subjected to MCE_R motions.

For the lower-bound period, the $0.2T$ requirement is now supplemented with an additional requirement that the lower-bound also should capture the periods needed for 90% mass participation in both directions of the building. This change is made for consistency with the similar 90% mass requirement in the Modal Response Spectrum Analysis procedure of Section 12.9.

In many cases, the substructure is included in the structural model and this substantially affects the mass participation characteristics of the system. Unless the foundation system is being explicitly designed using the results of the response-history analyses, the above 90% modal mass requirement pertains only to the superstructure behavior; the period range does not need to include the very short periods associated with the subgrade behavior.

C16.2.4.2 Scaling of Ground Motions

The Chapter 16 RHA scaling procedure is identical to the previous ASCE 7-10 procedure, but with the following changes:

1. Scaling is based directly on the maximum direction spectrum, rather than the SRSS spectrum. This change was made for consistency with the MCE_R ground motion now being explicitly defined as a maximum direction motion.
2. The approach of enforcing that the average spectrum “does not fall below” the target spectrum is replaced with requirements that (a) the average spectrum “matches the target spectrum” and (b) the average spectrum does not fall below 90% of the target spectrum for any period within the period range of interest. This change was made to remove the conservatism associated with the average spectrum being required to exceed the target spectrum at every period within the period range.

As mentioned above, the Chapter 16 RHA scaling procedure requires that a maximum direction response spectrum be constructed for each ground motion. For some ground motion databases, this response spectrum definition is already pre-computed and publically available (e.g. for the PEER NGA-West2 database, Ancheta 2012). There are also a number of software tools that can compute this spectrum for a given time history (e.g., Bispec). For users that may not want to directly compute the maximum direction spectra, an approximation is to compute the geometric mean response spectrum for each motion and then to apply the 2009 NEHRP maximum direction factors (from Table C21.2-1 of NEHRP 2009). Once this approximate maximum direction spectrum is computed for each ground motion, then the remainder of the scaling approach can be followed to determine the appropriate scale factors for each motion. For more detailed background on the definition of maximum direction spectra, and the calculation of such spectra, the reader is referred to the many recent publications on this topic (e.g., Huang et al., 2008; Stewart et al., 2011).

Figure C16-2 shows an example of the scaling process. This shows how the average of the maximum direction spectra meets the target spectrum (Figure C16-2a) and shows more detail for a single Loma Prieta motion in the scaled ground motion set (Figure C16-2b).

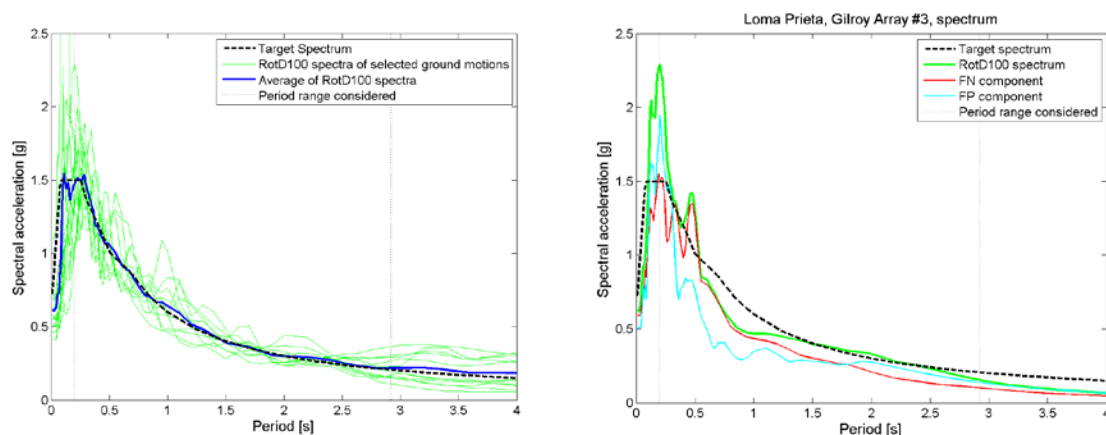

FIGURE C16-2 Ground Motion Scaling for Example A, Showing (a) the Ground Motion Spectra for all 11 Motions and (b) an Example for the Loma Prieta, Gilroy Array #3 Motion

C16.2.4.3 Spectral Matching of Ground Motions

Spectral matching of ground motions is defined as the modification of a real recorded earthquake ground motion in some manner such that its response spectrum matches a desired target spectrum across a period range of interest. Spectrally matched ground motions are permitted in lieu of motions scaled to the target spectrum. There are several spectral matching procedures in use, as described in the ATC-82 report. The recommendations in the ATC-82 report should be followed regarding appropriate spectral matching techniques to be applied.

This section requires that when spectral matching is applied, the average spectrum of the scaled motions must exceed the target spectrum over the period range of interest; this is intentionally a more stringent requirement, as compared to the requirement for scaled unmatched motions, because the spectral matching removes variability in the ground motion spectra.

The matched ground motions are also required to be scaled to meet the maximum direction spectral demands individually for both of the horizontal directions. Since those criteria are conservative for any particular direction, and are especially conservative when applied to both directions, this requirement effectively imposes a penalty on the use of spectrally matched ground motions and this imposed penalty is intentional. This penalty was imposed because recent research has reached differing conclusions on the unconservatism, or lack thereof, of RHA performed using spectrally matched ground motions (e.g., Luco and Bazzurro, 2007; Grant and Diaferia, 2012). The conservatism was introduced to the process due to this lack of consensus.

Spectral matching is not allowed for near-fault sites, unless the pulse characteristics of the ground motions are retained after the matching process has been completed. This is based on the concern that, when common spectral matching methods are utilized, the pulse characteristics of the motions may not be appropriately retained.

C16.2.5 Application of Ground Motions to the Structural Model

C16.2.5.1 Orientation of Ground Motions

The manner in which the two horizontal ground motions are oriented when being applied to the structural model is critically important and there is both little and inconsistent guidance for how this should be done. The debates about the appropriateness of various ground motion intensity measures (e.g. geometric mean versus maximum direction S_a ; Stewart et al., 2011) apply principally to structures analyzed using simplified procedures (Chapter 12) or with 2D RHA methods. As mentioned in the previous section on ground motion

intensity measures, the structural assessment results should not depend on what type of spectral acceleration definition is being used to quantify the ground motion, provided that each step of the process is completed in a manner that is consistent with the chosen spectral acceleration definition (selection, scaling, application to the structural model, and interpretation of response predictions). This section explains the guidelines for ground motion application for both non near-fault and near-fault sites.

Sites that are not Near-Fault. For sites that are not near-fault, the guidance given in recent design and assessment documents is both limited and inconsistent. Section 12.5.3 of this Standard specifies that the “orthogonal pairs of ground motion acceleration histories” should be “applied simultaneously” but does not state how the pairs of motions should be oriented. Due to this lack of guidance, this has led many designers to apply the horizontal ground motion pair in one orientation and then applied the same pair of ground motions again in a second orientation (typically 90 degrees from the original orientation). The LATBSDC guidelines (LATBSDC 2008) provides more guidance, stating that the motions should be oriented randomly and that there is no need for applying individual pairs of motions in multiple orientations. The PEER TBI guidelines (PEER TBI, 2009) require that the components be applied along the principal directions of the building but does not specify how the ground motion components should be oriented before they are applied to the structural model (e.g., randomly, oriented according to a maximum direction, etc.).

In this Standard, the maximum direction spectral acceleration is being used to describe the ground motion intensity. This spectral acceleration definition causes a perceived directional dependence to the ground motion. However, the direction in which the maximum spectral acceleration occurs is random at distances beyond 5 km from the fault (Huang et al., 2008), does not necessarily align with a principal direction of the building, and is variable from period-to-period. Accordingly, for the RHA procedure to result in an unbiased prediction of structural response, the ground motions should still be applied to the structure *in a random orientation*. On the surface, this may seem inconsistent with how the ground motions were scaled but there is no inconsistency in this process and the application of randomly-oriented pairs of motions is necessary to avoid causing a biased prediction of structural response.

Near-Fault Sites. As described in Section C16.2.3.3, for near-fault sites, there is a tendency for response spectra to be larger in the fault-normal direction than in the fault-parallel direction. For such sites, the fault-normal and fault-parallel components of the recorded ground motions should be maintained and applied to the corresponding orientations of the structure.

When the ground motions are applied to the building in the fault-normal and fault-parallel orientations, the demand in the fault-parallel direction of the building should not be under-predicted. In the development of the Chapter 16 RHA procedure, a requirement was considered to verify a minimum level of demand in the fault-parallel direction. Such a requirement was not included, both for simplicity and because the required elastic design step (per Section C16.1) already enforces a minimum strength for both directions of the building.

In accordance with Section C16.2.3.3, it should be recognized that a site can be near-fault from the standpoint of having a finite probability of pulse-like ground motion characteristics, but not near-fault in terms of polarization of ground motions in the fault-normal direction. The criteria of this section only apply to sites with the latter characteristics, which is more restrictive in terms of the applicable site-source distance range.

C16.2.5.2 Application of Input Ground Motion over Subterranean Levels

Please refer to the commentary in Section C16.3.10.

C16.3 MODELING AND ANALYSIS

C16.3.1 System Modeling

Nonlinear response history analysis offers several advantages over linear response history analysis, including the ability to model a wide variety of nonlinear material behaviors, geometric nonlinearities (including P-Delta and large displacement effects), gap opening and contact behavior, and nonlinear viscous damping, and to identify the likely spatial and temporal distributions of inelasticity. Nonlinear response history analysis has several disadvantages, including increased effort to develop the analytical model, increased time to perform the analysis (which is often complicated by difficulties in obtaining converged solutions), sensitivity of computed response to system parameters, large amounts of analysis results to evaluate, and the inapplicability of superposition to combine live, dead, and seismic load effects.

Although analytical models used to perform linear response spectrum analysis as part of the prescriptive Building Code procedures typically do not include representation of elements other than those that compose the intended lateral-force resisting system, the gravity-load-carrying system and some nonstructural components can add significant stiffness and strength. Because the goal of nonlinear response history analysis is to accurately predict the building's probable performance, it is important to include such elements in the analytical model and also to verify that their behavior will be acceptable. This may mean that contribution of stiffness and strength from elements considered as non-participating elements in other portions of this standard be included in the response history analysis model.

Expected material properties are used in the analysis model, attempting to characterize the expected performance as closely as possible. It is suggested that expected properties be selected considering actual test data for the proposed material. Where test data is not readily available, the designer may consider estimates as found in *ASCE 41* and the *PEER TBI Guidelines*.

Two-dimensional structural models may be useful for initial studies and for checking some specific issues in a structure; however, the final structural model used to confirm the structural performance shall be a three-dimensional model.

For certain structures, the response under both horizontal and vertical ground motions should be considered. Examples of structures where vertical ground motion contributes significantly to response include structures with long spans, vertical discontinuities or large cantilever elements. ATC-82 provides some guidance to designers considering the application of vertical ground motions. To properly capture the nonlinear dynamic response of structures where vertical dynamic response may have a significant influence on structural performance, it is at times necessary to include vertical mass in the mathematical model even though vertical ground motions are not included in the analysis. Typically the vertical mass is only provided at column nodes although it could be included at all vertical degrees of freedom provided the vertical stiffness of members has been modeled properly. Additional degrees of freedom (e.g. nodes at quarter points along the span of a beam) will need to be added to capture this effect, or horizontal elements will need to be modeled with consistent mass. Numerical convergence problems due to large oscillatory vertical accelerations have been noted (*NCJV 2011*) where base rotations due to wall cracking in fiber wall models is the primary source of vertical excitation. See also the commentary on Chapter 23.

Consideration of the additional vertical load of $(0.2S_{DS}) * D$ per Section 12.4.2 is inappropriate for response history analysis. Response history analyses are desired to reflect actual building response to the largest extent possible. Applying an artificial vertical load to the analysis model prior to application of a ground motion will result in an offset in the yield point of elements carrying gravity load due to the initial artificial stress. Similarly, applying an artificial vertical load to the model at the conclusion of a response history analysis is not indicative of actual building response. If vertical ground motions are expected to significantly affect response, application of vertical shaking to the analysis model is recommended. It should be noted that vertical response often occurs at higher frequencies than lateral response, and hence, a finer analysis time-step might be required when vertical motions are included.

For structures composed of planar seismic force-resisting elements connected by floor and roof diaphragms, the diaphragms should be modeled as semi-rigid in-plane, particularly when the vertical elements have largely different lateral stiffness (such as moment frames and walls). Biaxial bending and axial force interaction should be considered for corner columns, nonrectangular walls, and other similar elements.

C16.3.2 Gravity Load

Nonlinear response history analysis is load path dependent with the results depending on combined gravity and lateral load effects. The Maximum Considered Earthquake shaking and design gravity load combinations required in ASCE 7 have a low probability of occurring simultaneously. Therefore, the gravity load should instead be a realistic estimate of the expected loading on a typical day in the life of the structure. For this analysis, a single, representative gravity load case, characterizing the expected gravity loading at the time of the Maximum Considered Earthquake shaking is used. The dead load used in this analysis should be determined in a manner consistent with the determination of seismic mass. The live load is reduced from the nominal design live load to reflect both the low probability of the full design live load occurring simultaneously throughout the building and the low probability that the design live load and Maximum Considered Earthquake shaking will occur simultaneously.

The reduced live load values, of $0.8L_o$ for live loads that exceed 100 lb/ft^2 (4.79 kN/m^2) and $0.4L_o$ for all other live loads, were simply taken as the maximum reduction allowable in Sections 4.7.2 and 4.7.3.

It is important to note that although nonlinear response history analysis only need consider a single gravity load case, the designer is assumed to have used the various gravity load combinations required in Chapter 2 for the initial proportioning of the lateral force resisting system (LFRS).

Gravity loads are to be applied to the nonlinear model first and then ground shaking simulations applied. The initial application of gravity load is critical to the analysis so member stresses and displacements due to ground shaking are appropriately added to the initially stressed and displaced structure.

C16.3.3 P-Delta Effects

P-delta effects should be realistically included regardless of the value of the elastic story stability coefficient $\theta = PAI_e / (Vh)$. The elastic story stability coefficient is not a reliable indicator of the importance of P-Delta during large inelastic deformations. This is especially important for dynamic analyses with large inelastic deformations because significant ratcheting can occur. During these types of analyses when the global stiffness starts to deteriorate and the tangent stiffness of story shear to story drift approaches zero or becomes negative, P-delta effects can cause significant ratcheting (which is a precursor to dynamic instability) of the displacement response in one direction. The full reversal of drifts is no longer observed and the structural integrity is compromised. To ascertain the full effect of P-delta effects for a given system, a comparison of static pushover curves from a P-delta model and non P-delta model can be compared.

C16.3.4 Seismic Mass

When a building vibrates during an earthquake, only that portion of the mass or weight that is physically tied to the structure needs to be considered as effective. Hence, live loads (e.g. loose furniture, loss equipment, and human occupants) need not be included. However, certain types of live loads such as storage loads that may develop inertial forces, particularly where they are densely packed, should be considered.

Elements considered as contributing to the seismic mass should be consistent with the design assumptions utilized to initially proportion the structural elements in accordance with Chapter 12, such as permanent equipment, partitions, etc.

C16.3.5 Diaphragm Modeling

For reasons described in the commentary to Section 11.2, diaphragm modeling should be explicitly considered where force transfer is likely to occur.

Modeling of diaphragms is complex and can increase the runtime of analysis models significantly. Therefore, designers commonly model the flexibility of diaphragms only at locations where force transfer is likely to occur and use idealized diaphragm flexibility assumptions elsewhere (see Section 12.3). Diaphragms are typically modeled using a mesh of finite elements connected to the lateral force resisting system. The finite elements are modeled to capture the diaphragm's material properties, thickness, openings, and steps using a mesh of typically 1/10 to 1/5 of the bay length so that a reasonable approximation of its flexibility is represented. The stiffness of the diaphragm relative to the lateral force resisting system can have a significant effect on building response where discontinuities in lateral resistance occur. Stiffness modifiers on the gross-section stiffness properties are often used to approximate the effective stiffness of a diaphragm where cracking or other softening mechanisms are expected to occur. Due to the complex and uncertain behavior of a diaphragm's effective stiffness, it may be appropriate to analyze the structure using upper-bound and lower-bound effective stiffness assumptions and selecting design values that result from the largest forces from the two analyses.

C16.3.6 Torsion

Inherent torsion is actual torsion caused by the offset of the structure's center of mass and center of rigidity. Accidental torsion effects per Section 12.8.4.2 are artificial effects that attempt to account for actual variations in load and material strengths during building operation which will differ from modeling assumptions. Some examples of this would be non-uniformity of the actual mass in the building, unaccounted for openings in the diaphragm, torsional foundation input motion caused by the ground motion being out of phase at various points along the base, the lateral stiffness of the gravity framing, variation in material strength and stiffness due to typical construction tolerances, and incidental stiffness contribution by the nonstructural elements.

When the provision for accidental torsion was first introduced, it was to address buildings that appear to be symmetric, but are sensitive to torsional excitation. Common examples of this type of configuration are cruciform core or I-shaped core buildings. In reality there are many things that can cause a seemingly symmetric building to exhibit some torsional response. None of the aforementioned items are typically included in the analysis model; therefore, the accidental torsion approach was introduced to ensure that the structure has some minimum level of resistance to incidental twisting under seismic excitation.

The accidental torsion also serves as an additional check to provide more confidence in the torsional stability of the structure. During the initial proportioning of the structure using linear analysis (per Section 16.1.1), accidental torsion is required to be enforced in accordance with Section 12.8.4.2. When there is no inherent torsion in the building, accidental torsion is a crucial step in the design process because this artificial offset in the center of mass is a simple way to force a minimum level of twisting to occur in the building. The accidental torsion step (i.e. the required 5% force offsets) is also important when checking for plan irregularities in symmetric and possibly torsionally flexible buildings. Where there is already inherent torsion in the building, additional accidental torsion is actually not a crucial requirement (though still required, in accordance with Section 12.8.4.2) because the building model will naturally twist during analysis and no additional artificial torsion is required for this twisting to occur.

The mathematical model need only comply with the requirements of Section 12.7 which does not explicitly require accidental torsion to be modeled. It is generally accepted practice that when three-dimensional nonlinear analysis is utilized in conjunction with the requirements of the nonlinear response history procedure that the effects of accidental torsion need not be explicitly modeled. While consideration of accidental torsion (and amplification) is usually associated with the uncertainty regarding the center of mass and stiffness, it also accounts for torsional ground motion and associated response effects and the increased

torsional response associated with nonlinear behavior of the lateral force resisting system. Since the nonlinear behavior is being modeled and torsional ground motion effects are deemed to be small for conventional building structures, it is considered unnecessarily conservative to additionally include accidental torsion effects especially using the “dynamic” approach discussed in C12.9.5. Furthermore, for complex three-dimensional nonlinear response history analyses, it is often considered impractical to require multiple analyses to address all possibilities of eccentricity.

For buildings that have no significant inherent torsion, and configurations that are sensitive to torsion, such as buildings with “I”-shaped lateral force resisting systems, evaluation of nonlinear torsional response should be considered. Evaluation could include artificially varying the stiffness and strength of lateral elements in an unsymmetrical fashion to amplify torsional response or artificially displacing the center of mass.

C16.3.7 Stiffness of Elements Modeled with Elastic Properties

When creating an analysis model for response history analysis, the designer must consider how different portions of the structure will respond to earthquake shaking. It is often helpful to create a list of elements of the LFRS that are expected to respond in a non-linear fashion. For these yielding elements, non-linear material and/or component properties must be defined and input into the analysis model in order to create an accurate prediction of the structure’s response.

There are also those elements of the lateral-force-resisting system that are not anticipated to be loaded beyond their elastic limits (i.e. component actions deemed to be force-controlled). Some of these elements may result from the use of capacity design principles which limit the amount of demand delivered to certain portions of the structure. Commonly, elements for which response is limited to the elastic range are those for which overload could result in local or total collapse of the structure. Examples would be gravity load in columns, shear in shear walls, and collectors in diaphragms. For these elements/behaviors the use of an elastic component model may be appropriate. As these elements modeled with elastic properties provide an inaccurate representation of structural response when loaded beyond their elastic limits, the designer should verify that the calculated demand remains below the expected element capacities (note that this must already be done, for critical force-controlled components, when checking unacceptable responses in Section 16.4.1.1).

As stated earlier, the response history analysis should attempt to reflect the structural stiffness and weight distribution in as accurate a fashion as is practical. In order to represent the portions of the analysis model for which elastic material/stiffness properties are defined accurately, expected material properties should be considered. Thus, the actual yield strength of structural steel and crushing strength of concrete in lieu of the lower bound specified properties should be used. Stiffness properties for reinforced concrete elements should be reduced to account for the expected levels of cracking and other phenomena listed in the standard.

C16.3.8 Nonlinear Modeling

Members and connections subject to inelastic behavior will potentially undergo several cycles of reversed inelastic deformation during an applied ground motion. The mathematical model representing these elements must account for all important phenomena affecting the element response, including monotonic response, hysteretic behavior characterizing element loading and unloading without the effect of cyclic deterioration, and cyclic deterioration.

Cyclic deterioration can be represented in the model using one of several methods. Ideally the mathematical model will explicitly account for cyclic deterioration at the component level, and modify the hysteretic response based on the deformation history. Alternatively the cyclic deterioration can be incorporated into the force-displacement “backbone” curve (either by factoring the monotonic load-displacement curve, or by using a cyclic envelope curve) and deterioration not be explicitly considered in the model. Finally,

deterioration can be conservatively accounted for by modeling a full loss of component capacity at a deformation level consistent with the onset of cyclic deterioration.

Recommendations related to modeling approaches for nonlinear elements and components can be found in other documents such as ATC-72, NIST GCR 10-917-5, and NIST GCR 10-917-9.

Modeling of nonlinear effects at large deformation levels can add considerable complexity to a model. Simplifying a model by not modeling phenomena that occur at large deformations is generally acceptable, provided that it is demonstrated that during each ground motion the magnitude of element deformation does not exceed that corresponding to accurately modeled phenomena.

C16.3.9 Damping

Viscous damping will generally be represented by combined mass and stiffness (Rayleigh) damping. To ensure that the viscous damping does not exceed the target level in the primary modes of response, the damping is typically set at the target level for two periods (one below and one above) the fundamental frequency which will ensure damping at or below the target level at the primary modes. For very tall buildings the second and even third modes can have significant contributions to response; in this case the lower multiple on T_1 may need to be reduced to avoid excessive damping in these modes.

Viscous damping may alternatively be represented by modal damping, which allows for the explicit specification of the target damping in each mode.

The level of structural damping due to component-level hysteresis can vary significantly based on the degree of inelastic action. Typically hysteretic damping will provide a damping contribution of 1%-4% of critical.

Damping and/or energy dissipation due to supplemental damping and energy dissipation elements should be explicitly accounted for with component-level models and not included in the overall viscous damping term.

C16.3.10 Soil-Structure Interaction

The PEER TBI guidelines (PEER TBI 2009) and ATC-83 NIST GCR 11-917-14 report (NIST 2011) both recommend inclusion of subterranean building levels in the mathematical model of the structure. The modeling of the surrounding soil has several possible levels of sophistication, two of which are depicted below in (b) and (c) of Figure C16-3, which are considered most practical for current practice. For an MCE_R -level assessment, which is the basis for the Chapter 16 RHA procedure, the rigid bathtub model is preferred by PEER TBI and NIST (see Figure C16-3c). This model includes soil springs and dashpots and identical horizontal ground motions are input at each level of the basement. Such modeling approach, where the soil is modeled in the form of springs and/or dashpots (or similar) placed around the foundation, is encouraged but is not required. When spring and dashpot elements are included in the structural model, horizontal input ground motions are applied to the ends of the horizontal soil elements rather than being applied to the foundation directly. A simpler but less accurate model is to exclude the soil springs and dashpots from the numerical model and apply the horizontal ground motions at the bottom level of the basement (see Figure C16-3b) which is fixed at the base. Either the fixed-base (Figure C16-4b) or bathtub (Figure C16-4c) approaches are allowed, but the bathtub approach is encouraged because it is more accurate.

For the input motions, the PEER TBI guidelines allow the use of either the free-field motion, which is the motion defined in Section 16.2.2, or a foundation input motion modified for kinematic interaction effects. Guidelines for modeling kinematic interaction are contained in NIST (2011).

More sophisticated procedures for soil-structure interaction modeling, including the effects of multi-support excitation, can also be applied in RHA. Such analyses should follow the guidelines presented in NIST (2011).

Approximate procedures for the evaluation of foundation springs are provided in Chapter 19 of this Standard.

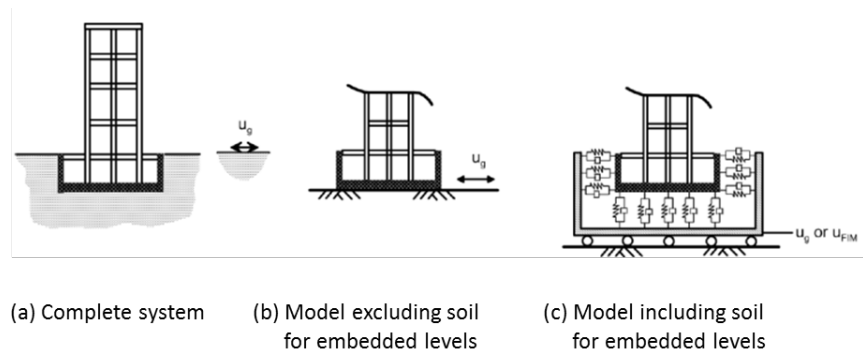

FIGURE C16-3 Illustration of the Method of Inputting Ground Motions into the Base of the Structural Model (Source NIST GCR 11-917-14 (NIST 2011))

C16.4 ANALYSIS RESULTS AND ACCEPTANCE CRITERIA

In the Chapter 16 RHA procedure, an average target spectrum is used with no defined variability in the spectral values, eleven ground motions are selected, the ground motions are then scaled (or spectrally matched) using an average-spectrum-based scaling procedure, and then structural analysis is done using a mean-centered (or “average”) structural model that does not account for any structural modeling uncertainties. This overall approach only provides meaningful information about the average structural responses; this approach does not provide any meaningful information about the variability in structural response or the proportion of motions that cause building collapse. For the acceptance criteria of this chapter, the average response is computed for each building response parameter of interest, where the “average” value is the simple statistical average (also commonly referred to as the “arithmetic mean”).

C16.4.1 Global Acceptance Criteria

C16.4.1.1 Unacceptable Responses

For use in the acceptance criteria of this chapter, an “unacceptable responses” is defined to include any of the following cases:

- Dynamic instability collapse,
- Non-convergence, or
- Response exceeding valid range of modeling of a deformation-controlled component (where the valid range of modeling can extend a reasonable amount beyond the range of deformations that have been experimentally tested), or
- Force demand that exceeding the average strength of a critical force-controlled component.

This section summarizes the rationale behind the acceptance criteria for unacceptable responses and how the criteria were developed. It must be made clear that these unacceptable response acceptance criteria are not the primary acceptance criteria ensuring adequate collapse safety of the building; the primary acceptance criteria are the story drift criteria and the element-level criteria discussed later in Section C16.4. The unacceptable response acceptance criteria were developed to be a secondary protection to supplement the primary criteria. The acceptance criteria were intentionally structured in this manner because there is high variability in unacceptable responses (as described in this section) and the other primary acceptance criteria are much more stable and reliable (because they are based on average values of 11 motions rather than the extreme response of 11 motions).

The Meaning of Unacceptable Responses. When using the Chapter 16 RHA procedure, the observance of a single unacceptable response (or, conversely, the observance of no unacceptable responses) is statistically insignificant because the use of only 11 ground motions does not provide a statistically reliable basis from observing an unacceptable response (or not observing one). Additionally, the observance or non-observance of an unacceptable responses will depend heavily on how the ground motions were selected and scaled (or spectrally matched) to meet the target spectrum.

Therefore, since the observance or non-observance of an unacceptable response is not statistically meaningful, the Chapter 16 acceptance criteria do not rely heavily on the prohibition of unacceptable responses in the attempt to “prove” adequate collapse safety of the building; this approach would not be defensible and would not be reliable. The many other acceptance criteria of Section 16.4 are relied upon to ensure adequate collapse safety of the building. If one desired to expand the unacceptable response acceptance criteria to provide true meaningful collapse safety information about the building, a more complex statistical inference approach would need to be utilized; this is discussed more in the sub-section at the end of Section C16.4.1.1.

The difficulty in the reliable prediction of unacceptable response cases leaves a large open question for how to interpret the meaning of such responses in the response-history analysis results. Even though occurrence of a single unacceptable response is statistically meaningless (per the above rationale), the occurrence of many unacceptable responses (e.g. 5 of 11) does become statistically meaningful. Additionally, a conscientious structural designer will be concerned about such occurrence and the occurrences of an unacceptable response may provide the designer with some insight into a possible weakness in the structural design.

The question becomes how unacceptable responses should be treated in the acceptance criteria. Some users presume that the acceptance criteria related to *average* response effectively disallows any unacceptable responses (because you cannot average-in an infinite response), while other users presume that *average* can also be interpreted as *median* which could allow nearly half of the ground motions to cause unacceptable responses. It was desirable for this Chapter 16 RHA procedure no longer be silent regarding the treatment of unacceptable responses, so the remainder of this section documents the rationale behind the unacceptable response criterion in Section 16.4.1.1.

Simple Collapse Statistics. The purpose of this section is to present some simple statistics to help better interpret the meaning of a collapse or other type of unacceptable response. The goal is that this will provide a clearer basis for making decisions regarding treatment of unacceptable responses in the acceptance criteria.

These simple statistics of this appendix are based on predicting the occurrence of collapse (or other unacceptable response) using the binomial distribution, based on the assumptions listed below. To keep the terminology of this section concise, all unacceptable responses will be lumped together and referred to as “collapse” in this section.

- The likelihood of collapse is predicted using the binomial distribution.
- The collapse probability of the building is 10% at the MCE_R level, which is the target for Risk Categories I-II (i.e. $P[C|MCE_R] = 10\%$).
- The total uncertainty in collapse capacity, in terms of the lognormal standard deviation $\beta_{COL,TOT}$, is 0.6. This value includes all sources of uncertainty and variability (record-to-record variability, modeling uncertainty, etc.). The value of 0.6 is the same value used in creating the risk-consistent hazard maps for ASCE 7-10 (NEHRP 2009) and is consistent with the values used in FEMA P695 (FEMA 2009).
- The record-to-record variability, $\beta_{COL,RTR}$, ranges from 0.25 to 0.40. This is the variability in the collapse capacity that would be expected from the analytical model. This $\beta_{COL,RTR}$ value is highly dependent on the details of the ground motion selection and scaling; values of 0.35-0.45 are

expected for motions that are not fit tightly to the target spectrum and values of 0.2-0.3 are expected for spectrally matched motions (FEMA 2009, Haselton et al. 2008 Chapter 6).

Based on the above assumptions, FIGURE C16-4 shows the collapse fragility curves for a building that meets the $P[C|MCE_R] = 10\%$ performance goal, with an assumed $\beta_{COL,RTR} = 0.40$. This figure shows that the median collapse capacity must be a factor of 2.16 above the MCE_R ground motion level, that the probability of collapse is 10% at the MCE_R when the full variability is included (as required), but that the probability of collapse is only 2.7% at the MCE_R when only the record-to-record variability is included. This 2.7% collapse probability is what would be expected from the structural model that is used in the RHA assessment procedure.

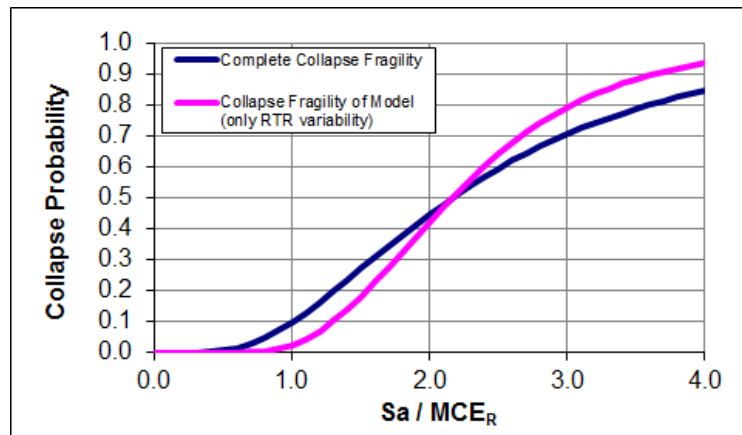

FIGURE C16-4 Collapse Fragilities for a Building with $P[C|MCE_R] = 10\%$ and $\beta_{COL,RTR} = 0.40$

The binomial distribution is now used to determine the likelihood of observing collapses for buildings with various levels of collapse safety, with Table C16-1 showing the results for an assumed value of $\beta_{COL,RTR} = 0.40$. For a building meeting the $P[C|MCE_R] = 10\%$ performance goal, Table C16-1a shows that there is a 74% chance of observing no collapses, a 23% chance of observing one collapse, a 3% chance of observing two collapses, and virtually no chance of observing more than two collapses. In comparison, for a building with $P[C|MCE_R] = 20\%$, there is a 30% chance of observing no collapses, a 38% chance of observing one collapse, a 22% chance of observing two collapses, and a 10% chance of observing more than two collapses. Table C16-1b shows the same results from a slightly different perspective; this table shows that, even for a building that meets the $P[C|MCE_R] = 10\%$ performance goal, there is a 26% chance of observing one or more collapses. From these tables, the following conclusions can be made:

- Even if no collapses are observed in the set of eleven records, this does not, in any way, prove that the $P[C|MCE_R] = 10\%$ performance goal of Table C.1.3.1b has been met. For example, even for a building with $P[C|MCE_R] = 20\%$, there is still a 30% chance that no collapses will be observed in the analysis. Therefore, the other non-collapse acceptance criteria (e.g. criteria for drifts and element demands) must be relied upon to enforce the 10% collapse probability goal.
- Even if the $P[C|MCE_R] = 10\%$ performance goal of Table C.1.3.1b is met, there is still a 26% chance that one or more collapses will be observed in the set of eleven records (i.e. there is a 26% likelihood of a “false positive”). Therefore, an acceptance criterion of “no collapses allowed” would be commonly violated by a building that fully meets the collapse safety goal of Table C.1.3.1b.
- If the $P[C|MCE_R] = 10\%$ performance goal of Table C.1.3.1b is met, it is highly unlikely (only a 3% chance) that two collapses will be observed in the set of eleven records. Therefore, an acceptance criterion that prohibits two collapses would be reasonable.

Table C16-1a Results of Simple Statistics for the Likelihood of Observing Collapses, for $\beta_{\text{COL,RTR}} = 0.40$ for Various $P[\text{C|MCE}_R]$ Values

Number of Collapses	$P[\text{C MCE}_R] = 0.05$	$P[\text{C MCE}_R] = 0.10$	$P[\text{C MCE}_R] = 0.15$	$P[\text{C MCE}_R] = 0.20$	$P[\text{C MCE}_R] = 0.30$
0 of 11	93%	74%	51%	30%	7%
1 of 11	7%	23%	36%	38%	21%
2 of 11	0%	3%	11%	22%	29%
3 of 11	0%	0%	2%	8%	24%
4 of 11	0%	0%	0%	2%	13%
5 of 11	0%	0%	0%	0%	5%

Table C16-1b Results of Simple Statistics for the Likelihood of Observing Collapses, for $\beta_{\text{COL,RTR}} = 0.40$ for $P[\text{C|MCE}_R] = 10\%$

Number of Collapses	Likelihood if $P[\text{C MCE}_R] = 10\%$
≥ 1 of 11	26%
≥ 2 of 11	3%
≥ 3 of 11	0%
≥ 4 of 11	0%
≥ 5 of 11	0%

The collapse likelihoods show in Table C16-1 are based on a relatively large record-to-record variability value of $\beta_{\text{COL,RTR}} = 0.40$. When the variability is suppressed in the ground motion selection and scaling, lower record-to-record variability values are expected, so Table C16- presents comparable results for $\beta_{\text{COL,RTR}} = 0.25$. This table shows that, for a building meeting the $P[\text{C|MCE}_R] = 10\%$ performance goal, the likelihood of observing a collapse response is very low. If spectral matching methods, or other selection-based methods, are used to suppress the record-to-record variability, then the observance of a collapse response is strongly suggestive of the building not meeting the $P[\text{C|MCE}_R] = 10\%$ performance goal.

Table C16-2a Results of Simple Statistics for the Likelihood of Observing Collapses, for $\beta_{\text{COL,RTR}} = 0.25$ for Various $P[\text{C|MCE}_R]$ Values

Number of Collapses	$P[\text{C MCE}_R] = 0.05$	$P[\text{C MCE}_R] = 0.10$	$P[\text{C MCE}_R] = 0.15$	$P[\text{C MCE}_R] = 0.20$	$P[\text{C MCE}_R] = 0.30$
0 of 11	100%	99%	93%	79%	30%
1 of 11	0%	1%	7%	19%	38%
2 of 11	0%	0%	0%	2%	22%
3 of 11	0%	0%	0%	0%	8%
4 of 11	0%	0%	0%	0%	2%
5 of 11	0%	0%	0%	0%	0%

Table C16-2b Results of Simple Statistics for the Likelihood of Observing Collapses, for $\beta_{\text{COL,RTR}} = 0.25$ for Various $P[\text{C|MCE}_R]$ Values

Number of Collapses	Likelihood if $P[\text{C MCE}_R] = 10\%$
≥ 1 of 11	1%
≥ 2 of 11	0%
≥ 3 of 11	0%
≥ 4 of 11	0%
≥ 5 of 11	0%

Requirement Limiting Unacceptable Responses. Based on the conclusions from the last section (which are based on the 10% collapse probability goal for Risk Categories I and II), when spectral matching is not utilized, the acceptance criteria require that not more than one motion of the eleven produce an unacceptable response. Following from the same above logic, when spectral matching is utilized, then the acceptance criteria require that no motions of the eleven produce an unacceptable response. As suggested in the previous section above, this criterion does not ensure that the $P[\text{C|MCE}_R] \leq 10\%$

performance goal has been met (the other acceptance criteria must enforce this); this criterion is only a secondary safeguard to ensure adequate performance.

For Risk Categories I and II, if more than eleven ground motions are used for analysis, then additional unacceptable responses may be permissible. Two unacceptable responses are permissible if twenty or more motions are used, three unacceptable responses are permissible when thirty or more motions are used, etc.

For Risk Categories III and IV, the collapse probability goals are 6% and 3%, respectively, at the MCE_R level. When the above computations are redone using these lower collapse probability targets, then this shows that the acceptance criteria should require that no motions of the eleven produce an unacceptable response for Risk Categories III and IV.

Calculation of Average Structural Responses When an Unacceptable Response Occurs. The typical approach is to compute the average building responses for use in the acceptance criteria (where the “average” is the simple statistical average, also called “arithmetic mean,” for each given building response parameter of interest). When an unacceptable response occurs, it is not possible to compute an average value of the building responses, for use in the other acceptance criteria, because one of the eleven response quantities is undefined. This applies for any of the three types of unacceptable responses, as follows:

- Dynamic instability collapse (responses are infinite)
- Non-convergence (responses are undefined)
- Response exceeding valid range of modeling (in which case, all responses predicted by the model are incorrect and shall be considered as undefined)
- Force demand exceeding the average strength of a critical force-controlled component (in which case, all responses predicted by the model are incorrect and shall be considered as undefined)

In this case, the average response estimates, for use when checking the other acceptance criteria, shall be taken as the counted median response multiplied by 1.2, but not less than the average response from the remaining motions.

To compute the median value, the unacceptable response shall be assumed as larger than the other responses and then the counted median value is taken to be the 6th largest response from the set of eleven responses (for the case when eleven motions are used). The required 1.2 inflation factor is based on a reasonable ratio of average to median values for a lognormal distribution ($\beta = 0.4$ results in average/median = 1.08, $\beta = 0.5$ results in average/median = 1.13, $\beta = 0.6$ results in average/median = 1.20, and $\beta = 0.7$ results in average/median = 1.28).

The requirement to also check the average of the remaining ten response results is simply an added safeguard to ensure that the 1.2*median value does not under-predict the average response values than should be used when checking the acceptance criteria.

Future Work on Unacceptable Responses. Although currently the purpose of this acceptance criterion is not to quantify the collapse probability (under MCE_R ground motions) of a proposed design, the acceptance criterion can be re-cast to do so in future provisions. The collapse probability can be inferred from the RHA results and compared to the target value (e.g., 10% for structures in Risk Category I or II). In this alternate light, existing statistical inference theory can be used to determine the number of acceptable responses, and the number of ground motions, required to conclude that the proposed design may have an acceptable collapse probability.

As was done in the previous section, RHA results can be thought of as following a binomial distribution. Based on this, one could use the observed counts of collapsed and non-collapsed responses (indicated by unacceptable and acceptable responses) to estimate the collapse probability of the proposed design, in a manner that accounts for the uncertainty in the estimated collapse probability. This uncertainty depends on the total number of ground motions. If few ground motions are used, there is a large uncertainty in the collapse probability. If many ground motions are used, there is a small uncertainty. For example, compare

a set of eleven ground motions with one unacceptable response to a set of 110 ground motions with ten unacceptable responses. Both sets have a most likely unacceptable response probability of 9.1%. The design with one unacceptable and ten acceptable responses has only a 34% chance that its unacceptable response probability is 10% or less. The design with ten unacceptable and 100 acceptable responses has a 56% chance that its unacceptable response probability is 10% or less.

In the current acceptance criterion, the choice to require eleven ground motions follows from the need to have confidence in the average values of the resulting element-level and story-level responses (Section C16.2.3.1). These element-level and story level responses are then used to *implicitly* demonstrate adequate collapse safety of the building (this philosophy is explained in Section 16.1). If future provisions seek to more *explicitly* ensure that the proposed design has an acceptable collapse probability, then this unacceptable response acceptance criterion should be revised using statistical inference theory to establish the number of required ground motions and the maximum number of unacceptable responses, as well as the element- and story-level response limits.

C16.4.1.2 Story Drift

The limit on average story drift is developed to be consistent with the other design procedures of this Standard (i.e. the ELF and RSA procedures in Sections 12.8 and 12.9). To this end, the basic Table 12.12-1 story drift limits are:

- Increased by a factor of 1.5, to reflect the analysis being completed at the MCE_R ground motion level rather than at $2/3$ of the MCE_R level, and
- Increased by another factor of 1.25, to reflect an average ratio of R/C_d .

These two above increases are the basis for the requirement that the average story drift be limited to 1.9 (which was rounded to 2.0) of the standard Table 12.12-1 limits.

The masonry-specific drift limits of Table 12.12-1 are not enforced in this section because the component-level acceptance criteria of Section 16.4.2 are expected to result in equivalent performance (i.e. a masonry building designed in accordance with Chapter 16 is expected to have similar performance to a masonry building designed using linear analysis methods and the more stringent drift limits of Table 12.12-1).

As mentioned above, this story drift limit is simply based on consistency with other ASCE 7 design procedures and is not clearly linked to the collapse safety goals of Table C.1.3.1b; it would be useful if a future research effort could more clearly link this story drift acceptance criterion to the intended safety goal.

The standard does not require checks on residual drift. Residual drifts are an indicator of incipient dynamic instability, and a prudent engineer will check for this explicitly in their analysis model. Limiting residual drifts is an important consideration for post-earthquake operability and for limiting financial losses, but such performance goals are not included in the scope of the ASCE 7 Standard. For Risk Category I-II buildings, the ASCE 7 Standard is primarily meant to ensure the protection of life safety. Additionally, residual drifts can be extremely difficult to predict reliably with available structural analysis tools.

C16.4.2 Element-Level Acceptance Criteria

The element-level acceptance criteria require that each element action first be classified as either a force-controlled action or a deformation-controlled action. Note that this is done for each *element action*, rather than for each *element*. For example, for a single column element, the flexural behavior may be classified as a deformation-controlled action whereas the axial behavior may be classified as a force-controlled action.

The deformation-controlled actions are those that have reliable inelastic deformation capacity without substantial strength decay, whereas the force-controlled actions pertain to brittle modes where inelastic deformation capacity cannot be assured. Based on how the acceptance criteria are structured, any element action that is modeled elastically must be classified as being force-controlled.

Some examples of force-controlled actions are as follows:

- Shear in reinforced concrete (other than diagonally reinforced coupling beams).
- Axial forces in columns.
- Punching shear in slabs without shear reinforcing.
- Connections that are not explicitly designed for the strength of the connected component such as for braces in braced frames.
- Displacement of elements resting on a supporting element without rigid connection (such as slide bearings).
- Axial forces in diaphragm collectors.

Some examples of deformation-controlled actions are as follows:

- Shear in diagonally reinforced coupling beams.
- Flexure in reinforced concrete columns and walls.
- Axial yielding in buckling restrained braces.
- Flexure in moment frames.

Section 16.4.2 further requires that the component actions be categorized, based on the consequence of their exceeding strength or deformation limits, as critical, ordinary, or non-critical, as defined in the following list. Due to the differences in consequence, the acceptance criteria are developed differently for each of the above classifications of component actions. The following two subsections include examples for how components are divided into these classifications.

- **Critical element actions:** Those in which failure would result in the collapse of multiple bays of multiple stories of the building or would result in a significant reduction of the seismic resistance of the structure.
- **Ordinary element actions:** Those in which failure would result in only local collapse, comprising not more than one bay in a single story, and would not result in a significant reduction of the seismic resistance of the structure.
- **Non-critical element actions:** Those in which failure would not result in either collapse or substantive loss of the seismic resistance of the structure.

The remainder of this section explains the acceptance criteria, and the development of those criteria for both deformation-controlled and force-controlled actions.

Element Grouping. Limits are placed on response quantities that are correlated to building performance and structural reliability. In order for compliance with these limits to meaningfully characterize overall performance and reliability, grouping of certain component actions for design purposes may be appropriate. For example, while symmetrical design forces may be obtained for symmetrical structures using equivalent-lateral-force and modal-response-spectrum analysis procedures, there is no guarantee that component actions in response history analysis of symmetrical models will be the same—or even similar—for identical components arranged symmetrically. Engineering judgment should be applied to the design to maintain symmetry by using the greater demands (that is, the demands on the more heavily loaded component determined using the appropriate factor on its average demand) for the design of both components. For this purpose using the average demands of the pair of components would not be appropriate, as this would reduce the demand used for design of the more heavily-loaded component.

While this is perhaps trivial in the case of true symmetry, it is also a concern in non-symmetrical structures. For these buildings, it may be appropriate to group structural components that are highly similar either in geometric placement or purpose. The demands determined using the suite average (the average response over all ground motions within a suite) may be very different for individual components within this grouping. This is a result both of the averaging process and the limited explicit consideration of ground motion to structure orientation in the provisions. Although the analysis may indicate that only a portion of

the grouped components do not meet the provisions, the engineer ought to consider whether such non-conformance should also suggest redesign in other similar elements. Thus response history analysis places a higher burden on the judgment of the engineer to determine the appropriate methods for extracting meaningful response quantities for design purposes.

C16.4.2.1 Force-Controlled Actions

Development of Requirements. The proposed acceptance criteria for force-controlled actions follow the framework established by the PEER TBI guidelines (PEER 2009), shown in Equation 3 below.

$$\lambda F_u \leq \phi F_{n,e} \quad (3)$$

where λ is a calibration parameter explained in this section, F_u is the average demand for the response parameter of interest, ϕ is the strength reduction factor from a material Standard, and $F_{n,e}$ is the nominal strength computed from a material standard considering expected material properties.

To determine the appropriate value of λ (for a given value of ϕ), we begin with the collapse probability goals of Table C.1.3.1b (for Risk Categories I and II) for MCE_R motions. These collapse probability goals include a 10% chance of a total or partial structural collapse and a 25% chance of a failure that could result in endangerment of individual lives. For the assessment of collapse, we then make the assumption that the failure of a critical force-controlled component would result in a total or partial structural collapse of the building. This is a conservative assumption.

Focusing first on the goal of 10% chance of a total or partial structural collapse, we assume that the component force demand and component capacity both follow a lognormal distribution, and that the estimate of $F_{n,e}$ represents the true expected strength of the component. We then calibrate the required λ value to achieve the 10% collapse probability goal. This is depicted in FIGURE C16-5 which shows the lognormal distributions of the component capacity and component demand.

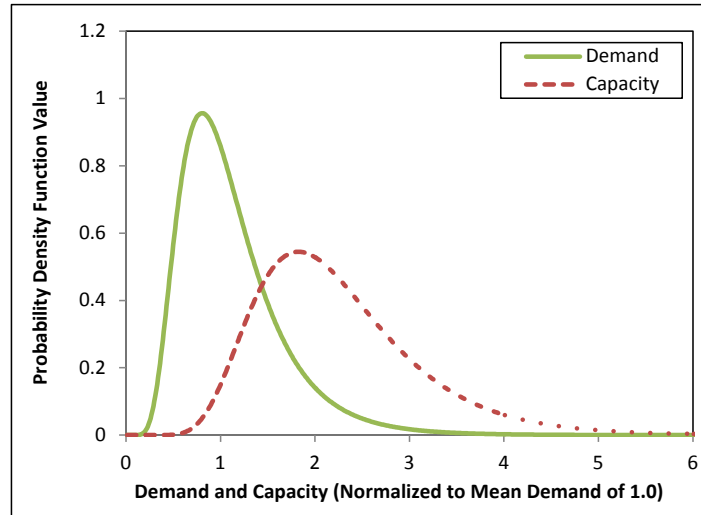

FIGURE C16-5 Illustration of Lognormal Distributions for Component Capacity and Component Demand (Normalized to an Average Capacity of 1.0); the Average Component Capacity is Calibrated to Achieve $P[C|MCE_R] = 10\%$

The calibration process is highly dependent on the uncertainties in both the demand and the capacity of the component.

Table C16-3a shows the uncertainties in force *demand* for analyses at the MCE_R ground motion level, for both the general case and the case where the response parameter is limited by a well-defined yield mechanism.

Table C16-3b similarly shows the uncertainty values for the component *capacity*.

Table C16-3a Assumed Variability and Uncertainty Values for the Component Force Demand and Capacity

Demand Dispersion (β_D) General	Demand Dispersion (β_D) Well-Defined Mechanism	Variabilities and Uncertainties in the Force Demand
0.40	0.20	Record-to-record variability (for MCE_R ground motions)
0.20	0.20	Uncertainty from estimating force demands using structural model
0.13	0.06	Variability from estimating force demands from average of only 11 ground motions
0.46	0.29	$\beta_{D-TOTAL}$

Table C16-3b Assumed Variability and Uncertainty Values for the Component Force Demand and Capacity

Capacity Dispersion (β_C) General	Capacity Dispersion (β_C) Well-Defined Mechanism	Variabilities and Uncertainties in the Final As-Built Capacity of the Component
0.30	0.30	Typical variability in strength equation for $F_{n,e}$ (from available data)
0.10	0.10	Typical uncertainty in strength equation for $F_{n,e}$ (extrapolation beyond available data)
0.20	0.20	Uncertainty in as-built strength due to construction quality and possible errors
0.37	0.37	$\beta_{C-TOTAL}$

The values shown in Table C16-3 are based on reference materials, as well as the collective experience and professional judgment of the development team.

In the above calibration process, the λ and ϕ values both directly affect the final strength of the component. Therefore, the calibration is completed to determine the required value of λ/ϕ needed to fulfill the 10% collapse safety objective. This is done by integrating together the lognormal distributions of demand and capacity (i.e. FIGURE C16-5) and determining the capacity required to meet the 10% collapse safety objective. Table C16-4 reports the final λ/ϕ values that come from such integration.

It should be clearly stated that this approach of calibrating the λ/ϕ ratio means that the final acceptance criterion is independent of the ϕ value specified by a material standard. If it is desirable for the acceptance criteria to be partially dependent on the value of ϕ , then the uncertainty factors of Table C16-3b would need to be made dependent on the ϕ value in some manner.

Table C16-2 Required Ratios of λ/ϕ to Achieve the 10% Collapse Probability Objective

Required Ratio of λ / ϕ General	Required Ratio of λ / ϕ Well-Defined Mechanism
2.1	1.9

Based on the Table C16-2 values being so similar, the Chapter 16 acceptance criterion is based on $\lambda/\phi = 2.0$ for all cases (for simplicity) and a separate case for a well-defined mechanism is not included. Additionally, the strength term is defined slightly differently. For Risk Categories III and IV, this full calculation was redone using the lower collapse probability goals of 6% and 3%, respectively, and it was found that scaling the force demands by I_e sufficiently achieves these lower collapse probability goals.

Equation 4 reiterates the final Chapter 16 acceptance criterion for critical force-controlled components to achieve the goal of a 10% chance of a structural collapse; this is the acceptance criterion for force-controlled actions that are classified as critical actions.

$$2.0I_eF_u \leq F_e \quad (4)$$

where F_u is the average demand for the response parameter of interest and F_e is the expected strength of the component.

This statistical calculation was then redone for the goal of 25% chance of a failure that could result in endangerment of individual lives. This resulted in a required ratio of 1.5 in Equation 4 (instead of 2.0) for

such force-controlled failure modes; this is the acceptance criterion for force-controlled actions that are classified as ordinary actions.

Force-controlled actions are deemed non-critical if the failure does not result in structural collapse or any meaningful endangerment to individual lives; this occurs in situations where gravity forces can reliably redistribute to an alternate load path and no failure will ensue. For non-critical force-controlled components, the acceptance criteria allow the use of $\lambda = 1.0$.

Calculation of Average Component Strengths. The expected strength of the component, F_e , is often computed as follows. First, a standard strength-prediction equation is used from a material standard with a strength reduction factor, ϕ , of 1.0; the expected material properties are also used in place of nominal material properties. This process provides the strength estimate of $F_{n,e}$ that was previously defined. In some cases, this estimate of strength ($F_{n,e}$) may still be conservative in comparison with the expected strength shown by experimental tests (F_e). If such conservatism exists, the $F_{n,e}$ value may be multiplied by a “component reserve strength factor” greater than 1.0, to produce the estimate of the expected strength (F_e). This process is illustrated below in FIGURE C16-6 which shows the $F_e / F_{n,e}$ ratios for the shear strengths from test data of reinforced concrete shear walls (Moehle 2012). For reinforced concrete shear walls, this figure shows that the ratio of $F_e / F_{n,e}$ depends on the flexural ductility of the shear wall, demonstrating that $F_e = 1.0 F_{n,e}$ is appropriate for the shear strength in the zone of high flexural damage and $F_e = 1.5 F_{n,e}$ may be appropriate in zones with no flexural damage.

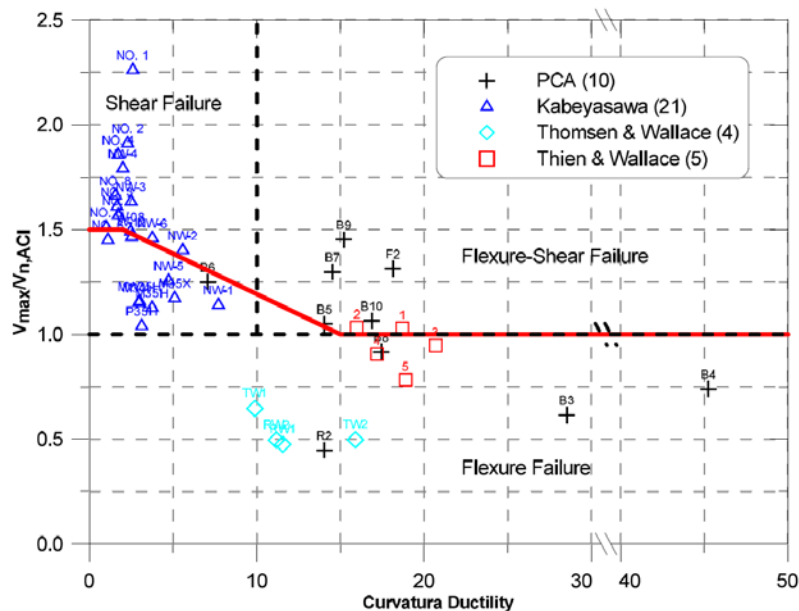

FIGURE C16-6 Expected Shear Strengths (in terms of $F_e / F_{n,e}$) for Reinforced Concrete Shear Walls, when Subjected to Various Levels of Flexural Ductility (from Wallace et al. 2013)

For purposes of comparison, the above Equation 3 requirement is comparable to the PEER TBI acceptance criteria value (PEER 2009) for the case that $\phi = 0.75$ and $F_e = 1.0 F_{n,e}$.

EXCEPTION: The exception allows for use of the capacity design philosophy for force-controlled components that are “protected” by inelastic fuses, such that the force delivered to the force-controlled component is limited by the strength of the inelastic fuse.

Examples of Failure Consequence Categorization for Force-Controlled Components. The following are some examples of force-controlled actions that are deemed to be critical actions:

- Steel Moment Frames (SMF):
 - Axial compression forces in columns due to combined gravity and overturning forces
 - Combined axial force, bending moments, and shear in column splices
 - Tension in column base connections (unless modeled inelastically, in which case it would be a deformation-controlled component)
- Steel Braced Frames (BRBF, SCBF):
 - Axial compression forces in columns due to combined gravity and overturning forces
 - Combined axial force, bending moments, and shear in column splices
 - Tension in brace and beam connections
 - Column base connections (unless modeled inelastically)
- Concrete Moment Frames:
 - Axial compression forces in columns due to combined gravity and overturning forces
 - Shear force in columns and beams
- Concrete Shear Walls:
 - Shear in concrete shear wall, in cases when there is limited ability for the shear force to transfer to adjacent wall panels. For cases of isolated shear walls (i.e. wall #1 in FIGURE C16-7), the shear force in this isolated wall is deemed as a critical action. In contrast, the shear force in a one wall pier that is in a group of wall piers (e.g. panel #2 of FIGURE C16-8) need not be deemed a critical action (especially when determining whether an analysis is deemed to represent an unacceptable response). For this case of a group of wall piers, it may be appropriate to consider the sum of the wall shears to be the critical action (e.g. the sum of wall shears in panels #1, #2, and #3 of FIGURE C16-8)
 - Axial (plus flexural) compression in concrete shear wall (for most cases)
 - Axial compression in outrigger columns
 - Axial (plus flexural) tension in outrigger column splices
- Other Types of Components:
 - Shear forces in piles and pile cap connections (unless modeled inelastically)
 - Shear forces in shallow foundations (unless modeled inelastically)
 - Punching shear in slabs without shear reinforcing (unless modeled inelastically)
 - Any structural members of lateral force resisting system that are not designed and modeled for inelastic action
 - Diaphragms that transfer a substantial amount of force (from more than one story)
 - Elements supporting discontinuous frames and walls

The following are some examples of force-controlled actions that are deemed to be ordinary actions:

- Steel Moment Frames (SMF):
 - Axial tension forces in columns due to overturning forces
 - Shear force in beams and columns
 - Column base connections (unless modeled inelastically)
 - Welded or bolted joints (as distinct from the inelastic action of the overall connection) between moment frame beams and columns
- Steel Braced Frames (BRBF, SCBF):

- Axial tension forces in columns due to overturning forces
- Concrete Moment Frames:
 - Splices in longitudinal beam and column reinforcement
- Concrete Shear Walls:
 - An ordinary classification would only apply in special cases where failure would not cause widespread collapse and would cause minimal reduction in the building seismic resistance
- Other Types of Components:
 - Axial forces in diaphragm collectors (unless modeled inelastically)
 - Shear and chord forces in diaphragms (unless modeled inelastically)
 - Pile axial forces
 - Pile bending
 - Foundation flexure

Force-controlled action can be deemed to be a non-critical action when the failure of the component would not result in either collapse or substantive loss of the seismic resistance of the structure.



FIGURE C16-7 Plan View of Sample Building Showing Arrangement of Concrete Shear Walls

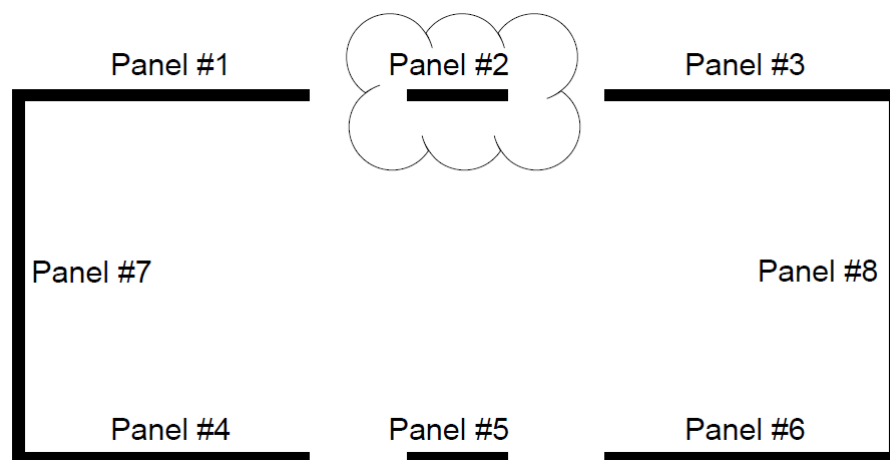

FIGURE C16-8 Plan View of Sample Building Showing Components of a Reinforced Concrete Core Shear Wall

C16.4.2.2 Deformation-Controlled Actions

This section explains the acceptance criteria for deformation-controlled component actions. This section also includes a discussion of how the ASCE 41 acceptance criteria (ASCE, 2013) can be used when adequate test data are unavailable for estimating the component deformation capacities.

Deformation Limit to Prevent Loss in Vertical-Load-Carrying-Capacity (LVCC). To determine the appropriate inelastic deformation limits, a process is utilized that is similar to the previous section for force-controlled components.

Table C16-a shows the uncertainties in deformation demand for structural analyses for MCE_R ground motions. Table C16-b similarly shows the uncertainties in the component deformation capacity at the point that LVCC occurs. These β_C values are larger than the comparable values for force-controlled components because the uncertainty is quite large when trying to quantify the deformation at which LVCC occurs.

Table C16-5a Assumed Variability and Uncertainty Values for the Component Deformation Demand and Capacity

Demand Dispersion (β_D)	Variabilities and Uncertainties in the Deformation Demand
0.40	Record-to-record variability (for MCE_R ground motions)
0.20	Uncertainty from estimating deformation demands using structural model (model. uncert.)
0.13	Variability from estimating deformation demands from average of only 11 ground motions
0.46	$\beta_{D-TOTAL}$

Table C16-5b Assumed Variability and Uncertainty Values for the Component Deformation Demand and Capacity

Capacity Dispersion (β_C)	Variabilities and Uncertainties in the Final As-Built Deformation Capacity of the Component
0.60	Typical variability in prediction equation for deformation capacity (from available data)
0.20	Typical uncertainty in prediction equation for def. cap. (extrapolation beyond data)
0.20	Uncertainty in as-built deformation capacity due to construction quality and errors
0.66	$\beta_{C-TOTAL}$

The results of integration show that the average deformation capacity must be a factor of 3.2 larger than the average deformation demand, in order to meet the 10% collapse safety objective (for total or partial structural collapse) for MCE_R ground motions. Using the inverse of this value, this leads to a requirement that the average deformation demand be limited to less than 0.3 of the average deformation capacity.

This 0.3 limit is quite conservative and assumes that immediate collapse will result when the deformation capacity is exceeded in a single component. Such immediate collapse may occur in some uncommon cases where no alternative load path exists; however, in most cases, there is at least one alternative load path and the gravity loads will redistribute and delay the occurrence of vertical collapse. In situations where gravity forces can reliably redistribute to an alternate load path, a ratio of 0.5 may instead be used in the acceptance criterion, to reflect the fact that immediate collapse will not result when the deformation capacity is exceeded in a single component. Note that the use of a 0.3 ratio in the acceptance criterion assumes that there is a 100% probability of building collapse when the deformation capacity is exceeded in a single component; the use of a 0.5 ratio instead implies a 40% probability of building collapse when the deformation capacity is exceeded in a single component. These are the acceptance criteria used for critical deformation-controlled actions.

This statistical calculation was then redone for the goal of a 25% chance of a failure that would result in endangerment of individual lives. The results of integration show that the average deformation capacity must be a factor of 2.0 larger than the average deformation demand, in order to meet the 25% goal for MCE_R ground motions; using the inverse of this value, this leads to a requirement that the average deformation demand be limited to less than 0.5 of the average deformation capacity. Similar to the logic

used above, if gravity forces can reliably redistribute to an alternate load path and delay the consequences of the failure, a ratio of 0.7 can be used in place of 0.5. These are the acceptance criteria used for ordinary deformation-controlled actions.

For non-critical deformation-controlled actions, by definition, the failure of such component would not result in any collapse and also would not result in substantive loss in the seismic strength of the structure. Accordingly, for such case, the inelastic deformation is not limited by the Section 16.4.2.2 acceptance criterion (because there is no meaningful consequence of failure for such component), but the inelastic deformation of such component is still limited by the unacceptable response criterion of Section 16.4.1.1 (i.e. the component must be adequately modeled up to the deformation levels that the component experiences in the structural simulation).

Examples of Failure Consequence Categorization for Deformation-Controlled Components. The following are some examples of deformation-controlled actions that are deemed to be critical actions:

- Steel Moment Frames (SMF)
 - Hinge rotations in beams and columns leading to significant strength/stiffness degradation
 - Deformations of non-ductile gravity beam to column connections
- Steel Braced Frames (BRBF, SCBF)
 - Axial deformations (tension/compression) in braces
 - Hinge rotations in beams and columns leading to significant strength/stiffness degradation
 - Deformations of non-ductile gravity beam to column connections
- Concrete Moment Frames
 - Hinge rotations in beams and columns leading to significant strength/stiffness degradation
 - Deformations of non-ductile slab-column connections in reinforced concrete gravity systems
- Concrete Shear Walls
 - Tensile strains in longitudinal wall reinforcement
 - Compression strains in longitudinal wall reinforcement and concrete
 - Flexural hinging or shear yielding of coupling beams
 - Deformations of non-ductile slab-column or slab-wall connections in reinforced concrete gravity systems
- Other Types of Components:
 - Soil uplift and bearing deformations in shallow foundations (when modeled inelastically)
 - Tensile pullout deformations or compression bearing deformations of pile foundations (when modeled inelastically)

The following are some examples of deformation-controlled actions that are deemed to be ordinary actions:

- Steel Moment Frames (SMF)
 - Deformations of ductile gravity beam to column connections
- Steel Braced Frames (BRBF, SCBF, or non-conforming braced frames)
 - Deformations of ductile gravity beam to column connections
- Concrete Moment Frames
 - Deformations of ductile slab-column connections in reinforced concrete gravity systems
- Concrete Shear Walls

- Deformations of ductile slab-column or slab-wall connections in reinforced concrete gravity systems

The following are some examples of deformation-controlled actions that could be deemed non-critical actions:

- Deformations in a coupling beam in a shear wall system, in the case that the failure of the coupling beam neither results in any collapse nor substantive loss to seismic resistance

Deformation Limit Related to Component Strength Loss. An additional deformation limit related to lateral strength loss of a component is not included because such a limit would lead to unnecessary conservatism in the design process. This conservatism comes from the fact that component strength loss does not necessarily lead to structural collapse; in many cases, substantial strength loss can occur in a single component well before the building reaches a collapse limit state.

In the development of the Chapter 16 requirements, a limit on building (or story) strength loss was considered, similar to the 20% maximum story strength loss required in the PEER TBI guidelines (2009). If one assumes that the structural model is able to appropriately simulate the effects of component strength loss (as is required by the limitations imposed on unacceptable responses), then a limit on building strength loss is theoretically unnecessary. In the development of the above-mentioned PEER TBI requirements, this assumption was not made; the belief was that the currently available structural modeling tools do not enable reliable prediction of structural response at large levels of building strength loss. In the Chapter 16 RHA procedure, it was desirable to include a similar maximum story strength loss requirement, but this was not done for two reasons: (1) no simple way could be found to clearly define the meaning of “story strength” or “building strength” in order to place a clear limit on such strength loss, and (2) for most structural systems, it is expected that the drift limits would control before a strength loss acceptance criterion would be triggered, thereby making a strength loss criterion less important for ensuring adequate building safety.

Use of ASCE 41 Acceptance Criterion Limits When Test Data are Unavailable. As the first step, test data should be pursued to establish the basis for the inelastic deformation acceptance criterion, as previously discussed. However, in many cases, such data are simply not available. In such cases where test data are not available, the ASCE 41 (ASCE 2013) information can be used as a basis for developing the numerical deformation-controlled acceptance criteria for use in the RHA procedure; this section discusses such appropriate usage of ASCE 41.

To determine the appropriate manner in which to use the ASCE 41 tabular acceptance criteria, the statistical basis for the acceptance criteria must first be understood (e.g. are the criteria average capacity values, conservative values, etc.). In this discussion, we will focus on the ASCE 41 Collapse Prevention acceptance criteria for secondary components, since this is what ASCE 41 recommends for use with nonlinear response-history analyses. ASCE 41-13 (ASCE 2013) states that the Collapse Prevention criteria are intended to be equivalent to the *average* deformations that would result in the loss of vertical-load-carrying-capacity, which is inconsistent with the acceptance criterion. Even though ASCE 41-13 defines the limit as an average value, this is not how many of the tabular Collapse Prevention acceptance criteria were actually developed in ASCE 41. For example, the acceptance criteria for conforming reinforced concrete columns are conservatively based on the 15th percentile value of test data for non-conforming columns (Elwood et al. 2007). In contrast, the acceptance criteria for structural steel components are based on average values, but these are average deformations at substantial lateral strength loss, which are still conservative estimates of when loss in vertical-load-carrying-capacity would occur. Overall, the statistical basis is not consistent for the various tabular Collapse Prevention acceptance criteria values of ASCE 41.

If the statistical basis of the ASCE 41 Collapse Prevention acceptance criterion is known for a specific type of structural component, one could then determine how to appropriately use the ASCE 41 tabular values to develop the appropriate acceptance criterion. In the absence of such information, it can be assumed that the tabular ASCE 41 Collapse Prevention values for secondary components represent 2/3 of the true

average values at which loss in vertical-load-carrying-capacity would occur. Based on this assumption, the following acceptance criteria may be used from ASCE 41 (for the case that $I_e = 1.0$):

- When the component is deemed as a critical component:
 - If redistribution is not reliable, then 50% of the ASCE 41 Collapse Prevention values for secondary components may be used as the acceptance criterion (based on a $0.3/I_e$ ratio).
 - If redistribution is reliable, and the exception is invoked, then 75% of the ASCE 41 Collapse Prevention values for secondary components may be used as the acceptance criterion (based on a $0.5/I_e$ ratio).
- When the component is deemed as an ordinary component:
 - If redistribution is not reliable, then 75% of the ASCE 41 Collapse Prevention values for secondary components may be used as the acceptance criterion (based on a $0.5/I_e$ ratio).
 - If redistribution is reliable, and the exception is invoked, then 100% of the ASCE 41 Collapse Prevention values for secondary components may be used as the acceptance criterion (based on a $0.7/I_e$ ratio).
- When the component is deemed as a non-critical component: The deformation is not limited by the acceptance criterion of this section (but is still limited by the unacceptable response criterion of Section 16.4.1.1).

C16.4.2.3 Components of the Gravity System

The Chapter 16 RHA procedure requires that the basic deformation-compatibility requirement of ASCE 7-10 Section 12.12.5 be imposed for gravity-system components, which are not part of the established seismic force-resisting system, but that this be done using the deformation demands predicted from response-history analysis under MCE_R -level ground motions.

If an analyst wanted to further investigate the performance of the gravity system (which is not required), the most direct and complete approach (but also the most time-consuming) would be to directly model the gravity system components as part of the structural model and then impose the same acceptance criteria used for the components of the seismic force-resisting system. An alternative approach (which is more common) would be to model the gravity system in a simplified manner and verify that the earthquake-imposed force demands do not control over the other load combinations and/or to verify that the average gravity system deformations do not exceed the deformation limits for deformation-controlled components.

C16.5 DESIGN REVIEW

No commentary for this section.

REFERENCES

- ASCE (2005). Seismic Design Criteria for Structures, Systems, and Components in Nuclear Facilities, ASCE/SEI 43-05. American Society of Civil Engineers, Reston, Virginia.
- ASCE (2007). Seismic Rehabilitation of Existing Buildings, ASCE/SEI 41-06. American Society of Civil Engineers, Reston, Virginia.
- ASCE (2010). Minimum Design Loads for Buildings and Other Structures, ASCE/SEI 7-10. American Society of Civil Engineers, Reston, Virginia.
- ATC-72 (2010). Modeling and Acceptance Criteria for Seismic Design and Analysis of Tall Buildings, Pacific Earthquake Engineering Research Center, 2010/111.
- Ancheta (2012) NGA West 2 database, 15WCEE
- Baker, J.W. (2011). The Conditional Mean Spectrum: a tool for ground motion selection. *Journal of Structural Engineering*. 137:3, 322–331.

- Bommer, J.J., Scott, S.G., and Sarma, S.K. (2000). Hazard-consistent earthquake scenarios. *Soil Dynamics and Earthquake Engineering*. 19:4, 219–231.
- Bradley, B.A. (2010). A generalized conditional intensity measure approach and holistic ground-motion selection. *Earthquake Engineering & Structural Dynamics*. 39:12, 1321–1342.
- Elwood, K.J., A.B. Matamoros, J.W. Wallace, D.E. Lehman, J.A. Heintz, A.D. Mitchell, M.A. Moore, M.T. Valley, L.N. Lowes, C.D. Comartin, and J.P. Moehle (2007). Update to the ASCE/SEI 41 Concrete Provision, *Earthquake Spectra*, Vol. 23, No. 3, pp. 493-523, August 2007.
- Grant, DN and R Diaferia (2012). “Assessing adequacy of spectrum-matched ground motions for response history analysis,” *Earthquake Engineering and Structural Dynamics*, DOI: 10.1002/eqe.2270.
- Haselton, C.B., A.B. Liel, G.G. Deierlein, B.S. Dean, and J.H. Chou (2011). “Seismic Collapse Safety of Reinforced Concrete Buildings: I. Assessment of Ductile Moment Frames,” *American Society of Civil Engineers Journal of Structural Engineering*, Volume 137, Number 4, pp. 481-491, April 2011.
- Haselton, C.B. and G.G. Deierlein (2007). *Assessing Seismic Collapse Safety of Modern Reinforced Concrete Frame Buildings*, PEER Report 2007/08, Pacific Engineering Research Center, University of California, Berkeley, California.
- Haselton, C.B. and J.W. Baker, 2006. “Ground motion intensity measures for collapse capacity prediction: choice of optimal spectral period and effect of spectral shape,” 8th National Conference on Earthquake Engineering (100th Anniversary Earthquake Conference), San Francisco, California, April 18-22, 2006, 10 pp.
- Hashash, Y.M.A. and Park, D., 2001, “Non-linear one-dimensional seismic ground motion propagation in the Mississippi embayment,” *Engineering Geology*, Vol. 62, Nos. 1-3, pp. 185-206.
- Huang, YN, AS Whittaker, and N Luco (2008). “Maximum spectral demands in the near fault region,” *Earthquake Spectra*, 24, 319–341.
- Idriss, I.M. and Sun, J.I., 1992, *User’s Manual for SHAKE91: A Computer Program for Conducting Equivalent Linear Seismic Response Analyses of Horizontally Layered Soil Deposits*, Center for Geotechnical Modeling, Dept. of Civil & Environmental Engineering., University of California, Davis.
- LATBSDC (2008). *An Alternative Procedure for Seismic Analysis and Design of Tall Buildings Located in the Los Angeles Region*. Los Angeles Tall Buildings Structural Design Council.
- Lin, T., C.B. Haselton, J.W. Baker (2012a). “Conditional-Spectrum-based ground motion selection. Part I: Hazard consistency for risk-based assessments,” *Earthquake Engineering and Structural Dynamics*.
- Lin, T., C.B. Haselton, J.W. Baker (2012b). “Conditional-Spectrum-based ground motion selection. Part II: Intensity-based assessments and evaluation of alternative target spectra,” *Earthquake Engineering and Structural Dynamics*.
- Luco, N and P Bazzurro (2007). “Does amplitude scaling of ground motion records result in biased nonlinear structural drift responses?,” *Earthquake Engineering and Structural Dynamics*, 36, 1813-1835.
- Naeim, F., and Lew, M. (1995). On the use of design spectrum compatible time histories. *Earthquake Spectra*. 11:1, 111–127.
- NIST GCR 10-917-9
- NIST (2011a). *Selecting and Scaling Earthquake Ground Motions for Performing Response History Analysis*, NIST/GCR 11-917-15, prepared by the NEHRP Consultants Joint Venture for the National Institute of Standards and Technology, Gaithersburg, Maryland.
- NIST (2011b). *Soil-Structure Interaction for Building Structures*, NIST/GCR 11-917-14, prepared by the NEHRP Consultants Joint Venture for the National Institute of Standards and Technology, Gaithersburg, Maryland.
- NIST (2010a). *Nonlinear Structural Analysis for Seismic Design: A Guide for Practicing Engineers*, NEHRP Seismic Design Technical Brief No. 4, NIST/GCR 10-917-5, prepared for the National Institute of Standards and Technology, Gaithersburg, Maryland.
- NIST (2010b). *Applicability of Nonlinear Multiple-Degree-of-Freedom Modeling for Design*, NIST/GCR 10-917-9, prepared by the NEHRP Consultants Joint Venture for the National Institute of Standards and Technology, Gaithersburg, Maryland.
- PEER (2009). *Guidelines for Performance-Based Seismic Design of Tall Buildings*, prepared by the Tall Buildings Initiative Guidelines Working Group for the Pacific Earthquake Engineering Research Center, University of California, Berkeley.
- Reiter, L. (1990). *Earthquake Hazard Analysis: Issues and Insights*. Columbia University Press, New York.
- Schnabel, P.B., Lysmer, J., and Seed, H.B., 1972, *SHAKE—A Computer Program for Earthquake Response Analysis of Horizontally Layered Sites*, Report EERC 72-12, Earthquake Engineering Research Center, University of California, Berkeley.
- Wallace J.W., C. Segura, and T. Tran (2013). “Shear Design of Structural Walls,” 10th International Conference on Urban Earthquake Engineering, Tokyo Institute of Technology, Tokyo, Japan, March 1-2, 2013, 7 pp.

COMMENTARY TO CHAPTER 17, SEISMIC DESIGN REQUIREMENTS FOR SEISMICALLY ISOLATED STRUCTURES

C17.1 GENERAL

Seismic isolation, also referred to as base isolation due to its common use at the base of building structures, is a design method used to substantially decouple the response of a structure from potentially damaging horizontal components of earthquake motions. This decoupling can result in response that is significantly reduced from that of a conventional, fixed-base building.

The significant damage to buildings and infrastructure following large earthquakes over the last three decades has led to the rapid growth of seismic isolation technology and the development of specific guidelines for the design and construction of seismically isolated buildings and bridges in the United States, as well as standardized testing procedures of isolation devices.

Design requirements for seismically isolated building structures were first codified in the United States as an appendix to the 1991 Uniform Building Code, based on “General Requirements for the Design and Construction of Seismic-Isolated Structures” developed by the Structural Engineers Association of California State Seismology Committee. In the intervening years, those provisions have developed along two parallel tracks into the design requirements in Chapter 17 of the ASCE/SEI 7 standard and the rehabilitation requirements in Section 9.2 of ASCE/SEI 41, Seismic Rehabilitation of Existing Buildings. The design and analysis methods of both standards are similar, but ASCE/SEI 41 allows more relaxed design requirements for the superstructure of rehabilitated buildings. The basic concepts and design principles of seismic isolation of highway bridge structures were developed in parallel and first codified in the United States in the 1990 AASHTO provisions Guide Specification for Seismic Isolation Design of Highway Bridges. The subsequent version of this code (AASHTO 1999) provides a systematic approach to determining bounding limits for analysis and design of isolator mechanical properties.

The present edition of the ASCE/SEI 7-Chapter 17 provisions contains significant modifications with respect to superseded versions, intended to facilitate the design and implementation process of seismic isolation, thus promoting the expanded use of the technology. Rather than addressing a specific method of seismic isolation, the standard provides general design requirements applicable to a wide range of seismic isolation systems. Because the design requirements are general, testing of isolation-system hardware is required to confirm the engineering parameters used in the design and to verify the overall adequacy of the isolation system. Use of isolation systems whose adequacy is not proved by testing is prohibited. In general, acceptable systems (a) maintain horizontal and vertical stability when subjected to design displacements, (b) have an inherent restoring force defined as increasing resistance with increasing displacement, (c) do not degrade significantly under repeated cyclic load, and (d) have quantifiable engineering parameters (such as force-deflection characteristics and damping).

The lateral force-displacement behavior of isolation systems can be classified into four categories, as shown in Figure C17.1-1, where each idealized curve has the same design displacement, DD.

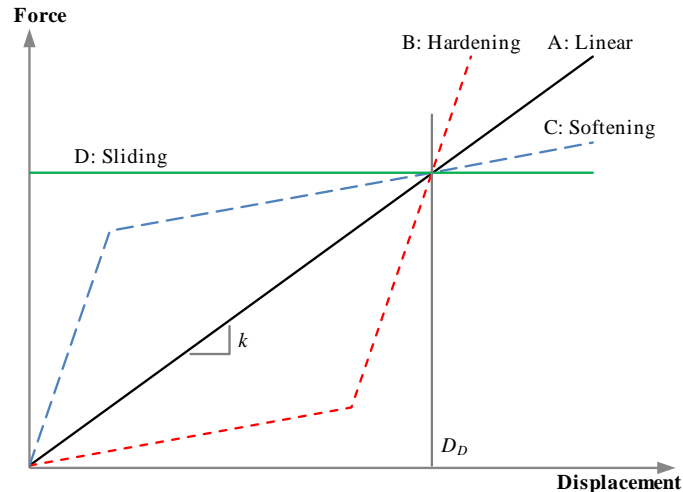

FIGURE C17.1 Idealized Force-Deflection Relationships for Isolation Systems (Stiffness Effects of Sacrificial Wind-Restraint Systems Not Shown for Clarity)

A linear isolation system (Curve A) has an effective period that is constant and independent of the displacement demand, and where the force generated in the superstructure is directly proportional to the displacement of the isolation system.

A hardening isolation system (Curve B) has a low initial lateral stiffness (or equivalently a long effective period) followed by a relatively high second stiffness (or a shorter effective period) at higher displacement demands. Where displacements exceed the design displacement, the superstructure is subjected to increased force demands, while the isolation system is subject to reduced displacements, compared to an equivalent linear system with equal design displacement, as shown in Figure C17.1-1.

A softening isolation system (Curve C) has a relatively high initial stiffness (short effective period) followed by a relatively low second stiffness (longer effective period) at higher displacements. Where displacements exceed the design displacement, the superstructure is subjected to reduced force demands, while the isolation system is subject to increased displacement demand than for a comparable linear system.

The response of a purely sliding isolation system without lateral restoring force capabilities (Curve D) is governed by friction forces developed at the sliding interface. With increasing displacements, the effective period lengthens while loads on the superstructure remain constant. For such systems, the total displacement caused by repeated earthquake cycles is highly dependent on the characteristics of the ground motion and may exceed the design displacement, DD . Since these systems do not have increasing resistance with increasing displacement which helps to re-center the structure and prevent collapse, the procedures of the standard cannot be applied, and use of the system is prohibited.

Chapter 17 of the present ASCE/SEI 7 provisions establishes isolator design displacements, shear forces for structural design, and other specific requirements for seismically isolated structures. All other design requirements, including loads (other than seismic), load combinations, allowable forces and stresses, and horizontal shear distribution, are the same as those for conventional, fixed-base structures. The main changes incorporated in this edition of the provisions include the following:

- Modified calculation procedure for the elastic design base shear forces from the DBE event to the MCE_R event using a consistent set of upper and lower bound stiffness properties and displacements. This modification simplifies the design and analysis process by focusing only on the MCE_R event.
- Relaxed permissible limits and criteria for the use of the equivalent lateral force (ELF) procedure. This modification minimizes the need to perform complex and computationally expensive non-

linear time history analyses to design the superstructure and isolation system on many base isolated structures.

- Enhanced definitions of design properties of the isolation system.
- Use of nominal properties in the design process of typical isolation bearings specified by the manufacturers based on prior prototype testing.
- These nominal properties are adjusted using the newly incorporated AASHTO 1999 lambda factor concept to account for response uncertainties and obtain upper and lower bound properties of the isolation system for the design process.
- New method for the vertical distribution of lateral forces associated with the ELF method of design.
- Simplified approach for incorporating a 5% accidental mass eccentricity in non-linear time history analyses.
- Reduction in the required number of peer reviewers on a seismic isolation project from the current 3-5 to a minimum of one peer reviewer. Also, peer reviewers are not required to attend the prototype tests.
- Calculation procedure to estimate permanent residual displacements that may occur in seismic isolation applications with relatively long period high yield/friction levels, and small yield displacements under a wide range of earthquake intensity.

C17.2 GENERAL DESIGN REQUIREMENTS

In an ideal seismic isolation application, the lateral displacement of the structure is primarily accommodated through large lateral displacement or deformation of the isolation system rather than internal deformation of the superstructure above. Accordingly, the lateral force-resisting system of the superstructure above the isolation system is designed to have sufficient stiffness and strength to prevent large, inelastic displacements. Therefore, the standard contains criteria that limit the inelastic response of the superstructure. Although damage control is not an explicit objective of the standard, design to limit inelastic response of the structural system directly reduces the level of damage that would otherwise occur during an earthquake. In general, isolated structures designed in accordance with the standard are expected to:

1. Resist minor and moderate levels of earthquake ground motion without damage to structural elements, nonstructural components, or building contents and
2. Resist major levels of earthquake ground motion without failure of the isolation system, significant damage to structural elements, extensive damage to nonstructural components, or major disruption to facility function.

Isolated structures are expected to perform considerably better than fixed-base structures during moderate and major earthquakes. Table C17.2-1 compares the expected performance of isolated and fixed-base structures designed in accordance with the standard. Actual performance of an isolated structure should be determined by performing non-linear time history analyses and computing inter-story drifts and floor acceleration demands for an array of ground motions. Those results can be used to compute post-earthquake repair costs of the structure using the ATC-58 Performance-Based Earthquake Engineering (PBEE) methodology and/or large-scale simulations of direct and indirect costs using HAZUS (1999). Evaluation of seismic performance enhancement using seismic isolation should include its impact on floor accelerations as well as inter-story drifts as these are key engineering demand parameters affecting damage in MEP equipment, ceilings and partitions, and building contents.

Table C17.2-1 Performance Expected for Minor, Moderate, and Major Earthquakes^a

Performance Measure	Earthquake Ground Motion Level Minor	Earthquake Ground Motion Level Moderate	Earthquake Ground Motion Level Major
Life-safety: Loss of life or serious injury is not expected	F, I	F, I	F, I
Structural damage: Significant structural damage is not expected	F, I	F, I	I
Nonstructural damage: Significant nonstructural or contents damage is not expected	F, I	I	I

Note: ^aF indicates fixed base; I indicates isolated.

Loss of function or discontinued building operation is not included in Table C17.2-1. For certain fixed-base facilities, loss of function would not be expected unless there is significant structural and nonstructural damage causing closure or restricted access to the building. In other cases, a facility with only limited or no structural damage would not be functional as a result of damage to vital nonstructural components or contents. Seismic isolation, designed in accordance to these provisions, would be expected to mitigate structural and nonstructural damage and to protect the facility against loss of function. The post-earthquake repair time required to rehabilitate the structure can also be determined through an ATC-58 PBEE evaluation.

C17.2.4 Isolation System

C17.2.4.1 Environmental Conditions

Environmental conditions that may adversely affect isolation system performance must be investigated thoroughly. Specific requirements for environmental considerations on isolators are now included in new Section 17.2.8. Unlike conventional materials whose properties do not vary substantially with time, the materials used in seismic isolators are typically subject to significant aging effects over the lifespan of a building structure. Because the testing protocol of Section 17.8 does not account for the effects of aging, contamination, scragging (temporary degradation of mechanical properties with repeated cycling), temperature, velocity effects, and wear, the designer must account for these effects by explicit analysis. The approach to accommodate these effects, introduced in the AASHTO specifications (1999), is to use property modification factors as specified in Sec. 17.2.8.4.

C17.2.4.2 Wind Forces

Lateral displacement over the depth of the isolation region resulting from wind loads must be limited to a value similar to that required for other stories of the superstructure.

C17.2.4.3 Fire Resistance

Where fire may adversely affect the lateral performance of the isolation system, the system must be protected so as to maintain the gravity-load resistance and stability required for the other elements of the superstructure supported by the isolation system.

C17.2.4.4 Lateral Restoring Force

The restoring force requirement is intended to limit residual displacements in the isolation system resulting from any earthquake event so that the isolated structure will adequately withstand aftershocks and future earthquakes. The potential for residual displacements is addressed in Sec. C17.2.6.2.

C17.2.4.5 Displacement Restraint

The use of a displacement restraint to limit displacements beyond the design displacement is discouraged. Where a displacement restraint system is used, explicit nonlinear response history analysis of the isolated structure for the MCE level is required using the provisions of Chapter 16 to account for the effects of engaging the displacement restraint.

C17.2.4.6 Vertical Load Stability

The vertical loads used to assess the stability of a given isolator should be calculated using bounding values of dead load, live load and the peak earthquake demand at the MCE level. Because earthquake loads are reversible in nature, peak earthquake load should be combined with bounding values of dead and live load in a manner that produces both the maximum downward force and the maximum upward force on any isolator. Stability of each isolator should be verified for these two extreme values of vertical load at peak MCE displacement of the isolation system. In addition, all elements of the isolation system require testing

or equivalent measures that demonstrate their stability for the MCE_R ground motion levels. This stability can be demonstrated by performing a nonlinear static analysis for an MCE_R response displacement of the entire structural system, including the isolation system, and showing that lateral and vertical stability is maintained. Alternatively, this stability can be demonstrated by performing a nonlinear dynamic analysis for the MCE_R motions using the same inelastic reductions as for the design earthquake (DE) and acceptable capacities except that member and connection strengths can be taken as their nominal strengths with resistance factors, ϕ taken as 1.0.

C17.2.4.7 Overturning

The intent of this requirement is to prevent both global structural overturning and overstress of elements caused by localized uplift. Isolator uplift is acceptable as long as the isolation system does not disengage from its horizontal-resisting connection details. The connection details used in certain isolation systems do not develop tension resistance, a condition which should be accounted for in the analysis and design. Where the tension capacity of an isolator is used to resist uplift forces, design and testing in accordance with Sections 17.2.4.6 and 17.8.2.5 must be performed to demonstrate the adequacy of the system to resist tension forces at the total maximum displacement.

C17.2.4.8 Inspection and Replacement

Although most isolation systems do not require replacement following an earthquake event, access for inspection, repair, and replacement must be provided. In some cases (Section 17.2.6) re-centering maybe required. the isolation system should be inspected periodically as well as following significant earthquake events and any damaged elements repaired or replaced.

C17.2.4.9 Quality Control

A testing and inspection program is necessary for both fabrication and installation of the isolator units. Due to the rapidly evolving technological advances of seismic isolation, reference to specific standards for testing and inspection is difficult for some systems, while reference for some systems is possible (e.g., elastomeric bearings should follow ASTM D 4014 requirements). Similar standards are yet to be developed for other isolation systems. Special inspection procedures and load testing to verify manufacturing quality should therefore be developed for each project. The requirements may vary depending on the type of isolation system used. Specific requirements for quality control testing are now given in Sec. 17.8.6.

C17.2.5 Structural System

C17.2.5.2 Building Separations

A minimum separation between the isolated structure and other structures or rigid obstructions is required to allow unrestricted horizontal translation of the superstructure in all directions during an earthquake event. The separation dimension should be determined based on the total design displacement of the isolation system, the maximum lateral displacement of the superstructure above the isolation, as well as the lateral deformation of the adjacent structures.

C17.2.5.4 Steel Ordinary Concentrically Braced Frames

Section 17.5.4.2 of this Standard 7-10 implies that only Seismic Force Resisting Systems permitted for fixed based building applications are permitted to be used in seismic isolation applications. Table 12.2-1 limits the height of steel ordinary concentrically braced frames (OCBFs) in fixed based multi-story buildings assigned SDC D and E to 35 feet and does not permit them in buildings assigned to SDC F. Section 17.2.5.4 permits them to be used for seismic isolation applications to heights of 160 feet in building assigned to SDC D, E and F provided that certain additional requirements are satisfied. The additional design requirements that must be satisfied include that the building must remain elastic at the Design Earthquake level (i.e. $R_1 = 1.0$), that the moat clearance displacement D_{TM} be increased by 20% and that the

braced frame be designed to satisfy Section F 1.7 of AISC 341-10. It should be noted that currently permitted OCBFs in seismically isolated building assigned to SDC D and E also need to satisfy Section F 1.7 of AISC 341-10.

Seismic isolation has the benefit of absorbing most of displacement of earthquake ground motions allowing the seismic force resisting system to remain essentially elastic. Restrictions in Chapter 17 on the seismic force resisting system limit the inelastic reduction factor to a value of 2 or less to assure essentially elastic behavior. A steel OCBF provides the benefit of providing a stiff super-structure with reduced drift demands on drift sensitive nonstructural components while providing significant cost savings as compared to special systems. Steel OCBFs have been used in the United States for numerous (perhaps most) new seismically isolated essential facility buildings since the seismic isolation was first introduced in the 1980s. Some of these buildings have had heights as high as 130 feet. The 160 foot height limit was permitted for seismic isolation with OCBFs in high seismic zones when seismic isolation was first introduced in the building code as an Appendix to the UBC in 1991. When height limits were restricted for fixed based OCBFs in the 2000 NEHRP Recommended Provisions, it was not recognized the effect could have on the design of seismically isolated buildings. Section 17.2.5.4 change rectifies that oversight. It is the judgment of this committee that height limits should be increased to the 160 foot level provided the additional conditions are met.

The AISC Seismic Committee (TC-9) studied the concept of steel OCBFs in building applications to heights of 160 feet in high seismic areas. They decided that additional detailing requirements are required which are found in Section F1.7 of AISC 341-10.

There has been some concern that steel ordinary concentrically braced frames may have an unacceptable collapse hazard if ground motions greater than MCE_R cause the isolation system to impact the surrounding moat wall. While there has not been a full P-695 study of ordinary steel concentrically braced frame systems, a recent conservative study of one structure using OCBFs with $R_I=1$ on isolation systems performed by Armin Masroor at SUNY Buffalo (Reference 1) indicates shown that an acceptable risk of collapse (10% risk of collapse given MCE ground motions) is achieved if a 15-20% larger isolator displacement is provided. The study does not include the backup capacity of gravity connections or the influence of concrete filled metal deck floor systems on the collapse capacity. Even though there is no requirement to consider ground motions beyond the Maximum Considered Earthquake ground motion in design, it was the judgment of this committee to provide additional conservatism by requiring a 20% in moat clearance. It is possible that further P-695 studies will demonstrate that the additional 1.2 factor of displacement capacity may not be needed.

C17.2.6 Elements of Structures and Nonstructural Components

To accommodate the differential horizontal and vertical movement between the isolated building and the ground, flexible utility connections are required. In addition, stiff elements crossing the isolation interface (such as stairs, elevator shafts, and walls) must be detailed to accommodate the total maximum displacement without compromising life-safety provision. The effectiveness and performance of different isolation devices in building structures under a wide range of ground motion excitations have been assessed through numerous experimental and analytical studies (Kelly et al. , 1980, 1981, 1985, Zayas et al. 1987; Constantinou et al. 1999; Mosqueda et al. 2004; Grant et al. 2004; Warn and Whittaker 2006; Buckle et al. 2006; Kelly and Konstantinidis 2011). The experimental programs included in these studies have typically consisted of reduced-scale test specimens, constructed with relatively high precision under laboratory conditions. These studies initially focused on elastomeric bearing devices although in recent years the attention has shifted to the single- and multi-concave Friction Pendulum bearings. The latter system provides the option for longer isolated periods.

Recent full-scale shake table tests (Ryan et al. 2012) and analytical studies (Katsaras et al. 2008) have shown that the isolation systems included in these studies with a combination of longer periods, relatively high yield/friction levels and small yield displacements will result in post-earthquake residual

displacements. In these studies, residual displacements ranging from 2 to 6 inches were measured and computed for isolated building structures with a period of 4 seconds or greater and a yield level in the range of 8 to 15% of the structure’s weight. This permanent offset may affect the serviceability of the structure and possibly jeopardize the functionality of elements crossing the isolation plane (such as fire-protection and weather proofing elements, egress/entrance details, elevators, joints of primary piping systems etc.). Since it may not be possible to re-center some isolation systems, isolated structures with such characteristics should be detailed to accommodate these permanent offsets.

The Katsaras report provides recommendations for estimating the permanent residual displacement in any isolation system based on an extensive analytical and parametric study. The residual displacements measured in full-scale tests (Ryan et al. 2012) are reasonably predicted by this procedure, which uses an idealized bi-linear isolation system shown in Figure C17.2.6.1. The three variables that impact the residual displacement are the isolated period (based on the second slope stiffness K_D), the yield/friction level (F_0) and the yield displacement D_y .

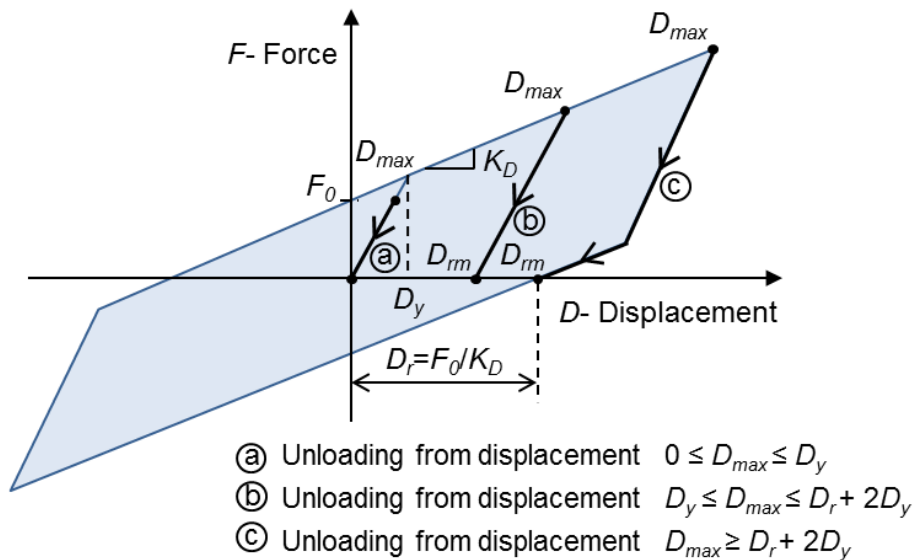

FIGURE C17.2.6.1 Definitions of Static Residual Displacement D_{rm} for a Bilinear Hysteretic System

The procedure for estimating the permanent residual displacement, D_{rd} (see Equation C17.2.6.1) is a function of the system yield displacement D_y , the static residual displacement, $D_r = F_0 / K_p$, and D_{rm} which is a function of D_m , the maximum earthquake displacement shown in Table C17.2.6-1. For most applications D_{rm} is typically equal to D_r .

Table C17.2.6-1 Values of D_{rm}

Range of Maximum Displacement, D_{max}	Static Residual Displacement, D_{rm}
$0 \leq D_{max} \leq D_y$	0
$D_y \leq D_{max} < D_r + 2D_y$	$D_r (D_{max} - D_y) / (D_r + D_y)$
$D_r + 2D_y \leq D_{max}$	D_r

$$D_{rd} = \frac{0.87 D_{rm}}{\left(1 + 4.3 \frac{D_{rm}}{D_r}\right) \left(1 + 31.7 \frac{D_y}{D_r}\right)} \tag{C17.2.6.1}$$

Thus there is a simple two-step process to estimate the permanent residual displacement, D_{rd}

- Calculate the static residual displacement, D_r based on the isolated period (using the second slope stiffness, K_D) and the yield/friction levels. Table C17.2.6.2 provides values of D_r for a range of periods from 2.5 to 20 seconds and a range of yield/friction levels from 0.03W to 0.15W.
- Using the value of D_r calculated for the isolation system and the yield displacement, D_y of the system, the residual displacement D_{rd} can be calculated from equation C17.2.6.1. Table C17.2.6.3 and Table C17.2.6.4 provide the residual displacements for earthquake displacements (D_m) of 10" and 20", respectively.

The yellow highlighted cells in Tables C17.2.6.3 and C17.2.6.4 correspond to permanent residual displacements exceeding 2". Note that for yield displacements of approximately 2", residual displacements will not occur for most isolation systems.

Table C17.2.6.2 Values of D_r (inches) for Various Isolated Periods and Yield/Friction Levels

T (Secs.)	Qd = 0.03	Qd = 0.06	Qd=0.09	Qd=0.12	Qd = 0.15
2.5	1.8	3.6	5.3	7.1	8.9
2.8	2.4	4.7	7.1	9.5	11.9
3.5	3.6	7.1	10.7	14.2	17.8
4.0	4.7	9.5	14.2	19.0	23.7
5.0	7.2	14.5	21.7	28.9	36.1
5.6	9.2	18.5	27.7	37.0	46.2
6.0	10.7	21.3	32.0	42.7	53.3
7.0	14.2	28.4	42.7	56.9	71.1
8.0	18.7	37.4	56.2	74.9	93.6
9.0	23.7	47.4	71.1	94.8	118.5
20.1	118.5	237.0	355.5	474.0	592.5

Table C17.2.6.3 Residual Displacements for a Maximum Earthquake Displacement of 10 inches

D_m (in)	10	10	10	10	10	10	10	10
D_y (in)	0.005	0.01	0.02	0.20	0.39	0.59	0.98	1.97
$D_r = 4.0$	0.63	0.60	0.56	0.25	0.16	0.11	0.07	0.04
$D_r = 7.9$	1.28	1.25	1.21	0.73	0.50	0.39	0.26	0.14
$D_r = 11.9$	1.86	1.84	1.79	1.22	0.90	0.71	0.50	0.27
$D_r = 15.8$	2.32	2.30	2.25	1.67	1.29	1.04	0.75	0.43
$D_r = 19.8$	2.72	2.70	2.66	2.07	1.65	1.37	1.01	0.59
$D_r = 23.7$	3.08	3.06	3.02	2.43	1.99	1.68	1.27	0.76
$D_r = 27.7$	3.39	3.37	3.34	2.75	2.30	1.97	1.51	0.92
$D_r = 31.6$	3.68	3.66	3.62	3.05	2.59	2.24	1.75	1.09
$D_r = 35.6$	3.93	3.91	3.87	3.32	2.85	2.49	1.97	1.25
$D_r = 39.5$	4.16	4.14	4.11	3.56	3.09	2.73	2.19	1.41

Table C17.2.6.4 Residual Displacements for a Maximum Earthquake Displacement of 20 inches

Dm (in)	20.00	20.00	20.00	20.00	20.00	20.00	20.00	20.00
Dy (in)	0.005	0.01	0.02	0.20	0.39	0.59	0.98	1.97
Dr = 4.0	0.63	0.60	0.56	0.25	0.16	0.11	0.07	0.04
Dr = 7.9	1.28	1.25	1.21	0.73	0.50	0.39	0.26	0.15
Dr = 11.9	1.93	1.90	1.85	1.28	0.95	0.76	0.54	0.31
Dr = 15.8	2.58	2.55	2.50	1.86	1.45	1.19	0.87	0.52
Dr = 19.8	3.23	3.20	3.15	2.47	1.98	1.65	1.24	0.75
Dr = 23.7	3.75	3.72	3.67	2.97	2.45	2.08	1.59	0.99
Dr = 27.7	4.22	4.20	4.15	3.45	2.90	2.50	1.95	1.24
Dr = 31.6	4.67	4.64	4.60	3.90	3.33	2.90	2.30	1.50
Dr = 35.6	5.08	5.06	5.02	4.32	3.74	3.30	2.65	1.76
Dr = 39.5	5.47	5.45	5.41	4.72	4.13	3.67	2.99	2.02

C17.2.8 Isolation System Properties

This section defines and combines sources of variability in isolation system mechanical properties measured by prototype testing, permitted by manufacturing specification tolerances, and occurring over the lifespan of the structure due to aging and environmental effects. Upper-bound and lower-bound values of isolation system component behavior (e.g., for use in RHA procedures) and maximum and minimum values of isolation system effective stiffness and damping based on these bounding properties (e.g., for use in ELF procedures) are established in this section. Values of property modification factors vary by product and cannot be specified generically in the provisions. Typical “default” values for the more commonly used systems are provided below. The designer and peer reviewer will be responsible for determining appropriate values of these factors on a project-specific and product-specific basis.

This section also refines the concept of bounding (upper-bound and lower-bound) values of isolation system component behavior by:

1. Explicitly including variability due to manufacturing tolerances, aging and environmental effects. ASCE/SEI 7-10 only addressed variability associated with prototype testing.
2. Simplifying design by basing bounding measures of amplitude-dependent behavior on only MCE_R ground motions. ASCE/SEI 7-10 used both design earthquake (DE) and MCE_R ground motions.

The new section also refines the concept of maximum and minimum effective stiffness and damping of the isolation system by use of revised formulas that:

1. Define effective properties of the isolation system on bounding values of component behavior (i.e., same two refinements, described above)
2. Eliminates the intentional conservatism of ASCE/SEI 7-10 that defines minimum effective damping in terms of maximum effective stiffness.

C17.2.8.2 Isolator Unit Nominal Properties

Isolator manufacturers typically supply nominal design properties that are reasonably accurate and can be confirmed by prototype tests in the design and construction phases. These nominal properties should be based on past prototype tests as defined in Section 17.8.2

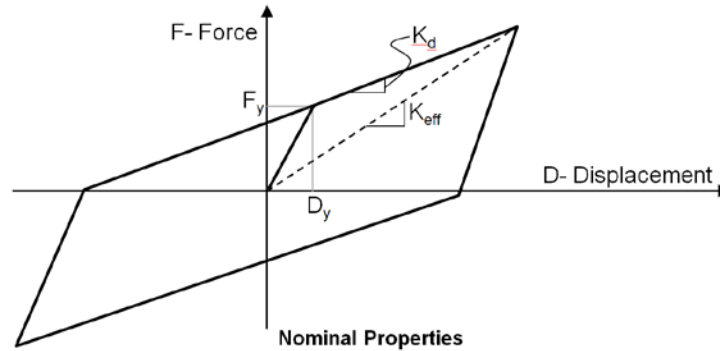

FIGURE C17.2.8.3-1 Example of the Nominal Properties of a Bilinear Force Deflection System

C17.2.8.3 Bounding Properties of Isolation System Components

The methodology for establishing lower and upper bound values for isolator basic mechanical properties based on property modification factors has been first presented in Constantinou et al. (1999). It has since then been revised in Constantinou et al. (2007) based on the latest knowledge of lifetime behavior of isolators. The methodology presented utilizes property modification factors to adjust isolator nominal properties based on considerations of natural variability in properties, effects of heating during cyclic motion, and the effects of aging, contamination, ambient temperature and duration of exposure that temperature, and history of loading. The nominal mechanical properties should be based on prototype (or representative) testing on isolators not previously tested, at normal temperature and under dynamic loading.

The methodology also modifies the property modification factors to account for the unlikely situation of having several events of low probability of occurrence occur at the same time (i.e. Maximum Earthquake, aging, low temperature, etc.) by use of property adjustments factors that dependent on the significance of the structure analyzed (values range from 0.66 for a typical structure to 1.0 for a critical structure). This standard presumes that the property adjustment factor is 0.75. However, the registered design professional may opt to use the value of 1.0 based on the significance of the structure (e.g. healthcare facilities, emergency operation centers, etc.) or based on the number of extreme events considered in the establishment of the property modification factor. For example, if only aging is considered, then a property adjustment factor of unity is appropriate.

Examples of application in the analysis and design of bridges may be found in Constantinou et al (2011). These examples may serve as guidance in the application of the methodology in this standard. Constantinou et al (2011) also presents procedures for estimating the nominal properties of lead-rubber and friction pendulum isolators again based on the assumption that prototype test data are not available. Data utilized in the estimation of the range of properties were based on available test data, all of which were selected to heighten heating effects. Such data would be appropriate for cases of high velocity motion and large lead core size or high friction values.

Recommended values for the specification tolerance on the average properties of all isolators of a given size isolator are typically in the +/-10% to +/- 15% range. For a +/-10% specification tolerance the corresponding lambda factors would be $\lambda_{(spec, max.)} = 1.10$ and $\lambda_{(spec, min.)} = 0.90$. Variations in individual isolator properties are typically greater than the tolerance on the average properties of all isolators of a given size as presented in Section 17.2.8.4. It is recommended that the isolator manufacturer be consulted when establishing these tolerance values.

Section 17.2.8.4 requires the isolation system to be designed with consideration given to environmental conditions including aging effects, creep, fatigue and operating temperatures. The individual aging and environmental factors are multiplied together and then the portion of the lambda factor differing from unity

is reduced by 0.75 based on the assumption that not all of the maximum values will occur simultaneously. As part of the design process it is important to recognize that there will be additional variations in the nominal properties due to manufacturing. The next section specifies the property modification factors corresponding to the manufacturing process or default values if manufacturer specific data is not available. These are combined with the property modification factors (Section 17.2.8.4) to determine the maximum and minimum properties of the isolators (Section 17.2.8.5) for use in the design and analysis process.

C17.2.8.4 Property Modification (λ) Factors

The lambda factors are used to establish maximum and minimum mathematical models for analysis, the simplest form of which is the linear static procedure used to assess the minimum required design base shear and system displacements. More complex mathematical models will account for various property variation effects explicitly (e.g. velocity, axial load, bilateral displacement, instantaneous temperature, etc.). In this case the cumulative effect of the lambda factors will reduce (combined lambda factor will be closer to 1.0). However, some effects such as specification tolerance and aging will likely always remain since they cannot be accounted for in mathematical models. Default lambda factors are provided in Table C17.2.8.4-1 isolators from unknown manufacturers that do not have qualification test data. Note that this table does not have any values of property modification factors for the actual stiffness (K_d) of sliding isolators. It is presumed that sliding isolators, whether flat or spherically shaped, are produced with sufficiently high accuracy so that their actual stiffness characteristics are known. The RDP may assign values of property modification factors different than unity for the actual stiffness of sliding bearings on the basis of data obtained in the prototype testing or on the basis of lack of experience with unknown manufacturers. Also note that this table provides values of property modification factors to approximately account for uncertainties in the materials and manufacture methods used. These values presume lack of test data or incomplete test data and unknown manufacturers. For example, the values in Table C17.2.8.4-1 for sliding bearings presume unknown materials for the sliding interfaces so that there considerable uncertainty in the friction coefficient values. Also, the data presume that elastomers used in elastomeric bearings have significant scragging and aging. Moreover, for lead-rubber bearings the data in the table presume that there is considerable uncertainty in the starting value (prior to any hysteretic heating effects) of the effective yield strength of lead.

Accordingly, there is considerable range in the upper and lower values of the property modification factors. Yet, these values should be used with caution since low quality fabricators could use materials and vulcanization and manufacturing processes that result in even greater property variations. The preferred approach for establishing property modification factors is through rigorous qualification testing of materials and manufacturing methods by a quality manufacturer, and dynamic prototype testing of full size specimens and by quality control testing at project specific loads and displacements.

For elastomeric isolators lambda factors and prototype tests may need to address axial–shear interaction, bilateral deformation, load history including first cycle effects and the effects of scragging of virgin elastomeric isolators, ambient temperature, other environmental loads, and aging effects over the design life of the isolator.

For sliding isolators lambda factors and prototype tests may need to address contact pressure, rate of loading or sliding velocity, bilateral deformation, ambient temperature, contamination, other environmental loads, and aging effects over the design life of the isolator.

Rate of loading or velocity effects are best accounted for by dynamic prototype testing of full-scale isolators. Property modification factors for accounting for these effects may be used in lieu of dynamic testing.

Generally, ambient temperature effects can be ignored for most isolation systems if they are in conditioned space where the expected temperature varies between 30°F and 100°F.

The following comments are provided in the approach to be followed for the determination of the bounding values of mechanical properties of isolators:

1. Heating effects (hysteretic or frictional) may be accounted for on the basis of a rational theory (e.g., see Kalpakidis et al., 2009, 2010, and Constantinou et al., 2009) so that only the effects of uncertainty in the nominal values of the properties, aging, scragging and contamination need to be considered. This is true for lead-rubber bearings where lead of high purity and of known thermo-mechanical properties is used. For sliding bearings, the composition of the sliding interface affects the relation of friction to temperature and therefore cannot be predicted by theory alone. Moreover, heating generated during high speed motion may affect the bond strength of liners. Given that there are numerous sliding interfaces (and typically proprietary), that heating effects in sliding bearings are directly dependent on pressure and velocity, and that size is important in the heating effects (Constantinou et al., 2009), full scale dynamic prototype and production testing is very important for sliding bearings.
2. Heating effects are important for sliding bearings and the lead core in lead-rubber bearings. They are not important and need not be considered for elastomeric bearings of either low or high damping. The reason for this is described in Constantinou et al. (2007) where it has been shown, based on theory and experimental evidence, that the rise in temperature of elastomeric bearings during cyclic motion (about one degree centigrade per cycle) is too small to significantly affect their mechanical properties. Prototype and production testing of full-size specimens at the expected loads and displacements should be sufficient to detect poor material quality and poor material bonding in plain elastomeric bearings, even if done quasi-statically.
3. Scragging and recovery to the virgin rubber properties (see Constantinou et al., 2007 for details) is dependent on the rubber compound, size of the isolator, the vulcanization process and the experience of the manufacturer. Also, it has been observed that scragging effects are more pronounced for rubber of low shear modulus and that the damping capacity of the rubber has a small effect. It has also been observed that some manufacturers are capable of producing low modulus rubber without significant scragging effects, whereas others cannot. It is therefore recommended that the manufacturer presents data on the behavior of the rubber under virgin conditions (not previously tested and immediately after vulcanization) so that scragging property modification factors can be determined. This factor is defined as the ratio of the effective stiffness in the first cycle to the effectiveness stiffness in the third cycle, typically obtained at a representative rubber shear strain (e.g., 100%). It has been observed that this factor can be as high as or exceed a value 2.0 for shear modulus rubber less than or equal to 0.45MPa (65psi). Also, it has been observed that some manufacturers can produce rubber with a shear modulus of 0.45MPa and a scragging factor of approximately 1.2 or less. Accordingly, it is preferred to establish this factor by testing for each project or use materials qualified in past projects.
4. Aging in elastomeric bearings has in general small effects (typically increases in stiffness and strength of the order of 10% to 30% over the lifetime of the structure), provided that scragging is also minor. It is believed that scragging is mostly the result of incomplete vulcanization which is thus associated with aging as chemical processes in the rubber continue over time. Inexperienced manufacturers may produce low shear modulus elastomers by incomplete vulcanization, which should result in significant aging.
5. Aging in sliding bearings depends on the composition of the sliding interface. There are important concerns with bimetallic interfaces (Constantinou et al., 2007), even in the absence of corrosion, so that they should be penalized by large aging property modification factors or simply not used. Also, lubricated interfaces warrant higher aging and contamination property modification factors. The designer can refer to Constantinou et al. (2007) for detailed values of the factor depending on the conditions of operation and the environment of exposure. Note that lubrication is meant to be *liquid* lubrication typically applied either directly at the interface or within dimples. Solid lubrication in the form of graphite or similar materials that are integrated in the fabric of liners

and used in contact with stainless steel for the sliding interface does not have the problems experienced by liquid lubrication.

Table C17.2.8.4-1 Default Upper and Lower Bound Multipliers

Variable Aging and Environmental Factors and Testing Factors	Unlubricated Interfaces – μ or Qd	Lubricated (liquid) Interfaces – μ or Qd	Plain Low Damping Elastomeric - K	LRB-Kd	LRB-Qd	HDR-Kd	HDR-Qd
Aging - λ_a	1.3	1.8	1.3	1.3	1	1.4	1.3
Contamination - λ_c	1.2	1.4	1	1	1	1	1
Example Upper Bound - $\lambda_{(ae,max)}$	1.56	2.52	1.3	1.3	1	1.4	1.3
Example Lower Bound - $\lambda_{(ae,min)}$	1	1	1	1	1	1	1
All cyclic effects, Upper	1.3	1.3	1.3	1.3	1.6	1.5	1.3
All cyclic effects, Lower	0.7	0.7	0.9	0.9	0.9	0.9	0.9
Example Upper Bound - $\lambda_{(test,max)}$	1.3	1.3	1.3	1.3	1.6	1.5	1.3
Example Lower Bound - $\lambda_{(test,min)}$	0.7	0.7	0.9	0.9	0.9	0.9	0.9
$\lambda_{(PM,max)} = (1 + (0.75 * (\lambda_{(ae,max)} - 1))) * \lambda_{(test,max)}$	1.85	2.78	1.59	1.59	1.6	1.95	1.59
$\lambda_{(PM,min)} = (1 - (0.75 * (1 - \lambda_{(ae,min)}))) * \lambda_{(test,min)}$	0.7	0.7	0.9	0.9	0.9	0.9	0.9
Lambda factor for Spec. Tolerance - $\lambda_{(spec,max)}$	1.15	1.15	1.15	1.15	1.15	1.15	1.15
Lambda factor for Spec. Tolerance - $\lambda_{(spec,min)}$	0.85	0.85	0.85	0.85	0.85	0.85	0.85
Upper Bound Design Property Multiplier	2.12	3.2	1.83	1.83	1.84	2.24	1.83
Lower Bound Design Property Multiplier	0.6	0.6	0.77	0.77	0.77	0.77	0.77
Default Upper Bound Design Property Multiplier	2.1	3.2	1.8	1.8	1.8	2.2	1.8
Default Lower Bound Design Property Multiplier	0.6	0.6	0.8	0.8	0.8	0.8	0.8

C17.2.8.5 Upper-Bound and Lower Bound Lateral Force-Displacement Behavior of Isolation System Components

An upper and lower bound representation of each type of isolation system component shall be developed using the lambda factors developed in Sec. 17.2.8.4. An example of a bi-linear force deflection loop is shown in Figure C17.2.8.3-2. In this example the upper and lower bound lambda factors are applied to the nominal properties of the yield/friction level and the second or bi-linear (k_D) slope of the lateral force-displacement curve to determine the upper and lower bound representation of isolation system component. The nomenclature shown in Figure C17.2.8.3-2 is important to note. The effective stiffness and effective damping are calculated for both the upper and lower bound properties at the corresponding D_m . The maximum and minimum effective stiffness and effective damping are then developed from these upper and lower bound lateral force-displacement relationships in Section 17.2.8.6.

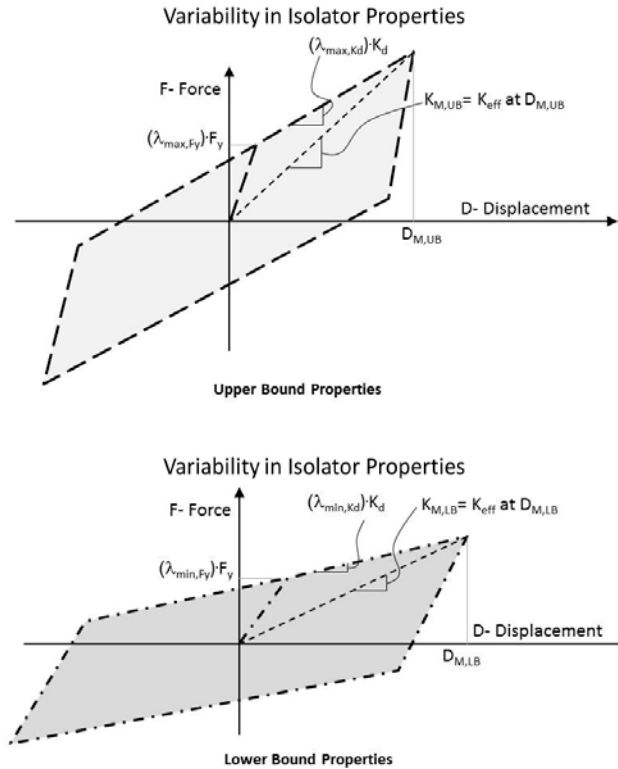

FIGURE C17.2.8.3-2 Example of the Upper and Lower Bound Properties of a Bilinear Force Deflection System

C17.3 GROUND MOTION FOR ISOLATED SYSTEMS

C17.3.1 Site-Specific Seismic Hazard

This new section consolidates existing site-specific hazard requirements from other sections.

C17.3.2 MCE_R Spectral Response Acceleration Parameters, S_{MS} , S_{M1}

The MCE_R spectrum parameters S_{MS} , S_{M1} are obtained from of Section 11.4.5 or 11.4.6 or 11.4.7.

C17.3.3 MCE_R Response Spectrum

The MCE_R spectrum is constructed from the S_{MS} , S_{M1} parameters of Section 11.4.5 or 11.4.6 or 11.4.7.

C17.3.4 MCE_R Ground Motion Records

Where response history analysis procedures are used, MCE_R ground motions should consist of not less than seven pairs of appropriate horizontal acceleration components.

C17.4 ANALYSIS PROCEDURE SELECTION

Three different analysis procedures are available for determining design-level seismic loads: the equivalent lateral force (ELF) procedure, the response spectrum procedure, and the response history procedure. For the ELF procedure, simple equations computing the lateral force demand at each level of the building structure (similar to those for conventional, fixed-base structures) are used to determine peak lateral displacement and design forces as a function of spectral acceleration and isolated-structure period and damping. The provisions of this section permit increased use of the ELF procedure, recognizing that the ELF procedure is adequate for isolated structures whose response is dominated by a single translational

mode of vibration and whose superstructure is designed to remain essentially elastic (limited ductility demand and inelastic deformations) even for MCE_R level ground motions. The ELF procedure is now permitted for the design of isolated structures at all sites (except Site Class F) as long as the superstructure is regular (as defined in new Section 17.2.2), has a fixed-base period (T) that is well separated from the isolated period (T_{min}), and the isolation system meets certain “response predictability” criteria with which typical and commonly-used isolation systems comply.

For the second and third procedures, which are required for irregular structures (Section 17.2.2) or especially flexible buildings, dynamic analysis (either response spectrum or response history procedures) is used to determine the peak response of the isolated structure. If a response history procedure is performed, the design forces for the structure can be determined using the response spectra procedure, and both have limits related to the ELF procedure. Limits on design forces calculated using response history analysis (RHA) are made more conservative, i.e., made the same as the limits on design forces calculated using response spectrum analysis (e.g., 80% of V_s , if superstructure is regular, 100% of V_s , if superstructure is regular). Previous limits on design forces calculated using RHA (e.g., 60% of V_s , if the superstructure is regular, 80% of V_s , if the superstructure is irregular) were considered too lenient.

The design requirements for the structural system are based on the forces and drifts obtained from the MCE_R earthquake using a consistent set of isolation system properties as discussed in C17.5. The isolation system—including all connections, supporting structural elements, and the “gap”—is required to be designed (and tested) for 100 percent of MCE_R demand. Structural elements above the isolation system are now designed to remain essentially elastic for the MCE_R earthquake. A similar fixed-base structure would be designed for design earthquake loads ($2/3 MCE_R$) reduced by a factor of 6 to 8 rather than the MCE_R demand reduced by a factor of up to 2 for a base isolated structure.

C17.5 EQUIVALENT LATERAL FORCE PROCEDURE

The lateral displacements given in this section approximates peak earthquake displacements of a single-degree-of-freedom, linear-elastic system of period, T , and effective damping, β . Equations 17.5-1 and 17.5-3 of ASCE 7-10 provided the peak displacement in the isolation system at the center of mass for both the design and MCE earthquakes respectively. In these prior equations, as well as the current equation the spectral acceleration terms at the isolated period, is based on the premise that the longer period portion of the response spectra decayed as $1/T$. This is a conservative assumption and is the same as that required for design of a conventional, fixed-base structure of period, T_M . A damping term, B , is used to decrease (or increase) the computed displacement demand where the effective damping coefficient of the isolation system is greater (or smaller) than 5 percent of critical damping.

A comparison of values obtained from Eq. 17.5-1 and those obtained from nonlinear time history analyses are given in Kircher et al. (1988) and Constantinou et al. (1993).

The ELF formulas in the new edition compute minimum lateral displacements and forces required for isolation system design based only on MCE_R level demands, rather than on a combination of design earthquake and MCE_R levels as in earlier editions of the provisions.

The calculations are performed separately for upper-bound and lower-bound isolation system properties, and the governing case shall be considered for design. Upper-bound properties will typically, but not always, result in a lower maximum displacement (D_M), higher damping (β_M), and higher lateral forces (V_b , V_{st} , V_s , and k).

Section 17.2.8 relates bounding values of effective period, stiffness and damping of the isolation system to upper-bound and lower-bound lateral force-displacement behavior of the isolators.

C17.5.3 Minimum Lateral Displacements

C17.5.3.1 Maximum MCE_R Displacements

The provisions of this section reflect the MCE_R -only basis for design and define maximum MCE_R displacement in terms of MCE_R response spectral acceleration, S_{M1} at the appropriate T .

In addition, and of equal significance, the maximum displacement (D_M) and the damping modification factor (B_M) are determined separately for upper-bound and lower-bound isolation system properties. In earlier provisions the maximum displacement (D_M) was defined only in terms of the damping associated with lower-bound displacement, and this was combined with the upper-bound stiffness to determine the design forces. This change is theoretically more correct, but removes a significant conservatism in the ELF design of the superstructure. This reduction in superstructure design conservatism is offset by the change from design earthquake to MCE_R ground motions as the basis for superstructure design forces.

C17.5.3.2 Effective Period at the Maximum MCE_R Displacement

The provisions of this section are revised to reflect the MCE_R -only basis for design and associated changes in terminology (although maintaining the concept of effective period). The effective period T_M is also determined separately for the upper and lower bound isolation properties.

C17.5.3.5 Total Maximum MCE_R Displacement

The provisions of this section are revised to reflect the MCE_R -only basis for design and associated changes in terminology. Additionally, the formula for calculating total (translational and torsional) maximum MCE_R displacement has been revised to include a term and corresponding equations that rewards isolation systems configured to resist torsion (see Wolff et al. 2013).

The isolation system for a seismically isolated structure should be configured to minimize eccentricity between the center of mass of the superstructure and the center of rigidity of the isolation system, thus reducing the effects of torsion on the displacement of isolation elements. For conventional structures, allowance must be made for accidental eccentricity in both horizontal directions. Figure C17.5-1 illustrates the terminology used in the standard. Equation 17.5-6 provides a simplified formula for estimating the response caused by torsion in lieu of a more refined analysis. The additional component of displacement caused by torsion increases the design displacement at the corner of a structure by about 15 percent (for one perfectly square in plan) to about 30 percent (for one long and rectangular in plan) if the eccentricity is 5 percent of the maximum plan dimension. These calculated torsional displacements correspond to structures with an isolation system whose stiffness is uniformly distributed in plan. Isolation systems that have stiffness concentrated toward the perimeter of the structure, or certain sliding systems that minimize the effects of mass eccentricity, result in smaller torsional displacements. The standard permits values of D_{TD} as small as $1.15 D_M$, with proper justification.

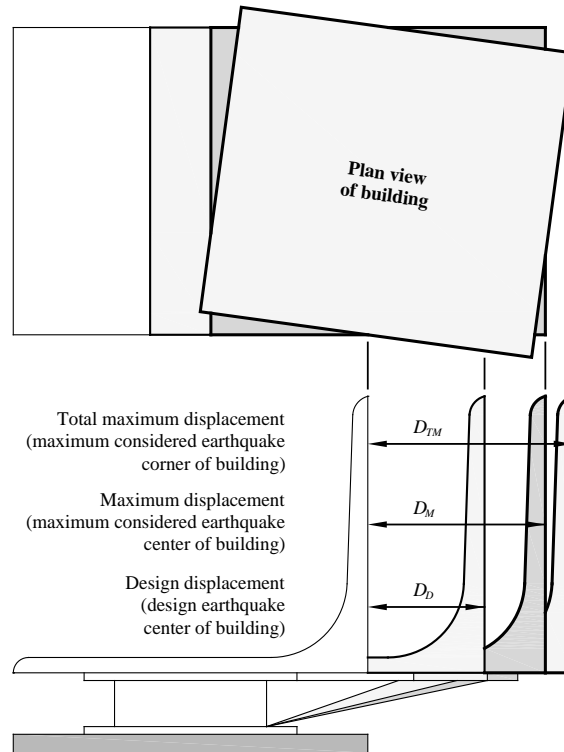

FIGURE C17.5-2 Displacement Terminology

C17.5.4 Minimum Lateral Forces

Figure C17.5-2 illustrates the terminology for elements at, below, and above the isolation system. Equation 17.5-7 specifies the peak elastic seismic shear for design of all structural elements at or below the isolation system (without reduction for ductile response). Equation 17.5-8 specifies the peak elastic seismic shear for design of structural elements above the isolation system. For structures that have appreciable inelastic-deformation capability, this equation includes an effective reduction factor ($R_1 = 3R/8$ not exceeding 2). This will ensure essentially elastic behavior of the superstructure above the isolators.

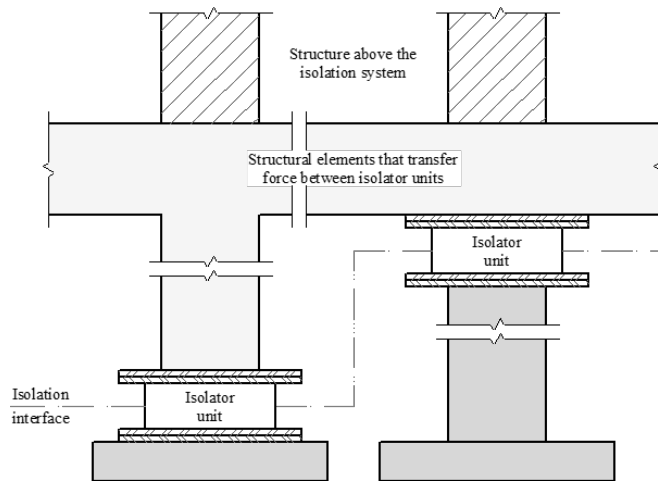

FIGURE C17.5 Isolation System Terminology

These provisions include two significant philosophic changes in the method of calculating the elastic base shear for the structure. In ASCE 7-10 and earlier versions of the provisions the elastic design base shears were determined from the design event (DBE) using a mixture of the upper bound effective stiffness and the maximum displacement obtained using the lower bound properties of the isolation system as shown schematically in Figure 17.5-1. This was known to be conservative. The elastic design base shear is now calculated from the MCE_R event with a consistent set of upper and lower bound stiffness properties, as shown in Equations 17.5-7 and Figure C17.5-1.

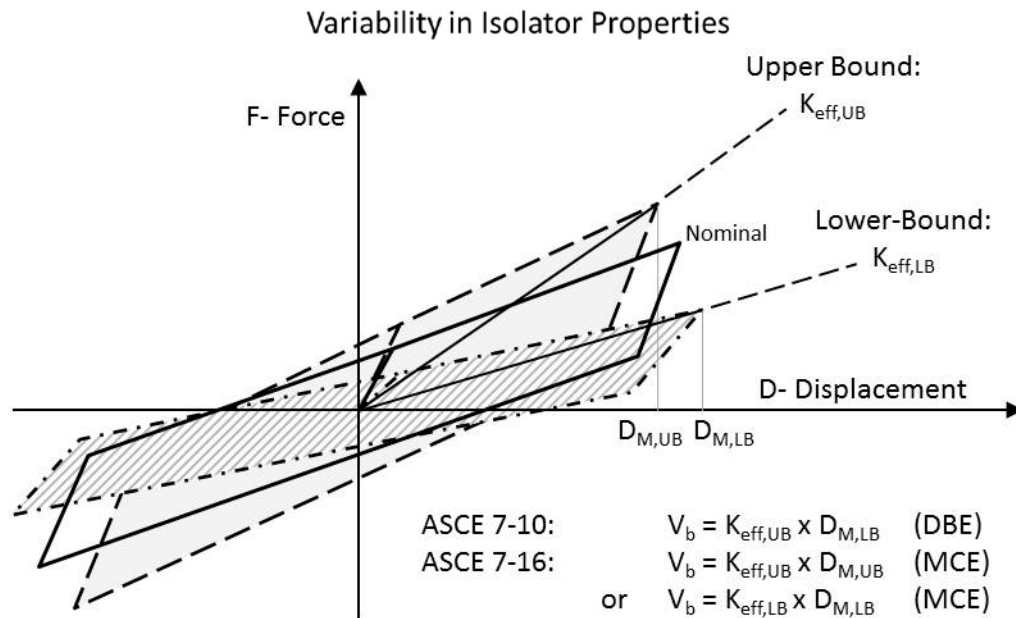

FIGURE 17.5-1 Example Nominal, Upper-Bound and Lower-Bound Bilinear Hysteretic Properties of Typical Isolator Bearing

A comparison of the old elastic design base shears for a range of isolation system design parameters and lambda factors using the ASCE 7-10 provisions and those using these new provisions is shown in Table C17.5-1. This comparison assumes that the DBE is 2/3 the MCE event and the longer period portion of both spectra decay as S_1/T . Table C17.5.1 shows a comparison between elastic design base shear calculated using the ASCE/SEI 7-10 and 7-16 editions for a range of yield levels, second slopes, and bounding properties multipliers.

The green cells in Table C17.5-1 indicate the new elastic design base shears are more than 10% higher the old provisions, the yellow cells indicate that the new elastic base shears are 0 to 10% higher than the old provisions and the white cells indicate the new elastic base shears are less than the old provisions.

Table C17.5-1 Comparison of Elastic Design Base Shears – ASCE 7-10 and 7-16

MCE $S_1 = 1.5$	Upper Bound Multipliers			Kd=1.15	YL=1.6	Lower Bound Multipliers			Kd=0.85	YL=0.85
	T2 (sec) =	2.00	2.00			3.00	3.00	4.00		
Yield Level =	0.05	0.10	0.05	0.10	0.05	0.10	0.05	0.1	0.05	0.1
New, $V_b / W =$	0.80	0.66	0.47	0.42	0.33	0.33	0.26	0.28	0.21	0.26
New/Old =	1.14	1.02	1.08	0.91	1.02	0.84	0.96	0.83	0.91	0.82
MCE $S_1 = 1.0$	Upper Bound Multipliers			Kd=1.0	YL=1.6	Lower Bound Multipliers			Kd=1.0	YL=0.85
	T2 (sec) =	0.77	0.71			0.52	0.42	0.35		
Yield Level =	0.05	0.10	0.05	0.10	0.05	0.10	0.05	0.1	0.05	0.1
New, $V_b / W =$	0.47	0.43	0.29	0.30	0.21	0.23	0.17	0.23	0.15	0.21
New/Old =	1.08	0.91	0.99	0.83	0.91	0.65	0.84	0.76	0.84	0.71
MCE $S_1 = 1.0$	Upper Bound Multipliers			Kd=1.35	YL=1.5	Lower Bound Multipliers			Kd=0.85	YL=0.85
	T2 (sec) =	0.54	0.47			0.33	0.32	0.24		
Yield Level =	0.05	0.10	0.05	0.10	0.05	0.10	0.05	0.1	0.05	0.1
New, $V_b / W =$	0.47	0.43	0.29	0.30	0.21	0.23	0.17	0.23	0.15	0.21
New/Old =	1.12	0.99	1.05	0.90	0.99	0.92	0.94	0.82	0.90	0.81
MCE $S_1 = 1.0$	Upper Bound Multipliers			Kd=1.3	YL=1.3	Lower Bound Multipliers			Kd=0.85	YL=0.85
	T2 (sec) =	0.55	0.47			0.33	0.31	0.24		
Yield Level =	0.05	0.10	0.05	0.10	0.05	0.10	0.05	0.1	0.05	0.1
New, $V_b / W =$	0.47	0.43	0.29	0.30	0.21	0.23	0.17	0.23	0.15	0.21
New/Old =	1.22	1.10	1.16	1.01	1.10	0.94	1.05	0.91	1.01	0.89

C17.5.4.1 Isolation System and Structural Elements below the Base Level

The provisions of this section are revised to reflect the MCE_R -only basis for design and associated changes in terminology. A new paragraph was added to this section to clarify that unreduced lateral loads should be used to determine overturning forces on the isolation system.

C17.5.4.2 Structural Elements above the Base Level

The provisions of this section are revised to reflect the MCE_R -only basis for design and associated changes in terminology, including the new concept of the “base level” as the first floor immediately above the isolation system.

An exception has been added to allow values of R_I to exceed the current limit of 2.0 provided that the pushover strength of the superstructure at the MCE drift or $0.015h_{sx}$ story drift exceeds (by 10%) the maximum MCE_R force at the isolation interface (V_b). This exception directly addresses required strength and associated limits on inelastic displacement for MCE demands. The pushover method is addressed in ASCE 41-13.

A new formula (Eq. 17.5-7) now defines lateral force on elements above the base level in terms of reduced seismic weight (seismic weight excluding the base level), and the effective damping of the isolation system, based on recent work (York and Ryan, 2008). In this formulation it is assumed that the base level is located immediately (within four feet) above the isolation interface. When the base level is not located immediately above the isolation interface (e.g., no floor slab just above the isolators), the full (unreduced) seismic weight of the structure above the isolation interface is used in Eq. 17.5.8 to conservatively define lateral forces on elements above the base level.

C17.5.4.3 Limits on V_s

The provisions of this section are revised to reflect the MCE_R -only basis for design and associated changes in terminology.

In Section 17.5.4.3, the limits given on V_s are revised to clarify that the force required to fully activate the isolation system should be based on either the upper-bound force-deflection properties of the isolation system or 1.5 times nominal properties, whichever is greater. Other limits include (a) the yield/friction level to fully activate of the isolation system and (b) the ultimate capacity of a sacrificial wind-restraint system that is intended to fail and release the superstructure during significant lateral load. These limits are needed so that the superstructure does not yield prematurely before the isolation system has been activated and significantly displaced.

C17.5.5 Vertical Distribution of Force

The provisions of this section are revised to incorporate a more accurate distribution of shear over height considering the period of the superstructure and the effective damping of the isolation system. The specified method for vertical distribution of forces calculates the force at the base level immediately above the base isolation plane, then distributes the remainder of the base shear among the levels above. That is, the mass of the “base slab” above the isolators is not included in the vertical distribution of forces.

The proposed revision to the vertical force distribution is based on recent analytical studies (York and Ryan, 2008 in collaboration with SEAONC Protective Systems Subcommittee PSSC). Linear theory of base isolation predicts that base shear is uniformly distributed over the height of the building, while the equivalent lateral force procedure of ASCE 7-10 prescribes a distribution of lateral forces that increase linearly with increasing height. The uniform distribution is consistent with the first mode shape of an isolated building while the linear distribution is consistent with the first mode shape of a fixed-base building. However, a linear distribution may be overly conservative for an isolated building structure, especially for one or two story buildings with heavy base mass relative to the roof.

The principle established in the York and Ryan study was to develop two independent equations: one to predict the superstructure base shear V_{st} relative to the base shear across the isolators V_b , and a second to distribute V_{st} over the height of the building. Considering a reduction in V_{st} relative to V_b allowed for the often significant inertial forces at the base level, which can be amplified due to disproportionate mass at the base level, to be accounted for in design. The study also assumed that the superstructure base shear was distributed over the height using a ‘k’ distribution (i.e. lateral force $\propto w_x h_x^k$ where w_x is the weight and h_x the height to level x), where $k = 0$ is a uniform distribution and $k = 1$ is a linear distribution. In the study, representative base-isolated multi-story single bay frame models were developed, and response history analysis was performed with a suite of 20 motions scaled to a target spectrum corresponding to the effective isolation system parameters. Regression analysis was performed to develop a best fit (relative to median results from response history analysis) of the superstructure to base shear ratio and k factor as a function of system parameters. The equations recommended in York and Ryan (2008) provided the best “goodness of fit” among several considered, with R^2 values exceeding 0.95. Note that Equations 17.5-8 and 17.5-11 in the code change are the same as Equations 15 and 17 in York and Ryan (2008), with one modification: the coefficient for k in Equation 17.5-11 has been modified to reflect that the reference plane for determining height should be taken as the plane of isolation, which is below the isolated base slab.

It is difficult to confirm in advance whether the upper-bound or lower-bound isolation system response will govern the design of the isolation system and structure. It is possible, and even likely, that the distribution corresponding to upper-bound isolation system properties will govern the design of one portion of the structure, and the lower-bound distribution will govern another. For example, lower-bound isolation system response may produce a higher displacement, D_M , a lower damping, β_M , but also a higher base shear, V_b . This could result in a vertical force distribution that governs for the lower-stories of the building. The

corresponding upper-bound case, with lower displacement, D_M , but higher damping, β_M , might govern design of the upper part of the structure, even though the base shear, V_b , is lower.

The proposal to adopt the approach in York and Ryan is part of an overall revamp that will permit the Equivalent Static Force method to be extended to a wider class of buildings. In York and Ryan (2008), the current method was shown to be quite conservative for systems with low to medium levels of damping combined with stiff superstructures but un-conservative for highly damped systems or systems with relatively flexible superstructures.

The proposal has undergone a high level of scrutiny by the code committee. First, regression analysis was performed using the original York and Ryan response history data set to fit several alternative distributions suggested by code committee members that were intuitively more appealing. In all cases, the equations recommended in York and Ryan were shown to best fit the data. Second, a few code committee members appropriately attempted to validate the equations using independently generated response history analysis data sets. Much discussion ensued following the discovery that the equations were un-conservative for a class of one and two-story buildings with long isolation periods and high levels of effective damping in the isolation system. This was most noticeable for one-and-two-story buildings, i.e. with relatively low W_{st}/W ratios, predominately single mode fixed-base response, and where T_{fb} aligned with the period based on the initial stiffness of the isolation system, T_{kl} . The York and Ryan data set was confirmed to contain similar cases to those generated independently, and the un-conservatism was rationalized as a natural outcome of the regression approach. In an attempt to remove the un-conservatism, equations were fit to the 84th percentile (median + 1σ) vertical force distributions based on the original York and Ryan dataset. However, the resulting distributions were unacceptably conservative and thus rejected.

The York and Ryan data set was subsequently expanded to broaden the range of fixed base periods for low-rise structures and to provide additional confirmation of the independent dataset. In addition, isolation system hysteresis loop shape was identified the most significant factor in the degree of higher mode participation resulting in increased V_{st}/V_b ratio and k -factor. The provisions now identify this variable as needing a more conservative k -factor.

When computing the vertical force distribution using the equivalent linear force procedure, the provisions now divide isolation systems into two broad categories according to the shape of the hysteresis loop. Systems that have an abrupt transition between pre-yield and post-yield response (or pre-slip and post-slip for friction systems) are described as “Strongly Bilinear” and have been found to typically have higher superstructure accelerations and forces. Systems with a gradual or multi-stage transition between pre-and post-yield response are described as “Weakly Bilinear” and were observed to have relatively lower superstructure accelerations and forces, at least for systems that fall with the historically adopted range of system strength/friction values (nominal isolation system force at zero displacement, $F_o = 0.03xW$ to $0.07xW$).

This limitation is acceptable because isolation systems with strength levels that fall significantly outside the upper end of this range are likely to have upper-bound properties that do not meet the limitations of Section 17.4.1, unless the post-yield stiffness or hazard level is high. Care should also be taken when using the equations to assess the performance of isolation systems at lower hazard levels as the equivalent damping can increase beyond the range of applicability of the original work.

Additional description of the two hysteresis loop types are provided in Table C17.5-2. An example of a theoretical loop for each system type is shown in Figure C17.5-4.

Table C17.5-2 Comparison of “Strongly Bilinear” and “Weakly Bilinear” Isolation Systems

Note: Eq. Term refers to the exponent in equation 17.5-11

System Type & Eq. Term ⁽¹⁾	Pre-to-Post-Yield Transition Characteristics	Cyclic Behavior Below bilinear Yield/Slip Deformation	Example Hysteresis Loop Shape	Example Systems
“Strongly Bilinear” (1-3.5β _M)	Abrupt transition from pre-yield/slip to post-yield/slip	Essentially linear elastic, with little energy dissipation	Figure C17.5-4a	<ul style="list-style-type: none"> • Flat sliding isolators with rigid backing. • Single concave FPS. • Double-concave FPS w\ same friction coefficients Top &Bottom.
“Weakly Bilinear” (1-2.5β _M)	Smooth or multi-stage transition from pre-yield/slip to post-yield/slip	Exhibits energy dissipation due to yielding or initial low level friction stage slip	Figure C17.5-4b	<ul style="list-style-type: none"> • Elastomeric+viscous dampers. • Triple-concave FPS. • High-damping rubber. • Lead-rubber. • Elastomeric backed sliders

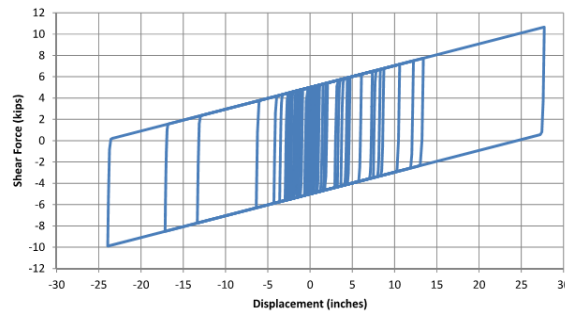

FIGURE C17.5-4a “Strongly Bilinear” Example Isolation System Example Loop

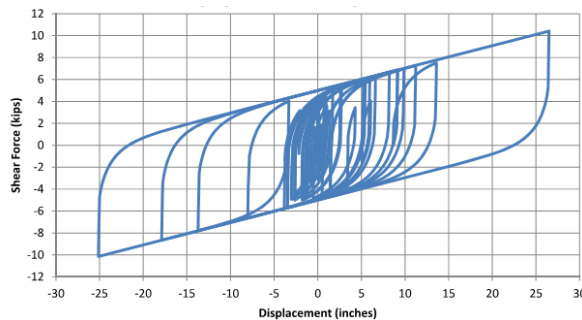

FIGURE C17.5-4b “Weakly Bilinear” Example Isolation System Example Loop

Capturing this acceleration and force increase in the equivalent linear force procedure requires an increase in the V_{st}/V_b ratio (Eq.17.5-8A) and the vertical force distribution k -factor (Eq. 17.5-11). Consequently, the provisions require a different exponent to be used in Eq. 17.5-8 for system that exhibit “Strongly Bilinear” behavior. Similar differences were observed in the k -factor (Eq. 17.5-11), but these findings were judged to be insufficiently well-developed to include in the provisions at this time and the more conservative value for “Strongly Bilinear” systems was adopted for both system types.

The exception in Section 17.5.5 is a tool to address the issue identified in the one and two story buildings on a project specific basis and to simplify the design of seismically isolated structures by eliminating the need to perform time-consuming and complex response history analysis of complete 3D building models

each time the design is changed. At the beginning of the project a response history analysis of a simplified building model (e.g. a stick model on isolators) is used to establish a custom inertia force distribution for the project. The analysis of the 3D building model can then be accomplished using simple static analysis techniques.

The limitations on use of the equivalent linear force procedure (Section 17.4.1) and on the response spectrum analysis procedure (Section 17.4.2.1) provide some additional limits. Item 17.4.1.6.(a) requires a minimum restoring force, which effectively limits post-yield stiffness to $K_d > F_o / D_M$, and also limits effective damping to 32% for a bilinear system.

Items 17.4.1.2 and 17.4.1.3 limit the effective period, $T_M \leq 4.5$ seconds, and effective damping, $\beta_M \leq 30\%$ explicitly.

C17.5.6 Drift Limits

Drift limits are divided by C_d/R for fixed-base structures since displacements calculated for lateral loads reduced by R are multiplied by C_d before checking drift. The C_d term is used throughout the standard for fixed-base structures to approximate the ratio of actual earthquake response to response calculated for reduced forces. Generally, C_d is 1/2 to 4/5 the value of R . For isolated structures, the R_I factor is used both to reduce lateral loads and to increase displacements (calculated for reduced lateral loads) before checking drift. Equivalency would be obtained if the drift limits for both fixed-base and isolated structures were based on their respective R factors. It may be noted that the drift limits for isolated structures generally are more conservative than those for conventional, fixed-base structures, even where fixed-base structures are assigned to Risk Category IV. The maximum story drift permitted for design of isolated structures is constant for all risk categories.

C17.6 DYNAMIC ANALYSIS PROCEDURES

This section specifies the requirements and limits for dynamic procedures. The design displacement and force limits on response spectrum and response history procedures are shown in Table C17.4-1.

A more detailed or refined study can be performed in accordance with the analysis procedures described in this section, compatible with the minimum requirements of Section 17.5. Reasons for performing a more refined study include:

1. The importance of the building.
2. The need to analyze possible structure–isolation system interaction where the fixed-base period of the building is greater than one-third of the isolated period.
3. The need to explicitly model the deformational characteristics of the lateral force-resisting system where the structure above the isolation system is irregular.
4. The desirability of using site-specific ground motion data, especially for very soft or liquefiable soils (Site Class F) or for structures located where S_1 is greater than 0.60.
5. The desirability of explicitly modeling the deformational characteristics of the isolation system. This point is especially important for systems that have damping characteristics that are amplitude-dependent, rather than velocity-dependent, because it is difficult to determine an appropriate value of equivalent viscous damping for these systems.

Where response history analysis is used as the basis for design, the design displacement of the isolation system and design forces in elements of the structure above are computed from the average of seven pairs of ground motion each selected and scaled in accordance with Section 17.3.2.

The provisions permit a 10% reduction of V_b below the isolation system and 20% reduction of V_b for the structure above the isolators if the structure is of regular configuration. The displacement reduction should not be greater than 20% if a dynamic analysis is performed.

In order to avoid the need to perform a large number of nonlinear response history analyses that include the suites of ground motions, the upper and lower bound isolator properties, and five or more locations of the center-of-mass, this provision allows the center-of-mass analysis results to be scaled and used to account for the effects of mass eccentricity in different building quadrants.

The following is a recommended method of developing appropriate amplification factors for deformations and forces for use with center-of-mass NRH analyses, which account for the effects of accidental torsion. The use of other rationally-developed amplification factors is permitted.

The most critical directions for shifting the calculated center of mass are such that the accidental eccentricity adds to the inherent eccentricity in each orthogonal direction at each level. For each of these two eccentric mass positions, and with lower-bound isolator properties, the suite of NLRH analyses should be run and the results processed in accordance with Section 17.6.3.4. The analysis cases are defined in Table C17.6.3.4.1.

Table C17.6.3.4.1 Analysis Cases for Establishing Amplification Factors

Case	Isolator Properties	Accidental Eccentricity
I	Lower bound	No
Ila	Lower bound	Yes, X direction
Ilb	Lower bound	Yes, Y direction

The results from Cases Ila and Ilb are then compared in turn to those from Case I. The following amplification factors (ratio of Case Ila or Ilb response to Case I response) are computed:

- a. The amplification of isolator displacement at the plan location with the largest isolator displacement;
- b. The amplification of story drift in the structure at the plan location with the highest drift, enveloped over all stories;
- c. The amplification of frame-line shear forces at each story for the frame subjected to the maximum drift.

The larger of the two resulting scalars on isolator displacement should be used as the displacement amplification factor, the larger of the two resulting scalars on drift should be used as the deformation amplification factor, and the larger of the two resulting scalars on force should be used as the force amplification factor. Once the amplification factors are established, the effects of accidental eccentricity should be considered as follows:

The nonlinear response history analysis procedure should be carried out for the inherent mass eccentricity case only, considering both upper and lower bound isolator properties. For each isolator property variation, response quantities should be computed in accordance with Section 17.6.3.4. All resulting isolator displacements should be increased by the displacement amplification factor, all resulting deformation response quantities should be increased by the deformation amplification factor and all resulting force quantities should be increased by the force amplification before being used for evaluation or design.

The procedure for scaling of dynamic analysis results to the ELF-based minima described in Section 17.6.4.3 is slightly different for response spectrum versus response history analysis. The reason for this difference is that it is necessary to create a consistent basis of comparison between the dynamic response quantities and the ELF-based minima (which are based on the maximum direction). When response spectrum analysis is performed, the isolator displacement, base shear and story shear at any level used for comparison with the ELF-based minima already correspond to a single, maximum direction of excitation. Thus the vector sum of the 100%/30% directional combination rule (as described in Section 17.6.3.3) need not be used. Note, however, that while the 100%/30% directional combination rule is not required in scaling response spectrum analysis results to the ELF-based minima of Section 17.6.4.3, the 100%/30% directional combination rule is still required for design of the superstructure by response spectrum analysis, per 17.6.3.3. When nonlinear response history analysis is performed, the isolator displacement and base shear

for each ground motion is calculated as the maximum of the vector sum of the two orthogonal components (of displacement or base shear) at each time step. The average of the maxima over all ground motions of these displacement and base shear vector-sum values is then used for comparison with the ELF-based minimum displacement and base shear per Section 17.6.4.3.

C17.7 DESIGN REVIEW

The provisions allow for a single peer reviewer to evaluate the isolation system design. The reviewer should be a registered design professional and if the engineer of record is required to be an SE the owner may consider ensuring that there is one SE on the peer review team. On more significant structures it is likely that the design review panel may include 2 or 3 individuals but for many isolated structures a single, well-qualified peer reviewer is sufficient. If a manufacturer with unknown experience in the US is selected as the supplier, the building owner may require the design reviewer to attend prototype tests.

The standard requires peer review to be performed by registered design professionals who are independent of the design team and other project contractors. The reviewer or review panel should include individuals with special expertise in one or more aspects of the design, analysis, and implementation of seismic isolation systems.

The peer reviewer or review panel should be formed before the development of design criteria (including site-specific ground shaking criteria) and isolation system design options. Furthermore, the review panel should have full access to all pertinent information and the cooperation of the general design team and regulatory agencies involved in the project.

C17.8 TESTING

The design displacements and forces determined using the standard assume that the deformational characteristics of the isolation system have been defined previously by comprehensive testing. If comprehensive test data are not available for a system, major design alterations in the structure may be necessary after the tests are complete. This change would result from variations in the isolation system properties assumed for design and those obtained by test. Therefore, it is advisable that prototype tests of systems be conducted during the early phases of design, if sufficient prototype test data are not available from a given manufacturer.

The design displacements and forces determined using the standard are based on the assumption that the deformational characteristics of the isolation system have been defined previously by comprehensive qualification and prototype testing. Variations in isolator properties are addressed by the use of property variation factors that account for expected variation in isolator and isolation system properties from the assumed nominal values. In practice, past prototype test data will very likely have been used to develop the estimate nominal values and associated lambda factors used in the design process, as described in Section 17.2.8.4.

When prototype testing is performed in accordance with Section 17.8.2 it serves to validate and check the assumed nominal properties and property variation factors used in the design. Where project specific prototype testing is not performed, it is possible to perform a subset of the checks described below on the isolator unit and isolation system test properties using data from the Quality Control test program, described in Section 17.8.6.

C17.8.2.2 Sequence and Cycles

Section 17.2.8.4 describes the method by which minimum and maximum isolator properties for design and analysis are established using property variation or lambda (λ) factors to account for affects such as specification tolerance, cyclic degradation, aging, etc. The structural analysis will therefore be performed twice, and the resulting demands are enveloped for design. For force-based design parameters and procedures this is relatively straightforward, as typically one case or the other will govern; primarily , but

not always, the upper-bound. However, for components dependent on both force and deformation, e.g. the isolators, there will exist two sets of axial load and displacement values for each required test. Lower bound properties will typically result in larger displacements and smaller axial loads, whereas upper bound properties will typically result in smaller displacements and larger axial loads. To avoid requiring that a complete set of duplicate tests be performed for the lower and upper bound conditions, Section 17.8.2.2 requires the results to be enveloped, combining the larger axial demands from one case with the larger displacements from the other. Strictly, these will not occur simultaneously, but the enveloping process is conservative.

The enveloping process will typically result in test axial loads that correspond to the maximum properties and displacements that correspond to minimum properties. Hence the test results determined using the enveloped demands may not directly relate to the design properties or analysis results determined for maximum and minimum properties separately. However, since the test demands envelope the performance range for the project, the registered design professional will be able use them to determine appropriate properties for both linear and nonlinear analysis using the same philosophy as provided here.

Two alternate testing protocols are included in Section 17.8.2.2. The traditional three-cycle tests are preserved in Item 2(a) for consistency with past provisions. These tests can be performed dynamically, but have often been performed at slow speed consistent with the capability of manufacturer's testing equipment. The alternate test sequence provided in Item 2(b) is more suited to full-scale dynamic-cyclic testing.

The Item (3) test displacement has been changed from D_{TD} to D_M reflecting the focus of the provisions on only the MCE_R event. Since this test is common to both test sequences 2(a) and 2(b) it becomes important for property determination. This is the only test required to be repeated at different axial loads when isolators are also axial load carrying elements, which is typically the case. This change was to counter the criticism that the total test sequence of past provisions represented the equivalent energy input of many MCE_R events back to back, and that prototype test programs could not be completed in a reasonable time if any provision for isolator cooling and recovery was included.

The current test program is therefore more reflective of code-minimum required testing. The registered design professional, and/or the isolator manufacturer, may wish to perform additional testing to more accurately characterize the isolator for a wider range of axial loads and displacements than is provided here. For example, this might include performing the Item 2(b) dynamic test at additional axial loads once the code-require sequence is complete.

Heat affects for some systems may become significant, and misleading, if insufficient cooling time is not included between adjacent tests. As a consequence in test sequence (4) only five cycles of continuous dynamic testing are required as this is a limit of most test equipment. The first-cycle or scragging effects observed in some isolators may recover with time, so back-to-back testing may result in an underestimation of these affects. Refer Constantinou et al. (MCEER Report No. 07-0012, 2007) and Kalpakidis et al. (MCEER Report No. 08-0027, 2008) for additional information. The impact of this behavior may be mitigated by basing cyclic lambda-factors on tests performed relatively early in the sequence before these effects become significant.

C17.8.2.3 Units Dependent on Loading Rates

Section 17.8.2.3 clarifies when dynamic testing is required. Many common isolator types exhibit velocity dependence, however, this testing can be expensive and can only be performed by a limited number of test facilities. The intent is not that dynamic testing of isolators be performed for every project. Sufficient dynamic test data must be available to characterize the cyclic performance of the isolator, in particular the change in isolator properties during the test, i.e. with-respect-to the test average value. Dynamic testing must therefore be used to establish the $\lambda_{(test, min)}$ and $\lambda_{(test, max)}$ values used in Section 17.2.8.4, since these values are typically underestimated from slow speed test data. If project prototype or production testing is to be performed at slow speeds, this testing would also be used to establish factors that account for the

effect of velocity and heating on the test average values of k_{eff} , k_d and E_{loop} . These factors can be thought of either as a separate set of velocity-correction factors to be applied on test average values, or can be incorporated into the $\lambda_{(\text{test}, \text{min})}$ and $\lambda_{(\text{test}, \text{max})}$ values themselves.

It may also be possible to modify the isolator mathematical model, for example, to capture some or all of the isolator velocity dependence e.g. the change in yield level of the lead core in a lead rubber bearing.

If project-specific prototype testing is undertaken, it may be necessary to adjust the test sequence in recognition of the capacity limitations of the test equipment and this is now explicitly recognized in Section 17.8.2.2. For example, tests that simultaneously combine maximum velocity and maximum displacement may exceed the capacity of the test equipment, and may also not be reflective of earthquake shaking characteristics. A more detailed examination of analysis results may be required to determine the maximum expected velocity corresponding to the various test deformation levels and to establish appropriate values for test.

Refer Constantinou et al. (MCEER Report No. 07-0012, 2007) for additional information.

C17.8.2.4 Units Dependent on Bilateral Load

All types of isolators have bilateral load dependence to some degree. The mathematical models used in the structural analysis may include some or all of the bilateral load characteristics for the particular isolator type under consideration. If not, it may be necessary to examine prototype test data to establish the impact on the isolator force-deformation response as a result of the expected bilateral loading demands. A bounding approach using lambda (λ) factors is one method of addressing bilateral load effects that cannot be readily incorporated in the isolator mathematical model.

Bilateral isolator testing is complex and only a few test facilities exist that are capable of performing these tests. Project specific bilateral load testing has not typically been performed for isolation projects completed to date. In lieu of performing project specific testing, less restrictive similarity requirements may be considered by the registered design professional compared to those required for test data submitted to satisfy similarity for Sections 17.8.2.2 and 17.8.2.5. Refer Constantinou et al. (MCEER Report No. 07-0012, 2007) for additional information.

C17.8.2.5 Maximum and Minimum Vertical Load

The exception to Section 17.8.2.5 permits that the tests may be performed twice, once with demands resulting from upper bound properties and once with lower bound properties. This option may be preferable for these isolator tests performed at D_{TM} , since the isolator will be closer to its ultimate capacity.

C17.8.2.7 Testing Similar Units

Section 17.8.2.7 now provides specific limits on related to the acceptability of data from testing of similar isolators. A wider range of acceptability is permitted for dynamic test data.

1. The submitted test data should demonstrate the manufacturer's ability to successfully produce isolators that are comparable in size to the project prototypes, for the relevant dimensional parameters, and to test them under force and displacement demands equal to comparable to those required for the project.
2. It is preferred that the submitted test data necessary to satisfy the registered design professional and design review be for as few different isolator types and test programs as possible. Nonetheless, it may be necessary to consider data for isolator A to satisfy one aspect of the required project prototype test program, and data from isolator B for another.
3. For more complex types of testing it may be necessary to accept a wider variation of isolator dimension or test demands than for tests that more fundamentally establish the isolator nominal operating characteristics – e.g. the testing required to characterize the isolator for loading rate dependence (Section 17.8.2.3) and bilateral load dependence (Section 17.8.2.4).

4. The registered design professional is not expected to examine quality control procedures in detail to determine whether the proposed isolators were manufactured using sufficiently similar methods and materials. Rather, it is the responsibility of the manufacturer to document the specific differences, if any, preferably via traceable quality control documentation, and substantiate that any variations are not significant.
5. In some cases the manufacturer may not wish to divulge proprietary information regarding methods of isolator fabrication, materials, or quality control procedures. These concerns may or may not be alleviated by confidentiality agreements or other means to limit the distribution and publication of sensitive material. Regardless, the final acceptability of the test information of similar units shall be at the sole discretion of the registered design professional and the design review, and not the manufacturer.
6. Similarity can be especially problematic in a competitive bid situation when successful selection may hinge on the success of one supplier in eliminating the need to fabricate and test project-specific prototype isolators. This can be addressed by determining acceptability of similarity data prior to bid, or by including more detailed similarity acceptance provisions in the bid documentation than have been provided herein.

Refer Constantinou et al. (MCEER Report No. 07-0012, 2007) and Shenton et al. (NISTIR 5800) for additional information.

C17.8.3 Determination of Force-Deflection Characteristics

The method of determining the isolator effective stiffness and effective damping ratio is specified in equations 17.8-1 and 17.8-2. Explicit direction is provided for establishment of effective stiffness and effective damping ratio for each cycle of test. A procedure is also provided for fitting a bilinear loop to a given test cycle, or to an average test loop to determine the post-yield stiffness, k_d . This process can be performed several different ways, however, the fitted bilinear loop should also match effective stiffness and energy dissipated per cycle from the test. Once k_d is established the other properties of the bilinear loop, f_y , f_o , etc. all follow from the bilinear model.

Depending on the isolator type, and the degree of sophistication of the isolator hysteresis loop adopted in the analysis, additional parameters may also be calculated such as different friction coefficients, tangent stiffness values, tri-linear loop properties, etc.

These parameters are used to develop a mathematical model of the isolator test hysteresis that replicates, as near as possible, the observed test response for a given test cycle. The model should result in a very close match to the effective stiffness and effective damping ratio, and should result in a good visual fit to the hysteresis loop with respect to the additional parameters. The mathematic loop model must, at a minimum, match the effective stiffness and loop area from the test within the degree of variation adopted within the $\lambda_{(\text{spec, min})}$ to $\lambda_{(\text{spec, max})}$ range.

Data from the first cycle (or half cycle) of testing is not usually representative of full cycle behavior and is typically discarded by manufacturers during data processing. An additional cycle (or half-cycle) is added at the end to provide the required number of test cycles from which data can be extracted. However, the first cycle of a test is often important when establishing upper bound isolator properties and should be included when determining the $\lambda_{(\text{test, min})}$ and $\lambda_{(\text{test, max})}$ factors. The form of the test loop will however be different to that of a full-scale loop, particularly for multistage isolator systems such as the double-or-triple-concave friction pendulum system. This may require different hysteresis parameters to be considered than the ones described by the bilinear model in Figure 17.8.3-1.

The effective stiffness and effective damping ratio are required in linear static and linear response spectrum analysis. However, even if a nonlinear response history analysis is performed these parameters are still required to check the required minimum lateral displacements and lateral forces of Sections 17.5.3 and 17.5.4 respectively.

C17.8.4 Determination of Isolator Unit Test Properties for Design

For each isolator type, the effective stiffness and effective damping ratio for a given test axial load, test displacement, and cycle of test are determined in accordance with Section 17.8.3. For the 17.8.2.2 Item 2(a) dynamic test sequence there are two cycles at each increment of test displacement, for the traditional slow-speed sequence there are three.

However, as part of a seismic isolation system, the axial load on a given isolator will vary during a single complete cycle of loading. The required range of variation is assumed to be defined by the test load combinations required in Section 17.2.4.6., and the appropriate properties for analysis are assumed to be the average of the properties at the three axial loads. The test performed for Section 17.8.2.2 Item (3) is critical to this evaluation since it is the three-cycle test performed at all three axial loads common to both the dynamic and slow-speed sequence.

In addition, since all isolators must undergo the same total horizontal cyclic loading as part of the same system, it is therefore assumed to be appropriate to assemble the total seismic isolation system properties using the following sequence:

1. Average the test results for a given isolator and cycle of loading across the three test axial loads. Also compute corresponding test lambda factors for each isolator type.
2. Sum up the total isolation system properties for each cycle of loading according to the number of isolators of each type.
3. Determining the maximum and minimum values of total system effective stiffness over the required three cycles of testing, and the corresponding values of the effective damping ratio. Also compute the test lambda factors for the overall isolation system.

Two sets of test lambda factors emerge from this process, those applicable to individual isolators determined in (1) and those applicable to the overall isolation system properties determined in (3). In general, the test lambda factors for individual isolator tests will be similar to that for each isolator type, which will be similar to that for the overall isolation system. If this is the case it may be more convenient to simplify the lambda factors assumed during design to reflect reasonable envelope values to be applied to all isolator types.

However, if the test lambda factors that emerge from project-specific prototype testing differ significantly from those assumed during design, it may be helpful to build up the system properties as described above, since the unexpectedly high test lambda factors for one isolator type may be offset by test lambda factors for another isolator type that were lower than the assumed values. In this circumstance the prototype test results may be considered acceptable, provided the torsional behavior of the system is not significantly affected, and that the isolator connection and adjacent members can accommodate any resulting increase in local force demands.

Also, note that a subset of the isolation system properties can be determined from QA/QC (Production) testing. This is typically performed at an axial load corresponding to the average $D+0.5L$ axial load for the isolator type and to a displacement equal to $2/3 D_M$. Keep in mind that isolator properties with target nominal three-cycle values estimated to match the average test value across three axial loads may not exactly match the values from production testing at the average dead load.

This is most commonly observed with effective stiffness and effective damping ratio values for friction based isolators, since the average of the three test axial loads required in Section 17.8.2.2 does not exactly match that present in the isolator during the lateral analysis (the seismic weight, typically $1.0 \times$ Dead Load). In this case some additional adjustment of properties may be required. Once the test effective stiffness and effective damping ratio of the isolation system have been established these are compared to the values assumed for design in Section 17.2.8.4, defined by the nominal values and the values of $\lambda_{(test, max.)}$ and $\lambda_{(test, min.)}$.

In practice, instead of performing prototype tests for direct use in analysis, it may be simpler to use prototype test data, or data from acceptable past testing of similar units (see Section 17.8.2.7), to establish isolator property dependence relationships for axial load, velocity, etc. If relationships are established for applicable hysteresis-loop parameters, such as yield force, friction ratio, initial stiffness and post-yield stiffness, these can be used to generate the required isolator unit and isolation system effective stiffness and effective damping ratios for the project over the required operating range.

C17.8.6 Production Tests

The number of production isolation units to be tested in combined compression and shear is 100%. The registered design professional is responsible for defining in the project specifications the scope of the manufacturing quality control test program. The registered design professional decides on the acceptable range of variations in the measured properties of the production isolation units. 100% of the isolators of a given type and size are tested in combined compression and shear and the allowable variation of the mean should be within the specified tolerance of Section 17.2.8.4 (typically $\pm 10\%$ or $\pm 15\%$). Individual isolators may be permitted a wider variation ($\pm 15\%$ or $\pm 20\%$) from the nominal design properties. For example, the mean of the characteristic strength, Q , for all tested isolators might be permitted to vary no more than $\pm 10\%$ from the specified value of Q , but the characteristic strength for any individual isolation unit might be permitted to vary no more than $\pm 15\%$ from the specified value of Q . Another commonly specified allowable range of deviation from specified properties is $\pm 15\%$ for the mean value of all tested isolation units, and $\pm 20\%$ for any single isolation unit.

The combined compression and shear testing of the isolators reveals the most relevant characteristics of the completed isolation unit, and permits the registered design professional to verify the production isolation units provide load-deflection behavior that is consistent with the structural design assumptions. Although vertical load-deflection tests have sometimes been specified in quality control testing programs, this test data is typically of little value. Consideration should be given to the overall cost and schedule impacts of performing multiple types of quality control tests, and only those tests that are directly relevant to verifying the design properties of the isolation units should be specified.

Where project specific prototype testing in accordance with Section 17.8.2 is not performed, the production test program shall evaluate the performance of each isolator unit type for the property variation effects from Section 17.2.8.4.

REFERENCES

- American Association of State Highway and Transportation Officials (AASHTO). (1999). Guide Specification for Seismic Isolation Design. AASHTO, Washington, D.C.
- American Society of Civil Engineers (ASCE). (2007). "Seismic rehabilitation of existing buildings." ASCE/SEI 41, ASCE, Reston, Va.
- Applied Technology Council. (1982). An Investigation of the Correlation between Earthquake Ground Motion and Building Performance, ATC Report 10. ATC, Redwood City, Calif.
- ASTM International. ((2012). "Standard specification for plain and steel-laminated elastomeric bearings for bridges." D4014, ASTM.
- Constantinou, M. C., Winters, C. W. and Theodossiou, D. (1993). "Evaluation of SEAOC and UBC analysis procedures, Part 2: Flexible superstructure." Proceedings of a Seminar on Seismic Isolation, Passive Energy Dissipation and Active Control, ATC Report 17-1. ATC, Redwood City, Calif.
- Constantinou, M. C., Tsopelas, P., Kasalanati, A., and Wolff, E. D. (1999). "Property modification factors for seismic isolation bearings." MCEER-99-0012, Multidisciplinary Center for Earthquake Engineering Research, Buffalo, N.Y.
- Constantinou, M. C., Whittaker, A. S., Kalpakidis, Y., Fenz, D. M., and Warn, G. P. (2007). "Performance of Seismic Isolation Hardware under Service and Seismic Loading," MCEER-07-0012, Multidisciplinary Center for Earthquake Engineering Research, Buffalo, N.Y.
- Constantinou, M.C., Kalpakidis, I., Filiatrault, A. and Ecker Lay, R. A. (2011). "LRFD-Based Analysis and Design Procedures for Bridge Bearings and Seismic Isolators", Report No. MCEER-11-0004, Multidisciplinary Center for Earthquake Engineering Research, Buffalo, NY.

-
- International Code Council. (2006). International Building Code. ICC, Washington, D.C.
- Kalpakidis, I., M.C. Constantinou, (2008). "Effects of Heat and Load History on the Behavior of Lead Rubber Bearings." MCEER-08-0027. Multidisciplinary Center for Earthquake Engineering Research, Buffalo, NY.
- Kalpakidis, I.V. and Constantinou, M.C. (2009). "Effects of Heating on the Behavior of Lead-Rubber Bearings. I: Theory," ASCE, J. Structural Engineering, Vol. 135, No.12, 1440-1449.
- Kalpakidis, I.V., Constantinou, M.C. and Whittaker, A.S. (2010). "Modeling Strength Degradation in Lead-Rubber Bearings under Earthquake Shaking," Earthquake Engineering and Structural Dynamics, Vol. 39, No. 13, 1533-1549.
- Kircher, C. A., Lashkari, B., Mayes, R. L., and Kelly, T. E. (1988). "Evaluation of nonlinear response in seismically isolated buildings." Proceedings of a Symposium on Seismic, Shock and Vibration Isolation, ASME PVP Conference.
- Lashkari, B., and Kircher, C. A. (1993). "Evaluation of SEAOC & UBC analysis procedures, Part 1: stiff superstructure." Proceedings of a Seminar on Seismic Isolation, Passive Energy Dissipation and Acti., ATC.
- Masroor, Armin, Assessing the Collapse Hazard of Base Isolated Buildings Considering Pounding of Moat Walls using the P-695 Methodology, Proceedings of the 2013 EERI Annual Meeting, Seattle, Washington.
- Shenton, H., NISTIR 5800. (1996). Guidelines for Pre-Qualification, Prototype and Quality Control Testing of Seismic Isolation Systems.
- Warn, G.P. and Whittaker, A.S. (2004). "Performance Estimates in Seismically Isolated Bridge Structures", Engineering Structures, Vol. 26, 1261-1278.
- York, K., Ryan, K. (2008). "Distribution of Lateral Forces in Base-Isolated Buildings Considering Isolation System Nonlinearity," Journal of Earthquake Engineering, 12:1185-1204.

Page intentionally left blank

COMMENTARY TO CHAPTER 18, SEISMIC DESIGN REQUIREMENTS FOR STRUCTURES WITH DAMPING SYSTEMS

C18.1 GENERAL

The requirements of this chapter apply to all types of damping systems, including both displacement-dependent damping devices of hysteretic or friction systems and velocity-dependent damping devices of viscous or viscoelastic systems (Soong and Dargush 1997, Constantinou et al. 1998, Hanson and Soong 2001). Compliance with these requirements is intended to produce performance comparable to that for a structure with a conventional seismic force-resisting system, but the same methods can be used to achieve higher performance.

The damping system (DS) is defined separately from the seismic force-resisting system (SFRS), although the two systems may have common elements. As illustrated in Fig. C18.1-1, the DS may be external or internal to the structure and may have no shared elements, some shared elements, or all elements in common with the SFRS. Elements common to the DS and the SFRS must be designed for a combination of the two loads of the two systems. When the DS and SFRS have no common elements, the damper forces must be collected and transferred to members of the SFRS.

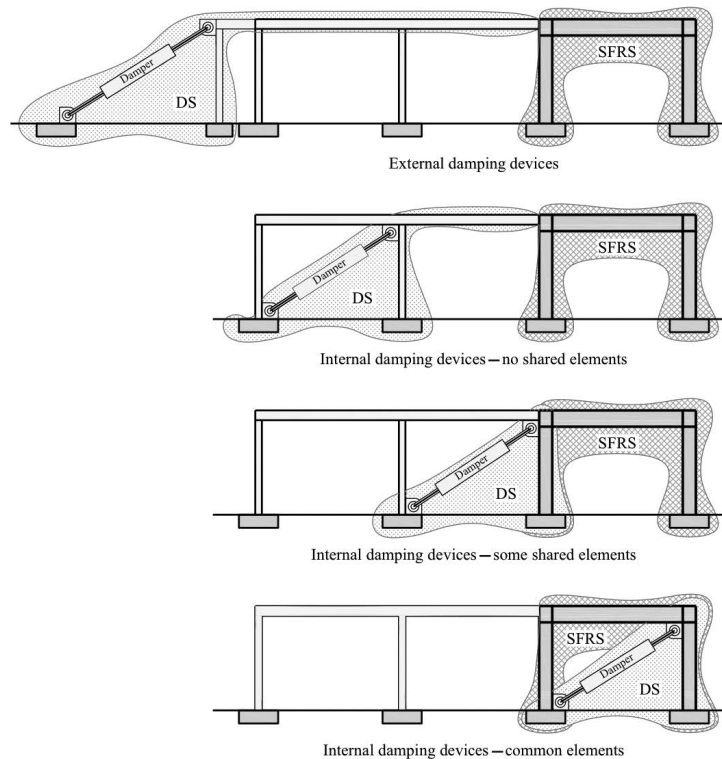

FIGURE C18.1-1 Damping System (DS) and Seismic Force-Resisting System (SFRS) Configurations

C18.2 GENERAL DESIGN REQUIREMENTS

C18.2.1 System Requirements

Structures with a DS must have a SFRS that provides a complete load path. The SFRS must comply with all of the height, Seismic Design Category, and redundancy limitations and with the detailing requirements specified in this standard for the specific SFRS. The SFRS without the damping system (as if damping

devices were disconnected) must be designed to have not less than 75 percent of the strength required for structures without a DS that have that type of SFRS (and not less than 100 percent if the structure is horizontally or vertically irregular). The damping systems, however, may be used to meet the drift limits (whether the structure is regular or irregular). Having the SFRS designed for a minimum of 75 percent of the strength required for structures without a DS provides safety in the event of damping system malfunction and produces a composite system with sufficient stiffness and strength to have controlled lateral displacement response.

The analysis and design of the SFRS under the base shear, V_{\min} from (18.2.-1) or (18.2.-2), or, if the exception applies, under the unreduced base shear, V , should be based on a model of the SFRS that excludes the damping system.

C18.2.1.2 Damping System

The DS must be designed for the actual (unreduced) MCE_R forces (such as peak force occurring in damping devices) and deflections. For certain elements of the DS (such as the connections or the members into which the damping devices frame), other than damping devices, limited yielding is permitted provided such behavior does not affect damping system function or exceed the amount permitted for elements of conventional structures by the standard.

Further, force-controlled actions in elements of the DS must consider seismic forces that are 1.2 times the computed average MCE_R response. Note that this increase is applied for each *element action*, rather than for each *element*. Force-controlled actions are associated with brittle failure modes where inelastic deformation capacity cannot be assured. The 20% increase in seismic force for these actions is required to safeguard against undesirable behavior.

C18.2.2 Seismic Ground Motion Criteria

It is likely that many projects incorporating a supplemental damping system will simply use design and MCE_R spectra based on the mapped values referenced in Chapter 11. Site-specific spectra are always permitted, and must be used for structures on Site Class F.

When nonlinear response-history analysis is used, ground motions are selected, scaled and applied in accordance with the procedures of Chapter 16, with the exception that a minimum of 7 rather than 11 ground motions are required. The use of seven motions is consistent with current practice for design of code-compliant structures, and is considered an adequate number to estimate the mean response for a given hazard level. No other provisions of Chapter 16 apply to structures incorporating supplemental damping systems.

C18.2.3 Procedure Selection

The nonlinear response-history procedure for structures incorporating supplemental damping systems is the preferred procedure, and Chapter 18 is structured accordingly. This method, consistent with the majority of current practice, provides the most realistic predictions of the seismic response of the combined SFRS and DS. If the nonlinear response-history procedure is adopted, the relevant sections of Chapter 18 are 18.1 through 18.6.

However, via the exception, response spectrum (RS) and equivalent lateral force (ELF) analysis methods can be used for design of structures with damping systems that meet certain configuration and other limiting criteria (for example, at least two damping devices at each story configured to resist torsion). In such cases, additional nonlinear response history analysis is used to confirm peak responses when the structure is located at a site with S_1 greater than or equal to 0.6. The analysis methods of damped structures are based on nonlinear static “pushover” characterization of the structure and calculation of peak response using effective (secant) stiffness and effective damping properties of the first (pushover) mode in the direction of interest. These concepts are used in Chapter 17 to characterize the force-deflection properties of isolation

systems, modified to incorporate explicitly the effects of ductility demand (post-yield response) and higher mode response of structures with dampers. Like conventional structures, damped structures generally yield during strong ground shaking, and their performance can be influenced strongly by response of higher modes.

The RS and ELF procedures presented in Chapter 18 have several simplifications and limits, as outlined below:

1. A multiple-degree-of-freedom (MDOF) structure with a damping system can be transformed into equivalent single-degree-of-freedom (SDOF) systems using modal decomposition procedures. This assumes that the collapse mechanism for the structure is a SDOF mechanism so that the drift distribution over height can be estimated reasonably using either the first mode shape or another profile, such as an inverted triangle. Such procedures do not strictly apply to either yielding buildings or buildings that are non-proportionally damped.
2. The response of an inelastic SDOF system can be estimated using equivalent linear properties and a 5-percent-damped response spectrum. Spectra for damping greater than 5 percent can be established using damping coefficients, and velocity-dependent forces can be established either by using the pseudovelocity and modal information or by applying correction factors to the pseudovelocity.
3. The nonlinear response of the structure can be represented by a bilinear hysteretic relationship with zero post-elastic stiffness (elastoplastic behavior).
4. The yield strength of the structure can be estimated either by performing simple plastic analysis or by using the specified minimum seismic base shear and values of R , Ω_0 , and C_d .
5. Higher modes need to be considered in the equivalent lateral force procedure to capture their effects on velocity-dependent forces. This is reflected in the residual mode procedure.

FEMA 440 (2005) presents a review of simplified procedures for the analysis of yielding structures. The combined effects of the simplifications mentioned above are reported by Ramirez et al. (2001) and Pavlou and Constantinou (2004) based on studies of three-story and six-story buildings with damping systems designed by the procedures of the standard. The RS and ELF procedures of the standard are found to provide conservative predictions of drift and predictions of damper forces and member actions that are of acceptable accuracy when compared to results of nonlinear dynamic response history analysis. When designed in accordance with the standard, structures with damping systems are expected to have structural performance at least as good as that of structures without damping systems. Pavlou and Constantinou (2006) report that structures with damping systems designed in accordance with the standard provide the benefit of reduced secondary system response, although this benefit is restricted to systems with added viscous damping.

If either the RS or ELF procedures are adopted, the relevant sections of Chapter 18 are 18.1, 18.2, 18.7, 18.5 and 18.6.

C18.2.4.1 Device Design

Damping devices may operate on a variety of principles and utilize materials that affect their short-term and long-term performance. This commentary provides guidance on the behavior of some of these devices in order to justify the language in the standard and in order to assist the engineer in deciding on the upper and lower bound values of mechanical properties of the devices for use in analysis and design.

Damping devices that have found applications or have potential for application may be classified as follows:

1. Fluid viscous dampers (or oil dampers) that operate on the principle of orificing of fluid, typically some form of oil (Constantinou et al., 2007). These devices are typically highly engineered and precision made so that their properties are known within a narrow range. That is, when the devices are tested, their properties show small variability. An issue is heating that may have significant effects (Makris et al., 1998) which can be alleviated or eliminated by using accumulators or by

utilizing materials with varying thermal expansion properties so that the orifice size is automatically adjusted with varying temperature. However, their long-term behavior may be affected by a variety of potential problems:

- Devices using accumulators include valves that may fail over time depending on the quality of construction and history of operation. It is not possible to know if and when a valve may fail.
 - Fluid is maintained in the device by seals between the body and the moving piston of the device, which may leak either as a result of wear due to excessive cumulative travel or poor construction. For buildings, excessive cumulative travel is rarely an issue. When seals leak, the output of the device will reduce depending on the reduction of internal pressure of the device. It is recommended that potential leakage of oil not be considered in establishing lower bound values of property modification factors (as it is not possible to know) but rather utilize a periodic inspection and maintenance program recommended by the manufacturer to detect problems and make corrections.
 - Orifices may be very small in diameter and therefore may result in clogging when impure oil is used or the oil is contaminated by particles of rubber used in the sealing of fluid in poorly constructed devices or by metal particles resulting from internal corrosion or due to oil cavitation when poor quality materials are used. Typically, rubber should not be used in sealing and parts should be threaded rather than welded or connected by post-tensioning. Larger diameter orifices should be preferred.
2. Visco-elastic fluid or solid devices. These devices operate on the principle of shearing of highly viscous fluids or viscoelastic solids. They have a strong dependence of properties on frequency and temperature. These effects should be assessed by qualification testing. Their long-term behavior is determined by the behavior of the fluid or solid used, both of which are expected to harden with time. The engineer should request the supplier for data on the aging of the material based on observations in real time. Information based on accelerated aging is not useful and should not be utilized (Constantinou et al., 2007).
 3. Metallic yielding devices. Yielding steel devices are typically manufactured of steel with yield properties that are known within a narrow range. Nevertheless, the range of values of the yield strength can be determined with simple material tests. Also, testing some of the devices should be used to verify the information obtained in coupon testing. Aging is of least concern as corrosion may only slightly reduce the section geometrical properties. An inspection and maintenance program should eliminate the concern for aging.
 4. Friction devices. Friction devices operate on the principle of preloaded sliding interfaces. There are two issues with such devices:
 - The preload may reduce over time due to creep in sliding interface materials or the preloading arrangement, or wear in the sliding interface when there is substantial service-load related motion or after high speed seismic motion. It is not possible to know what the preload may be within the lifetime of the structure but the loss may be minimized when high strength bolts are used and high strength/low wear materials are used for the sliding interface.
 - The friction coefficient at the sliding interface may substantially change over time. The engineer is directed to Constantinou et al. (2007) for a presentation on the nature of friction and the short-term and long-term behavior of some sliding interfaces. In general, reliable and predictable in the long-term friction may be obtained when the sliding interface consists of a highly polished metal (typically stainless steel) in contact with a non-metallic softer material that is loaded to high pressure under confined conditions so that creep is completed in short time. However, such interfaces also result in low friction (and thus typically used in sliding isolation bearings). The engineer is referred to Chapter 17 and the related commentary for such cases. Desirable high friction (from a performance standpoint) may be obtained by use of metal to metal sliding interfaces.

However, some of these interfaces are absolutely unreliable as they promote severe additional corrosion and they should never be used (British Standards Institution, 1990). Other bi-metallic interfaces have the tendency to form solid solutions or intermetallic compounds with one another when in contact without motion. This leads to cold welding (very high adhesion or very high friction). Such materials are identified by compatibility charts (Rabinowicz, 1995). The original Rabinowicz charts categorized pairs of metals as incompatible (low adhesion) to compatible and identical (high adhesion). Based on that characterization, identical metals and most bi-metallic interfaces should be excluded from consideration in sliding interfaces. Excluding interfaces that include lead (too soft), molybdenum, silver and gold (too expensive), only interfaces of Tin-Chromium, Cadmium-Aluminum and Copper-Chromium are likely to have low adhesion. Of these, the Tin-Chromium interface has problems of additional corrosion (British Standard Institution, 1983) and should not be used. Accordingly, only bi-metallic interfaces of Cadmium-Aluminum and Copper-Chromium may be useful. The materials in these interfaces have similar hardness so that creep-related effects are expected to be important leading to increased true area of contact and increased friction force over time (Constantinou et al., 2007). This leads to the conclusion that all bi-metallic interfaces result in significant changes in friction force over time that is not possible to predict, and therefore these types of interfaces should not be used.

5. Lead Extrusion devices. These devices operate on the principle of extruding lead through an orifice. The behavior of the device is dependent on the rate of loading and temperature and its force output reduces with increasing cycling due to heating effects. These effects can be quantified by testing so that the nominal properties and property modification factors can be established. Leakage of lead during the lifetime of the device is possible during operation and provided that the seals fail, although the effects cannot be expected to be significant. Leakage is preventable by utilization of proven sealing technologies and by qualification testing to verify (Skinner et al., 1993).

The registered design professional must define the ambient temperature and the design temperature range. The ambient temperature is defined as the normal in-service temperature of the damping device. For devices installed in interior spaces, this temperature may be taken as 70°F, and the design temperature range could come from the project mechanical engineer. For devices installed exposed to exterior temperature variation, the ambient temperature may be taken as the annual average temperature at the site, and the design temperature range may be taken as the annual minimum and maximum temperatures. Since the design temperature range is implicitly tied to MCE_R analysis through λ factors for temperature, the use of maximum and minimum temperatures over the design life of the structure are considered too severe.

C18.2.4.4 Nominal Design Properties

Device manufacturers typically supply nominal design properties that are reasonably accurate based on previous prototype test programs. The nominal properties can be confirmed by project-specific prototype tests during either the design or construction phases of the project.

C18.2.4.5 Maximum and Minimum Damper Properties

Specification Tolerance on Nominal Design Properties: As part of the design process it is important to recognize that there will be variations in the production damper properties from the nominal properties. This difference is due to manufacturing variation. Recommended values for the specification tolerance on the average properties of all devices of a given type and size are typically in the $\pm 10\%$ to $\pm 15\%$ range. For a $\pm 10\%$ specification tolerance the corresponding λ factors would be $\lambda_{(\text{spec, max})} = 1.1$ and $\lambda_{(\text{spec, min})} = 0.9$. Variations for individual device properties may be greater than the tolerance on the average properties of all devices of a given type and size. It is recommended that the device manufacturer be consulted when establishing these tolerance values.

Property Variation (λ) Factors and Maximum and Minimum Damper Properties: Section 18.2.4.5 requires the devices to be analyzed and designed with consideration given to environmental conditions including the effects of aging, creep, fatigue and operating temperatures. The individual aging and environmental factors are multiplied together and then the portion of the resulting λ factor (λ_{ae}) differing from unity is reduced by 0.75 based on the assumption that not all of the maximum / minimum aging and environmental values will occur simultaneously.

Results of prototype tests may also indicate the need to address device behavior whereby tested properties differ from the nominal design properties because of test-related effects. Such behavior may include velocity effects, first cycle effects and any other testing effects that cause behavior different from the nominal design properties. This behavior is addressed through a testing λ factor (λ_{test}), which is a multiple of all the individual testing effects.

The specification (λ_{spec}), environmental (λ_{ae}) and testing (λ_{test}) factors are used to establish maximum (λ_{max}) and minimum (λ_{min}) damper properties for each device type and size for use in mathematical models of the damped structure in accordance with equations (18.2-3a) and (18.2-3b). These factors are typically applied to whatever parameters govern the mathematical representation of the device.

It should be noted that more sophisticated mathematical models will account for various property variation effects directly (e.g. velocity, temperature, etc.). When such models are used, the cumulative effect of the λ factors will reduce (become closer to 1.0), since some of the typical behaviors contributing to λ_{max} and λ_{min} will be already included explicitly in the model. Some effects, such as specification tolerance and aging will likely always remain since they cannot be accounted for in mathematical models.

EXAMPLE

Data from prototype testing as defined in Section 18.6.1 are used to illustrate the λ factors and the maximum and minimum values to be used in analysis and design. The viscous damper under consideration has the following nominal force-velocity constitutive relationship, with kips and inch units:

$$F = C \operatorname{sgn}(V) |V|^\alpha = 128 \operatorname{sgn}(v) |V|^{0.38}$$

The solid line in Figure C18.2-1 depicts the nominal force-displacement relationship.

Prototype tests of damper corresponding to the following conditions were conducted.

- Force-velocity characteristic tests, all conducted at ambient temperature of 70° F.
 - 10 full cycles performed at various amplitudes
- Temperature tests, three fully reversible cycles conducted at various velocities at the following temperatures
 - 40° F
 - 70° F
 - 100° F

The data from prototype tests for each cycle (maximum and negative) are shown as data points in Figure C18.2-1.

Also shown in the figure are the variations from nominal in the force-velocity relationships for this damper. The relationships are obtained by changing the damper constant (C) value. No variation is considered for the velocity exponent, α . The following diagrams are shown:

- A pair of lines corresponding to damper nominal constitutive relationship computed with the C value increased or decreased by 10%. These lines account for the λ_{test} factors as defined in Section 18.2.5.4: $\lambda_{(test,max)} = 1.1$, $\lambda_{(test,min)} = 0.9$. For these particular devices, the variation in properties due to aging and environmental factors is taken as $\pm 5\%$ ($\lambda_{(ae,max)} = 1.05$, $\lambda_{(ae,min)} = 0.95$),

and the specification tolerance is set at $\pm 5\%$ ($\lambda_{(spec,max)} = 1.05$, $\lambda_{(spec,min)} = 0.95$). These values should be developed in conjunction with the device manufacturer based on their history of production damper test data and experience with aging and other environmental effects. Using these values in equations (18.2-3a) and (18.2-3b) results in $\lambda_{max} = 1.20$ and $\lambda_{min} = 0.82$. These values satisfy the minimum variation requirements of Section 18.2.4.5. They are rounded to $\lambda_{max} = 1.2$ and $\lambda_{min} = 0.8$.

- A pair of lines corresponding to the cumulative maximum and minimum λ values (accounting for testing, specification tolerance and other factors listed in Section 18.2.5.4) computed with the nominal C value increased or decreased by 20%.

For this example, analysis with minimum and maximum damper properties should be conducted by using 80% and 120% of the nominal value for C, respectively. The analysis with maximum damper properties will typically produce larger damper forces for use in the design of members and connections, whereas the analysis with minimum damper properties will typically produce less total energy dissipation and hence larger drifts.

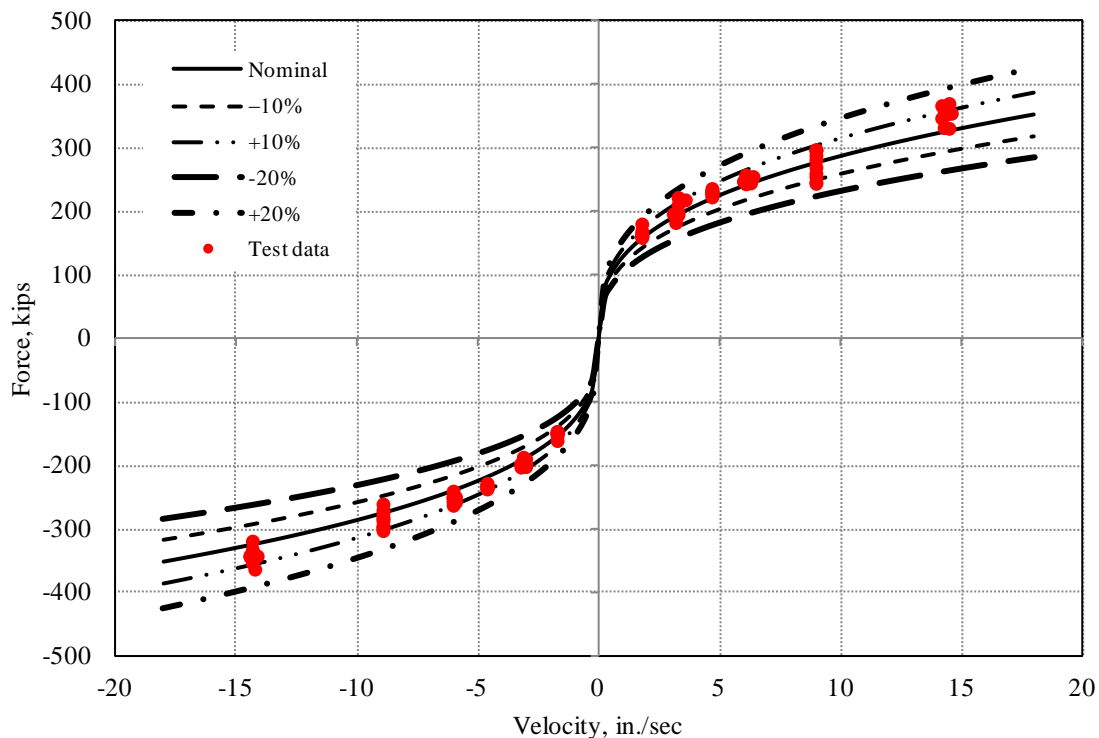

FIGURE C18.2-1 Force-Velocity Relationship for a Nonlinear Viscous Damper

C18.2.4.6 Damping System Redundancy

This provision is intended to discourage the use of damping systems with low redundancy in any story. At least four damping devices should be provided in each principal direction, with at least two devices in each direction on each side of the center of stiffness to control torsional response. In cases where there is low damping system redundancy by this definition, all damping devices in all stories must be capable of sustaining increased displacements (with associated forces) and increased velocities (with associated displacements and forces) relative to a system with adequate redundancy. The penalty is 130%.

C18.3 NONLINEAR PROCEDURES

Those elements of the SFRS and the DS which respond essentially elastically at MCE_R (based on a limit of 1.5 times the expected strength calculated using $\phi=1$), are permitted to be modeled elastically. Modeling parameters and acceptance criteria provided in ASCE 41 with performance objective defined in Table 2.2, as modified in this chapter, are deemed satisfactory to meet the requirements of this section.

The hardware of all damping devices (for example the cylinder of a piston-type device) and the connections between the damping devices and the remainder of the structure must remain elastic at MCE_R (see 18.2.1.2). The nonlinear behavior of all other elements of both the SFRS and the DS must be modeled based on test data, which must not be extrapolated beyond the tested deformations. Strength and stiffness degradation must be included if such behavior is indicated. However, the damping system must not become nonlinear to such an extent that its function is impaired.

Nonlinear response-history analysis is performed at both the design earthquake (DE) and the MCE_R levels. Accidental eccentricity is included at MCE_R , but need not be included at the DE level, since the SFRS design checks from 18.2.1.1 include accidental eccentricity. However, the results from the nonlinear response history analysis (NLRHA) at DE using a model of the combined SFRS and DS must be used to re-check all elements of the SFRS, since the checks of 18.2.1.1 are conducted using a representation of the structure excluding the damping system. This requirement is defined in 18.4.1. The damping system is designed and evaluated based on the results of the MCE_R analyses, as defined in 18.4.2.

For sites not classified as near fault, individual pairs of horizontal ground motion components are not required be applied to the model in multiple orientations. However, for all other sites each pair of horizontal ground motion components shall be applied to the building at orthogonal orientations such that the mean of the component response spectra for the records applied in each direction is approximately equal (close to +/-10%) to the mean of the component response spectra of all records applied for the period range specified in Section 18.2.2.2. The design peer reviewer would be the judge of what constitutes “approximately equal”.

C18.3.2 Accidental Mass Eccentricity

In order to avoid the need to perform a large number of NLRHA that include the suites of ground motions, the upper and lower bound damper properties, and five or more locations of the center-of-mass, the exception in this provision allows the center-of-mass analysis results to be scaled and used to account for the effects of mass eccentricity in different building quadrants.

The following is one suggested method of developing appropriate amplification factors for deformations and forces for use with center-of-mass NLRHA, to account for the effects of accidental eccentricity. The use of other rationally developed amplification factors is permitted and encouraged given that the artificial shift of the center-of-mass changes the dynamic characteristics of the analyzed structure and may lead to the paradox of reduced torsional response with increasing accidental eccentricity (Basu et al., 2014).

The most critical directions for moving the calculated center of mass are such that the accidental eccentricity adds to the inherent eccentricity in each orthogonal direction at each level. For each of these two eccentric mass positions, and with minimum damper properties, the suite of NLRHA should be run and the results processed in accordance with Section 18.3.3. The analysis cases are defined in Table C18.3.2.

Table C18.3.2 Analysis Cases for Establishing Amplification Factors

Case	Damper Properties	Accidental Eccentricity
I	Minimum	No
IIa	Minimum	Yes, X direction
IIb	Minimum	Yes, Y direction

The results from Cases IIa and IIb are then compared in turn to those from Case I. The following amplification factors (ratio of Case IIa or IIb response to Case I response) are computed:

- a. The amplification for story drift in the structure at the plan location with the highest drift, enveloped over all stories;
- b. The amplification for frame-line shear forces at each story for the frame subjected to the maximum drift.

The larger of the two resulting scalars on drift should be used as the deformation amplifier, and the larger of the two resulting scalars on force should be used as the force amplifier. Once the amplification factors are established, the effects of accidental eccentricity should be considered as follows:

The NLRHA procedure should be run for the inherent mass eccentricity case only, considering both maximum and minimum damper properties. For each damper property variation, response quantities should be computed in accordance with Section 18.3.3. All resulting deformation response quantities should be increased by the deformation amplifier and all resulting force quantities should be increased by the force amplifier before being used for evaluation or design.

C18.4 SEISMIC LOAD CONDITIONS AND ACCEPTANCE CRITERIA FOR NONLINEAR RESPONSE-HISTORY PROCEDURE

C18.4.1 Seismic Force Resisting System

All elements of the SFRS are checked under two conditions. First, the SFRS (excluding the damping system) is checked under the minimum base shear requirements of 18.2.1.1. Second, the demands from the NLRHA at DE (with a model of the combined SFRS and DS) must be used to re-check all elements of the SFRS.

There are three limiting values for the analytically computed drift ratios at MCE_R

Table 12.12-1 lists the allowable drifts for structures. These limiting drift ratios are checked against drift ratio demands computed from the code procedure. Since the code design is an implied DE intensity, the drift ratios in the table are also intended to be used at analysis conducted at this level.

1. 3% limit: For most common structures the DE allowable drift ratio (Δ_a/h) is 2%. Because for most cases, the ratio of MCE_R to DE intensity is 1.5, then the allowable drift ratio at MCE will become 3% ($1.5 \times 2\%$)
2. 1.9 factor: When NLRHA analysis is used, the code (Section 16.2.4.3 of ASCE 7-10) allows the DE drift ratios computed from analysis to be limited to 125% of the DE drift ratio limits of Table 12.12-1. Therefore, the MCE_R drift ratios are limited to 1.9 (approximately equal to 1.5×1.25) of limits of Table 12.12-1.
3. 1.5 R/C_d factor: The deflections δ_x of Section 12.8-15 are computed by amplifying the deflections computed from analysis by the deflection amplification factor (C_d). The elastic deflections, used in Chapter 12, themselves are computed at DE intensity using elastic analysis with forces that are reduced by the response modification factor, R . Thus, for purpose of comparing drift ratios computed from NLRHA with Table 12.12-1, the entries of the table need to be modified by the R/C_d factor for comparison at DE level. Therefore the allowable drift ratios at MCE_R correspond to $1.5 R/C_d$ of entries of the table.

EXAMPLE: 5 story steel SMF in Risk category I or II

1. Allowable drift ratio from Table 12.12-1 = 2%
2. Allowable drift ratio for structures with dampers using NLRHA then would be the smallest of
 - 3%
 - $1.9 \times 2\% = 3.8\%$

- $1.5 \times (8/5.5) \times 2\% = 4.4\%$
3. 3% controls. Thus all computed drift ratios from NLRHA should be 3% or less at MCE_R

C18.5 DESIGN REVIEW

The independent design review of many structures incorporating supplemental damping may be performed adequately by one registered and appropriately experienced design professional. However, for projects involving significant or critical structures, it is recommended that a design review panel consisting of two or three registered and appropriately experienced design professionals be used.

C18.6 TESTING

C18.6.1.2 Sequence and Cycles of Testing

The use of $1/(1.5T_1)$ as the testing frequency is based on a softening of the combined SFRS and DS associated with a system ductility of approximately 2. Test 2 (d) ensures that the prototype damper is tested at the maximum force from analysis.

It should be noted that velocity-dependent devices (for example, those devices characterized by $F = Cv^a$) are not intended to be characterized as frequency-dependent under item 4 of this section.

C18.6.1.3 Testing Similar Devices

In order for existing prototype test data to be used to satisfy the requirement of 18.6.1, the conditions of this provision must be satisfied. It is imperative that identical manufacturing and quality control procedures be used for the pre-existing prototype and the project-specific production damping devices. The precise interpretation of “similar dimensional characteristics, internal construction, and static and dynamic internal pressures” and “similar maximum strokes and forces” is left to the registered design professional and the design review team. However, variations in these characteristics of the pre-existing prototype device beyond approximately $\pm 20\%$ from the corresponding project-specific values should be cause for concern.

C18.6.2 Production Testing

The registered design professional is responsible for defining in the project specifications the scope of the production damper test program, including the allowable variation in the average measured properties of the production damping devices. The registered design professional must decide on the acceptable variation of damper properties on a project-by-project basis. This range must agree with the specification tolerance from 18.2.4.5. The standard requires that all production devices of a given type and size are tested.

Individual devices may be permitted a wider variation (typically $\pm 15\%$ or $\pm 20\%$) from the nominal design properties. For example, in a device characterized by $F = Cv^a$, the mean of the force at a specified velocity for all tested devices might be permitted to vary no more than $\pm 10\%$ from the specified value of force, but the force at a specified velocity for any individual device might be permitted to vary no more than $\pm 15\%$ from the specified force.

The production dynamic cyclic test is identical (except for three versus five cycles) to one of the prototype tests of 18.6.1.2, so that direct comparison of production and prototype damper properties is possible.

The exception is intended to cover those devices that would undergo yielding or be otherwise damaged under the production test regime. The intent is that piston-type devices be 100% production tested, since their properties cannot be shown to meet the requirements of the project specifications without testing. For other types of damping devices, whose properties can be demonstrated to be in compliance with the project specifications by other means (for example, via material testing and a manufacturing quality control program), the dynamic cyclic testing of 100% of the devices is not required. However, in this case, the registered design professional must establish an alternative production test program to assure the quality of

the production devices. Such a program would typically focus on such things as manufacturing quality control procedures (identical between prototype and production devices), material testing of samples from a production run, welding procedures, dimensional control, etc. At least one production device must be tested at 0.67 times the MCE_R stroke at a frequency equal to $1/(1.5T_1)$, unless the complete project-specific prototype test program has been performed on an identical device. If such a test results in inelastic behavior in the device, or the device is otherwise damaged, that device cannot be used for construction.

C18.7 ALTERNATE PROCEDURES AND CORRESPONDING ACCEPTANCE CRITERIA

This section applies only to those cases where either the RS or the ELF procedure is adopted.

C18.7.1 Response-Spectrum Procedure and C18.7.2 Equivalent Lateral Force Procedure

Effective Damping: In the standard, the reduced response of a structure with a damping system is characterized by the damping coefficient, B , based on the effective damping, β , of the mode of interest. This approach is the same as that used for isolated structures. Like isolation, effective damping of the fundamental mode of a damped structure is based on the nonlinear force-deflection properties of the structure. For use with linear analysis methods, nonlinear properties of the structure are inferred from the overstrength factor, Ω_0 , and other terms.

Figure C18.7-1 illustrates reduction in design earthquake response of the fundamental mode caused by increased effective damping (represented by coefficient, B_{1D}). The capacity curve is a plot of the nonlinear behavior of the fundamental mode in spectral acceleration-displacement coordinates. The reduction caused by damping is applied at the effective period of the fundamental mode of vibration (based on the secant stiffness).

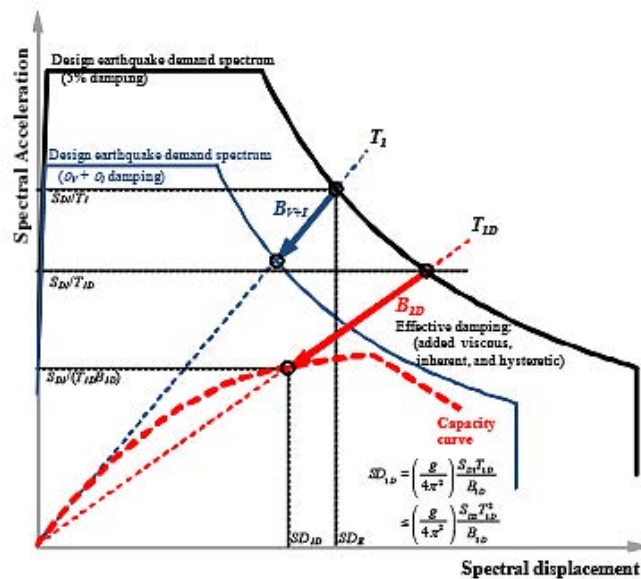

FIGURE C18.7-1 Effective Damping Reduction of Design Demand

In general, effective damping is a combination of three components:

1. Inherent Damping (β_I)—Inherent damping of the structure at or just below yield, excluding added viscous damping (typically assumed to be 2 to 5 percent of critical for structural systems without dampers).

2. Hysteretic Damping (β_H)—Postyield hysteretic damping of the seismic force-resisting system and elements of the damping system at the amplitude of interest (taken as 0 percent of critical at or below yield).
3. Added Viscous Damping (β_V)—The viscous component of the damping system (taken as 0 percent for hysteretic or friction-based damping systems).

Both hysteretic damping and added viscous damping are amplitude-dependent, and the relative contributions to total effective damping change with the amount of postyield response of the structure. For example, adding dampers to a structure decreases postyield displacement of the structure and, hence, decreases the amount of hysteretic damping provided by the seismic force-resisting system. If the displacements are reduced to the point of yield, the hysteretic component of effective damping is zero, and the effective damping is equal to inherent damping plus added viscous damping. If there is no damping system (as in a conventional structure), effective damping simply equals inherent damping.

Linear Analysis Methods: The section specifies design earthquake displacements, velocities, and forces in terms of design earthquake spectral acceleration and modal properties. For equivalent lateral force (ELF) analysis, response is defined by two modes: the fundamental mode and the residual mode. The residual mode is a new concept used to approximate the combined effects of higher modes. Although typically of secondary importance to story drift, higher modes can be a significant contributor to story velocity and, hence, are important for design of velocity-dependent damping devices. For response spectrum analysis, higher modes are explicitly evaluated.

For both the ELF and the response spectrum analysis procedures, response in the fundamental mode in the direction of interest is based on assumed nonlinear (pushover) properties of the structure. Nonlinear (pushover) properties, expressed in terms of base shear and roof displacement, are related to building capacity, expressed in terms of spectral coordinates, using mass participation and other fundamental-mode factors shown in Fig. C18.7-2. The conversion concepts and factors shown in Fig. C18.4-2 are the same as those defined in Chapter 9 of ASCE/SEI 41 (2007), which addresses seismic rehabilitation of a structure with damping devices.

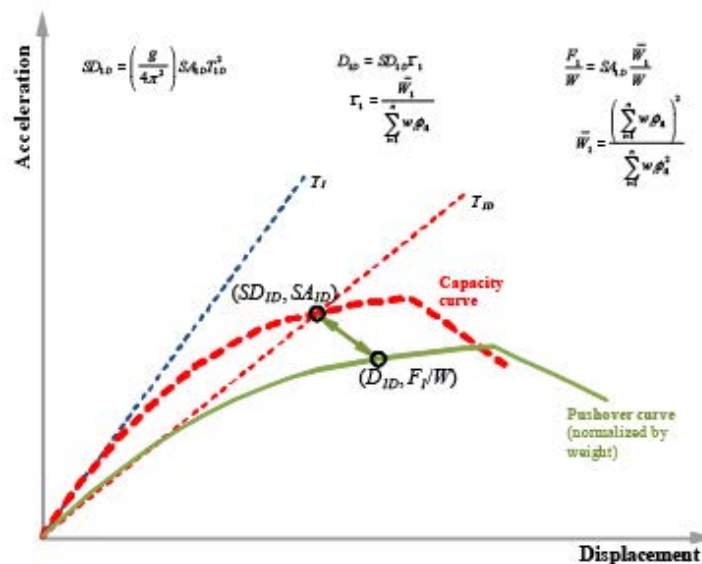

FIGURE C18.7-2 Pushover and Capacity Curves

Where using linear analysis methods, the shape of the fundamental-mode pushover curve is not known, so an idealized elastoplastic shape is assumed, as shown in Fig. C18.7-3. The idealized pushover curve is intended to share a common point with the actual pushover curve at the design earthquake displacement,

D_{1D} . The idealized curve permits definition of the global ductility demand caused by the design earthquake, μ_D , as the ratio of design displacement, D_{1D} , to yield displacement, D_Y . This ductility factor is used to calculate various design factors; it must not exceed the ductility capacity of the seismic force-resisting system, μ_{max} , which is calculated using factors for conventional structural response. Design examples using linear analysis methods have been developed and found to compare well with the results of nonlinear time history analysis (Ramirez et al. 2001).

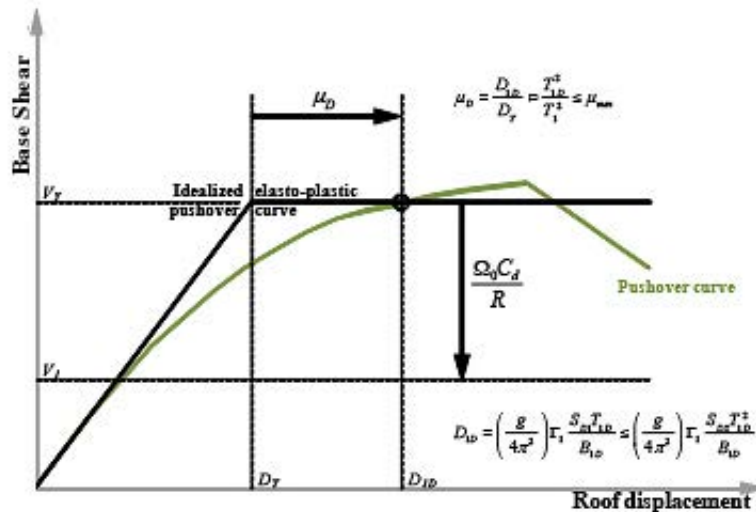

FIGURE C18.7-3 Pushover and Capacity Curves

Elements of the damping system are designed for fundamental-mode design earthquake forces corresponding to a base shear value of V_Y (except that damping devices are designed and prototypes are tested for maximum considered earthquake response). Elements of the seismic force-resisting system are designed for reduced fundamental-mode base shear, V_1 , where force reduction is based on system overstrength (represented by Ω_0), multiplied by C_d/R for elastic analysis (where actual pushover strength is not known). Reduction using the ratio C_d/R is necessary because the standard provides values of C_d that are less than those for R . Where the two parameters have equal value and the structure is 5 percent damped under elastic conditions, no adjustment is necessary. Because the analysis methodology is based on calculating the actual story drifts and damping device displacements (rather than the displacements calculated for elastic conditions at the reduced base shear and then multiplied by C_d), an adjustment is needed. Because actual story drifts are calculated, the allowable story drift limits of Table 12.12-1 are multiplied by R/C_d before use.

C18.7.3 Damped Response Modification

C18.7.3.1 Damping Coefficient

Values of the damping coefficient, B , in Table 18.7-1 for design of damped structures are the same as those in Table 17.5-1 for isolated structures at damping levels up to 20 percent, but extend to higher damping levels based on results presented in Ramirez et al. (2001). Table C18.7-1 compares values of the damping coefficient as found in the standard and various resource documents and codes. FEMA 440 and the draft of Eurocode 8 present equations for the damping coefficient, B , whereas the other documents present values of B in tabular format.

Table C18.7-1 Values of Damping Coefficient, B

Effective Damping, β (%)	Table 17.5-1 of ASCE/SEI (2010), AASHTO (1999), CBC (2001, seismically isolated structures)	Table 18.6-1 of ASCE/SEI (2010) (structures with damping systems)	FEMA 440 (2005)	Eurocode 8 (2005)
2	0.8	0.8	0.8	0.8
5	1.0	1.0	1.0	1.0
10	1.2	1.2	1.2	1.2
20	1.5	1.5	1.5	1.6
30	1.7	1.8	1.8	1.9
40	1.9	2.1	2.1	2.1
50	2.0	2.4	2.4	2.3

The equation in FEMA 440 is

$$B = \frac{4}{5.6 - \ln(100\beta)}$$

The equation in Eurocode 8 (2005) is

$$B = \sqrt{\frac{0.05 + \beta}{0.10}}$$

C18.7.3.2 Effective Damping

The effective damping is calculated assuming the structural system exhibits perfectly bilinear hysteretic behavior characterized by the effective ductility demand, μ , as described in Ramirez et al. (2001). Effective damping is adjusted using the hysteresis loop adjustment factor, q_H , which is the actual area of the hysteresis loop divided by the area of the assumed perfectly bilinear hysteretic loop. In general, values of this factor are less than unity. In Ramirez et al. (2001), expressions for this factor (which they call Quality Factor) are too complex to serve as a simple rule. Equation 18.6-5 provides a simple estimate of this factor. The equation predicts correctly the trend in the constant acceleration domain of the response spectrum, and it is believed to be conservative for flexible structures.

C18.7.4.5 Seismic Load Conditions and Combination of Modal Responses

Seismic design forces in elements of the damping system are calculated at three distinct stages: maximum displacement, maximum velocity, and maximum acceleration. All three stages need to be checked for structures with velocity-dependent damping systems. For displacement-dependent damping systems, the first and third stages are identical, whereas the second stage is inconsequential.

Force coefficients C_{mFD} and C_{mFV} are used to combine the effects of forces calculated at the stages of maximum displacement and maximum velocity to obtain the forces at maximum acceleration. The coefficients are presented in tabular form based on analytic expressions presented in Ramirez et al. (2001) and account for nonlinear viscous behavior and inelastic structural system behavior.

REFERENCES

- American Association of State Highway and Transportation Officials (AASHTO). (2010). *Guide Specifications for Seismic Isolation Design*, Washington, D.C.
- American Society of Civil Engineers/Structural Engineering Institute (ASCE/SEI). (2014), "Seismic Evaluation and Retrofit of Existing Buildings." *ASCE/SEI 41-13*, ASCE, Reston, Va.
- Basu, D., Constantinou, M. C. and Whittaker, A. S., "An equivalent accidental eccentricity to account for the effects of torsional ground motion on structures", *Engineering Structures*, Vol. 69, 2014, 1-11.
- British Standards Institution (1983). *Commentary on Corrosion at Bimetallic Contacts and its Alleviation*, PD 6484:1979, London, UK.

- California Buildings Standards Commission (CBC). (2013). *California Building Code*. Sacramento, Calif.
- Constantinou, M. C., Soong, T. T., and Dargush, G. F. (1998). *Passive Energy Dissipation Systems for Structural Design and Retrofit*, Monograph 1, Multidisciplinary Center for Earthquake Engineering Research, University of Buffalo, State University of New York, Buffalo, N.Y.
- Constantinou, M.C., Whittaker, A.S., Kalpakidis, Y. Fenz, D.M. and Warn, G.P. (2007). *Performance of Seismic Isolation Hardware under Service and Seismic Loading*, Report No. MCEER-07-0012, Multidisciplinary Center for Earthquake Engineering Research, Buffalo, NY.
- European Committee for Standardization (Eurocode 8). (2005). "Design of structures for earthquake resistance. Part 2: Bridges." *Eurocode 8*, European Committee for Standardization.
- Federal Emergency Management Agency (FEMA). (2005). "Improvement of nonlinear static seismic analysis procedures." *FEMA 440*, Federal Emergency Management Agency, Washington, D.C.
- Hanson, R. D., and Soong, T. T. (2001). "Seismic design with supplemental energy dissipation devices." *MNO-8*, Earthquake Engineering Research Institute, Oakland, Calif.
- Makris, N., Roussos, Y., Whittaker, A. S. and Kelly, J. M. (1998), "Viscous Heating of Fluid Dampers. I: Large-amplitude Motions," *Journal of Engineering Mechanics*, Vol. 124, No. 11, pp 1217-1223.
- Pavlou, E., and Constantinou, M. C. (2004). "Response of elastic and inelastic structures with damping systems to near-field and soft-soil ground motions." *Engrg. Struct.*, 26, 1217–1230.
- Pavlou, E., and Constantinou, M. C. (2006). "Response of nonstructural components in structures with damping systems." *J. Struct. Engrg.*, 132(7), 1108–1117.
- Rabinowicz, E. (1995), *Friction and Wear of Materials*, J. Wiley & Sons, Inc., New York.
- Ramirez, O. M., Constantinou, M. C., Kircher, C. A., Whittaker, A., Johnson, M., Gomez, J. D., and Chrysostomou, C. Z. (2001). Development and Evaluation of Simplified Procedures of Analysis and Design for Structures with Passive Energy Dissipation Systems, Technical Report MCEER-00-0010, Revision 1, Multidisciplinary Center for Earthquake Engineering Research, University of Buffalo, State University of New York, Buffalo, N.Y.
- Skinner, R.I., Robinson, W. H. and McVerry, G. H. (1993), *An Introduction to Seismic Isolation*, J. Wiley & Sons, Ltd., England.
- Soong, T. T., and Dargush, G. F. (1997). *Passive Energy Dissipation Systems in Structural Engineering*, J. Wiley & Sons, London, U.K.

OTHER REFERENCES (NOT CITED)

- Miyamoto, H. K., Gilani, A. S., J., Wada, A. and Ariyaratana, C. (2011) "Identifying the Collapse Hazard of Steel Special Moment-Frame Buildings with Viscous Dampers using the FEMA P-695 Methodology." *Earthquake Spectra*, 27(4), 1147–1168.
- Newmark, N. M., and Hall, W. J. (1969). "Seismic design criteria for nuclear reactor facilities." *Proceedings of the 4th World Conference in Earthquake Engineering*, Santiago, Chile.
- Ramirez, O. M., Constantinou, M. C., Gomez, J., Whittaker, A. S., and Chrysostomou, C. Z. (2002a). "Evaluation of simplified methods of analysis of yielding structures with damping systems." *Earthquake Spectra*, 18(3), 501–530.
- Ramirez, O. M., Constantinou, M. C., Whittaker, A. S., Kircher, C. A., and Chrysostomou, C. Z. (2002b). "Elastic and inelastic seismic response of buildings with damping systems." *Earthquake Spectra*, 18(3), 531–547.
- Ramirez, O. M., Constantinou, M. C., Whittaker, A. S., Kircher, C. A., Johnson, M. W., and Chrysostomou, C. Z. (2003). "Validation of 2000 NEHRP provisions equivalent lateral force and modal analysis procedures for buildings with damping systems." *Earthquake Spectra*, 19(4), 981–999.
- SEAOC (2013). 2012 IBC SEAOC Structural/Seismic Design Manual Volume 5: Examples for Seismically Isolated Buildings and Buildings with Supplemental Damping, Sacramento, Calif.
- Whittaker, A. S., Constantinou, M. C., Ramirez, O. M., Johnson, M. W., and Chrysostomou, C. Z. (2003). "Equivalent lateral force and modal analysis procedures of the 2000 NEHRP provisions for buildings with damping systems." *Earthquake Spectra*, 19(4), 959–980.

Page intentionally left blank

COMMENTARY TO CHAPTER 19, SOIL-STRUCTURE INTERACTION FOR SEISMIC DESIGN

C19.1 GENERAL

In an earthquake, the shaking is transmitted up through the structure from the geologic media underlying and surrounding the foundation. The response of a structure to earthquake shaking is affected by interactions among three linked systems: the structure, the foundation, and the geologic media underlying and surrounding the foundation. The analysis procedures in Chapters 12 and 15 idealize the response of the structure by applying forces to the structure, which is typically assumed to have a fixed base at the foundation-soil interface. In some cases, the flexibility of the foundation elements and underlying soils is included in the analysis model. The forces that are applied to the structure are devised based on parameters representing free-field ground motions. The term “free-field” refers to motions not affected by structural vibrations or the foundation characteristics of the specific structure and represents the condition for which the design spectrum is derived using the procedures given in Chapter 11 and Chapter 21. In most cases, however, the motions at the foundation that are imparted to the structure are different from the free-field motions. This difference is due to the effects of the interaction of the structure and the geologic media. A seismic soil-structure interaction (SSI) analysis evaluates the collective response of these systems to a specified free-field ground motion.

SSI effects are absent for the theoretical condition of rigid geologic media, which is typical of analytical models of structures. Accordingly, SSI effects reflect the differences between the actual response of the structure and the response for the theoretical, rigid base condition. Visualized within this context, three SSI effects can significantly affect the response of structures:

1. **Foundation Deformations:** Flexural, axial, and shear deformations of foundation elements occur as a result of loads applied by the superstructure and the supporting geologic media. Additionally the underlying geologic media deforms due to loads from the foundations. Such deformations represent the seismic demand for which foundation components should be designed. These deformations can also significantly affect the overall system behavior, especially with respect to damping.
2. **Inertial Interaction Effects:** Inertia developed in a vibrating structure gives rise to base shear, moment, and torsional excitation, and these loads in turn cause displacements and rotations of the foundation relative to the free field. These relative displacements and rotations are only possible because of flexibility in the soil-foundation system, which can significantly contribute to the overall structural flexibility in some cases. Moreover, the relative foundation-free field motions give rise to energy dissipation via radiation damping (i.e., damping associated with wave propagation into the ground away from the foundation, which acts as the wave source) and hysteretic soil damping, and this energy dissipation can significantly affect the overall damping of the soil-foundation-structure system. Because these effects are rooted in the structural inertia, they are referred to as inertial interaction effects.
3. **Kinematic Effects:** The differences between foundation and free-field motions result from two processes. The first is related to the structure and foundation inertia and consists of the relative foundation-free field displacements and rotations described above. The second is known as kinematic interaction and results from the presence of stiff foundation elements on or in soil, which causes foundation motions to deviate from free-field motion as a result of base slab averaging and embedment effects.

Chapter 19 addresses all three types of SSI effects. Procedures for calculating kinematic and inertial effects were taken from recommendations in NIST GCR 12-917-21 (2012). Further discussion of SSI effects can be found in the NIST document and some of the references cited in that document.

The first effect, foundation deformation, is addressed by explicitly requiring the design professional to incorporate the deformation characteristics of the foundation into their analysis model. Including foundation deformations is essential for understanding soil-structure interaction (SSI). Therefore, the flexibility of the foundation must be modeled to capture translational and rotational movement of the structure at the soil-foundation interface.

For the linear procedures, this requirement to model the flexibility of the foundation and soil means that springs should be placed in the model to approximate the effective linear stiffness of the deformations of the underlying geologic media and the foundation elements. This could be done by placing isolated spring elements under the columns and walls, by explicitly modeling the foundation elements and geologic media in the mathematical model or some combination of the two. For the response history procedure, this would mean that in addition to the stiffness of the subsurface media and foundation elements, the nonlinear parameters of those materials would be incorporated into the analytical model. Because of the uncertainty in estimating the stiffness and deformation capacity of geologic media, upper and lower bound estimates of the properties should be used and the condition which produces the more conservative change in response parameters from a fixed-base structure must be used.

Inertial interaction effects are addressed through the consideration of foundation damping. Inertial interaction in structures tends to be important for stiff structural systems such as shear walls and braced frames, particularly where the foundation soil is relatively soft. The provisions provide a method for estimating radiation damping and soil hysteretic damping.

The two main kinematic interaction effects are included in these provisions: Base Slab Averaging and Embedment effects. The kinematic interaction effects cause the motion input into the structure to be different from the free field motions. The provisions provide a means by which a free-field site specific response spectrum can be modified to account for these kinematic interaction effects to produce a foundation-input spectrum.

In Section 19.1.1, the prohibition of using the cap of S_s included in Section 12.8.1.3 is because of the belief that the reason why structures meeting the requirements of that section have performed satisfactorily in past earthquakes is partially attributable to SSI effects. Taking advantage of that predetermined cap on S_s and then subsequently reducing the base shear due to SSI effects may therefore amount to double counting the SSI effects.

C19.2 SSI ADJUSTED STRUCTURAL DEMANDS

When the equivalent lateral force procedure is used, the equivalent lateral force is computed using the period of the flexible base structure and is modified for foundation damping. For the Modal Analysis Procedure, a response spectrum, which has been modified for foundation damping and then divided by (R/I_e) , is input into the mathematical model. The lower-bound limit on the design base shear based on the equivalent lateral force procedures per section 12.9.4 still applies, but the equivalent lateral force base shear modified to account for SSI effects replaces the base shear for the fixed-base case.

For both the equivalent lateral force and response spectrum procedures, the total reduction due to SSI effects is limited to a percentage of the base shear determined in accordance with Section 12.8.1, which varies based on the R-factor. This limitation on potential reductions due to SSI reflects the limited understanding of the effects of SSI interact with the R-Factor. All of the SSI effects presented herein are based on theoretical linear elastic models of the structure and geologic media. That is why reductions of 30% are permitted for $R = 3$ or less. It is felt that those systems will exhibit limited inelastic response and therefore, a larger reduction in the design force due to SSI should be permitted. For higher R-factor systems, where significant damping due to structural yielding is expected, the contribution of foundation damping is assumed to have little effect on the reduction of the response. Some reduction is permitted due to an assumed period lengthening resulting from the incorporation of base flexibility, potential reduction in mass

participation in the fundamental mode because two additional degrees of freedom are present due to translation and rotation of the base, and limited foundation damping interacting with the structural damping.

Reductions to the response spectrum due to foundation damping and kinematic interaction effects are for the elastic 5% damped response spectrum typically provided to characterize free-field motion. In addition, studies have indicated that there is a fair amount of scatter when measured reductions between the free-field motion and the foundation input motion are compared with the theoretical models (Stewart, 2000).

Modifications for kinematic interaction effects are not permitted for the equivalent lateral force and modal response spectrum procedures. The equations for predicting the kinematic interaction effects are based on modifications to the linear elastic response spectrum. Studies have not been performed to verify if they are similarly valid for inelastic response spectra, on which the R-factor procedures are based. Additionally, the magnitude of the modification for kinematic interaction effects is dependent on the period of the structure, with the greatest modifications occurring in the short period range. Because the fundamental periods of most structures lengthen as they yield, what would potentially be a significant modification at the initial elastic period may become a smaller modification as the structure yields. Without an understanding of how the period may lengthen in the equivalent lateral force or modal response spectrum procedures, there is a potential for a user to overestimate the reduction in the response parameters due to kinematic interaction effects. Thus their use is not permitted until further study has been performed.

All types of SSI effects are permitted to be considered in a response history analysis per Chapter 16. If SSI effects are considered, the site-specific response spectra should be used as the target to which the acceleration histories are scaled. The requirement to use a site-specific response spectrum was placed in the provisions because of the belief that it provided a more realistic definition of the earthquake shaking than is provided by the general response spectrum in Section 11.4. A more realistic spectrum was required for proper consideration of SSI effects, particularly kinematic interaction effects. The general response spectrum uses predetermined factors to modify the probabilistic or deterministic seismic hazard spectra for the soil conditions. These factors are sufficient for most design situations. However, if SSI effects are to be considered and the response spectrum modified accordingly, then more accurate representations of how the underlying geologic media alters the spectral ordinates should be included before the spectrum is modified due to the SSI effects.

A site specific response spectrum that includes the effects of SSI can be developed with explicit consideration of SSI effects, by modifying spectra developed for free-field motions through the use of the provisions in Sections 19.3 and 19.4, or a combination of the two approaches. If the foundation damping is not specifically modeled in the analytical model of the structure, the input response spectra can include the effects of foundation damping. Typically, the base slab averaging effect is not explicitly modeled in the development of a site specific response spectrum and the provisions in Section 19.4.1 are used to modify the free-field site specific spectrum to obtain the foundation input spectrum. Embedment effects can be modeled directly by developing the site specific spectrum at the foundation base level, as opposed to the ground surface. Alternatively, the site specific spectrum for the free-field can be developed at the ground level and the provisions of Section 19.4.2 used to adjust it to the depth corresponding to the base of foundation.

The limitations on the reductions from the site specific free-field spectrum to the foundation input spectrum are based on several factors. The first is the scatter between measured ratios of foundation input motion to free-field motion versus the ratios from theoretical models (Stewart, 2000). The second is the inherent variability of the properties of the underlying geologic media over the footprint of the structure. While there is a requirement to bound the flexibility of the soil and foundation springs, there are no corresponding bounding requirements applied to the geologic media parameters used to compute the foundation damping and kinematic modifications. The last factor is the aforementioned lack of research into the interaction between SSI effects and yielding structures. Some studies have shown that there are reductions for most cases of SSI when coupled with an R-factor based approach (Jarernprasert, et al., 2013), but in some specific

cases amplification in demand from what would have been expected of a fixed-based structure has been reported.

There is also a limitation placed on the maximum reduction for an SSI modified site specific response spectrum with respect to the general response spectrum developed based on the USGS seismic hazard parameters. This limitation is due to similar concerns expressed in C21.3 regarding the site specific hazard studies generating unreasonably low response spectra. There is a similar concern that combining SSI effects with site specific ground motions could significantly reduce the seismic demand from that based on the USGS seismic hazard parameters. However, it was recognized that these modifications are real and the limit could be relaxed, but not eliminated, if there were (1) adequate peer review of the site specific seismic hazard analysis and the methods used to determine the modifications attributable to SSI effects, and (2) approval of the jurisdictional authority.

Peer review would include, but not be limited, to the following:

1. The development of the site specific response spectrum used to scale the ground motions is confirmed by the reviewer to accurately capture the ground-free field or free-field at foundation depth spectrum.
2. Springs representing the stiffness of the foundation and underlying subsurface media are confirmed accurate and the bounding parameters are agreed to.
3. The peer reviewer confirms that the base-slab and first slab above the base are sufficiently rigid to allow base-slab averaging to occur, including verification that the base slab is detailed to act as a diaphragm.
4. The peer reviewer verifies and agrees with the assumptions that go into the development of the soil damping and radiation ratios and that the dashpots included in the model properly capture that damping ratio.

The SSI effects can be used in a response history analysis per Chapter 16. Two options for the modeling of the SSI are as follows:

1. Create a nonlinear finite element (FE) model of the structure, foundation, and geologic media. The mesh for the geologic media should extend to an appropriate depth and horizontal distance away from the foundation with transmitting boundaries along the sides to absorb outgoing seismic waves generated by the foundation. The motion should be input at the base of the FE model and should propagate upward as shear waves. The free field response spectrum can be reduced for kinematic SSI only per the provisions in Section 19.4, but embedment effects would not be allowed in the reduction because the waves propagating up from the depth of the foundation to the surface would automatically include kinematic effects of embedment.
2. Create a nonlinear finite element model of the structure and foundation, with springs and dashpots attached to the perimeter walls and base of the foundation to account for the soil-foundation interaction. Guidance on the development of dashpots can be found in NIST 12-917-21 (2012). The free field response spectrum can be reduced for kinematic SSI per Section 19.4, but embedment effects may or may not be allowed in the reduction depending on whether or not (i) the motion is allowed to vary with depth along the embedded portion of the foundation, and (ii) the free field motion used as input motion is defined at the ground surface or at the bottom of the basement. The dashpots would account for the radiation and hysteretic damping of the geologic media, either per Section 19.3 or more detailed formulations.

C19.3 FOUNDATION DAMPING

The procedures in Section 19.3 are used to estimate a SSI system damping ratio based on the underlying geologic media and interaction of the structure and its foundation with this geologic media. There are two main components that contribute to foundation damping: soil hysteretic damping and radiation damping. The provisions in this section provide simplified ways to approximate these effects. However, they are

complex phenomena and there are considerably more detailed methods to predict their effects on structures. The majority of the provisions in this section are based on material in NIST GCR 12-917-21 *Soil Structure Interaction for Building Structures* (2012). Detailed explanations of the background of these provisions, supplemental references and more sophisticated methods for predicting radiation damping can be found in that report.

Radiation damping refers to energy dissipation from wave propagation away from the vibrating foundation. As the ground shaking is transmitted into the structure's foundation, the structure itself begins to translate and rock. The motion of the foundation relative to the free field motion creates waves in the geologic media which can act to counter the waves being transmitted through the geologic media due to the earthquake shaking. The interference is dependent on the stiffness of the geologic media and the structure, the size of the foundation, type of underlying geologic media and period of the structure.

Soil hysteretic damping occurs due to shearing within the soil and at the soil-foundation interface.

The method previously given in Chapter 19 for evaluating inertial SSI effects only accounted for radiation damping. This chapter was optional and was rarely used in practice. There are several reasons for this situation. First, because the guidelines were written in such a way that base shear demand could only decrease through consideration of SSI, so SSI effects were ignored in order to be conservative. Second, many design engineers who have attempted to apply the method on projects have done so for major, high-rise structures for which they felt that evaluating SSI effects could provide cost savings. Unfortunately, inertial interaction effects are negligible for these tall, flexible structures, hence the design engineers realized no benefit from their efforts. Thereafter they subsequently stopped using the procedures. The use of the procedures actually yield the most benefit for short-period ($T < 1$ s), stiff structures with stiff, interconnected foundation systems (i.e., mats or interconnected footings) founded on soil.

Foundation damping effects tend to be important for stiff structural systems such as shear walls and braced frames, particularly where they are supported on relatively soft soil sites such as Site Classes D and E. This is determined by taking the ratio of the fundamental period of the structure including the flexibility of the foundation and underlying subsurface media (flexible-base model) and the fundamental period of the structure assuming infinite rigidity of the foundation and underlying subsurface media (fixed-base model). Analytically, this ratio can be determined by computing the period of the structure with the foundation/soil springs in the model and then replacing those springs with rigid support.

Figure C19.3-1 illustrates the effect of the period ratio, \tilde{T}/T , on the foundation damping, β_f . \tilde{T}/T is the ratio of the fundamental period of the SSI system to the period of the fixed-base structure. The figure shows that for structures with larger height, h , to foundation half-width, B , aspect ratios, the effects of foundation damping become less. In this figure, the aspect ratio of the foundation is assumed to be square and only radiation damping is considered – soil damping is assumed to be zero.

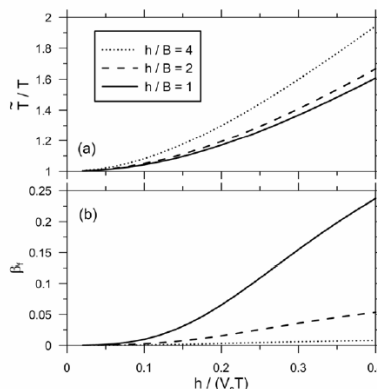

FIGURE C19.3-1 Example Foundation Damping Figures (from NIST, 2012)

These inertial interaction effects are influenced considerably by the shear modulus of the underlying subgrade, specifically the modulus that coincides with the seismic shaking being considered. As noted in the standard, shear modulus G can be evaluated from small-strain shear wave velocity as $G = (G/G_o)G_o = (G/G_o)\gamma v_{s0}^2/g$ (all terms defined in the standard). Shear wave velocity, v_{s0} , should be evaluated as the average small-strain shear wave velocity within the effective depth of influence below the foundation. The effective depth should be taken as half the lesser dimension of the foundation, which in the provisions is defined as B . Methods for measuring v_{s0} (preferred) or estimating it from other soil properties are summarized elsewhere (e.g., Kramer 1996).

The radiation damping procedure is conservative and will underestimate the foundation damping for shaking in the long direction where the foundation aspect ratios exceed 2:1, but could be potentially unconservative where wall and frame elements are close enough so that waves emanating from distinct foundations destructively interfere with each other across the period range of interest. That is why the limit of spacing of the vertical lateral force resisting elements is imposed on the use of these provisions.

For structures supported on footings, the above formulas can generally be used with B and L calculated using the footprint dimensions of the entire structure, provided that the footings are interconnected with grade beams and/or a sufficiently rigid slab-on-grade. An exception can occur for structures with both shear walls and frames, for which the rotation of the foundation beneath the wall may be independent of that for the foundation beneath the column (this type is referred to as weak rotational coupling). In such cases, B and L are often best calculated using the dimensions of the wall footing. Very stiff foundations like structural mats, which provide strong rotational coupling, are best described using B and L values that reflect the full foundation dimension. Regardless of the degree of rotational coupling, B and L should be calculated using the full foundation dimension if foundation elements are interconnected or continuous. Further discussion can be found in FEMA 440 and NIST GCR 12-917-21. The use of spread footings that are not interconnected in seismic regions is not recommended.

The radiation damping provisions conservatively exclude the effects of embedment. Embedment typically increases the amount of radiation damping if the basement or below grade foundation stays in contact with the soil on all sides. Because there is typically some gapping between the soil and the sides the basement or foundation, these embedment effects will be less than the models predict. There are some additional issues with the procedures for embedded foundations. For the case where the embedment is significant, but the soils along the sides are much more flexible than the bearing soils, a high impedance contrast between the first two layers is recognized as a potential problem regardless of the embedment. The NIST GCR 12-917-21 report therefore recommends ignoring the additional contributions due to embedment, but still using the soil properties derived below the embedded base.

The equations in Sections 19.3.3 and 19.3.4 are for shallow foundations. This is not to say that radiation damping does not occur with deep (pile or caisson) foundation systems, but the phenomenon is more complex. Soil layering and group effects are important, and there are the issues of the possible contributions of the bottom structural slab and pile caps. Because the provisions are based on the impedance produced by a rigid plate in soil, these items cannot be easily taken into account. Therefore, more detailed modeling of the soil and the embedded foundations is required to determine the foundation impedances. The provisions permit such modeling, but do not provide specific guidance for it. Guidance can be found for example in NIST GCR 12-917-21 and its references.

Soil hysteretic damping occurs due to nonlinear shearing which occurs as seismic waves propagate through the subsurface media and reach the base of the structure. Soil hysteretic damping can have an effect on the overall system damping when the soil strains are high. The table in the provisions was derived based on relationships found in EPRI (1993) and Vucetic and Dorby (1991) that relate the ratio between G/G_o to cyclic shear strain in the soil, and then to soil damping. The values in the table are based on conservative assumptions about overburden pressures on granular soils and plasticity index of clayey soils. This does

not preclude the geotechnical engineer from providing more detailed estimates of soil damping. However, the cap on reductions will typically be reached at around an additional 5% damping ratio (10% total damping ratio) and further reductions would require peer review.

C19.4 KINEMATIC INTERACTION EFFECTS

Kinematic interaction effects are broadly defined as the difference between the ground motion measured in a free field condition and the motion which would be measured at the structure's foundation, assuming it and the structure were massless (i.e., inertial SSI was absent). The difference between free field and foundation input motions are due to the characteristics of the structure foundation, exclusive of the soil and radiation damping effects in the preceding section. There are two main types of kinematic interaction effects – base slab averaging and embedment. The provisions provide simplified methods for capturing these effects. The basis for the provisions and additional background material can be found in FEMA 440 and NIST GCR 12-917-21.

FEMA 440 specifically recommends against applying these provisions to very soft soil sites such as E and F. These provisions retain the prohibition for site class F. That is not to say that kinematic interaction effects are not present at F site, but that these specific provisions should be not used; rather, more detailed site-specific assessments are permitted to be used to determine the possible modifications at those sites.

C19.4.1 Base Slab Averaging

Base slab averaging refers to the filtering of high frequency portions of the ground shaking due to the incongruence of motion over the base. For this filtering to occur the base of the structure must be rigid or semi-rigid with respect to the vertical lateral force resisting elements. If the motions are out of phase from one end of the foundation to the other and the foundation is sufficiently rigid, then the motion on the foundation would be different from the ground motion at either end. The ground motions at any point under the structure are not in phase with ground motions at other points along the base of the structure. That incongruence leads to interference over the base of the structure which translates into the motions imparted to the foundation which are different from the ground motions. Typically this phenomenon results in a filtering out of short period motions, which is why the reduction effect is much more pronounced in structures with short fundamental periods, as illustrated in Figure C19.4-1.

Figure C19.4-1 illustrates the increase in reduction as the base area parameter, b_e , increases. This parameter is computed as the square root of the foundation area. Therefore, for larger foundations, base slab averaging effects are more significant.

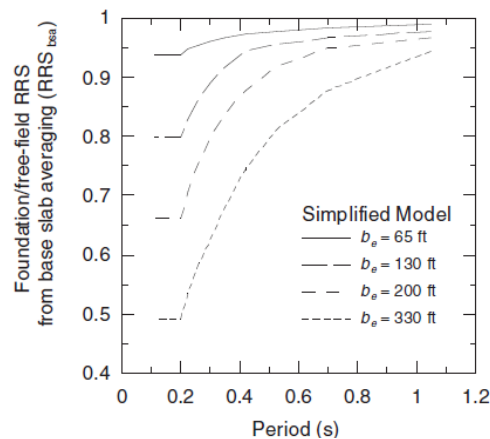

FIGURE C19.4-1 Example Base-Slab Averaging Response Spectra Ratios

For base slab averaging effects to occur, foundation components must be interconnected with grade beams or a concrete slab that is sufficiently stiff to permit the base to move as a unit and allow this filtering effect to occur. That is why requirements are placed on the rigidity of the foundation diaphragm relative to the vertical lateral force resisting elements at the first story. Additionally requirements are placed on the floor diaphragm or roof diaphragm, in the case of a one-story structure needing to be stiff in order for this filtering of ground motion to occur. FEMA 440 indicates that there is a lack of data regarding this effect when either the base slab is not interconnected or the floor diaphragms are flexible. It is postulated that reductions between the ground motion and the foundation input motion may still occur. Because cases like this have not been studied in FEMA 440 or NIST GCR 12-917-21 explicitly, the requirements for foundation connectivity and stiff or rigid diaphragms above the foundation have been incorporated into the provisions.

The underlying models have only been studied up to an effective base size of 260 ft, which is why that limitation has been placed on Eq. 19.4-4. FEMA 440 postulates that this effect is likely to still occur for larger base areas, but there have not been sufficient study to compare the underlying equations to data at larger effective base sizes.

Also, because the reduction can become quite significant and because studies of these phenomena has indicated variability between the theoretically predicted modifications and actual measured modifications (Stewart et al., 1999 and Stewart 2000), a 0.75 factor is applied to the equations that are found in NIST GCR 12-917-21 to provide an upper-bound estimate of the reductions with respect to the theoretical models. This is why the equations differ from those found in NIST GCR 12-917-21.

Lastly, the method has not been rigorously studied for structures on piles (FEMA 440); however, it is considered reasonable to extend the application to pile-supported structures in which the pile caps are in contact with the soil and are laterally connected to one another.

C19.4.2 Embedment

The kinematic interaction effects due to embedment occur because the seismic motions vary with depth below the ground surface. It is common for these effects to be directly considered in a site-specific response spectrum by generating response spectra and acceleration histories at the embedded base of the structure instead of the ground surface. If that is not done, then these effects can be accounted for using the provisions in this section. However, these provisions should not be used if the response spectrum has already been developed at the embedded base of the structure. The embedment effect model was largely based on studies of structures with basements. The provisions can also be applied to structures with embedded foundations without basements where the foundation is laterally connected at the plane taken as the embedment depth. However, the provisions are not applicable to embedded individual spread footings.

As with Base Slab Averaging, the reduction can become quite significant and studies of these phenomena has indicated variability between the theoretically predicted modifications and actual measured modifications (Stewart et al., 1999). Again, a 0.75 factor is applied to the equations found in NIST GCR 12-917-21 to provide a slightly conservative estimate of the reductions with respect to the theoretical models. This is why the equations differ from those found in NIST GCR 12-917-21 and FEMA 440. Additionally, the underlying models upon which the provisions are based have only been validated in NIST GCR 12-917-21 up to an effective embedment depth of approximately 20 ft, which is why a depth limitation has been placed on Eq. 19.2-4.

REFERENCES

- American Society of Civil Engineers/Structural Engineering Institute (ASCE/SEI). (2006). "Seismic rehabilitation of existing buildings." *ASCE/SEI 41-06*, ASCE, Reston, Va.
- Electrical Power Research Institute, EPRI (1993). "Guidelines for determining design basis ground motions," *Rpt. No. EPRI TR-102293*, Electrical Power Research Institute, Palo Alto, CA.
- Federal Emergency Management Agency (FEMA). (2005). *Improvement of nonlinear static seismic analysis procedures. FEMA 440*. Federal Emergency Management Agency, Washington, D.C.

- Jarempasert, S., Bazan-Zurita, E., and Bielak, J. (2013). "Seismic Soil-Structure Interaction Response of Inelastic Structures." *Soil Dynamics and Earthquake Engineering* Vol. 47, 132-143.
- Kramer, S. L. (1996). *Geotechnical Earthquake Engineering*, Prentice Hall, Upper Saddle River, N.J.
- NIST (2012). Soil-structure interaction for building structures, *Report No. NIST GCR 12-917-21*, National Institute of Standards and Technology, U.S. Department of Commerce, Washington D.C. Project Technical Committee: Stewart, J.P. (Chair), C.B. Crouse, T. Hutchinson, B. Lizundia, F. Naeim, and F. Ostadan
- Salgado, R. (2006). *The Engineering of Foundations*. McGraw-Hill.
- Stewart, J. P., Seed, R. B., and Fenves, G. L. (1999). "Seismic soil-structure interaction in buildings. II: Empirical findings." *J. Geotech. and Geoenviron. Engrg.*, 125(1), 38-48.
- Stewart, J.P. (2000). "Variations between foundation-level and free-field earthquake ground motions," *Earthquake Spectra*, 16 (2), 511-532.
- Vucetic, M. and R. Dobry (1991). "Effect of soil plasticity on cyclic response," *J. Geotech. Eng.*, 117, 89-107.

Page intentionally left blank.

COMMENTARY TO CHAPTER 20, SITE CLASSIFICATION PROCEDURE FOR SEISMIC DESIGN

C20.1 SITE CLASSIFICATION

Site classification procedures are given in Chapter 20 for the purpose of classifying the site and determining site coefficients and site-adjusted maximum considered earthquake ground motions in accordance with Section 11.4.3. Site classification procedures are also used to define the site conditions for which site-specific site response analyses are required to obtain site ground motions in accordance with Section 11.4.7 and Chapter 21.

C20.3 SITE CLASS DEFINITIONS

C20.3.1 Site Class F

Site Class F conditions are conditions for which the site coefficients F_a and F_v in Tables 11.4-1 and 11.4-2 may not be applicable for site-response analyses required by Section 11.4.7. For short-period structures, it is permissible to determine values of F_a and F_v assuming that liquefaction does not occur because ground motion data obtained in liquefied soil areas during earthquakes indicate that short-period ground motions generally are attenuated because of liquefaction, whereas long-period ground motions may be amplified. This exception does not affect the requirements in Section 11.8 to assess liquefaction potential as a geologic hazard and to develop hazard mitigation measures as required.

Sections C20.3.2 through C20.3.5. These sections and Table 20.3-1 provide definitions for Site Classes A through E. Except for the additional definitions for Site Class E in Section 20.3.2, the site classes are defined fundamentally in terms of the average small-strain shear wave velocity in the top 100 ft (30 m) of the soil or rock profile. If shear wave velocities are available for the site, they should be used to classify the site. However, recognizing that in many cases shear wave velocities are not available for the site, alternative definitions of the site classes also are included. These definitions are based on geotechnical parameters: standard penetration resistance for cohesionless soils and rock, and standard penetration resistance and undrained shear strength for cohesive soils. The alternative definitions are intended to be conservative because the correlation between site coefficients and these geotechnical parameters is more uncertain than the correlation with shear wave velocity. That is, values of F_a and F_v tend to be smaller if the site class is based on shear wave velocity rather than on the geotechnical parameters. Also, the site class definitions should not be interpreted as implying any specific numerical correlation between shear wave velocity and standard penetration resistance or undrained shear strength.

Although the site class definitions in Sections 20.3.2 through 20.3.5 are straightforward, there are aspects of these assessments that may require additional judgment and interpretation. Highly variable subsurface conditions beneath a building footprint could result in overly conservative or unconservative site classification. Isolated soft soil layers within an otherwise firm soil site may not affect the overall site response if the predominant soil conditions do not include such strata. Conversely, site response studies have shown that continuous, thin, soft clay strata may affect the site amplification.

The site class should reflect the soil conditions that affect the ground motion input to the structure or a significant portion of the structure. For structures that receive substantial ground motion input from shallow soils (for example, structures with shallow spread footings, with laterally flexible piles, or with basements where substantial ground motion input to the structure may come through the side walls), it is reasonable to classify the site on the basis of the top 100 ft. (30 m) of soils below the ground surface. Conversely, for structures with basements supported on firm soils or rock below soft soils, it may be reasonable to classify the site on the basis of the soils or rock below the mat, if it can be justified that the soft soils contribute little to the response of the structure.

Buildings on sites with sloping bedrock or highly variable soil deposits across the building area require careful study because the input motion may vary across the building (for example, if a portion of the building is on rock and the rest is over weak soils). Site-specific studies including two- or three-dimensional modeling may be used in such cases to evaluate the subsurface conditions and site and superstructure response. Other conditions that may warrant site-specific evaluation include the presence of low shear wave velocity soils below a depth of 100 ft (30 m), location of the site in a sedimentary basin, or subsurface or topographic conditions with strong two- and three-dimensional site-response effects. Individuals with appropriate expertise in seismic ground motions should participate in evaluations of the need for and nature of such site-specific studies.

C20.4 DEFINITIONS OF SITE CLASS PARAMETERS

Section 20.4 provides formulas for defining site classes in accordance with definitions in Section 20.3 and Table 20.3-1. Eq. (20.4-1) is for determining the effective average small-strain shear wave velocity, \bar{v}_s , to a depth of 100 ft (30 m) at a site. This equation defines \bar{v}_s as 100 ft (30 m) divided by the sum of the times for a shear wave to travel through each layer within the upper 100 ft (30 m), where travel time for each layer is calculated as the layer thickness divided by the small-strain shear wave velocity for the layer. It is important that this method of averaging be used because it may result in a significantly lower effective average shear wave velocity than the velocity that would be obtained by directly averaging the velocities of the individual layers.

For example, consider a soil profile that has four 25-ft-thick layers with shear wave velocities of 500, 1,000, 1,500, and 2,000 ft/s. The arithmetic average of the shear wave velocities is 1,250 ft/s (corresponding to Site Class C), but Eq. (20.4-1) produces a value of 960 ft/s (corresponding to Site Class D). The Eq. (20.4-1) value is appropriate because the four layers are being represented by one layer with the same wave passage time.

Eq. (20.4-2) is for classifying the site using the average standard penetration resistance blow count, \bar{N} , for cohesionless soils, cohesive soils, and rock in the upper 100 ft (30 m). A method of averaging analogous to the method of Eq. (20.4-1) for shear wave velocity is used. The maximum value of N that may be used for any depth of measurement in soil or rock is 100 blows/ft. For the common situation where rock is encountered, the standard penetration resistance, N , for rock layers is taken as 100.

Eqs. (20.4-3) and (20.4-4) are for classifying the site using the standard penetration resistance of cohesionless soil layers, \bar{N}_{ch} , and the undrained shear strength of cohesive soil layers, \bar{s}_u , within the top 100 ft (30 m). These equations are provided as an alternative to using Eq. (20.4-2) for which N values in all geologic materials in the top 100 ft (30 m) are used. Where using Eqs. (20.4-3) and (20.4-4), only the respective thicknesses of cohesionless soils and cohesive soils within the top 100 ft (30 m) are used.

COMMENTARY TO CHAPTER 21, SITE-SPECIFIC GROUND MOTION PROCEDURES FOR SEISMIC DESIGN

C21.0 GENERAL

Site-specific procedures for computing earthquake ground motions include dynamic site response analyses and probabilistic and deterministic seismic hazard analyses (PSHA and DSHA), which may include dynamic site response analysis as part of the calculation. Use of site-specific procedures may be required in lieu of the general procedure in Sections 11.4.1 through 11.4.6; Section C11.4.7 explains the conditions under which the use of these procedures is required. Such studies must be comprehensive and must incorporate current scientific interpretations. Because there is typically more than one scientifically credible alternative for models and parameter values used to characterize seismic sources and ground motions, it is important to formally incorporate these uncertainties in a site-specific analysis. For example, uncertainties may exist in seismic source location, extent, and geometry; maximum earthquake magnitude; earthquake recurrence rate; ground motion attenuation; local site conditions, including soil layering and dynamic soil properties; and possible two- or three-dimensional wave-propagation effects. The use of peer review for a site-specific ground motion analysis is encouraged.

Site-specific ground motion analysis can consist of one of the following approaches: (a) PSHA and possibly DSHA if the site is near an active fault, (b) PSHA and/or DSHA followed by dynamic site response analysis, and (c) dynamic site response analysis only. The first approach is used to compute ground motions for bedrock or stiff soil conditions (not softer than Site Class D). In this approach, if the site consists of stiff soil overlying bedrock, for example, the analyst has the option of either (a) computing the bedrock motion from the PSHA or DSHA and then using the site coefficient (F_a and F_v) tables in Section 11.4.3 to adjust for the stiff soil overburden or (b) computing the response spectrum at the ground surface directly from the PSHA or DSHA. The latter requires the use of attenuation equations for computing stiff soil-site response spectra (instead of bedrock response spectra).

The second approach is used where softer soils overlie the bedrock or stiff soils. The third approach assumes that a site-specific PSHA or DSHA is not necessary but that a dynamic site response analysis should or must be performed. This analysis requires the definition of an outcrop ground motion, which can be based on the 5% damped response spectrum computed from the PSHA or DSHA or obtained from the general procedure in Section 11.4. A representative set of acceleration time histories is selected and scaled to be compatible with this outcrop spectrum. Dynamic site response analyses using these acceleration histories as input are used to compute motions at the ground surface. The response spectra of these surface motions are used to define a maximum considered earthquake (MCE) ground motion response spectrum.

The approaches described in the aforementioned have advantages and disadvantages. In many cases, user preference governs the selection, but geotechnical conditions at the site may dictate the use of one approach over the other. If bedrock is at a depth much greater than the extent of the site geotechnical investigations, the direct approach of computing the ground surface motion in the PSHA or DSHA may be more reasonable. On the other hand, if bedrock is shallow and a large impedance contrast exists between it and the overlying soil (i.e., density times shear-wave velocity of bedrock is much greater than that of the soil), the two-step approach might be more appropriate.

Use of peak ground acceleration as the anchor for a generalized site-dependent response spectrum is discouraged because sufficiently robust ground motion attenuation relations are available for computing response spectra in western U.S. and eastern U.S. tectonic environments.

C21.1 SITE RESPONSE ANALYSIS

C21.1.1 Base Ground Motions

Ground motion acceleration histories that are representative of horizontal rock motions at the site are required as input to the soil model. Where a site-specific ground motion hazard analysis is not performed, the MCE response spectrum for Site Class B (rock) is defined using the general procedure described in Section 11.4.1. If the model is terminated in material of Site Class A, C, or D, the input MCE response spectrum is adjusted in accordance with Section 11.4.3. The U.S. Geological Survey (USGS) national seismic hazard mapping project website (<http://earthquake.cr.usgs.gov/research/hazmaps/>) includes hazard deaggregation options that can be used to evaluate the predominant types of earthquake sources, magnitudes, and distances contributing to the probabilistic ground motion hazard. Sources of recorded acceleration time histories include the databases of the Consortium of Organizations for Strong Motion Observation Systems (COSMOS) Virtual Data Center website (www.cosmos-eq.org), the Pacific Earthquake Engineering Research Center (PEER) Strong Motion Data Base website (http://peer.berkeley.edu/products/strong_ground_motion_db.html/), and the U.S. National Center for Engineering Strong Motion Data (NCESMD) website (<http://www.strongmotioncenter.org>). Ground motion acceleration histories at these sites generally were recorded at the ground surface and hence apply for an outcropping condition and should be specified as such in the input to the site response analysis code (Kwok et al. 2007 have additional details).

C21.1.2 Site Condition Modeling

Modeling criteria are established by site-specific geotechnical investigations that should include (a) borings with sampling; (b) standard penetration tests (SPTs), cone penetrometer tests (CPTs), and/or other subsurface investigative techniques; and (c) laboratory testing to establish the soil types, properties, and layering. The depth to rock or stiff soil material should be established from these investigations. Investigation should extend to bedrock or, for very deep soil profiles, to material in which the model is terminated. Although it is preferable to measure shear wave velocities in all soil layers, it is also possible to estimate shear wave velocities based on measurements available for similar soils in the local area or through correlations with soil types and properties. A number of such correlations are summarized by Kramer (1996).

Typically, a one-dimensional soil column extending from the ground surface to bedrock is adequate to capture first-order site response characteristics. For very deep soils, the model of the soil columns may extend to very stiff or very dense soils at depth in the column. Two- or three-dimensional models should be considered for critical projects when two- or three-dimensional wave propagation effects may be significant (for example, sloping ground sites). The soil layers in a one-dimensional model are characterized by their total unit weights and shear wave velocities from which low-strain (maximum) shear moduli may be obtained and by relationships defining the nonlinear shear stress–strain behavior of the soils. The required relationships for analysis are often in the form of curves that describe the variation of soil shear modulus with shear strain (modulus reduction curves) and by curves that describe the variation of soil damping with shear strain (damping curves). In a two- or three-dimensional model, compression wave velocities or moduli or Poisson ratios also are required. In an analysis to estimate the effects of liquefaction on soil site response, the nonlinear soil model also must incorporate the buildup of soil pore water pressures and the consequent reductions of soil stiffness and strength. Typically, modulus reduction curves and damping curves are selected on the basis of published relationships for similar soils (for example, Vucetic and Dobry 1991, Electric Power Research Institute 1993, Darendeli 2001, Menq 2003, and Zhang et al. 2005). Site-specific laboratory dynamic tests on soil samples to establish nonlinear soil characteristics can be considered where published relationships are judged to be inadequate for the types of soils present at the site. Shear and compression wave velocities and associated maximum moduli should be selected based on field tests to determine these parameters or, if such tests are not possible, on published relationships and experience for similar soils in the local area. The uncertainty in the selected maximum shear moduli,

modulus reduction and damping curves, and other soil properties should be estimated (Darendeli 2001 and Zhang et al. 2008). Consideration of the range of stiffnesses prescribed in Section 12.13.3 (increasing and decreasing by 50%) is recommended.

C21.1.3 Site Response Analysis and Computed Results

Analytical methods may be equivalently linear or nonlinear. Frequently used computer programs for one-dimensional analysis include the equivalent linear program SHAKE (Schnabel et al. 1972 and Idriss and Sun 1992) and the nonlinear programs FLAC (Itasca 2005); DESRA-2 (Lee and Finn 1978); MARDES (Chang et al. 1991); SUMDES (Li et al. 1992); D-MOD_2 (Matasovic 2006); DEEPSOIL (Hashash and Park 2001); TESS (Pyke 2000); and OpenSees (Ragheb 1994, Parra 1996, and Yang 2000). If the soil response induces large strains in the soil (such as for high acceleration levels and soft soils), nonlinear programs may be preferable to equivalent linear programs. For analysis of liquefaction effects on site response, computer programs that incorporate pore water pressure development (effective stress analyses) should be used (for example, FLAC, DESRA-2, SUMDES, D-MOD, TESS, DEEPSOIL, and OpenSees). Response spectra of output motions at the ground surface are calculated as the ratios of response spectra of ground surface motions to input outcropping rock motions. Typically, an average of the response spectral ratio curves is obtained and multiplied by the input MCE response spectrum to obtain the MCE ground surface response spectrum. Alternatively, the results of site-response analyses can be used as part of the PSHA using procedures described by Goulet et al. (2007) and programmed for use in OpenSHA (www.opensha.org; Field et al. 2005). Sensitivity analyses to evaluate effects of soil-property uncertainties should be conducted and considered in developing the final MCE response spectrum.

C21.2 RISK-TARGETED MAXIMUM CONSIDERED EARTHQUAKE (MCE_R) GROUND MOTION HAZARD ANALYSIS

Site-specific risk-targeted maximum considered earthquake (MCE_R) ground motions are based on separate calculations of site-specific probabilistic and site-specific deterministic ground motions.

Both the probabilistic and deterministic ground motions are defined in terms of 5% damped spectral response in the maximum direction of horizontal response. The maximum direction in the horizontal plane is considered the appropriate ground motion intensity parameter for seismic design using the equivalent lateral force (ELF) procedure of Section 12.8 with the primary intent of avoiding collapse of the structural system.

Most ground motion relations are defined in terms of average (geometric mean) horizontal response. Maximum response in the horizontal plane is greater than average response by an amount that varies with period. Maximum response may be reasonably estimated by factoring average response by period-dependent factors, such as 1.1 at short periods and 1.3 at a period of 1.0 s (Huang et al. 2008). The maximum direction was adopted as the ground motion intensity parameter for use in seismic design in lieu of explicit consideration of directional effects.

C21.2.1 Probabilistic (MCE_R) Ground Motions

Probabilistic seismic hazard analysis (PSHA) methods and subsequent computations of risk-targeted probabilistic ground motions based on the output of PSHA are sufficient to define MCE_R ground motion at all locations except those near highly active faults. Descriptions of current PSHA methods can be found in McGuire (2004). The primary output of PSHA methods is a so-called hazard curve, which provides mean annual frequencies of exceeding various user-specified ground motion amplitudes. Risk-targeted probabilistic ground motions are derived from hazard curves using one (or both for comparison purposes) of the methods described in the following two subsections.

C21.2.1.1 Method 1

The simpler but more approximate method of computing a risk-targeted probabilistic ground motion for each spectral period in a response spectrum is to first interpolate from a site-specific hazard curve the ground motion for a mean annual frequency corresponding to 2% probability of exceedance in 50 years (namely 1/2,475 per year). Then this “uniform-hazard” ground motion is factored by a so-called risk coefficient for the site location that is based on those mapped in Figs. 22-17 and 22-18. Via the method explained in the next subsection, the mapped risk coefficients have been computed from the USGS hazard curves for Site Class B and spectral periods of 0.2 and 1.0 s.

C21.2.1.2 Method 2

The direct method of computing risk-targeted probabilistic ground motions uses the entire site-specific hazard curve that results from PSHA. The computation is detailed in Luco et al. (2007). Summarizing, the hazard curve is combined with a collapse fragility (or probability distribution of the ground motion amplitude that causes collapse) that depends on the risk-targeted probabilistic ground motion itself. The combination quantifies the risk of collapse. Iteratively, the risk-targeted probabilistic ground motion is modified until combination of the corresponding collapse fragility with the hazard curve results in a risk of collapse of 1% in 50 years. This target is based on the average collapse risk across the western United States that is expected to result from design for the probabilistic MCE ground motions in ASCE 7-10.

C21.2.2 Deterministic (MCE_R) Ground Motions

Deterministic ground motions are to be based on characteristic earthquakes on all known active faults in a region. The magnitude of a characteristic earthquake on a given fault should be a best estimate of the maximum magnitude capable for that fault but not less than the largest magnitude that has occurred historically on the fault. The maximum magnitude should be estimated considering all seismic-geologic evidence for the fault, including fault length and paleoseismic observations. For faults characterized as having more than a single segment, the potential for rupture of multiple segments in a single earthquake should be considered in assessing the characteristic maximum magnitude for the fault.

For consistency, the same attenuation equations and ground motion variability used in the PSHA should be used in the deterministic seismic hazard analysis (DSHA). Adjustments for directivity and/or directional effects should also be made, when appropriate. In some cases, ground motion simulation methods may be appropriate for the estimation of long-period motions at sites in deep sedimentary basins or from great ($M \geq 8$) or giant ($M \geq 9$) earthquakes, for which recorded ground motion data are lacking.

C21.2.3 Site-Specific MCE_R

Because of the deterministic lower limit on the MCE_R spectrum (Fig. 21.2-1), the site-specific MCE_R ground motion is equal to the corresponding risk-targeted probabilistic ground motion wherever it is less than the deterministic limit (e.g., 1.5g and 0.6g for 0.2 and 1.0 s, respectively, and Site Class B). Where the probabilistic ground motions are greater than the lower limits, the deterministic ground motions sometimes govern, but only if they are less than their probabilistic counterparts. On the MCE_R ground motion maps in ASCE/SEI 7-10, the deterministic ground motions govern mainly near major faults in California (like the San Andreas) and Nevada. The deterministic ground motions that govern are as small as 40% of their probabilistic counterparts.

C21.3 DESIGN RESPONSE SPECTRUM

Eighty percent of the design response spectrum determined in accordance with Section 11.4.5 was established as the lower limit to prevent the possibility of site-specific studies generating unreasonably low ground motions from potential misapplication of site-specific procedures or misinterpretation or mistakes in the quantification of the basic inputs to these procedures. Even if site-specific studies were correctly performed and resulted in ground motion response spectra less than the 80% lower limit, the uncertainty in

the seismic potential and ground motion attenuation across the United States was recognized in setting this limit. Under these circumstances, the allowance of up to a 20% reduction in the design response spectrum based on site-specific studies was considered reasonable.

C21.4 DESIGN ACCELERATION PARAMETERS

The S_{DS} criteria of Section 21.4 are based on the premise that the value of the parameter S_{DS} should be taken as 90 percent of peak value of site-specific response spectral acceleration regardless of the period (greater than or equal to 0.2 s) at which the peak value of response spectral acceleration occurs. Consideration of periods beyond 0.2 s recognizes that site-specific studies (e.g., softer site conditions) can produce response spectra with ordinates at periods greater than 0.2 s that are significantly greater than those at 0.2 s. Periods less than 0.2 s are excluded for consistency with the 0.2-s period definition of the short-period ground motion parameter, S_s , and recognizing that certain sites (e.g., CEUS sites) could have peak response at very short periods that would be inappropriate for defining the value of the parameter S_{DS} . The upper-bound limit of 5 s precludes unnecessary checking of response at periods that cannot govern the peak value of site-specific response spectral acceleration. Ninety percent (rather than 100 percent) of the peak value of site-specific response spectral acceleration is considered appropriate for defining the parameter S_{DS} (and the domain of constant acceleration) since most short-period structures will have a design period that is not at or near the period of peak response spectral acceleration. Away from the period of peak response, response spectral accelerations will be less and the domain of constant acceleration is adequately described by 90 percent of the peak value. For those short-period structures with a design period at or near the period of peak response spectral acceleration, anticipated yielding of structure during MCE_R ground motions will effectively lengthen the period and shift dynamic response to longer periods at which spectral demand will always be less than that at the peak of the spectrum.

The S_{D1} criteria of Section 21.4 are based on the premise that the value of the parameter S_{D1} should be taken as 100 percent of the peak value of site-specific response spectral acceleration for a period range, $1 \text{ s} \leq T \leq 2 \text{ s}$, for stiffer sites ($v_{s,30} \text{ ft/s} > 1,200 \text{ ft/s}$) similar to the previous requirements of Section 21.4 of ASCE 7-10 and for a period range, $1 \text{ s} \leq T \leq 5 \text{ s}$, for softer sites ($v_{s,30} \text{ ft/s} \leq 1,200 \text{ ft/s}$) which are expected have peak values of response spectral velocity at periods greater than 2 s. The criteria use the maximum value of the product, TS_a , over the period range of interest to effectively identify the period at which the peak value of response spectral velocity occurs. Consideration of periods beyond 1 s accounts for the possibility that the assumed $1/T$ proportionality for the constant velocity portion of the design response spectrum begins at periods greater than 1 second or is actually $1/T^n$ (where $n < 1$). Periods less than 1 s are excluded for consistency with the definition of the 1-second ground motion parameter, S_1 . Peak velocity response is expected to occur at periods less than or equal to 5 s and periods beyond 5 s are excluded by the criteria to avoid potential misuse of very long-period ground motions that may not be reliable. One hundred percent (rather than a reduced percentage) of the peak value of site-specific response spectral acceleration at the period of peak velocity response is considered appropriate for defining the value of the parameter S_{D1} since response spectral accelerations can be approximately proportional to the assumed $1/T$ shape of the domain of constant velocity for design periods of interest.

C21.5 MAXIMUM CONSIDERED EARTHQUAKE GEOMETRIC MEAN (MCE_G) PEAK GROUND ACCELERATION

Site-specific requirements for determination of PGA are provided in a new Section 21.5 that is parallel to the procedures for developing site-specific response spectra in Section 21.2. The site-specific MCE peak ground acceleration, PGA_M , is taken as the lesser of the probabilistic geometric mean peak ground acceleration of Section 21.5.1 and the deterministic geometric mean peak ground acceleration of Section 21.5.2. Similar to the provisions for site-specific spectra, a deterministic lower limit is prescribed for PGA_M with the intent to limit application of deterministic ground motions to the site regions containing active faults where probabilistic ground motions are unreasonably high. However, the deterministic lower limit

for PGA_M (in g) is set at a lower value, $0.5 F_{PGA}$, than the value set for the zero-period response spectral acceleration, $0.6 F_a$. The rationale for the value of the lower deterministic limit for spectra is based on the desire to limit minimum spectral values, for structural design purposes, to the values given by the 1997 Uniform Building Code (UBC) for Zone 4 (multiplied by a factor of 1.5 to adjust to the MCE level). This rationale is not applicable to PGA_M for geotechnical applications, and therefore a lower value of $0.5 F_{PGA}$ was selected. Section 21.5.3 of ASCE 7-10 states that the site-specific MCE peak ground acceleration cannot be less than 80% of PGA_M derived from the PGA maps. The 80% limit is a long-standing base for site-specific analyses in recognition of the uncertainties and limitations associated with the various components of a site-specific evaluation.

REFERENCES

- Chang, C.-Y., Mok, C. M., Power, M. S., and Tang Y. K. (1991). *Analysis of Ground Response at Lotung Large-Scale Soil-Structure Interaction Experiment Site*, Report NP-7306-SL. Electric Power Research Institute, Palo Alto, Calif.
- Darendeli, M. (2001). "Development of a new family of normalized modulus reduction and material damping curves." Ph.D. Dissertation, Department of Civil Engineering, University of Texas, Austin.
- Electric Power Research Institute. (1993). *Guidelines for Determining Design Basis Ground Motions*, Report EPRI TR-102293. EPRI, Palo Alto, Calif.
- Field, E. H., Gupta, N., Gupta, V., Blanpied, M., Maechling, P., and Jordan, T. H. (2005). "Hazard calculations for the WGCEP-2002 forecast using OpenSHA and distributed object technologies." *Seismological Res. Letters*, 76, 161–167.
- Goulet, C. A., Stewart, J. P., Bazzurro, P., and Field, E. H. (2007). "Integration of site-specific ground response analysis results into probabilistic seismic hazard analyses." Paper 1486, *Proceedings of the 4th International Conference on Earthquake Geotechnical Engineering*, Thessaloniki, Greece.
- Hashash, Y. M. A., and Park, D. (2001). "Non-linear one-dimensional seismic ground motion propagation in the Mississippi embayment." *Engrg. Geology*, 62(1–3), 185–206.
- Huang, Y.-N., Whittaker, A. S., and Luco, N. (2008). "Maximum spectral demands in the near-fault region." *Earthquake Spectra*, 24(1), 319–341.
- Idriss, I. M., and Sun, J. I. (1992). *User's Manual for SHAKE91*. Center for Geotechnical Modeling, Department of Civil and Environmental Engineering, University of California, Davis.
- Itasca Consulting Group. (2005). *FLAC, Fast Lagrangian Analysis of Continua*, Version 5.0. Itasca Consulting Group, Minneapolis, Minn.
- Kramer, S. L. (1996). *Geotechnical Earthquake Engineering*, Prentice-Hall.
- Kwok, A. O. L., Stewart, J. P., Hashash, Y. M. A., Matasovic, N., Pyke, R., Wang, Z., and Yang, Z. (2007). "Use of exact solutions of wave propagation problems to guide implementation of nonlinear seismic ground response analysis procedures." *J. Geotech. and Geoenviron. Engrg.*, 133(11), 1385–1398.
- Lee, M. K. W., and Finn, W. D. L. (1978). DESRA-2, Dynamic Effective Stress Response Analysis of Soil Deposits with Energy Transmitting Boundary Including Assessment of Liquefaction Potential, Soil Mechanics Series 36, Department of Civil Engineering, University of British Columbia, Vancouver, Canada.
- Li, X. S., Wang, Z. L., and Shen, C. K. (1992). SUMDES, a Nonlinear Procedure for Response Analysis of Horizontally-Layered Sites Subjected to Multi-Directional Earthquake Loading. Department of Civil Engineering, University of California, Davis.
- Luco, N., Ellingwood, B. R., Hamburger, R. O., Hooper, J. D., Kimball, J. K., and Kircher, C. A. (2007). "Risk-targeted versus current seismic design maps for the conterminous United States." *Proceedings of the SEAOC 76th Annual Convention*. Structural Engineers Association of California, Sacramento, Calif.
- Matasovic, N. (2006). "D-MOD_2—A computer program for seismic response analysis of horizontally layered soil deposits, earthfill dams, and solid waste landfills." *User's Manual*, GeoMotions, LLC, Lacey, Wash., 20 (plus Appendices).
- McGuire, R. K. (2004). *Seismic Hazard and Risk Analysis*, Monograph, MNO-10. Earthquake Engineering Research Institute, Oakland, Calif., 221.
- Menq, F. (2003). "Dynamic properties of sandy and gravelly soils." Ph.D. Dissertation, Department of Civil Engineering, University of Texas, Austin.
- Parra, E. (1996). "Numerical modeling of liquefaction and lateral ground deformation including cyclic mobility and dilation response in soil systems." Ph.D. Dissertation, Department of Civil Engineering, Rensselaer Polytechnic Institute, Troy, N.Y.
- Pyke, R. M. (2000). "TESS: A computer program for nonlinear ground response analyses." TAGA Engineering Systems & Software, Lafayette, Calif.
- Ragheb, A. M. (1994). "Numerical analysis of seismically induced deformations in saturated granular soil strata." Ph.D. Dissertation, Department of Civil Engineering, Rensselaer Polytechnic Institute, Troy, N.Y.

- Schnabel, P. B., Lysmer, J., and Seed, H. B. (1972). *SHAKE: A Computer Program for Earthquake Response Analysis of Horizontally Layered Sites*, Report EERC 72-12, Earthquake Engineering Research Center, University of California, Berkeley.
- Vucetic, M., and Dobry, R. (1991). "Effect of soil plasticity on cyclic response." *J. Geotech. Engrg.*, 117(1), 89–107.
- Yang, Z. (2000). "Numerical modeling of earthquake site response including dilation and liquefaction." Ph.D. Dissertation, Department of Civil Engineering and Engineering Mech., Columbia University, New York.
- Zhang, J., Andrus, R. D., and Juang, C. H. (2005). "Normalized shear modulus and material damping ratio relationships." *J. Geotech. and Geoenviron. Engrg.*, 131(4), 453–464.
- Zhang, J., Andrus, R. D., and Juang, C. H. (2008). "Model uncertainty in normalized shear modulus and damping relationships." *J. Geotech. and Geoenviron. Engrg.*, 134(1), 24–36.

OTHER REFERENCES (NOT CITED)

- Abrahamson, N. A. (2000). "Effects of rupture directivity on probabilistic seismic hazard analysis." *Proceedings of the Sixth International Conference on Seismic Zonation*, Palm Springs, Calif.
- Somerville, P. G., Smith, N. F., Graves, R. W., and Abrahamson, N. A. (1997). "Modification of empirical strong ground motion attenuation relations to include the amplitude and duration effects of rupture directivity." *Seismological Res. Letters*, 68, 199–222.

Page intentionally left blank

COMMENTARY TO CHAPTER 22, SEISMIC GROUND MOTION, LONG-PERIOD TRANSITION AND RISK COEFFICIENT MAPS

Like the 2009 *NEHRP Recommended Seismic Provisions* and ASCE/SEI 7-10, the 2015 *Provisions* continue to use risk-targeted maximum considered earthquake (MCE_R) ground motion contour maps of 0.2 s and 1 s spectral response accelerations (Figures 22-1 through 22-8), maximum considered earthquake geometric mean (MCE_G) peak ground acceleration maps (Figures 22-9 through 22-13), and mapped risk coefficients at 0.2 s and 1 s (Figures 22-18 and 22-19). However, the basis for these mapped values for the conterminous United States (US) has been updated by the US Geological Survey (USGS), as described below. Furthermore, consistent with the site-specific procedures of Section 21.2.1.2 of ASCE/SEI 7-10, but unlike the MCE_R ground motion maps therein (and unlike the site-specific procedures of the 2009 *Provisions*), the logarithmic standard deviation of the collapse fragility used in determining the mapped MCE_R values for the conterminous US has also been updated (from 0.8 to 0.6). Although the 2015 *Provisions* also continue to use mapped long-period transition periods (Figures 22-14 through 22-17), these mapped values have not been updated. Even for the conterminous US, no significant changes are expected to the deaggregation computations that underlie the mapped long-period transition periods in ASCE/SEI 7-10.

The MCE_R ground motion, MCE_G peak ground acceleration, and risk coefficient maps incorporate the latest seismic hazard models developed by the USGS for the United States National Seismic Hazard Maps, including the latest seismic, geologic, and geodetic information on earthquake rates and associated ground shaking.

For the conterminous US, the latest USGS model is documented in Petersen et al. (2013, 2014). This 2014 model supersedes versions released in 1996, 2002, and 2008. The most significant changes for the 2014 model fall into four categories, as follows:

1. For Central and Eastern US (CEUS) sources:
 - Developed a moment magnitude-based earthquake catalog through 2012, replacing the 2008 mb-based catalog;
 - Updated earthquake catalog completeness estimates, catalog of statistical parameters, treatment of non-tectonic seismicity, and treatment of magnitude uncertainty;
 - Updated the distribution for maximum magnitude (M_{max}) for background earthquakes based on a new analysis of global earthquakes in stable continental regions;
 - Updated the zonation for maximum magnitude, keeping the two-zone model that distinguishes craton and margin zones used in previous maps, and added a new four-zone model based on the Central and Eastern US Seismic Source Characterization for Nuclear Facilities Project (CEUS-SSCn, 2012) delineating the craton, Paleozoic margin, Mesozoic margin, and Gulf Coast;
 - Updated the smoothing algorithms for background seismicity, keeping the previous fixed-length Gaussian smoothing model, and adding a nearest-neighbor-type adaptive smoothing model;
 - Updated the New Madrid source model, including fault geometry, recurrence rates of large earthquakes, and alternative magnitudes from M6.6–M8.0 (keeping the highest weight about M7.5);
 - Adapted seismic sources such as Charleston, Wabash, Charlevoix, Commerce lineament, East Rift Margin, Marianna based on the CEUS-SSCn (2012) model; and
 - Updated the treatment of earthquakes that are potentially induced by underground fluid injection.
2. For Intermountain West and Pacific Northwest crustal sources:

- Considered recommendations from the Basin and Range Province Earthquake Working Group on magnitude-frequency distributions for fault sources, smoothing parameters, comparison of historical and modeled seismicity rates, treatment of magnitude uncertainty, assessment of maximum magnitude, modeling of antithetic fault pairs, slip rate uncertainties, and dip uncertainty for normal faults (Lund, 2012);
 - Updated the earthquake catalog and treatment of magnitude uncertainty in rate calculations;
 - Incorporated dips for normal faults of 35°, 50°, and 65° but applied the fault earthquake rate using only the 50° dip to the three alternatives;
 - Updated fault parameters for faults in Utah based on new datasets and models supplied by the Utah Geological Survey and the Working Group on Utah Earthquake Probabilities;
 - Introduced new combined geologic and geodetic inversion models for assessing fault slip rates on fault sources;
 - Implemented new models for Cascadia earthquake-rupture geometries and rates based on onshore (paleotsunami) and offshore (turbidite) studies;
 - Updated the model for deep (intraslab) earthquakes along the coasts of Oregon and Washington, including a new depth distribution for intraslab earthquakes;
 - Allowed for an Mmax up to M8.0 for crustal and intraslab earthquakes; and
 - Added the Tacoma fault source and updated the South Whidbey Island fault source in Washington.
3. For California sources:
- The USGS worked in cooperation with the Southern California Earthquake Center and the State of California to develop a new seismic source model based on the Uniform California Earthquake Rupture Forecast, Version 3 (UCERF3; Working Group on California Earthquake Probabilities, 2013) and new earthquake forecasts for California, which include many more multi-segment ruptures than in previous editions of the maps. These models were developed over the past several years and involved a major update of the methodology for calculating earthquake recurrence.
4. For ground motion models (or “attenuation relations”):
- Included new earthquake ground motion models for active shallow crustal earthquakes (NGA-West2) and subduction zone-related interface and intraslab earthquakes;
 - Adjusted the additional epistemic uncertainty model to account for regional variability and data availability;
 - Updated ground motion prediction equation weights using a new residual analysis based on the Next Generation Attenuation (NGA)-East ground motion database, reevaluated model weights in light of a preliminary Electric Power Research Institute (EPRI) ground motion study, and included newly published ground motion prediction equations for stable continental regions;
 - Incorporated new and evaluated older ground motion models: five equations for the applied for Western US (WUS), nine for the CEUS, and four for the subduction interface and intraslab earthquakes; and
 - Increased the maximum distance from 200 km to 300 km when calculating ground motion from WUS crustal sources.

The 2014 updated National Seismic Hazard Maps differ from the 2008 maps in a variety of ways. The new ground motions vary locally depending on complicated changes in the underlying models. In the CEUS, the new earthquake catalog, completeness models, smoothing algorithms, magnitude uncertainty adjustments, and fault models increase the hazard in some places, and the new ground-motion model-weighting scheme generally lowers the ground motions. The resulting maps for the CEUS can differ by

± 20 percent compared to the 2008 maps due to interactions between the various parts of model summarized in the bullets above. In the Intermountain West region the combined geologic and geodetic inversion models increase the hazard along the Wasatch fault and central Nevada region, but the new NGA-West2 ground motions tend to lower the hazard on the hanging walls of normal faults with respect to the 2008 maps. These counteracting effects can result in complicated patterns of changes. In the Pacific Northwest, the new Cascadia source model causes the hazard to increase by up to 40 percent in the southern Cascadia subduction zone due to the addition of possible M8 and greater earthquakes, but causes the hazard to decrease slightly along the northern Cascadia subduction zone because of reduced earthquake rates relative to the 2008 USGS hazard model. Subduction ground motions from the new models fall off faster with distance than motions in previous models, but they also tend to be higher near fault ruptures. In California, the new UCERF3 model accounts for earthquakes that rupture multiple faults yielding larger magnitudes than applied in the previous model, but with smaller recurrence rates. However, they also include new ground motion models for strike-slip earthquakes, new slip rates from combined geodetic-geologic inversions, new faults, and an adaptive smoothing seismicity model that can locally increase the hazard compared to the previous model. At a specific site, it is important to examine all model changes, documented in Petersen et al. (2013, 2014), to determine why the ground motions may have increased or decreased.

The combined impacts of the updates to the USGS hazard model and to the collapse-fragility logarithmic standard deviation (or “beta value”) on the MCE_R and MCE_G ground motion maps are demonstrated in Tables C22.2 through C22.4, for the same 34 locations considered in the 2009 *Provisions*, listed in Table C22.1. In the tables, the MCE_R (S_S and S_I) and MCE_G (PGA) ground motions from the proposed maps are compared with those from ASCE/SEI 7-10 (and their equivalents from the 1997 Uniform Building Code). Furthermore, the updated site coefficients of these *2015 Provisions* and those of ASCE/SEI 7-10 are applied to the corresponding mapped values, to provide examples of the *design* spectral response accelerations (S_{DS} and S_{DI}) and *site-adjusted* peak ground accelerations (PGA_M) for an undetermined site class (Site Class D in ASCE/SEI 7-10, the worst case of Site Classes C and D in these *2015 Provisions*). Lastly, the seismic design categories (SDC’s) corresponding to the design spectral response accelerations are also compared in the tables.

It is important to bear in mind that the updated S_{DS} , S_{DI} , and PGA_M values in the *2015 Provisions* columns of the tables, and the updated SDC’s, include the approved changes to the site coefficients, an up to 20% increase for an undetermined site class. Nevertheless, from Tables C22.2 and C22.3 it is apparent that the more severe SDC from S_{DS} and S_{DI} does not change for all but two of the 34 locations. The exceptions are the locations in Los Angeles and San Mateo, where the SDC based on S_{DI} (and S_I) alone decreases from E to D. For the Las Vegas location, the SDC based on S_{DS} alone increases from C to D, but the SDC based on S_{DI} was already D in ASCE/SEI 7-10. Close examination of the S_S map reveals a few additional areas where the SDC based on S_{DS} alone increases relative to ASCE/SEI 7-10, most notably:

- In southeastern New Hampshire, central Virginia, and at the border between Tennessee and North Carolina, S_S increases because of (i) inclusion of a widely-used adaptive (as opposed to fixed-length) algorithm for smoothing historical seismicity rates, which increases hazard in areas of clustered historical seismicity, and (ii) changes to historical earthquake magnitudes and their rates based on the Central and Earthquake US Seismic Source Characterization for Nuclear Facilities Project (CEUS-SSCn, 2012), funded by the Department of Energy, the Electric Power Research Institute, and the Nuclear Regulatory Commission.
- In southwestern Oklahoma, S_S increases because of inclusion of a much broader range of potential earthquake magnitudes and rates for the Meers fault, based on (CEUS-SSCn, 2012). At the aforementioned 34 locations, the *2015 Provisions* PGA values of Table C22.4, which have only been impacted by the updates to the USGS National Seismic Hazard Maps (not the updated beta value), are within $\pm 20\%$ of the respective ASCE/SEI 7-10 values, with the exceptions below.

Recall that a 20% decrease is the most allowed when a site-specific hazard analysis is performed in accordance with Chapter 21.

- For the San Diego location, the increase in the PGA value (and S_S value discussed below) is due to a combination of the addition of more offshore faults, the consideration of geodetic (GPS) data, the inclusion of lower-magnitude earthquakes that can contribute significantly to PGA values (and 0.2 s spectral response accelerations), and the increases in the ground motions for large-magnitude earthquakes near strike-slip faults from the updated NGA-West2 attenuation relations.
- For Vallejo, the increase in the PGA value is primarily due to lengthening of the West Napa fault based on the Statewide Community Fault Model (see WGCEP, 2013).
- For Reno, the increase in the PGA value is primarily due to the NGA-West2 attenuation relations. Note that the NGA-West2 attenuation relations are based on double the strong motion data used for the NGA-West1 relations.
- For Las Vegas, the increase in the PGA value (and S_S and S_I values discussed below) is primarily due to an increase in the estimated rate of earthquakes on the Eglington fault, based on recent studies and a recommendation from the State Geologist of Nevada
- For Memphis, the increase in the PGA value is due to consideration of an alternative model for the New Madrid Seismic Zone based on the aforementioned (CEUS-SSCn, 2012).
- For Charleston, the increase in the PGA value (and S_S value discussed below) is due to reevaluation of the data from the Charleston earthquakes and consequent revision of the Charleston seismic source model by (CEUS-SSCn, 2012). The USGS adopted this revised model based on its own analysis, as well as the recommendations of its Steering Committee and participants of a regional workshop. The 2015 Provisions S_S values of Table C22.2 have been impacted by the update to the ASCE/SEI 7-10 beta value (ground motion changes of up to approximately 10%), in addition to the updated USGS National Seismic Hazard Maps. The only locations where the S_S values have changed by more than 20% with respect to ASCE/SEI 7-10 are San Diego, Santa Barbara, Las Vegas, and Charleston. Please see the explanation below of the changes in the USGS National Seismic Hazard Maps at the Santa Barbara location, and the explanations above for the San Diego, Las Vegas, and Charleston locations. For the other locations listed above – Vallejo, Reno, and Memphis – the S_S values have changed by at most 2%.
- For the Santa Barbara location, the decrease in the S_I value is a combination of the decrease in ground motions over reverse faults from the NGA-West2 attenuation relations, and the fact that more multi-fault earthquakes have been allowed in UCERF3 (WGCEP, 2013), relative to the hazard model underlying the ASCE/SEI 7-10 ground motion maps. This, in effect, lowers the rate of earthquakes and hence lowers the probabilistic ground motions. The 2015 Provisions S_I values of Table C22.3 have also been impacted by the update to the ASCE/SEI 7-10 beta value (changes of up to approximately 10%) and the updated USGS National Seismic Hazard Maps. The only locations where the S_I values have changed by more than 20% with respect to ASCE/SEI 7-10 are Irvine, Santa Barbara, and Las Vegas. Please see the explanation below of the changes in the USGS National Seismic Hazard Maps at the Irvine location, and the explanations above for the Santa Barbara and Las Vegas locations. For the other locations listed above – San Diego, Vallejo, Reno, Memphis, and Charleston – the S_I values have changed by at most 13%.
- For the Irvine location, the decrease in the S_I values is due primarily to a decrease in ground motions over reverse faults from the NGA-West2 attenuation relations, and secondarily to the allowance for more multi-fault earthquake in UCERF3 that is described in the preceding bullet.

In summary, with the updates to the USGS National Seismic Hazard maps for the conterminous US and the updated logarithmic standard deviation of the collapse fragilities, i) the seismic design categories for 32 of the 34 Table C22.1 locations do not change with respect to ASCE/SEI 7-10; ii) the PGA values change by -15% to +17% for 28 of the 34 locations; iii) the S_S values change by -19% to +7% for 30 of the locations; and iv) the S_I values change by -17% to +13% for 31 of the locations.

Table C22.1 From the 2009 Provisions, the 34 Locations (Latitudes and Longitudes) for which MCE_R and MCE_G Ground Motions from these 2015 Provisions and ASCE/SEI 7-10 are Compared in Tables C22.2 Through C22.4

It is important to note that these locations are each just one of many in the named cities, and their ground motions may be significantly different than those at other locations in the cities.

Region	City and Location of Site			County or Metropolitan Statistical Area	
	Name	Latitude	Longitude	Name	Population
Southern California	Los Angeles	34.05	-118.25	Los Angeles	9,948,081
Southern California	Century City	34.05	-118.40		
Southern California	Northridge	34.20	-118.55		
Southern California	Long Beach	33.80	-118.20		
Southern California	Irvine	33.65	-117.80	Orange	3,002,048
Southern California	Riverside	33.95	-117.40	Riverside	2,026,803
Southern California	San Bernardino	34.10	-117.30	San Bernardino	1,999,332
Southern California	San Luis Obispo	35.30	-120.65	San Luis Obispo	257,005
Southern California	San Diego	32.70	-117.15	San Diego	2,941,454
Southern California	Santa Barbara	34.45	-119.70	Santa Barbara	400,335
Southern California	Ventura	34.30	-119.30	Ventura	799,720
Southern California	Total Population - S. California		22,349,098	Population - 8 Counties	21,374,778
Northern California	Oakland	37.80	-122.25	Alameda	1,502,759
Northern California	Concord	37.95	-122.00	Contra Costa	955,810
Northern California	Monterey	36.60	-121.90	Monterey	421,333
Northern California	Sacramento	38.60	-121.50	Sacramento	1,233,449
Northern California	San Francisco	37.75	-122.40	San Francisco	776,733
Northern California	San Mateo	37.55	-122.30	San Mateo	741,444
Northern California	San Jose	37.35	-121.90	Santa Clara	1,802,328
Northern California	Santa Cruz	36.95	-122.05	Santa Cruz	275,359
Northern California	Vallejo	38.10	-122.25	Solano	423,473
Northern California	Santa Rosa	38.45	-122.70	Sonoma	489,290
Northern California	Total Population - N. California		14,108,451	Population - 10 Counties	8,621,978
Pacific Northwest	Seattle	47.60	-122.30	King WA	1,826,732
Pacific Northwest	Tacoma	47.25	-122.45	Pierce WA	766,878
Pacific Northwest	Everett	48.00	-122.20	Snohomish WA	669,887
Pacific Northwest	Portland	45.50	-122.65	Portland Metro OR (3)	1,523,690
Pacific Northwest	Total Population - OR and WA		10,096,556	Population - 6 Counties	4,787,187
Other WUS	Salt Lake City	40.75	-111.90	Salt Lake UT	978,701
Other WUS	Boise	43.60	-116.20	Ada/Canyon ID (2)	532,337
Other WUS	Reno	39.55	-119.80	Washoe NV	396,428
Other WUS	Las Vegas	36.20	-115.15	Clarke NV	1,777,539
Other WUS	Total Population - ID/UT/NV		6,512,057	Population - 5 Counties	3,685,005
CEUS	St. Louis	38.60	-90.20	St. Louis MSA (16)	2,786,728
CEUS	Memphis	35.15	-90.05	Memphis MSA (8)	1,269,108
CEUS	Charleston	32.80	-79.95	Charleston MSA (3)	603,178
CEUS	Chicago	41.85	-87.65	Chicago MSA (7)	9,505,748
CEUS	New York	40.75	-74.00	New York MSA (23)	18,747,320
CEUS	Total Population - MO/TN/SC/IL/NY		48,340,918	Population - 57 Counties	32,912,082

Table C22.2 A Comparison of the Short-Period MCE_R Spectral Response Accelerations (S_S values) from these 2015 Provisions and ASCE/SEI 7-10 (and their Equivalents from the 1997 Uniform Building Code), for the 34 Locations Listed in Table C22.1

It is important to bear in mind that the design spectral response accelerations (SDS values) and the seismic design categories in the table include the impacts of the updated site coefficients of these 2015 Provisions.

Region	Location Name	1997 UBC		ASCE/SEI 7-10			2015 Provisions		
		Zone	$2.5 \cdot C_a$	S_s (g)	S_{DS} (g) *	SDC_s ***	S_s (g)	S_{DS} (g) **	SDC_s ***
Southern California	Los Angeles	4	1.10	2.40	1.60	D	1.97	1.58	D
Southern California	Century City	4 (NF)	1.32	2.16	1.44	D	2.11	1.69	D
Southern California	Northridge	4	1.10	1.69	1.13	D	1.74	1.39	D
Southern California	Long Beach	4 (NF)	1.43	1.64	1.10	D	1.68	1.35	D
Southern California	Irvine	4	1.10	1.55	1.03	D	1.25	1.00	D
Southern California	Riverside	4	1.10	1.50	1.00	D	1.50	1.20	D
Southern California	San Bernardino	4 (NF)	1.32	2.37	1.58	D	2.33	1.86	D
Southern California	San Luis Obispo	4	1.10	1.12	0.78	D	1.09	0.87	D
Southern California	San Diego	4 (NF)	1.43	1.25	0.84	D	1.58	1.26	D
Southern California	Santa Barbara	4 (NF)	1.43	2.83	1.89	D	2.12	1.70	D
Southern California	Ventura	4 (NF)	1.43	2.38	1.59	D	2.02	1.62	D
Southern California	Weighted Mean		1.25	1.83	1.22		1.75	1.40	
Northern California	Oakland	4 (NF)	1.43	1.86	1.24	D	1.88	1.51	D
Northern California	Concord	4	1.10	2.08	1.38	D	2.22	1.78	D
Northern California	Monterey	4	1.10	1.53	1.02	D	1.33	1.06	D
Northern California	Sacramento	3	0.90	0.67	0.57	D	0.57	0.51	D
Northern California	San Francisco	4	1.10	1.50	1.00	D	1.50	1.20	D
Northern California	San Mateo	4 (NF)	1.28	1.85	1.23	D	1.80	1.44	D
Northern California	San Jose	4	1.10	1.50	1.00	D	1.50	1.20	D
Northern California	Santa Cruz	4	1.10	1.52	1.01	D	1.59	1.27	D
Northern California	Vallejo	4 (NF)	1.19	1.50	1.00	D	1.50	1.20	D
Northern California	Santa Rosa	4 (NF)	1.65	2.51	1.67	D	2.41	1.93	D
Northern California	Weighted Mean		1.18	1.60	1.08		1.59	1.28	
Pacific Northwest	Seattle			1.36	0.91	D	1.40	1.12	D
Pacific Northwest	Tacoma			1.30	0.86	D	1.36	1.08	D
Pacific Northwest	Everett			1.27	0.85	D	1.20	0.96	D
Pacific Northwest	Portland			0.98	0.72	D	0.89	0.71	D
Pacific Northwest	Weighted Mean			1.22	0.83		1.20	0.96	
Other WUS	Salt Lake City			1.54	1.03	D	1.54	1.24	D
Other WUS	Boise			0.31	0.32	B	0.31	0.32	B
Other WUS	Reno			1.50	1.00	D	1.47	1.17	D
Other WUS	Las Vegas			0.49	0.46	C	0.65	0.55	D
Other WUS	Weighted Mean			0.85	0.65		0.92	0.77	
CEUS	St. Louis			0.44	0.42	C	0.46	0.44	C
CEUS	Memphis			1.01	0.74	D	1.02	0.82	D
CEUS	Charleston			1.15	0.80	D	1.42	1.13	D
CEUS	Chicago			0.13	0.14	A	0.12	0.13	A
CEUS	New York			0.28	0.29	B	0.29	0.30	B
CEUS	Weighted Mean			0.30	0.29		0.30	0.30	

* The ASCE/SEI 7-10 SDS values are calculated using the ASCE/SEI 7-10 F_a site coefficients, for an undetermined site class (assigned Site Class D in ASCE/SEI 7-10).

** The 2015 Provisions SDS values are calculated using the updated 2015 Provisions F_a site coefficients, also for an undetermined site class (assigned the worst case of Site Classes C and D in the 2015 Provisions).

*** The SDCs categories corresponding to the SD1 values (and Risk Category I/II/III) are assigned using Table 11.6-1 (of ASCE/SEI 7-10) alone.

Table C22.3 A Comparison of the 1.0-Second MCE_R Spectral Response Accelerations (S_1 values) from these 2015 Provisions and ASCE/SEI 7-10 (and their Equivalents from the 1997 Uniform Building Code), for the 34 Locations Listed in Table C22.1

It is important to bear in mind that the design spectral response accelerations (SD_1 values) and the seismic design categories in the table include the impacts of the updated site coefficients of these 2015 Provisions.

Region	Location Name	1997 UBC		ASCE/SEI 7-10			2015 Provisions		
		Zone	$2.5 \cdot C_a$	S_1 (g)	SD_1 (g) *	SDC_1 ***	S_1 (g)	SD_1 (g) **	SDC_1 ***
Southern California	Los Angeles	4 (NF)	0.72	0.84	0.84	E	0.70	0.79	D
Southern California	Century City	4 (NF)	0.93	0.80	0.80	E	0.75	0.85	E
Southern California	Northridge	4	0.64	0.60	0.60	D	0.60	0.68	D
Southern California	Long Beach	4 (NF)	1.02	0.62	0.62	D	0.61	0.69	D
Southern California	Irvine	4	0.64	0.57	0.57	D	0.45	0.55	D
Southern California	Riverside	4	0.64	0.60	0.60	D	0.58	0.67	D
Southern California	San Bernardino	4 (NF)	0.93	1.08	1.08	E	0.93	1.06	E
Southern California	San Luis Obispo	4 (NF)	0.77	0.43	0.45	D	0.40	0.51	D
Southern California	San Diego	4 (NF)	1.02	0.48	0.49	D	0.53	0.62	D
Southern California	Santa Barbara	4 (NF)	1.02	0.99	0.99	E	0.77	0.88	E
Southern California	Ventura	4 (NF)	1.02	0.90	0.90	E	0.76	0.86	E
Southern California	Weighted Mean		0.83	0.70	0.70		0.63	0.73	
Northern California	Oakland	4 (NF)	1.04	0.75	0.75	D	0.72	0.81	D
Northern California	Concord	4 (NF)	0.77	0.73	0.73	D	0.67	0.76	D
Northern California	Monterey	4 (NF)	0.77	0.56	0.56	D	0.50	0.60	D
Northern California	Sacramento	3	0.54	0.29	0.35	D	0.25	0.35	D
Northern California	San Francisco	4 (NF)	0.74	0.64	0.64	D	0.60	0.68	D
Northern California	San Mateo	4 (NF)	0.95	0.86	0.86	E	0.74	0.83	D
Northern California	San Jose	4 (NF)	0.69	0.60	0.60	D	0.60	0.68	D
Northern California	Santa Cruz	4 (NF)	0.72	0.60	0.60	D	0.60	0.68	D
Northern California	Vallejo	4 (NF)	0.87	0.60	0.60	D	0.60	0.68	D
Northern California	Santa Rosa	4 (NF)	1.28	1.04	1.04	E	0.94	1.06	E
Northern California	Weighted Mean		0.81	0.65	0.65		0.61	0.70	
Pacific Northwest	Seattle			0.53	0.53	D	0.49	0.59	D
Pacific Northwest	Tacoma			0.51	0.51	D	0.47	0.57	D
Pacific Northwest	Everett			0.48	0.49	D	0.43	0.53	D
Pacific Northwest	Portland			0.42	0.44	D	0.39	0.50	D
Pacific Northwest	Weighted Mean			0.48	0.49		0.45	0.55	
Other WUS	Salt Lake City			0.56	0.56	D	0.55	0.65	D
Other WUS	Boise			0.11	0.17	C	0.11	0.17	C
Other WUS	Reno			0.52	0.52	D	0.52	0.61	D
Other WUS	Las Vegas			0.17	0.24	D	0.21	0.30	D
Other WUS	Weighted Mean			0.30	0.34		0.32	0.41	
CEUS	St. Louis			0.17	0.24	D	0.16	0.25	D
CEUS	Memphis			0.35	0.40	D	0.35	0.45	D
CEUS	Charleston			0.37	0.41	D	0.41	0.52	D
CEUS	Chicago			0.06	0.10	B	0.06	0.10	B
CEUS	New York			0.07	0.11	B	0.06	0.10	B
CEUS	Weighted Mean			0.09	0.14		0.09	0.13	

* The ASCE/SEI 7-10 SD_1 values are calculated using the ASCE/SEI 7-10 F_v site coefficients, for an undetermined site class (assigned Site Class D in ASCE/SEI 7-10).

** The 2015 Provisions SD_1 values are calculated using the updated 2015 Provisions F_v site coefficients, also for an undetermined site class (assigned the worst case of Site Classes C and D in the 2015 Provisions).

*** The SDC_1 categories corresponding to the SD_1 values (and Risk Category I/II/III) are assigned using Table 11.6-2 (of ASCE/SEI 7-10) alone.

Table C22.4 A Comparison of the MCE_G Peak Ground Accelerations (PGA values) from these 2015 Provisions and ASCE/SEI 7-10, for the 34 Locations Listed in Table C22.1

It is important to bear in mind that the site-adjusted peak ground accelerations (PGAM values) in the table include the impacts of the updated site coefficients of these 2015 Provisions. The footnotes of the table contain additional details.

Region	Location Name	ASCE/SEI 7-10		2015 Provisions	
		PGA (g)	PGAM (g) *	PGA (g)	PGAM (g) **
Southern California	Los Angeles	0.91	0.91	0.84	1.01
Southern California	Century City	0.81	0.81	0.91	1.09
Southern California	Northridge	0.62	0.62	0.71	0.86
Southern California	Long Beach	0.64	0.64	0.74	0.89
Southern California	Irvine	0.60	0.60	0.53	0.63
Southern California	Riverside	0.50	0.50	0.50	0.60
Southern California	San Bernardino	0.91	0.91	0.98	1.18
Southern California	San Luis Obispo	0.44	0.47	0.48	0.58
Southern California	San Diego	0.57	0.57	0.72	0.86
Southern California	Santa Barbara	1.09	1.09	0.93	1.11
Southern California	Ventura	0.91	0.91	0.88	1.06
Southern California	Weighted Mean	0.70	0.70	0.74	0.89
Northern California	Oakland	0.72	0.72	0.79	0.95
Northern California	Concord	0.79	0.79	0.90	1.07
Northern California	Monterey	0.59	0.59	0.58	0.69
Northern California	Sacramento	0.23	0.31	0.24	0.32
Northern California	San Francisco	0.57	0.57	0.58	0.70
Northern California	San Mateo	0.73	0.73	0.78	0.93
Northern California	San Jose	0.50	0.50	0.57	0.69
Northern California	Santa Cruz	0.59	0.59	0.67	0.81
Northern California	Vallejo	0.51	0.51	0.62	0.74
Northern California	Santa Rosa	0.97	0.97	1.02	1.22
Northern California	Weighted Mean	0.59	0.60	0.65	0.78
Pacific Northwest	Seattle	0.56	0.56	0.60	0.72
Pacific Northwest	Tacoma	0.50	0.50	0.50	0.60
Pacific Northwest	Everett	0.52	0.52	0.51	0.62
Pacific Northwest	Portland	0.42	0.46	0.40	0.48
Pacific Northwest	Weighted Mean	0.50	0.51	0.51	0.61
Other WUS	Salt Lake City	0.67	0.67	0.70	0.84
Other WUS	Boise	0.12	0.19	0.14	0.21
Other WUS	Reno	0.50	0.50	0.62	0.74
Other WUS	Las Vegas	0.20	0.28	0.28	0.37
Other WUS	Weighted Mean	0.34	0.39	0.41	0.51
CEUS	St. Louis	0.23	0.31	0.27	0.36
CEUS	Memphis	0.50	0.50	0.61	0.73
CEUS	Charleston	0.75	0.75	0.93	1.12
CEUS	Chicago	0.07	0.11	0.06	0.09
CEUS	New York	0.17	0.25	0.18	0.26
CEUS	Weighted Mean	0.17	0.23	0.18	0.25

* The ASCE/SEI 7-10 PGAM values are calculated using the ASCE/SEI 7-10 FPGA site coefficients, for an undetermined site class (assigned Site Class D in ASCE/SEI 7-10).

** The 2015 Provisions PGAM values are calculated using the updated 2015 Provisions FPGA site coefficients, also for an undetermined site class (assigned the worst case of Site Classes C and D in the 2015 Provisions).

Like previous versions of the USGS national seismic hazard model, the 2014 model purposefully excludes swarms of earthquakes that may be casually related to industrial fluid processes such as hydrocarbon production or wastewater disposal. The excluded swarms are identified in Figure 15 of Petersen et al. (2014). Whereas an average of 21 earthquakes per year of magnitude greater than three occurred from 1967 to 2000 in the CEUS, more than 300 such earthquakes have occurred from 2010 through 2012. Thus, in the areas of the excluded swarms, the seismic hazard might be higher than that estimated by the 2014 USGS model; on the other hand, it could decrease significantly in the coming years with changes in the fluid processes. Treatment of the potentially-induced earthquake swarms in hazard modeling is a topic of active research.

In 2012, the USGS developed seismic hazard models for Guam and the Northern Mariana Islands (Guam/NMI) and for American Samoa using the same type of seismic hazard analysis that underlies the 2008 model for the conterminous US. The hazard models for the islands are documented in Mueller et al. (2012) and Petersen et al. (2012), respectively. In comparing the MCE_R ground motion maps derived from these USGS hazard models to the geographically-constant values stipulated for Guam and American Samoa (Tutuila) in the 2010 and previous editions of ASCE/SEI 7, it is important to bear in mind that the latter were not computed via seismic hazard modeling. According to the commentary of the *1997 Provisions*, the geographically-constant values were merely conversions, via rough approximations, from values on the *1994 Provisions* maps that had been in use for nearly 20 years. As such, they did not take into account the 1993 Guam earthquake that was the largest ever recorded in the region and caused considerable damage, the 2009 earthquake near American Samoa that caused a tsunami, nor the 2008 “Next Generation Attenuation (NGA)” and another 2006 empirical ground motion prediction equation that have now been used for both Guam/NMI and American Samoa. This and other such information is directly used in the seismic hazard modeling that is the basis for the MCE_R ground motion, MCE_G peak ground acceleration, and risk coefficient maps for Guam/NMI and American Samoa in these *2015 Provisions*.

RISK-TARGETED MAXIMUM CONSIDERED EARTHQUAKE (MCE_R) GROUND MOTION MAPS

As introduced in the 2009 *Provisions* and ASCE/SEI 7-10, the MCE_R ground motion maps are derived from underlying USGS seismic hazard models in a manner that is significantly different from that of the mapped values of MCE ground motions in previous editions of the *Provisions* and ASCE/SEI 7. These differences include use of (1) probabilistic ground motions that are risk-targeted, rather than uniform-hazard, (2) deterministic ground motions that are based on the 84th percentile (approximately 1.8 times median), rather than 1.5 times median response spectral acceleration for sites near active faults, and (3) ground motion intensity that is based on maximum, rather than the average (geometrical mean), response spectra acceleration in the horizontal plane.

The MCE_R ground motion maps have been prepared in accordance with the site-specific procedures of Section 21.2. More specifically, they represent the lesser of probabilistic ground motions defined in Section 21.2.1 and deterministic ground motions defined in Section 21.2.2, in accordance Section 21.2.3. The preparation of the probabilistic and deterministic ground motions is described below.

The probabilistic ground motions have been calculated using Method 2 of Section 21.2.1 and the latest USGS hazard curves (of mean annual frequency of exceedance versus ground motion level) computed in accordance with Section 21.2 at gridded locations covering the US and its territories. The USGS hazard curves are first converted from geometric-mean ground motions (output by the ground motion attenuation relations available to the USGS) to ground motions in the maximum direction of horizontal spectral response acceleration, with one exception. The USGS hazard curves for Hawaii, without conversion, are deemed to represent the maximum-response ground motions, due to the attenuation relations applied there. For the other regions, the conversions were done by applying the factors specified in the site-specific procedures (Section 21.2) of ASCE/SEI 7-10, namely 1.1 at 0.2 s and 1.3 at 1.0 s. The collapse fragilities used in calculating the probabilistic ground motions have a logarithmic standard deviation (or “beta value”)

of 0.6, as specified in ASCE/SEI 7-10 (Section 21.2.1), for the conterminous US, Guam and the Northern Mariana Islands, and American Samoa. For the other regions (Hawaii, Puerto Rico and the US Virgin Islands, and Alaska), where the latest USGS hazard curves pre-date the change of the logarithmic standard deviation from the 2009 *Provisions* to ASCE/SEI 7-10, the beta value is 0.8. Please see (Luco et al., 2007) for more information on the development of risk-targeted probabilistic ground motions.

The deterministic ground motions have been calculated using the “characteristic earthquakes on all known active faults” (quoted from Section 21.2.2) that the USGS uses in computing the probabilistic hazard curves. The largest characteristic magnitude considered by the USGS on each fault, excluding any lower-weighted magnitudes from the USGS logic tree for epistemic uncertainty, is used for the deterministic ground motions. The active faults considered for the deterministic ground motions are those that have evidence of slip during Holocene time (the past 12,000 years, approximately), plus those with reported geologic rates of slip larger than 0.1 mm/year. This slip rate can result in a magnitude 7 earthquake, which on average corresponds to 1.2 meter of slip (Wells and Coppersmith, 1994), over a 12,000-year time period; it (0.1 mm/year) also is the slip rate assigned by the Working Group on California Earthquake Probabilities (WGCEP, 2013) to faults that, with the information available, could only be categorized as having a slip rate less than 0.2 mm/year. At a user-inputted location, the fault (among hundreds) and corresponding magnitude that govern its deterministic ground motion is outputted by the USGS web tool briefly described in a section of this commentary below. For all the deterministic faults and magnitudes, the USGS has computed median (50th percentile), geometric-mean ground motions. To convert to maximum-response ground motions, the same scale factors described in the preceding paragraph for probabilistic ground motions are applied. To approximately convert to 84th percentile ground motions, the maximum-response ground motions are multiplied by 1.8.

MAXIMUM CONSIDERED EARTHQUAKE GEOMETRIC MEAN (MCE_G) PGA MAPS

Like the 2009 *Provisions* and ASCE/SEI 7-10, but not previous editions, the 2015 *Provisions* include contour maps of maximum considered earthquake geometric mean (MCE_G) peak ground acceleration, PGA, Figures 22-9 through 22-13, for use in geotechnical investigations (Section 11.8.3). In contrast to the MCE_R ground motion maps, the maps of MCE_G PGA are defined in terms of geometric mean (rather than maximum direction) intensity and a 2 percent in 50-year hazard level (rather than 1 percent in 50-year risk). Like the MCE_R ground motion maps, the maps of MCE_G PGA are governed near major active faults by deterministic values defined as 84th-percentile ground motions. The MCE_G PGA maps have been prepared in accordance with the site-specific procedures of Section 21.5 of these 2015 *Provisions*.

LONG-PERIOD TRANSITION MAPS

The maps of the long-period transition period, T_L , (Figures 22-14 through 22-17) were introduced in ASCE/SEI 7-05. They were prepared by the USGS in response to BSSC recommendations and subsequently included in the 2003 edition of the *Provisions*. See Section C11.4.5 for a discussion of the technical basis of these maps. The value of T_L obtained from these maps is used in Equation 11.4-7 to determine values of S_a for periods greater than T_L .

The exception in Section 15.7.6.1, regarding the calculation of S_{ac} , the convective response spectral acceleration for tank response, is intended to provide the user the option of computing this acceleration with three different types of site-specific procedures: (a) the procedures in Chapter 21, provided they cover the natural period band containing T_c , the fundamental convective period of the tank-fluid system, (b) ground-motion simulation methods using seismological models, and (c) analysis of representative accelerogram data. Elaboration of these procedures is provided below.

With regard to the first procedure, attenuation equations have been developed for the western United States (Next Generation Attenuation, e.g., Power et al., 2008) and for the central and eastern United States (e.g., Somerville et al., 2001) that cover the period band, 0 to 10 seconds. Thus, for $T_c \leq 10$ seconds, the

fundamental convective period range for nearly all storage tanks, these attenuation equations can be used in the same PSHA/DSHA procedures described in Chapter 21 to compute $S_a(T_c)$. The 1.5 factor in Equation 15.7-11, which converts a 5 percent damped spectral acceleration to a 0.5 percent damped value, could then be applied to obtain S_{ac} . Alternatively, this factor could be established by statistical analysis of 0.5 percent damped and 5 percent damped response spectra of accelerograms representative of the ground motion expected at the site.

In some regions of the United States, such as Pacific Northwest and southern Alaska, where subduction-zone earthquakes dominate the ground-motion hazard, attenuation equations for these events only extend to periods between 3 and 5 s, depending on the equation. Thus, for tanks with T_c greater than these periods, other site-specific methods are required.

The second site-specific method to obtain S_a at long periods is simulation through the use of seismological models of fault rupture and wave propagation (e.g., Graves and Pitarka, 2004; Hartzell and Heaton, 1983; Hartzell et al., 1999; Liu et al., 2006; Zeng et al., 1994). These models could range from simple seismic source-theory and wave-propagation models, which currently form the basis for many of the attenuation equations used in the central and eastern United States for example, to more complex numerical models that incorporate finite fault rupture for scenario earthquakes and seismic wave propagation through 2-D or 3-D models of the regional geology, which may include basins. These models are particularly attractive for computing long-period ground motions from great earthquakes ($M_w \geq \sim 8$) because ground-motion data are limited for these events. Furthermore, the models are more accurate for predicting longer-period ground motions because: (a) seismographic recordings may be used to calibrate these models and (b) the general nature of the 2-D or 3-D regional geology is typically fairly well resolved at these periods and can be much simpler than would be required for accurate prediction of shorter period motions.

A third site-specific method is the analysis of the response spectra of representative accelerograms that have accurately recorded long-period motions to periods greater than T_c . As T_c increases, the number of qualified records decreases. However, as digital accelerographs continue to replace analog accelerographs, more recordings with accurate long-period motions will become available. Nevertheless, a number of analog and digital recordings of large and great earthquakes are available that have accurate long-period motions to 8 seconds and beyond. Subsets of these records, representative of the earthquake(s) controlling the ground-motion hazard at a site, can be selected. The 0.5 percent damped response spectra of the records can be scaled using seismic source theory to adjust them to the magnitude and distance of the controlling earthquake. The levels of the scaled response spectra at periods around T_c can be used to determine S_{ac} . If the subset of representative records is limited, then this method should be used in conjunction with the aforementioned simulation methods.

RISK COEFFICIENT MAPS

Like those in the 2009 *Provisions* and ASCE/SEI 7-10 (where they were introduced), the risk coefficient maps in these 2015 *Provisions* (Figures 22-18 and 22-19) provide factors, C_{RS} and C_{RI} , that are used in the site-specific procedures of Chapter 21 (Section 21.2.1.1 Method 1). These factors are implicit in the MCE_R ground motion maps.

The mapped risk coefficients are the ratios of i) risk-targeted probabilistic ground motions (for 1%-in-50-years collapse risk) derived from the USGS probabilistic seismic hazard curves, as described in the MCE_R ground motion maps section above, to ii) corresponding uniform-hazard (2%-in-50-years ground motion exceedance probability) ground motions that are simply interpolated from the USGS hazard curves. Note that these ratios (risk coefficients) are invariant to maximum-response scale factors that are applied to both the numerator and denominator.

GROUND MOTIONS WEB TOOL

The USGS has developed a companion web tool that calculates location-specific spectral values based on latitude and longitude. The calculated values are based on the gridded values used to prepare the maps. The spectral values can be adjusted for Site Class effects within the program using the Site Classification Procedure in Section 20.1 and the site coefficients in Sections 11.4 and 11.8. The companion tool may be accessed at a USGS website (<http://earthquake.usgs.gov/hazards/designmaps/>) or through the SEI website at <http://content.seinstitute.org>. The software tool should be used to establish spectral values for design because the maps found in this chapter are too small to provide accurate spectral values for many sites.

UNIFORM-HAZARD AND DETERMINISTIC GROUND MOTION MAPS

Implicit in the MCE_R ground motion, MCE_G PGA, and risk coefficient maps provided in this chapter are uniform-hazard (2%-in-50-years ground motion exceedance probability) and deterministic (84th percentile) ground motions. The 2009 Provisions provided maps of such uniform-hazard and deterministic ground motions, but ASCE/SEI 7-10 and these 2015 Provisions do not. Instead, uniform-hazard and deterministic ground motion maps consistent with this chapter are provided via a USGS website (<http://earthquake.usgs.gov/hazards/designmaps/>). Furthermore, values from these maps can be obtained via the ground motion software tool previously described.

It is important to note that the provided uniform-hazard ground motion maps are for maximum direction of horizontal spectral response acceleration. As such, they are different than the maps of geometric mean spectral response acceleration provided on other USGS websites (e.g., <http://earthquake.usgs.gov/hazards/products/>). The provided deterministic ground motion maps are also for the maximum direction, but no geometric mean counterparts are provided on USGS websites. The USGS prepares the deterministic ground motion maps solely for the development of MCE_R and MCE_G ground motion maps, following the definition of deterministic ground motions in Section 21.2.2 (with the 84th percentile approximated as 1.8 times the median).

REFERENCES

- Building Seismic Safety Council. 2009. "NEHRP Recommended Seismic Provisions for New Buildings and Other Structures: Part 1, Provisions," FEMA P-750.
- CEUS-SSCn. 2012. Central and Eastern United States seismic source characterization for nuclear facilities: Electric Power Research Institute, US Department of Energy, and US Nuclear Regulatory Commission.
- Graves, R. W., and A. Pitarka. 2004. "Broadband Time History Simulation using a Hybrid Approach," Paper 1098 in *Proceedings of the 13th World Conference on Earthquake Engineering*, Vancouver, Canada.
- Hartzell, S., and T. Heaton. 1983. "Inversion of Strong Ground Motion and Teleseismic Waveform Data for the Fault Rupture History of the 1979 Imperial Valley, California Earthquake," *Bulletin of the Seismological Society of America*, 73:1553-1583.
- Hartzell, S., S. Harmsen, A. Frankel, and S. Larsen. 1999. "Calculation of Broadband Time Histories of Ground Motion: Comparison of Methods and Validation Using Strong Ground Motion from the 1994 Northridge Earthquake," *Bulletin of the Seismological Society of America*, 89:1484-1504.
- Liu, P., R. J. Archuleta, and S. H. Hartzell. 2006. "Prediction of Broadband Ground-Motion Time Histories: Hybrid Low/High-Frequency Method with Correlated Random Source Parameters," *Bulletin of the Seismological Society of America*, 96:2118-2130.
- Luco, N. B.R. Ellingwood, R.O. Hamburger, J.D. Hooper, J.K. Kimball, and C.A. Kircher. 2007. "Risk-Targeted versus Current Seismic Design Maps for the Conterminous United States," in *Proceedings of the SEAOC 76th Annual Convention*. Structural Engineers Association of California, Sacramento, California.
- Lund, W.R., ed. 2012. Basin and Range Province Earthquake Working Group II—Recommendations to the U.S. Geological Survey National Seismic Hazard Mapping Program for the 2014 update of the National Seismic Hazard Maps: Utah Geological Survey Open-File Report 591, 16 p.
- Mueller, C. S., K. M. Haller, N. Luco, M. D. Petersen, and A. D. Frankel. 2012. "Seismic Hazard Assessment for Guam and the Northern Mariana Islands," USGS Open File Report 2012-1015. USGS, Golden, Colorado.
- Petersen, M.D., Moschetti, M.P., Powers, P.M., Mueller, C.S., Haller, K.M., Frankel, A.D., Zeng, Y., Rezaeian, S., Harmsen, S.C., Boyd, O.L., Field, E.H., Chen, R., Rukstales, K.S., Luco, N., Wheeler, R.L., Williams, R.A., and Olsen, A.H. 2013.

- “Documentation for the 2014 Update of the United States National Seismic Hazard Maps,” USGS Administrative Report prepared for the Building Seismic Safety Council.
- Petersen, M.D., and others. 2014. “Documentation for the 2014 Update of the United States National Seismic Hazard Maps,” USGS Open File Report 2014-1091.
- Petersen, M. D., S. C. Harmsen, K. S. Rukstales, C. S. Mueller, D. E. McNamara, N. Luco, and M. Walling. 2012. “Seismic Hazard of American Samoa and Neighboring South Pacific Islands: Data, Methods, Parameters, and Results,” USGS Open File Report 2008-1087. USGS, Golden, Colorado.
- Power, M., B. Chiou, N. Abrahamson, Y. Bozorgnia, T. Shantz, and C. Roblee. 2008. “An Overview of the NGA Project,” *Earthquake Spectra Special Issue on the Next Generation of Ground Motion Attenuation (NGA) Project.* Earthquake Engineering Research Institute, March.
- Somerville, P. G., N. Collins, N. Abrahamson, R. Graves, and C. Saikia. 2001. *Earthquake Source Scaling and Ground Motion Attenuation Relations for the Central and Eastern United States*, Final Report to the USGS under Contract 99HQGR0098.
- Working Group on California Earthquake Probabilities (Field, E. H., Biasi, G. P., Bird, P., Dawson, T. E., Felzer, K. R., Jackson, D. D., Johnson, K. M., Jordan, T. H., Madden, C., Michael, A. J., Milner, K. R., Page, M. T., Parsons, T., Powers, P. M., Shaw, B. E., Thatcher, W. R., Weldon, R. J., and Y. Zeng). 2013. “Uniform California Earthquake Rupture Forecast, Version 3 (UCERF3) – The Time-Independent Model,” USGS Open-File Report 2013-1165.
- Zeng, Y., J. G. Anderson, and G. Yu. 1994. “A Composite Source Model for Computing Synthetic Strong Ground Motions,” *Geophys. Research Letters*, 21:725-728.

COMMENTARY RATIONALE

This proposal updates the conterminous United States (US) maps of risk-targeted maximum considered earthquake (MCE_R) spectral response accelerations, maximum considered earthquake geometric mean (MCE_G) peak ground accelerations, and risk coefficients, and the associated commentary to Chapter 22 (“Seismic Ground Motion, Long-period Transition and Risk Coefficient Maps”). The primary reason for updating these maps is that, for consideration by the PUC, the US Geological Survey (USGS) has updated the National Seismic Hazard Maps for the conterminous US (Petersen et al., 2013 and 2014). The most significant improvements included in the USGS update, and their impacts on the National Seismic Hazard Maps, are summarized in the proposed updates to the Chapter 22 commentary.

The secondary reason for updating the MCE_R spectral response acceleration and risk coefficient maps of ASCE/SEI 7-10 is that they were developed using collapse fragilities with a logarithmic standard deviation (or “beta value”) of 0.8, as specified in the site-specific ground motion procedures of the 2009 *Provisions* (Section 21.2.1.2), instead of 0.6, as specified in ASCE/SEI 7-10 (also Section 21.2.1.2). The proposed conterminous US maps have been developed using the 0.6 value of ASCE/SEI 7-10. The impact on the MCE_R spectral response accelerations is as large as +/-10% to +/-15%. Note that the MCE_R spectral response acceleration maps for Guam and the Northern Mariana Islands (NMI) and American Samoa that have previously been accepted for the 2015 *Provisions* and the 2015 *International Building Code* were also developed using the 0.6 value. This proposal does not update the maps for Alaska, Hawaii, and Puerto Rico and the US Virgin Islands (USVI), for two reasons. First, the underlying USGS seismic hazard models for those regions have not been updated since ASCE/SEI 7-10. Second, for those regions an update of the logarithmic standard of the collapse fragilities alone would generally decrease the MCE_R spectral response accelerations, by up to about 10%.

Page intentionally left blank.

COMMENTARY TO CHAPTER 23A, VERTICAL GROUND MOTIONS FOR SEISMIC DESIGN

C23.1 DESIGN VERTICAL RESPONSE SPECTRUM

C23.1.1 General

ASCE/SEI 7-05 and the earlier editions of the *Provisions* use the term $0.2S_{Ds}D$ to reflect the effects of vertical ground motion. Where a more explicit consideration of vertical ground motion effects is advised—as for certain tanks, materials storage facilities, and electric power generation facilities—the requirements of this chapter may be applied. Historically, the amplitude of vertical ground motion has been inferred to be two-thirds ($2/3$) the amplitude of the horizontal ground motion. However, studies of horizontal and vertical ground motions over the past 25 years have shown that such a simple approach is not valid in many situations (e.g., Bozorgnia and Campbell, 2004, and references therein) for the following main reasons: (a) vertical ground motion has a larger proportion of short-period (high-frequency) spectral content than horizontal ground motion and this difference increases with decreasing soil stiffness and (b) vertical ground motion attenuates at a higher rate than horizontal ground motion and this difference increases with decreasing distance from the earthquake.

The observed differences in the spectral content and attenuation rate of vertical and horizontal ground motion lead to the following observations regarding the vertical/horizontal (V/H) spectral ratio (Bozorgnia and Campbell, 2004):

1. The V/H spectral ratio is relatively sensitive to spectral period, distance from the earthquake, local site conditions, and earthquake magnitude (but only for relatively soft sites) and relatively insensitive to earthquake mechanism and sediment depth;
2. The V/H spectral ratio has a distinct peak at short periods that generally exceeds $2/3$ in the near-source region of an earthquake; and
3. The V/H spectral ratio is generally less than $2/3$ at mid-to-long periods.

Therefore, depending on the period, the distance to the fault, and the local site conditions of interest, use of the traditional $2/3V/H$ spectral ratio can result in either an underestimation or an overestimation of the expected vertical ground motions.

The procedure for defining the design vertical response spectrum in the *Provisions* is based on the studies of horizontal and vertical ground motions conducted by Campbell and Bozorgnia (2003) and Bozorgnia and Campbell (2004). These procedures are also generally compatible with the general observations of Abrahamson and Silva (1997) and Silva (1997) and the proposed design procedures of Elnashai (1997).

C23.1.2 General Design Procedure

In order to be consistent with the shape of the horizontal design response spectrum, the vertical design response spectrum has four regions defined by the vertical period of vibration (T_v). Based on the study of Bozorgnia and Campbell (2004), the periods that define these regions are approximately constant with respect to the magnitude of the earthquake, the distance from the earthquake, and the local site conditions. In this respect, the shape of the vertical response spectrum is simpler than that of the horizontal response spectrum.

The equations that are used to define the design vertical response spectrum are based on three observations made by Bozorgnia and Campbell (2004):

1. The short-period part of the 5 percent damped vertical response spectrum is controlled by the spectral acceleration at $T_v = 0.1$ second;
2. The mid-period part of the vertical response spectrum is controlled by a spectral acceleration that decays as the inverse of the 0.75 power of the vertical period of vibration ($T_v^{-0.75}$); and

3. The short-period part of the V/H spectral ratio is a function of the local site conditions, the distance from the earthquake (for sites located within about 60 km of the fault), and the earthquake magnitude (for soft sites).

The *Provisions* do not include seismic design maps for the vertical spectral acceleration at $T_v = 0.1$ second and do not preserve any information on the earthquake magnitudes or the source-to-site distances that contribute to the horizontal spectral accelerations that are mapped. Therefore, the general procedure recommended by Bozorgnia and Campbell (2004) was modified to use only those horizontal spectral accelerations that are available from the seismic design maps, as follows:

1. Estimate the vertical spectral acceleration at $T_v = 0.1$ second from the ratio of this spectral acceleration to the horizontal spectral acceleration at $T = 0.2$ second for the Site Class BC boundary (i.e., the boundary between Site Classes B and C ($\bar{v}_s = 760$ m/sec), the reference site condition for the 2008 U.S. Geological Survey National Seismic Hazard Maps). For earthquakes and distances for which the vertical spectrum might be of engineering interest (magnitudes greater than 6.5 and distances less than 60 km), this ratio is approximately 0.8 for all site conditions (Campbell and Bozorgnia, 2003).
2. Estimate the horizontal spectral acceleration at $T = 0.2$ second from the Next Generation Attenuation (NGA) relationship of Campbell and Bozorgnia (2008) for magnitudes greater than 6.5 and distances ranging between 1 and 60 km for the Site Class BC boundary ($\bar{v}_s = 760$ m/sec). The relationship of Campbell and Bozorgnia (2008), rather than that of Campbell and Bozorgnia (2003), was used for this purpose in order to be consistent with the development of the 2008 U.S. Geological Survey National Seismic Hazard Maps, which use the NGA attenuation relationships to estimate horizontal ground motions in the western United States. Similar results were found for the other two NGA relationships that were used to develop the seismic hazard and design maps (Boore and Atkinson, 2008; Chiou and Youngs, 2008).
3. Use the dependence between the horizontal spectral acceleration at $T = 0.2$ second and source-site distance estimated in Item 2 and the relationship between the V/H spectral ratio, source-site distance, and local site conditions in Bozorgnia and Campbell (2004) to derive a relationship between the vertical spectral acceleration and the mapped MCE_R spectral response acceleration parameter at short periods, S_S .
4. Use the dependence between the vertical spectral acceleration and the mapped MCE_R spectral response acceleration parameter at short periods, S_S , in Item 3 to derive a vertical coefficient, C_v , that when multiplied by 0.8 and the design horizontal response acceleration at short periods, S_{DS} , results in an estimate of the design vertical spectral acceleration at $T_v = 0.1$ second.

C23.1.3 Detailed Design Procedure

The following description of the detailed design procedure listed in Section 23.1 refers to the illustrated design vertical response spectrum in Figure C23.1-1.

Vertical Periods Less Than or Equal to 0.025 Second. Equation 23.1-1 defines that part of the design vertical response spectrum that is controlled by the vertical peak ground acceleration. The 0.3 factor was approximated by dividing the 0.8 factor that represents the ratio between the vertical spectral acceleration at $T_v = 0.1$ second and the horizontal spectral acceleration at $T = 0.2$ second by 2.5, the factor that represents the ratio between the design horizontal spectral acceleration at $T = 0.2$ second, S_{DS} , and the zero-period acceleration used in the development of the design horizontal response spectrum. The vertical coefficient, C_v , in Table 23.1-1 accounts for the dependence of the vertical spectral acceleration on the amplitude of the horizontal spectral acceleration and the site dependence of the V/H spectral ratio as determined in Items 3 and 4 above. The factors are applied to S_{DS} rather than to S_S because S_{DS} already includes the effects of local site conditions and the 2/3 factor that is required to reduce the horizontal spectral acceleration from its MCE_R value to its design value.

Vertical Periods Greater Than 0.025 Second and Less Than or Equal to 0.05 Second. Equation 23.1-2 defines that part of the design vertical response spectrum that represents the linear transition from the part of the spectrum that is controlled by the vertical peak ground acceleration and the part of the spectrum that is controlled by the dynamically amplified short-period spectral plateau. The factor of 20 is the factor that is required to make this transition continuous and piecewise linear between these two adjacent parts of the spectrum.

Vertical Periods Greater Than 0.05 Second and Less Than or Equal To 0.15 Second. Equation 23.1-3 defines that part of the design vertical response spectrum that represents the dynamically amplified short-period spectral plateau.

Vertical Periods Greater Than 0.15 Second and Less Than or Equal To 2.0 Seconds. Equation 23.1-4 defines that part of the design vertical response spectrum that decays with the inverse of the vertical period of vibration raised to the 0.75 power.

C23.1.4 Limits Imposed on S_{av}

Two limits are imposed on the design vertical response spectrum defined by Equations 23.1-1 through 23.1-4 and illustrated in Figure 23.1-1. The first limit restricts the vertical period of vibration to be no larger than 2 seconds. This limit accounts for the fact that such large vertical periods are rare (structures are inherently stiff in the vertical direction) and that the vertical spectrum might decay differently with period at longer periods. There is an allowance for developing a site-specific design vertical response spectrum if this limit is exceeded (see Section 11.4 or Chapter 21 for guidance on applying site-specific methods). The second limit restricts the design vertical response spectrum to be no less than 50 percent of the design horizontal response spectrum. This limit accounts for the fact that a V/H spectral ratio of one-half ($1/2$) is a reasonable, but somewhat conservative, lower bound over the period range of interest, based on the results of Campbell and Bozorgnia (2003) and Bozorgnia and Campbell (2004).

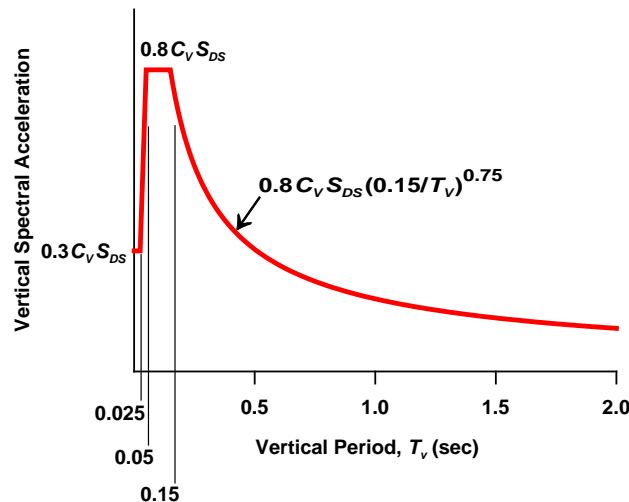

FIGURE C23.1-1 Illustrative Example of the Design Vertical Response Spectrum

REFERENCES

- Abrahamson, N. A., and W. J. Silva. 1997. "Empirical Response Spectral Attenuation Relations for Shallow Crustal Earthquakes," *Seismological Research Letters*, 68:94-127.
- Boore, D. M., and G. M. Atkinson. 2008. "Ground-Motion Prediction Equations for the Average Horizontal Component of PGA, PGV, and 5%-Damped PSA at Spectral Periods Between 0.01 S and 10.0 s", *Earthquake Spectra*, 24:99-138.
- Bozorgnia, Y., and K. W. Campbell. 2004. "The Vertical-to-Horizontal Response Spectral Ratio and Tentative Procedures for Developing Simplified V/H and Vertical Design Spectra," *Journal of Earthquake Engineering*, 8:175-207.

- Campbell, K. W., and Y. Bozorgnia. 2008. "NGA Ground Motion Model for the Geometric Mean Horizontal Component of PGA, PGV, PGD and 5% Damped Linear Elastic Response Spectra for Periods Ranging from 0.01 to 10 s," *Earthquake Spectra*, 24:139-171.
- Campbell, K. W., and Y. Bozorgnia. 2003. "Updated Near-source Ground Motion (Attenuation) Relations for the Horizontal and Vertical Components of Peak Ground Acceleration and Acceleration Response Spectra," *Bulletin of the Seismological Society of America*, 93:314-331.
- Chiou, B. S.-J., and R. R. Youngs. 2008. "An NGA Model for the Average Horizontal Component of Peak Ground Motion and Response Spectra," *Earthquake Spectra*, 24:173-215.
- Elnashai, A. S. 1997. "Seismic Design with Vertical Earthquake Motion," in *Seismic Design for the Next Generation of Codes*, edited by P. Fajfar and H. Krawinkler. Balkema, Rotterdam, p. 91-100.
- Silva, W. 1997. "Characteristics of Vertical Strong Ground Motions for Applications to Engineering Design," in *FHWA/NCEER Workshop on the National Representation of Seismic Ground Motion for New and Existing Highway Facilities*, Technical Report NCEER-97-0010. National Center for Earthquake Engineering Research, Buffalo, New York.

COMMENTARY TO CHAPTER 24, ALTERNATIVE SEISMIC DESIGN REQUIREMENTS FOR SEISMIC DESIGN CATEGORY B BUILDINGS

C24.1 GENERAL

In recent years, engineers and building officials have become concerned that the seismic design requirements for Seismic Design Category (SDC) B are complex and are difficult to implement because the SDC B requirements could not be easily separated from the many other seismic design requirements that are not applicable to SDC B. Additionally, a systematic examination of SDC B design requirements was warranted, because some of the existing Chapter 12 and Chapter 13 requirements may be unnecessary for the design of buildings at sites with moderate seismicity since the requirements have only a minimal influence on design.

In accordance with Section 11.1.3, the alternative seismic design procedure presented in this chapter may be used for the structural systems and nonstructural components of buildings assigned to SDC B. This chapter is equivalent to the procedures described in Chapters 12 and 13 of this Standard, but differs in two ways. First, the text and requirements presented in this chapter are substantially simpler and shorter, because the chapter has been editorially simplified to only include the requirements that apply in SDC B. Second, some of the seismic design requirements have been eliminated or simplified based on technical study. These technical simplifications apply to seismic design requirements which are applicable in SDC B, in accordance with Chapters 12 and 13, but do not have significant influence on the resulting design or seismic performance. As described in more detail below, the implications of removing or simplifying seismic design requirements was carefully evaluated through design studies and nonlinear structural analyses. The commentary that follows describes the important differences between Chapter 24 and the seismic design requirements of Chapter 12 and 13.

Nonbuilding structures (Chapter 15), seismically isolated structures (Chapter 17), and structures with damping systems (Chapter 18) are not permitted to be designed using the alternative procedures of Chapter 24.

C24.2 STRUCTURAL DESIGN BASIS

The requirements of this section closely follow those of Section 12.1. The only modifications in this section are editorial simplifications, in which requirements have been eliminated when not applicable to SDC B buildings. In particular, a small change has been made in the design strength calculation for connections. In SDC B, all connections must be designed for 5% of the weight of the smaller portion of the structure. There is no need to calculate 0.133 times S_{DS} , as required in Chapter 12, because the 5% limiting value will always govern designs in SDC B.

C24.3 STRUCTURAL SYSTEM SELECTION

The requirements of this section closely follow those of Section 12.2. The only modifications in this section are editorial simplifications, in which requirements have been eliminated when not applicable to SDC B buildings. For example, numerous requirements found in Section 12.2, e.g. the requirements for Steel Intermediate Moment Frames in SDC D, have been eliminated because they are not applicable to SDC B buildings.

Additionally, the Table of Design Coefficients and Factors for Seismic Force-Resisting Systems (Table 24.3-1) has been substantially editorially simplified. Structural systems not commonly used in SDC B have been removed, including all “special” systems, which are used primarily in the higher SDCs. When rows were deleted from the Table of Design Coefficients and Factors for Seismic Force-Resisting Systems (Table 24.3-1), the numbering of the rows was intentionally kept unchanged and identical to the numbering used in Table 12.2-1. In addition, the columns relating to Structural System Limitations have been removed

because all systems in the table are allowable in SDC B. The few remaining systems that have height limits imposed in SDC B have the height limits listed directly in the table, rather than in a separate column.

C24.4 DIAPHRAGM FLEXIBILITY AND CONFIGURATION IRREGULARITIES

The requirements of this section closely follow those of Section 12.3. The only modifications in this section are editorial simplifications, in which requirements have been eliminated when not applicable to SDC B buildings. The tables defining Horizontal Structural Irregularities and Vertical Structural Irregularities (Tables 24.4-1 and 24.2-2) have been simplified to only include the irregularities that affect the design procedures in SDC B. Other irregularities, while they may be present, do not affect the design requirements and have been eliminated from the table. The numbering of the irregularities in Table 24.4-1 and Table 24.4-2 was intentionally kept identical to those of Tables 12.3-1 and 12.3-2. The irregularities of Tables 12.3-1 and 12.3-2 omitted from the Chapter 24 tables are horizontal irregularities Type 2 and 3, and vertical irregularities Type 1a, 1b, 2, 3, and 5a. These irregularities were omitted because they do not apply to SDC B.

C24.5 SEISMIC LOAD EFFECTS AND COMBINATIONS

The equations for seismic load effects and load combinations in the alternative design procedure are consistent with those for the general procedure of Chapter 12, with the one notable exception being that the requirement for including the vertical seismic load effect has been removed. Accordingly, E_v is taken as zero in the Section 24.5 requirements and the $E_v = 0.2S_{DS}D$ term in the design load combinations has been removed.

The elimination of the vertical load effect requirement in SDC B was supported by design studies. These studies indicated that, due to the small S_{DS} values in SDC B and, the small associated increase in design dead loads due to vertical seismic effects, there is no meaningful difference in member sizes and detailing if the vertical seismic load is considered in SDC B. Note that in the general Chapter 12 requirement, E_v may already be taken as zero when $S_{DS} < 0.125g$, so this change simply expands the range of S_{DS} values for which E_v may be zero up to $S_{DS} < 0.33g$.

Additionally, the redundancy factor, ρ , has been removed from the load combinations because this factor is always equal to unity for SDC B buildings.

The final simplification in Section 24.5 is that the seismic load effect including the overstrength factor, E_m , must be computed using Equation 24.5-2 and the exception has been removed. If the designer wants to use the more complex method of computing the maximum force that can be developed in the element, then Chapter 24 cannot be used and the general procedures of Chapters 12 and 13 must be used.

C24.6 DIRECTION OF LOADING

The requirements of this section closely follow those of Section 12.5. Most of the text in Section 12.5 is related to SDC C and above, so the procedures in Section 24.6 have been shortened substantially.

C24.7 ANALYSIS PROCEDURE SELECTION

The structural analysis procedure must be either the Equivalent Lateral Force Analysis or the Modal Analysis procedure. If a designer desires to use the more advanced response-history analysis procedure (with the approval of the authority having jurisdiction), then Chapter 24 cannot be used, and the building must be designed in accordance with the provisions in Chapters 12, 13, and 16.

C24.8 MODELING CRITERIA

The requirements of this section closely follow those of Section 12.7 and only small editorial changes have been made.

C24.9 EQUIVALENT LATERAL FORCE PROCEDURE

In this section, the seismic design requirements have been simplified using both editorial and technical simplifications. The discussion below describes the technical differences between the general procedures of Chapter 12 and the alternative procedures of this chapter.

C24.9.1 Seismic Base Shear

Determination of the seismic base shear is similar to the general procedure of Chapter 12. The primary technical simplification is the elimination of the long-period region of the spectrum, i.e. for $T > T_L$. In the Chapter 24 design procedure, longer period structures are to be designed following the same $1/T$ spectral shape used in the velocity sensitive region of the spectrum. The elimination of the long period region of the spectra is conservative, but it is not expected that it will affect many, if any, designs in SDC B.

Reductions associated with soil structure interaction are not permitted when using the alternative Chapter 24 design procedures.

C24.9.2 Period Determination

The approximate period, T_a , is computed according to Equation 24.9-5, and the other period determination equations from Chapter 12 have been eliminated for simplicity. As in Chapter 12, the fundamental period of the structure may not exceed $C_u T_a$, but in these alternative procedures, for simplicity, C_u is taken as a constant value of 1.6. This 1.6 value is used because the Chapter 12 C_u values range only from 1.6 to 1.7 for all sites in SDC B. Use of the constant lower-bound 1.6 value is both simpler and slightly conservative, but will not result in any substantial change in the building design.

C24.9.4.2 Accidental Torsion

To simplify the process of computing member forces from seismic effects, the accidental torsional moment need not be included in design of SDC B buildings, unless the building has a Type 1b horizontal irregularity (Extreme Torsional Irregularity).

The decision to remove the accidental torsion requirement for most regular buildings is supported by rigorous analytical studies using nonlinear dynamic analysis of SDC B buildings designed both with and without use of the accidental torsion requirements. These analytical studies showed that the collapse resistance of buildings was not significantly altered if the accidental torsion requirements were eliminated in the design, for buildings with a torsional irregularity ratio of up to 1.4 (which is the torsional irregularity ratio corresponding to Type 1b horizontal irregularity). For structures with extreme torsional irregularities, the additional strength resulting from the use of the accidental torsion design requirements becomes critical for maintaining sufficient building collapse resistance. The details of this study, including the detailed design information for the 240 buildings analyzed, are available in Liel et al. (2012).

C24.10 MODAL RESPONSE SPECTRUM ANALYSIS

The requirements of this section closely follow those of Section 12.9 and only small changes have been made. The section on Scaling of Drifts was removed for editorial reasons because it does not apply to SDC B. Also, for simplicity, reductions associated with soil structure interaction are not permitted when using these Chapter 24 alternative procedures, and the associated guidelines were removed from the simplified procedure.

C24.11 DIAPHRAGMS, CHORDS AND COLLECTORS

The requirements of this section closely follow those of Section 12.10, and only minor editorial simplifications were made to remove requirements not applicable to SDC B buildings.

C24.13 DRIFT AND DEFORMATION

The requirements of this section closely follow those of Section 12.12. The only modifications in this section are editorial simplifications, in which requirements have been eliminated when not applicable to SDC B buildings.

One specific editorial simplification is that the table for Allowable Story Drifts (Table 24.13-1) has been simplified to only provide the displacement limits for Risk Categories I, II and III, since it is not possible for Risk Category IV to occur in SDC B.

C24.14 FOUNDATION DESIGN

The requirements of this section closely follow those of Section 12.13. The only modifications in this section are editorial simplifications, in which requirements have been eliminated when not applicable to SDC B buildings.

C24.15 SEISMIC DESIGN REQUIREMENTS FOR EGRESS STAIRWAYS AND PARAPETS

Section 24.15 includes all of the seismic design criteria for nonstructural components in Seismic Design Category B. In the general procedures of Chapter 13, all mechanical and electrical components and most architectural components in SDC B are exempt. Accordingly, Section 24.15 seismic design requirements are oriented exclusively toward egress stairways and parapets.

Additional editorial and technical simplifications have been made to the seismic design requirements for nonstructural components. The discussion below describes the technical differences between the general procedures of Chapter 13 and the alternative procedures of Section 24.15.

C24.15.2 General Design Requirements

The alternative procedure does not permit manufacturer's certification that a component is qualified by testing or experience data; this simplification was made because it is expected that the use of this approach would be rare in SDC B. If it is desirable to use one of these removed approaches in design of nonstructural components, Chapter 24 should not be used and the general provisions of Chapters 12 and 13 should be followed.

Additionally, the requirements related to flexibility and consequential damage were removed in the alternative procedures because they are not required for the design of egress stairways or parapets.

C24.15.3 Seismic Design Force

The alternative seismic design requirements do not permit accelerations to be determined by the modal analysis procedures, as this approach is not commonly used in SDC B.

C24.15.4 Design of Egress Stairways for Seismic Relative Displacements

Only egress stairways are required to be designed for seismic relative displacements because design for seismic relative displacements does not affect the design of parapets.

REFERENCES

DeBock, J., A.B. Liel, C.B. Haselton, J.D. Hooper, and R.A. Henige (2013). "Importance of Seismic Design Accidental Torsion Requirements for Building Collapse Capacity," Earthquake Spectra.

Appendix

2015 NEHRP RECOMMENDED SEISMIC PROVISIONS PROJECT PARTICIPANTS

BSSC BOARD OF DIRECTION

Chair

Jim. W. Sealy, FAIA, Dallas, TX

Vice-Chair

James R. Cagley, P.E., S.E., Chairman of the Board Cagley & Associates, Rockville, MD (representing: the Applied Technology Council)

Secretary

Melvyn Green, Secretary, Melvyn Green & Associates, Torrance, CA (representing the Earthquake Engineering Research Institute)

Members

Remington B. Brown, Insurance Institute for Building and Home Safety, Tampa, FL (representing the Insurance Institute for Building and Home Safety)

Charles J. Carter, PhD., P.E., S.E., Vice President of Engineering and Research, American Institute of Steel Construction, Chicago, IL (representing the American Institute of Steel Construction)

Bradford K. Douglas, P.E., Vice President, Engineering American Wood Council, Leesburg, VA (representing the American Wood Council)

Jennifer Goupil, P.E., Director, Structural Engineering Institute, American Society of Civil Engineers, Reston, VA (representing the American Society of Civil Engineers)

Perry A. Haviland, FAIA, Oakland, CA (representing the American Institute of Architects)

John R. Hayes, Jr. ("Jack"), PhD., P.E., NEHRP Director, National Institute of Standards and Technology (NIST), Gaithersburg, MD (representing the National Institute of Standards and Technology)

Jay W. Larson, P.E., F. ASCE, Managing Director, Construction Technical American Iron and Steel Institute, Bethlehem, PA (representing the American Iron and Steel Institute)

Ron Lynn, Clark County Government Center, Las Vegas, NV (representing the Code Officials)

Greg Schindler, SE, Associate, KPFF Consulting Engineers, Seattle, WA (representing the National Council of Structural Engineers Association)

Matthew Senecal, P.E., Senior Engineer, American Concrete Institute, Farmington Hills, MI (representing the American Concrete Institute)

Stephen S. Szoke, P.E., Director, Codes and Standards, Portland Cement Association, Skokie, IL (representing the Portland Cement Association)

Jason J. Thompson, Vice President of Engineering, National Concrete Masonry Association, Herndon, VA (representing the National Concrete Masonry Association)

BSSC MEMBER ORGANIZATIONS

American Concrete Institute

Representative: Matthew Senecal

American Consulting Engineers Council

Representative: Marie Ternieden

American Institute of Architects

Representative: Perry Haviland

American Institute of Steel Construction

Representative: Charles Carter

American Iron and Steel Institute

Representative: Bonnie Manley

American Society of Civil Engineers

Representative: Jennifer Goupil

American Society of Heating, Refrigerating and Air-Conditioning Engineers, Inc.

Representative: Robert Simmons

American Welding Society

Representative: Andrew Davis

American Wood Council

Representative: Douglas Bradford

APA – The Engineered Wood Association

Representative: Thomas Skaggs

Applied Technology Council

Representative: James Cagley

Association of Engineering and Environmental Geologists

Representative: Gary Luce

Brick Industry Association

Representative: Charles Clark

Building Owners and Managers Association International

Representative: Ron Burton

California Seismic Safety Commission

Representative: Richard McCarthy

Concrete Masonry Association of California and Nevada

Representative: Kurt Siggard

Concrete Reinforcing Steel Institute

Representative: Mike Mota

Division of the State Architect, California

Representative: Ronald LaPlante

Earthquake Engineering Research Institute

Representative: Melvyn Green

General Services Administration-Seismic Program

Representative: James Sampson

Institute for Business and Home Safety

Representative: Remington Brown

International Code Council

Representative: Steve Ikkanda

International Masonry Institute

Representative: David Sovinski

Masonry Institute of America

Representative: John Chrysler

Metal Building Manufacturers Association

Representative: Lee Shoemaker

National Association of Home Builders

Representative: Gary Ehrlich

National Concrete Masonry Association

Representative: Jason Thompson

National Council of Structural Engineers Associations

Representative: Kevin Moore

National Institute of Standards and Technology

Representative: John (Jack) Hayes

National Ready Mixed Concrete Association

Representative: Robert Garbini

Portland Cement Association

Representative: Steve Szoke

Precast/Prestressed Concrete Institute

Representative: Jason Krohn

Rack Manufacturers Institute

Representative: Victor Azzi

Steel Deck Institute

Representative: Robert Paul

Structural Engineers Association of California

Representative: Don Schinske

Structural Engineers Association of Central California

Representative: Roy Lobo

Structural Engineers Association of Colorado

Representative: James Harris

Structural Engineers Association of Illinois

Representative: Jon Sfura

Structural Engineers Association of Kansas & Missouri

Representative: Alan Wiley

Structural Engineers Association of Kentucky

Representative: Mark Caldwell

Structural Engineers Association of Northern California

Representative: Ken Miles

Structural Engineers Association of Oregon

Representative: Aaron Burkhardt

Structural Engineers Association of San Diego

Representative: Cathy Riley

Structural Engineers Association of Southern California

Representative: Bahram Zarin-Afsar

Structural Engineers Association of Texas

Representative: William Wallace

Structural Engineers Association of Utah

Representative: Parry Brown

Structural Engineers Association of Washington

Representative: Tom Xia

The Masonry Society

Representative: Philip Samblanet

Western States Clay Products Association

Representative: Jeff Elder

Wisconsin Department of Administration

Representative: Owen Landsverk

PROVISIONS UPDATE COMMITTEE

Chair

David Bonneville, S.E., Senior Principal, Degenkolb Engineers, San Francisco, CA

Members

Robert Bachman, S.E., Principal, RE, Bachman Consulting Engineers, Laguna Niguel, CA
 Kelly Cobeen, P.E., S.E., Associate Principal, Wiss, Janney, Elstner Associates, Emeryville, CA
 C. B. Crouse, Ph.D., P.E., Principal Engineer/Vice-President, URS Corporation, Seattle, WA
 J. Daniel Dolan, Ph.D., P.E., Professor, Washington State University, Pullman, WA
 S. K. Ghosh, Ph.D., President, S. K. Ghosh Associates, Palatine, IL
 John Gillengerten, S.E., Consulting Engineer, Shingle Springs, CA
 Ronald O. Hamburger, S.E., SECB, Senior Principal, Simpson Gumpertz and Heger, San Francisco, CA
 James R. Harris, Ph.D., P.E., Founder and Principal, J. R. Harris and Company, Denver, CO
 John Hooper, S.E., Senior Principal/Director of Earthquake Engineering, Magnusson Klemencic, Seattle, WA
 Gyimah Kasali, G.E., Ph.D., Executive Principal, Rutherford and Chekene, San Francisco, CA
 Dominic Kelly, P.E., S.E., Principal, Simpson Gumpertz and Heger, Waltham, MA
 Charles Kircher, P.E., Ph.D., Principal, Charles Kircher and Associates, Palo Alto, CA
 Philip Line, URS Corporation
 James Malley, S.E., P.E., Group Director and Senior Principal, Degenkolb Engineers, San Francisco, CA
 Bonnie Manley, P.E., Regional Director, Steel Market Development Institute, American Iron and Steel Institute, Norfolk, MA
 Robert Pekelnicky, S.E., Principal, Degenkolb Engineers, San Francisco, CA
 Rafael Sabelli, S.E., Director of Seismic Design, Walter P. Moore and Associates, Inc., San Francisco, CA
 John Silva, S.E., Director Codes and Standards, Hilti, Inc., San Francisco, CA
 J. G. (Greg) Soules, P.E., S.E., FASCE, Consulting Structural Engineer, Spring, TX
 Jason Thompson, Director of Engineering, National Concrete Masonry Association, Washington, DC

ISSUE TEAMS AND STUDY GROUPS

IT 01, Incorporation of P-695/P-795 Methodologies

Chair

Ronald O. Hamburger, S.E., SECB, Senior Principal, Simpson Gumpertz and Heger, San Francisco, CA

Members

Daniel Cheney, International Code Council Evaluation Service
 Curt Haselton, California State University, Chico
 Charles Kircher, Charles Kircher and Associates
 Richard Klingner, University of Texas
 Philip Line, American Wood Council
 James Malley, Degenkolb Engineers
 Bonnie Manley, American Iron and Steel Institute
 David Mar, Tipping and Mar Engineering
 Steven Pryor, Simpson Strong Tie
 John Silva, Hilti
 John Wallace, University of California, Los Angeles

IT02, Evaluation of Performance Objectives and Re-evaluation of Seismic Design Categories

Chair

James R. Harris, Ph.D., P.E., Founder and Principal, J. R. Harris and Company, Denver, CO

Members

Robert Bachman, RE Bachman Consulting Engineers
David Bonneville, Degenkolb Engineers
Daniel Dolan, Washington State University
Wanda Edwards, Institute for Business & Home Safety
Gary Ehrlich, National Association of Home Builders
Ronald Hamburger, Simpson Gumpertz and Heger
Robert Hanson, University of Michigan
John (Jay) Harris, National Institute of Standards and Technology
Eric Hines, Tufts University/LeMessurier Consultants
William Holmes, Structural Engineer
John Hooper, Magnusson Klemencic Associates
Robert Jackson
Charles Kircher, Charles Kircher and Associates
Brian Kehoe, Wiss, Janney, Elstner Associates, Inc. (WJE)
Philip Line, American Wood Council
Nicolas Luco, U.S. Geological Survey
Michael Mahoney, Federal Emergency Management Agency
James Malley, Degenkolb Engineers
Jack Moehle, University of California, Berkeley
Robert Pekelnicky, Degenkolb Engineers
Harold Sprague, Black and Veatch
Mai Tong, Federal Emergency Management Agency

IT03, Anchorage to Concrete/ AC I 318 Appendix D

Chair

Kevin Moore, S.E., SECB, Principal, Simpson Gumpertz and Heger, San Francisco, CA (representing the National Council of Structural Engineers Associations)

Members

Hussain Bhatia, Hussain, Office of Statewide Health Planning and Development
Paul Evans, University of California, San Diego
Brent Hungerford, Walter P. Moore and Associates
Tara Hutchinson, University of California, San Diego
Steven Pryor, Simpson Strong Tie
John Silva, Hilti
Greg Soules, Chicago Bridge and Iron
Harold Sprague, Black and Veatch
Derrick Watkins, Tobolski Watkins Engineering

IT04, Response History Analysis

Chair

Curt Haselton, Ph.D., Professor of Civil Engineering, California State University of California, Chico, CA

Members

Jack Baker, Stanford University
 Ayse Celikbas
 Finley Charney, Virginia Polytechnic Institute and State University
 C.B. Crouse, URS Corporation
 Greg Deierlein, Stanford University
 Ken Elwood, University of Aukland
 Andy Fry, Magnusson Klemencic Associates
 Mahmoud Hachem, Degenkolb Engineers
 Ronal Hamburger, Simpson Gumpertz and Heger
 Robert Hanson, University of Michigan
 John (Jay) Harris, National Institute of Standards and Technology
 John Hooper, Magnusson Klemencic Associates
 Afshar Jalalian, Rutherford & Chekene
 Jordan Jarrett, Virginia Polytechnic Institute and State University
 Charles Kircher, Charles Kircher and Associates
 Nicolas Luco, U.S. Geological Survey
 Steve Mahin, University of California, Berkeley
 Silvia Mazzoni, Degenkolb Engineers
 Mark Moore, ZFA Structural Engineers
 Anna Olsen, U.S. Geological Survey
 Robert Pekelnicky, Degenkolb Engineers
 Graham Powell, University of California, Berkeley
 Rafael Sabelli, Walter P. Moore and Associates
 Mark Sinclair, Degenkolb Engineers
 Chng-Soo Doo, San Francisco Bay Area Rapid Transit District
 Jon Stewart, University of California, Los Angeles
 Mai Tong, Federal Emergency Management Agency
 Andrew Whittaker, State University of New York, Buffalo
 Reid Zimmerman, Rutherford & Chekene

IT06, Diaphragm Issues

Chair

S. K. Ghosh, Ph.D., President, S. K. Ghosh Associates, Palatine, IL

Members

Ned Cleland, Blue Ridge Design
 Kelly Cobeen, Wiss, Janney, Elstner Associates
 Robert Fleischman, University of Arizona
 William Gould, Hilti
 John (Jay) Harris, National Institute of Standards and Technology
 Jerry Hatch, NCI Group, Inc.

Neil Hawkins, University of Illinois at Urbana-Champaign
Dominic Kelly, Simpson Gumpertz and Heger
Richard Klingner, University of Texas
Jason Krohn, Precast/Prestressed Concrete Institute
John Leuenberger, Degenkolb Engineers
Philip Line, American Wood Council
Bonnie Manley, American Iron and Steel Institute
Jeffry Martin, Verco Decking, Inc.
Tom Meyer, Magnusson Klemencic Associates
Jose Restrepo, University of California, San Diego
Mario Rodriguez, National Autonomous - University of Mexico
Richard Sause, Lehigh University
Tom Sputo, Steel Deck Institute
Dichuan Zhang, Nazarbayev University, Kazakhstan

IT07, System Exclusions and Height Limits and SDCs

Chair

John Hooper, S.E., Senior Principal/Director of Earthquake Engineering, Magnusson Klemencic, Seattle, WA

Members

Robert Bachman, RE Bachman Consulting Engineers
Ronald Hamburger, Simpson Gumpertz and Heger
James Harris, J. R. Harris and Company
Eric Hines, Tufts University/LeMessurier Consultants
Charles Kircher, Charles Kircher and Associates
Robert Pekelnicky, Degenkolb Engineers

IT08, Liquefaction and Other Site Problems

Chair

C. B. Crouse, Ph.D., P.E., Principal Engineer/Vice-President, URS Corporation, Seattle, WA

Members

Robert Bachman, RE Bachman Consulting Engineers
Gyimah Kasali, Rutherford & Chekene

IT09, Foundation/Soil/Structure Interface

Chair

Martin Johnson, Director, ABS Consulting, Irvine, CA

Members

Robert Bachman, RE Bachman Consulting Engineers
C. B. Crouse, URS Corporation
Gyimah, Kasali, Rutherford & Chekene
Mark Moore, ZFA Structural Engineers

Robert Pekelnicky, Degenkolb Engineers
Jon Stewart, University of California, Los Angeles
Michael Valley, Structural Engineer

IT11, Design Mapping Issues Task Group

Chair

Nicolas Luco, Ph.D., Research Structural Engineer, U.S. Geological Survey, Golden, CO

Members

Robert Bachman, RE Bachman Consulting Engineers
Philip Caldwell, Apex Engineering
C.B. Crouse, URS Corporation
Daniel Dolan, Washington State University
James Harris, J. R. Harris and Company
John Hooper, Magnusson Klemencic Associates
Charles Kircher, Charles Kircher and Associates

SG1, Chapters 17 & 18

Chair

Ron Mayes, Ph.D., Staff Consultant, Simpson Gumpertz and Heger, San Francisco, CA

Members

Ian Aitken, SIE Corporation
Adi Aviram, Simpson Gumpertz and Heger
Bob Bachman, RE Bachman Consulting Engineers
Geoff Bomba, Forell/Elsesser
Cameron Black, SIE Corporation
Martin Button, Button Engineering
Michael Constantinou, State University of New York, Buffalo
Amir Gilani, Miyamoto International
Robert Hanson, University of Michigan
Amarnath Kasalanti, Dynamic Isolation Systems
Charlie Kircher, CA Kircher & Associates
Justin Marshall, Auburn University
Troy Morgan, Exponent
Gilberto Mosqueda, University of California, San Diego
Robert Pekelnicky, Degenkolb Engineers
Keri Ryan, University of Nevada, Reno
K. Mark Sinclair
Matt Skokan, Saiful Bouquet
Andrew Taylor, KPFF Consulting Engineers
Rene Vignos, Forell/Elsesser
Nicholas Wetzel, Simpson Gumpertz and Heger
Andrew Whittaker, State University of New York, Buffalo
Gordon Wray, Degenkolb Engineers
Victor Zayas, Earthquake Protection System
Reid Zimmerman, KPFF Consulting Engineers

SG2, Chapter 19 Soil-Structure Interaction

Chair

Robert Pekelnicky, S.E., Principal, Degenkolb Engineers, San Francisco, CA

Members

Robert Bachman, RE Bachman Consulting Engineers
Jacob Bielak, Carnegie Mellon University
David Bonneville, Degenkolb Engineers
C.B. Crouse, URS Corporation
John Gillengerten, Consulting Engineer
John (Jay) Harris, National Institute of Standards and Technology
Gyimah Kasali, Rutheford & Chekene
Dominic Kelly, Simpson Gumpertz and Heger
Jon Stewart, University of California, Los Angeles

SG3, Modal Response Spectrum Analysis

Chair

James Malley, S.E., P.E., Group Director and Senior Principal, Degenkolb Engineers, San Francisco, CA

Members

Robert Bachman, RE Bachman Consulting Engineers
Finley Charney, Virginia Polytechnic Institute and State University
Robert Hanson, University of Michigan
James Harris, J. R. Harris and Company
John (Jay) Harris, National Institute of Standards and Technology
John Hooper, Magnusson Klemencic,
Charles Kircher, Charles Kircher and Associates
Robert Tovani, Computers and Structures, Inc.

FEDERAL EMERGENCY MANAGEMENT AGENCY PROJECT PERSONNEL

Robert D. Hanson, PhD, PE, FEMA Subject Matter Expert, Professor Emeritus, University of Michigan, Dublin, Ohio
Mai (Mike) Tong, PhD, Physical Scientist, Building Science Branch, Risk Reduction Division, Federal Insurance and Mitigation Administration, Federal Emergency Management Agency, Washington, DC

NATIONAL EARTHQUAKE HAZARD REDUCTION PROGRAM LIAISON

John (Jack) R. Hayes Jr., Director, NEHRP, National Institute of Standards and Technology, Gaithersburg, Maryland

NATIONAL INSTITUTE OF STANDARDS AND TECHNOLOGY REPRESENTATIVE

John (Jay) Harris, PhD, Research Structural Engineer, Engineering Laboratory, National Earthquake Hazards Reduction Program, National Institute of Standards and Technology (NIST), Gaithersburg, MD

UNITED STATES GEOLOGICAL SURVEY REPRESENTATIVE

Nicolas Luco, PhD, Research Structural Engineer, U.S. Geological Survey, Golden, CO

**NATIONAL INSTITUTE OF BUILDING SCIENCES BUILDING SEISMIC SAFETY COUNCIL,
WASHINGTON, DC**

Philip Schneider, AIA, Executive Director (March 2013 – 2015)

Dana (Deke) Smith, FAIA, Executive Director (August 2011 – March 2013)

Claret Heider, Executive Director (October 2009 – August 2011)

Drew Rouland, Program Director (August 2011 – 2015)

Roger Grant, Program Director (August 2011 – 2015)

Bernard Murphy, P.E., Director, Special Projects (October 2009 –November 2010)

Support Personnel

Degenkolb Engineers, San Francisco, CA

Bryan Bindrich, S.E., Project Engineer

Chad Closs, S.E., Project Engineer

Rosa Bertino, Office Manager

Wanda Rizer, Crown Point, IN

Wanda Rizer, Art Director

Outreach Process Partners, LLC

Darieus Za Gara, Consultant



FEMA

FEMA P-1050-1 Vol I
Catalog No. 15169-1