

# Active Traffic Management Feasibility and Screening Guide



**Notice**

This document is disseminated under the sponsorship of the U.S. Department of Transportation in the interest of information exchange. The U.S. Government assumes no liability for the use of the information contained in this document.

The U.S. Government does not endorse products or manufacturers. Trademarks or manufacturers' names appear in this report only because they are considered essential to the objective of the document.

**Quality Assurance Statement**

The Federal Highway Administration (FHWA) provides high-quality information to serve Government, industry, and the public in a manner that promotes public understanding. Standards and policies are used to ensure and maximize the quality, objectivity, utility, and integrity of its information. FHWA periodically reviews quality issues and adjusts its programs and processes to ensure continuous quality improvement.

Cover photograph sources:

Left and right pictures: California Department of Transportation

Background picture: Picture of Washington State Department of Transportation Active Traffic Management system in Seattle, Washington, courtesy of Telegra, Inc.

### Technical Report Documentation Page

<b>1. Report No.</b> FHWA-HOP-14-019	<b>2. Government Accession No.</b>	<b>3. Recipient's Catalog No.</b>	
<b>4. Title and Subtitle</b> Active Traffic Management (ATM) Feasibility and Screening Guide		<b>5. Report Date</b> May 2015	
		<b>6. Performing Organization Code</b>	
<b>7. Author(s)</b> Louis Neudorff, Keith McCabe		<b>8. Performing Organization Report No.</b>	
<b>9. Performing Organization Name And Address</b> CH2M HILL 901 New York Ave NW, Suite 4000 East Washington, DC 20001 Under contract to Kittelson and Associates, Inc.		<b>10. Work Unit No. (TRAI5)</b>	
		<b>11. Contract or Grant No.</b> DTFH61-12-D-00049-T13003	
<b>12. Sponsoring Agency Name and Address</b> U.S. Department of Transportation Federal Highway Administration Office of Operations 1200 New Jersey Avenue SE Washington, DC 20590		<b>13. Type of Report and Period Covered</b> Final Report	
		<b>14. Sponsoring Agency Code</b> HOP	
<b>15. Supplementary Notes</b> The Task Manager for FHWA is James Colyar.			
<b>16. Abstract</b> Active Traffic Management (ATM) concepts, strategies, and supporting technologies have been receiving significant attention given the potential operational benefits that have and can potentially accrue from deploying these strategies. Implementing these ATM concepts and strategies can also involve significant capital costs, followed by ongoing operations and maintenance requirements. As such, some or all ATM strategies may not be cost effective for certain segments and links of the surface transportation network.  The Active Traffic Management Feasibility and Screening Guide was developed to assist transportation agencies and planning organizations in making informed investment decisions regarding ATM by determining the feasibility of ATM strategies before committing significant resources towards any subsequent project development and design activities. The Guide was based on an extensive review of literature and This Guide, coupled with interviews with several practitioners who have been directly involved in the feasibility analyses, design, deployment, and/or operation of ATM strategies. It presents a recommended process for agencies to follow as they consider ATM deployment at the feasibility and screening analyses level. Following the guidance will help practitioners to identify specific roadway segments most suited for ATM and the appropriate strategies, and the expected costs and range of benefits.			
<b>17. Key Words</b> active traffic management, adaptive ramp metering, adaptive signal control, dynamic junction control, dynamic lane assignment, dynamic lane reversal, dynamic merge control, dynamic shoulder lane, dynamic speed limit, queue warning, transit signal priority		<b>18. Distribution Statement</b> No restrictions	
<b>19. Security Classif. (of this report)</b> Unclassified	<b>20. Security Classif. (of this page)</b> Unclassified	<b>21. No. of Pages</b> 113	<b>22. Price</b> Free



# SI\* (Modern Metric) Conversion Factors

APPROXIMATE CONVERSIONS TO SI UNITS				
SYMBOL	WHEN YOU KNOW	MULTIPLY BY	TO FIND	SYMBOL
<b>LENGTH</b>				
in	inches	25.4	millimeters	mm
ft	feet	0.305	meters	m
yd	yards	0.914	meters	m
mi	miles	1.61	kilometers	km
<b>AREA</b>				
in <sup>2</sup>	square inches	645.2	square millimeters	mm <sup>2</sup>
ft <sup>2</sup>	square feet	0.093	square meters	m <sup>2</sup>
yd <sup>2</sup>	square yard	0.836	square meters	m <sup>2</sup>
ac	acres	0.405	hectares	ha
mi <sup>2</sup>	square miles	2.59	square kilometers	km <sup>2</sup>
<b>VOLUME</b>				
fl oz	fluid ounces	29.57	milliliters	mL
gal	gallons	3.785	liters	L
ft <sup>3</sup>	cubic feet	0.028	cubic meters	m <sup>3</sup>
yd <sup>3</sup>	cubic yards	0.765	cubic meters	m <sup>3</sup>
NOTE: volumes greater than 1000 L shall be shown in m <sup>3</sup>				
<b>MASS</b>				
oz	ounces	28.35	grams	g
lb	pounds	0.454	kilograms	kg
T	short tons (2000 lb)	0.907	megagrams (or "metric ton")	Mg (or "t")
<b>TEMPERATURE (exact degrees)</b>				
°F	Fahrenheit	5 (F-32)/9 or (F-32)/1.8	Celsius	°C

SI\* (MODERN METRIC) CONVERSION FACTORS

APPROXIMATE CONVERSIONS TO SI UNITS				
SYMBOL	WHEN YOU KNOW	MULTIPLY BY	TO FIND	SYMBOL
<b>ILLUMINATION</b>				
fc	foot-candles	10.76	lux	lx
fl	foot-Lamberts	3.426	candela/m <sup>2</sup>	cd/m <sup>2</sup>
<b>FORCE and PRESSURE or STRESS</b>				
lbf	poundforce	4.45	newtons	N
lbf/in <sup>2</sup>	poundforce per square inch	6.89	kilopascals	kPa
APPROXIMATE CONVERSIONS FROM SI UNITS				
SYMBOL	WHEN YOU KNOW	MULTIPLY BY	TO FIND	SYMBOL
<b>LENGTH</b>				
mm	millimeters	0.039	inches	in
m	meters	3.28	feet	ft
m	meters	1.09	yards	yd
km	kilometers	0.621	miles	mi
<b>AREA</b>				
mm <sup>2</sup>	square millimeters	0.0016	square inches	in <sup>2</sup>
m <sup>2</sup>	square meters	10.764	square feet	ft <sup>2</sup>
m <sup>2</sup>	square meters	1.195	square yards	yd <sup>2</sup>
ha	hectares	2.47	acres	ac
km <sup>2</sup>	square kilometers	0.386	square miles	mi <sup>2</sup>
<b>VOLUME</b>				
mL	milliliters	0.034	fluid ounces	fl oz
L	liters	0.264	gallons	gal
m <sup>3</sup>	cubic meters	35.314	cubic feet	ft <sup>3</sup>
m <sup>3</sup>	cubic meters	1.307	cubic yards	yd <sup>3</sup>
<b>MASS</b>				
g	grams	0.035	ounces	oz
kg	kilograms	2.202	pounds	lb

<b>APPROXIMATE CONVERSIONS TO SI UNITS</b>				
<b>SYMBOL</b>	<b>WHEN YOU KNOW</b>	<b>MULTIPLY BY</b>	<b>TO FIND</b>	<b>SYMBOL</b>
Mg (or "t")	megagrams (or "metric ton")	1.103	short tons (2000 lb)	T
<b>TEMPERATURE (exact degrees)</b>				
°C	Celsius	1.8C+32	Fahrenheit	°F
<b>ILLUMINATION</b>				
lx	lux	0.0929	foot-candles	fc
cd/m <sup>2</sup>	candela/m <sup>2</sup>	0.2919	foot-Lamberts	fl
<b>FORCE and PRESSURE or STRESS</b>				
N	newtons	0.225	poundforce	lbf
kPa	kilopascals	0.145	poundforce per square inch	lbf/in <sup>2</sup>





# Contents

---

<b>Acronyms and Abbreviations</b> .....	<b>xv</b>
<b>1 Chapter 1. Introduction and Background</b> .....	<b>1</b>
1.1 Purpose of this Document .....	1
1.2 Context of ATM Feasibility and Screening Guidance.....	2
1.3 How to Use the Guidance .....	3
1.4 Overview of ATM Feasibility and Screening Process .....	5
1.5 Overview of ATM Strategies .....	8
1.6 ATM in the Context of ATDM.....	11
<b>2 Chapter 2. Get Started—Preparation</b> .....	<b>13</b>
2.1 Ensure ATM Supports Regional Goals.....	13
2.2 Identify Relevant Objectives for ATM.....	20
2.2.1 Tools for Linking ATM Strategies with Goals and Objectives .....	21
2.3 Define Network to Be Analyzed.....	23
2.4 Identify and Collaborate With Stakeholders .....	23
2.4.1 Stakeholder Education and Outreach.....	25
2.4.2 Compliance-Related Outreach.....	26
2.5 Commence Data Collection .....	27
2.6 Review Recent Literature.....	29
<b>3 Chapter 3. Assess Agency Policies and Capabilities for Active Traffic Management....</b>	<b>31</b>
3.1 Define Applicable ATM Strategies in Terms of Network Features, Project Scope, Agency Policies, and Legal Considerations .....	32
3.1.1 Roadway Network and Facility Type.....	32
3.1.2 Agency Policies and Practices .....	32
3.1.3 Legal Considerations .....	32
3.2 Confirm Supporting Institutional Framework Is in Place.....	33
<b>4 Chapter 4. Identify Major Roadway Segments for Potential Active Traffic Management.....</b>	<b>35</b>
4.1 Determine Level of Existing Transportation Systems Management and Operations and Intelligent Transportation System Deployment .....	35
4.2 Identify Major Segments That Will Likely Benefit From Deploying Active Traffic Management .....	37
4.2.1 Safety Problems .....	37
4.2.2 Recurring Congestion and Bottlenecks.....	38
4.2.3 Other Considerations.....	38
4.3 Segment Screening Examples .....	40
4.3.1 Washington State Department of Transportation .....	40
4.3.2 California Department of Transportation.....	40
4.3.3 New Jersey Department of Transportation .....	42

<b>5</b>	<b>Chapter 5. Analyze and Prioritize Individual Roadway Links and Active Traffic Management Strategies .....</b>	<b>45</b>
5.1	Analyze and Prioritize Individual Roadway Links.....	45
5.1.1	Example of a Detailed Quantitative Analysis of Freeway Links for ATM..	46
5.2	Dynamic Speed Limits and Dynamic Lane Assignment .....	49
5.2.1	Crash Rates.....	51
5.2.2	Recurring Reductions or Variations in Speed .....	51
5.2.3	Major Reconstruction .....	51
5.2.4	Other Potential Safety Improvements.....	51
5.2.5	Dynamic Speed Limits Only.....	52
5.2.6	Arterial Applications .....	52
5.3	Queue Warning.....	53
5.3.1	Crash Rates.....	53
5.3.2	Queue Warning in Conjunction with Dynamic Speed Limits and Dynamic Lane Assignment .....	54
5.3.3	Congestion and Sight Distance .....	55
5.4	Dynamic Shoulder Lanes.....	55
5.4.1	Recurrent Congestion .....	56
5.4.2	Shoulder Width and Ability to Accommodate Traffic Flow .....	56
5.4.3	Minimum Length.....	59
5.4.4	Safety Concerns .....	59
5.4.5	Transit Operations .....	60
5.4.6	An ATDM Approach .....	61
5.5	Dynamic Junction Control.....	61
5.5.1	Congestion .....	62
5.5.2	Variations in Mainline and Ramp Volumes.....	63
5.5.3	Shoulder Widths and Structure .....	63
5.5.4	An ATDM Approach .....	63
5.6	Adaptive Ramp Metering.....	63
5.7	Adaptive Traffic Signal Control .....	66
5.8	Transit Signal Priority.....	67
5.8.1	Bus Delays at Signalized Intersections and Their Impacts on Schedules..	67
5.8.2	Bus Headways and Frequency of Service .....	69
5.8.3	Automated Vehicle Location on Buses .....	69
5.8.4	Far-Side Bus Stops.....	69
5.9	Dynamic Lane Reversal .....	69
5.9.1	Volumes in Excess of Capacity .....	70
5.9.2	Unbalanced Directional Flows .....	70
5.9.3	Adequate Capacity at Termini .....	71
5.9.4	An ATDM Approach .....	72
5.10	Dynamic Merge Control.....	72
5.10.1	Dynamic Early Merge .....	72
5.10.2	Dynamic Late Merge .....	73
5.11	Tying and Integrating Selected Strategies Together.....	74

<b>6</b>	<b>Chapter 6. Estimate Benefits and Costs</b> .....	<b>77</b>
6.1	Consider Key ATM Cost Factors .....	77
6.1.1	Capital Costs.....	78
6.1.2	Gantries and Sign Supports for Dynamic Speed Limits, Dynamic Lane Assignments, and Dynamic Shoulder Lanes.....	80
6.1.3	Operations and Maintenance Costs .....	86
6.2	Perform High-Level Estimates of Benefits and Costs Using Available Tools .....	87
6.2.1	Benefit Quantification.....	87
6.2.2	Analysis Period .....	87
6.2.3	Sketch Planning.....	89
6.2.4	Highway Capacity Manual.....	89
6.2.5	Tool for Operations Benefit/Cost .....	90
6.2.6	Summary .....	92
<b>7</b>	<b>Chapter 7. Next Steps</b> .....	<b>93</b>
7.1	Stakeholder Involvement.....	93
7.2	Performance Measures.....	93
7.3	Conformance with Regional Intelligent Transportation System Architecture .....	95
7.4	Regulations and Manual on Uniform Traffic Control Devices Standards.....	95
7.5	The Future.....	98

**Appendices**

- A References and Interviews/Reviewers
- B Active Traffic Management Screening Checklist

**List of Figures**

Figure 1. Diagram. An Objectives-Driven, Performance-Based Approach for Metropolitan Planning for Operations (2) .....	3
Figure 2. Diagram. Systems Engineering Vee Diagram (24) .....	3
Figure 3. Diagram. Active Transportation and Demand Management (ATDM) Context and Activities.....	11
Figure 4. Diagram. Active Transportation and Demand Management (ATDM) and the Trip Chain.....	11
Figure 5. Flowchart. Assessing Agency Policies and Capabilities for Active Traffic Management (ATM) .....	31
Figure 6. Flowchart. Identify Major Roadway Segments for Potential Active Traffic Management (ATM) .....	36
Figure 7. Diagram. Continuum of Operations Strategies (Based on Materials from the Second Strategic Highway Research Program [SHRP2] L36 Pilot Regional Operations Forums). 37	
Figure 8. Tabulation. Corridor Screening Results (Washington State Department of Transportation [WSDOT]) (26).....	41
Figure 9. Tabulation. Corridor Screening Results for California Department of Transportation (Caltrans) District 7 (27).....	42
Figure 10. Tabulation. Segment Screening Results for New Jersey Department of Transportation (NJDOT) (28) .....	43
Figure 11. Plot. Interstate 95 (I-95) Crashes by Mile (29).....	46
Figure 12. Plot. 95th Percentile Speeds along Interstate 95 (I-95) (29) .....	47

Figure 13. Graph. Interstate 95 (I-95) Line Chart of Safety, Congestion, and Overall Score (29)..... 49

Figure 14. Flowchart. Considerations and Criteria for Selecting Dynamic Speed Limit (DSpL) and Dynamic Lane Assignment (DLA) Strategies ..... 50

Figure 15. Photograph. Example of Side-Mounted Dynamic Speed Limit (DSpL) Sign ..... 52

Figure 16. Flowchart. Considerations and Criteria for Selecting Queue Warning (QW) ..... 54

Figure 17. Graph. Speed-Volume Relationship of Dynamic Shoulder Lane (DShL), from Germany (31) ..... 55

Figure 18. Flowchart. Considerations and Criteria for Selecting Dynamic Shoulder Lanes (DShL) ..... 57

Figure 19. Photograph. Emergency Refuge Area in the United Kingdom (13)..... 59

Figure 20. Flowchart. Considerations and Criteria for Selecting Dynamic Junction Control ..... 62

Figure 21. Flowchart. Process for Screening Ramp Management Strategies (11) ..... 64

Figure 22. Diagram. Should You Consider Adaptive Traffic Signal Control? (37) ..... 66

Figure 23. Flowchart. Considerations and Criteria for Selecting Transit Signal Priority (TSP) ..... 68

Figure 24. Flowchart. Considerations and Criteria for Selecting Reversible Lane Control..... 71

Figure 25. Diagram. Dynamic Early Merge System (54) ..... 73

Figure 26. Photograph. Conceptual Verge (Side)-Mounted Sign for Active Traffic Management (ATM) as Studied in the United Kingdom (46) ..... 83

Figure 27. Diagram. Current Managed Motorways Concept ..... 84

Figure 28. Photograph. Dynamic Shoulder Lane (DShL) Signage in Northern Virginia ..... 85

Figure 29. Photograph. Conceptual Dynamic Shoulder Lane (DShL), Dynamic Speed Limit (DSpL), and Queue Warning (QW) Signage for Los Angeles Area (27)..... 86

Figure 30. Flowchart. Active Transportation and Demand Management (ATDM) Analysis for the Highway Capacity Manual (HCM) (47)..... 90

**List of Tables**

Table 1. Overview of Active Traffic Management (ATM) Feasibility and Screening Process..... 1

Table 2. Acronyms Used for Active Traffic Management (ATM) Strategies Addressed in This Guidance..... 4

Table 3. Active Traffic Management (ATM) Feasibility and Screening Guidance: Process Steps, Activities, and Example Application..... 5

Table 4. Active Traffic Management (ATM) Strategies..... 8

Table 5. Summary of Active Traffic Management (ATM) Benefits from U.S. Deployments ..... 14

Table 6. Summary of Active Traffic Management (ATM) Benefits from European Deployments ..... 17

Table 7. Sample Objectives for Active Traffic Management (ATM) ..... 20

Table 8. Goals from the Active Management Screening Tool (AMST) ..... 22

Table 9. Goals from the Turbo Architecture Planning Module ..... 23

Table 10. Summary of the Extent to Which Active Traffic Management (ATM) Strategies May Help Solve Transportation Issues and Help Achieve Regional Goals ..... 24

Table 11. Desired Information and Data for Preliminary Active Traffic Management (ATM) Screening..... 28

Table 12. Advantages and Disadvantages of Shoulder Use Alternatives ..... 58

Table 13. Sample Cost of Active Traffic Management (ATM) Systems ..... 79

Table 14. Active Traffic Management (ATM) Components to be Included in Capital Costs ..... 81

Table 15. Summary of Guidance on Transportation Systems Management and Operations (TSM&O) Strategies Provided By Tool for Operations Benefit/Cost (TOPS-BC)..... 91

Table 16. National Intelligent Traffic System (ITS) Architecture Service Packages Directly Applicable to Active Traffic Management (ATM) Strategies..... 96



# Acronyms and Abbreviations

---

AASHTO	American Association of State Highway and Transportation Officials
ADM	Active Demand Management
AMST	Active Management Screening Tool
APM	Active Parking Management
ARM	adaptive ramp metering
ATDM	Active Transportation and Demand Management
ATM	Active Traffic Management
ATSC	adaptive traffic signal control
BOS	bus on shoulder
Caltrans	California Department of Transportation
CMP	Congestion Management Process
DJC	dynamic junction control
DLR	dynamic lane reversal
DLA	dynamic lane assignment
DMC	dynamic merge control
DMS	dynamic message sign
DOT	Department of Transportation
DShL	dynamic shoulder lane
DSpL	dynamic speed limit
FHWA	Federal Highway Administration
FTA	Federal Transit Administration
GP	general purpose
Guide	<i>Active Traffic Management Feasibility and Screening Guide</i>
HOT	high-occupancy toll
HOV	high-occupancy vehicle
I-105	Interstate 105
I-35W	Interstate 35 West
I-5	Interstate 5
I-95	Interstate 95
ICM	Integrated Corridor Management
ITS	Intelligent Transportation System
km/h	kilometers per hour
LOS	level of service
MnDOT	Minnesota Department of Transportation
MOE	measurements of effectiveness
mph	miles per hour
MPO	Metropolitan Planning Organization

## ACRONYMS AND ABBREVIATIONS

---

MTP	metropolitan transportation plan
MUCTD	Manual on Uniform Traffic Control Devices
NCHRP	National Cooperative Highway Research Program
NEPA	National Environmental Policy Act
NJDOT	New Jersey Department of Transportation
NJIT	New Jersey Institute of Technology
PennDOT	Pennsylvania Department of Transportation
PTI	planning time index
QW	queue warning
SHRP2	Second Strategic Highway Research Program
TMC	transportation management center
TOPS-BC	Federal Highway Administration Operations Benefit/Cost Analysis Tool
TSM&O	transportation systems management and operations
TSP	transit signal priority
UPA	Urban Partnership Agreement
VHT	vehicle hours traveled
VMT	vehicle miles traveled
vph	vehicles per hour
WSDOT	Washington State Department of Transportation



# Chapter 1. Introduction and Background

## 1.1 Purpose of this Document

Active Traffic Management (ATM) concepts, strategies, and supporting technologies have been receiving significant attention of late, given the potential operational benefits that have and can potentially accrue from deploying these strategies. Implementing these ATM concepts and strategies can also involve significant capital costs, followed by ongoing operations and maintenance requirements. As such, some or all ATM strategies may not be cost effective for certain segments and links of the surface transportation network.

The Federal Highway Administration (FHWA) has developed this *Active Traffic Management Feasibility and Screening Guide* (the Guide) to assist transportation agencies and planning organizations with making informed investment decisions regarding ATM by determining the feasibility of ATM strategies before committing significant resources towards any subsequent project development and design activities. This Guide presents a recommended process—a series of steps summarized in Table 1—for agencies to follow as they consider ATM deployment at the feasibility and screening analyses level. At the end of the process, practitioners will be able to answer the following questions with reasonable confidence:

- What roadway networks and facilities would be best suited for ATM in my region?
- What specific or combination of ATM strategies would work best?
- What would be the range of expected benefits?
- What would be the expected costs (capital and ongoing)?

**TABLE 1. OVERVIEW OF ACTIVE TRAFFIC MANAGEMENT (ATM) FEASIBILITY AND SCREENING PROCESS**

<b>Get Started: Preparation</b>
<ul style="list-style-type: none"> <li>• Ensure ATM supports regional goals</li> <li>• Identify relevant objectives for ATM</li> <li>• Define network to be analyzed</li> <li>• Identify and collaborate with stakeholders</li> <li>• Commence data collection</li> <li>• Review recent literature</li> </ul>
<b>Assess Agency Policies and Capabilities for ATM</b>
<ul style="list-style-type: none"> <li>• Define applicable ATM strategies in terms of network features, project scope, agency policies, and legal considerations</li> <li>• Confirm supporting institutional framework is in place</li> </ul>
<b>Identify Major Roadway Segments for Potential ATM</b>
<ul style="list-style-type: none"> <li>• Determine level of TSM&amp;O deployment along segments. Consider other TSM&amp;O strategies in lieu of ATM as appropriate</li> <li>• Identify major segments that will likely benefit from deploying ATM, based on congestion, crash rates, bottlenecks, and other considerations</li> </ul>
<b>Analyze and Prioritize Individual Roadway Links and ATM Strategies</b>
<ul style="list-style-type: none"> <li>• Analyze and prioritize individual links for ATM deployment</li> <li>• Determine appropriate ATM strategies for each link</li> <li>• Combine strategies for each link and ensure compatibility across the network.</li> </ul>
<b>Estimate Benefits and Costs</b>
<ul style="list-style-type: none"> <li>• Consider key ATM cost factors</li> <li>• Perform high-level estimates of benefits and costs using available tools</li> </ul>

With the answers to these questions in hand, agencies can then develop and define specific ATM projects for implementation that are also aligned with their region's needs, goals, objectives, and the overall metropolitan transportation planning process. The results from the applying the Guide can also set the stage for performing more detailed analyses in accordance with the principles of systems engineering (e.g., develop a Concept of Operations). Perhaps most importantly, the results from applying this guidance can help an agency (or agencies) make a business case to managers and decision-makers of the value of applying ATM in their region.

## 1.2 Context of ATM Feasibility and Screening Guidance

The ATM feasibility and screening guidance provided herein should not be viewed as a stand-alone exercise but rather as an integral part of other established processes, particularly the metropolitan transportation planning process and the systems engineering process as summarized below.

The guidance can be used to define an ATM program as part of the **metropolitan transportation planning process**, including identifying ATM projects as part of a long-range transportation plan update or regional or statewide transportation improvement plans. The FHWA and the Federal Transit Administration (FTA) promote using an “objectives-driven, performance-based approach to planning for operations” as an effective way to integrate transportation systems management and operations (TSM&O) into metropolitan transportation plans (MTPs) and the congestion management process (CMP). This approach includes the activities and elements shown in Figure 1, with several of the activities highlighted in the red box addressed as part of the ATM feasibility and screening process. These activities are based on the regional goals and operations objectives. Moreover, the ATM screening activities may identify additional outcome-based objectives, which also can be used to develop relevant performance measures for ATM, for inclusion in the regional transportation plans.

The guidance can be used to explore ATM concepts as part of the **systems engineering process** (i.e., the “Concept Exploration” step as shown in Figure 2), providing information to include in a Concept of Operations for an ATM project. This information may include, but not be limited to, the goals and objectives of the proposed ATM system, the system stakeholders, the ATM strategies to be deployed and the specific roadway segments, and preliminary spacing and layout of ATM signage. The guidance activities also support developing performance measures and a public outreach strategy.



FIGURE 1. DIAGRAM. AN OBJECTIVES-DRIVEN, PERFORMANCE-BASED APPROACH FOR METROPOLITAN PLANNING FOR OPERATIONS (2)

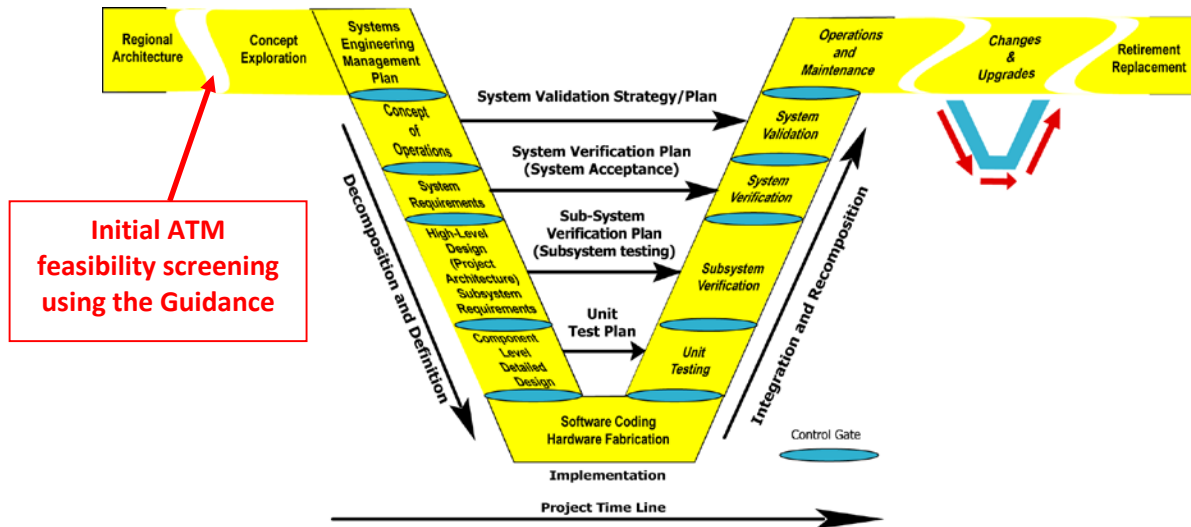

FIGURE 2. DIAGRAM. SYSTEMS ENGINEERING VEE DIAGRAM (24)

### 1.3 How to Use the Guidance

This Guide is intended for operations, engineering, and planning staff from local and state departments of transportation (DOTs), metropolitan planning organizations (MPOs), transit agencies, and other transportation and regional entities, universities, and consultants who are interested in deploying, or supporting the deployment of, one or more ATM strategies and need some background information on ATM and guidance for identifying which combinations of strategies and locations would likely result in the greatest operational benefits in the most

cost-effective manner. The guidance has been developed to allow the screening process to be carried out in a short time with minimal costs, assuming basic operations data are available for the roadway network being considered.

In addition to supporting the planning and systems engineering processes as previously discussed, the guidance may also be used to structure an ATM feasibility and screening workshop, including agenda items and presentation materials, to go through many of the steps and activities discussed herein. The guidance may also be used as the basis for a scope of services and request for proposals for the screening to be performed by others.

Overall, the process explained in this guidance was designed to be flexible and used in a variety of formats. As previously noted, it can be completed either in-house by agency staff, a regional planning entity, or contracted out to be performed by others. It can be completed as an informal 1-day workshop or as a more formal study with a project sponsor and guided by a diverse group of stakeholders. It can be completed within the context of the planning process or within the project development process (at the beginning of systems engineering). However the process is used, the bottom line is that it can help an agency make a business case to managers and decision-makers of the value of applying ATM concepts in their region.

This Guide is based on an extensive review of literature as listed in Appendix A,<sup>1</sup> coupled with interviews with several practitioners who have been directly involved in the feasibility analyses, design, deployment, and/or operation of ATM strategies (also listed in Appendix A). The amount of information and guidance provided herein differs depending on the specific ATM strategy being addressed. More guidance is provided for such strategies as dynamic speed limit (DSpL), dynamic lane assignment (DLA), queue warning (QW), dynamic shoulder lane (DShL), dynamic junction control (DJC), dynamic lane reversal (DLR) and dynamic merge control (DMC), which are relatively new to the TSM&O community within the United States, as compared with the information provided for adaptive ramp metering (ARM), adaptive traffic signal control (ATSC), and transit signal priority (TSP) for which thorough documentation and guidance documents already exist (and are referenced herein). Flowcharts showing a sequence of decision points are provided throughout the document to aid in the screening process. Table 2 lists the acronyms for the various ATM strategies frequently used in this Guide.

**TABLE 2. ACRONYMS USED FOR ACTIVE TRAFFIC MANAGEMENT (ATM) STRATEGIES ADDRESSED IN THIS GUIDANCE**

- ARM—Adaptive Ramp Metering
- ATSC—Adaptive Traffic Signal Control
- DJC—Dynamic Junction Control
- DLA—Dynamic Lane Assignment (or Dynamic Lane Use Control)
- DLR—Dynamic Lane Reversal
- DMC—Dynamic Merge Control
- DShL—Dynamic Shoulder Lane
- DSpL—Dynamic Speed Limit
- QW—Queue Warning
- TSP—Transit Signal Priority

---

<sup>1</sup> Literature reviewed in preparation for this Guide are listed in Appendix A and cited in the text via parentheses; for example "(reference number from Appendix A)."

## 1.4 Overview of ATM Feasibility and Screening Process

Table 3 provides an overview of the ATM feasibility and screening process, along with the relevant chapter in this Guide for each step. An ATM feasibility and screening checklist is provided in Appendix B that can be used by practitioners to track and document their progress in working through the process. The process steps and activities described in the subsequent chapters are not intended as a rigid step-by-step approach. Instead, practitioners can combine or skip steps as appropriate. Moreover, some of the approaches and factors identified and the levels of detail presented herein may not always be relevant to each practitioner’s specific situation. Practitioners should always keep in mind that the primary purpose of this Guide is to allow them to develop preliminary recommendations about which ATM strategies are most appropriate for their operational conditions, prioritize where these strategies should be deployed, and make these informed decisions with a minimum of effort and time.

The final chapter of this Guide (Chapter 7) discusses a few of the “next steps” after the optimum ATM strategies and locations have been identified. Which of these next steps are undertaken, and when, will depend on the context in which the screening has occurred—for example, whether the results of the screening are the start of the systems engineering process, are to identify an ATM program and specific projects as part of the planning and programming processes, or perhaps some combination. Specific “next steps” include continuing the stakeholder outreach process (including public education), developing performance measures, ensuring conformance with the regional Intelligent Transportation System (ITS) architecture, and regulatory considerations (e.g., Manual on Uniform Traffic Control Devices [MUTCD]).

**TABLE 3. ACTIVE TRAFFIC MANAGEMENT (ATM) FEASIBILITY AND SCREENING GUIDANCE: PROCESS STEPS, ACTIVITIES, AND EXAMPLE APPLICATION**

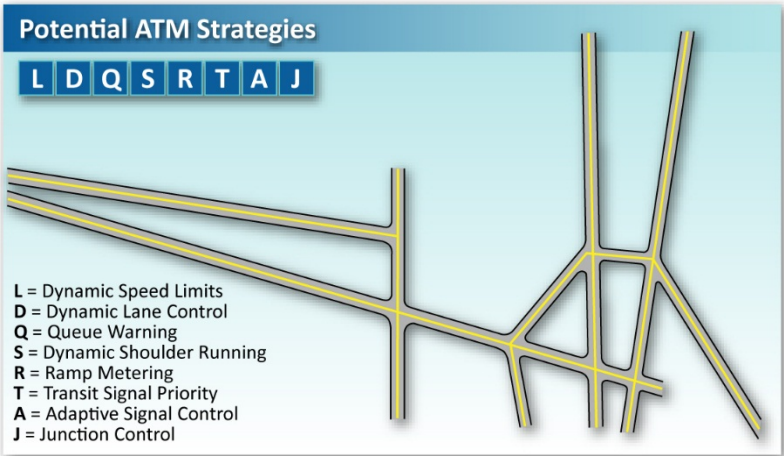
Steps	Chapter 2	Example Application (Graphical View)
<b>Get Started—Preparation</b>		 <p data-bbox="609 1711 1323 1743">Graphic shows a generic roadway and all available ATM strategies.</p>
Ensure ATM supports regional goals.	2.1	
Identify relevant objectives for ATM.	2.2	
Define network to be analyzed.	2.3	
Identify and collaborate with stakeholders.	2.4	
Commence data collection.	2.5	
Review recent literature.	2.6	

**TABLE 3. ACTIVE TRAFFIC MANAGEMENT (ATM) FEASIBILITY AND SCREENING GUIDANCE: PROCESS STEPS, ACTIVITIES, AND EXAMPLE APPLICATION**

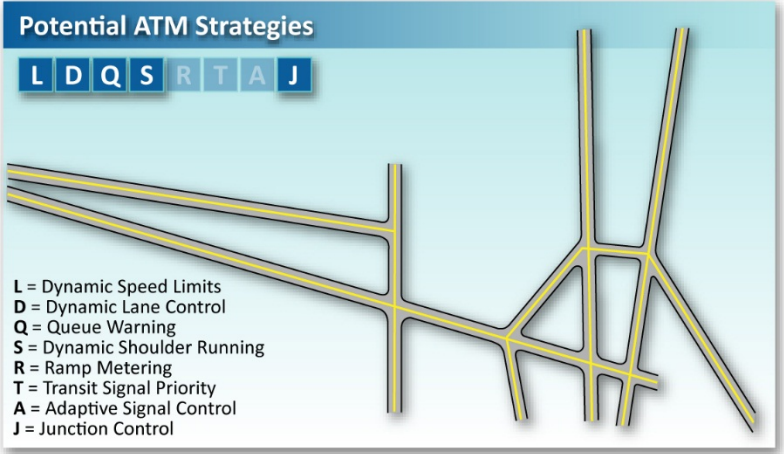
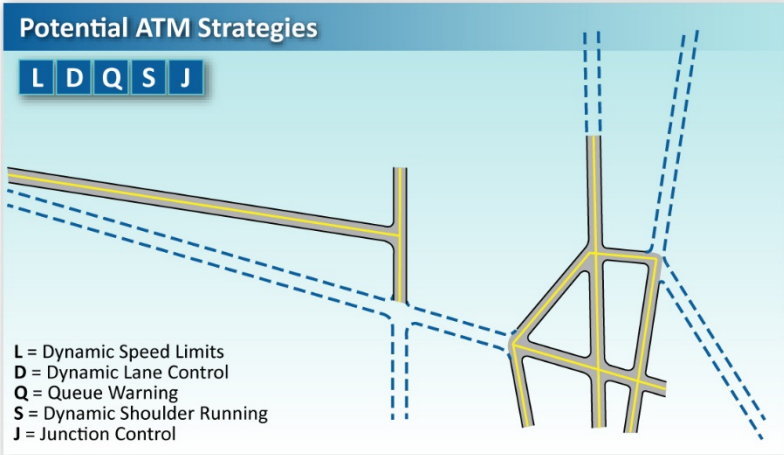
Steps	Example Application (Graphical View)	
<p><b>Assess Agency Policies and Capabilities for Active Traffic Management</b></p> <p>Define applicable ATM strategies in terms of network features, project scope, agency policies and legal considerations.</p> <p>Confirm supporting institutional framework is in place.</p>	<p><b>Chapter 3</b></p> <p>3.1</p> <p>3.2</p>	 <p>In the graphic, strategies “A” and “T” are not appropriate to the agency’s transportation network (i.e., freeway), and strategy “R” does not conform to agency’s policies.</p>
<p><b>Identify Major Roadway Segments for Potential Active Traffic Management</b></p> <p>Determine level of TSM&amp;O deployment along segments; consider other TSM&amp;O strategies in lieu of ATM as appropriate.</p> <p>Identify major segments that will likely benefit from deploying ATM, based on congestion, crash rates, bottlenecks, and other considerations.</p>	<p><b>Chapter 4</b></p> <p>4.1</p> <p>4.2, 4.3, and 4.4</p>	 <p>In the graphic, the “blue-dashed” segments are less likely to benefit from ATM strategies relative to others. Chapter 4.5 provides examples of this step.</p>

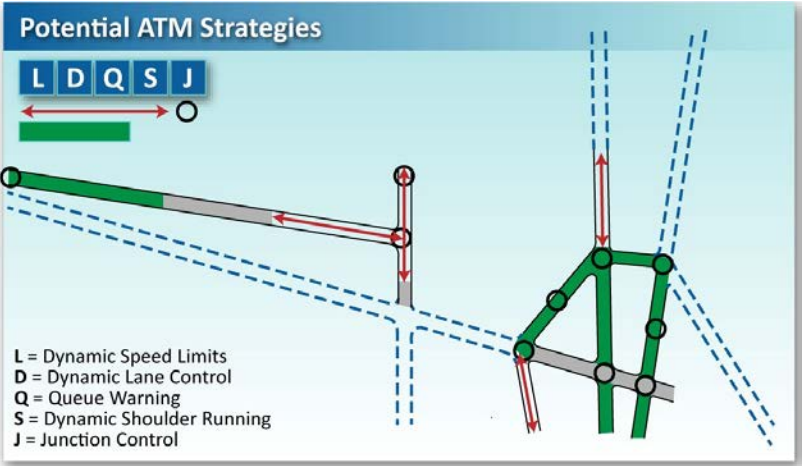
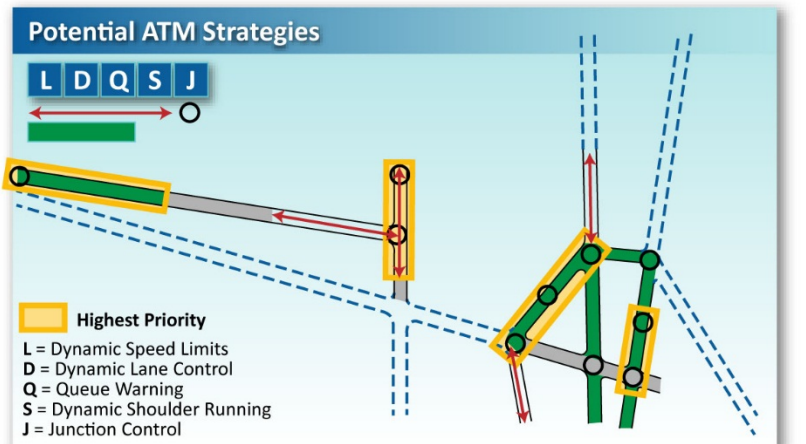

**TABLE 3. ACTIVE TRAFFIC MANAGEMENT (ATM) FEASIBILITY AND SCREENING GUIDANCE: PROCESS STEPS, ACTIVITIES, AND EXAMPLE APPLICATION**

Steps	Example Application (Graphical View)	
<p><b>Analyze and Prioritize Individual Roadway Links and ATM Strategies</b></p> <p>Analyze and prioritize individual links for ATM deployment.</p> <p>Determine appropriate ATM strategies for each link.</p> <ul style="list-style-type: none"> <li>• DSpl/DLA</li> <li>• QW</li> <li>• DShL</li> <li>• DJC</li> <li>• ARM</li> <li>• ATSC</li> <li>• TSP</li> <li>• DLR</li> <li>• DMC</li> </ul> <p>Combine strategies for each link and ensure compatibility across the network.</p>	<p><b>Chapter 5</b></p> <p>5.1</p> <p>5.2 to 5.10</p> <p>5.2</p> <p>5.3</p> <p>5.4</p> <p>5.5</p> <p>5.6</p> <p>5.7</p> <p>5.8</p> <p>5.9</p> <p>5.10</p> <p>5.11</p>	 <p><b>Potential ATM Strategies</b></p> <p>L = Dynamic Speed Limits  D = Dynamic Lane Control  Q = Queue Warning  S = Dynamic Shoulder Running  J = Junction Control</p> <p>In the graphic, strategies “L,” “D,” and “Q” are recommended for links shown in “green,” with strategy “S” also included (in addition to “L,” “D,” and “Q”) for those links with “red” arrows. Circles indicate locations for “J.”</p>
<p><b>Estimate Benefits and Costs</b></p> <p>Consider key ATM cost factors.</p> <p>Perform high-level estimates of benefits and costs using available tools.</p>	<p><b>Chapter 6</b></p> <p>6.1</p> <p>6.2</p>	 <p><b>Potential ATM Strategies</b></p> <p>L = Dynamic Speed Limits  D = Dynamic Lane Control  Q = Queue Warning  S = Dynamic Shoulder Running  J = Junction Control</p> <p><b>Highest Priority</b></p> <p>In the graphic, those segments outlined in yellow provide the greatest estimates benefit/cost ratio and are, therefore, the highest priority for moving ATM forward.</p>

## 1.5 Overview of ATM Strategies

ATM is defined on the FHWA website as follows (1)

*“The ability to dynamically manage recurrent and non-recurrent congestion based on prevailing and predicted traffic conditions. Focusing on trip reliability, it maximizes the effectiveness and efficiency of the facility. It increases throughput and safety through the use of integrated systems with new technology, including the automation of dynamic deployment to optimize performance quickly and without delay that occurs when operators must deploy operational strategies manually. ATM approaches focus on influencing travel behavior with respect to lane/facility choices and operations.”*

Table 4 defines the ATM strategies covered in this Guide, with the strategies listed in alphabetical order.

**TABLE 4. ACTIVE TRAFFIC MANAGEMENT (ATM) STRATEGIES (1)**



ATM Strategy	Photographic Representation
<p><b>Adaptive Ramp Metering (ARM)</b>—This strategy consists of deploying traffic signal(s) on ramps to dynamically control the rate vehicles enter a freeway facility. ARM uses traffic responsive or adaptive algorithms (as opposed to local traffic responsive or fixed-time rates) that can optimize either local or systemwide conditions. This, in essence, smooths the flow of traffic onto the mainline, allowing efficient use of existing freeway capacity.</p>	 <p>(Source: Pennsylvania DOT)</p>
<p><b>Adaptive Traffic Signal Control (ATSC)</b>—This strategy continuously monitors arterial traffic conditions and the queuing at intersections and dynamically adjusts the signal timing to smooth the flow of traffic along coordinated routes and to optimize one or more operational objectives (such as minimize overall stops and delays or maximize green bands). ATSC approaches typically monitor traffic flows and modifies specific timing parameters to achieve operational objectives.</p>	 <p>(Source: ITE)</p>



TABLE 4. ACTIVE TRAFFIC MANAGEMENT (ATM) STRATEGIES (1)







ATM Strategy	Photographic Representation
<p><b>Dynamic Junction Control (DJC)</b>—This strategy consists of dynamically allocating lane access on mainline and ramp lanes in interchange areas where high traffic volumes are present, and the relative demand on the mainline and ramps change throughout the day. For off-ramp locations, this may consist of assigning lanes dynamically either for through movements, shared through-exit movements, or exit-only. For on-ramp locations, this may involve a dynamic lane reduction on the mainline upstream of a high-volume entrance ramp.</p>	 <p>(Source: Reference 31)</p>
<p><b>Dynamic Lane Assignment (DLA)</b>—This strategy, also known as dynamic lane use control, involves dynamically closing or opening of individual traffic lanes as warranted and providing advance warning of the closure(s), typically through dynamic lane control signs, to safely merge traffic into adjoining lanes. DLA is often installed in conjunction with dynamic speed limits and also supports the ATM strategies of DShL and DJC.</p>	 <p>(Source: Washington State DOT)</p>
<p><b>Dynamic Lane Reversal (DLR)</b>—This strategy, also known as or contraflow lane reversal, involves, consists of the reversal of lanes in order to dynamically allocate the capacity of congested roads, thereby allowing capacity to better match traffic demand throughout the day.</p>	 <p>(Source: New York State DOT)</p>
<p><b>Dynamic Merge Control (DMC)</b>—This strategy, also known as dynamic late merge or dynamic early merge, consists of dynamically managing the entry of vehicles into merge areas with a series of advisory messages approaching the merge point that prepare motorists for an upcoming merge and encouraging or directing a consistent merging behavior. Applied conditionally during congested (or near congested) conditions, such as a work zone, DMC can help create or maintain safe merging gaps and reduce shockwaves upstream of merge points.</p>	 <p>(Source: Michigan DOT)</p>

TABLE 4. ACTIVE TRAFFIC MANAGEMENT (ATM) STRATEGIES (1)

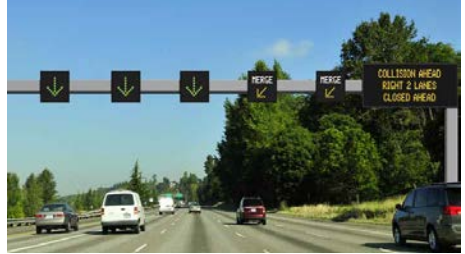
ATM Strategy	Photographic Representation
<p><b>Dynamic Shoulder Lane (DShL)</b>—This strategy, which has also been called hard shoulder running or temporary shoulder use, allows drivers to use the shoulder as a travel lane(s) based on congestion levels during peak periods and in response to incidents or other conditions as warranted during nonpeak periods. This strategy is frequently implemented in conjunction with DSpL and DLA. This strategy may also be used as a managed lane (e.g., opening the shoulder as temporary bus-only lane).</p>	 <p>(Source: Virginia DOT)</p>
<p><b>Dynamic Speed Limit (DSpL)</b>—This strategy, which has also been called variable speed limit, adjusts speed limit displays based on real-time traffic, roadway, and/or weather conditions. DSpL can either be enforceable (regulatory) speed limits or recommended speed advisories, and they can be applied to an entire roadway segment or individual lanes. This “smoothing” process helps minimize the differences between the lowest and highest vehicle speeds.</p>	 <p>(Source: Washington State DOT)</p>
<p><b>Queue Warning (QW)</b>—This strategy involves real-time displays of warning messages (typically on dynamic message signs and possibly coupled with flashing lights) along a roadway to alert motorists that queues or significant slowdowns are ahead, thus reducing rear-end crashes and improving safety. QW may be included as part of DSpL and DLA strategies.</p>	 <p>( Source: Missouri DOT)</p>
<p><b>Transit Signal Priority (TSP)</b>—This strategy manages traffic signals by using sensors or probe vehicle technology to detect when a bus nears a signal controlled intersection, turning the traffic signals to green sooner or extending the green phase, thereby allowing the bus to pass through more quickly and help maintain scheduled transit vehicle headways and overall schedule adherence.</p>	 <p>(Source: New York City Transit)</p>

## 1.6 ATM in the Context of ATDM

ATM is an integral component of a broader concept known as Active Transportation and Demand Management (ATDM; Figure 3), which FHWA defines as follows (1)

*“...[the] dynamic management, control, and influence of travel demand, traffic demand, and traffic flow of transportation facilities. Through ATDM, regions attain the capability to monitor, control, and influence travel, traffic, and facility demand of the entire transportation system and over a traveler’s entire trip chain.”*

This trip chain includes the following activities as described below and shown in Figure 4:



FIGURE 3. DIAGRAM. ACTIVE TRANSPORTATION AND DEMAND MANAGEMENT (ATDM) CONTEXT AND ACTIVITIES

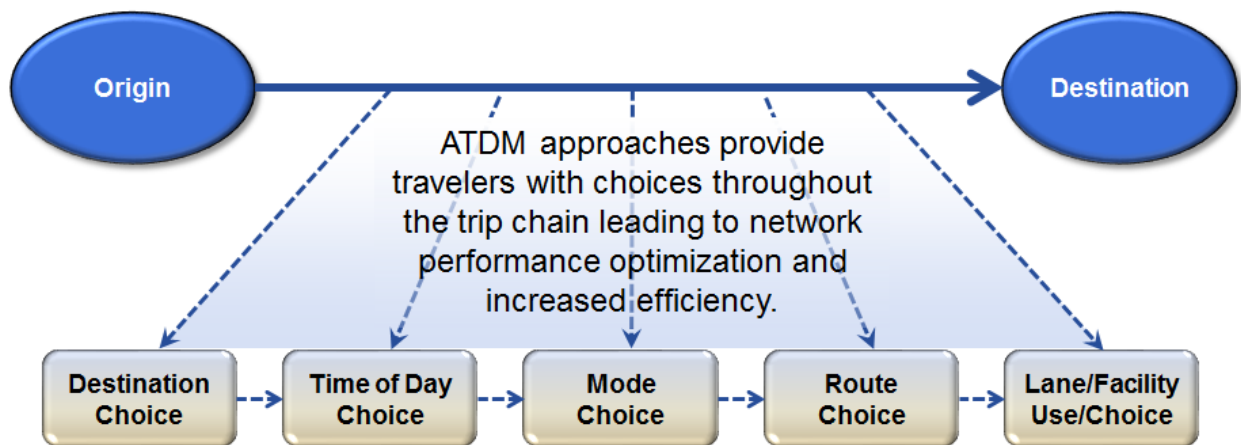

FIGURE 4. DIAGRAM. ACTIVE TRANSPORTATION AND DEMAND MANAGEMENT (ATDM) AND THE TRIP CHAIN

- Before and/or at the beginning of the trip via Active Demand Management (ADM) strategies and concepts (e.g., dynamic ride sharing, multimodal and comparative traveler information, and dynamic pricing) to reduce or redistribute travel demand to alternate modes, routes, or departure times.
- At the end of the trip via Active Parking Management (APM) strategies and concepts (e.g., dynamic parking pricing and real-time parking availability information) to affect the demand, distribution, availability, and management of parking.
- During the trip via ATM strategies and concepts as discussed in this Guide.

Active management needs to occur before, during, and at the end of the trip chain. Also, while the focus of this Guide is on ATM strategies and concepts applied during the trip, users should keep in mind that these ATM strategies can work synergistically with ADM and APM concepts. Consideration should, therefore, be given when applying the Guidance to roadway segments

with parallel ADM and/or APM efforts and how such efforts might work in concert with the ATM recommendations identified during the this feasibility and screening process.

In an ATDM context, ATM involves using available technology to make changes proactively before conditions warrant them versus in reaction to them (or merely on a recurring time-of-day schedule)—in other words, to make the operation of these strategies truly “dynamic.” Following are some examples (1)

- **Adaptive Ramp Metering**—With an ATDM approach, real-time and anticipated traffic volumes on the freeway facility and ramps, and possibly the parallel arterial streets, are used to dynamically control the rate of vehicles entering the freeway facility.
- **Dynamic Junction Control**—With an ATDM approach, volumes on the mainline lanes and ramps are continuously monitored, and lane access is dynamically changed based on the real-time and anticipated conditions.
- **Dynamic Lane Assignment**—With an ATDM approach, the network is continuously monitored, and real-time incident data and predicted congestion information are used to control the lane use ahead of lane closures and dynamically manage the lane closure process to reduce rear-end and other secondary crashes.
- **Dynamic Shoulder Lanes**—With an ATDM approach, real-time and anticipated congestion levels are used to determine the need for using a shoulder lane as a regular or special purpose travel lane (e.g., transit only), instead of a fixed time-of-day schedule for using the shoulder for a travel lane.
- **Dynamic Speed Limits**—With an ATDM approach, real-time and predicted traffic conditions are used to adjust the speed limits dynamically to meet an agency’s goals and objectives for safety, mobility, and environmental impacts.
- **Queue Warning**—With an ATDM approach, the traffic conditions are monitored continuously, and the warning messages are dynamic based on the location and severity of the queues and slowdowns.
- **Transit Signal Priority**—With an ATDM approach, current and predicted traffic congestion, multiagency bus schedule adherence information, and number of passengers affected may all be considered to determine conditionally if, where, and when TSP may be applied.

# Chapter 2. Get Started—Preparation

---

This chapter addresses a number of activities that need to be accomplished to prepare for the process of determining ATM feasibility.

## 2.1 Ensure ATM Supports Regional Goals

The aforementioned “Objectives-Driven, Performance-Based Approach for Metropolitan Planning for Operations” (as shown in Figure 1) stresses the importance of any operations-oriented program or project being consistent with regional goals and the associated objectives. Reference 3 (“ATDM Lessons Learned”) also addresses this, noting that without this connection, “agencies will struggle with communicating the concept to stakeholders and partners and will not have a benchmark against which the project can be measured.” As a practical point, a project that is consistent with regional goals is an “easier sell.”

The potential benefits resulting from ATM strategies are often quite impressive, as summarized in Tables 5 (from U.S. deployments) and 6 (from European deployments).<sup>2</sup> As such, ATM can be tied to several goals, including those listed below:

- **Safety**—ATM strategies such as dynamic speed limits and queue warning can reduce rear-end crashes that result from a motorist’s inability to reduce speed quickly enough when congestion is initially observed. ATM strategies such as dynamic lane assignment may also help to reduce side-swipe and lane-change collisions at the ramp and freeway merge points and weaving areas. Moreover, congestion, regardless of its cause, increases the potential for collisions to occur; as noted below, ATM can help reduce congestion.
- **Mobility**—In general, ATM strategies such as dynamic speed limit, dynamic lane assignment, and queue warning can reduce turbulence in freeway traffic flow, which helps delay or prevent flow breakdown from occurring. Dynamic shoulder lanes can provide additional capacity when it is needed (e.g., peak travel periods). The reduction in crashes (i.e., the safety goal) also enhances mobility by reducing nonrecurring congestion. On arterials, the ATM strategy of adaptive traffic signal control by providing a broad “green band” along the road can provide smoother flow and maximize throughput.<sup>3</sup>

---

<sup>2</sup> In general, the ATM benefits from Europe are greater than those in the United States. There are several possible reasons for this: a relatively limited number of ATM deployments in the United States, coupled with the fact that Europeans may have a better understanding of what ATM signage means given their longer history of experience. Another likely factor is the extensive use of automated speed enforcement in Europe, which undoubtedly promotes compliance.

<sup>3</sup> A number of U.S. practitioners have been somewhat cautious in terms of promoting the mobility benefits of DSpl and DLA control. The underlying principle behind these “smoothing” ATM strategies is that a slower, more consistent, flow is less likely to break down into a congested condition, therefore improving travel times. Moreover, such smoothing of traffic flow should also allow a slight increase in throughput. As shown in Table 6 (specifically the Netherlands example), this may not always be the case. Moreover, explaining these nuances of traffic flow theory as part of a public outreach program may prove counterproductive. As such, safety has been the primary focus when promoting DSpl and DLA strategies in the United States.





**TABLE 5. SUMMARY OF ACTIVE TRAFFIC MANAGEMENT (ATM) BENEFITS FROM U.S. DEPLOYMENTS**

ATM Strategy	Location and Reference	Benefits
Adaptive Traffic Signal Control	<p>Range per the U.S. Department of Transportation Intelligent Transportation System Joint Program Office Benefits Database (8)</p> <ul style="list-style-type: none"> <li>• Reductions in stops of 10 to 41 percent.</li> <li>• Reductions in delays of 5 to 42 percent.</li> </ul>	
Ramp Metering	<p>Multiple locations(11):</p> <ul style="list-style-type: none"> <li>• Portland, Oregon: 43 percent reduction in peak period collisions and 173 percent increase in average travel speed.</li> <li>• Seattle, Washington: 39 percent reduction in collision rate and 52 percent reduction in average travel time.</li> <li>• Minneapolis, Minneapolis: 24 percent reduction in peak period collisions 16 percent increase in peak-hour travel speed.</li> <li>• Long Island, New York: 15 percent reduction in collision rate and 9 percent increase in average travel speed.</li> </ul>	
<p>Dynamic Speed Limits, Dynamic Lane Assignment, and Queue Warning</p>	<p>Seattle: ATM strategies were deployed along a 7-mile stretch of northbound Interstate 5 (I-5) just south of downtown Seattle, a corridor that was already actively managed via ramp metering, a robust incident management program, and traveler <i>information</i>.(5)</p>  <p>(Source: Washington State DOT)</p>	<ul style="list-style-type: none"> <li>• A before-and-after study (3 years for each period) showed total crashes decreased 4.1 percent along the ATM segment. (During the same period, the southbound segment of I-5 -- without ATM -- experienced a 4.4 percent increase in the number of crashes.)</li> </ul>
Transit Signal Priority	<p>Multiple Locations (12)</p> <ul style="list-style-type: none"> <li>• In Tacoma, Washington, the combination of TSP and signal optimization reduced transit signal delay approximately 40 percent in two corridors.</li> <li>• TriMet (Portland, Oregon) was able to avoid adding one more bus by using TSP and experienced a 10 percent improvement in travel time and as much as a 19 percent reduction in travel time variability.</li> <li>• In Chicago, PACE buses realized an average 15 percent reduction (3 minutes) in running time. Actual running time reductions varied from 7 to 20 percent, depending on the time of day.</li> <li>• Los Angeles experienced as much as a 25 percent reduction in bus travel times with TSP.</li> </ul>	

**TABLE 5. SUMMARY OF ACTIVE TRAFFIC MANAGEMENT (ATM) BENEFITS FROM U.S. DEPLOYMENTS**

ATM Strategy	Location and Reference	Benefits
<p>Dynamic Speed Limits, Dynamic Lane Assignment, Queue Warning and Dynamic Shoulder Lanes (for high-occupancy toll [HOT] lanes)</p>	<p>Minneapolis: Dynamic speed advisories (i.e., not legal limits) and dynamic lane assignment strategies—along with conversion of high-occupancy vehicle lanes to HOT lanes and using Dynamic Shoulder Lanes for HOT operations—were deployed in Minneapolis on Interstate 35W (I-35W), a corridor that was already actively managed via ramp metering, a robust incident management program, and traveler information. The work also included transit and geometric improvements. A formal evaluation was conducted as part of the Urban Partnership Agreement.(6,7)</p>  <p>(Source: Minnesota DOT)</p>	<ul style="list-style-type: none"> <li>• The Dynamic Speed Limit system positively impacted the most severe congestion (speeds below 10 to 15 miles per hour [mph]).</li> <li>• The instances and spread of extreme congestion waves has been reduced.</li> <li>• On average, the morning peak experienced 17 percent less congestion with the DSPL system in place.</li> <li>• Crash reductions in the 6-month post-deployment period were as follows:             <ul style="list-style-type: none"> <li>○ 9 percent for fatal plus injury crashes</li> <li>○ Greater than 20 percent for property damage only, and for total crashes, when the change in vehicle miles traveled was accounted for on I-35W.</li> </ul> </li> <li>• Small compliance to the advisory speed limits was observed.</li> </ul>
<p>Dynamic Speed Limits</p>	<p>While not an actual deployment, the University of California-Riverside used their Comprehensive Modal Emission Model and data from the California Freeway Performance Measurement System to evaluate the deployment of a system providing dynamic speed recommendations to drivers—based on traffic conditions and other external variables such as weather conditions—on freeways in Southern California.(10)</p>	<ul style="list-style-type: none"> <li>• Smoothing traffic flow during congested conditions could result in approximately 10 to 20 percent reductions in fuel consumption and carbon dioxide emissions, without drastically affecting overall travel times.</li> </ul>

**TABLE 5. SUMMARY OF ACTIVE TRAFFIC MANAGEMENT (ATM) BENEFITS FROM U.S. DEPLOYMENTS**

ATM Strategy	Location and Reference	Benefits
<p>Dynamic Junction Control</p>	<p>Los Angeles: A junction control system was installed in Los Angeles at the northbound State Route 110 connector to northbound I-5. The system consists of blank-out signs, allowing the lane adjacent to the exit-only lane to also be used as an exit lane (in addition to remaining a through lane) during peak periods.<sup>(9)</sup></p>  <p>(Source: Caltrans)</p>	<p>Following implementation of DJC:</p> <ul style="list-style-type: none"> <li>• Average ramp delay reduced from greater than 20 minutes to under 5 minutes.</li> <li>• Crashes decreased 30 percent from previous year.</li> </ul>
<p>Dynamic Shoulder Lanes (Bus on Shoulder [BOS] operations)</p>	<p>A 2-year “BOS” pilot program was implemented in Illinois on the Interstate 55 corridor in Du Page and Cook Counties.<sup>(50)</sup></p>  <p>(Source: Illinois DOT)</p>	<ul style="list-style-type: none"> <li>• Pace bus on-time performance increased from 68 to 92 percent.</li> <li>• Ridership increased threefold.</li> <li>• The number of bus trips was increased to accommodate increased demand.</li> <li>• There were no impacts on safety.</li> <li>• BOS program was made permanent, paving the way for shoulder operations on other highways and tollways in the region.</li> </ul>
<p>Dynamic Shoulder Lanes (Bus on Shoulder [BOS] operations)</p>	<p>The Minneapolis metro area uses BOS operations extensively, with over 300 miles of bus-only shoulders, ensuring fast, reliable travel times for commuters on thousands of buses daily <sup>(52)</sup>. Several other locations also use the shoulder for bus operations.</p>	



**TABLE 6. SUMMARY OF ACTIVE TRAFFIC MANAGEMENT (ATM) BENEFITS FROM EUROPEAN DEPLOYMENTS**

ATM Strategy	Location, Reference, and Benefits
General; freeway ATM	<p>The FHWA 2006 International Scan of ATM systems in Europe,<sup>(13)</sup> which focused on Dynamic Speed Limits, Dynamic Lane Assignment, Queue Warning, and Dynamic Shoulder Lanes, identified multiple benefits. Depending on the location and the combination of strategies deployed, specific ATM benefits measured in Europe included the following:</p> <ul style="list-style-type: none"> <li>• An increase in average throughput for congested periods of 3 to 7 percent.</li> <li>• An increase in overall capacity of 3 to 22 percent.</li> <li>• A decrease in primary incidents of 3 to 30 percent.</li> <li>• A decrease in secondary incidents of 40 to 50 percent.</li> <li>• An overall smoothing of speeds during congested periods.</li> <li>• An increase in trip reliability.</li> <li>• The ability to delay the onset of freeway breakdown.</li> </ul>
Dynamic Speed Limits, Dynamic Lane Assignment	<p>An evaluation of the Managed Motorway System on the M25 (London Orbital) in the United Kingdom <sup>(14)</sup> showed a decrease in the number of shockwaves, with a reduction from a typical seven shockwaves per morning rush hour, down to a typical five. Other benefits included the following:</p> <ul style="list-style-type: none"> <li>• Injury crashes decreased by 10 percent.</li> <li>• Damage-only crashes decreased by 30 percent.</li> <li>• Emissions decreased overall by between 2 and 8 percent.</li> <li>• Weekday traffic noise adjacent to the scheme was reduced by 0.7 decibels.</li> </ul>
Dynamic Shoulder Lanes	<p>Dynamic Shoulder Lanes in Germany <sup>(33)</sup> during peak period reduced congestion by 30 percent, and crashes caused by traffic jams reduced 25 percent.</p>
Dynamic Speed Limits	<p>A comprehensive program of field trials with several new applications of DSPL on motorways was carried out in The Netherlands in 2009 and 2010. Following are some of the key findings <sup>(15)</sup></p> <ul style="list-style-type: none"> <li>• Lowering the speed limits from 120 kilometers per hour (km/h) (74.6 mph) to 100 km/h (62.1 mph) or 80 km/h (49.7 mph) before and during heavy rain reduced average speeds by 9 to 13 km/h (5.6 to 8.1 mph) on top of the reduction drivers would apply in the absence of the dynamic speed limit. Traffic safety was improved substantially.</li> <li>• A shockwave algorithm designed to improve throughput by lowering the speed limit from 120 km/h (74.6 mph) to 60 km/h (37.3 mph)—with intermediate speed limits of 100 km/h and 80 km/h—actually reduced throughput in some sections.</li> <li>• Allowing a higher speed limit during the night increased the acceptance of a lower speed limit throughout the day.</li> <li>• Analysts concluded that using dynamic speed limits to reduce airborne pollution of particulate matter will only be effective when the traffic emission as part of the total concentration is relatively high.</li> </ul>

**TABLE 6. SUMMARY OF ACTIVE TRAFFIC MANAGEMENT (ATM) BENEFITS FROM EUROPEAN DEPLOYMENTS**

ATM Strategy	Location, Reference, and Benefits
Dynamic Speed Limits, Dynamic Lane Assignment, and Dynamic Shoulder Lanes	<p>An evaluation of the M42 in the United Kingdom identified the following benefits (17)</p> <ul style="list-style-type: none"> <li>• Property damage only crashes reduced by 30 percent.</li> <li>• Personal injury crashes declined from 5.2 per month before to 1.5 per month after implementation.</li> <li>• Overall, drivers had a slightly longer journey on the M42 with dynamic shoulder lanes, due to the reduced speed limits in operation. The journey times were, however, much more reliable. On average, over all weekdays, the variability of journey times was reduced between 27 and 34 percent.</li> <li>• When maximum speed was increased from 55 mph to 60 mph (with shoulder lanes), average journey times dropped 4 percent with no increase in incidents.</li> <li>• Carbon dioxide emissions and fuel consumption per vehicle reduced by 4 percent, and particulate matter emissions reduced 10 percent. These results reflect changes in individual vehicle emissions and do not consider the effects of any overall increases in traffic that may have come about as a result of the increased capacity when shoulder lanes are in operation.</li> </ul>
Dynamic Speed Limits, Dynamic Lane Assignment, and Dynamic Shoulder Lanes	<p>An assessment of noise impacts arising from implementing of “Smart Motorway” concepts along the M6 in the Birmingham area(18) showed the following:</p> <ul style="list-style-type: none"> <li>• Reductions in road traffic noise primarily through the reduction in speed.</li> <li>• Reductions in noise occurred even with an increase in throughput.</li> <li>• Daily average noise levels decrease by 0.3 to 1.7 decibels.</li> </ul>
Dynamic Junction Control	<p>A junction (interchange) control system in the Netherlands,(16) in which the rightmost lane on the motorway is closed to facilitate the merging of two lanes from the ramp, provided the following mobility benefits:</p> <ul style="list-style-type: none"> <li>• 8 percent decrease in mean travel times on ramp, and 7 percent decrease in mean travel times on the mainline.</li> <li>• 13 percent decrease in vehicle hours of delay on ramp, and 4 percent decrease in vehicle hours of delay on the mainline.</li> </ul>
Queue Warning	<p>In Germany, crashes were reduced by 20 percent on an autobahn with QW, while they increased by 10 percent on a similar autobahn without QW.(16)</p>

- **Reliability**—Linked to the mobility improvements noted above are improvements to travel time reliability. By reducing crashes and the resulting nonrecurring congestion, coupled with creating more uniformity in travel speeds and reducing shock waves, ATM strategies work toward making travel more reliable.
- **Environmental**—ATM has resulted in reduced emissions and reduced noise along freeways where various strategies have been implemented.<sup>4</sup> A related benefit and possible goal involves adaptation and resiliency to extreme weather events, helping to optimize traffic flow before severe weather (e.g., in support of evacuations) and immediately following its aftermath.
- **Improved transit operations**—Selected ATM strategies—specifically transit signal priority, dynamic shoulder lanes when opened only to transit vehicles (also known as a bus bypass shoulder or bus on shoulder), and adaptive ramp metering that accommodates a transit by-pass lane—can help promote transit-oriented goals and objectives. Moreover, any ATM strategy that improves a facility’s overall operation will also benefit transit operations.
- **Commercial vehicle operations and the economy**—Improving the overall operation of a facility with significant truck traffic will help improve commercial vehicle operations. One criterion used in the United Kingdom (41) for prioritizing roadways for ATM includes improving “access to international gateways (such as London Heathrow Airport or the Port of Felixstowe) to best support the national economy.” The United Kingdom has focused on these key routes to maximize benefits for freight movements as well as for motorists.
- **Livability**— “Livability” can be defined as “using the quality, location, and type of transportation facilities and services available to help achieve broader community goals, such as increasing travel choices, improving economic competitiveness, and enhancing unique community characteristics.” (19) Adaptive traffic signal control and transit signal priority can help local communities manage individual arterials to meet such goals. Moreover, improved transit operations can also enhance livability and the associated goal of accessibility.

*While it may not be an operational goal, per se, ATM contributes to the notion of “preservation.” Constructing new lanes or roadways is no longer a sustainable strategy due in large part to the relatively high cost of these projects coupled with environmental concerns. ATM helps transportation agencies preserve and improve the performance of their transportation network by getting more use out of its current infrastructure.*

Many, if not all, of these goals will likely be included in the regional transportation plan for any metropolitan area in the United States Given the extent to which ATM strategies can help

<sup>4</sup> Any environmental benefits from dynamic shoulder lanes are noted to possibly vary from neutral to an overall improvement, depending on specific site conditions. While reducing congestion and flow breakdown reduces the emissions per vehicle, there may be an overall increase in traffic as a result of the increased capacity when DShL is in operation. As noted in Reference 35 from the United Kingdom “...smoother traffic flow is likely to reduce individual vehicle emissions for a given average speed. This effect is likely to be outweighed by additional emissions from higher speeds and any extra, induced traffic using the network as a result of the additional capacity provided by hard shoulder running. Therefore overall, we expect that hard shoulder running will lead to an increase in traffic emissions compared to a 'do nothing' scenario. However, the impact of hard shoulder running on traffic emissions is expected to be lower than the impact of road widening.”

promote so many regional goals, the list of potential ATM strategies likely will not be reduced much, if at all, as part of this step. That said, this initial activity can help to accomplish the following:

- Prioritize the ATM strategies based on the priorities established in the region for the transportation goals and objectives.
- Provide a strong foundation for including ATM strategies in the transportation planning process. The two Urban Partnership Agreement (UPA) sites that included ATM—Minnesota Department of Transportation (MnDOT) and Washington State Department of Transportation (WSDOT)—made this linkage between ATM and the regional goals.(3)

## 2.2 Identify Relevant Objectives for ATM

As shown in Figure 1, the regional goals provide a basis for developing operations objectives. Recognizing the difference between goals and objectives is important. A goal broadly describes what the region and/or state wants to accomplish. Objectives are specific, measurable statements of performance that will lead to accomplishing the regional goals. Reference 2 (FHWA’s *Advancing Metropolitan Planning for Operations*) emphasizes the importance of each operations objective having “SMART” characteristics (i.e., **s**pecific, **m**easurable, **a**greed, **r**ealistic, and **t**ime-bound). The reference also notes that operations objectives are preferably described in terms of those system performance **outcomes** experienced by users (e.g., levels of congestion, crashes, travel times and delays, travel time reliability, mode choices, and access to traveler information.) The public cares about these measures, and they provide the basis for determining the extent to which the operational goals are being achieved.

Such outcome-based SMART objectives may not yet be included in the regional transportation plan or a transportation agency’s list of goals and objectives. The objectives may instead be fairly generic in nature, not providing any specific or measurable parameters. If this is the case, the ATM screening process may provide an opportunity to identify ATM-related SMART objectives—aligned with the regional goals—for subsequent inclusion in the regional and/or agency transportation plans, such as those listed in Table 7 (and taken from Reference 2). Many of the ATM benefits identified in Tables 5 and 6 align with these objectives.

**TABLE 7. SAMPLE OBJECTIVES FOR ACTIVE TRAFFIC MANAGEMENT (ATM)**

Goal	Outcome-Oriented Objectives
Mobility	<ul style="list-style-type: none"> <li>• Reduce the percentage of facility miles experiencing recurring congestion during the peak periods by X percent by year Y</li> <li>• Increase the percent of freeway interchanges/major interchanges operating at LOS Z or better during peak periods by X percent by year Y.</li> <li>• Reduce the daily hours of recurring congestion on major facilities from X to Y by year Z.</li> <li>• Reduce average delay per traveler by X percent by year Y.</li> <li>• Reduce the regional average travel time index by X percent per year. (Travel time index is the ratio of average peak period travel time as compared to free-flow travel time.)</li> </ul>

**TABLE 7. SAMPLE OBJECTIVES FOR ACTIVE TRAFFIC MANAGEMENT (ATM)**

Goal	Outcome-Oriented Objectives
Reliability	<ul style="list-style-type: none"> <li>• Reduce total person hours of delay by time period (peak, off-peak) caused by all transient (i.e., nonrecurrent) events such as traffic incidents, special events, and work zones) by X percent in Y years.</li> <li>• Decrease the average buffer index (for multiple routes, corridors, or trips) by X percent over Y years.</li> <li>• Reduce the average planning time index (for specific routes or corridors) by X (no units) over the next Y years.</li> </ul>
Safety	<ul style="list-style-type: none"> <li>• Reduce the crash rate (per person-hours, vehicle miles of travel) by severity (e.g., fatal, serious injury), and corridor/facility type (including work zones) by X percent in Y years.</li> <li>• Reduce the number of serious injuries/fatalities (statewide/regionally, by corridor/facility) by X percent in Y years.</li> <li>• Reduce the number of congestion-inducing incidents occurring at freeway interchanges and ramps by X percent by year Y.</li> </ul>
Environmental/ Resiliency	<ul style="list-style-type: none"> <li>• Reduce emissions (carbon dioxide, nitrogen oxides, carbon monoxide, and particulate matter) from vehicles and other transportation-related sources (on a corridor, region, or statewide basis) by X percent in Y years.</li> <li>• Reduce the per capita time (transport-related) to evacuate Z persons in the region/state by X percent over Y years.</li> </ul>
Economic Competitiveness	<ul style="list-style-type: none"> <li>• Decrease the annual average travel time index for freight-significant routes by X points in Y years.</li> <li>• Decrease point-to-point travel times on selected freight-significant highways by X minutes (or percent) within Y years.</li> <li>• Reduce buffer index on regional freight routes during peak and off-peak periods by X percent in Y years.</li> </ul>

## 2.2.1 Tools for Linking ATM Strategies with Goals and Objectives

This section describes two tools that are available to assist in identifying ATM strategies that can help promote regional goals and objectives—the Active Management Screening Tool and Turbo Architecture.

### 2.2.1.1 Active Management Screening Tool

The FHWA Office of Planning sponsored a project (20) to develop an Active Management Screening Tool (AMST) for use by those agencies that employ a CMP. The purpose of the AMST is to help those agencies better assess the potential of active management strategies for their region within the CMP. The AMST ascertains, at the appropriate screening level, major attributes about candidate corridors that help to determine whether any active management strategy is suitable and appropriate. ATM management strategies included in the tool are temporary shoulder use on freeways; speed harmonization; queue warning; ramp metering; dynamic merge control; and automated enforcement. Other strategies such as various managed lane approaches (e.g., high-occupancy

express toll, dedicated truck, and exclusive transitways) are also included in the tool. The following three levels of detail are provided:

- **Level 1: Goals**—Designed for use at a high level for planning and/or general educational purposes, this level focuses primarily on introducing the broad overview of active management and descriptions of potential strategies based on broad regional goals (Refer to Table 8).
- **Level 2: Objectives**—Designed to provide more detail regarding potential active management strategies for a region and/or corridor of interest, this level focuses on providing active management strategy alternatives based on a refinement of broad regional goals with specific objectives. Objectives identified in the AMST are noted to be fairly generic; that is, they don’t provide “SMART” characteristics as previously discussed.
- **Level 3: Corridor Characteristics**—Designed for users who want to rank the most appropriate active management strategies for the region and/or corridor based on specific information such as constraints and their relative weighting of the objectives.<sup>5</sup>

**TABLE 8. GOALS FROM THE ACTIVE MANAGEMENT SCREENING TOOL (AMST)**

• Provide a reliable alternative	• Modify travel demand
• Provide a transportation system that can handle current and future demand	• Improve accessibility
• Increase mobility and accessibility by offering travel options	• Improve the safety of corridor travel
• Provide additional facility capacity	• Maintain level of safety on a facility
• Optimize existing capacity	• Minimize environmental impacts
• Optimize existing managed lanes capacity	• Preserve neighborhoods
• Improve congested roadways	• Maintain land use patterns
• Enhance alternative modes of travel	• Develop transportation improvements that help offset costs
	• Maximize the benefit/cost ratio of investment

### 2.2.1.2 Turbo Architecture Tool

Turbo Architecture is a software application that supports development of regional and project ITS architectures using the National ITS Architecture as a starting point. Version 7 of the National ITS Architecture (21) and the associated Turbo Architecture application include a tool in the Planning Module whereby a user can select from a list of goals (Table 9) or by a key word search, and the tool will identify the relevant service packages. The selected service packages can then be linked to the associated ATM strategies. (Additional information on relevant service packages for ATM is provided in Chapter 7.)

<sup>5</sup> As part of the effort to develop the ATM guidance, the project team exercised the AMST to ascertain its overall validity and to identify any potential issues. Based on this review, the tool appears to work well for screening strategies against goals (Level 1) and objectives (Level 2). Level 3 appears to have stability issues. Often when using Level 3, and including all the goals and objectives with minimal constraints, the result obtained was “There are no suitable strategies for the combination of selections you chose.” Accordingly, Level 3 of the AMST is currently not recommended for use in this ATM screening process.

**TABLE 9. GOALS FROM THE TURBO ARCHITECTURE PLANNING MODULE**

- Enhance mobility, convenience, and comfort for transportation system users
- Enhance the integration and connectivity of the transportation system
- Improve the safety of the transportation system
- Improve the security of the transportation system
- Increase operational efficiency and reliability of the transportation system
- Preserve the transportation system
- Reduce environmental impacts
- Support regional economic productivity and development

### 2.2.1.3 Matrix Format

Using an established tool to ensure that a link exists between the regional goals and ATM strategies is not necessary. Knowledge of the benefits from ATM (as summarized in previous Table 5 and 6 and as available from the number of references) can be “manually” linked using a matrix relating the various ATM strategies with how well they help achieve the regional goals, operations objectives, and/or associated problem areas and needs. One such example of a potential matrix in this regard is provided in Table 10. Based on this information, an initial selection of ATM concepts and strategies can be made.

## 2.3 Define Network to Be Analyzed

Defining the roadway network for ATM screening is important. No criteria are provided in this regard; there is no maximum or minimum size. These guidelines have been developed so that practitioners can narrow down both geographic and functional options through succeeding steps and levels of detailed analyses. For example, if the network is quite large (e.g., a statewide analysis), then the activities discussed in Chapter 4, Identify Major Roadway Segments for Potential Active Traffic Management, may prove quite useful. If the network under consideration is relatively small, then skipping this effort and going directly to the detailed ATM strategy analyses described in Chapter 5, Analyze and Prioritize Individual Roadway Links and ATM Strategies, is possible.

## 2.4 Identify and Collaborate With Stakeholders

Successful ATM deployments require a well-planned, interdisciplinary collaboration with planning, operations, design, maintenance, and enforcement. Successful implementation also benefits from the following:

- High-level champions who sustain or lead a change in agency culture change to a more operations-oriented focus.
- Overcoming the “we never did this before” attitude.
- Funding and organizational commitments for adequate long-term operations and maintenance.

**TABLE 10. SUMMARY OF THE EXTENT TO WHICH ACTIVE TRAFFIC MANAGEMENT (ATM) STRATEGIES MAY HELP SOLVE TRANSPORTATION ISSUES AND HELP ACHIEVE REGIONAL GOALS**

Regional Goal	Issue/Consideration	ATM Strategies <sup>a</sup>						
		DSpL/ DLA <sup>b</sup>	DShL	DShL (Bus on Shoulder)	DJC	ARM	TSP	ATSC
Safety	High rate of crashes along roadway segments	●	○	○	◐	●	○	◐
	High rate of crashes in vicinity of interchange	◐	○	○	●	●	○	○
	High rate of secondary crashes	●	○	○	◐	◐	○	○
Mobility	Congestion along segment during peak period	◐	●	◐	◐	●	◐	●
	Congestion in vicinity of interchange	◐	◐	○	●	●	○	◐
Reliability	Significant variation in average speeds	●	◐	○	◐	●	●	●
	Significant variations in traffic flows (special events)	●	●	○	●	◐	●	●
Environment	Nonattainment area	●	○	◐	○	◐	◐	●
	Concern with greenhouse gas emissions	●	○	◐	○	◐	◐	●
Preservation	Delay need for major (and costly) capacity expansion	◐	●	○	●	●	○	◐
	Support work zone management/alternative routes	●	●	◐	●	◐	○	◐
	Climate change adaption/resiliency (evacuation routes)	◐	●	○	●	○	○	◐
Livability/ accessibility	Delays to buses	◐	◐	●	◐	◐	●	◐
	“Livable Streets” (arterials)	○	○	○	○	○	●	●

Notes:

● = major improvement; ◐ = some improvement; ○ = neutral or not applicable

<sup>a</sup> DSpL = Dynamic Speed Limits, DLA = Dynamic Lane Assignment, DShL = Dynamic Shoulder Lane, DJC = Dynamic Junction Control, ARM = Adaptive Ramp Metering, TSP = Transit Signal Priority, ATSC = Adaptive Traffic Signal Control.

<sup>b</sup> Dynamic speed limits and dynamic lane assignment are frequently deployed together



Stakeholder education is an ongoing process, starting with the initial screening as described herein, and continuing through project funding and the various phases of the systems engineering process. Examples of likely ATM stakeholders—particularly at the beginning of the process—include state and local DOT staff (i.e., executives, operations staff, maintenance personnel, planning, and budgeting), MPOs, transit agencies, enforcement agencies and other emergency responders, FHWA, and FTA. In addition to the ongoing internal and external coordination necessary for such a project, it is also important to engage with those entities, such as elected and/or appointed officials and their staff, who approve project funding and budget and/or approve changes to rules, policies, and even legislation that may be necessary to support ATM operations. The traveling public are also important stakeholders; however, outreach and education to this stakeholder group in earnest is not recommended until after the screening process is complete and the next steps are considered.<sup>6</sup>

### 2.4.1 Stakeholder Education and Outreach

For stakeholders who do not have a working knowledge of ATM, implementing an education and outreach program during the early stages of the ATM effort will help build trust in the proposed investments. Such a program could be carried out as part of the screening process and used to inform stakeholders of the purposes, benefits, operation, and performance outcomes of ATM strategies, including how the ATM strategies can contribute to achieving regional goals and objectives.

During the screening process, outreach activities will likely focus on stakeholder education within the implementing agency and MPO. Following are some examples:

- Senior managers within the agency and the MPO, who are ultimately responsible for approving the budgets and funding necessary for implementing ATM and for the subsequent operations and maintenance activities, are obvious stakeholders. It is likely not a coincidence that the initial deployments of DSPL and DLA systems in this country occurred at locations (i.e., Washington and Minnesota) where agency (and in some cases MPO) officials participated in the 2006 international scanning tour. Additionally, representatives from the Netherlands visited and spoke to the Virginia DOT Commissioner and Deputy Commissioner (who were initially skeptical) about the benefits of ATM.

*Peer exchanges, involving counterparts from other states or countries with ATM experience, as well as FHWA, can be very beneficial in helping to inform agency staff—be they executives, designers, operators, or enforcement—and possibly elected officials (e.g., MPO Board), of ATM benefits and convince them that implementing ATM strategies will help to improve operations and further meet the needs of the driving public (i.e., the agency’s customers).*

*An example of this approach is the 2007 Executive Forum on Reducing Traffic Congestion – Real Opportunities from Europe and the U.S (51), sponsored by the Puget Sound Regional Council and Washington State DOT, and it included state officials and legislators, city and county officials, enforcement, along with staff from the DOT and MPO.*

<sup>6</sup> There is some discussion of public outreach in Chapter 7, Next Steps.

- ATM (and other ATDM-related) strategies are based on the notion of automated operations. Transportation management center (TMC) operators may not be familiar or comfortable with such an increased level of automation and/or on the use of decision support systems. Additionally, if a region has operators who search for innovation and are on top of the latest technology, then these operators will provide valuable input into how the system can be most effective. Staff with the knowledge, skills, and abilities to effectively operate ATM strategies (as well as maintain the additional ITS equipment for ATM) is critical to success. Therefore, operators should be included in these initial outreach activities (followed, in subsequent stages of ATM deployment, by training on the procedures for effective operation.)
- System design and maintenance staff should also be involved in these agency-based outreach activities, because they, too, will have an important role to play in the ATM system.

### 2.4.2 Compliance-Related Outreach

The success of many ATM strategies—particularly dynamic speed limits, along with dynamic lane assignment, dynamic shoulder lanes and junction control (where lanes may be opened or closed to traffic)—depends on the extent to which drivers comply with the associated signing. Public outreach and education will, therefore, be a critical component of any ATM program. This effort typically occurs as the new signage is being considered and designed, and is not explicitly addressed in this feasibility and screening guidance; however, the costs associated with such a public education and outreach program (e.g., brochures, media spots, blogs, social media) need to be included in the preliminary ATM cost estimate as discussed in Chapter 6.

As noted in a U.K. study on Managed Motorways and ATM,<sup>(17)</sup> “We cannot prudently rely *solely* upon willing compliance, because our assumptions about driver behavior also rely on them understanding that there is a risk of enforcement if they do not comply. Enforcement may also be necessary to sustain compliance levels over time.” Without steady and consistent enforcement presence, dynamic speed limits and lane control and other new ATM strategies likely will not be as effective in smoothing traffic flow and enhancing safety. In Europe, agencies often employ automated enforcement to ensure compliance with posted speed limits. Automated speed enforcement in the United States is still uncommon (outside of school and work zones), and there is substantial discontent for such programs by the public. Accordingly, an increased law enforcement presence will likely be needed.<sup>(4)</sup> This will require ongoing outreach and coordination with the state and local police, starting with the screening process. There are several considerations in this regard, such as the following:

- Having the legal authority for the DOT to vary speed limits.
- How the dynamic speeds (and related ATM strategies) will be enforced (regulatory or advisory), including support from law enforcement and legislative parties to enforce the ATM techniques. As an example, Oregon state law permits variable speed limits, but the system recently installed on Highway 217 in the Portland area uses speed advisories. The police had some concerns with enforcing the variable legal limits; issues included having access to all the speed displays in real time (to determine whether a driver was exceeding

the speed limit) and having a record of all posted speed limits by date and time in a format that would provide a chain of evidence that would be admissible in court. Oregon has a rule regarding traveling at unsafe speeds, which will be the basis for enforcement vis-à-vis the posted advisories.

- Identifying locations where law enforcement can be safely stationed to view compliance and where noncomplying vehicles can be safely pulled over without adversely affecting traffic operations, with any additional cost for geometric changes to accommodate this included in the preliminary cost estimate.
- Procedures and supporting technologies for providing real-time information to police officers in the field about the legal limits being displayed and when the last change to the speed display was made (i.e., officers generally will not issue a citation until the new speed limit has been in place for a number of minutes) and for documenting the displayed speed limit by location and time of day in such a way that will be accepted by the courts should legal speed limits be displayed. Like other considerations noted herein, this does not impact the screening process, per se; but any associated costs should be included in the preliminary ATM cost estimate.

Enforcement staff should be brought into the discussion at the beginning of the screening process to educate them as to the operational concepts and benefits associated with ATM strategies (likely focusing on the safety and incident management benefits) and also to solicit their input and concerns. Peer exchanges with other enforcement organizations with ATM experience can help in garnering enforcement support.

## 2.5 Commence Data Collection

This ATM screening guidance has been developed so that collecting extensive amounts of new data will not be required. The process includes a quantitative analysis of roadway segments and links to further refine ATM strategies and priorities, but it is envisioned that this will be based on existing data to the greatest extent possible. However, gathering and compiling this available information can take time and is, therefore, included in the “Get Started – Preparation” phase of the process. Table 11 lists these desired data. In addition to these data (as well as being potential sources of some of the information) existing documentation regarding regional goals and objectives and the performance of the transportation network should also be collected and reviewed at the beginning of the screening process. Examples of these documents include the regional and statewide long-range transportation plans, the CMP documentation, highway safety improvement plans, the regional/statewide ITS architecture, ITS strategic plan, regional concept of transportation operations, and any performance management plans.

With respect to the last item in Table 11, roadway geometry will likely impact costing and selecting ATM strategies, particularly for dynamic shoulder lanes, junction control, and ramp metering. Lane and shoulder widths, as well as the existing pavement structural capabilities, will need to be considered for implementing shoulder lanes and junction control. Additionally, ramp tapers will have to be considered when deploying shoulder lanes to verify that movements to/from ramps onto and from the mainline can be done so safely. Ramp lengths

and widths will also impact the length of ramp queues during ramp metering operations, potentially requiring geometric enhancements to prevent the queues from backing up into the arterial street feeding the ramp. For those instances where widening is required, be it a ramp, shoulder, or emergency pull-out area, the physical ability to do so may be restricted because of limited right-of-way, existing infrastructure (e.g., structures associated with bridges, overpasses, tunnels, retaining walls, major utilities), and/or environmental concerns near the right-of-way.(4)

**TABLE 11. DESIRED INFORMATION AND DATA FOR PRELIMINARY ACTIVE TRAFFIC MANAGEMENT (ATM) SCREENING**

<p><b>Crash data:</b> 3 years or more of most recent information, including the following:</p> <ul style="list-style-type: none"> <li>• Time and date of crash.</li> <li>• Location of crash and direction of travel (e.g., vicinity of ramp).</li> <li>• Type of crash (e.g., rear end, side swipe, head on, fixed object).</li> <li>• Severity of crash (e.g., damage only, slight injury, serious injury, death).</li> <li>• Classifications of vehicles involved.</li> <li>• Weather conditions at time of crash.</li> <li>• Primary vs. secondary crash.</li> </ul>
<p><b>Collision patterns</b> can provide insight into not only whether ATM can reduce observed problems, but also which strategies would be best suited to the specific types of collisions occurring along various highway segments.</p>
<p><b>System performance data:</b> Preferably by roadway link (e.g., between interchanges) and/or milepost.</p> <ul style="list-style-type: none"> <li>• Average link speed information, speed profiles, and/or delay costs by time of day (15-minute intervals) and for different operational conditions (e.g., special events, work zones, and adverse weather). Speed profiles not only identify congested segments and bottlenecks but also those segments with significant variability in speeds, scenarios that may be improved by ATM. Speed profiles and associated performance data should ideally cover one calendar year (all days and all hours) to capture seasonal differences.</li> <li>• The system performance data should allow the flexibility to isolate certain days and operational scenarios such as peak periods, major incident conditions, special events, and holidays.</li> </ul>
<p><b>Volume Data</b></p> <ul style="list-style-type: none"> <li>• Volume data (volume/capacity ratios as an indication of recurrent congestion that may be helped by dynamic shoulder lanes).</li> <li>• Ramp (on and off) and mainline volume data at interchanges (for determining the feasibility of junction control and ramp management strategies).</li> </ul>
<p><b>Recurring and potentially hazardous weather conditions and issues</b></p> <ul style="list-style-type: none"> <li>• Frequency and locations.</li> <li>• Impacts.</li> </ul>
<p><b>Transit information:</b> For such strategies as transit signal priority and exclusive bus-on-shoulder operation.</p> <ul style="list-style-type: none"> <li>• Bus routes and service frequency (headways per number of buses per hour).</li> <li>• Type of bus service (local, express, bus rapid transit).</li> <li>• Schedule reliability and/or variability.</li> <li>• Number of passengers.</li> </ul>
<p><b>Air quality data:</b> As may be available.</p>

**TABLE 11. DESIRED INFORMATION AND DATA FOR PRELIMINARY  
ACTIVE TRAFFIC MANAGEMENT (ATM) SCREENING**

**Ongoing and planned major roadway improvements:** Such major reconstruction activities may provide a cost-effective approach for the initial implementation or expansion of ATM.

**Existing operations and ITS assets: Freeway, arterials, and ramps.**

- Current TSM&O strategies.
- Communications, power, detectors, closed-circuit television, dynamic message sign, signal control and controller types.
- Roadway mapping and geometry

## 2.6 Review Recent Literature

As previously noted, the information and recommended guidance herein was derived from an extensive review of literature coupled with interviews of several practitioners who have been involved with ATM projects. ATM, however, is an evolving set of proactive strategies, not only in the United States but also in several European countries where the practice has been established for several years, and new information is always being obtained, compiled, and published. FHWA, therefore, recommends that the practitioner determine whether any new approaches and recommendations have come to light that might impact or otherwise influence the ATM decisions resulting from this Guide.



# Chapter 3. Assess Agency Policies and Capabilities for Active Traffic Management

The activities associated with this step are shown in Figure 5. The initial activity shown is ensuring that ATM concepts and strategies help achieve regional goals and objectives, as discussed in the previous chapter (Sections 2.1 and 2.2). The other activities are discussed below. This step can occur either concurrently with, or upon completion of the “Get Started – Preparation” step.

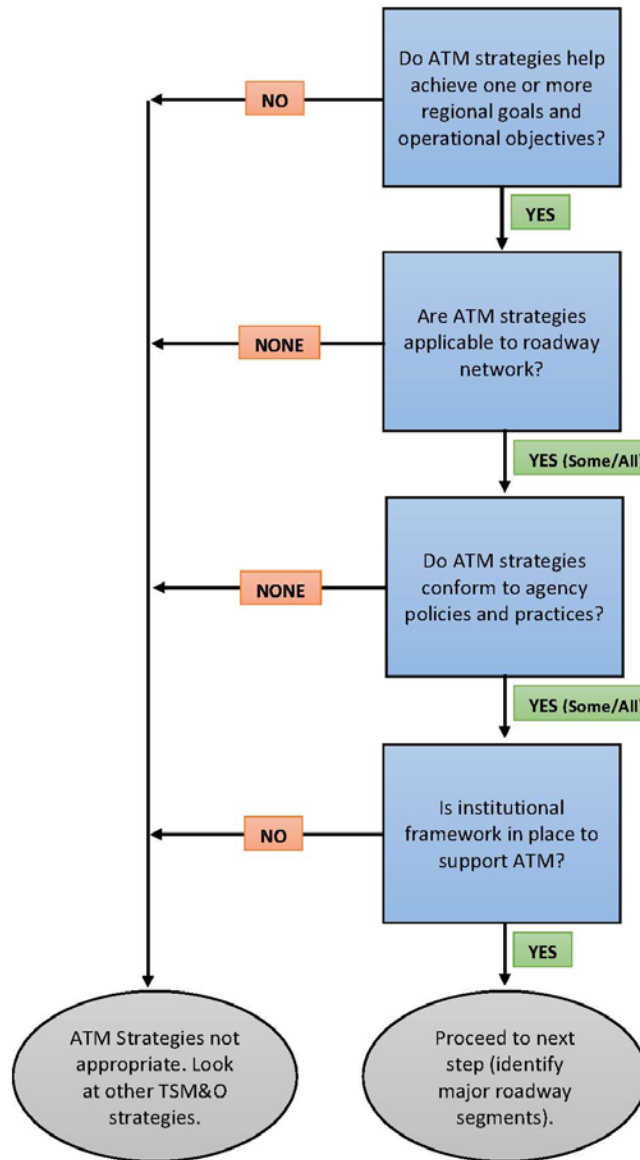

FIGURE 5. FLOWCHART. ASSESSING AGENCY POLICIES AND CAPABILITIES FOR ACTIVE TRAFFIC MANAGEMENT (ATM)

## 3.1 Define Applicable ATM Strategies in Terms of Network Features, Project Scope, Agency Policies, and Legal Considerations

This step involves several activities and considerations as noted below.

### 3.1.1 Roadway Network and Facility Type

The types of roadway facilities included in the network that will be analyzed can potentially filter out some of the ATM strategies. For example, if the network only includes limited access roadways (as may be the case if this ATM screening process is being performed by a state DOT), then ATSC and TSP may be eliminated from consideration. Similarly, if the network being analyzed consists of only arterials, then some of the more-freeway oriented strategies (e.g., dynamic shoulder lanes, queue warning, dynamic speed limits) may not be appropriate (although not necessarily).

### 3.1.2 Agency Policies and Practices

Another important consideration includes the agency's operations and facility policies—both formal and informal ones—and practices. These may eliminate one or more ATM strategies. For example, some agencies have tended to avoid ramp metering or shoulder use due to earlier unsuccessful deployments or because agency management is unconvinced of the benefits or perceive high public resistance. Nevertheless, it still may be worthwhile to include such strategies in this initial screening as a way to show the possible benefits (and making a business case) for moving forward. The practitioner needs to be sensitive to such informal policies and high resistance to some ATM concepts and strategies and gauge whether it is worth eliminating them from the process at this point.

### 3.1.3 Legal Considerations

In addition to any policy considerations, state and local laws and regulations should be reviewed to determine whether some ATM strategies are even possible and/or how they might need to be implemented. This effort may result in initiating the process to modify certain laws and regulations to better accommodate ATM. Possible legal and regulatory restrictions might impact the following ATM strategies:

- **Dynamic speed limits**—The speed displays in Minneapolis are “advisories” because there is no statutory authority for variable legal limits. On the other hand, the Pennsylvania Code 212.108, Speed Limits, permits using variable speed limits, stating “...to improve safety, speed limits may be changed as a function of traffic speeds or densities, weather or roadway conditions or other factors.” The code also states that “...variable speed limit sign shall be placed ... at intervals not greater than 1/2 mile throughout the area with the speed limit,” a legal requirement that will impact spacing and the associated costs.
- **Dynamic shoulder lanes and dynamic junction control**—Using the shoulder for purposes other than as a temporary vehicle refuge may not be allowed. A related issue is that some states may have statutes making it illegal to pass a vehicle by using the shoulder (e.g., “In no event shall such movement be made by driving off of the pavement or main traveled portion of the roadway.”) The issue becomes one of whether the shoulder is considered



part of the main traveled portion of the roadway when dynamic shoulder lanes are in operation. Another potential legal concern involves lane restrictions for trucks. If trucks are restricted from specific lanes and/or allowed in only certain lanes (e.g., outside or inside lanes), then opening the shoulder to traffic (in essence, adding a lane during certain periods of the day) may change how these restrictions can be interpreted from an operational perspective. It is probably best to check state statutes and get a legal opinion as may be appropriate.

## 3.2 Confirm Supporting Institutional Framework Is in Place

Having the appropriate institutional framework in place to support ATM operations (as well as other TSM&O activities) is very important. The Second Strategic Highway Research Program (SHRP2) has found that reaching the full potential of TSM&O is not primarily a “technology” issue or knowledge of best operations practices. The key is to put in place and manage specific supportive business and technical processes and supporting institutional arrangements—in essence, to “mainstream operations” into the institutional framework of the transportation agency.

The SHRP2 L06 product,(22) *Institutional Architectures to Advance Operational Strategies*, identifies the following six dimensions of organizational capability:

- **Business processes**—Formal scoping, planning and programming, and budgeting (resources).
- **Systems and technology**—Using systems engineering, systems architectures, standards (and standardization), and interoperability.
- **Performance**—Defining measures, data acquisition and analytics, and utilization.
- **Culture**—Technical understanding, leadership, outreach, and program legal authority.
- **Organization and staffing**—Programmatic status, organizational structure, staff development, recruitment and retention.
- **Collaboration**—Relationships and partnering among levels of government and with public safety agencies, local governments, MPOs, and the private sector.

For each of these six dimensions, four levels of capability maturity have been defined, where the term “maturity” is related to the degree of formality and optimization of these processes in support of effective operations, with the maturity increasing from level 1 (Performed), to level 2 (Managed), to level 3 (Integrated), and to level 4 (Optimized).

FHWA is currently developing capability maturity frameworks for various operations activities, including incident management, work zone management, special event management, road weather management, traffic signal management, and traffic management. These frameworks should be available soon on the FHWA Planning for Operations website. Per a beta version of the matrix for assessing the capability maturity framework for “traffic management,” proper deployment of ATM strategies as defined herein, with their dynamic nature and reliance on automation, would place an agency at Level 4 for the “Systems and Technology” dimension, which reads as follows:

*“Automation of traffic management processes is based on historical, current, and predicted data. New and emerging technologies are deployed on a continuous basis to improve system efficiency.”*

Accordingly, it may be best for any agencies wishing to pursue ATM (and any ATDM-related activity for that matter) to be moving towards Level 2, and preferably Level 3, for several of the dimensions defined under the “Traffic Management Capability Maturity Framework.”<sup>7</sup> Relevant examples of these capability maturity levels—per the draft traffic management framework—are described below:

- **Business Processes**— “Traffic management development and deployment processes are standardized and have a more system-wide approach that is well documented” (Level 3).
- **Performance Measurement**—“Agencies identify desired outcome measures and consistently utilize performance measure analyses to improve strategy deployment and overall operations” (Level 3).
- **Organization and Workforce**—“Core staff knowledge, skills, and abilities are identified within the traffic management arena, and roles are linked across various responsible groups” (Level 2).
- **Culture**—“Traffic management is recognized as valuable and a key role of the agency. Select agency managers lead efforts for traffic management” (Level 2).
- **Collaboration**—“Agencies collaborate on traffic management at a high level via engagement of regional stakeholders” (Level 3).

It is probably not essential for agencies to be at these traffic management capability maturity levels to pursue ATM, but it will likely make the life-cycle process and management of ATM strategies much easier and more effective.

---

<sup>7</sup> This should not be confused with the more general TSM&O program-oriented CMM framework that several DOTs and other transportation entities are using as part of a FHWA/AASHTO SHRP-2 Implementation program. This broad CMM framework addresses the institutional aspects of an agency’s program. The Traffic Management Capability Maturity Frameworks uses the same six CMM dimensions but provides more focused agency guidance for traffic management.

# Chapter 4. Identify Major Roadway Segments for Potential Active Traffic Management

---

Having identified potential ATM strategies that can help satisfy agencies' regional transportation goals and objectives and that conform to the type of roadway network, agency policies, and any potential legal constraints, the next step is to identify individual roadway segments where ATM strategies are likely to provide operational benefits. There are no hard and fast rules as to the length of these roadway "segments." A general rule of thumb is to use major interchanges and/or intersections—where traffic flow characteristics often change—as the termini for these segments; or perhaps to make the entire facility a "segment" in the case of a connecting roadway or spur.

This screening activity (as summarized in Figure 6) is envisioned as primarily a qualitative assessment using readily available information (e.g., CMP, corridor studies, and other existing information and reports), coupled with local knowledge of the ATM stakeholders.

## 4.1 Determine Level of Existing Transportation Systems Management and Operations and Intelligent Transportation System Deployment

*Active Traffic Management: The Next Step in Congestion Management* is the document (13) that summarizes the results of the 2006 European scanning tour, which essentially introduced many ATM strategies to the United States. This document's title represents the appropriate view for any agency considering ATM strategies. Congestion management activities involve numerous strategies and supporting ITS technologies. TSM&O can be viewed as forming a continuum of approaches and systems (as shown in Figure 7), starting with the more conventional (and primarily reactive) strategies such as time-of-day signal control, basic traveler information (e.g., radio and dynamic message signs (DMS), a few ramp meters at bottleneck locations, and incident response); and then to the more advanced and proactive (i.e., "smart") approaches as provided by ATM. The next step is to integrate all these individual strategies together (e.g., Integrated Corridor Management [ICM]) as part of an overall ATDM philosophy.<sup>8</sup> These more advanced strategies and technologies build upon the preceding ones, creating a series of "steps."

Just because a roadway segment is experiencing significant congestion, safety, and/or environmental problems, it does not necessarily mean that ATM strategies are the optimum solution. Before considering advanced TSM&O approaches such as ATM, the more conventional operations strategies and supporting ITS technologies should already be in place and thoroughly used. Implementing or enhancing the more conventional TSM&O strategies, such as incident management and enhanced traveler information, may be more appropriate before implementing ATM strategies. In other words, the deployment of ATM strategies should

---

<sup>8</sup> And one can only surmise where this operations continuum will lead in the future with Connected Vehicles, automated driving functions, "big data" and predictive capabilities.

represent the “next step” rather than a “quantum leap” for managing congestion and enhancing safety.

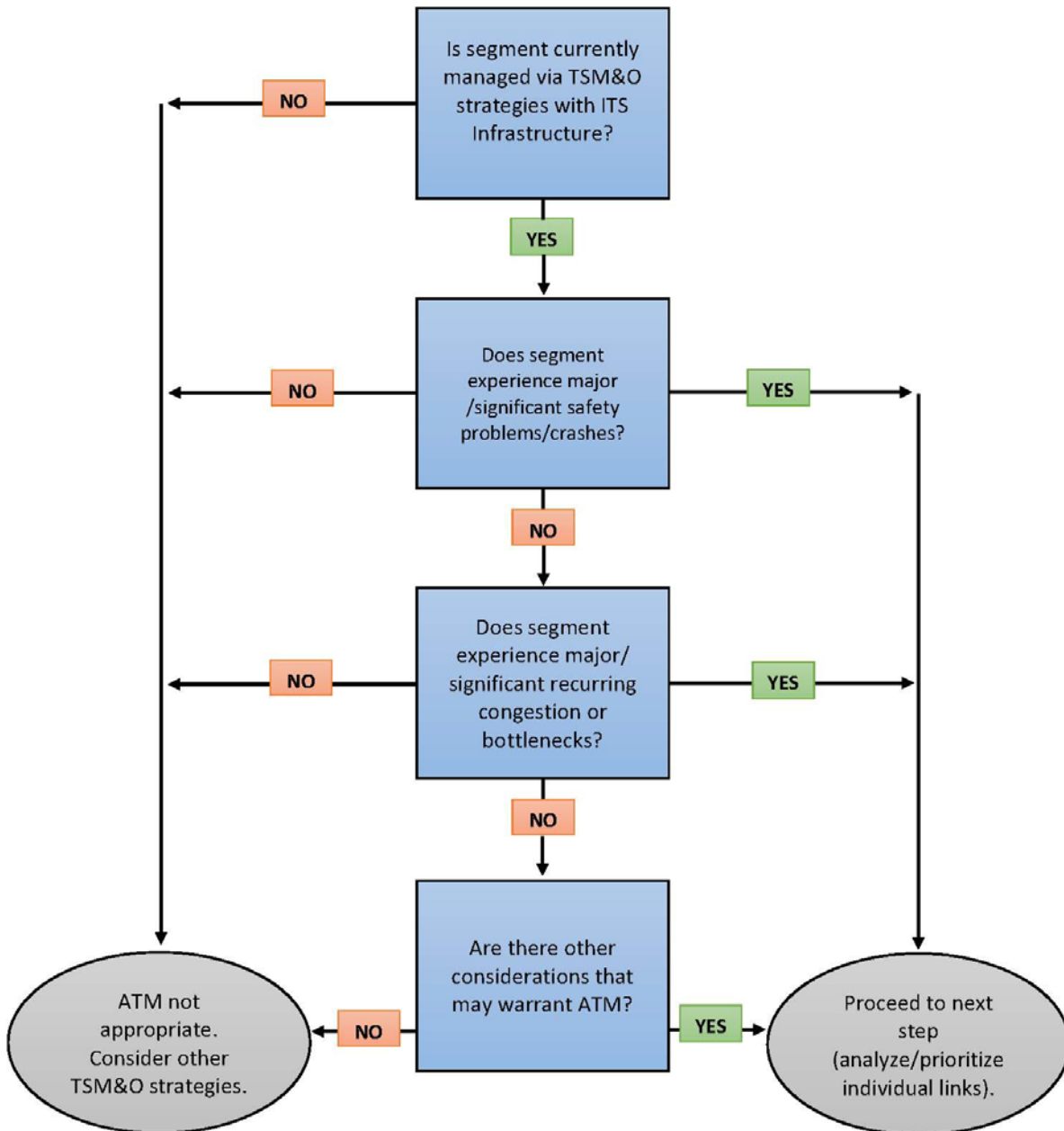

FIGURE 6. FLOWCHART. IDENTIFY MAJOR ROADWAY SEGMENTS FOR POTENTIAL ACTIVE TRAFFIC MANAGEMENT (ATM)

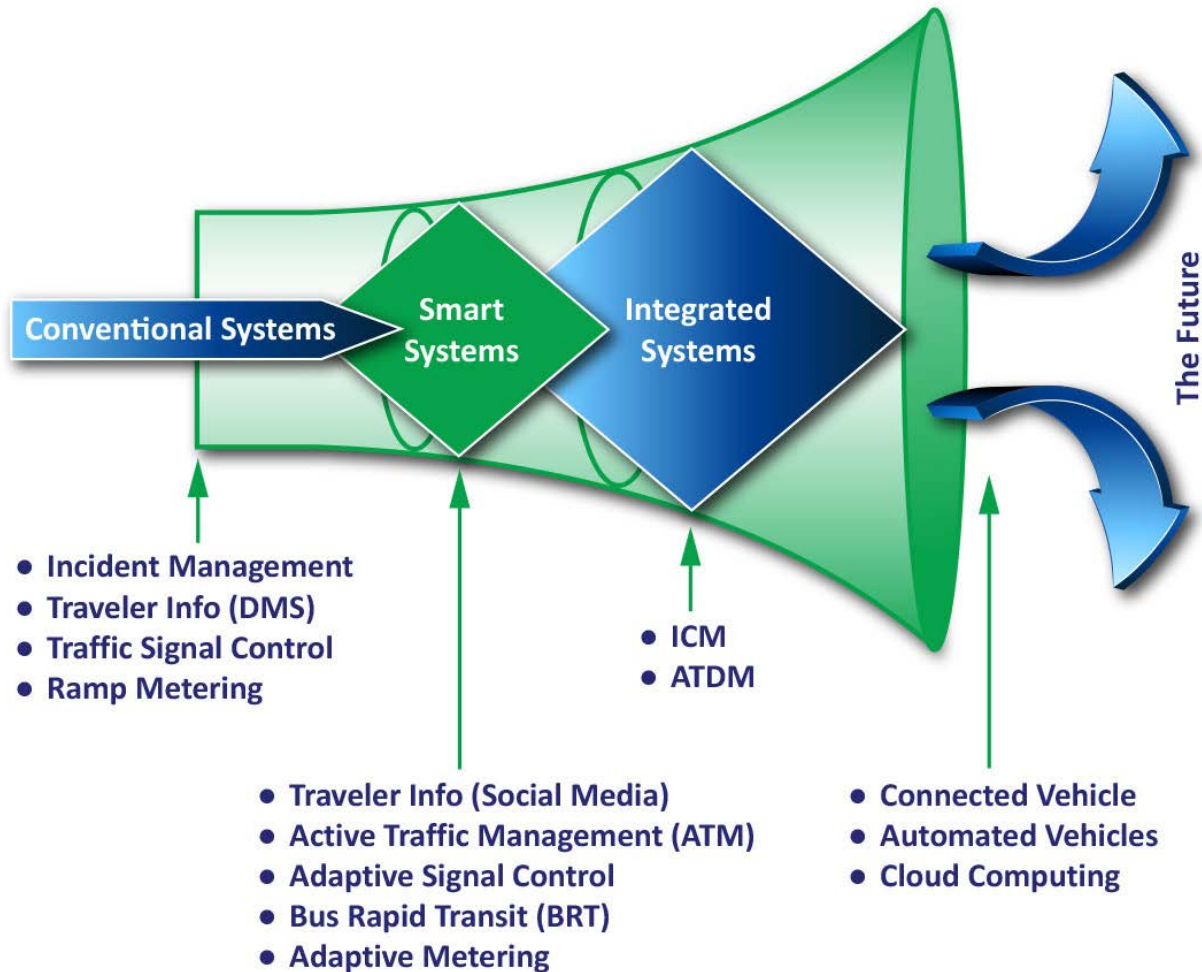

FIGURE 7. DIAGRAM. CONTINUUM OF OPERATIONS STRATEGIES (BASED ON MATERIALS FROM THE SECOND STRATEGIC HIGHWAY RESEARCH PROGRAM [SHRP2] L36 PILOT REGIONAL OPERATIONS FORUMS)

Moreover, having basic ITS infrastructure (e.g., detection, closed-circuit television [CCTV], communications and power) already in place will likely reduce the costs of deploying ATM. The current functionality should be reviewed to determine whether the existing ITS infrastructure can be used for both the original intent as well as the proposed ATM strategies to obtain the greatest benefit from existing system investments.

## 4.2 Identify Major Segments That Will Likely Benefit From Deploying Active Traffic Management

As has already been discussed, ATM strategies can provide significant benefits in terms of improved safety and reduced congestion, as well as other providing other positive attributes. Segments that have one or more of these issues are likely to benefit from ATM.

### 4.2.1 Safety Problems

Roadway segments where there are a historically large number of crashes and incidents relative to other segments, and the resulting non-recurrent congestion, are strong candidates for ATM. This increased level of crashes may be a result of recurring congestion patterns, sudden

changes to prevailing conditions (e.g., horizontal or vertical curves), adverse weather (e.g., recurring fog, wind, snow or ice conditions), or some other reason. ATM strategy implementation likely will vary depending on the prevalence and type of crashes occurring at these locations (as is further discussed in Chapter 5). For instance, a queue warning or dynamic speed limit system may be appropriate if there is an increased incidence of rear-end or lane change crashes that occur near a specific location on the highway. Junction control may also be appropriate if there are large numbers of side-swipe or rear-end collisions at or immediately downstream of entrance ramps during certain times of day. Dynamic speed limits may help reduce crashes along roadway segments that experience frequent adverse weather (e.g., fog, wind, snow, and ice) causing safety hazards for drivers.

### 4.2.2 Recurring Congestion and Bottlenecks

Roadway segments with frequent recurring congestion are often excellent candidates for ATM strategies. This congestion may be caused by several conditions, including the following:

- **High traffic volumes**—Roadways where traffic volumes often approach capacity or persist for long durations may benefit from ATM such as DShL, ARM, and ATSC. This is especially true if future capacity expansion cannot be created because lack of construction funding, geometric or environmental constraints, or because creating new full-time capacity does not conform to state, regional, or local policy.(4) A related consideration is the extent to which the congestion is directional—heavy in one direction one part of the day, heavy in the opposite direction during another period—a scenario that might benefit from dynamic lane reversal.
- **Capacity-reducing bottlenecks**—Bottlenecks, especially lane reductions, weaving and merging areas at ramps, and other geometric bottlenecks, reduce capacity and cause congestion. Using dynamic shoulder lanes, dynamic junction control and/or adaptive ramp metering during peak periods may be beneficial at bottlenecks to increase capacity and reduce the resulting congestion. Additionally, strategies like dynamic speed limits, dynamic lane assignment and queue warning could be potential applications that can reduce shock waves in traffic and warn of oncoming congestion, smoothing traffic flow before reaching an affected area.(4)

### 4.2.3 Other Considerations

Other situations that might highlight (or conversely diminish) roadway segments for potential deployment of ATM include the following:

- **Transit operations**—ATM strategies are especially beneficial within corridors in which transit is a major component and whose operations are subject to high variability (e.g., schedule adherence). Transit use can be improved by providing time savings and reliability to its users. ATM strategies that reduce the instability in traffic flow, like DSpl and DJC, may help stabilize traffic flow and enhance reliability. Similarly, transit-oriented ATM strategies, such as bus-only shoulder lanes (a form of DShL) and transit signal priority, may further enhance transit operations.
- **Construction activity and opportunity**—Ongoing or planned construction activities may influence ATM feasibility and implementation priorities. ATM strategies may be deemed

more feasible or at least ranked higher for implementation if the opportunity exists to piggyback the installing ATM infrastructure on current or planned construction activities in corridor segments where ATM strategies are desired. ATM strategies may also be used as part of the overall maintenance and protection of traffic plans—for example, implementing DSpl, DLA, and/or QW on the approaches to a long-term work zone; implementing DShL, ATSC, and/or TSP along parallel facilities that will be used as alternative routes and/or modes for traffic diverting around the construction area; and implementing dynamic merge control at lane reduction points. Implementing ATM strategies as part of a larger roadway construction project may expedite implementation and possibly reduce costs. At the same time, a major roadway reconstruction project involving geometric changes may impact the need for ATM concepts and strategies, possibly resolving safety and/or congestion issues or relocating such traffic problems to other segments of the network following construction.

- **Integrated Corridor Management**—A corridor consisting of multiple and parallel networks (e.g., freeway, managed lanes, arterial) and/or modes (e.g., bus, rail) may benefit from ATM in the context of ICM. The goal of ICM is to optimize using existing infrastructure and leverage underutilized capacity on major multi-network corridors. Several potential ICM strategies identified in the ICM Implementation Guidance (24) encompass the dynamic use of ATM strategies, including dynamic speed limits, lane use control, dynamic shoulder lanes, dynamic lane reversal, transit signal priority, and dynamically modifying ramp metering rates and arterial signal timing.
- **Roadway geometrics**—The width, location, and continuous length of shoulders, on the mainline and on ramps, will impact the feasibility of dynamic shoulder lanes and junction control, while ramp configurations and storage may impact the ability to implement ramp metering (additional details are provided in the next chapter).
- **Roadway use**—The primary use of the roadway segment may be considered as part of the screening and prioritization. Examples in this regard include whether the roadway serves special event venues and/or recreation areas with the resulting variations (often significant) in traffic volumes, whether the roadway serves major economic areas or major freight and intermodal facilities (with the resulting commercial vehicle traffic), or whether a roadway is used as an evacuation route. The existence of managed lane facilities (e.g., HOV, HOT) may also be considered.
- **Data availability**—Certain data are required to quantitatively assess the applicability and benefits of various ATM techniques (see Table 11). Data availability might be an important consideration when screening candidate roadway segments and/or links and when establishing a baseline from which the benefits of ATM can be compared. Practitioners should assess the availability and possibility of acquiring the necessary congestion, safety, and other information needed to demonstrate ATM benefits. Demonstrating positive performance will help gain the needed support to move ATM into the next stages of the regional transportation planning process or the systems engineering process (e.g., Concept of Operations and requirements), leading to deploying ATM strategies or expanding current ATM systems in the future. If acquiring the needed data for certain roadway segments is not

feasible, then justifying implementation of ATM at these locations relative to other transportation investments may not be possible.

- **Institutional considerations**—Implementing ATM strategies will likely require significant coordination with outside agencies, such as police and other enforcement entities, other transportation providers (e.g., toll and bridge authorities), MPOs and other planning groups, local jurisdictions, and transit agencies. Some roadway segments may require more such interagency coordination than others. The screening process may consider the amount of coordination required for each segment (or series of segments), identifying if there are any concerns that exceed those generally expected for all segments. Having the support of decision-makers and an ATM champion in the lead agency and other involved agencies may also be considered.

### 4.3 Segment Screening Examples

The approach taken by a number of agencies, including WSDOT, California Department of Transportation (Caltrans), and New Jersey DOT (NJDOT), has been to develop a screening matrix with the roadway segments listed horizontally and a variety of screening criteria listed vertically. Several different approaches exist for filling in the matrix as discussed below. The scoring effort can be performed as a workshop activity, or a smaller group can prepare a draft screening matrix and send out to the other stakeholders for review and comment, followed by a meeting to discuss and finalize.

#### 4.3.1 Washington State Department of Transportation

WSDOT (25, 26) and their consultant (Parsons Brinckerhoff) established a set of screening criteria to select candidate corridors in the Seattle area where ATM strategies could be applied. The project team then qualitatively assessed each freeway corridor based on these criteria: a scale of 0, 1, and 2 to designate high potential (2), moderate potential (1), and no potential (0) for each segment with respect to each criterion used, with a comparison matrix used to aid in the screening process. Speed, congestion, and collision data and patterns were reviewed to target specific locations; potential ATM strategies were reviewed to determine whether implementing them would mitigate the existing congestion or crash patterns. ATM opportunities were also noted by strategy and location in the matrix for each corridor.

A corridor screening workshop was conducted during which the project team described ATM strategies, the screening criteria, methodology, and results of the initial screening to members of WSDOT, the Washington State Patrol, and the MPO. The workshop participants participated in a roundtable discussion of each corridor's particular roadway and traffic attributes, as well as the potential to implement ATM techniques based on the screening criteria. The group discussed the initial ratings and the unique aspects of each corridor. Discussions ranged from the need to consider the effect of corridor impacts on the entire system to the location of specific junction control possibilities. Figure 8 presents the modified individual and summary ratings for each corridor.

#### 4.3.2 California Department of Transportation

Caltrans District 7(27) other regional stakeholders, and their consultant (Cambridge Systematics) established a set of screening criteria to select a corridor for initial ATM implementation within the Los Angeles metropolitan area. The qualitative assessment used descriptive terms such as "very



high/very good,” “high/good,” “moderate,” “poor,” “none,” and “unknown” to rate corridors and fill out the matrix, followed by an overall assessment at the bottom as shown in Figure 9. The 17-mile Interstate 105 (I-105) corridor was subsequently selected for more detailed analyses and subsequent implementation.

Evaluation Criteria	Corridors				
	I-5 (Corson to 128th)	I-405 (I-5 to I-5)	SR 167 (Full Length)	I-90 (I-5 to SR 18)	SR 520 (Full Length)
Data Availability	2	2	2	2	2
Infrastructure	2	2	2	2	2
Traffic Conditions	2	2	1.5	1	2
Near-term Construction	1	2	1	1	1
Long-term Construction	1.5	2	1.5	2	2

Active Traffic Management Strategy	Corridors				
	I-5 (Corson to 128th)	I-405 (I-5 to I-5)	SR 167 (Full Length)	I-90 (I-5 to SR 18)	SR 520 (Full Length)
Speed Harmonization & Queue Warning	2	2	1	2	1
Junction Control	1	1	1	1	2
Hard Shoulder Running	1	2	2	2	0
Traveler Info & Dynamic Re-Routing	2	2	1	1	1
Construction Mitigation	2	2	1	2	1
HOT Lane Interaction	1.5	1.5	2	1	1.5

Summary	Corridors				
	I-5 (Corson to 128th)	I-405 (I-5 to I-5)	SR 167 (Full Length)	I-90 (I-5 to SR 18)	SR 520 (Full Length)
	18	20.5	16	17	15.5

0 =	No Potential
1 =	Moderate Potential
2 =	High Potential

	Very Likely
	Some Issues
	Not Likely

FIGURE 8. TABULATION. CORRIDOR SCREENING RESULTS (WASHINGTON STATE DEPARTMENT OF TRANSPORTATION [WSDOT]) (26)

Evaluation Criterion	Assessment Rating							
	I-210 (A) 12mi SR-134 to I-605	I-210 (B) 15mi I-605 to Padua Ave	I-710 21mi Long Beach to Alhambra	I-105 17mi Sepulveda Blvd to I-605	I-405 south 13mi I-605 to I-110	I-405 mid 8mi I-110 to I-105	I-405 north 18mi I-105 to US-101	I-5 10mi I-605 to SR-60
<b>Congestion and Safety</b>								
Peak period congestion levels	High	High	High	Very High	High	Very High	Oversaturated	Oversaturated
Accident rate	Moderate	Moderate	Moderate	High	High	High	High	Moderate
Congestion variability	High	High	High	High	High	High	High	High
<b>Characteristics</b>								
Truck traffic	Moderate	Moderate	High	Moderate	Moderate	Moderate	Moderate	Moderate
Diversion potential	Very Good	Very Good	Good	Very Good	Moderate	Poor	Moderate	Good
Shoulders available?	Moderate	Moderate	Poor	Good	Moderate	Moderate	Poor	Moderate
HOV/Managed lanes available?	Good	Good	Poor	Good	Good	Good	Good	Poor
Ramp/arterial storage	Good	Good	Good	Excellent	Good	Moderate	Good	Poor
<b>ITS Infrastructure</b>								
Highway detection/surveillance	Good	Good	Good	Good	Good	Excellent	Good	Good
Arterial detection/surveillance	None	None	None	None	None	None	None	None
Ramp metering	Good	Good	Good	Good	Good	Excellent	Excellent	Good
Traveler information dissemination	Good	Good	Poor	Good	Good	Good	Good	Good
<b>Institutional Coordination</b>								
Agency coordination required	Moderate	Moderate	High	High	Low	Moderate	Low	Moderate
Availability of ATM Champion	Unknown	Unknown	Unknown	Unknown	Unknown	Torrance unsupportive?	LA or Inglewood?	Unknown
<b>Available Analysis Tools</b>								
Mesosopic Simulation	No	No	AIMSUN-soon	AIMSUN-soon	No	AIMSUN-soon	No	No
Microscopic Simulation	VISSIM	VISSIM	AIMSUN-soon	AIMSUN-soon	Paramics	AIMSUN-soon?	Paramics	Paramics
<b>Overall Potential Opportunity</b>	●	●	●	●	●	●	●	●

FIGURE 9. TABULATION. CORRIDOR SCREENING RESULTS FOR CALIFORNIA DEPARTMENT OF TRANSPORTATION (CALTRANS) DISTRICT 7 (27)

### 4.3.3 New Jersey Department of Transportation

NJDOT, New Jersey Institute of Technology (NJIT), other statewide stakeholders, and their consultant (CH2M HILL) performed a preliminary screening of all the limited access roadways in New Jersey owned and managed by NJDOT—the initial step in a project to identify an initial ATM deployment area in the state and prioritize other potential ATM projects (28). A set of screening criteria were identified and grouped together in terms of existing ITS/TSM&O, traffic flow considerations, and other use considerations as shown in Figure 10. Preliminary scoring was conducted based on input and local knowledge of former NJDOT staff on the project team, coupled with a review of maps (provided by NJIT and NJDOT) that identified congested corridors, high crash locations and rates, major bottleneck locations (in terms of delays and frequency of occurrence), ITS/TSM&O deployment (e.g., available conduit, service patrol coverage, DMS, and TRANSMIT readers) and designated high growth areas in the state. The segments were scored for their TSM&O/ITS capability as follow:

- 10: Segment fully instrumented and operated/managed.
- 5: Segment partially instrumented and operated/managed.
- 0: Segment has minimal TSM&O or no instrumentation.

Those segments that had mostly 5s (or less) for their ITS-related scores (highlighted in yellow in Figure 10) were not considered good candidates for the initial deployment of ATM relative to the other segments in the state that had greater ITS infrastructure and TSM&O-related activities.

Corridors	I-287 95 - 78	I-287 78 - 80	I-287 80 - NY	I-78 PA - 287	I-78 287 - GSP	I-78 GSP - NY	I-80 PA - RT 46	I-80 RT 46 - RT 15
<b>EXISTING ITS / TSMO</b>								
Incident Management / Service Patrols	10	10	5	5	10	10	0	5
Traveler Info (DMS / Transmit)	10	10	5	5	10	10	5	5
Other (Detection / Communication Conduit)	10	10	5	5	10	10	0	5
<b>TRAFFIC FLOW CONSIDERATIONS</b>								
Safety Issues / High Crash Rates	15	10	5	5	10	20	10	5
Recurring Congestion Problems	20	10	10	20	20	20	10	20
Interchange Bottlenecks	20	20	0	20	20	20	0	0
Composite Recurring Congestion Score	20	15	10	20	20	20	10	20
<b>OTHER USE CONSIDERATIONS</b>								
Special Event Traffic	5	0	0	0	5	5	0	0
Commercial Traffic / Serves Truck Terminus	5	5	0	5	5	5	5	5
Severe Weather Issues / Evacuation Route	5	5	5	5	5	5	5	5
Potential ICM Corridor	5	0	5	0	5	5	0	5
Planned Major Construction Along Route	0	0	5	0	0	0	0	0
Within Smart Growth Area	5	5	5	0	5	5	0	0
<b>TOTAL</b>	60	40	N/A	N/A	55	65	N/A	N/A
Priority Segment (congestion / safety)								
Potential Priority Segment								
NOT a Priority Segment								

**FIGURE 10. TABULATION. SEGMENT SCREENING RESULTS FOR NEW JERSEY DEPARTMENT OF TRANSPORTATION (NJDOT)<sup>9</sup> (28)**

Traffic flow considerations addressed safety and congestion. These traffic-related were scored as follows (with the highest point structure given the importance of these criteria):

- 15 to 20: Significant issue, problem, or need within this segment (relative to others in the state).
- 10: Moderate issue, problem, or need within this segment (relative to others in the state).
- 0 to 5: Minor issue, problem, or need within this segment or no issue at all (relative to others in the state).

Those segments with a maximum score of 20 in either the safety or recurrent congestion areas (highlighted in “green” in the spreadsheet) were identified as strong candidates for ATM.

The other use considerations—such as special event traffic, commercial traffic, severe weather concerns, evacuation route, and potential ICM corridor—were scored as follows:

- 5: The segment provides this current/potential use.
- 0: The segment does not provide this current/potential use.

All scores for safety, recurrent congestion, and other considerations were then totaled (except for those segments eliminated from consideration due to the lack of sufficient ITS and/or TSM&O). These total scores were used to identify any additional segments that were not previously identified for more detailed analysis as part of the safety and recurring congestion

<sup>9</sup> This is only a partial representation. In all, 24 different segments were evaluated.

analysis. These segments (highlighted in blue in Figure 10) might be candidates for ATM, but not as high priority as the other segments highlighted in green.

The next chapter discusses screening criteria for taking roadway segments and corridors designated as potential ATM locations and identifying specific links and strategies.

# Chapter 5. Analyze and Prioritize Individual Roadway Links and Active Traffic Management Strategies

---

In this step of the process, individual “links,” interchanges, and ramps that make up the longer roadway segments selected in the previous step are analyzed in greater detail, prioritized, and the appropriate ATM strategies selected. The term “link” is used herein to define a one-way, continuous stretch of a roadway between two (often adjacent) interchanges or intersections, or on an individual milepost basis, with multiple links comprising one of the aforementioned segments. How a “link” is defined will depend on the geocoding of the available data, or it may be based on interchange to interchange, the TMC standards,<sup>10</sup> or mileposts.

## 5.1 Analyze and Prioritize Individual Roadway Links

A quantitative approach for identifying and ranking roadway links as to their overall suitability for ATM strategies can take many forms, including the following:

- **Traffic simulation**—After identifying the roadway corridor using the screening matrices as discussed in the previous chapter, WSDOT and Caltrans District 7 used microsimulation models to identify and analyze the specific links and associated strategies and to estimate the conceptual benefits of the various ATM techniques. As noted at the beginning of this document, this Guide is intended to provide a relatively quick and low-cost approach for practitioners to analyze and recommend ATM strategies and locations for their deployment. Simulation is, therefore, not included in the screening guidance; although if a region already has a model that has been recently coded and calibrated, then using simulation may be useful. Refer to the FHWA Traffic Analysis Toolbox for general guidance on applying simulation tools: <http://www.ops.fhwa.dot.gov/trafficanalysistools/index.htm>.
- **Expansion of the segment screening**—The screening matrices may be expanded to provide a much greater level of detail. The high-priority segments could be divided into shorter, directional “links,” with the scoring based on an analysis of geocoded data. For example (using the NJDOT example from the previous chapter), the link with the highest crash rate would receive a score of “20,” while the link with the lowest crash rate would receive a “0.” The scores of all the other links would be prorated between 0 and 20 based on their crash rates relative to the highest and lowest.
- **Pennsylvania Department of Transportation (PennDOT) Interstate 95 (I-95) ATM Project**—The approach used for the PennDOT I-95 ATM project (29) can also be used as described below.

---

<sup>10</sup> TMC in this context stands for “Traffic Management Channel,” a standard used for broadcasting real-time traffic information that includes location, the area, and highway segment or point location affected.

### 5.1.1 Example of a Detailed Quantitative Analysis of Freeway Links for ATM

As part of the PennDOT I-95 Corridor Program, a Transportation Operations Innovative Strategies Group was formed to look at the wide range of TSM&O strategies for deployment, including ATM, along the 51-mile I-95 corridor between the Delaware and New Jersey state lines. A quantitative assessment was performed to rank the targeted sites in terms of greatest need for ATM-type measures. This was accomplished by ranking the safety and congestion problems in terms of the severity of the problems that could be addressed by ATM.

#### 5.1.1.1 Safety Analysis

Figure 11 is a plot of the total crashes per 0.5 mile for a segment of the I-95 corridor. The X axis shows the location as mile post, and the Y-axis total crashes over a 5-year period per 0.5 mile. These are then categorized into bands of low, medium, and high. A visual analysis of the graph shows three distinct areas: below 20, between 20 and 40, and above 40. This is a comparative analysis between different locations; thus, the need to set boundaries between the categories of low, medium, and high in relative terms. This process can be performed for total crashes, rear-end crashes, and side-swipe and angle crashes (depending on the categories given in the data; some data may not have all of the separate categories). Each 0.5-mile (or 1 mile or greater distance, depending on the granularity of the data) is then given a combined safety score in accordance with which band and/or level the segment fall into, for example:

Safety Band	Score
Medium	66 percent
High	100 percent
Low	33 percent

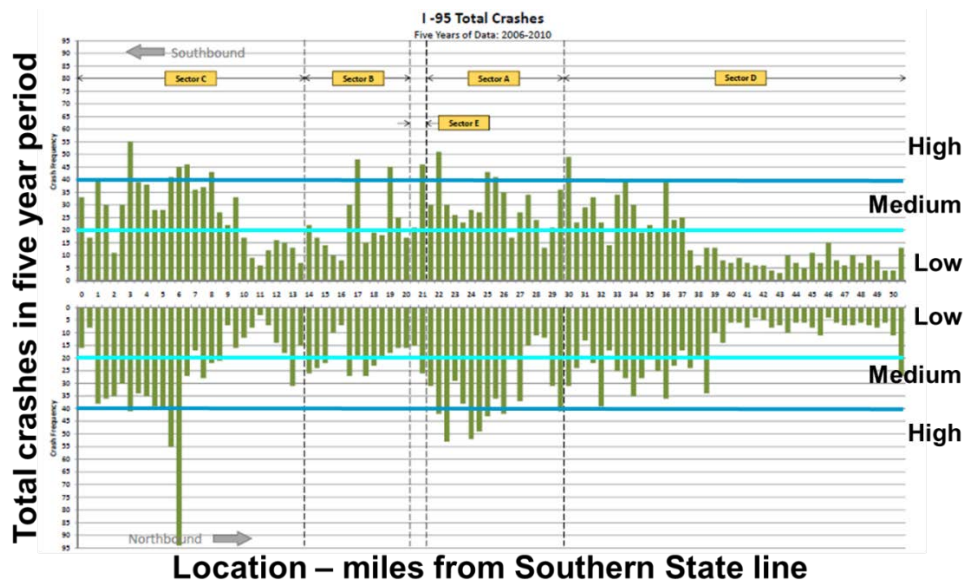

FIGURE 11. PLOT. INTERSTATE 95 (I-95) CRASHES BY MILE (29)

### 5.1.1.2 Congestion Analysis

Speed and congestion data were processed to produce average speeds and the 95th percentile speeds for each location as shown in Figure 12. The speeds were then categorized into three levels of congestion as follows based on the lowest speed<sup>11</sup>:

- High congestion: Less than 30 miles per hour (mph)
- Medium congestion: 30 to 50 mph
- Low congestion: above 50 mph

The output of this step is an average congestion score for each location. A simple average congestion score for each location could take the following form:

Item	Speed Category	Score
Average AM Peak	Medium	66 percent
Average Off Peak	Low	33 percent
Average PM Peak	High	100 percent
Combined Congestion Score	Medium	66 percent

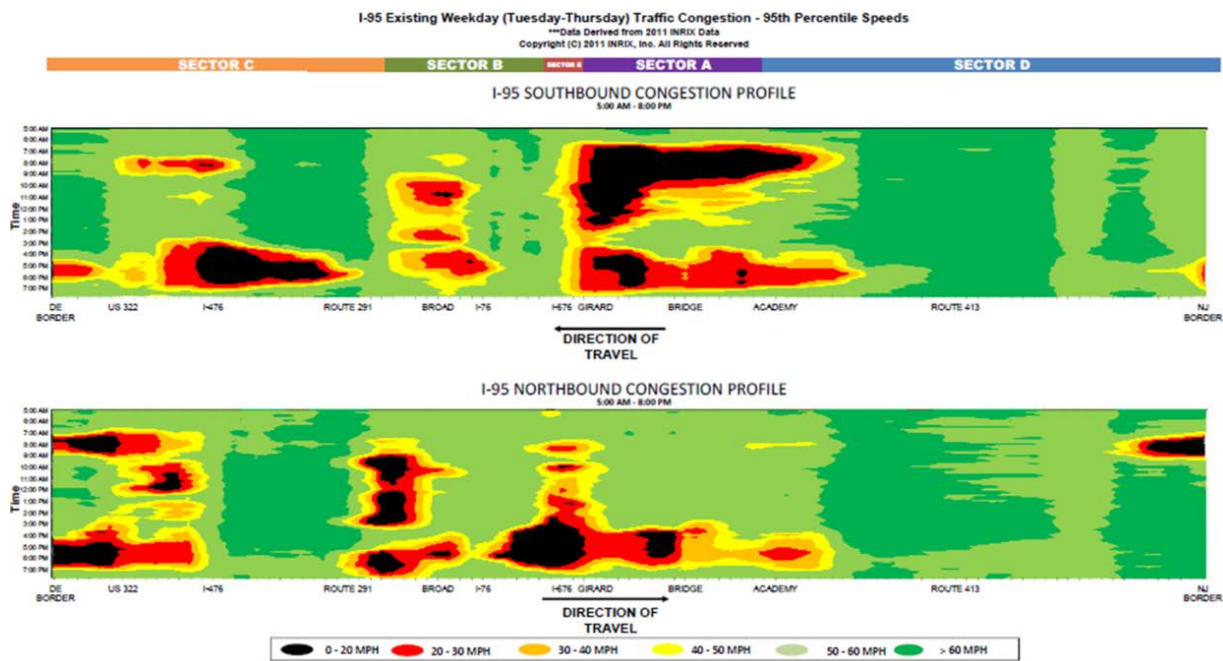

FIGURE 12. PLOT. 95TH PERCENTILE SPEEDS ALONG INTERSTATE 95 (I-95) (29)

<sup>11</sup> Or this may be done using volume/capacity ratios.

For roadway links where special events are a frequent cause of congestion, the average and 95th percentile speeds can be used for these locations for event and nonevent days, and a more complex scoring paradigm used as follows:

Item	Speed Category	Score
Average AM Peak	Medium	66 percent
Average Off Peak	Low	33 percent
Average PM Peak	High	100 percent
Combined Congestion Score	Medium	66 percent
95th percentile AM peak	High	100 percent
95th percentile Off Peak	Low	33 percent
95th percentile PM Peak	High	100 percent
50th percentile Event	Medium	66 percent
95th percentile Event	High	100 percent
Combined Congestion Score	High	75 percent

### 5.1.1.3 Combined Scores

The safety and congestion scores for each link were then combined (i.e., averaged together) with equal weighting given to both categories, although one category could be given a greater weight based on agency priorities. The combined safety and congestion scores can be used to determine the highest priority areas and links using either tabular form or a line chart as shown in Figure 13. (Note: in Figure 13, two horizontal lines are drawn at the 75 percent and 55 percent scores to indicate two levels of priority).

### 5.1.1.4 Other Considerations

The methodology and weightings can be modified slightly to account for other considerations that might impact the need for ATM—for example, adding another 10 percent (or other number as desired by the agency) to the combined score if the link meets other criteria, such as the following:

- Major reconstruction planned along the link where lane closures will result in significant congestion, or the link is part of the approach to the future work area, or the link may experience additional traffic (resulting in significant congestion) as a result of traffic diverting away from the work zone.
- Frequent adverse weather conditions (e.g., snow, flooding, fog, wind) that result in traffic problems, slowdowns, low visibility, or safety hazards for travelers.
- Link is designated as an evacuation route for hurricanes or other severe weather events.



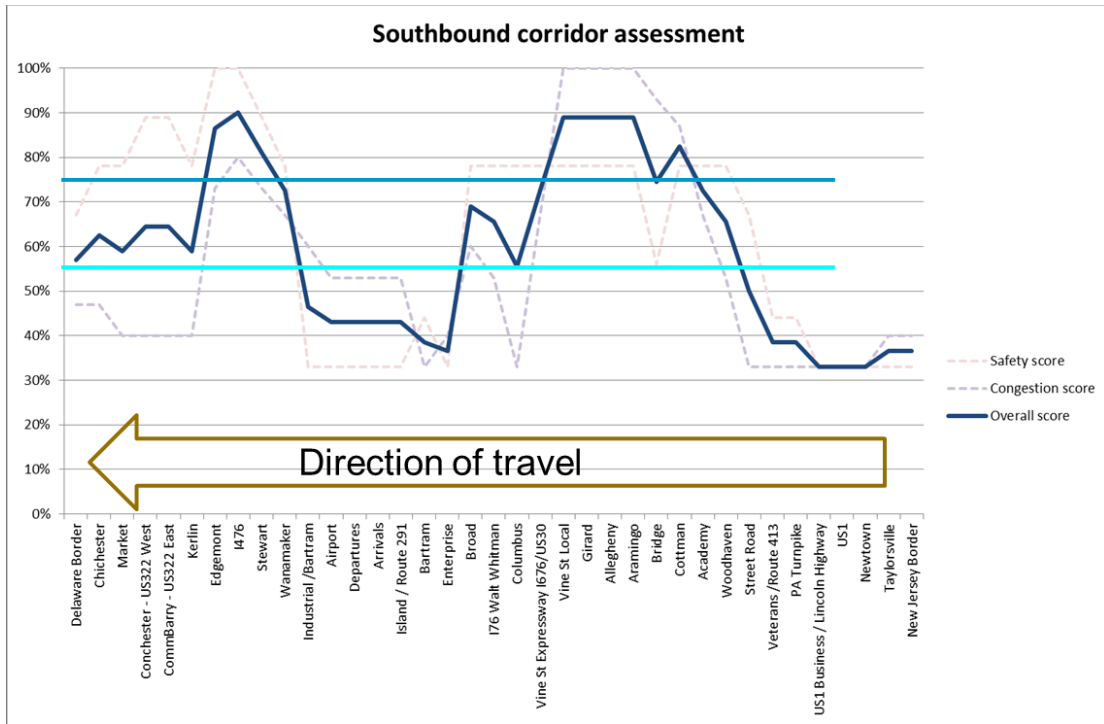

FIGURE 13. GRAPH. INTERSTATE 95 (I-95) LINE CHART OF SAFETY, CONGESTION, AND OVERALL SCORE (29)

- The link directly serves or provides an alternate route for special event traffic.
- The link carries significant commercial vehicles or serves a commercial terminus.
- The route is part of a potential ICM corridor.

Having prioritized the roadway links and segments for ATM, the next step is to identify the specific ATM strategies for each link and segment. Criteria and guidance for individual ATM strategies are provided in the rest of this chapter. No priority is intended by the order of these individual strategy discussions. The first set of strategies (DSpL, DLA, QW, DShL, and DJC) have primarily been used for limited access roadways (although there is no reason why they could not also be used along arterials). The discussion next shifts to ARM—a freeway-oriented strategy, although one where arterial street conditions can impact ARM operation (and vice-versa) in a truly dynamic scenario. The next two strategies discussed—ATSC and TSP—are arterial focused. The last two ATM strategies discussed are DLC and DMC, both of which are directly applicable to either freeway or arterial operations.

## 5.2 Dynamic Speed Limits and Dynamic Lane Assignment

The combination of DSpL and DLA can help reduce crashes, both primary and secondary ones, and also provide additional traffic management capabilities during incident management activities. Additionally, reducing the posted speed as volumes are predicted to increase can help smooth the traffic flow, and more consistent flow is less likely to break down into congested conditions.

DSpL and DLA can be, and often are, implemented along roadway segments together. For deployments in the United States to date, these two ATM strategies have used the same DMS (e.g., full matrix color DMS) to display the speed and lane assignment information (as shown previously in Table 4), although not simultaneously. Different DMS for speeds and lane control can also be used. Figure 14 provides an overview of the screening criteria for the implementation of DSpL and DLA strategies. Additional details are provided below.

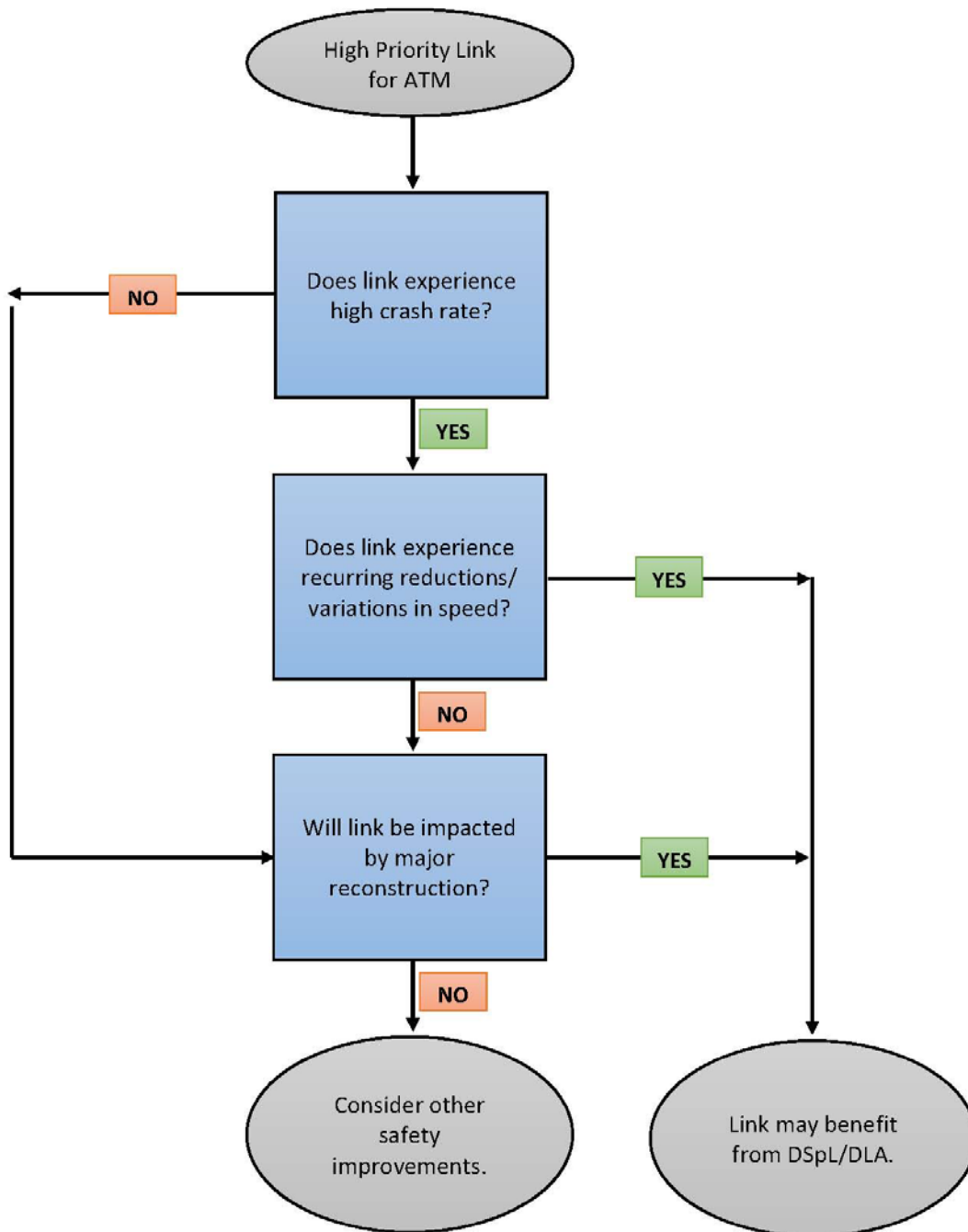

FIGURE 14. FLOWCHART. CONSIDERATIONS AND CRITERIA FOR SELECTING DYNAMIC SPEED LIMIT (DSpL) AND DYNAMIC LANE ASSIGNMENT (DLA) STRATEGIES

### 5.2.1 Crash Rates

The information from the previous screening activities (i.e., segments, quantitative assessment of links) can be used to identify which links have highest crash rates (e.g., the “safety score” as shown in previous Figure 13). Where the information is available, the proportion of rear-end and/or side-swipe crashes should be considered, because these crash types are most likely to be decreased by implementing DSpL and DLA strategies. Similarly, if there is a high proportion of secondary crashes, then this may indicate a safe stopping distance problem and the associated need for DSpL.(30)

### 5.2.2 Recurring Reductions or Variations in Speed

The literature on DSpL provides several (and not too dissimilar) examples for what constitutes “significant recurrent congestion” and the associated variations in average speed, and these may be considered when identifying links for DSpL (and possibly DLA):

- Level of Service (LOS) E or F for minimum 3 hours during the peak hour and for 5 hours per day.(31)
- Typical peak-hour volume exceeds 1,100 vehicles per hour (vph) per lane.(30)
- The link has a history of reduced speeds of 40 mph or less for a least 1 hour on typical days (55 mph posted speed).(30)

Recurring reductions and variations in speeds may also occur in an area that regularly experiences adverse weather conditions (e.g., snow, water on the road, fog, wind, blowing snow) or varying demands and volumes from day to day (e.g., roadway serving a state capital, where the recurrent congestion can vary depending on when the legislature is in session). This can result in traffic problems and slowdowns, and in the case of poor weather conditions, also low visibility or safety hazards for travelers. Such conditions can justify the need for DSpL.(30)

### 5.2.3 Major Reconstruction

As previously discussed, DSpL and DLA strategies may help to manage traffic during major roadway reconstruction activities. Following are examples:

- In advance of reconstruction area limits (i.e., “expanding the work zone”), allowing dynamic reduction in speeds and lane closure preparations in advance of the actual work area.
- Links and segments that are expected to experience a significant increase in traffic (and the associated congestion and crashes) as a result of traffic being diverted away from a work zone involving numerous lane closures or closure of the entire roadway during construction.

### 5.2.4 Other Potential Safety Improvements

There may be links and segments that experience relatively high crash rates but are not subject to significant recurring congestion and traffic volumes that would likely be a causal factor for variations in speeds. In such instances, the crash problem may be the result of roadway geometrics (e.g., horizontal and vertical curves, ramp bottlenecks, other substandard geometric designs), possibly coupled with a number of trucks and other slow moving vehicles. In these instances, other safety enhancements, such as geometric improvements should be considered and assessed. Additionally, ATM strategies such as queue warning signs (as discussed in Chapter

5.3) and dynamic junction control (as discussed (as discussed in Chapter 5.5, may also be viable options.

### 5.2.5 Dynamic Speed Limits Only

Dynamic speed limits can be implemented without the accompanying DLA signs over each lane, as has been done in Delaware, on the New Jersey Turnpike, and in St. Louis (among other locations). Using post-mounted DSPL signs installed on the side of the roadway (Figure 15) will likely be appropriate along those roadway links and segments where variations in speeds are caused by recurring weather conditions, day-to-day variations in speeds, or where side-swipe crashes are not an issue; or as a lower-cost approach to providing dynamic speed limits to segments that are not as high priority as others. It is noted, however, that driver compliance to side-mounted DSPL may be lower compared to signs installed on gantries over each lane.



**FIGURE 15. PHOTOGRAPH. EXAMPLE OF SIDE-MOUNTED DYNAMIC SPEED LIMIT (DSPL) SIGN**  
(Source: Florida DOT)

### 5.2.6 Arterial Applications

The previous discussions have focused on screening and potentially deploying DSPL and DLA strategies along limited access roadways. These strategies may also be applied on arterial segments.

#### 5.2.6.1 Dynamic Lane Assignments on Arterials

National Cooperative Highway Research Program (NCHRP) 447 (12) addresses DLA along arterials, stating the following:

“...dynamic lane assignment works by allowing agencies to change lane assignments to meet different traffic demands. For example, an approach with heavy left-turn movements in the morning peak can operate with dual left-turn lanes during that peak period. Later, the second left-turn lane can be changed to a through movement once the left-turn demand has abated.

These lane assignment changes usually are implemented through the use of changeable overhead signs.”<sup>12</sup>

Dynamic turn restrictions are another form of arterial DLA and provide the ability to restrict certain turning movements only when necessary to improve the intersection safety and operations. Potential applications of dynamic turn restrictions are identified in Reference 12 as follows:

- Prohibit right turn on red (using dynamic no-turn-on-red signs) only during the cross street’s left-turn phase to help accommodate heavy U-turn volumes. The restriction would not be in effect when the cross street through movements are running.
- Improve safety by prohibiting right turn on red only when the opposing left turn is running a lagging left-turn phase.
- Implement dynamic turn restrictions at intersections where pedestrians have their own phase (pedestrian exclusive phase) or there are heavy pedestrian volumes. Right turn on red is restricted during this exclusive pedestrian phase to reduce conflicts but can be allowed during the cross street through movement.
- Implement dynamic turn restrictions at intersections with transit trains running through them. An arterial roadway with a light rail running down the center can allow permitted left turns across the tracks at intersections except when a train is nearby. When this happens, a blank-out sign can illuminate with the left-turn restriction until the light rail train has passed. This removes the threat of vehicles turning in front of the train.

#### 5.2.6.2 Dynamic Speed Limits on Arterials

ATM measures involving dynamic speed limits on arterials were not included in the aforementioned NCHRP 447 Synthesis because “there are insufficient installations of the measures on U.S. arterials for a synthesis of current U.S. practice.”(12)

### 5.3 Queue Warning

Queue warning consists of the real-time display of warning messages (typically on DMS, and possibly coupled with flashing lights) along a roadway to alert motorists that queues or significant slowdowns are ahead, thus reducing rear-end crashes and improving safety.

Figure 16 provides an overview of the screening criteria for implementing queue warning, with additional information provide below.

#### 5.3.1 Crash Rates

The information from the previous screening activities (i.e., segments, quantitative assessment of links) can be used to identify which links have the highest crash rates, particularly in terms of rear-end crashes.. Where the information is available, the proportion of secondary crashes should be considered, because this may indicate a safe stopping distance problem and the associated need for queue warning.

---

<sup>12</sup> This is a form of junction control as discussed later.

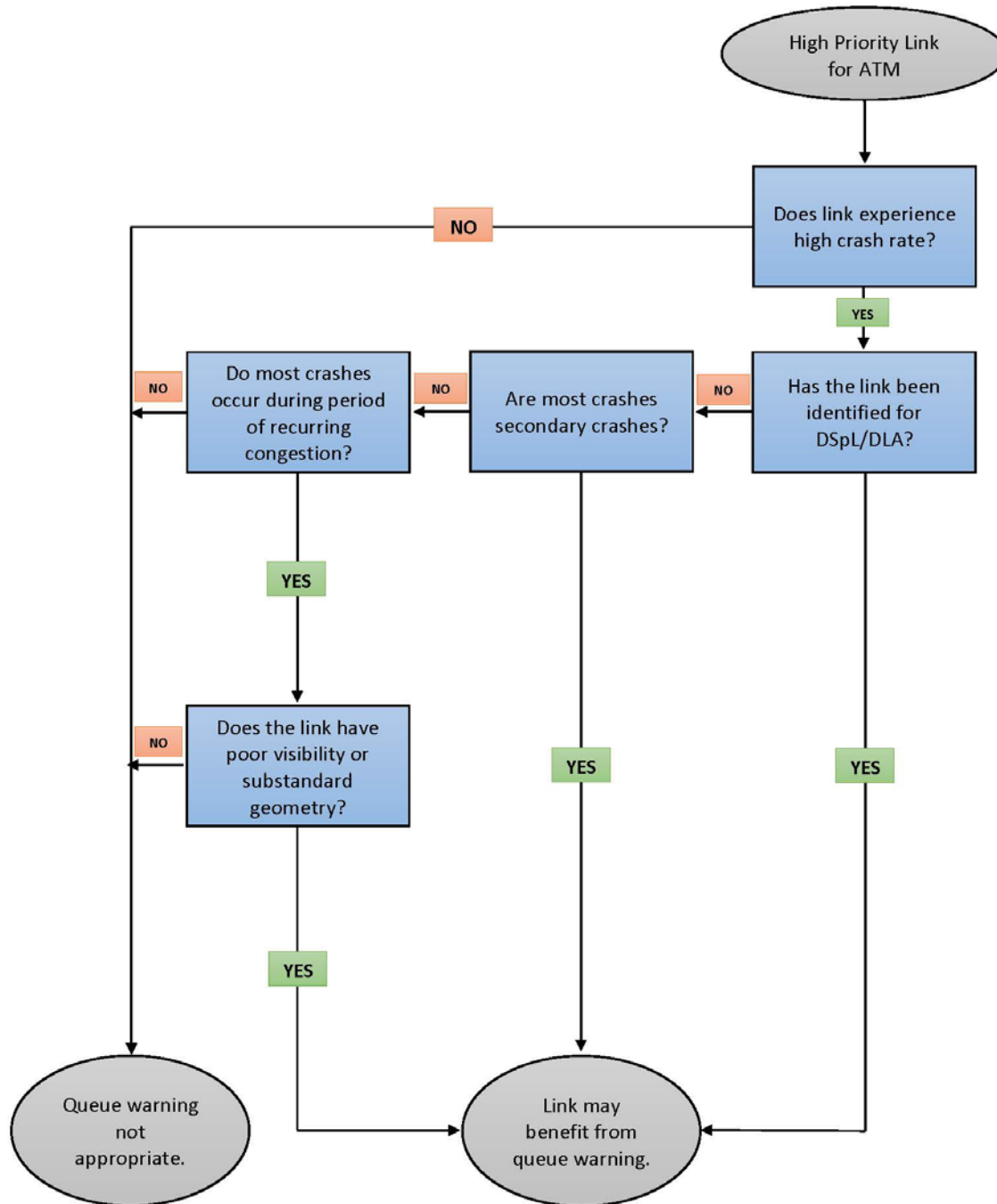

FIGURE 16. FLOWCHART. CONSIDERATIONS AND CRITERIA FOR SELECTING QUEUE WARNING (QW)

### 5.3.2 Queue Warning in Conjunction with Dynamic Speed Limits and Dynamic Lane Assignment

The guidance criteria for queue warning have much in common with the guidance criteria identified in Figure 14 for DSpL and DLA. As a general rule, queue warning signs should be (and often are) installed on the same gantries used for DSpL and DLA signs, thereby providing drivers an explanation as to why the speed limits and/or advisories are being reduced and/or a lane(s) is being closed. These queue warning messages further allow drivers to further anticipate an

upcoming situation of emergency braking and slowing down, avoiding erratic behavior, and reducing queuing-related collisions. Understanding the reason for the reduced speeds may also enhance driver self-compliance. Moreover, the incremental cost of including DMS on the DSpl and DLA gantries to provide queue warning messages is relatively small.

### 5.3.3 Congestion and Sight Distance

As previously noted, recurring congestion typically results in an increased crash rate. This can be further exacerbated by poor visibility (e.g., sight distance restricted by vertical grades, horizontal curves, or inadequate illumination), leading to an increase in secondary crashes. In the absence of data on the number of secondary crashes, the combination of a high overall crash rate (with most crashes occurring during periods of recurring congestion), coupled with visibility and sight distance issues along the link, indicates that queue warning may be an effective strategy.

## 5.4 Dynamic Shoulder Lanes

The temporary addition of a shoulder lane allows congested roadways to have higher throughput—even if the speeds are reduced—as indicated in Figure 17 (from Germany). In the figure, adding the third lane in the form of temporary shoulder use, while slightly decreasing speed, actually delays the onset of congestion and breakdown and increases the facility’s overall throughput. By increasing capacity and encouraging more uniform speeds, the traffic flows more smoothly and efficiently, which can improve trip travel time reliability.

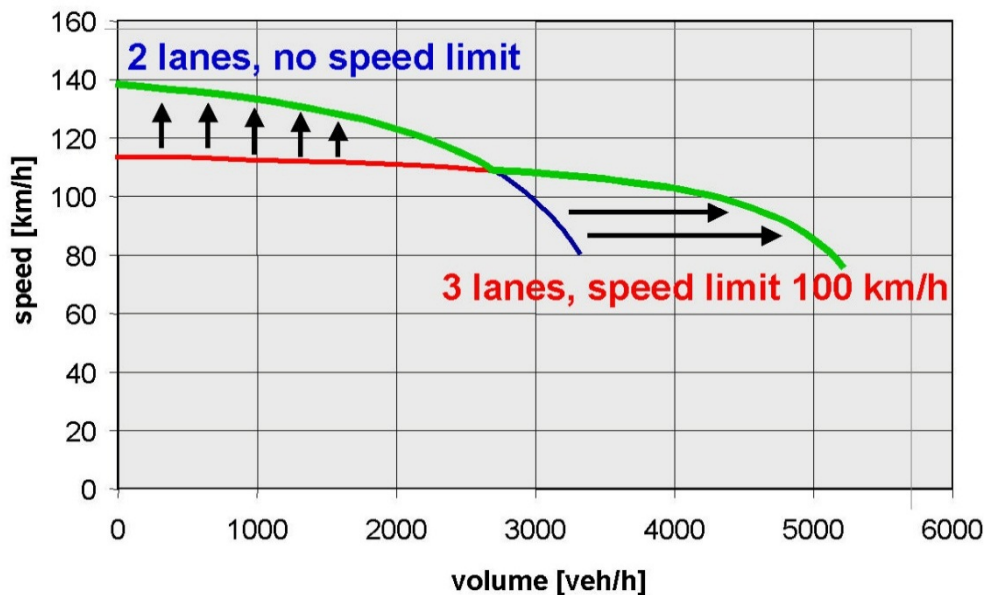

FIGURE 17. GRAPH. SPEED-VOLUME RELATIONSHIP OF DYNAMIC SHOULDER LANE (DShL), FROM GERMANY (31)

The actual increase in the roadway capacity from opening the shoulder to traffic is dependent on several factors, including the following: (32)

- **Junction (interchange) frequency**—weaving movements may affect capacity.

- **Proportion of commuters**—a high proportion of commuters may lead to a higher capacity because a great proportion of drivers are used to travelling through the scheme.
- **Geometry**—a tight geometry may reduce capacity.
- **Proportion of large trucks/heavy vehicles**—a high proportion may reduce capacity.
- **Interchange treatment**—continuing the DShL operations through interchanges is likely to lead to a greater capacity.
- **Environment**—weather conditions.

The maximum practical capacity of a shoulder lane has been found to be in the range of 1,200 to 1,500 vph (with the adjacent general purpose [GP] lanes at 1,800 to 2000 vph). Moreover, speeds tend to be 5 to 10 MPH slower than adjacent GP lanes.<sup>13</sup>

Figure 18 provides an overview of the screening considerations and criteria for implementing shoulder lanes, with additional information provide below.

#### 5.4.1 Recurrent Congestion

Given that dynamic shoulder lanes add temporary capacity to the roadway, recurrent congestion, as is often represented by the volume/capacity ratio, over several hours a day represents a key criterion and screening consideration. The information from the previous screening activities (i.e., segment review, quantitative assessment of links) can be used to identify which links have the greatest recurring congestion issues. Following are criteria used in Europe in this regard:

- Minimum of 1,500 vehicles per lane per hour (United Kingdom).
- LOS D exceeded during the peak hours (Germany; where LOS D is equivalent to a demand/capacity ratio between 0.75 and 0.90).

#### 5.4.2 Shoulder Width and Ability to Accommodate Traffic Flow

The literature is fairly consistent with regards to the minimum shoulder widths for DShL as follows:

- Minimum shoulder width of 10 feet can be provided (with 11 to 12 feet being desired if trucks and buses are allowed to use the shoulder lane).
- Other lane widths no less than 11 feet (e.g., restriping to accommodate shoulder width).

If these width criteria cannot be met, then minor widening along those segments where the roadway pavement is too narrow to accommodate shoulder lanes will be required; or perhaps not pursue the DShL strategy for this link or segment.

---

<sup>13</sup> <http://www.ops.fhwa.dot.gov/atdm/research/index.htm#susap1>



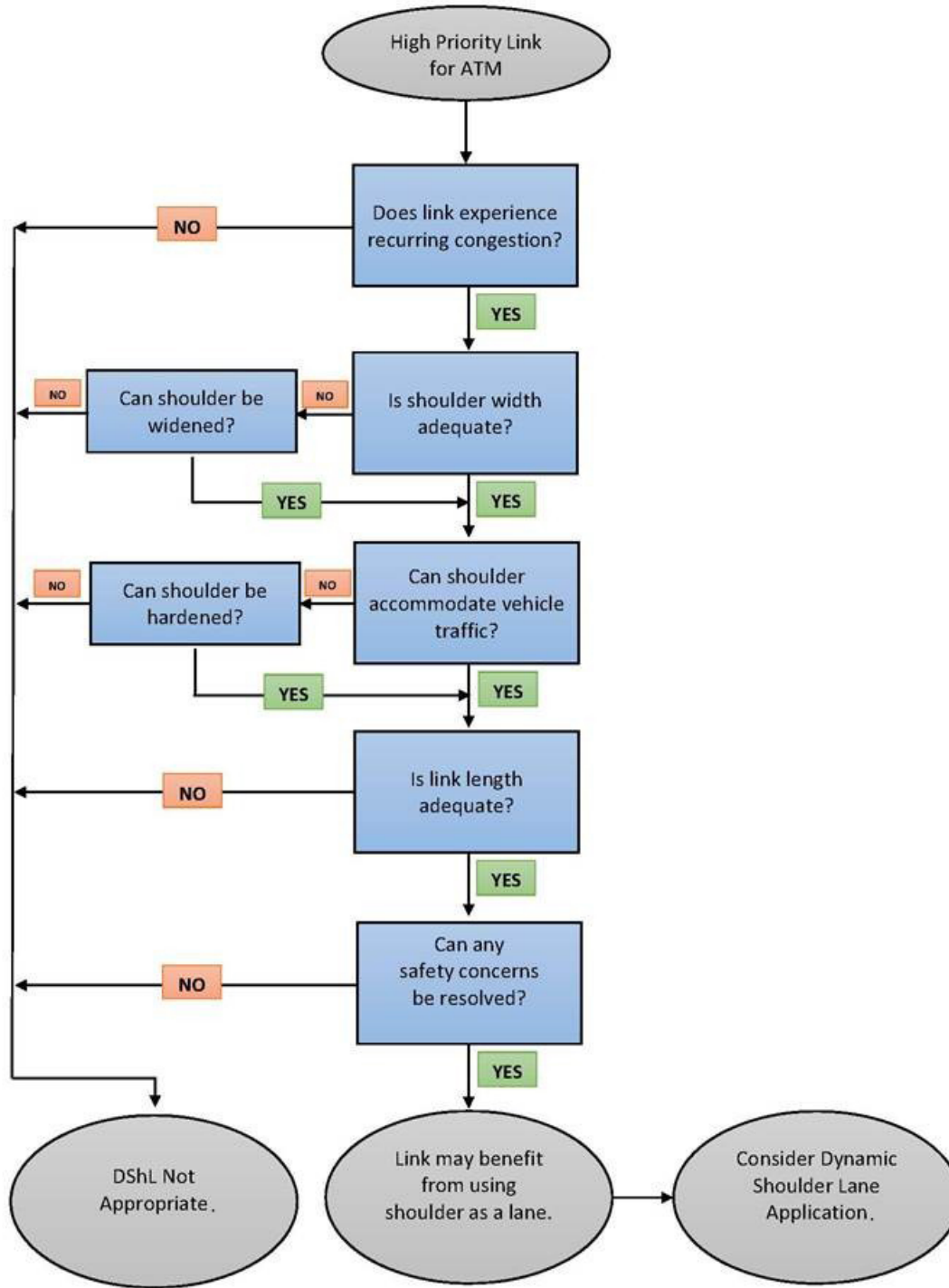

FIGURE 18. FLOWCHART. CONSIDERATIONS AND CRITERIA FOR SELECTING DYNAMIC SHOULDER LANES (DShL)

Other considerations with respect to shoulder location, design, and geometrics include the following (44):

- Pavement depth and strength
- Clearance from edge to structures and safety barriers

- Removal and/or modification of special surfacing or pavement markings (e.g., rumble strips) or drainage structures
- Sight distance for the operating speed, particularly on curves
- Management of the lane through interchanges

With respect to the first bullet above, a potential issue, particularly for older roadways, is the extent to which the shoulder has been designed (i.e., “hardened”) to accommodate traffic, including trucks. If not, then the shoulder may need to be reconstructed. If the shoulder can accommodate passenger cars, but not heavy vehicles such as trucks and buses, then special signage may be required.

The shoulder for DShL can be provided along either the inside or outside shoulder. Table 12 (31) summarizes the advantages and disadvantages of shoulder use alternatives in this regard. A related issue involves managing the shoulder lane through interchanges and dealing with the associated merge issues, particularly for right side shoulder lanes (assuming most on and off ramps are on the right side). An exit-only shoulder lane will have more merging issues with vehicles returning to adjacent GP lanes prior to exit ramps. A carry-through shoulder lane design will have less main line merging issues but more issues with ramp merging, including acceleration distance.

**TABLE 12. ADVANTAGES AND DISADVANTAGES OF SHOULDER USE ALTERNATIVES (31)**

Design Alternatives	Advantages	Disadvantages
Use of left shoulder	<ul style="list-style-type: none"> <li>• Left shoulder not used as much for emergency stop or emergency enforcement.</li> <li>• Least expensive if width is available.</li> <li>• Trucks often restricted from left lane.</li> </ul>	<ul style="list-style-type: none"> <li>• Usually requires restriping.</li> <li>• Sight distance problems with some median treatments.</li> </ul>
Use of right shoulder	<ul style="list-style-type: none"> <li>• Often the easiest to implement.</li> </ul>	<ul style="list-style-type: none"> <li>• Right shoulder is preferred area for emergency stops and enforcement.</li> <li>• Sight distance changes at merge and diverge areas of ramps.</li> </ul>
Use of both shoulders	<ul style="list-style-type: none"> <li>• Not recommended.</li> <li>• Use ONLY in extreme cases.</li> </ul>	<ul style="list-style-type: none"> <li>• Requires restriping.</li> <li>• Safety concerns (no refuge).</li> <li>• Enforcement difficult.</li> <li>• Incident response longer.</li> <li>• Maintenance more difficult and more expensive.</li> </ul>

All geometric issues associated with dynamic shoulder lanes are not required to be analyzed in great detail as part of the screening process. While reviewing roadway as-built plans is beneficial, finding these might not always be possible. Nevertheless, the screening process should include a drive-through to ascertain the existence of shoulders and their locations (i.e.,

inside and/or outside), an approximation of existing lane and shoulder widths, the ability to accommodate emergency refuge areas (as discussed below), and the appropriate treatments through interchanges.

### 5.4.3 Minimum Length

A 3-mile minimum for DShL appears to be a general consensus from the literature. While this is not a hard and fast rule, DShL (as well as DSpL and DLA) does require a strategic approach to provide a more consistent driving experience and to minimize the potential for driver confusion. A related consideration is that the DShL segment must extend through the roadway bottleneck (e.g., interchange). If it does not extend beyond the bottleneck, then traffic is simply fed at a greater rate into the segment that is already over capacity, thereby compounding the congestion.<sup>14</sup>

### 5.4.4 Safety Concerns

Safety concerns of removing the breakdown safety shoulder when the shoulder is open to traffic may limit public and policymaker acceptance of this DShL strategy. Traditionally, the shoulder has been used as an area of safe refuge and as an emergency pull off area. Operating the shoulder as a GP lane may cause concern unless it can be shown that this operational approach can be accomplished in a safe, consistent fashion. When a breakdown does occur, a motorist may not have safe clearance to exit the vehicle. This can be mitigated to some extent by locating emergency refuge pull-outs at regular intervals along the roadway for DShL. Figure 19 shows the installation of an emergency refuge area in the United Kingdom.



**FIGURE 19. PHOTOGRAPH. EMERGENCY REFUGE AREA IN THE UNITED KINGDOM (13)**

(Source: UK Highways Agency)

---

<sup>14</sup> If DShL is required only near an interchange, then a form of junction control – as discussed in Chapter 5, Section 5.5 – should be considered.

The literature typically recommends that such emergency refuge areas be included as part of a DShL project and installed every 0.5 to 1.5 miles, depending on the crash history, frequency of ramps, available right-of-way, and the topography. Further enhancing the existing operations and ITS technologies, such as additional monitoring equipment (e.g., shoulder detection, CCTV) and service patrols that allow effective incident response when vehicles breakdown (or are involved in a crash) and pull into the areas, should be considered. Video cameras should also be regularly spaced to allow operators to check for obstacles before opening the shoulder to traffic and to monitor operations while shoulder use is permitted.

Another safety concern with DShL is the potential reduction of the clear zone distance. While agencies be able to move some fixed objects, guardrails, and other barrier treatments, such accommodations are not always possible. Thus, when traffic is allowed to travel in the shoulder, the effective clear zone and sight distance may be reduced to distances below the minimum allowed, necessitating a reduction in speed limits (via DSpL).

Other safety concerns to consider as part of the screening process (e.g., sign displays and DShL operations and the associated costs) include the following:

- Concerns on the part of emergency responders of being able to quickly get to an incident scene if the shoulder is used as travel lane. The use of DLA signage over the shoulder can be used to dynamically close the shoulder between the incident sight and an upstream on-ramp, thereby providing fast access by emergency responders via the section of closed shoulder.
- The shoulder in northern climates is often used to temporarily store snow during snow removal operations, in which case DShL may not be possible. A related weather issue is where shoulders have been designed to allow ponding during major rain events. In such circumstances, installing moisture sensors along the shoulder to aid in determining whether to open or close the shoulder as a travel lane might be necessary.
- The potential need to install technology to monitor the shoulders for stopped (i.e., disabled) vehicles. Several agencies require maintenance crews or safety service patrols to drive along the segment and check for any disabled vehicles or debris on the shoulder prior to opening the shoulder as a travel lane.

#### **5.4.5 Transit Operations**

Another approach to temporary shoulder use is for transit only. Also known as a bus bypass shoulder or bus on shoulder, with this approach, only transit vehicles are allowed to utilize the designated shoulder, often with driving instructions for bus drivers to ensure the safety of the operation and all the freeway users.

References 31, 34, and 52 include some criteria for transit-only shoulder use, indicating that a facility should have the following:

- Predictable congestion delays during the peak period (e.g., MnDOT standards for bus on shoulder operations indicate that the speed must drop below 35 mph during the peak period or approaches to intersections must suffer continuous queues.)
- 11.5-foot shoulder width.

- Sufficient pavement strength to sustain bus load.
- A significant number of high ridership buses per hour (e.g., MnDOT guidelines indicate that at least six transit buses must use the roadway per day and the delay savings must be greater than eight minutes per mile per week).
- LOS D or worse for two or more hours for at least one peak period to have room for improvement of bus travel time reliability.
- MnDOT guidelines issued to bus drivers state that buses may not use the shoulder when the traffic is moving faster than 35 MPH; and when using the shoulder, drivers are not allowed to drive more than 15 mph faster than main traffic, and the maximum speed on the shoulder is 35 mph. Buses must also yield to any vehicle entering the shoulder, including at freeway ramps or intersections.

#### 5.4.6 An ATDM Approach

Shoulder lanes are in use along several roadways in the United States, with the shoulder being opened based solely on a time-of-day and/or day-of-week schedule. From a “proactive” ATDM perspective, “dynamic” shoulder lanes should also be activated as required based on congestion levels during peak periods, to accommodate special event traffic, and in response to incidents<sup>15</sup> or other conditions as warranted during nonpeak periods. Finally, DShL may be a precursor to permanent roadway widening. Permanent use of the shoulder as a travel lane may also be a possibility, as is being done in the United Kingdom.

### 5.5 Dynamic Junction Control

Junction control (or it may be referred to as “interchange control” in the United States to reflect the difference in terminology between the United States and the United Kingdom) involves the dynamic allocation of lane access on mainline and ramp lanes in interchange areas, thereby accommodating increased volumes where the relative demand on the mainline and ramps change throughout the day. For example, this may involve the following:

- A lane reduction on the mainline upstream of a high-volume entrance ramp to provide an additional free-flow lane on the entrance ramp.
- Assigning a mainline lane for shared through-exit movements or exit-only movements at an off-ramp.
- Using the shoulder(s) for traffic flow on the mainline and/or ramp to accommodate the additional volumes and associated movements in advance of, through, or downstream from the interchange for a relative short distance (e.g., use of a shoulder lane as an acceleration lane for a two-lane entrance ramp that culminates in a lane drop.).

Figure 20 provides an overview of the screening criteria for implementing junction control with additional information provide below.

---

<sup>15</sup> From an incident management perspective, dynamic operation of DShL can mean closing the shoulder during peak periods to general traffic to allow emergency responders to quickly get to the incident scene and then opening then opening the shoulder to help reduce the incident-related congestion.

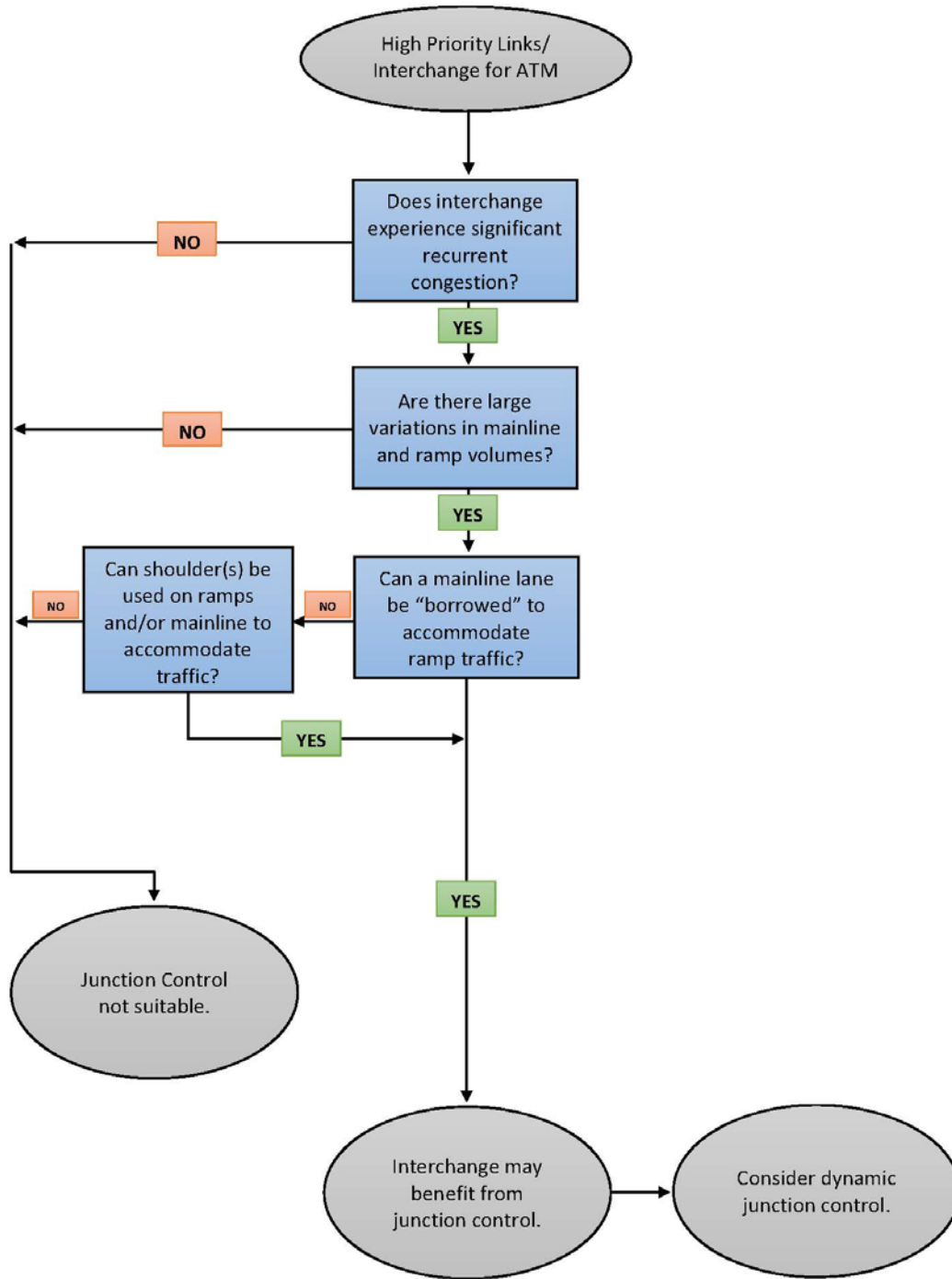

FIGURE 20. FLOWCHART. CONSIDERATIONS AND CRITERIA FOR SELECTING DYNAMIC JUNCTION CONTROL

### 5.5.1 Congestion

The information from the previous screening activities (i.e., identify segments, quantitative assessment of links) will likely identify recurrent congestion, bottleneck, and/or safety problems near interchanges, and these interchanges will be candidates for junction control. The most likely candidates will be those interchanges that experience significant recurrent congestion

with high volumes of entering or exiting ramp, with one reference<sup>(31)</sup> noting minimum ramp volumes of “900 vehicles per hour per lane, if not higher.”

### **5.5.2 Variations in Mainline and Ramp Volumes**

For junction control to properly work, significant temporal variations in mainline and ramp volumes must exist, plus the ability to accommodate these varying volumes by “shifting” lane assignments between the mainline and the ramps, including their respective shoulders being used as travel lanes – within the interchange area. Moreover, temporarily “borrowing” a mainline to accommodate entering or exiting traffic should only be employed if adequate capacity can be maintained on the rest of the mainline lanes, not causing LOS E (or worse) on the rest of the mainline.<sup>(31)</sup> Accommodating the increased interchange volumes by temporary using the shoulder(s) as travel lane(s) on the ramps and/or mainline might also be possible.

### **5.5.3 Shoulder Widths and Structure**

If the mainline and/or ramp shoulders are used as part of a junction control strategy—in essence, a form of DShL over a relatively short distance—then minimum shoulder and lane widths, and the ability of the shoulder to accommodate traffic flow, are important considerations as discussed in previous Chapter 5, Section 5.4.2 (e.g., minimum shoulder widths of 10 feet; other mainline widths of no less than 11 feet; and other ramp lanes at least 10 feet).

### **5.5.4 An ATDM Approach**

From a “proactive” ATDM perspective, junction control should be implemented and operated in a dynamic manner as required based on congestion levels during peak periods to accommodate special event traffic and in response to incidents near the interchange or other conditions as warranted during nonpeak periods. This requires continuously monitoring the mainline and ramps and dynamically changing lane access in the interchange area based on the real-time and anticipated conditions. Another important consideration is implementing DSpL and DLA signage across all lanes upstream of the interchange—on both the mainline and the ramps—to the extent that all drivers are provided with sufficient advance warning of any changes in lane use and (as may be required) speed limits.

## **5.6 Adaptive Ramp Metering**

Ramp metering consists of deploying traffic signal(s) on ramps to dynamically control the rate vehicles enter a freeway facility, thereby smoothing the flow of traffic onto the mainline and allowing more efficient use of existing freeway capacity. In an ATDM context, adaptive ramp metering uses traffic responsive or adaptive algorithms (as opposed to pretimed or fixed-time rates) that can optimize either local or systemwide conditions based on real-time and/or anticipated traffic volumes on the freeway facility, the metered ramps, and possibly the parallel arterial streets that feed the ramps.

The *Ramp Management and Control Handbook* (11) provides comprehensive guidance and recommended practices on managing and controlling traffic on ramps with freeway facilities. The Handbook describes a process, illustrated in Figure 21, that may be used to narrow down the list of available ramp management strategies to those that meet an agency’s goals, objectives, and policies and can be applied to remedy specific problems and/or situations. In

other words, practitioners should begin the process of selecting ramp management strategies by focusing their efforts on narrowing the list of available strategies to those that may be best applied based on existing situations or problems.

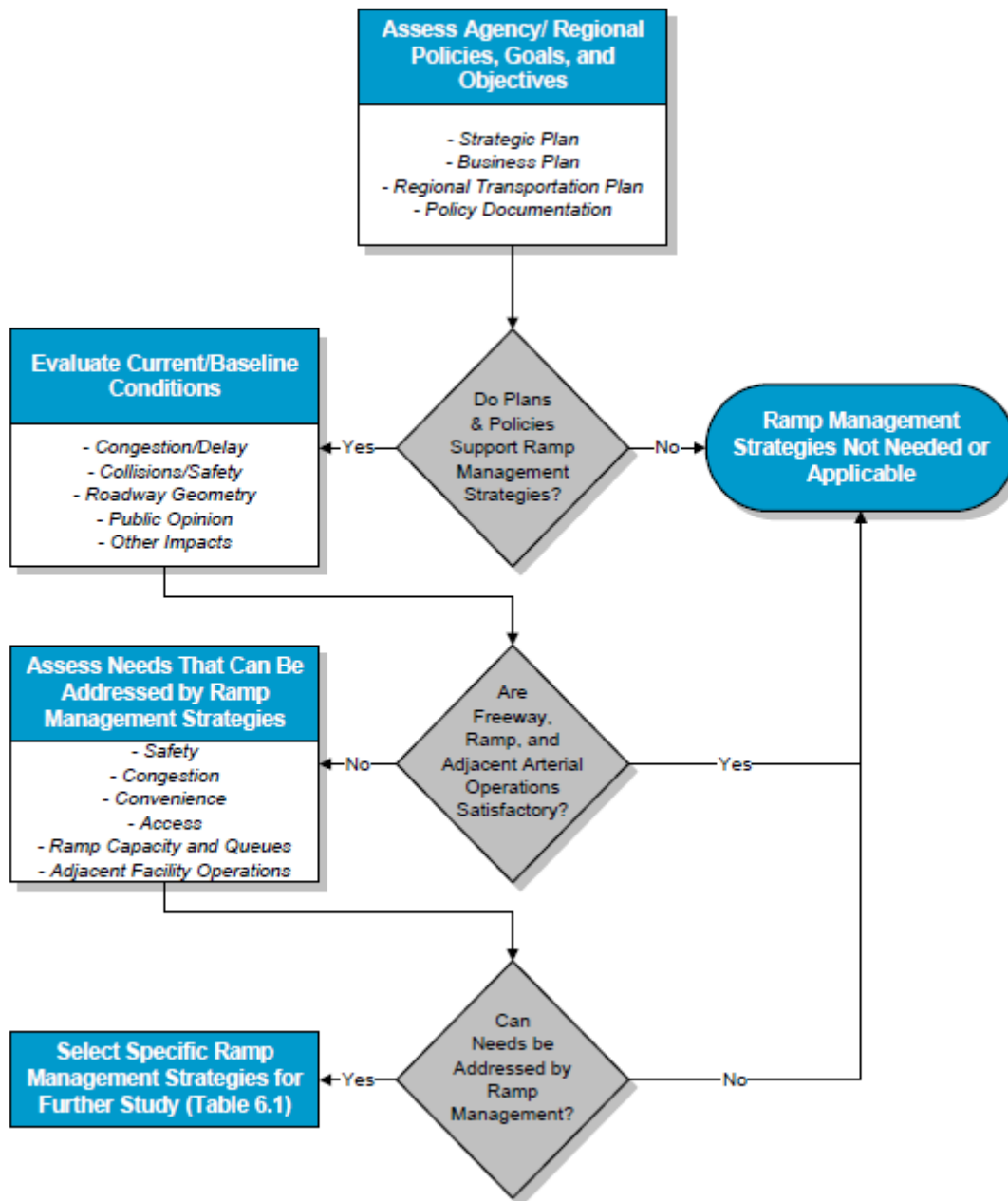

FIGURE 21. FLOWCHART. PROCESS FOR SCREENING RAMP MANAGEMENT STRATEGIES (11)

ARM may be viewed primarily as a systemwide approach for addressing more complex problems than local ramp metering. The *Ramp Management and Control Handbook* identifies “systemwide traffic responsive ramp metering” as “providing optimal metering rates based on real-time conditions throughout the system or corridor, noting that system-wide ramp metering may be the preferable option where (11)



- Collision problems are not clustered at isolated locations, but rather extend along a facility or throughout a corridor.
- Multiple bottlenecks/locations of recurring congestion on the freeway are observed.
- Optimization of freeway throughput requires coordinated rates for several ramp meters.
- The situation requires the improved ability to address non-recurring congestion problems.
- Flexibility to address changing conditions over time more rapidly is needed.”

The Enterprise Pooled Fund Study, *Warrants for the Installation and Use of Technology Devices for Transportation Operations and Maintenance (36)* includes the following warrant for “corridor-wide ramp meter deployment,” which is based on work done by MnDOT:

**Warrant:** Corridor-wide Ramp Meter Deployment

**Purpose:** This warrant addresses the need for a “zone” of ramp meters along a stretch of freeway (typically considered in 3- to 6-mile segments).

**1. Control factors:** During the AM or PM peak period, the zone in consideration has at least 30 minutes per commute day (measured in 5-minute increments) where the demand is equal to or exceeds 95 percent of the downstream capacity, according to the following equation:

$$MV + OR > (ER + MC) \cdot .95$$

Where:

MV = Upstream mainline volume (in vehicles per 5 minutes)

OR = Sum of on-ramp volumes of ramps within the zone (in vehicles per 5 minutes)

ER = Sum of exit ramp volumes within the zone (in vehicles per 5 minutes)

MC = Downstream mainline capacity (in vehicles per 5 minutes)

Or

Platoons from signalized intersections are recognized to adversely impact all on-ramps feeding the freeway segment under consideration. For example, if hourly volume, based on maximum 30-second volume readings projected to hourly volumes, exceed 1,100 vph (regardless of overall hourly volume).

*Note: Overall hourly volume entering from arterials may be relatively low (e.g., 700 vph). However, during periods when platoons arrive, if 30-second readings of volumes represent 1,100 vph or greater, then this factor is considered met.*

And

**2. Safety factors:** There is one or multiple area(s) within the zone where crashes are understood to exceed the typical crash rate (at the ramp gore point or within 500 feet in either direction of the gore point) for the metropolitan area.

And

**3. Functionality factors:** Volumes at ramps being considered for meters, within the zone, fall within the range of 240 to 900 vph per lane during peak periods.

Adaptive ramp metering represents an emerging area of dynamic control. Accordingly, practitioners are recommended to review<sup>16</sup> the results of pilot deployments of adaptive ramp metering such as Interstate 210 in Los Angeles County (which is ongoing at the time of preparing this Guide).

## 5.7 Adaptive Traffic Signal Control

ATSC continuously monitors arterial traffic conditions and dynamically adjusts the signal timing to smooth the flow of traffic along coordinated routes and to optimize one or more operational objectives (such as minimize overall stops and delays or maximize green bands). The *Model Systems Engineering Documents for Adaptive Signal Control (37)* includes a figure (reproduced herein as Figure 22) stating the following:

*Look at the questions and statements in the figure. If one or more of these statements or questions applies to you, then adaptive control may be able to help you, and you should proceed.*

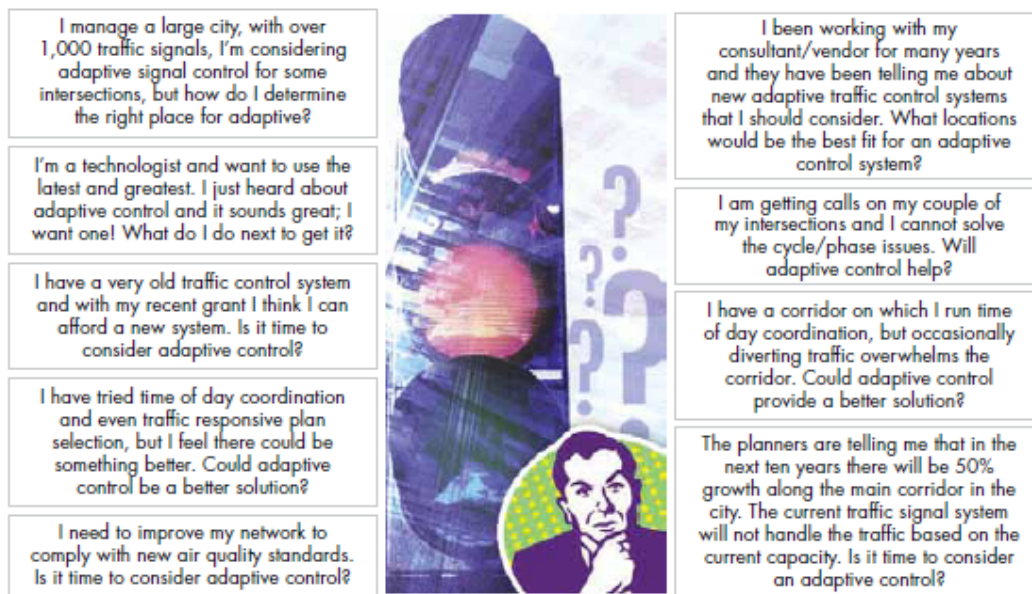

**FIGURE 22. DIAGRAM. SHOULD YOU CONSIDER ADAPTIVE TRAFFIC SIGNAL CONTROL? (37)**

Other advantages and improvements resulting from ATSC (37) include the following:

- Recognize changes in traffic conditions and react quickly and automatically to accommodate those changes (e.g., special event traffic, traffic diverting from the freeway in

<sup>16</sup> The “Updated Literature Review” as part of the “Getting Ready” activities.

response to an incident, other fluctuations in traffic that may not occur according to a regular schedule).

- Overcome the institutional boundaries that currently prevent the signals under the control of the different jurisdictions from operating in a coordinated fashion.
- More efficiently accommodate rail, emergency vehicles, and transit vehicles and more quickly recover from preemption and priority.
- Improve the management of queues within the network.

## 5.8 Transit Signal Priority

This ATM strategy manages traffic signals by using sensors or on-board vehicle technology to detect when a bus nears a signal controlled intersection, turning the traffic signals to green sooner or extending the green phase, thereby allowing the bus to pass through the intersection more quickly and help maintain scheduled transit vehicle headways and overall schedule adherence. Priority is not the same as “preemption.” Priority is the preferential treatment of one vehicle class (such as a transit vehicle) over another vehicle class at a signalized intersection without causing the traffic signal controllers to drop from coordinated operations. TSP is typically “conditional,” depending on such considerations as the amount of time (e.g., signal cycles) since the last priority was given, whether the bus is on schedule or not (i.e., generally there is no need for priority if the bus is currently operating on schedule), and the bus loading (i.e., number of passengers). Priority may be accomplished by a number of methods, including the beginning and end times of greens on identified phases, the phase sequence, and inclusion of special phases, without interrupting the general timing relationship between specific green indications at adjacent intersections.

Figure 23 provides an overview of the screening criteria for implementing TSP. These criteria are derived from information contained in *The Transit Signal Priority Planning and Implementation Handbook*, (38) with additional information provided below.

### 5.8.1 Bus Delays at Signalized Intersections and Their Impacts on Schedules

The *Transit Signal Priority Planning and Implementation Handbook* (38) notes that many transit systems do not have good information on the impact of traffic signal delay on their operations.<sup>17</sup> Accordingly, the following questions need to be asked and the associated information collected to the greatest extent possible:

- Is there measurable delay or unreliability due to traffic signals?
- How much delay could be saved on a particular route by providing TSP?

---

<sup>17</sup> The date of the Handbook is 2005. Guidance might have changed with the installation of GPS-based, computer-aided dispatch systems for transit operations since that date.

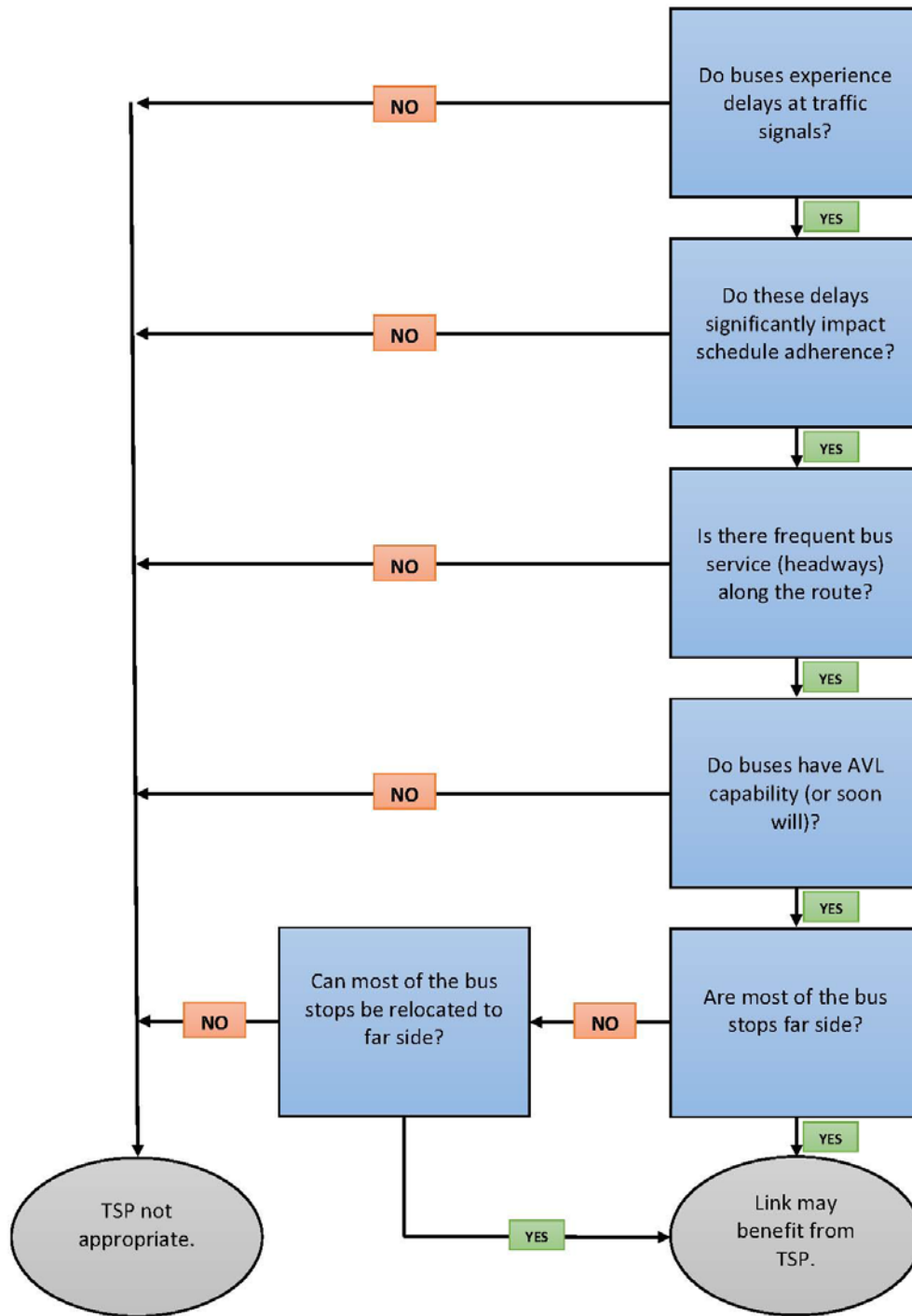

FIGURE 23. FLOWCHART. CONSIDERATIONS AND CRITERIA FOR SELECTING TRANSIT SIGNAL PRIORITY (TSP)

- Has the cost (capital and operating) of intersection delay and congestion to the transit system been calculated?
- Have transit schedulers been consulted about the locations and extent of intersection delay?

- Has data on intersection bus delay already been collected? If not, are alternative approaches and/or sources available to collect time-distance data and measure intersection delay (for example, current automated vehicle location [AVL] systems can provide distribution of running times by route segment, by time of day, and day-of-week that can be used to measure vehicle speed and intersection delay).
- Have any saturated intersections along major bus corridors been identified?

### 5.8.2 Bus Headways and Frequency of Service

The *Transit Signal Priority Planning and Implementation Handbook (38)* notes that bus headways along TSP corridors ranged from 90 seconds to more than 30 minutes. During the peak hour, most agencies reported headways from 5 to 30 minutes, depending on the route and type of service (e.g., bus, light rail transit, express). Level of ridership on the buses is a related consideration.

### 5.8.3 Automated Vehicle Location on Buses

There are several advantages to whether the buses along a potential TSP route have AVL capability. Depending on the TSP system architecture, a communications link can be established between the transit operations center and the traffic management center to let the individual signalized intersections know when a bus is approaching; or this can be accomplished wirelessly directly between the bus and the traffic signal controller without AVL. The primary advantage of an AVL-enabled bus system, assuming the transit management system also includes real-time information on schedule adherence, is that the bus should not need to request priority if it is not behind schedule.

### 5.8.4 Far-Side Bus Stops

Far-side bus stops is an important operational consideration. If a bus requests and receives signal priority, only to stop at a bus stop before traveling through the signalized intersection, then it does neither the transit schedule adherence nor the arterial coordination any good. In fact, it probably makes matters worse.

## 5.9 Dynamic Lane Reversal

This strategy, also known as contraflow lane reversal, consists of reversing lanes to dynamically allocate the capacity of congested roads, thereby allowing capacity to better match traffic demand throughout the day. Reversible traffic lanes add capacity to a road and decrease congestion by borrowing capacity from the other (off-peak) direction.

DLR can be applied to both freeways and arterials. There are several examples of lane reversal systems being applied on freeway segments, particularly on bridges and tunnels (and the approaches thereto) — areas where it is difficult to widen. Contraflow operations are also implemented on freeways for managed lanes (e.g., bus only lanes, such as the Lincoln Tunnel into New York City).

Figure 24 provides an overview of the screening criteria for implementing DLR, with additional information provided below. This is based primarily on information contained in *NCHRP Synthesis 340 – Convertible Roadways and Lanes. (35)* Additionally, the literature tends to focus

on arterial applications of DLR, although the criteria and considerations noted for arterial streets are transferrable to freeway operations.

### 5.9.1 Volumes in Excess of Capacity

The information from the previous screening activities (i.e., segments, quantitative assessment of links) can be used to identify which directional links have the greatest recurring congestion issues (e.g., the “congestion score” as shown in previous Figure 13), indicating a situation where the volumes are in excess of capacity. The aforementioned NCHRP Synthesis 340, referencing ITE criteria also indicates the following:

- Average speed of a freeway should decrease by at least 25 percent during the trouble periods over the normal speed.
- For arterials, there should be a noticeable back-up at signalized intersections leading to vehicles missing one or more green signal intervals.

### 5.9.2 Unbalanced Directional Flows

The operational principle behind reversible lanes is to take advantage of unused capacity in one direction of (minor) flow to increase the capacity in the congested direction of (major) flow—in essence, borrowing a lane from the minor flow and giving it to the major flow. Obviously, there must be unused capacity in the minor flow direction so that taking a lane away does not cause undue congestion in that direction. Additionally, DLR operations are most effective when highly unbalanced directional flows are present. Specific considerations in this regard (as noted in NCHRP Synthesis 340 (35)) include the following:

- The ratio of a major to minor traffic count should be at least 2:1, preferably 3:1. Otherwise, installing a contraflow lane could cause a new traffic problem on the minor-flow side of the freeway (from Institute of Transportation Engineers).
- The 2001 American Association of State Highway and Transportation Officials (AASHTO) *Green Book* states that reversible operations are justified when “65 percent or more of the traffic moves in one direction during peak hours.” A generally accepted principle is that the minor flow direction should not be less than two lanes for the minor-flow direction (e.g., one through and one turning on arterial streets). AASHTO also suggests that with “a six-lane street width directional distribution of approximately 65 to 35 percent, four lanes can be operated inbound and two lanes outbound.”
- A high proportion of commuter-type traffic should traverse the area without turns or stops.
- A relatively low percentage of heavy vehicles should be in the minor-flow direction.

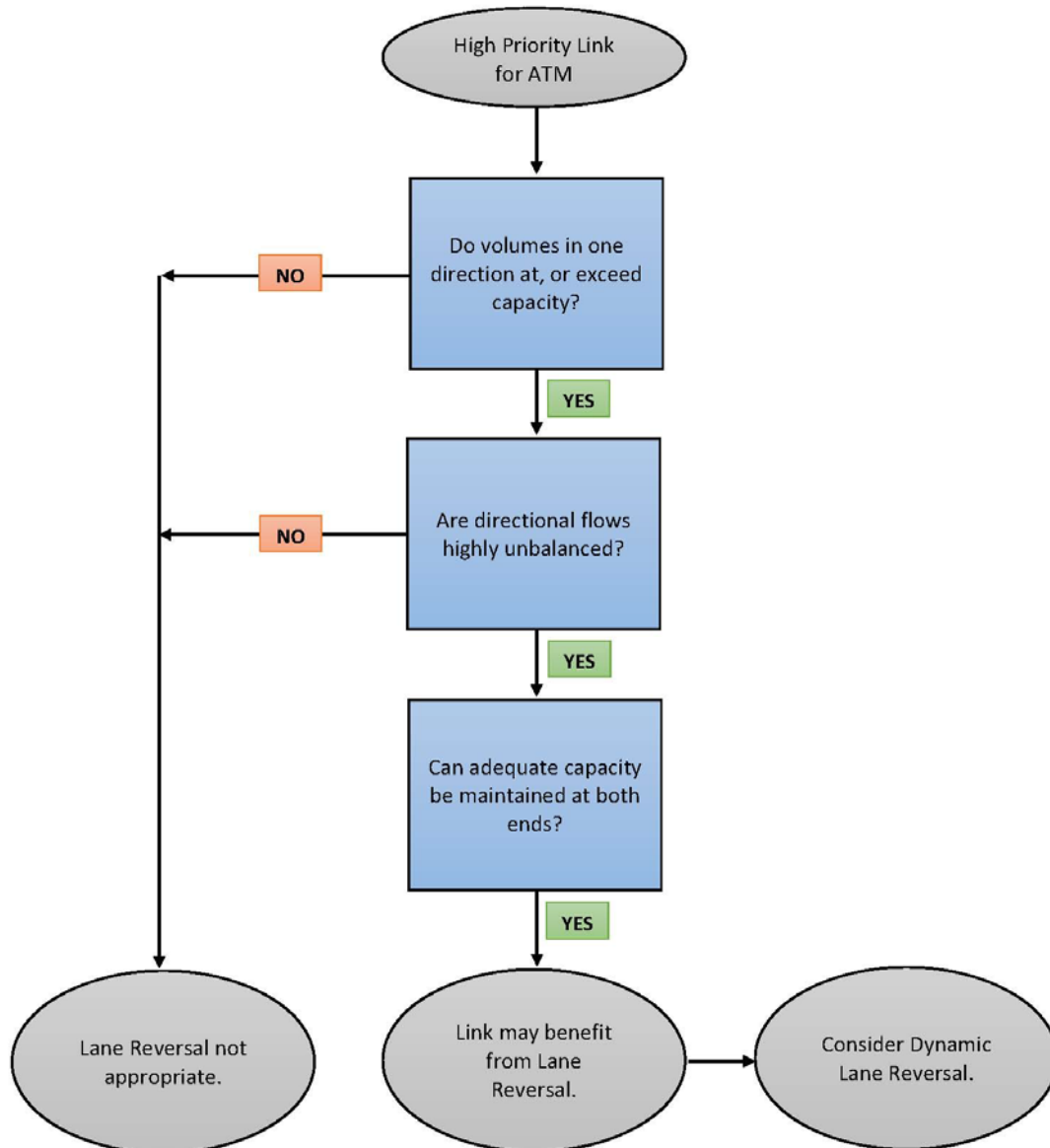

FIGURE 24. FLOWCHART. CONSIDERATIONS AND CRITERIA FOR SELECTING REVERSIBLE LANE CONTROL

### 5.9.3 Adequate Capacity at Termini

Adequate capacity must be maintained at both termini, and the transition from the normal operation to the reversible segment must be easy for drivers to negotiate. Inadequate capacity of these points will likely create bottlenecks that can diminish (or even eliminate) the utility of the reversible section. Other capacity- and roadway-related considerations include the following:

- Adequate space in the roadway platform to place barrier systems to separate directions of travel. (Note: on lower speed roadways, opposing traffic flows may not need to be physically separated. On high speed facilities, opposing flows likely should be separated either through use of a separate reversible roadway or moveable barriers.)

- Adequate space in the roadway cross-section to install required control devices (e.g., lane use control signals and dynamic speed displays as may be required to reduce speeds).

#### **5.9.4 An ATDM Approach**

Being a form of lane assignment, an ATDM approach, in which the directional flows are continuously monitored and real-time incident data are used to control the reversible lanes (i.e., “dynamic” lane reversal) should be considered in addition to static time-of-day/day-of-week operations. That said, where a physical (and moveable) barrier is used to separate directions, reversing lanes may be a relatively long and involved procedure and may not lend itself to all such “dynamic” applications, unless the situation is expected to last for several hours or longer. Examples in this regard may include into and out of special event venues and during evacuations before major coastal storms and hurricanes and when evacuated residents are allowed back into the impacted area.

### **5.10 Dynamic Merge Control**

Dynamic merge control, also known as dynamic late merge or dynamic early merge, consists of dynamically managing the entry of vehicles into merge areas with a series of advisory messages (e.g., displayed on a DMS) approaching the merge point that prepare motorists for an upcoming merge and then encouraging or directing a consistent merging behavior. DMC can help create or maintain safe merging gaps and reduce shockwaves upstream of merge points.

No criteria are provided in this Guide. This strategy appears to have been mostly applied in work zones involving lane closures and in advance of median crossovers where one roadway is closed to traffic to provide a work space and two-lane, two-way traffic is maintained on the other roadway. DMC eliminates the “forced lane merge phenomenon” when some drivers try to avoid slow moving traffic by traveling in a lane that is about to end and then attempt to force a merge at the last moment. This is a dangerous driving maneuver for the driver, other motorists, and workers in the construction zone. A forced-lane merge of this type may cause hostility and “road rage” among the other patiently waiting drivers.(39)

#### **5.10.1 Dynamic Early Merge**

The idea behind the dynamic early merge is to create a dynamic no-passing zone to encourage drivers to merge into the open lane before reaching the end of a queue, and to prohibit them from using the closed lane to pass vehicles in the queue and merge just before reaching the lane closure. Figure 25 provides a schematic of the Indiana Early Merge System, which consists of dynamic “Do Not Pass/When Flashing” sign trailers that are equipped with detectors to capture speed, volume and lane occupancy data at the detection zone. A series of five signs dynamically communicate with one another to create a variable length of no passing zone by activating the signs in an on-and-off flashing mode based on the detected traffic volume and occupancies.



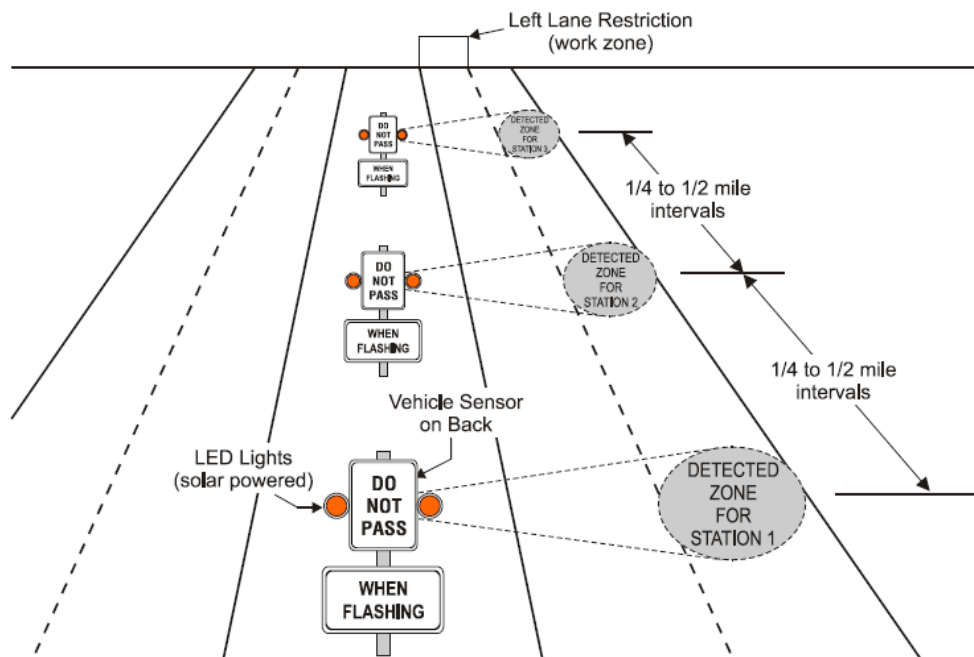

FIGURE 25. DIAGRAM. DYNAMIC EARLY MERGE SYSTEM (54)

Field testing and simulation of this approach identified the following: (40)

- It was found the merging operations was smooth and uniform in advance of the lane closure, with few rear-end crashes.
- The system did not increase throughput.
- The spacing of the signs should be logarithmic instead of uniform to account for the reduction in speed as traffic approaches the lane closure.
- Preliminary benefit/cost estimates indicate that implementing the system is justified at lane closures where the capacity of the single lane will be exceeded at least 15 to 20 times per week.

A study of a similar dynamic early merge system in Michigan,(39) involving a three- to two-lane transition into a work zone, concluded that the early merge system will operate efficiently during medium to moderately high-density levels, (LOS D to E). This is also more appropriate for a long-term work zone.

### 5.10.2 Dynamic Late Merge

The dynamic late merge approach is the opposite of the dynamic early merge approach in that drivers are encouraged to use either the open or closed lane(s) until they reach the merge point at the lane closure taper, rather than merging as soon as possible into the open lane. One example of the dynamic late merge is the system developed by PennDOT. This system was implemented as a means to reduce the road rage engendered between drivers who merge into the open lane early and those who remain in the closed lane and merge into the open lane near the front of the queue at the last possible moment. Approximately 1.5 miles in advance of the

lane closure, “USE BOTH LANES TO MERGE POINT” signs are placed on both sides of the roadway. These signs are followed by conventional “ROAD WORK AHEAD” and advance lane closed signs. Finally, “MERGE HERE TAKE YOUR TURN” signs are placed on both sides of the roadway near the beginning of the taper.(40)

The concept behind late merge is to make more efficient use of roadway storage space by allowing drivers to use all available traffic lanes to the merge point. Once the merge point is reached, the drivers in each lane take turns proceeding through the work zone. The combined effect of maximized storage and orderly merging operations may have the potential to increase throughput, reduce queue lengths, shorten travel times, and discourage aggressive driving.(40)

Conceptually, the lengths of the queues that form as a result of congestion are reduced by about 50 percent, because the queued vehicles are stored in two lanes instead of only one. The shorter queue lengths reduce the likelihood of them extending back beyond the work zone’s advance warning signs and surprising approaching drivers, which in turn reduces the potential of rear-end crashes. In addition, drivers experience less anxiety about knowing which lane is closed, because either lane can be used to reach the merge point. The availability of both lanes also reduces the frustration levels of drivers. Drivers in the open lane are less likely to be irritated by others passing by them in the closed lane, because this maneuver is permissible with the dynamic late merge. Drivers are able to select the lane with the shortest queue and not be concerned about others blocking their path to the merge point.(40)

A University of Nebraska study (40) found that dynamic late merge had a higher capacity than dynamic early merge. Moreover, they found that the dynamic early merge increases travel times, especially under high-traffic volumes. Based on these findings, the study states that the best system of merge control during peak periods is the dynamic late merge. The study did note a concern about the potential for driver confusion at the merge point with the dynamic late merge, especially under high-speed, low-volume conditions, which could adversely affect safety. Under these conditions, drivers might find it more difficult to decide who has the right-of-way; this indecision could increase the potential for collisions at the merge point. As such, dynamic late merge may not be the best approach during off-peak periods.

## 5.11 Tying and Integrating Selected Strategies Together

The final activity of this step is to take the individual strategy recommendations for the various links and combine them, identifying and grouping the multiple ATM strategies that may have been defined for each link. While ATM strategies can be deployed singularly to address a specific need or problem, many strategies are complementary, and combining them can often help to achieve systemwide goals and objectives of safety, congestion management and mobility, traveler information, and environmental needs, resulting in synergistic operations and benefits. For example:

- From the European perspective, dynamic shoulder lanes are almost always deployed in conjunction with dynamic speed limits and dynamic lane control signing.(31) This has generally not been the practice to date in the United States, where several shoulder lane deployments are stand-alone, only providing signage for shoulder use (i.e., a lane use control sign over the shoulder and/or a static sign indicating the times of the day when the

shoulder may be used. It is noted that recent shoulder lane systems in the United States that are truly dynamic—such as Minneapolis and Northern Virginia—include DSpL and DLA across all lanes.

- Queue warning systems are frequently combined with DSpL and DLA systems to enhance operations, utilizing the queue warning DMS to provide information to motorists as to the reason for reduced speeds and lane closures. The Dutch system alerts motorists of queues with flashing lights in addition to variable speed signs.(16)
- Ramp metering and wider concepts for ATDM can help lock in the benefits of additional capacity and merit consideration in the design of future DShL schemes.(41)
- Many ATM strategies have a large number of design elements in common (e.g., sign supports, gantries, detection systems), and combining them may provide economies of scale in terms of costs.

Perhaps the most important consideration in this activity of combining ATM strategies is to take a strategic approach to the entire roadway, or long segments of it, providing some ATM elements in the “gaps,” even where they are not justified on a stand-alone basis. For example, say that the screening process has identified two 7-mile stretches of roadway for implementing DSpL, DLA, and QW, and these two segments are only 2 or 3 miles apart, with no ATM having been recommended for this intervening segment. It may be worthwhile to also include some ATM in this “gap.” Such a strategic approach will help deliver a more consistent driving experience, minimizing the possibility for confusion by drivers.

*A strategic approach to ATM deployment is critical, providing a continuity of strategies and a more consistent driving experience.*



## Chapter 6. Estimate Benefits and Costs

---

As a result of the screening activities performed as described in the previous chapters, practitioners will have identified a series of strategies and associated roadway segments and links where ATM may be deployed so as to meet one or more regional goals and improve the mobility, reliability, and/or safety of the transportation system. The next and final step of the screening process is to estimate the benefits and costs of these initial recommendations, further refining and prioritizing them accordingly.

A benefit/cost analysis is also an important consideration within the broader “Objectives-Driven, Performance-Based Approach for Metropolitan Planning for Operations” and CMP, as shown in Figure 2. Due to the current transportation improvement funding environment, transportation planners and operations personnel will likely need to compare more traditional infrastructure projects (e.g., widening, bottleneck removal) and TSM&O-oriented strategies, including ATM. Because both of these different types of projects are often competing for the same funds, a benefit/cost analysis provides a framework for prioritizing and ranking widely varying improvement types.

### 6.1 Consider Key ATM Cost Factors

As noted in the FHWA Operations Benefit/Cost Analysis Tool (TOPS-BC) (23), estimating the life-cycle costs of TSM&O strategies (such as ATM) is often complex. Compared with more traditional infrastructure improvements, TSM&O improvements typically incur a greater proportion of their costs as continuing operations and maintenance costs, as opposed to upfront capital costs. Much of the equipment associated with TSM&O strategies also typically has a much shorter anticipated useful life than many traditional improvements, and must be replaced as it reaches obsolescence. Planners and operations practitioners must fully consider and account for all the costs of TSM&O strategies when evaluating and developing deployment and operations and maintenance plans. Failure to recognize and accurately forecast these costs may result in future funding or resource shortfalls, or worse, the inability to properly operate and maintain deployed TSM&O improvements.(23)

TOPS-BC recommends the following structure for organizing cost data:

- **Capital costs**—The upfront costs necessary to procure and install equipment related to the operations strategy. These costs will be shown as a total (one-time) expenditure and will include the capital equipment costs, as well as the soft costs required for design and installation.
- **Operations and maintenance costs**—Those continuing costs necessary to operate and maintain the deployed strategy, including labor costs. While these costs have provisions for upkeeping and replacing minor system components, they do not contain provisions for wholesale equipment replacement when the equipment reaches the end of its useful life. These operations and maintenance costs will be presented as annual estimates.

- **Replacement costs**—The periodic cost of replacing and/or redeploying system equipment as it becomes obsolete and reaches the end of its expected useful life to ensure the continued system operation.

TOPS-BC further recommends that, due to the complexity of many TSM&O deployments, these cost figures may be further segmented to ensure their usefulness. Within each of the capital, operations and maintenance, and annualized cost estimates, costs should be further disaggregated to show the infrastructure and incremental costs. These are defined as follows:

- **Infrastructure costs**—Basic “backbone” infrastructure equipment (including labor) necessary to enable the system. For example, deployment of nearly all of the ATM strategies requires that certain infrastructure first be deployed at the traffic management center to support the roadside ITS elements. This may include costs such as additional computer hardware, new software algorithms and the associated user interface, and the additional staff and labor to operate the system. Another potential infrastructure component is a new or enhanced communications backbone if the existing network does not have the capacity to accommodate ATM. Once this equipment is in place, multiple roadside elements (e.g., gantries and signs, ramp meter and traffic signal controllers, additional detectors and other surveillance) may be integrated and linked to this backbone infrastructure without experiencing significant incremental costs (e.g., the equipment does not need to be redeployed every time a new camera is added to the system).
- **Incremental costs**—Costs necessary to add one additional roadside element (or unit of length, such as a mile of shoulder preparation) to the deployment. For example, the incremental costs for the DSPL and DLA system include the costs of purchasing and installing one additional gantry, including the signs and controller. Other deployments may include incremental costs for multiple units.

Structuring the cost data in this framework provides the ability to readily scale the cost estimates to the size of potential deployments. Infrastructure costs would be incurred for any new technology deployment such as ATM strategies. Incremental costs would be multiplied with the unit (e.g., number of intersections equipped, number of ramps equipped, miles of shoulder prepared for use as travel lane, and number of ATM gantry locations) and added to the infrastructure costs to determine the total estimated deployment cost. Presenting the costs in this scalable format provides the opportunity to easily estimate the costs of expanding or contracting the size of the deployment and allows the cost data to be reutilized for evaluating other corridors.

### 6.1.1 Capital Costs

Although not as expensive as constructing a new lane, the funding requirements for ATM can be high. This is particularly the case for dynamic speed limits and dynamic lane control, which can require installing numerous large gantries with over-the-lane signs, and for dynamic shoulder lanes, which require overhead lane (i.e., shoulder) control signing as a minimum, and possibly construction to strengthen or otherwise prepare the shoulder to carry traffic, to minimize any clear zone issues (e.g., install and relocate guiderails) and to provide emergency refuge areas. . Example costs for systems incorporating dynamic speed limits and dynamic lane

assignment, plus dynamic shoulder lanes in some cases, are provided in Table 13 along with the dates of the costs. Additional cost information for all the ATM strategies addressed herein may be found in ITS Joint Programs Office Knowledge Resources web site (including benefit and cost databases) at <http://www.itsknowledgeresources.its.dot.gov/>. (8)

**TABLE 13. SAMPLE COST OF ACTIVE TRAFFIC MANAGEMENT (ATM) SYSTEMS**

Location (Year)			
United Kingdom M42 (2008)	DSpL, DLA, and DShL with shoulder treatments	\$15 million per route mile <sup>(32)</sup> ; equates to \$7.5 million per directional mile	5.6 million British pounds per kilometer, converted using current exchange rate of 1.68 dollars per pound
Washington State I-5 (2010)	DSpL, DLA, and QW	\$23 million for 7-mile northbound segment; equates to \$3.2 million per directional mile for three-lane section <sup>(5,42)</sup> \$4 million per directional mile for five-lane section <sup>(42)</sup>	Gantries roughly every 0.5 mile; included new fiber network Per directional mile costs are 2008 conceptual cost estimates
Washington State I-90 and SR 520 (2010-2012)	DSpL, DLA, and QW	\$38.4 million for 17-mile segment (both directions) (I-90 = 9 miles; SR 520 = 8 miles); equates to \$1.1 million per direction mile	Included 44 sign locations and new fiber network
Minnesota I-35W (2010)	DSpL, DLA, and DShL for HOT	\$21.5 million for 10-mile stretch; equates to \$1.1 million per direction mile <sup>(43)</sup>	Costs for sign structures, DMS, and communications
Minnesota I-94 (2010)	DSpL, DLA, and QW	\$15 million for 4-mile stretch; equates to \$3.75 million per route mile, or \$1.9 million per direction mile	Conceptual cost estimate
Philadelphia I-95 (2014)	DSpL and DLA	\$ 950,000 per directional mile <sup>(29)</sup>	Preliminary cost estimate using “hybrid” gantry approach. Power and communications already in place.
New Jersey (2015)	DSpL, DLA, and QW	\$1.8 million per directional mile <sup>(28)</sup>	Preliminary cost estimate using “hybrid” gantry approach. Gantries include walkway for maintenance access.

Note: This sample cost information should be used with some degree of caution. They vary quite a bit—and may not be applicable to one’s own application—due to a number of factors, such as gantry spacing, gantry design, need for new supporting infrastructure (e.g., communications, detection), any enhancements to the shoulder lanes, and software costs).

The costs per directional mile vary widely. Of course, each ATM deployment will be different in terms of signage, support structures, and the extent to which new supporting infrastructure (e.g., communications, detection, power) is needed. Also, the literature is not always clear about what these cost figures actually include. For example, the M42 costs<sup>(32)</sup> and the highest per mile costs identified in the Table 13 (in part due to the inclusion of DShL and close spacing

of gantries) include “outturn costs, covering the total cost of all the design, development, delivery, construction, infrastructure and support costs from inception to maintenance handover.” The Washington state I-5 costs do not include software, because this development was performed in-house by WSDOT staff. Other costs shown only address the sign structures, DMS, and communications. Another consideration is the ability to piggy back the ATM elements onto a roadway construction project, as was the case for Minnesota I-35W, which offered the opportunity to “capture significant cost savings.”(43)

As discussed in previous chapters, because of these high costs, roadway links and segments that experience significant recurring congestion (i.e., the traffic volumes exceed capacity during peak periods), and where the crash rates are much higher than the region or statewide average, are generally the best suitable candidates for ATM implementation, because benefits will be greater on these segments rather than roadways where congestion is held to a relatively small period during the peak period. In developing the preliminary capital costs as part of the screening process, remembering and including all the likely elements of the ATM system as summarized in Table 14 are important.

### **6.1.2 Gantries and Sign Supports for Dynamic Speed Limits, Dynamic Lane Assignments, and Dynamic Shoulder Lanes**

Estimating capital costs will require some decisions, or at least informed assumptions, in several areas. One area in this regard involves gantries for freeway ATM strategies, particularly for DSpL, DLA, and DShL. The number and type of sign gantries can represent a major capital cost.

Initial deployments of dynamic speed limits and dynamic lane assignment in the United Kingdom and in the United States used gantries spanning the entire roadway with DMS (for displaying speed limits and lane control) over each and every lane, with larger DMS to the side for queue warning messages and other information. Moreover, these gantries were spaced such that the driver was presented with a “continuum of information with ‘intervisibility’ of signs on successive gantries for the driver.”(33) This resulted in gantry spacing of between 600 meters (0.37 miles) to 1,000 meters (0.62 miles). On the M42 in the United Kingdom, the gantry spacing is 500 and 800 meters (nominally .33 to 0.5 mile). The concern was that compliance would be less if gantries were spaced too far apart. The spacing of gantries for the Washington State and Minnesota systems followed suit and are located at roughly 0.5-mile intervals on average.

Costs saving approaches are continuously being evaluated, including the tradeoffs of increasing the spacing between gantries, detectors, and emergency refuge areas. In England, the earlier ATM implementations are now considered conservative, and experience indicates that greater spacing may be appropriate. The current philosophy is that spacing needs to be sufficient so that drivers know they are still on a controlled roadway.



TABLE 14. ACTIVE TRAFFIC MANAGEMENT (ATM) COMPONENTS TO BE INCLUDED IN CAPITAL COSTS

Potential Components	ATM Strategies
<b>Activities associated with the systems engineering process</b> —These can include developing the Concept of Operations and requirements document, design and contract documents, testing and acceptance activities, and construction engineering. There may be additional costs for some ATM strategies (e.g., DShL) for developing environmental assessments and/or environmental impact statements.	All
<b>DMS and supporting sign supports and gantries</b> —Related cost considerations for sign supports and gantries include the number of lanes being spanned and the type of roadway that gantries/mast arms are being placed on (at-grade or structure). Having sufficient right-of-way to place the foundations is another potential cost issue.	DSpL, DLA, QW, DShL, DJC, DLR
<b>Any widening and shoulder reconstruction</b> — This can include repaving the shoulder, modifying drainage structures, adding guardrails, and completely reconstructing or only widening the shoulder. This may also include installing emergency refuge areas. Roadways on structure, or the presence of bridge piers and related appurtenances near the roadway, may significantly increase the cost of these improvements. Moreover, such conditions might conceivably preclude implementing ATM along a particular segment, interrupting the necessary continuity.	DShL, DJC
<b>Ramp terminal treatments</b> —These can include ramp widening, shoulder hardening and/or additional storage or new turn lanes on arterials. Signage and support structures along the ramps may also be required.	ARM, DJC
<b>Traffic signal controllers</b> —The need to upgrade or replace traffic software and controllers to ensure compatibility with ATM strategies is a critical issue to consider because it might represent the most significant cost items in some projects.	ATSC, TSP, ARM
<b>Detection and surveillance</b> —With the increased emphasis on dynamic and automated operations, nearly all ATM strategies require extensive detector subsystems. DSpL and DLA strategies often require per-lane data, while DShL may require installing detectors along the shoulder and/or additional CCTV to allow full coverage of the shoulder and the emergency refuge areas. Detection requirements (and costs) for ATSC are somewhat higher than those for conventional traffic-actuated control systems.	All
<b>Communications and power</b> —The need to install communications and power to support the ATM field components can further increase the costs, often significantly. Practitioners need to determine how existing infrastructure and strategies can be leveraged to support ATM elements and what improvements must be made to adequately support new ITS devices installed as part of the strategy.	All
<b>Software</b> —Automating ATM strategies and “dynamic” operations will likely require additional software algorithms, including decision support systems that can assist operators with quickly inputting necessary information (e.g., confirm that a lane is closed, confirm that the shoulder is clear of any vehicles) and approving a new signing sequence, as may be appropriate. Developing the initial rules base and other database parameters for the software algorithms should also be included.	All
<b>Central hardware and TMC enhancements</b> —Depending on the size of the new system, additional central hardware (servers, communications modems, workstations, video displays) may be required. This in turn may require alterations or enhancements to the TMC.	All

**TABLE 14. ACTIVE TRAFFIC MANAGEMENT (ATM) COMPONENTS TO BE INCLUDED IN CAPITAL COSTS**

Potential Components	ATM Strategies
<b>Training</b> —Existing and new operations staff will likely require training on how ATM operations will work and their associated responsibilities, including information that they will need to input to new algorithms and decision support systems. If new types of field hardware are to be installed, maintenance staff will also require training. “Bus on Shoulder” strategies will require initial training of bus operators.	All
<b>Public outreach and communications campaigns</b> —As previously discussed, ATM strategies such as DSpL, DLA, and DShL will likely be new to the motoring public, and an extensive public outreach program may be required as part of the overall compliance effort.	All
<b>Mobilization and contingency costs</b>	All

The U.K. Highways Agency<sup>18</sup> analyzed a new application of the Managed Motorways toolkit, with the overall aim of delivering “schemes that will provide comparable benefits to those expected of current Managed Motorways schemes, but at a reduced cost and with shorter timescales for implementation.” (45) Their findings suggested that there was a relationship between the spacing of information update points and the speed of individual drivers; mean speed and spot speed under gantries were higher when gantries were spaced further apart, and participants exhibited a greater degree of “surfing” behavior as gantry spacing increased.

Through the use of visualization and response monitoring software, a driving-simulator trial, and questionnaires, equivalent options for verge (i.e., side-) and gantry-mounted information provision, in general, were determined to be comprehended equally well. Within the driving-simulator trial, participant driving behavior was comparable in response to either signing option. Moreover, the findings also indicated that presenting several information elements on a single side-mounted sign had a minimal impact on driver comprehension. The overall results suggested that side-mounted signing is equal to gantry-mounted signing at instructing drivers to move out of a particular lane. An example of the verge-mounted sign display, as seen from a “driver’s eye” perspective, is shown in Figure 26.

<sup>18</sup> On April 1, 2015, the Highway Agency was replaced by Highways England, a government-owned company responsible for England’s motorways and major A roads.



**FIGURE 26. PHOTOGRAPH. CONCEPTUAL VERGE (SIDE)-MOUNTED SIGN FOR ACTIVE TRAFFIC MANAGEMENT (ATM) AS STUDIED IN THE UNITED KINGDOM (46)**  
(Source: UK Highways Agency)

Reference 46 from the United Kingdom lays out the Highways Agency latest design concepts for DSpL, DLA, and QW. The general layout is shown in Figure 27. The design concept consists of the following:

- Driver information, including speed limits, lane availability and closures, and text legends (e.g., queue warnings) and pictograms is provided at intervals not exceeding 1,500 meters (0.93 mile).
- The first sign display downstream of a merge is a full-lane gantry supporting over the lane signs (for displaying DSpL and DLA messages) and a DMS for other messages of a strategic nature.
- Other ATM signs (i.e., between junctions and in accordance with the maximum spacing) are verge-mounted as shown in previous Figure 19.
- Refuge areas provided at maximum intervals of 2,500 meters (1.55 miles).
- Full CCTV are equipped with with pan, tilt, and zoom.

How such a signing approach might work in the United States depends on several factors, including the number of lanes in the directional cross-section (the U.K. study was based on a four-lane cross-section in a single direction), driver perception of such a diagrammatic concept (and the need for outreach and education), and conformance to the MUTCD.

A similar hybrid arrangement has also been proposed for PennDOT District 6 (in the Philadelphia area). One of the ATM design concepts involved coordinating gantry locations with fixed signage and eliminating conflicting or redundant static signage where possible.

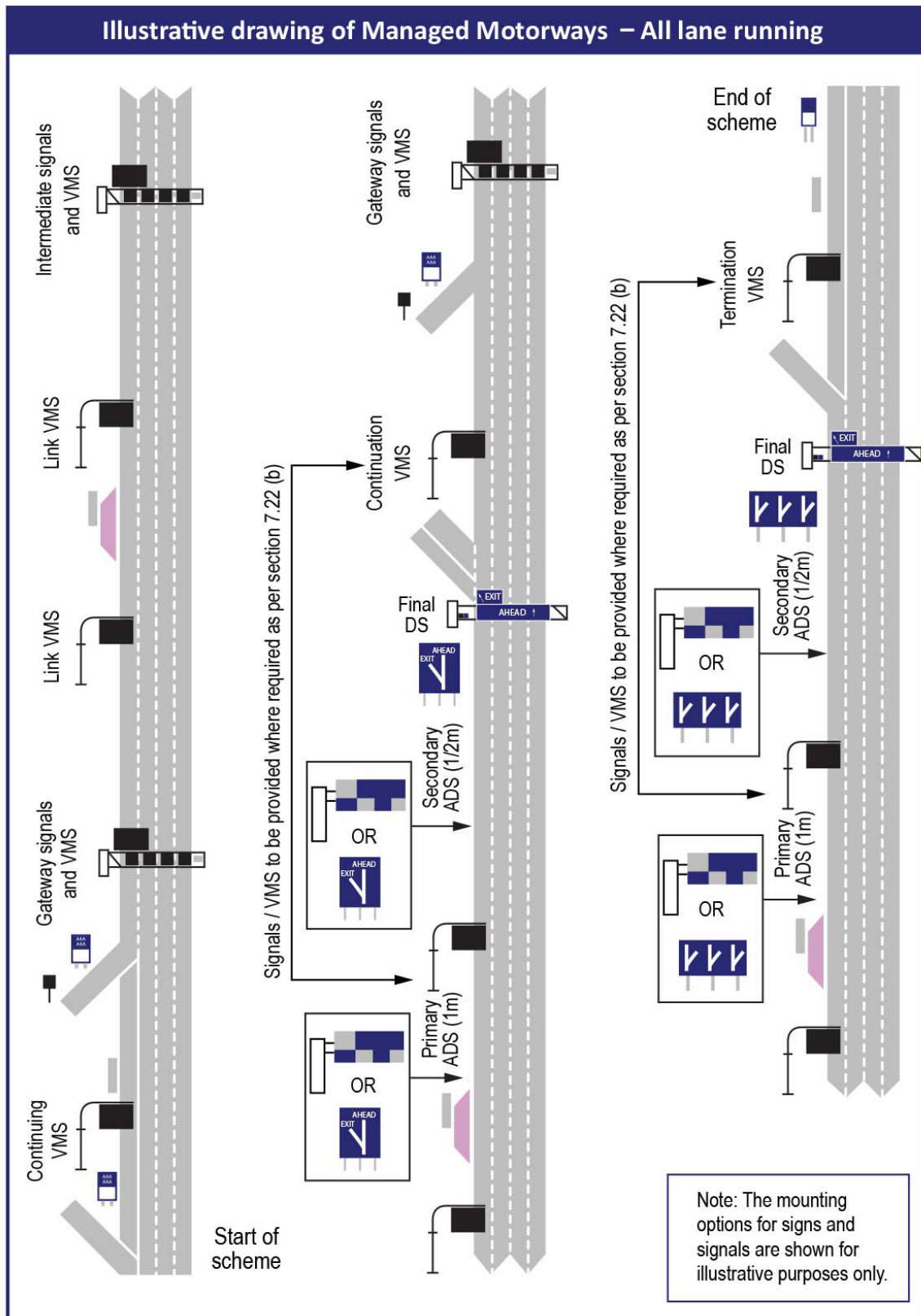

**FIGURE 27. DIAGRAM. CURRENT MANAGED MOTORWAYS CONCEPT**  
(Adapted for UK Highways Agency -46)

One concern was to not overwhelm the driver with various visual stimuli. In particular, this meant placing the ATM gantries no closer than 600 feet, and preferably 800 feet in accordance with the MUTCD, from an existing or planned fixed-guide sign assembly. Based on plan and field reviews, this criterion was determined to preclude installing ATM gantries every 0.5 mile in accordance with the Pennsylvania code (that permits variable speed limits, but requires that they be placed at a maximum spacing of every 0.5-mile). Accordingly, a hybrid layout was developed with the following nominal spacing:

- Full ATM gantry installed every mile (+/-).
- Two sets of side-mounted VSL signs—with each set consisting of a sign on the left and right of the directional roadway—installed equidistant (+/-) between the ATM gantries and from one another (i.e., approximately 1/3 mile after and prior to the ATM gantry).
- As shown in previous Table 12, the estimated capital costs are much less than the “a gantry every 0.5-mile” approach.

Signage decisions for DShL should also be assumed as part of the cost analysis. As a minimum, lane control signs should be installed over the shoulder to indicate when the shoulder lane is open or closed (as shown in Figure 28) to permit dynamic operations of DShL.



**FIGURE 28. PHOTOGRAPH. DYNAMIC SHOULDER LANE (DShL) SIGNAGE IN NORTHERN VIRGINIA**  
(Source: Virginia DOT)

As previously noted, the general approach in Europe is to deploy DSpL and DLA signage across all lanes (including the shoulder) as part of the DShL strategy. In this manner, roadway operations can be fully optimized to provide measurable benefits to the motoring public. Examples in this regard include the ability to reduce speed limits and/or advisories across all lanes as may be appropriate when shoulder lanes are in operation and the ability to close any running lane to facilitate emergency vehicle access should a crash occur. Another possible approach is to use lane control signage only over the shoulder and supplement this with queue warning DMS and side-mounted dynamic speed limit signs as shown in Figure 29.



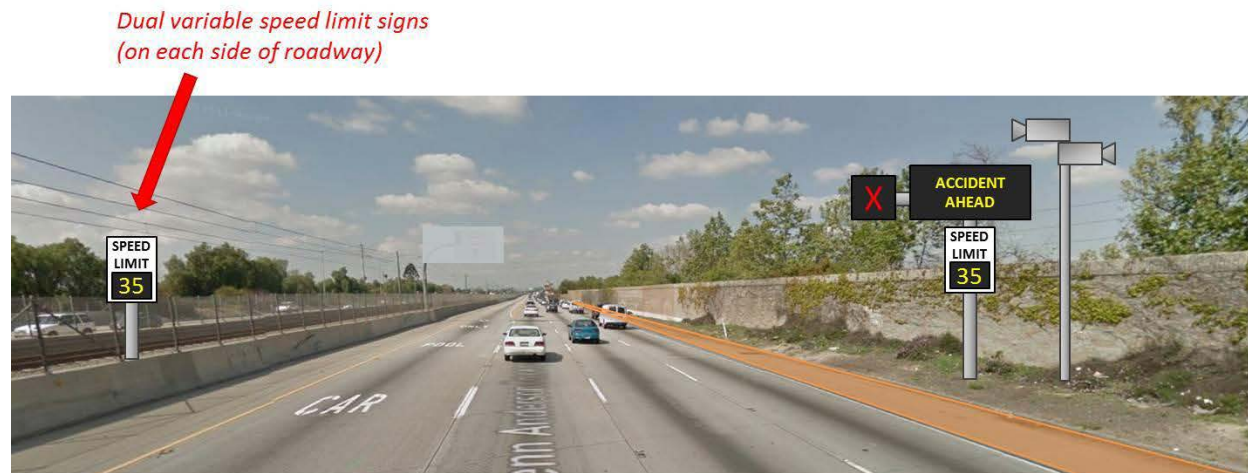

**FIGURE 29. PHOTOGRAPH. CONCEPTUAL DYNAMIC SHOULDER LANE (DSHL), DYNAMIC SPEED LIMIT (DSPL), AND QUEUE WARNING (QW) SIGNAGE FOR LOS ANGELES AREA (27)**

(Source: Caltrans)

### 6.1.3 Operations and Maintenance Costs

Like any other investment that involves the application of advanced technology, ATM should only be implemented if agency budgets can support effective and continual operations. In other words, if agency budgets cannot support continued, effective, and safe operation, then ATM strategies should likely be deemed not feasible until such time that funding is available. As discussed in Chapter 3, Section 3.3, having the appropriate institutional framework in place to support ongoing ATM operations and maintenance is viewed as a necessary condition for moving forward with the ATM screening process and any subsequent design and deployment.

Operations costs include the following:

- **Labor costs tied to the operation of ATM strategies**—This can include staffing for TMC operations. To effectively manage the ATM techniques, the TMC will need to be staffed with operators 24 hours a day, 7 days a week. Depending on the size of the ATM system implemented, existing TMC operators' workload might increase, and additional staff might be required. However, the system should be largely automated with operators mainly being responsible for monitoring or possible manual override.
- **Updating and maintaining operating procedures**—Besides the additional labor costs associated with operations, there are other costs tied to operation of ATM strategies. These include updating standard operating procedures and the system rules based on operating experience.
- **Compliance and outreach**—Public outreach is an ongoing concern. Moreover, it may be necessary to budget funds for continuing police enforcement. As an example, to support the M42 pilot, the U.K. Highways Agency was able to negotiate an enforcement agreement with West Midlands Police. As part of that agreement police staff, information technology licensing and accommodation costs were estimated to total £77,000 (approximately \$125,000) per annum (cost to the Highways Agency).(41)

Maintenance costs represent another on-going cost. Implementing ATM strategies will result in significant additions to existing ITS inventories; and this will require a consistent and continuing program of preventive and reactive maintenance. This may require additional maintenance staff, spare parts, and ongoing training. In some cases, this cost may include additional hardware and software to track maintenance activities such as those associated with a maintenance decision support system. Roadway maintenance procedures (e.g., pothole repair, sweeping, snow removal) may also need to be expanded or changed to for shoulder lanes. While implementing ATM can be expected to improve the operational performance of the traffic network, it is important to bear in mind that, regardless of what strategies are selected, a considerable level of ongoing commitment and expertise will be required to realize the full potential of the system. This is not a “set and forget” process. If agency budgets cannot support the ongoing operations and maintenance needs of ATM, then ATM strategies should not be deployed.

## **6.2 Perform High-Level Estimates of Benefits and Costs Using Available Tools**

Quantifying the life-cycle benefits and costs of the selected ATM strategies at an order of magnitude level of analysis, and by roadway and/or roadway segment, will help decision-makers compute a preliminary benefit-cost ratio for a project. Available tools and approaches are briefly discussed below.

### **6.2.1 Benefit Quantification**

In addition to making assumptions on several key cost factors (or including various cost alternatives in the analysis), identifying which ATM measures of effectiveness will be used, how these will be estimated, and how the resulting benefits will be monetized is important. As discussed in earlier chapters, estimated benefits may be expressed in terms of reduced travel times and/or delay, reduced delays, reduced number of crashes, and reduced emissions. Improved reliability is also an emerging measure of effectiveness that might be considered for ATM.

Converting the estimated benefits into dollar values, using estimated values of time, fuel, crashes (including property damage, injury, and fatality), emissions, and reliability, among others, will then be necessary. The state DOT may have such conversion values, or national averages may be used, such as those found in TOPS-BC (23). Another critical aspect of monetizing benefits is to annualize them and then estimate the total dollar value of the benefits over the life-cycle of the system. This life-cycle period must be the same as the analysis period used for the estimating costs, as discussed below.

### **6.2.2 Analysis Period**

It is essential that the analyses utilize a common period of time – the “analysis period” – to assess life-cycle costs and benefits, and to compare the resulting benefit-cost ratios for different alternatives and scenarios. The analysis period should be long enough to include the initial construction up to (and possibly beyond) the point where it becomes necessary to replace many of the system components (e.g., DMS, controllers). This period should also capture the comprehensive benefits that flow as a result of an improvement over the life cycle

of the deployment (i.e., a practitioner would not want to compare the total costs for a strategy with a single-year estimate of benefits.) The purpose of this approach is to spread out both the benefits and costs over an appropriate timeframe to allow for a meaningful analysis. For ATM strategies, a 10, 15, or 20 year time horizon should be considered.

A related issue in any kind of evaluation, including life-cycle benefit-cost analysis, is the difficulty of making value comparisons among projects that are not measured in equal units. Even when values are stated in monetary units such as dollars, the values still may not be comparable, for at least two reasons:

- **Inflation:** Expenditures typically occur at various points in the past or future and are therefore measured in different value units because of changes in price (e.g., a 1990 dollar would, in general, have purchased more real goods and services in 1990 than would a 2010 dollar in 2010). A general trend toward higher prices over time, as measured in dollars, is called inflation. A general trend toward lower prices is called deflation. Dollars that include the effects of inflation or deflation over time are known as nominal, current, or data year dollars. Dollars that do not include an inflation or deflation component (i.e., their purchasing power remains unchanged) are called constant or base year dollars.
- **Discounting:** Costs or benefits (in constant dollars) occurring at different points in time—past, present, and future—cannot be compared without allowing for the opportunity value of time. The opportunity value of time as it applies to current versus future funds can be understood in terms of the economic return that could be earned on funds in their next best alternative use (e.g., the funds could be earning interest) or the compensation that must be paid to induce people to defer an additional amount of current year consumption until a later year. Adjusting for the opportunity value of time is known as discounting.

Analytically, adjusting for inflation and discounting are entirely separate concerns, and they should not be confused by attempting to calculate both at once. Instead, future costs and benefits of a project should be expressed in constant dollars and then discounted to the present at a discount rate that reflects only the opportunity value of time (known as a real discount rate). This is because public sector project benefits should be dependent only upon real gains (cost savings or expanded output), rather than purely price effects.

Through the use of a real discount rate, the following transformations can be performed to facilitate comparison of the constant dollar costs of alternative transportation projects:

- **Relocation in Time.** A single figure can be “moved” (transformed into an equivalent value) backward or forward in time, without altering its real value, known as its “present worth”.
- **Annualized Cost.** This is the average annual expenditure that would be expected to deploy, operate, and maintain the operations strategy and replace (or redeploy) any equipment as it reaches the end of its useful life. Within this cost figure, the capital costs will be amortized over the anticipated life of each individual piece of equipment. This annualized figure is added with the reoccurring annual operations and maintenance cost to produce the annualized cost figure. This figure is particularly useful in estimating the long-term budgetary impacts of TSM&O deployments.



- Present Value. Any combination of flows (finite or infinite) and lump sums can be summed into a single value at a single point in time.

### 6.2.3 Sketch Planning

Conceptual capital costs can be roughly estimated using a variety of sources, including costs from other ATM deployments, the ITS Joint Programs Office Knowledge Resources Website (<http://www.itsknowledgeresources.its.dot.gov/>) (8), and product manufacturers via their corporate websites. If receiving a capital cost estimate from another public agency, be aware that costs cannot be directly applied to analyzed roadways without considering factors such as number of lanes, presence and condition of shoulders, presence and capacity of existing communications and power, presence of structures and soil conditions, and cost savings achieved with coordination with other planned and ongoing construction activity. As previously discussed, it is crucial to estimate the annual costs for operations and maintenance and also include equipment replacement as part of the life-cycle costs.

A planning-level estimate of the potential benefits of an ATM deployment can be derived using the documented benefits from other implemented ATM systems, in the United States and in Europe as may be appropriate. For example:

- Operational impacts are assessed by estimating changes in travel time and/or delay (e.g., percent reduction in existing excess travel times and delays based on documented results from other implementations.) The aggregate time savings can then be translated into a dollar value using estimates of the value of time from the *Urban Mobility Report* by the Texas Transportation Institute (2009) or other widely cited sources. Safety impacts are assessed by estimating reductions in crashes (e.g., percent reduction in existing crash experience, perhaps by crash type, based on documented results from other implementations.) The estimated crash reductions can then be translated into a dollar savings using average per property damage only, injury, and fatality crash costs from standard references. These projected crash benefits can then be accrued over the same analysis interval as the cost and operational analyses.
- Reliability improvements should also be addressed. A number of SHRP2 products are being developed for converting reliability benefits into dollar values (see <http://www.fhwa.dot.gov/goshrp2/Solutions/Reliability/List> for more information).

This sketch planning approach lends itself to the use of one or more spreadsheets. As a general rule, values smaller than the observed safety and operations benefits from other systems should be assumed, thereby providing a conservative benefit-cost ratio. This is particularly true if basing the safety benefits on European systems, where drivers' long-term experience with ATM systems and the existence of automated speed enforcement likely improves overall compliance as compared to the U.S. systems.

### 6.2.4 Highway Capacity Manual

The Highway Capacity Manual (53) recently adopted Chapter 35 dedicated to ATDM strategies.(47) The ATDM analysis methodology is designed to provide estimates of the effects of ATDM strategies on a facility in terms of throughput, travel time, speed, delay, and travel

time reliability. The analysis considers a “before” case before the ATDM strategies are implemented and an “after” case with the ATDM strategies implemented.

The approach provides a conceptual analysis framework, recommended measures of effectiveness, and an initial set of recommended methodologies for evaluating the impacts of ATDM strategies on highway and street system demand, capacity, and performance. As ATDM is currently farther advanced on freeways than on urban streets, the new chapter focuses on the analysis of freeway facilities.(47)

The ATDM analysis framework (Figure 30) is designed to provide estimates of the effects of ATDM strategies on person throughput, mean facility or system travel time (and therefore delay), and facility or system travel time reliability for two conditions: (1) before implementation of ATDM strategy and (2) on opening day of implementation of the ATDM strategy. The ATDM analysis method is designed to address the following menu of ATDM strategies, several of which are the ATM strategies discussed in the guidance:

- Travel demand management strategies
- Weather traffic management plan
- Traffic incident management plan
- Work zone traffic management plan
- DSpL (speed harmonization)
- HOV/HOT lane management strategies
- Shoulder lane strategies
- Median lane strategies
- Truck controls
- Ramp metering

### 6.2.5 Tool for Operations Benefit/Cost

The TOPS-BC (23) tool is a spreadsheet-based tool designed to assist practitioners in conducting benefit-cost analysis of operations strategies by providing four key capabilities, including the following:

- The ability for users to investigate the expected range of impacts associated with previous deployments and analyses of many TSM&O strategies.
- A screening mechanism to help users identify appropriate tools and methodologies for conducting a benefit-cost analysis based on their analysis needs.
- Framework and default cost data to estimate the life-cycle costs of various TSM&O strategies, including capital, replacement, and continuing operations and maintenance costs.
- A framework and suggested impact values for conducting simple benefit/cost analysis for selected TSM&O strategies.

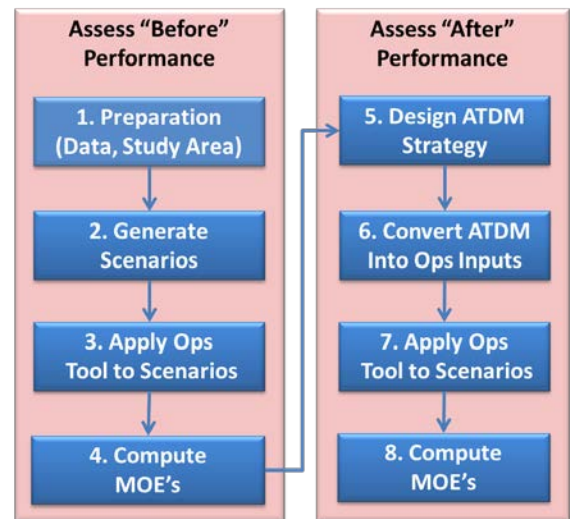

FIGURE 30. FLOWCHART. ACTIVE TRANSPORTATION AND DEMAND MANAGEMENT (ATDM) ANALYSIS FOR THE HIGHWAY CAPACITY MANUAL (HCM) (47)

A desk reference<sup>19</sup> was developed in parallel with the tool. TSM&O strategies covered in the TOPS-BC tool are identified in Table 15.

**TABLE 15. SUMMARY OF GUIDANCE ON TRANSPORTATION SYSTEMS MANAGEMENT AND OPERATIONS (TSM&O) STRATEGIES PROVIDED BY TOOL FOR OPERATIONS BENEFIT/COST (TOPS-BC) (23)**

<b>TSM&amp;O Strategy</b>	<b>Discussed in <i>Desk Reference</i></b>	<b>TOPS-BC Analysis Capability</b>
<b>Physical Strategies</b>		
Arterial Signal Coordination	●	●
Arterial Transit Signal Priority	●	●
Transit Automatic Vehicle Location	●	●
Ramp Metering	●	●
Incident Management	●	●
Pretrip Traveler Information	●	●
En-route Traveler Information	●	●
Work Zone Management	●	●
HOT Lanes	●	●
Speed Harmonization	●	●
Hard Shoulder Running	●	
Travel Demand Management	●	●
<b>Supporting Strategies</b>		
Traffic Surveillance	●	\$
Traffic Management Centers	●	\$
Communications	●	\$
<b>Nonphysical Strategies</b>		
ATDM	●	
System Integration	●	
Interagency Coordination	●	
Regional Concepts for Transportation Operations	●	

Notes:

- = Guidance or analysis capability provided
- \$ = Life-cycle cost estimation capability only

<sup>19</sup> <http://ops.fhwa.dot.gov/publications/fhwahop12028/index.htm>

Although TOPS-BC does not specifically model all ATM strategies, if users have an understanding of the various cost elements associated with a particular ATM strategy (or combination of strategies), coupled with information from other sources on the range of likely ATM impacts and costs, TOPS-BC can provide the framework for structuring project-specific ATM costs and benefits, TOPS-BC can also annualize these costs and benefits to compute a benefit/cost ratio. Moreover, TOPS-BC is being updated by FHWA to reflect lessons learned from the user experience to date.

### **6.2.6 Summary**

Using any of the methodologies noted above should allow the practitioner to refine and prioritize the ATM recommendations by roadway segment based on benefit-cost ratio, benefits from an initial deployment, available funding, or some combination. Including additional links to provide more continuity and consistency of service to the road user should also be considered.

Another approach, particularly if the proposed ATM strategies are new to the region, may be to select a few ATM strategies and roadway segments that show the greatest benefit relative to costs, and then make this a demonstration/pilot project to test and evaluate ATM and to build trust. This approach serves three different purposes. First, it allows the technical systems and equipment to be tested to ensure that they are meeting their functional requirements. Second, it provides a basis for measuring the benefits and impacts of applying ATM. Finally, it provides a way to test ATM on a limited basis and, thereby, allay the concerns from DOT staff and operators, decision-makers, and the driving public. This, in turn, can help build a level of mutual trust that will enable further implementation of ATM across a region.

With the information in hand from initial ATM screening activities, agencies should be able to define ATM projects, including roadway segments and ATM strategies and the associated estimated benefits and costs, to be incorporated into the metropolitan transportation planning process for subsequent funding. If funding has already been provided as a general DOT budget item, then the screening information will provide an excellent starting point for developing a Concept of Operations and the associated more detailed analysis efforts as part of the systems engineering and broader project development process.

# Chapter 7. Next Steps

---

Completing the ATM feasibility and screening process, as discussed in the previous chapters, is just the beginning. At this juncture, agencies can use the results from the screening process for two general directions:

- Agencies use the screening results to present business cases to their management to obtain funding for follow-on activities associated with the systems engineering and broader project development process, including the immediate steps of developing ATM Concepts of Operations and the environmental/National Environmental Policy Act (NEPA) process as may be required.
- Agencies use the screening results for planning purposes to create ATM deployment programs and/or strategic plans providing a blueprint for ATM in the region or for a particular agency. These plans can be incorporated into the regional transportation planning process, including the regional long-range transportation plan, Regional ITS Architecture, and/or regional and/or statewide transportation improvement plans.
- Consideration should also be given as to how the ATM screening results fit into the broader ATDM concept, including whether there are any parallel Active Demand Management (ADM) and/or Active Parking Management (APM) efforts or initiatives in the region, and how those efforts could work in concert with future ATM deployments.

This chapter does not provide guidance on developing a Concept of Operations for ATM or for incorporating ATM in the regional or agency transportation planning processes; several references and examples are available to guide the practitioner in this regard. Rather, this chapter highlights a few key issues that will need to be addressed during these next steps, the knowledge of which will be of use while applying the initial screening guidance.

## 7.1 Stakeholder Involvement

Engaging with stakeholders as part of the screening process is discussed in Chapter 2. This is a continuing process, and regardless of which direction an agency takes, the number of stakeholders and the need for interaction will increase. Moreover, the driving public will become an important stakeholder requiring public outreach and education activities to help ensure they fully understand the ATM operational concepts.

## 7.2 Performance Measures

Performance measures indicate how well the transportation system is performing and are inextricably tied to operations objectives. Developing performance measures is an integral part of the objectives-driven, performance-based approach to planning (as shown in previous Figure 1). The performance measures selected should provide adequate information to planners, operators, and decision-makers on progress toward achieving their operations objectives.(2)

ATM-related performance measures will likely be necessary for both the planning process and Concept of Operations. Should detailed analyses be performed via simulation, the performance measures should guide the modeling process. Performance measures will also be critical to

monitoring the performance of the implemented ATM strategies, thereby allowing operators to make tweaks to implemented strategies to maximize benefits they offer. Moreover, the ability to expand coverage of ATM strategies may largely hinge on the ability to both monitor ATM strategies and demonstrate that strategies work toward meeting regional transportation goals.

A number of potential measures of effectiveness are identified in the literature. The *Active Traffic Management Guidebook (4)* identifies the following examples of performance measures used in European ATM deployments:

- Speed differential between lanes.
- Duration of speed less than x mph.
- Frequency of speed less than x mph.
- Flow and/or speed plots.
- Lane utilization.
- Headway distribution.
- Vehicle speed distribution.
- Vehicle hour delay.

The *Guide for Highway Capacity and Operations Analysis of Active Transportation and Demand Management Strategies (47)* recommends four measures of effectiveness for evaluating the achievement of one or more ATDM objectives. These measures, as identified in the reference, are computed across all of the scenarios to obtain overall results:

- **Person miles traveled** is a measure of the productivity of the highway system in terms of the number of people moved by the system and the number of miles they are moved.
- **Average system speed** (mph) is a measure of the efficiency of the highway system, and it is computed by adding the vehicle miles traveled (VMT)-served for each scenario and then dividing by the sum of the scenario vehicle hours traveled (VHT), including any vehicle entry delay. A key objective of ATDM is to maximize the system's productivity, serving the greatest amount of VMT at the least cost to travelers in terms of VHT. Thus, changes in the average system speed are a good overall indicator of the relative success of the ATDM strategy at achieving its objective of improving efficiency.
- The **average delay per mile** traveled is useful for conveying the results in a manner that can be related to personal experience. The average delay is measured in terms of vehicle-seconds delay per VMT.
- The **planning time index** (PTI) is a measure of the reliability of travel times on the facility. It is the ratio of the 95th percentile highest predicted travel time to the free-flow travel time. For example, a PTI of 1.20 means that the traveler must allow 20 percent extra time over free-flow travel time to get to their destination on time with a 95 percent level of confidence.

Another ATM performance measure of great importance is safety. Potential before and after performance measures in this regard include the following:

- Crash rates (by crash type).
- Number of crashes per segment.
- Number of secondary crashes and rates.
- Number of property-damage only crashes and rates.
- Number of injury crashes and rates.
- Percent vehicles exceeding speed limit by x percent.

### 7.3 Conformance with Regional Intelligent Transportation System Architecture

The initial activity shown in Figure 2, the Systems Engineering Vee Diagram, is the “Regional ITS Architecture.” FHWA Rule 940 (23 CFR 940) requires ITS projects that are funded, in whole or in part, with the Highway Trust Fund to conform to the National ITS Architecture and standards. The rule states that “conformance with the National ITS Architecture is interpreted to mean the use of the National ITS Architecture to develop a regional ITS architecture, and the subsequent adherence of all ITS projects to that regional ITS architecture.”

The National ITS Architecture identifies a series of transportation services for which transportation systems apply. These transportation services are addressed through 95 unique Service Packages. A Service Package is a group of different subsystems and communication flows needed to deliver a desired transportation service. Service Packages can work separately or in combination to address the real-world transportation needs and desires identified through traditional planning activities. Service Packages directly related<sup>20</sup> to the ATM strategies are listed in Table 16. Three of these—ATMS22: Variable Speed Limits, ATMS23: Dynamic Lane Management and Shoulder User, and ATMS24: Dynamic Roadway Warning—were recently created to support ATM and included in the National ITS Architecture as part of Version 7.0 (released in late 2013). Accordingly, while not necessary for the ATM screening process described herein, it may be necessary to update the Regional ITS Architecture to include these ATM-related Service Packages as the systems engineering process continues such that the proposed ATM system, as subsequently documented in the Concept of Operations and Requirements, does indeed “conform” to Rule 940.

### 7.4 Regulations and Manual on Uniform Traffic Control Devices Standards

The potential for changes in legislation to support certain ATM strategies (dynamic shoulder lanes, dynamic speed limits/displays) has been previously noted. ATM signage and procedures, particularly for dynamic lane assignment and possibly dynamic speed limits, as used in Europe and in the initial ATM implementations in the United States are not currently described in the MUTCD. This is particularly the case for DLA displays to alert drivers that a lane is closed downstream and that they should merge left or right.<sup>21</sup>

<sup>20</sup> Other Service Packages support ATM operations, including, but not limited, to, surveillance, incident management, road weather data, work zone management.

<sup>21</sup> Washington State uses a yellow downward diagonal arrow. Minnesota uses yellow chevrons pointing left or right.

**TABLE 16. NATIONAL INTELLIGENT TRAFFIC SYSTEM (ITS) ARCHITECTURE SERVICE PACKAGES DIRECTLY APPLICABLE TO ACTIVE TRAFFIC MANAGEMENT (ATM) STRATEGIES**

Service Package	Name	Description
APTS09	Transit Signal Priority	Determines the need for transit priority on routes and at certain intersections and requests transit vehicle priority at these locations.
ATMS03	Traffic Signal Control	Provides the central control and monitoring equipment, communication links, and the signal control equipment that support traffic control at signalized intersections. A range of traffic signal control systems are represented by this service package.
ATMS04	Traffic Metering	Provides central monitoring and control, communications, and field equipment that support metering of traffic and supports the complete range of metering strategies including ramp, interchange, and mainline metering.
ATMS06	Traffic Information Dissemination	Provides driver information using roadway equipment, such as dynamic message signs.
ATMS07	Regional Traffic Management	Provides for sharing traffic information and control among traffic management centers to support regional traffic management strategies.
ATMS09	Transportation Decision Support and Demand Management	Recommends courses of action to traffic operations personnel based on an assessment of current and forecast road network performance
ATMS18	Reversible Lane Management	Provides for the management of reversible lane facilities; also includes the equipment used to electronically reconfigure intersections and manage right-of-way to address dynamic demand changes and special events.
ATMS19	Speed Warning and Enforcement	Monitors vehicle speeds and supports warning drivers when their speed is excessive; also the service includes notifications to an enforcement agency to enforce the speed limit of the roadway.
ATMS22	Variable Speed Limits	Sets variable speed limits along a roadway to create more uniform speeds, to promote safer driving during adverse conditions (such as fog), and/or to reduce air pollution; also known as speed harmonization.
ATMS23	Dynamic Lane Management and Shoulder Use	Provides for active management of travel lanes along a roadway, including the associated hardware and control electronics that are used to manage and control specific lanes and/or the shoulders.
ATMS24	Dynamic Roadway Warning	Includes systems that dynamically warn drivers approaching hazards on a roadway (e.g., roadway weather conditions, road surface conditions, traffic conditions including queues, obstacles or animals in the roadway and any other transient event that can be sensed).
MC08	Work Zone Management	Manages work zones, controlling traffic in areas of the roadway where maintenance, construction, and utility work activities are underway.



Steps for experimental approval should be taken when a project timeline is set to ensure approval when the system will be activated. Per the MUTCD,(49) “a successful experiment is one where the research results show that the public understands the new device or application, the device or application generally performs as intended, and the device does not cause adverse conditions. The ‘experimenter’ must evaluate conditions both before and after installation of the experimental device and describe the measurements of effectiveness (MOEs) of the safety and operational benefits (e.g., better visibility, reduced congestion).” The request for experimentation should originate with the agency and be sent to the FHWA MUTCD Team with a courtesy copy to the local FHWA Division Office. The FHWA must approve the experiment before it begins. All requests should include the following information:

- A statement of the nature of the problem, including data that justifies the need for a new device or application.
- A description of the proposed change, how it was developed, and how it deviates from the current MUTCD.
- Any illustration(s) that enhances understanding of the device or its use.
- Supporting data that explains how the experimental device was developed, if it has been tried, the adequacy of its performance, and the process by which the device was chosen or applied.
- A legally binding statement certifying that the concept of the traffic control device is not protected by a patent or copyright.
- The proposed time period and location(s) of the experiment.
- A detailed research or evaluation plan providing for close monitoring of the experimentation, especially in the early stages of field implementation, including before and after studies as well as quantitative data enabling a scientifically sound evaluation of the performance of the device.
- An agreement to restore the experimental site to a condition that complies with the provisions of the MUTCD within 3 months following completion of the experiment. The agreement must also provide that the sponsoring agency will terminate the experiment at any time if it determines that the experiment directly or indirectly causes significant safety hazards. If the experiment demonstrates an improvement, the device or application may remain in place until an official rulemaking action occurs.
- An agreement to provide semiannual progress reports for the duration of the experimentation and a copy of the final results to the FHWA's Office of Transportation Operations within 3 months of the conclusion of the experiment.

FHWA recently completed a project to evaluate ATM sign displays and to identify potential gaps in the MUTCD in this regard. The project is completed, but the findings and recommendations are still being reviewed by the TMC Pooled Fund Study and FHWA, and have not been released to date.

Shoulder lanes and junction control strategies may also require FHWA approval for design exceptions and modifications once a shoulder is turned into a travel lane. These may include the following:

- Safety clear zone offset distance to hazards (since the travel lane will be pushed out 12 feet further). A common mitigation measure is to add and/or modify protective barrier.
- Vertical clearance (bridges on a grade may not have full clearance over what was once the shoulder).
- Stopping sight distance (in particular, around horizontal curves where the new travel lane is in close proximity to barrier wall).
- Lane width (e.g., 10-foot shoulder used as DShL).
- Drainage.
- Pavement structure (was the shoulder pavement constructed sufficiently to accommodate the new design load if used as a temporary travel lane).

Deploying dynamic shoulder lanes and junction control may require expanding the roadway footprint for widening the shoulders and to accommodate pull-out refuge areas. By moving traffic closer to the edge of the right-of-way, noise might increase near the right-of-way. In these circumstances, developing environmental assessments and/or environmental impact statements in accordance with the National Environmental Policy Act (NEPA) process might be necessary; this is an activity that should be included in the cost estimate.

## 7.5 The Future

One of the early activities in the ATM feasibility and screening process is reviewing recent literature on ATM strategies—from the United States and abroad—to determine whether any new approaches, guidelines, and/or standards have come to light that might impact or otherwise influence the screening process as described herein and any subsequent design activities. There has been an often rapid evolutionary path in the design and operational approaches for several ATM strategies, such as sign displays and layouts, the spacing of sign gantries and supports, operating algorithms and automated decision support mechanisms, and the associated real-time data needs. Moreover, several ATM strategies are in their relative infancy in the United States, and there will undoubtedly be many lessons learned and new requirements (e.g., MUTCD standards for lane control and dynamic speed displays, updates to the National ITS Architecture, and use of automated speed enforcement) as ATM matures in this country. Such future developments will impact not only the feasibility screening but also ATM design and operations. It is most important that the practitioner be aware of any such future developments when looking at potential ATM strategies and the optimum roadway locations.

There is also the long-term future of a connected vehicle environment and its potential impact on ATM. There are many possibilities in this regard—for example, data that permits better short-term predictions of congestion and safety concerns and real-time environmental data that are used to dynamically change speed limits and signal timing to minimize emissions. Who

knows, but in-vehicle displays and automated vehicles may completely eliminate the need for ATM infrastructure signs altogether sometime in the distant future. But that is the subject of another Guidance document years from now.



## Appendix A References

---



## References and Interviews/Reviewers

---

1. Federal Highway Administration (FHWA). 2014. ATM Website. Available at <http://ops.fhwa.dot.gov/atdm/approaches/atm.htm>. Last update September 22, 2014.
2. Federal Highway Administration (FHWA). 2010. *Advancing Metropolitan Planning for Operations: The Building Blocks of a Model Transportation Plan Incorporating Operations—A Desk Reference*. FHWA-HOP-10-027 and Associated Guidebook FHWA-HOP-10-26. April.
3. Federal Highway Administration (FHWA). 2013. *The Active Transportation and Demand Management (ATDM) Program: Lessons Learned*. FHWA-HOP-13-018. March.
4. Federal Highway Administration (FHWA). 2012. *Active Traffic Management Guidebook*. FHWA-HOP-12-020. April.
5. Washington State Department of Transportation (WSDOT). 2014. *2014 Corridor Capacity Report*. Thirteenth edition of the Annual Congestion Report. October.
6. Minnesota Traffic Observatory. 2013. *Effectiveness of Urban Partnership Agreement Traffic Operations Measures in the I-35W Corridor - Final Report*. CTS 13-22. University of Minnesota, Department of Civil Engineering, Minnesota Traffic Observatory. August.
7. Federal Highway Administration (FHWA). 2013. *Urban Partnership Agreement: Minnesota Evaluation: Final Report*. FHWA-JPO-13- 048. January 4.
8. Intelligent Transportation Systems Joint Programs Office. 2014. *DOT ITS Knowledge Resources* (including benefit and cost databases). Available at <http://www.itsknowledgeresources.its.dot.gov/>. U.S. Department of Transportation, Research and Innovative Technology Administration.
9. Moinuddin, Sheik. 2012. *Dynamic Lane Management – An ITS Solution to Enhance Safety and Mobility: NB SR 110 to NB I-5 Connector*. Slide presentation by Sheik Moinuddin, California Department of Transportation. July.
10. Barth, M. and K. Boriboonsomsin. 2008. *Real-World CO2 Impacts of Traffic Congestion*. Transportation Research Record No. 2058.
11. Federal Highway Administration (FHWA). 2006. *Ramp Management and Control Handbook*. FHWA-HOP-06-001. January.
12. National Cooperative Highway Research Program (NCHRP). 2013. *Active Traffic Management for Arterials – A Synthesis of Highway Practice*. NCHRP 447.
13. Federal Highway Administration (FHWA). 2007. *Active Traffic Management: The Next Step in Congestion Management*. FHWA-PL-07-012 (Scanning Tour Report). July.

14. Harbord, Brian, Joanna White, Keith McCabe, Andy Riley, and Steve Tarry. 2007. "Calmed and Controlled – Improving Efficiency, Safety, and Emissions." *Traffic Technology International* pp. 100-105.
15. Stoelhorst, Henk. 2011. *Summary Results of Dutch Field Trials with Dynamic Speed Limits (DYNAMAX)*. Paper 2248 at ITS World Congress. Rijkswaterstaat, Centre for Transport and Navigation, The Netherlands. October 18.
16. Federal Highway Administration (FHWA). 2010. *Synthesis of Active Traffic Management Experiences in Europe and the United States*. FHWA-HOP-10-031. May.
17. Department for Transport. 2008. *Advanced Motorway Signaling and Traffic Management Feasibility Study*. A report to the Secretary of State for Transport, London, United Kingdom. March.
18. Monk-Steel, Andrew. 2014. *Smart Motorways and Road Traffic Noise*. Presentation to ITS U.K. Smart Environment Interest Group. July 15.
19. Federal Highway Administration (FHWA). 2012. *The Role of Transportation Systems Management & Operations in Supporting Livability and Sustainability: A Primer*. FHWA-HOP-12-004. January.
20. Texas Transportation Institute. 2014. *Active Management Screening Tool (AMST)*. Available at <http://active-traffic.tamu.edu/tools>. Texas A&M University.
21. Research and Innovative Technology Administration. 2014. *National ITS Architecture (including Turbo Architecture)*. Available at <http://www.iteris.com/itsarch/>. U.S. Department of Transportation, Research and Innovative Technology Administration. September.
22. American Association for Highway Safety and Transportation Officials (AASHTO). 2012. *Institutional Architectures to Advance Operational Strategies*. SHRP2 L06. Available at <http://www.aashtosomguidance.org/>. Prepared by Steve Lockwood, PB Consult, Inc. April 15.
23. Federal Highway Administration (FHWA). 2013. *Operations Benefit/Cost Analysis TOPS-BC User's Manual: Providing Guidance to Practitioners in the Analysis of Benefits and Costs of Management and Operations Projects*. FHWA-HOP-13-041 and Associated Desk Reference – FHWA-HOP-12-028. June.
24. Federal Highway Administration (FHWA). 2006. *ICM Implementation Guide*. FHWA-JPO-06-042.
25. Washington State Department of Transportation (WSDOT). 2007. *Active Traffic Management (ATM) Feasibility Study*. Prepared by PB Americas, Inc., Carter + Burgess, EarthTech, Inc. and Telvent Farradyne. November.
26. Washington State Department of Transportation (WSDOT). 2007. *Active Traffic Management Phase 1 White Paper*. Prepared by PB Americas, Inc., Carter + Burgess, EarthTech, Inc. and Telvent Farradyne. March.



27. Cambridge Systematics. Undated. Various Materials from the Caltrans District 7 ATM Corridor Assessment. Prepared for California Department of Transportation.
28. CH2M HILL. Undated. Various Materials from the New Jersey Institute of Technology/New Jersey Department of Transportation Statewide Active Traffic Management Project. Prepared for New Jersey Institute of Technology/New Jersey Department of Transportation.
29. CH2M HILL. Undated. Various Materials and Reports from the Pennsylvania Department of Transportation District 6-0 I-95 Innovative Traffic Management Strategies and Active Traffic Management Concept of Operations efforts. Prepared for Pennsylvania Department of Transportation District 6-0.
30. University Transportation Center for Mobility. 2011. *Best Practices and Outreach for Active Traffic Management*. UTCM 10-01-54-2 (TTI). December.
31. Federal Highway Administration (FHWA). 2010. *Efficient Use of Highway Capacity – Report to Congress*. FHWA-HOP-10-023. May.
32. Department for Transport. 2008. *Managed Motorway Implantation Guidance – Dynamic Use of the Hard Shoulder*. Interim Advice Note 111/08; U.K. Highways Agency, Department for Transport. May.
33. Federal Highway Administration (FHWA). 2011. *Freeway Geometric Design for Active Traffic Management in Europe*. FHWA-PL-11-004 (Scanning Tour Report). March.
34. Texas Transportation Institute. *Mobility Investment Strategies*. Available at <http://mobility.tamu.edu/mip/strategies.php>. Summaries of several ATM strategies including: Dynamic Merge Control, Queue Warning, Ramp Flow Control, Temporary Shoulder Use, Variable Speed Limits, and Reversible Traffic Lanes. Texas A&M University.
35. National Cooperative Highway Research Program (NCHRP). 2004. *Convertible Roadways and Lanes – A Synthesis of Highway Practice*. NCHRP Synthesis 340.
36. ENTERPRISE Program. 2013. *Warrants for the Installation and Use of Technology Devices for Transportation Operations and Maintenance*. Available at <http://enterprise.prog.org/itswarrants/rampmeter1.html>. Enterprise Transportation Pooled Fund Study (Ramp Metering).
37. Federal Highway Administration (FHWA). 2012. *Model Systems Engineering Documents for Adaptive Signal Control*. FHWA-HOP-11-027. August.
38. Federal Transit Administration (FTA). 2005. *Transit Signal Priority: A Planning and Implementation Handbook*. Funded by the U.S. Department of Transportation. May.
39. Wayne State University (WSU). 2004. *Development and Evaluation of an Advanced Dynamic Lane Merge Traffic Control System for 3 to 2 Lane Transition Areas in Work Zones*. Prepared for Michigan Department of Transportation, Construction and Technology Division. January.
40. McCoy, Patrick. T. and Geza Pesti. 2013. *Dynamic Late Merge Control Concept for Work Zones on Rural Freeways*. Prepared by University of Nebraska. Prepared for U.S. Department of Transportation, Federal Highway Administration. May.

41. Department of Transport. 2009. *Britain's Transport Infrastructure Motorways and Major Trunk Roads*. U.K. Highways Agency, Department for Transport January.
42. Washington State Department of Transportation (WSDOT). 2010. *I-5 Active Traffic Management – Final Draft Case Study – Seattle, Washington*. Prepared by PB Americas, Inc., Carter + Burgess, EarthTech, Inc. and Telvent Farradyne. January 13.
43. Minnesota Department of Transportation (MNDOT). 2010. *I-35W Active Traffic Management – Draft Case Study – Minneapolis, Minnesota*. Prepared by Parsons Brinckerhoff. January 31
44. Vic Roads. 2013. *Managed Freeways – Handbook for Lane Use Management, Variable Speed Limits, Traveler Information*. July.
45. U.K. Highways Agency. 2011. *Managed Motorways Concept Development – Synthesis of Evidence Report and Key Findings Report*.
46. U.K. Highways Agency. 2013. *Managed Motorways – All Lane Running*. Interim Advice Note 161/13 and accompanying Concept of Operations v2.0. August.
47. Federal Highway Administration. 2013. *Guide for Highway Capacity and Operations Analysis of Active Transportation and Demand Management Strategies*. FHWA-HOP-13-042. June.
48. ENTERPRISE Program. 2013. *Warrants for the Installation and Use of Technology Devices for Transportation Operations and Maintenance; Enterprise Pooled Fund (Variable Speed Limits)*. Available at <http://enterprise.prog.org/itswarrants/vsl.html>.
49. Federal Highway Administration (FHWA). 2009. *Manual on Uniform Traffic Control Devices*. Available at [http://mutcd.fhwa.dot.gov/kno\\_2009r1r2.htm](http://mutcd.fhwa.dot.gov/kno_2009r1r2.htm).
50. Illinois Department of Transportation. 2014. *Bus on Shoulder Pilot Program–2-Year Effectiveness Report: I-55 from I-355 to Kedzie Avenue*. March.
51. Puget Sound Regional Council and Washington State Department of Transportation (PSRC and WSDOT). 2007. *Forum Proceedings: Reducing Traffic Congestion–Real Opportunities from Europe and the U.S.* June.
52. MetroTransit. 2014. *Transit Advantages*. Available at <http://www.metrotransit.org/transit-advantages.aspx>.
53. Transportation Research Board. 2010. *Highway Capacity Manual*. Available at <http://hcm.trb.org/?qr=1>. National Academy of Sciences, Transportation Research Board, Washington, DC.
54. Virginia Transportation Research Council. August 2004. *Evaluation of the Late Merge Work Zone Traffic Control Strategy (VTRC 05-R6)*

**INTERVIEWS AND REVIEWERS**

Melissa Ackert	Florida District 4
Vassili Alexiadis	Cambridge Systematics (Southern California ATM Feasibility Study)
Morgan Balogh	Washington State DOT
Les Jacobson	Parsons Brinkerhoff (Washington State ATM)
Brian Kary	Minnesota DOT
Beverly Kuhn	Texas Transportation Institute
Maria Filippelli	San Diego Association of Governments (SANDAG)
Phil Masters	Delcan (formerly with Ministry of Transport, Ontario, Canada)
Dennis Mitchell	Oregon DOT
Tom Phillips	Leidos (formerly with Virginia DOT)
Deena Platman	Metro Portland
Frank Quon	LA Metro
Marco Ruano	Caltrans



**Appendix B**  
**Active Traffic Management Screening Checklist**

---



## Active Traffic Management Screening Checklist

General Information			
State/Region/Corridor			
Lead Agency/Agencies			
Purpose of Screening	Projects for Planning Process; initial Systems Engineering; Other		
Reviewed By		Date	

<b>Get Started - Preparation</b>	<b>Complete (Yes, In Progress, No or Not Applicable)</b>	<b>Comments</b>
Do ATM strategies support one or more regional goals?		
Have relevant operational objectives been identified?		
Has the roadway network been identified and defined?		
Have ATM stakeholders been identified?		
Has the stakeholder collaboration process been initiated?		
Has the necessary data and other information been collected?		
Has recent literature on ATM been identified and reviewed?		
Additional Comments		

<b>Assess Agencies Policies and Capabilities for ATM</b>	<b>Complete (Yes, In Progress, No or Not Applicable)</b>	<b>Comments</b>
Have ATM strategies been identified in terms of type of network?		
Have ATM strategies been identified in terms of agency polices (both formal and informal)?		
Have potential legal constraints and issues been identified?		
Is supporting institutional framework in place (or will be)?		
Additional Comments		
<b>Identify Major Roadway Segments for Potential ATM</b>	<b>Complete (Yes, In Progress, No or Not Applicable)</b>	<b>Comments</b>
Have “major” segments been identified?		
Do selected segments have existing TSM&O and ITS deployed?		
Will segments likely benefit from ATM; and for what reasons:		
<ul style="list-style-type: none"> <li>• Recurring Congestion</li> </ul>		
<ul style="list-style-type: none"> <li>• Bottlenecks</li> </ul>		
<ul style="list-style-type: none"> <li>• Safety</li> </ul>		
<ul style="list-style-type: none"> <li>• Other considerations</li> </ul>		
Have other TSM&O strategies been considered?		
Additional Comments		



<b>Analyze and Prioritize Individual Roadway Links &amp; ATM Strategies</b>	<b>Complete (Yes, In Progress, No or Not Applicable)</b>	<b>Comments</b>
Have individual links within major segments been identified?		
Have links been analyzed and prioritized for ATM deployment?		
Have appropriate ATM strategies been identified for each link:		
• Dynamic speed limits/lane assignment		
• Queue warning		
• Dynamic shoulder lanes		
• Dynamic Junction control		
• Adaptive ramp metering		
• Adaptive Traffic Signal Control		
• Transit Signal Priority		
• Dynamic Lane Reversal		
• Dynamic Merge Control		
Have identified ATM strategies for each link been combined?		
Have any gaps in ATM coverage been addressed for continuity?		
Additional Comments		
<b>Estimate Benefits and Costs and Finalize ATM Recommendations</b>	<b>Complete (Yes, In Progress, No or Not Applicable)</b>	<b>Comments</b>
Have all costing assumptions been made?		
Have relevant measures of effectiveness (for calculating benefits) been identified?		
Have ATM benefits (monetized) and costs been estimated and compared (B/C ratio)?		
Have priorities (by links and strategies) been finalized and presented to decision makers?		
Additional Comments		



U.S. Department of Transportation  
**Federal Highway Administration**

U.S. Department of Transportation  
Federal Highway Administration  
Office of Operations  
1200 New Jersey Avenue, SE  
Washington, DC 20590

Office of Operations Web Site:  
[www.ops.fhwa.dot.gov](http://www.ops.fhwa.dot.gov)

FHWA-HOP-14-019  
May 2015