



US Army Corps
of Engineers

EM 1110-2-1009
1 June 2002

ENGINEERING AND DESIGN

Structural Deformation Surveying

ENGINEER MANUAL

DEPARTMENT OF THE ARMY
US Army Corps of Engineers
Washington, DC 20314-1000

EM 1110-2-1009

CECW-EE

Manual
No. 1110-2-1009

1 June 2002

Engineering and Design
STRUCTURAL DEFORMATION SURVEYING

1. Purpose. This manual provides technical guidance for performing precise structural deformation surveys of locks, dams, and other hydraulic flood control or navigation structures. Accuracy, procedural, and quality control standards are defined for monitoring displacements in hydraulic structures.

2. Applicability. This manual applies to all USACE commands having responsibility for conducting periodic inspections of completed civil works projects, as required under ER 1110-2-100, Periodic Inspection and Continuing Evaluation of Completed Civil Works Structures.

FOR THE COMMANDER:

3 Appendices
(See Table of Contents)

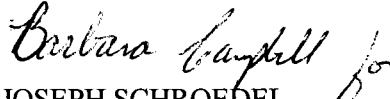
JOSEPH SCHROEDEL
Colonel, Corps of Engineers
Chief of Staff

CECW-EE

Manual
No. 1110-2-1009

1 June 2002

**Engineering and Design
STRUCTURAL DEFORMATION SURVEYING**

Table of Contents

Subject	Paragraph	Page
Chapter 1		
Introduction		
Purpose.....	1-1	1-1
Applicability.....	1-2	1-1
Distribution.....	1-3	1-1
References.....	1-4	1-1
Scope of Manual.....	1-5	1-1
Background.....	1-6	1-1
Deformation Survey Techniques.....	1-7	1-2
Life Cycle Project Management.....	1-8	1-3
Metrics.....	1-9	1-4
Trade Name Exclusions.....	1-10	1-4
Abbreviations and Terms.....	1-11	1-4
Mandatory Requirements.....	1-12	1-4
Proponency and Waivers.....	1-13	1-4
Chapter 2		
Planning, Design, and Accuracy Requirements		
Standards for Deformation Surveys.....	2-1	2-1
Accuracy Requirements for Performing Deformation Surveys.....	2-2	2-2
Overview of Deformation Surveying Design.....	2-3	2-3
Professional Associations.....	2-4	2-7
Causes of Dam Failure.....	2-5	2-8
Foundation Problems in Dams.....	2-6	2-8
Navigation Locks.....	2-7	2-10
Deformation Parameters.....	2-8	2-11
Location of Monitoring Points.....	2-9	2-12
Design of Reference Networks.....	2-10	2-13
Reference Point Monumentation.....	2-11	2-17
Monitoring Point Monumentation.....	2-12	2-19
Design of Measurement Schemes.....	2-13	2-21
Measurement Reliability.....	2-14	2-23
Frequency of Measurements.....	2-15	2-25
Mandatory Requirements.....	2-16	2-27

Subject	Paragraph	Page
Chapter 3		
Deformation Measurement and Alignment Instrumentation		
General.....	3-1	3-1
Angle and Distance Measurements.....	3-2	3-2
Differential Leveling.....	3-3	3-6
Total Station Trigonometric Elevations.....	3-4	3-7
Global Positioning System (GPS).....	3-5	3-7
Photogrammetric Techniques.....	3-6	3-11
Alignment Measurements.....	3-7	3-12
Extension and Strain Measurements.....	3-8	3-14
Tilt and Inclination Measurements.....	3-9	3-16
Non-Geodetic Measurements.....	3-10	3-18
Optical Tooling Technology.....	3-11	3-20
Laser Tooling methods.....	3-12	3-21
Laser Alignment Technology.....	3-13	3-22
Laser Alignment Techniques.....	3-14	3-25
Laser Alignment Error Sources.....	3-15	3-27
Laser Beam Propagation.....	3-16	3-29
Laser Alignment Equipment.....	3-17	3-31
Current Laser Alignment Surveys		
--Libby and Chief Joseph Dams, Seattle District.....	3-18	3-34
Suspended and Inverted Plumblines.....	3-19	3-38
Comparison of Alignment and Plumblines.....	3-20	3-39
Tiltmeter Observations.....	3-21	3-41
Mandatory Requirements.....	3-22	3-42
Chapter 4		
Sources of Measurement Error and Instrument Calibrations		
Surveying Measurement Errors.....	4-1	4-1
Optical Pointing Error.....	4-2	4-2
Instrument Leveling Error.....	4-3	4-4
Instrument Centering Error.....	4-4	4-5
Horizontal Angle Measurement Error.....	4-5	4-7
Electronic Distance Measurement Error.....	4-6	4-7
Zenith Angle Measurement Error.....	4-7	4-9
Refraction of Optical Lines of Sight.....	4-8	4-10
Theodolite System Error.....	4-9	4-15
Reflector Alignment Error.....	4-10	4-15
EDM Scale Error.....	4-11	4-15
EDM Prism Zero Error.....	4-12	4-16
EDM Cyclic Error.....	4-13	4-18
Calibration Baselines.....	4-14	4-18
Equipment for Baseline Calibration.....	4-15	4-20
Procedures for Baseline Calibration.....	4-16	4-20
Mandatory Requirements.....	4-17	4-22

Subject	Paragraph	Page
Chapter 5		
Angle and Distance Observations--Theodolites, Total Stations and EDM		
Scope.....	5-1	5-1
Instrument and Reflector Centering Procedures	5-2	5-1
Angle and Direction Observations.....	5-3	5-3
Distance Observations.....	5-4	5-5
Electro-Optical Distance Measurement	5-5	5-7
EDM Reductions	5-6	5-10
Atmospheric Refraction Correction.....	5-7	5-10
Mandatory Requirements	5-8	5-14
Chapter 6		
Settlement Surveys--Precise Differential Leveling Observations		
Scope.....	6-1	6-1
Precise Geodetic Leveling.....	6-2	6-1
Differential Leveling Reductions	6-3	6-5
Total Station Trigonometric Heights	6-4	6-7
Mandatory Requirements	6-5	6-7
Chapter 7		
Alignment, Deflection, and Crack Measurement Surveys--Micrometer Observations		
Scope.....	7-1	7-1
Relative Alignment Deflections from Fixed Baseline	7-2	7-1
Micrometer Crack Measurement Observations.....	7-3	7-5
Mandatory Requirements	7-4	7-11
Chapter 8		
Monitoring Structural Deformations Using the Global Positioning System		
Purpose.....	8-1	8-1
Background.....	8-2	8-1
Scope of Chapter.....	8-3	8-2
Section I		
Monitoring Structural Deformation with GPS		
Surveying Requirements	8-4	8-3
Surveying Procedures	8-5	8-5
Data Processing Procedures	8-6	8-8
GPS Monitoring Applications	8-7	8-10
GPS Survey Reporting and Results.....	8-8	8-14

Subject	Paragraph	Page
Section II		
GPS Performance on Monitoring Networks		
Principles of GPS Carrier Phase Measurement.....	8-9	8-15
GPS Receiving System Performance	8-10	8-18
Sources of Error in GPS Measurements	8-11	8-21
GPS Performance on Monitoring Networks	8-12	8-23
Section III		
Data Quality Assessment for Precise GPS Surveying		
Quality Assessment Tools	8-13	8-28
GPS Session Status	8-14	8-29
Data Post-Processing.....	8-15	8-31
Post-Processing Statistics	8-16	8-33
Closure and Station Checks	8-17	8-36
Section IV		
GPS Multipath Error		
Description of Multipath Signals.....	8-18	8-38
Data Cleaning Techniques for GPS Surveys	8-19	8-40
Mandatory Requirements	8-20	8-42
Chapter 9		
Preanalysis and Network Adjustment		
General.....	9-1	9-1
Theory of Measurements.....	9-2	9-1
Least Squares Adjustment	9-3	9-3
Adjustment Input Parameters	9-4	9-5
Adjustment Output Parameters.....	9-5	9-10
Adjustment Procedures	9-6	9-16
Sample Adjustment--Yatesville Lake Dam.....	9-7	9-19
Mandatory Requirements	9-8	9-31
Chapter 10		
Relative Distance Ratio Assessment Methods		
Introduction.....	10-1	10-1
Deformation Monitoring Using Ratio Methods	10-2	10-4
Mandatory Requirements	10-3	10-16

Subject	Paragraph	Page
Chapter 11		
Analysis and Assessment of Results		
General.....	11-1	11-1
Geometrical Analysis.....	11-2	11-2
Statistical Modeling.....	11-3	11-6
Deterministic Modeling.....	11-4	11-7
Hybrid Analysis Method.....	11-5	11-8
Automated Data Management.....	11-6	11-9
Scope of Deformation Analysis.....	11-7	11-11
Mandatory Requirements.....	11-8	11-11

Chapter 12
Data Presentation and Final Reports

Report Format.....	12-1	12-1
Displacement Data Presentation.....	12-2	12-3
Data Management.....	12-3	12-3
Mandatory Requirements.....	12-4	12-4

Appendix A References

Appendix B Applications: Deformation Surveys of Locks and Dams

**Central & Southern Florida Flood Control Project
(Jacksonville District)**

**Surveying for Lock Structure Dewatering
(Lock and Dam No. 4, St. Paul District)**

**Appendix C Applications: Monitoring Schemes for Concrete Dams
(Libby Dam, Seattle District)**

Glossary

Chapter 1 Introduction

1-1. Purpose

This manual provides technical guidance for performing precise structural deformation surveys of locks, dams, and other hydraulic flood control or navigation structures. Accuracy, procedural, and quality control standards are defined for monitoring displacements in hydraulic structures.

1-2. Applicability

This manual applies to all USACE commands having responsibility for conducting periodic inspections of completed civil works projects, as required under ER 1110-2-100, Periodic Inspection and Continuing Evaluation of Completed Civil Works Structures.

1-3. Distribution

This publication is approved for public release; distribution is unlimited.

1-4. References

Referenced USACE publications and bibliographic information are listed in Appendix A.

1-5. Scope of Manual

The primary emphasis of this manual is placed on the technical procedures for performing precise monitoring surveys in support of the Corps periodic inspection and dam safety programs. General planning criteria, field and office execution procedures, data reduction and adjustment methods, and required accuracy specifications for performing structural deformation surveys are provided. These techniques are applicable to periodic monitoring surveys on earth and rock-fill dams, embankments, and concrete structures. This manual covers both conventional (terrestrial) and satellite (GPS) deformation survey methods used for measuring external movements. This manual does not cover instrumentation required to measure internal loads, stresses, strains, or pressures within a structure--refer to the references at Appendix A for these activities. Example applications on Corps projects are provided at Appendix B (Deformation Surveys of Locks and Dams) and Appendix C (Monitoring Schemes for Concrete Dams). The manual is intended to be a reference guide for structural deformation surveying, whether performed by in-house hired-labor forces, contracted forces, or combinations thereof. This manual should be directly referenced in the scopes of work for Architect-Engineer (A-E) survey services or other third-party survey services.

1-6. Background

The Corps of Engineers has constructed hundreds of dams, locks, levees, and other flood control structures that require periodic surveys to monitor long-term movements and settlements, or to monitor short-term deflections and deformations. These surveys are usually performed under the directives of ER 1110-2-100, Periodic Inspection and Continuing Evaluation of Completed Civil Works Structures. In some USACE commands, these types of surveys may be referred to as "PICES Surveys" -- an acronym which derives from the ER directive.

a. Structural deformation. Dams, locks, levees, embankments, and other flood control structures are subject to external loads that cause deformation and permeation of the structure itself, as well as its foundations. Any indication of abnormal behavior may threaten the safety of the structure. Careful monitoring of the loads on a structure and its response to them can aid in determining abnormal behavior of that structure. In general, monitoring consists of both measurements and visual inspections, as outlined in ER 1110-2-100. To facilitate the monitoring of hydraulic structures, they should be permanently equipped with proper instrumentation and/or monitoring points according to the goals of the observation, structure type and size, and site conditions.

b. Concrete structures. It should be intuitive that deformations and periodic observations will vary according to the type of structure. Differences in construction materials are one of the larger influences on how a structure deforms. For example, concrete dams deform differently than earthen or embankment dams. For concrete dams and other concrete flood control devices, deformation is mainly elastic and highly dependent on reservoir water pressure and temperature variations. Permanent deformation of the structure can sometimes occur as the subsoil adapts to new loads, concrete aging, or foundation rock fatigue. Such deformation is not considered unsafe if it does not go beyond a predetermined critical value. Therefore, periodic observations are typically configured to observing relatively long-term movement trends, to include abnormal settlements, heaving, or lateral movements. Conventional geodetic survey methods from external points and of centimeter-level accuracy are sufficient to monitor these long-term trends. Highly accurate, short-term deflections or relative movements between monoliths due to varying temperature or hydraulic loading are more rarely required. These may include crack measurements or relative movements between monoliths over different hydraulic loadings. Relative movement deflections to the ± 0.01 -inch accuracy level are common.

c. Earthen embankment structures. Earthen or embankment dams and levees obviously will deform altogether differently than concrete ones. With earthen dams, the deformation is largely characterized as more permanent. The self-weight of the embankment and the hydrostatic pressure of the reservoir water largely force the fill material (and in turn, the foundation, if it too consists of soil) to settle, resulting in a vertical deflection of the structure. The reservoir water pressure also causes permanent horizontal deformation perpendicular to the embankment centerline. With earthen dams, elastic behavior is slight. Deformation survey accuracy requirements are less rigid for earthen embankments, and traditional construction survey methods will usually provide sufficient accuracy. Typical surveys include periodic measurement of embankment crest elevations and slopes to monitor settlements and slope stability. For embankment structures, surveys accuracies at the ± 0.1 foot level are usually sufficient for monitoring long-term settlements and movements.

d. Long-term deformation monitoring. Depending on the type and condition of structure, monitoring systems may need to be capable of measuring both long-term movement trends and short-term loading deformations. Long-term measurements are far more common and somewhat more complex given their external nature. Long-term monitoring of a structure's movement typically requires observations to monitoring points on the structure from external reference points. These external reference points are established on stable ground well removed from the structure or its construction influence. These external reference points are inter-connected and termed the "reference network." The reference network must also be monitored at less-frequent intervals to ensure these reference points have not themselves moved. Traditional geodetic survey instruments and techniques may be employed to establish and monitor the reference network points.

1-7. Deformation Survey Techniques

a. Reference and target points. The general procedures to monitor the deformation of a structure and its foundation involve measuring the spatial displacement of selected object points (i.e., target points)

from external reference points that are fixed in position. Both terrestrial and satellite methods are used to measure these geospatial displacements. When the reference points are located in the structure, only relative deformation is determined--e.g., micrometer joint measurements are relative observations. Absolute deformation or displacement is possible if the reference points are located outside the actual structure, in the foundation or surrounding terrain and beyond the area that may be affected by the dam or reservoir. Subsequent periodic observations are then made relative to these absolute reference points. Assessment of permanent deformations requires absolute data.

b. Reference point network. In general, for concrete dams it is ideal to place the reference points in a rock foundation at a depth unaffected by the reservoir. Once permanently monumented, these reference points can be easily accessed to perform deformation surveys with simple measurement devices. Fixed reference points located within the vicinity of the dam but outside the range of its impact are essential to determination of the deformation behavior of the structure. Thus, monitoring networks in the dam plane should be supplemented by and connected to triangulation networks and vertical control whenever possible.

c. Monitoring techniques. The monitoring of dam or foundation deformation must be done in a manner such that the displacement is measured both horizontally and vertically (i.e., measurement along horizontal and vertical lines). Such measurements must include the foundation and extend as far as possible into it. Redundancy is essential in this form of deformation monitoring and is achieved through measuring at the points intersecting the orthogonal lines of the deformation network. If a dam includes inspection galleries and shafts, deformation values along vertical lines can be obtained by using hanging and/or inverted plumb lines and along horizontal lines by traverses--both of these methods are standard practice for deformation monitoring. Where there are no galleries or shafts (e.g., embankment dams, thin arch dams, or small gravity dams), the same result can be achieved by an orthogonal network of survey targets on the downstream face. These targets are sighted by angle measurements (typically combined with optical distance measurements) from reference points outside the dam.

d. Relative displacement observations. A more routine, less costly, and more frequent monitoring process can be employed to monitor the short term behavior of dams by simply confining observation to trends at selected points along the crest and sometimes vertical lines. Such procedures typically involve simple angle measurement or alignment (supplementing the measuring installation) along the crest to determine horizontal displacement, and elevation determination by leveling to determine vertical displacement (i.e., settlement). Even with this monitoring process, it is essential to extend leveling to some distance beyond the abutments. Alternative methods to that described include settlement gauges, hose leveling devices, or extensometers.

1-8. Life Cycle Project Management

As outlined in ER 1110-2-100, structural stability assessment surveys may be required through the entire life cycle of a project, spanning decades in many cases. During the early planning phases of a project, a comprehensive monitoring plan should be developed which considers survey requirements over a project's life cycle, with a goal of eliminating duplicate or redundant surveys to the maximum extent possible. During initial design and preconstruction phases of a project, reference points should be permanently monumented and situated in areas that are conducive to the performance of periodic monitoring surveys. During construction, fixed monitoring points should be established on the structure at points called for in the comprehensive monitoring plan.

1-9. Metrics

Both English and metric (SI) units are used in this manual. Metric units are commonly used in precise surveying applications, including the horizontal and vertical survey work covered in this manual. Structural movements are usually recorded and reported in SI units. Some measurement instruments (e.g., micrometers) use English units. In all cases, the use of either metric or non-SI units shall follow local engineering and construction practices. Accuracy standards and tolerances specified in this manual are generally stated at the 95% confidence level.

1-10. Trade Name Exclusions

The citation or illustration in this manual of trade names of commercially available survey products, including other auxiliary surveying equipment, instrumentation, and adjustment software, does not constitute official endorsement or approval of the use of such products.

1-11. Abbreviations and Terms

Engineering surveying terms and abbreviations used in this manual are explained in the Glossary.

1-12. Mandatory Requirements

ER 1110-2-1150 (Engineering and Design for Civil Works Projects) prescribes that mandatory requirements be identified in engineer manuals. Mandatory requirements in this manual are summarized at the end of each chapter. Mandatory accuracy standards, quality control, and quality assurance criteria are normally summarized in tables within each chapter. The mandatory criteria contained in this manual are based on the following considerations: (1) dam safety assurance, (2) overall project function, (3) previous Corps experience and practice has demonstrated the criteria are critical, (4) Corps-wide geospatial data standardization requirements, (5) adverse economic impacts if criteria are not followed, and (6) HQUSACE commitments to industry standards.

1-13. Proponency and Waivers

The HQUSACE proponent for this manual is the Engineering and Construction Division, Directorate of Civil Works. Technical development and compilation of the manual was coordinated by the US Army Topographic Engineering Center (CEERD-TS-G). Comments, recommended changes, or waivers to this manual should be forwarded through MSC to HQUSACE (ATTN: CECW-EE).

Chapter 2 Planning, Design, and Accuracy Requirements

2-1. Standards for Deformation Surveys

a. General. This chapter provides guidance for planning and implementing structural deformation surveys on US Army Corps of Engineers civil works projects. It discusses criteria and objectives used for designing geodetic monitoring networks and for developing reliable and economical measurement schemes based on precise engineering surveying methods. Monitoring provides engineering data and analysis for verifying design parameters, for construction safety, for periodic inspection reports, and for regular maintenance operations. Safety, economical design of man-made structures, efficient functioning and fitting of structural elements, environmental protection, and development of mitigative measures in the case of natural disasters (land slides, earthquakes, liquefaction of earth dams, etc.) requires a good understanding of causes (loads) and the mechanism of deformation, which can be achieved only through the proper measurement and analysis of deformable bodies.

b. Dam safety. US Army Corps of Engineers owns and operates a wide range of large engineering structures, including major infrastructure facilities for navigation, flood protection, and large dams. The responsibility to minimize the risk to the public is critical due to the potential loss of life and property that a structural failure could cause. USACE dams and reservoirs must be inspected so that their structural condition and design assumptions can be evaluated and verified. As a result of major disasters in the United States, the federal government revised laws for supervision of the safety of dams and reservoirs. The Dam Inspection Act, PL 92-367, 8 August 1972, authorized the Secretary of the Army, acting through the Chief of Engineers, to undertake a national program of inspection of dams.

c. Engineer regulations. Standards for conducting instrumentation surveys and for periodic inspections are contained in the following publications.

- ER 1110-2-100, Periodic Inspection and Continuing Evaluation of Completed Civil Works Structures
- ER 1110-2-110, Instrumentation for Safety--Evaluation of Civil Works Projects
- EP 1110-2-13, Dam Safety Preparedness

Guidance for Civil Works projects provides for an adequate level of instrumentation to enable designers to monitor and evaluate the safety of the structures, and to address the need for inspection and evaluation for stability and operational adequacy, as well as safety. ER 1110-2-100 states that a systematic plan will be established for the inspection of those features relating to safety and stability of the structure and to the operational adequacy of the project. Operational adequacy means the inspecting, testing, operating, and evaluation of those components of the project whose failure to operate properly would impair the operational capability and/or usability of the structure. Appendix A of ER 1110-2-100 addresses provisions to collect and permanently retain specific engineering data relating to the project structure and examine records that detail the principal design assumptions and stability, stress analysis, slope stability, and settlement analyses.

d. Specialized standards. Federal geospatial data standards, established in OMB Circular No. A-16, Coordination of Surveying, Mapping, and Related Spatial Data Activities, provide for activities conducted to meet special agency program needs. USACE engineering and construction guidance for geospatial data products prescribes voluntary industry standards and consensus standards, except where they are non-existent, inappropriate, or do not meet a project's functional requirement. Specialized standards for conducting deformation surveys are justified as long as products are consistent with

effective government wide coordination and efficient, economical service to the general public. Deformation monitoring often requires specialized surveying methods that are planned and executed according to specialized techniques and procedures.

2-2. Accuracy Requirements for Performing Deformation Surveys

a. General. The following table provides guidance on the accuracy requirements for performing deformation surveys. These represent either absolute or relative movement accuracies on target points that should be attained from survey observations made from external reference points. The accuracy by which the external reference network is established and periodically monitored for stability should exceed these accuracies. Many modern survey systems (e.g., electronic total stations, digital levels, GPS, etc.) are easily capable of meeting or exceeding the accuracies shown below. However, it is important that accuracy criteria must be defined relative to the particular structure's requirements, not the capabilities of a survey instrument or system.

Table 2-1. Accuracy Requirements for Structure Target Points (95% RMS)

Concrete Structures Dams, Outlet Works, Locks, Intake Structures:

Long-Term Movement	± 5-10 mm
Relative Short-Term Deflections	
Crack/Joint movements	
Monolith Alignment	± 0.2 mm
Vertical Stability/Settlement	± 2 mm

Embankment Structures Earth-Rockfill Dams, Levees:

Slope/crest Stability	± 20-30 mm
Crest Alignment	± 20-30 mm
Settlement measurements	± 10 mm

Control Structures Spillways, Stilling Basins, Approach/Outlet Channels, Reservoirs

Scour/Erosion/Silting	± 0.2 to 0.5 foot
-----------------------	-------------------

b. Accuracy design examples. As an example to distinguish between instrument accuracy and project accuracy requirements, an electronic total station system can measure movement in an earthen embankment to the ±0.005-foot level. Thus, a long-term creep of say 3.085 feet can be accurately measured. However, the only significant aspect of the 3.085-foot measurement is the fact that the embankment has sloughed "3.1 feet" -- the ±0.001-foot resolution (precision) is not significant and should not be observed even if available with the equipment. As another example, relative crack or monolith joint micrometer measurements can be observed and recorded to ±0.001-inch precision. However, this precision is not necessarily representative of an absolute accuracy, given the overall error budget in the micrometer measurement system, measurement plugs, etc. Hydraulic load and temperature influences can radically change these short-term micrometer measurements at the 0.01 to 0.02-inch level, or more. Attempts to observe and record micrometer measurements to a 0.001-inch precision with a ±0.01-inch temperature fluctuation are wasted effort on this typical project.

2-3. Overview of Deformation Surveying Design

a. General. USACE Engineering Divisions and Districts have the responsibility for formulating inspection plans, conducting inspections, processing and analyzing instrument observations, evaluating the condition of the structures, recommending inspection schedules, and preparing inspection and evaluation reports. This section presents information to aid in fulfilling these objectives.

b. Monitoring plan. Each monitored structure should have a technical report or design memorandum published for the instrumentation and/or surveying scheme to document the monitoring plan and its intended performance. A project specific measurement scheme and its operating procedures should be developed for the monitoring system (Figure 2-1). Separate designs should be completed for the instrumentation plan and for the proposed measurement scheme.

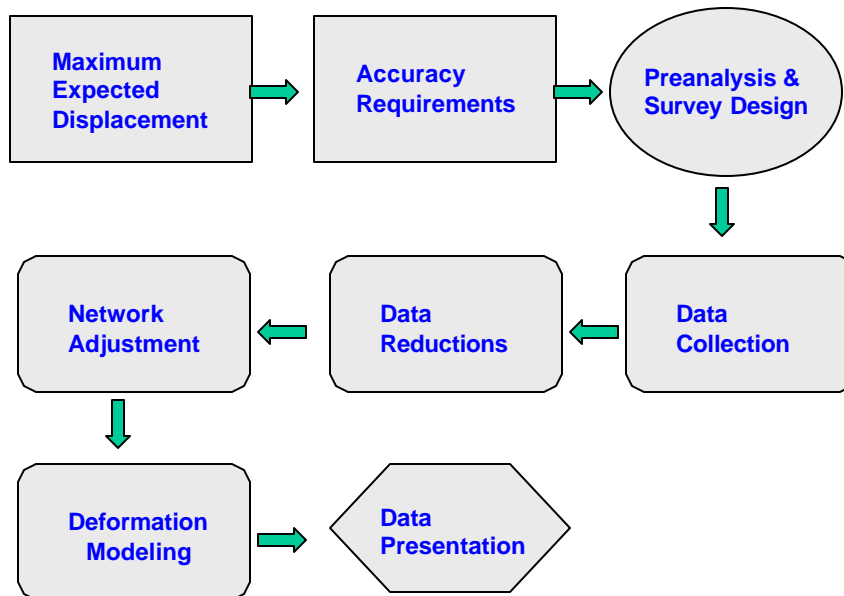

Figure 2-1. Deformation Survey Data Flow

(1) Survey system design. Although accuracy and sensitivity criteria may differ considerably between various monitoring applications, the basic principles of the design of monitoring schemes and their geometrical analysis remain the same. For example, a study on the stability of magnets in a nuclear accelerator may require determination of relative displacements with an accuracy of ± 0.05 mm while a settlement study of a rock-fill dam may require only ± 10 mm accuracy. Although in both cases, the monitoring techniques and instrumentation may differ, the same basic methodology applies to the design and analysis of the deformation measurements.

(a) Instrumentation plan (design). The instrumentation plan is mainly concerned with building or installing the physical network of surface movement points for a monitoring project. Contained in the instrumentation plan are specifications, procedures, and descriptions for:

- Required equipment, supplies, and materials,
- Monument types, function, and operating principles,
- Procedures for the installation and protection of monuments,
- Location and coverage of monitoring points on the project,
- Maintenance and inspection of the monitoring network.

The plan contains drawings, product specifications, and other documents that completely describe the proposed instrumentation, and methods for fabrication; testing; installation; and protection and maintenance of instruments and monuments.

(b) *Measurement scheme (design)*. The design of the survey measurement scheme should include analysis and specifications for:

- Predicted performance of the structure,
- Measurement accuracy requirements,
- Positioning accuracy requirements,
- Number and types of measurements,
- Selection of instrument type and precision,
- Data collection and field procedures,
- Data reduction and processing procedures,
- Data analysis and modeling procedures,
- Reporting standards and formats,
- Project management and data archiving.

The main technique used to design and evaluate measurement schemes for accuracy is known as "network preanalysis." Software applications specially written for preanalysis and adjustment are used to compute expected error and positioning confidence for all surveyed points in the monitoring network (see Chapter 9).

(2) Data collection. The data collection required on a project survey is specifically prescribed by the results of network preanalysis. The data collection scheme must provide built-in levels of both accuracy and reliability to ensure acceptance of the raw data.

(a) *Accuracy*. Achieving the required accuracy for monitoring surveys is based on instrument performance and observing procedures. Minimum instrument resolution, data collection options, and proper operating instructions are determined from manufacturer specifications. The actual data collection is executed according to the results of network preanalysis so that the quality of the results can be verified during data processing and post-analysis of the network adjustment.

(b) *Reliability*. Reliability in the raw measurements requires a system of redundant measurements, sufficient geometric closure, and strength in the network configuration. Geodetic surveying methods can yield high redundancy in the design of the data collection scheme.

(3) Data processing. Raw survey data must be converted into meaningful engineering values during the data processing stage. Several major categories of data reductions are:

- Applying pre-determined calibration values to the raw measurements,
- Finding mean values for repeated measurements of the same observable,
- Data quality assessment and statistical testing during least squares adjustment,
- Measurement outlier detection and data cleaning prior to the final adjustment.

Procedures for data reductions should be based on the most rigorous formulas and data processing techniques available. These procedures are applied consistently to each monitoring survey to ensure comparable results. Network adjustment software based on least squares techniques is strongly recommended for data processing. Least squares adjustment techniques are used to compute the coordinates and survey accuracy for each point in the monitoring network. Network adjustment processing also identifies measurement blunders by statistically testing the observation residuals.

(4) Data analysis. Geometric modeling is used to analyze spatial displacements (see Chapter 11). General movement trends are described using a sufficient number of discrete point displacements (d_n):

$$d_n(\Delta x, \Delta y, \Delta z) \text{ for } n = \text{point number}$$

Point displacements are calculated by differencing the adjusted coordinates for the most recent survey campaign (f), from the coordinates obtained at some reference time (i), for example:

$$\begin{aligned} \Delta x &= x_f - x_i && \text{is the x coordinate displacement} \\ \Delta y &= y_f - y_i && \text{is the y coordinate displacement} \\ \Delta z &= z_f - z_i && \text{is the z coordinate displacement} \\ \Delta t &= t_f - t_i && \text{is the time difference between surveys.} \end{aligned}$$

Each movement vector has magnitude and direction expressed as point displacement coordinate differences. Collectively, these vectors describe the displacement field over a given time interval. Displacements that exceed the amount of movement expected under normal operating conditions will indicate possible abnormal behavior. Comparison of the magnitude of the calculated displacement and its associated survey accuracy indicates whether the reported movement is more likely due to survey error:

$$|d_n| < (e_n)$$

where

$$|d_n| = \text{sqrt}(\Delta x^2 + \Delta y^2 + \Delta z^2) \text{ for point } n, \text{ is the magnitude of the displacement,}$$

$$(e_n) = \text{max dimension of combined 95\% confidence ellipse for point } n = (1.96) \text{ sqrt}(\sigma_f^2 + \sigma_i^2),$$

and

σ_f is the standard error in position for the (final) or most recent survey,
 σ_i is the standard error in position for the (initial) or reference survey.

For example, if the adjusted coordinates for point n in the initial survey were:

$$\begin{aligned} x_i &= 1000.000 \text{ m} \\ y_i &= 1000.000 \text{ m} \\ z_i &= 1000.000 \text{ m} \end{aligned}$$

and the adjusted coordinates for the same point in the final survey were:

$$\begin{aligned} x_f &= 1000.006 \text{ m} \\ y_f &= 1000.002 \text{ m} \\ z_f &= 1000.002 \text{ m} \end{aligned}$$

then the calculated displacement components for point n would be:

$$\begin{aligned} \Delta x &= 6 \text{ mm} \\ \Delta y &= 2 \text{ mm} \\ \Delta z &= 2 \text{ mm} \end{aligned}$$

Assuming that the horizontal position has a standard deviation of $\sigma_h = 1.5$ mm for both surveys, and similarly the vertical position has a standard deviation of $\sigma_v = 2.0$ mm, as reported from the adjustment results, then the combined (95 percent) confidence in the horizontal displacement would be:

$$(1.96) \sqrt{(\sigma_f^2 + \sigma_i^2)} = (1.96) \sqrt{(2.25 + 2.25)} \sim 4.2 \text{ mm at 95\% confidence}$$

The magnitude of the horizontal displacement is:

$$|d_h| = \sqrt{(\Delta x^2 + \Delta y^2)} = \sqrt{(36 + 4)} = 6.3 \text{ mm}$$

These results show that the horizontal component exceeds the expected survey error margin and is likely due to actual movement of point n in the horizontal plane.

Confidence in the vertical displacement would be:

$$(1.96) \sqrt{(\sigma_f^2 + \sigma_i^2)} = (1.96) \sqrt{(4 + 4)} \sim 5.5 \text{ mm at 95\% confidence}$$

The magnitude of the vertical displacement is:

$$|d_v| = 2.0 \text{ mm}$$

The magnitude of the vertical displacement is much smaller than the confidence in the vertical displacement, and it therefore does not indicate a significant vertical movement. If the structure were to normally experience cyclic movement of 10 mm (horizontally) and 1 mm (vertically) over the course of one year, and if our example deformation surveys were made six months apart, then the above results would be consistent with expected behavior. Specialized methods of geometrical analysis exist to carry out more complex deformation modeling, and it is sometimes possible to identify the causes of deformation based on comparing the actual displacements to alternative predicted displacement modes for the specific type of structure under study. Refer to Chapter 11 for a more detailed discussion.

(5) Data presentation. Survey reports for monitoring projects should have a standardized format. Reports should contain a summary of the results in both tabulated and graphical form (Chapter 12). All supporting information, analyses, and data should be documented in an appendix format. Conclusions and recommendations should be clearly presented in an executive summary.

(6) Data management. Survey personnel should produce hardcopy survey reports and complete electronic copies of these reports. Survey data and processed results should be archived, indexed, and cross-referenced to existing structural performance records. These should be easily located and retrievable whenever the need arises. Information management using computer-based methods is strongly recommended. One of the main difficulties with creating a data management system that includes historical data is the time and cost required to transfer existing hardcopy data into an electronic database for each project. Gradual transition to fully electronic data management on future project surveys should be adopted. Data management tools such as customized software, database software, and spreadsheet programs should be used to organize, store, and retrieve measurement data and processed results. A standard format for archiving data should be established for all monitoring projects.

c. Management plan. Sound administration and execution of the monitoring program is an integral and valuable part of the periodic inspection process. Personnel involved in the monitoring and instrumentation should maintain a regular interaction with the senior program manager. Structural

monitoring encompasses a wide range of tasks performed by specialists in different functional areas. All participants should have a general understanding of requirements for the complete evaluation process.

- General Engineering for planning and monitoring requests, preparation/presentation of data and results, and quality assurance measures,
- Surveying for data collection (in-house or contract requirements), data reduction, processing, network adjustment, quality assurance, and preparing survey reports,
- Geotechnical and Structural Engineering for analysis and evaluation of results and preparation of findings and recommendations,
- Technical Support for data management, archiving, computer resources, archiving final reports, and electronic information support.

Safety requires consideration of more than just technical factors. Systems should be in place so that any voice within the organization can be heard. Even experts can make mistakes and good ideas can come from any level within an organization. Meetings and/or site visits including all participants are held to ensure that information flows freely across internal boundaries. Integration of separate efforts should be on going and seamless rather than simply gluing together individual final products.

d. External review. An organization must be willing to accept, in fact it should seek, the independent review of its engineering practices. Large structures require defensive engineering that considers a range of circumstances that might occur that threatens their safety. A contingency plan to efficiently examine and assess unexpected changes in the behavior of the structure should be in place. Outside experts should be consulted from time-to-time, especially if a project structure exhibits unusual behavior that warrants specialized measurement and analysis.

2-4. Professional Associations

a. General. The development of new methods and techniques for monitoring and analysis of deformations and the development of methods for the optimal modeling and prediction of deformations have been the subject of intensive studies by many professional groups at national and international levels.

b. Organizations. Within the most active international organizations that are involved in deformation studies one should list:

- International Federation of Surveyors (FIG) Commission 6 which has significantly contributed to the recent development of new methods for the design and geometrical analysis of integrated deformation surveys and new concepts for analyses and modeling of deformations;
- International Commission on Large Dams (ICOLD) with its Committee on Monitoring of Dams and their Foundations;
- International Association of Geodesy (IAG) Commission on Recent Crustal Movements, concerning geodynamics, tectonic plate movement, and modeling of regional earth crust deformation.
- International Society for Mine Surveying (ISM) Commission 4 on Ground Subsidence and Surface Protection in mining areas;

- International Society for Rock Mechanics (ISRM) with overall interest in rock stability and ground control; and
- International Association of Hydrological Sciences (IAHS), with work on ground subsidence due to the withdrawal of underground liquids (water, oil, etc.).

2-5. Causes of Dam Failure

a. Concrete structures. Deformation in concrete structures is mainly elastic and for large dams highly dependent on reservoir water pressure and temperature variations. Permanent deformation of the structure can sometimes occur as the subsoil adapts to new loads, concrete aging, or foundation rock fatigue. Such deformation is not considered unsafe if it does not go beyond a pre-determined critical value. Monitoring is typically configured to observing relatively long-term movement trends, including, abnormal settlements, heaving, or lateral movements. Some ways concrete dams can fail are:

- Uplift at the base of gravity dams leading to overturning and downstream creep.
- Foundation failure or buttress collapse in single or multiple arched dams
- Surrounding embankments that are susceptible to internal erosion.

b. Embankment structures. Deformation is largely inelastic with earthen dams characterized by permanent changes in shape. Self-weight of the embankment and the hydrostatic pressure of the reservoir water force the fill material and the foundation (if it consists of soil) to consolidate resulting in vertical settlement of the structure. Reservoir water pressure also causes permanent horizontal deformation mostly perpendicular to the embankment centerline. Some causes of damage to earthen dams are:

- Construction defects that cause the structure to take on anisotropic characteristics over time,
- Internal pressures and paths of seepage resulting in inadequately controlled interstitial water.

Usually these changes are slow and not readily discerned by visual examination. Other well-known causes of failure in earthen dams are overtopping at extreme flood stage and liquefaction due to ground motion during earthquakes.

c. Structural distress. The following warning signs are evidence for the potential failure of dams.

- Significant sloughs, settlement, or slides in embankments such as in earth or rockfill dams,
- Movement in levees, bridge abutments or slopes of spillway channels, locks, and abutments,
- Unusual vertical or horizontal movement or cracking of embankments or abutments,
- Sinkholes or localized subsidence in the foundation or adjacent to embankments and structures,
- Excessive deflection, displacement, or vibration of concrete structures
- Tilting or sliding of intake towers, bridge piers, lock wall, floodwalls),
- Erratic movement, binding, excessive deflection, or vibration of outlet and spillway gates,
- Significant damage or changes in structures, foundations, reservoir levels, groundwater conditions and adjacent terrain as a result of seismic events of local or regional areas,
- Other indications of distress or potential failure that could inhibit the operation of a project or endanger life and property.

2-6. Foundation Problems in Dams

a. General. Differential settlement, sliding, high piezometric pressures, and uncontrolled seepage are common evidences of foundation distress. Cracks in the dam, even minor ones, can indicate a foundation problem. Clay or silt in weathered joints can preclude grouting and eventually swell the

crack enlarging it and causing further stress. Foundation seepage can cause internal erosion or solution. Potential erosion of the foundation must be considered as erosion can leave collapsible voids. Actual deterioration may be evidenced by increased seepage, by sediment in seepage water, or an increase in soluble materials disclosed by chemical analyses. Materials vulnerable to such erosion include dispersive clays, water reactive shales, gypsum and limestone.

b. Consolidation. Pumping from underground can cause foundation settlement as the supporting water pressure is removed or the gradient changed. Loading and wetting will also cause the pressure gradient to change, and may also cause settlement or shifting. The consequent cracking of the dam can create a dangerous condition, especially in earthfills of low cohesive strength. Foundations with low shear strength or with extensive seams of weak materials such as clay or bentonite may be vulnerable to sliding. Shear zones can also cause problems at dam sites where bedding plane zones in sedimentary rocks and foliation zones in metamorphics are two common problems. An embankment may be most vulnerable at its interface with rock abutments. Settlement in rockfill dams can be significantly reduced if the rockfill is mechanically compacted. In some ways, a compacted earth core is superior to a concrete slab as the impervious element of a rockfill dam. If the core has sufficient plasticity, it can be flexible enough to sustain pressures without significant damage. Several dam failures have occurred during initial impoundment.

c. Seepage. Water movement through a dam or through its foundation is one of the important indicators of the condition of the structure and may be a serious source of trouble. Seeping water can chemically attack the components of the dam foundation, and constant attention must be focused on any changes, such as in the rate of seepage, settlement, or in the character of the escaping water. Adequate measurements must be taken of the piezometric surface within the foundation and the embankment, as well as any horizontal or vertical distortion in the abutments and the fill. Any leakage at an earth embankment is potentially dangerous, as rapid erosion may quickly enlarge an initially minor defect.

d. Erosion. Embankments may be susceptible to erosion unless protected from wave action on the upstream face and surface runoff on the downstream face. Riprap armour stone on the upstream slope of an earthfill structure can protect against wave erosion, but can become dislodged over time. This deficiency usually can be detected and corrected before serious damage occurs. In older embankment dams, the condition of materials may vary considerably. The location of areas of low strength must be a key objective of the evaluation of such dams. Soluble materials are sometimes used in construction, and instability in the embankment will develop as these materials are dissolved over time. Adverse conditions which deserve attention include: poorly sealed foundations, cracking in the core zone, cracking at zonal interfaces, soluble foundation rock, deteriorating impervious structural membranes, inadequate foundation cutoffs, desiccation of clay fill, steep slopes vulnerable to sliding, blocky foundation rock susceptible to differential settlement, ineffective contact at adjoining structures and at abutments, pervious embankment strata, vulnerability to conditions during an earthquake.

e. Liquefaction. Hydraulic fill dams are particularly susceptible to earthquake damage. Liquefaction is a potential problem for any embankment that has continuous layers of soil with uniform gradation and of fine grain size. The Fort Peck Dam experienced a massive slide on the upstream side in 1938, which brought the hydraulic fill dam under suspicion. The investigation at the time focused blame on an incompetent foundation, but few hydraulic fills were built after the 1930's. Heavy compaction equipment became available in the 1940's, and the rolled embankment dam became the competitive alternative.

f. Concrete deterioration. Chemical and physical factors can age concrete. Visible clues to the deterioration include expansion, cracking, gelatinous discharge, and chalky surfaces.

2-7. Navigation Locks

a. Lock wall monoliths. Periodic monitoring is provided to assess the safety performance of lock structures. Instrumentation should be designed to monitor lateral, vertical, and rotational movement of the lock monoliths, although not all structural components of a lock complex (e.g., wall/monoliths, wing walls, gates, dam) may need to be monitored. Navigation locks (including access bridge piers) and their surroundings are monitored to determine the extent of any differential movements between wall monoliths, monolith tilt, sheet pile cell movement, cracking, or translation or rotation affecting sections of the lock structure.

(1) Foundation. Piezometers are used to monitor uplift pressures beneath the lock structure. Water level monitoring is made through wells fitted with a vibrating wire pressure transducer or designed for manual measurement with a portable water level indicator. Inclinator casings are anchored in stable zones under the structure and are used to monitor lateral movement of selected monoliths. Probe readings are made at 2-ft increments to measure the slope of the casing. Foundation design concerns soil/structure interactions, pile or soil bearing strength, settlement, scour protection, stability for uplift, sliding, and overturning, slide activity below ground level, earthquake forces and liquefaction, horizontal stresses in underlying strata and residual strength, rock faults that penetrate foundation sedimentary materials, and evidence of movement in unconsolidated sediment along the rim and foundation of the surrounding basin.

(2) Expected loads. Lock structures experience dynamic loads due to hydraulic forces, seismic and ice forces, earth pressures, and thermal stresses. Static loads include weight of the structure and equipment. Horizontal water pressure and uplift on lock walls vary due to fluctuating water levels, and horizontal earth pressures and vertical loading vary with drained, saturated, or submerged backfill and siltation. Seismic forces and impact loads from collisions are accounted for in dynamic analysis for design of the structure. Loads are generated by filling and emptying system turbulence and barge mooring, ice and debris, wave pressure, wind loads, and differential water pressure on opposite sides of sheetpile cutoffs at the bottom of the lock monolith. Loads are generated by gate and bulkhead structures, machinery and appurtenant items, superstructure and bridge loads imparted to lock walls, temperature, and internal pore pressure in concrete.

(3) Dewatering maintenance. All locks have temporary closures for dewatering the lock chamber during maintenance activities or emergencies. Lock wall monitoring is conducted at both gate monoliths and selected interior chamber monoliths to detect any potential movement due to changing loads as the water level is lowered during lock chamber dewatering. Monitoring wells placed in the landside embankment are checked regularly to determine ground water levels that exert pressure on the landside wall. Monitoring surveys are conducted for measuring the lateral displacement of the lock walls with respect to each other and to stable ground. These are made continuously, and at regular time intervals until the chamber is completely dewatered.

b. Lock miter gates. Observations for distress in miter lock gates may include one or more of the following: top anchorage movement, elevation change, miter offset, bearing gaps, and downstream movement.

c. Sheet pile structures. Distress in sheet pile structures may include one or more of the following: misalignment, settlement, cavity formation, or interlock separation.

d. Rubble breakwaters and jetties. Observations for breakwaters and jetties include the seaside and leeside slopes and crest: seaside/leeside slope - protection side walls should be examined for; armor loss, armor quality defects, lack of armor contact/interlock, core exposure/loss, other slope defects.

Crest/cap - peak or topmost surface areas should be examined for breaching, armor loss, core exposure/loss. Any number of measurements may be needed to monitor the condition of breakwaters, jetties, or stone placement. These may involve either lower accuracy conventional surveying, photogrammetric, or hydrographic methods.

e. Scour monitoring. Hydrographic surveys for scour monitoring employ equipment that will produce full coverage bathymetric mapping of the area under investigation. The procedures and specifications should conform to standards referenced in EM 1110-2-1003, Hydrographic Surveying. Scour monitoring surveys should specify accuracy requirements, boundaries of coverage area, bathymetry contour interval, delivery file formats, and the required frequency of hydrographic surveying.

2-8. Deformation Parameters

a. General. The main purpose for monitoring and analysis of structural deformations is:

- To check whether the behavior of the investigated object and its environment follow the predicted pattern so that any unpredicted deformations could be detected at an early stage.
- In the case of abnormal behavior, to describe as accurately as possible the actual deformation status that could be used for the determination of causative factors which trigger the deformation.

Coordinate differencing and observation differencing are the two principal methods used to determine structural displacements from surveying data. Coordinate differencing methods are recommended for most applications that require long-term periodic monitoring. Observation differencing is mainly used for short-term monitoring projects or as a quick field check on the raw data as it is collected.

(1) Coordinate differencing. Monitoring point positions from two independent surveys are required to determine displacements by coordinate differencing. The final adjusted Cartesian coordinates (i.e., the coordinate components) from these two surveys are arithmetically differenced to determine point displacements. A major advantage of the coordinate differencing method is that each survey campaign can be independently analyzed for blunders and for data adjustment quality. However, great care must be taken to remove any systematic errors in the measurements, for example by applying all instrument calibration corrections, and by rigorously following standard data reduction procedures.

(2) Observation differencing. The method of observation differencing involves tracking changes in measurements between two time epochs. Measurements are compared to previous surveys to reveal any observed change in the position of monitoring points. Although observation differencing is efficient, and does not rely on solving for station coordinates, it has the drawback that the surveyor must collect data in an identical configuration, and with the same instrument types each time a survey is conducted.

b. Absolute displacements. Displacements of monumented points represent the behavior of the dam, its foundation, and abutments, with respect to a stable framework of points established by an external reference network.

(1) Horizontal displacements. Two-dimensional (2D) displacements are measured in a critical direction, usually perpendicular to the longitudinal axis of dam, at the crest, and other important points of embankments (abutments, toes, etc.) using conventional geodetic methods. Alignment techniques for alignment-offset measurements are made in relation to a pair of control points having well-known coordinates. Horizontal movement can also be determined with respect to plumb lines having a stable anchor point (see EM 1110-2-4300, Instrumentation for Concrete Structures).

(2) Vertical displacements. Vertical displacements are measured in relation to stable project benchmarks, such as deeply anchored vertical borehole extensometers, or alternatively, to deep benchmarks located near the dam using geodetic methods (differential leveling). Hydrostatic leveling is also sometimes used to determine settlements. Settlement gauges are used to detect settlements of the foundation, or of interior structural parts which are not readily accessible (core, foundation contact). Settlements of individual layers of embankments should be monitored through settlement gauges installed in the different layers (refer to EM 1110-2-2300, Earth and Rock-Fill Dams General Design and Construction Consideration).

c. Relative displacements. These measurements are intended to determine small differential movements of points representative of the behavior of the dam, its foundation, and abutments with respect to other points on the structure, or even on the same structural element.

(1) Deflections. Relative deflections (inclinations) of a concrete dam are measured by direct or inverted plumb lines. Alignment survey techniques are used in the interior galleries of dams to determine the relative movements between monoliths with respect to a horizontal reference line set along the longitudinal axis of the dam. Relative horizontal displacements of points inside embankments are detected by means of inclinometer probes sent through tubes set in drilled shafts. Foundation subsidence and tilts are measured with geodetic leveling, hydrostatic leveling, and tiltmeters. The last two are usually permanently installed in galleries.

(2) Extensions. Combinations of geodetic leveling with suspended invar wires equipped with short reading scales at different levels of the dam and connected to borehole extensometers can supply information on the relative vertical movements as well as on the absolute vertical displacements and relative tilts. Extensometers have become important instruments for measuring differential foundation movements. Strain gauges are embedded in the concrete during construction, installed on the faces of the dam after completion, or embedded in foundation boreholes. Joint measurements are justified in the case of joints separating two unsealed structures or to check grouting in dome or arch-gravity dams. Cracks are measured by the same methods with the instruments being installed on the surface.

2-9. Location of Monitoring Points

a. Normal conditions. Monitoring schemes include survey stations at the points where maximum deformations have been predicted plus a few observables at the points which, depending on previous experience, could signal any potential unpredictable behavior, particularly at the interface between the monitored structure and the surrounding material.

b. Unusual conditions. Once any abnormal deformations are noticed, then additional observables are added at the locations indicated by the preliminary analysis of the monitoring surveys as being the most sensitive to identification of causative factors.

c. Long-term monitoring. The spatial distribution of survey monuments should provide complete coverage of the structure, extending to stable areas of the project if possible. A minimum of four (4) monitoring points are recommended to model behavior in a plane section (tilts, subsidence, etc.). For linear structures, monuments are placed at intervals that provide coverage along the structure's total length, and generally not more than 100 meters apart, when using conventional instruments, to allow for measurement check ties to nearby monuments. The following are suggested guidelines for the location of survey monuments for long-term monitoring applications listed according to the type of structure. Refer also to the generalized monitoring schemes shown in Figures 2-2 through 2-6.

(1) Gravity and concrete dams. For gravity dams, each separate block should have at least one monitoring point. Tilts of the foundation should be measured at the center point for small structures, and at not less than three points for larger structures.

(2) Multiple-arch and buttress dams. Monitoring points for multiple-arch and buttress dams should be located at the head and downstream toe of each buttress. For massive buttresses and large arches, special attention should be paid to the foundations of the buttresses. If buttresses are traversed by construction joints, the behavior of joints should be observed.

(3) Arch-gravity dams and thick arch dams. Absolute displacements of dam toe and abutments are critical for arch-gravity dams and thick arch dams. For small structures, the deformation of the central block is to be monitored. For large structures the measurement of deformations in each block is required.

(4) Thin arch dams. Measurement of horizontal and vertical displacements are required along the crest for thin arch dams. Special attention should be given to the central cantilever, abutments, and abutment rock.

(5) Embankment and earthen dams. Measurement of horizontal and vertical displacements are required at the dam crest, and upstream and downstream toe locations for embankment dams. Surface displacement monuments should be located to provide coverage across the length of the dam extending to the adjacent stable areas. Provisions should be made to detect relative and absolute movement of armor on the dam face. Typically, the spacing of points near abutments and appurtenant structures are closer by about 50 percent than for the points at the midsection of the crest to provide denser movement data with respect to the surrounding sides, spillways, and foundation areas. New or temporary monitoring points may be concentrated in areas where significant movement is detected or repairs are underway.

(6) Navigation lock monoliths. Monitoring points are set on each lock chamber wall, typically with at least two alignment pins situated close to each monolith joint on each wall. The centerline of the alignment pins are placed in a longitudinal alignment between at least two major monumented control points to facilitate making deflection/offset alignment measurements--see Figures 2-4 and 2-5. Alignment pins are placed after proper curing of the structural concrete, and set back about six (6) inches perpendicularly from the centerline of the monolith joint, with one bolt located on either side of the joint.

2-10. Design of Reference Networks

a. General. Having multiple control stations in the reference network is critical for improving the reliability of deformation surveys, and for investigating the stability of reference monuments over time. Each control station in the reference network should be intervisible to a maximum number of structural monitoring points (placed on the structure) and to at least two other reference monuments. The number of reference points for vertical control should be not less than three (3), and preferably four (4) benchmarks. For horizontal control the minimum number of reference points should be at least four (4), preferably six (6). Reference stations are usually located at both ends of the dam, along its longitudinal axis, at the elevation of the dam crest. Geometry and reliability of the reference network can be improved by adding control stations either upstream or downstream from the crest or on the structure itself.

b. Project datum selection. A project datum defines the relative positions and coordinates established on the reference network. Coordinates of monitoring points are also calculated with respect to the project datum. The project datum for large monitoring projects should be based on geodetic NAD83 (or WGS84) coordinates. A geodetic coordinate system is recommended because positioning can be directly related to a standard reference ellipsoid. Network adjustment processing software often requires definition of the project datum in geodetic coordinates. Geodetic coordinates are also compatible with

standard formulas used to transform 3D positions into two-dimensional plane projections, and can incorporate data from Global Positioning System (GPS) surveys. See Figures 2-2 and 2-3.

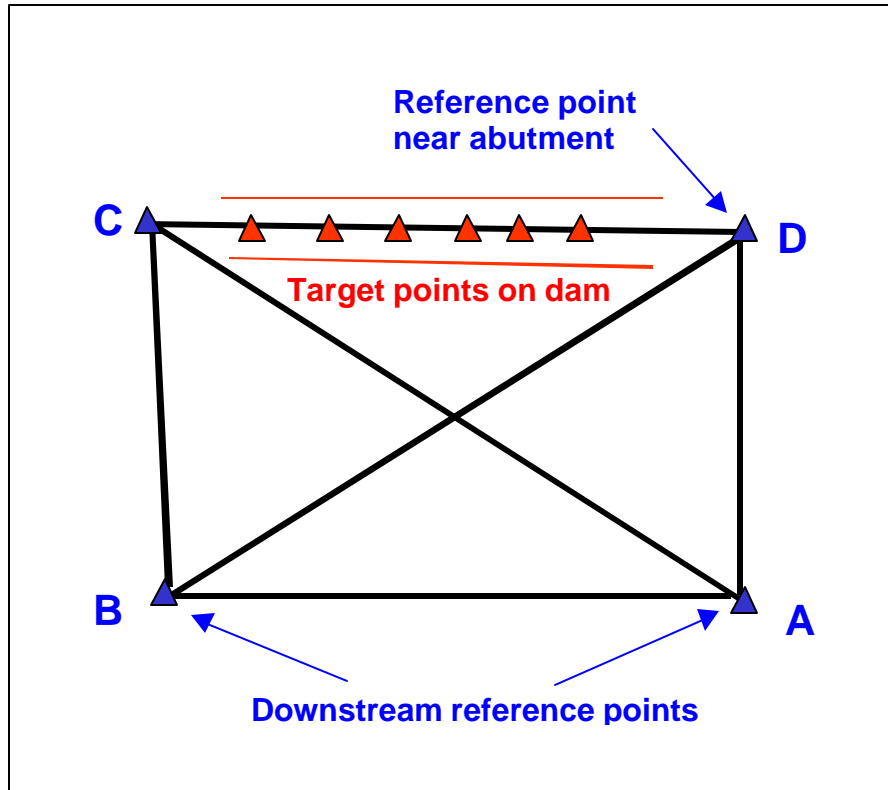

Figure 2-2. Strong monitoring scheme for a concrete or earth/rockfill dam



Figure 2-3. Reference network configuration for a concrete dam depicting reference points near abutments and at downstream locations

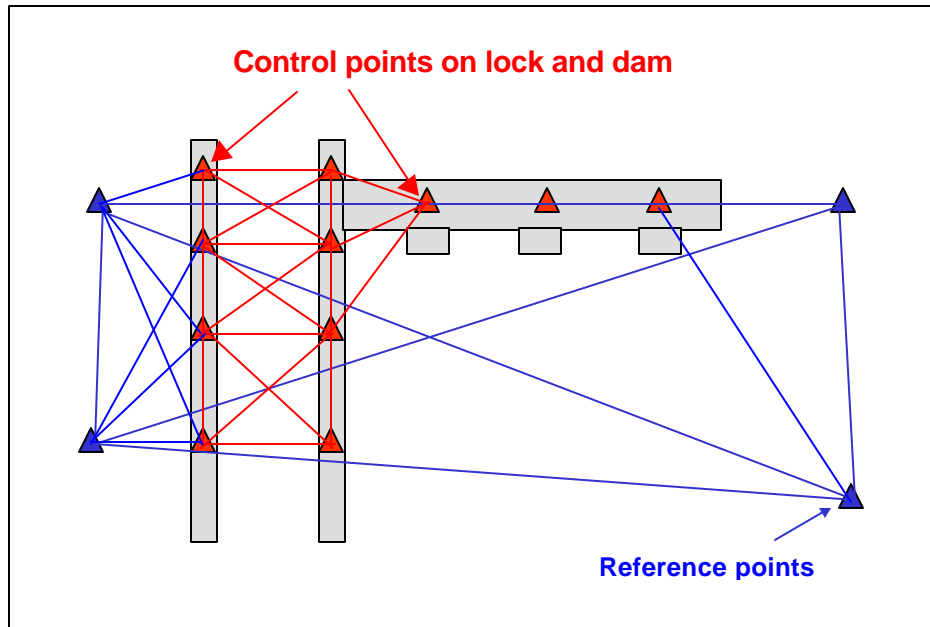

Figure 2-4. Strong monitoring scheme for a lock and dam

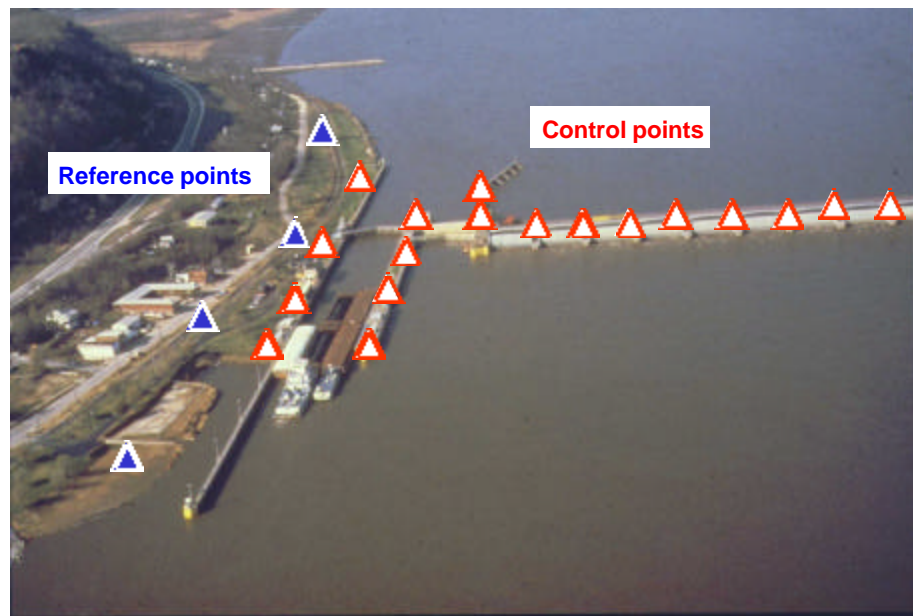

Figure 2-5. Idealized monitoring scheme for controlling target points on the lock and dam

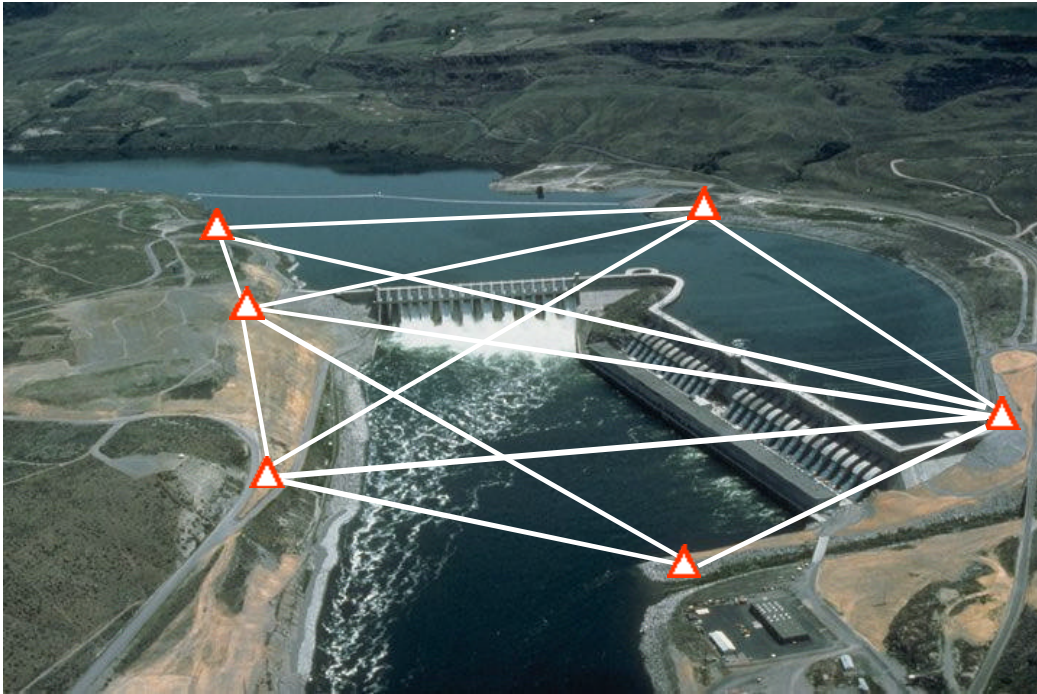

Figure 2-6. Idealized reference network surrounding a hydroelectric dam. External reference points are established at downstream points and on reservoir to provide strong geodetic network

(1) Reference station coordinates. Coordinates are initially established on at least one or two stations in the reference network from National Geodetic Reference System (NGRS) control monuments available in the local area. Coordinates are then transferred by direct measurement to the remaining stations in the reference network before the first monitoring survey. 3D coordinates should be established on all structure control points and reference stations for projects that combine horizontal and vertical positioning surveys.

(2) Monitoring point coordinates. Geodetic or state plane coordinate systems are recommended for monitoring networks because standard mapping projection will provide consistency in coordinate transformations. Arbitrary coordinate systems based on a local project construction datum are more difficult to work with if there is a need for transforming from the local datum. Independent vertical positioning surveys are needed to augment 2D horizontal positioning networks. Vertical settlements are then computed apart from the horizontal displacement components.

c. Reference network stability. Reference network stations can be independently measured using higher precision survey methods than used for the general monitoring network. The reference network survey is also analyzed in a separate network adjustment to check for any change in reference station coordinates between monitoring campaigns. GPS technology alone, or GPS combined with high precision EDM distance measurements is suggested for reference network stability monitoring. Multiple EDM distance ties provide additional network redundancy as an external check on the GPS results. Detection and analysis of unstable reference points in the reference network has been successfully implemented using the Iterative Weighted Similarity Transformation (IWST). This analysis indicates whether any particular reference station has experienced significant movement between monitoring surveys by transforming observed displacements independent of the network constraints.

2-11. Reference Point Monumentation

a. General. A monument used for deformation monitoring is any structure or device that defines a point in the survey network. Monuments can be classified as either a reference point or a monitoring point. A reference point typically is located away from the structure and is to be "occupied" during the survey, while a monitoring (or object) point is located directly on the structure and is to be "monitored" during the survey. Each must have long term stability of less than 0.5 mm both horizontally and vertically with respect to the surrounding area. A permanent one (1) mm diameter reference mark, or forced centering device, should be used for every monitoring point monument. Further information on specific monument design and installation is provided in EM 1110-1-1002, Survey Markers and Monumentation.

b. Reference point monuments. Reference points can be either a steel pipe pile or cast-in-place reinforced concrete pile--Figure 2-7. If a steel pipe pile is used, the nominal diameter will be no less than 20 cm, while the wall thickness will be no less than that for standard weight pipe. If using a cast-in-place reinforced concrete pile, the nominal diameter will also be no less than 20 cm (Figure 2-8).



Figure 2-7. Reference point monumentation. Concrete pier construction vicinity of a hurricane gate structure. Forced centering plug set into concrete pier. (Jacksonville District)

c. Reference point installation. Reference points placed in the earth are installed to a depth equal to at least twice the depth of frost penetration in the project area. The reference point extends above ground level to a convenient height (e.g., 1.5 m) where the equipment can be force centered. Typically, at the top of such a reference point pile, a stainless steel plate not less than 2 cm thick is cast into the top of the pile using a minimum of four steel reinforcing bar anchors welded to the underside of the plate. In the center of the plate, a 5/8 inch diameter 11NC steel bolt is welded to the plate to allow survey equipment to be attached.

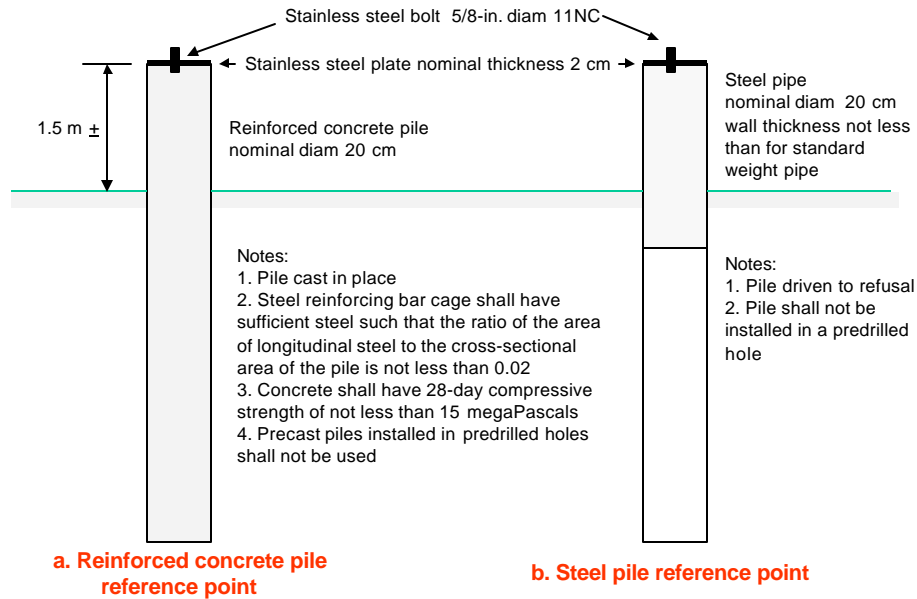

Figure 2-8. Reference point monumentation. Detail for reinforced concrete pile or steel pile construction

(1) Steel pipe pile. A steel pipe pile is installed by driving it until refusal. If refusal occurs at a depth of less than twice the depth of frost penetration in the project area, the pile is removed and its installation attempted in another location. Steel pipes placed in oversized pre-drilled holes and backfilled will not be used as reference points. For pipe piles terminating at or slightly below ground level, a convex stainless steel plate and stub will be installed as described above. The plate will be convex as required for leveling observations and will have an etched cross at the highest point of the convex surface for horizontal observation. It is recommended that such piles also have a cylindrical rim and cover around it for protection. If a cylindrical rim and cover is used, it is further recommended the cover be buried for easy recovery with a metal detector, as well as to minimize the chance of vandalism.

(2) Cast-in-place reinforced concrete pile. A cast-in-place reinforced concrete pile is installed by first drilling a hole to at least twice the depth of frost penetration in the project area. The cage of steel reinforcing bars used will have cross-sectional area of steel to concrete of not less than 0.02. After the cage is formed, it is placed in the hole. Concrete with a 28-day compressive strength of not less than 15 megaPascals is then poured into the form. Precast reinforced concrete piles driven into pre-drilled holes or placed in oversized pre-drilled holes and backfilled will not be used for reference points. Reference points installed in rock or concrete consist of a stainless steel plate as described above, except with a steel reinforcing bar stub welded to the underside. For installation, a hole at least 50% larger than the stub is drilled into sound rock or concrete. The plate with the stub attached is secured to the rock or concrete using adequate epoxy adhesive to completely fill the void between the stub and the rock or concrete.

(3) Insulation. Projects subjected to cold weather conditions will have an insulation sleeve installed around the reference point pile that extends above the ground. The installation of a sleeve is to eliminate the possibility of temperature induced pile movements that may be the result of solar radiation (i.e., temperature variation due to time of day). When this is the case, the sleeve should have an R value of not less than 10.

(4) Stability. If possible, the reference points should be installed at least a year prior to their use to minimize the effects of pile rebound and shrinkage. If this is not practical, no less than a month prior to its use will suffice.

2-12. Monitoring Point Monumentation

a. Monitoring point marks. Monitoring points installed in earth consist of a nominal 3 m length of square steel hollow structural section with a nominal side length of 5 cm and a wall thickness not less than that for a standard weight square steel hollow structural section. The base of the section is sharpened by cutting it at a 45 degree angle. Welded approximately 15 cm from the base is one length of 10 mm thick 20 cm diameter circular helix with a pitch of 7 cm. Welded to the top of the pipe is a steel plate not less than 5 mm thick. In the center of the plate a 5/8 inch 11NC steel bolt on to which survey equipment is to be connected is drilled through and welded to the plate. Some method (e.g., through the use of a cap) should be used to protect the threads of the bolt during the time survey equipment is not attached.

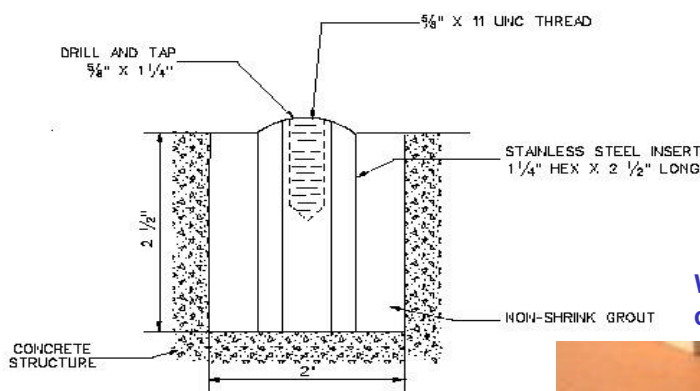

Wild tribrach with forced centering device



Figure 2-9. Target plug set on concrete structure. Forced centering device on tribrach shown upside down

b. Monitoring point installation. Monitoring points set directly in rock or concrete may be either a steel bolt or a steel insert into which survey equipment is force centered--see Figure 2-9. Installation of these types of monuments is as follows:

(1) Steel bolt. The steel bolt is drilled through and welded to a 5 cm diameter, 1 cm thick steel plate. A steel reinforcing bar stub of suitable length is welded to the head of the bolt. A hole approximately 50% larger than the stub is drilled in sound rock or concrete. The plate with the stub attached is secured to the rock or concrete using adequate epoxy adhesive to completely fill the void between the stub and the rock or concrete. The threads of the bolt should be protected during the time survey equipment is not attached (e.g., by use of a cap).

(2) Steel insert. Steel inserts have been designed as commercial off-the-shelf items. Manufacturer instructions for proper installation of the insert should be followed.

(3) Other materials. Monitoring points on materials (e.g., steel, masonry, etc.) other than described in the previous paragraphs will be permanently affixed. For object points to be mounted on steel, a steel bolt welded to the steel may be suitable. For masonry, or other material, a steel bolt, plate and rear stub or a steel insert may be suitable.

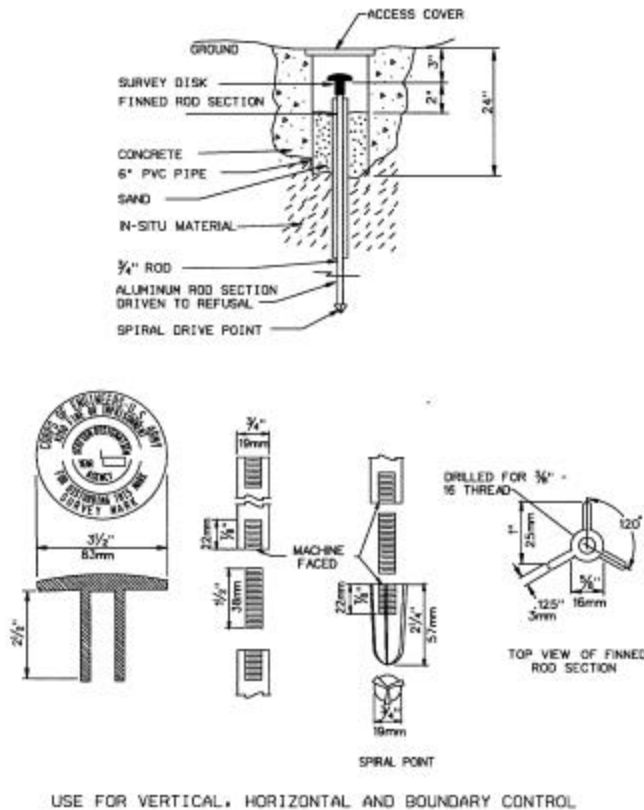

Figure 2-10. External deep-driven benchmark design--for vertical control only

c. Monitoring point targets. A target is a device with a well-defined aiming point that is placed vertically over or attached to a monument. The purpose of a target is to connect the measurement to a physical object. A target is typically installed only for the period of the survey, in some cases, the monument may be a target itself.

(1) Optical theodolites. Force-centered, standard target sets designed for one second theodolites, or the actual reference mark on the monument itself can be used as a target.

(2) Electronic total station. Force-centered, standard target set/prism combination used with a particular total station. Target set/prism combinations not matched to a particular total station will not be used. Target set/prism combinations for total stations which are non-coaxial, will be tilting target set/prism combinations that allow for alignment with the line of observation.

(3) EDM prisms. EDM targets will be the reflectors included with the EDM unit. Prisms not matched to a particular EDM will not be used.

(4) Chaining points. Targets for taped distances will be the monuments themselves.

(5) Leveling points. Targets for leveled height difference measurements will be the monuments themselves. If the monuments are steel inserts, the targets will be stainless steel plugs designed for the purpose. If more than one plug is to be used on a project, the plugs will be of the same size. Standard vertical control benchmarks may also be used, as shown in Figure 2-10.

(6) Panel points. Photogrammetric survey targets will consist of a high contrast, white dot on a black background. The diameter of the white dot is chosen so as to yield an average image diameter of 60 microns. The black background typically is 5 times the diameter of the white target.

(7) GPS reference marks. Targets for GPS surveys shall be the monuments themselves. Antenna offsets will be measured to relate the antenna phase center to the station marks.

d. Identification. A unique identifier (e.g., numeric or alphanumeric) will be stamped on the point as appropriate for all installed reference and monitoring points. Permanent records will be kept of the identifier, description, location and condition of each reference and monitoring point.

2-13. Design of Measurement Schemes

a. Optimal design methods. The optimization of *geodetic positioning* networks is concerned with accuracy, reliability, and economy of the survey scheme as the design criteria. Design of *deformation monitoring* schemes is more complex and differs in many respects from the design of simple positioning networks. Monitoring design is aimed at obtaining optimum accuracies for the deformation parameters (e.g. strain, shear, rotations, etc.), rather than for the coordinates of the monitoring stations. This allows using various types of (geodetic and non-geodetic) observables with allowable configuration defects. Multi-objective analytical design methodologies are known but not presently implemented within USACE because their practical application has not been demonstrated in any real-life examples. These techniques allow for a fully analytical, multi-objective optimal design of integrated deformation monitoring schemes with geodetic and geotechnical instrumentation. The method gives a simultaneous solution for the optimal configuration and accuracy of the monitoring scheme according to the given criteria and restrictions concerning the locations of some observation stations and required accuracy of the deformation parameters.

b. Expected movement thresholds. The design of deformation surveys from simple positioning accuracy criteria requires knowledge of the maximum expected displacement for all monitoring points on the structure. The amount of expected deformation is predicted using either deterministic modeling (by finite or boundary element methods), or empirical (statistical) prediction models. For example, predicted displacements from an engineering analysis may be documented in design memorandums prepared for construction, or from displacement trends established by geotechnical instruments. Displacements predicted at specific monument locations are requested from design engineers and then documented in the Instrumentation Plan.

c. Accuracy requirements. Positioning accuracy required for each monitored point is directly related to the maximum expected displacement occurring under normal operating conditions. Accuracy requirements are computed by equating the maximum allowable positioning error to some portion of the total magnitude of movement that is expected at each point. Specifically, the positioning accuracy (at the 95% probability level) should be equal to one fourth (0.25 times) the predicted value of the maximum displacement for the given span of time between the repeated measurements. Maximum possible accuracy is required once any abnormal deformations are noticed. With higher accuracy measurements it

is easier to determine the mechanism of any unpredicted deformations. Therefore, monitoring surveys may require updating of the initial measurement design over the duration of the monitoring project.

d. Survey error budget. The basis for computing the allowable survey error budget is as follows:

(1) Accuracy should be less than one-third of the predicted value for the maximum expected displacement (D_{max}) over the given span of time between two surveys. This ensures that the total uncertainty in coordinates (plus and minus) is less than two-thirds of the total predicted movement as a minimum safety factor.

$$P_{error} < (1/3) D_{max} \tag{Eq 2-1}$$

where

P_{error} = allowed positioning error
 D_{max} = maximum expected displacement

(2) Displacements are calculated by differencing coordinates obtained from two monitoring surveys. Therefore, the total allowable displacement error (σ_d) must combine uncertainty in both the initial (σ_1) and final (σ_2) surveys:

$$\sigma_d = \text{sqrt}(\sigma_1^2 + \sigma_2^2) \tag{Eq 2-2}$$

where

σ_1 = positioning uncertainty of initial survey
 σ_2 = positioning uncertainty of final survey

Positioning accuracy will be approximately equal (σ_0) if the same methods and instruments are used on each survey:

$$\sigma_0^2 = \sigma_1^2 = \sigma_2^2$$

and

$$\sigma_d = \text{sqrt}(2) \cdot (\sigma_0) \tag{Eq 2-3}$$

Therefore, the error budget should be divided by a factor of the square root of 2.

$$P_{error} = (\sigma_d) / \text{sqrt}(2)$$

(3) The developments above assume positioning uncertainty at the 95 percent confidence level.

$$P_{95\%} < [(1/3) D_{max}] / \text{sqrt}(2) \tag{Eq 2-4}$$

or approximately $P_{95\%} = (0.25) (D_{max})$. Expressed as a standard error (one-sigma value), it would need to be divided by the univariate confidence level expansion factor of 1.96, and changed to:

$$P_{one-sigma} < [(1/3) D_{max}] / [\text{sqrt}(2) \cdot (1.96)] \tag{Eq 2-5}$$

or approximately $P_{one-sigma} = (0.12) (D_{max})$.

(4) Accuracy Requirement Example. To detect an expected displacement component of x mm from two independent monitoring surveys (same methods), it should be determined with an accuracy of:

$$\begin{aligned}(x/3)/(1.41) &\sim x/4 \text{ mm, at the 95 percent confidence level, or} \\ (x/4)/(1.96) &\sim x/9 \text{ mm, at one standard error.}\end{aligned}$$

As a 'rule of thumb,' the measurements of a deformation component should be performed with a standard deviation (an error at one-sigma level) about nine (9) times smaller than the expected maximum value of the deformation. At the 95 percent confidence level this equates to approximately four (4) times smaller than the expected maximum value of the deformation.

e. Network preanalysis. Two closely related techniques for processing survey data are *preanalysis* and *adjustment* of geodetic networks.

- Preanalysis is a measurement design technique used to statistically verify whether a proposed monitoring survey meets pre-set accuracy requirements. It requires the user to choose approximate coordinates for each survey point, plan a desired measurement configuration, and assign a standard deviation to each measurement based on instrument specifications. Preanalysis yields an expected precision for each monitoring station in the network for a given survey design.

- Adjustment requires the user to process actual survey data. Usually data is collected according to the same measurement scheme developed from preanalysis. Survey adjustment yields best-fit coordinates and precision for each monitoring station in the network.

Both preanalysis and adjustment use the same underlying mathematical model to produce results. Although the required computations are complex, this problem is always transparent to the user because processing is done by software applications. Preanalysis specifies the expected positioning uncertainty based on random error only, therefore, a weight is assigned to each survey measurement based on its predicted standard deviation, which is computed *a priori* using known variance estimation formulas. Measurement uncertainties are propagated mathematically into a predicted error value for each station coordinate. This error is reported graphically by a point confidence ellipse, or by a relative confidence ellipse between two points. Each point confidence ellipse (error ellipse) encloses a region of maximum positioning uncertainty at a given statistical confidence level (usually 99-percent for preanalysis and 95-percent for adjustment). The corresponding vertical positioning error is reported by a point confidence interval for each point. Once accuracy requirements are specified for positioning the monitoring points, different survey designs can be proposed, tested, and modified until the coordinate error becomes small enough to detect a target level of movement based on accuracy requirements. Instruments used for each survey design are then selected based on the preanalysis results. Refinements to the survey design are made by judiciously adding or removing observations to create a finished measurement scheme. Once the accuracy performance of each survey design has been verified, the selected instruments, the number and type of measurements, and the survey network layout can be specified for field data collection.

2-14. Measurement Reliability

a. General. Reliability addresses the geometric strength of the observation scheme, measurement redundancy, and techniques for minimizing measurement biases. Statistical methods can determine the maximum level of undetected systematic error using outlier detection. Some reliability factors are:

- Redundant measurements,
- External checks on the validity of the data,
- Instrument calibrations,

- Reference network stability analysis,
- Rigorous data processing techniques,
- Multiple connections between stations.

b. Redundancy. Multiple sources of monitoring data (instruments and observations) allow for checking the consistency of deformation surveying measurements. Redundancy on monitoring surveys provides a means to check results, such as by collecting twice as many measurements as unknown coordinates, and by keeping parallel but separate sets of instruments that use different measurement methods. For example, relative displacements can be obtained from tiltmeters and geodetic leveling. A properly designed monitoring scheme should have a sufficient connection of measurements using different measuring techniques and such geometry of the scheme that self-checking through closures would be possible. Redundancy is also a requirement for using least squares adjustment techniques in data processing.

c. Instrument calibrations. Calibrations of surveying instruments are highly standardized and are essential for valid results when coordinate differencing is used to compute displacements. Major sources of systematic error and types of calibrations and procedures are presented in Chapter 4.

d. Stable point analysis. Accuracy in displacement measurements depends greatly on the stability of the network of reference stations. The reference network survey is analyzed separately to detect unstable reference stations in monitoring networks (see references listed in Section A-2 of Appendix A).

e. Rigorous data processing. Most surveying observations will require post processing before being used in a network adjustment or in the calculation of final displacements, e.g., for the elimination of nuisance parameters and the management of various data reductions and transformations. Some of the available reduction formulas are more accurate and complete than others. In general, the more rigorous version of a given formula is recommended for processing data on deformation networks.

f. Design of complex monitoring schemes. Survey networks can be broken down into several sub-networks to obtain specialized deformation information where each small piece can be analyzed in separate network adjustment, or so that measurements made on an isolated structural element can be connected to the whole. Dividing the network into distinct parts makes it simpler to isolate and identify gross errors and provides for additional observations between each sub-network to strengthen the overall measurement scheme. Specialized sub-networks increase the reliability of the survey results.

(1) Cross-sections. Surface monuments can be co-located with geotechnical instrumentation that are installed on the interior of the structure (e.g., service galleries of a dam). Geodetic monitoring points and fixed instrumentation placed on the same monolith provides the monitoring scheme with a high degree of redundancy.

(2) Survey sub-networks. Monitoring networks can be broken down into different types of smaller surveys (i.e., networks).

- *Regional reference network* established by a few widely distributed, off-site, reference points to provide regional information in seismically or geologically active areas;

- *Main reference network* of project reference points, situated in stable areas surrounding the structure, are used as a base to survey the monitoring points on the structure. The reference network is surveyed independently to investigate the stability of the reference stations, and to obtain higher accuracy of the coordinates of the reference stations.

- *Secondary network* of control monuments, installed directly on the structure, provides for a system of measurement ties between each other (i.e., between other structure control points). Control points in the secondary network are inter-connected by measurements and are also directly connected by measurements to the main reference network. For example, on navigation locks, angles and distances could be observed between secondary control points on adjacent lock walls, to tie together the separate alignment sections that are installed on each lock wall.

- *Localized networks* consist of the major body of survey monitoring points, grouped between secondary control points, for example, sections of multiple alignment pins that are placed between two control points on the structure. Such localized surveys provide monitoring coverage over the entire structure and in any critical areas. Alignment section surveys are examples of localized networks, as well as the point data gathered from localized instrumentation such as jointmeters or plumbline stations.

(3) Seismic network stations. Pre-surveyed positions can be established on any number of additional localized monitoring points (i.e., points not intended for routine observation) to determine the nature and extent of large displacements due to earthquakes. Continuous geodetic measurements also can be used for monitoring the consequences of seismic activity. One or more points on the structure are connected to a regional reference network, such as wide-area GPS arrays used for tectonic studies.

2-15. Frequency of Measurements

a. General. Geodetic monitoring surveys (for periodic inspections) are conducted at regular time intervals rather than by continuous measurements that are more typical of automated structural or geotechnical instrumentation. The time interval between deformation surveys will vary according to the purpose for monitoring, but is generally correlated to condition of the structure. Design factors such as the structure's age, hazard classification, safety regulations, and probability of failure determines an appropriate frequency for surveys, or the need for establishing more frequent survey campaigns.

b. Continuous monitoring. With automatic data acquisition, such as by DGPS or robotic total stations, the frequency of measurements does not impose any problem because the data can be decoded at a pre-programmed time interval without difficulty and at practically no difference in cost of the monitoring process. Continuous monitoring systems with geodetic measurements are not yet commonly used and the frequency of measurements of individual observables must be carefully designed to compromise between the actual need and the cost.

c. Age-based criteria. Guidelines for the frequency for conducting monitoring surveys (e.g., International Committee on Large Dams) follow a time table based on the age of the structure.

(1) Pre-construction. It will be useful to carry out some geodetic and piezometric measurements of the abutments before and during construction.

(2) Initial filling. A complete set of measurements should be made before the first filling is started. The dates of successive measurements will depend on the level the water has reached in the reservoir. The closer the water is to the top level, the shorter will be the interval between measurements. For instance, one survey should be conducted when the water reaches 1/4 of the total height; another survey when the water reaches mid-height; one survey every tenth of the total height for the third quarter; one survey every 6 ft of variation for the fourth quarter. The interval between two successive surveys should never exceed a month until filling is completed.

(3) Stabilizing phase. Measurements should be more frequent in the years immediately following the first filling when active deformation is in progress. Geodetic surveys can be carried out four times a year and other geotechnical measurements can be made once every 1 to 2 weeks.

(4) Normal operation. After the structure is stable, which can take up to 5 to 10 years or more, the above frequencies can be reduced by half. The frequencies of measurement can be reduced further according to what is learned during the first years of operation.

(5) Remedial phase. Once a structure begins showing significant signs of stress or advanced deterioration, measurement frequencies based on the stabilizing phase can be resumed to track potential failure conditions. It should be possible to conduct intensive investigations in areas undergoing the most critical distress to determine the causes of the deformations and plan for repairs.

d. Hazard based criteria. The frequency for conducting monitoring surveys are related to the hazard classification. Table 2-2 recommends monitoring frequency according to the hazard classification (HIGH, MEDIUM, or LOW) assigned to the structure.

Table 2-2. Structure Classification

STRUCTURES IN DISTRESS		STRUCTURES NOT IN DISTRESS			
Class I: HIGH RISK		Class II: MEDIUM		Class III: LOW	
CONTINUOUS MONITORING		MONITOR YEARLY OR EVERY OTHER YEAR		MONITOR EVERY OTHER YEAR	
Type A	<i>POTENTIAL FAILURE IMMINENT</i>	Type A	<i>Large Structures</i>	Type A	<i>Large Structures</i>
Type B	<i>POTENTIAL FAILURE SUSPECTED</i>				
Type C	<i>DAMS OR RESERVOIRS UNDERGOING INITIAL IMPOUNDMENT</i>	Type B	<i>Smaller Structures</i>	Type B	<i>Smaller Structures</i>

(1) Class I: HIGH RISK STRUCTURES. The high risk of Class I structures may warrant continuous monitoring of the structure.

(a) Type A: Potential Failure Imminent. Gather data as prudent. Data is very valuable for later analysis of why the structure failed. Use any method available to gather data without risk of life or interference in processes ongoing to save the structure and/or alert the population at risk.

(b) Type B: Potential Failure Suspect. Monitor structure continuously. After potential solution to save structure is applied, use continuous monitoring until is determined that structure is stabilized.

(c) Type C: Dams or Reservoirs Undergoing Initial Impoundment. Gather initial data before impoundment procedures start. Monitor continuously until failure is suspected or until impoundment procedures have halted. Continue monitoring continuously until it is determined that structure has stabilized and will maintain as planned under load.

(2) Class II: MEDIUM RISK STRUCTURES. Such structures are of a category of risk such that monitoring every year to every other year is prudent. Structures of this category are stable, but whose failure would affect a population area, result in a high dollar loss of downstream property, cause a devastating interruption of the services provided by the structure.

(3) Class III: LOWER RISK STRUCTURES. Such structures are of a category of risk such that monitoring every other year is prudent. Structures of this category are stable, but whose failure would not affect a population area, not result in a high dollar loss of downstream property, not cause a devastating interruption of the services provided by the structure.

e. Risk assessment criteria. Conditions that indicate an increased probability of failure, such as, historical earthquake frequency and magnitude, predicted maximum flood stage and frequency, structure design lifetime, combined with knowledge of the expected impacts to life and property downstream can be used to assess the relative risk from different failure modes at a given project. This information can aid in determining the frequency for monitoring surveys, especially on structures that have innovative or specialized design features. Examples of certain load cases used in the analysis of stability and calculation of stresses have been categorized in EM 1110-2-2200 (Gravity Dam Design).

f. Technical instructions and scopes of work. Appendix B contains a sample contract scope of work for performing periodic deformation monitoring surveys. As is outlined in the example scope, some of the specialized monitoring instrumentation is furnished by the Government. Not all Architect-Engineer firms can be expected to have monitoring equipment on hand due to the limited requirement for such work. Often, a Government representative may be required to accompany the survey team on site.

2-16. Mandatory Requirements

The standards outlined in paragraphs 2-2 and 2-3, including Table 2-1 (Accuracy Requirements for Structure Target Points), are mandatory.

Chapter 3 Deformation Measurement and Alignment Instrumentation

3-1. General

This chapter describes the different techniques and equipment that are used in measuring external structural deformations.

a. Geodetic and geotechnical measurements. The measuring techniques and instrumentation for deformation monitoring have traditionally been categorized into two groups according to the disciplines of professionals who use the techniques:

- geodetic surveys, which include conventional (terrestrial), photogrammetric, satellite, and some special techniques (interferometry, hydrostatic leveling, alignment, etc.)
- geotechnical/structural measurements of local deformations using lasers, tiltmeters, strainmeters, extensometers, joint-meters, plumb lines, micrometers, etc.

b. Comparison of measurement methods. Each measurement type has its own advantages and drawbacks. Geodetic surveys, through a network of points interconnected by angle and/or distance measurements, usually supply a sufficient redundancy of observations for the statistical evaluation of their quality and for a detection of errors. They give global information on the behavior of the deformable structure while the geotechnical measurements give very localized and, very frequently, locally disturbed information without any check unless compared with some other independent measurements. On the other hand, geotechnical instruments are easier to adapt for automatic and continuous monitoring than conventional geodetic instruments. Conventional terrestrial surveys are labor intensive and require skillful observers, while geotechnical instruments, once installed, require only infrequent checks on their performance. Geodetic surveys have traditionally been used mainly for determining the absolute displacements of selected points on the surface of the object with respect to some reference points that are assumed to be stable. Geotechnical measurements have mainly been used for relative deformation measurements within the deformable object and its surroundings. However, with the technological progress of the last few years, the differences between the two techniques and their main applications are not as obvious as twenty years ago.

(1) For example, inverted plumb-lines and borehole extensometers, if anchored deeply enough in bedrock below the deformation zone, may serve the same way as, or even better than, geodetic surveys for determining the absolute displacements of the object points. Geodetic surveys with optical and electro-magnetic instruments (including satellite techniques) are always contaminated by atmospheric (tropospheric and ionospheric) refraction, which limits their positioning accuracy to about ± 1 ppm to ± 2 ppm (at the standard deviation level) of the distance. So, for instance, given a 500 m average distance between the object and reference points, the absolute displacements of the object points cannot be determined to an accuracy better than about ± 2 mm at the 95% probability level. In some cases this accuracy is not adequate. On the other hand, precision electro-optical geodetic instruments for electronic distance measurements (EDM) with their accuracies of ± 0.3 mm over short distances may serve as extensometers in relative deformation surveys. Similarly, geodetic leveling, with an achievable accuracy of better than ± 0.1 mm over distances of 20 m may provide better accuracy for the tilt determination (equivalent to ± 1 second of arc) than any local measurements with electronic tiltmeters. Measurements of small concrete cracks can be made to a high degree of accuracy using micrometers--see Chapter 7 for micrometer observation procedures. New developments in three-dimensional coordinating systems with electronic theodolites may provide relative positioning in almost real-time to an accuracy of ± 0.05 mm

over distances of several meters. The same applies to new developments in photogrammetric measurements with the solid state cameras (CCD sensors). The satellite-based Global Positioning System (GPS), which, if properly handled, offers a few millimeters accuracy in differential positioning over several kilometers. GPS is replacing conventional terrestrial surveys in many deformation studies and, particularly, in establishing the reference networks.

(2) From the point of view of the achievable instrumental accuracy, the distinction between geodetic and geotechnical techniques no longer applies. With the recent technological developments in both geodetic and geotechnical instrumentation, at a cost one may achieve almost any practically needed instrumental resolution and precision, full automation, and virtually real-time data processing. Thus, the array of different types of instruments available for deformation studies has significantly broadened within the last few years. This creates a new challenge for the designers of the monitoring surveys: what instruments to choose, where to locate them, and how to combine them into one integrated monitoring scheme in which the geodetic and geotechnical/structural measurements would optimally complement each other.

3-2. Angle and Distance Measurements

Manually operated transits and theodolites have been traditionally used for angle measurement in structural deformation surveying. Distances were measured using precise surveying chains (tapes) or manually operated electronic distance measurement (EDM) devices. Electronic total station devices, such as those shown in Figure 3-1, have largely replaced these older instruments and techniques.

a. Electronic theodolites. Over the last two decades, the technological progress in angle measurements has been mainly in the automation of the readout systems of the horizontal and vertical circles of the theodolites. The optical readout systems have been replaced by various, mainly photo-electronic, scanning systems of coded circles with an automatic digital display and transfer of the readout to electronic data collectors or computers. Either decimal units (gons) or traditional sexagesimal units of degrees, minutes, and seconds of arc may be selected for the readout ($360 \text{ deg} = 400 \text{ gons}$). The sexagesimal system of angular units is commonly accepted in North America. As far as accuracy is concerned, electronic theodolites have not brought any drastic improvements in comparison with precision optical theodolites. Some of the precision electronic theodolites, such as the Kern E2 (discontinued production), Leica (Wild) T2002 and T3000, and a few others, are equipped with microprocessor controlled biaxial sensors (electronic tiltmeters) which can sense the inclination (misleveling) of the theodolite to an accuracy better than 0.5 inch and automatically correct not only vertical but also horizontal direction readouts. In optical theodolites in which the inclination is controlled only by a spirit level, errors of several seconds of arc in horizontal directions could be produced when observing along steeply inclined lines of sight. Therefore, when selecting an electronic theodolite for precision surveys, one should always choose one with the biaxial leveling compensator. Atmospheric refraction is a particular danger to any optical measurements, particularly where the line-of sight lies close to obstructions. The gradient of air temperature in the direction perpendicular to the line of sight is the main parameter of refraction.

b. Three-dimensional coordinating systems. Two or more electronic theodolites linked to a microcomputer create a three-dimensional (3D) coordinating (positioning) system with real-time calculations of the coordinates. The systems are used for the highest precision positioning and deformation monitoring surveys over small areas. Leica (Wild) TMS and UPM400 (Geotronics, Sweden) are examples of such systems. If standard deviations of simultaneously measured horizontal and vertical angles do not exceed 1 inch, then positions (x, y, z) of targets at distances up to ten meters away may be determined with the standard deviations smaller than 0.05 millimeters. Usually short invar rods of known length are included in the measuring scheme to provide scale for the calculation of coordinates.



Figure 3-1. Leica TCA 2003 and TM 5100 electronic total stations used for high precision machine alignment and deformation measurements. Accuracy specified at 1.0 mm (distance) and 0.5 sec (angular)

c. Electronic Distance Measurements (EDM). Short range (several kilometers), electro-optical EDM instruments with visible or near infrared continuous radiation are used widely in engineering surveys. The accuracy (standard deviation) of EDM instruments may be expressed in a general form as:

$$\sigma = \text{sqrt} (a^2 + b^2 \cdot S^2) \quad (\text{Eq 3-1})$$

where "a" contains errors of the phase measurement and calibration errors of the so-called zero correction (additive constant of the instrument and of the reflector), while the value of "b" represents a scale error due to the aforementioned uncertainties in the determination of the refractive index and errors in the calibration of the modulation frequency. Typically, the value of "a" ranges from 3 mm to 5 mm. In the highest precision EDM instruments, such as the Kern ME5000, Geomensor CR234 (Com-Rad, U.K.), and Tellurometer MA200 (Tellumat, U.K.), the "a" value is 0.2 mm to 0.5 mm based on a high modulation frequency and high resolution of the phase measurements in those instruments. One recently developed engineering survey instrument is Leica (Wild) DI2002 that offers a standard deviation of 1 mm over short distances. Over distances longer than a few hundred meters, however, the prevailing error in all EDM instruments is due to the difficulty in determining the refractive index.

d. Pulse type measurement. Recently, a few models of EDM instruments with a short pulse transmission and direct measurement of the propagation time have become available. These instruments, having a high energy transmitted signal, may be used without reflectors to measure short distances (up to

200 m) directly to walls or natural flat surfaces with an accuracy of about 10 millimeters. Examples are the Pulsar 500 (Fennel, Germany) and the Leica (Wild) DIOR 3002. Cyra Technologies, Inc has developed automated laser scanning instruments which can be used to scan accurate (± 5 mm), real-time detailed models of structures and construction sites--see Figure 3-2.

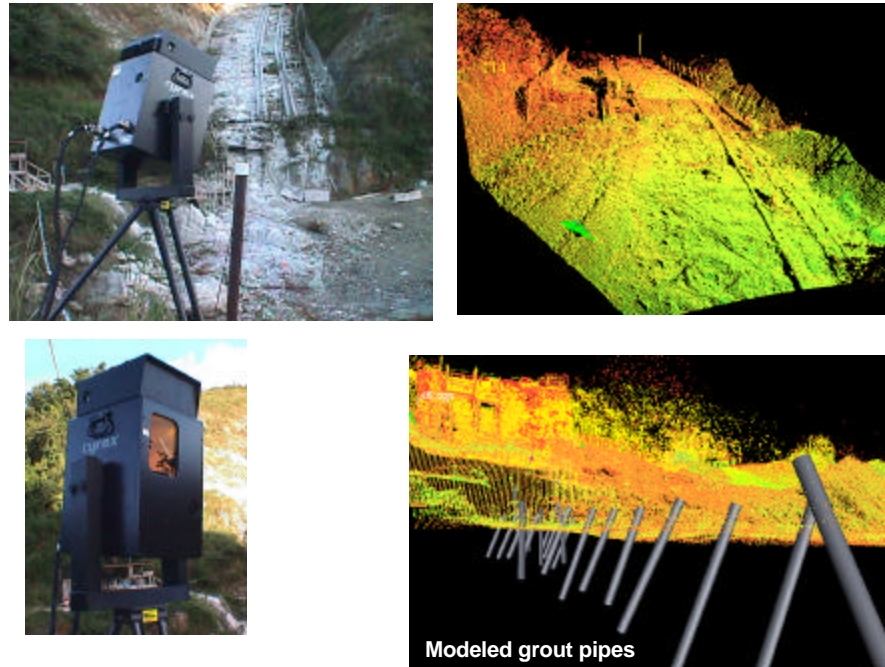

Figure 3-2. Real-time laser modeling during 1999 construction of Portugues Dam near Ponce, Puerto Rico--Cyrax Model 2400 (Jacksonville District, Arc Surveying & Mapping, Inc, Cyra Technologies, Inc.)

e. Dual frequency instruments. Only a few units of a dual frequency instrument (Terrameter LDM2 by Terra Technology) are available around the world. They are bulky and capricious in use but one may achieve with them a standard deviation of ± 0.1 mm ± 0.1 ppm. Due to a small demand, its production has been discontinued. Research in the development of new dual frequency instruments is in progress.

f. Total stations. Any electronic theodolite linked to an EDM instrument and to a computer creates a total surveying station which allows for a simultaneous measurement of the three basic positioning parameters, distance, horizontal direction, and vertical angle, from which relative horizontal and vertical positions of the observed points can be determined directly in the field. Several manufacturers of survey equipment produce integrated total stations in which the EDM and electronic angle measurement systems are incorporated into one compact instrument with common pointing optics, as illustrated in Figure 3-1. Different models of total stations vary in accuracy, range, sophistication of the automatic data collection, and possibilities for on-line data processing. One total station model specifically designed for precision engineering surveys is the Leica (Wild) TC2002 which combines the precision of the aforementioned electronic theodolite, Leica (Wild) T2002, with the precision EDM instrument, Leica (Wild) DI2002, into one instrument with a coaxial optics for both the angle and distance measurements.

g. *Theomat Coaxial Automated Total Station (TCA)*. Leica Company Inc. produces the TCA2003 automated total station instrument, which is designed for conducting deformation monitoring surveys. The TCA2003 system uses a standard tribrach mounting system and internal NiCad batteries or an external 12-volt battery and/or AC power inverter. The user controls measurement functions with a keyboard display. Data collection is carried out via PCMCIA type 1 S-RAM data collector cards having a 2-4 MB capacity (approximately 8000 measurements), that can be directly downloaded to a PC equipped with the proper communications port drivers. It is equipped with a manual-use and/or automatic correcting biaxial compensator to minimize leveling error. The instrument telescope has a 32× lens magnification, so pointing errors are limited to not less than approximately 1 arc-second. The 42-mm objective lens is non-panfocal so that the magnification in this system is fixed. Higher magnification would be desirable for monitoring applications. The angle measurement system uses an absolute encoder with four independent circle readings made at each pointing. An eccentricity in the reading scale any more than 0.5 arc-seconds would be calibrated out at the factory by programming a look-up table of corrections for all possible circle readings. Internally, the EDM tracks a decade modulated infrared (IR) carrier wave having a 0.6 mm resolution at 120 meters. The EDM system specifications are for 1 mm and 1 ppm precision to a single prism at a range of 2500 feet

h. *Automatic Target Recognition (ATR)*. Early automated vision systems were installed in precision theodolites by the 1980's. Its operating components consisted of an external video camera imaging system and a separate servomotor drive. Modern systems are more sophisticated being packaged internally and having an active beam sensing capability. An emitted IR signal is transmitted to the prism that passively reflects the signal back to the instrument. The return spot is imaged on a high-resolution (500 x 500) pixel CCD array. The center of gravity (centroid) is located in relation to the current position of the optical cross-hairs (reticule). An initial calibration process is carried out immediately after setting up the instrument, where a reference object is sighted so that the fixed orientation of the telescope is registered to the ATR image coordinates. To run the system after calibration, a series of targets are sighted so the instrument can be trained to their location at least once. With the approximate coordinates of each target prism stored in memory, the ATR system can then take over the pointing, reading, and measuring functions completely within the instrument. Target search radius, data rejection thresholds, and other controls can be programmed into the operating menus by the user. The search pattern is set by default to one-third of the telescope field of view, but this range can be narrowed to provide better search and recognition performance once the instrument has been trained to a given point. Factory reliability tests on the servomotor drive have proven continuous operation of the system over four consecutive years in a continuous measurement mode.

i. *Data communications and software*. Recorded data can be downloaded to an external file or automatically communicated via RS-232, UHF radio link, spread spectrum radio, or radio modem over up to one kilometer. Although data is transmitted in relatively short streams, its onboard communications capability is not yet Internet (TCICP) compatible. Software applications for the system range from writing ASCII file output to pre-packaged analysis software (APS Win) for tracking and monitoring changes in the measurements. Two versions of the APS Win Software can be purchased. The first is a full system that has data collection, processing, and analysis capabilities. The second is a light version with only data logging features. Custom data collector software can also be programmed manually using a software package known as Geobasic, which provides a high-level programmers development environment. The APS Win package can be used to remotely configure measurement sequences, such as; the number of targets, target sighting sequence, and time interval between measurements. However, the repetition time can be set to no less than once a minute. Downloading the data through a PC computer is "drag & drop" via a survey office (file manager) software package. A proprietary data format is used to collect the data, which is translated, into readable ASCII text files by the GSI editor program.

j. Survey robots. For continuous or frequent deformation measurements, a fully automatic system based on computerized and motorized total stations has recently been developed. The first commercial system was Georobot. Recent advanced systems include for example, the Geodimeter 140 SMS (Slope Monitoring System) and the Leica (Wild) APS and Georobot III systems based on the motorized TM 3000 series of Leica (Wild) electronic theodolites linked together with any Leica (Wild) DI series of EDM. These can be programmed for sequential self-pointing to a set of prism targets at predetermined time intervals, can measure distances and horizontal and vertical angles, and can transmit the data to the office computer via a telemetry link. Similar systems are being developed by other manufacturers of surveying equipment. The robotic systems have found many applications, particularly in monitoring high walls in open pit mining and in slope stability studies. Generally, the accuracy of direction measurements with the self-pointing computerized theodolites is worse than the measurements with manual pointing.

3-3. Differential Leveling

a. General. Differential leveling provides height difference measurements between a series of benchmarks. Vertical positions are determined to very high accuracy (± 1 mm) over short distances (10-100's of meters) using precision levels. Two major classes of precision levels commonly used for making deformation measurements are automatic levels and digital levels.

b. Automatic levels. The old method of geometrical leveling with horizontal lines of sight (using spirit or compensated levels) is still the most reliable and accurate, though slow, surveying method. With high magnification leveling instruments, equipped with the parallel glass plate micrometer and with invar graduated rods, a standard deviation smaller than 0.1 mm per set-up may be achieved in height difference determination as long as the balanced lines of sight do not exceed 20 meters. In leveling over long distances (with a number of instrument set-ups) with the lines of sight not exceeding 30 m, a standard deviation of 1 mm per kilometer may be achieved in flat terrain. The influence of atmospheric refraction and earth curvature is minimized by balancing the lines of sight between the forward and backward leveling rods. A dangerous accumulation of refraction error, up to 15 mm for each 100 m difference in elevation, may take place along moderately inclined long routes due to unequal heights of the forward and backward horizontal lines above the terrain.

c. Digital levels. The recently developed Leica NA2000 and NA3000 digital automatic leveling systems with height and distance readout from encoded leveling rods (Figure 3-3) has considerably increased the speed of leveling (by about 30%) and decreased the number of personnel needed on the survey crew. Some users of the digital level complain that its compensating system demonstrates systematic deviations in windy weather and, therefore, cannot be classified as a high precision level unless some improvements are introduced by the manufacturer.

d. Tilt measurements by leveling. Monolith tilt on dams can be determined from leveling observations using the dimensions and tilting axis of the object. For example, a well-spaced (e.g., rectangular) four-point configuration of points provides the attitude of a plane that can be solved by least squares surface fitting to the measurements. The required survey data inputs are the height differences between the points and an absolute height tied to at least one point, either transferred or assumed from a given reference. The unknown two-axis tilt parameters (α_x and α_y) are derived from the solution of the equation for the plane.



Figure 3-3. Lieca NA 2002 automated digital level and section from bar-coded invar level rod

3-4. Total Station Trigonometric Elevations

a. Zenith angle methods. High precision electronic theodolites and EDM equipment allow for the replacement of geodetic leveling with more economical trigonometric height measurements. An accuracy better than 1 mm may be achieved in height difference determination between two targets 200 m apart using precision electronic theodolites for vertical angle measurements and an EDM instrument. The measurements must be performed either reciprocally, with two theodolites simultaneously, or from an auxiliary station with equal distances to the two targets (similar methodology as in spirit leveling) to minimize atmospheric refraction effects.

b. Measurement accuracy. Zenith angle heighting accuracy is practically independent of the height differences and is especially more economical than conventional leveling in hilly terrain, and in all situations where large height differences between survey stations are involved. Trigonometric height traversing (reciprocal or with balanced lines of sight) with precision theodolites and with the lines of sight not exceeding 250 m can give a standard deviation smaller than 2 mm per kilometer. For standard height transfer applications, with automatic data collection and on-line processing, measurements are achieved independent of the terrain configuration. The refraction error is still the major problem with increasing the accuracy of trigonometric leveling.

3-5. Global Positioning System (GPS)

a. General. The satellite Global Positioning System (shown in Figures 3-4 and 3-5) offers advantages over conventional terrestrial methods. Intervisibility between stations is not strictly necessary, allowing greater flexibility in the selection of station locations than for terrestrial geodetic surveys. Measurements can be taken during night or day, under varying weather conditions, which makes GPS measurements economical, especially when multiple receivers can be deployed on the structure during the survey. With the recent developed rapid static positioning techniques, the time for the measurements at

each station is reduced to a few minutes. Reference EM 1110-1-1003, NAVSTAR Global Positioning System Surveying.



Figure 3-4. GPS equipment setup on a concrete hydropower dam - spillway and intake structure

b. Measurement accuracy. GPS is still a new and not perfectly known technology from the point of view of its optimal use for deformation surveying and understanding related sources of error. The accuracy of GPS relative positioning depends on the distribution (positional geometry) of the observed satellites and on the quality of the observations. Several major sources of error contaminating the GPS measurements are:

- signal propagation errors--tropospheric and ionospheric refraction, and signal multipath,
- receiver related errors--antenna phase center variation, and receiver system noise,
- satellite related errors--such as orbit errors and bias in the fixed station coordinates.

GPS errors relative to deformation survey applications are discussed in detail in Chapter 8.



Figure 3-5. Standard GPS equipment for precise surveying. From left to right; graduated rods for antenna height measurement, GPS antenna with ground plane, tribrach, antenna/tribrach adapter, antenna cable, data download cable, surveyors tripod, GPS receiver, camcorder batteries, power cord for support module, 12V battery with attached cable, support module for data downloading.

c. GPS positioning accuracy. Experience with the use of GPS in various deformation studies indicate that with the available technology the accuracy of GPS relative positioning over areas of up to 50 km in diameter can be expressed in terms of the variance of the horizontal components of the GPS baselines over a distance (S):

$$\sigma^2 = (3\text{mm})^2 + (10^{-6} \cdot S)^2 \quad (\text{Eq 3-2})$$

Systematic biases (rotations and change in scale of the network) are identified and eliminated through proper modeling at the stage of the deformation interpretation. The accuracy of vertical components of the baselines is 1.5 to 2.5 times worse than the horizontal components. Systematic measurement errors over short distances (up to a few hundred meters) are usually negligible and the horizontal components of the GPS baselines can be determined with a standard deviation of 3 mm or even smaller. Recent improvements to the software for the GPS data processing allow for an almost real time determination of changes in the positions of GPS stations.

d. Systematic GPS errors. Different types of errors affect GPS relative positioning in different ways. Some of the errors may have a systematic effect on the measured baselines producing scale errors and rotations. Due to the changeable geometrical distribution of the satellites and the resulting changeable systematic effects of the observation errors, repeated GPS surveys for the purpose of monitoring deformations can affect derived deformation parameters (up to a few ppm). Attention to the systematic influences should be made when a GPS network is established along the shore of a large body of water and measurements are performed in a hot and humid climate. The solution for systematic parameters in a GPS network may be obtained by:

- combining GPS surveys of some baselines (with different orientation) with terrestrial surveys of a compatible or better accuracy,
- establishing several points outside the deformable area (fiducial stations) which would serve as reference points.

These aspects must be considered when designing GPS networks for any engineering project.

e. Automated GPS surveys. USACE developed a fully automated system for high-precision deformation surveys with GPS. With the Continuous Deformation Monitoring System (CDMS) GPS antennas are located at multiple points on the structure. At least two other GPS antennas must be located over reference points that are considered stable. The GPS antennas are connected to computers using a data telemetry link. A prototype CDMS system used 10-channel Trimble 4000SL and Trimvec post processing software. An operator could access the on-site computer network through a remote hook-up in the office. In 1989 the system was installed at the Dworshak Dam on the Clearwater River near Orofino, Idaho (Figure 3-6). The demonstration results show that CDMS can give accuracies of 3 mm both horizontally and vertically over a 300 m baseline.

GPS reference stations

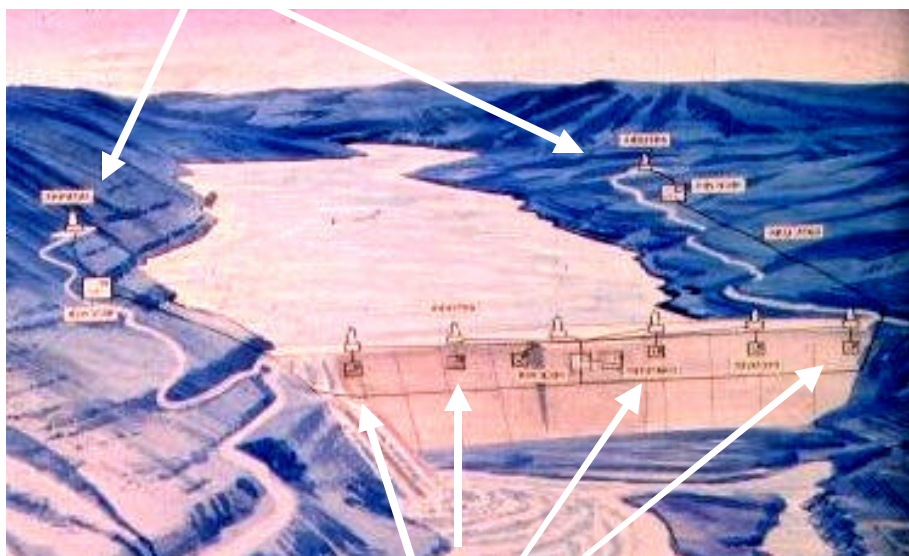

Target points on dam

Figure 3-6. 1989 Concept sketch depicting GPS deformation monitoring surveys on a dam. GPS monitoring was first applied at Dworshak Dam, Idaho. (Walla Walla District)

Although GPS does not require the intervisibility between the observing stations it requires an unobstructed view to the satellites which limits the use of GPS only to reasonably open areas. One should also remember that there might be some additional sources of errors (e.g., multipath, etc.) in GPS measurements.

f. GPS receiver specifications. When performing GPS based deformation surveys, the receiver used must be geodetic quality, multi-channel, single frequency, and capable of one second data sampling. The receiver should also be capable of recording the GPS carrier frequency, receiver clock time, and signal strength for each data sample. A GPS receiver is required for each reference station in the reference network. The same model receiver/antenna combination should be used for each setup. Pre-processing of GPS survey data, at a minimum, must include determination of the 3D coordinate differences and associated variance-covariance matrix in the 3D coordinate system for all baselines observed, and data screening to eliminate possible outliers. When performing GPS-based deformation surveys, procedures should be done in accordance with the guidance in Chapter 8 of this manual.

3-6. Photogrammetric Techniques

a. General. If an object is photographed from two or more survey points of known relative positions (known coordinates) with a known relative orientation of the camera(s), relative positions of any identifiable object points can be determined from the geometrical relationship between the intersecting optical rays which connect the image and object points. If the relative positions and orientation of the camera are unknown, some control points on the object must be first positioned using other surveying techniques. Aerial photogrammetry has been extensively used in determining ground movements in ground subsidence studies in mining areas, and terrestrial photogrammetry has been used in monitoring of engineering structures. The main advantages of using photogrammetry are the reduced time of field work; simultaneous three dimensional coordinates; and in principle an unlimited number of points can be monitored. The accuracy of photogrammetric point position determination has been much improved in the past decade, which makes it attractive for high precision deformation measurements.

b. Terrestrial photogrammetry. Special cameras with minimized optical and film distortions must be used in precision photogrammetry. Cameras combined with theodolites (phototheodolites), for instance the Wild P-30 model, or stereocameras (two cameras mounted on a bar of known length) have found many applications in terrestrial engineering surveys including mapping and volume determination of underground excavations and profiling of tunnels. The accuracy of photogrammetric positioning with special cameras depends mainly on the accuracy of the determination of the image coordinates and the scale of the photographs. The image coordinates may, typically, be determined with an accuracy of about 10 μm , though 3 μm is achievable. The photo scale may be approximately expressed as:

$$\text{Photo Scale} = f / S \tag{Eq 3-3}$$

where

f = the focal length of the camera lens
S = the distance of the camera from the object.

Using a camera with f = 100 mm, at a distance S = 100 m, with the accuracy of the image coordinates of 10 μm , the coordinates of the object points can be determined with the accuracy of 10 mm. Special large format cameras with long focal length are used in close range industrial applications of high precision. For instance, the model CRC-1 (Geodetic Services, Inc.) camera with f = 240 mm, can give sub-millimeter accuracy in 'mapping' objects up to a few tens of meters away. Recently, solid state cameras with CCD (charge couple device) sensors have become available for close range

photogrammetry in static as well as in dynamic applications. Continuous monitoring with real time photogrammetry becomes possible with the new developments in CCD cameras and digital image processing techniques.

c. Photogrammetric standards. When performing photogrammetric based deformation surveys, only metric cameras will be used. Typically, only one camera is necessary as it is moved from station to station. The instrument used for image coordinate measurement (e.g., monocomparator, stereocomparator, or analytical stereocomparator) will be capable of 1 micron or better resolution.

d. Photogrammetry operations. When performing photogrammetric based deformation surveys, the metric camera used will be mounted in or on a suitable camera platform (e.g., camera tripod). During exposure, movement of the camera will be minimized. If using an airplane or helicopter for the platform, a camera with an image motion compensator must be used. Typically, 5 to 20 exposure stations are necessary to insure sufficient precision for the object point coordinates are determined. To ensure the whole photo taking portion of the survey is performed correctly, it is highly recommended that only experienced personnel be used for this phase of the survey. The photogrammetric reduction process also should be done by experienced personnel trained in image coordinate measurement with the appropriate equipment. If practicable, it is recommended that this process be automated in order to eliminate potential gross errors possible with self-calibration. EM 1110-1-1000, Photogrammetric Mapping, and photogrammetric product manufacturer guidelines should be referred to for more specifics on the photogrammetric process.

e. Pre-processing photo control survey data. Pre-processing of conventional survey data consists of applying statistical tests at the time the observations are made in order to reject probable outliers, and applying atmospheric, instrument calibration, standardization, and geometric corrections so data can be imported to subsequent network adjustment software. Pre-processing of conventional survey observations can either be done manually or by appropriate verified and validated PC based programs.

f. Pre-processing photogrammetric survey data. Pre-processing of photogrammetric based survey data will include the screening of measured image coordinates in order to reject observation which are outliers and determination of 3D object coordinates and associated variance-covariance matrix in the local coordinate system. Determination of the 3D object coordinates should be accomplished by a computer based bundle adjustment program with self-calibration. Also, in the bundle adjustment, the focal length, position of the principal point, coefficients of radial and asymmetric lens distortion, and photographic media unflatness will be treated as weighted unknowns. Atmospheric refraction can be neglected if the exposure distance is kept to what is recommended.

3-7. Alignment Measurements

a. General. Alignment surveys cover an extremely wide spectrum of engineering applications from the tooling industry, through measurements of amplitude of vibrations of engineering structures, to deformation monitoring of nuclear accelerometers several kilometers long. Each application may require different specialized equipment. The methods used in practice may be classified according to the method of establishing the reference line:

- mechanical method in which stretched wire (e.g., steel, nylon) establishes the reference line,
- direct optical method (collimation) with optical line of sight or a laser beam to mark the line,
- diffraction method where a reference line is created by projecting a pattern of diffraction slits.

b. Mechanical methods. Mechanical alignment methods with tensioned wires used as the reference lines have found many applications, including dam deformation surveys. This is due to their

simplicity, high accuracy, and easy adaptation to continuous monitoring of structural deformations using inductive sensors applicable over distances up to a few hundred meters. Accuracies of 0.1 mm are achievable using mechanical alignment methods.

c. Direct optical methods. Direct optical methods (Figure 3-7) utilize either an optical telescope and movable targets with micrometric sliding devices or a collimated laser beam (projected through the telescope) and movable photo-centering targets. Besides the aforementioned influence of atmospheric refraction, pointing and focusing are the main sources of error when using optical telescopes. Refer to Chapter 7 for details on performing micrometer alignment observations.

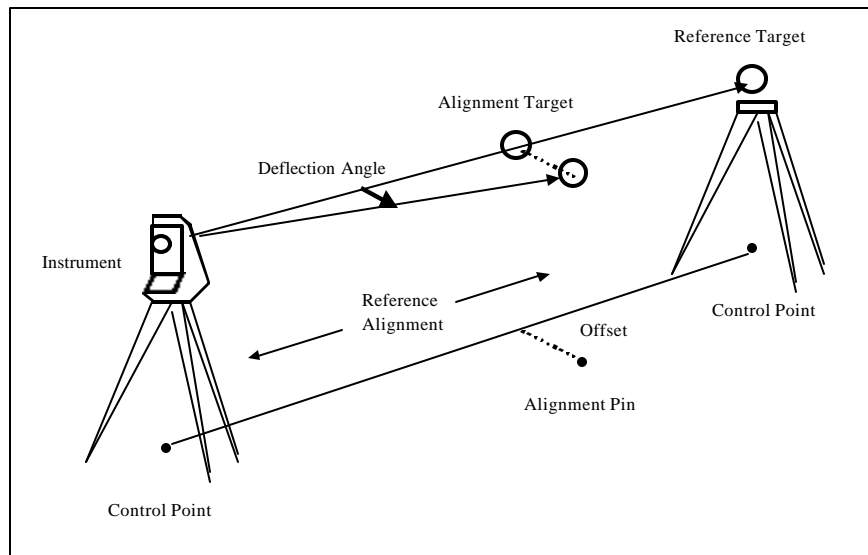

Figure 3-7. Direct optical alignment technique. Deflection angle method used to measure baseline offsets in conventional alignment surveys

d. Aligning telescopes. Special aligning telescopes with large magnification (up to 100 \times) are available from, among others, Fennel-Cassell (Germany) and Zeiss-Jena (Germany). Aligning telescopes for the tooling industry and machinery alignment are available in North America from Cubic Precision. When the optical line of sight is replaced by a collimated laser beam, then the accuracy of pointing may be considerably improved if special self-centering laser detectors with a time integration of the laser beam energy are used. The use of laser allows for automation of the alignment procedure and for continuous data acquisition. Attention must be paid to the stability of the laser cavity when using the laser beam directly as the reference line. A directional drift of the laser beam as high as 4 inches per deg C may occur due to thermal effects on the laser cavity. This effect is decreased by a factor of the magnification when projecting the laser through a telescope.

e. Diffraction methods. In diffraction alignment methods, a pinhole source of monochromatic (laser) light, the center of a plate with diffraction slits, and the center of an optical or photoelectric sensor are the three basic points of the alignment line. If two of the three points are fixed in their position, then the third may be aligned by centering the reticule on the interference pattern created by the diffraction grating. It should be pointed out that movements of the laser and of its output do not influence the accuracy of this method of alignment because the laser serves only as a source of monochromatic light placed behind the pinhole and not as the reference line. Therefore, any kind of laser may be employed in this method, even the simplest and least expensive ones, as long as the output power requirements are

satisfied. Various patterns of diffraction slits are used in practice. The highest accuracy and the longest range are obtained with the so-called Fresnel zone plates that act as focusing lenses. For instance, rectangular Fresnel zone plates with an electro-optical centering device were used in alignment and deformation measurements of a 3 km long nuclear accelerator giving relative accuracy (in a vacuum) of 10^{-7} of the distance. In the open atmosphere, the thermal turbulence of air seems to have a smaller effect when using the Fresnel zone plates than in the case of direct optical alignment. The laser diffraction alignment methods have successfully been applied in monitoring both straight and curved (arch) dams using self-centering targets with automatic data recording.

f. Micrometer translation stages. Developments in the manufacture of translation stages for scientific and laboratory use (such as for laser and optical alignment work), as well as other specialized products used in the field of industrial metrology include a broad array of alignment measurement tools (such as scales, precise micrometers, and right angle prisms). Modern linear translation stages can reliably provide extremely high resolution (1/1000 inch at one-sigma) with very stable material and mechanical properties. Translation stages with large travel ranges are available to adapt these off-the-shelf devices to monitoring applications, especially alignment surveys.

3-8. Extension and Strain Measurements

a. Types of extensometers. Various types of instruments, mainly mechanical and electro-mechanical, are used to measure changes in distance in order to determine compaction or upheaval of soil, convergence of walls in engineering structures and underground excavations, strain in rocks and in man-made materials, separation between rock layers around driven tunnels, slope stability, and movements of structures with respect to the foundation rocks. Depending on its particular application, the same instrument may be named an extensometer, strainmeter, convergencemeter, or fissuremeter. The various instruments differ from each other by the method of linking together the points between which the change in the distance is to be determined and the kind of sensor employed to measure the change. The links in most instruments are mechanical, such as wires, rods, or tubes. The sensors usually are mechanical, such as calipers or dial gauges. In order to adapt them to automatic and continuous data recording, electric transducers can be employed using, for instance, linear potentiometers, differential transformers, and self-inductance resonant circuits. In general, when choosing the kind of transducer for automatic data acquisition, one should consult with an electronics specialist on which kind would best suit the purpose of the measurements in the given environmental conditions. One should point out that the precision EDM instruments, as described earlier with their accuracy of 0.3 mm over short distances, may also be used as extensometers particularly when the distances involved are several tens of meters long. If an extensometer is installed in the material with a homogeneous strain field, then the measured change (dl) of the distance (l) gives directly the strain component (e):

$$e = dl/l \tag{Eq 3-4}$$

in the direction of the measurements. To determine the total strain tensor in a plane (two normal strains and one shearing), a minimum of three extensometers must be installed in three different directions.



Various slide and vernier calipers

Inside & outside micrometers



Figure 3-8. Assortment of Starrett micrometers and calipers that can be used for measuring short distances in concrete structures to an accuracy of 0.0005 inch or better

b. Wire and tape extensometers. Maintaining a constant tension throughout the use of the wire or tape extensometer is very important. In some portable extensometers, the constant tensioning weight has been replaced by precision tensioning springs. One should be careful because there are several models of spring tensioned extensometers on the market which do not provide any means of tension calibration. As the spring ages, these instruments may indicate false expansion results unless they are carefully calibrated on a baseline of constant length before and after each measuring campaign.

(1) Invar wire strain gauge. Among the most precise wire extensometers are the Kern Distometer (discontinued production) and the CERN Distinvar (Switzerland). Both instruments use invar wires and special constant tensioning devices which, if properly calibrated and used, can give accuracies of 0.05 mm or better in measurements of changes of distances over lengths from about 1 m to about 20 meters. Invar is a capricious alloy and must be handled very carefully to avoid sudden changes in the length of the wire. When only small changes in temperature are expected or a smaller precision (0.1 mm to 1 mm) is required, then steel wires or steel tapes are more comfortable to use.

(2) Vibrating wire strain gauge. Special high precision strainmeters of a short length (up to a few decimeters) are available for strain measurements in structural material and in homogeneous rocks. An example is a vibrating wire strain gauge available from Rocktest (Irad Gage). The instrument employs a 150 mm steel wire in which the changeable resonant frequency is measured. An accuracy of one microstrain (10^{-6}) is claimed in the strain measurements which corresponds to 0.15 μm relative displacements of points over a distance of 150 mm.

c. Rod, tube, and torpedo extensometers. Steel, invar, aluminum, or fiberglass rods of various lengths, together with sensors of their movements, may be used depending on the application. Multiple point measurements in boreholes or in trenches may be made using either a parallel arrangement of rods anchored at different distances from the sensing head, or a string (in series) arrangement with intermediate sensors of the relative movements of the rods. A typical accuracy of 0.1 mm to 0.5 mm may be achieved up to a total length of 200 m (usually in segments of 3 m to 6 m). The actual accuracy depends on the temperature corrections and on the quality of the installation of the extensometer. When installing rods in plastic conduit (usually when installing in boreholes), the friction between the rod and the conduit may significantly distort the extensometer indications if the length of the extensometer exceeds a few tens of meters. The dial indicator readout may be replaced by potentiometric or other transducers with digital readout systems. Telescopic tubes may replace rods in some simple applications, for instance, in measurements of convergence between the roof and floor of openings in underground mining. Several models of torpedo borehole extensometers and sliding micrometers are available from different companies producing geotechnical instrumentation. For example, Extensofor (Telemac, France) consists of a 28 mm diameter torpedo 1.55 m long with an inductance sensor at each end. Reference rings on the casing are spaced within the length of the torpedo. The sensors and reference rings form the inductance oscillating circuits. The torpedo is lowered in the borehole and stopped between the successive rings recording changes in distances between the pairs of rings with a claimed accuracy of 0.1 millimeter. Boreholes up to several hundreds of meters long can be scanned.

d. Interferometric measurements of linear displacements. Various kinds of interferometers using lasers as a source of monochromatic radiation are becoming common tools in precision displacement measurements. A linear resolution of 0.01 μm , or even better, is achievable. One has to remember, however, that interferometric distance measurements are affected by atmospheric refractivity in the same way as all EDM systems. Therefore, even if temperature and barometric pressure corrections are applied, the practical accuracy limit is about 10^{-6}S (equivalent to 1 μm per meter). Thermal turbulence of air limits the range of interferometric measurements in the open atmosphere to about 60 meters. The laser interferometer has found many industrial and laboratory applications in the measurement of small displacements and the calibration of surveying instruments.

e. Use of optical fiber sensors. A new development in the measurements of extensions and changes in crack-width employs a fully automatic extensometer that utilizes the principle of electro-optical distance measurements within fiber optic conduits. The change in length of the fiber optic sensors are sensed electro-optically and are computer controlled.

f. Precise concrete crack measurements. Distances between cracks in concrete structures are typically measured using precision micrometers or calipers, such as those as shown in Figure 3-8. Details on micrometer crack observing procedures are covered in Chapter 7.

3-9. Tilt and Inclination Measurements

a. Methods of tilt measurement. The measurement of tilt is usually understood as the determination of a deviation from the horizontal plane, while inclination is interpreted as a deviation from the vertical. The same instrument that measures tilt at a point can be called either a tiltmeter or an inclinometer depending on the interpretation of the results. Geodetic leveling techniques can achieve an accuracy of 0.1 mm over a distance of 20 m, which would be equivalent to about 1.0 inch of angular tilt. This accuracy is more than sufficient in most engineering deformation measurements. Various in-situ instruments are used when higher accuracy or continuous or very frequent collection of data on the tilt changes is necessary:

- Engineering Tiltmeters and Inclinometers
- Suspended and Inverted Plumb Lines
- Hydrostatic Levels

Other specialized instruments such as mercury/laser levels have been developed but are not commonly used in practice.

b. Tiltmeters and inclinometers. There are many reasonably priced models of various liquid, electrolytic, vibrating wire, and pendulum type tiltmeters that satisfy most of the needs of engineering surveys. Particularly popular are servo-accelerometer tiltmeters with a small horizontal pendulum. They offer ruggedness, durability, and low temperature operation. The output signal (volts) is proportional to the sine of the angle of tilt. The typical output voltage range for tiltmeters is ± 5 V, which corresponds to the maximum range of the tilt. Angular resolution depends on the tilt range of the selected model of tiltmeter and the resolution of the voltmeter (e.g., 1 mV). There are many factors affecting the accuracy of tilt sensing. A temperature change produces dimensional changes of the mechanical components, changes in the viscosity of the liquid in the electrolytic tiltmeters, and of the damping oil in the pendulum tiltmeters. Drifts of tilt indications and fluctuations of the readout may also occur. Thorough testing and calibration are required even when accuracy requirements are not very high. Tiltmeters have a wide range of applications. A series of tiltmeters if arranged along a terrain profile may replace geodetic leveling in the determination of ground subsidence. Similarly, deformation profiles of tall structures may be determined by placing a series of tiltmeters at different levels of the structure. A popular application of tiltmeters in geomechanical engineering is in slope stability studies and in monitoring embankment dams using the torpedo (scanning) type borehole inclinometers (usually the servo-accelerometer type tiltmeters). The biaxial inclinometers are used to scan boreholes drilled to the depth of an expected stable strata in the slope. By lowering the inclinometer on a cable with marked intervals and taking readings of the inclinometer at those intervals, a full profile of the borehole and its changes may be determined through repeated surveys. Usually the servo-accelerometer inclinometers are used with various ranges of inclination measurements, for instance, ± 6 deg, ± 54 deg, or even ± 90 deg. If a 40 m deep borehole is measured every 50 cm with an inclinometer of only 100 inch accuracy, then the linear lateral displacement of the collar of the borehole could be determined with an accuracy of 2 millimeters. Fully automatic (computerized) borehole scanning inclinometer systems with a telemetric data acquisition have been designed for monitoring slope stability.

c. Suspended and inverted plumb lines. Two kinds of mechanical plumbing are used in controlling the stability of vertical structures:

- (1) Suspended Plumb Lines,
- (2) Floating or Inverted Plumb Lines.

Inverted plumb lines have an advantage over suspended plumb lines in the possibility of monitoring absolute displacements of structures with respect to deeply anchored points in the foundation rocks that may be considered as stable. In the case of power dams, the depth of the anchors must be 50 m or even more below the foundation in order to obtain absolute displacements of the surface points. If invar wire is used for the inverted plumb line, vertical movements of the investigated structure with respect to the bedrock can also be determined. Caution must be used in installing plumb lines. If the plumb line is installed outside the dam, a vertical pipe of a proper inner diameter should be used to protect the wire from the wind. The main concern with floating plumb lines is to ensure verticality of the boreholes so that the wire of the plumb line has freedom of motion. The tank containing the float is generally filled with oil or with water to which some anti-freeze can be added. The volume of the float should be such as to exert sufficient tension on the wire. Thermal convection displacements in a float tank may easily develop from thermal gradients that may affect measurements--requiring the whole tank to be thermally

insulated. Several types of recording devices that measure displacements of structural points with respect to the vertical plumb lines are produced by different companies. The simplest are mechanical or electromechanical micrometers. With these, the plumb wire can be positioned with respect to reference lines of a recording (coordinating) table to an accuracy of ± 0.1 mm or better. Traveling microscopes may give the same accuracy. Automatic sensing and recording is possible, for instance, with a Telecoordinator (Huggenberger, Switzerland) and with a Telependulum (Telemac, France). Automated vision systems use CCD video cameras to image the plumb line with a resolution of about 3 micrometer over a range of 75 mm. Two sources of error that may sometimes be underestimated by users are the influence of air currents and the spiral shape of wires. The plumb line should be protected within a pipe (e.g., PVC tube) with openings only at the reading tables to reduce the influence of the air pressure.

d. Optical plummets. High precision optical plummets (e.g., Leica ZL (zenith) and NL (nadir) plummets) offer accuracy of up to 1/200,000 for precise centering, and both can be equipped with laser. Atmospheric refraction remains as a major source of error for optical instruments.

e. Hydrostatic leveling. If two connected containers are partially filled with a liquid, then the heights h_1 and h_2 of the liquid in the containers are related through the hydrostatic equation

$$h_1 + P_1 / (g_1 r_1) = h_2 + P_2 / (g_2 r_2) = \text{constant} \quad (\text{Eq 3-5})$$

where P is the barometric pressure, g is gravity, and r is the density of the liquid which is a function of temperature. The above relationship has been employed in hydrostatic leveling. The ELWAAG 001 (Bayernwerke, Germany) is a fully automatic instrument with a traveling (by means of an electric stepping motor) sensor pin that closes the electric circuit upon touching the surface of the liquid. Hydrostatic leveling is frequently used in the form of a network of permanently installed instruments filled with a liquid and connected by hose-pipes to monitor change in height differences of large structures. The height differences of the liquid levels are automatically recorded. The accuracy ranges from 0.1 mm to 0.01 mm over a few tens of meters depending on the types of instruments. The main factor limiting the survey accuracy is the temperature effect. To reduce this effect the instrument must either be installed in a place with small temperature variations, or the temperature along the pipes must be measured and corrections applied, or a double liquid (e.g., water and mercury) is employed to derive the correction for this effect. Water of a constant temperature is pumped into the system just before taking the readings for the highest accuracy applications. The instruments with direct measurement of the liquid levels are limited in the vertical range by the height of the containers. This problem may be overcome if liquid pressures are measured instead of the changes in elevation of the water levels, where pneumatic pressure cells or pressure transducer cells may be used.

3-10. Non-Geodetic Measurements

a. General. Deformation of large structures (e.g., dams) is caused mainly by reservoir loads, temperature, self-weight of the dam, and earth pressure. A monitoring system should therefore include regular measurements of the reservoir level and temperature and pressure data.

b. Reservoir level measurement. Reservoir levels today should be measured with pressure balances. Double checking the measurements must be done and can be facilitated by installing a manometer on either an existing or new pipe connected to the reservoir. The measurement range should extend at least as far as the dam crest allowing observation and judgment of the flood risk and assessment of peak inflows.

c. Temperature measurement. Temperature measurement is required to determine the impact of temperature variations on the structure itself, as well as whether precipitation consists of rain or snow and, if applicable, whether the snow melt period has begun. Temperature measurement should be done at least daily. The thermometers should be placed at various locations within the dam, either embedded in the structure itself or within drillholes. Redundancy should be provided for by using a greater number of thermometers than otherwise would be required.

d. Precipitation measurement. Precipitation measurement should be done by using a precipitation gauge. Daily readings are recommended. The gauging station does not need to be located at the dam site, but should not be too far away so as to not be representative of the precipitation level at the structure itself. Every large structure has some form of seepage through the structure itself or its foundation, even with a grout curtain. In concrete dams, seepage typically is small and limited to permeable areas of the concrete, joints, and contact between rock and concrete. Any abnormal seepage is an immediate warning that something may be wrong with the structure or foundation. In general, seepage flows cause uplift pressure which must be monitored in view of its critical impact on the overall stability of the structure. In embankment (i.e., earthen) dams, seepage flow through the structure itself is similar to that observed in its foundation as the material from which both are made are pervious. Seepage flows not only cause uplift pressure in these structures, but also pore-water pressure. The pattern of seepage and water pressures on the structure (especially on the foundation and impervious core) has a significant impact on the behavior of the dam.

e. Seepage rate. The total seepage rate is the seepage at the face of the structure taken as a whole. Seepage rate can be measured volumetrically by using a calibrated container and a stopwatch or a gauging weir or flume. Partial seepage rates are taken in isolated zones of the structure found to be representative for the area examined. Such rates should be monitored periodically. In the course of monitoring seepage, if an abnormality (i.e., a change in normal seepage rate) is detected, the critical zone and cause of the seepage is easier to identify.

f. Chemical property analysis. If the structure is constructed of soluble or easily erodable material, the seepage should be monitored for turbidity and chemical content also. Doing so will permit the assessment of the overall stability of the embankment and foundation materials.

g. Pore-water pressure measurement. Structures usually are designed with specific pore-water pressure values that should not be exceeded. Pressure cells typically are designed or built into the structure themselves to measure pore-water pressure. The linking together of several cells forms a profile for the structure. The greater the number of measurement profiles and number of cells per profile, the more useful the data obtained will be. Even though pressure cells can be installed in structures themselves, rehabilitation of existing ones is not always practicable. Where pressure cells cannot be used to monitor pore-water pressure, the phreatic line in selected points will be monitored. Standpipe piezometers mounted in the embankment at several cross sections should be used to monitor the phreatic line.

h. Uplift pressure. Seepage underneath a structure causes uplift pressure that can severely alter the stabilizing effect of the structure's self weight. Uplift pressure can be reasonably controlled by a grout curtain and drainage holes, but uplift pressure and the physical effectiveness of these control measures should be carefully monitored. Piezometers connected to a manometer are a reliable means to measure the uplift pressure in cross-sections and several points on the upstream and downstream face of the structure.

i. Discharge measurement. If the foundation is being drained, drainage discharge should be monitored by either volumetric gauging or gauging weir. Any change in flow rate may be indicative of

clogging in the drainage system. If possible, the discharge of any spring, river, stream, or flood control structure downstream of the structure should be monitored.

3-11. Optical Tooling Technology

a. General. This section discusses modern optical metrology. A set of methods known in industry as optical tooling is used to create precise lines and planes in space from which measurements are made using light.

b. Definition of optical tooling. Optical tooling is a means for establishing and utilizing a line of sight (LOS) to obtain precise reference lines and reference planes from which accurate measurements are made with position sensitive targets [Williams, 1989]. Measurements are made by a person interpreting a scale or optical micrometer by looking through an alignment telescope, or the lines and planes are created by a laser with digital measurements. Optical tooling uses the principle that light travels in straight lines so as to enable precise measurements and level lines with every point is perpendicular to the force of gravity (e.g., plumb lines can be set to a given level datum). Right angles also can be produced quickly and precisely with auxiliary equipment components. In the assembly, maintenance, and calibration of industrial equipment, or alignment of precision systems, up to four basic alignment elements are used.

- straightness
- flatness
- squareness
- plumb

A number of techniques have been developed to make these measurements and in some cases it is no longer necessary to interpret readings or to make constant adjustments and calculations to produce accurate results. For example, in laser alignment applications, direct precision measurements are made rapidly and consistently based on existing technology.

c. Straightness. In aligning several points, a tight wire is often used as a reference line. This technique has some drawbacks and can introduce inaccuracy. Wire has weight, which causes it to sag, and over long distances this sag can become considerable. Wire vibrates, can bend or kink, and when stretched in the area to be measured, and equipment cannot be moved around for fear of disturbing the wire reference line. Even a gentle breeze can cause the wire to move a considerable amount because of the relatively large aerodynamic drag on a thin wire. In laser alignment, the Line of Sight (LOS) is established by a laser beam instead of a tight wire. The laser LOS reference has no weight, cannot sag, kink, or be disturbed, nor is it a safety hazard. It constitutes a precise reference for determining straightness to within thousandths of an inch. Straightness applications are employed for establishing an alignment survey reference line.

d. Flatness. A shop level and a straightedge are traditionally employed to determine flatness. The shop level must be moved from part to part over large horizontal areas to measure the degree of flatness of each individual surface upon which the level is placed. Flatness over a considerable area must be assured in the erection of large machinery, surface tables and large machine tools. Conventional bubble levels and "laser levels," offer a way to produce a level datum over a wide area. Laser technology has overcome the many disadvantages of bubble levels and assures levelness to within a few thousandths of an inch over hundreds of feet. This high degree of levelness is accomplished by horizontally sweeping the laser beam manually or via a motor driven rotary stage. This revolving line of laser light becomes a horizontal "plane of sight," giving a precise horizontal reference datum, sometimes called a waterline.

e. Squareness. Perfect squareness implies that one plane forms a 90 degree angle with another intersecting plane. When a steel square is used to test for this condition, measurements rely upon the trueness of the steel square, which can vary from square to square with time. Steel squares have a definite limit in their physical dimensions and consequently the testing of very large surface becomes less accurate and slower. Laser alignment methods use a transparent penta prism in conjunction with a simple alignment laser. This optical element will split the beam from the laser into two parts; one beam passes through the prism undeviated, the other beam is reflected at a 90 deg angle. Other systems use three independently mounted lasers that are orthogonal to each other.

f. Plumb. A plumbline and pendulum are used to establish a single vertical reference line. As vertical distances increase, settling time, vibration, air currents, and other disturbances will have increased effects on the measurements. In the laser alignment method there are several ways to produce a plumb reference; it can be a plane or a line. To form a plumbline, an alignment laser with auto-collimating capability is used with a pool of almost any liquid. Autocollimation senses the angle of an external mirror by reflecting its beam back into the laser head. A position sensor, beamsplitter, and lens measures the angle of the reflected beam. When the laser is adjusted such that the internal sensor reads zero in both axes, then the laser is producing a plumb line. If the laser beam is emitted from a manual or motor driver rotary base whose rotary axis is level, then the swept plane of light is a vertical plane. Position detectors in this plane will give an indication of how far to one side or other they are with respect to the plane.

3-12. Laser Tooling Methods

a. Straightness alignment. Before lasers and electronic targets came into use, alignment consisted of sighting through two points, near and far, and deciding if an object placed in-between them was to the left or right, or up or down with respect to this LOS. The choice of the two reference points is still the most important selection process of a straightness survey. For example, if a heavy machine tool is being surveyed, the two reference points that determine the LOS should be located off of the machine. If for any reason the machine were to move or to deflect, then all measurements would be in error. The two reference points should be located close enough to be convenient to use and/or out of the way of other people working in the area. Transits and alignment telescopes were the first instruments used to make these types of measurements. The use of transits and telescopes require one person to interpret a reading scale placed on the object of interest; and usually a second person is holding the scale against the object. It is a two person job that takes time and much training to accomplish. This type of alignment measurement, commonly called straightness, is the most basic of all alignment applications.

b. Alignment transfer. A another common requirement is to establish a second LOS perpendicular or parallel to an original LOS. To establish a perpendicular LOS with lasers, a special prism is used called a penta prism or optical squares as they are often called. Prisms have the property that rotation around its axis does not deviate the reflected beam at all, and therefore it does not have to be critically mounted. Tooling bars are also used to establish a parallel LOS with respect to an existing LOS, especially if the distance is relatively short, for example a meter or less. These bars are made of steel and hold electronic targets at a precise distance from a center point. Using two bars from the original LOS establishes a parallel LOS. If the distance between the two LOS is large, then transfer can be done using the penta prism twice; the first time to turn the beam 90 degrees, followed by a certain distance, and concluded by turning the beam back 90 degrees. Care must be taken that two LOS are truly parallel which is usually confirmed from a level reference datum.

c. Oriented alignment. The next alignment application involves measuring the alignment error between two different LOS datums. A typical application is to determine the lateral offset and angular error between two shafts (alignment segments). The shafts essentially define the two LOS. The measurement is made by setting up a laser source parallel to one shaft. Targets are placed on the second

shaft and surveyed in. Then the shafts are rotated 180 degrees and surveyed in again. The measured survey difference is equal to twice the shaft offset. If the target is placed at two axial locations and measured for offset, then the difference in the offsets divided by twice the axial separation is the angular error in radians.

d. Alignment plane. A more sophisticated alignment application is to quickly sweep a laser beam to generate a plane of light. The advantage of this is that many targets can be aligned using one laser source. In simple straightness applications the target location is restricted to the active area of the position sensor. In swept plane alignment the targets are sensitive in only one dimension. A typical application to establish a level plane is to put three or more targets at the same (desired) waterline location and adjust the structure to the targets until all targets read the same. The targets for a swept plane alignment can be static, meaning they require the laser beam to be constantly directed in to them. Usually the laser beam is swept by hand by rotating a knob on the laser source. If the laser plane is moving at high speed, say once a second or faster, then the targets must capture and hold the position of the laser beam as the beam sweeps by. The problem becomes harder to accomplish at longer distance because the beam is on the detector for such short periods of time. Physical high and low spots can be discovered and measured by moving the targets around the surface.

3-13. Laser Alignment Technology

a. General. The first laser alignment systems appeared in 1961 shortly after the invention of the helium-neon (HeNe) laser. The HeNe laser was the first practical way to produce continuous wave (CW) light. The high degree of coherence and Gaussian intensity profile allowed it to be easily collimated, or formed into a beam that could propagate a long distance without much spreading. Usually the 1 mm diameter of the HeNe laser was expanded to 6 to 12 mm to provide for good collimation over a useful range. The physics of propagating laser beams dictate that the larger the initial diameter of the beam, the less it will spread. Position sensitive targets that can intercept the laser beam at various places along the path of the beam will provide a straightness measurement and a simple concept for an alignment system.

b. Alignment targeting systems. The first 2D position sensitive targets initially consisted of four square photodetectors grouped together in a 2 x 2 arrangement called a quadcell [Discol, 1978]. The laser beam position on the surface of this target was computed with analog signal processing. The most basic target alignment method simply detects when the beam exactly straddles the boundary between two photodetectors. This nulling system was very repeatable and it gave the same accuracy independent of the power of the laser beam. This method does not give meaningful data when the laser beam is displaced from its nulled position. Developments in targeting technology made since the 1970's are described in the following paragraphs.

(1) Position sensor photocells. The first position sensitive targets appeared in the early 1970's. These used the difference in the outputs of two photocells, opposite each other, to measure displacement. This method was accurate to about 1/8 of a laser beam diameter. Measurement beyond this distance caused the difference (displacement) signal to decrease in value, finally reaching a terminal value when the laser beam was completely on only one photocell. In fact, with a quad-cell (or bi-cell target for 1D applications) it is never possible to measure any farther than 1/2 of a beam diameter from side to side. Another major drawback in this method is that the measurement is proportional to laser power. Variations in power received on the detector due to atmospheric attenuation, laser warm-up, power supply or temperature, would require manual adjustment of signal gain. An interim solution was to frequently check the displacement value a given target was producing with a field checking fixture. This item was nothing more than a cylinder that slipped over the front of a target containing a 1/4 inch thick glass window tipped at a small but precise angle. This fixture produced a known lateral displacement of the

laser beam at the surface of the target. If the measurement was too large or small, then a pot was adjusted to return the measurement to its correct value.

(2) Improved signal processing. The next development in target technology occurred in the mid-1970's to improve the signal processing and produce a displacement signal that was independent of laser beam power. This was done using an integrated circuit called an analog divider. Analog dividers were formerly large, rack mounted instruments that had been drastically reduced in size and cost to a single integrated circuit with the advent of microelectronics. The measurement signal was computed by dividing the difference of the two photocell outputs by their sum. Since both the difference signal and the sum signal are proportional to laser power, dividing one by the other results in a ratiometric signal that does not depend on incident laser power, and so it truly measured laser beam position on the target. Significant disadvantages remained that were a nonlinear measurement, a linear measurement range restricted to about 1/8 of a beam diameter, and sensitivity to ambient light. Ambient light could be occluded by the use of tubes placed over the ends of targets or by using interference filters which rejected any light not of the laser's wavelength. But these filters are expensive and tubes are cumbersome. The effect of ambient light or shadows cast on the surface of the detector could be rejected if the laser was amplitude modulated. However, modulating a HeNe laser is particularly difficult because of the 1000 volts required to keep the plasma tube excited. Practically, only a 10% modulation depth is achievable on a HeNe laser. This essentially cuts down on the useful signal level by a factor of 10 because the static or DC level of the laser is rejected by the processing circuitry.

(3) Measurement range linearity. The advent of lateral effect photodiode (LEP), or Walmark photodiode in the late 1970's allowed for larger and more linear measurement ranges. The LEP is a planar piece of doped silicon that produces a signal that is proportional to the intensity and the position of the "center of intensity" of the light falling on it. Unlike a quadcell, the LEP does not range saturate when the light spot has moved more than 1/2 beam diameter. The LEP produces a monotonically increasing signal as the light spot moves across its surface. The LEP does not distinguish structure, that is, it is not an imaging sensor. It will produce the same signal if a small diameter laser beam of a given power strikes it, as well as the same power spread out in a large diameter. This is usually not a problem. One advantage of the LEP is that it is very fast compared to photocells; some have an upper frequency limit of a megahertz. The typical LEP was termed a tetralateral type as it had 4 electrodes and a ground return path. These LEP types still exhibited some linearity errors at measuring ranges farther than 25% of its active diameter. Today there are duo-lateral types with shaped electrodes on the planar surface that give a very linear signal. Some targets now use CCD (charge coupled array) detectors, as for example, those typically used in video cameras. CCD targets are much more expensive and slower than LEP types. They have one big advantage; since they can sense structured light they can determine the centroid of a beam even in the presence of noise or a non-circular beam. They do this by using digital signal processing (DSP) techniques. Therefore, these type of targets are more expensive because the signal processing required is actually image processing, which is computationally time intensive. As the price of CCDs and DSPs come down and their speed goes up, more and more targets will use CCD array as their optical position sensors.

(4) Digital signal processing. Microprocessors appeared in the early 1980's and allowed greater flexibility and processing of signals. Now a system could be almost entirely digital in nature. This allowed them to be connected to networks and send their data over great distances. An LEP could be corrected for its errors by calibrating it during manufacture and storing the errors in a software look up table or by using curve fitting routines. When a measurement is made a curve fitting routine adjusts the raw data from the LEP into a very accurate displacement signal. One huge advantage with this technique is that it allows all targets to be metrologically identical independent of the particular LEP used. The lookup table can be stored in a memory chip right in the target, next to the LEP. Usually this is done with a non-volatile memory component such as an electrically erasable read-only memory. Finally, the

duolateral LEP appeared in the late 1980's that essentially provided better than 0.1% linearity across the whole detector surface.

c. Laser sources. As mentioned previously, the first sources of laser light were HeNe lasers. At the beginning they had a very short life, usually less than 1000 hours. Eventually their lifetime was increased by perfecting the glass-metal seals of the plasma tube. One bad characteristic of He-Ne is their efficiency which is less than 0.1%. Virtually all of the 5W or so of power required for a 5 milliwatt laser appears as heat. Recent developments in laser source technology are described in the following paragraphs.

(1) Pointing error. A critical design characteristic for an alignment system is the pointing error of the laser. For gas lasers such as the HeNe, the direction that the laser points at startup is not going to be the same as what it points to after 1 hour due to drift. Typical drift rates are 0.1 to 1 milliradian per hour and maximum drift can be as large as 10 milliradians. This amount of pointing error would cause a 1 inch shift at 8 feet. Plasma tube type lasers such as the HeNe are notoriously bad for pointing stability. Even after they have warmed up, a gentle breeze across its case will cause the laser beam to steer in a different direction. This type of error always causes errors in measurement unless the operator can make the measurements in less time than the drift occurs, or re-aims the laser at a known reference point frequently.

(2) Laser diodes. In the early 1990's the first visible laser diodes were introduced for use as a collimated source. They are small, low cost, require very little power, have efficiencies of 5 to 10% and vanishingly small drift rates. Optically, however, they are inferior to gas lasers. The light from a typical laser diode is emitted from a small rectangular aperture about 1 x 3 microns in size. Because of this small aperture the light diffracts, or spreads strongly with distance; it also has two different spreading angles because the aperture is rectangular. If a good quality lens is placed such that its back focal length coincides with the laser diode emitting surface, the beam produced will be elliptical in cross section and suffer from astigmatism. The astigmatism is a consequence of the aperture and results in a beam that always has two waists instead of one. Much effort is required to transform the light from a laser diode into a high quality collimated beam appropriate for use in precision alignment systems. Moreover, the LEP detector works best with a beam of circular cross section and that has one waist. Therefore, three approaches are used to improve the quality of a collimated beam from a laser diode; internal and external cylindrical optics; external prism optics; and fiber coupling.

(3) Cylindrical lens optics. A cylindrical lens is used to make the diffracted light emerging from the laser diode to have the same diverging angles in both axes. It is now possible to buy a laser diode with this lens inside the typical 9 mm diameter by 5 mm long laser diode case. Unless this lens is chosen carefully there still can be significant astigmatism in the optical system.

(4) External prism optics. External prism pairs can be used to circularize the laser beam, but it does not solve the astigmatism problem.

(5) Fiber coupling optics. The best way found to date that lets a laser diode have most of the same properties as a HeNe laser is to couple the light from a laser diode into a single mode optical fiber. This is usually done inside a small package that integrates the laser diode with a pair of aspheric lenses that efficiently couples the light into the fiber. The light emerging from the other end of the fiber is of uniform cross section, has no astigmatism, and has a well defined diffraction angle. The fiber end is then placed at the back focal length of a lens. The collimated beam produced is nearly the same as that produced by a HeNe laser. By choosing different focal length lenses the laser beam can be of any diameter desired. The drift rates of these laser sources are caused not by the laser, but by the package in which it is enclosed. If a steel case is used, maximum drift can be as low as a few arc-seconds. The light from a laser diode is polarized in one plane. The fiber coupling method does introduce a random

polarization to the beam after it has traveled through the fiber. Randomly polarized light is usually not a problem for an alignment target consisting of a lateral effect photodiode.

d. Mechanical tooling. In all laser measurement applications a question always arises as to how to mount the targets and laser sources. Usually commercial equipment vendors will supply their own proprietary mounting hardware. There is only one non-proprietary optical tooling standard for precise positioning of targets and lasers. It is called the National Aerospace Standard (NAS) and is based on all components fitting into precision 2.25 inch diameter bores. The NAS mechanical interface is used for locating and mounting of all optical tooling instruments. This universal mounting system consists of a tooling sphere and a 3 point cup mount. The tooling sphere is a truncated 3.5 inch diameter steel sphere. These sphere are 2 inches thick and have a 2.25 inch diameter bore machined precisely though the center of the sphere. The optical target, or laser source is inserted into the bore of the sphere and then the sphere is mounted onto a three point mount and clamped. The targets are designed so the optical sensors sit exactly at the center of the sphere, and if the target is tipped slightly, then the reading doesn't change.

3-14. Laser Alignment Techniques

a. General. Different techniques for conducting laser alignment surveys are presented in this section. These are related to methods for conducting surveys using single target alignments, two target alignments, and laser scanning systems.

b. Single target laser alignment. The main disadvantage of early laser alignment systems is that they only employed a single target. The target placed at a reference station establishes one end of the LOS and the center of the laser beam is the other end of the LOS. For single target surveys, the laser source is first carefully aimed at the center of the target, then the operator moves the target from its reference position to use it at intermediate locations. There are two problems with single target laser alignment:

- (1) the operator is unaware of any movement of the laser beam; and
- (2) alignment errors are introduced unless the reference laser position is frequently checked.

The only way to check for beam movement is to stop alignment operations, remove the target from its working location and move it to the reference station position. The position of the laser beam on the target at the reference station is then checked, and the laser beam re-aimed if necessary. This method is only useful for detecting slow variations in laser beam position at the reference station, for example, caused by thermal disturbances in the structure being aligned, or in long-term (e.g., geologic) instabilities at the laser source location. High frequency disturbances such as vibration can not be corrected at all.

c. Two target laser alignment. If two targets are used, then the measurement becomes more accurate because of the addition of a reference target situated at the far end of the LOS that constantly monitors beam position. The intermediate target used by the operator must allow for passage of light through to reach the reference target. The intermediate target is called the alignment or transparent target. In this approach, two different pointing compensation methods are used with transparent targets, namely, passive and active systems.

(1) Passive pointing compensation. If the two dimensional coordinates of the laser beam on the reference and alignment target are measured simultaneously, then the position of the alignment target with respect to a line between the laser and the reference target can be measured independent of any pointing error of the laser. The laser beam need not even be precisely aimed onto the center of the reference target. Instead, the coordinates of the laser beam at both targets are used to compensate for any laser beam movement. When the position of the laser beam is sampled rapidly, the system compensates

for thermal pointing errors, initial alignment errors, and vibration errors. In Figure 3-9 the line between the center of the reference target and the center of the laser beam source defines the LOS, not the laser beam. The laser beam is shown directed upward representing a laser pointing error. The transparent alignment target is shown centered with respect to the LOS. The pointing or wedge error as measured at the reference target is (h), because of similar triangles the pointing error is h' or (d/D) · (h) at the alignment target. Subtracting this error from the measured beam position at the alignment target results in a compensated (C_{XY}) alignment measurement, or true position of the target in both the x and y axes:

$$C_{XY} = h'_{XY} - (d/D)(h_{XY}) \quad (\text{Eq 3-6})$$

The LOS is defined by two points: one point being the center of the laser case and the other being the center of the reference target. The constants d and D are measured in the field or have been previously entered into the computer. Absolute target distances are not required, only the ratiometric distance, d/D. In some applications absolute distances are known and entered into the computer interface. In other applications ratiometric distances are more convenient to use. This technique is particularly useful at long laser-to-target distances, as angular errors at the laser create large position errors at the targets. Another advantage of passive pointing compensation is that the operator does not have to precisely aim the laser to dead center on the target. This allows operators to quickly set up the system. Because of how this technique uses geometric principles, it is called similar triangle compensation or passive pointing compensation.

(2) Active pointing compensation. Perhaps the most recent method to compensate for errors in steering the laser beam, due to thermal, mechanical or atmospheric effects, is to actively steer the laser. This technique uses all of the same components as passive pointing compensation, except the laser is now fitted with internal or external pitch and yaw pointing actuators. The reference target sends its error signals back to the laser where beam steering occurs to null out the error. The system acts as an optical servo mechanism. One advantage of this method over that of the similar triangle method is that absolute or ratiometric distances are not needed. Since the laser is always on the reference target center, no mathematical compensation needs to be applied. Any transparent target placed in the beam at any distance from the laser simply determines beam position. In this method the laser beam is the LOS.

(3) Scanning systems. Scanning systems can be a simple single-axis laser system that is manually rotated, or have 3 axes with each axis motor driven. The simplest laser sources for these types of system are small boxes with leveling feet and bubble vials. The user must set up the source to a level condition before it can be used. For three axis systems, once a level has been established, the other two axes will sweep out vertical planes of light that are perpendicular to each other. The most sophisticated scanning sources sweep out the beam automatically via a motor and they also contain internal level sensors. Some even control the degree of "levelness" by servo correcting the source if it moves off of level. A simpler method uses a pendulum on which a lightweight laser diode source is attached. The targets for these type of sources are always one dimensional. For a manually rotated source the electronics are similar to 2D targets; the user must aim the beam by hand into the target's window. For dynamic scanning the targets use very fast detectors as the beam sweeps by in only a few microseconds for a target located at some distance and a scan rate of 60 RPMs or higher. Sometimes LEPs are used as the sensor. For very high speed systems a bi-cell sensor is used. The sensor is rectangular and oriented in its long direction. A typical size would be 30 mm tall by 5 mm wide. But this sensor is split along its diagonal into two triangular shaped photodetectors. The two triangular shaped parts of the bi-cell are each connected to a timing circuit. When the time the laser beam spends on each segment is equal, the beam is exactly in the middle of the bi-cell. Deviations up or down produce a difference in timing that is exactly proportional to distance. The main advantage of scanning systems is that many targets can be placed in the scan zone.

It has a 360 degree scanning window and is designed mainly for leveling applications with accuracy the same as simple laser alignment.

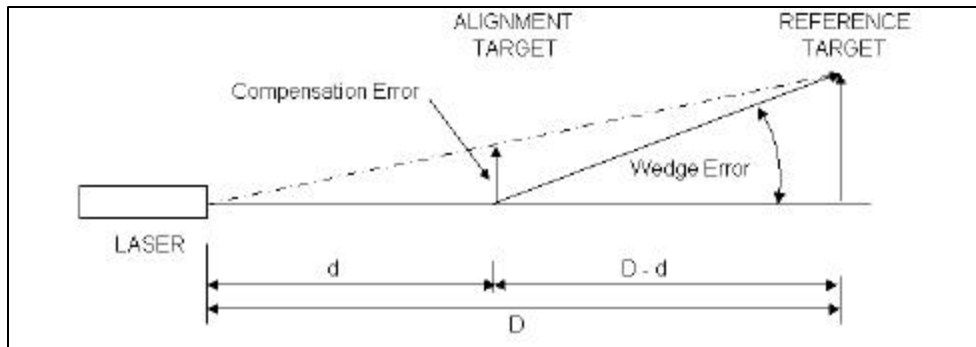

Figure 3-9. Geometry of a two target laser alignment.

3-15. Laser Alignment Error Sources

a. *General.* Any laser alignment system has associated measurement errors. Even if active and passive pointing compensation is not employed, any transparent target must not produce steering or deviation of the laser beam as it passes through it. The system's accuracy depends on the laser beam traveling in a straight line from the laser, through (possibly several) transparent target(s) and finally to the reference target. The transparent target will usually have: some sort of a beam splitter; and have windows on each end of it. Each window and the beam splitter possess a small amount of wedge error that acts to mis-steer the beam. Although the wedge error of these components is usually small (tens of arc-seconds), at long distances the displacement error can become large. There are two types of errors which can be injected into the error compensation equation; that due to steering of the laser beam by the transparent target (wedge angle error), and that due to the target being slightly tipped (deviation error).

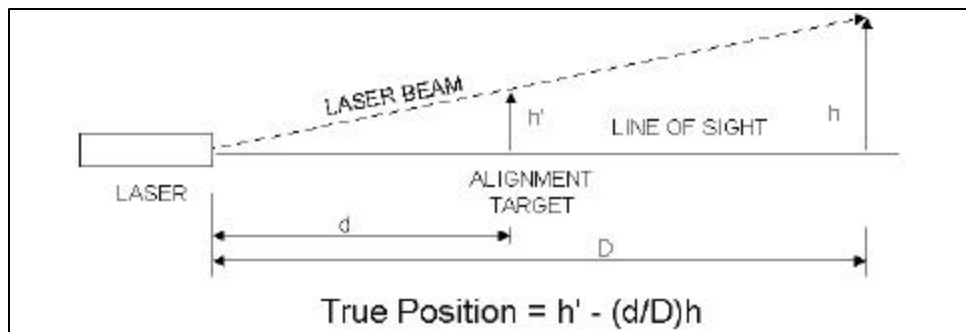

Figure 3-10. Two target alignment showing wedge error.

b. *Wedge angle error.* Rotation adjustment of the wedge prisms on the transparent target allows for the refractive error to be adjusted to less than one arc-second. Figure 3-10 shows a two target system with the laser beam initially centered on the alignment target. The alignment target is shown with a wedge error of δ and it steers the incident laser beam away from the LOS. The laser beam strikes the surface of the reference target at a distance of $(D-d)\delta$ from its center. The compensation equation then produces an error, ϵ , of magnitude:

$$\epsilon = (d/D) \delta (D-d) \tag{Eq 3-7}$$

due to the wedge error δ of the transparent alignment target. Inspection shows this error is zero when the alignment target is situated at a distance of 0 or D from the laser source. If the alignment target was situated next to the reference target ($d = D$), then it would impart no significant steering error at the reference target. If it were located next to the laser ($d = 0$), then the wedge error as seen at the alignment target is also zero. The error is greatest when the alignment target is located halfway between the laser source and the reference target. Table 3-1 below shows how transparent target wedge error affects system alignment accuracy as a function of laser-to-reference target distance (D). The table assumes the alignment target is situated at D/2, or at one-half of the laser-to-reference target distance.

Table 3-1. Compensation Error Due to Residual Target Wedge Angle

Wedge(δ)	50-ft	100-ft	300-ft
10 arcsec	0.0075 in.	0.015 in.	0.045 in.
1 arcsec	0.00075 in.	0.0015 in.	0.0045 in.
.5 arcsec	0.00037 in.	0.00075 in.	0.0022 in.

c. Target deviation. Another error source is due to tipping of the target, causing a deviation of the laser beam as it passes through the windows and/or beam splitter. Deviation errors do not grow with distance as do pointing errors. Table 3-2 below indicates the magnitude of deviation error due to target tipping in yaw or pitch for a total glass thickness of 8 mm. This thickness represents the thickness of the windows and beamsplitter in a transparent target.

Table 3-2. Deviation Error Due to Target Tipping

Tipping Angle	Error
1 degree	0.0018 in.
3 degrees	0.0054 in.

d. Target accuracy. Most modern position sensitive targets used in alignment contain dedicated microprocessors. They can communicate their data over a bus or through the air with optical data links. The electronics of each target usually consist of a microprocessor; non-volatile, electrically erasable programmable memory (EEPROM); analog-to-digital converters; filters and serial communication drivers. Targets come in a variety of different sensing areas and virtually all use lateral photodiode detectors to sense laser beam position. Quad-cells are almost never used due to their small sensing range. Since each lateral photodiode detector has slightly different linearity, manufacturers now calibrate each target on a precision motion platform. Stored within each target are corrections for its detector. The result is that all targets are metrologically identical. A good rule of thumb for target accuracy is 1 part in 500 of a target's sensor diameter. For example, a target with a LEP sensor diameter of 1 inch would have a position accuracy of ± 0.002 inches.

3-16. Laser Beam Propagation

a. General. A propagating laser beam does not remain parallel as is frequently assumed. Even with "perfect" projection optics the laser beam obeys the laws of physics; the dominant law here is diffraction. All laser beams follow a prescribed propagation characteristic that depends on two conditions:

- (1) how the beam was launched, and
- (2) what type of disturbances it encounters along its path.

The first is greatly controllable; the second is usually not.

b. Laser beam launch conditions. The only two parameters which govern how a laser beam behaves after it is launched are: initial diameter and wavelength [Yoder, 1986]. For a given wavelength, the larger the initial diameter the less the beam will spread with distance. For a given distance, a laser beam with a long wavelength will grow in diameter faster than a laser beam of a shorter wavelength. These propagation characteristics are embedded in the exact equation below which is a result of electromagnetic theory.

$$\omega_z = \omega_0 \cdot \text{sqrt} [1 + (\lambda z / \pi \omega_0^2)^2] \quad (\text{Eq 3-8})$$

where ω_0 is the initial laser beam radius; ω_z is the laser beam radius at a distance z from the source, and λ is the wavelength of light. At long distances the equation simplifies to:

$$\omega_z = (\lambda z / \pi \omega_0) \quad (\text{Eq 3-9})$$

It can be seen how two quantities govern beam spread; wavelength and initial diameter. A laser whose beam is approximately parallel over a reasonable distance is called a collimated beam. Approximately is an appropriate term, because any propagating laser beam has associated with it a waist, or the place along the beam path where it has the smallest diameter. Sometimes this waist is located some distance from the laser source. At other times the beam waist is at the laser source. The beam waist is chosen to be located at a certain point, and to possess a particular diameter, depending on desired beam propagation characteristics. There is a distance over which the laser beam remains essentially parallel which is called its depth of field. The depth of field of a propagating laser beam is defined as the distance over which the laser beam does not grow by more than $\text{sqrt}(2)$ of its initial diameter or its waist diameter. Table 3-3 below illustrates the relationship between initial beam diameter and depth of field. The beam waist is located exactly in the middle of the depth of field. The diameter of the beam waist is $1/\text{sqrt}(2)$ or 0.707 of the initial beam diameter. The chart assumes a wavelength (λ) of 635 nanometers, which is the wavelength of the visible diode lasers used in laser tooling. The z -range over which this condition holds for an initial beam diameter of d_i is:

$$Z_R = (\pi d_i^2) / (4\lambda) \quad (\text{Eq 3-10})$$

Table 3-3. Depth of Field for Different Laser Beam Diameters

Initial Diameter	Depth of Field (m)	Depth of Field (feet)
1 mm	1.2	4
4 mm	20	64
10 mm	123	403
20 mm	492	1614
25 mm	769	2522

c. Atmospheric conditions. A beam of light propagating in a vacuum obeys the laws of diffraction and is not affected by any other source. The index of refraction for a vacuum is defined as exactly equal to one (1). However, in an atmosphere the beam will behave differently. The index of refraction of air being slightly larger (than one) causes changes in the propagation characteristics of a light beam. Two dominant effects on the beam are to make it move or quiver, and another that is commonly called "scintillation;" which means the intensity of the light beam varies as a function of time.

(1) Refraction. Much work has been conducted on the effects of atmospheric turbulence on propagating light. The index of refraction of air being different along the path length causes these two effects. The index of refraction of air is strongly affected by temperature, and to a lesser extent pressure and water vapor pressure (humidity). An expression for the index of refraction (n) due to temperature (T), pressure (P), and humidity (H) is given by:

$$n = 1 + 10^{-6} (79/T) [P + (4800H/T)] \quad (\text{Eq 3-11})$$

where T is in degrees Kelvin ($K^\circ = C^\circ + 273$), and where P and H are in millibars. It can be appreciated that it is a weak effect by the 10^{-6} factor in front of the second term. For most applications the expression is simplified by keeping pressure at a normal 1013 millibars and ignoring humidity.

(2) Scintillation. Perhaps the best known treatise on how the atmosphere affects light and sound propagation was by Tatarskii (1959). He identified how wind velocity affects scintillation and what the power spectral density was of the scintillations. He also determined how random side-to-side motions are scaled with distance and how propagation was affected by different atmospheric conditions. Measurements were made for all regions of the atmosphere, from the ground, through the troposphere, and into the stratosphere. Most of the measurements involved the frequency of the scintillations and not the positional shift of the light beam. Precision optical displacement devices and even lasers were not available when most measurements were made in the mid-1940's and early 1950's. Perhaps the most important contribution made was the introduction of atmospheric structure constants. These parameters provided information on how turbulent the atmosphere was including correlation distance as one of these important constants.

(3) Correlation distance. This is lateral distance from a propagating beam of light under which the scintillation and turbulence would be completely different for a neighboring beam. For a quiet atmosphere where there is gentle and thorough mixing of the air layers, the correlation distance ρ is equal to [Smith, 1993]:

$$\rho = \text{sqrt}(\lambda L) \quad (\text{Eq 3-12})$$

where λ is the wavelength of the light and L is the distance from the source. The correlation distance is important because it affects the choice of beam diameter. For example, if a range of L = 123 meters is used (from Table 3-3, depth of field for a 10 mm diameter beam), then for a λ of 0.635 microns (0.635×10^{-6} m) the correlation distance is 8 mm. What this means is that since the laser beam diameter required for good collimation is approximately the same size as the correlation distance, the beam will undergo a slight amount of fading. The fading is due to one side of the beam interfering with the other side, after traveling a long distance, and so experiencing a different atmosphere. If the beam were less than the correlation distance this effect would not happen. Indeed, experience has shown in the field that on "long shots" if one holds a piece of paper up to beam at a long distance from the source, the spot on the paper will change shape quickly. It will be circular one moment and highly elliptical the next. A non-circular beam will cause errors in laser beam position measurement, because LEP targets measure the centroid of the laser beam.

d. Remedies to atmosphere effects. There are a few ways to remedy these atmospheric error effects. One is to make certain that there is no cross-beam wind component. This can be achieved with tubes physically enclosing the beam path. Another method is to blow air down the laser beam path with fans. The idea is to eliminate cross beam wind components with a down beam velocity component. If air conditioning is used in the building, it should be turned off as the extremely cold air mixing with hot air gives rise to the worst beam deflections possible. Some other remedies are to change either the range or the wavelength used. For example, decreasing the alignment range to 50 meters would decrease the correlation distance to 5.6 mm. Conversely, if a blue wavelength laser were used with a λ of 0.42 microns the correlation distance would be about 6.4 mm at 123 meters. The basic consideration in long distance shots is to have the beam diameter as small as or smaller than the correlation distance. The highest expected frequency of scintillations is:

$$f(\mathbf{v}) = \mathbf{v}/(\text{sqrt}(\lambda L)) \quad (\text{Eq 3-13})$$

where \mathbf{v} the cross-beam velocity component of the wind. It should be noted that L in this equation and the above one can not take on any value--i.e., the range L must be located in the far field of the source. Usually, this distance is on the order of 10 meters. For the same situation as above with L = 123 meters, λ of 0.635 microns, and a 1 meter/sec velocity, the maximum frequency of beam scintillation is 113 Hz. As in any data acquisition system, if one samples laser beam position at the target at least twice this frequency, then aliasing errors will not occur.

3-17. Laser Alignment Equipment

a. Commercial systems. This section describes some laser alignment equipment, from ON-TRAK Photonics, Inc. (shown in Figure 3-11), and AGL Construction Lasers and Machine Control Systems. Table 3-4 contains a partial list of manufacturers of laser alignment and scanning systems with tabulated measurement ranges, target capture areas, accuracies, and product data such as whether the vendor can design scanning, alignment, and custom systems. This list is not meant to be all inclusive.

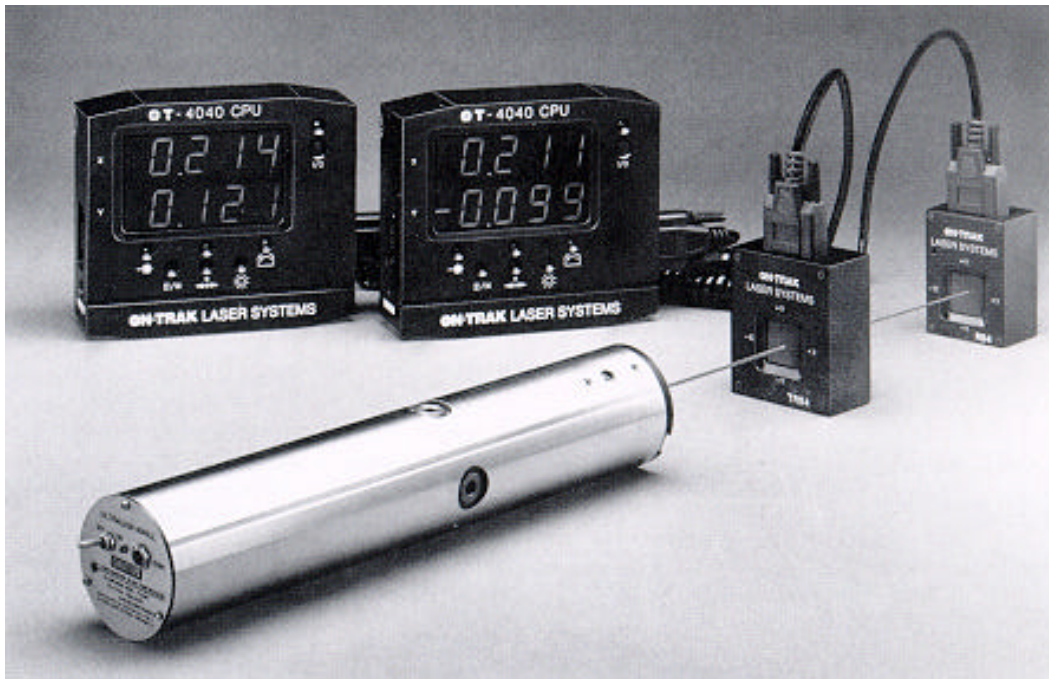

Figure 3-11. Laser alignment system from ON-TRAK Photonics, Inc.

Table 3-4. Laser system manufacturers and performance

Manufacture	Scan	Align	Custom	Range	Area in.	Accuracy in.
On-Trak	Y	Y	Y	2700 ft.	0.500	0.001
Hamar	Y	Y	Y	100 ft.	0.075	0.001
Pruf-Tecnik		Y		30 ft.	0.100	0.001
PinPoint		Y		30 ft.	0.250	0.010

b. *OT-6000 alignment laser system.* ON-TRAK Photonics, Inc. produces a commercial laser alignment system used for measuring 2D spatial deflections from a laser reference line. Components of the system are:

- OT-6010 Transparent Laser Alignment Target
- OT-6020 Reference Laser Alignment Target
- OT-6000 DIM Digital Interface Module
- OT-6000LL Alignment Laser
- OT-6000 DT Data Terminal

Components are sold separately and must be configured and installed on-site by the user. The next four sections describe each major system component by product type.

(1) Transparent Laser Alignment Target OT-6010. Raw measurement data is gathered by an alignment target sensor. The OT-6010 transparent laser alignment target consists of a 22.5 mm (0.885 DIA) diameter dual-axis sensor, with an active area set in a vertical 2D plane (X-Z position) orthogonal to the laser beam. A transparent sensor material, having >85% beam transmission, allows up to 6 targets to

be simultaneously aligned to a single laser reference. Each target piece is cased in a 3 inch square by 3.25 inch housing with a precision NAS Standard Tooling Sphere mount at its base. Power supply (standard 110V AC) and digital communications are made over the same cable using an RS-485 to RS-232 converter located in the OT-6000DIM Digital Interface Module. Windows Terminal, hyperterminal, or other standard communications software is required to operate the system. Target beam-center detection accuracy is 0.001 inch with programmable resolution set in increments of 0.0001 inch. Beam deviation through the target is <1 arc-second with a ± 0.0005 inch centering tolerance when mounted to the NAS tooling sphere.

(2) Reference Laser Alignment Target OT-6020. One non-transparent reference alignment target (OT-6020), with similar specifications to the OT-6010 targets, is used to terminate each installed series of transparent targets.

(3) Central Processing Unit (CPU) OT-4040. An interchangeable OT-4040 CPU system is required for each laser target. The CPU consists of a self-contained, battery operated laser signal processing unit that is networked to a host computer. The system uses an RS-232 serial communications port for data collection, target addressing, and self-calibration. The CPU Unit displays absolute X-Y position to the operator with a 0.001 inch resolution. Features include adjustable laser pulse averaging controls, programmable LED brightness, zero offset position adjustment, and target status by remote query accessed via the network and an RS-232 communications port.

(4) Alignment Laser OT-6000LL. A reference line for the survey alignment is established by a collimated source of laser light. The OT-6000LL alignment laser is a CDRH II class, 670 nm frequency solid state Diode laser that outputs a maximum 60 micro-Joules by 20 ms at 5 Hz, providing an operating range of 100 feet. It is enclosed in a 12-inch, hardened stainless steel casing with a Rockwell C64 hard chrome surface weighing 6.5 lbs (outside diameter is NAS standard 2.2498 inches, plus 0.000 inch and minus 0.0003 inch). The system is powered by an AC wall charger through internal NiCad batteries. Performance of the laser includes an alignment stability (drift) of less than 0.005 inches per hour, beam centering to within ± 0.001 inch relative to the mechanical center, parallelism within ± 2 arc seconds, and produces a beam diameter of 8 mm at 100 feet.

c. *AGL Total Control Laser (TCL)*. AGL Construction Lasers and Machine Control Systems produces a commercial laser alignment and digital laser theodolite package used for tunneling, mining, and alignment control. Components of the system are:

- Laser transmitter
- Alignment Base Plate
- Digital laser theodolite

Components are sold separately and must be configured and installed on-site by the user. The next three sections describe each system component by product type.

(1) Laser transmitter. The AGL is a 1.9 mw He-Ne laser with a wavelength of 632.8 Nm. The system runs on 12 volt DC battery, is water resistant, with a length of 19.5 inches and a weight of 6.25 lbs. Sighting through the target set-ups is aided by a sighting telescope mounted to the top of the laser unit. The chart below (Table 3-5) gives manufacturer supplied beam diameter properties as a function of distance.

Table 3-5. AGL laser system beam diameter and range.

Range (meters)	Beam diameter (mm)
0	9.4
213	20
427	45
609	66

(2) Alignment base plate. The system operates with an assortment of mounting devices that attach to a tripod. A mounting plate is used to attach the instrument or targets to either a leveling base or a tilting base tribrach. In operation, the alignment control system is made by positioning three base plates in a row. The TCL system is mounted to the first plate, with in-line targets positioned on the other two plates. The targets are positioned at the desired line of control and the laser is adjusted so the beam passes through the hole on the targets. If the laser alignment is disturbed, the beam will become blocked indicating loss of control. The beam is used as a guide to mount additional targets down range as work progresses. The tilting base is used to control alignment attitude and the leveling base is used for straightness alignments with respect to the gravity vector.

(3) LDT50 digital laser theodolite. The LDT50 system combines a laser diode system and theodolite for alignment and orientation monitoring applications. The laser beam range in this system is over 1300 feet with two-stage power output and switching between a focused or a parallel beam mode. The theodolite has a dual-axis compensator for reducing leveling error.

3-18. Current Laser Alignment Surveys--Libby and Chief Joseph Dams, Seattle District

The following sections are extracted from a USATEC 1999 report "Design and Evaluation of Geodetic Surveys for Deformation Monitoring at the US Army Engineer District, Seattle." This report contains technical guidance that may have Corps-wide application.

a. General. Laser alignment is a major tool in deformation monitoring surveys at both Libby and Chief Joseph dams (Seattle District). The technology currently used dates back to the late 1960's when laser was still a novelty in engineering applications. At that time, intensive research was conducted on the propagation of laser in turbulent atmosphere (Chrzanowski and Ahmed, 1971), and on development of time integrated and self-aligning laser centering targets (Chrzanowski, 1974). The equipment employed at the Libby and Chief Joseph dams is the simplest available at that time, consisting of a low power HeNe laser (with expected large thermal directional drift of its output), collimated with a 50 mm diameter collimator lens and a simple divided (Wheatstone bridge balancing) photodetector for sensing the center of energy of the laser beam. Since the detector does not perform a time integration of the scintillating laser spot, the alignment distance is limited by air turbulence to only about 250 m. The translation stage of the photodetector is also of a very old design equipped with a vernier readout whereas newer translation stages have micrometer or digital readout systems. Although the system can still give a resolution of better than 1 mm, it is cumbersome and labor intensive to use. The accuracy of the deflection measurements is designed to meet a 3 mm tolerance at the 95 percent confidence level. An upgraded laser system should have a beam-center detection precision in the range of $\pm 1-2$ mm at the 95% confidence level at its maximum operating range. At most a total uncertainty in deflection measurement should be no greater than 5 mm at the 95% confidence level.

b. Alignment equipment. The existing laser system has the following potential weaknesses:

- uses out-of-date technology;
- has a limited working range;
- requires excessive warm-up time;
- exhibits low reliability in beam centering at long range;
- lacks internal checks for station centering;
- lacks direct referencing to the alignment end-points;
- relies on manual reading and manual target alignment;
- experiences systematic drift in orientation during the survey;
- sensitive to atmospheric disturbances;
- affected by refraction errors in the measurements.

The current laser system uses a Spectra-Physics LT-3, Stabilite model 120T HeNe gas laser, (model 257 exciter), with a Model 336 Multiwavelength Collimating Lens, 450-650 nm, 50 mm CA, 200 mm EFL@ 587.6 nm. The target system is a custom fabricated light sensor (detector). The target housing consists of a 6-inch diameter cylinder with a single vertical splitter plate dividing the casing into two chambers (bi-cell). A cadmium sulfide photo resistive cell is mounted to each chamber and wired into a Wheatstone bridge circuit. In use the target sensor is known to be centered on the laser beam when the light intensity on the two photo resistive cells is equal as indicated by a null reading on a microamp meter. A translucent diffusion screen allows coarse beam centering to be performed by eye before fine measurement is attempted. The target sensor has both horizontal and vertical motion provided by a manually operated translation stage. Vertical travel range is 1.7 inches, horizontal travel is 4.0 inches. Target adjustments are made by threaded-rods (actuators) with the amount of travel referenced to horizontal and vertical vernier scales that are rigidly mounted to the target assembly.

c. Alignment surveys. Laser targets are forced centered into permanent floor or wall inserts next to each monolith joint. Offsets are recorded in the U/D stream direction between the target's zero position over the survey monuments, and the center of the laser beam. The operator translates the target onto the alignment by mechanical adjustment (actuators). Beam-position centering is made visually from meter readings and by moving the target until a null readout is obtained. The meter tends to display more erratic output as the target is moved to its maximum operating distance. Offset measurements are repeated three times on a vernier scale with 0.001-inch resolution. Reading errors are related mainly to system and operator bias, and to the operating resolution of the vernier scale. Data is recorded by hand on standard data cards that are printed on sheets of paper and then the data is transferred a PC text file.

d. Gallery environment. Each gallery has overhead lamps that are turned off during the survey. Flashlights are needed to navigate between target stations. Movement in the gallery is restricted to avoid creating air currents across the laser beam or near the targets. Disturbed atmospheric conditions may delay work for up to 10 minutes after walking near a target station. This slows down the measurements and moving equipment during the surveys. Localized air turbulence also influences beam collimation and laser accuracy/detection performance. It takes roughly 3-15 minutes to finish the readings at a single laser target station. Setup and warm-up times are approximately 30-40 minutes for each time the laser is moved to a new base segment station. Average survey completion times are on the order of 7-8 hours per gallery.

e. Laser survey procedures. Due to the length of the laser survey at the two dams (760 m at Libby Dam and 590 m at Chief Joseph Dam), the survey is broken into a number of segments. The adjacent segments are oriented relative to one another using common points observed in the overlap

region. This observation scenario is depicted in Figure 3-12. The offset measurements from the different laser segments are referred to the baseline between the two reference endpoints.

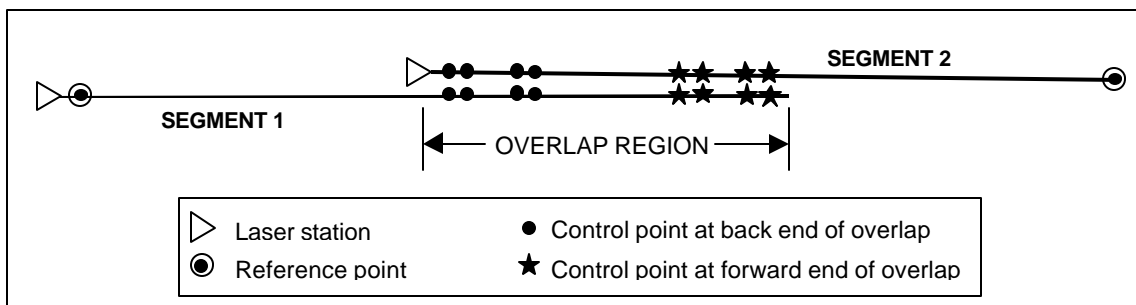

Figure 3-12. Connection of laser survey segments by observation of common points.

Deterioration of the laser beam image with distance from the transmitter has restricted the segment length to approximately 800 feet (240 m), with about 250-340 feet (75-100 m) of overlap between segments. This results in a five-segment survey at Libby Dam and a four-segment survey at Chief Joseph Dam.

f. Laser surveys and refraction. It has been observed that there is no way to quantitatively evaluate the problem of long-period distortions of the reference line due to refraction (which could be caused by horizontal temperature gradients), while the high-frequency, small-amplitude oscillations caused by atmospheric turbulence could be reduced by limiting the length of the traverse segments. High-frequency oscillations caused some difficulties for the observer in photo-electrically centering the target on the laser beam. Therefore, a survey procedure was developed which minimized the effects of atmospheric turbulence. At each survey segment, the survey would proceed from the end target (the one farthest away from the laser) to the closest target, so as to minimize the disturbance of air between the target and the laser. This procedure minimizes the effect of atmospheric turbulence on the readings, and allows the observer to collect a set of readings which have good internal precision (i.e., they are close to the same value). However, the effect of atmospheric turbulence is random, and thus will be averaged out if enough measurements are taken. The survey procedure does nothing to minimize the much more serious and difficult to detect problem of systematic refraction caused by horizontal temperature gradients. In fact, the effect of refraction is most pronounced when the measurements are collected in this way, because the air between laser and target is allowed to settle into thermal layers. The refraction problem can be reduced by disturbing or mixing the air between laser and target, which causes the refraction to be randomized. This would also affect the internal precision of the survey, but the overall accuracy would be improved. At both Chief Joseph and Libby dams, a horizontal temperature gradient could exist due to the fact that one wall of the gallery is closer to the pool while the other wall is closer to the outside air. Even if there is no gradient due to the two walls being different temperatures, it is quite possible that the walls themselves have a different temperature than the air in the gallery. For this reason, it is crucial to keep any optical lines of sight as far from the wall as possible. At Chief Joseph dam, the laser survey is run down the center of the gallery; this is the best possible place for the survey. At Libby Dam, however, the survey is performed very close to the wall (less than 30 cm).

g. Alignment calculation procedures. To determine the relative orientation of the laser segments, a procedure is used as illustrated in Figure 3-13. For each overlap region, a number of points are called 'forward' overlap points and others are called 'back' overlap points. Numerous trials are conducted to fit each possible pair of back and forward overlap points as 'control' points. In each trial, two control points are fixed to be coincident, and the average error of superposition is calculated for the rest of the overlap points. The combination of control points that yields the lowest average error of superposition is chosen to define the relative orientation of the adjacent segments. For the remaining overlap points, readings

from the forward segment (i.e., the segment where the overlap points are closer to the laser) are used in the offset calculation, and data from the back segment is discarded. When all of the segments have been processed for relative orientation, the whole line is constrained by setting the offsets of the two endpoints to zero.

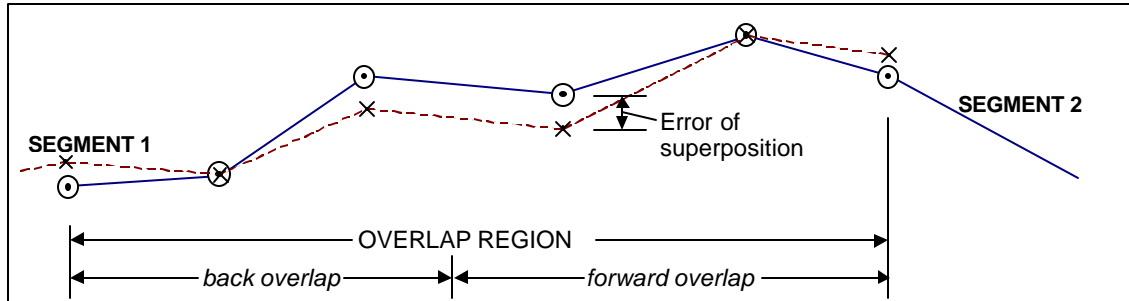

Figure 3-13. Segment orientation using two overlap points

Reducing the laser survey data by this method has several drawbacks:

- the overlap error at two points is artificially constrained to be zero, when it is known that these two points are observed with the same level of accuracy as the other overlap points.
- the method does not make optimal use of all available data. For example, data from the back segment of the overlap is discarded. Although the readings from the forward segment should be higher quality (due to the fact that the targets are closer to the laser in this segment), this is not enough to justify ignoring the only redundant observations made in the survey. A better procedure for orienting traverse segments is to use data from all of the overlap points, while incorporating the knowledge that measurements from the back segment have a higher standard deviation than those in the forward segment.
- there is no way to include any external information to yield a better estimate of the offsets. The laser alignment procedure has the same error propagation characteristics as a straight survey traverse; where the uncertainty perpendicular to the survey line increases with distance from the control points. If additional information is used to constrain the measured offsets along the traverse (e.g., from plumbline data), it would dramatically improve the precision of the results.
- statistical assessment of the offset solution is restricted to an analysis of the superposition error between individual segments. There is no calculation made of the estimated precision of the derived offset values based on the survey data.

In conclusion, it is recommended to use a more flexible and rigorous data reduction scheme, based on least squares methods, for processing the relative orientation of laser alignment segments.

h. Laser survey accuracy evaluation. From previous studies evaluating the precision of the laser system it was concluded that the probable error (i.e., at the 50% confidence level), of the derived offset is ± 0.031 inches (0.79 mm). This corresponds to a standard deviation of:

$$\sigma = \pm 0.042 \text{ inches (1.07 mm),}$$

meaning that the derived deflections would have a 95% confidence value of:

$$(1.07) (\text{sqrt } (2)) (1.96) = 2.97 \text{ mm.}$$

This accuracy evaluation is a useful for understanding the internal precision of the alignment system. However, this evaluation does not account for the effect of systematic environmental influences and therefore does not indicate a real accuracy for the system. The data was reduced using four independent sets of survey control, but, all of the observations in each epoch were collected as part of the same observation campaign, and thus could have been affected by the same amount of systematic refraction. In order to get a valid accuracy assessment, there are two choices:

(1) Either, run the alignment survey several times under different atmospheric conditions and observe the spread in offset values. In this case, all of the surveys would have to be completed over a short period of time, so that movement of the structure does not affect the results.

(2) Compare the deflections obtained from the alignment surveys with collocated deflection data obtained from a different independent source.

The first option would require entirely new field observations. The second option, however, has been investigated using deflection data from plumbline readings at Libby Dam. A summary of this comparison indicates a standard deviation of 5.3 mm for the two sets of deflection values (i.e., differencing of pairs of data at the same epoch). A 95% confidence value of:

$$(5.3 \text{ mm}) (1.96) = 10.4 \text{ mm}$$

was obtained, and is a more realistic assessment of the accuracy of deflections from the laser alignment system. This result assumes that the Libby Dam plumbines have been properly installed and carefully observed. This accuracy level can also be used to approximate accuracies for the Chief Joseph surveys, bearing in mind that it is slightly shorter than Libby Dam, and that it is run down the center of the gallery rather than close to one wall.

3-19. Suspended and Inverted Plumblines

Suspended and inverted (floating) plumblines are among the most accurate, easy to maintain, and reliable instruments used in structural monitoring. The two inverted plumblines at Libby Dam Monoliths 6 and 46 monitor the stability of the end points of the laser alignment system. Plumbline readings since 1991 indicate that both monoliths are stable within ± 0.25 mm (0.01 inch) in the U/D direction and within ± 1 mm (0.04 inch) along the axis of the dam. Monoliths 23 and 35 contain both suspended and inverted plumblines. At each monolith, the suspended plumblines extend from the upper inspection gallery to the drainage and grouting gallery. The inverted plumblines extend from the drainage and grouting gallery to an anchor 10 m deep in the bedrock. Therefore, suspended and inverted readings at the drainage and grouting gallery can be combined to give the total displacement of the upper inspection gallery with respect to the bedrock. The combined readings at these two monoliths indicate very smooth cyclic deflections of the dam (particularly at Monolith 23 as shown in Figure 3-14). Movement is well correlated with the cyclic water load changes, with a maximum total range of deflections of about 18 mm (0.7 inch).

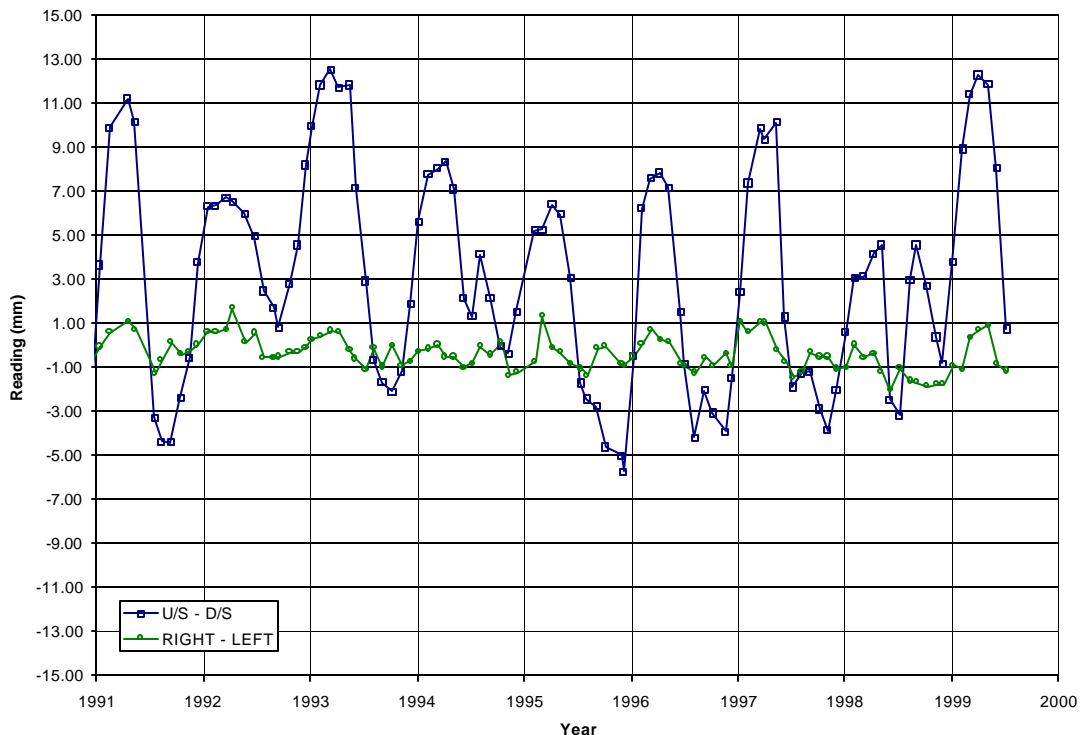

Figure 3-14. Combined readouts from suspended and inverted plumbelines at Monolith 23, Libby Dam

3-20. Comparison of Alignment and Plumbline Systems

a. *General.* The results of the laser alignment have been treated as an independent survey without any attempt to correlate or integrate the results with indications of other instruments, particularly with the reliable plumbline measurements. As such, there was no control on the stability of the end points of the alignment line and no check on possible refraction effects. For example, at Libby Dam, alignment surveys have been carried out twice yearly, in May and in November. One should note that these two epochs of observations do not coincide with the maxima and minima of the dam deflections that occur in March and in September as indicated by the plumbline results. This is working against the principal rule stated earlier for monitoring the maximum expected deformation. Figures 3-15 and 3-16 show plots of the May and November laser survey displacements for the years 1991-1999, respectively. There are large changes in the displacements of individual monoliths from one year to another, reaching a maximum of 20 mm between 1997 and 1999. One cannot explain or correlate the results with water level or temperature changes. In order to interpret those deflections, the results at station 23R have been compared with plumbline readings interpolated to the time of the alignment surveys (see Table 3-6). Discrepancies between the two types of surveys far exceed the errors of plumbline readings that are estimated at 0.3 mm. The maximum discrepancy (31 October, 1994) reaches 8.1 mm, exceeding by 10 times the actual (plumbline survey) deflection of the dam in comparison with 1991 data. Using the discrepancies (Δ) from Table 3-6 as indicating true errors of the alignment survey, the error in the laser deflection survey is equal to 10.4 mm at 95% confidence level. This means, that when employing currently used procedures and calculation methods, the alignment surveys cannot detect displacements smaller than 10.4 mm.

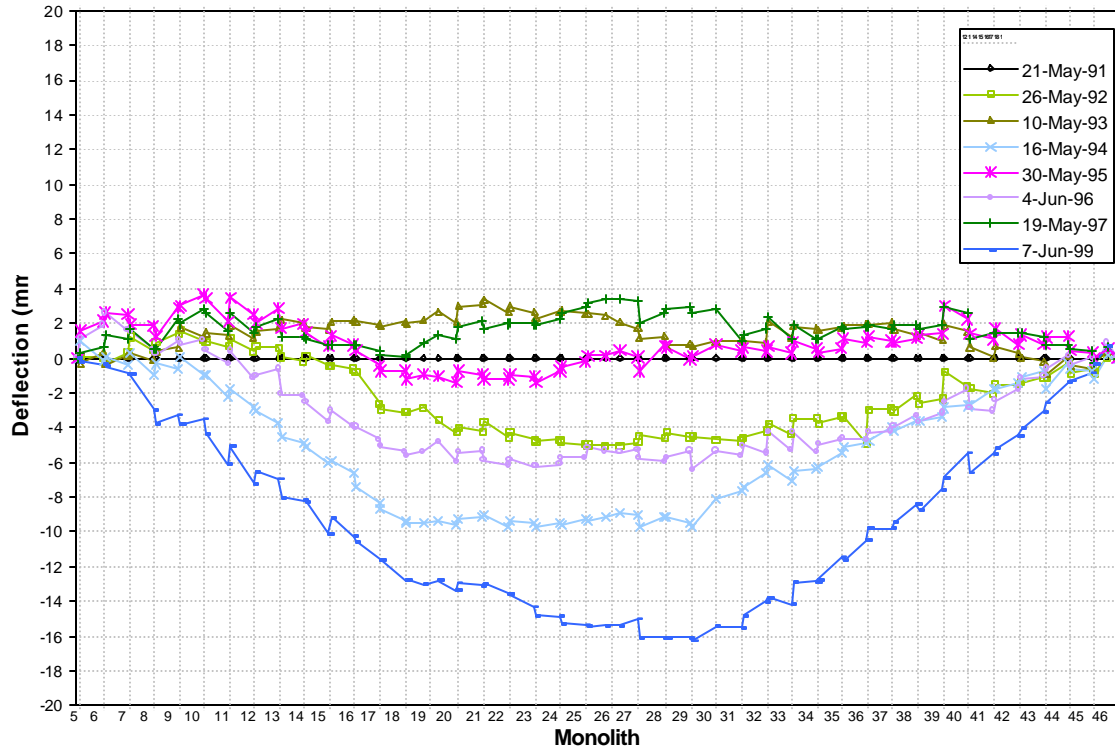

Figure 3-15. May results of Libby laser alignment (1991 base)

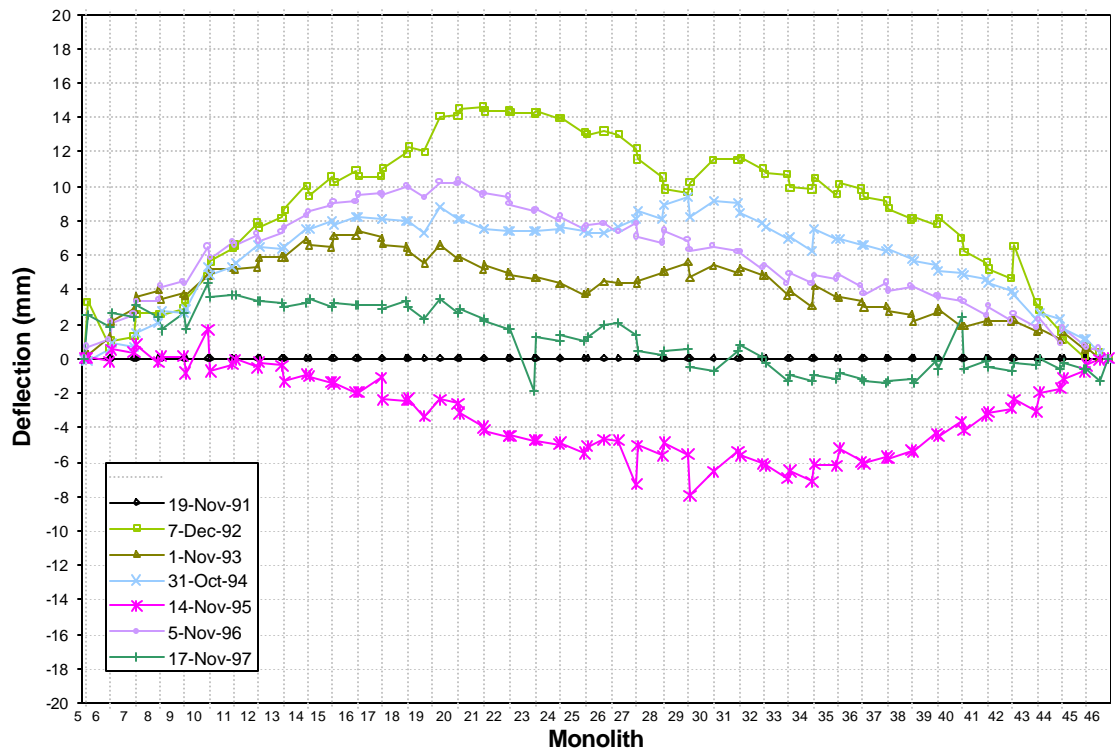

Figure 3-16. November results of laser alignment (1991 base)

Table 3-6. Comparison of laser alignment with plumbline data

Date	Plumb (mm)	Reduced (1991)	Laser (mm)	Diff Δ (mm)	Temp (°C)	ΔT/Δy (°C/m)
1991-05-21	6.9	0.0	0.0	0.0	13	
1992-05-26	5.8	-1.1	-4.6	-3.5	14	-0.05
1993-05-10	11.8	4.9	2.5	-2.4	11	-0.03
1994-05-16	5.2	-1.7	-9.4	-7.7	14	-0.11
1995-05-30	3.7	-3.2	-1.0	2.2	18	0.03
1996-06-04	3.5	-3.4	-6.1	-2.7	14	-0.04
1991-11-19	0.4	0.0	0.0	0.0	8	
1992-12-07	7.1	6.7	14.2	7.5	3	0.10
1993-11-01	-1.3	-1.7	4.6	6.3	12	0.09
1994-10-31	-0.3	-0.7	7.4	8.1	12	0.12
1995-11-14	-5.0	-5.4	-4.3	1.1	8	0.02

b. Refraction effects. The only reasonable explanation for the large error of the laser alignment surveys is the influence of atmospheric refraction. Using the values of (Δ) from Table 3-6, one can calculate the expected changes of gradients of temperature between the 1991 survey and subsequent epochs of observations. Those values are listed in the last column of Table 3-6, assuming a survey length of 760 m and atmospheric pressure of 1000 mb. The results vary between -0.11 deg C/m and +0.12 deg C/m. Considering the fact that the alignment surveys are performed within a few inches from the wall of the gallery, those values of gradient changes would be quite realistic.

3-21. Tiltmeter Observations

Tiltmeters require extremely careful and frequent calibration for temporal drift of the output, effect of temperature changes, and linearity of the conversion factor (Volts vs. angular units). Therefore, tiltmeters are among the least reliable instruments for permanent installations.

a. Drift calibrations. Accelerometer type tiltmeters should be calibrated for drift on a stable tilt-plate station, situated off of the structure, having a known or monitored reference tilt value. Drift error is modeled by solving for changes in tilt as a function of time at a reference tilt station immediately prior to and after each survey. Corrections are interpolated for each tilt measurement using observed time and drift rate from the model.

b. Temperature corrections. Before drift calibrations are computed, a thermal correction needs to be applied to account for changes in the shape of the accelerometer unit at ambient temperature. This is especially important when comparing tilt measurements made over different seasons of the year. A correction is based on a temperature coefficient (Δα) supplied by the manufacturer:

$$\Delta\alpha/\Delta T = \pm(0.03 \% \text{ reading} + 3 \text{ arc sec})/\text{deg F}$$

Actual temperature readings are made in the gallery during the tiltmeter surveys. Readings in areas exposed to sunlight should be taken in the early morning before thermal instabilities affect the shape of the structure. Final tilt angle values are converted to a length-to-distance ratio using a pre-selected baselength distance. Linear horizontal displacements are found using the elevation difference between each tilt plate and the bottom of the monolith (as a radius of rotation) assuming the monolith behaves as a rigid body. Higher resolution electrolytic tiltmeters are available that operate by a liquid bubble level

EM 1110-2-1009

1 Jun 02

sensor (50 mm vial length). These instruments are permanently fixed to the structure and have a repeatability of ± 3 arc-seconds with automated reading systems.

3-22. Mandatory Requirements

There are no mandatory requirements in this chapter.

Chapter 4 Sources of Measurement Error and Instrument Calibrations

4-1. Surveying Measurement Errors

a. Random error. Random error is broadly characterized as small, uncontrolled deviations in an observed measurement value. The expected range of uncertainty in measurements due to random error is known as precision, and is described by the standard deviation (σ) of the distribution of observations about their mean value. Measurement precision can be estimated by standard statistical analysis or predicted *a priori* from error propagation formulas. Error sources in geodetic measurements with conventional instruments (e.g., theodolites) are:

- pointing error
- centering error
- leveling error
- reading error

An expected variance can be calculated for each type of error component. These are added together to estimate the measurement standard deviation. Measurement precision is critical information for analyzing positioning accuracy through survey preanalysis and for assigning appropriate weights to measurements in a least squares network adjustment.

b. Systematic error. Systematic error is caused by deficiencies in the physical or computation model used to process the measurements. Systematic error can produce a biased value for the estimated mean (i.e., it is significantly different than the desired true value). For example, systematic errors in EDM instruments include:

- EDM/prism zero error
- EDM scale error
- EDM signal refraction error
- EDM cyclic error

Corrections to these systematic errors are determined by various instrument calibration techniques. Error is eliminated from the data during post-processing by applying the resulting correction values to the measurements. Where systematic errors cannot be adequately determined, sometimes their effects can be randomized with specialized observation procedures. For example, if the surveying measurements are repeated under different field conditions--e.g., at different times of the day, under different weather conditions, and even on different days.

c. Instrument calibrations. Measuring equipment used for deformation monitoring surveys must be maintained in adjustment and undergo periodic calibration so as to minimize systematic error. Manufacturer specifications and recommendations will be used as the basis for any internal instrument adjustments. EDM instruments must be calibrated for the instrument/prism zero correction and for scale error, as these may change with time. EDMs should be calibrated at least once a year for engineering projects of high precision, or before and after an important project. The calibration for zero error must account for all actual combinations of EDM-reflector pairings that are used on the survey since each reflector may produce a different error value (i.e., there is a different constant for each pairing).

4-2. Optical Pointing Error

a. Optical pointing. All measurements with optical theodolites are subject to pointing error due to such factors as: target design, prevailing atmospheric conditions, operator bias, and focusing. The approximate magnitude of a single-direction pointing error (i.e., standard deviation) is directly related to the magnification of the theodolite telescope.

$$\sigma_p = 45'' / M \quad (\text{Eq 4-1})$$

where

$$\begin{aligned} \sigma_p &= \text{instrument pointing error (arcseconds)} \\ M &= \text{objective lens magnification} \end{aligned}$$

For example, an objective lens with 30 times magnification would have a pointing error (σ_p) of approximately 1.5 arcseconds (one-sigma) for a single direction. Taking repeated measurements from the same setup reduces the standard deviation by a factor of $1/\sqrt{n}$, with n being the number of repetitions (see Figure 4.1). The standard deviation (due to pointing error) of a single direction measured by repetition in (n) sets can be determined from the following formula:

$$\sigma_\delta = \sigma_p / \sqrt{n} \quad (\text{Eq 4-2})$$

where

$$\begin{aligned} \sigma_\delta &= \text{single direction pointing error (arcseconds)} \\ \sigma_p &= \text{instrument pointing error} \\ n &= \text{number of repeated sets} \end{aligned}$$

This result assumes that each pointing to the backsight and foresight has the same precision.

b. Empirical determination of pointing error. Pointing error can be determined for a given instrument by making direct observations to a target point (for use with an optical theodolite with micrometer scales). First, the operator sets and levels the instrument and target according to standard techniques. Next, the operator points the theodolite crosshairs to the target and records the direction reading. Repeat the pointing procedure at least twenty times to gather a sufficient number of direction readings for calculating a mean error value from the data. Then compute the standard deviation of the resulting test data (in arcseconds). The result is an empirical pointing uncertainty for the instrument. The reading error component must be subtracted from the combined pointing and reading error.

$$\sigma_p = \sqrt{(\sigma_p + \sigma_r)^2 - (\sigma_r)^2} \quad (\text{Eq 4-3})$$

where

$$\begin{aligned} \sigma_p &= \text{instrument pointing error (arcseconds)} \\ (\sigma_p + \sigma_r) &= \text{combined pointing and reading error} \\ \sigma_r &= \text{instrument reading error (arcseconds)} \end{aligned}$$

Reading error (σ_r) is determined independently from either the standard deviation of a series of twenty readings of the theodolite scales with the instrument's motion locked, or from the instrument specifications.

c. Minimization of pointing error. Instrument pointing error degrades the precision of horizontal and vertical angle measurements to a greater degree on long baselines. It can be minimized by observing

survey targets under high magnification. Some instruments, such as the Leica T3000 Electronic precision theodolite, are equipped with interchangeable eyepieces that provide up to 59 times magnification (compared to 30-43 times when focused to infinity with a standard eyepiece). The technique of averaging repeated sets of angles is used to reduce instrument pointing error when greater lens magnification is not available.

d. Atmospheric disturbance. Air turbulence can greatly interfere with instrument pointing accuracy. This is especially true on structures exposed to direct sunlight (e.g., dams, concrete lock walls). Very little can be done to eliminate these effects except to observe under more favorable conditions, such as in the early morning hours, on overcast days, and during cooler seasons. Repeated sets of angles will again reduce instrument pointing error with poor observing conditions. The spread of repeated measurements (final standard deviation after repetitions) should be checked to see whether it exceeds the required measurement accuracy.

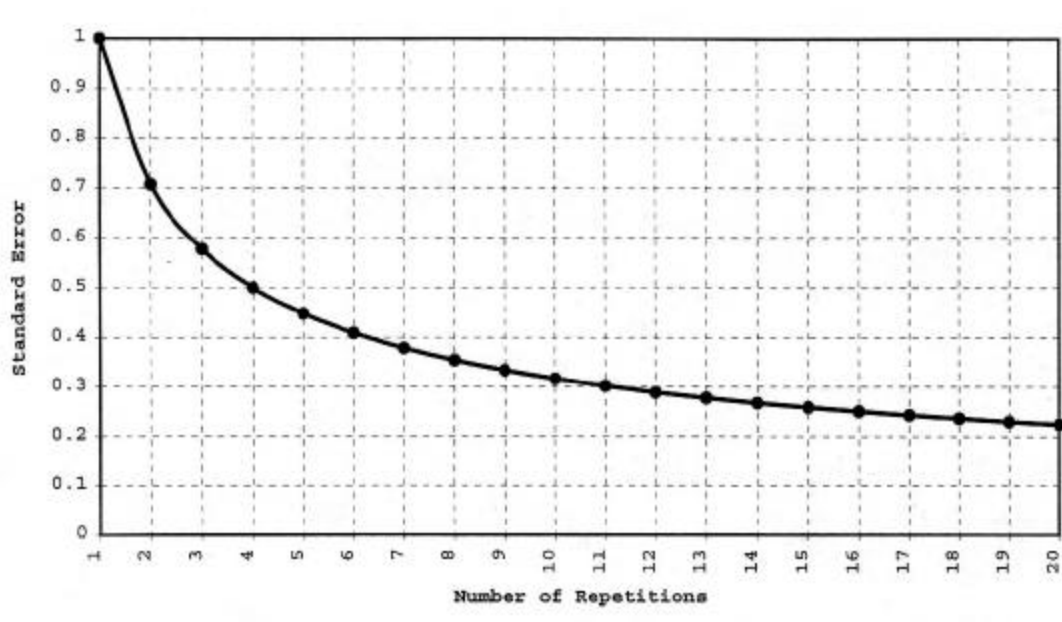

Figure 4-1. Standard error decreases as repeated number of directions increases

e. Electronic pointing. Precision EDM instruments use electronic pointing instead of optical pointing to retrieve the EDM signal. Electronic pointing is a trial-and-error targeting procedure used to find the peak reading of the EDM signal strength indicator as the instrument fine motion screws are adjusted. A stronger signal return produces more accurate distance measurements and minimizes the use of anomalous phase patterns near the return signal beam edges. This is especially critical when making measurements over short distances (i.e., less than 20 m), where the EDM 'phase inhomogeneity' effect will be most pronounced.

f. Minimization of electrical pointing error. The modulation wave front issuing from a properly designed and operating instrument is at all points equidistant from the center of the instrument. However, the wave front may be distorted in passing through the modulator, and then a portion of the wave may be ahead or behind the remainder. An instrument senses both reflectors as equidistant because the phase of the modulated wave is the same for both. If the instrument is moved in azimuth slightly, the distance that it reads would change. This type of error may be detected simply by multiple pointings at a reflector. If different pointings yield different results, it may be necessary to take several readings in the field, swinging off the target and then back until two or three sets of readings agree well. Practice in the field

may help eliminate this problem as an experienced operator tends to point and adjust an instrument in the same way for each measurement.

4-3. Instrument Leveling Error

a. General. Even when exercising great care in setting up the instrument, there is a definite limit to the ability to level the instrument due to the sensitivity of the plate level bubble. Therefore, at least some inclination of the instrument's vertical axis with respect to the plumb line is unavoidable. Theodolite inclination error is computed (for the purpose of measurement design) as:

$$\sigma_I = (0.2) \text{ (bubble sensitivity per division)}$$

or at five times less than the level bubble sensitivity of the instrument (e.g., for a thirty-second bubble one gets approximately $30''/5 = 6''$ leveling error). The effect of vertical axis inclination error (σ_I) on the measured horizontal angle, is computed as:

$$\sigma_L = (\sigma_I) / [\tan(Z)] \tag{Eq 4-4}$$

where

- σ_L = leveling error (arcseconds)
- σ_I = inclination error
- Z = measured zenith angle

Leveling errors affect the accuracy of horizontal angle measurements mainly when observing over steep vertical angles. This situation is common in monitoring embankment dams where reference monuments set on the crest of the dam are used to observe monuments set at the toe of the structure (or vice-versa). As a result the measurements between the backsight and foresight stations will be subject to 'standing axis' error causing incorrect horizontal circle readings.

b. Standing axis correction. The inclination of the instrument's vertical axis can be measured and corrected for with a special observing technique. First, with the instrument properly leveled and centered, the inclined target (above or below) is directly sighted through the scope. With the theodolite vertical circle clamp locked, the vertical angle (V_{TAR}) is read and recorded, then the horizontal clamp is loosened. Next, the instrument is turned 90 degrees to the right of the line-of-sight and the vertical circle (still locked) is again read and recorded (V_R). Next, the instrument is rotated 90 degrees to the left of the line-of-sight and the vertical circle reading (still locked) in its new position is also recorded (V_L). The maximum value of the leveling error correction for a single pointing is half the difference of the right and left vertical circle readings multiplied by the tangent of the vertical angle initially measured to the inclined target.

$$LC = [(V_R - V_L) / 2] \tan(V_{TAR}) \tag{Eq 4-5}$$

where

- LC = leveling correction (arcseconds)
- V_R = recorded vertical angle right,
- V_L = recorded vertical angle left,
- V_{TAR} = vertical angle to target.

The horizontal circle reading is corrected by this amount right or left according to its sign (i.e., with a positive inclination value, the correction is added as a right deflection).

c. Predetermined tolerance. Not every horizontal direction will need to be corrected for leveling error. The standing axis correction needs to be computed only for steep lines of sight. A vertical angle threshold value can be pre-determined from the leveling sensitivity of the instrument to decide if the correction needs to be applied on a given target sighting. This tolerance angle is found by solving the above correction equation for the V_{TAR} term with a known inclination error for the instrument. For example, with an instrument plate bubble sensitivity of 30 arcseconds (taken from manufacturer's instrument specifications), and a maximum allowable tolerance for the final correction value of one (1) arcsecond; vertical angles greater than 10 degrees from horizontal would require the correction. On embankment dams, toe monument stations observed from reference stations on the dam crest at the opposite end of the structure will typically have vertical angles less than 10 degrees.

d. Internal bi-axial compensator. Modern instruments, such as the Leica TC2002 Total Station and the T3000 Electronic precision theodolite, can correct horizontal angle readings for slight mis-levelment error by employing a bi-axial compensator. The compensator senses the degree of non-verticality of the vertical axis using two liquid sensors mounted along perpendicular horizontal axes within the instrument. Some instruments equipped with a bi-axial compensator will automatically compute and apply corrections to the horizontal circle reading.

4-4. Instrument Centering Error

a. General. Either forced centering or an optical plummet built in to the tribrach are standard means for centering during instrument/target setups. Centering errors are caused when the vertical axis of the instrument (or target/prism) is not coincident with (i.e., collimated above) the reference mark on the control point monument.

b. Short baselines. The uncertainty (standard deviation) of an angle measurement due to centering error can be approximated for the case where centering methods and distances between backsight and foresight stations are similar:

$$\sigma_b = \text{sqrt} [(\sigma_c^2) (r^2) (4/D^2)] \quad (\text{Eq 4-6})$$

where

σ_b = angle uncertainty due to centering error

σ_c = centering standard deviation

r = 206264.8

D = distance between stations (mm)

The centering standard deviation (σ_c) is computed as:

$$\sigma_c = (0.5\text{mm}) (HI)$$

for tribrach optical plummets, and,

$$\sigma_c = (0.1\text{mm}) (HI)$$

for forced centering.

In each case the height of instrument (HI) is measured in meters. For example, a measurement made over a distance of 100 m using standard tripods and tribrachs (with optical plummet), can introduce as much as 3.1 arcseconds error in the horizontal angle. Therefore, taking repeated sets of angles (re-centering

between sets) is recommended to reduce the effects of centering error. As the distance increases between the instrument and target stations, the influence of centering error is reduced. Therefore, centering errors will be especially dangerous for horizontal angle measurements that are made over very short baselines.

c. Optical plummets. Nadir and zenith plummet surveying instruments (Figure 4-2) are specially designed for precise centering and collimation. These types of instruments are available commercially for geodetic, deformation monitoring, and mining surveying applications. Their use has been recommended for deformation surveys because high centering tolerances are required to ensure survey repeatability.

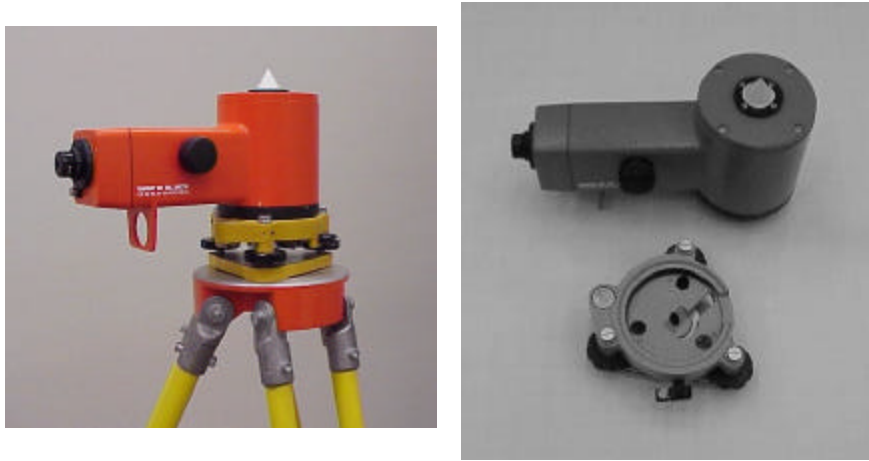

Figure 4-2. Nadir plummet instrument from Leica Co. Nadir plummets operate like an automatic level but establish a vertical line of sight. The tribrach is centered over the surveyor's mark using the nadir plummet. Then a theodolite or a GPS antenna is placed in the tribrach by forced centering



Figure 4-3. Comparison of optical plummet centering devices. The left-hand image shows the field-of-view and centering circle for a standard optical plummet fixed-mounted in a tribrach. The right hand image shows the greater magnification and centering ability provided by a nadir plummet instrument. Both images show the same brass disk at an instrument height of approximately 1.5 meters

d. Reference marks. Ground based survey control monuments should be designed with a well-defined reference mark--see Figure 4-3. This visual feature will minimize difficulty in re-establishing an instrument or target over the reference point, thus, ensuring greater repeatability in centering. Further information on monuments and targets for deformation surveys can be found in Chapter 2 and in the references listed in Appendix A.

4-5. Horizontal Angle Measurement Error

a. General. The precision (standard deviation) of horizontal angle measurements made with a theodolite can be predicted by a summation of variances as follows:

$$\sigma_{\text{angl}} = \text{sqrt} [\sigma_p^2 + \sigma_r^2 + \sigma_b^2 + \sigma_L^2] \quad (\text{Eq 4-7})$$

where

- σ_{angl} = horizontal angle error (arcseconds)
- σ_p = pointing error
- σ_r = reading error
- σ_b = centering error
- σ_L = leveling error

The above variance components can be determined from the formulas presented in Sections 4-2 thru 4-4.

b. Example horizontal angle error. Using the above formulas, for an objective lens magnification equal to 30 times, and centering with a tribrach optical plummet with a 1.5 m HI, and a level bubble sensitivity of 20"/2 mm with a zenith angle of 85 degrees, and a 100 meter slope distance to the backsight and foresight stations, the precision of the horizontal angle is estimated to be approximately 3.5 arcsec. Using this same example with two independent sets of repeated measurements, the standard deviation of the angle measurement is approximately 2.4 arcseconds (at the one-sigma level). Using an electronic theodolite equipped with biaxial compensator, leveling and reading error are negligible.

4-6. Electronic Distance Measurement Error

a. General. The precision (standard deviation) of distance measurements made with EDM instruments may be expressed in a general form as:

$$\sigma = \text{sqrt} [a^2 + b^2 \cdot S^2] \quad (\text{Eq 4-8})$$

where

- a = errors of the phase measurement, centering, and calibration errors
- b = scale error due to uncertainties in the determination of the refractive index and the calibration of the modulation frequency,
- S = measured distance.

The standard deviation for near infrared (NIR) and lightwave carrier EDM instruments can be determined by the following summation of variance components:

$$\sigma_s = \text{sqrt} [\sigma_{\text{res}}^2 + \sigma_c^2 + \sigma_{\text{cal}}^2 + \sigma_{\text{ref}}^2] \quad (\text{Eq 4-9})$$

where

- σ_s = slope distance measurement error
- σ_{res} = resolution of instrument
- σ_c = centering error
- σ_{cal} = calibration error
- σ_{ref} = refractive index correction error

(1) Resolution (σ_{res}). EDM Measurement resolution varies according to each specific type of instrument, but is generally a function of both the modulated wavelength and its sensitivity to detecting signal phase difference. The constant value used for EDM resolution (σ_{res}) is normally given in the manufacturer's equipment specifications.

(2) Refraction correction error (σ_{ref}). The accuracy of the computed refractive index correction depends on the accuracy of the temperature and pressure values input into the refraction correction formula. To compute the effect of inaccurate temperature and pressure on the corrected distance the following approximation can be used:

$$\sigma_{ref} = \text{sqrt} [[(\sigma_N^2) / N^2] \cdot (S^2)] \quad (\text{Eq 4-10})$$

where

- σ_{ref} = error in refraction correction determination
- σ_N = error in refractive index determination
- N = estimated refractive index
- S = slope distance

For a simplified estimate of the refraction correction error, an approximate formula for the above quantities can be used. The following refraction correction error equations neglect the partial water vapor pressure without creating an extreme distortion to the distance error estimation:

$$N = 1 + [(N_G) (P)] / [(3.709) (T)] / (1 \times 10^6) \quad (\text{Eq 4-11})$$

$$\sigma_N = \text{sqrt} [(A^2) (\sigma_{Temp}^2) + (B^2) (\sigma_{Press}^2)] / [1 \times 10^{12}] \quad (\text{Eq 4-12})$$

where

- $N_G = (287.604) + [(4.8864) / (\lambda^2)] + [(0.068) / (\lambda^4)]$
- λ = EDM carrier frequency wavelength (micrometers)
- $T = 273.15 + t$
- t = temperature in °C (std. = 15°C)
- P = pressure in mbar (std. = 1013.25 mb)
- $A = [(-N_G / 3.709) (P / T^2)]^2$
- $B = [(N_G / 3.709) / (T)]^2$
- σ_{Temp} = temperature measurement uncertainty
- σ_{Press} = pressure measurement uncertainty

Relative humidity is the least critical parameter for determination of refractive index for light and NIR source EDM instruments. Temperature differences between stations can be substituted for temperature measurement uncertainty to give more conservative estimates of the refraction correction error. The error also can be determined sufficiently by simply multiplying the distance by 1 ppm for every °C of temperature measurement error to roughly obtain the standard deviation of the refraction correction term.

(3) Centering error (σ_c). The estimated centering error for distance measurements (σ_c) can be calculated according to formulas presented earlier in this chapter. For distance measurements the centering error from both the instrument and target are combined:

$$\sigma_c = \text{sqrt}(\sigma_{\text{inst}}^2 + \sigma_{\text{tar}}^2) \quad (\text{Eq 4-13})$$

where

σ_{inst} = instrument centering error
 σ_{tar} = target centering error

(4) Calibration error (σ_{cal}). Calibration error refers to the precision (standard deviation) of the correction constants determined from instrument calibrations. These are standard outputs of statistical tests performed during the calibration data reduction process (typically less than instrument resolution).

(5) Slope-to-Horizontal distance error. Uncertainty in horizontal distances stem from both the precision of the height difference determination and the precision of the slope distance measurement.

$$\sigma_{\text{horz}} = (S / H) \text{sqrt}(\sigma_s^2 + \sigma_{\text{hdiff}}^2) \quad (\text{Eq 4-14})$$

where

σ_{horz} = horizontal distance error
 σ_s = slope distance error
 σ_{hdiff} = height difference error
S = slope distance
H = horizontal distance

b. Example EDM distance error. With an EDM instrument resolution of 3.0 mm, carrier wavelength of 0.850 micrometer, and centering with a tribrach optical plummet with a 1.5 m HI for both the instrument and target stations, the resulting distance determination will have an uncertainty of approximately 3.2 mm (one-sigma level, at 15°C, 1013 mb, over a distance of 200 m), assuming temperature and pressure were measured to 1°C and 3 mb, respectively. If a temperature difference of 7°C is substituted for temperature error, the distance error estimate increases to 3.5 mm. Using the example values above and a height difference uncertainty of 3 mm, station height difference reductions add approximately 1 mm (one-sigma error) to the horizontal distance over a 20 m height difference.

4-7. Zenith Angle Measurement Error

a. General. Zenith angle measurements are determined by the difference of two direction measurements, with one direction defined by the vertical axis of the theodolite. Theodolite-based zenith angle measurement precision can be predicted as follows:

$$\sigma_{\text{zen}} = \text{sqrt}(\sigma_p^2 + \sigma_r^2 + \sigma_I^2 + \sigma_{\text{ref}}) \quad (\text{Eq 4-15})$$

where

σ_{zen} = zenith angle error (arcseconds)
 σ_p = pointing error
 σ_I = inclination error
 σ_r = reading error
 σ_{ref} = refraction error

The above variance components can be determined from the formulas presented in sections 4-2 thru 4-3. One of the main sources of systematic error in zenith angle measurement is due to atmospheric refraction. Zenith angle error can be roughly determined as a function of the slope distance:

$$\sigma_{\text{ref}} = \text{sqrt} [(S^2) / (4 R^2) (r^2) (4)] \quad (\text{Eq 4-16})$$

where

- σ_{ref} = refraction error (arcseconds)
- S = measured slope distance (m)
- R = mean radius of the earth (~ 6374000 m)
- r = 206264.8

For example, over a distance of 100 m, the expected error due to refraction would be approximately 3 arcseconds.

b. Trigonometric height traversing. Station height differences determined from zenith angle and horizontal or slope distance measurements are not always as accurate as differential leveling. Methods of trigonometric heighting are warranted where differential leveling would accumulate excessive random error. If differential leveling is attempted over steep slopes between crest and toe stations on a dam, then most of the total error in the height difference is introduced during the numerous instrument set-ups. In cases like this, trigonometric height traversing can directly substitute for differential leveling methods.

4-8. Refraction of Optical Lines of Sight

a. General. All types of measurements with optical instruments are affected by atmospheric refraction. The line is refracted when the air temperature is not homogeneous but varies across the line of sight with a gradient of dT/dy . Refraction effects are most pronounced in leveling and zenith angle measurements when the line of sight is near the ground surface (e.g., 2 meters or less), and has a significantly different temperature than the layers of air above the surface. The horizontal effects of refraction may also be dangerous if the line of sight of the observed horizontal direction runs parallel and very close to prolonged objects of a different temperature, such as walls in tunnels, galleries of long dams, or rows of transformers or turbines at a different temperature than air flowing in the center of the gallery.

b. Refraction effects. If the temperature gradient (dT/dy) across the line of sight is constant at all points of the line, then the line is refracted along a circular curve (Figure 4-4) producing an error ('e') of pointing to a survey target.

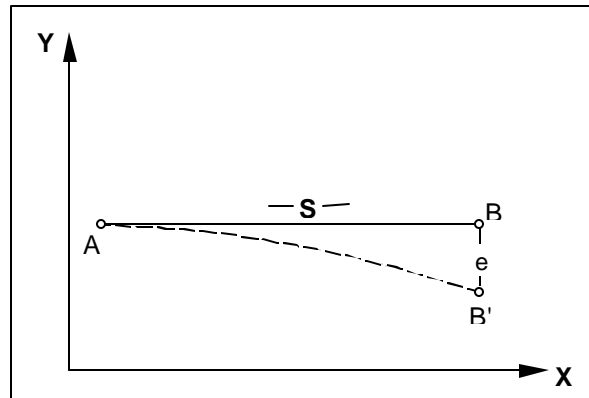

Figure 4-4. Refracted line of sight

The value of 'e' can be estimated from:

$$e = (k)(S^2) / (2R) \quad (\text{Eq 4-17})$$

where

k is a coefficient of refraction,
S is the distance to the target,
R is the earth radius.

The coefficient of refraction (k) is a function of temperature gradient (dT/dy) and it can be approximated (for the average wavelength of the optical spectrum) by:

$$k = 508.8 (P/T^2)(dT/dy) \quad (\text{Eq 4-18})$$

where

P is barometric pressure [in mb],
T is the average (absolute) air temperature in Kelvin,
t in deg C and T in Kelvin are related by $T = 273.15 + t$.

By taking the average radius of earth (R = 6371 km), and substituting (Eq 4-17) into (Eq 4-18), the pointing error may be expressed as a function of the gradient of temperature:

$$e = 3.9 \cdot (PS^2/T^2)(dT/dy) \cdot 10^{-5} \quad (\text{Eq 4-19})$$

For example, given a line of sight S = 200 m; temperature of air t = +30 deg C (i.e., T = 303.15 Kelvin); barometric pressure 1000 mb, and a constant gradient of temperature across the line of sight, dT/dy = 0.5 deg C/m. From (Eq 4-19) above, we have:

$$k = 2.8 \text{ and } e = 8.5 \text{ mm.}$$

Usually, the temperature gradient differs from one point to another, producing an irregular shape of the refracted line of sight (Figure 4-5). In this case, the gradient of temperature and the coefficient of refraction also change along the line of sight (x direction) and k is a function of position [k(x)]. The pointing error should be calculated from:

$$e = (1/R) \text{ integral } [k(S-x) dx]; \text{ from } 0 \text{ to } S \quad (\text{Eq 4-20})$$

If gradients of temperature are measured at discrete points, say in the middle of each segment s_i in Figure 4-5, then the integral (Eq 4-20) can be solved using, for example, Simpson's rule, to obtain:

$$e = 1/2R \{ s_1 [k_1 S + k_2(S-s_1)] + s_2 [k_2(S-s_1) + k_3(S-s_1-s_2)] + \dots \\ \dots + s_{n-1} [k_{n-1}(S-s_1-s_2-\dots-s_{n-2}) + k_n(S-s_1-s_2-\dots-s_{n-2})] + s_{n-1} [k_n(S-s_1-\dots-s_{n-1})] \} \quad (\text{Eq 4-21})$$

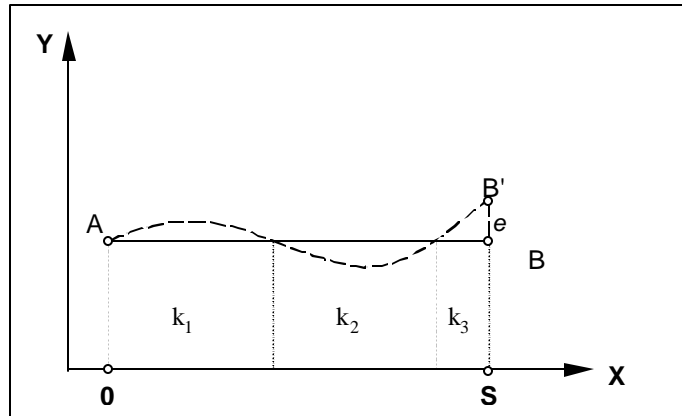

Figure 4-5. Effects of changeable gradients of temperature

For example, let us take $S = 200$ m divided into 4 segments of $s_i = 50$ m each, and consider two cases:

(I) For $k_1 = 2.8$ (same as previous example)

where $k_2 = k_3 = k_4 = 0$.

In this first case, we assume that the refraction takes place only within the first 50 m from the instrument, while there is no refraction ($dT/dy = 0$) over the rest of the line.

(II) For $k_4 = 2.8$

where $k_1 = k_2 = k_3 = 0$.

In this second case, the refraction takes place only in the last segment, near the survey target.

For both cases,

$t = 30$ deg C
 $P = 1000$ mb
 $R = 6371$ km.

From Equation 4-21 we have:

For Case I: $e = 3.8$ mm
 For Case II: $e = 1.9$ mm

The effects of refraction are more dangerous near the instrument than near the target (see Figure 4-6). Thus, instruments should be located as far away as possible from any surfaces having different temperature than the surrounding air.

c. Effects on alignment measurements. In alignment surveys between two fixed stations A and B (Figure 4-7), the line of sight from A is constrained to point to a target at B. If the gradient of temperature across the line of sight is constant between A and B, then the alignment reference line will be refracted along a circular path with the largest error of alignment being in the middle between A and B. Even when the alignment surveys would be performed in segments (i.e., resetting the alignment telescope or laser in

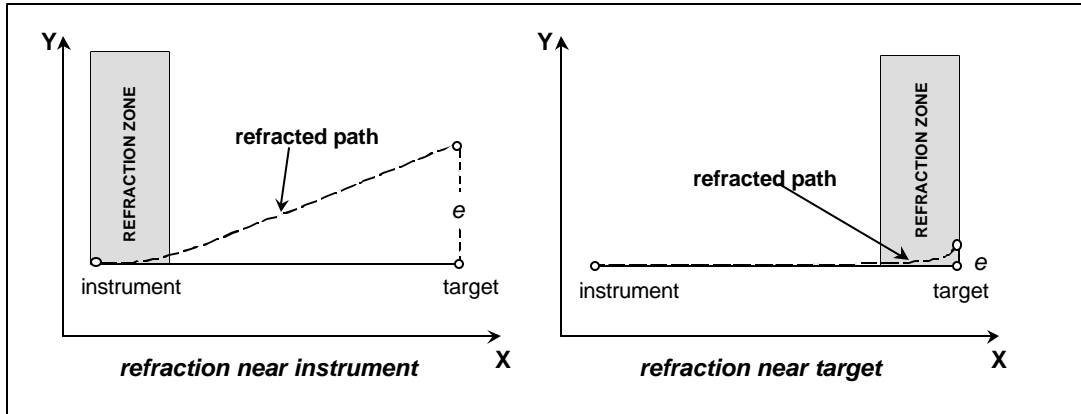

Figure 4-6. Effects of refraction near instrument vs. near target

steps between A and B), the whole survey will follow the same refracted circular curve. For example, when using a HeNe laser ($\lambda = 0.63 \mu\text{m}$) the maximum error (Δy) in the center of the refracted path can be calculated from:

$$\Delta y = [(PS^2)/(101760 T^2)](dT/dy) \quad (\text{Eq 4-22})$$

where

P is barometric pressure in [mb],
T is temperature in Kelvin,
S is total length of the alignment line.

With example values of $S = 500 \text{ m}$, $T = 300 \text{ K}$, $P = 1000 \text{ mb}$, and $dT/dy = 0.2 \text{ deg C}$. The error of alignment is $\Delta y = 5.4 \text{ mm}$.

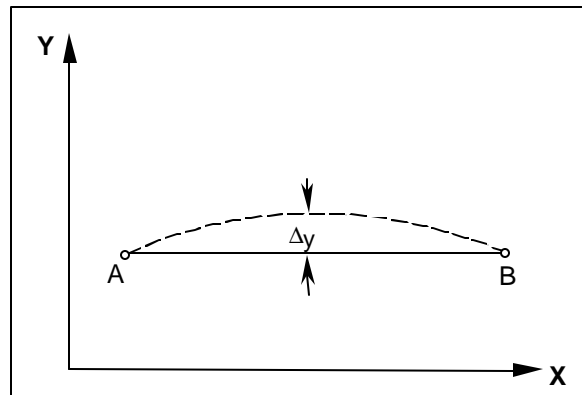

Figure 4-7. Refraction effects on alignment survey

d. Methods of reducing refraction effects. The effects of refraction can be reduced by:

(1) avoiding lines of sight running closer than one meter from any prolonged surface that may have a different temperature than the surrounding air,

(2) Measuring the gradients of temperature with several temperature sensors of high precision (resolution of at least 0.05 deg C) and calculating the refraction correction, or

(3) Using two sources of radiation of a different wavelength (i.e., dispersion method).

The first method is the most practical, but it does not assure a refraction-free line of sight. The second method, though applicable in practice, requires special instrumentation and tedious measurements. The third method requires very expensive and difficult to acquire instrumentation and it is applicable only in scientific measurements of the highest precision (e.g., in industrial metrology). In deformation surveys only the first method seems to be feasible. If both walls in narrow galleries are exposed to different temperature, e.g., one wall being exposed to water and another to the sun radiation, even placing the alignment line in the center of the gallery may not sufficiently reduce the refraction effect. In the latter case, non-optical methods may be used in the displacement measurements.

e. Effects on direction measurements. Refraction occurs in deflection angle and direction measurements with optical theodolites. With a uniform temperature gradient over the length (S) of the line of sight, the refraction error (e_{ref}) in arcseconds of the observed direction may be approximated by:

$$e_{ref} = (8") [(S)(P) / (T^2)] (dT/dx) \quad (\text{Eq 4-23})$$

where

- S = distance between stations (m)
- P = barometric pressure (mb)
- T = temperature in Kelvin ($T = 273.15 + t^{\circ}C$)
- dT/dx = temperature gradient

For example, If a gradient of only $0.1^{\circ}C/m$ persists over a distance of 500 m at $P = 1000$ mb and $t = 27^{\circ}C$, it will cause a directional error of 4.4 arcseconds.

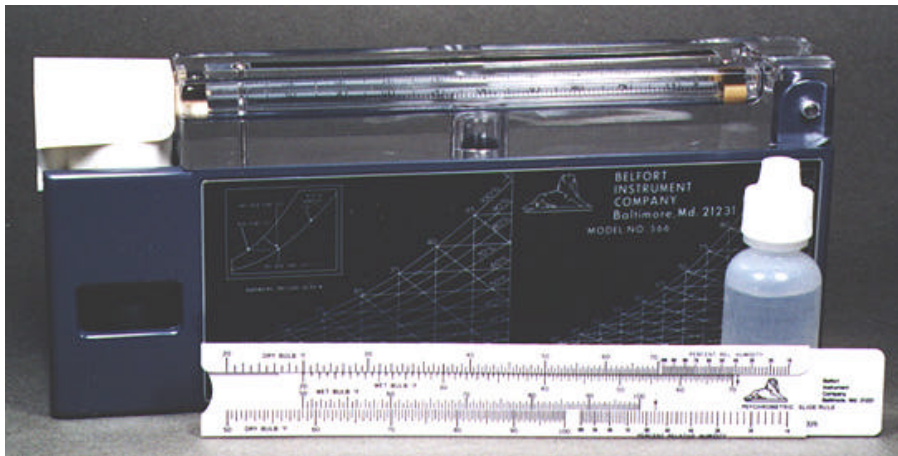

Figure 4-8. Aspirating Psychrometer from Belfort Instrument Co. Psychrometers are equipped with two thermometers, one with a wet bulb and one with a dry bulb. The wet bulb is covered with a wick that must be saturated with distilled water. A battery-operated fan in the aspirating psychrometer draws air over the bulbs. The cooling effect of evaporation produces a lower reading on the wet bulb, which is then used to determine the relative humidity. The dry bulb is read directly from the dry thermometer. These readings are used to compute the refractive index correction for the atmosphere in precise distance measurement.

4-9. Theodolite System Error

a. General. Theodolite instruments used for angle measurement can have small misalignments in the system attributed to its manufacturing or normal wear from repeated use and handling. Theodolite misadjustments produce systematic error in angle measurements. For example:

- Trunnion axis not perpendicular to line-of-sight
- Horizontal axis not perpendicular to vertical axis
- Vertical circle index error
- Inclined cross-hairs
- Plate eccentric to rotation axis

b. Elimination of instrument errors. The main technique used to eliminate the above instrument biases is to observe the target in both the direct and reverse positions of the theodolite at all times. All of the systematic errors noted above will cancel when measurements are made in two positions of the theodolite (e.g., double centering).

4-10. Reflector Alignment Error

a. General. Older model reflector prisms can introduce small errors in both distance and direction measurements due to mis-orientation. The magnitude of the error is based on factors such as the EDM wavelength, the prism dimensions, the refractive index of the prism glass, and the horizontal and vertical misalignment angle (non-perpendicular to the line-of-sight). It has been determined for older prism designs that less than 0.5 mm error in distance will be caused by a misalignment angle under 10 degrees from the line-of-sight, which is well within the normal ability to point the reflector toward the EDM. With directions (horizontal and vertical) the error can be limited to less than 1 arcsecond (over 500 m) with a misalignment of less than 10 degrees. The angular error is highly dependent on the distance from the instrument in that shorter distances will produce larger errors.

b. Modern reflector design. Reflector prisms in use today have been specifically re-designed to minimize the influence of misalignments on distance measurement accuracy. With standard prisms the resulting distance errors are negligible for small misalignments. However, attention to consistent and accurate pointing of the prism toward the instrument is still recommended practice.

4-11. EDM Scale Error

a. Temperature frequency drift. Short term drift of the oscillator frequency in EDM instruments is most likely to occur during the warm-up of its internal electronic components. If a frequency drift persists throughout the course of a survey, then the measurements will contain a time dependent bias that can reach a maximum drift value of up to 3 ppm (depending on the instrument and environment).

b. Frequency drift due to aging. Frequency drift can also occur as a result of mechanical aging of the oscillator crystal over time, so that the EDM develops a bias in its internal measuring scale (in some instruments less than 1 ppm per year). This can be a critical factor in deformation surveys when the same EDM instrument is used for repeated surveys and the resulting observations are compared over time.

c. Scale error calibration. For precise surveying applications, it is recommended that the EDM be calibrated for scale error at least once a year. The most common method for EDM scale factor calibration is from measurements made over a certified calibration baseline. Scale error is determined by comparing a series of distances measured along a linear array of stations where the station coordinates are

precisely known. The known distances between stations are differenced from the product of the measured distance and an unknown scale factor, as shown in the following linear equation:

$$[(k)(S)] - (D) = 0 \quad (\text{Eq 4-24})$$

where

- k = unknown scale factor
- S = measured distance
- D = fixed distance (known)

The horizontal distance measurements (S) are processed together in a linear least squares adjustment to solve for the unknown scale factor parameter (k). Once the scale error has been determined, all subsequently measured distances are multiplied by the constant scale factor (k) to yield a corrected distance.

d. Frequency counter methods. An alternative to using a baseline for EDM scale calibration is to send the instrument back to the manufacturer for a direct reading of its oscillator frequency. This laboratory procedure uses a high grade electronic frequency counter to compare the actual and reference frequencies of the EDM under controlled conditions. The instrument must have a built-in port connector so that the frequency may be sampled to solve for the instrument scale factor.

4-12. EDM Prism Zero Error

a. Additive constant or zero error. The additive constant is an unknown systematic bias that is present in all distance measurements made with a particular EDM instrument-prism combination. The bias is usually small for instruments using light waves. The bias is an absolute constant offset that exists between the optical and mechanical centers of the reflector prism and the electrical center of the EDM instrument when centered over the setup station. Distances uncorrected for zero error will produce discrepancies in the final station coordinates of survey points. These can be detected from check measurements; such as multiple observations made over a network of points or when more than two distance intersections are compared as a check on the monument positions.

b. Correction determination. Measured distances can be corrected for zero error by a determination of the additive constant of the instrument-prism combination on a calibration baseline. The calibration process relies on comparing distances that are measured over a set of fixed stations. The four station baseline and observing configuration shown in figure 4-9 allows each of the six *measured* distances (m_i) to be written as the sum of each true distance (d_i) and one unknown constant bias term (z).

$$m_i = (d_i + z) \text{ for } i = 1 \text{ thru } 6$$

This basic equation is repeated for each observed station-pair (p_i) along the baseline and the method of parametric linear least squares is used to solve for the constant term (z). For example each measured and true distance can be expressed using station coordinates as:

$m_1 = (p_2 - p_1) + z$	i.e., $d_1 = p_2 - p_1$
$m_2 = (p_3 - p_1) + z$	i.e., $d_2 = p_3 - p_1$
$m_3 = (p_4 - p_1) + z$	i.e., $d_3 = p_4 - p_1$
$m_4 = (p_3 - p_2) + z$	i.e., $d_4 = p_3 - p_2$
$m_5 = (p_4 - p_2) + z$	i.e., $d_5 = p_4 - p_2$
$m_6 = (p_4 - p_3) + z$	i.e., $d_6 = p_4 - p_3$

Since

$$\begin{array}{rcllcl}
 m_1 & = & -p_1 & +p_2 & +0 & +0 & +z \\
 m_2 & = & -p_1 & +0 & +p_3 & +0 & +z \\
 m_3 & = & -p_1 & +0 & +0 & +p_4 & +z \\
 m_4 & = & 0 & -p_2 & +p_3 & +0 & +z \\
 m_5 & = & 0 & -p_2 & +0 & +p_4 & +z \\
 m_6 & = & 0 & +0 & -p_3 & +p_4 & +z
 \end{array}$$

By setting the coordinate of the initial point (p_1) to zero, leaving three unknown coordinates (p_2 , p_3 , and p_4) and one unknown constant (z), this system of equations can be represented in matrix form as:

$$\mathbf{A} \mathbf{x} = \mathbf{b}$$

where

$$\mathbf{A} = \begin{vmatrix} +1 & 0 & 0 & +1 \\ 0 & +1 & 0 & +1 \\ 0 & 0 & +1 & +1 \\ -1 & +1 & 0 & +1 \\ -1 & 0 & +1 & +1 \\ 0 & -1 & +1 & +1 \end{vmatrix}$$

$$\mathbf{x} = [p_2 \quad p_3 \quad p_4 \quad z]^T$$

$$\mathbf{b} = [m_1 \quad m_2 \quad m_3 \quad m_4 \quad m_5 \quad m_6]^T$$

The unknown parameter (z) is common to each measurement so an over determined set of measurements is used to detect the discrepancy it causes between measurements. The least squares solution:

$$\mathbf{x} = (\mathbf{A}^T \mathbf{P} \mathbf{A})^{-1} \mathbf{A}^T \mathbf{P} \mathbf{b}$$

uses a diagonal weight matrix (\mathbf{P}) populated with the inverse of the variances computed for each distance measurement. In practice, 5 to 7 fixed points are needed, which adds to the observing time but also provides sufficient redundancy for statistically testing the significance of the additive constant parameter. National Geodetic Survey (NGS) standards for baseline calibration recommend a four-station baseline to simultaneously solve for both the scale factor and the additive constant, but this requires measurements both forward and backward from each station and uses *known* distances between stations. In either case, standard data reductions must be applied to the measurements (e.g., refractive index and slope distance reductions) before solving for the additive constant. Software applications are available from NGS that cover all aspects of EDM baseline calibration including data collection and associated least squares computations. The residuals from the data adjustment should be plotted and examined visually for any obvious trends that would indicate there are systematic errors remaining in the measurements. The resulting calibration constant is added to each measured distance, with an opposite algebraic sign, to obtain the corrected distance. The accuracy of the correction itself will depend on the number of observations made and their precision.

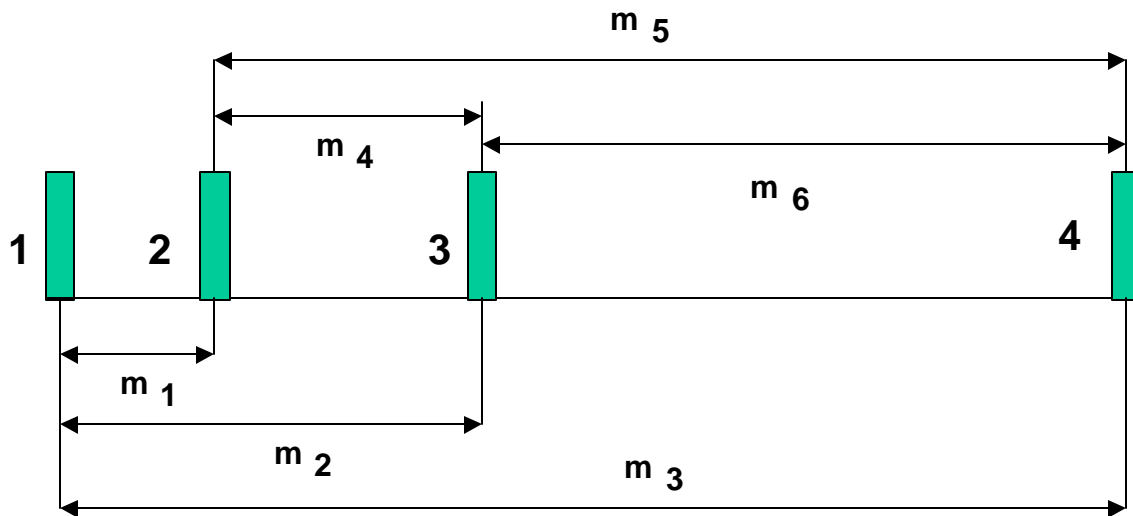

Figure 4-9. Zero error calibration baseline concept

4-13. EDM Cyclic Error

Stray radiation and signal interference inside the EDM unit can occur at the same phase as the internal reference signal. A sinusoidal pattern of deviations in the measured phase can systematically change the distance measurements. The stability of the EDM internal electronics can also vary with age, therefore, the cyclic error can change significantly over time. Cyclic error is inversely proportional to the strength of the returned signal, so its effects will increase with increasing distance (i.e., low signal return strength). Calibration procedures exist to determine the EDM cyclic error that consist of taking bench measurements through one full EDM modulation wavelength, and then comparing these values to known distances and modeling any cyclic trends found in the discrepancies. This procedure requires a specialized calibration baseline designed to detect the presence of cyclic error from the spacing of the measurement intervals.

4-14. Calibration Baselines

a. General. Construction of an EDM calibration baseline requires preparation for the design, layout, monumentation, and proposed calibration techniques. It should be noted that establishing a calibration baseline and keeping it in good order can be expensive and time consuming when maintenance is considered. Use of an established baseline that is available within the local area would be far more economical than to build a new facility.

b. Standard baselines. A standard baseline design recommended by the National Geodetic Survey should be used for EDM instrument calibrations. Guidance is provided on EDM calibrations and baselines in the following publications:

- NOAA Technical Memorandum NOS NGS-8, Establishment of Calibration Base Lines,
- NOAA Technical Memorandum NOS NGS-10, Use of Calibration Base Lines.

These documents shall be consulted before building a new calibration baseline and for conducting EDM instrument calibrations following NGS methods.

c. Specialized baselines. NGS calibration baselines have at least four monuments set in an alignment that deviates no more than 5 degrees of arc, which provides 12 measured distances in a complete calibration session--see Figure 4-9. NGS conventions for baseline design have monuments set out at 0, 150, 400-430, and 1,000-1,400 m along a straight line. If this spacing is not convenient to the local terrain, it is recommended to place the intermediate monuments at an even multiple of the unit wavelength of the EDM instrument to be calibrated (e.g., multiples of 10 m). This 'multiple of 10' rule of thumb is meant to ensure that the EDM phase detector will sample the return signal at the same point along the carrier wave for each measurement (i.e., resolve the partial wavelength at the same point along the carrier wave to avoid the effects of cyclic error in the calibration process). Alternative designs for calibration baselines can be developed for special purposes (see Rueger, 1990). A determination of monument spacing for specialized calibration baselines is made using baseline design formulas with the following input parameters:

- Total length of baseline
- EDM instrument reference wavelength
- Total number of baseline monuments

Trial and error combinations of different values for the above design parameters can be tested and the results examined to evaluate each baseline configuration. Designing a specialized baseline is warranted where unique EDM resolution, signal frequency, and range limits are encountered. A baseline design should provide distance combinations that evenly span the working range of the EDM, and the length of the baseline should be optimized at the minimum range of the EDM when operating under poor atmospheric conditions with a single reflector prism.

d. Tripod method. The EDM/prism calibration process (i.e., additive constant determination) can be made using a very short (30-50 m) alignment of at least five tripods instead of on a permanent baseline. Good results have been obtained by this method; however, forced centering on tripods is less stable than on pillars. For longer baselines, the stations should be no more than four minutes of arc out of line, and the tops of the tripods should be set in as straight a vertical alignment as possible relative to each other (within a few cm or less). Accurate tripod arrangement minimizes deviations in the line-of-sight from any single instrument setup station and will speed up the field observations. Precise leveling is used to determine the elevation of each ground point (monument) and fixed height offset measurements are made to each (tripod mounted) prism. Elevation and offset measurements are made to reduce the slope distances to horizontal distances.

e. Stability. If pillars are selected as monuments, it should be recognized that their stability can be influenced by various types of movements, namely, those due to external forces, settlement and tilt, dry shrinkage of concrete, swelling, and thermal expansion. The horizontal instability of concrete pillars due to thermal expansion is based on the operating height, width, and temperature change. Pillars should be set below the frost line and insulated in cold regions. The initial observation of baseline distances is delayed until the concrete has set through at least one freeze-thaw cycle.

f. Site selection. Permanent baselines should be easily accessible allowing transport and setup of the instrument and prisms. A roadway alongside the baseline will speed-up the movement of equipment and personnel between stations. Stations should have about 20 ft clearance on either side, and are set back 1/4 mile from high voltage lines and transmitters, and 100 feet from metal fences. Reconnaissance of the proposed baseline location (site visit, aerial photographs, topographic, geologic maps, etc.) is recommended to investigate soil type, relief, atmospheric conditions (avoid completely unvegetated areas with no shade). Once a suitable location has been found, a preliminary survey and stake out of temporary points can be made at the proposed distances.

4-15. Equipment for Baseline Calibration

A list of the equipment required for establishing a calibration baseline is provided below. Excluding the first two items (theodolite and EDM) these are also recommended for conducting calibration sessions.

- 1 Wild T2000 Theodolite
- 2 Wild DI2000 Electronic Distance Meter
- PC type laptop computer
- NGS calibration software
- 1 Nadir Plummet instrument
- 1 calibrated prism and mounting bracket
- tribrachs and tripods for each station
- 2 communication radios
- 2 psychrometers
- 2 barometers
- 2 (fan driven) thermistors
- 2 tripods and poles for thermistors
- 2 thermistor recording and reading units
- 12 volt battery power supply
- 1 hand tape measure
- 2 shade umbrellas

Calibration baselines are established with an instrument that has a higher precision than the instruments that are intended for calibration (ideally by an order of magnitude), however this is not always feasible for modern EDM instruments because of their extremely high precision.

4-16. Procedures for Baseline Calibration

a. General. Procedures for conducting measurements on a calibration baseline consist of setting the instrument at the baseline initial station and recording the distances to all of the others in sequence. The instrument is then moved up to the next pillar in line and the process is repeated until all of the baseline stations have been occupied (all distance combinations forward and backward are usually observed from each instrument setup). With a four-monument baseline, a total of 12 distances are used to solve four unknown baseline coordinates and each calibration parameter.

b. Preparation. First, set up the tripods and tribrachs over each station on the baseline. The tripods should be close to the same elevation (i.e., in an alignment or with a slightly up-sloping tilt away from the zero station to maintain visibility throughout the length of the baseline). The tripod is leveled by eye so that the tripod head on which the tribrach is mounted is as near level as possible. The tripod head is further leveled by mounting a calibrated Wild type target (with precise level bubble) into the tribrach, and then adjusting the legs to the position where the bubble is level in four positions under rotation.

c. Collimation. Accurate centering is critical for the measurement of baseline distances. After the tripod head is level, the target is replaced by a precision Nadir Plummet having an internal level compensator. The tribrach and Nadir Plummet assembly is then translated (without rotation) until it is centered. The collimation is then checked in four positions (90 degree rotations) around the center point. If the centering is not well-established, then slight adjustments are made to the centering and leveling of the tribrach until it is collimated. The leveling screws of the tribrach should be moved as little as possible because the offset from the tripod head to the top of the tribrach mounting plate needs to be measured and recorded, so if it is kept constant, a pre-calibrated value for the prism height above the tripod head can be used (reference marks are sometimes painted on the leveling screws and on the upper tribrach housing to

verify the offset is correct for the setup). The height of the tripod head is measured in four positions using the hand tape measure and a mean value is added to the constant height offset value between the theodolite optical center and the base of the tribrach (known beforehand), giving the height of instrument above the monument. This value is then added to the known elevation of the baseline monument.

d. Calibration procedures. The procedures for the baseline calibration presented below are to be repeated for each instrument setup. The observing procedures used to establish coordinates on a new baseline follow the same basic methodology used for actual instrument calibration.

(1) The instrument is placed at the baseline initial point and powered on while the prism is set up at the next station along the baseline. Thermistors are mounted on a vertical 3 meter pole, one at the top, and one at the level of the instrument, perpendicular to the direction of the sun, and oriented so that the front end faces into the prevailing wind. The two thermistors measure the temperature gradient, and are capable of reading to a tenth of a degree Celsius. A barometer is placed nearby the instrument and is capable of reading to one hundredth of an inch Hg. A similar thermistor and barometer arrangement is set up at the prism station. A psychrometer reading (Figure 4-8) is initially recorded, and thereafter, repeated only when the instrument is moved to the next setup. The top/bottom thermistor and barometer readings are recorded on both ends of the measured line at the start and finish of the measurements for each EDM setup (two different EDM instruments are used at each station when establishing a new baseline).

(2) Mount the first EDM to the theodolite and point it in the direct position at the center of the forward target (Note: it is important that the EDM ppm value is set to zero). Obtain adequate return signal strength and then measure five consecutive distances to the forward target. The values are recorded to the tenth of a millimeter. Reverse the scope and read five more distances. At the conclusion of the set, read and record the temperatures and pressure at both the instrument and prism stations, (the exact same procedure is then followed for the second EDM instrument when establishing a new baseline).

(3) Once the measurements for one baseline distance segment are finished (i.e., one station pair), the instrument stays at the same station and the prism moves to the next point along the baseline.

(4) At each instrument setup distances are measured to every other monument forward and back.

(5) If computed values for the instrument-prism constant exceed instrument tolerances, then the measurements must be repeated.

e. Calibration results. Field book records should include the following information:

- distance measurements,
- from station name,
- to station name,
- instrument serial number,
- prism serial number,
- date and time of observation,
- height of instrument/prism,
- meteorological observations,
- units of measurement,
- geometrical reductions,
- calculation of calibration parameters,

This information is compiled into a calibration report for use in data reductions.

EM 1110-2-1009

1 Jun 02

4-17. Mandatory Requirements

There are no mandatory requirements in this chapter.

Chapter 5 Angle and Distance Observations--Theodolites, Total Stations, and EDM

5-1. Scope

This chapter describes the field procedures for measuring angles with precision theodolites and measuring distances using electronic distance measurement (EDM) systems. Both these operations are now combined using electronic total stations.



Figure 5-1. AGA Geodimeter Model 220 electro-optical distance meter mounted in Wild tribrach force-centered into rigid concrete instrument pedestal.

5-2. Instrument and Reflector Centering Procedures

a. General. Accurate centering of instruments, reflectors, or tribrachs, over the monument reference marks (as illustrated in Figure 5-1) is a critical procedure for collecting deformation measurements. Specifications for instrument/prism centering are presented below for tribrach optical plummets, nadir plummets, and forced centering.

b. Built-in optical plummet. Tribrach centering procedures apply to equipment with an optical plummet incorporated in the instrument or with a detachable tribrach that will rigidly attach to the instrument.

(1) Calibration. Tribrach optical plummets shall be calibrated at the beginning of each project using the procedures outlined in the manufacturer's manual. Failure to perform, certify, and record this

calibration process can be grounds for rejecting all subsequent data obtained with an uncalibrated tribrach.

(2) Tolerances. Tribrachs shall be collimated over the object point mark to an accuracy of ± 1 mm using the built-in optical plummet. Tripod heads shall be aligned as nearly horizontal as is possible prior to final centering procedures.

(3) Leveling. Final tribrach leveling and centering shall be performed using a level vial from either a mounted theodolite or a standard Wild target. The built-in circular level bubble is not considered accurate enough for this process and should only be used for rough tripod head alignment. All centering leveling vials should be calibrated at the beginning of each project and this fact recorded.

(4) Equipment mounting. Once the tripods and tribrachs have been accurately centered over each end of the line, then the instrument and reflector may be inserted into the tribrachs without further adjustment. Extreme care shall be taken to avoid disturbing the tribrach during the insertion and measurement process.

(5) Check observations. Upon completion of all observations from a particular tripod, a final level and centering check shall be performed to insure no movement has occurred during this process. If significant movement is detected during this final check, then the entire observation process shall be repeated.

c. Nadir plummet. A Nadir plummet (Figure 4-2) can be used for centering instead of the tribrach optical plummet. A nadir plummet is precision centering device with a built-in automatic level for use in vertical sighting and collimation. Some models have the capability to define the plumbline to 1 part in 200,000. These plummets have up to five (5) times greater magnification than the optical plummet supplied with the standard Wild-type tribrach. The station reference mark (no larger than 1 mm in diameter), may need to be artificially illuminated under low light conditions for optimal viewing under this increased magnification. Nadir plummet centering should be conducted as follows.

(1) After the tripod is setup over the reference mark, the tripod head is leveled as closely as possible in two perpendicular directions using a tribrach with a Wild-type target and its sensitive level bubble.

(2) Once the tribrach is leveled, the nadir plummet is exchanged with the target in the tribrach and then precisely centered over the mark by a series of fine translation adjustments of the tribrach.

(3) Final collimation is confirmed by observing the mark under rotation in four perpendicular directions about the plummet axis and by re-observing the tribrach level in two perpendicular directions with the target level vial.

d. Forced centering. The highest centering accuracies can be achieved using forced centering techniques. A centering uncertainty of 0.1 mm/m can be expected for trivet/pillar plate combinations, permanent threaded pins, and machined sleeve-type insert pins. If possible, both the instrument and reflector should be mounted by forced-centering.

(1) Forced centering pins. Threaded pins on pillars will be used in forced centering mode. Tribrachs with standard target level vials may be used to level tribrachs directly on threaded pins or over plugs.

(2) Tribrach and tripod combinations. With tripods, standard Wild-type tribrachs should be used as a forced centering mount. Interchangeable tribrachs shall be used such that the instrument or reflector may be readily exchanged without affecting centering of the tripod/tribrach mount.

(3) Reflector rods. Threaded aluminum rods for direct insert in monitoring plugs may be used to support reflectors. When reflector rods are screwed directly into grouted plugs, the same rod shall be used for each successive project survey. Therefore, the rod number should be recorded so that the same rod is always used at a particular plug. Reflector HI should be kept as low as possible in order to minimize the effects of potential non-verticality of the rods.

e. Instrument stability. In precise surveys, towers, stands, and tripods must be substantial. The use of driven stakes or some type of quick setting cement or dental plaster for tripod leg support may be required. Catwalks that provide support away from tripod legs may be necessary under some soil or platform conditions to ensure that the instrument/reflector is unaffected by nearby motion. Use of fixed pillars is always preferred over less-rigid tripods, if possible.

5-3. Angle and Direction Observations

a. General. When using an optical or electronic theodolite for angle measurement, it will be accurately plumbed over the occupied point by either forced centering, attaching the theodolite to the point with a tribrach, or using a tripod and tribrach with an optical plummet, as applicable.

b. Specifications. The following specifications are provided for angle and direction observations:

(1) Repetitions. Both horizontal and zenith angles will be observed in at least four sets. The instrument will be re-centered and re-leveled between each set. With well designed targets and proper methodology, an angle measurement accuracy of 1" is possible with precision electronic theodolites if four sets of observations are taken in two positions of the telescope.

(2) Double centering. Face left and face right (direct and reverse) point and reads will be made for all targets in all theodolite work. The requirement of two positions must always be followed in order to eliminate errors caused by mechanical misalignment of the theodolite's axial system.

(3) Reading precision. All horizontal and vertical circle readings will be recorded to 0.1 arc second.

(4) Horizon closure. For each station pair (i.e., angle between the backsight and foresight), the method of observing independent angles will be used. A full set will consist of a direct angle measurement and a separate horizon closure angle measurement. Their sum will be taken to find the closure to 360 degrees.

(5) Parallax. Sighting parallax shall be minimized during each pointing operation. The reticule should be focused first and then the objective lens.

(6) Magnification. The theodolite shall have a minimum telescope magnification of 30 times or better.

(7) Leveling sensitivity. Theodolites shall have a plate level vial with a sensitivity of 20 seconds per 2 mm graduation or better. Once measurements are made, the level of the instrument will be checked. If found to be greater than 10 seconds, the measurements will be repeated with a leveled instrument.

When using an electronic theodolite and bi-axial compensator, the instrument will be leveled within 2 minutes of arc.

(8) Observing conditions. Avoid measurements close to any surface that has a different temperature than the surrounding air (walls of structures or soil exposed to the sun's radiation, walls of deep tunnels, etc.). If any suspicion of refraction influence arises, the surveys should be repeated in different conditions in order to randomize its effect. Ideally, observations should be limited to days when the weather conditions are fairly neutral (e.g., cloudy day with a light breeze). Days with temperature extremes should be avoided. If the instrument must be used when the temperature is hot, then it should be protected from the sun by an umbrella.

c. Data reduction procedures. Angles collected by the method of repeated sets will be reduced to a mean value using the station adjustment technique (see example below).

(1) Mean value. For each sighted direction in the set, determine the face-left and face-right mean direction value, starting with the backsight observation.

(2) Reduced value. Subtract the initial or backsight circle reading from the mean direction value of the foresight in the measurement set (backsight value will then be reduced to zero).

(3) Independent sets. Repeat the above procedures for each of the four independent direct angle sets and calculate the mean value for each direction,

(4) Horizon closure. Repeat each of the above steps for each corresponding horizon closure angle set.

(5) Closure correction. Difference the sum of the means of the direct and closure sets from 360 degrees. Distribute the misclosure equally to correct the final mean reduced value from each set. The general form for the misclosure is expressed as:

$$W = 360^\circ - (\beta_d + \beta_c) \tag{Eq 5-1}$$

where

W = horizon misclosure
 β_d = mean direct angle
 β_c = mean closure angle

and the correction value is determined as:

$$C = W / 2$$

where

C = correction value
W = horizon misclosure

d. Example data reductions. The station adjustment procedure for reduction of horizontal angles is demonstrated in the following example.

SET 1: Direct

PT	FL	FR	Mean	Reduced
1	0-0-30.0	0-0-38.6	0-0-34.3	0-0-00.0
2	3-0-36.6	3-0-40.8	3-0-38.7	3-0-04.4
Reduced Mean Value = 3-0-04.4				

SET 1: Closure

PT	FL	FR	Mean	Reduced
2	0-0-30.0	0-0-38.6	0-0-34.3	0-0-00.0
1	357-0-25.4	357-0-27.2	357-0-26.3	356-59-52.0
Reduced Mean Value = 356-59-52.0				

SET 2: Direct

PT	FL	FR	Mean	Reduced
1	0-0-30.0	0-0-34.4	0-0-32.2	0-0-00.0
2	3-0-38.4	3-0-40.8	3-0-39.6	3-0-07.4
Reduced Mean Value = 3-0-07.4				

SET 2: Closure

PT	FL	FR	Mean	Reduced
2	0-0-30.0	0-0-34.4	0-0-32.2	0-0-00.0
1	357-0-26.4	357-0-26.8	357-0-26.6	356-59-54.4
Reduced Mean Value = 356-59-54.4				

SET 3: Direct

PT	FL	FR	Mean	Reduced
1	0-0-30.0	0-0-37.4	0-0-33.7	0-0-00.0
2	3-0-40.6	3-0-43.0	3-0-41.8	3-0-08.1
Reduced Mean Value = 3-0-08.1				

SET 3: Closure

PT	FL	FR	Mean	Reduced
2	0-0-30.0	0-0-34.2	0-0-32.1	0-0-00.0
1	357-0-23.3	357-0-26.5	357-0-24.9	356-59-52.8
Reduced Mean Value = 356-59-52.8				

SET 4: Direct

PT	FL	FR	Mean	Reduced
1	0-0-30.0	0-0-32.2	0-0-31.1	0-0-00.0
2	3-0-36.3	3-0-38.5	3-0-37.4	3-0-06.3
Reduced Mean Value = 3-0-06.3				

SET 4: Closure

PT	FL	FR	Mean	Reduced
2	0-0-30.0	0-0-35.2	0-0-32.6	0-0-00.0
1	357-0-24.2	357-0-25.8	357-0-25.0	356-59-52.4
Reduced Mean Value = 356-59-52.4				

Resulting in the following reduced values:

Direct Mean value = **3-0-06.6**
Closure Mean value = **356-59-52.9**

Misclosure = 360 - (359-59-59.5)
Horizon Closure value = + 0.5"
Correction value = + 0.25"

Final Direct Angle value: **3-0-06.9**
Final Close Angle value: **356-59-53.1**

5-4. Distance Observations

a. General. Distances of 10 m or less can be measured with a steel or invar tape. Distances of 30 m or less can be measured with a tensioned steel tape, invar tape (or invar wire that can be attached to the steel bolt or insert directly), a subtense bar, or an EDM. An EDM is the preferred instrument for distances beyond 30 m. Microwave based EDM systems shall not be used.

b. Distance measurement with a tape. Distances measured between monuments will be made point-to-point whenever possible. If unable to measure point-to-point, a tripod and theodolite will be plumbed and leveled over the points and the distance measured between the trunnion axis of the setup. If tensioned equipment is used, the uncorrected distance should be measured to 0.01 mm. Distance measurements by tape will be independently made at least two times by repeating the required setup. When a mean uncorrected distance is determined using a steel tape, invar tape, or invar wire measuring unit, the following corrections will be applied, when appropriate, to determine true distance.

(1) Temperature correction. The correction for thermal expansion of steel tapes between the observed and standardized tape distance (ignore if using an invar tape) will be:

$$dL = k_a \cdot L \cdot (T - T_o) \quad (\text{Eq 5-2})$$

where

$k_a = 0.0000116$
 L = measured length (m)
 T = measured ambient temperature ($^{\circ}\text{C}$)
 T_o = standardized temperature ($^{\circ}\text{C}$)

(2) Tension correction. The tension correction between the observed and standardized tape distance will be:

$$dL = (P - P_o) (L) / (a) (E) \quad (\text{Eq 5-3})$$

where

P = applied tension (kg)
 P_o = standardized tension (kg)
 L = measured length (m)
 a = cross-sectional area of tape (cm^2)
 $E = 2.1 \cdot 10^{-6}$

(3) Sag correction. The correction due to the unsupported length(s) of the tape will be:

$$dL = (w^2) (L^2) / (24) (P^2) \quad (\text{Eq 5-4})$$

where

w = weight of tape per unit length (kg/m)
 L = distance between supports (m)
 P = applied tension (kg)

(4) Slope correction. The slope distance and height difference correction if applicable will be:

$$H = \text{sqrt} (S^2 - dH^2) \quad (\text{Eq 5-5})$$

where

H = horizontal distance
 S = slope distance
 dH = height difference

(5) Standardized tape. The correction due to calibrated standardization error will be:

$$dL = \text{true length} - \text{nominal length}$$

c. Distance measurement with a subtense bar. If measuring the distance with a subtense bar, the subtense bar and theodolite will be plumbed and leveled over the points defining each end of the line of observation as described in the previous paragraphs. The optical sight will be used to set the subtense bar perpendicular to the line of observation. The angle subtended by the subtense bar will be measured with four independent sets by the theodolite. Record the height of the instrument and height of the target to at

least one (1) mm for later reduction of the point-to-point distance. Procedures for angle and direction setups will be followed for optical theodolites.

5-5. Electro-Optical Distance Measurement



Figure 5-2. EDM observations at control structure in Central & Southern Florida Flood Control Project. EDM force-centered in concrete pedestal at external reference point. (Jacksonville District and Arc Surveying & Mapping, Inc.)

a. General. If measuring the distance with an EDM, including those incorporated within total stations, the instrument will be accurately plumbed and leveled over the point, or force-centered in a monument as shown in Figure 5-2.

b. Specifications. The following specifications are provided for making EDM distance observations:

(1) Warm-up period. Prior to its use, an EDM should be allowed to "warm up" according to manufacturer specifications. An EDM should be operated with fully charged batteries in the manufacturer recommended range of operating temperatures.

(2) Signal strength. Prior to measurements with the EDM, the target prism will be set perpendicular to within 10 deg of the line-of-sight. Distances will be measured after electronic pointing has yielded a maximum signal strength return. If necessary, the prism will be adjusted to maximize the strength of the signal.

(3) Repetitions. EDM measurements made to target point reflectors will be repeated at least three (3) times by re-setting and re-pointing the EDM instrument and performing the observation. Five separate distance readings for each pointing will be recorded to determine their mean value.

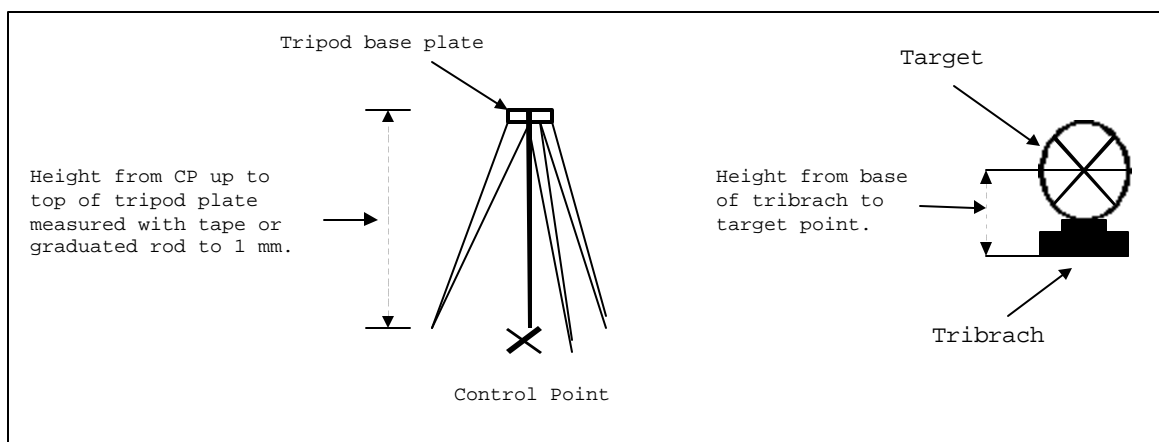

Figure 5-3. Reference points to measure height of target or GPS antenna height. A vertical height is measured between the ground control point (CP) and the top surface of the tripod base plate. The distance between the bottom of the tribrach and the center of the target is added to the height of the tripod base plate to determine the height of target. For GPS antennas, the manufacturers L1 phase center offset value as specified from the antenna base is added to the height measured from the base of the tribrach to the top of the tribrach/antenna mounting adapter

(4) Reading precision. Repeated observations will be recorded to the least count on the EDM or to the nearest 0.001 or 0.0001 meter. The mean result will be recorded to the same degree of precision.

(5) Forward distances. Distances will be observed in one direction when the instrument is set up on positive centered concrete instrument stands. If required, measurements in both directions will be made between fixed instrument stands or when using tripod supports if the one-way distance deviated over 5 mm from previous survey observations.

(6) Meteorological data. Barometric pressure, dry bulb temperature, and wet bulb temperature will be measured at the instrument stations and at the target station.

(a) Temperature and pressure will be measured in a location shaded from the sun, exposed to any wind, at least 5 feet above the ground, and away from the observer and instrument.

(b) Barometers shall be capable of 2 mm mercury precision or better (record pressure to 1 mbar).

(c) Thermometers and psychrometers will be capable of 1 degree Celsius precision or better (record temperature to nearest 1°C).

(d) A zero (0) ppm value for refraction will be entered into the EDM instrument when refractive index corrections are calculated using the formulas listed in Section 5-7.

(7) Instrument-Reflector combinations. An EDM instrument must be paired with a specific (numbered) reflector. Only one instrument/reflector combination shall be used for a particular line. The serial numbers of the instrument and reflector shall be recorded for each observation to verify this fact.

(8) Eccentricity observations. These offset measurements shall be made for each EDM distance.

(a) The height of EDM and height of prism will be measured to 1 mm, and similarly for the theodolite and target if used--see Figure 5-3. Some prism assemblies may be adjusted for lateral eccentricities, as shown in Figure 5-4.

(b) Engineer scales or pocket tape is used for measuring instrument/reflector heights over base.

(c) Instrument stands with elevations determined relative to domed plugs must be corrected when HI measurements are relative to the plug base.

(d) The EDM instrument shall have the mechanical center marked such that accurate instrument heights may be determined for each observation. The center of the reflector shall be similarly marked.

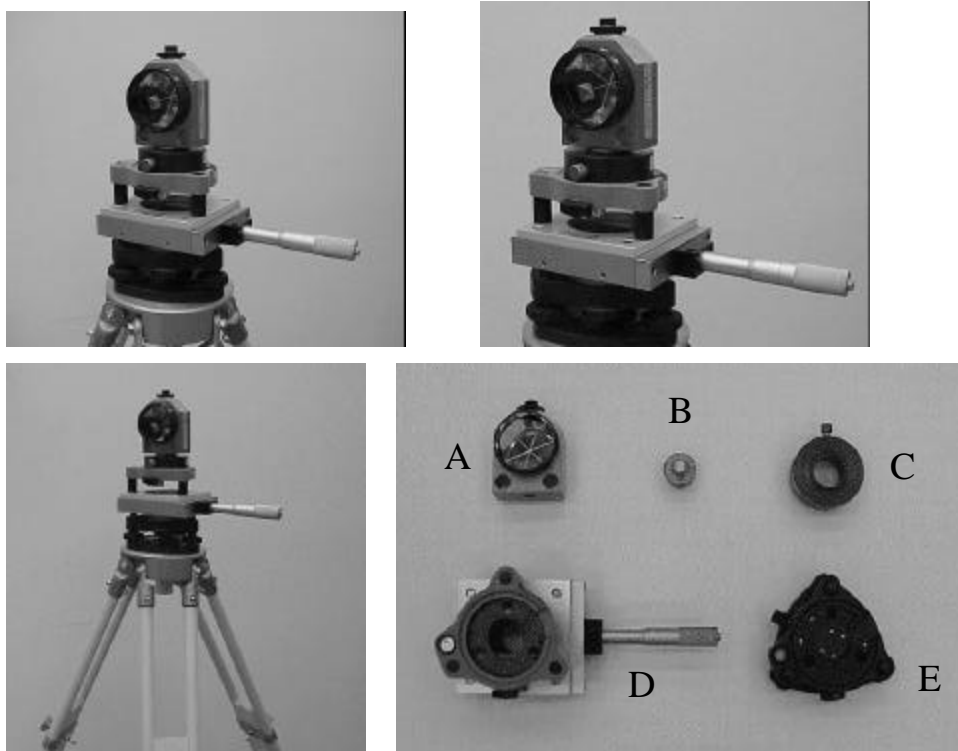

Figure 5-4. Typical EDM reflector mounted in precision adjustable tribrach. Reflector (A), 5/8-11 Adapter (B), Adapter ring (C), Translation Stage (D), Tribrach (E) used for alignment-offset measurements

(9) Instrument/prism constant. For each EDM/prism combination used, the calibration constant shall be recorded in the field book for each observation. Accordingly, the instrument and reflector serial numbers also must be noted in the field book. Incorrect instrument/reflector serial numbers or constants will result in rejection of all data.

(10) Instrument scale factor. The constant scale factor for EDM distances shall be recorded in the field book for each survey. Accordingly, the instrument serial number must be noted in the field book.

5-6. EDM Reductions

a. Field corrections. Horizontal distances will be computed and verified/checked in the field against previously surveyed values with the application of the following corrections and constants.

- (1) Instrument/Prism Constant.
- (2) Horizontal and Vertical Eccentricities.
- (3) Slope-to-Horizontal Correction.
- (4) Scale Factor.
- (5) Refraction correction

No corrections to sea level need be applied in projects involving short lines (i.e., less than 1000 m) or projects near sea level. For horizontal distances, slope distances shall be reduced using the elevation differences determined from differential levels. Field notes and computation/reduction recording forms shall show the application and/or consideration of all the correction factors described above.

b. Tolerances. The spread from the mean of the observations (3 sets of 5 readings each) shall not exceed 0.002 meters, or else re-observe the series. Measurements taken in both directions should agree to 0.002 meter after measurements are corrected for slope and atmospheric refraction, as required. If the distances are not rejected, a single uncorrected distance will be computed as the mean of the three independent distance measurements.

c. Distance reductions. Three dimensional mark-to-mark spatial straight line distances will be computed for use in network adjustments based on the following corrections.

(1) Refraction correction. EDM Distances will be corrected for atmospheric refraction using standard reduction formulas. A determination of the refractive index correction for ambient atmospheric conditions will be made based on meteorological data collected on-site.

(2) Additive constant. Zero error corrections determined from instrument/reflector calibration will be applied to distances measured with a particular EDM and prism combination.

(3) Scale error. Correction for EDM frequency scale error will be applied to the EDM distances.

(4) Geometric corrections. Instrument to station eccentricities will be eliminated for both stations using corrections for EDM, prism, theodolite, and target heights.

5-7. Atmospheric Refraction Correction

a. General. EDM distances must be corrected for the actual refractive index of air along the measured line. Measurement of atmospheric conditions at several points along the optical path must be performed with well calibrated thermometers and barometers in order to achieve the 1 ppm accuracy. If the meteorological conditions are measured only at the instrument station (usual practice), then errors of a few parts per million may occur, particularly in diversified topographic conditions. In order to achieve the accuracy better than 1 ppm, one must measure meteorological conditions every few hundred meters (200m - 300m) along the optical path.

finding the appropriate ppm correction value and applying this numerically to the distance recorded in the field book (instead of within the instrument).

$$D_{\text{CORR}} = [(\text{ppm} / 1 \cdot 10^6) (D_{\text{MEAS}})] + D_{\text{MEAS}} \quad (\text{Eq 5-6})$$

where

D_{CORR} = field corrected distance
ppm = parts per million term
 D_{MEAS} = measured distance set with zero ppm

Distance checks in the field are made by comparing the ppm corrected measurements to the corrected results from previous observation campaigns. Ppm correction values are supplied by look-up tables or simple nomogram type graphs that are specific to each instrument. Ppm methods only give approximate refraction correction values based on local temperature and pressure measurements.

c. Measurement of temperature and pressure. When greater accuracy in distance measurement is required, temperature, pressure, and relative humidity measurements are critical for calculating a rigorous refractive index correction. One should always use rigorous formulas to calculate the refractive index correction rather than diagrams or simplified calculation methods supplied by the manufacturers.

(1) Pressure. Pressure should be measured with a barometer at both ends of the line. The mean of the two values is used in the refractive index correction equation. If it is not possible to place barometers at both ends of the line, place a barometer at the instrument end, and use the elevations of the two ends together with the pressure measured at the instrument to calculate the pressure at the other end.

(2) Temperature. Temperature should be measured with a psychrometer at both ends of the line. The mean of the two values is used in the refractive index correction equation. It is more difficult to properly measure temperature. Thermometers must be well shielded from the sun's radiation by enclosing in a reflective insulating shield. However, this permits heat to build up within the shield, and thus a small fan or some other means must be used to move air over the temperature sensing device so that the true air temperature is read. Measurements near the ground can be a poor indication of the true temperature.

(3) Relative humidity. The influence of relative humidity is important in the highest precision measurements. Psychrometers with wet and dry thermometers should be used to determine correction components for water vapor content.

d. Refractive index correction formulas. Distance reduction calculations for determination of the refraction (first velocity) correction for precise electro-optical distance measurements are presented below. The formulas and derivations are developed fully in Rueger, 1990--see Appendix A. The refraction correction is as follows:

$$d = (n_R / n_L) d_{\text{MEAS}} \quad (\text{Eq 5-7})$$

where

d = corrected distance
 n_L = ambient refractive index
 n_R = reference refractive index
 d_{MEAS} = measured distance

The reduction is essentially an application of the scale factor (n_R / n_L) to the measured distance. The scale factor relates the instrument reference refractive index to the refractive index based on ambient atmospheric conditions. The ambient refractive index (n_L) is:

$$n_L = 1 + [(A + B) / (1 \cdot 10^8)] \quad (\text{Eq 5-8})$$

where

$$A = \{ [E1 \cdot (E2 / E3)] + [E4 \cdot (E5 / E6)] \} \cdot D_s$$

$$E1 = 1646386.0$$

$$E2 = 238.0185 + \sigma^2$$

$$E3 = (238.0185 - \sigma^2)^2$$

$$E4 = 47729.9$$

$$E5 = 57.362 + \sigma^2$$

$$E6 = (57.362 - \sigma^2)^2$$

$$B = [F1 + F2 - F3 + F4] \cdot D_w$$

$$F1 = 6487.31$$

$$F2 = 174.174 \sigma^2$$

$$F3 = 3.55750 \sigma^4$$

$$F4 = 0.61957 \sigma^6$$

$$D_s = (P_s / T) \cdot [1 + P_s \cdot (G1 - (G2 / T) + (G3 / T^2))]$$

$$G1 = 57.90 \cdot 10^{-8}$$

$$G2 = 9.325 \cdot 10^{-4}$$

$$G3 = 0.25844$$

$$D_w = (P_w / T) \cdot [1 + P_w \cdot (1 + (H1 \cdot P_w)) \cdot H2]$$

$$H1 = 3.7 \cdot 10^{-4}$$

$$H2 = H3 + H4 - H5 + H6$$

$$H3 = -2.37321 \cdot 10^{-3}$$

$$H4 = 2.23366 / T$$

$$H5 = 710.792 / T^2$$

$$H6 = (7.75141 \cdot 10^{-4}) / T^3$$

where

$$\sigma = 1/\lambda$$

λ = instrument carrier wavelength, (in micrometers),

D_s = density factor of dry air

D_w = density factor of water vapor

P = total atmospheric pressure (mbar)

P_w = partial water vapor pressure (mbar)

$P_s = (P - P_w)$ = partial pressure of dry air (mbar)

T = Temperature in Kelvin (K) = (273.15 + t)

t = temperature in Celsius ($^{\circ}\text{C}$)

The reference refractive index value (n_R) is obtained from the manufacturer's specifications for a given EDM instrument. Water vapor pressure (P_w) is determined by the difference between wet and dry bulb (psychrometer) temperatures as follows:

$$P_w = ep - [(0.000662) (P) (t_D - t_w)]$$

where

P = pressure (mb)
 t_D = dry bulb temperature ($^{\circ}\text{C}$)
 t_w = wet bulb temperature ($^{\circ}\text{C}$)
 $ep = (C + D) (E) \exp (F / G)$
 $C = 1.0007$
 $D = (3.46 \cdot 10^{-6}) (P)$
 $E = 6.1121$
 $F = (17.502) (t_w)$
 $G = (240.97) + (t_w)$

e. Reference line ratio methods. Using a special observing procedure, one may account for the influence of refraction without explicit use of temperature and pressure measurements. Corrections are obtained by using the ratio of a measured and a known distance to find the effective scale change due to refraction. These procedures are described in Chapter 10.

f. Summary data sheets. A summary data sheet for EDM distance observations is shown in Figure 5-6 on the following page.

5-8. Mandatory Requirements

The corrections and calibrations to observed distance measurements are considered mandatory.

	INSTRUMENT @ CDM - 2 DISTANCE TO:	INITIAL DISTANCE JUNE 1991	40 TH READING DEC 1996	CHANGE (MTRS)	CUM. CHANGE (MM)	41 ST READING JAN 1997	CHANGE (MTRS)	CUM. CHANGE (MM)	42 ND READING APR 1998	CHANGE (MTRS)	CUM. CHANGE (MM)
692.9998	SSRM 1	692.9890	693.0005	0.0007	11.5	693.0008	0.0003	11.8	692.9964	-0.0044	7.4
719.7269	SSRM 2	719.7209	719.7268	-0.0001	5.9	719.7289	0.0021	8.0	719.7220	-0.0069	1.1
678.0597	SSRM 3	678.0380	678.0600	0.0003	22.0	678.0609	0.0009	22.9	678.0543	-0.0066	16.3
705.4121	SSRM 4	705.3855	705.4121	0.0000	26.6	705.4131	0.0010	27.6	705.4045	-0.0086	19.0
732.8935	SSRM 5	732.8772	732.8930	-0.0005	15.8	732.8943	0.0013	17.1	732.8868	-0.0075	9.6
760.6852	SSRM 6	760.6642	760.6853	0.0001	21.1	760.6854	0.0001	21.2	760.6812	-0.0042	17.0
788.1278	SSRM 7	788.1400	788.1269	-0.0009	-13.1	788.1284	0.0015	-11.6	788.1203	-0.0081	-19.7
668.2854	SSRM 8	668.2606	668.2853	-0.0001	24.7	668.2841	-0.0012	23.5	668.2821	-0.0020	21.5
696.0971	SSRM 9	696.0571	696.0975	0.0004	40.4	696.0979	0.0004	40.8	696.0945	-0.0034	37.4
723.9291	SSRM 10	723.9081	723.9281	-0.0010	20.0	723.9297	0.0016	21.6	723.9176	-0.0121	9.5
751.7767	SSRM 11	751.7551	751.7761	-0.0006	21.0	751.7763	0.0002	21.2	751.7680	-0.0083	12.9
779.7186	SSRM 12	779.7121	779.7182	-0.0004	6.1	779.7188	0.0006	6.7	779.7114	-0.0074	-0.7
663.9446	SSRM 13	663.9126	663.9447	0.0001	32.1	663.9446	-0.0001	32.0	663.9399	-0.0047	27.3
691.9190	SSRM 14	691.8944	691.9176	-0.0014	23.2	691.9192	0.0016	24.8	691.9113	-0.0079	16.9
719.8884	SSRM 15	719.8851	719.8881	-0.0003	3.0	719.8877	-0.0004	2.6	719.8810	-0.0067	-4.1
664.6144	SSRM 16	664.5753	664.6148	0.0004	39.5	664.6150	0.0002	39.7	664.6086	-0.0064	33.3
692.6458	SSRM 17	692.6186	692.6448	-0.0010	26.2	692.6468	0.0020	28.2	692.6400	-0.0068	21.4
720.5207	SSRM 18	720.5187	720.5204	-0.0003	1.7	720.5215	0.0011	2.8	720.5158	-0.0057	-2.9
670.9071	SSRM 19	670.8744	670.9073	0.0002	32.9	670.9075	0.0002	33.1	670.9017	-0.0058	27.3
698.6566	SSRM 20	698.6312	698.6568	0.0002	25.6	698.6555	-0.0013	24.3	698.6511	-0.0044	19.9
675.0941	SSRM 21	675.0642	675.0948	0.0007	30.6	675.0947	-0.0001	30.5	675.0878	-0.0069	23.6
CERRILLOS DAM MONITORING SPILLWAY POINTS HORIZONTAL REFERENCE POINT READINGS											

Figure 5-6. Data sheet for periodic distances to fixed points on spillway. 42 observations made during period 1990 through 1998--only last three tabulated in report. Note some monitor points have moved some 8 to 4 cm since initial construction of the dam. Cerrillos Dam, Puerto Rico (Jacksonville District).

Chapter 6 Settlement Surveys--Precise Differential Leveling Observations

6-1. Scope

This section covers standards and specifications for performing precise differential leveling surveys, as required to monitor settlements in concrete and embankment structures. The standards described are developed around precision leveling instruments used for long-distance geodetic leveling runs. For many structures where level runs are relatively short, adequate results may be obtained with traditional leveling methods (e.g., three-wire or even single-wire observations).



Figure 6-1. Precise leveling runs on levee in Everglades and gate structure. Parallel plate micrometer level with invar rods. (Jacksonville District)

6-2. Precise Geodetic Leveling

Vertical settlement determined by precision differential leveling is performed using compensatory auto-collimation leveling instruments with fixed or attached parallel plate micrometers, and observing invar double (offset) scale metric rods with supporting struts (Figure 6-1). Automated digital bar-code levels may also be used. In general, 1 to 3 fixed reference points (bedrock benchmarks) are used to check for potential movement of various points on the structure. One of the reference points is held fixed with all subsequent vertical changes tabulated relative to this fixed reference point. Vertical ties between reference bedrock benchmarks are performed only to monitor potential movement on the reference points, and to enable selection of the best reference point to hold fixed when two or more benchmarks (BM) are

available. Leveling should be referenced to stable benchmarks placed in close proximity to the structure to minimize systematic errors that can accumulate during the transfer of elevation from vertical control outside the project area. A stability monitoring program designed specifically for the network of benchmarks should be established by leveling through each project benchmark. Deep bench, rod extensometers (preferably at least two), placed directly on the structure and anchored at depth in bedrock (isolated from surrounding soil), will also provide a stable vertical reference. If benchmarks are located within the zone of deformation, the vertical network should be made to close on the same benchmark it started from so that relative height differences and closures will provide a measure of internal precision.

a. Leveling standards. Precision leveling shall be performed in conformance with the methods and accuracy specifications contained in NOAA Manual NOS NGS 3, Geodetic Leveling, unless modified in the following guidance. Those performing PICES survey work are expected to be thoroughly familiar with the contents of this reference manual. Other applicable reference manuals include:

- ER 1110-2-1806, Earthquake Design and Analysis for Corps of Engineer Dams
- EM 1110-2-1911, Construction Control for Earth and Rock-Fill Dams
- EM 1110-2-2300, Earth and Rockfill Dams, General Design and Construction Considerations
- EM 1110-1-1904, Settlement Analysis

This last reference provides guidelines for calculations of vertical displacements and settlement of soil under shallow foundations supporting various types of structures and under embankments.

b. Equipment specifications. Specifications applicable to differential leveling equipment for deformation monitoring surveys are presented as follows.

(1) Instruments. Instrumentation used should meet requirements for First-Order geodetic leveling, employing either spirit levels or compensator levels with micrometers, or bar code digital levels. For spirit leveling, the instrument will be an automatic level with telescope magnification of 40 times or better, a compensator with a sensitivity of 10 " per 2 mm level vial graduation, and a parallel plate micrometer capable of 0.1 mm readings.

(2) Leveling staves. The rod to be used should be an invar, double scale rod, or one with a permanently attached circular level, both having graduations equal to the range of the parallel plate micrometer (Figure 6-2).

(3) Turning plates (pins). Turning plates should not be used on turf; driven turning pins will be required in this type of terrain. Turning plates should only be used on pavement or hard packed soil.

c. Instrument calibration requirements. Prior to conducting leveling operations the following calibrations will be performed.

(1) Maintenance. Precise level rods and instruments will be cleaned and lab calibrated-maintained at least annually.

(2) C-factor collimation calibration. The C-factor shall be determined at the beginning of each PICES structure observation in accordance with the procedures outlined in Section 3 of NOAA Manual NOS NGS 3. The C-factor determination is made using Kukkamaki's method, also referred to as a Peg Test (Figure 6-3). A slightly different calibration format used by the Jacksonville District is shown in Figure 6-6 at the end of this chapter.

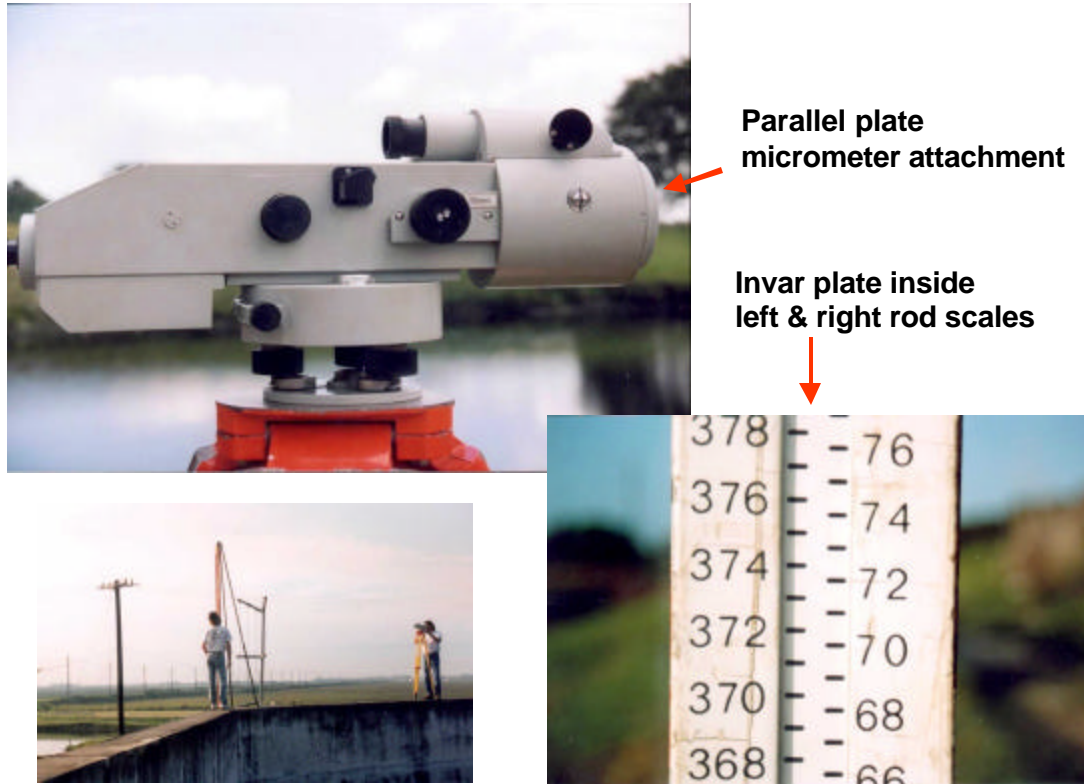

Figure 6-2. Zeiss Ni1 automatic level with parallel plate micrometer attached. Double-scale Invar rod with constant 3.01550 meter difference in left and right scales

(3) Rejection criteria. The C-factor shall conform to the reject/readjustment criteria of Table 3-1 of NOAA Manual NOS NGS 3, which is 0.005 cm/m. Daily C-factor calibrations are not essential provided if the instrument is consistently falling within 0.004 cm/m and backsight/foresight distances (individual setup and accumulated) stay within 1m/2m respectively. C-factor calibrations shall be performed at least twice weekly when continuously leveling at a single PICES structure, upon commencing leveling at a new structure, or daily if the C-factors exceed prescribed limits.

d. Leveling procedures. When determining elevation by precise spirit leveling, the following guidelines will be followed.

(1) Double-run level sections. Sections shall not exceed one kilometer in length. Level lines will be run in two directions. Either one or two double scale invar rods will be used. For short runs, traditional three-wire procedures are allowable. Section runs will be conducted via shortest route between benchmarks.

(2) Sighting convention. Each section shall start and end with the head rod (Rod A) on the BM or reference point. The head rod (Rod A) is always observed first on each setup, whether it is a backsight or foresight observation. The instrument shall be leveled with the telescope pointing towards the head rod (Rod A), thus alternating towards the backsight and foresight at alternate instrument stations.

GEODETTIC LEVELING MICROMETER OBSERVATIONS (4h)										U.S. DEPARTMENT OF COMMERCE NATIONAL OCEANIC AND ATMOSPHERIC ADMINISTRATION		PAGE / of /		
YR.	MO.	DAY	CODE	INSTRUMENT SERIAL NO.	CODE	ROD SERIAL NO.	CODE	ROD SERIAL NO.	COLLIMATION CHECK	TIME				
90	10	16	231	580218	316	149972	316	149974	EXAMPLE					
FROM		BM DESIGNATION		TO		BM DESIGNATION		TIME		TEMPERATURE		CORRECTIONS		
		KUKKAMÄKI METHOD						909010925C		153 153 17		CWS		
SET NO.	STADIA BACK S	m	STADIA FORE S	m	LOW SCALE BACK/FORE	Δh	HIGH SCALE BACK/FORE	Δh	Δh	Δh	REMARKS			
1	309	100317	100	30924	822	90172	2924	+02	Δh_1					
	2990	3070		31796		93096			-220					
$\Delta s_1 = 0.0$ m														
2	279	198287	400	27992	802	87240	2906	+04	Δh_2					
	2592	2470		28794		90146			-8040					
$\Delta s_2 = 20.2$ m														
$d = +21$														
Adjust to read this														
5 mm/hcm														
-0.950 mm $\Delta h_1 - \Delta h_2$														
-0.200 mm $e_{20} - e_{10}$														
-1.150 mm														
20.2 m $-\Delta s_2$														
C = -0.057 mm/m														
to adjust:														
8														
-0.46 hcm														
After adjustment:														
1	312	100320	99	31203	826	90432	2924	-02						
	3020	3101		32029		93356			-250					
$\Delta s_1 = 0.1$														
2	282	200290	400	28217	823	87492	2924	+01						
	2620	2500		29040		90416			-235					
$\Delta s_2 = 20.0$														
$d = +21$														
5														
-0.075														
-0.200														
-0.275														
20.0														
C = -0.014														

Figure 6-3. C-factor determination using Kukkamaki method

(3) Rod readings. Observing and recording are similar to conventional leveling procedures. The readings will be recorded manually in the field book or electronically to 0.01 mm. An acceptable version of the NGS Micrometer Leveling form may be used (8.5 x 11 inch loose leaf format--Figure 6-4). Field books and data recorders are also acceptable. Level sketches and abstracts shall also be prepared.

(4) Stadia distance. The maximum length of the line of sight should not be more than 50 m. Foresight and backsight distances should be balanced. If the distances cannot be balanced, they will be recorded so that the height difference can be adjusted during data reduction.

(5) Foresight sideshots. Sideshots shall start from a rigid BM and not from a TBM. Multiple foresight shots are allowable from a single backsight assuming distances are allowable.

(6) Rod settlement. If using one level rod, it will be moved from backsight to foresight as quickly as possible to minimize the effects of rod and instrument settlement.

(7) Rod index error. An even number of setups will be made for all differential level section runs in order to eliminate possible rod index errors.

(8) Ground refraction. The line of sight will not be less than 0.5 m above the ground to minimize line-of-sight refraction due to higher temperature gradients near ground level.

NOAA FORM 16-101 12-77										U.S. DEPARTMENT OF COMMERCE NATIONAL OCEANIC AND ATMOSPHERIC ADMINISTRATION										PAGE
GEODETIC LEVELING MICROMETER OBSERVATIONS (Δh) EXAMPLE																				101
TR.		NO.		DAY		CODE		INSTRUMENT SERIAL NO.		U CODE		ROD SERIAL NO.		CODE		ROD SERIAL NO.		TIME		
80		11		24		23		4565114		376		145692376		145694						
FROM					TO					TIME					TEMPERATURE					
P 416 1956					TBM 857 892 STAFF 9 FT					8 11 30 11 50 6					10 50 1 0 15 0 1					
LET	STADIA	M	STADIA	IP	LOW SCALE	Δh	HIGH SCALE	Δh	Δh	REMARKS										
UM	FACE	2	FORE	2	BACK/FORE		BACK/FORE													
1	0	0	0	0	0	0	0	0	0	Vertical mark adj .51										
0	1	6	3	0	0	0	0	0	0	Red 1 on staff +592.50										
										593.01										
2	2	6	7	0	4	5	0	2	6											
2	2	4	0	0	6	5	0	2	2											
										-2.0										
3	2	8	0	0	3	8	8	1	6											
2	4	1	3	0	9	2	1	9	8											
										-1.0										
4	2	7	0	0	5	0	2	7	0											
2	2	5	8	0	0	0	2	7	0											
										Staff inaccessible.										
										Leveling to 9.00 ft										
										graduation.										
										.50										
										592.50										
										592.80										
										Mean Δh =										
										-123.195										
										200										
										-0.61693 m										

Figure 6-4. Sample precise level notes--parallel plate micrometer leveling with invar rods.

6-3. Differential Leveling Reductions

a. *Field checks.* Leveling data sheets will be checked in the field with the resulting differential elevation for each run clearly noted, along with pertinent plug offset characteristics, if any, and accumulated stadia lengths per circuit/section. See the example at Figure 6-4. A slightly different recording format developed by Jacksonville District is shown in Figure 6-7 at the end of this chapter.

b. *Leveling tolerances.* Measurement and closure checks will be made on site with the following tolerances. For additional information on leveling reductions consult NOAA Manual NOS NGS 3.

- (1) Single observation. The setup will be re-observed if the disagreement between the left and right side scale elevations on either rod exceeds 0.25 millimeters for that setup.
- (2) Stadia distance. Backward and forward stadia distances can differ by no more than 2 meters per setup and 4 meters accumulated along a section.
- (3) Re-observation criteria. Re-run level line if external misclosure exceed tolerance value, for newly established points, or for re-observations when misclosures are rejected on single runs.
- (4) Closure requirements. Section level run closure tolerances are calculated as follows.

(a) Misclosure tolerance (TOL) for a section run is not to exceed:

$$\text{TOL} = \pm 3 \text{ mm} \cdot \text{sqrt}(K)$$

(Eq 6-1)

where K is measured in kilometers (km)

(b) For short lines, the minimum tolerance for a section run is not to exceed:

$$\text{TOL} = \pm 1 \text{ mm (for } K \text{ less than 0.33 km)}$$

(5) Height difference. If data collected with an automatic level is not rejected, a single height difference shall be computed as the mean of the height difference computed from the left scale readings and the height difference computed from the right scale readings. If the foresight and backsight readings are unbalanced, the single height difference shall be corrected for vertical collimation error.

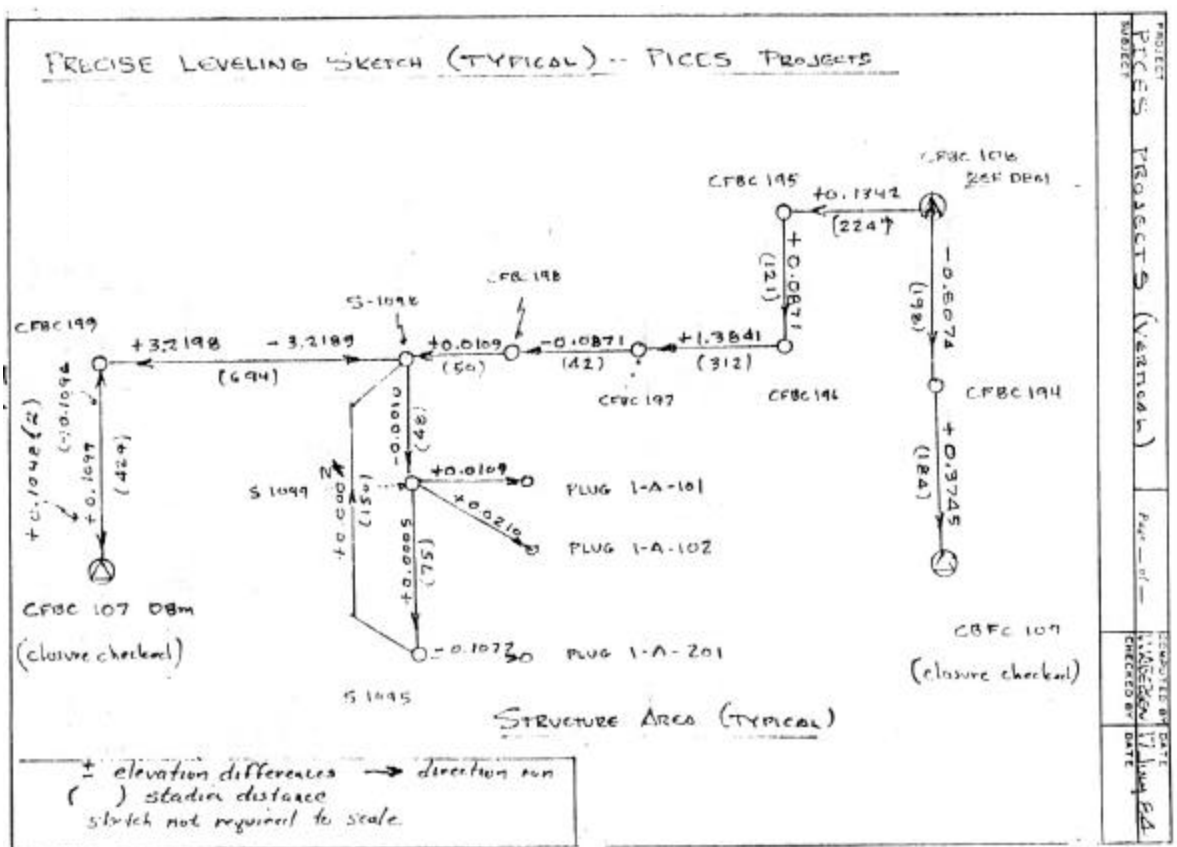

Figure 6-5. Sample sketch of level loops and level lines around a lock & dam structure on Cross Florida Barge Canal (Jacksonville District)

(6) Tabulation accuracy. Record elevations to the nearest ten-thousandth (0.0001) meter on the final reported elevations and settlement. Elevations (and elevation differences) on field sketches and abstracts should be tabulated to the nearest 0.0001 meters.

c. Final height difference reductions. Redundant elevations (i.e., computed from different level loops on circuits from the reference BMs) may be simply averaged regardless of lengths run. Since most

leveling surveys will involve lines run directly from a reference BM, final adjusted structure elevations are simply algebraic sums of height differences from the BM using field verified sketch/abstract data.

d. Additional processing. More extensive leveling adjustment procedures, such as least squares processing, may be necessary in the case of:

- Complicated section loop connections,
- Three dimensional adjusted networks,
- Newly established projects,
- Settlement anomalies,
- Abnormal movement of BMs,
- Redefinition of BM elevation using past data.

e. Report tabulation. Tabulated (carried forward) elevations or averaged elevations will be made from the field sketch/abstract, holding the BM elevation fixed and computing changes in elevation from prior observations. Anomalies should be noted on the report tabulation. Recommendations to change the reference BM (to another BM) should be noted and pursued accordingly.

f. Sketches. Field sketches (see sample at Figure 6-5) of level circuits, section, loops, or spurs shall be made to clearly show observed elevation differences, leveling direction, and stadia distances--all taken directly from the (checked) Micrometer Leveling recording forms. From such a sketch, elevations may be easily carried forward from the reference BM -- an essential computation in verifying external misclosures and should be stapled to all the data sheets acquired for an individual structure. Elevations carried forward (from the BM) may be listed on a separate sheet--i.e., an Abstract.

6-4. Total Station Trigonometric Heights

EDM/Total Station trigonometric heighting can be used to determine height differences in lieu of spirit leveling. In general, these elevation differences will not be as accurate as those obtained from spirit/differential levels. Exceptions would occur in mountainous terrain where differential leveling is difficult to conduct. EDM trigonometric height observations conducted over terrain where atmospheric extremes may be present (e.g., across a large valley or river) must be observed using the technique of simultaneous reciprocal measurements.

a. Weather conditions. Observations with an EDM should be limited to days when favorable atmospheric conditions (e.g., slightly cloudy with a light breeze) are prevalent.

b. Setup requirements. Proper targets and instrument height (HI) measuring instruments, as well as sound HI measurement procedures, should be followed at all times.

c. Measurements. Zenith angles and slope distances should be measured in both the direct and inverted telescope positions. Recording and reductions follow similar procedures for horizontal angle and EDM distance measurements.

6-5. Mandatory Requirements

The precise leveling closure and calibration standards in paragraphs 6-3 and 6-4 are considered mandatory.

*	Y	R	M	O	DAY	CODE	INSTRUMENT SERIAL NO.	M	CODE	ROD SERIAL NO.	CODE	ROD SERIAL NO.		TIME
														SITE:
COLLIMATION CHECK - KUKKAMAKI'S METHOD														
														TIME
														TEMPERATURE
														C
														BEGIN
														END
														BEGIN
														END
														OBS
														S

BACKSIGHT										FORESIGHT													
LOW SCALE					HIGH SCALE					LOW SCALE					HIGH SCALE								
STADIA	S _L B				S _H B				S _B	(H-L)	STADIA	S _L F				S _H F				S _F	(H-L)		
	3	0	1	5	5	0						3	0	1	5	5	0						
MEAN BS ₁ = _____										MEAN FS ₁ = _____													
BS ₁ - FS ₁ = h ₁ = _____																							
	3	0	1	5	5	0						3	0	1	5	5	0						
MEAN BS = _____										MEAN FS = _____													
e ²⁰ = <u>-.0027</u>										e ⁴⁰ = <u>.0108</u>													
BS ² = _____										FS ² = _____													
BS ² - FS ² = h ₂ = _____																							
C = $\frac{h_1 - h_2}{S_F^2 - S_B^2}$ = _____										If C < + 0.005 C/M/M no adjustment is required													

Adjustment : The new correct reading for the high scale foresight rod reading is computed by

New high scale = old high scale - (C X 40) = _____

Figure 6-6. Recording form for Kukkamaki Method of collimation calibration (Jacksonville District)

Chapter 7 Alignment, Deflection, and Crack Measurement Surveys --Micrometer Observations

7-1. Scope

This chapter describes micrometer observation methods for accurately measuring small relative deflections or absolute deformations in hydraulic structures.

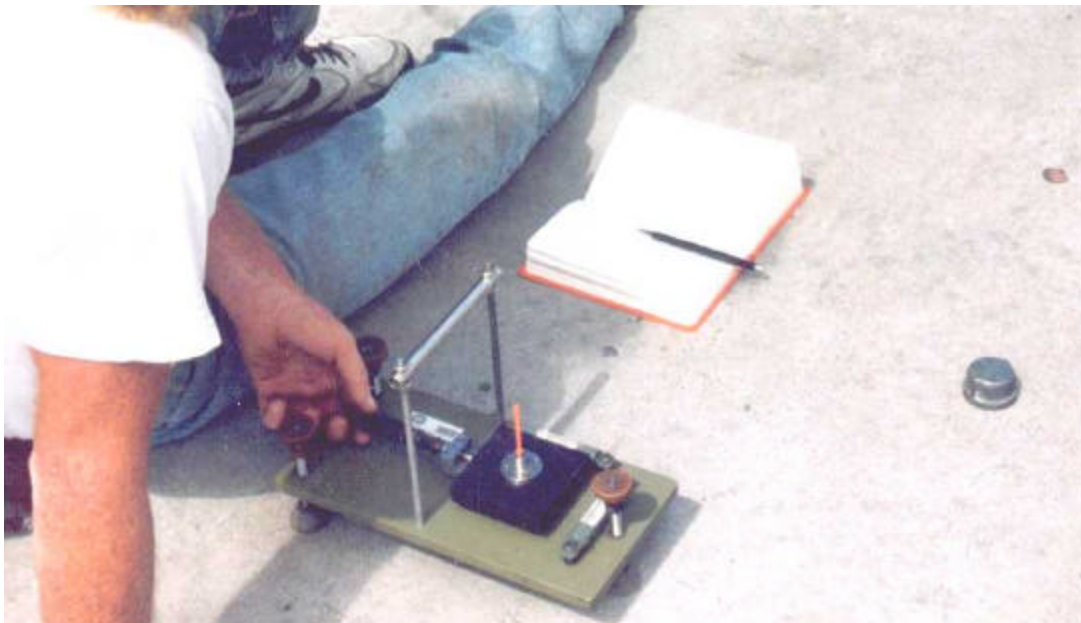

Figure 7-1. Alignment micrometer measurements relative to fixed baseline

7-2. Relative Alignment Deflections from Fixed Baseline

Deflections of points along structural sections can be monitored by observing their offset from an alignment established by two baseline control points. The deflection of a point relative to a fixed baseline is observed either by micrometer target methods (translation stage--Figure 7-1) or by directly observing the deflection angle to the alignment pin with a theodolite. The lateral movement is computed relative to the alignment using trigonometric identities. Alignment requirements for each structure will be listed in tabular form on project instructions, identifying the baseline reference points used (instrument/target stands), the deflection points to be observed, and structure loading requirements (e.g., lock fill elevations). Requirements for establishing new alignment points, and constructing reference baseline instrument/target stands will be detailed as required. Additional background on relative deflection techniques is described in EM 1110-2-4300, Instrumentation for Concrete Structures.

a. General. Relative deflections on structures are monitored by measuring the position of a series of alignment pins set at regular intervals along an alignment section--e.g., the reference baseline "A" shown in Figure 7-2. Baselines typically range from 100 to 1000 feet in length, depending on the

structure. The baseline is established perpendicular to the direction in which deflection observations are required--e.g., along the axis of a dam. Alignment control points located on the structure form a sub-network where each pair of structure control points acts as a separate alignment section for making deflection measurements. The alignment control point (CP) positions are tied directly to the reference network pillars using the established project coordinate system. Separate or adjacent alignment sections should be tied together using conventional measurements from at least two other nearby control points and from at least two reference network stations. Precision distance ties between alignment section control points should be made to strengthen positioning of the alignment control points.

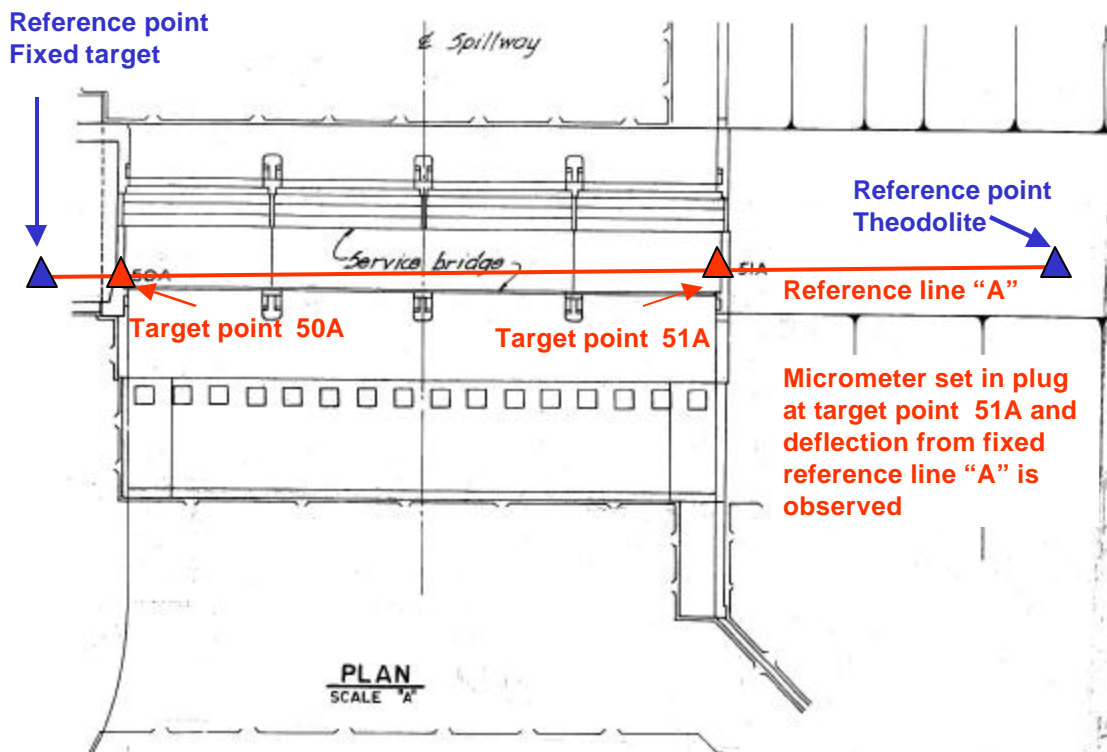

Figure 7-2. Typical relative alignment deflection measurements of concrete structures relative to fixed baseline. Micrometer deflections relative to line between theodolite and target set on external points. Port Mayaca Spillway (S-308C), Central and Southern Florida Flood Control Project, Jacksonville District

b. Instrumentation specifications. Guidance on recommended alignment survey equipment and procedures are presented as follows.

- (1) Instruments. Optical or electronic theodolites such as the Wild T-2 or T-3 theodolite or other similar instruments such as electronic total stations may be used.
- (2) Targets. An inverted "V" or conic plug inserts, prism tribrach combinations with target housings, or other specialized metrology type targets are acceptable.
- (3) Monuments. Permanent alignment pins or other permanent disk type monuments are acceptable. Structure monitoring target points (or plugs) are normally set (grouted) within ± 0.5 inch

from the reference baseline. Established control point monuments on the structure should be used instead of temporary point-on-line reference marks.

(4) Alignment micrometer. A translation stage type mechanism with forced centering plug insert with a tribrach or an inverted "V" or conic target mount on the micrometer is acceptable. See EM 1110-2-4300, Instrumentation for Concrete Structures, for details on forced-centering monument construction and monolith alignment marker design.

c. Observing procedures. These guidelines are provided for determining offsets using theodolite-based methods for measurements of deflection angles or with a micrometer-based translation stage.

(1) Equipment set-up. The theodolite and reference target(s) must be set up on concrete instrument stands or stable tripods using forced centering devices. After force centering the theodolite, accurately level theodolite to its reversing point and re-level to the reversing point before each observation--this leveling/re-leveling procedure is critical. Next, remove parallax from the theodolite's cross-hairs. The reference target on the opposite end of the reference line is aligned by forced-centering, ensuring the target is aligned vertically over the plug center. For each alignment pin, the orientation of the stage axis to the alignment should be perpendicular to within 5 degrees to the alignment. This alignment tolerance is easily achieved in the field.

(2) Establishing alignment. Both the theodolite and target are force-center mounted at each end of the reference baseline to establish the alignment and measure a reference line distance tie. When using two instruments, each respectively is centered over a monumented control point that establishes the alignment section, and each instrument backsights the center circular element within the other theodolite objective lens.

(3) Deflection angle method. A series of small deflection angles can be measured between the initial position of the micrometer target when centered over the alignment pin and the reference line. For the deflection angle method, the instrument is set up at either end of the alignment section, and the prism or micrometer assembly is centered over the alignment pin closest to one end of the alignment. The theodolite's vertical cross-hair is centered on the reference target and four (4) alignment deflection sets are observed with the theodolite in both direct and reverse positions. Redundancy can be increased by combining both the micrometer offset measurement method with the small deflection angle method by also sighting the translated position of the target when it is collimated with the alignment section reference line and recording the micrometer offset measurement and in-line distance. The procedure for the combined method would be as follows. For each alignment pin, establish the initial alignment as usual. Turn the instrument onto the prism target centered directly over the alignment pin, read and record the small deflection angle and measure the distance to the alignment pin, then turn the instrument back onto the original alignment and observe the conventional micrometer offset and in-line distance.

(4) Micrometer offset measurements. Sight the alignment reference target and move the alignment micrometer/target into to collimation with theodolite alignment. Radios may be required for communication between the instrumentman and micrometer operator. Five (5) independent offset measurements should be observed with the alignment micrometer in the LEFT position. (i.e., micrometer is to left of baseline as viewed from the theodolite's position). The offset distance from the alignment pin is measured by moving the target on-line, and recording the offset distance with the micrometer scale. Read alignment micrometer to nearest ± 0.001 (thousandth) inch. Rotate alignment micrometer 180 degrees to its RIGHT position and observe five (5) additional offsets. Always run the micrometer against the spring such that after each offset measurement, the micrometer should be backed off a few hundredths

of an inch. Reversing the micrometer to the LEFT and RIGHT positions eliminates index error in the device.

(5) Alignment pin in-line distances. Extensional (in-line) movement components for each alignment pin are determined by measuring the in-line distance to the prism/target when collimated over the alignment pin and when collimated to the reference baseline. When using two instruments for the alignment, the offset reading and in-line distance is repeated and confirmed by the instrument at the other end of the line when the offset bar is rotated 180 degrees.

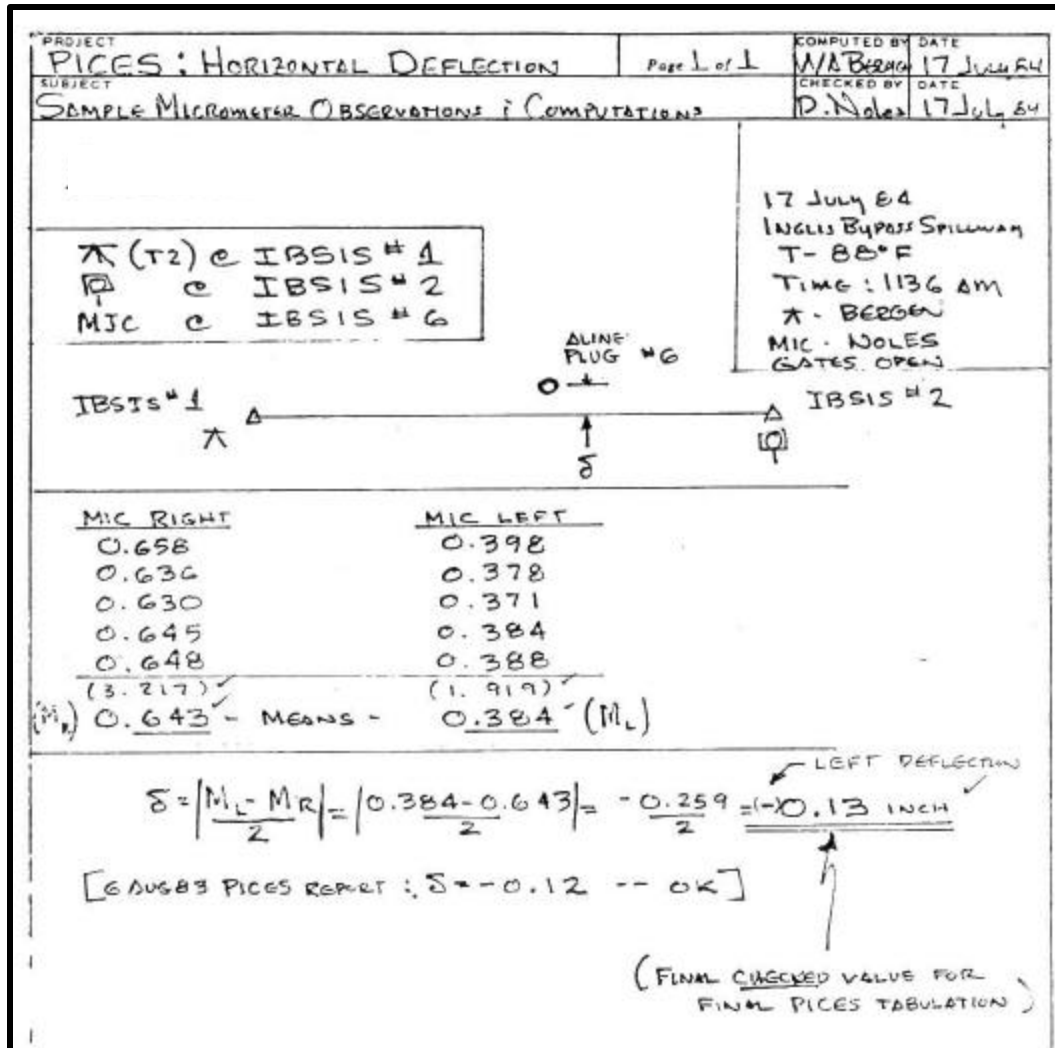

Figure 7-3. Field alignment micrometer alignment observations and reduction--Inglis Bypass Spillway, Cross Florida Barge Canal, Jacksonville District

d. *Field computations and tolerances.* A mean value for the LEFT and RIGHT micrometer observations (5 each) will be calculated and reported to the nearest 0.001 inch--see sample field notes at Figure 7-3. The difference between the mean of the LEFT set and the mean of the RIGHT should not exceed ± 0.02 (two-hundredths) inch. If the difference between the two means does exceed this limit

then both the LEFT and RIGHT set must be re-observed. Large variations probably indicate poor target centering, instrument parallax not eliminated, or mis-levelment of the theodolite. The final left/right deflection angle will be computed in the field after each alignment observation. All field reductions shall be independently checked in the field.

e. Final micrometer data reductions. From the mean value for the micrometer left/right readings, compute the adjusted deflection as follows:

(1) Deflection Calculation. The deflection (D) will be calculated as:

$$D = (ML - MR) / 2 \quad \text{(Eq 7-1)}$$

Where

ML = mean value of the five (5) LEFT micrometer readings on baseline

MR = mean value of the five (5) RIGHT micrometer readings on baseline

D = the calculated value for the "+" Right deflection off baseline to structure point as viewed from theodolite position.

(2) Recording. Round adjusted deflection to the nearest 0.01 inch. Additional accuracy and recording requirements for micrometer based measurements are found below.

(3) Check sum. The sum of the micrometer LEFT and RIGHT means will not necessarily total to 1.000 inch, given the micrometer index errors.

(4) Tabulation. Tabulate field computed deflection values for the final report using a standard field survey book or similar recording form for both observations, computations, and adjustments of data. A sample micrometer alignment field record is shown in Figure 7-3.

(5) Summary sheets. Figure 7-4 depicts a typical summary data sheet for sequential alignment observations.

7-3. Micrometer Crack Measurement Observations

a. General. This section describes absolute micrometer joint or crack measurement procedures using micrometers. Crack/joint observations are measured relative to grouted bronze plugs set 12 inches (\pm) on center across a concrete crack or structural construction joint where periodic monitoring is required. Monitoring points are usually set on each adjacent monolith. Monitoring is performed periodically for long-term trends or during short-term load deformation studies. Often, three plugs are set across each crack or joint in a triangular pattern. In most cases, two opposite plugs set perpendicular to the joint/crack plane will be adequate. Expected short-term accuracy is on the order of ± 0.0005 inch, relative to the fixed calibration reference bar. Errors due to the nonalignment (vertical) of the crack plugs relative to one another could effect observational accuracy (and long-term repeatability) upwards of ± 0.01 inch. Given all of the above errors and uncertainties, estimated long-term crack measurement accuracy is at the ± 0.005 to 0.010 inch level; totally independent of short-term movements in the structure due to load or temperature influences. Crack and joint measurement requirements are typically listed in tabular form, including instructions for varying hydraulic head levels against the monoliths, if applicable. Requirements and instructions for setting new monitoring points will be provided as required. Structure loading requirements will also be provided for each new observation point.

REFERENCE POINT WITH INSTRUMENT AT IS#	INITIAL DISTANCE	5TH READING	CHANGE INCHES	CUM. CHANGE INCHES	6TH READING	CHANGE INCHES	CUM. CHANGE INCHES	7TH READING	CHANGE INCHES	CUM. CHANGE INCHES
L 2 MIC RIGHT	0.292	NOT VISIBLE								
L 1 MIC RIGHT	0.690	NOT VISIBLE								
L 2 MIC LEFT	0.729	NOT VISIBLE								
L 1 MIC LEFT	0.278	NOT VISIBLE								

6 TH READING MAR 1995	REFERENCE POINT WITH INSTRUMENT AT IS	INITIAL DISTANCE	7TH READING	CHANGE INCHES	CUM. CHANGE INCHES	8TH READING	CHANGE INCHES	CUM. CHANGE INCHES	9TH READING	CHANGE INCHES	CUM. CHANGE INCHES
0.6290	L 1 MIC RIGHT	0.4915	0.6990	0.0700	0.2075						
0.8588	L 2 MIC RIGHT	0.6560	0.9060	0.0472	0.2500						
0.3350	L 1 MIC LEFT	0.5094	0.3500	0.0150	-0.1594						
0.0460	L 2 MIC LEFT	0.3570	0.0960	0.0500	-0.2610						

NOTES:

- All distances are in hundredths of an inch and changes in hundredths of an inch.
- Location of the points is shown in the Pre-Inspection Brochure on Plates 38 and 39.
- Readings from IS-4 rejected due to guardrail built on line.
- Continued readings on L2 MIC RIGHT from 5 th reading of April 1994.

S-352 SPILLWAY (HGS 5)
(SPILLWAY)
ALIGNMENT MONITORING POINT READINGS
(Continued from Plate 73 in 1995 report)

PLATE 78

Figure 7-4. Data summary sheet for alignment observations between 1990 and 1996. Only the first (1990) and last (seventh) observations are recorded. The change is measured relative to the previous observation in 1995 (shown in left margin). The cumulative change is relative to the original (1990) measurement. Hurricane Gate Structure 5, Jacksonville District.



Figure 7-5. Starrett vernier caliper crack measurements between monoliths. Central & Southern Florida Flood Control Project (Jacksonville District and Arc Surveying & Mapping, Inc)

b. *Equipment specifications.* The following equipment and instruments are used for crack and joint extension measurements.

(1) Inside micrometer. Any standard machine tooling inside micrometer may be used for crack measurements. Precision calipers may also be employed in lieu of an inside micrometer (Figure 7-5).

(2) Inside micrometer calibration bar. 12 inch c/c standard reference for all micrometer observations. An independent re-calibration of this bar is necessary to monitor long term stability.

(3) Plug inserts. Stainless steel threaded half-inch inserts are used and inserted into the dual or triad points across monolith joints or cracks--Figure 7-6. Inserts are stamped to insure consistent use on periodic measurements. The 0.500-inch O/D inserts should be precision machined to an accuracy of ± 0.001 inch, and verified by micrometer measurement.

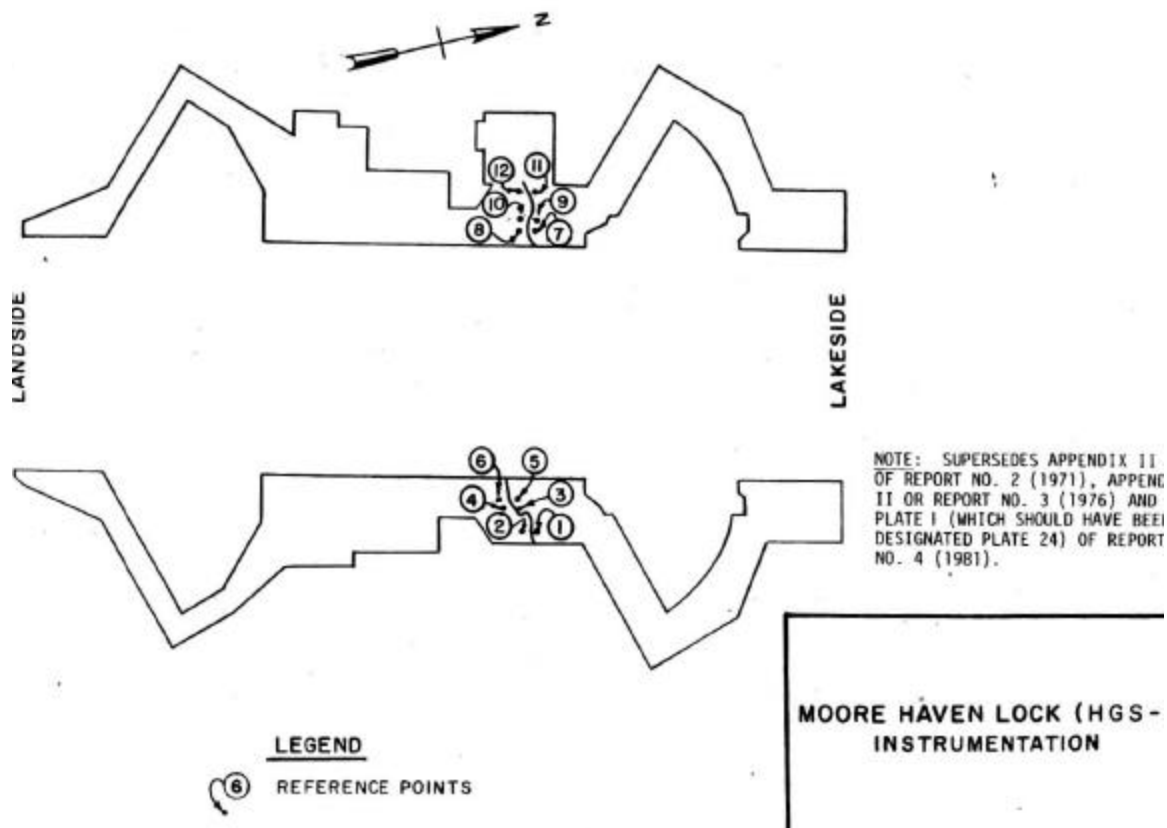

Figure 7-6. Typical monitoring point scheme across existing cracks on a concrete structure--HGS-1, Central and Southern Florida Flood Control Project (Jacksonville District)

c. *Crack measurement techniques.* The following procedures are used for crack and joint extension measurements.

(1) Micrometer measurement. Insert plug pins and measure crack or joint distance using an inside micrometer or caliper. Hold micrometer ends as low as possible on each plug pin. Gently rotate each end for minimum distance observation.

(2) Reading procedures. Read micrometer/caliper values to nearest 0.001 (thousandth) inch. Read in both directions (i.e., reverse micrometer ends) between crack plugs and mean result to nearest 0.001 (thousandth) inch. Do not attempt to interpolate between 0.001-inch values. Record a single minimum reading for each direction and mean as required.

(3) Tolerances. Readings in each direction should not vary by more than ± 0.001 inch unless it can be verified that the crack plugs are grossly misaligned vertically. This can be verified by raising the micrometer at both ends to confirm non-verticality of the grouted plugs.

(4) Dial micrometer. The following applies to a inside micrometer with dial. Lock micrometer to nearest 0.025 inch division and use dial indicator to obtain minimum distance. (Maximum reading on scale which is subtracted from the preset micrometer value). Ensure dial range is within 0.025-inch micrometer setting range to avoid misreadings and insure relatively constant spring tension. The following example illustrates crack measurement data.

Micrometer set at:	11.475 inches
Maximum dial scale reading (minimum distance):	<u>-0.021 inch</u>
Observed uncorrected micrometer length:	11.454 inches

(5) Triad crack/plug configurations. Three marked pins shall be used in the same plug upon each inspection, per the following convention:

- "L" Lowest numbered crack plug
- "H" Highest numbered crack plug
- "b" "Blank" -- in medium numbered crack plug

For example, at "Inglis Lock" the following naming convention might be used:

<u>PLUG</u>	<u>PLUG</u>
IL19N4	"L"
IL19N5	Blank
IL19N6	"H"

Normally, only one forward/reverse observation will be required for each pair of plugs -- approximately a 1 to 2 minute procedure. Additional observations under different structural loading conditions or temperature conditions will not be performed unless specifically requested in the project instructions. In cases where observations are taken over varying points in time or condition, they will not be meaned; given the external structural variability on the measurements.

(6) Tolerance specifications. The measurement rejection criteria are ± 0.001 inch between each direction reversal and ± 0.001 inch from nominal calibration bar constant. Failure to obtain agreement in each direction may be due to non-verticality of the plugs; in which case, no re-observations are necessary.

(7) Recording formats and reductions. Standard field survey books for both observations and corrected/adjusted lengths are normally used. All observations and reductions shall be computed and verified in the field--and recorded directly into the field survey book. Micrometer data are corrected for calibration constants as shown above. Quick comparisons should be made with previous observations to preclude against blunders. Tabulate field reduced distance into final reports and compute changes from past readings, as shown in the example at Figure 7-7. Standard forms for periodic crack measurements are also found in EM 1110-2-4300.

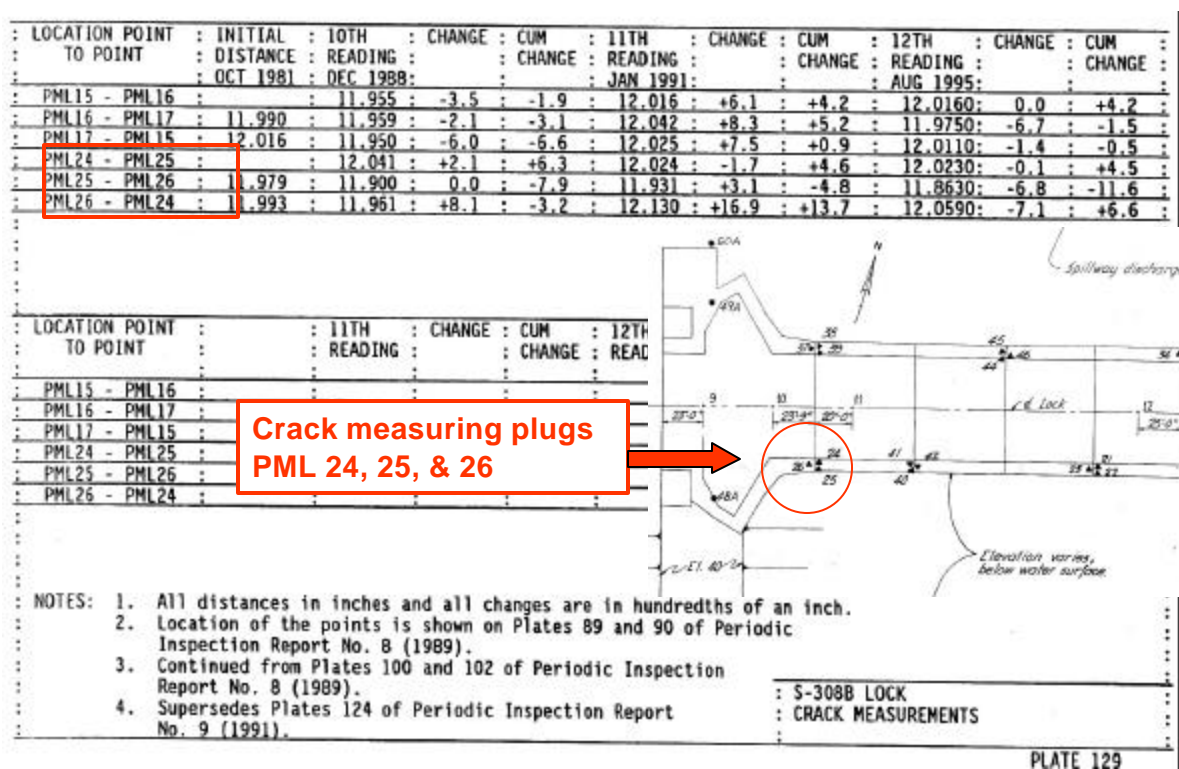

Figure 7-7. Port Mayaca Lock (St. Lucie Canal) crack measurements--1981 to 1995. Distance changes are tabulated for successive readings. Cumulative changes are recorded relative to the initial observation in October 1981.

d. *Micrometer calibration bars.* The calibration bar is used to insure the micrometer is accurate by verifying a 12.000-inch center to center distance. The calibration bar should be kept shaded to prevent dimensional changes. Calibrate caliper/micrometer prior to structure observation using an independent reference. The single, meaned, forward/backward micrometer positions on the calibration bar should be observed/recorded to the nearest 0.001 inch.

(1) Calibration example. The following example illustrates calibration of a Starrett Micrometer. The resulting micrometer and caliper calibration correction is then applied to all subsequent crack readings.

	FORWARD	BACKWARD
Micrometer	11.475	11.475
<u>Dial</u>	<u>-0.021</u>	<u>-0.020</u>
Reading	11.454	11.455
Meaned Calibration Reading = 11.454 inches		
CALIBRATION CORRECTION		
(Nominal Calibration Bar Length)		12.000
- (Calibration Reading)		<u>-11.454</u>
Calibration Correction		00.546 inches

(2) Observation record example. The following is a typical example of a field book entry for a crack observation using a Starrett Inside Micrometer:

Cross Florida Barge Canal, Inglis Lock & Spillway
Points: IL19N4 to IL19N5
19 July 1984 0845
Mic-Bergen, Notes-Noles, Bergen
T - 86° F, Rain
Lock Full @ 36.0' elev.

FWD		BACK
11.475	Mic	11.475
<u>-0.019</u>	<u>Dial</u>	<u>-0.020</u>
11.456		11.455
Mean =		11.456 in
Calibration Correction =		<u>+ 0.546 inch</u>
Corrected Plug Reading = (IL19N4 to IL19N5)		12.002 inches

The corrected plug-to-plug reading (12.002 inches) may be directly inserted on tabulation report with no further adjustments required.

e. Periodic micrometer calibration. Independent annual calibrations should be performed on the following components:

- Inside Micrometer or Calipers
- Reference Calibration Bar
- Threaded ½ inch Plug Inserts

(1) Temperature effects. Calibrations should be checked over the normal temperature range that these devices are subject to in order to determine if expansion (temperature dependent) corrections become significant.

(2) Non-verticality of plugs. There is no method for eliminating the error due to non-verticality of the plugs other than using identical inserts on each visit. Use of inside/outside precision calipers will eliminate most independent calibration requirements other than the calipers themselves and insure true roundness and alignment of the threaded plug inserts. The need for a reference calibration bar may also be eliminated.

7-4. Mandatory Requirements

Micrometer observation and calibration procedures outlined in this chapter are considered mandatory.

Chapter 8 Monitoring Structural Deformations Using the Global Positioning System

8-1. Purpose

This chapter provides technical guidance on the use of the Global Positioning System (GPS) for monitoring and measuring three-dimensional (3D) displacements on large engineering structures. Applications of GPS for the determination of long-term stability and movement on dams, navigation locks, and other similar types of construction projects are described. Technical guidance on procedures, standards, and specifications recommended for data collection and analysis are included.

8-2. Background

The specialized surveying practices described in previous chapters tend to be time and labor intensive. GPS surveying techniques for structural monitoring have a high potential for reduction in manpower needed for conducting deformation surveys. Although GPS can yield positions that are comparable to (and may even exceed) the accuracy levels expected for conventional surveys, its use in the past was limited because of a requirement for lengthy station occupation times. Reduced occupation times have now been realized through the use of specialized instrumentation and enhanced software analysis, resulting in reliable sub-centimeter accuracy from much shorter observing sessions. The technical guidance presented in this chapter contains the procedures and standards for the use of GPS measurements on deformation monitoring projects.

a. GPS overview. The GPS is a satellite-based positioning and navigation service used to obtain geodetic coordinates at a user location in the 1984 World Geodetic System (WGS84). GPS also has the capability for obtaining precise carrier phase measurements for relative positioning between two survey stations. Positional accuracy requirements on the order of 5 mm (horizontal and vertical) at the 95% confidence level can be reliably met using GPS technology, with certain limitations. Station occupation times can be reduced to approximately 15-30 minutes per station. Specialized receiver-antenna equipment adequate for use on monitoring surveys is widely available as commercial off-the-shelf products. GPS observation data can be converted to Receiver Independent Exchange (RINEX) format. RINEX is a universal means to store GPS raw data and orbit ephemeris files. Multiple GPS receiver units can be deployed and operated for many hours to conduct monitoring project surveys. Processing outputs and collected data supply high reliability and statistical assessments routinely applicable to network adjustment position determination. Simultaneous positioning can be obtained on stations normally configured for conventional surveying operations. No highly specialized data collection requirements are needed; however, data processing can become technically complex in more advanced applications of data filtering and data cleaning.

b. GPS applications and precautions. With further refinement of the data processing strategies presented in this chapter, lower cost and better performance on monitoring surveys could be expected from current GPS technology. At the present time, GPS surveying can be used to substitute for conventional monitoring techniques using the standards presented in this chapter. Attention to actual GPS data quality and prevention of systematic biases in the measurements must be made to ensure adequate results. GPS signal disturbances can be unavoidable under certain field conditions. Appropriate measures must be taken to obtain clean (unbiased) GPS data through mission planning, reconnaissance, and careful data post-processing and evaluation of the results. GPS is highly recommended for conducting surveys of the reference network of stable points surrounding the project structure. With high accuracy coordinates on at least two reference stations, and reasonably clean GPS data collected at monitoring points, high accuracy relative positioning can be routinely achieved. GPS users must take

special care to minimize signal obstructions at sites that are prone to generating multipath signal reflections. Methods for accomplishing this are presented in this chapter.

8-3. Scope of Chapter

This chapter is divided into four sections, as summarized below.

Section I: Monitoring Structural Deformations with GPS. This section presents practical guidance for GPS monitoring survey operations. Surveying requirements for accuracy, system performance, and equipment are discussed. Surveying procedures and specifications for planning, fieldwork, and data collection are covered. Data processing procedures are covered which describe the software and processing requirements for baselines and networks, including least squares adjustment techniques. GPS monitoring applications included in this section cover planning surveys for reconnaissance, and criteria for the installation of GPS monitoring networks. Also included are procedures for performing reference network surveys that are conducted for separate high accuracy positioning tasks, and production surveys configured to follow conventional survey procedures and layouts. In addition, procedures for performing specialized GPS surveys are described--as may be required for continuous monitoring, or monitoring under hazardous conditions.

Section II: GPS Performance on Monitoring Networks. This section presents results of field tests conducted to evaluate GPS surveying capabilities on monitoring networks. Principles of GPS carrier phase measurements are summarized, including operational components and user survey controls. GPS receiving system performance, including random and systematic error sources, are discussed. Sources of error in GPS measurements are described relative to GPS system status and site specific effects that present major problems over short baseline networks. Examples are included of GPS performance in actual USACE project monitoring cases, which demonstrate comparable results to conventional surveys.

Section III: Data Quality Assessment for Precise GPS Surveying. This section presents examples and techniques for describing problems with GPS data quality in monitoring applications. Quality assessment tools, including statistics and quality control software, are discussed. Data post-processing, software, and statistics used to solve for baseline position components and evaluate results are described. This section also demonstrates how external network quality can be determined by closure and station checks using multiple inter-connected baselines.

Section IV: Mitigation of Multipath Signals. This section presents information for minimizing and removing multipath errors, which are a major source of systematic error in precise short baseline surveys. A description of multipath effects on GPS carrier signals is discussed. Possible techniques for data cleaning and data re-processing are presented, as are data filtering techniques that can be used to minimize errors and improve solution quality. Also covered are tests on using signal strength values for carrier phase measurement weighting that indicate improvements in removing bias and more robust ambiguity resolution.

Section I Monitoring Structural Deformation with GPS

8-4. Surveying Requirements

a. Accuracy requirements. Typical accuracy requirements for PICES surveys range between 10 mm horizontally and 2 mm vertically for concrete structures, and up to 30 mm horizontally and 15 mm vertically for embankment structures--see Table 2-1. Surveying accuracy specifications are meant to ensure detection of a given amount of movement under normal operating conditions. Allowable survey error thresholds are related to the maximum expected displacement that would occur between repeated measurement campaigns. For each survey, final positioning accuracies at the 95% probability level should be less than or equal to one-fourth (0.25) of the predicted displacement value. In addition to the maximum displacement criteria stated above, the expected velocity and/or frequency (cyclic behavior) should be considered as a further practical basis for the design of accuracy requirements. Specification of accuracy requirements is a major factor in the evaluation of performance for a given GPS-based measurement scheme.

(1) Concrete structures. Long-term movement studies on large concrete structures (mass gravity dams) indicate that normal maximum relative horizontal deflections between any two monolith pairs are on the order of 20-30 mm, due mainly to cyclic-seasonal temperature and pool elevation changes. This implies an accuracy of 5-7 mm in relative horizontal positioning from each survey is required at the 95% confidence level, which is slightly less than the published standard.

(2) Embankment structures. Settlement of earth and rockfill embankments decreases as a function of time (due to consolidation). Normal vertical subsidence is on the order of 400 mm over a 5-10 year stabilizing phase, progressing most actively in the first two years. Mean settlement rates of approximately 50 mm/yr, up to a maximum of 140 mm/yr are typical. Horizontal displacements on embankment structures follow similar stabilizing trends with maximum displacements on the order 90-100 mm, occurring at peak rates of 30 mm/yr. Positioning accuracies of approximately 10 mm/yr vertically and 5-10 mm/yr horizontally are required at the 95% confidence level.

(3) Navigation locks. Navigation lock structures are subject to foundation uplift pressures (especially when dewatered for repairs), and progressive deterioration from use, age, and river environment effects. Lock monitoring includes events such as, ground motion due to nearby seismic activity, scour and associated wall settlements, and inward rotation of wall monoliths away from retaining embankments. Relative movement (tilt) on the order of 20 mm or less between the base and top walls would approach minimum safety and stability thresholds. Survey accuracies on the order of 2-3 mm are required to observe movement trends and give adequate warning time to evacuate the lock chamber(s) before failure.

b. System requirements. A successful GPS-based deformation measurement system must meet the following performance requirements:

(1) The system should provide relative horizontal and vertical positioning accuracies comparable to those obtained from existing conventional deformation surveys, within stated accuracy requirements of approximately 5 mm or less at the 95% confidence level.

(2) Station occupation times should be reduced to minutes per station, approximately the amount of time required for completion of a typical monitoring survey in one working day.

(3) The system must operate with commercial off-the-shelf (COTS) equipment having nominal power requirements, such as the geodetic quality GPS equipment and computers available from commercial sources. It is desired that the system not require classified access for full performance.

(4) The system must collect data that conforms to Receiver Independent Exchange (RINEX) standards for subsequent data post-processing. Raw GPS data logging capability must extend over a full eight hours for multiple reference stations.

(5) The system must provide redundant observations of monitoring point positions so that reliability, statistical assessments, and detection of outliers are enabled. Applicable GPS positions, baselines, and measurement weights must be compatible with requirements for geodetic network adjustment processing.

(6) The system must provide localized coverage over a network of survey points that would be typically installed on project sites. The system should be capable of simultaneously positioning multiple receivers/users on the structure.

(7) It is desired that no specialized operational procedures be required to initialize the system and conduct a mission. Any needed pre-mission operations must be within the capability of the survey crew to perform.

c. Equipment requirements. Only precise carrier phase relative positioning techniques will yield accuracies sufficient for GPS structural deformation surveys. Commercial off-the-shelf (COTS) geodetic type receiver/antenna equipment has the operational capabilities necessary for collecting high-quality carrier phase data. An inventory of recommended components for such a system are as follows:

(1) Receiver. A geodetic quality GPS receiver must have: L1/L2 phase measurement capability, with at least a one second data logging rate; up-to-date receiver firmware version, and hardware boards that include any features available for high fidelity carrier tracking, and RF suppression in static surveying mode; minimum 3-10 megabyte internal raw data storage with a port connection enabled for logging to a laptop computer, data collector, or data communications system; and other accessories for protection and transport, such as carrying cases.

(2) Antenna. At minimum, the antenna must be a dual frequency GPS L1/L2 microstrip antenna with flat ground plane or choke ring, and type-matched to GPS receiver. Both L1/L2 antenna phase center offsets must be published within 1 mm as measured along the mechanical axis to the antenna reference base-plate. Standard antenna base attachment rod/bolt, with 5/8-inch-diameter, 11NC tooling, or other precision forced centered attachment system is required. Standard antenna-to-tribrach mounting adapters and Wild-type tribrachs may be used as a forced centering assembly.

(3) Transmission cables. Antenna-receiver, and data communications (RS-232 serial port interface, or special), connector cables with maximum length of 35 ft. (or suitable number of line amplifiers to prevent degradation of signal and noise amplifying losses) are required.

(4) Power supply. Power supply (AC/UPS) and/or 12V DC battery power (gel cell, camcorder) with compatible charger units and cables. System needs to operate for 10 hours or more without recharge, therefore power requirement design must include peripheral device load. For example, a 12V DC 80 (+) amp deep-cycle marine battery, protective case, and cigarette lighter adapter cable for PC.

(5) Software. Data downloading, logging, or processing software needed for retrieving raw data files, and/or for communication with an external computer and/or other permanent data storage media.

(6) Computer. Computer equipment should consist of at least a 486 PC type computer and operating system having: 9-pin RS 232 serial and 25-pin parallel port interface connections; minimum 200 megabyte hard disk; internal battery and external power port; 12V DC power inverter with external power port connector; external tape/disk drive with PC connector cables and software; and multiple external disks with large (100 MB) storage capacity.

(7) Field equipment. Miscellaneous equipment may include: steel tape or rods for antenna height measurements, wide base opening tribrachs, and nadir plummet for precise tribrach centering; stable surveyors tripod; meteorological instruments; field book; and ground tarp.

(8) Post-processing software. GPS survey data and baseline processing software with RINEX conversion capability.

For multiple equipment systems deployed on a project, efforts should be made to replicate each unit as closely as possible. This includes specifications for hardware manufacturer, model, and physical specifications (e.g., cable lengths), firmware version, and software. Variations in measurement performance between different receiver-antenna system are reduced because equipment related biases are common to each system.

8-5. Surveying Procedures

a. Background. The objective of deformation surveys is to determine the position of object points on the monitored structure. Horizontal and vertical positions are now usually determined by conventional surveying instruments (e.g., EDM, theodolite or total station). Conventional surveys are established from a network of reference stations in stable areas nearby the project site. Distance, angle, and height difference measurements are made to object points on the structure. Work procedures consist of moving equipment from point-to-point and observing, recording, and checking field data on-site. Field data collection is designed for high-reliability by making repeated observations, obtaining check loop closures, conducting instrument calibrations, and collecting auxiliary data (if necessary). Extensive data processing is required to convert raw survey data into useful engineering values (via data cleaning, data reductions, final position determination, and displacement calculations). Final coordinates are based on a least squares adjustment of the survey observations using the fixed coordinates of the reference network. Position differences are observed over time at each object point. These define a specific displacement field valid for the time span between two surveys. The total set of point displacements are modeled as a geometric surface that analytically represents changes in the location, shape, and size of the structure (or its components). Deformation model parameters (linear strain, differential or block rotation, and translations) are used to solve for deformations at any desired part of the structure. The sensitivity and significance of these parameters depend on the number, spacing, and accuracy of the surveyed point positions.

b. GPS deformation surveys. GPS has several advantages over conventional surveys. It provides flexibility in the location of monitoring stations, semi-automated data collection and processing, reliable 3D positioning between two points, built-in error analysis and export capability for survey adjustments, and potentially faster hands-off field survey operation. The fieldwork and procedures for GPS deformation surveys can be conducted in ways that are very similar to conventional surveying field operations described in earlier chapters of this manual. Following is a discussion of recommended procedures for conducting GPS deformation surveys, including preparation, fieldwork, processing, and monitoring applications.

c. Preparation for fieldwork. Data collection efforts with GPS equipment require a moderate level of planning and coordination.

(1) Mission planning. Typically a GPS monitoring survey will require occupations of multiple station points. If multiple receiver units are employed, then coordination of different occupation sequences should be specified prior to the fieldwork. The schedule of station occupation times is based on GPS mission planning. Satellite constellation status and local observing conditions are determined from two main sources of information: (1) GPS mission planning software and, (2) Notice Advisory to NAVSTAR Users (NANU) bulletins. Both should be consulted prior to performing fieldwork.

(a) Mission planning. Software is used to predict the number of visible satellites, DOP values, the location of each satellite (azimuth and elevation above horizon), and continuous coverage for each SV over a given time period. The user must supply a recent GPS satellite ephemeris file and specify the time and geographic location of interest.

(b) Notice Advisory to NAVSTAR Users (NANU). GPS constellation status information is reported by announcements known as Notice Advisory to NAVSTAR Users (NANU). The US Air Force Space Command Master Control Station distributes NANU messages as frequently as new information becomes available. Automated Data Services (ADS) can be checked daily for current outages and scheduled events through the US Naval Observatory (USNO) Internet link at: <http://tycho.usno.navy.mil>. ADS NANU message contents will either describe any warning conditions or indicate nominal operation of the satellite constellation. NANU message files and archived messages are obtained from U.S. Coast Guard Navigation Center (NAVCEN) at: <http://www.navcen.uscg.mil>. The information contained in the archived NANU files include the NANU message number, relevant start and stop date referred to the Day of Year (DOY) that begins at 0000 UT, Message Type (Forecast Outages, Unscheduled Outages, Other), Space Vehicle (SV) and code (PRN), reported Condition, and POC for further information. Standardized message types are designated by abbreviations that describe the condition being reported. NANU bulletins should be checked in advance of and after completion for the times scheduled to conduct GPS monitoring surveys.

(2) GPS equipment. Sufficient time must be budgeted to assemble and organize GPS surveying equipment for transport and/or shipping to the project site immediately prior to the scheduled work. Access to project AC power may require coordination with on-site personnel and all portable DC battery units must be fully pre-charged. A standard property inventory or packing list should be prepared to ensure all necessary equipment is available. Maintenance and inspection of this inventory should be completed before and after each monitoring survey. Items to check include: the condition of exposed parts of the receiver system and accessories, cables and connectors, spare cables, tribrachs and tripods or forced centering brackets, and any loose or missing mechanical parts. Electronics (GPS receiver) and/or computer data storage systems need to be cleaned of any obsolete session files, and then tested for cold start power up/down. All items should be packed and transported in protective cases as appropriate.

d. Fieldwork procedures. Data collection efforts depend on consistent fieldwork practices. The recommended sequence of events for each monitoring station occupation is as follows.

(1) Preparation. Setup tripod, forced centering device, or other stable antenna-mounting frame over monitoring point at station mark. Attach tribrach/trivet assembly, level, and precisely center over reference mark to within 1 mm accuracy. Insert antenna mount adapter into antenna base plate and secure, then place antenna/adapter into tribrach/trivet receptor assembly and orient the direction of the antenna. Attach antenna cable to antenna port and feed it to the corresponding receiver data port plug. Connect 12V DC power supply to the receiver unit power port using battery power cable, or through

extension cord, power inverter (e.g., 300W), and receiver power cables when using AC power supply. Power up receiver unit to begin satellite acquisition search.

(2) Receiver user-defined parameters. Mask angle is set to zero (0) degrees, PDOP cutoff is set to 20 or higher, data logging rate is set to one (1) second, power port control is set to enable primary external battery, P (Y)-code tracking is disabled, and data type is set to normal (full) data collection.

(3) Station data logging. Antenna heights are measured twice to within less than 1 mm and recorded on station data sheet. The antenna ground plane is oriented to magnetic/true north, and secured. Once the receiver unit has acquired at least five satellites (L1/L2 tracking), the survey session can begin. Initiate data logging using the appropriate user controls. Filename and antenna heights are entered in the field through the user interface keyboard. Filenames should reflect station names and antenna heights are designated as vertical or slant range to the ground plane.

(4) At the end of the station observing session, the data logging function is terminated through the user interface and the receiver unit is powered off. Antenna heights should be re-checked. Equipment is disassembled and transported to the next station setup.

e. Data collection procedures. The following data collection scheme may be used at each station to conduct the monitoring survey.

(1) Session length. A session length of 15-30 minutes (L1/L2 GPS carrier phase data) is required to meet minimum positioning accuracies using two simultaneously observed reference stations. On stations where unfavorable signal quality is expected, session lengths may need to be increased based on the outcome of reconnaissance surveys.

(2) Redundancy. Stations are positioned relative to at least two stable reference stations in the reference network. Simultaneous data collection at all three stations is required. Greater redundancy can be obtained by observing each station twice at different time periods. This ensures that the satellite constellation has changed over a significant time period (1-2 hours minimum).

(3) Coverage. A minimum of five (5) visible satellites must be tracked at all times--preferably five or more satellites will have continuous tracking throughout the session. GPS mission planning software should be used to maximize the number of continuously tracked satellites in each session.

(4) GPS data types. At a minimum, L1 phase and C/A code data must be recorded by the receiver at specified logging rates. Dual frequency data should be collected where possible to enable data quality checks and to provide additional GPS observations that enhance survey reliability.

(5) Station data. Specific information related to the data collection must be noted and recorded on the appropriate log sheets. These include: station name, L1/L2 phase center offsets (m), receiver and antenna serial numbers, observer name, date of survey, start and stop times of each session, notes about problems encountered, entered filename and antenna height, antenna cable lengths (m), and session number if occupation is repeated.

(6) Recording interval. A one (1) second data logging rate should be used in all data collected for monitoring surveys. The logging rate is defined as the time interval (in seconds) between each data value recorded in the receiver's internal memory or written to an external storage device. This can produce very large data files that can overload even very fast CPUs if processed as recorded. Some file editing to window the data into manageable pieces is possible once full processing for reference station coordinates has been completed.

8-6. Data Processing Procedures

a. General. Guidance for processing raw data is designed to meet the accuracy requirements set out on paragraph 8-4 (Surveying Requirements). A variety of software applications are available for GPS data post-processing and adjustment. Commercial software is adequate for most GPS monitoring surveys, with some limitations. Scientific versions are more complex and may require auxiliary data to enable certain user-functions. These higher-end packages are capable of extensive and customized processing with robust levels of output and statistics. Recommended procedures for GPS data post-processing on monitoring surveys are summarized below. Background on data processing mechanics is presented in Section III of this chapter.

b. Software requirements. Most GPS post-processing software has standard features for loading data and processing baselines. This is because different applications generally have the same requirements for internal treatments of GPS data and computations. Capabilities for baseline processing software should include the following considerations. Both static and kinematic mode post-processing should be available using a standard session input data file (e.g., RINEX). Satellite data deletion and data editing should be available that is indexed by SV number or by session measurement (indexed by time epoch). A standard text editor or user-developed software programs should be available for measurement editing in the RINEX file. GPS L1 and L2 carrier phase measurement and C/A code position solutions should be available. The option for using only L1 signal or L2 signal data should be selectable for position solution output. RINEX data and ephemeris file input data should be enabled without any special problems. Extraction of ASCII format position data in X-Y-Z, Cartesian WGS84 coordinates, with subsequent conversion of solution data to WGS84 geodetic coordinates, and to projected northing, easting, and vertical coordinates, should be available.

c. Raw GPS data. Information required for post-processing raw GPS observations and GPS ephemeris files are summarized below.

(1) Observation files. Raw data is downloaded from the GPS receiver and imported to the processing software using a computer. Data files stored in binary form must be translated to native data structures that are unique to each software. A universal standard for GPS data transfer is known as RINEX format. This is an ASCII text file format containing a header section followed by time tags with blocks of GPS observations listed under each time tag--refer to Section III.

(2) Ephemeris files. Orbit data is broadcast in real-time (by the GPS satellite) in the GPS signal navigation message. An ephemeris file stored by the receiver contains the decoded satellite orbit data. The broadcast ephemeris can be extracted from the raw GPS data file or is sometimes stored separately with a conventional file name extension (e.g. *.eph). A more refined orbit, known as the precise ephemeris, contains smoother, more accurate post-processed orbit data. A daily precise ephemeris is available over the Internet from the USCG NAVCEN website. Precise ephemeris files usually can be obtained in either binary (*.E18) or ASCII (*.SP3) format. Both may require the post-processing software to be able to interpret these formats. GPS ephemeris files are also produced and archived in RINEX format by university and scientific organizations.

d. Baseline processing. Processing steps for a single GPS baseline are outlined below.

(1) Baseline input data. Computation of baselines requires the following information supplied or edited by the user: station names specified for each endpoint of the baseline, antenna heights in meters for both baseline stations, separate filename for GPS data collected at each station, approximate coordinates

for each station with position quality, receiver and antenna type with known phase center offset, and session start and stop times for each station observation set.

(2) Baseline processor controls. Setup functions for baseline processing require the following control values supplied by the user. Fixed station WGS84 geodetic coordinates must be supplied for at least one occupied station. Accuracy at the fixed station should be close to the centimeter level for best results (e.g., ambiguity resolution). Generally, fixed station coordinates from initial GPS installation surveys or prior monitoring surveys can be used. Satellite elevation mask angle is set between 15-20 degrees. For poor quality data the mask angle may need to be increased (if selectable for each SV). An alternative is to directly edit the RINEX file to remove satellite data at user-selected low elevations, based on data quality assessment statistics or other criteria. GPS baselines are processed for L1 solution only, with the output log file option set to calculate residuals for each double difference combination that was used in processing. Double difference residuals will not be reported for at least one satellite throughout the processing session, as it will be fixed internally as a reference. Set the software to use both L1 and L2 phase and code data if available. This additional data is used by the software to improve ambiguity resolution. Select at least a 95 percent confidence level for reporting all statistical outputs and for measurement outlier detection. The software may supply a default statistical testing value that is equivalent to using a formal 95% confidence in the statistics. Both static and kinematic processing modes can be run using the same baseline processor settings without affecting the mean position solution. Select options for full information logging for each solution output file. Processor log files are typically created for both viewing and printing the baseline processing results. If there is a large amount of output data, printed log files may be easier to view than manually scrolling through it on the monitor.

(3) Evaluation of processing output. The results of each baseline solution are examined for completeness and then compared to survey design specifications. Acceptable mean and standard deviation of residuals are generally in the range of 3 mm and 4 mm respectively, with a fixed L1 phase only solution. Standard deviations of each X-Y-Z baseline component are less than 2.0 mm (one-sigma). Processing variance factor should be between 0.5 and 2.0, and the ratio of fixed to float RMS should be greater than seven (7). Distribution of all double difference residuals should pass the Chi-squared goodness of fit test at the 95 percent confidence level. Scaled point confidence ellipse major semi-axis should be less than 3-5 mm (95%) for each station. The baseline processor software must remove all cycle slips and measurement outliers in data.

e. Network processing requirements. The steps used for processing multiple baselines in a monitoring network are outlined below.

(1) Reference network. The reference network is processed before the monitoring network in order to establish high accuracy control coordinates for each reference station. All simultaneously observed baselines are processed separately between each reference station that was occupied during the survey. One station is selected as a master station having an averaged code position or transferred area control known in WGS84 Geodetic coordinates. These coordinates are established during network installation surveys. Control coordinates on the master station are held fixed in a minimally constrained network adjustment of all reference network baselines. Static session mode solutions are all that is generally required for processing the reference network baselines. Data and post processed results should be examined to remove any obviously poor data following session status and data editing criteria presented in Section III of this chapter. Input controls and output statistics listed above should be satisfied for all reference network baselines. If there are four or more reference stations, then stable point analysis can be applied to detect movements in the reference network. Processing outputs and edited data files are saved separately as part of the project data archive.

(2) Monitoring network. All stable reference network stations are fixed with control coordinates established by the reference network survey processing results. Each monitoring station data file is processed baseline-by-baseline using each simultaneously observed reference station data file. Input controls and output statistics listed above should be satisfied for all monitoring network baselines. Misclosures and data quality checks should be made for baseline post-processing involving each monitoring point following criteria presented above. Processing outputs and edited data files are saved separately as part of the project data archive. Solution files are prepared for export to network adjustment software. An initial adjustment using only minimal constraints can be run between the master reference station and all of the monitoring points to examine initial survey quality.

f. Network adjustment requirements. Once all of the data has been processed and validated, GPS baseline ties will connect the entire surveyed network of monitoring points. All post-processed GPS solution vectors are processed using least squares network adjustment software. Weights are usually supplied by the baseline processing covariance matrix of parameters. The resulting coordinates for each point in the monitoring network define the final 3D position of each monitoring station. Stable reference station coordinates are fixed in the project coordinate system. Standard network adjustment procedures and outputs are obtained for the GPS monitoring survey. At a minimum, error ellipses (95%) are compared to accuracy requirements, and residuals examined for systematic bias.

g. Position displacements. Final coordinates are differenced from the previous survey adjustment to determine the 3D displacement at each survey station. An examination of plotted movement trends (coordinate differences) and comparison of direction and magnitude to the maximum expected displacement is made to summarize deformations of the structure. Any unusual or unexpected movement trends should be traced back so that the supporting GPS data is validated a second time.

8-7. GPS Monitoring Applications

a. General. Various kinds of GPS project surveys are made to obtain specialized information about the structure and its surroundings. These can be classified into four different application types, namely: planning surveys, reference surveys, production surveys, and specialized surveys.

b. Planning surveys. Reconnaissance and installation surveys are made before implementing an extensive program for GPS monitoring. In most cases it will be necessary to collect information about site-specific GPS performance. This involves fieldwork and measurement tests conducted in the planning stages of the design to check proposed new or upgraded project monitoring systems.

(1) Reconnaissance surveys. After it has been established that GPS surveys are a strong candidate system for obtaining deformation measurements (based on job requirements), a site visit is required for reconnaissance. These surveys are made to determine possible locations for monitoring stations, to identify any site-specific data collection problems, and to estimate system installation and future operation/maintenance requirements.

(2) Station placement tests. The objective of the site visit is to collect GPS test data at locations where monitoring is requested (as specified in the monitoring plan). A second objective is to establish temporary points within the area of interest where the best quality data can be obtained. The reconnaissance survey should reflect the proposed permanent survey system as closely as possible using only enough points to check data quality. Baselines are observed at each major section of the structure, especially if site conditions change to where data may be suspect. As few as 2 to 3 baselines on the structure, and, at minimum, one session on each reference station should be observed. Session lengths should be at least one hour for each test station, and at least one baseline session on the structure should be greater than 3 hours. Once the data has been collected and processed, an analysis of its suitability at

each proposed location is made by data evaluation methods presented in Section III. If problems are encountered with a particular station, these will be relocated or be reported to the monitoring system designers for alternative placements.

(3) Example placements. Typical station placement tests might include: stations at the crest and toe of embankment structures; across the total length of the crest of concrete dams, with separate baseline ties to rock abutments made from at least one of the crest monoliths; for navigation locks, station ties from the bank area to the riverside wall, along the length of one wall, and in any areas where stations must be located near walls or obstructions. One test method is to use multiple GPS units deployed over a cross-section of 2 to 3 GPS monitoring points, with simultaneous logging on least one reference station. Most important is that all reference network stations should be occupied and observed for at least one session during reconnaissance surveys.

(4) Maximum baseline length. GPS baselines should not exceed 1 to 2 km from the furthest reference station, if possible. Better results are obtained if only hundreds of meter distances separate the stations. A test should be made over the maximum length baseline on the project to determine the expected low-end precision for the surveys. The GPS baseline length test is at least 3 hours in duration to ensure the solution converges to a stable accuracy level. Baseline accuracy can be examined to determine if the test results meet specifications set out in Section III.

(5) Multipath detection tests. Baseline results and statistics are examined according to methods presented in Section III and IV--to detect the presence of multipath error.

(6) Receiver signal tests. Two GPS stations located near each other on the structure--say within 10 meters--allow both receivers to collect data that should be nearly identical. Data processing results can verify signal error levels where there are large nearby obstructions (several meters away) or vertical walls extending above the antenna.

(7) Mission planning. Reconnaissance surveys can verify mission planning results through comparison with actual GPS data. Data types such as, number of satellites, continuous coverage, DOP values, elevation angles, and visibility windows for specific satellites are examined to confirm design values. Any potential trouble spots in the observing area should be identified before making permanent station installations.

c. Installation surveys. After permanent monitoring stations are selected (and monumented) an initial GPS network survey must be made to complete the installation. This procedure involves a site visit with all field equipment required to conduct the installation survey. The initial survey of project baselines should be made to higher standards than those designed for production monitoring. Additional GPS data will yield high accuracy initial positions and supply a relatively large amount of data for a final system performance checkout. The surveying methods used for the initial survey of the reference network are identical to those used for production work. Data collected at each of the monitoring points on the structure may have 25-50 percent longer sessions, or at least one hour of data (whichever is greater).

d. Reference network surveys. The reference network consists of stable monuments set near the structure as a permanent reference frame for tracking movement of the structure. Surveys of the reference network require the highest accuracy measurements on monitoring projects. The precise relative position of each station in the reference network is needed to produce better accuracy during production surveys. The following design specifications for reference network surveys are recommended.

(1) Number of stations. A minimum of two reference stations must be occupied during the entire data collection phase of the production surveys. Three or four stations may be required if the project site

has difficult station placements (due to terrain, sky visibility, long baselines) or special high position reliability requirements. At least one (preferably two) continuously occupied control points on the structure (tied into the reference network surveys) will allow short baselines to be observed to the monitoring points.

(2) Session length. At least 3-4 hours continuous occupation time at each reference station is required. More than 4 hours will improve the reliability of the positioning. Reference station surveys are conducted at the same time as production surveys. Data editing for reference surveys is less critical than for production surveys because there is usually a larger percentage high accuracy data. A reasonably clean data set must be obtained for the reference network but this is not usually a problem because observations are made over much longer sessions.

(3) Visibility. Wide-open areas with sky visibility in the south direction are preferred. Large objects (buildings, walls, fence lines) in the vicinity of the station should not extend above the antenna ground plane if possible. Areas free of any obstructions that produce signal reflections (e.g., buildings, water bodies, and metal structures) are most favorable. Sometimes tourist overlooks and open areas near parking or picnic facilities can provide the best locations for reference stations on reservoir projects.

(4) Structure reference points. It is recommended that at least one control point station be placed on the structure itself. With this structure (reference) point scheme there will always be a high-order station at a short distance to the monitoring points. The structure station is tied into the surrounding permanent reference network using long observation GPS baseline data. The longer observing session provides better positioning accuracy and better ambiguity resolution to the monitoring points.

(5) Station occupation. Reference stations should be constructed and maintained according to guidance presented in previous chapters. Antennas should be force-centered to within 1 mm tolerance. Antenna heights should be no less than 1.5 meters from the ground. Obstructions in the immediate area should be no closer than 1 meter to the antenna. Geodetic L1/L2 antennas with ground plane are required, and choke ring antennas can be used to improve multipath suppression.

(6) Project datum selection. Coordinates in the WGS84 system should be used to define the project datum if possible. Observing ties to NGS or other local high-order control networks can be used to establish initial coordinates on monitoring reference networks.

e. Production surveys. GPS production surveys share many practices with conventional surveying. For example, setting station monuments, occupying these stations, data processing and reductions, and archiving results. Advantages over conventional surveys include less reliance on station intervisibility, automatic data collection, semi-automatic data processing, electronic data transfer and storage, and flexibility in deployment. GPS techniques presented in this section attempt to match the work flow and field procedures familiar in conventional surveys as closely as possible. Processing production survey data includes both kinematic and static mode solutions. Kinematic mode allows the user to examine and edit positioning data within a series of discrete position solutions. Static processing provides adjustment residuals and robust session statistics. Results of both types of processing should be compared during the evaluation of the survey.

(1) Kinematic surveys. Kinematic positions are processed sequentially from the raw data to obtain an output at every measurement epoch, provided the integer ambiguity for each satellite is resolved. Kinematic processing involves downloading data from each receiver as would be done for a static session file and then either converting to RINEX or retaining as a binary file. Selecting the kinematic processing option will force a solution in kinematic mode. All other processing options are set as if it were a static session. One reference station is held fixed with its high accuracy coordinates. Next,

process the L1/L2 data for each two-station baseline and extract the time series of WGS84 X-Y-Z positions for the monitored point as an ASCII file. Export the data in columns to a spreadsheet or similar software package. Various statistics can be computed such as a mean value for each coordinate component (X, Y, and Z), point differences from the mean, and plotting the position deviation time series. Problem data is identified by inspection and testing according to the quality control procedures in Section III. Clean data is separated by selecting time epochs associated with the best data quality statistics and then reported or re-processed. An average of the highest quality kinematic positions is made to obtain the final position for the monitored point with respect to the reference station.

(2) Static session processing. Data collected in static survey mode is processed as a block to produce an average position over a given time span. This has the advantage of providing a high degree of redundancy over the entire GPS observing session. Interpretation of statistical outputs is simplified when using a static session mode; however, biases can more easily corrupt the processing session as a whole. Static surveys work best at stations where GPS data has been confirmed to be of high quality, such as where the observing conditions are historically very favorable.

f. Specialized surveys. GPS can be used for continuous deformation monitoring as a permanent installation, during temporary repair work, or where human occupations are potentially hazardous.

(1) Continuous monitoring systems. GPS can produce real-time continuous positioning for monitoring applications. The main practical drawback is the high cost associated with permanently installing multiple receiver units on the structure and the specialized software to process and display the desired outputs. Although equipment prices have lowered in recent years, deployment of more than a few systems on a structure can be cost prohibitive. Generally, continuous GPS monitoring is used for plate motion and tectonic studies that cover wide regional areas. For example, there is the seismic monitoring array in the western U.S., and the extensive global GPS tracking networks established by the International GPS Service for Geodynamics (IGS). Localized GPS networks have also been developed that track movements on structures in a continuous operating mode. These systems are configured for either static or real-time survey operations with a GPS receiver, antenna, data communications system, (e.g., radio-link, fiber-optic line), and a power supply. A single off-site GPS base station is used to assemble and process outputs from multiple GPS units mounted on the structure. Communications to the base station are through spread spectrum radio and may broadcast either raw data, data corrections, or positions, depending on the processing configuration. Batteries are used as either a primary or backup power supply. With adequate power and receiver system protection, these units are designed to operate continuously for extended periods of time. Problem situations and data corruptions can arise in continuous operation--for example, occasional abnormal GPS satellite status, extreme weather, equipment failure, accidents, bird nesting on antennas, and power interruptions. Software required to process continuous GPS data will usually have to be specially developed to suit the proposed equipment, data types, and desired outputs. One of the advantages of continuous monitoring systems is their ability to collect data over very long sessions that can be processed and archived as daily session files. Millimeter accuracies are typical for daily GPS sessions collected over relatively short baselines. Another advantage to continuous GPS monitoring is the ability to customize outputs, such as for high accuracy, increased sensitivity to movement in a particular direction, or to warn the user if movement exceeds a safety threshold.

(2) Hazardous conditions. Conventional GPS surveys can be used in situations where the structure is undergoing repairs. In hazardous conditions, GPS can be set up to log continuously in kinematic solution mode to provide near-instantaneous movement data to site personnel. Usually these surveys are a temporary source of movement data. A typical configuration is with a GPS rover and a base station providing continuous real-time position output. Each system is equipped with communications to enable monitoring at a safe distance while providing the same outputs as conventional GPS monitoring.

8-8. GPS Survey Reporting and Results

a. General. This paragraph describes survey reporting, data organization, and permanent storage of GPS data and results.

b. Survey reporting. GPS monitoring surveys produce large amounts of data and processing outputs. Some of this information is critical to examine and save--other parts are not valuable or are not required for the overall objectives of the survey. Important types of information include the final position outputs from the least squares network adjustment. This includes a numerical summary in the form of tables for the previous and current surveys. Graphs, charts, and diagrams that document the performance of the survey at each monitoring station are useful as supporting data. For example, condensed tables of processing results, statistics, kinematic positioning plots, displacement trends, and reference network survey reports each as a separate appendix. Statistics should provide survey point positioning error reports for each station at the 95 percent confidence level. Plots of station error ellipses in their respective locations (site plan) help visualize the final survey quality. Sessions that undergo any specific data editing or have specific data quality problems can be placed in a separate appendix. Reporting formats should follow practices established for conventional monitoring surveys.

c. GPS data storage. Monitoring survey data and results must be archived for future reference and possible use. Raw data files, processing outputs, and final results should be maintained in electronic form for data compression. Raw data should be converted to RINEX and stored along with ephemeris data as a separate data directory. Generally, information will be stored in sub-directories according to the project name, survey campaign, and by date it was collected or processed. Most GPS processing software provides an option to archive the entire survey in a single compressed file. Precautions must be taken against the processing software (version) eventually going out of date where archived project files can not be retrieved. Enough information should be saved to reconstruct the final results from each survey using a non-proprietary data archiving system. Custom processing outputs, such as edited output files, plots, and the final report should also be archived in a separate computer file and directory. An index to the project survey files is critical and should be placed in a 'readme' file that is easily accessible. For example, have all survey data in a separate directory, including raw data, ephemeris data, and any edited data files (annotated in the comment section to describe file edits). A separate directory is reserved for storing processed outputs such as the software-specific project archive, session log files containing error reports, and data quality indicators. A separate directory is reserved for the project network adjustment and its associated results and outputs. A separate directory is reserved for baseline processing solution files covering static mode sessions and any spreadsheets used to examine kinematic station position solutions. The recommended media for project archiving is write-once compact disk (CD). Generally, one CD for each completed monitoring survey will supply enough permanent data storage capacity and will keep all related survey data and results in one place.

Section II GPS Performance on Monitoring Networks

8-9. Principles of GPS Carrier Phase Measurement

a. General. There are two different methods for positioning with GPS signals, namely: (1) code range and (2) carrier phase. Only GPS carrier phase is accurate enough to be used for monitoring surveys. Code ranges are described below only to complete and simplify the carrier phase discussion that follows.

b. Navigation message. A navigation data message, containing satellite and system information, is broadcast by each satellite to enable GPS code range positioning at the receiver. The 50 Hz navigation message is modulated onto each GPS carrier signal in 25 data frames each containing 1500 bits of data. Each frame is further divided into 300 bit sub-frames containing: satellite clock bias terms (offsets from GPS master clock); satellite health information; broadcast ephemeris (predicted satellite position in orbit as a function of time); almanac data (low precision clock and orbit data for all GPS satellites); constellation health and configuration; text messages; and GPS-UTC time offsets. The navigation message data stream is compiled into a separate block of data known as the ephemeris file. The GPS ephemeris file is required for data post-processing.

c. GPS code range. GPS satellites continuously transmit a spread spectrum signal composed of two binary phase-modulated (PM) pseudo random noise (PRN) codes called C/A code and P(Y) code, and a navigation data message (ephemeris). Transmitted RF signal power is diffused over a wide bandwidth to resist signal jamming and interference. Each GPS code output is controlled by a pre-defined chip sequence unique to each satellite at a given time, and are set to maintain low cross-correlation values (i.e., orthogonal). PRN codes follow binary phase shift key (BPSK) formulas with a known structure that allows the GPS receiver to generate an exact replica code sequence. Cross-correlation and tracking of the received PRN code recovers precise Space Vehicle (SV) timing data from an on-board atomic standard. Local receiver generated codes are synchronized to the transmitted code using delay lock loop (DLL) signal processor. Differences between received and internal code sequences are minimized during correlation and the active incremental time shifts that occur as a result of correlation matching are measured and recorded. Time differences are converted to a range value between the antenna and each GPS satellite. With at least four satellites being tracked, a unique intersection point is defined in relation to World Geodetic System 1984 (WGS84) coordinates. GPS code ranges provide an absolute point position that can be output in WGS84 geodetic coordinates. Code ranges do not provide high position accuracy in relation to the requirements for monitoring structural surveys. Code ranges are used in signal processing operations involving carrier phase data, such as initial signal acquisition, code stripping, and timing.

d. GPS carrier phase. GPS code and navigation data are modulated onto two separate L-band frequency (microwave) EM carrier transmission links (L1 and L2). The L1 frequency carrier has a 19.03 cm wavelength, and the L2 frequency carrier has a 24.42 cm wavelength. GPS carrier signals propagate as electro-magnetic waves; therefore, signal phase can be tracked in the receiver unit by the use of phase lock loop (PLL) circuits. Carrier phase measurements are the basis for high precision surveys for relative positioning. The L1/L2 phase states in two receivers are simultaneously tracked and recorded at regular epochs by each receiver. Data collected by the GPS receivers is then referenced to a common GPS time system, which is a requirement for later post-processing. The signal phase processed through each receiver channel is accumulated by counting the number of cycles and fractions of cycles that have registered over a given span of time under continuous cycle lock. Both the instantaneous phase difference and integer number of full wavelengths (integer ambiguity) between each satellite-receiver pair are

known at each receiver station. Various linear combinations of the measured phase are processed in a least squares adjustment to compute coordinates differences between each station. These phase measurement combinations include single, double, and triple differences. The most important of these observables is the double difference phase. It has the desirable property of enabling the use of GPS carrier waves for precise ranging and for eliminating major sources of systematic error.

e. GPS operational components. Components of the receiver/antenna instrument assembly provide the operational capability to measure GPS carrier phase. GPS surveying equipment consists of antenna, coupling circuits, transmission line, and receiver unit. Performance of GPS equipment is highly dependent on the type of electronic, control, and signal processing components in the receiver unit and the manufacturing quality of the antenna element.

(1) Antenna. GPS microstrip antennas are manufactured to precise dimensions and tolerances to enable uniform signal reception. GPS antennas operate by generating an electrical response to an incoming EM signal with high sensitivity to signals arriving in the half-space above the antenna element. The antenna response is localized at the edges of the microstrip (patch) antenna board. The local EM field created by the signal waveform is sampled at the phase center of the antenna. An average position for the distributed field intensity is the best-fit center of phase for the antenna. This location is where the antenna senses the GPS signal and defines the positioning reference point in GPS surveying. Due to slight uncontrollable manufacturing defects, phase center position uniformity can vary between different antennas as a function of satellite elevation angle and azimuth.

(2) Pre-amplifier. The amount of RF power at a specific frequency is low for GPS spread spectrum signals. Usually it is embedded below thermal noise levels (-160 to -166 dB) before waveform correlation and de-spreading is used for carrier recovery. Input signals are amplified by low noise pre-amplifiers located at the base of the GPS antenna (this happens after RF interference bandpass filtering).

(3) Antenna cables. Coaxial transmission cables carry input signal voltages from the antenna pre-amp to the antenna port plug-in on the receiver casing. Cables are specially designed to have matched characteristic line impedance and VSWR transmit properties with respect to both the antenna and receiver terminals. Therefore, substitutions to standard cable equipment supplied by the manufacturer are not recommended.

(4) Signal converters. Downconverter frequency mixing lowers carrier input to an intermediate frequency (IF) where analog-to-digital (A/D) conversion and sideband filtering takes place.

(5) Receiver channels. Digital IF signals are input to receiver channels and combined with replica in-phase (I) and quadrature (Q), orthogonal sine/cosine carrier maps (periodic replica waveforms) generated by the receiver's internal reference oscillator. Code, data, and carrier stripping for each SV occurs in the receiver channel.

(6) Phase Lock Loop (PLL). Two signals are input to a PLL circuit, one external and one internal. The PLL is essentially a clock that adjusts its frequency (or phase) to match an input signal. PLL electronic control techniques maintain the phase of the internal (local) oscillator signal close to the phase of the external GPS signal to allow phase tracking. Components of the PLL circuit are the phase detector (comparator), loop filter, voltage controlled oscillator, and frequency divider.

(a) Phase detector. The phase detector produces an output voltage as a function of phase difference between the two input signals that are maintained in phase lock.

(b) Loop filter. Tuning filters integrate and scale phase/voltage input to produce noise reduction at its output. Slower narrow bandwidth loop filters supply greater noise reduction at the expense of signal dynamic range.

(c) Voltage Controlled Oscillator (VCO). Quartz oscillator crystals control VCO frequency response as a function of input voltage. Loop filter inputs are used to adjust VCO frequency to effect PLL tracking feedback.

(d) Frequency dividers. A variable phase matching range is maintained in the PLL feedback path by programmable counter and divider ratio logic that steps output frequency in controlled increments of the input reference frequency.

f. Phase tracking. Phase tracking is controlled by the operation of PLL circuits. Time-varying carrier signal inputs create a voltage response in the phase detector due to a phase difference between the input and reference signals. Carrier loop filters amplify and clean this phase/voltage response to generate a feedback frequency (phase) shift in VCO output. Range matching is then supplied by frequency dividers to prepare the updated reference signal for feedback to the phase detector, which closes the PLL circuit. These tracking system controls are performed by microprocessor chips, and used to monitor incoming GPS carrier signals. Accumulated phase travel is recorded at user-defined GPS time epochs. These cycle count values are stored in binary form in receiver memory.

(7) Internal data memory. Data storage is handled by magnetic media that is typically installed in blocks of 1-10 MB per memory board. The manufacturer upgrades memory at additional cost to the user. Microprocessors control read-write functions through a LCD screen and user interface, or by pre-programmed survey controls.

g. User survey controls. Most COTS GPS systems are equipped to allow a range of user programming options that specify its operation on a given survey. Some systems have limited user input capabilities (eg., power on/off) to simplify installation and use at permanent sites, such as on construction equipment. These types of systems are designed to give continuous, real-time position outputs to external radio-link, processor, or software systems. Other GPS units consist of stripped down OEM board processors used for highly specific positioning and navigation applications controlled by a custom computer system.

(1) Observing parameters. These options must be set to specific values before data logging commences.

(a) Mask angle. Mask angle defines the cutoff elevation angle (0-90 degrees) above the horizontal plane used for search, acquisition, and tracking of GPS satellites.

(b) PDOP cutoff. Position Dilution of Precision (PDOP) describes expected GPS code position quality. PDOP cutoff defines the value below which the receiver will cease tracking a GPS satellite signal.

(c) Data logging rate. Specifies the time increment that will initiate recording a new block of GPS observations to memory for storage and downloading.

(d) File name. Alphanumeric code that identifies individual session files in receiver memory. Typically COTS GPS receivers will supply a default file name that can be changed during downloading or post-processing.

(e) Antenna height. The user can enter antenna height measurements into the session file, or a default value of zero is typically provided.

(2) System parameters. Because GPS receivers are designed for many different surveying applications, alternate operational modes may be available to the user, which must be selected in advance.

(a) Data type. This is a generic setting that designates whether the receiver will automatically reduce the scope of observations that will be logged to memory.

(b) L1/L2 operation. P-code tracking in crypto-keyed receivers must be disabled before normal data logging will be allowed. Full wavelength L2 carrier phase measurements are unavailable due to anti-spoofing (A/S), therefore, cross-correlation with L1 phase or signal squaring is used to reconstruct L2 phase for dual frequency applications.

(c) Communications. Typically any functions related to external communications need to be disabled for proper static surveying operations.

(3) Operating parameters. Most receivers have customized features that provide convenient status information to the user.

(a) Power controls. Systems with multiple power source inputs will have some means to check the level of battery charge or a switch to enable a particular power port.

(b) Tracking status. Various screens are available to determine the number of activated SV tracking channels, L1/L2 signal acquisition and lock, and code position updates.

8-10. GPS Receiving System Performance

a. General. The RMS error of GPS receiver PLL carrier phase tracking can be characterized by the phase measurement precision, and by systematic errors that distort the clean GPS signal waveform during its transmission, propagation, and reception. Thermal noise and oscillator deviations are principle sources of random noise in GPS receiver units. Systematic error is mainly caused by physical correlation between the GPS signal and its path environment. The adequacy of GPS surveying can be established in part by these internal and external receiving system errors. GPS receiving system performance is a major factor in determining whether surveying systems requirements have been met. Following is a description of performance and operational limitations that must be accounted for in the design and execution of GPS monitoring surveys.

b. Receiving system noise. Superior phase tracking performance is obtained if the formal (random) error in the phase measurement, and in the VCO clock stability, are limited to a sequence of low noise, zero-mean error states. Under healthy observing conditions, the random error in carrier phase tracking can be modeled directly from the values for received signal carrier-to-noise power density ratio (c/n_0), and PLL filter noise bandwidth (B). These parameters determine an effective tracking channel noise figure in each receiver. Major random error sources in GPS signal tracking are: receiver system thermal (Gaussian) noise (which is dependent on received signal frequency), and short-term phase tracking jitter induced by random deviations in PLL stability and feedback control inputs associated with receiver clock performance (Allan variance of local oscillator). For most GPS static surveying applications, a base resolution of 1/100 part of the wavelength is used as a practical limit for best-case tracking performance. By combining minimum detectable carrier-to-noise (C/N) deviations with a lower-end PLL noise bandwidth (2 MHz typical), at nominal L1/L2 wavelengths, and accounting for clock

stability performance in modern receivers, a maximum of 2-3 mm of phase uncertainty is expected for GPS phase measurements.

(1) Thermal noise. The equation for approximating the error on the carrier phase (L1 or L2) due to thermal noise is:

$$\sigma_{\text{PLL}} = (\lambda / 2 \pi) (\text{sqrt} [B / (c/n_0)]) \text{ (m)} \quad (\text{Eq 8-1})$$

where

B is the carrier tracking loop bandwidth (Hz),
 λ is the wavelength of the carrier (m),
 c/n_0 is the carrier-to-noise density expressed as a ratio,

and

$$c/n_0 = 10^{(C/N_0)/10} \text{ for } C/N_0 \text{ expressed in dB-Hz.}$$

This equation gives a nominal value for the L1 noise of 0.2 mm for a 2 Hz noise bandwidth and a C/N_0 value of 45 dB-Hz. There is an inherent tradeoff between phase measurement resolution and dynamic tracking range in the general design of PLL filters. Better performance on monitoring projects will be obtained from narrow bandwidth correlators. This is because the ground antenna is stationary for the duration of the observing session and satellite-receiver dynamics are always well below PLL tracking thresholds. Higher phase resolution at lower PLL bandwidth is practically limited by received noise power and tolerance to sluggish loop response times.

(2) Clock stability. The equation for approximating RMS phase jitter in the tracking loop has been given by,

$$\sigma_2 = (\lambda / 2 \pi) P (\sigma_A) f_L / B \cdot \text{(m)} \quad (\text{Eq 8-2})$$

where

P is an empirical constant based on the PLL loop-order,
 f_L is the frequency of the carrier (Hz),
 σ_A is the Allan deviation expressed as a function of short-term gate time (τ),

Allan deviation is determined for a given PLL filter according to the expected receiver clock frequency stability ($\Delta f/f$) as a function of the loop filter bandwidth.

$$\sigma_A = (\lambda / 2 \pi)^{-1} (\sigma_\theta) / (\omega_L \tau) \quad (\text{Eq 8-3})$$

where

$\tau = B^{-1}$ (sec),
 $\omega_L = 2 \pi f_L$ (rad/sec).

This equation gives a nominal value for the L1 noise of 0.7 mm for an 18 Hz noise bandwidth and specified Allan deviation (σ_A) of less than $1 \cdot 10^{-10}$ (dimensionless). The performance of the Voltage Controlled Oscillator (VCO) also contributes to the phase measurement resolution through the random

clock drift tolerance term (Allan variance) that impacts the synchronized reference time epoch value reported by the VCO. Actual phase measurements consist of a time-smoothed PLL output that is dependent on the clock stability and PLL correlator bandwidth.

(3) Received signal noise. Signals arriving from GPS satellites are received as continuous, quasi-periodic waves, composed of code and data modulated carrier signals plus Doppler frequency shift. Antenna excitation and response is caused by local electric field variations at the antenna phase center. Pure carrier signals (e.g., sine waves) have a line spectrum of discrete frequencies (harmonics), described mathematically by Fourier series analysis of the antenna-input data. The near-field electric field at the antenna also contains signal distortion effects and noise from: local sources of RF interference; coupled EM interactions (imaging) between the antenna/ground plane, local electric field, and nearby conductors; diffraction signal scattering at the edges of the ground plane; signal reception through side lobes (antenna illumination below ground plane); and signal multipath. The presence of external EM noise and environmental field effects lowers the spectral purity of transmitted GPS L1/L2 signals. Unwanted noise power components are characterized as random signals, described statistically by signal power spectral density, and noise field strength parameters of the antenna. L2 signals are generally noisier than L1 signals, and this noise generally reduces the precision of carrier phase measurements. Measurement noise is also modeled as random error produced by physical correlation in the generation, propagation, and reception of GPS signals.

c. Correlation in GPS data. Correlation describes the extent to which measurement errors will be similar as a result of common external observing conditions and as a result of math modeling applied to the data. High data correlation reduces the statistical independence between measurement errors and lowers the significance of random error parameters (mean and variance). This highlights the importance of using error treatments in post processing that do not neglect data correlation. Both spatial and time correlation can influence GPS performance and if possible their effects on error estimates should be accounted.

(1) Physical correlation in GPS data. GPS signal behavior is understood to be highly correlated when common-mode conditions occur due to geometry, environment, and system specifications used to mechanize GPS operations. Important sources of physical correlation in GPS data are: geometry of the satellite constellation; ephemeris (orbit) errors; frequency dependent atmospheric propagation delays; satellite and receiver clock synchronization; receiver system throughput latency; spectral receiving system noise; and multipath interference. Spatial correlation in GPS data can be largely related to baseline length and common mode GPS system status. Biases are minimized by differencing data and by allowing satellites-in-view to change position (over time) which yields a range of Dilution of Precision (DOP) states throughout the survey. Changing satellite geometry tends to randomize small residual biases that occur over short baselines. Correlation times in GPS data are based on both the session length and the data sample rate needed to span a large percentage of independent (uncorrelated) observations. If the session is averaged for longer than the total period of the correlated error signal, then short-term measurement deviations will be evenly distributed about an unbiased mean value. Data sample rates lower than the data correlation time produce unrealistically low errors.

(2) Mathematical correlation in GPS data. Double difference combinations made during baseline processing will create mathematical correlation in the processed output--especially as a tendency to magnify initial measurement errors according to statistical error propagation laws ending up in the covariance matrix of parameters. As a result, error estimates (baseline component standard deviations) are generally overly optimistic. Other sources of math correlation are determined by the specific processing scheme implemented in the GPS software. The most common sources are due to: data differencing (single, double, triple); least squares filtering; dual frequency L1/L2 atmospheric delay correction; L1/L2 cross-correlation used to recover L2-carrier data under A/S; dual frequency ambiguity

resolution techniques (widelane, narrowlane); choice of reference satellite; specific SV double difference combinations; and the elimination of nuisance parameters in the normal equations matrix. The manner in which math correlation is handled is largely dependent on level of rigor used for statistical error treatment in the software and the proper formulation of error estimates in the covariance matrix of parameters.

d. External data correlation. Studies of the effects of physical correlation on accuracy estimates in GPS relative positioning have shown that double difference residuals are subjected to empirical modeling based on various forms of the autocovariance function. The study method was designed to isolate a distinct error estimate for both mathematical and physical correlation in GPS double difference residuals. Significant trends in the residuals were modeled to describe baseline error as a consequence of neglecting physical data correlation. Results over medium length baselines indicate that standard deviations of coordinate components are typically reported at much lower than actual values (perhaps by a factor of two). Other relevant findings include a determination of error correlation times for L1 and L2 GPS double differences persisting over 4-5 minutes of data. This could be interpreted as the minimum observing time period needed to produce independent measurement error values where physical correlation is not explicitly accounted for in the processor's weighting scheme. A corresponding 20 percent increase in the standard deviation of each coordinate component is indicated. Other empirical results deal with fixed and float ambiguity variance ratio estimates that are compared against the convergence times between math and physical correlation trials. Convergence to typical error levels reported by the software (variance ratio of 7.0) required about 10 minutes to occur. Finally, GPS double difference observations can be positively correlated for a period of up to 20 minutes on shorter test baselines. These results are an important indicator of expected performance on monitoring networks for two reasons. First, baselines are expected to be shorter than used in the above trials (1-2 km), therefore the reported impacts of correlation could be used as an upper limit for tolerance to physical correlation in deformation studies. Second, guidance presented in Section I is mainly compatible with these independently established GPS observing tolerance limits.

8-11. Sources of Error in GPS Measurements

a. General. The observation equation for the GPS carrier phase can be written in length units as:

$$\Phi = \rho + c (dT - dt) + \lambda N - d_{ion} + d_{trop} + d_{mp} + \text{noise} \quad (\text{Eq 8-4})$$

where ρ represents the geometric range between the satellite and receiver, c represents the speed of light in a vacuum, dT and dt represent the receiver and satellite clock errors respectively, λ represents the signal wavelength, N the integer cycle ambiguity, d_{ion} represents the phase advance due to the ionosphere, d_{trop} represents the delay due to the neutral atmosphere (predominantly the troposphere), d_{mp} represents the delay due to multipath in the antenna environment, and noise in the signal. Additional small terms such as satellite and receiver hardware delays have been ignored. By differencing observations recorded simultaneously at two receivers from two satellites, any common mode errors at either the satellites or the receivers should cancel. The error terms left in the double difference observable are d_{ion} , d_{trop} , and d_{mp} --as the effect of receiver error, satellite clock error, and satellite position error are almost completely removed. A differential ambiguity term (DN) is retained in the double difference equation. The noise component has been amplified in the double difference, by assuming that noise is equal for the raw observations at two receivers, and the noise of the double difference observation is then approximately twice as large. This increase is the trade-off accepted for greatly reducing the impact of the clock errors. Over very short baselines with negligible height difference the trade-off is even more worthwhile, since atmospheric effects almost completely cancel.

b. Cycle slips. Correctly fixing ambiguities requires continuous carrier phase observations with no cycle discontinuities over the observation time series. Any cycle slips must be removed prior to estimating the station coordinates. The data sets from each occupied station are pre-processed individually to scan the carrier phase observation time series for large jumps and excessively noisy data. An output file of the pseudorange and carrier phases is produced that is free of large cycle slips. Cycle slips of a small magnitude (at the level of several tens of cycles) are best detected from the time series of double difference observations, where many of the potential biases have canceled. Cycle-slip detection is generally implemented as an automated data cleaning process that depends on high quality data and sufficient redundancy to allow lots of data to be rejected (sometimes unnecessarily).

c. Baseline length. A simple expression for relating common mode GPS range error (Δr) to baseline error (Δb) uses the ratio of baseline length (b) to satellite range (R).

$$(\Delta b / b) = (\Delta r / R) \quad (\text{Eq 8-5})$$

For satellite range of 20,000 km and baseline length of 1 km, a common mode error of 20 meters is necessary to produce 1 millimeter of baseline error. This relationship emphasizes the advantage to maintaining short baselines on high precision networks. Short baselines should limit common GPS errors to less than 20 meters and permit cancellation of highly correlated errors.

d. Atmospheric delay. Ionosphere and troposphere delays are expected to be highly correlated over short baselines, although small residual effects may persist depending on atmospheric differences between receiver stations. For this error to increase to harmful levels would require baselines over 1 kilometer, or very substantial station height differences (which may occur on some dam sites). Uncorrelated delay bias is modeled and removed from the data on medium range baselines (10-100 km). However, these correction schemes are not accurate enough to determine slight differential biases at short baseline noise levels.

e. L1/L2 data combinations. GPS software will allow the user to process data in combinations of L1 and L2 carrier frequencies each having different levels of observation noise. Any combination of these two observables (e.g., ionosphere-free L1/L2) will increase noise levels due to error propagation. Over short baselines the ionospheric effect is expected to cancel so there is no advantage to be gained by using anything other than the L1 observations for positioning purposes. L2 observations however, could be useful for cycle slip detection and data quality control. The L2 residuals are approximately 1.5 times noisier (RMS 6.6 mm) than the L1 residuals (RMS 4.4 mm), and the L3 residuals are approximately 3 times noisier (RMS 12.8 mm). Figure 8-1 shows how some of the structure in the L1 residuals is magnified by the L3 combination. The symmetric pattern of the residuals is due to the particular formulation of the double difference observations.

f. Satellite geometry. The spatial distribution of satellites in the sky will influence how random error propagates into the final position. Since GPS satellites are not uniformly distributed, certain areas of the sky will have less satellite coverage at a given time. If GPS satellites are evenly and widely spread out, then stronger geometric intersections are possible for code range positioning and carrier phase measurements. Because there is total lack of sky coverage below the GPS antenna, vertical DOP values and GPS height errors can be 1-2 times greater, respectively, than HDOP and horizontal position errors.

g. Blunders. Operator mistakes produce large discrepancies in processed GPS data. Only system redundancy built into the observing scheme can detect blunders--see Section IV. Two common survey blunders are incorrect antenna height measurements and incorrect filenames entered into the receiver.

h. Multipath. See Section IV of this chapter.

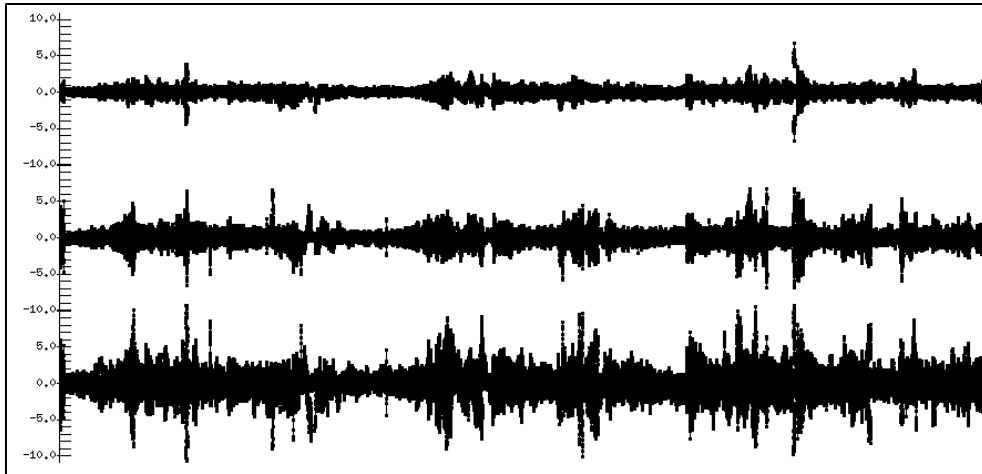

Figure 8-1. Typical carrier phase residual noise levels from double difference processing; from top to bottom, (a) GPS L1 frequency, (b) GPS L2 frequency, (c) GPS L1/L2 widelane combination.

8-12. GPS Performance on Monitoring Networks

a. General. Results of accuracy performance and operational adequacy of GPS surveying for monitoring applications are presented in this section. Data collected under controlled conditions and at USACE monitoring projects are described. Simulated deformations are used to test GPS capability to detect movement over short baselines. Comparisons are made against conventional surveying performance and requirements outlined in Section I of this chapter.

b. GPS performance trials. Factors used to evaluate GPS performance include: user-set parameter values for data collection and processing; observing session length; satellite constellation status--to determine expected repeatability, accuracy, and/or problems with GPS use on monitoring projects. Results are empirically based on field tests and GPS data analysis.

(1) Coordinate repeatability. Figure 8-2 shows coordinate repeatability obtained from 42 GPS data sets collected in short-session time blocks (15 minutes, 20 degree mask angle) with fixed values for integer ambiguities. Discrepancies in the height component vary the most, with the largest variations being correlated to epochs with low numbers of observations. Two-sigma (95%) repeatability is approximately 6 mm for the height component and a peak height discrepancy of almost 10 mm. Horizontal coordinate components have generally better repeatability than vertical components. The level of repeatability and bias are due to systematic error effects not averaged out over the short time spans and likely caused by multipath. Baseline component formal errors with the height residuals, determined from the trace of the inverted normal equation matrix are representative of the Dilution of Precision (DOP) for the satellite constellation over the solution epochs. Periods of high height residuals correspond to times where no satellites are below approximately 30 degrees. Therefore, for short observation periods, some pre-observing planning can minimize the potential DOP values.

(2) Solution convergence. Solution convergence to millimeter level accuracy defines the session length requirement for establishing project fixed control in surveys conducted on reference networks. Reference stations normally would be occupied for many hours during production surveys. Figure 8-3 shows convergence times for simulated reference network baselines. Convergence to the millimeter level

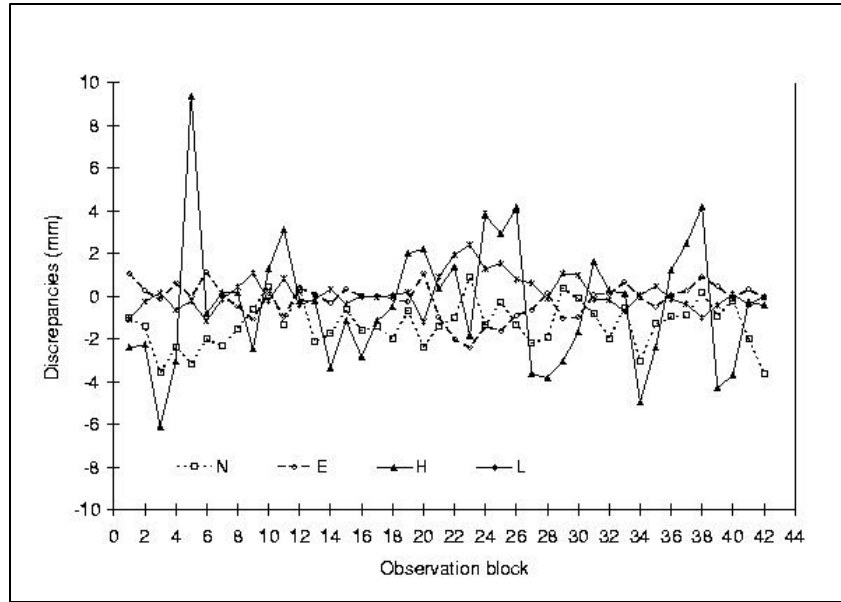

Figure 8-2. GPS coordinate component repeatability from 15-minute sessions over short baselines.

takes place within several (3-5) hours in low multipath environments. Horizontal coordinate components converge very quickly (less than one hour) leaving the height component more variable. In higher multipath environments, convergence takes place almost one order of magnitude later, which is within ten or twelve hours. Not only does the convergence take longer, but there is a greater variation of the position components over the whole position time series. These results are particularly important for selecting the location of reference stations where high accuracy control is required and that the role of multipath is crucial when attempting to use GPS for positioning tolerances at the millimeter level.

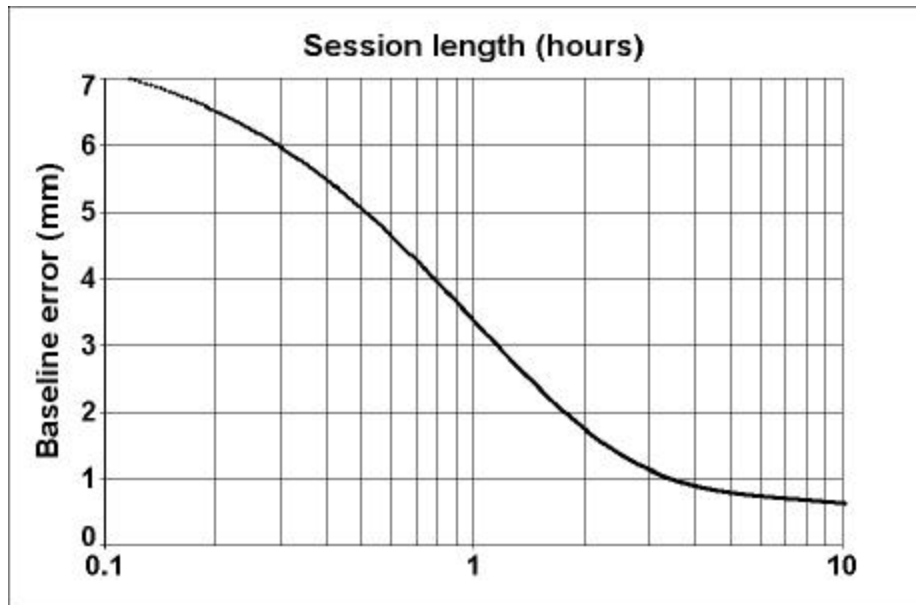

Figure 8-3. Accuracy convergence time plotted as log session length needed to exceed average baseline position error.

(3) Multipath errors. Signal interference from multipath is described in Section IV. The plots presented below illustrate some of the signs of multipath in GPS carrier phase data. Figure 8-4 shows an example of high levels of multipath on one satellite pair. The time difference between various peaks on the plot are approximately 230 and 240 seconds with a peak value of approximately 4 cm, which is almost 80% of the total limit for L1 multipath before cycle slips are expected to occur. Figure 8-5 shows three traces from two satellite pairs to see the reduction in multipath as the mask angle increases. These plots show that considerable multipath can still remain when the mask angle is set up to 20 degrees.

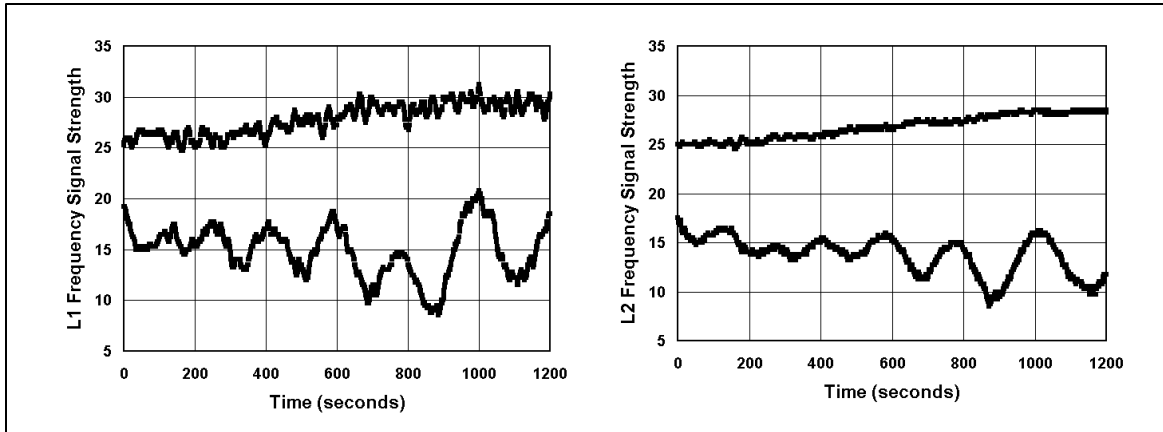

Figure 8-4. Typical GPS multipath curves found in L1 (left), and L2 (right) signal strength profiles. Lower series represents high multipath error, upper series represents normal signal strength profile.

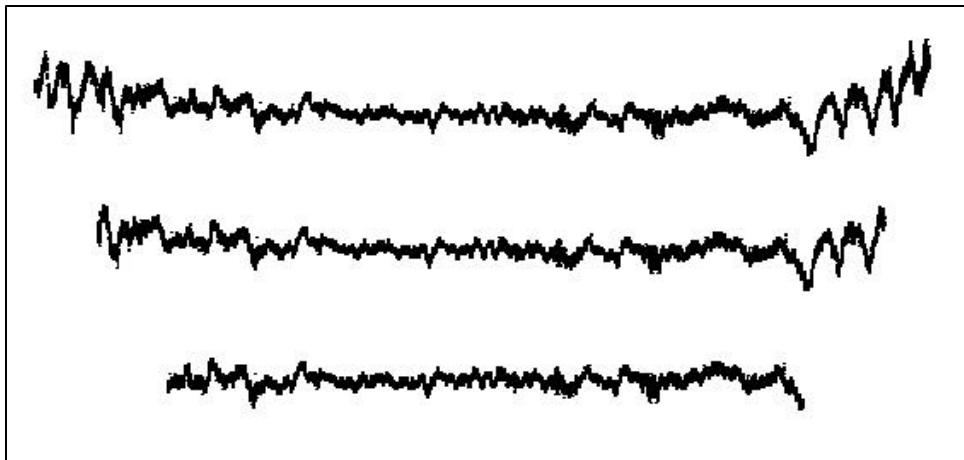

Figure 8-5. Multipath error profile plotted against processing mask angle; satellite elevation top to bottom, (a) 10 degrees, RMS 6.3 mm (b) 20 degrees, RMS 4.4 mm (c) 30 degrees, RMS 2.9 mm.

(4) Ambiguity resolution. When integer ambiguities were fixed for 42 blocks of 15-minute data, three blocks had at least one satellite incorrectly fixed, which equates to 7% of incorrect blocks, but only 3% of incorrect ambiguities over all 42 blocks. Re-processing with different mask angles did not improve the results and in fact produced more incorrect ambiguities in more sessions. These results can be considered typical for GPS monitoring applications. Constraining the a-priori station coordinates to one centimeter so that all of the ambiguities in all the blocks are correctly resolved makes an improvement.

(5) Satellite ephemeris. Evaluation of monitoring data sets indicates that for static mode sessions either the broadcast or precise ephemeris can be used without causing significant changes in the solutions.

(6) Antenna mask angle. Changing the satellite elevation mask angle will produce slightly different processed coordinates. Discrepancies between solutions for 20 and 30 degree mask angle are generally less than 1 mm except for the height components thus producing a large difference in the coordinates. High mask angles (>20-30 deg) tend to eliminate too much raw data, depending on the number of satellites-in-view. Using lower elevation satellite data will improve the overall satellite geometry but the data is usually of poor quality. As is the convention with lower order GPS surveys, a 15-20 degree mask angle is recommended, especially where additional height control is available on-site. In practice, data quality indicators can be used to find an optimal mask angle for baseline processing.

(7) Session length. Height coordinates deviations over small networks are at the sub-centimeter level--sometimes even at stations with high multipath. As long as the integer ambiguities can be reliably resolved, then short observation sessions of fifteen (15) minutes should be able to achieve results within 6 mm 95 percent of the time. Simulated displacement tests show convergence to less than 1 mm in the coordinate components after approximately 15 minutes with one-second data.

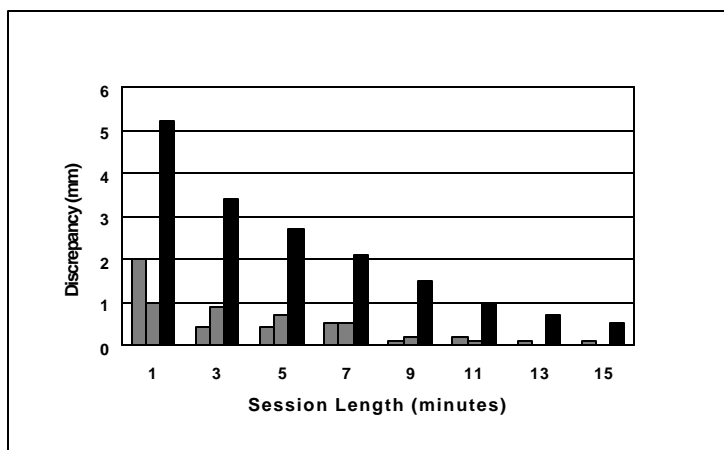

Figure 8-6. Convergence of coordinate component discrepancies to the true position with a simulated displacement of 2.5 mm. For each session the components are plotted north, east, height respectively.

Small displacements (millimeters) can be detected using two reference stations, having highly accurate relative positions determined from long observation sessions, and high quality carrier phase data (low systematic error). Figure 8-6 shows convergence in northing, easting, and height components every two minutes over a 15 minute session representing optimal performance for GPS deformation surveys in open areas. Slightly longer sessions (20-30 minutes) provide additional data redundancy and lower multipath effects. Very short baselines (10 m) measured directly across the upstream and downstream edges of a dam crest have compared to about 1 mm with precise leveling data.

c. GPS monitoring trials. GPS surveys can accurately reproduce positioning with conventional instruments with 2-3 mm point positioning error at 95 percent confidence level. Figure 8-7 shows a typical comparison between GPS and conventional surveys with average discrepancy of 1-3 mm and up to 5 mm can occur under slightly adverse conditions. Typical baseline component standard deviations are optimistically reported at less than 1 mm, data adjustment variance factors range from 1.2 to 4.3 (based on software) also optimistic due to a one second data logging rate. Error estimates in the covariance matrix of parameters are scaled up by the variance factor value to produce realistic error reporting. Horizontal point confidence ellipse dimensions range from 0.1 to 0.5 mm, also optimistic by perhaps a factor of ten

based on repeated surveys on monitoring networks. Baseline solutions should have fixed integer ambiguities, float solutions are generally unacceptable. A-posteriori variance ratios (RMS) between fixed and float solutions are found to range between 10 to 30, with an average of 20, indicating reasonably high confidence in the fixed integer solution. A minimum value of seven (7) should be produced or problems with ambiguity resolution might be suspected. Sometimes GPS data is unusable or will not process due to poor observing conditions

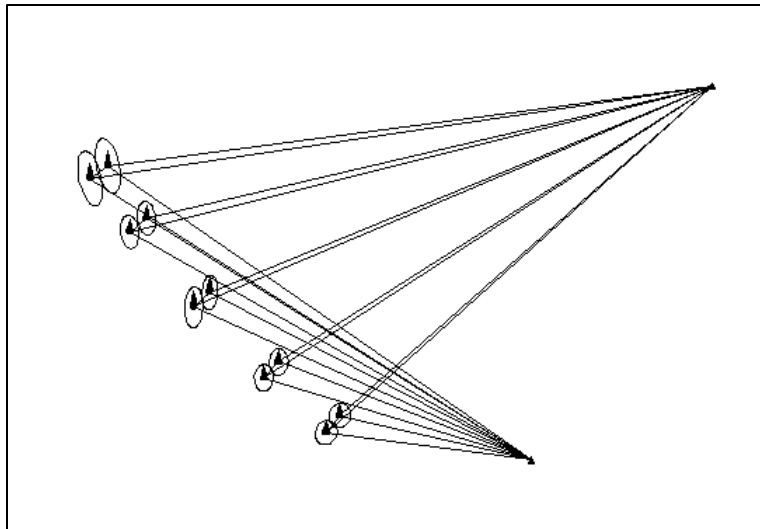

Figure 8-7. Network map of 10 monitoring points compared between GPS and precise conventional surveying results. Error ellipses are plotted at ten times actual size. Overall differences are less than 2-3 mm in all cases.

Section III Data Quality Assessment for Precise GPS Surveying

8-13. Quality Assessment Tools

a. General. A major task for meeting accuracy requirements on GPS deformation monitoring surveys is to obtain high quality raw data and to eliminate or minimize low quality data whenever possible. Data quality indicators are used to assess the effectiveness of a given GPS session. The following paragraphs describe techniques to evaluate GPS monitoring data sets for quality control (QC).

b. Mission planning software. See Section I of this chapter.

c. RINEX data processing. Pre-processing begins with converting binary GPS data into a Receiver Independent Exchange Format (RINEX) file. Most commercial GPS post-processing software packages include a computer utility for converting to RINEX and for importing translated RINEX data files to the main baseline processor. Software applications are available over the Internet for GPS data QC using these RINEX files. QC programs are designed to extract observing status and summary information about a GPS session and are more specialized than simple RINEX converters.

(1) RINEX format. RINEX files contain raw GPS data in a readable ASCII text format that allows the user to directly inspect and edit the survey session. RINEX observation files contain station metadata in a header file followed by a time sequence of GPS observation blocks. RINEX ephemeris files contain GPS orbit parameters that define the position each satellite as a function of time. Further details on the structure and content of RINEX formatted data files can be obtained from Internet resources (e.g., IGS website). A short description of RINEX observation file information is presented below.

(2) RINEX header. The header section appears first in a RINEX file. The header contains the following information: RINEX Software Version; Conversion Date; Station Marker Name; Observer/Agency; Receiver/Antenna serial number(s) and GPS antenna type (special code for each type); Approximate (user) Position (WGS84 X-Y-Z); Antenna Height Offsets (delta H/E/N); Data Types (actual logged set of observables); Time of First Observation (in GPS Time); Text Comments (user entered); and an End of Header record. Some header fields may be empty because the file is populated initially with information that a user enters in the receiver. The header file can be edited to add information about the project by using the comment line header code.

(3) RINEX time tags. RINEX data blocks start with a GPS time tag which includes: Year, Month, Day, Hour, Minute, Second in GPS time, along with the actual number of satellites represented in each data block, followed by each unique satellite identifier number. Every logging epoch that contains data will have an initial time tag. If data was not logged, then the corresponding time epochs will be skipped until new data is acquired.

(4) RINEX data. Observation blocks are organized into seven (7) columns containing: L1 phase; L2 phase; L1 C/A code; L1 P(Y) code; L2 P(Y) code; L1 SNR; and L2 SNR (signal-to-noise ratio) data types, in that order. Phase is recorded in cycles, code is recorded in meters, and SNR is either recorded as a manufacturer supplied gain equivalent (similar to dB), or as a conventionally scaled SNR value ranging between 0-9. Individual observation blocks are recorded sequentially for each logging epoch until the end of the session (file) is reached. Some data blocks may contain missing data records for one or more data types. These will be listed as blank or zero entries in their respective column(s).

d. TEQC data processing. One widely used QC application is called TEQC (translation, editing, and quality control) which is distributed on the Internet by UNAVCO (University NAVSTAR Consortium).

(1) TEQC software. TEQC offers a command line DOS or UNIX system interface and is used for general data pre-processing. Users must download the compressed TEQC application software and a companion user manual to operate the software. The program defines a GPS session as a single-site GPS receiver setup where full GPS data has been logged. TEQC requires a RINEX format GPS data file and a RINEX format GPS ephemeris file for running full quality control functions. RINEX ephemeris files can be downloaded from the Central Bureau of IGS (International GPS Service for Geodynamics) public FTP site. Ephemeris files are compiled from data collected at IGS data centers. Each IGS station contributes to the global adjusted precise GPS ephemeris file for each day. Once these files have been pre-processed, basic graphics programs ('qcview.exe' and graphics driver 'egavga.bgi') are available for plotting TEQC results (also available on-line from UNAVCO).

(2) TEQC descriptive statistics. Data pre-processing packages like TEQC provide the following output to aid in the evaluation of a GPS session.

(a) Status information. A summary file is created that contains information on continuous L1/L2 tracking status for each SV; input data and ephemeris filenames; session start and stop times; data logging interval; total number and list of satellites observed; receiver tracking capability; at different elevation angles the number of observations, possible observations, and missing observations; clock drift and rate; clock resets and gaps; number and percentage of cycle slips; time of first and last observations; session length; and other status statistics. The summary file also contains parameters used by the QC program.

(b) Observation summary. For each SV, total number of observations of each type (i.e., L1, L2, C/A, etc.), above horizon, above mask angle, and for each observable; L1/L2 code multipath levels and cycle slips for each SV; SV elevation angles and signal strength counts summarized in 5 degree bins.

(c) Auxiliary files. In addition to the summary file contents listed above, for each session, each satellite, and over each recording epoch, auxiliary files are created that contain SV elevation angles, azimuths, L1/L2 signal strength data, and L1/L2 code multipath indicators. These can be readily plotted and examined for each session.

8-14. GPS Session Status

a. General. Data quality is highly related to the observing status during a given GPS session. Actual GPS survey results are compared with expected performance to detect poor quality data. Data editing and removal is one means to improve the GPS session. Guidance presented below is meant to highlight problem areas with GPS data and to list them as a group for convenient reference.

b. Satellite health status and NANU warnings. Satellites designated with an unhealthy status, or those undergoing prescribed orbit maintenance maneuvers, will alert the receiver to its degraded situation and automatically store this condition flag in the raw data. Users need to become aware of any scheduled changes in constellation status by checking NANU bulletins. The following NANU message types are used.

(1) Forecast outages. Forecasted NANU messages begin with the prefix "FCST": FCSTDV Forecast Delta-V gives scheduled outage times for Delta-V maneuvers. The satellite is moved for maintenance and the user may be required to download a new almanac. FCSTMX Forecast Maintenance gives scheduled outage times for Ion Pump Operations or software tests. FCSTEXTD Forecast Extension

extends the scheduled outage time "Until Further Notice"; references the original NANU. FCSTSUMM Forecast Summary gives the exact outage times for the scheduled outage, including the FCSTEXTD; sent after the maintenance is complete and the satellite is set healthy to users; references original NANU. FCSTCANC Forecast Cancellation cancels a scheduled outage; new maintenance time not yet determined; references the original NANU. FCSTRESCD Forecast Rescheduled reschedules a scheduled outage; references the original NANU.

(2) *Unscheduled outages.* Unscheduled outage NANU messages begin with the prefix "UN": "UNUSUFN Unusable Until Further Notice" notifies the user that a satellite will be unusable to all users until further notice. UNUSABLE with a reference NANU closes out an UNUSUFN NANU and gives the exact outage times for the outage; references the UNUSUFN NANU. UNUNOREF UNUSABLE with no reference NANU gives times for outages that were resolved before a UNUSUFN NANU could be sent.

(3) *Other.* Other outage NANU messages can cover any remaining conditions. USABINIT Initially Usable notifies the user that a satellite is set healthy for the first time. LEAPSEC Leap Second is used to notify users of an impending Leap Second. GENERAL informs the user of general GPS information.

c. Continuous L1/L2 signal lock. Maintaining continuous phase lock on both L1 and L2 signals is a critical requirement for obtaining high quality data. Loss-of-lock on any satellite indicates a problem with its signal reception and tracking. Intermittent data gaps should be suspected of having lower quality data at or near the affected signal loss times. GPS L2 signals will generally experience tracking problems before L1 signals (on same SV) due to greater relative noise power on L2. If possible, only data collected from satellites that maintain continuous signal lock should be used for final baseline processing.

d. SV tracking time. Signal tracking is related to the amount of time a given GPS satellite is in continuous view of the receiver/antenna. Satellites that are just rising, setting, or are only in view for short periods of time (less than 15 minutes) are to be suspected as unfit. Problems encountered with data collected in a short tracking window includes high data correlations based on short averaging time and low signal strength. Mission planning can be used to rank each satellite by tracking window length for an overall comparison between SVs throughout the session (Figure 8-8).

e. Satellites-in-view. GPS satellites are more densely placed over the mid-to-lower earth latitudes. Southern sky exposures in CONUS yield higher satellite-to-receiver coverages. A minimum of five (5) satellites is recommended for reliable GPS processing results. Generally, eight (8) or more GPS satellites are available at optimal observing times. Extra satellites in view increases data redundancy and provides the user the option to select only the highest quality data within a session. A percentage of GPS data can be judiciously removed prior to re-processing. A comparison is made of before and after processing statistics to judge its impact on solution quality. Line-of-site coverage can be determined before fieldwork begins using GPS mission planning software. Sky view plots (Figure 8-8) are modified to fit a particular site by horizon templates that graphically trace any shadow zones on the sky visibility diagram (e.g., polar-plot with an above view perspective). Areas with a denied signal are defined by a series of approximate cutoff elevations and azimuths. These are gathered with compass and inclinometer instruments during reconnaissance surveys. Obstructions are areas with moderate to high topographic relief (hillside, slopes, embankments), large solid objects (buildings, walls), or permanent objects that may block antenna signal reception (trees, poles, overhead wires). Satellite elevation and azimuth data can be extracted as numerical values from RINEX files using TEQC software, or viewed as skyplots generated from mission planning software.

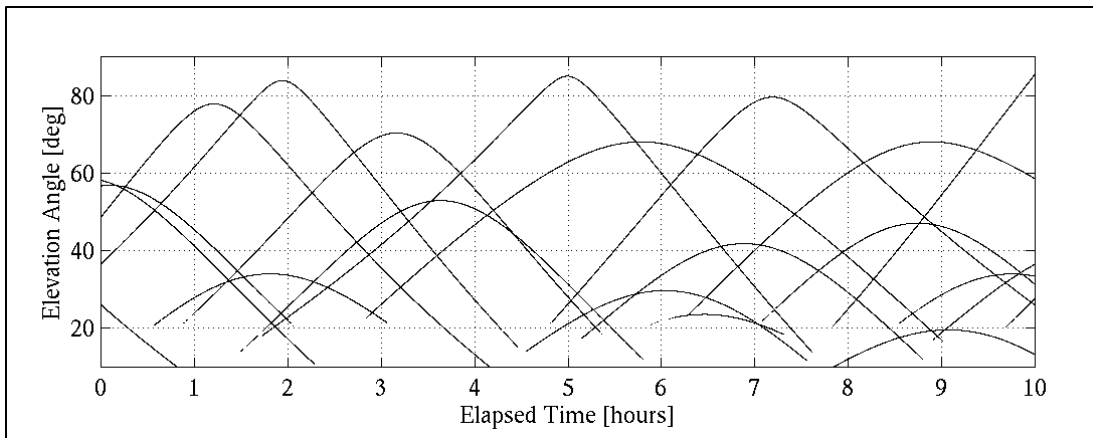

Figure 8-8. Skyplot of available GPS satellites plotted as a function of elevation angle and elapsed time (azimuth).

f. Dilution of Precision (DOP). GDOP and PDOP (Geometric and Position DOP respectively) are measures of geometric and position strength related to satellite constellation geometry and user range error. PDOP is computed as the ratio range error to the single station position error used in code range positioning. PDOP has a minimum theoretical value of one (1), which represents the ideal case of no position error increases occurring due to satellite geometry. Periods of PDOP greater than four (4) are suspect in practice. Both the geometry and the number of tracked SVs are highly correlated to DOP values. Effects of low and high DOP windows can be observed in GPS performance results.

g. Satellite elevation angle. Satellites at low elevations generally produce low quality signals because of signal multipath, refraction, attenuation, and reduced antenna gain. In theory, data from lower elevation satellites will improve satellite geometry, however, any benefit from geometry is offset by poor signal quality. Satellites at elevation angles below 20 degrees above the local horizon, and directly at zenith, experience the greatest problems with signal quality.

h. L1/L2 signal strength. Signal strength on L1/L2 carriers is measured by the receiver as a carrier-to-noise density (C/N) ratio. C/N is a function of transmitter power; satellite elevation angle; antenna gain pattern; signal attenuation; and receiver noise power. GPS signal quality is related to the behavior of its signal strength profile. Low signal strength values indicate relatively higher noise power, and therefore greater uncertainty in phase measurement. Erratic signal strength values also indicate high signal disturbances. Raw signal strength data shown in Figure 8-9 has a typical range of 35 SNR units (dB) with a precision of 0.25 units. Since both GPS frequencies are susceptible to interference there is often a correlation in the shape of the L1/L2 SNR profiles for each satellite. Generally, the SNR profile for the L2 signal will be smoother and lower magnitude than the L1 signal.

8-15. Data Post-Processing

Baseline processing is carried out in steps, starting with raw data as input and finishing with baseline coordinate differences as output. The steps for processing a single GPS baseline are outlined below.

a. Code position. An average absolute position (WGS84) is computed using C/A code pseudoranges and GPS ephemeris data.

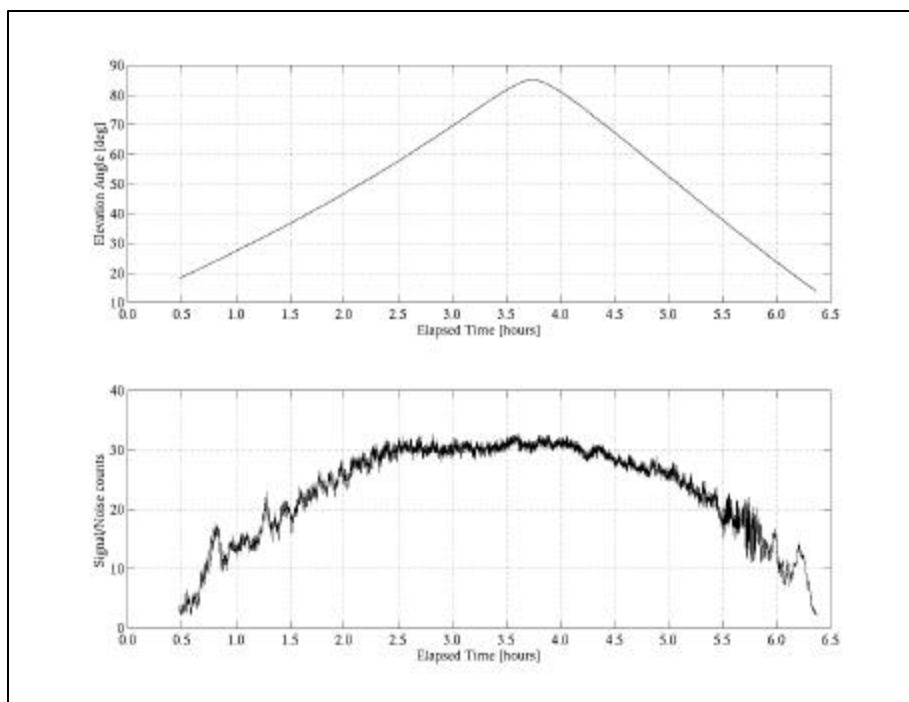

Figure 8-9. Plot of satellite elevation angle and corresponding GPS signal strength profile.

b. Phase differencing. Accumulated L1/L2 carrier phase measurements associated with each GPS satellite are extracted from the two separate raw GPS data files (one file for each GPS receiver). Simultaneous L1/L2 phase measurements from each receiver are differenced to create single difference (SD) data. Differencing the SD data between pairs of satellites forms double differences (DD). The double differencing scheme can be carried out in various combinations of the satellites that were tracked during the observing session. A typical DD scheme involves taking one satellite as a reference and then differencing it against all others remaining. The resulting DD data is then differenced once more, over consecutive time epochs, to form a triple difference (TD). The purpose of differencing is to simplify the GPS observation equations mainly by canceling specific common errors in each receiver's data. Several types of GPS biases are highly correlated and are eliminated by double differencing. For example, satellite orbit errors, and satellite and receiver clock biases are canceled completely. Refraction and signal propagation delays created during transit through the earth's ionosphere and troposphere are minimized.

c. Cycle slip detection. Triple difference data eliminates the so-called "integer ambiguity", a nuisance parameter that exists for each satellite-receiver combination. The ambiguity parameter can be pictured as the unknown number of whole carrier cycles that were in transit when logging began at the receiver station. This value is a constant offset (i.e., number of cycles) which needs to be determined by the software for high accuracy carrier phase processing. One use of TD datasets is to detect cycle slips. Because ambiguities are constant over time, triple difference data will not carry them because TD is a time difference. If the signal tracking process experiences cycle jumps during data collection, then they will be revealed as a large spike in the TD dataset. The cycle slip height on the TD curve roughly corresponds to the number of cycles (in meters) that were skipped. Any detected cycle slips are corrected by re-aligning the phase data by whole cycles to create a smooth continuous curve as a function of time.

d. Float solution. A first run double difference solution uses pre-processed GPS data that was corrected for any cycle slips. This float solution resolves the initial cycle ambiguities into real-valued quantities, and then computes an approximate baseline solution. Ambiguities in the float solution are processed as un-rounded decimal cycle counts assigned to each satellite-receiver pair.

e. Fixed solution. Since the number of cycle ambiguities is known to be an integer value, the float ambiguities are rounded or fixed to the nearest whole number. If the real-number float value is very close to an integer then the rounding is done with high confidence. Fixed solutions will increase the math model accuracy compared to the float solution. Different possible combinations of integer ambiguity values are estimated for each satellite-receiver pair and the best-fit combination is determined by statistical testing. Re-processing GPS data with the correct integer ambiguity values will result in a double difference fixed ambiguity baseline solution.

f. Statistical evaluation. GPS baseline processing results are analyzed after a fixed DD solution is obtained. Typical processing outputs include a separate time series of DD residuals for each receiver-satellite DD pair (i.e., for each measurement epoch). Global measures of solution quality are reported as solution statistics, such as, the data adjustment variance factor, the standard deviation and covariance matrix entries for each baseline component, and fixed to float solution variance ratios.

g. Network adjustment. After the GPS data has been processed a set of baseline solutions will connect the network of monitoring points. All post-processed solution vectors are then adjusted using least squares network adjustment software. The first adjustment is made using minimal constraints, i.e., only the coordinates for one reference station are held fixed, which permits the user to examine the internal errors within the network. Once the first adjustment has been edited to remove outlier measurements, the coordinates of each stable reference station are fixed for the final adjustment. The resulting geodetic coordinates for each monitoring point in the network defines its 3D position.

8-16. Post-Processing Statistics

a. General. Statistics are used to assess processing output and position solution quality, especially with respect to random errors, measurement residuals, and the overall solution fit to the data. Some of the most critical parameters to check after each post-processing session are described below.

b. Double difference residuals. Both L1 and L2 phase measurements will produce DD residuals from the baseline processing adjustment. The following statistics and descriptors for each series of DD residuals are checked to reveal possible low quality data.

(1) Shape of residuals. Measurement errors that contain only random error will be distributed according to the normal probability density function (PDF). Histograms of GPS DD residuals compared with an assumed normal PDF will indicate skewness or systematic error in the data. DD residual time-series profiles vary between satellite pairs and each pair should be visually examined for large deviations from the mean or any kinds of regular patterns in the residual values that might reveal systematic error. Clean data will have a zero-mean (horizontal line) profile containing high frequency random noise (Figure 8-10). An obvious systematic error in a DD residual plot does not mean data quality for that satellite pair is bad. An error trend in one residual series can sometimes show up belonging to the other satellites in view because the solution itself has been biased to an incorrect value as a result of math correlations. A possible reason for this is the GPS software assigning a greater weight to biased data, and because of incorrect assumptions made in its pre-set internal data weighting criteria. Signal quality and session status criteria, independent of math correlations, are recommended for guiding interpretations about the shape of DD residuals. See also Figure 8-11.

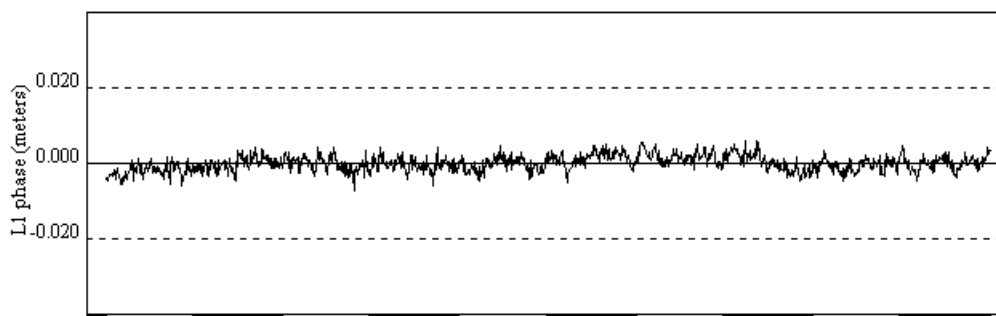

Figure 8-10. An example of GPS (L1) double difference residuals taken from baseline processing demonstrates a typical profile for relatively clean data.

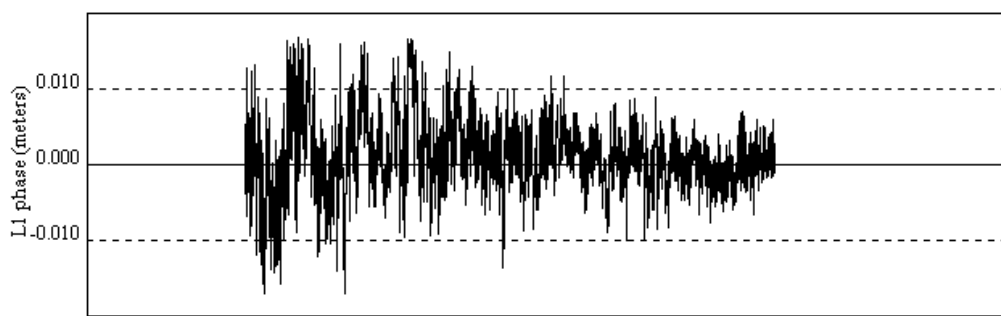

Figure 8-11. An example of double difference residual taken from GPS baseline processing showing effects on L1 signal as satellite rises. Residuals become smaller with time and with higher elevation angle.

(2) Mean value of residuals. Double difference residuals will not be exactly equal to zero even with the highest quality data. Slight shifts in the mean value (less than 5 mm in normal data) are evident in most processing results. If the mean values of several different DD residuals are shifted in the same direction (plus or minus), then this may indicate a low frequency bias in the data. This trend is seen when double differencing involves one reference satellite where its associated biases are mathematically correlated with other SVs. A mean shift less than 3-5 mm indicates good data (however this must be true on all satellites), a shift of 5-10 mm or more usually indicates the presence of measurement bias.

(3) Standard deviation of residuals. The standard deviation (unbiased RMS) of the DD residuals specifies the level of random error in the phase data. Signal noise components, time variable correlations, session length, and GPS processing techniques determines the standard deviation of the DD residuals. Each satellite pair can be ranked according to its RMS value. A standard deviation greater than 4 mm is a cutoff value for identifying poor data. Although standard deviation itself is not sensitive to bias, a large standard deviation can indicate trouble with GPS signal quality.

(4) L1/L2 residuals. Signal disturbance in the local antenna environment is identified by inspection or cross-correlation of L1 and L2 DD residuals (Figure 8-12). With anti-spoofing (A/S) full wavelength L2 data is not directly recovered by P(Y) code-stripping in receiver tracking channels. An L1/L2 cross-correlation or squaring processes is used to reconstruct L2 carrier from its L1 difference (i.e., with respect to L1). Largely similar (L1/L2) DD residual profiles indicates the corresponding recovery

correction term must be relatively constant (or linearly related). This indicates L2 is experiencing the same signal effects as L1. If two (L1/L2) residual profiles are largely different, then the L1 and L2 signals deviate by a significantly variable difference term, and L1/L2 signals are subject to separate external influences. If the L1/L2 profiles are highly correlated, then the signals are behaving the same.

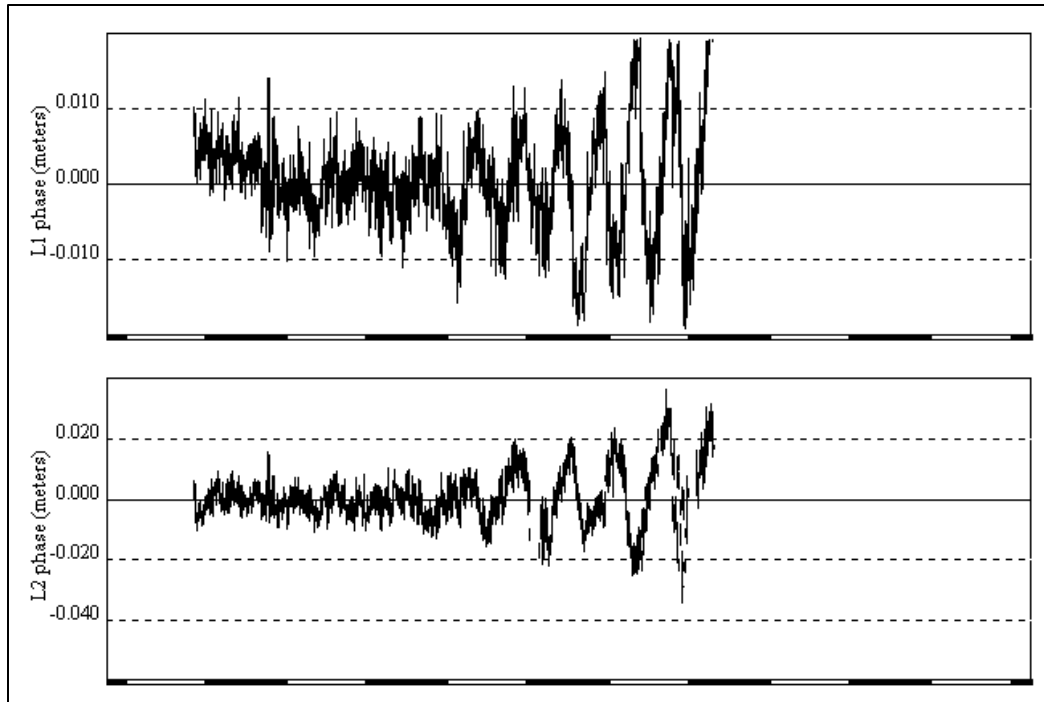

Figure 8-12. Comparison between L1 (above), and L2 (below), double difference residuals taken from GPS data corrupted by multipath.

(5) Reference satellite. Double differencing GPS data can be carried out under different combinations of satellites. A common DD scheme is to select one high elevation satellite to be the reference and then differencing its data from all others. Biases in the reference satellite data will show up in the residual profiles of non-reference satellites because of math correlation. Most baseline processors do not give the user an option to select or change reference satellites. If the processor will allow the user to select the DD scheme, then each satellite's data can be differenced between "neighboring" satellites to lower DD math correlations.

c. Fixed and float solution. The RMS ratio between fixed and float solutions (variance ratio) is an output statistic used to describe the amount of confidence held in the fixed solution. High ratio values (greater than 7 and up to 40 or above) indicate the fixed solution ambiguity is far better than the next best solution ambiguity. Values near one (1) indicate the need for closer examination of the GPS data for quality problems. Only fixed solutions should be accepted for GPS monitoring surveys. Float solution data should be edited, using data quality indicators as a guide, until a fixed solution is obtained. Correct estimates of ambiguity parameters are critical for high accuracy positioning over short baselines, especially for kinematic solutions to prevent excessive data dropouts. The software can accept incorrect ambiguities at a given statistical confidence level. Normally, a float solution will result if the integer ambiguity search does not converge below a set confidence threshold. Float solutions can be addressed first by increasing the number of allowed processing iterations in the software.

d. Cycle slip counts. PLL filtering bandwidth limits signal tracking to a set frequency range. Large transient shifts in input can exceed PLL tracking design. These events create difficulty maintaining accurate signal phase lock. Signal disturbances falling within the PLL tracking range can still cause cycle slips because the PLL only discriminates 2π phase shifts. If tracking skips any number of whole cycles (0.5% of data or less is nominal), then it is possible for the PLL to re-acquire phase lock at the new locus of phase well before the next measurement cycle arrives. Any detected cycle slips indicate periods of rapid change in signal dynamics, which implies lower phase tracking and measurement resolution.

e. Adjustment variance factor. Formal errors are directly influenced by the observation residuals through the a-posteriori variance factor. This is a scalar quantity with an expected value equal to one (1.0). The variance factor is used to scale random error as reported in the parameter covariance matrix. Values more than one indicates an overly optimistic weighting scheme was applied to the measurements. Values less than one indicate an overly pessimistic observation weighting scheme. GPS observing sessions will typically have a variance factor greater than one because physical and mathematical correlations have been ignored. Values more than 3-5 indicate the need for closer examination of the GPS data for quality problems.

f. Adjustment covariance matrix. The covariance matrix of parameters is an upper triangular (symmetric) matrix containing the precision values for ΔX , ΔY , and ΔZ baseline components. The variance of each coordinate component is found along the matrix diagonal. The statistical correlation (covariance) between coordinate components is defined by the off-diagonal elements. Covariance matrix entries are used to determine and report absolute and relative positioning error ellipses. GPS covariance matrix values should be less than 1×10^{-6} for baselines used on monitoring networks. The covariance matrix that is output from baseline processing is used to weight the baseline coordinate differences during network adjustment.

g. Error ellipses. A standard output from the baseline processing adjustment is the confidence ellipse (or error ellipse). An error ellipse graphically (and geometrically) portrays the region of positioning uncertainty associated with the adjusted coordinates at a given statistical confidence level. Absolute or point error ellipses apply only to individual stations. Relative error ellipses apply to the baselines between two stations. Both types are based on the entries in the covariance matrix of parameters. The largest dimension of the error ellipse is called the major semi-axis. Its length indicates the maximum expected position error at a selected confidence level (usually 95 percent). The semi-major axis of the point ellipse is compared with the positioning accuracy requirements established for the project. If the value is greater than the allowed position error, then the survey does not meet the design specification. Generally this will not be the case because error levels reported by baseline processing are often much too optimistic. GPS error ellipses can be oriented toward a particular direction (azimuth) indicating greater uncertainty in those position components.

8-17. Closure and Station Checks

a. Baseline misclosures. Loop misclosures are computed by comparing at least four interconnected baselines. Point misclosures are computed from at least two reference stations and one monitoring point on the structure. Closures that are statistically different from zero indicate potential bias in the data. Misclosures are automatically smoothed to an average value for the baseline component in the network adjustment. A test on the sample mean (i.e., position) is used to assess bias in misclosures. Baselines with misclosures greater than 5 mm are candidates for further quality checks. Any three baselines connected in a triangle will contain only one misclosure value, but two different point misclosure schemes can be checked.

(1) Reference station ties. For production surveys only short (15-30 minute) observing sessions are made between any three points (two reference stations and the monitoring point on the structure). Each reference station is fixed with coordinates from higher accuracy surveys based on collecting many hours of data just between the two reference stations. The first type of misclosure assessment uses only the baseline computed between the reference stations. A test on the mean for position change is made using the long and short GPS sessions between the two reference stations. Coordinate components from each session are differenced and tested against an expected value of zero. A test on the variance is used to assess coordinate precision. A design standard deviation of 1.44 mm can be used as the expected precision for each coordinate component to ensure positioning is below 5 mm at 95 percent.

(2) Monitoring station ties. The second type of misclosure assessment compares the two baselines from each reference station to the monitored point. A test on the mean is made on the misclosure between each reference station baseline and the mean position of the monitoring point computed using both baselines. This second test will indicate the combined position change at the monitored point derived from both reference stations. Fixing the average adjusted position of the monitored point allows for inspection of short session data propagated back to each reference station. The position change at each reference station can then be examined. If there are problems with only one particular reference station (during the short session), then its raw data should be examined further and either cleaned or the station de-weighted before processing the final network adjustment.

b. Code positions. Processing code positions at each station can be done separately to investigate the statistics of the code data. Although code positioning results will not be used to monitor the structure, data quality for each station and each satellite can be checked. Code measurement time delays are especially well-related to signal quality. In the TEQC software, an MP (code multipath) parameter is extracted from code solutions to indicate the relative amount of multipath on each satellite code range.

c. Kinematic position solution. Static GPS data can be forced to process as a kinematic time series of positions. Kinematic positions are in some ways more easily inspected and reviewed for quality than the static session. One test used to identify poor quality kinematic data is to compute an expected phase error based on the RMS of the signal strength data coming from each satellite. The expected phase error is determined at each measurement epoch and then ranked in increasing order. This process is repeated for each satellite-receiver combination, so that the signal strength RMS is again ranked in increasing order between satellites. If there are time periods of more than several minutes at each receiver where the RMS is consistently below two (2) for at least five (5) satellites, then these will generally represent higher quality data blocks. RINEX file editing with user-developed software can extract and process the signal strength data. Re-processed results should be checked against the unedited kinematic solution time series. Only slight improvements should be observed in position output.

d. Multipath detection. SNR profiles and DD residuals can be inspected for the presence of multipath by comparing their deviation profiles. To recover these profiles, L1/L2 SNR values can be extracted from RINEX files, and DD residuals for each satellite pair are output from the processing adjustment. A multipath signature is verified by comparing the shape (deviations) of the SNR profile to each double difference residual series at corresponding time epochs for both L1 and L2 frequencies. They will show similar trends and relative amounts of deviation if systematic error is present. This is true with multipath because it affects both L1/L2 signal frequencies in a similar manner.

Section IV GPS Multipath Error

8-18. Description of Multipath Signals

a. General. GPS signal interference is a major source of systematic error in GPS monitoring surveys. Multipath signals are a predominant cause of interference in GPS carrier phase measurements over short baselines. This section describes the characteristics of multipath signals as a source of error in precise baseline determination.

b. Properties of multipath signals. Multipath signals are an unavoidable operational trait of the GPS system in obstructed environments and will occur repeatedly under the right conditions.

(1) Data correlation over sidereal day. The GPS satellite constellation occupies the same position in orbit with respect to the earth once every sidereal day. A GPS sidereal day differs from a standard solar day by approximately four minutes less each day (i.e., about 23-hrs 56 min). If the local antenna environment is unchanged and the antenna remains stationary, then multipath reception will be repeated over two consecutive sidereal days. In practice, this behavior is not perfectly repeatable due to variable signal reception, noise power levels, orbit or atmospheric changes, and it assumes similar equipment, data collection, and processing procedures. Inspection of double difference residuals over consecutive days can verify the presence of multipath (Figure 8-13). Auto-correlation of the double difference residuals for satellite pairs observed over consecutive days can estimate the time shift more precisely than inspection.

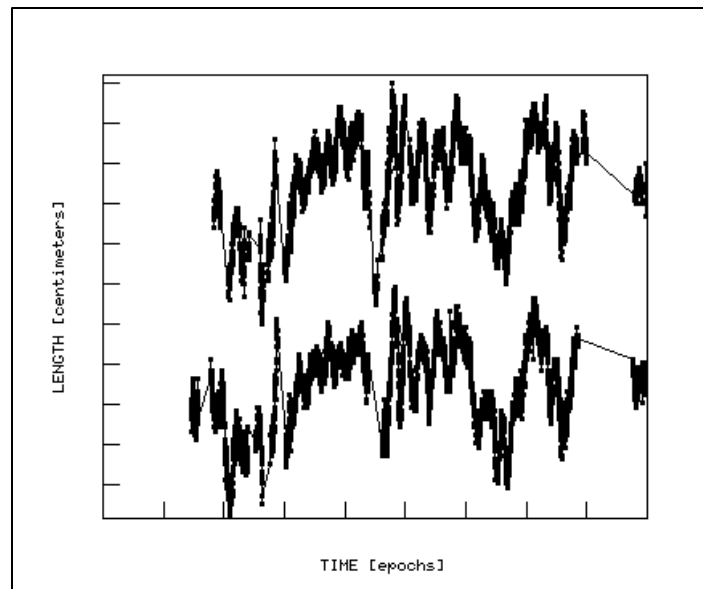

Figure 8-13. GPS (L1) double difference residuals from sessions separated by exactly one sidereal day showing correlation of multipath errors.

(2) Reflector distance dependence. Large phase errors can occur with small changes in antenna-reflector distance. At L1/L2 wavelengths, a change in distance of only 5 cm can produce a maximum phase error of 90 degrees (i.e., 1/4 of L1 wavelength). As GPS satellites move in orbit with respect to the receiver, signals may strike different reflectors and travel along different paths to the antenna. A time-

varying multipath signal is then expected to occur based on path difference between direct and reflected signals. A simple geometric model describes this interference at the antenna site.

$$\phi / d \sin(\theta) = 2 \pi / \lambda \quad (\text{Eq 8-6})$$

Phase difference (ϕ) depends on path length difference between direct and reflected signal paths, and a path length difference of one (L1 or L2) wavelength (λ) corresponds to a phase difference over one complete wave cycle (2π). Dependence of phase on reflector distance from this ratio is:

$$\phi = (2\pi/\lambda) d \sin(\theta) \quad (\text{Eq 8-7})$$

where

- ϕ = phase difference
- λ = wavelength
- d = antenna-reflector distance
- θ = angle of incidence

characterizes the geometric relationship of phase and reflector distance for multipath signals.

(3) Dependence on signal frequency. The duration of multipath in GPS data will vary with signal frequency. Figure 8-14 shows a characteristic profile for the time period of L1/L2 multipath signals. Long-period multipath is a major difficulty in GPS data because its resulting bias is absorbed into the baseline solution as a position offset. Since multipath is not expected to be correlated between different satellites, detection of low frequency bias can be attempted by inspection of raw GPS data. Figure 8-14 shows that reflectors close to the antenna will most adversely affect GPS signals.

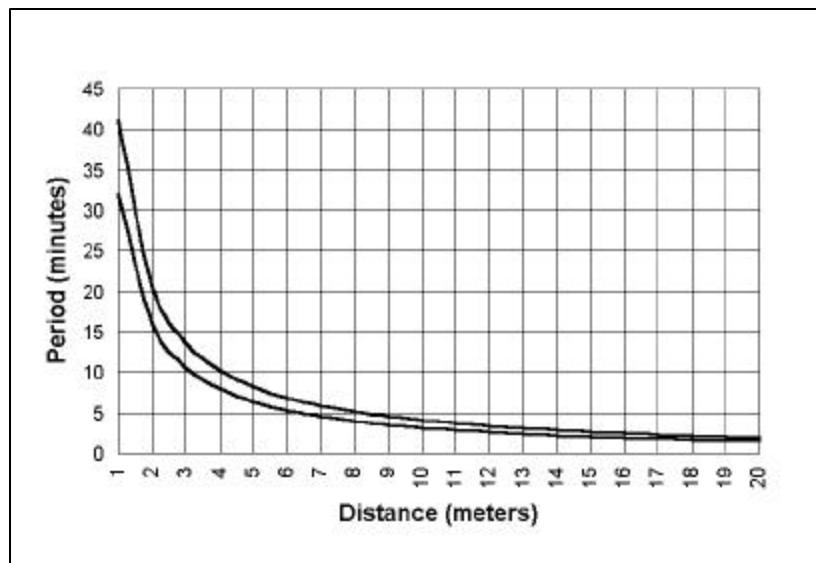

Figure 8-14. Plot of theoretical multipath period against reflector distance for L1 and L2 GPS signals. GPS L1 frequency is modeled in the lower curve.

(4) Session length dependence. Multipath can persist from a few minutes to several hours based on distance to the reflector. Sampling at least one complete interference wavelength eliminates long period multipath by averaging its effects by additive and subtractive phase cancellations. Session lengths less than 30 minutes would have to have a minimum antenna separation of 1.5 meters from surrounding reflectors (see Figure 8-14).

(5) Signal strength variations. A basic characteristic of EM waves is that energy is propagated in a direction perpendicular to the surface of uniform phase. Changes in signal phase are coupled to changes in signal strength through the interference phenomena produced by multipath. Inspection of observation double difference residuals show an empirical correlation to associated signal strength values. Both types of data have a quasi-cyclic patterned profile in receiver-to-satellite data contaminated by multipath. In the context of code phase DGPS applications a simple relationship exists between phase variance and signal-to-noise ratio (SNR) as in, for example, Omega system receivers. An empirical SNR value calculated from phase variance could be used as a measure of expected signal strength deviation in GPS data. Recovery and reporting of SNR observables from GPS receivers currently lacks specification in RINEX format observation files, due in part by the fact that GPS product manufacturers are not obligated to provide SNR values, or may provide them in a reduced or proprietary format without background details about their source.

(6) Satellite elevation angle dependence. Multipath has a greater chance of occurring and surviving to reach the antenna from low elevation satellites. This is because multipath signals are less likely to experience multiple bounces, and because antennas do not receive signals equally well in all directions. Low elevation direct signals have lower receive power levels due to antenna gain pattern (lower gain near horizon). Multipath then has relatively higher signal power compared to low elevation direct signal power. Partial multipath rejection can be built into the antenna by shaping the antenna gain pattern (choke ring antenna) or increasing the mask angle.

8-19. Data Cleaning Techniques for GPS Surveys

a. General. Several different strategies are available for suppressing multipath effects in GPS data. These can be broadly categorized by hardware, environment, and data processing.

b. Modification of antenna environment. Some of the most effective methods for reducing multipath involve blocking the reflected signal before it is sensed by the antenna.

(1) Source modeling. A proposed multipath reduction strategy is to exploit the dependence of multipath on site geometry and to calibrate its effects using detailed maps of reflections in the antenna environment. Creating a topographic site model that accurately predicts multipath signal propagation would be difficult if the nature of local reflectors is highly variable, giving rise to numerous complicated signal interactions. If there are only simple sources of reflection at each station, then the modeling process would need to be repeated for many different station occupations. Processing corrections for multipath interference based on site geometry are not yet generally practical for GPS.

(2) Choke ring antennas. Specially designed choke ring antennas are manufactured to enhance attenuation of surface waves traveling along the surface of the antenna. Choke ring antennas have a series of precisely sized concentric metal collars mounted on top of the ground plane that serve to attenuate surface waves on the ground plane caused by ground reflections under the antenna. Choke ring antennas are not generally useful for stopping reflections coming from above the antenna, such as from vertical walls, rooftops, etc.

(3) Antenna placement. A universal technique for reducing multipath is to place the antenna in a low signal reflection environment. This is probably the most important requirement for reducing effects of multipath in GPS carrier phase data. Even smaller objects and trees near the station (up to several to tens of meters) can produce significant multipath interference. Site reconnaissance is essential for selecting premium locations for GPS stations.

(4) RF absorbent ground planes. Certain high performance materials have applications in reducing multipath reflections. Sheets or blocks of radio frequency absorbent foam are placed around the antenna and/or antenna mount. These have been tested to partially intercept and attenuate multipath and other EM interference in the local antenna environment, but still should be considered as a specialized approach for dealing with multipath.

c. Robust GPS observing strategies. Optimizing the session observing conditions and enhancing the likelihood of collecting large amounts of uncorrupted GPS data can reduce multipath effects.

(1) Session length. GPS performance over specified session lengths is described in Section II. Increased session length tends to randomize the periodic signature of multipath bias. If the GPS session length is greater than the total period of the error signal, then the phase deviations will have a more uniform distribution about the mean. A one-second sampling rate should be used mainly for the purpose of data inspection and quality control. Actual processing of longer station occupations with 5-10 second data rates usually provides the same mean baseline solution.

(2) Data redundancy. Redundant measurements provide checks on the GPS data and increases overall reliability of the survey. Several different applications of redundancy can be applied on GPS monitoring surveys.

(a) Multiple reference stations. Measurements from multiple reference stations can be used to improve positioning accuracy. More accurate positioning is obtained by collecting data at each monitoring station with more than one baseline tie. Well connected survey configurations create sub-networks that robustly tie each monitoring point to the reference network.

(b) Multiple station occupations. Multiple sessions and occupations can be used to improve positioning accuracy. GPS data logged under different observing conditions causes systematic errors to tend to cancel when repeated baseline solutions are averaged. Surveys with extremely short observation windows (1-5 minutes) should be re-occupied several times (separated by at least one hour).

(3) Continuous monitoring. Monitoring sessions that span multiple days can use data stacking techniques. Double difference residuals associated with repeated daily measurements (for example over one week) are added together to recover a correlated multipath signature. Cross-correlation will magnify systematic error that can be isolated from random error in the residuals.

d. Kinematic solution processing. Kinematic data processing schemes are well-suited for selective data editing because position outputs are reported at each logging epoch (e.g., one second). The objective in kinematic solution post-processing is to select the highest quality data for re-processing. Averaging only clean GPS data and eliminating poor quality data improves final position accuracy. Data quality indicators can be used to identify periods of corrupted or less reliable data. The relative data quality for every epoch in the position output series is ranked and then combined into continuous blocks that represent the best data. Common GPS data quality indicators are presented in Section III. This process can be defeated in cases where undetected systematic errors have been absorbed into the baseline solution. It is important to use data quality indicators that provide independent information about potential systematic error. Signal strength values and session status parameters are likely to be better

EM 1110-2-1009
1 Jun 02

sources for position weighting models than residuals. A data quality hierarchy should be used to clean and reprocess kinematic data. For example, eliminate satellites that have discontinuous phase tracking, then low elevation satellites, and then data with low signal strength or erratic deviations in signal strength. In practice, signal strengths below about 20 dB (out of a range of 30-40 dB) start to be unreliable. These editing schemes are analogous to weighting schemes that can be applied directly to the phase data.

8-20. Mandatory Requirements

There are no mandatory requirements in this chapter.

Chapter 9 Preanalysis and Network Adjustment

9-1. General

This chapter discusses preanalysis and network adjustment techniques for processing deformation surveying observations. A basic problem in surveying is to determine coordinates for a network of points using various types of measurements that establish a known geometrical relationship between them. Points with unknown spatial coordinates are connected into the network by the measurements. Surveying observation equations provide a mathematical model that organizes the measurements into a consistent form where methods for finding a unique solution for the unknown coordinates are possible. Instrumentation surveys should always be designed to gather more data than is absolutely necessary to determine station coordinates because this improves the reliability of the results. With extra measurements, unavoidable random errors create discrepancies depending on which set of measurements is used, and there is no unique solution for the coordinates. When this is the case, network adjustment techniques are used to estimate the most accurate set of possible coordinates by the least squares principle of minimizing errors in the measurements. Network adjustment permits all of the available survey measurements to be processed together to determine a weighted mean value for the coordinates. Coordinate accuracy is determined by the application of error propagation to the observation equations. A pre-determined uncertainty (standard deviation) is assigned each measurement, which then propagates to the coordinates during the adjustment. The probable error in the coordinates is reported by the point confidence ellipse for each point or by the relative confidence ellipse between two points. It is essential to determine the positioning accuracy, and without adequate knowledge of the probable error in coordinates the survey should be considered incomplete.

9-2. Theory of Measurements

a. Random variables. Survey measurements are geometrical quantities with numerical values assigned to them with a certain accuracy. The ‘observable’ is a term used to indicate the type of surveying measurement, such as direction, distance, azimuth, coordinate difference, and height difference. An ‘observation’ refers to the specific number assigned to the observable. Surveying observations always contain random deviations where each observation error is called an instance of a random variable. Random variables have a well-known expected frequency distribution (Gaussian or normal) that can be rigorously described by simple parameters.

b. Measures of central tendency. The influence of random error is minimized by computing the mean value of a series of observations, which is also the most probable estimate of the unknown true value. The mean value of a sample can be computed as follows:

$$\bar{x} = \sum (x_i) / n \quad (\text{Eq 9-1})$$

where

\bar{x} = sample mean
 x_i = observations (where $i = 1$ through n)
 n = number of observations

The accuracy of the sample mean is very sensitive to bias or systematic error in the measurements. An incorrect value for the sample mean, due to measurement bias, is shifted away from the true population mean.

c. Measures of dispersion. The variance of a sample of measurements is an estimator of precision or repeatability. The variance describes how closely the measurements are grouped around the sample mean. The sample variance is computed from the average of the squares of the measurement deviations about the mean. A large variance implies lower precision and greater dispersion. The standard deviation or unbiased root mean square (RMS) error is the positive square root of the variance. The sample variance (s^2), or population variance (σ^2) are calculated as follows:

Sample Variance:

$$s^2 = (\sum (x_i - \bar{x})^2) / (n - 1) \quad (\text{Eq 9-2})$$

Population Variance:

$$\sigma^2 = (\sum (x_i - \mu)^2) / N \quad (\text{Eq 9-3})$$

where

x_i = observations (where $i = 1$ through n)

s^2 = sample variance

\bar{x} = sample mean = $(\sum x_i) / n$

n = number of observations

σ^2 = population variance

μ = population mean = $(\sum x_i) / N$

N = number of elements within the population

When the population mean (μ) is unknown, the sample variance (s^2) is computed using the sample mean (\bar{x}). Another measure of dispersion is the range (R) of a data sample:

$$R = | x_{\text{MAX}} - x_{\text{MIN}} | \quad (\text{Eq 9-4})$$

where

R = range

x_{MAX} = maximum value

x_{MIN} = minimum value

The range R is the absolute value of the difference between the minimum and maximum value.

d. Blunders. Blunders are the result of mistakes by the user or inadvertent equipment failure. For example, an observer may misread a level rod by a tenth of a foot or a malfunctioning data recorder may cause erroneous data storage. Blunders are minimized by adopting consistent measurement procedures that contain self-checks. Blunders must be detected and removed before a final usable set of data can be compiled. Techniques used to identify blunders in the data include:

- calculation of loop and traverse closures to check whether the misclosure is within tolerances
- standard deviation of a series of measurements to check if the spread is within tolerance
- comparison of misclosures to a well-determined or to an assumed true position

e. Systematic error. Systematic error is the result of an inadequate mathematical model that omits some necessary physical or mathematical parameter that is necessary to exactly describe the relationship between measurements and coordinates. Systematic error is removed through calibrations and data reductions that are made before entering the data into the network adjustment software. Unremoved systematic errors are detected statistically by an examination of the observation residuals and using the Chi-square Goodness-of-Fit test.

f. Random error. Random error is an inherent result of the measurement process. Least squares processing requires the assumption that only random errors exist within the data. If all systematic errors and blunders have been removed, then observations will contain only random error.

9-3. Least Squares Adjustment

a. General. The Least Squares principle is widely applied to the adjustment of surveying measurements because it defines a consistent set of mathematical and statistical procedures for finding unknown coordinates using redundant observations. If the number of available measurements exceeds the minimum number required for a unique solution, then an adjustment is used to optimally fit a solution to all measurements. Application of the least squares principle relies on the condition that the weighted sum of the squares of the residuals is a minimum. The least squares adjusted coordinates are unique and have both maximum probability of being correct and minimum probable error.

b. Observation weighting. Not all surveying data will be collected with the same level of precision. Therefore, the measurements are weighted relative to each other according to their different precisions. Weights are based on a standard deviation prescribed to each measurement, and these are calculated (by the adjustment software) as the inverse of the measurement variance as follows:

$$w_i = 1 / \sigma_i^2 \quad (\text{Eq 9-5})$$

where

w_i = observation weight value
 σ_i = measurement standard deviation

Observation weighting gives greater influence to the most precise measurements during the network adjustment process. Large standard deviations mean greater measurement uncertainty and lower precision for the measurements, which are then given less weight in the adjustment.

c. Error propagation. Formulas for propagation of variances assume that standard deviations of observations are small enough to be approximated by the squared differential changes of the observables: $\sigma_x^2 = dx dx$, and covariances by their products: $\sigma_{xy} = dx dy$. For a function $x(a,b)$ of observations a and b , the squared differential of the function x is:

$$(dx)^2 = \left(\frac{\partial x}{\partial a}\right)^2 da^2 + \left(\frac{\partial x}{\partial b}\right)^2 db^2 + 2 \left(\frac{\partial x}{\partial a}\right)\left(\frac{\partial x}{\partial b}\right) da db$$

which may be generalized to any number of observables. For another function $y(a,b)$ of the same observables a and b , the differentials of the functions x and y are:

$$dx = \left(\frac{\partial x}{\partial a}\right) da + \left(\frac{\partial x}{\partial b}\right) db$$

$$dy = \left(\frac{\partial y}{\partial a}\right) da + \left(\frac{\partial y}{\partial b}\right) db$$

which are multiplied to calculate the covariance $dx dy$.

$$dxdy = (\frac{\partial x}{\partial a})(\frac{\partial y}{\partial a}) da^2 + (\frac{\partial x}{\partial b})(\frac{\partial y}{\partial b}) db^2 + [(\frac{\partial x}{\partial a})(\frac{\partial y}{\partial b}) + (\frac{\partial x}{\partial b})(\frac{\partial y}{\partial a})] dadb$$

Substitution of standard deviations of a and b for the differentials gives the following error propagation result in x :

$$\sigma_x^2 = (\frac{\partial x}{\partial a})^2 \sigma_a^2 + (\frac{\partial x}{\partial b})^2 \sigma_b^2 + 2 (\frac{\partial x}{\partial a})(\frac{\partial x}{\partial b}) \sigma_{ab}$$

and in the case of uncorrelated measurements, the variances and covariance in x and y are:

$$\begin{aligned} \sigma_x^2 &= (\frac{\partial x}{\partial a})^2 \sigma_a^2 + (\frac{\partial x}{\partial b})^2 \sigma_b^2 \\ \sigma_y^2 &= (\frac{\partial y}{\partial a})^2 \sigma_a^2 + (\frac{\partial y}{\partial b})^2 \sigma_b^2 \\ \sigma_{xy} &= (\frac{\partial x}{\partial a})(\frac{\partial y}{\partial a}) \sigma_a^2 + (\frac{\partial x}{\partial b})(\frac{\partial y}{\partial b}) \sigma_b^2 \end{aligned} \tag{Eq 9-6}$$

d. Covariance matrix of observations. Error propagation formulas are used to calculate a standard deviation for each measurement in the adjustment (see Chapter 4). Once the measurements have been individually assigned a standard deviation, they are assembled into the covariance matrix of observations, and the adjustment software converts to measurement weights by finding the matrix inverse.

e. Covariance matrix of parameters. Before the network adjustment process is completed, the probable error in positioning is computed for each point. Entries of the covariance matrix of parameters contain the position accuracy information. The covariance matrix of parameters is derived from covariance matrix of observations by error propagation using a math model supplied by the adjustment software. Some degree of correlation of position error will likely exist between different stations in the network where the points have been tied together by redundant measurements of the same type.

f. Standard error ellipse. The geometric representation of the entries in the covariance matrix of parameters is through error ellipses describing the boundary of probable error around each point position. The maximum uncertainty in position is equivalent to the magnitude of the major semi-axis of this ellipse (i.e., its greatest dimension) for a given probability level used for reporting results. Its orientation and shape are also determined from the numerical entries of the covariance matrix of parameters. The error ellipse concept is illustrated by Figure 9-1, which depicts the intersection of two lines-of-position.

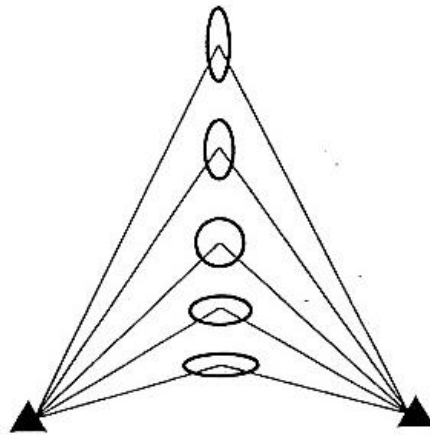

Figure 9-1. Error ellipses resulting from two lines of position at varying angles of intersection

g. Confidence level. For measurements made with the same level of precision, “one standard error” represents an uncertainty equivalent to the expectation that 67% of the measurements will fall within a distance of plus or minus one standard deviation from the mean. The 95% confidence level represents the probability that a data value lies within approximately two standard deviations from the mean. The probability of 95 percent (0.05 significance level) is usually accepted for the assessment of deformation measurements, meaning that the true position of an object point lies within a distance of $1.96\text{-}\sigma$ from the computed mean with 95% probability. Other multipliers can be used depending on the confidence required in the final positioning accuracy. For example:

- 1.96- σ corresponds to 95% probability,
- 2.58- σ corresponds to 99% probability,
- 3.00- σ corresponds to 99.7 % probability.

A probability value of 99% is usually accepted in practice as certainty.

h. Degrees of freedom. The number of redundant measurements in an adjustment is expressed as the degrees of freedom (*df*) of the adjustment. It is calculated as the difference between the number of independent observations and the number of unknown coordinate components in the math model.

$$df = n - u$$

(Eq 9-7)

where

- n = number of observations
- u = number of unknowns

i. Residuals. The residual (*v*) is the difference between the adjusted value of an observation (i.e., as it was fit to the adjusted station position) and the actual input measurement value. Each measurement will have a residual value after the adjustment process. The residual value represents the amount by which the measurement failed to match to the adjusted position.

j. Statistical testing. Statistical tests are widely used to determine if a given quantity (e.g., residual) is compatible with, or significantly different from, some other quantity (e.g., the mean or variance of a set of related residuals). For example, one might test whether a particular measurement is compatible with the mean, or whether it should be removed from the adjustment as a blunder, based on the statistical testing of residuals. Statistical tests indicate whether one should accept or reject the null hypothesis. A null hypothesis (H_0) is a statement that is assumed to be true until proven otherwise, conversely the alternative hypothesis (H_a) will be true if the null hypothesis is false. For example:

- H_0 : An observation is compatible with the mean,
- H_a : An observation is an outlier.

Statistical tests on the residuals would determine which of the above statements is supported by the data. For network adjustments, statistical testing is widely used for data quality assessment.

9-4. Adjustment Input Parameters

a. General. Background information is provided below for building network adjustment files. These computer files typically have a standard list of inputs that are needed to produce results from the adjustment software. Introductory geodesy textbooks or an adjustment software user's guide can provide further background for understanding of the principles and practice of network adjustments.

b. Adjustment input data. The following sections describe both necessary and optional input data for a typical network adjustment. Refer to the adjustment data sample for Yatesville Lake Dam at the end of this chapter for supporting illustrations.

(1) Authorized project name. This record contains basic information for organizing and indexing the project, such as, project name, type of network, date of survey, user comments, etc.

(2) Ellipsoid parameters. The major and minor semi-axes dimension for the reference ellipsoid are required to define the geodetic reference system. These parameters describe the size and shape of the reference ellipsoid to be used for 3D adjustments with geodetic coordinates. Usually a menu-based list of common reference ellipsoids are presented and indexed (by name) to be selected by the user.

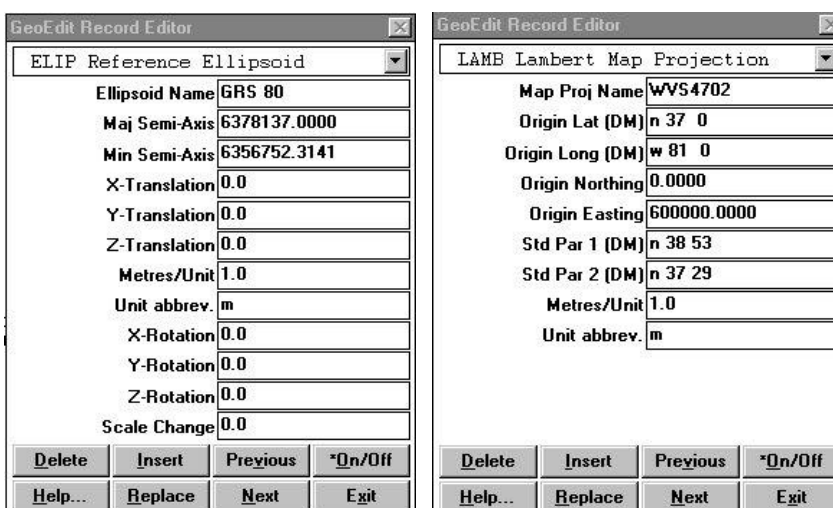

Figure 9-2. User option screens to select the reference ellipsoid and map projection for the adjustment. GRS80 is the ellipsoid that corresponds to NAD83 coordinates. Major and Minor Semi-Axes define the dimensions of the ellipsoid. Units are in meters with translations, rotations, and scale change set to zero. Under the map projection record screen, the projection type and name is selected from a pick list and then automatically populated with the standard Lambert Map Projection values (e.g., West Virginia South Projection in this example).

(3) Map projection parameters. Most software will require the user to select a standard map projection when adjusting plane coordinates. The parameters defining the projection are specified in the input file by, for example, projection type, name, units of measurement, standard parallel(s), central meridian, false easting, false northing, as typical categories. Actual parameter values used will depend on the type of projection chosen and the project's geographic location. See Figure 9-2.

(4) Computation mode. Many adjustment software applications can process either preanalysis (survey design) files or the actual data in an adjustment. Therefore, either adjustment or preanalysis mode is selected by the user. The least squares processing algorithm is identical for both functions but the computational mode must be specified in the input file. The major difference between these modes is that preanalysis does not require actual observations for its computations of expected position error.

(5) Measurement units. All data and constants must be entered in the correct linear and angular units. Never input one variable (e.g., coordinates) in feet and another variable (e.g., measurements) in meters. Most software packages cannot accommodate mismatched units.

(6) Statistical confidence level. For adjustment computations use 95 percent confidence level (significance level of 0.05) for computing adjustment statistics. It is recommended to use 99 percent confidence for preanalysis and design of field surveys. The significance level defines how error magnitudes are statistically tested and reported during the adjustment.

(7) Residual rejection criteria. This criteria defines the probability distribution to be used for data quality assessment and the critical values needed for outlier detection. The Tau distribution will be used to calculate statistics for most adjustments. Tau test statistics apply to data sets with prior unknown mean and variance values (which is the typical case for survey data). This means that normal distribution probability values are converted to Tau values by the software.

(8) Approximate station coordinates (Figure 9-3). In order to process data in an adjustment, each station in the network must be given an estimated position. Approximate coordinates accurate to one (1) meter are sufficient for most networks, although with deformation networks, accuracies less than 0.1 meter should be available. It is imperative that these values are realistic, otherwise the adjustment may not converge to the correct solution. Adjustments use iterative methods to correct the initial coordinates until the change between successive computations falls below a certain tolerance (this adjustment convergence limit is usually set at 0.1 mm). For monitoring networks, the station coordinates coming from previous instrumentation surveys are usually well known, and should be used as approximate coordinates on the current adjustment. If for some reason there are no existing station coordinates for a given control point, such as for new monuments, then traverse sideshot data or plotting from large scale maps can be used to roughly determine new approximate coordinates.

(9) Network constraints. Network constraints provide information to the adjustment software about the absolute position and orientation of the network. In practice, all of the stations in the monitoring network will have some form of position constraint (by their approximate coordinates) that defines their relationship to the project datum. In most adjustment software packages each coordinate component can be fixed separately, which permits breaking the network down into separate 2D and 1D adjustment schemes. There are several different types of network constraints available for adjustment processing, each having different advantages and uses.

(a) Minimum constraint. Any station in the reference network can be held fixed for a minimally constrained adjustment, although usually there is a “master” reference station on each project that is selected to serve as its main control point. For 3D networks, the coordinates of the selected constraint point are fixed along with the orientation and scale of the three axes of the network coordinate system. A minimally constrained adjustment is carried out mainly to validate the measurement data, check for blunders and systematic errors, and to look at the internal consistency of the measurements. The results from a minimum constraint adjustment will show only errors due to measurements without adding in any potential errors coming from inaccurate control station coordinates. Table 9-1 lists the ordinary minimum constraints for adjustment of conventional survey observations.

(b) Fully constrained. In a fully constrained adjustment all stations in the reference network are assumed to have well-known coordinates (i.e., are stable points), and these are fixed with zero error in the adjustment input file. With fully constrained adjustments only the monitoring point stations are

*												
PLH	111	SG2	n	38	8	44.850910	w	82	22	53.155010	158.1660	
PLH	111	EL1	n	38	8	39.238950	w	82	22	56.596230	189.8584	
PLH	000	D-2	N	38	08	44.96390	W	82	23	6.98524	213.5943	
PLH	000	SG1	N	38	08	38.33506	W	82	22	59.71445	203.0432	
*												
NEO	000	U1				127914.204				478737.790	220.0	WVS4702
NEO	000	U2				127939.886				478709.217	220.0	WVS4702
NEO	000	U3				127973.044				478677.195	220.0	WVS4702
NEO	000	U4				128008.556				478647.869	220.0	WVS4702
NEO	000	U5				128033.501				478629.927	220.0	WVS4702
NEO	000	U6				127893.902				478665.303	202.0	WVS4702
NEO	000	U7				127930.722				478629.834	202.0	WVS4702
NEO	000	U8				127970.066				478597.315	202.0	WVS4702
NEO	000	D1				127921.990				478744.299	220.0	WVS4702
NEO	000	D2				127947.196				478716.215	220.0	WVS4702
NEO	000	D3				127979.791				478684.729	220.0	WVS4702
NEO	000	D4				128014.747				478655.858	220.0	WVS4702
NEO	000	D5				128039.215				478638.251	220.0	WVS4702
NEO	000	D6				127987.591				478754.896	193.0	WVS4702
NEO	000	D7				128017.056				478726.426	193.0	WVS4702
NEO	000	D8				128048.472				478700.450	193.0	WVS4702

Figure 9-3. Approximate coordinates for each survey station in an example network. PLH stands for latitude, longitude, and ellipsoid height. NEO stands for Northing, Easting, and Orthometric height. The code 111 in the second column means each coordinate is fixed, and the code 000 means each coordinate is unfixed. The third column contains an abbreviated station name. The next three columns contain the approximate coordinate values for each station. The last column stands for West Virginia State plane projection 4702.

allowed to float and adjust in position. The drawback to a fully-constrained network adjustment is that any errors due to inaccurate reference station coordinates will be transferred to the monitoring points. Therefore, it is important that the reference network stations be surveyed independently with higher precision, and then checked against previous reference network surveys for stability.

(c) Weighted constraints. With a weighted constraints adjustment every station in the monitoring network, both the reference stations and the monitoring points, are assigned weights. No station is fixed absolutely with zero error, but the reference stations are usually given higher weights. The weights are assigned according to prior knowledge of their positioning uncertainty (i.e., point confidence ellipses) obtained from the results of a previous network adjustment.

- Reference stations are given a weight based on the covariance matrix of parameters resulting from the most recent project adjustment, or the adjustment of an independent network survey.
- Monitoring point stations are generally given a lower or essentially zero weight in relation to the reference network stations.

Coordinates for each station are assigned a separate weight matrix for position (e.g., a diagonal matrix constructed from the standard deviation of each coordinate component). A weighted constraints adjustment provides the most rigorous form of adjustment error propagation.

(d) Specialized constraints. When GPS survey observations are combined with photogrammetric surveys, the localized 3D coordinates (e.g., x, y, z coordinates) and associated variance-covariance matrix from the photogrammetric survey observations and subsequent bundle adjustment will be included. When only using photogrammetric surveys, free network constraints (i.e., inner constraints) will be used to define the datum. When photogrammetric surveys are combined only with conventional surveys, the

Table 9-1. Minimum Constraints¹

Network Type	Minimum Constraint
1D (i.e., z)	z of 1 point held fixed
2D (i.e., x, y) with distance	x and y of 1 point held fixed azimuth of 2nd point held fixed (standard deviation of azimuth = 0.1")
2D (i.e., x, y) without distance	x and y of 2 points held fixed
3D (i.e., x, y, z) with distance	x, y, and z of 1 point held fixed azimuth and zenith angle to 2nd point held fixed, zenith angle to 3rd point held fixed (standard deviation of azimuth and zenith angles = 0.1")
3D (i.e., x, y, z) without distance	x, y, z of 3 points held fixed

¹x = x horizontal value

y = y horizontal value

z = z vertical value (i.e., elevation)

NOTE: minimum constraints applied to opposite sides of network.

datum will be defined by the constraints used in a conventional survey adjustment. If photogrammetric surveys are combined only with GPS survey observations, the GPS survey observations will be used to define the datum (e.g., location, orientation, scale). In each of these examples where a covariance matrix is required, it is an example of using a weighted constraints approach.

(10) Observation type. The type of observation must be declared for each measurement. Standard observation equations are built into the software for each different type of measurement that defines the adjustment math model. The level of detail and rigor used in defining the observation equations determines the quality of the adjustment software. Examples of survey observation types include; distance, angle, azimuth, direction, absolute coordinates, 2D and 3D coordinate differences, elevation, height difference, geoid height, and others. See Figure 9-4.

(11) Station connections. Network geometry identifies how the measurements are connected to each other in relation to distance, height, and orientation. Station names (or other point identifiers) are referenced to each observation, and are required for every measurement used in the adjustment.

(12) Measurement value. Every observation record will contain the final reduced mark-to-mark measurement value in its prescribed units. The coordinate system expected for most conventional observations is the Local Astronomic System. This system is defined to correspond with a level reference plane, as used by most conventional instruments, and a horizontal reference alignment (i.e., using the local plumbline and Astronomic North for vertical and horizontal orientation respectively).

(13) Measurement standard deviation. Every observation data record will contain an estimated standard deviation. Its actual value is pre-computed from variance formulas prescribed for each observation type (Chapter 4).

* * Baseline tie-in						
*						
DSET						
DIR	EL1	SG1		0 0	0.00	0.58
DIR	EL1	SG2		135 59	38.54	0.58
*						
DSET						
DIR	SG1	D-2		0 0	0.00	2.69
DIR	SG1	SG2		79 22	58.17	2.69
DIR	SG1	EL1		110 44	34.01	2.69
*						
DSET						
DIR	SG2	EL1		0 0	0.00	1.37
DIR	SG2	SG1		12 38	48.45	1.37
DIR	SG2	D-2		64 45	17.11	1.37
*						
DIST	EL1	SG1			81.9538	0.001
ZANG	EL1	SG1		80 44	28.10	1.0
*						
DIST	EL1	SG2			194.8543	0.001
ZANG	EL1	SG2		99 21	36.79	1.0

Figure 9-4. Adjustment input example showing conventional observations used to tie between reference stations. Each record contains the type of observation, station names, measurement, and standard deviation value.

9-5. Adjustment Output Parameters

a. Adjustment output. The following sections describe typical output data from an adjustment--refer to the sample adjustment of Yatesville Lake dam.

(1) Degrees of freedom. The degrees of freedom describes the level of redundancy for a given survey adjustment. Greater degrees of freedom generally means greater statistical reliability of the solution. If possible, the degrees of freedom should be more than twice the number of unknown parameters (coordinates) in the adjustment.

(2) Flagged outliers. A measurement is flagged and rejected as an outlier if an observation residual turns out to be larger than the statistical confidence interval established for the set of observation residuals as a whole.

(3) Standardized residuals. Higher values for a standardized residual means a low degree of fit, and indicates the measurement associated with it may be suspect. The value of the standardized residual for each observation is compared to the standardized residuals of similar measurements to determine relative data quality.

(4) Confidence ellipse. The point confidence ellipse represents the accuracy of the adjusted position stated at the probability (significance) level selected for the adjustment. Its dimensions and orientation (size and shape) are described by:

- Major semi-axis,
- Minor semi-axis,
- Vertical confidence interval,
- Azimuth or orientation of major semi-axis.

The magnitude of the major semi-axis of the point confidence ellipse represents the maximum expected error in horizontal position. The orientation of the confidence ellipse represent the principal direction of the maximum position error. The vertical error bar represents the maximum expected vertical positioning error. See examples at Figure 9-5.

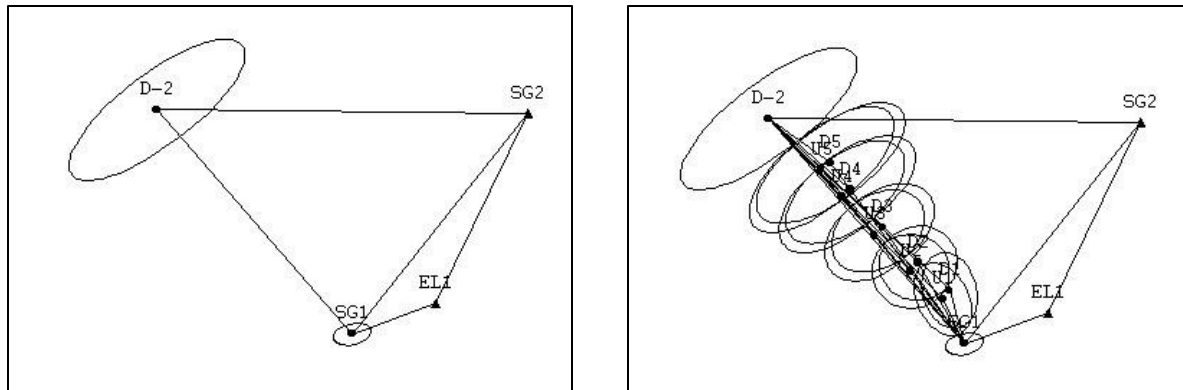

Figure 9-5. Adjustment output plots showing the reference network and monitoring network. The left-hand plot shows only the reference network stations with their error ellipses. The right-hand plot shows both the reference stations and the structure monitoring points with their error ellipses.

(5) Misclosures. (Figure 9-6). Large misclosures can signal problems with initial approximate coordinates. If an adjustment processing does not converge on a solution, then the approximate coordinates should be checked for possible data entry blunders. The station coordinates corresponding to the largest misclosure should be checked first as the most likely source of error.

```

=====
GeoLab V2.4d                WGS 84                ECREST1                UNITS: m,DMS                Page 0002
=====
Misclosures (pass 1):
TYPE AT          FROM          TO          OBSERVATION  STD. DEV.  MISC
-----
GROUP: 00002231.SSF,obs#: 16 day 98 OPT          98 0 17:
DXCT             SG2             D4          -252.4681    0.0008    0.0008
DYCT             SG2             D4          -94.7024     0.0017   -0.0022
DZCT             SG2             D4          -30.0746     0.0016    0.0039
GROUP: 00002235.SSF,obs#: 20 day 98 OPT          98 0 16:
DXCT             SG2             U3          -227.3046    0.0007    0.0014
DYCT             SG2             U3          -117.2940    0.0018    0.0008
DZCT             SG2             U3          -62.5023     0.0016    0.0010
GROUP: 00002227.SSF,obs#: 21 day 98 OPT          98 0 17:
DXCT             SG2             U4          -259.7704    0.0008    0.0009
DYCT             SG2             U4          -99.6715     0.0017   -0.0023
DZCT             SG2             U4          -34.9894     0.0016    0.0037
=====

```

Figure 9-6. Adjustment output showing an example of misclosures for some observations. All misclosures shown are only a few centimeters, which indicates the approximate coordinates and the observations are a close match.

(6) Adjusted coordinates. (Figure 9-7). The main result of an adjustment is the adjusted coordinates for each station in the network. The output coordinates should be converted to a Cartesian System (x, y, z) for directly calculating linear displacements.

```

=====
GeoLab V2.4d                ECREST1                UNITS: m,DMS                Page 0004
=====
Adjusted PLH Coordinates:
=====
CODE FFF STATION          LATITUDE          LONGITUDE          ELIP-HEIGHT
          STD DEV          STD DEV          STD DEV
-----
PLH 000 D1                N 38 08 39.907802 W 82 23 0.259213          186.9275
          0.0005                0.0004                0.0010
PLH 000 D2                N 38 08 40.711910 W 82 23 1.427794          187.0958
          0.0004                0.0003                0.0009
PLH 000 D4                N 38 08 42.873908 W 82 23 3.947207          187.0954
          0.0003                0.0003                0.0009
PLH 000 D5                N 38 08 43.658989 W 82 23 4.685115          186.8972
          0.0006                0.0004                0.0018
PLH 111 EL1              N 38 08 39.238950 W 82 22 56.596230          189.8584
          0.0000                0.0000                0.0000
PLH 111 SG2              N 38 08 44.850910 W 82 22 53.155010          158.1660
          0.0000                0.0000                0.0000
PLH 000 U1                N 38 08 39.652228 W 82 23 0.521696          186.9883
          0.0006                0.0004                0.0010
PLH 000 U2                N 38 08 40.471523 W 82 23 1.710551          187.1150
          0.0004                0.0003                0.0009
PLH 000 U3                N 38 08 41.531445 W 82 23 3.045857          187.2968
          0.0005                0.0004                0.0011
PLH 000 U4                N 38 08 42.669274 W 82 23 4.271490          187.1721
          0.0003                0.0003                0.0009
PLH 000 U5                N 38 08 43.469769 W 82 23 5.023436          186.9739
          0.0006                0.0004                0.0019
=====

```

Figure 9-7. Adjustment output showing the final adjusted coordinates for each station in the network.

(7) Goodness-of-fit. Residuals as a whole will either pass or fail the Goodness-of-Fit test. A Failed Chi-square test can indicate that there are measurement biases still remaining in the input data or that there are still some unremoved outliers. The Goodness-of-Fit test compares the shape of the actual distribution of residuals and the standard normal distribution to determine its degree of fit. If the test fails it indicates that the errors were not randomly distributed as should be expected in an adjustment. Separate Goodness-of-Fit tests can be made on the residuals from different types of measurements (e.g., distances, angles, or height differences, etc.). Partitioning the data into separate groups to make separate statistical tests is a procedure used to locate problems with particular types of measurements. A lack of fit between observations and coordinates can be determined for any particular group of measurements by examining the histogram of residuals. See also the sample output in Figure 9-8.

(8) A posteriori variance factor. The a posteriori variance factor is produced by the adjustment and indicates the precision for the results by incorporating the observation residuals into the assessment of coordinate accuracy. If the adjustment weighting scheme is too optimistic or too pessimistic, then the variance factor provides a scale factor to the adjustment covariance matrix. A posteriori variance factor values greater than one (1.0) indicate that the observation weights were overly-optimistic, values less than one (1.0) indicate that the observation weights were overly-pessimistic.

b. Test on the variance. The a posteriori variance factor is a global indicator of the quality of the adjustment and its weighting scheme. It is assessed by comparing its computed value to its expected value (i.e., 1.0) using a statistical test on the variance. The a posteriori variance factor is computed for an adjustment by dividing the quadratic form of the residuals by the degrees of freedom.

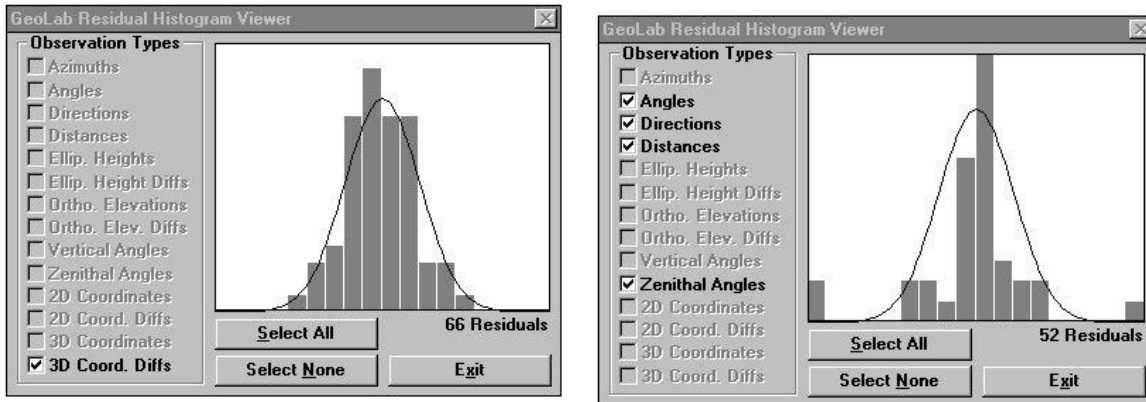

Figure 9-8. Histogram plots for the observation residuals. The left-hand plot shows normally distributed residuals for the GPS observations. The right-hand plot shows a few observations at the lateral margins indicating there are some outliers present in the conventional survey data.

$$\sigma^2 = (\mathbf{V}^t \mathbf{W} \mathbf{V}) / df \quad (\text{Eq 9-8})$$

where

- σ^2 = A posteriori variance factor
- \mathbf{V} = Residual vector
- \mathbf{W} = Covariance matrix of observations
- df = Degrees of freedom

The null and alternative hypotheses for the test on the variance are as follows,

$$\begin{aligned} H_0 : \sigma^2 &= \sigma_0^2 \quad \therefore \sigma^2 / \sigma_0^2 = 1 \\ H_a : \sigma^2 &\neq \sigma_0^2 \quad \therefore \sigma^2 / \sigma_0^2 \neq 1 \end{aligned}$$

The test fails, and the null hypothesis is rejected, if:

$$df(\sigma^2) / \xi \chi^2_{df, 1-\alpha/2} < \sigma^2 < df(\sigma^2) / \xi \chi^2_{df, \alpha/2}$$

where $\xi \chi^2_{df, 1-\alpha/2}$ and $\xi \chi^2_{df, \alpha/2}$ are critical values from the Chi-square (χ) distribution tables based on a significance level alpha (α) and the degrees of freedom (df).

c. Detection and removal of outliers. An outlier is a measurement that is statistically incompatible with similar types of measurements from a given survey. Outlier detection is a quality control procedure essential to pre-processing and data cleaning. An observation is tested against the confidence level of the mean using a simple statistical test with a known or assumed variance.

$$\mu - (\sigma \xi) < \text{obs}_i < \mu + (\sigma \xi) \quad (\text{Eq 9-9})$$

The probability value ξ is determined from standard normal probability density tables using degrees of freedom equal to the number of observations and significance level (0.05).

d. Statistical assessment of residuals. Measurement outliers should be removed from the adjustment processing. Outliers can be identified by sequentially testing each standardized residual to determine if its value exceeds a defined rejection threshold. The Tau test uses the Tau distribution to compute rejection critical values.

(1) Tau Test probability. The Tau (τ) distribution can be derived from the Student-t distribution (t) using the following formula:

$$\tau = [(df)^{0.5} t_{df-1}] / [(df-1) + (t_{df-1}^2)]^{0.5} \quad (\text{Eq 9-10})$$

df = degrees of freedom
 t = Critical value from the Student-t distribution

Tau test critical values are computed for a significance value (α) and degrees of freedom (df).

(2) Standardized Residuals. A standardized residual (v') is defined as the observation residual divided by the standard deviation of the residual.

$$v' = v / \sigma_v \quad (\text{Eq 9-11})$$

where

v' = Standardized residual
 v = Computed residual
 σ_v = Standard deviation of the residual

Standardized residuals are computed to allow direct comparison between residuals of the same type. A much higher value for one of the standardized residuals indicates that it does not fit well compared to other standardized residuals, and its corresponding observation may be flagged as an outlier. When computing standardized residuals, the standard deviation of the residual (σ_r) can be replaced with the standard deviation of the corresponding observation (σ_o). However, because the residual standard deviation is smaller than the observation standard deviation,

$$|v| / \sigma_o < |v| / \sigma_v$$

an outlier may not be rejected. Therefore, it is recommended that the significance value (α) be increased for outlier detection in order to decrease the corresponding confidence level when using the observation standard deviation (σ_o).

(3) Outlier rejection. The rejection threshold for testing for measurement outliers is computed for a significance level (α) using the Tau distribution. The outlier rejection statistic for the standardized residual,

$$|v'| < (\xi_{\tau, df, 1-\alpha/2}) \sigma_v$$

determines if the standardized residual exceeds the rejection threshold, if so it is considered an outlier. The suggested significance value for the technique is $\alpha = 0.01$. The outlier rejection technique is based on univariate statistical testing which is most effective when only one significant outlier is present in the network.

e. *Rejection criteria.* The following table provides guidance on assessing rejection tolerances for various instruments.

Table 9-2. Rejection Criteria for Preprocessing of Deformation Survey Data

Type of Instrument	Type of Measurement	Test	Action to Follow if Data is Rejected
Theodolite ¹ or Subtense Bar ¹ or Theodolite ¹ (Trigonometric Leveling)	Angle	1. Reduced data must be less than 2 seconds from the mean reduced direction --> Otherwise, reject	Reobserve the portion of the survey rejected
	Angle	2. Reduced zenith angle not being used to compute a height difference must be less than 4 seconds from the mean reduced direction --> Otherwise, reject	
	Elevation	3. Reduced and corrected zenith angle not being used to compute a height difference must be less than 2 seconds from the mean reduced and corrected zenith angle --> Otherwise, reject	
Steel or Invar Tape	Distance	1. Difference between two independently measured distances must be less than 2 mm --> Otherwise, reject	Remeasure the distance rejected
EDM Distance or EDM Elevation		1. Maximum difference among the four independent measured distances must be less than 5 mm --> Otherwise, reject	Remeasure the distance rejected
Automatic Level Setup	Elevation	1. Difference between readings on the left and right hand scale must be within 0.25 mm of rod constant --> Otherwise, reject 2. Difference between height difference determined from the foresight and backsight readings on the left rod scale and that determined from foresights and backsight readings from the rights scale must be less than 0.25 mm --> Otherwise, reject	Reobserve the portion of the survey rejected
Network of Level Setups	Elevation	1. Height difference misclosure in a loop must be less than $3 \text{ mm} * \sqrt{K}$ (K in km) --> (Minimum = 1 mm) Otherwise, reject	Formulate different loops to determine height differences between points common to loops which have been rejected; or, reobserve the portion of the survey rejected
Level and Meter Rule	HI	1. Difference between two independent readings must be less than 0.5 mm --> Otherwise, reject	Remeasure the distance rejected
Mono/stereo-comparator	Photo image coordinates	1. As applied by photogrammetry software for hardware used --> Otherwise, reject 2. Discrepancy between double measured image coordinates is less than 2 microns --> Otherwise, reject	Remeasure image coords
GPS Receivers	Horizontal coordinates and elevation	1. Tests as detailed in EM 1110-1-1003	Reoccupy baseline

¹ When performing these data reductions, no atmospheric, instrumental, standardization, and geometric corrections are necessary for angular observation made with a theodolite, except in the case of zenith angles which are observed for the purpose of determining height differences (in which case, earth curvature and refraction need be considered. Because a deformation survey is on a localized network, skew-normal, arc-to-chord, and normal section to geodetic correction need not be applied.

9-6. Adjustment Procedures

a. General. This section provides an overview of processing procedures and data requirements for using network adjustment software applications.

b. Coordinate system. Network adjustments that solve for coordinate positions do so in a defined coordinate system. Some software applications will require the use of geodetic coordinates. Geodetic coordinates are transferred to the reference network if non-geodetic coordinates are used on the project.

(1) Geodetic coordinates. NAD83 coordinates are recommended for new projects and projects that incorporate GPS measurements. The project reference network should be tied directly to established NAD83 control by a separate survey. This avoids potentially inaccurate coordinate transformations that might be needed when processing the network adjustment based on local coordinates.

(2) Map projection coordinates. Horizontal positions defined with coordinates based on a map projection are readily handled by most adjustment software applications. State Plane coordinates or Universal Transverse Mercator (UTM) coordinates still require having an underlying geodetic coordinate system related to a standard reference ellipsoid.

(3) Local coordinate system. Station and offset coordinates, based on a local construction datum, are often used for reporting survey results. Some software applications are available that work reasonably well using only simple plane coordinates. However, an arbitrary coordinate system may restrict user options for processing an adjustment.

c. Three dimensional networks. Measurement data combined from separate horizontal and vertical surveys are often used to determine 3D coordinates of network stations. Three dimensional networks yield the most robust adjustment results because there are a large number of redundant measurements needed to reliably interconnect the horizontal and vertical network components. Elevations are required on all reference stations for 3D networks, along with zenith angle measurement ties to common points in the vertical network.

d. Separate horizontal and vertical networks. Horizontal and vertical networks can be adjusted independently if they are setup in the proper manner. For example, with horizontal networks, the elevations for all horizontal network stations should be fixed to a constant, average height, for the entire network (project) and horizontal distances should be used instead of mark-to-mark slope distances. Vertical network stations require approximate horizontal coordinates for processing the vertical adjustment and for error propagation. Vertical networks should include zenith angle ties from the reference network stations where possible and establishing accurate elevations at the reference stations.

e. Configuration defects. Repeated deformation surveys should involve measurements made over the same station configuration using the same sub-sets of network stations, otherwise the comparison between epochs may fail to give adequate results due to configuration defects (i.e., missing observations). During processing and analysis of the adjustment, the same minimal and fixed constraints should be applied for both survey epochs and each survey should be adjusted with the same statistical tests and confidence level.

f. Observation weighting. Observations will be assigned weights according to the a priori estimation of variance for each measurement (i.e., using the standard deviation computed for each measurement).

(1) For conventional surveys, the standard deviations and error models applicable to each type of measurement are to be used in the survey data adjustment. The formulas for variance estimation are provided in Chapter 4.

(2) When GPS survey observations are used in the deformation survey, they will be adjusted with either the GPS based 3D coordinates or coordinate differences and their associated variance-covariance matrices according to EM 1110-1-1003, NAVSTAR Global Positioning System Surveying.

g. Survey adjustment. Final processing of the survey data should be made using least squares adjustment techniques and software. For each adjustment the following quantities will be determined.

- adjusted point coordinates,
- variance-covariance matrix of parameters,
- point confidence ellipse major semi-axis,
- standardized residuals for each observation,
- a posteriori variance factor,
- total redundancy of the network,

h. Data quality assessment. For each adjustment the following data quality indicators will be checked.

(1) Examination of misclosures. Computed misclosure values should not exceed one (1) meter, otherwise examine and correct initial approximate coordinates.

(2) Point confidence ellipse dimensions. The computed major semi-axis of each point confidence ellipse should not exceed the stated accuracy requirement for the survey. See sample outputs in Figures 9-9 and 9-10.

=====					
GeoLab V2.4d		WGS 84		UNITS: m, DMS	Page 0011
=====					
2-D and 1-D Station Confidence Regions (95.000 percent):					
STATION	MAJOR SEMI-AXIS	AZ	MINOR SEMI-AXIS	VERTICAL	

D1	0.0015	28	0.0007	0.0019	
D2	0.0010	11	0.0007	0.0018	
D4	0.0009	157	0.0007	0.0019	
D5	0.0014	161	0.0009	0.0035	
U1	0.0015	28	0.0007	0.0019	
U2	0.0010	11	0.0007	0.0018	
U3	0.0012	162	0.0008	0.0022	
U4	0.0009	157	0.0007	0.0019	
U5	0.0015	161	0.0010	0.0037	

Figure 9-9. Adjustment output showing confidence regions for each adjusted horizontal and vertical position of each station in the network. At the 95-percent confidence level, horizontal position uncertainty (MAJOR SEMI-AXIS) is between 0.9-1.5 mm, and vertical position uncertainty ranges between 1.8-3.7 mm.

(3) Goodness of fit test. The distribution of residuals should pass the Chi-square test for Goodness of Fit at the 0.05 significance level (95% confidence).

(4) Outlier detection. Standardized residuals should be within the tolerance limits for rejection as an outlier as established by the residual rejection critical value at the 95 percent confidence level. Observations flagged as outliers should be removed and the adjustment repeated. Only the single

observation associated with the greatest magnitude residual should be removed before reprocessing the adjustment. Outlier detection should be carried out only on a minimally constrained network.

(5) Chi-Square test on variance factor. The computed a posteriori variance factor should pass the Chi-square test. If the variance factor does not pass because of a value less than 0.5 or greater than 2.0, then observation weights should be verified, and if found to be realistic, then the covariance matrix of parameters should be multiplied by the estimated variance factor to scale its values.

(6) Redundancy number. The computed degrees of freedom should be no less than the number of unknown coordinate components, preferably two or more times greater.

i. Reference network stability. Examination of a separate adjustment of the reference network will be done to check whether the reference points were stable between epochs. Any reference points that are not found to be stable will be left unconstrained in the network adjustment. All reference network points found to be stable are held fixed.

j. Calculation of displacements. After a network adjustment is completed for two different instrumentation surveys, the adjusted coordinates for each monitoring point are extracted and differenced to calculate point displacements, and identify significant movement between the separate time epochs.

k. Required submittal documents. The contracting officer should require the contractor to supply the final adjustment for each project. The contractor should supply a list containing any observations that were removed due to blunders. The contractor must provide USACE with an analysis explaining the methodology used in the adjustment, assumptions, and possible error sources.

GeoLab V2.4d		WGS 84		ECREST1		UNITS: m,DMS		Page 0012
2-D and 1-D Relative Station Confidence Regions (95.000 percent):								
FROM	TO	MAJ-SEMI	AZ	MIN-SEMI	VERTICAL	DISTANCE	PPM	
D1	EL1	0.0015	28	0.0007	0.0019	91.5964	15.95	
D1	SG2	0.0015	28	0.0007	0.0019	232.3432	6.29	
D1	U1	0.0013	28	0.0006	0.0017	10.1468	130.57	
D2	EL1	0.0010	11	0.0007	0.0018	126.1441	7.97	
D2	SG2	0.0010	11	0.0007	0.0018	240.2176	4.18	
D2	U2	0.0008	11	0.0005	0.0014	10.1167	77.22	
D4	EL1	0.0009	157	0.0007	0.0019	211.2129	4.15	
D4	SG2	0.0009	157	0.0007	0.0019	271.3172	3.23	
D4	U4	0.0008	157	0.0006	0.0016	10.1080	75.40	
D5	EL1	0.0014	161	0.0009	0.0035	239.5408	6.01	
D5	SG2	0.0014	161	0.0009	0.0035	284.6099	5.06	
D5	U5	0.0015	161	0.0010	0.0038	10.0953	152.96	
EL1	U1	0.0015	28	0.0007	0.0019	96.4764	15.60	
EL1	U2	0.0010	11	0.0007	0.0018	130.2362	7.73	
EL1	U3	0.0012	162	0.0008	0.0022	172.2461	6.99	
EL1	U4	0.0009	157	0.0007	0.0019	214.7678	4.08	
EL1	U5	0.0015	161	0.0010	0.0037	243.1797	6.25	
SG2	U1	0.0015	28	0.0007	0.0019	242.2878	6.21	
SG2	U2	0.0010	11	0.0007	0.0018	249.9477	4.03	
SG2	U3	0.0012	162	0.0008	0.0022	263.3080	4.57	
SG2	U4	0.0009	157	0.0007	0.0019	280.4268	3.12	
SG2	U5	0.0015	161	0.0010	0.0037	293.5370	5.18	

Figure 9-10. Adjustment output showing relative confidence regions for horizontal and vertical position between each station in the network. At the 95-percent confidence level, horizontal position uncertainty (MAJ-SEMI) is between 0.8-1.5 mm, and vertical position uncertainty is between 1.4-3.8 mm.

9-7. Sample Adjustment -- Yatesville Lake Dam

INPUT DATA

TITL Yatesville Lake Dam 16th Observation
 ELIP GRS 80 6378137.0000 6356752.3141
 COMP ADJ
 PADJ YES NO NO NO NO NO
 PRES YES NO
 PSOL YES YES
 RTST TAU MAX
 PMIS YES YES
 CONV 0.0001
 MAXI 10
 VARF YES YES NO
 CONF YES YES NO YES NO
 LUNT ft 0.3048006096
 CLEV 95.0
 LAMB KYN1601 n 37 30 w 84 15 0.0000 500000.0000 n 38 58 n 37 58 1.0 m

*Reference Station Coordinates

NEO	111	R-1	231672.634	2087616.903	682.105	KYN1601
NEO	111	R-2	231581.816	2086624.431	682.250	KYN1601
NEO	111	R-3	231897.263	2087483.998	682.247	KYN1601
NEO	111	R-4	231717.570	2086570.072	682.732	KYN1601

*Monitoring Station Coordinates

NEO	000	C-1	231697.820	2087338.110	680.370	KYN1601
NEO	000	C-2	231704.340	2087188.450	680.340	KYN1601
NEO	000	C-3	231710.460	2087038.150	680.320	KYN1601
NEO	000	C-4	231717.360	2086888.340	680.300	KYN1601
NEO	000	C-5	231724.560	2086738.540	680.280	KYN1601
NEO	000	D-1	231866.180	2087190.540	655.740	KYN1601
NEO	000	D-2	231872.090	2087040.500	655.710	KYN1601
NEO	000	D-3	231878.660	2086891.070	655.830	KYN1601
NEO	000	U-1	231570.700	2087176.720	660.230	KYN1601
NEO	000	U-2	231576.970	2087027.520	660.540	KYN1601
NEO	000	U-3	231581.980	2086877.240	660.350	KYN1601

*Horizontal Angle Observations

ANGL	R-1	R-4	U-1	344 30	18.50	1.97
ANGL	R-1	R-4	U-2	348 19	23.00	1.75
ANGL	R-1	R-4	U-3	350 33	15.30	1.64
ANGL	R-1	R-4	C-1	2 42	19.50	2.69
ANGL	R-1	R-4	C-2	1 46	28.70	2.01
ANGL	R-1	R-4	C-3	1 16	55.10	1.76
ANGL	R-1	R-4	C-4	1 3	16.80	1.65
ANGL	R-1	R-4	C-5	0 55	31.30	1.59
ANGL	R-1	R-4	D-1	21 57	27.50	2.26
ANGL	R-1	R-4	D-2	16 37	48.20	1.74
ANGL	R-1	R-4	D-3	13 23	18.90	1.64
ANGL	R-4	R-1	U-1	11 9	3.70	1.71
ANGL	R-4	R-1	U-2	14 37	36.10	1.91

EM 1110-2-1009

1 Jun 02

ANGL	R-4	R-1	U-3	21	21	29.40	2.36
ANGL	R-4	R-1	C-1	359	0	53.20	1.62
ANGL	R-4	R-1	C-2	358	46	3.70	1.71
ANGL	R-4	R-1	C-3	358	24	40.50	1.92
ANGL	R-4	R-1	C-4	357	34	45.70	2.43
ANGL	R-4	R-1	C-5	355	9	53.30	3.18
ANGL	R-4	R-1	D-1	344	4	22.50	1.71
ANGL	R-4	R-1	D-2	339	21	32.60	1.88
ANGL	R-4	R-1	D-3	330	53	32.00	2.53

*Distance Observations

DIST	R-1	U-1				452.374	0.0051
DIST	R-1	U-2				597.508	0.0054
DIST	R-1	U-3				745.544	0.0057
DIST	R-1	C-1				279.948	0.0049
DIST	R-1	C-2				429.643	0.0050
DIST	R-1	C-3				580.016	0.0053
DIST	R-1	C-4				729.973	0.0057
DIST	R-1	C-5				879.943	0.0060
DIST	R-1	D-1				468.998	0.0049
DIST	R-1	D-2				610.542	0.0054
DIST	R-1	D-3				755.003	0.0059
DIST	R-2	U-1				552.872	0.0054
DIST	R-2	U-2				403.735	0.0051
DIST	R-2	U-3				253.770	0.0049
DIST	R-2	C-1				723.094	0.0058
DIST	R-2	C-2				577.216	0.0054
DIST	R-2	C-3				433.294	0.0051
DIST	R-2	C-4				296.703	0.0049
DIST	R-2	C-5				182.774	0.0047
DIST	R-3	C-1				247.126	0.0048
DIST	R-3	C-2				352.963	0.0050
DIST	R-3	C-3				483.427	0.0053
DIST	R-3	C-4				622.264	0.0057
DIST	R-3	C-5				765.236	0.0061
DIST	R-3	D-1				296.296	0.0049
DIST	R-3	D-2				445.017	0.0054
DIST	R-3	D-3				593.831	0.0058
DIST	R-4	U-1				624.623	0.0054
DIST	R-4	U-2				479.110	0.0051
DIST	R-4	U-3				336.535	0.0049
DIST	R-4	C-1				768.341	0.0058
DIST	R-4	C-2				618.551	0.0054
DIST	R-4	C-3				468.170	0.0051
DIST	R-4	C-4				318.295	0.0049
DIST	R-4	C-5				168.650	0.0047
DIST	R-4	D-1				638.628	0.0055
DIST	R-4	D-2				495.922	0.0052
DIST	R-4	D-3				360.176	0.0054

*Zenith Angle Observations

ZANG	R-1	U-1		92	46	23.50	2.00
ZANG	R-1	U-2		92	4	2.39	2.33
ZANG	R-1	U-3		91	40	25.10	2.75
ZANG	R-1	C-1		90	21	16.00	2.00

ZANG	R-1	C-2	90	14	8.70	2.03
ZANG	R-1	C-3	90	10	35.30	2.11
ZANG	R-1	C-4	90	8	35.70	2.23
ZANG	R-1	C-5	90	7	11.20	2.32
ZANG	R-1	D-1	93	13	22.60	2.20
ZANG	R-1	D-2	92	28	38.20	2.64
ZANG	R-1	D-3	91	59	38.90	2.85
ZANG	R-4	U-1	92	3	55.30	2.83
ZANG	R-4	U-2	92	39	15.70	2.57
ZANG	R-4	U-3	93	48	46.20	2.24
ZANG	R-4	C-1	90	10	37.60	2.42
ZANG	R-4	C-2	90	13	19.00	2.36
ZANG	R-4	C-3	90	17	44.50	2.24
ZANG	R-4	C-4	90	26	14.30	2.14
ZANG	R-4	C-5	90	49	54.70	2.06
ZANG	R-4	D-1	92	25	22.00	2.77
ZANG	R-4	D-2	93	7	23.20	2.56
ZANG	R-4	D-3	94	17	0.40	2.29

*Orthometric Height Difference Observations

OHDF	R-1	C-1			-1.733	0.006
OHDF	C-1	C-2			-0.027	0.003
OHDF	C-2	C-3			-0.025	0.003
OHDF	C-3	C-4			-0.014	0.003
OHDF	C-4	C-5			-0.022	0.003
OHDF	C-5	R-4			2.451	0.006
OHDF	R-1	U-1			-21.882	0.012
OHDF	U-1	U-2			0.3208	0.003
OHDF	U-2	U-3			-0.193	0.003
OHDF	U-3	R-2			21.883	0.012
OHDF	R-3	D-1			-26.484	0.012
OHDF	D-1	D-2			-0.027	0.003
OHDF	D-2	D-3			0.116	0.003
OHDF	D-3	R-4			26.886	0.012

END

EM 1110-2-1009
1 Jun 02

ADJUSTMENT OUTPUT

```

=====
Yatesville Lake Dam 16th Observation
GeoLab V2.4d      UNITS: ft,DMS      GRS 80      08:15:19, Thu Jun 16, 1998
=====

```

```

INI file:      C:\WINDOWS\GEOLAB.INI
Input file:    C:\GEOLAB2\YATES\YLD16.IOB
Output file:   C:\GEOLAB2\YATES\YLD16.LST

```

PARAMETERS		OBSERVATIONS	
Description	Number	Description	Number
No. of Stations	15	Directions	0
Coord Parameters	33	Distances	38
Free Latitudes	11	Azimuths	0
Free Longitudes	11	Vertical Angles	0
Free Heights	11	Zenithal Angles	22
Fixed Coordinates	12	Angles	22
Astro. Latitudes	0	Heights	0
Astro. Longitudes	0	Height Differences	14
Geoid Records	0	Auxiliary Params.	0
All Aux. Pars.	0	2-D Coords.	0
Direction Pars.	0	2-D Coord. Diffs.	0
Scale Parameters	0	3-D Coords.	0
Constant Pars.	0	3-D Coord. Diffs.	0
Rotation Pars.	0		
Translation Pars.	0		
-----		-----	
Total Parameters	33	Total Observations	96

Degrees of Freedom = 63

SUMMARY OF SELECTED OPTIONS

OPTION	SELECTION
Computation Mode	Adjustment
Maximum Iterations	10
Convergence Criterion	0.00010
Confidence Level for Statistics	95.000
Covariance Matrix Computation	Full
Residual Rejection Criterion	Tau Max
Confidence Region Types	1D 2D Station
Variance Factor (VF) Known	Yes
CMULT (Multiply Parm Cov With VF)	Yes
RMULT (Multiply Res Cov With VF)	No
Full Inverse Computed	Yes
Normals Reordered	Yes
Coordinates Generated	No
Geoid Interpolation Method	Bi-Linear

MISCLOSURES

TYPE	AT	FROM	TO	OBSERVATION	STD.DEV.	MISC
ANGL	R-1	R-4	U-1	344 30 18.5	2.0	-4.9
ANGL	R-1	R-4	U-2	348 19 23.0	1.8	-1.5
ANGL	R-1	R-4	U-3	350 33 15.3	1.6	1.5
ANGL	R-1	R-4	C-1	2 42 19.5	2.7	-4.7
ANGL	R-1	R-4	C-2	1 46 28.7	2.0	-1.3
ANGL	R-1	R-4	C-3	1 16 55.1	1.8	-1.9
ANGL	R-1	R-4	C-4	1 3 16.8	1.6	1.2
ANGL	R-1	R-4	C-5	0 55 31.3	1.6	-0.4
ANGL	R-1	R-4	D-1	21 57 27.5	2.3	-0.3
ANGL	R-1	R-4	D-2	16 37 48.2	1.7	-2.0
ANGL	R-1	R-4	D-3	13 23 18.9	1.6	-0.2
ANGL	R-4	R-1	U-1	11 9 3.7	1.7	1.8
ANGL	R-4	R-1	U-2	14 37 36.1	1.9	2.0
ANGL	R-4	R-1	U-3	21 21 29.4	2.4	5.3
ANGL	R-4	R-1	C-1	359 0 53.2	1.6	1.1
ANGL	R-4	R-1	C-2	358 46 3.7	1.7	-0.1
ANGL	R-4	R-1	C-3	358 24 40.5	1.9	3.7
ANGL	R-4	R-1	C-4	357 34 45.7	2.4	1.7
ANGL	R-4	R-1	C-5	355 9 53.3	3.2	4.7
ANGL	R-4	R-1	D-1	344 4 22.5	1.7	-0.8
ANGL	R-4	R-1	D-2	339 21 32.6	1.9	-2.4
ANGL	R-4	R-1	D-3	330 53 32.0	2.5	1.6
DIST		R-1	U-1	452.3740	0.0051	0.0102
DIST		R-1	U-2	597.5080	0.0054	0.0087
DIST		R-1	U-3	745.5440	0.0057	0.0101
DIST		R-1	C-1	279.9480	0.0049	0.0005
DIST		R-1	C-2	429.6430	0.0050	0.0078
DIST		R-1	C-3	580.0160	0.0053	0.0052
DIST		R-1	C-4	729.9730	0.0057	0.0023
DIST		R-1	C-5	879.9430	0.0060	0.0019
DIST		R-1	D-1	468.9980	0.0049	0.0046
DIST		R-1	D-2	610.5420	0.0054	-0.0023
DIST		R-1	D-3	755.0030	0.0059	0.0004
DIST		R-2	U-1	552.8720	0.0054	-0.0036
DIST		R-2	U-2	403.7350	0.0051	-0.0116
DIST		R-2	U-3	253.7700	0.0049	-0.0010
DIST		R-2	C-1	723.0940	0.0058	-0.0080
DIST		R-2	C-2	577.2160	0.0054	-0.0086
DIST		R-2	C-3	433.2940	0.0051	-0.0086
DIST		R-2	C-4	296.7030	0.0049	0.0010
DIST		R-2	C-5	182.7740	0.0047	-0.0060
DIST		R-3	C-1	247.1260	0.0048	-0.0009
DIST		R-3	C-2	352.9630	0.0050	0.0026
DIST		R-3	C-3	483.4270	0.0053	0.0026
DIST		R-3	C-4	622.2640	0.0057	0.0046
DIST		R-3	C-5	765.2360	0.0061	0.0089
DIST		R-3	D-1	296.2960	0.0049	0.0070
DIST		R-3	D-2	445.0170	0.0054	0.0100
DIST		R-3	D-3	593.8310	0.0058	0.0076

MISCLOSURES

TYPE	AT	FROM	TO	OBSERVATION	STD.DEV.	MISC
DIST		R-4	U-1	624.6230	0.0054	-0.0114
DIST		R-4	U-2	479.1100	0.0051	-0.0030
DIST		R-4	U-3	336.5350	0.0049	-0.0092
DIST		R-4	C-1	768.3410	0.0058	-0.0049
DIST		R-4	C-2	618.5510	0.0054	0.0058
DIST		R-4	C-3	468.1700	0.0051	-0.0071
DIST		R-4	C-4	318.2950	0.0049	-0.0008
DIST		R-4	C-5	168.6500	0.0047	-0.0103
DIST		R-4	D-1	638.6280	0.0055	-0.0072
DIST		R-4	D-2	495.9220	0.0052	-0.0039
DIST		R-4	D-3	360.1760	0.0054	0.0002
ZANG		R-1	U-1	92 46 23.5	2.0	3.5
ZANG		R-1	U-2	92 4 2.4	2.3	-6.5
ZANG		R-1	U-3	91 40 25.1	2.8	1.8
ZANG		R-1	C-1	90 21 16.0	2.0	-3.7
ZANG		R-1	C-2	90 14 8.7	2.0	-0.8
ZANG		R-1	C-3	90 10 35.3	2.1	-2.3
ZANG		R-1	C-4	90 8 35.7	2.2	2.1
ZANG		R-1	C-5	90 7 11.2	2.3	-0.9
ZANG		R-1	D-1	93 13 22.6	2.2	-1.0
ZANG		R-1	D-2	92 28 38.2	2.6	-4.9
ZANG		R-1	D-3	91 59 38.9	2.9	-4.5
ZANG		R-4	U-1	92 3 55.3	2.8	-0.2
ZANG		R-4	U-2	92 39 15.7	2.6	-4.2
ZANG		R-4	U-3	93 48 46.2	2.2	-4.1
ZANG		R-4	C-1	90 10 37.6	2.4	-0.3
ZANG		R-4	C-2	90 13 19.0	2.4	-1.7
ZANG		R-4	C-3	90 17 44.5	2.2	-0.5
ZANG		R-4	C-4	90 26 14.3	2.1	-3.3
ZANG		R-4	C-5	90 49 54.7	2.1	-5.3
ZANG		R-4	D-1	92 25 22.0	2.8	-1.7
ZANG		R-4	D-2	93 7 23.2	2.6	-3.9
ZANG		R-4	D-3	94 17 0.4	2.3	-1.9
EHDF		R-1	C-1	-1.7330	0.0060	-0.0020
EHDF		C-1	C-2	-0.0270	0.0030	-0.0030
EHDF		C-2	C-3	-0.0250	0.0030	0.0050
EHDF		C-3	C-4	-0.0140	0.0030	-0.0060
EHDF		C-4	C-5	-0.0220	0.0030	0.0020
EHDF		C-5	R-4	2.4510	0.0060	0.0010
EHDF		R-1	U-1	-21.8820	0.0120	0.0070
EHDF		U-1	U-2	0.3208	0.0030	-0.0108
EHDF		U-2	U-3	-0.1930	0.0030	0.0030
EHDF		U-3	R-2	21.8830	0.0120	0.0170
EHDF		R-3	D-1	-26.4840	0.0120	-0.0230
EHDF		D-1	D-2	-0.0270	0.0030	-0.0030
EHDF		D-2	D-3	0.1160	0.0030	0.0040
EHDF		D-3	R-4	26.8860	0.0120	0.0160

ADJUSTED NEO COORDINATES (Reference Stations)

CODE	FFF	STATION	NORTHING STD DEV	EASTING STD DEV	O-HEIGHT STD DEV	MAPPROJ
NEO	111	R-1	231672.6340 0.0000	2087616.9030 0.0000	682.1050 0.0000	KYN1601
NEO	111	R-2	231581.8160 0.0000	2086624.4310 0.0000	682.2500 0.0000	KYN1601
NEO	111	R-3	231897.2630 0.0000	2087483.9980 0.0000	682.2470 0.0000	KYN1601
NEO	111	R-4	231717.5700 0.0000	2086570.0720 0.0000	682.7320 0.0000	KYN1601

ADJUSTED NEO COORDINATES (Monitoring Stations)

CODE	FFF	STATION	NORTHING STD DEV	EASTING STD DEV	O-HEIGHT STD DEV	MAPPROJ
NEO	000	C-1	231697.8239 0.0024	2087338.1127 0.0025	680.3734 0.0017	KYN1601
NEO	000	C-2	231704.3414 0.0026	2087188.4534 0.0023	680.3451 0.0018	KYN1601
NEO	000	C-3	231710.4664 0.0026	2087038.1552 0.0023	680.3205 0.0018	KYN1601
NEO	000	C-4	231717.3605 0.0025	2086888.3414 0.0023	680.3052 0.0016	KYN1601
NEO	000	C-5	231724.5637 0.0019	2086738.5470 0.0024	680.2838 0.0012	KYN1601
NEO	000	D-1	231866.1792 0.0030	2087190.5461 0.0024	655.7464 0.0025	KYN1601
NEO	000	D-2	231872.0906 0.0028	2087040.5051 0.0025	655.7199 0.0023	KYN1601
NEO	000	D-3	231878.6622 0.0030	2086891.0720 0.0027	655.8359 0.0023	KYN1601
NEO	000	U-1	231570.7087 0.0028	2087176.7277 0.0025	660.2268 0.0023	KYN1601
NEO	000	U-2	231576.9741 0.0028	2087027.5281 0.0025	660.5493 0.0022	KYN1601
NEO	000	U-3	231581.9820 0.0027	2086877.2482 0.0024	660.3560 0.0022	KYN1601

1 Jun 02

RESIDUALS

(critical value = 3.504):

TYPE	AT	FROM	TO	OBSERVATION	RESIDUAL	STD RES	
ANGL	R-1	R-4	U-1	344 30	18.5	-1.8	-1.4
ANGL	R-1	R-4	U-2	348 19	23.0	-0.5	-0.4
ANGL	R-1	R-4	U-3	350 33	15.3	1.7	1.3
ANGL	R-1	R-4	C-1	2 42	19.5	-1.7	-1.0
ANGL	R-1	R-4	C-2	1 46	28.7	-0.5	-0.3
ANGL	R-1	R-4	C-3	1 16	55.1	0.5	0.4
ANGL	R-1	R-4	C-4	1 3	16.8	1.3	0.9
ANGL	R-1	R-4	C-5	0 55	31.3	0.6	0.4
ANGL	R-1	R-4	D-1	21 57	27.5	0.5	0.3
ANGL	R-1	R-4	D-2	16 37	48.2	-1.3	-1.0
ANGL	R-1	R-4	D-3	13 23	18.9	0.5	0.4
ANGL	R-4	R-1	U-1	11 9	3.7	-1.6	-1.2
ANGL	R-4	R-1	U-2	14 37	36.1	-0.8	-0.6
ANGL	R-4	R-1	U-3	21 21	29.4	2.2	1.6
ANGL	R-4	R-1	C-1	359 0	53.2	-0.0	-0.0
ANGL	R-4	R-1	C-2	358 46	3.7	-0.5	-0.4
ANGL	R-4	R-1	C-3	358 24	40.5	0.9	0.7
ANGL	R-4	R-1	C-4	357 34	45.7	1.4	1.0
ANGL	R-4	R-1	C-5	355 9	53.3	0.6	0.4
ANGL	R-4	R-1	D-1	344 4	22.5	-0.0	-0.0
ANGL	R-4	R-1	D-2	339 21	32.6	-1.9	-1.6
ANGL	R-4	R-1	D-3	330 53	32.0	0.9	0.6
DIST		R-1	U-1		452.37400	0.0009	0.2281
DIST		R-1	U-2		597.50800	-0.0003	-0.0556
DIST		R-1	U-3		745.54400	0.0015	0.3063
DIST		R-1	C-1		279.94800	-0.0019	-0.4906
DIST		R-1	C-2		429.64300	0.0045	1.0975
DIST		R-1	C-3		580.01600	0.0004	0.0859
DIST		R-1	C-4		729.97300	0.0009	0.1864
DIST		R-1	C-5		879.94300	-0.0050	-0.9516
DIST		R-1	D-1		468.99800	-0.0016	-0.4173
DIST		R-1	D-2		610.54200	-0.0074	-1.6738
DIST		R-1	D-3		755.00300	-0.0011	-0.2223
DIST		R-2	U-1		552.87200	0.0041	0.9087
DIST		R-2	U-2		403.73500	-0.0041	-0.9908
DIST		R-2	U-3		253.77000	0.0067	1.6943
DIST		R-2	C-1		723.09400	-0.0047	-0.9416
DIST		R-2	C-2		577.21600	-0.0050	-1.0598
DIST		R-2	C-3		433.29400	-0.0018	-0.3996
DIST		R-2	C-4		296.70300	0.0024	0.5768
DIST		R-2	C-5		182.77400	0.0012	0.2831
DIST		R-3	C-1		247.12600	-0.0057	-1.3969
DIST		R-3	C-2		352.96300	-0.0011	-0.2477
DIST		R-3	C-3		483.42700	-0.0046	-0.9979
DIST		R-3	C-4		622.26400	0.0031	0.6163
DIST		R-3	C-5		765.23600	0.0012	0.2193
DIST		R-3	D-1		296.29600	0.0005	0.1289
DIST		R-3	D-2		445.01700	0.0042	0.9480

RESIDUALS

(critical value = 3.504):

TYPE	AT	FROM	TO	OBSERVATION	RESIDUAL	STD RES
DIST		R-3	D-3	593.83100	0.0053	1.1113
DIST		R-4	U-1	624.62300	-0.0058	-1.3055
DIST		R-4	U-2	479.11000	0.0031	0.7507
DIST		R-4	U-3	336.53500	-0.0030	-0.7783
DIST		R-4	C-1	768.34100	-0.0023	-0.4694
DIST		R-4	C-2	618.55100	0.0092	1.9861
DIST		R-4	C-3	468.17000	-0.0020	-0.4592
DIST		R-4	C-4	318.29500	0.0005	0.1364
DIST		R-4	C-5	168.65000	-0.0032	-0.8759
DIST		R-4	D-1	638.62800	-0.0017	-0.3722
DIST		R-4	D-2	495.92200	0.0006	0.1438
DIST		R-4	D-3	360.17600	0.0025	0.6040
ZANG		R-1	U-1	92 46 23.5	1.8	1.2
ZANG		R-1	U-2	92 4 2.4	-3.4	-1.6
ZANG		R-1	U-3	91 40 25.1	3.4	1.3
ZANG		R-1	C-1	90 21 16.0	-1.2	-0.9
ZANG		R-1	C-2	90 14 8.7	1.7	1.0
ZANG		R-1	C-3	90 10 35.3	-2.1	-1.1
ZANG		R-1	C-4	90 8 35.7	3.5	1.6
ZANG		R-1	C-5	90 7 11.2	-0.0	-0.0
ZANG		R-1	D-1	93 13 22.6	1.7	1.0
ZANG		R-1	D-2	92 28 38.2	-1.6	-0.6
ZANG		R-1	D-3	91 59 38.9	-2.9	-1.1
ZANG		R-4	U-1	92 3 55.3	-1.2	-0.4
ZANG		R-4	U-2	92 39 15.7	-0.0	-0.0
ZANG		R-4	U-3	93 48 46.2	-0.1	-0.1
ZANG		R-4	C-1	90 10 37.6	0.7	0.3
ZANG		R-4	C-2	90 13 19.0	0.0	0.0
ZANG		R-4	C-3	90 17 44.5	-0.3	-0.1
ZANG		R-4	C-4	90 26 14.3	0.1	0.1
ZANG		R-4	C-5	90 49 54.7	-0.5	-0.5
ZANG		R-4	D-1	92 25 22.0	0.4	0.2
ZANG		R-4	D-2	93 7 23.2	0.3	0.1
ZANG		R-4	D-3	94 17 0.4	1.6	1.0
OHDF		R-1	C-1	-1.73300	0.0014	0.2570
OHDF		C-1	C-2	-0.02700	-0.0014	-0.7042
OHDF		C-2	C-3	-0.02500	0.0004	0.2296
OHDF		C-3	C-4	-0.01400	-0.0013	-0.6835
OHDF		C-4	C-5	-0.02200	0.0006	0.2837
OHDF		C-5	R-4	2.45100	-0.0028	-0.4848
OHDF		R-1	U-1	-21.88200	0.0038	0.3277
OHDF		U-1	U-2	0.32080	0.0017	1.0556
OHDF		U-2	U-3	-0.19300	-0.0003	-0.1841
OHDF		U-3	R-2	21.88300	0.0110	0.9415
OHDF		R-3	D-1	-26.48400	-0.0166	-1.4262
OHDF		D-1	D-2	-0.02700	0.0005	0.3296
OHDF		D-2	D-3	0.11600	-0.0000	-0.0223
OHDF		D-3	R-4	26.88600	0.0101	0.8668

ADJUSTMENT STATISTICS

S T A T I S T I C S S U M M A R Y

Residual Critical Value Type	Tau Max
Residual Critical Value	3.5042
Number of Flagged Residuals	0
Convergence Criterion	0.0001
Final Iteration Counter Value	3
Confidence Level Used	95.0000
Estimated Variance Factor	0.6826
Number of Degrees of Freedom	63

Chi-Square Test on the Variance Factor:

4.9528e-01 < 1.0000 < 1.0013e+00

THE TEST PASSES

NOTE: All confidence regions were computed using the following factors:

Variance factor used	=	0.6826
1-D expansion factor	=	1.9600
2-D expansion factor	=	2.4477

For relative confidence regions, precisions are computed from the ratio of the major semi-axis and the spatial distance between the two stations.

2-D and 1-D Station Confidence Regions (95.000 percent):

STATION	MAJOR SEMI-AXIS	AZMTH	MINOR SEMI-AXIS	VERTICAL
C-1	0.0066	128	0.0052	0.0033
C-2	0.0067	149	0.0052	0.0036
C-3	0.0067	155	0.0052	0.0036
C-4	0.0066	148	0.0052	0.0032
C-5	0.0061	106	0.0045	0.0024
D-1	0.0074	178	0.0060	0.0049
D-2	0.0069	3	0.0062	0.0045
D-3	0.0074	17	0.0065	0.0046
U-1	0.0068	11	0.0061	0.0046
U-2	0.0068	175	0.0060	0.0043
U-3	0.0068	162	0.0058	0.0043

HISTOGRAMS

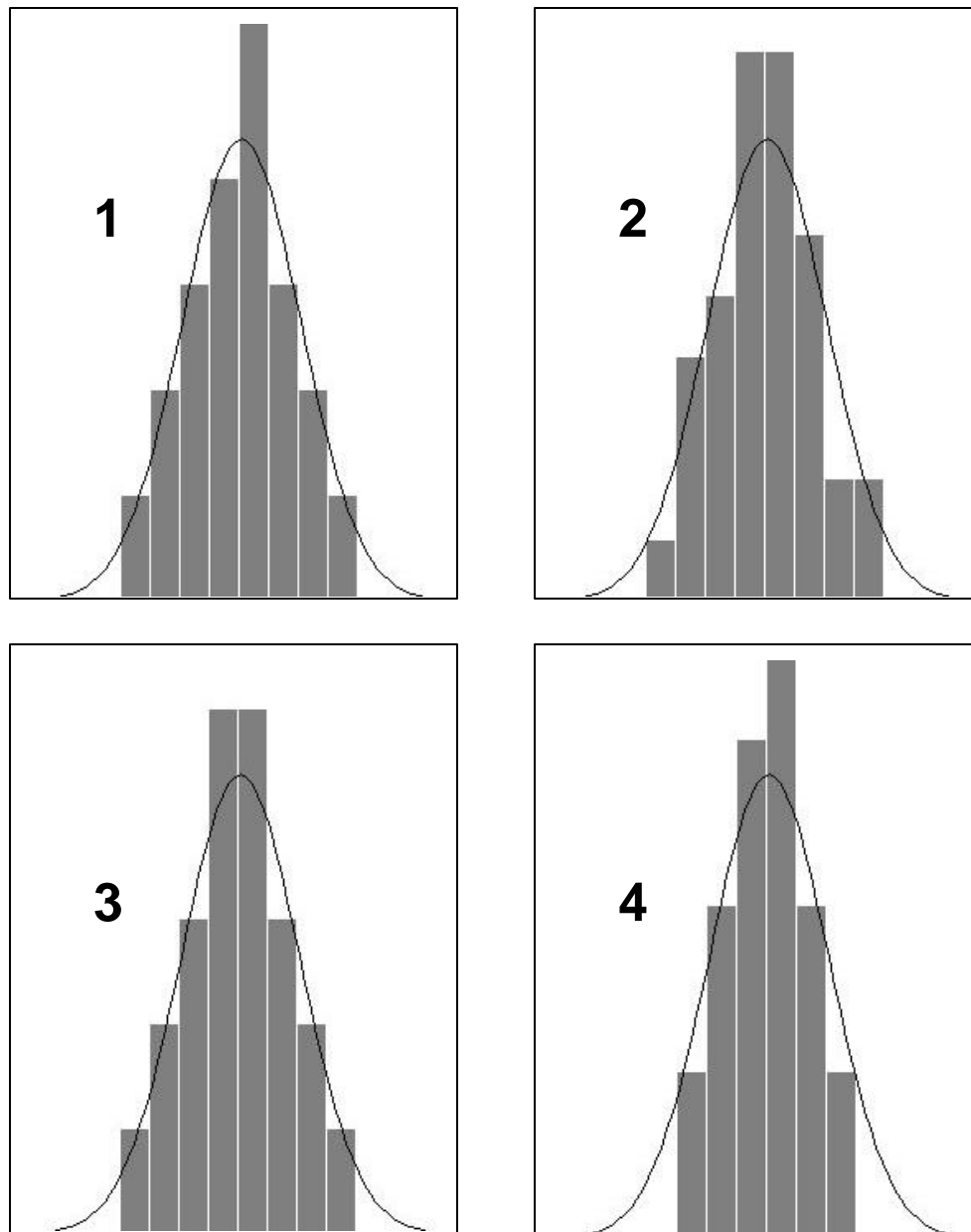

Figure 9-11. Adjustment histograms of the measurement residuals plotted for different observation types. (1) Histogram of horizontal angle observations. (2) Histogram of distance observations. (3) Histogram of zenith angle observations. (4) Histogram of height difference observations. Each example is normally distributed with no observation outliers present. The horizontal axis indicates the magnitude of the residual. Residuals are grouped into different classes, each covering a portion of the total range of observed values. The vertical axis indicates the relative frequency or number of residuals found in each class.

NETWORK MAPS

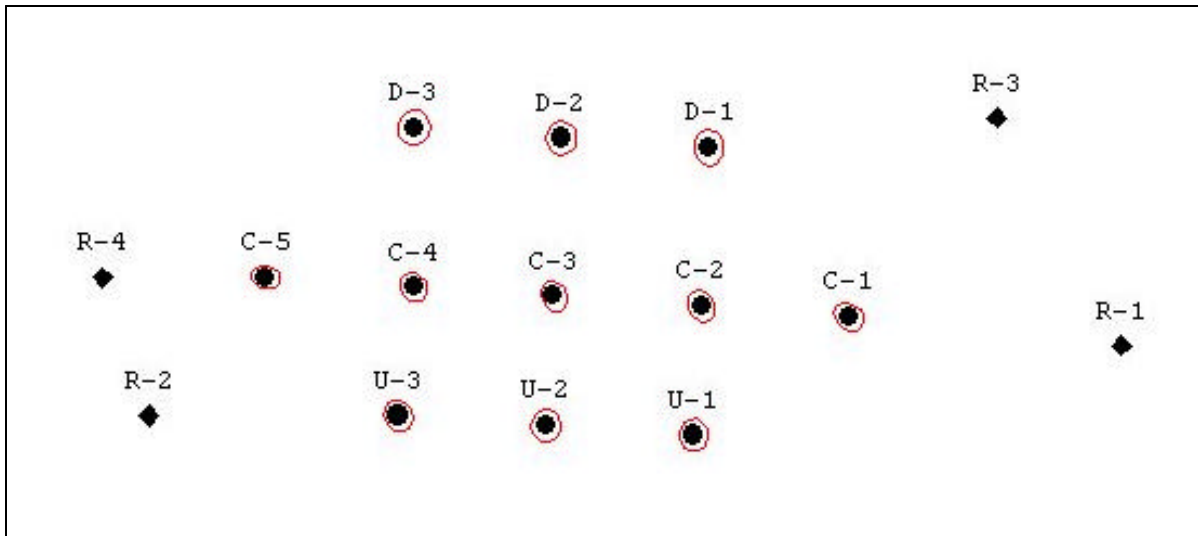

Figure 9-12. Adjustment network map (plan view) showing station names, relative locations, and the point confidence ellipse (95 percent) for horizontal positioning plotted around each point. Network map and confidence ellipses are plotted at different scales. Circles indicate monitoring points and diamonds represent reference stations.

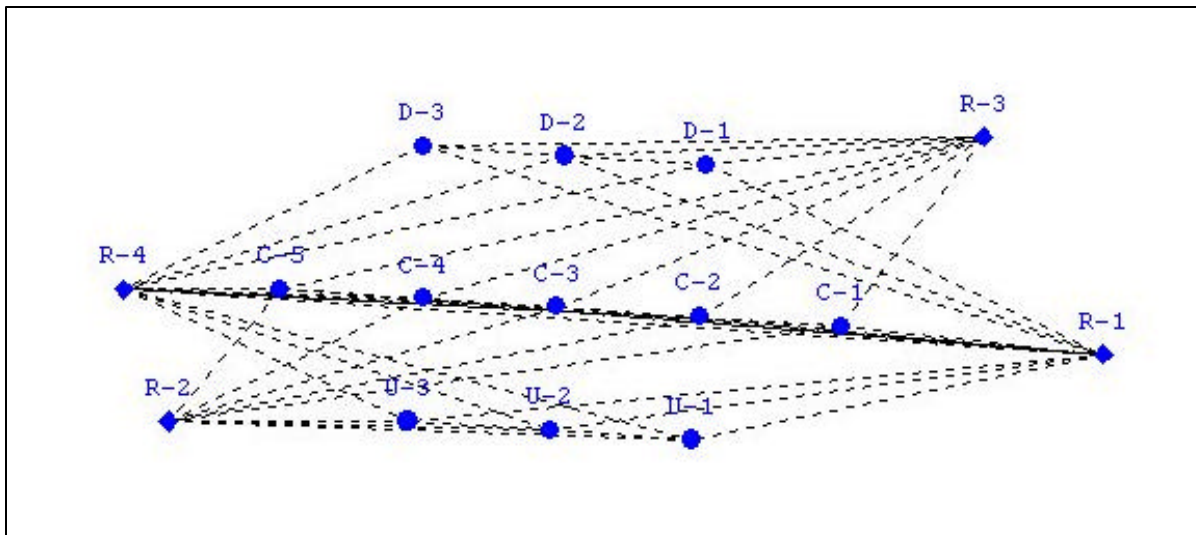

Figure 9-13. Adjustment network map showing station names and connections between points based on observations made during data collection. R-1 thru R-4 are reference stations, C-1 thru C-5 are centerline monitoring points, U-1 thru U-3 are upstream monitoring points at the base of the structure, D-1 thru D-3 are downstream monitoring points at the base of the structure.

9-8. Mandatory Requirements

The rejection criteria in Table 9-2 is considered mandatory.

Chapter 10 Relative Distance Ratio Assessment Methods

10-1. Introduction

Certain EDM biases such as refraction and scale error in EDM distance measurements can be minimized between two survey epochs, without calculating corrections, by application of "reference line ratio" methods. This method uses the fact that distance measurements made over similar line lengths under similar atmospheric conditions are affected equally by refraction (i.e., scale error). If measurements are made initially between two reference stations separated by a known distance, the ratio between the measured and known distance will provide a scale bias value for the network. The true distance to any other station will be proportional to the scale bias determined for the known baseline. This is also true for surveys conducted at any later epoch, where the atmospheric conditions will be different, but the ratio between a reference line and the measured line can be used to detect changes in the ratio of their distances. Thus, it is not necessary to explicitly determine EDM scale error or refractive index when using this technique. Although significant accuracy improvements are reported (when compared to results based on applying calculated refraction corrections), the disadvantage of using this method is that its accuracy is based on assumptions about uniform local atmospheric conditions. Techniques to reduce refractive index errors in measurements by using ratios, or reference lines, include two important rules:

Rule 1: Refractive index errors, resulting from end point measurements of temperature and pressure, tend to be the same for all lines measured from one point within a short period of time.

Rule 2: The ratios of observed distances, measured from one point within a short period of time, are constant.

Note: For both rules, a short period of time is 30 minutes or less.

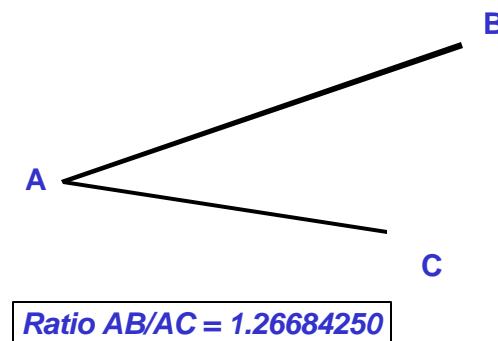

Figure 10-1. Ratio of two lines

a. *General principle.* In Figure 10-1, lines AB and AC are measured from a common point. Rule 1 states that if refractive index measurements are made at points A, B, and C within a short period, the errors in the measurements tend to be the same at all three points. If the true temperature along line AB is 20°C, but the mean of measurements made at A and B is 24°C (a condition typical of daytime), then the mean of temperature measurements at the end points of line AC would also be expected to be 4°C higher than the true temperature along that line. Because 1°C is approximately equivalent to 1 ppm

of distance, both lengths will be in error by 4 ppm. However, if the measured length of AB is divided by the measured length of AC, the resulting ratio will equal the ratio of the true lengths. Thus, the *ratio* of two measured lengths will be more accurate than either of the lengths that were used to form the ratio. For example:

AB was measured to be 2839.611 meters,
AC was measured to be 2241.487 meters.

Their ratio is:

$$AB/AC = 1.26684250.$$

Both lines were in error by 4 ppm because of temperature-measuring errors; therefore, the true lengths were:

$$AB = 2839.611 + 0.0114 \text{ (4 ppm)}$$
$$AC = 2241.487 + 0.0090 \text{ (4 ppm)}.$$

The ratio of the true lengths is:

$$2839.6224/2241.4960 = 1.26684250,$$

the same as the ratio of measured lengths.

b. Corrected and observed ratios. When ratios are formed from measurements that have had refractive index corrections applied, they will be called *corrected ratios*. The property of the corrected ratio is that it is very accurate. From corrected ratios, angles may be computed that are frequently within a few tenths of an arc second of their true values. A second set of ratios can be obtained from the same measurements by using the data before the application of the refractive index corrections. These are called *observed ratios*, and they have been formed from lines that have had no temperature or pressure corrections applied. Rule two states that the observed ratio is constant. This means that the observed ratio of two lines measured today will agree with the observed ratio of the same two lines measured months or years later. This will be true even though the observed lengths of the individual lines have changed greatly because of changes in atmospheric conditions between the two sets of measurements. The observed ratios will not, however, be the same as the corrected ratios unless certain conditions are met. To understand this, let us assume for a moment that an instrument has been set upon a hilltop. In the valley below, two points have been selected that are equidistant from the hilltop stations and are at the same elevation. The observed distances to the two points would appear the same because the distances are equal and both lines pass through roughly the same atmosphere. A point is then selected that is the same distance from the hilltop station as the other points, but with a higher elevation. When the observed distances are recorded, the two lengths to the valley points are the same, but the observed length to the higher elevation point is shorter. Because air density decreases with elevation, the light traversing the higher line travels faster and returns sooner. The instrument then shows the distance to be shorter. Two lessons can be learned from this. The first lesson is that if the mean elevations of two lines measured from a point are the same, the ratio of the observed distances is equal to the ratio of the corrected distances. In the example above, the observed distances to the valley points are the same, and the ratio of the two observed lengths is 1. The true lengths to the two points are the same so that the ratio of the corrected lengths is also 1. This is often the case with dams where the alignment markers along the crest of the dam are all within a few meters of the same elevation. This property of *observed ratios* will be used later on. The second lesson is that when the elevations of the end points to which measurements are being made are different, the ratio of observed lengths is not the same as the ratio of corrected (true)

lengths because the refractive indices along the two lines are different. Even though it is not accurate, the observed ratio does not change with time and it may be used to detect changes in position. Furthermore, the observed ratio may be corrected by means of an atmospheric model. In many respects, ratios have properties similar to those of angles. In triangulation, the sum of the three angles of a triangle must equal 180 degrees, and a knowledge of two angles permits calculation of the third. Similarly, the product of three ratios obtained from a triangle must equal 1, and a knowledge of two ratios permits calculation of the third. For a triangle with sides A, B, and C as measured from vertices 1, 2, and 3 (Figure 10-2), the ratio measured from vertex 1 is A_1 / B_1 , using a counterclockwise convention (A_1/B_1 rather than B_1/A_1) with the subscript designating the vertex from which the ratio was measured. Two other ratios, B_2/C_2 and C_3/A_3 , may also be measured. If the measurements are perfect, then:

$$\begin{aligned} A_1 &= A_3 \\ B_1 &= B_2 \\ C_2 &= C_3 \end{aligned}$$

and the ratios are simplified to:

$$(A_1 / B_1) (B_2 / C_2) (C_3 / A_3) = 1$$

If the measurements are not perfect (the usual case), the degree to which the product failed to equal 1 is a measure of the precision of the measurements. If only two ratios were measured, the third may be calculated. For example:

$$A_1 / B_1 = (C_2 / B_2) (A_3 / C_3)$$

Angles may be calculated directly from the ratios by using a modified cosine formula. The use of ratios yields angles as a result, and the angles determined from the ratios are more accurate than those determined from the lengths alone because a ratio is more accurate than either of the lengths from which it is derived. When the angles of a triangle do not sum to 180, the triangle may be adjusted by taking one-third of the difference between 180 and the sum of the angles and by applying it as a correction to each angle. With ratios, a correction may be made to each ratio. In measuring dams or other large structures, with the ratio method, refractive index errors are less important because relative displacement values are needed, and therefore relative, rather than absolute, distances may be used.

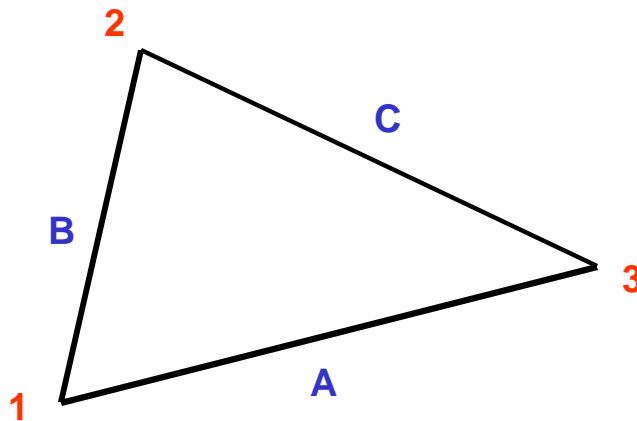

Figure 10-2. Ratios in a triangle

10-2. Deformation Monitoring Using Ratio Methods

This section provides guidance on performing deformation surveys using EDM ratio difference techniques. These surveys are done using an EDM or total station. Standard trilateration techniques are used to compute movements. This process requires measurement of the reference control network and the structure itself.

a. The reference control network. In monitoring possible movements of the structure with this technique, points on the structure, object points, must be related to points that have been selected for stability, usually at some distance from the structure itself. All movements of the structure are related to one or more of these reference points. It is important that these reference points not move (i.e., they are stable), and for this reason, they should be placed in geologically stable positions. They should also afford a good geometry for trilateration measurements. Good geometry, in turn, consists of measuring along the line where movement is expected. For example, if measurements of upstream or downstream movements are required, the reference point should be located correspondingly either upstream or downstream. Also, the point should be at a sufficient distance from the structure so that the end points, as well as the center, can be monitored with good geometry. In Figure 10-3, a dam is shown with both an upstream and downstream control monument. Geometrically, measurements from both the upstream side of the dam will be poor, while those from the downstream side will be much stronger. If movement in two dimensions is desired, a point off the end of the dam should also be chosen. For best results, the angle of intersection should be as close to 90 deg as possible. Figure 10-4 depicts two acceptable selections of reference network control figures.

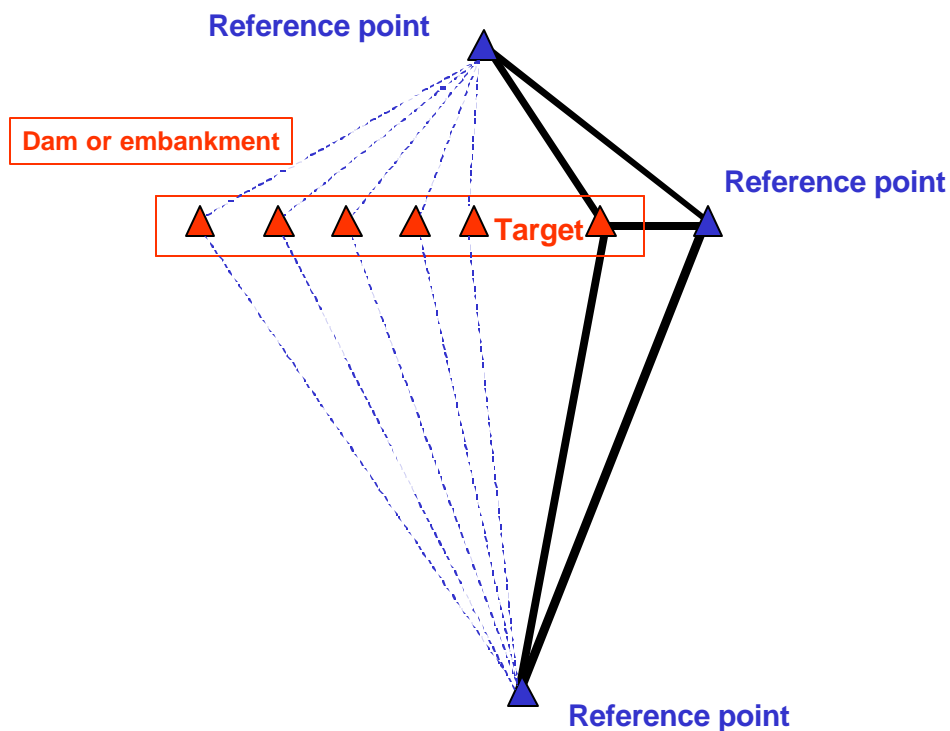

Figure 10-3. Control Monuments for a Dam

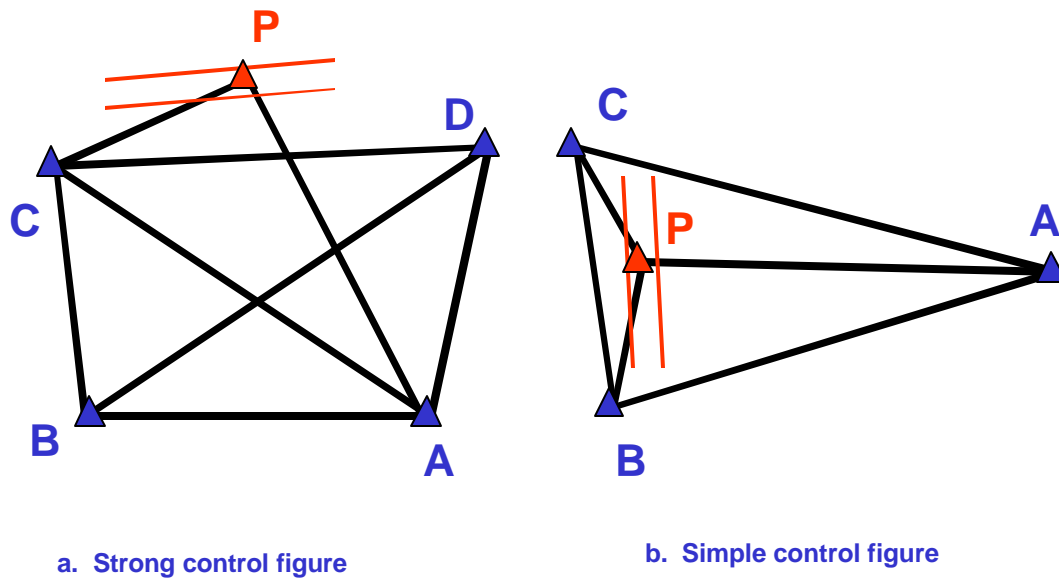

Figure 10-4. Strong and simple control figures around a structure

(1) A final criteria for the selection of reference control monuments is intervisibility. Because the control figure also provides a means of correcting for refractive index when optical electronic instrumentation is used, the points selected for control at the ends of the dam must be visible from the upstream and/or downstream points.

(2) In trilateration, lengths to an unknown station from each of two control points will give the position of the unknown station in two dimensions. Measurements from three control stations will give three positions of the unknown station and may be used as a check of survey accuracy. Figure 10-4a and 10-4b show good control figures for the measurement of a dam. In the figures, A, B, C, and D are control monuments, and all are intervisible. In Figure 10-4b, point P is an unknown station on the dam and is measured from control points A, B, and C. Positions of P are calculated from measurements of lines AP and BP, from lines BP and CP, and from lines AP and CP. The agreement between the three positions obtained for point P is a measure of the accuracy of the survey.

(3) When measurements are made of lines exceeding 600 meters, a major source of error is the inability to determine accurately the refractive index along the line. An error in temperature of 1 degree or in pressure of 2.5 mm (0.1 inches) of mercury will cause an error in length of one part per million. These errors may be minimized by considering the ratio of two lines that have been measured within 30 minutes of each other. The errors of each line tend to be the same so that taking a ratio greatly reduces the magnitude of the error. This may be shown by again referring to Figure 10-4a. Point D has been selected as a reference point. Its position was chosen so that it would be in stable ground, it would be visible from the other control points, and the lines to it from the other control points would pass through similar atmospheric conditions to those from the control points to unknown positions on the dam.

(4) The first time a structure is visited to make trilateration measurements, both ratios and conventional measurements are made to determine the shape and size of the control figure. The simplest example would be the triangular figure shown in Figure 10-4b. All control monuments should be

occupied by the EDM or total station. At each point, measurements should be made to all of the other control monuments within a short period of time. In the case of the triangle ABC in Figure 10-4b, monument A would be occupied and lengths AC and AB measured. Similar measurements should then be made as the EDM occupies stations B and C. Each line should then be reduced to the level or spheroid and the have the refractive index corrections applied. A typical set of measurements for triangle ABC is:

	<u>Length (in m)</u>	<u>Ratio</u>
A to	C 2547.447 B 2774.589	AC/AB 0.9181349
B to	A 2774.583 C 734.480	BA/BC 3.7776155
C to	B 734.478 A 2547.430	CB/CA 0.2883212

$$(AC/AB)*(BA/BC)*(CB/CA) = 1.0000018$$

	<u>Adjusted Angles</u>
A	15° 05' 47.84"
B	64° 35' 55.08"
C	100° 18' 17.08"

By way of comparison, angles calculated from the mean lengths would be:

A	15° 05' 47.59"
B	64° 35' 53.76"
C	100° 18' 18.65"

The adjusted angles determined from corrected ratios are more accurate than the angles determined from the means of the lengths of the sides because ratios are more accurate than the lengths of which they are composed.

(5) It may be seen from this example that the result of working with ratios is angles, and that in effect very accurate triangulation is being carried out using an EDM or total station. As in the case of triangulation, a baseline is necessary to determine the scale when ratios are used. Choose one of the sides of the triangle to serve as a baseline, and use the mean length as the scale for the triangle. In this example, AB has been chosen and its length is 2774.586 meters. Next, by using the sine formula and the angles determined from ratios, the other two sides may be determined:

$$\frac{2774.586}{\sin C} = \frac{BC}{\sin A} = \frac{AC}{\sin B}$$

$$BC = 734.481$$

$$AC = 2547.443$$

(6) The angles obtained by these methods are of the highest accuracy. The scale, however, is only as accurate as the mean of the two measurements of the baseline. Fortunately, this is not a serious

problem with measurements of dams because changes in lengths are desired rather than the absolute lengths themselves.

(7) The final task in establishing the control network is to assign coordinates to A, B, and C. These may be fitted into an existing network, or a local control net may be set up for the project.

(8) At a later date, the control figure may once again be occupied. The same procedure may be used, and the angles determined and compared with those obtained during the first survey. This, however, requires the use of temperature and pressure measuring devices each time the figure is surveyed.

(9) An easier method is to use the observed ratios, for these do not require knowledge of the refractive index. Remember that the observed ratios remain constant, and thus comparison of observed ratios from the first survey with observed ratios from the second survey are sufficient to determine whether any of the control monuments have moved. In fact, measurements of temperature and pressure need only be made of the control lines in order to give the proper scale to the figure. And these measurements need only be made the first time a project is surveyed. From that time on, only observed distances are required. In addition, all of the measurements from the control monuments to stations on the dam will be observed distances. Measurements of temperature and pressure are not necessary.

b. Points on the dam. When positions have been established for the monuments in the control figure, observed ratios will be used to determine the refractive index corrections for measurements of points on the dam. Referring again to Figure 10-4b, the lines AC, AB, and BC have been corrected for refractive index and may be used as reference lines. For measurements from control monument A, either AC or AB may be used as a reference line. A good reference line is one which traverses approximately the same atmosphere as is found along the lines to points on the dam and is almost the same length or longer. If we call the corrected length of the reference line R_{Corr} and the observed length of the same line R_{Obs} , the following equation may be written:

$$R_{\text{Obs}} \cdot k = R_{\text{Corr}} \quad (\text{Eq 10-1})$$

where k is a constant owing to the atmospheric conditions along the line at the time it was measured. Because the reference line has been selected to travel through approximately the same atmosphere as that to points on the dam, k is also the atmospheric constant for lines measured to the dam. If P_{Obs} is the observed length to a point on the dam, then P_{Corr} may be found from:

$$P_{\text{Obs}} \cdot k = P_{\text{Corr}} \quad (\text{Eq 10-2})$$

This technique enables the surveyor to correct for refractive index without using temperature and pressure measuring equipment. However, k is not really a constant because it changes slowly with time. For this reason, it must be remeasured at approximately 30 minute intervals, and it must be assumed it changes in a linear fashion.

(1) The following example will detail the previous phenomena. In Figure 10-5, the EDM has been set up at A. Measurements are made of AC, AP_1 , AP_2 , AP_3 , and again AC.

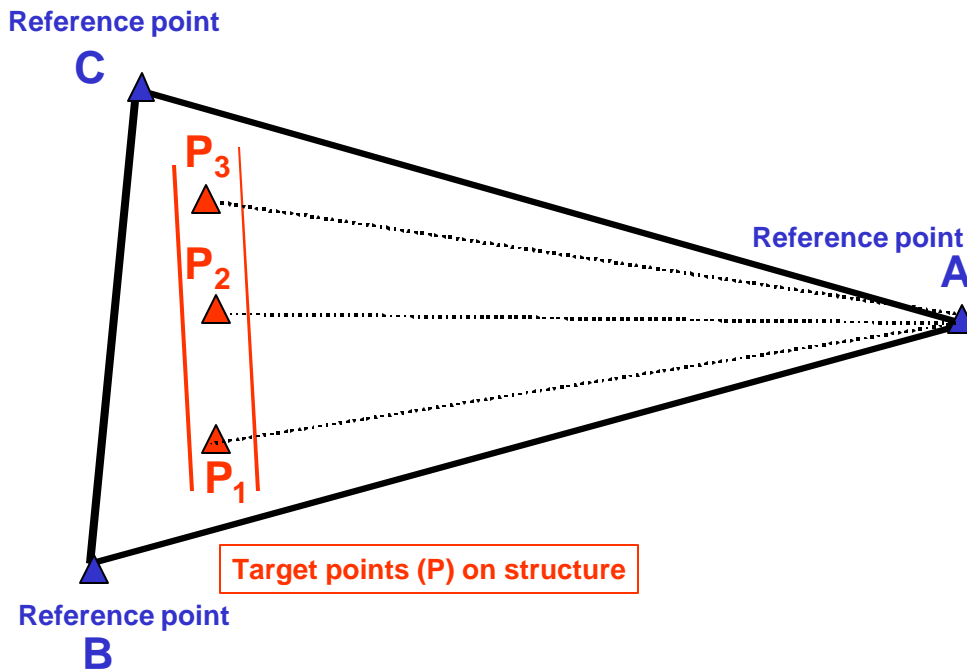

Figure 10-5. Use of a Reference Line

After the observed lengths have been reduced to the level or the spheroid, the measurements from control monument A were recorded as listed in Table 10-1.

Table 10-1. Measurement Taken (Example Deformation Survey)

To Station	Time	Observed Length (D_{Obs})	Refractive Index Constant (k)	Corrected Distance (D_{Corr})
C	1330	2547.326	1.0000459	2547.443
P ₁	1335	2477.075	1.0000454	2477.187
P ₂	1340	2407.354	1.0000449	2407.462
P ₃	1345	2445.152	1.0000445	2445.261
C	1350	2547.331	1.0000440	2547.443*

Note: AC is the reference line

The first and last measurements are of AC. The length of AC is known and is used as a reference line to calculate the value of the refractive index constant. At first, the constant was 1.0000459 (2547.443/2547.326), but because of changes in the atmosphere, it changed to 1.0000440 (2547.443/2547.331). The value of k at intermediate times may be found by assuming that the change was linear. Thus, a value of k may be found for the times when P₁, P₂, and P₃ were measured. Applying the appropriate value of k to the observed length, D_{Obs} , of AP₁ gives $2477.075 * 1.0000454 = 2477.187$ as its corrected length, D_{Corr} .

(2) Any length in a control figure may serve as a reference line, although some lines will be better than others. From A, AB would also serve. From B however, BC would be a better choice than BA because it passes through a similar atmosphere to that found in measuring from B to P₁, P₂, and P₃.

c. *Reduction to the spheroid.* Mention has been made of reducing lines either to the level or the spheroid. In very accurate work where lines exceed 1 km, the surface upon which a survey is being made can no longer be considered a plane. If distances are reduced to the level and used to calculate angles, the angles thus obtained may not agree with angles obtained from a theodolite. Further, the position of a point calculated from the lengths to two control monuments may not agree with the position of the same point when measured from two other control monuments. To prevent problems of this type, figures with line lengths in excess of 1 km should be reduced to the spheroid instead of the level.

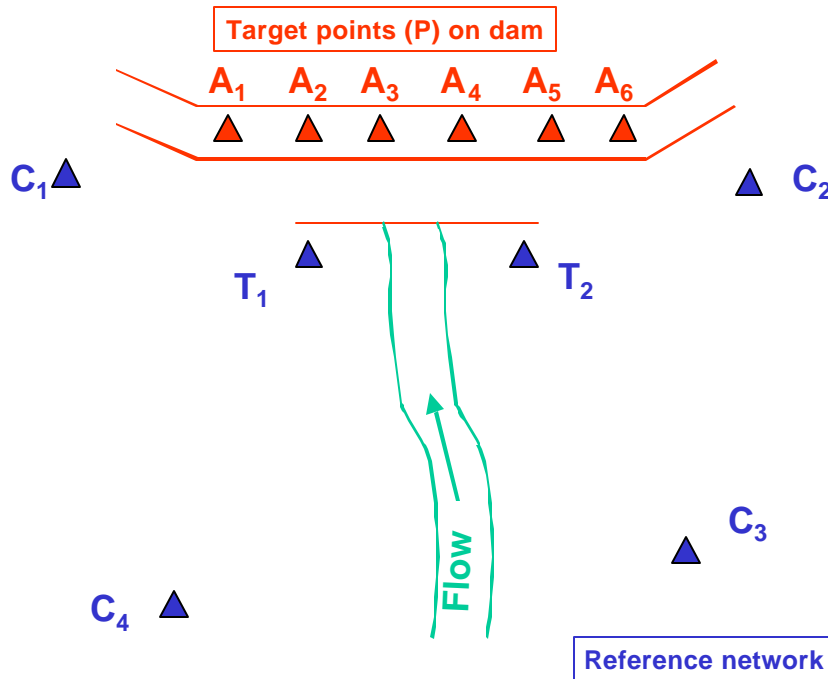

Figure 10-6. Example survey scheme on a concrete dam.

d. *Example deformation survey.* The example survey developed in the following paragraphs combines the principles developed for ratio lines. A diagram of the control setup and dam are shown in Figure 10-6. Control pedestals have been set at points C1, C2, C3, and C4. Markers A1 through A6 have been set along the crest of the dam, and T1 and T2 have been set near the toe of the dam. Elevations have been measured to obtain the list in Table 10-2.

(1) Each of the control monuments was occupied with an EDM, and measurements were made to the other three control monuments. Temperatures and pressures were also taken at both ends of the lines. After measuring the control lines, the lengths to stations on the dam were measured from three of the control monuments. Temperatures and pressures were not taken for these lines.

Table 10-2. Elevations for Example Deformation Survey

Point	Elevation (m above sea level)
A1	410.724
A2	410.718
A3	410.706
A4	410.721
A5	410.712
A6	411.245
C1	419.911
C2	413.275
C3	463.701
C4	521.537
T1	329.623
T2	329.394

(2) On a separate occasion, the following lengths were measured from C3:

Table 10-3. Measurements from C3 for Example Deformation Survey

#	To	Time	Observed Distance D _s (meters)	Mean Temp. (°C)	Mean Press. (inches Hg)
1	C1	0930	1081.105	16.4	28.26
2	C4	0935	945.03216.4	28.09	
3	C2	0940	703.78817.0	28.27	
4	C1	0945	1081.104	16.7	28.26
5	C1	1025	1081.101		
6	A1	1035	968.241		
7	A2	1045	924.456		
8	C1	1050	1081.103		
9	A3	1100	882.721		
10	A4	1115	843.323		
11	C1	1120	1081.104		
12	A5	1130	806.626		
13	A6	1145	772.950		
14	C1	1150	1081.104		
15	C1	1300	1081.100		
16	T1	1305	872.886		
17	T2	1315	836.021		
18	C1	1300	1081.097		

Measurements began with the control figure. Either C1 or C2 could have been used for a reference line, but in this case C1 has been chosen. Because it was the reference line, it was measured before and after the remaining control lines. This practice helped to check for both drift in the instrument and in the atmospheric conditions. When the control lines were completed, the operator next measured to points on the dam. Forty minutes had elapsed after completion of the contour line measurements before the field party with reflectors was set up on the dam. Because the reference line should be measured approximately every 30 minutes, the observed distance to C1 was again measured (measurement 5). A reflector was left unattended at C1 because it was no longer necessary to read the temperature and pressure. Remember temperature and pressure measurements are made only on the control lines and only when a study is made for the first time at a particular dam. The next time the dam is visited, perhaps 6 or

12 months later, it will not be necessary to measure refractive index. Possible movement in the control figure may be checked at that time by a comparison of ratios of observed distances.

(3) Measurements were made that same afternoon from C1. Only the control lines were measured. Three sets of positions will be obtained for the stations on the dam from C2, C3, and C4. Measurements from C1 would do little to improve the accuracy of these positions in the upstream-direction. Table 10-4 below gives the lengths from C1 recorded for that session.

Table 10-4. Measurements from C3 for Example Deformation Survey

#	To	Time	Observed Distance D _s (meters)	Mean Temp. (° C)	Mean Press. (inches Hg)
19	C2	1400	566.21219.0	28.28	
20	C3	1405	1081.095	18.8	28.20
21	C4	1410	989.41818.5	28.09	
22	C2	1415	566.21518.8	28.28	

(4) A week later, monument C4 was occupied and measurements were taken. These measurements are shown in Table 10-5 below.

Table 10-5. Measurements from C4 for Example Deformation Survey

#	To	Time	Observed Distance D _s (meters)	Mean Temp. (° C)	Mean Press. (inches Hg)
23	C1	0835	989.4466.1	28.85	
24	C2	0840	1138.277	6.1	28.87
25	C3	0845	945.0505.8	28.78	
26	C1	0850	989.4456.2	28.85	
27	C1	0900	989.444		
28	A1	0905	1031.587		
29	A2	0915	1042.973		
30	A3	0925	1057.756		
31	C1	0930	989.438		
32	A4	0940	1075.788		
33	A5	0945	1096.925		
34	A6	0955	1120.924		
35	C1	1000	989.432		
36	T1	1010	981.303		
37	T2	1020	987.682		
38	C1	1025	989.431		

(5) Later that day, monument C2 was occupied and measurements were taken. These measurements are shown in Table 10-6 below and completed the field measurement phase.

Table 10-6. Measurements from C2 for Example Deformation Survey

#	To	Time	Observed Distance D _s (meters)	Mean Temp. (° C)	Mean Press. (inches Hg)
39	C1	1230	566.2258.1	29.04	
40	C4	1235	1138.273	7.6	28.87
41	C3	1240	703.7997.8	28.97	
42	C1	1245	566.2258.3	29.04	
43	A1	1250	398.146		
44	A2	1300	337.350		
45	A3	1310	276.652		
46	C1	1315	566.225		
47	A4	1320	216.070		
48	A5	1330	155.828		
49	A6	1335	96.436		
50	C1	1345	566.224		

(6) The first step in the data reduction is to reduce all the lines (D_s) to the spheroid. This has been done and is shown in Table 10-7 below.

Table 10-7. Corrected Line Lengths

#	C3 To	Time	Observed Distance D _{Obs} (meters)	Corrected Distance (meters)
1	C1	0930	1080.143	1080.156*
2	C4	0935	943.188	943.201*
3	C2	0940	701.931	701.940*
4	C1	0945	1080.142	1080.155*
5	C1	1025	1080.141	(1080.155)
6	A1	1035	966.724	966.736
7	A2	1045	922.873	922.884
8	C1	1050	1080.141	(1080.154)
9	A3	1100	881.068	881.078
10	A4	1115	841.599	841.609
11	C1	1120	1080.142	(1080.154)
12	A5	1130	804.828	804.837
13	A6	1145	771.115	771.124
14	C1	1150	1080.142	(1080.154)
15	C1	1300	1080.138	(1080.154)
16	T1	1305	862.473	862.486
17	T2	1315	825.111	825.125
18	C1	1320	1080.135	(1080.154)

#	C1 To	Time	Observed Distance D _{Obs} (meters)	Corrected Distance (meters)
19	C2	1400	566.136	566.144*
20	C3	1405	1080.133	1080.149*
21	C4	1410	984.112	984.128*
22	C2	1415	566.139	566.147*

#	C4 To	Time	Observed Distance D _{Obs} (meters)	Corrected Distance (meters)
23	C1	0835	984.140	84.137*
24	C2	0840	1133.034	1133.030*
25	C3	0845	943.206	943.203*
26	C1	0850	984.139	984.136*
27	C1	0900	984.138	(984.134)
28	A1	0905	1025.543	1025.540
29	A2	0915	1036.993	1036.992
30	A3	0925	1051.857	1051.858
31	C1	0930	984.132	(984.134)
32	A4	0940	1069.987	1069.991
33	A5	0945	1091.232	1091.238
34	A6	0955	1115.403	1114.411
35	C1	1000	984.126	(984.134)
36	T1	1010	962.289	962.297
37	T2	1020	968.747	968.756
38	C1	1025	984.125	(984.134)

#	C2 To	Time	Observed Distance D _{Obs} (meters)	Corrected Distance (meters)
39	C1	1230	566.149	566.147*
40	C4	1235	1133.149	1133.027*
41	C3	1240	701.942	701.940*
42	C1	1245	566.149	(566.146)
43	A1	1250	398.112	398.110
44	A2	1300	337.318	337.316
45	A3	1310	276.622	276.621
46	C1	1315	566.149	(566.146)
47	A4	1320	216.041	216.040
48	A5	1330	155.797	155.796
49	A6	1335	96.408	96.408
50	C1	1345	566.148	(566.146)

Note: * - Denotes length corrected from temperature and pressure measurements.
() - Denotes true length.

(7) When the lines have been reduced to the spheroid, the next step is to define the size and shape of the control figure, in this case a doubly braced quadrilateral. There are several ways to do this. One way is that the figure contains four triangles, and these may be individually treated in the same manner as the triangle in Figure 10-4a. Another way would be to use the means of the six lines in the figure and adjust these by means of a quadrilateral adjustment. This is the technique that was used in the present case to obtain the following adjusted lengths:

C1 to C2	566.146 meters
C1 to C3	1080.154
C1 to C4	984.134
C2 to C3	701.940
C2 to C4	1133.029
C3 to C4	943.202

(8) The control figure may be fit into an existing coordinate system or a local system may be devised just for the dam. For the example dam, a local system was used. C4 was selected as a starting point was assigned coordinates of $x = 1000.000$ and $y = 1000.000$. The coordinates of C3 were then chosen to place C3 at a distance of 943.202 meters from C4; they are $x = 1943.202$ and $y = 1000.000$; The placement of C4 and C3 has determined the scale and orientation of the figure. Using the positions of C3 and C4 and the appropriate lengths, the positions of C1 and C2 can be determined to be:

$$C1: \quad x = 1366.527 \qquad y = 1913.333$$

$$C2: \quad x = 1890.936 \qquad y = 1699.991$$

(9) The establishment of the control figure needs be done only once. From that time on, it is only necessary to check for movements of the control monuments. This may be done by comparing observed ratios taken at some later time with the original set.

(10) Returning to Table 10-7, one may now calculate the corrected lengths D_c to the stations on the top and toe of the dam from the control monuments. This is done by using reference lines to make refractive index corrections.

(11) Measurements 15 through 18 from Table 10-7 are given in Table 10-8 below.

Table 10-8. Changes of Correction Factor with Time

#	C3 To	Time	D_o (meters)	Correction Factor	D_c^* (meters)
15	C1	1300	1080.138	1.0000148	(1080.154)
16	T1	1305	862.473	1.0000155	862.486
17	T2	1315	825.111	1.0000169	825.125
18	C2	1320	1080.135	1.0000135	(1080.154)

* () denotes true length.

(12) At 1300, when the distance to C1 was measured, the observed distance, D_{Obs} , was found to be 1080.138 meters. This line, C3 to C1, is a part of the control figure, and its correct length has been determined to be 1080.154 meters. The atmospheric correction at 1300 may then be found by dividing. The correction is $1080.154/1080.138 = 1.0000148$. Later, at 1320, the atmospheric correction has become 1.0000176. Assuming the change in correction has been linear as a function of time over the 20 minute interval, we may calculate the correction factor at 1305 and 1315 when observed distances were measured to T1 and T2. Multiplying the observed distance by the corresponding atmospheric correction gives the corrected distance, D_{Corr} , to T1 and T2. Thus in Table 10-7, the values in parenthesis in column 5 are the correct or true lengths of reference lines, and the values without an asterisk or parenthesis are the corrected lengths that have been calculated from reference lines.

(13) Finally, with the corrected lengths and the coordinates of the control monuments from which they were measured, it is possible to calculate the positions of the points on the dam. Because three lengths were measured to stations on the crest of the dam, three solutions will be obtained. Geometrically, some solutions will be superior to others. For stations at the toe of the dam, only one solution is possible.

(14) In Table 10-9, positions of the crest and toe markers are given for various line combinations, In the case of the crest markers, and adjusted position is also given.

Table 10-9. Crest and Toe Station Positions

Station	X	Y	From
A1	1533.713	1875.726	C2 to C3
	1533.710	1875.720	C2 to C4
	1533.705	1875.723	C3 to C4
A2	1533.709	1875.722	Adjusted
	1590.161	1852.688	C2 to C3
	1590.158	1852.682	C2 to C4
	1590.153	1852.685	C3 to C4
A3	1590.157	1852.684	Adjusted
	1646.583	1829.648	C2 to C3
	1646.588	1829.656	C2 to C4
	1646.594	1829.652	C3 to C4
A4	1646.589	1829.653	Adjusted
	1703.041	1806.615	C2 to C3
	1703.038	1806.609	C2 to C4
	1703.033	1806.613	C3 to C4
A5	1703.037	1806.612	Adjusted
	1759.465	1783.585	C2 to C3
	1759.467	1783.588	C2 to C4
	1759.470	1783.584	C3 to C4
A6	1759.468	1783.586	Adjusted
	1815.919	1760.547	C2 to C3
	1815.915	1760.542	C2 to C4
	1815.912	1760.545	C3 to C4
T1	1815.915	1760.544	Adjusted
	1568.152	1776.672	C3 to C4
T2	1608.187	1754.053	C3 to C4

(15) If desired, alignment may be determined from positions. Using the crest stations A1 and A6 as end points, the alignment of A2 through A5 is given in Table 10-10. T1 and T2 are also included in the alignment to help monitor any tilt in the dam. Alignment done from positions is not affected by curved dams, by bends, or by differences in elevations.

Table 10-10. Alignment

Station	Distance from A1 (meters)	Distance off Line (meters)*
A2	60.968	0.00
A3	121.919	- 0.001
A4	182.888	+ 0.001
A5	243.836	- 0.004
T1		+78.691
T2		+84.505

* + = Downstream
- = Upstream

EM 1110-2-1009

1 Jun 02

10-3. Mandatory Requirements

There are no mandatory requirements in this chapter.

Chapter 11 Analysis and Assessment of Results

11-1. General

This chapter provides guidance on the interpretation of results from periodic monitoring surveys of hydraulic structures.

a. Concept of the integrated analysis. Even the most precise monitoring surveys will not fully serve their purpose if they are not properly evaluated and utilized in a global integrated analysis. The analysis of deformation surveys includes:

- *Geometrical Analysis:* describes the geometrical status of the deformable body, its change in shape and dimensions, as well as rigid body movements (translations and rotations) of the whole deformable body with respect to a stable reference frame, or of a block of the body with respect to other blocks, and
- *Physical Interpretation:* which consists of:

Stochastic Interpretation: a statistical (stochastic) method that analyzes (through a regression analysis) the correlations between observed deformations and observed loads (external and internal causes producing the deformation),

Deterministic Interpretation: a method utilizing information on the loads, properties of the materials, and physical laws governing the stress-strain relationship; which describes the state of internal stresses and the relationship between the causative effects (loads) and deformations.

Once the load-deformation relationship is established, the results of the physical interpretation may be used for the development of prediction models. Through a comparison of predicted deformation with the results of the geometrical analysis of the actual deformations, a better understanding of the mechanism of the deformations is achieved. On the other hand, the prediction models supply information on the expected deformation, facilitating the design of the monitoring scheme as well as the selection of the deformation model in the geometrical analysis. Thus, the expression "integrated analysis" means a determination of the deformation by combining all types of measurements, geodetic and geotechnical, even if scattered in time and space, in the simultaneous geometrical analysis of the deformation, comparing it with the prediction models, enhancing the prediction models; which in turn, may be used in enhancing the monitoring scheme. The process is iteratively repeated until the mechanism of deformation is well understood and any discrepancies between the prediction models and actual deformations are properly explained.

b. Deformation modeling. Recently, the concept of integration has been developed in which all three--the geometrical analysis of deformation and both methods of the physical interpretation--are combined into a simultaneous solution for all the parameters to be sought. Implementation of the method still requires further development. The deterministic and statistical modeling of deformations have been used in the analysis of dam deformations, at least in some countries, for many years. As aforementioned, the geometrical analysis has been done so far in a rather primitive way, with geotechnical/structural engineers analyzing separately the geotechnical observation data and surveyors taking care of the geodetic survey observations. The geotechnical analyses have usually resulted only in a graphical display

of temporal trends for individual observables and the geodetic analysis would result in a plot of displacements obtained from repeated surveys that may not even be properly adjusted and analyzed for the stability of the reference points. Over the past ten years, an intensive study by the FIG working group has resulted in the development of proper methods for the analysis of geodetic surveys and has led to the development of the so-called "UNB Generalized Method" of the geometrical deformation analysis, which can combine any type of observations (geotechnical and geodetic) into one simultaneous analysis.

11-2. Geometrical Analysis

a. Identification of unstable reference points. In most deformation studies, the information on absolute movements of object points with respect to some stable reference points is crucial. One problem that is frequently encountered in practice in the reference networks is the instability of the reference points. This may be caused either by wrong monumentation of the survey markers or by the points being located too close to the deformation zone (wrong assumption in the design about the stability of the surrounding area). Any unstable reference points must be identified first, and before absolute displacements of the object points are calculated. Otherwise, the calculated displacements of the object points and subsequent analysis and interpretation of the deformation of the structure may be significantly distorted. Given a situation where points A, B, C, and D are reference points used to monitor a number of object points on a structure; if point B has moved (but this is not recognized) and it is used with point A to identify the common datum for two survey campaigns, then all the object points and reference points C and D will show significant changes in their coordinates even when, in reality, all but point B are truly stable.

b. Iterative Weighted Similarity Transformation (IWST). A method to detect unstable reference points has been developed which is based on a special similarity transformation that minimizes the first norm (absolute value) of the observed vector of displacements of the reference points. The IWST approach to stability monitoring can be performed easily for one-dimensional reference networks and by an iterative weighting scheme for multi-dimensional reference networks until all the components of the displacement vectors (d_i) satisfy the condition:

$$\sum \| d_i \| = \text{minimum} \quad (\text{Eq 11-1})$$

In each iterative solution, the weights (p_i) of each displacement are changed to be:

$$p_i = 1 / d_i$$

After the last iteration (convergence), any transformed displacement vectors that exceed their transformed point error ellipses (at 95% probability) are identified as unstable reference points. The displacements obtained from the transformation are, practically, datum independent, i.e., that whatever minimum constraints have been used in the least squares adjustment of the survey campaigns, the display of the transformed displacements will always be the same. Thus, the obtained results represents the actual deformation trend which is used later on in selecting the best fitting deformation model.

c. Stable point analysis. Quality control for reference networks requires analysis of the stability of each reference station, for example by the Iterative Weighted Similarity Transformation (IWST).

(1) Data processing setup. Software routines must be coded for automated data processing. The input data for IWST processing consists of the adjusted station coordinates for the reference network (for both the current and previous monitoring survey), and each associated covariance matrix of parameters. Both data sets are available from network adjustment post-processing results. Test statistic critical values,

degrees of freedom, and the pooled adjustment variance factor are also required for post-processed statistical assessment.

(2) IWST processing algorithm. The following matrix equation is solved iteratively until the solution converges on a fixed transformation value (e.g., to less than 0.01 mm).

$$(d)' = [I - H(H^T W H)^{-1} H^T W](d) = [S](d) \quad (\text{Eq 11-2})$$

where

d' = transformed displacement vector
 d = initial displacement vector
 I = Identity matrix
 H = datum defect matrix
 W = weight matrix

The identity matrix is a matrix with ones along the diagonal and zeroes elsewhere. The datum defect matrix (H) is designed for the particular type of survey datum used. For example, for GPS surveys it has a block diagonal structure with a 3 by 3 identity matrix in each block representing the union of datum defects from each survey (i.e., 3D translations only). The weight matrix (W) is a diagonal matrix with the entries equal to the inverse of each coordinate component displacement. The displacement vector contains the displacements between the two surveys for each point. The dimensions of each matrix must be compatible with n as the number of stations, for example if (d) is $3n \times 1$, then H , W , and I are $3n \times 3n$. The transformation covariance matrix is initially the sum of each adjustment covariance matrix, where the covariance matrix (Q) is also modified at each iteration by:

$$Q' = S Q S^T \quad (\text{Eq 11-3})$$

with S defined above.

d. Geometrical deformation analysis. In order to be able to use any type of geodetic and geotechnical observations in a simultaneous deformation analysis, the UNB Generalized Method of the geometrical analysis has been developed. The method is applicable to any type of geometrical analysis, both in space and in time, including the detection of unstable reference points and the determination of strain components and relative rigid body motion within a deformable body. It permits using different types of surveying data (conventional, GPS, and geotechnical/structural measurements). It can be applied to any configuration of the monitoring scheme as long as approximate coordinates of all the observation points are known with sufficient accuracy. The approach consists of three basic processes:

- identification of deformation models;
- estimation of deformation parameters;
- diagnostic checking of the models and final selection of the "best" model.

A brief description of the approach is given below.

(1) Deformation parameters. The change in shape and dimensions of a 3D deformable body is fully described if 6 strain components (3 normal and 3 shearing strains) and 3 differential rotations at every point of the body are determined. These deformation parameters can be calculated from the well-known strain-displacement relations if a displacement function representing the deformation of the object is known. Since, deformation surveys involve only discrete points, the displacement function must be approximated through some selected deformation model which fits the observed changes in

coordinates (displacements), or any other types of observables, in the statistically best way. The displacement function may be determined, for example, through a polynomial approximation of the displacement field.

(2) Displacement function. A displacement function can be expressed in matrix form in terms of a deformation model $\mathbf{B} \mathbf{c}$ as:

$$\mathbf{d}(x,y,z,t-t_0) = (u,v,w)^T = \mathbf{B}(x,y,z,t-t_0) \mathbf{c} \quad (\text{Eq 11-4})$$

where

\mathbf{d} = displacement of a point (x,y,z) at time t (with respect to a reference time t_0)
u, v, w = components of the displacement function in the x,y,z directions, respectively,
 \mathbf{B} = deformation matrix with its elements being some selected base functions,
 \mathbf{c} = vector of unknown coefficients (deformation parameters).

(3) Deformation models. Examples of typical deformation models (displacement functions) for a two-dimensional analysis are given below.

(a) Single point displacement or a rigid body displacement of a group of points, say, block B with respect to block A. The deformation model is expressed by the following displacement functions:

$$\begin{aligned} \mathbf{u}_A &= 0, & \mathbf{v}_A &= 0 \\ \mathbf{u}_B &= \mathbf{a}_o, & \mathbf{v}_B &= \mathbf{b}_o \end{aligned}$$

where the subscripts represent all the points in the indicated blocks, and \mathbf{a}_o and \mathbf{b}_o are constants.

(b) Homogeneous strain in the whole body and differential rotation. The deformation model is linear and it may be expressed directly in terms of the strain components ($\epsilon_x, \epsilon_y, \epsilon_{xy}$) and differential rotation, ω , as:

$$\begin{aligned} \mathbf{u} &= \epsilon_x X + \epsilon_{xy} Y - \omega Y \\ \mathbf{v} &= \epsilon_{xy} X + \epsilon_y Y + \omega X \end{aligned} \quad (\text{Eq 11-5})$$

(c) A deformable body with one discontinuity, say, between blocks A and B, and with different linear deformations in each block plus a rigid body displacement of B with respect to A. Then the deformation model is written as:

$$\begin{aligned} \mathbf{u}_A &= \epsilon_{xA} X + \epsilon_{xyA} Y - \omega_A Y \\ \mathbf{v}_A &= \epsilon_{xyA} X + \epsilon_{yA} Y + \omega_A X \end{aligned} \quad (\text{Eq 11-6})$$

and

$$\begin{aligned} \mathbf{u}_B &= \mathbf{a}_0 + \epsilon_{xB} (X - X_0) + \epsilon_{xyB} (Y - Y_0) - \omega_B (Y - Y_0) \\ \mathbf{v}_B &= \mathbf{b}_0 + \epsilon_{xyB} (X - X_0) + \epsilon_{yB} (Y - Y_0) + \omega_B (X - X_0) \end{aligned} \quad (\text{Eq 11-7})$$

where x_0, y_0 are the coordinates of any point in block B.

(4) Combined models. Usually, the actual deformation model is a combination of the above simple models or, if more complicated, it is expressed by non-linear displacement functions which require fitting of higher-order polynomials or other suitable functions. If time dependent deformation parameters are sought, then the above deformation models will contain time variables.

(5) Displacement function. A vector $\delta \mathbf{l}$ of changes in any type of observations, for instance, changes in tilts, in distances, or in observed strain, can always be expressed in terms of the displacement function. For example, the relationship between a displacement function and a change ds in the distance observed between two points i and j in two monitoring campaigns may be written as:

$$ds_{ij} = \left[\frac{(x_j - x_i)}{s} \right] u_j + \left[\frac{(y_j - y_i)}{s} \right] v_j - \left[\frac{(x_j - x_i)}{s} \right] u_i - \left[\frac{(y_j - y_i)}{s} \right] v_i \quad (\text{Eq 11-8})$$

where

$$\begin{array}{ll} u_j & v_j \\ u_i & v_i \end{array}$$

are components of the displacement function at points:

$$\begin{array}{ll} x_j & y_j \\ x_i & y_i \end{array}$$

respectively. For example, with a horizontal tiltmeter, the change $d\tau$ of tilt between two survey campaigns may be expressed in terms of the vertical component (w) of the displacement function as:

$$d\tau = (\partial w / \partial x) \sin \alpha + (\partial w / \partial y) \cos \alpha \quad (\text{Eq 11-9})$$

where

α = the orientation angle of the tiltmeter.

The functional relationships for any other types of observables and displacement functions are written in matrix form as:

$$\delta \mathbf{l} = \mathbf{A} \mathbf{B}_{\delta \mathbf{l}} \mathbf{c} \quad (\text{Eq 11-10})$$

where \mathbf{A} is the transformation matrix (design matrix) relating the observations to the displacements of points at which the observations are made, and $\mathbf{B}_{\delta \mathbf{l}}$ is constructed from the above matrix \mathbf{B} ($x, y, z, t-t_0$) and related to the points included in the observables.

(6) Best-fit deformation models. For redundant observations, the elements of the vector \mathbf{c} and their variances and covariances are determined through least-squares approximation, and their statistical significance can be calculated. One tries to find the simplest possible displacement function that would fit to the observations in the statistically best way. The search for the 'best' deformation model (displacement function) is based on either *a priori* knowledge of the expected deformations (for instance from the finite element analysis) or a qualitative analysis of the deformation trend deduced from all the observations taken together. In the case of the observables being the relative displacements obtained from geodetic surveys, the iterative weighted transformation of the displacements gives the best picture of the actual deformation trend helping in the spatial trend analysis. In the case of a series of observations taken

over a prolonged period of time, plotting of individual observables versus time helps to establish the deformation trend and the deformation model in the time domain. In the analysis, one has to separate the known deformation trend from the superimposed investigated deformation. For example, in order to distinguish between the cyclic (seasonal) thermal expansion of a structure with a one-year period of oscillation and a superimposed deformation caused by other effects which are, for instance, linear in time, all the measurements can be analyzed through a least-squares fitting of the cyclic function

$$y = a_1 \cos(\omega t) + a_2 \sin(\omega t) + a_3 t + a_4 + a_5 \delta(t_i) + \dots, \quad (\text{Eq 11-11})$$

to the observation data, where $\omega = 2\pi/\text{yr}$, and (a_3) is the rate of change of the observation (extension, tilt, inclination, etc.). The amplitude and phase of the sinusoid can be derived from (a_1) and (a_2) . The constant (a_4) is the y-intercept and the constants (a_5, \dots) are possible slips (discontinuities) in the data series where $\delta(t_i)$ is the Kronecker's symbol which is equal to 1 when $t > t_i$, with t_i being the time of the occurrence of the slip, and is equal to 0 when $t < t_i$.

(7) Deformation modeling procedures. Geometrical deformation analysis using the UNB Generalized Method is done in four steps:

- (a) Trend analysis in space and time domains, and the selection of a few alternative deformation models, seem to match the trend and make physical sense.
- (b) Least-squares fitting of the model or models into the observation data and statistical testing of the models.
- (c) Selection of the 'best' model that has as few coefficients as possible with as high a significance as possible (preferably all the coefficients should be significant at probabilities greater than 95%) and which gives as small a quadratic form of the residuals as possible.
- (d) Graphical presentation of the displacement field and the derived strain field.

The results of the geometrical analysis serve as an input into the physical interpretation and into the development of prediction models as discussed above.

11-3. Statistical Modeling

a. General. The statistical method establishes an empirical model of the load-deformation relationship through regression analysis, which determines the correlations between observed deformations and observed loads (external and internal causes producing the deformation). Using this model, the forecasted deformation can be obtained from the measured causative quantities. A good agreement between the forecasts and the measurements then tell us that the deformable body behaves as in the past. Otherwise, reasons should be found and the model should be refined.

b. Cause-effect model. Interpretation by the statistical method requires a suitable amount of observations, both of causative quantities and of response effects. Let $d(t)$ be the observed deformation of an object point at time t . For a concrete dam, for example, it can usually be decomposed into three components:

$$d(t) = d_H(t) + d_T(t) + d_r(t) \quad (\text{Eq 11-12})$$

where $d_H(t)$, $d_T(t)$, $d_r(t)$ are the hydrostatic pressure component, thermal component, and the irreversible component due to the non-elastic behavior of the dam, respectively. The component $d_H(t)$ is a function of water level in the reservoir, and can be modeled by a simple polynomial:

$$d_H(t) = a_0 + a_1 H(t) + a_2 H(t)^2 + \dots + a_m H(t)^m \quad (\text{Eq 11-13})$$

where $H(t)$ is the elevation of the water in the reservoir. The component $d_T(t)$ can be modeled in various ways depending on the information on hand. If some key temperatures $T_i(t)$, for $i = 1, 2, \dots, k$, in the dam are measured, then:

$$d_T(t) = b_1 T_1(t) + b_2 T_2(t) + \dots + b_k T_k(t) \quad (\text{Eq 11-14})$$

If air temperature is used, the response delay of concrete dams to the change in air temperature should be considered. If no temperature is measured, the thermal component can be modeled by a trigonometric function.

c. Elastic deformation. The irreversible component $d_r(t)$ may originate from a non-elastic phenomena like creep of concrete or creep of rock, etc. Its time-dependent behavior changes from object to object. It may be modeled, for example, with an exponential function. The following function is appropriate for concrete dams:

$$d_r(t) = c_1 t + c_2 \ln(t) \quad (\text{Eq 11-15})$$

Coefficients (a_i , b_i , c_i) in the above equations are determined using the least squares regression analysis. The final model suggests the response behavior of the different causative factors and is used for prediction purposes.

d. Plastic deformation. For an earth dam, the thermal effect is immaterial and the irreversible component becomes dominant. It should be mentioned that the statistical method for physical interpretation is applicable not only to observed displacements, but also to other monitored quantities, such as stress, pore water pressure, tilt of the foundation, etc. The only difference is that the response function for each causative quantity may change.

11-4. Deterministic Modeling

a. General. The deterministic method provides information on the expected deformation from information on the acting forces (loads), properties of the materials, and physical laws governing the stress-strain relationship. Deformation of an object will develop if an external force is applied to it. The external forces may be of two kinds: surface force, i.e., forces distributed over the surface of the body, and body forces, which are distributed over the volume of the body, such as gravitational forces and thermal stress. The relation between the acting forces and displacements is discussed in many textbooks on mechanics. Let \mathbf{d} be the displacement vector at a point and \mathbf{f} be the acting force. They are related as:

$$\mathbf{L}^T \mathbf{D} \mathbf{L} \mathbf{d} + \mathbf{f} = 0 \quad (\text{Eq 11-16})$$

where \mathbf{D} is the constitutive matrix of the material whose elements are functions of the material properties (e.g., Young's modulus and Poisson's ratio) and \mathbf{L} is a differential operator transforming displacement to strain. If initial strain ϵ_0 and initial stress σ_0 exist, the above equation becomes:

$$\mathbf{L}^T \mathbf{D} \mathbf{L} \mathbf{d} + (\mathbf{L}^T \sigma_0 - \mathbf{L}^T \mathbf{D} \sigma_0) + \mathbf{f} = 0 \quad (\text{Eq 11-17})$$

In principle, when the boundary conditions are given, either in the form of displacements or in the form of acting forces, and the body forces are prescribed, the differential equation can be solved. However, direct solution may be difficult, and numerical methods such as the finite element or boundary element of finite differences methods are used. The finite element method (FEM) is the most commonly used method in structural and geotechnical engineering, particularly in modeling dam deformations.

b. Finite element method. The basic concept of the FEM is that the continuum of the body is replaced by an assemblage of small elements which are connected together only at the nodal points of the elements. Within each element a displacement function (shape function) is postulated and the principle of minimum potential is applied, i.e., the difference between the work done by acting forces and the deformation energy is minimized. Therefore, the differential operator \mathbf{L} is approximated by a linear algebraic operator. Numerous FEM software packages are available in the market ranging significantly in prices depending on their sophistication and adaptability to various types of material behavior. Software packages have been developed for 2D and 3D finite element elastic, visco-elastic, and heat transfer analyses of deformations. FEM has found many practical applications in dam deformation analyses, in tectonic plate movements, in ground subsidence studies and in tunneling deformations.

c. Deterministic modeling. In the deterministic modeling of dam deformations, the dam and its foundation are subdivided into a finite element mesh. The thermal component (dT) and hydrostatic pressure component (dH) are calculated separately. Assuming some discrete water level in the reservoir, the corresponding displacements of the points of interest are computed. A displacement function with respect to water level is obtained by least squares fitting of a polynomial to the FEM-computed discrete displacements. Then, the displacements at any water level can be computed from the displacement function. In computation of the thermal components, the temperature distribution inside the structure should first be solved. Again, FEM could be used, based on some measured temperatures (boundary conditions). Both the coefficient of thermal diffusivity and the coefficient of expansion of concrete are required. The thermal components for the points of interest are calculated using FEM with computed temperature at each nodal point. The total deformation is the sum of these two components plus possible action of some other forces, e.g., swelling of concrete due to alkali aggregate reaction which can also be modeled. FEM is certainly a powerful tool in the deterministic modeling of deformations. One has to remember, however, that the output from the FEM analysis is only as good as the quality of the input and as good as the experience of the operator who must have a good understanding of not only the computer operation but, particularly, good knowledge in the mechanics of the deformable bodies.

11-5. Hybrid Analysis Method

a. General. Interpretation by statistical methods requires a large amount of observations, both of causative quantities and of response effects. The method is not suitable at the early stage of dam operation when only short sets of observation data are available. Some portions of the thermal and hydrostatic pressure effects may not be separated by the statistical modeling if the changes in temperature and in the elevation of water in the reservoir are strongly correlated. The deterministic method proves very advantageous in these aspects. The deterministic method is of an *a priori* (design) nature. It uses the information on geometric shape and material properties of the deformable body and acting loads to calculate deformations. Due to many uncertainties in deterministic modeling, e.g., imperfect knowledge

of the material properties, possibly wrong modeling of the behavior of the material (non-elastic behavior), and approximation in calculations, the computed displacements may depart significantly from observed values $d(t)$. With the discrepancy produced by uncertainties in Young's modulus of elasticity, E , and the thermal coefficient of expansion (α), the deterministic model can be enhanced by combining it with the statistical method, in the form:

$$d(t) + v(t) = x d_H(t) + y d_T(t) + c_1 t + c_2 \ln(t) \quad (\text{Eq 11-18})$$

where $v(t)$ is the residual, $d_H(t)$ and $d_T(t)$ are the hydrostatic and thermal components, respectively, calculated from the deterministic modeling, and the last two terms take care of the possible irreversible component. The functional model for the irreversible component may vary and can be changed by examining the residuals. The unknowns (x , y , c_1 , and c_2) are estimated from the observations using the least squares estimation. The coefficient x is a function of Young's modulus and y is a function of the thermal expansion coefficient of concrete:

$$\begin{aligned} x &= E_0 / E \\ y &= \alpha / \alpha_0 \end{aligned} \quad (\text{Eq 11-19})$$

where E_0 and α_0 are the values used in the deterministic modeling.

b. Material properties. There must be a calibration of the constants of the material properties using the discrepancies between the measured displacements of a point at different epochs and that calculated from FEM. One must be aware, however, that if the real discrepancy comes from other effects than the incorrect values of the constants (e.g., non-elastic behavior), the model may be significantly distorted. A concept of a global integration has been developed, where the geometrical analysis of deformations and both methods of physical interpretation are combined. Using this concept, deformation modeling and understanding of the deformation mechanism can be greatly enhanced.

11-6. Automated Data Management

a. Advantages and limitations of automation. In the total effort of deformation monitoring, the quality of the analysis of the behavior of the object being monitored depends on the location, frequency, type, and reliability of the data gathered. The data concerned is any geotechnical observable as well as any conventional geodetic observable (angle, distance, height difference, etc.). Apart from the location and type of instrumentation, the frequency and reliability of the data can be enhanced by employing an "automatic" system of data gathering or acquisition and processing (including the deformation analysis). A data management system encompasses everything that happens to the data from the instant at which it is sensed to the time of analysis. Under ordinary circumstances, the interval of time between sensing and analysis may extend over several days or more. Under critical conditions, this may have to be nearly instantaneous in order to provide a warning, if necessary. The volume of data may consist of only several items (in the simplest routine investigation) to many hundreds or thousands (in very complex, critical situations, particularly if vibration behavior is of interest). The rate of sampling may be annually, monthly, weekly, daily, hourly, or even more frequently. The amount of human involvement may range from total (a "manual" system) to virtually none (an "automatic" system). Neither extreme is practical. A manual system is labor intensive and liable to errors or blunders and is less flexible in the re-examination of data. An automatic system is attractive but has some limitations. Although a "data acquisition system" strictly involves the gathering of data, the phrase has been used by many to mean the whole system of data management. Advantages and limitations of an automatic data acquisition system are summarized in the following two lists.

Advantages of an automatic data acquisition system:

- personnel costs for reading instruments and analyzing data are reduced,
- more frequent readings are possible,
- retrieval of data from remote or inaccessible locations is possible,
- instantaneous transmission of data over long distances is possible,
- increased reading accuracy can be achieved,
- increased flexibility in selecting required data can be provided,
- measurement of rapid fluctuations, pulsations, and vibrations is possible,
- recording errors are fewer and immediately recognizable, and
- data can be stored electronically in a format suitable for direct computer analysis.

Limitations of an automatic system:

- a knowledgeable observer is replaced by hardware,
- an excess of data could be generated, leading to a failure in timely response,
- the data may be blindly accepted, possibly leading to a wrong conclusion,
- there could be a high initial cost and, possibly, a high maintenance cost,
- often requires site-specific or custom components that may be initially unproven,
- complexity may require an initial stage of debugging,
- specialized personnel may be required for regular field checks and maintenance,
- a manual method is required as backup,
- a reliable and continuous source of power is required, and
- the system may be susceptible to damage by weather or construction activity.

With an appropriate compromise between manual and automatic functions, a properly designed and working system can minimize the effects of the limitations mentioned above. Therefore, the advantages of an automatic ("semi-automatic") system easily outweigh its disadvantages.

b. Automated data system. A data management system with a PC computer or programmed data collector provides for direct connection to (and sometimes control of) instrumentation and for keyboard entry for other equipment. The system should accommodate manually recorded data or data directly acquired from instrumentation. The raw data are contained in observation files, archived for security, and are processed or "reduced" (using calibration, test values, etc.) into data files which are then used by various analysis and display software applications.

(1) Field checks. A check file is required for access either during data collecting or available in hardcopy. The check file contains expected values predicted from stochastic (statistical) analyses of the data files and provides for a warning in the field. A warning is also given in the processing if the currently processed value differs beyond a set tolerance from the most recent value in the data file.

(2) Integrated analysis. Any data or derived data, whether geotechnical or geodetic (repeated in a suitable time series), can be brought together in the integrated deformation analysis of a structure. A time series is analyzed for trends with the separation of seasonal and long term behavior. The method of least squares fitting provides a full statistical analysis of the trend with the detection of outlying or erroneous data. It is possible to derive a new series from two original series or to create a series from repeated geodetic campaigns (e.g., tilt derived from leveling). The system can also show several series of data simultaneously, without fitting, to provide a graphical comparison of the series.

(3) Interpretation of results. Geodetic data is treated traditionally in campaigns for adjustment and spatial trend analysis. Once the observations have been repeated a sufficient number of times, they can be treated as a time series. Geotechnical series are treated in a similar manner (e.g., time series analysis, spatial series analysis, and plots). The trend analyses are automated by command files that are setup to control fitting and automated plotting of several series in succession. All of the data can be used together in simultaneous integrated geometrical analyses following the UNB Generalized Method, or several series can be plotted simultaneously without fitting. With both the observation files and the data files as ASCII text files, they are accessible through any text editor for manual entry or editing and can be input to other software applications.

c. Desirable characteristics of an automated system. Overall, the desirable characteristics of a data management system for deformation surveys includes:

- Data integrity (offering checks in the field and later processing).
- Data security (automatic archiving and regular data file backup).
- Automated acquisition, processing, and analysis.
- Compatibility and integration with other observables.
- Flexibility in access to the data for possible manual entry and editing.
- Data openness (useable by other software).
- Flexibility to be modified for additional instrumentation or other forms of analysis.
- On-site immediate access to data or any of the forms of analysis.
- Near-real time results of trend or other analyses.
- Testing and calibration is an integral component of the system.

11-7. Scope of Deformation Analysis

Over the past 10 years there has been significant progress in the development of new methods for the geometrical and physical analyses of deformation surveys. FIG has been leading in the developments, particularly in the areas of integrated geometrical analysis of structural deformations and combined integrated analysis. However, due to lack of interdisciplinary cooperation and insufficient exchange of information, FIG developments have not yet been widely adapted in practice. General worldwide use of the geometrical analysis methods is still poor, including even the basic analysis of geodetic monitoring networks. The above comments lead to the following:

- The analysis of deformation surveys should be in hands of interdisciplinary teams consisting of geotechnical, structural, and surveying engineers specialized in both geometrical and physical analyses.
- More use should be made of the concepts and developed methodologies for the geometrical integrated analysis and combined deterministic-statistical modeling of deformations.

11-8. Mandatory Requirements

There are no mandatory requirements in this chapter.

Chapter 12 Data Presentation and Final Reports

12-1. Report Format

All surveying field work and analysis leads to a final presentation of the results. Contained in the final Survey Report are the field notes, supporting analysis, results, and a report of conclusions. The report format should include the following standard components.

a. Title page. The title page should list summary project information such as, the authorized project name, document reference number, date, and reference to the survey.

b. Introduction. This section summarizes the main results in abstract form, and presents an outline of the project report describing the purpose and execution of the survey.

c. Project description. Includes a description of the monitoring network using text, tables, and figures.

(1) Site plan that shows the layout of the structure superimposed with the monitoring network. Figures with plan or cross-sectional views showing the outline of the structure, location of deformation network points, and their names. All reference points shown in the figures will be denoted by one symbol, while all object points will be denoted by a different symbol.

(2) List of approximate coordinates for each network station giving,

- Station Name
- Point ID
- 3D coordinates

(3) Project features described and indexed in a summary paragraph, including,

- nature and definition of project datum
- number of stations
- designated sub-networks
- date of present survey
- list of previous surveys completed.

(4) Monument descriptions as to:

- type of monument
- recovery information
- physical condition
- reference marks.

d. Equipment. Inventory of equipment used to complete the survey, including:

- identification of each instrument model
- serial number.

e. Survey design. This section describes the features used in the design of surveys including:

- types of measurements
- redundancy
- stations measured
- observation weights

If preanalysis was conducted, a summary of the resulting output files can be substituted.

f. Computations and results. The results section will contain the following components.

(1) A summary list of:

- methods for data reductions
- calibration values
- initial and final measurement values

(2) A list of the final coordinates for each station along with associated point confidence ellipses,

(3) A list of the calculated positions for the most recent prior survey. These results also will be tabulated in digital form independent of the report.

(4) Graphical displays of the network with horizontal and vertical displacements will include point movements plotted as vectors with their associated error bars and/or error ellipses. Statistically significant movements will be flagged. Only displacements between two chosen epochs will be plotted on a given figure. Displacement contours will not be plotted.

(5) Reference network stability analysis showing results of independent monitoring of the reference network stations.

(6) Cumulative displacements will be reported. Final reports will include figures showing 1D cumulative displacements of critical points in critical directions versus time. Examples of critical cumulative displacements include movements in the downstream and vertical directions of a small number of points on the crest of a dam, or movements in the downhill and vertical directions of a small number of representative points in an earthen dam or levee. The error bar associated with each displacement will be plotted. Data from all deformation analyses performed on the project will be included. Statistically significant cumulative displacements will be flagged.

g. Conclusions. Comparison of the displacements and displacement accuracy to the expected values for structural movement. Discussion of the overall quality and accuracy of the survey.

h. References. Any additional source material should be referenced. An index to the archived digital data and field notes should be provided.

i. Network adjustment. Adjustment results will be reported as a separate section. The final report will include a tabular summary of each network adjustment including the following information:

- network constraints applied,
- names of points used, or point ID numbers,
- adjusted point coordinates to the nearest 0.1 mm,
- standard deviations of point coordinates to the nearest 0.1 mm,

- dimensions of error bars to the nearest 0.1 mm at the one standard deviation level for 1D network points.
- dimensions of the axes of the error ellipses to the nearest 0.1 mm (one standard deviation),
- orientation angle to the nearest 0.1 degree for 2D network points,
- dimensions of the axes of the error ellipses to the nearest 0.1 mm,
- out-of-plane angles to the nearest 0.1 degree for 3D network point coordinates,
- quadratic form of the residuals,
- total redundancy of the network,
- estimated a posteriori variance factor.
- standardized residuals for each observation,

j. Initial and final surveys. Final reports of calculated displacements will include:

- a summary of coordinate data from both adjustments used to compute final displacements.
- displacements reported to the nearest 1 mm and associated direction to the nearest 0.1 degree.

12-2. Displacement Data Presentation

a. General. Regular use of engineering illustrations and other visual aids such as, graphs and plots, give an immediate picture of the structure's behavior. It is equally important to have tabulated displacement values, accuracy evaluations, and data quality indicators that support the reliability and significance of the results. Each single epoch displacement vector should be plotted on a schematic of the structure along with its associated point error ellipse for the base epoch. To enhance clarity, vertical movement components are plotted on a separate elevation view.

b. Data plots. Various types of summary data plots can be used for interpreting the structural displacement time history.

(1) Most recent epoch. For plots of the most recent survey epoch, the displacements are compared to the initial baseline survey (to indicate total net movement). The actual displacements are compared against the maximum amount of expected movement.

(2) Critical areas. Detailed plots can be made for areas that require greater attention, such as structural or foundation interfaces.

(3) Trend plots. Cumulative trends in the coordinate data sets from year to year should be computed to determine if the movement behavior is consistent over time. Displacement velocity and acceleration trends can refine the frequency needed for future surveys.

12-3. Data Management

a. General. The organization and management of historical movement data should be given high priority on deformation monitoring projects because information about the structure has to be kept for a long period of time. This information may also need to be retrieved on short notice in the event of problems with the structure. One strategy for data management is to create a dedicated database file system to archive project survey information.

b. Data management. Database systems can quickly extract and summarize dam status information, and the data can be used to produce graphs, written reports, or specific status summaries on demand. These systems sort and organize large volumes of data for generally any attributes that can be listed in table form. It is also an ideal format to archive raw survey data and to store processed results in a

EM 1110-2-1009
1 Jun 02

permanent file. The database also simplifies project management tasks by tracking annual progress, setting work priorities, schedules, and recording costs. Standardized dam status record-keeping also enables comparisons of structural performance from projects throughout USACE.

12-4. Mandatory Requirements

There are no mandatory requirements in this chapter.

Appendix A References

A-1. Referenced Publications

PL 92-367

The Dam Inspection Act

ER 1110-2-100

Periodic Inspection and Continuing Evaluation of Completed Civil Works Structures

ER 1110-2-110

Instrumentation for Safety Evaluations of Civil Works Projects

ER 1110-2-1150

Engineering and Design for Civil Works Projects

ER 1110-2-1806

Earthquake Design and Analysis for Corps of Engineer Dams

EP 1110-2-13

Dam Safety Preparedness

EM 1110-1-1000

Photogrammetric Mapping

EM 1110-1-1002

Survey Markers and Monumentation

EM 1110-1-1003

NAVSTAR Global Positioning System Surveying

EM 1110-1-1005

Topographic Surveying

EM 1110-1-1904

Settlement Analysis

EM 1110-2-1911

Construction Control for Earth and Rock-Fill Dams

EM 1110-2-1003

Hydrographic Surveying

EM 1110-2-1908

Instrumentation of Embankment Dams and Levees

EM 1110-2-2200

Gravity Dam Design

EM 1110-2-1009
1 Jun 02

EM 1110-2-2300
Earth and Rock-Fill Dams General Design and Construction Considerations

EM 1110-2-4300
Instrumentation for Concrete Structures

USATEC 1996
US Army Topographic Engineering Center 1996. "Handbook for Transformation of Datums, Projections, Grids and Common Coordinate Systems." TEC-SR-7.

USATEC 1999
US Army Topographic Engineering Center 1999. "Design and Evaluation of Geodetic Surveys for Deformation Monitoring at the US Army Engineer District, Seattle."

Federal Geodetic Control Committee 1984
Federal Geodetic Control Committee. 1984. "Standards and Specifications for Geodetic Control Networks," Rockville, MD.

Federal Geodetic Control Committee 1988
Federal Geodetic Control Committee. 1988 (Reprinted with Corrections: 1 Aug 1989). "Geometric Geodetic Accuracy Standards and Specifications for Using GPS Relative Positioning Techniques (Preliminary)," Rockville, MD.

National Geodetic Survey 1977
National Geodetic Survey. 1977. "Use of Calibration Base Lines," NOAA Technical Memorandum NOS NGS 10, Rockville, MD.

National Geodetic Survey 1982
National Geodetic Survey. 1982. "Establishment of Calibration Base Lines," NOAA Technical Memorandum NOS NGS 8, Rockville, MD.

National Geodetic Survey 1988
National Geodetic Survey. 1988. "Guidelines for Submitting GPS Relative Positioning Data to the National Geodetic Survey," Rockville, MD.

National Geodetic Survey (ND)
NOAA Manual NOS NGS 3, "Geodetic Leveling"

Office of Management and Budget 1990
Office of Management and Budget. 1990 (19 Oct). "Coordination of Surveying, Mapping, and Related Spatial Data Activities," Circular No. A-16, Washington, D.C.

Chrzanowski, A. and F.A. Ahmed 1971
"Alignment Surveys in a Turbulent Atmosphere Using Laser." Proceedings of the American Congress on Surveying and Mapping, Washington, D.C., 07-12 March, pp. 494-513.

Chrzanowski, A. 1974
"Precision Alignment Surveys Using Laser." Proceedings of the XIVth International Congress of Surveyors, Washington, D.C., 07-16 September, 6 pp.

Discol, W. (Ed.) 1978
Handbook of Optics, McGraw Hill.

Rüeger 1990
Rüeger, J.M. 1990. *Electronic Distance Measurement, An Introduction*. Springer-Verlag, 266 pp.

Smith, F. 1993
"The Infrared and Electro-Optical Systems Handbook" Vol. 2, Atmospheric Propagation of Radiation, SPIE Press.

Tatarskii, V. I. 1959
"The Effects of the Turbulent Atmosphere on Wave Propagation", Moscow.

Williams, C.S., Becklund, O.A. and D.C. Williams 1989
Optical Methods of Engineering Metrology. (ISBN 0-412-39640-8), 477 pp.

Yoder, D. 1986
Introduction to the Optical Transfer Function, Wiley-Interscience, (ISBN: 0-471-94770-9), Opto-Mechanical System Design, New York.

A-2. Related Publications

Although not necessarily referenced in this manual, the following publications contain technical background information that relates to the performance and analysis of precise structural deformation surveys.

Baker, L.R. (ND)
Specification and Measurement of Optical Systems. (ISBN 0-8194-0960-X), 250 pp.

Bomford 1980
Bomford, G. 1980. *Geodesy*. Clarendon, 855 pp.

Chen 1989
Chen, Y.C., Chrzanowski, A., and J.M. Secord 1989. "A Strategy for the Analysis of the Stability of Reference Points in Deformation Surveys." *CISM Journal ACSGC*, Vol 44, No. 2, Summer 1990, pp.141-149.

Chrzanowski, A., A. Jarzymbowski, and M. Kaspar 1976
"A Comparison of Precision Alignment Methods." *The Canadian Surveyor*, Vol. 30, No. 2, pp. 81-96.

Chrzanowski, A. 1982
"Use of Tiltmeters in Continuous Monitoring of Ground Subsidence." Proceedings of the 7th Conference of Southern African Surveyors, Johannesburg, 25-29 January, 9 pp.

Chrzanowski 1986
Chrzanowski, A., Chen, Y.C., and J.M. Secord 1986. "Geometrical Analysis of Deformation Surveys." Proceedings of the Deformation Measurements Workshop, MIT, Cambridge, pp. 170-206.

Chrzanowski 1987
Chrzanowski, A., 1987. "Geotechnical and other Non-Geodetic Methods in Deformation Measurements." Papers of the Deformation Measurements Workshop, MIT, Cambridge, 1986.

Chrzanowski 1992

Chrzanowski, A., Avella, S., Chen, Y.C., and J. M. Secord 1992. "Existing Resources, Standards, and Procedures for Precise Monitoring and Analysis of Structural Deformations - Volumes 1-2." U.S. Army Topographic Engineering Center, TEC-0025.

Chrzanowski, A. and A. Szostak-Chrzanowski 1995

"Identification of Dam Deformation Mechanism." Proceedings of the MWA International Conference on Dam Engineering, Kuala Lumpur, Malaysia, 01-02 August, pp. 179-187.

Department of Defense 1987

"Department of Defense World Geodetic System 1984 - Its Definition and Relationships with Local Geodetic Systems." 1987. DMA Technical Report 8350.2.

Kavanagh 1989

Kavanagh, B.F. 1989. *Surveying With Construction Applications*. Prentice Hall, 458 pp.

Kuang Shan-Long 1991

Kuang Shan-Long 1991. "Optimization and Design of Deformation Monitoring Schemes." University of New Brunswick, TR No. 157.

Leick and Lambert 1990

Leick, Alfred, and Lambert, Steven. 1990. *GPS Satellite Surveying*, John Wiley, New York.

Mayoud, M., E. Menant, and J.P. Quesnel 1990

"Technological Evolution of Measurement Tools: Dilemmas, Illusions and Realities", Proceedings, International Workshops on Accelerator Alignment, Argonne, pp. 229-235.

Mikhail and Ackermann 1976

Mikhail, Edward M., and Ackermann, Friedrich E. 1976. *Observations and Least-Squares*, IEP Series Civil Engineering, New York.

Nickerson 1978

Nickerson, B.G. 1978. "A Priori Estimation of Variance for Surveying Observables." University of New Brunswick, TR No. 57, 50 pp.

Richardus 1984

Richardus, P. 1984. *Project Surveying*. A.A. Balkema, Boston, 650 pp.

Secord 1985

Secord, J.M. 1985. "Implementation of a Generalized Method for the Analysis of Deformation Surveys." University of New Brunswick, TR. No. 117.

Soler and Hothem 1988

Soler, T., and Hothem, L. 1988. "Coordinate Systems used in Geodesy - Basic Definitions and Concepts," *Journal on Surveying and Engineering, American Society of Civil Engineers*.

Trolinger, J.D. (ND)

Optical Inspection and Testing. (ISBN 00-8194-1039-X), 284 pp.

A-3. URL Addresses

a. URL addresses for selected USACE commands:

Headquarters, US Army Corps of Engineers	http://www.usace.army.mil
HQ Publications: Engineer Manuals, Regulations Pamphlets & Circulars	http://www.usace.army.mil/inet/usace-docs/
CADD/GIS Technology Center	http://tsc.wes.army.mil
Coastal and Hydraulics Laboratory	http://chl.wes.army.mil
Cold Regions Research and Engineering Laboratory	http://www.crrel.usace.army.mil
Hydrologic Engineering Center (HEC)	http://www.wrc-hec.usace.army.mil
Joint Airborne LIDAR Bathymetry Technical Center of Expertise (JALBTCX)	http://shoals.sam.usace.army.mil
Topographic Engineering Center (TEC)	http://www.tec.army.mil

b. URL addresses for selected governmental agencies; standards organizations; and GPS surveying equipment manufacturers:

Ashtech Precision Products	http://www.ashtech.com
Cyra Technologies	http://www.cyra.com
Federal Geographic Data Committee (FGDC)	http://www.fgdc.gov
FGDC Bathymetric Subcommittee	http://www.csc.noaa.gov/fgdc_bsc
FGDC Federal Geodetic Control Subcommittee	http://www.ngs.noaa.gov/FGCS/fgcs.html
National Oceanographic and Atmospheric Administration (NOAA)	http://www.noaa.gov
NOAA National Ocean Service (NOS)	http://www.nos.noaa.gov
NOAA Coast Survey	http://chartmaker.ncd.noaa.gov
NOAA National Geodetic Survey (NGS)	http://www.ngs.noaa.gov
Trimble Navigation Limited	http://www.trimble.com
US Coast Guard Navigation Center (NAVCEN)	http://www.navcen.uscg.mil
University of New Brunswick (UNB)	http://www.unb.ca

Appendix B
Applications: Deformation Surveys of Locks and Dams
Central & Southern Florida Flood Control Project and Lock Dewatering Project

The following A-E Scope of Work illustrates technical requirements for deformation surveys of typical concrete lock structures. This sample project requires four types of deformation observations:

- Concrete crack measurements with inside micrometer
- Monolith deflection observations with a target micrometer
- Horizontal distance/coordinate trilateration observations with EDM
- Vertical settlement observations with precise parallel plate differential leveling

A project sketch is at Figure B-1.

TECHNICAL REQUIREMENTS

STRUCTURAL DEFORMATION MONITORING SURVEYS

CENTRAL AND SOUTHERN FLORIDA FLOOD CONTROL PROJECT

Spillway (Caloosahatchee River) S-77
WP Franklin Lock and Dam (Caloosahatchee River) S-79
St Lucie Lock and Dam (St. Lucie Canal) S-80
Port Mayaca Lock and Spillway (St. Lucie Canal) S-308B & S-308C
Moore Haven Lock (Caloosahatchee River) HGS-1

1. LOCATION OF WORK. The project is located in the vicinity of Clewiston, Florida.

2. SCOPE OF WORK.

2a. Perform Structural Deformation Monitoring Surveys (Periodic Inspection and Continuing Evaluation of Completed Civil Works Structures--i.e., PICES) for determination of long-term structural movements. Measurements are made from points external to the structure to determine horizontal, vertical, alignment, concrete crack, and structural joint movement.

2b. The services to be rendered by the Contractor include all the work described in these technical requirements. Details not specifically described in these instructions are nevertheless a firm requirement if they can be identified as an item, or items, commonly a part of professional grade work of a comparative nature.

2c. The Contractor shall furnish all necessary materials, labor, supervision, equipment (other than furnished by Government), and transportation necessary to execute and complete all work required by these specifications.

2d. The Corps of Engineers, Survey Section shall be contacted the same day that the Contractor plans to commence the work. The POC for this project is Bynum Lunsford at (904) 232-1602.

2e. Rights-of-Entry must be obtained verbally and recorded in the field book before entering private property. Enter the name and address of the property owner contacted.

2f. COMPLIANCE. All Surveying and Mapping products and related work shall be in strict compliance with the applicable Engineering Manuals and with related technical standards and publications:

- EM-1110-1-1000 (Photogrammetric Mapping)
- EM 1110-1-1002 (Survey Markers and Monumentation),
- EM-1110-1-1003 (NAVSTAR Global Positioning System Surveying)
- EM-1110-2-1003 (Hydrographic Surveying)
- EM-1110-1-2909 (Geospatial Data And System)
- Tri-Services A/E/C CADD Standards, Spatial Data Standards and related Spatial Data Products
- Florida Statutes Chapter 177, Chapter 472 and Rule Chapter 61G17, Florida Administrative Code.

3. FIELD SURVEY EFFORT. The area of work is outlined on Enclosure 1 Quad map, Enclosure 2 structure drawings, Enclosure 3 PICES historic report tabulation, Enclosure 4 technical requirements, and Enclosure 5 PICES detailed field measurement procedures.

3a. STRUCTURAL MOVEMENT MEASUREMENTS. Obtain horizontal EODM trilateration observations and vertical settlement measurements for S - 77 Spillway (Caloosahatchee River), vertical settlement measurements and horizontal alignment measurements for S - 79 WP Franklin Lock and Dam (Caloosahatchee River), vertical settlement measurements, horizontal EODM trilateration observations, and horizontal alignment measurements for S - 80 St Lucie Lock and Dam (St. Lucie Canal), horizontal alignment measurements, vertical settlement measurements, and crack measurements for S -308B & S - 308C Port Mayaca Lock and spillway (St. Lucie Canal), vertical settlement measurements for Moore Haven Lock (Caloosahatchee River) structures on Central And Southern Florida Flood Control Project.

3b. VERTICAL SETTLEMENT MEASUREMENTS

3b1. GENERAL. Vertical settlement is determined by precision differential leveling methods. Fixed reference points (bedrock benchmarks) are used to check for potential movement of various settlement points on the structure. Leveling shall be performed in conformance with the methods and accuracy of 1st-Order Geodetic Leveling.

3b2. PROJECT REQUIREMENTS AND INSTRUCTIONS. Each structure has a drawing showing the locations of the benchmarks, structure settlement points and instrument stands along with a tabular report indicating differential changes from previous reading and columns for this year's data set.

3b3. EQUIPMENT. The Government will furnish a first-order level, self supporting rods and turning pins.

3b4. RECORDING FORMATS. Micrometer leveling forms will be furnished. Level sketches and abstracts shall be prepared on 8 1/2" x 11" sheets.

3b5. OBSERVING PROCEDURES. Levels between reference BM's and structure points shall be run using single run/double rod precise leveling methods. Double run/double rod leveling methods are required when single run lines do not meet external misclosure tolerances.

3b6. INTERNAL MISCLOSURE TOLERANCES. Misclosure Tolerance = $3 \text{ mm} \times \sqrt{K}$ (where K is distance in kilometers)

3b7. EXTERNAL MISCLOSURE TOLERANCE. If results do not compare with previously published report elevations double run line to verify that external misclosure excess is due to settlement of points and not due to internal problems.

3b8. INSTRUMENT CALIBRATION REQUIREMENTS. C - Factor calibrations shall be performed twice weekly, or at the beginning of leveling at a new structure, or daily if outside prescribed limits.

3b9. FIELD/OFFICE COMPUTATIONS AND REDUCTIONS. Leveling data sheets shall be checked in the field for resultant differential elevations for each run--sketches internal and external tolerances. Compile values into the current PICES report.

3c. HORIZONTAL EODM TRILATERATION OBSERVATIONS.

3c1. GENERAL. Distances to structural monitoring points are observed from one or more rigid instrument stands remote from (not influenced by) the structure. Observed structural movement vectors generally being perpendicular to the structures probable plane of failure.

3c2. PROJECT REQUIREMENTS AND INSTRUCTIONS. Each structure has a drawing showing the locations of the benchmarks, structure reference points and instrument stands along with a tabular report indicating differential changes from previous reading and columns for this year's data set.

3c3. EQUIPMENT. If available a short-range precision Electronic Distance Meter with numbered reflector and calibrated over a baseline. If unavailable equipment will be furnished by the Government.

3c4. RECORDING FORMATS. Standard field survey books, showing readings, atmospheric conditions, height, computations and reductions.

3c5. OBSERVING PROCEDURES. Two sets of five observations.

3c6. INTERNAL REJECTION CRITERIA. A spread for mean of 10 observations (2 sets of 5) shall not vary by more than ± 0.002 meter' otherwise, reobserve series.

3c7. EXTERNAL REJECTION CRITERIA. Change of ± 0.005 meter from previous PICES length observations.

3c8. CALIBRATION REQUIREMENTS. Calibration must be performed with each available reflector and the resultant system constants for the instrument/reflector pair clearly identified by serial numbers.

3c9. FIELD/OFFICE COMPUTATIONS AND REDUCTIONS. Final corrected (atmospheric, system constant, eccentricities, slope & elevation) horizontal distances will be computed and verified/checked in the field. Compile values into the current PICES report.

3d. HORIZONTAL ALIGNMENT DEFLECTION MEASUREMENTS.

3d1. GENERAL. Horizontal deformation of points on structural sections are monitored by observing magnitudes (by micrometer) with precision theodolite relative to fixed points on a baseline not influenced by the structure.

3d2. PROJECT REQUIREMENTS AND INSTRUCTIONS. Each structure has a drawing showing the locations of the benchmarks, structure reference points and instrument stands along with a tabular report indicating differential changes from previous reading and columns for this year's data set.

3d3. EQUIPMENT. If available Wild T-2 with force centering tribrach targets, plug inserts and alignment micrometer. If unavailable equipment will be furnished by the Government.

3d4. RECORDING FORMATS. Standard field survey books, showing readings, atmospheric conditions, height, computations and reductions.

3d5. OBSERVING PROCEDURES. Two sets of five observations with micrometer left and right.

3d6. INTERNAL REJECTION CRITERIA. Plus or minus 0.02" spread from mean.

3d7. EXTERNAL REJECTION CRITERIA. None.

3d8. CALIBRATION REQUIREMENTS. None.

3d9. FIELD/OFFICE COMPUTATIONS AND REDUCTIONS. Mean left and right micrometer observations to the nearest 0.001". Variation for left or right mean in the 5 set series should not exceed +/- 0.02; if so reobserve. Compile values into the current PICES report.

3e. CRACK MEASUREMENTS.

3e1. GENERAL. Measurements are made relative to grouted plugs set across a concrete crack or structural construction joint.

3e2. PROJECT REQUIREMENTS AND INSTRUCTIONS. Each structure has a drawing showing the locations of the benchmarks, structure reference points and instrument stands along with a tabular report indicating differential changes from previous reading and columns for this year's data set.

3e3. EQUIPMENT. The Government will furnish Starrett Inside Micrometer

3e4. RECORDING FORMATS. Standard field survey books, showing readings, computations and reductions.

3e5. MEASUREMENT PROCEDURES. Read Micrometer in both directions between crack plugs and mean results to the nearest 0.001".

3e6. INTERNAL REJECTION CRITERIA. One thousand inch between each direction; +/- 0.001" from nominal calibration bar.

3e7. EXTERNAL REJECTION CRITERIA. None.

3e8. CALIBRATION REQUIREMENTS. None.

3e9. FIELD/OFFICE COMPUTATIONS AND REDUCTIONS. Compile checked and verified values into the current PICES report.

3e. CONTROL. The vertical reference datum is assumed 100.00 meters. A horizontal reference datum is not required.

3f. All original field notes shall be kept in standard pocket size field books and shall become the property of the Government. The first four pages of the field books shall be reserved for indexing and the binding outside edge shall be free of all marking.

4. OFFICE REVIEW AND COMPUTATIONS. The Contractor shall make the necessary computations to verify the correctness of all measurements and apply the proper theory of location in accordance with the law or precedent and publish the results of the survey. The contractor shall submit the original field notes and horizontal and vertical abstract (computation abstract) to Survey Section.

5. CONTRACTOR QUALITY CONTROL/GOVERNMENT QUALITY ASSURANCE.

- The Contractor is responsible for quality control.
- Government personnel may perform inspections of the Contractor's field operations at any time during the prosecution of this work. The Contractor shall explain calibration procedures and operational activities related to their field effort.
- If during the Government's review of the Contractor's products it becomes apparent that little or no review has been done, the Government will return the entire project to the Contractor for correction.

6. DELIVERIES. On completion, all data required shall be delivered or mailed to Design Branch, Survey Section at the address shown in the contract, and shall be accompanied by a properly numbered, dated and signed letter or shipping form, in duplicate, listing the materials being transmitted. All digital data shall be submitted on CD-ROM's. All costs of deliveries shall be borne by the Contractor. Items to be delivered include, but are not limited to the following:

6a. Horizontal and Vertical Field Books.

6b. Bound 8-1/2" x 11" abstracts, reductions, computations, adjustments, and tabular summaries fully annotated with independent checks.

6c. PICES report tabulations.

SUBMITTED BY _____ B. Lunsford

Engineering Division
Design Branch

EM 1110-2-1009
1 Jun 02

SUBJECT: Contract No. DACW17-99-D-0046

Mr. John Morgan
Morgan & Ekland, Inc.
8745 U. S. Highway 1
Wabasso, Florida 32970

Mr. Morgan:

Reference contract number DACW17-99-D-0046 for Surveying and Mapping Services. The Government desires to execute a delivery order under subject contract for the following project:

STRUCTURAL DEFORMATION MONITORING SURVEYS
CENTRAL AND SOUTHERN FLORIDA
FLOOD CONTROL PROJECT
CLEWISTON, FLORIDA (SURVEY NO. 00-211)

Please review the enclosed Scope of Work outlining the Technical Requirements and submit an itemized fee proposal for this work within 10 working days of receipt of this document. Please furnish this fee proposal to the attention of the Chief, Design Branch.

This request does not constitute a notice to proceed for the Delivery Order. Please do not commence work or incur any costs chargeable to the Government. You are cautioned that preparation of this fee proposal is entirely at your own risk and the Government can assume no obligation for payment of any related expenses incurred by your firm.

Bynum Lunsford of the Survey Section is the point of contact. Please call him at 904-232-1602 if you have questions or need additional information.

Sincerely,

Walter Clay Sanders, P.E
Assistant Chief, Engineering Division

Enclosures

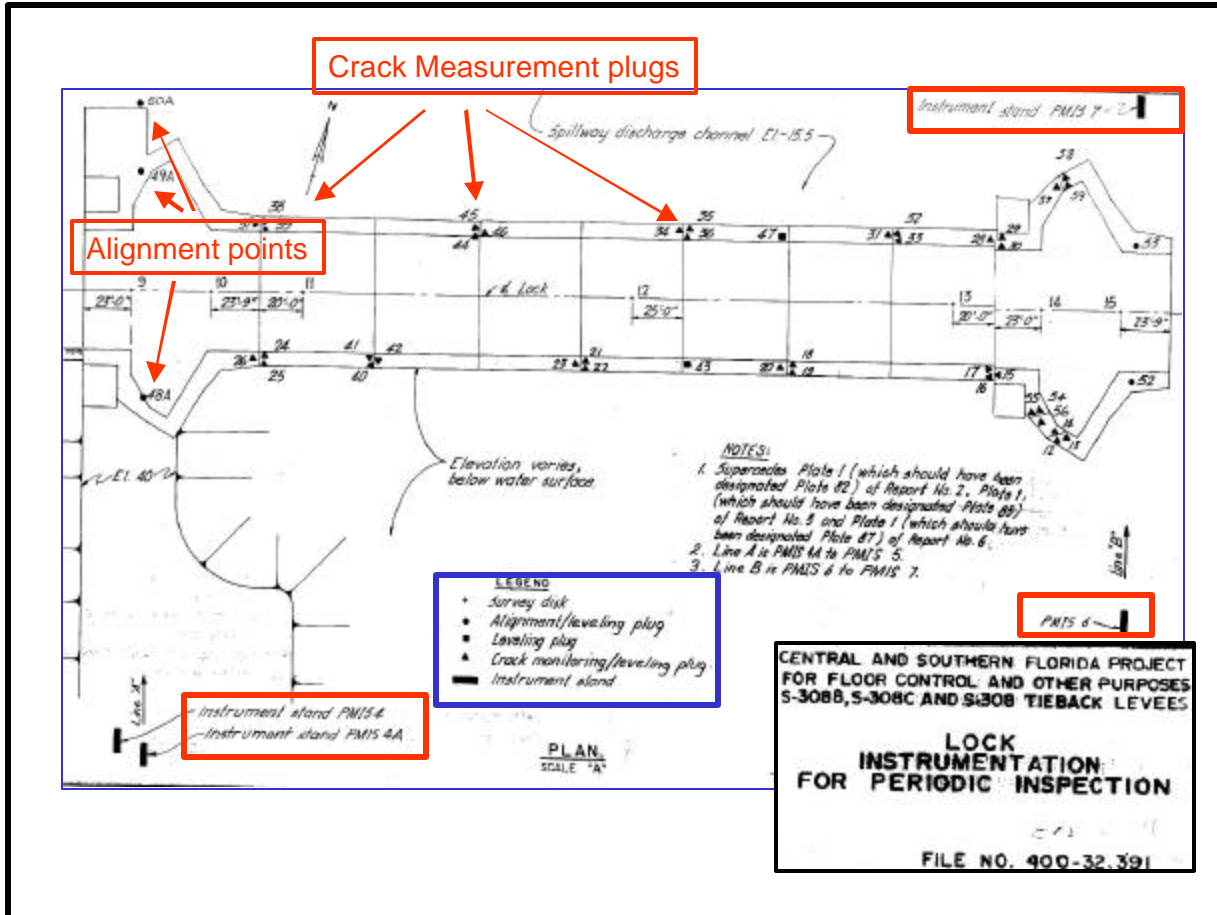

Figure B-1. Structural monitoring and target points for Port Mayaca Lock and Spillway, Central & Southern Florida Flood Control Project.

Surveying for Lock Structure Dewatering Lock & Dam No. 4

The following project illustrates plans and procedures for deformation surveys of concrete lock structures. The most common lock structure uses concrete gravity walls founded on either piling or rock. Maintenance of navigation locks requires full dewatering of the lock chamber and most flow passages. Monitoring the relative position of the gate monoliths and wall movement is made to ensure safety and stability of the structure. This example represents a typical wall monitoring operation for lock dewatering. Deformation surveys of this type are usually short-term and include the following types of observations.

- Monolith deflection observations with inside micrometer
- Horizontal distance/coordinate observations with surveying instruments.
- Vertical settlement observations with differential leveling
- Water level measurements read inside the lock chamber
- Peizometer and well observations on the landside embankment

1. Project Location and Description.

Lock No. 4 is located in Alma, Wisconsin, at river mile 752.8 on the upper Mississippi River--Figures B-2 and B-3. The lock is 600 feet long by 110 feet wide, and raises and lowers traffic 7 feet. The dam is 6,867 feet long including movable gate sections and earth fill dike. The movable gate section consists of six roller gates and 22 tainter gates. Pool 4 formed by this dam is 44.1 river miles encompassing 22 mile long Lake Pepin, a natural lake in the main channel of the Mississippi. Lock and Dam No. 4 was completed in 1935, with major rehabilitation completed in 1994 adding 50 years to its serviceability.



Figure B-2. Aerial View of Lock and Dam No. 4, Alma, WI.

2. Preparation and General Procedures.

Work will be conducted in 2 – 12 hour shifts, each consisting of Party Chief, Instrumentman, Rodman. The Wild T2002 will be checked and adjusted 48 hours before surveys start and according to manufacturers specifications. Tribrachs will be adjusted before starting instrumentation surveys. Barometric pressure (station pressure) will recorded every hour on the hour. Temperature will be recorded every hour on the hour. Atmospheric correction (combination of pressure and temperature) will be recorded and applied to the instrument before each session of measurements. One person will measure the wells and piezometers, the gauge inside the chamber and number and size of pumps that are running every two hours.

2. Equipment List.

- Wild Leica TC2002, Di2000 With 2 Charged Batteries.
- EDM Battery Charger
- 2 Single Prisms
- 8 Tripods
- 8 Tribrachs
- 30 Sand Bags ½ Filled With Dry Sand
- Barometer (Station Type, Not Sea Level)
- Thermometer
- Wild TC2002 Hand Book With Graphs For Environmental Corrections
- Piezometer Gauge Reader (Eng. Div)
- Small Plastic Bags To Cover Tribrachs
- Umbrella To Keep Instrument Dry If Raining
- Water Gauge And Weight For Inside Chamber
- Roto Hammer, Anchors, Washers And Pedestals
- Lead Wool 15#
- 4 Flashlights
- Hammer And Chisel
- 10 lb. Maul
- Field Books
- Warm, Dry Clothes

3. Instrumentation Procedures.

The following instrumentation procedures were followed during the Lock #4 dewatering project 2000. (Refer to Figures B-4 through B-9).

a. A new baseline will be set along the landside parking lot and Hwy 35. The existing baseline monuments must be abandoned for a location greater than 25' from the Railroad tracks. The new base line monuments will be 1 inch steel rebar 4 feet in length with punch holes. They will be aligned dead center with each other. These monuments will be checked once per day to ensure there is no movement.

b. Set Leica TC2002 at monument 0+00 on the Intermediate wall, back sight monument L-3 (Station 0+00) on the old baseline. Then turn right angles up and down the Intermediate wall (I-wall) and set lead plugs with brass tacks at station 2+97.09A, 3+65.86A, 4+01.32A, 1+73.68B and 2+68.18B. Align tacks dead center with each other.

c. Set the instrument at each of the above stations on the I-wall and turn right angles across the lock chamber and set stainless steel pedestals. Station 0+00 on the landwall is a brass disc, do not set a

pedestal here. At landwall station 4+01.32A and 3+65.86A, set a new pedestal at each station on Control Building. These pedestals on the building will be heated and bent to the vertical position on the building.

d. With the instrument set at Stations 0+00 on the I-wall, back sight monument L-3 (Station 0+00) on the old base line and plunge line ahead to the parking lot to 0+00 on the new base line. Make punch hole.

e. Move the instrument to station 0+00 on the new base line, back sight station 0+00 on the I-wall. Turn right angles to the other two base line monuments and make punch marks dead center with each other.

f. All measurements will be made from the I-wall to the landwall, to the new base line, and to the building pedestals.

g. Start with measuring the alignment on the new base line each day for three days.

- Move the instrument to I-wall station 4+01.32A, measure the distance in meters to station 4+01.32A on the opposite landwall and to station 4+01.32A on the building. Measure the distance 5 times to each station and record and average the readings.
- Move the instrument to I-wall station 3+65.86A and measure the distance in meters to station 3+65.86A on the landwall and to the building. Measure the distance 5 times to each station and record and average the readings.
- Move the instrument to I-wall station 2+97.09A and measure the distance in meters landwall station 2+97.09A and to the new base line station 2+97.09A. Measure the distance 5 times to each station and record and average the readings.
- Move the instrument to I-wall station 0+00 and measure the distance in meters to landwall station 0+00 and to the new base line 0+00. Measure the distance 5 times to each station and record and average the readings.
- Move the instrument to I-wall station 1+73.68B and measure the distance in meters to landwall station 1+73.68B. Measure the distance 5 times to each station and record and average the readings.
- Move instrument to I-wall station 2+68.18B and measure the distance in meters to landwall station 2+68.18B on the landwall. Measure the distance 5 times to each station and record and average the readings.

This procedure will be repeated two to three days before de-watering to initialize the system. When the drawdown starts, this system will be measured every two hours during drawdown. After the lock is de-watered, the system will be measured once per day for five days, then once per week thereafter until the chamber is refilled, then once per day for two days. The monitoring will then be completed.

4. Special Instructions.

The water inside the lock chamber is not to drop faster than ½ foot per hour. This is a very critical task and pumps may need to be shut down to maintain this ½ foot per hour. There will be 6 – 8 inch Flyght pumps and 2 – 6 inch Flyght pumps operating to dewater the lock. If the water is dropping at a faster rate,

shut down the 6 inch pumps first. Observe the water gauge in the chamber for the next hour and adjust the number of operating pumps accordingly.

While observing the monitoring system and 0.006 m of movement is determined, notify the Structural Branch (POC and phone numbers are posted) that you have detected movement of 6 mm or more and then keep repeating the measurements at that station every ½ hour, or until instructed otherwise.

The water level inside the wells and in the piezometers are very critical. Try to maintain the target level on the form provided. If large increases are detected, notify Geotechnical Branch (POC and phone numbers are posted) that you have detected a large change in water levels. If this happens, you will need to measure the water levels more frequently, and possibly adjust the valves on the wells.



Figure B-3. Lock and Dam No. 4 showing Intermediate Wall and Land Wall.

U.S. ARMY CORPS OF ENGINEERS, ST PAUL DISTRICT									
Date	Time	Temp	Pumps	Gauge Reading	Date	Time	Temp	Pumps	Gauge Reading
				In Chamber					in Chamber
12/10/00	2200	-1	4 - 8" Flygt	14.74	12/11/00	2230		5 - 8" Flygt	8.30
12/11/00	2400	-1	5 - 8" Flygt	14.60		2300		5 - 8" Flygt	8.20
	30	-1	5 - 8" Flygt	14.60		2330		5 - 8" Flygt	8.10
	100	-1	5 - 8" Flygt	14.60		2400		5 - 8" Flygt	8.10
	130	-1	5 - 8" Flygt	14.30	12/12/00	30		5 - 8" Flygt	7.9
	200	-1	5 - 8" Flygt	14.10		100		5 - 8" Flygt	7.9
	230	-1	5 - 8" Flygt	14.00		230		5 - 8" Flygt	7.5
	300	-1	5 - 8" Flygt	13.80		300		5 - 8" Flygt	7.5
	330	-2	5 - 8" Flygt	13.70		330		5 - 8" Flygt	7.2
	400	-2	5 - 8" Flygt	13.60		400		5 - 8" Flygt	7.0
	430	-2	5 - 8" Flygt	13.60		430		5 - 8" Flygt	6.9
	500	-2	5 - 8" Flygt	13.50		500		5 - 8" Flygt	6.5
	530	-2	5 - 8" Flygt	13.40		530		5 - 8" Flygt	6.4
	600	-2	5 - 8" Flygt	13.40		600	-.7	5 - 8" Flygt	6.3
	630	-2	5 - 8" Flygt	13.40		630	-.7	5 - 8" Flygt	6.3
	700	-2	5 - 8" Flygt	13.30		700	-1.0	5 - 8" Flygt	6.3
	730	-2	5 - 8" Flygt	13.30		730	-1.0	5 - 8" Flygt	6.3
	800	-2	5 - 8" Flygt	13.20		800	-1.0	5 - 8" Flygt	6.3
	830	-2	5 - 8" Flygt	13.20		830	-1.0	5 - 8" Flygt	6.3
	900	-2	5 - 8" Flygt	13.00		900	-3	5 - 8" Flygt	6.1
	1100	0	5 - 8" Flygt	12.40		1000	-3	5 - 8" Flygt	5.8
	1130	1	5 - 8" Flygt	12.00		1030	-3	4 - 8" Flygt	5.5
	1200	3	5 - 8" Flygt	11.70		1100	-2	4 - 8" Flygt	5.4
	1230	3	5 - 8" Flygt	11.50		1230	0	4 - 8" Flygt	5.0
	1300	2	5 - 8" Flygt	11.30		1330	1	5 - 8" Flygt	4.8
	1330	3	5 - 8" Flygt	11.15		1400	-1	5 - 8" Flygt	4.6
	1400	3	5 - 8" Flygt	11.00		1430	-1	5 - 8" Flygt	4.5
	1430	3	5 - 8" Flygt	10.80		1600	-2	5 - 8" Flygt	3.9
	1500	2	5 - 8" Flygt	10.50		1630	-2	5 - 8" Flygt	3.7
	1530	2	5 - 8" Flygt	10.35		1700	-3	5 - 8" Flygt	3.5
	1600	2	5 - 8" Flygt	10.10		1730	-.4	5 - 8" & 1 - 6"	3.3
	1630	2	5 - 8" Flygt	9.90		1800	-.4	5 - 8" & 1 - 6"	3.1
	1700	2	5 - 8" Flygt	9.70		1830	-.4	5 - 8" & 1 - 6"	2.8
	1730	2	5 - 8" Flygt	9.50		1900	-.4	5 - 8" & 1 - 6"	2.6
	1830	2	5 - 8" Flygt	9.30		2000	-.4	5 - 8" & 1 - 6"	2.3
	1900	2	5 - 8" Flygt	9.10		2030	-.3	5 - 8" & 1 - 6"	1.8
	1930		5 - 8" Flygt	9.10		2230	-.3	3 - 8" & 1 - 6"	1.5
	2000		5 - 8" Flygt	8.70	12/13/00	30	-.3	3 - 8" & 1 - 6"	1.1
	2030		5 - 8" Flygt	8.60		100	-.3	2 - 8" & 1 - 6"	Iced up
	2100		5 - 8" Flygt	8.50		400	-.2	2 - 8" & 1 - 6"	Iced up
	2130		5 - 8" Flygt	8.40		600	-.2	2 - 8" & 1 - 6"	Dewatered
	2200		5 - 8" Flygt	8.30					

Figure B-4. Water level (Gauge) readings recorded during dewatering operations.

U.S. ARMY CORPS OF ENGINEERS ST. PAUL DISTRICT													
Lock #4 Monitoring Measurements													
NEW BASELINE SURVEY (NBL)													
Date	Time	Temp F	Press.	0+00 NBL	2+97.09A NBL	3+65.86A NBL							
8-Dec-00	1300	12 Deg F	30.1	0.00	0.00	0.00							
9-Dec-00	1400	12 Deg F	30.1	0.00	0.00	0.00							
INITIAL SURVEY (Distances in Meters)													
				0+00 I wall	0+00 I wall	2+97A I wall	2+97A I wall	3+66A I wall	3+66A I wall	4+01A I wall	4+01A I wall	1+74B I wall	2+68B I wall
				0+00 L wall	0+00 NBL	2+97A L wall	2+97A NBL	3+66A L wall	3+66A Bldg	4+01A L wall	4+01A Bldg	1+74B L wall	2+68B L wall
8-Dec-00	1400	12 Deg F	30.1	35.2018	86.3114	35.5933	86.3105	34.7282	42.1385	34.7468	42.1747	34.6993	34.6021
9-Dec-00	900	16 Deg F	30.0	35.2027	86.3095	35.5945	86.3125	34.7290	42.1395	34.7477	42.1742	34.6998	34.6065
9-Dec-00	1030	16 Deg F	30.0	35.2042	86.3092	35.5945	86.3122	34.7292	42.1386	34.7463	42.1752	34.7014	34.6065
INITIAL SURVEY (Average Values)				35.2029	86.3100	35.5941	86.3117	34.7288	42.1389	34.7469	42.1750	34.7002	34.6050
MONITORING SURVEY													
Date	Time	Temp F	Press.	0+00 I wall	0+00 I wall	2+97A I wall	2+97A I wall	3+66A I wall	3+66A I wall	4+01A I wall	4+01A I wall	1+74B I wall	2+68B I wall
				0+00 L wall	0+00 NBL	2+97A L wall	2+97A NBL	3+66A L wall	3+66A Bldg	4+01A L wall	4+01A Bldg	1+74B L wall	2+68B L wall
11-Dec-00	2400	-1	30.05	35.2018	86.3090	35.5990	86.3122	34.7293	42.1395	34.7488	42.1785	34.6976	34.6050
11-Dec-00	200	-1	30.05	35.2032	86.3090	35.5935	86.3127	34.7291	42.1383	34.7557	42.1735	34.6981	34.6030
11-Dec-00	400	-2	30.05	35.2031	86.3086	35.5954	86.3140	34.7355	42.1440	34.7465	42.1736	34.6981	34.6037
11-Dec-00	600	-2	30.05	35.2020	86.3084	35.5959	86.3145	34.7313	42.1397	34.7471	42.1746	34.6996	34.6047
11-Dec-00	800	-2	30.05	35.2021	86.3082	35.5939	86.3136	34.7300	42.1400	34.7491	42.1763	34.6987	34.6031
11-Dec-00	1000	1	30.05	35.2029	86.3084	35.5951	86.3132	34.7320	42.1405	34.7494	42.1773	34.6983	34.6033
11-Dec-00	1200	3	30.00	35.2049	86.3078	35.5941	86.3119	34.7294	42.1392	34.7488	42.1769	34.6980	34.6042
11-Dec-00	1400	3	29.95	35.2038	86.3078	35.5947	86.3126	34.7292	42.1389	34.7479	42.1776	34.6986	34.6038
11-Dec-00	1600	2	29.95	35.2007	86.3077	35.5930	86.3126	34.7304	42.1396	34.7475	42.1752	34.6984	34.6030
11-Dec-00	1800	2	29.97	35.2015	86.3076	35.5945	86.3131	34.7295	42.1419	34.7482	42.1771	34.6978	34.6038
11-Dec-00	2000	2	29.98	35.2006	86.3075	35.5954	86.3111	34.7301	42.1402	34.7475	42.1753	34.6994	34.6028
11-Dec-00	2200	0	29.95	35.2015	86.3075	35.5942	86.3136	34.7288	42.1395	34.7466	42.1765	34.6970	34.6028
12-Dec-00	2400	-1	29.90	35.2025	86.3079	35.5949	86.3130	34.7326	42.1390	34.7470	42.1722	34.6999	34.6044
12-Dec-00	200	-1	29.95	35.2036	86.3079	35.5941	86.3136	34.7298	42.1377	34.7471	42.1746	34.6972	34.6042
12-Dec-00	400	-7	30.00	35.2040	86.3084	35.5937	86.3150	34.7287	42.1388	34.7441	42.1744	34.6989	34.6021
12-Dec-00	600	-7	30.09	35.2011	86.3083	35.5936	86.3122	34.7288	42.1404	34.7425	42.1749	34.6978	34.6030
12-Dec-00	800	-10	30.25	35.2024	86.3072	35.5949	86.3135	34.7288	42.1412	34.7430	42.1753	34.6990	34.6038
12-Dec-00	1000	-1	30.30	35.2021	86.3076	35.5941	86.3145	34.7315	42.1415	34.7497	42.1769	34.7000	34.6044
12-Dec-00	1200	9	30.30	35.2024	86.3077	35.5952	86.3136	34.7305	42.1417	34.7493	42.1770	34.6995	34.6053
12-Dec-00	1400	6	30.30	35.2024	86.3075	35.5945	86.3126	34.7314	42.1413	34.7486	42.1763	34.6996	34.6058
12-Dec-00	1600	0	30.30	35.2032	86.3075	35.5960	86.3139	34.7315	42.1411	34.7496	42.1760	34.7012	34.6060
12-Dec-00	1800	-4	30.30	35.2037	86.3077	35.5963	86.3142	34.7308	42.1412	34.7481	42.1755	34.7007	34.6051
12-Dec-00	2000	-4	30.30	35.2057	86.3075	35.5940	86.3124	34.7307	42.1422	34.7475	42.1780	34.6999	34.6027
12-Dec-00	2200	-3	30.30	35.2005	86.3072	35.5951	86.3132	34.7308	42.1389	34.7456	42.1727	34.6984	34.6019
13-Dec-00	2400	-3	30.30	35.2005	86.3073	35.5938	86.3125	34.7302	42.1403	34.7464	42.1726	34.7002	34.6024
13-Dec-00	200	-2	30.00	35.2004	86.3071	35.5966	86.3133	34.7329	42.1402	34.7473	42.1753	34.6996	34.6038
13-Dec-00	600	-2	30.00	35.2004	86.3068	35.5966	86.3121	34.7318	42.1401	34.7481	42.1750	34.6986	34.6046

Figure B-5. Distances measured across lock chamber walls using conventional instrumentation.

GPS Wall Monitoring - Baselines (meters)

Hours	I-wall 1	I-wall 2	I-wall 3	L-wall 1	L-wall 2	L-wall 3
0	113.9190	53.1768	112.2112	104.0844	25.1903	101.7617
2	113.9219	53.1775	112.2121	104.0818	25.1895	101.7612
5	113.9189	53.1768	112.2126	104.0806	25.1915	101.7619
9	113.9199	53.1789	112.2127	104.0792	25.1914	101.7589
15	113.9189	53.1782	112.2128	104.0815	25.1906	101.7589
22	113.9189	53.1739	112.2113	104.0825	25.1894	101.7599
28	113.9180	53.1775	112.2163	104.0823	25.1890	101.7619
35	113.9160	53.1768	112.2126	104.0798	25.1904	101.7596

Figure B-6. Processed GPS baselines from the reference station.

GPS Wall Monitoring - Differences (millimeters)

Hours	I-wall 1	I-wall 2	I-wall 3	L-wall 1	L-wall 2	L-wall 3
0	0.1	-0.3	-1.5	2.9	0.0	1.2
2	3.0	0.4	-0.8	0.7	-0.8	0.9
5	0.0	-0.3	-0.3	-0.5	1.2	1.6
9	1.0	1.8	-0.2	-1.9	1.1	-1.4
15	0.0	1.1	-0.1	0.4	0.3	-1.4
22	0.0	-3.2	-1.6	1.4	-0.9	-0.4
28	-0.9	0.4	3.4	1.2	-1.3	1.6
35	-2.9	-0.3	-0.3	-1.3	0.1	-0.7

Figure B-7. Processed GPS baseline differences from the initial survey.

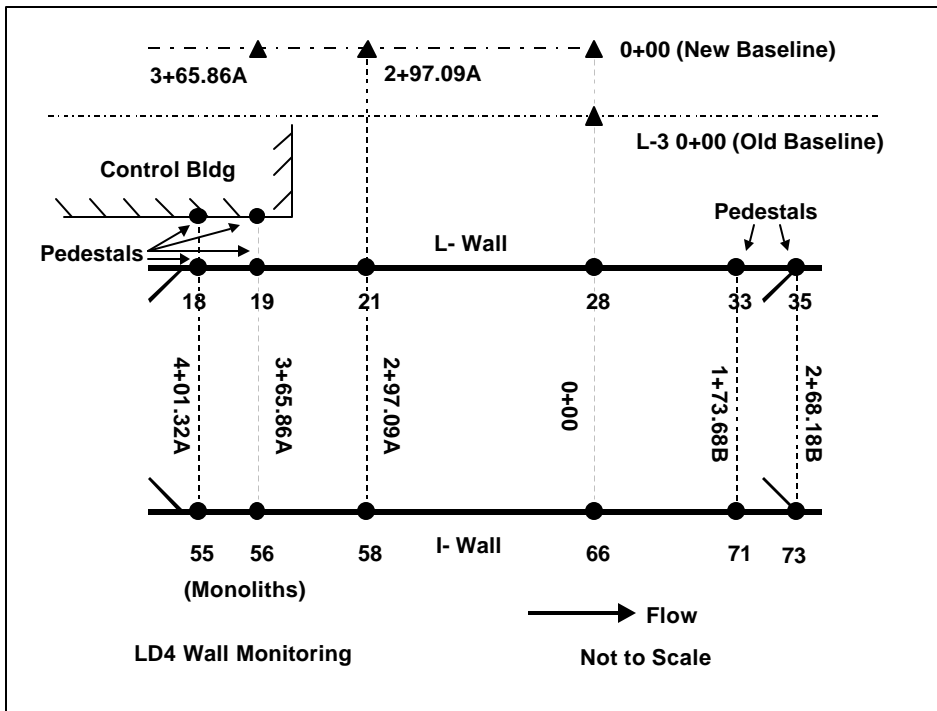

Figure B-8. Instrumentation Plan and Measurement Scheme for conventional deformation surveys.

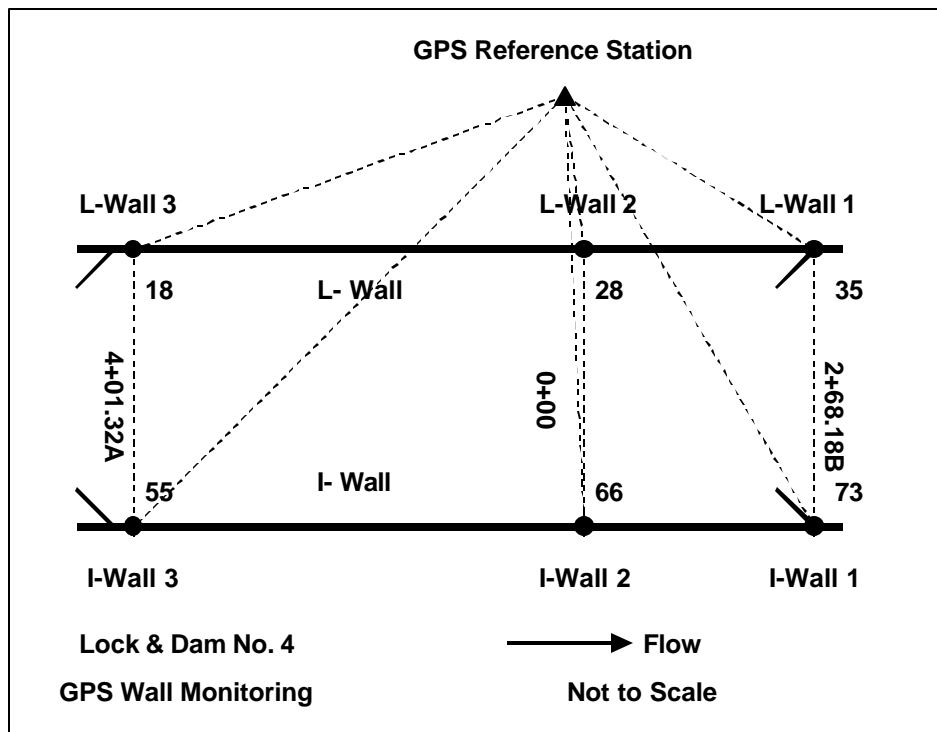

Figure B-9. Instrumentation Plan and Measurement Scheme for GPS-based deformation surveys.

Appendix C

Applications: Monitoring Schemes for Concrete Dams

C-1. Background

The following study is taken from a report prepared by the US Army Topographic Engineering Center "Design and Evaluation of Geodetic Surveys for Deformation Monitoring at the US Army Engineer District, Seattle." This study of monitoring requirements for Libby Dam illustrates many of the factors that need to be considered in establishing and maintaining a monitoring program.

C-2. Project Description

The Libby Dam project is located in Lincoln, County, Montana on the Kootenai River 17 miles upstream of the City of Libby (USGS 1:24,000 quad map - *Alexander Mountain*). Libby Dam (Figure C-1) consists of 46 concrete monoliths including spillway (monoliths 28-30) and intake (monoliths 20-27).



Figure C-1. Libby Dam.

It has a total length of 880 meters, and a maximum height of about 120 meters. It is classified as having a high downstream hazard potential in the event of failure. The Seattle District, US Army Corps of Engineers designed Libby Dam and its reservoir is used primarily for flood control and power production.

C-3. Reference Network

The reference network (Table C-1) proposed for Libby Dam consists of four reference stations (R1, R2, R3, and R4) on the surrounding abutments, and four stations (C06, C23, C35, C46) located on the crest of the structure on monoliths 6, 23, 35, and 46. Reference station R1 is located on the southwest pillar of the structure enclosing an existing weather station upstream of the dam on the right abutment. Reference station R2 is located on an existing survey observation pillar on the right abutment near the picnic area upstream of the dam. Reference station R3 is located on the left abutment on top of the rock face used for monitoring potential abutment instability. Reference station R4 is an alternate located next to a monumented gravity station near the observation deck on the right abutment. Structure reference points on the upper deck of the dam crest are located at monoliths 6, 23, 35, and 46, each collocated with existing suspended and inverted plumb lines. GPS control stations on monoliths 6 and 46 are not

collocated with fixed points for the laser surveys. Alignment fixed points could be either re-situated to monoliths 6 and 46, or have measured ties to the plumbline station (i.e., at monoliths 6 and 46).

Table C-1. Approximate NAD83 State Plane coordinates (MT West projection 1602 in meters), for Libby Dam Reference Network.

Station	Northing	Easting	Height
R1	479020.0	170214.0	765.0
R2	478690.0	169884.0	740.0
R3	478010.0	170590.0	838.0
R4	478420.0	169494.0	777.0
C06	478505.0	169771.0	736.0
C23	478315.0	170022.0	736.0
C35	478181.0	170198.0	736.0
C46	478058.0	170360.0	736.0

C-4. Reference Network Reconnaissance

a. General. Photographs of proposed locations for reference stations are shown in Figures C-3 thru C-5. Pillars have been installed for monitoring with conventional instruments, which also appear suitable for GPS occupations, being less than 2 kilometers from the farthest point on the dam crest and acceptable for precision baseline measurement. Monitoring to proposed locations at the top of the left abutment also would be within acceptable range for GPS surveys.

b. Intervisibility study. A study was undertaken of the Libby Dam site to identify zones on the surrounding abutments, and areas upstream and downstream where reference stations could be situated with a direct line-of-sight to the structure. Figure C-2 shows reference station placements that will allow

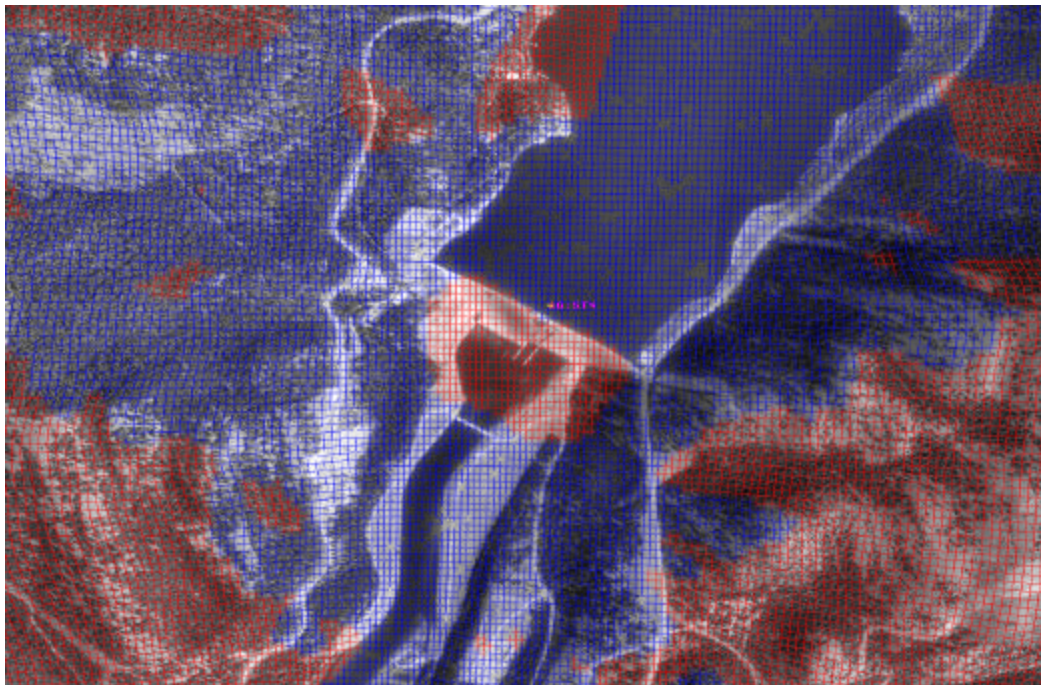

Figure C-2. Intervisibility diagram for reference station placements, blue areas visible, red areas obstructed.

dual-use of GPS and conventional surveying equipment. Blue gridlines represent areas that are visible; red grid-lines represent areas that would be obstructed. The inter-visibility map was developed from a low resolution USGS Digital Elevation Model (DEM), draped with a B/W Digital Orthophoto Quarter Quad (DOQQ) raster image. Although the diagram only meets map accuracy standards, geology and soils maps could be overlain to identify candidate areas for stable reference points.



Figure C-3. Reference Station (R1), Libby Dam.



Figure C-4. Reference Station (R2), Libby Dam.



Figure C-5. Existing survey station, Libby Dam.

C-5. Monitoring Requirements

a. General. Displacements of the dam are related mainly to annual cyclic forces from changes in reservoir elevation and to a lesser extent temperature of the concrete mass. Measured displacements under normal operating conditions are typically no greater than 2 cm in the horizontal plane, and no greater than 0.5 cm in the vertical direction. Both the amount and direction of movement across different structural components (i.e., monolith sections near the powerhouse, spillway, abutment contact zones, foundation areas, etc.) can show a significant and complex variation. Predicting detailed deformations would be difficult without further engineering analysis.

b. Expected deformation and monitoring tolerances. Libby dam is exposed to significant seasonal water level changes of up to 46 m (Figure C-6) and seasonal temperature changes. Data on the expected deformation of the dam is crucial in evaluating instrumentation. Simplified analysis of the expected effects of the changeable pool level was conducted to learn what magnitude of accuracy tolerances should be accepted for designing the deformation measurements.

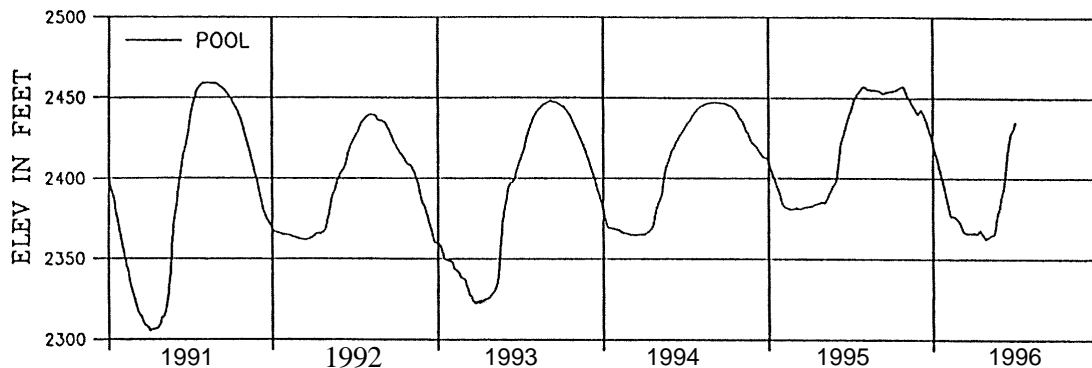

Figure C-6. Water level variations at Libby Dam

c. Deterministic prediction of displacements. The Finite Element Method (FEM) has been used in analyzing a typical cross-section of Libby dam at monolith 23. Figure C-7 shows the FEM mesh and the distortion of the dam when the water load reaches its highest level. As this was a simplified analysis, effects from galleries, penstocks, and other openings were neglected. Since no information on elasticity parameters were available, two FEM analyses of the effects of the changeable water level were performed for two values of the Young modulus:

- (1) $E_1 = 15 \text{ GPa}$
- (2) $E_2 = 25 \text{ GPa}$

with the Poisson ratio kept at:

$$\nu = 0.30.$$

Figures C-8 and C-9 show the expected tilts of the dam for the maximum (114 m) and minimum (68 m) expected water levels. The results show that the top of the dam (upper gallery) has a maximum total horizontal U/D displacement between:

$$\Delta d = -12.5 \text{ mm to } +13 \text{ mm, or } 25.5 \text{ mm for } E_1$$
$$\Delta d = -7.5 \text{ mm to } +8 \text{ mm, or } 15.5 \text{ mm for } E_2$$

at the center of the dam when the water level changes by 46 m. On average, one may expect a total maximum change of displacements between low and high water levels of about 20 mm. This estimate does not consider the effect of thermal variations of the structure. It may be expected, however, that temperature induced horizontal displacement in the upper gallery would be of a magnitude of very few millimeters, while vertical displacements at the top of the dam could reach about 20 mm (assuming a 20°C maximum change of concrete temperature at the upper levels). The monitoring surveys should be designed to detect:

$$(20 \text{ mm} \div 3)/(\sqrt{2}) = 5 \text{ mm displacements at the 95\% probability level.}$$

The standard deviation of each positioning/offset component in an individual observation epoch should then be smaller than:

$$(20 \text{ mm})/9 = 2.2 \text{ mm.}$$

C-6. Existing Measurement Systems

a. General. Instrumentation is placed in Libby Dam to monitor the structural behavior; ensure safety; determine bending, tilting, and displacement; and check design assumptions and theoretical computations. Instrumentation includes measurement of interior concrete temperatures, joint movements, uplift pressures, structural deflections, and internal concrete stresses. Instruments were also placed in the rock slope adjacent to and above the left abutment for a distance of 2,000 feet upstream to detect movement in the left bank slope. Some measurements are automatically recorded via remote phone line connections and the data are reduced and stored in the District office. A report summarizing the instrumentation evaluations, with data plots, is published twice a year and provided to Operations Division.

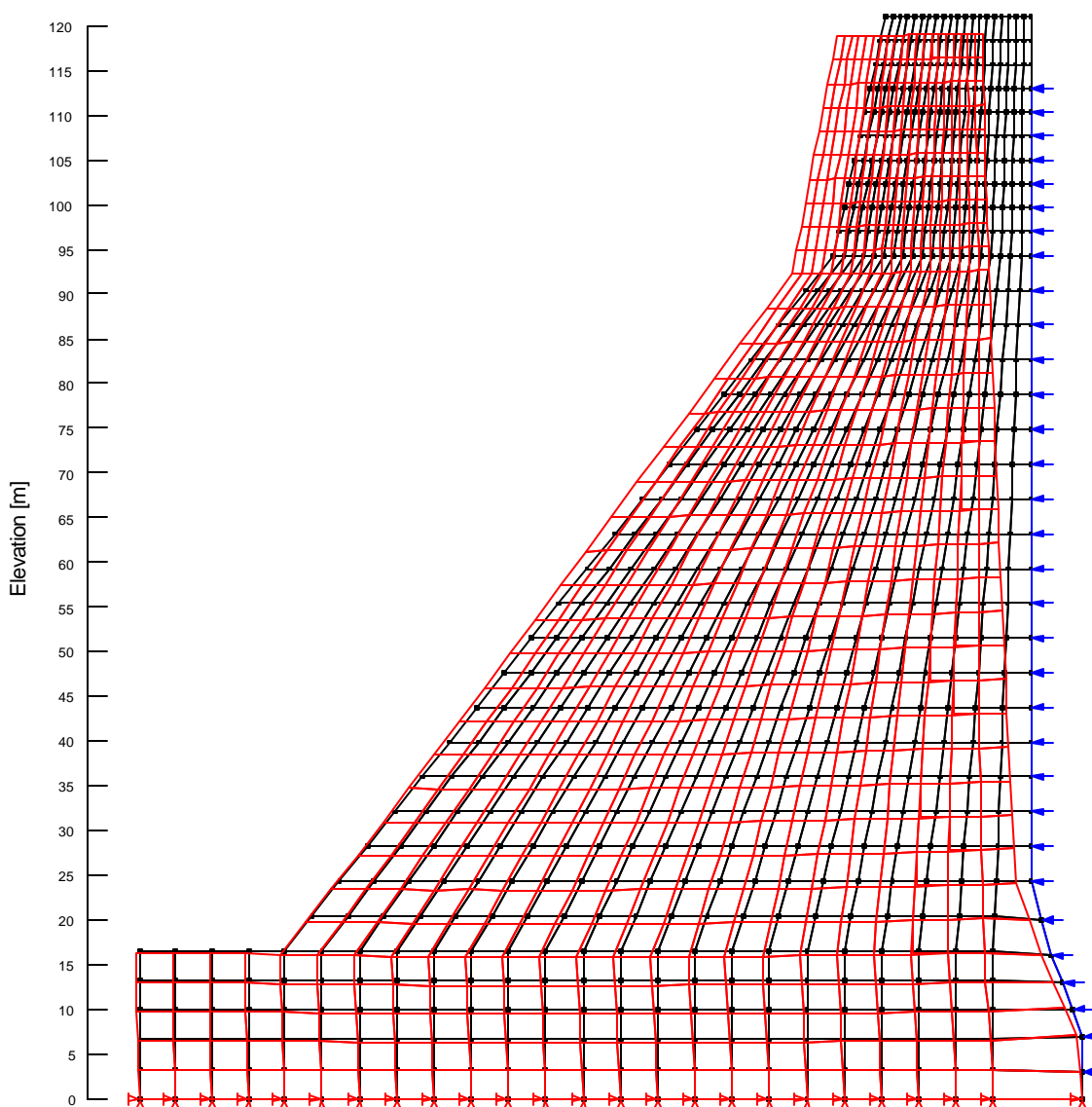
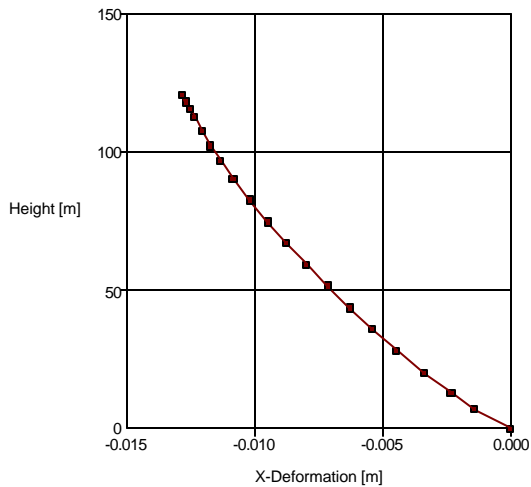

Figure C-7. FEM mesh and displacements ($E = 25 \text{ GPa}$, water level = 114 m; displacements 1000 times)

b. Instrumentation. Historical data for all instrumentation readings since 1981 have been published and are updated on an annual basis. Laser alignment surveys are conducted twice a year in the upper service gallery section of the dam. Data for plumb lines, uplift pressure cells, drains, and the left abutment are collected monthly with a review for data quality and interpretation made by personnel in District Geotechnical and Environmental Restoration Branch. A geologist reviews left abutment data on a monthly basis and a structural engineer performs a quarterly dam information review.

c. Laser alignment surveys. The existing laser alignment system was installed in 1975 for monitoring the longitudinal alignment of the dam. The lateral offsets of a number of survey points are measured from a baseline established by a laser beam reference. Surveys are scheduled during expected maximum upstream and downstream deflections of the dam indicated by plumb line data.

X-Deformation vs. Height, Hw=114m, E=15GPa



X-Deformation vs. Height, Hw =114m, E=25GPa

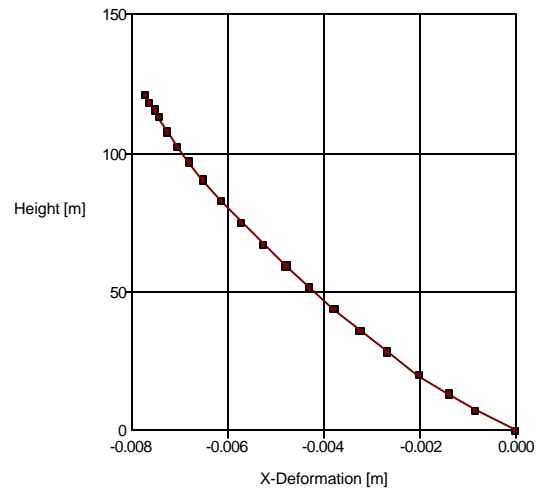
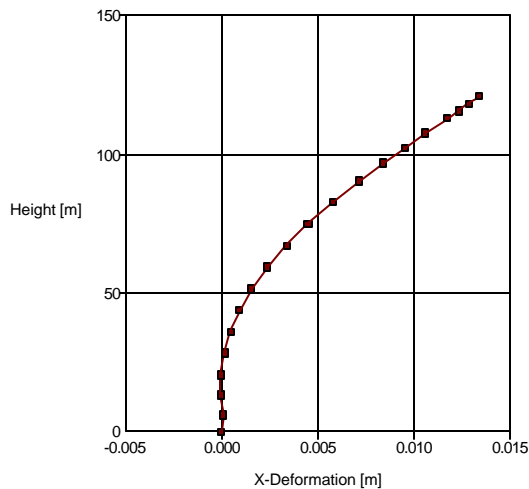

Figure C-8. Displacement due to water load at high pool

X-Deformation vs. Height, Hw=68m, E=15GPa



X-Deformation vs. Height, Hw=68m, E=25GPa

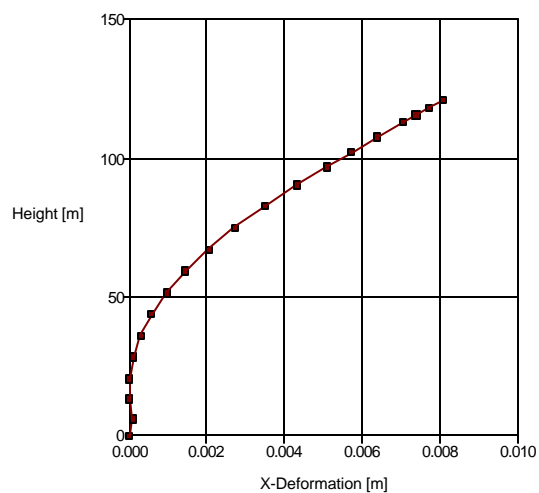

Figure C-9. Displacement due to water load at low pool

d. Inverted and conventional plumbines. Suspended plumbines are installed in monoliths 23 and 35, both are collocated with inverted plumbines set in observation rooms connected to the upper, lower, and drainage service galleries. Inverted plumbines are installed in monoliths 6 and 46, and in monoliths 23 and 35. Until 1975 both sets of plumbline data in monolith 23 showed gradual downstream deflection believed to reflect structural and foundation stabilization. Subsequent data indicates movement is primarily related to reservoir pool and concrete temperature variations. Maximum displacement ranges between 1.5 and 0.5 cm respectively for suspended and inverted plumbines. Isolated lateral movement toward the right bank of approximately 1 mm per year was observed at the base of monolith 35. Inverted plumbline stations are read automatically using optical sensing-reading systems connected to the local data communications network. Plumbline readings since 1991 indicate that both monoliths are stable within "0.25 mm (0.01") in the U/D direction and within "1 mm (0.04") along the axis of the dam.

Monoliths 23 and 35 contain both suspended and inverted plumbines. At each monolith, the suspended plumbines extend from the upper inspection gallery to the drainage and grouting gallery. The inverted plumbines extend from the drainage and grouting gallery to an anchor 10 m deep in the bedrock. Suspended and inverted readings at the drainage and grouting gallery can be combined to give the total displacement of the upper inspection gallery with respect to the bedrock. The combined readings at these two monoliths indicate very smooth cyclic deflections of the dam. Movement is well-correlated with the cyclic water load changes, with a maximum total range of deflections of about 18 mm (0.7").

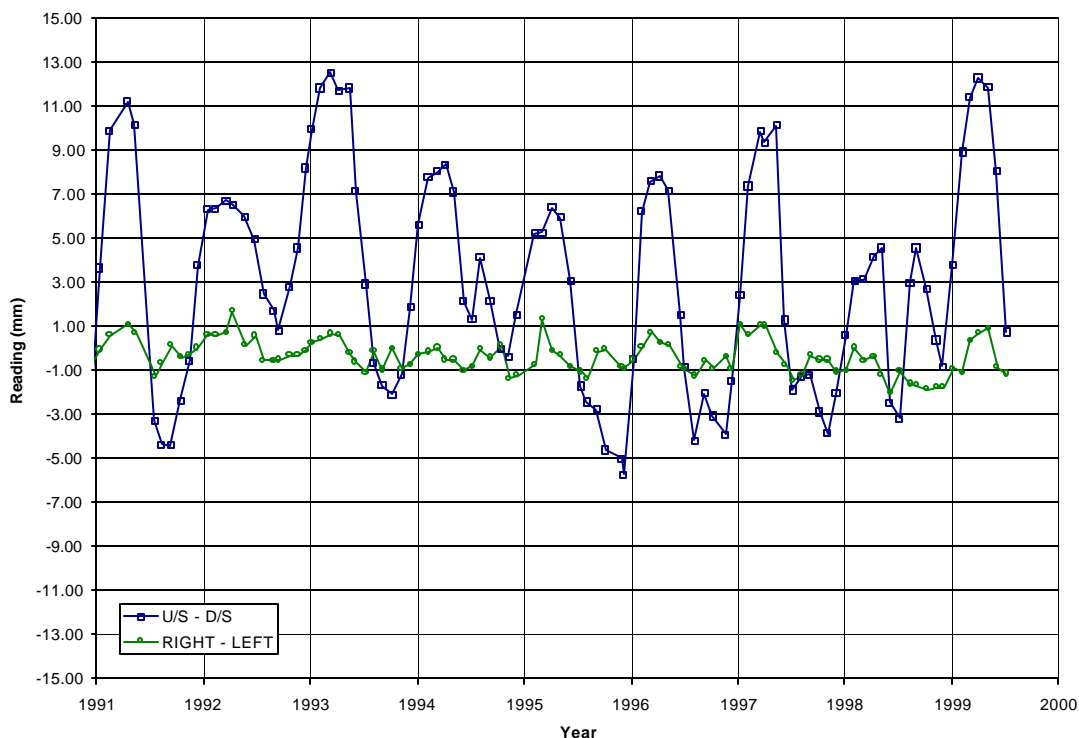

Figure C-10 Combined readouts from suspended and inverted plumbines.

This value agrees well with the predicted FEM value of about 20 mm. Due to the good performance of the plumbines, their data create an excellent control for other instrumentation, particularly alignment and tiltmeter surveys. Plumbines indicate that the maximum U/S deflections occur in March and maximum D/S deflections occur in September, agreeing well with the time of maximum and minimum water levels.

e. Jointmeters. Relative movement across monolith joints is measured by a set of joint meters embedded in concrete. Gauges are located at monolith joints 21/22, 22/23, and 32/33. Annual maximum displacements are on the order of 1-3 mm recorded during spring season. Monoliths adjacent to the left abutment were instrumented in 1992 with an additional twenty, 3D, joint meters to assist in the evaluation of possible deep-seated movement in the left abutment. As of 1995, no significant movement trends have been observed from these gauges.

f. Foundation deformation meters. Downstream of the axis of the dam (10 and 240 feet), deformation meters are installed 10, 20, and 60 feet deep in each of the foundation monoliths 18, 23, and 29. These measured foundation movement during construction and initial impoundment. Currently these meters are read monthly and show only minor movement (1-3 mm cyclic motion correlated to pool elevation).

g. Uplift pressure cells. Uplift pressure cells are installed at the foundation in monoliths 14, 18, 23, 29, 34, and 41. Pressure cells are used to monitor both drainage effectiveness and foundation uplift pressure. Gradients downstream of the grout curtain are reported well below design assumptions.

h. Resistance thermometers. Temperature data to delineate the varying thermal profile through the monoliths is collected infrequently from resistance thermometers installed in monoliths 29 and 33. The stabilized mean ultimate interior temperature of the dam is 44-46 degrees F. Changing water and ambient air temperature mainly causes concrete temperature changes.

i. Strong motion accelerographs. Instruments to record the response of the dam to seismic motion are installed in the dam (2), powerhouse (1), and downstream above the right abutment. No earthquakes have occurred of sufficient magnitude to trigger the instruments.

j. Extensometers. Numerous types of wire and rod extensometers are installed to monitor potential movement in the left abutment nearby a series of rock tendons set after a rockslide that occurred in 1971. X-type (wire) extensometers are used to monitor movement at specific rock joints.

k. Tiltmeters. Tiltmeter stations are collocated with plumb lines in monoliths 23 and 35 in the upper and lower service gallery, and in the drainage and grouting gallery. Data from portable and installed tiltmeters are collected on a monthly basis. Automated tiltmeter data from the upper service gallery is collected on a weekly basis from the same elevation as the plumb line reading station. The portable tiltmeter system operates by a vertically oriented, uniaxial, force-balanced, servo accelerometer, with a tilt resolution of 10 arc seconds, assuming measurements are made in two orientations in a horizontal plane (instrument is rotated by 180 degrees between readings).

C-7. Dam and Powerhouse Structure Alignment Surveys

Laser alignment surveying represents a major part of the data collected about the overall behavior of the structure. Surveying provides a comprehensive picture of movement trends and/or anomalies unlike most other types of instrumentation. Alignment offsets are measured at a series of monuments located next to each monolith joint. The reference line is established using a projected laser beam between two fixed points located on monoliths 6 and 46. The laser beam does not directly occupy the alignment reference line during a given measurement campaign. Instead, four separate alignment segments are established between the endpoints of the primary alignment. No information is collected to tie the endpoints of the laser survey to reference monuments in stable areas outside of the structure.

C-8. Abutments and Surroundings

a. Left Abutment. Analysis of several years of instrumentation data suggests that movement is occurring deep within the left abutment rib. Movements define a very large wedge of rock, failing at its toe by rotation and/or deflection slightly upstream and moving along a complex set of joint surfaces. Forces from the main portion of the block projecting into the dam foundation where it could create unacceptable levels of residual stress. Movement of possibly several inches may be necessary before full resistance of the buttress fill is realized. Jointmeters were installed in 1992 to verify that the observed rock movement is not affecting left abutment monoliths. Evaluation of deep seated left abutment movement is not yet complete. Upgraded monitoring of left bank instrumentation is anticipated depending on the results of the completed evaluation. One to several monitoring points could be incorporated into surveying scheme to provide data about surface deformations at the left abutment.

b. Reservoir rim slide activity. Minor erosion, sliding, and isolated areas of rock slope instability along the left bank of the reservoir have been observed. Inspections indicate that the reservoir banks

appear to be in good condition and any unstable areas pose no threat to Libby Dam. If the need arises to collect further information on localized settlements or displacements in upstream areas, some additional monitoring points could be incorporated into the survey design.

c. Regional effects. Local tectonic activity and cyclic loading of the reservoir were investigated early on by means of: a regional gravity network; a tiltmeter on the right bank 3 miles upstream; a five station seismic network for microearthquake monitoring; and a trilateration survey network in the vicinity of the dam to monitor horizontal displacements. In years of operation no significant seismicity related to impoundment was exhibited.

C-9. Summary of Instrumentation

The deformation monitoring scheme at Libby consists of two parts: structural monitoring of the dam itself and geotechnical monitoring of the unstable slope at the left abutment. The main deformation monitoring scheme at the dam consists of:

- Suspended plumbines in monoliths 23 and 35 (from the top to the Drainage/Grouting gallery),
- Inverted (floating) plumbines anchored about 10 m into bedrock and extended to the upper gallery at monoliths 6 and 46,
- Inverted (floating) plumbines anchored about 10 m into bedrock and extended to the drainage and grouting gallery where they meet with the two suspended plumbines.
- Laser Alignment System in the upper gallery between monoliths 6 and 46 of a total length of 760 m with two target stations at each monolith.
- Two in-situ installed and one portable tiltmeters in the upper gallery in monolith 35;
- Jointmeters between a number of monoliths.
- In addition, a number of pressure cells, thermistors, piezometers, strong motion accelerographs, and deformation meters with automatic data recording installed in the foundation monoliths are observed. No geodetic observations except the laser alignment system are conducted at Libby Dam. Several borehole extensometers (wire and rod Multi-Point Borehole Extensometer type) are installed and monitored at the slope of the left abutment.

C-10. Upgrades to Gallery Traversing System

a. General. The recent development of precision total stations (e.g., Leica TCA1800 and TCA2003) with self-pointing to corner cube reflectors permits efficient, semi-automatic measurements to a number of targets in a robotic mode. Monitoring deflections of the monoliths using geodetic measurement techniques consists of running a traverse along the center of the inspection gallery. Targets mounted on the monolith walls would be observed from the traverse stations. For maximum reliability and efficiency, the targets should be permanently mounted corner cube reflectors. It would then be possible to use ATR to perform the measurements. With appropriate data collection software, all the observer would have to do at each instrument setup is point the instrument approximately at each target in one round of observations. The total station would then be guided by the data collector to do the rest of the observations on its own.

b. Traversing system configurations. Because the measurements are made from tripod setups, each different survey configurations uses temporary theodolite stations, with control being defined by selected wall targets. Observations are made between adjacent theodolite stations, meaning that the surveys will require up to three tripods and the use of forced centering techniques. Two different possibilities have been considered for providing survey control.

- *Endpoint Station Control.* The first and last monoliths in the survey are considered to be stable. These two monoliths each have three permanently mounted prisms with fixed positions as the only control points in the survey, (a datum bias is introduced if one of the end monoliths is unstable).
- *Plumbline Station Control.* The second method uses plumbline data control, which improves reliability and accuracy. Each monolith with a plumbline will have an additional, permanently mounted, reflector prism serving as control. Movements indicated by the differences in plumbline readings will be introduced as movements of these control points in the adjustment of the survey data.

Three different preanalysis trials were made for the traversing system. The first scheme is shown in Figure C-11, which uses the endpoint monoliths as survey control. Theodolite station spacing is 100 meters, or every 6th monolith, with a theodolite setup in each of the two end monoliths. The second scenario is shown in Figure C-12. It is similar to the first, but 200 m spacing between theodolites is used. The third observation scheme is shown in Figure C-13. It uses 200 m station spacing, but plumbline data is used to control the survey. All scenarios use a standard deviation of 1.0" for direction measurements, 2.0" for zenith angle measurements, and 1.0 mm for distance measurements; these specifications are based on, for example, a Leica TCA1800 total station.

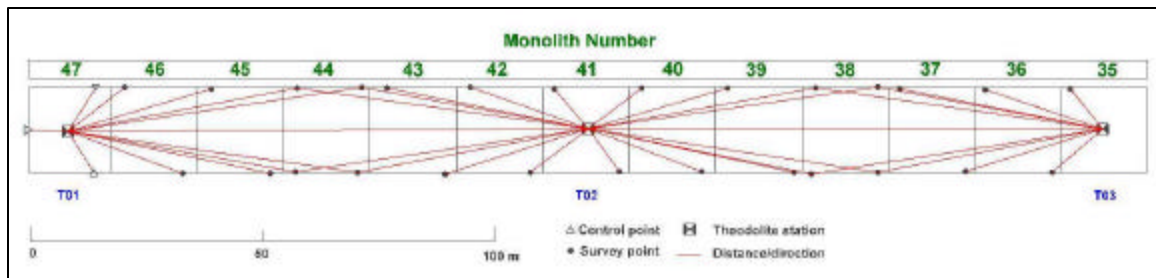

Figure C-11. 3D traverse survey with 100 m station spacing.

Figure C-11 shows a 3D traverse survey with sighting between adjacent theodolite stations. Maximum sight length to target is 60 m requiring 8 instrument setups, and 144 direction, distance, and zenith angle measurements. The largest U/D stream standard deviation is 1.2 mm or 3.3 mm at 95 percent confidence. This configuration gives good results in all three dimensions. The maximum dimension of any error ellipse for a single epoch is 3.0 mm at the 95% confidence level.

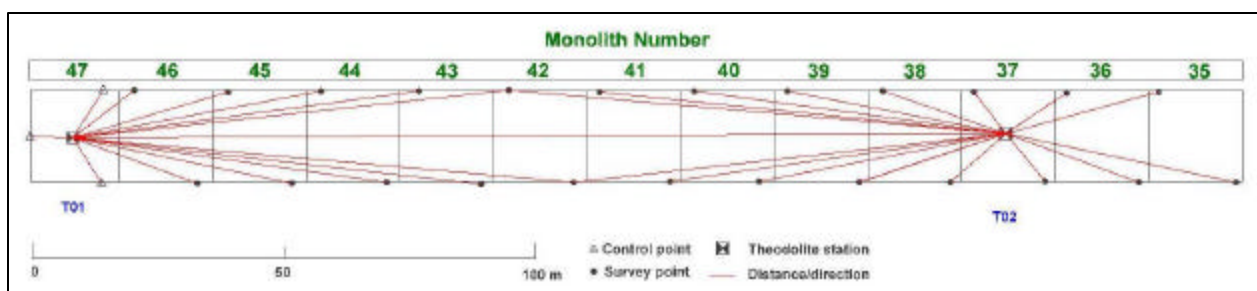

Figure C-12. 3D geodetic survey with 200 m station spacing.

Figure C-12 shows a 3D traverse survey with sighting between adjacent theodolite stations. Maximum sight length to target is 100 m requiring 5 instrument setups, and 99 direction, distance, and zenith angle measurements. The largest U/D stream standard deviation is 1.4 mm or 3.8 mm at 95 percent confidence. This configuration requires considerably less work than the survey with 60 m station spacing, with slightly lower precision.

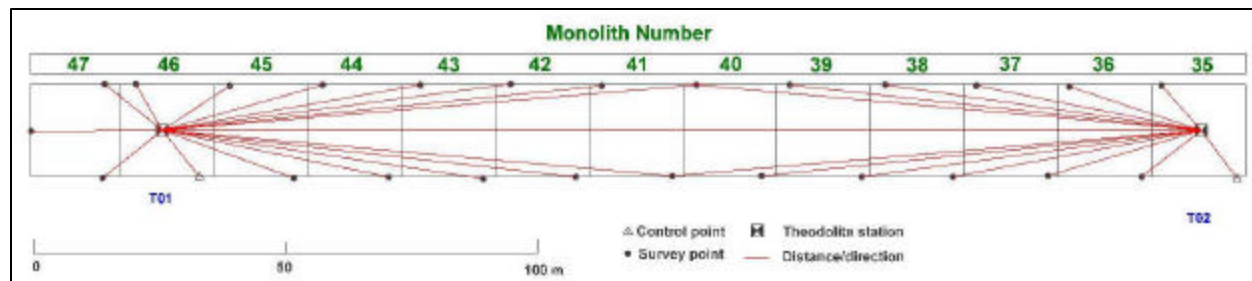

Figure C-13. 3D geodetic survey with 200 m station spacing and plumbline control.

Figure C-13 shows a 3D traverse survey with sighting between adjacent theodolite stations. Maximum sight length to target is 100 m (with plumbline control) requiring 6 instrument setups, and 108 direction, distance, and zenith angle measurements. The largest U/D stream standard deviation is 0.7 mm or 1.8 mm at 95 percent confidence. This configuration gives much better results than the other schemes because of the plumbline control distributed at points along the traverse. The survey using 200 m station spacing and plumbline control is the preferred alternative. It provides excellent precision, with a manageable number of observations. The observation effort could be further reduced by using only one target per monolith. It would then be very easy to complete the survey in a few hours by one observer.

C-11. Upgrades to Other Instrumentation

a. Plumblines. Suspended and inverted plumblines are among the most reliable types of instrumentation that can be used for the measurement structural displacement and tilt. Data from the suspended and inverted plumblines should be combined to yield displacements of the top of the suspended plumbline with respect to the anchor of the inverted plumbline. It would also be possible to monitor the movement of the suspension point by performing GPS measurements on the deck immediately above the plumbline.

b. Tilt measurements. Tiltmeters should be carefully calibrated for thermal and temporal drift. Changes in structural tilt indicated by the plumbline readings are of the order of 30 arc-seconds (variation of approximately 18 mm at monolith 23, with a distance from the anchor point of 120 m assumed).

c. Geodetic leveling. The level of observed changes in tilt given by the plumblines could easily be detected by using geodetic leveling. A good-quality geodetic level and careful observation procedures should be capable of determining height differences with a standard deviation of 0.1 mm. If the survey benchmarks are located a distance of 4 m apart, this gives an angular precision of 5 arc-seconds for a single survey. Tilt differences would be determined with an accuracy of:

$$(5)(1.96)(\sqrt{2}) = 14 \text{ arc-seconds.}$$

Tilt differences could be evaluated in both the upstream/downstream and left/right directions, as indicated in Figure C-14. This gives leveling a decided advantage over tiltmeter measurements, which have a stated standard deviation of 10 arc-seconds and need frequent calibration.

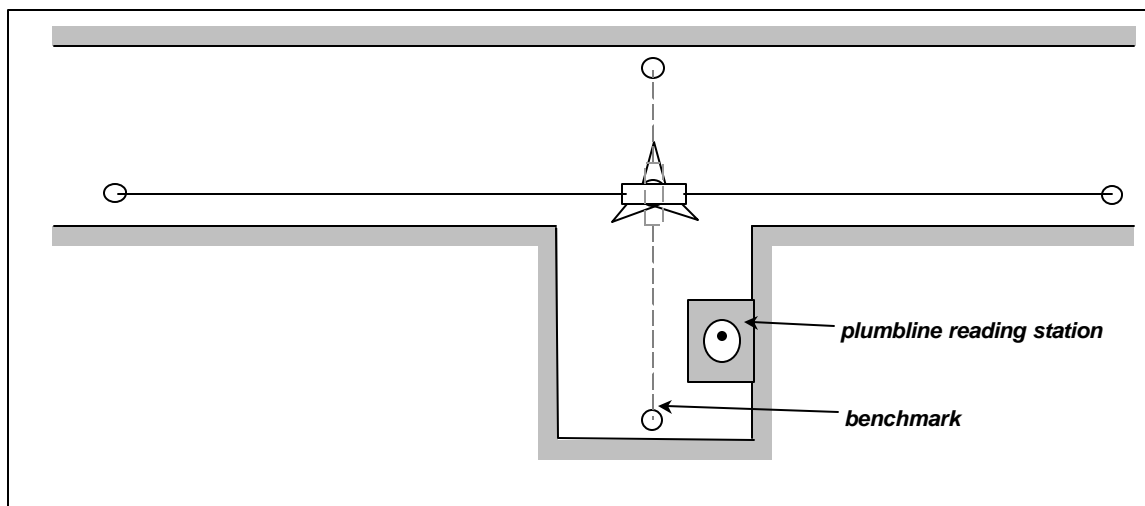

Figure C-14. Tilt measurement with a geodetic level.

d. Vertical movement within galleries. Monitoring schemes are primarily concerned with upstream/downstream structural movements. However, seasonal variations in water level and temperature can result in vertical structural movements as well, possibly with a greater magnitude than the upstream/downstream deflections. Instrumentation can provide verification of the expected vertical movements and/or structural expansion. Determination of vertical structural movements, and an evaluation of possible structural expansion, can be accomplished if an observation scheme is implemented as shown in Figure C-15. Within each gallery, a survey benchmark can be installed on each monolith to be monitored. Measurements in an individual gallery will yield the relative vertical displacements between monoliths at the gallery height.

e. Vertical movement between galleries. To determine the relative height changes between the different galleries (caused by expansion of the structure), a suspended invar wire with attached scales is used. At each gallery, the scale is observed along with the benchmarks. A change in height difference between the scale and a nearby benchmark (located in the same monolith) represents the change in height between the benchmark and the wire suspension point. This is valid only if the wire has a much lower coefficient of thermal expansion than does the structure, and this is why invar wire should be used.

f. Vertical movement between the dam and bedrock. The inter-gallery changes in height differences are all made with respect to the structure itself. To determine whether or not there is a rigid-body movement of the structure with respect to the underlying bedrock, an Multi-point Borehole Extensometer (MPBX) is installed near the lowest reading station. This MPBX must have anchors deep in the bedrock. If the height differences from the wire scale to the MPBX reference plate are combined with the MPBX readings, the change in height difference can then be derived for any of the wire scales with respect to the bedrock and thus for any of the gallery benchmarks with respect to the bedrock.

C-12. Upgrades to Geodetic Surveying Systems

Conventional geodetic surveying and GPS surveying systems are proposed for positioning points on the upper deck of the dam crest (Figure C-16). Representative preanalysis trials and measurement schemes developed for these surveys are illustrated in the Figures C-17 and C-18.

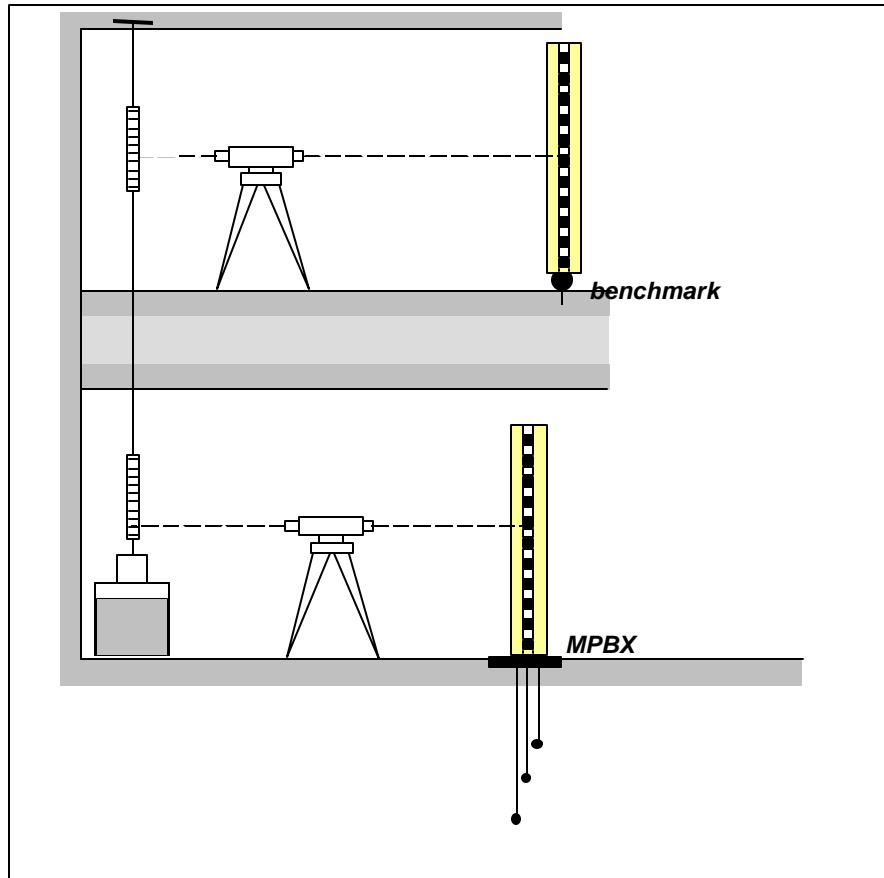

Figure C-15. Measurement of vertical structural expansion with invar wire.

C-13. Schematic Design of Monitoring

a. *Reference network.* Area monitoring network consists of 4 GPS stations with:

- 2 GPS stations in a stable area within one kilometer from the dam (downstream areas may generally be more stable);
- Optionally, 1-2 GPS stations at the unstable slope to provide control for the results coming from the borehole extensometers.

b. *Structure control network.* Structural monitoring network consists of:

- 2 GPS stations at the upper deck on monoliths 6 and 35, supplemented (if needed) by two survey stations (pillar type with the self-centering plates) at monoliths 23 and 46 to connect the network with the plumbblines in those monoliths;

c. *Localized networks.* Local Structural monitoring consists of:

- GPS or conventional geodetic surveys across the crest of the structure, or geodetic traversing in the upper service gallery, between plumb-lines at monoliths 6, 23, 35, and 46;
- Leveling between monoliths 6 to 46 with one benchmark in each of the intermediate monoliths.
- Existing (four) inverted and (two) suspended plumb-lines;
- Existing jointmeters;
- One vertical invar wire extensometer with leveling scales at the upper gallery, lower gallery and in the drainage gallery;
- One vertical borehole rod extensometer (MPBX type) in the drainage gallery, with three rods of 5m, 10m, and 15 m in the bedrock (if possible);
- Existing borehole extensometers at the face of the unstable slope;

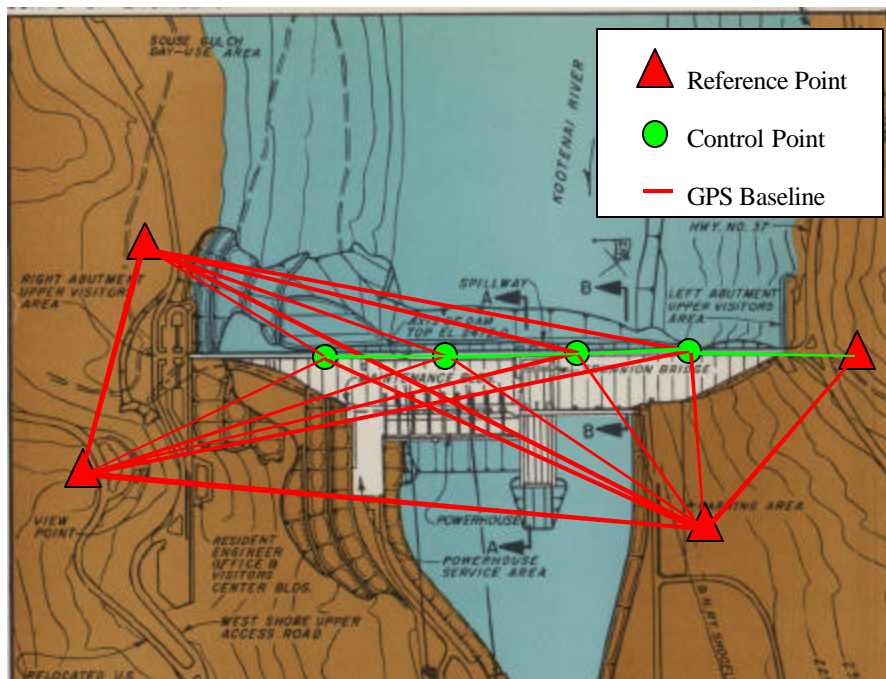

Figure C-16. Schematic Plan of monitoring survey

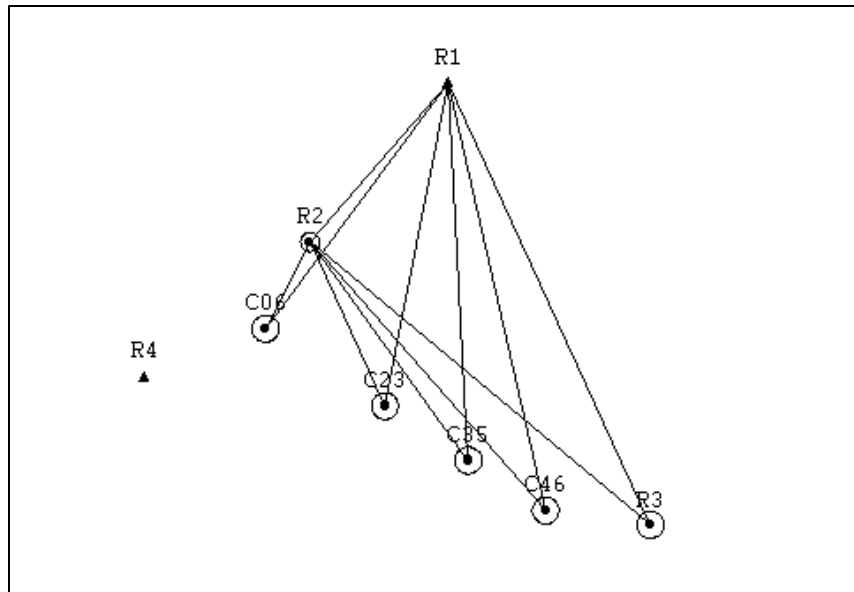

Figure C-17. GPS Reference Network Preanalysis

Largest Position Error: 2.0 mm
 Number of Stations: Total 5 (1-fixed and 4-unknown)
 Number of Setups: 5 Occupations (Stations R1,R2,R3,C06,C46)
 Number of Observations: 33 measurements
 Repeated Observations: 2 (baselines)
 Instrument: Geodetic Quality GPS receiver

2-D and 1-D Station Confidence Regions (99.000 percent):

STATION	MAJOR SEMI-AXIS (m)	VERTICAL (m)
C06	0.0020	0.0017
C23	0.0020	0.0017
C35	0.0020	0.0017
C46	0.0020	0.0017
R2	0.0014	0.0012
R3	0.0020	0.0017

Comments: Reference network surveys using only GPS systems. Survey scheme meets accuracy requirements using additional ties to points located on the structure.

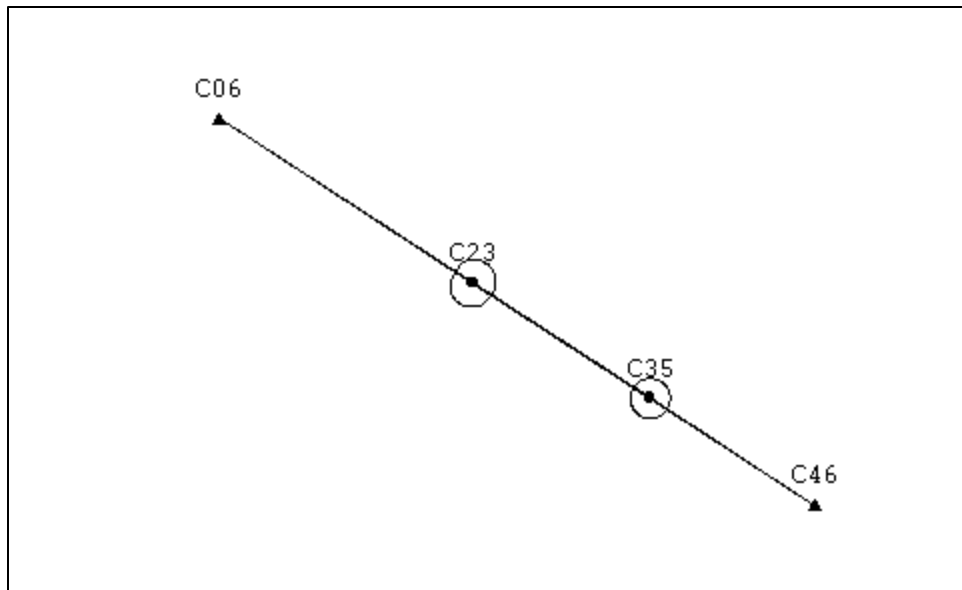

Figure C-18. Structure Control Network

Description: Structure Network
 Largest 2D Position Error: 3.1 mm
 Number of Stations: Total 4 (2-fixed and 2-unknown)
 Number of Setups: 4 Occupations (C06,C23,C35,C46)
 Number of Observations: 20 measurements
 Repeated Observations: 2 (repeated sets)
 Instrument: Total Station

2-D and 1-D Station Confidence Regions (99.000 percent):

STATION	MAJOR SEMI-AXIS (m)	VERTICAL (m)
C23	0.0031	0.0155
C35	0.0026	0.0113

Comments: 2-point structure control network on dam using only conventional surveys. Survey scheme ties the plumbline stations with observations from traversing only between endpoints. The survey meets accuracy requirements. Forced centering is used to reduce centering error in angle measurement.

Glossary

1. Abbreviations and Acronyms

1D	One-Dimensional
2D	Two-Dimensional
2DRMS	Twice the distance root mean square
3D	Three-Dimensional
A-E	Architect-Engineer
ATR	Automatic Target Recognition
BM.....	Benchmark
CCD.....	Charged Couple Device
CDMS	Continuous Deformation Monitoring System
CONUS.....	CONtinental United States
CORPSCON	CORPS CONvert
COTS	Commercial Off the Shelf
CW.....	Civil Works
DD	Double Differencing
deg.....	Degree
DoD	Department of Defense
DOP	Dilution of Precision
DGPS.....	Differential GPS
DSP.....	Digital SignalProcessing
EDM	Electronic Distance Measurement
EM.....	Engineer Manual
EP	Engineer Pamphlet
ER.....	Engineer Regulation
FEM.....	Finite Element Method
FGCS.....	Federal Geodetic Control Subcommittee
FIG.....	International Federation of Surveyors
FOA	Field Operating Activity
ft	feet
GDOP	Geometric Dilution of Precision
GIS.....	Geographic Information System
GPS.....	Global Positioning System
GRS80.....	Geodetic Reference System of 1980
HARN.....	High Accuracy Regional Networks
HDOP	Horizontal Dilution of Precision
Hg.....	Mercury
HI.....	Height of Instrument
HQUSACE.....	Headquarters, US Army Corps of Engineers
IR.....	Infrared
IWST.....	Iterative Weighted Similarity Transformation
LEP	Lateral Effect Photodiode
LOS.....	Line of Sight
mm.....	Millimeter
MSC.....	Major Subordinate Command
NAD83.....	North American Datum of 1983
NANU	Notice Advisory to NAVSTAR Users
NAVD88	North American Vertical Datum 1988
NGRS.....	National Geodetic Reference System

NGS	National Geodetic Survey
NGVD29	National Geodetic Vertical Datum 1929
NOAA	National Oceanic and Atmospheric Administration
NOS	National Ocean Service
O/D	Outside Diameter
OMB	Office of Management and Budget
PICES	Periodic Inspection and Continuing Evaluation of (Completed CW) Structures
PLL	Phase Lock Loop
PRN	Pseudo Random Noise
QC	Quality Control
RINEX	Receiver Independent Exchange
RMS	Root Mean Square
SD	Single Differencing
SI	International System of Units
SPCS	State Plane Coordinate System
SV	Space vehicle
TBM	Temporary Benchmark
TD	Triple Differencing
UHF	Ultra High Frequency
UNB	University of New Brunswick
USC&GS	US Coast & Geodetic Survey
USACE	US Army Corps of Engineers
USATEC	US Army Topographic Engineering Center
URL	Universal Resource Locator
UTC	Universal Time Coordinated
UTM	Universal Transverse Mercator
USNO	US Naval Observatory
VCO	Voltage Controlled Oscillator
VDOP	Vertical Dilution of Precision
WGS84	World Geodetic System of 1984

2. Terms

Absolute GPS

Operation with a single receiver for a desired position. This receiver may be positioned to be stationary over a point. This mode of positioning is the most common military and civil application.

Accuracy

The degree to which an estimated (mean) value is compatible with an expected value. Accuracy implies the estimated value is unbiased.

Adjustment

Adjustment is the process of estimation and minimization of deviations between measurements and a mathematical model.

Altimeter

An instrument that measures elevation differences usually based on atmospheric pressure measurements.

Altitude

The vertical angle between the horizontal plane of the observer and a directional line to the object.

Angle of Depression
A negative altitude.

Angle of Elevation
A positive altitude.

Angular Misclosure
Difference in the actual and theoretical sum of a series of angles.

Archiving
Storing of documents and information.

Azimuth
The horizontal direction of a line clockwise from a reference plane, usually the meridian. Often called forward azimuth to differentiate from back azimuth.

Backsight
A sight on a previously established traverse or triangulation station and not the closing sight on the traverse. A reading on a rod held on a point whose elevation has been previously determined.

Baseline
Resultant three-dimensional vector between any two stations with respect to a given coordinate system. The primary reference line in a construction system.

Base net
The primary baseline used for densification of survey stations to form a network.

Base Points
The beginning points for a traverse that will be used in triangulation or trilateration.

Base Control
The horizontal and vertical control points and coordinates used to establish a base network. Base control is determined by field surveys and permanently marked or monumented for further surveys.

Benchmark
A permanent material object, natural or artificial, on a marked point of known elevation.

Best Fit
To represent a given set of points by a smooth function, curve, or surface which minimizes the deviations of the fit.

Blunder
A mistake or gross error.

Calibration
Determining the systematic errors in an instrument by comparing measurements with correct values. The correct value is established either by definition or by measurement with a device which has itself been calibrated or of much higher precision.

Chi-square Testing
Non-parametric statistical test used to classify the shape of the distribution of the data.

Circle Position

A prescribed setting (reading) of the horizontal circle of a direction theodolite, to be used for the observation on the initial station of a series of stations that are to be observed.

Circuit Closure

Difference between measured or adjusted value and the true or published value.

Collimation

A physical alignment of a survey target or antenna over a mark or to a reference line.

Collimation Error

The angle between the actual line of sight through an optical instrument and an alignment.

Confidence Level

Statistical probability (in percent) based on the standard deviation or standard error associated with the normal probability density function. The confidence level is assigned according to an expansion factor multiplied by the magnitude of one standard error. The expansion factor is based on values found in probability tables at a chosen level of significance.

Control

Data used in geodesy and cartography to determine the positions and elevations of points on the earth's surface or on a cartographic representation of that surface. A collective term for a system of marks or objects on the earth or on a map or a photograph whose positions or elevation are determined.

Control Densification

Addition of control throughout a region or network.

Control Monuments

Existing local control or benchmarks that may consist of any Federal, state, local or private agency points.

Control Point

A point with assigned coordinates is sometimes used as a synonym for control station. However, a control point need not be realized by a marker on the ground.

Control Survey

A survey which provides coordinates (horizontal or vertical) of points to which supplementary surveys are adjusted.

Control Traverse

A survey traverse made to establish control.

Coordinate Transformation

A mathematical process for obtaining a modified set of coordinates through some combination of rotation of coordinate axes at their point of origin, change of scale along coordinate axes, or translation through space.

Datum

Any numerical or geometrical quantity or set of such quantities which serve as a reference or base for other quantities.

Differential GPS

Process of measuring the differences in coordinates between two receiver points, each of which is simultaneously observing/measuring satellite code ranges and/or carrier phases from the NAVSTAR GPS constellation. Relative positioning with GPS can be performed by a static or kinematic modes.

Differential Leveling

The process of measuring the difference of elevation between any two points by spirit leveling.

Direction

The angle between a line or plane and an arbitrarily chosen reference line or plane. At a triangulation station, observed horizontal angles are referred to a common reference line and termed horizontal direction. A line, real or imaginary, pointing away from some specified point or locality toward another point. Direction has two meanings: that of a numerical value and that of a pointing line.

Direct Leveling

The determination of differences of elevation through a continuous series of short horizontal lines. Vertical distances from these lines to adjacent ground marks are determined by direct observations on graduated rods with a leveling instrument equipped with a spirit level.

Dumpy Level

The telescope permanently attached to the leveling base, either rigidly to by a hinge that can be manipulated by a micrometer screw.

Earth-Centered Ellipsoid

Center at the Earth's center of mass and minor semi-axis coincident with the Earth's axis of rotation.

Easting

The distance eastward (positive) or westward (negative) of a point from a particular meridian taken as reference.

Eccentricity

The ratio of the distance from the center of an ellipse to its focus on the major semi-axis.

Electronic Distance Measurement (EDM)

Timing or phase comparison of electro-magnetic signal to determine an interferometric distance.

Elevation

The height of an object above some reference datum.

Ellipsoid

Formed by revolving an ellipse about its minor semi-axis. The most commonly used reference ellipsoids in North America are: Clarke 1866, Geodetic Reference System of 1980 (GRS 80), World Geodetic System of 1972 (WGS 72) and World Geodetic System of 1984 (WGS 84).

Ellipsoid height

The magnitude h of a point above or below the reference ellipsoid measured along the normal to the ellipsoid surface.

Error

The difference between the measured value of a quantity and the theoretical or defined value of that quantity.

Error Ellipse

An elliptically shaped region with dimensions corresponding to a certain probability at a given confidence level.

Error of Closure

Difference in the measured and predicted value of the circuit along the perimeter of a geometric figure.

Finite Element Method

Obtaining an approximate solution to a problem for which the governing differential equations and boundary conditions are known. The method divides the region of interest into numerous, interconnected subregions (finite elements) over which simple, approximating functions are used to represent the unknown quantities.

Fixed Elevation

Adopted as a result of tide observations or previous adjustment of spirit leveling, and which is held at its accepted value in any subsequent adjustment.

Foresight

An observation to the next instrument station. The reading on a rod that is held at a point whose elevation is to be determined.

Frequency

The number of complete cycles per second existing in any form of wave motion.

Geodesy

Determination of the time-varying size and figure of the earth by such direct measurements as triangulation, leveling and gravimetric observations.

Geodetic Control

Established and adjusted horizontal and/or vertical control in which the shape and size of the earth have been considered in position computations.

Geodetic Coordinates

Angular latitudinal and longitudinal coordinates defined with respect to a reference ellipsoid.

Geodetic Height

See Ellipsoid height.

Geodetic Leveling

The observation of the differences in elevation by means of a continuous series of short horizontal lines of sight.

Geodetic Reference System of 1980

Reference ellipsoid used to establish the NAD83 system of geodetic coordinates.

GPS (Global Positioning System)

DoD satellite constellation providing range, time, and position information through a GPS receiver system.

Histogram

A graphical representation of relative frequency of an outcome partitioned by class interval. The frequency of occurrence is indicated by the height of a rectangle whose base is proportional to the class interval.

Horizontal Control

Determines horizontal positions with respect to parallels and meridians or to other lines of reference.

Index Error

A systematic error caused by deviation of an index mark or zero mark on an instrument having a scale or vernier, so that the instrument gives a non-zero reading when it should give a reading of zero. The distance error from the foot of a leveling rod to the nominal origin (theoretical zero) of the scale.

Indirect Leveling

The determination of differences of elevation from vertical angles and horizontal distances.

Interior Angle

An angle between adjacent sides of a closed figure and lying on the inside of the figure. The three angles within a triangle are interior angles.

International Foot

Defined by the ratio 30.48/100 meters.

International System of Units (SI)

A self-consistent system of units adopted by the general Conference on Weights and Measures in 1960 as a modification of the then-existing metric system.

Intersection

Determining the horizontal position of a point by observations from two or more points of known position. Thus measuring directions or distances that intersect at the station being located. A station whose horizontal position is located by intersection is known as an intersection station.

Intervisibility

When two stations are visible to each other in a survey net.

Invar

An alloy of iron containing nickel, and small amounts of chromium to increase hardness, manganese to facilitate drawing, and carbon to raise the elastic limit, and having a very low coefficient of thermal expansion (about 1/25 that of steel).

Least Count

The finest reading that can be made directly (without estimation) from a vernier or micrometer.

Least Squares Adjustment

The adjustment of the values of either the measured angles or the measured distances in a traverse using the condition that the sum of the squares of the residuals is a minimum.

Level

Any device sensitive to the direction of gravity and used to indicate directions perpendicular to that of gravity at a point.

Level Datum

A level surface to which elevations are referred. The generally adopted level datum for leveling in the U.S. is mean sea level. For local surveys, an arbitrary level datum is often adopted and defined in terms of an assumed elevation for some physical mark.

Level Net

Lines of spirit leveling connected together to form a system of loops or circuits extending over an area.

Line of Sight

The line extending from an instrument along which distant objects are seen, when viewed with a telescope or other sighting device.

Local Coordinate System

Where the coordinate system origin is assigned arbitrary values and is within the region being surveyed and used principally for points within that region.

Local Datum

Defines a coordinate system which is used only over a region of very limited extent.

Mean Angle

Average value of the angles.

Metric Unit

Belonging to or derived from the SI system of units.

Micrometer

In general, any instrument for measuring small distances very accurately. In astronomy and geodesy, a device, for attachment to a telescope or microscope, consisting of a mark moved across the field of view by a screw connected to a graduated drum and vernier. If the mark is a hairlike filament, the micrometer is called a filar micrometer.

Misclosure

The difference between a computed and measured value.

Monument

A physical object used as an indication of the position on the ground of a survey station.

NADCON

The National Geodetic Survey developed the conversion program NADCON (North American Datum Conversion) to convert to and from North American Datum of 1983. The technique used is based on a bi-harmonic equation classically used to model plate deflections. NADCON works exclusively in geographical coordinates (latitude/longitude).

National Geodetic Vertical Datum 1929

Formerly adopted as the standard geodetic datum for heights, based on an adjustment holding 26 primary tide stations in North America fixed.

Network

Interconnected system of surveyed points.

Non-SI units

Units of measurement not associated with International System of Units (SI).

North American Datum of 1927

Formerly adopted as the standard geodetic datum for horizontal positioning. Based on the Clarke ellipsoid of 1866, the geodetic positions of this system are derived from a readjustment of survey observations throughout North America.

North American Datum of 1983

Adopted as the standard geodetic datum for horizontal positioning. Based on the Geodetic Reference System of 1980, the geodetic positions of this system are derived from a readjustment of survey observations throughout North America.

North American Vertical Datum of 1988

Adopted as the standard geodetic datum for heights.

Northing

A linear distance, in the coordinate system of a map grid, northwards from the east-west line through the origin (or false origin).

Open Traverse

Begins from a station of known or adopted position, but does not end upon such a station.

Optical Micrometer

Consists of a prism or lens placed in the path of light entering a telescope and rotatable, by means of a graduated linkage, about a horizontal axis perpendicular to the optical axis of the telescope axis. Also called an optical-mechanical compensator. The device is usually placed in front of the objective of a telescope, but may be placed immediately after it. The parallel-plate optical micrometer is the form usually found in leveling instruments.

Optical Plummet

A small telescope having a 90° bend in its optical axis and attached to an instrument in such a way that the line of sight proceeds horizontally from the eyepiece to a point on the vertical axis of the instrument and from that point vertically downwards. In use, the observer, looking into the plummet, brings a point on the instrument vertically above a specified point (usually a geodetic or other mark) below it.

Order of Accuracy

Defines the general accuracy of the measurements made in a survey. The order of accuracy of surveys are divided into four classes labeled: first order, second order, third order and fourth or lower order.

Origin

That point in a coordinate system which has defined initial coordinates and not coordinates determined by measurement. This point is usually given the coordinates (0,0) in a coordinate system in the plane and (0,0,0) in a coordinate system in space.

Orthometric Height

The elevation H of a point above or below the geoid.

Parallax

The apparent displacement of the position of a body, with respect to a reference point or system, caused by a shift in the point of observation.

Philadelphia Leveling Rod

Having a target but with graduations so styled that the rod may also be used as a self-reading leveling rod. Also called a Philadelphia rod. If a length greater than 7 feet is needed, the target is clamped at 7 feet and raised by extending the rod. When the target is used, the rod is read by vernier to 0.001 foot. When the rod is used as a self-reading leveling rod, the rod is read to 0.005 foot.

Photogrammetry

Deducing the physical dimensions of objects from measurements on photographs of the objects.

Plumb Line

The direction normal to the geopotential field. The continuous curve to which the gradient of gravity is everywhere tangential.

Positional Error

The amount by which the actual location of a cartographic feature fails to agree with the feature's true position.

Precision

The amount by which a measurement deviates from its mean.

Project Control

Control used for a specific project.

Project Datum

Datum used for a specific project.

Quadrangle

Consisting of four specified points and the lines or line segments on which they lie. The quadrangle and the quadrilateral differ in that the quadrangle is defined by four specified angle points, the quadrilateral by four specified lines or line-segments.

Random Error

Randomly distributed deviations from the mean value.

Readings

The observed value obtained by noting and/or recording scales.

Real-time

An event or measurement reported or recorded at the same time as the event is occurring through the absence of delay in getting, sending and receiving data.

Reciprocal Leveling

Measuring vertical angles or making rod readings from two instrument positions for the purpose of compensating for the effects of refraction.

Rectangular Coordinate Systems

Coordinates on any system in which the axes of reference intersect at right angles.

Redundant Measurements

Taking more measurements than are minimally required for a unique solution.

Reference Point

Used as an origin from which measurements are taken or to which measurements are referred.

Rejection Criterion

Probabilistic confidence limit used to compare with measurements to determine if the measurements are behaving according to a hypothesized prediction.

Refraction

The bending of rays by the substance through which the rays pass. The amount and direction of bending are determined by its refractive index.

Relative Accuracy

Indicated by the dimensions of the relative confidence ellipse between two points. A quantity expressing the effect of random errors on the location of one point or feature with respect to another.

Repeating Theodolite

Designed so that the sum of successive measurements of an angle can be read directly on the graduated horizontal circle.

Resection

Determining the location of a point by extending lines of known direction to two other known points.

Sexagesimal System

Notation by increments of 60. As the division of the circle into 360° , each degree into 60 minutes, and each minute into 60 seconds.

Set-up

In general, the situation in which a surveying instrument is in position at a point from which observations are made.

Spheroid

Used as a synonym for ellipsoid.

Spirit Level

A closed glass tube (vial) of circular cross-section. Its center line forms a circular arc with precise form and filled with ether or liquid of low viscosity, with enough free space left for a bubble of air or gas.

Stadia Constant

The sum of the focal length of a telescope and the distance from the vertical axis of the instrument on which the telescope is mounted to the center of the objective lens-system.

Standard Error

The standard deviation of the errors associated with physical measurements of an unknown quantity, or statistical estimates of an unknown quantity or of a random variable.

Systematic Error

Errors that affect the position (bias) of the mean. Systematic errors are due to unmodeled affects on the measurements that have a constant or systematic value.

EM 1110-2-1009
1 Jun 02

State Plane Coordinate System (SPCS)

A planar reference coordinate system used in the United States.

Strength of Figure

A number relating the precision in positioning with the geometry with which measurements are made.

Subtense Bar

A bar with two marks at a fixed, known distance apart used for determining the horizontal distance from an observer by means of the measuring the angle subtended at the observer between the marks.

Taping

Measuring a distance on the using a surveyor's tape.

Three-wire Leveling

The scale on the leveling rod is read at each of the three lines and the average is used for the final result.

Transformation

Converting a position from one coordinate system to another.

Traverse

A sequence of points along which surveying measurements are made.

Triangulation

Determination of positions in a network by the measurement of angles between stations.

tribrach

The three-armed base, of a surveying instrument, in which the foot screws used in leveling the instrument are placed at the ends of the arms. Also called a leveling base or leveling head.

Trigonometric heighting

The trigonometric determination of differences of elevation from observed vertical angles and measured distances.

Trilateration

Determination of positions in a network by the measurement of distances between stations using the intersection of two or more distances to a point.

U.S. Survey Foot

The unit of length defined by 1200/3937 m

Variance-Covariance Matrix

A matrix whose elements along the main diagonal are called the variances of the corresponding variables; the elements off the main diagonal are called the covariances.

Vernier

An auxiliary scale used in reading a primary scale. The total length of a given number of divisions on a vernier is equal to the total length of one more or one less than the same number of divisions on the primary scaled.

Vertical Angle

An angle in a vertical plane either in elevation or depression from the horizontal.

Vertical Circle

A graduated scale mounted on an instrument used to measure vertical angles.

Vertical Datum

Any level surface used as a reference for elevations. Although a level surface is not a plane, the vertical datum is frequently referred to as the datum plane.

World Geodetic System of 1984

Adopted as the standard geodetic datum for GPS positioning. Based on the World Geodetic System reference ellipsoid.

Zenith Angle

Measured in a positive direction downwards from the observer's zenith to the observed target.

Zenith Distance

The complement of the altitude, the angular distance from the zenith of the celestial body measured along a vertical circle.