

TECHNICAL MANUAL

**RELIABILITY-CENTERED  
MAINTENANCE (RCM) FOR  
COMMAND, CONTROL,  
COMMUNICATIONS, COMPUTER,  
INTELLIGENCE, SURVEILLANCE,  
AND RECONNAISSANCE (C4ISR)  
FACILITIES**

APPROVED FOR PUBLIC RELEASE: DISTRIBUTION IS  
UNLIMITED

---

HEADQUARTERS, DEPARTMENT OF THE ARMY

6 OCTOBER 2006

**REPRODUCTION AUTHORIZATION/RESTRICTIONS**

This manual has been prepared by or for the Government and, except to the extent indicated below, is public property and not subject to copyright. Reprint or republication of this manual should include a credit substantially as follows: "Department of the Army, TM 5-698-2, Reliability-Centered Maintenance (RCM) for Command, Control, Communications, Computer, Intelligence, Surveillance, and Reconnaissance (C4ISR) Facilities, 6 October 2006.

**APPROVED FOR PUBLIC RELEASE: DISTRIBUTION IS UNLIMITED**

## **RELIABILITY-CENTERED MAINTENANCE (RCM) FOR COMMAND, CONTROL, COMMUNICATIONS, COMPUTER, INTELLIGENCE, SURVEILLANCE, AND RECONNAISSANCE (C4ISR) FACILITIES**

### **CONTENTS**

	<i>Paragraph</i>	<i>Page</i>
CHAPTER 1. INTRODUCTION TO RELIABILITY-CENTERED MAINTENANCE		
Purpose.....	1-1	1-1
Scope.....	1-2	1-1
References.....	1-3	1-1
Availability, maintenance, and reliability .....	1-4	1-1
The reliability-centered maintenance (RCM) concept.....	1-5	1-3
Benefits of RCM.....	1-6	1-4
Origins of RCM .....	1-7	1-4
Relationship of RCM to other disciplines.....	1-8	1-5
CHAPTER 2. ESSENTIAL ELEMENTS OF A SUCCESSFUL RCM PROGRAM		
RCM implementation plan.....	2-1	2-1
Data collection requirements .....	2-2	2-3
Data analysis .....	2-3	2-4
Commitment to life cycle support of the program .....	2-4	2-4
RCM as a part of design.....	2-5	2-5
Focus on the four Ws .....	2-6	2-5
CHAPTER 3. MAINTENANCE OF SYSTEMS		
Introduction.....	3-1	3-1
Categories of maintenance .....	3-2	3-1
Categorization by when maintenance is performed .....	3-3	3-2
Maintenance concepts.....	3-4	3-4
Packaging a maintenance program.....	3-5	3-5
CHAPTER 4. FUNDAMENTAL CONCEPTS OF A RELIABILITY-CENTERED MAINTENANCE PROGRAM		
Objectives of RCM .....	4-1	4-1
Applicability of preventive maintenance .....	4-2	4-1
Failure .....	4-3	4-2
Reliability modeling and analysis.....	4-4	4-3
CHAPTER 5. THE RELIABILITY-CENTERED MAINTENANCE PROCESS		
Overview.....	5-1	5-1
C4ISR candidates for RCM analysis.....	5-2	5-1
RCM data sources .....	5-3	5-2
PM tasks under RCM.....	5-4	5-4
The RCM process.....	5-5	5-5
Specific considerations for implementing RCM for C4ISR facilities.....	5-6	5-28
Evaluation of alternatives.....	5-7	5-30

**CONTENTS**

	<i>Paragraph</i>	<i>Page</i>
<b>CHAPTER 6. CONTRACTING FOR MAINTENANCE</b>		
Introduction to maintenance contracting.....	6-1	6-1
Approach for C4ISR facilities.....	6-2	6-2
Measures of performance.....	6-3	6-2
Scope of the contract.....	6-4	6-3
Monitoring performance .....	6-5	6-3
Incentives .....	6-6	6-4
<b>APPENDIX A REFERENCES</b>		
<b>APPENDIX B STATISTICAL DISTRIBUTION USED IN RELIABILITY AND MAINTAINABILITY</b>		
Introduction to statistical distribution .....	B-1	B-1
The exponential distribution .....	B-2	B-1
The weibull distribution.....	B-3	B-2
The normal distribution .....	B-4	B-3
The lognormal distribution .....	B-5	B-4
<b>APPENDIX C AVAILABILITY AND OPERATIONAL READINESS</b>		
Availability .....	C-1	C-1
Operational readiness.....	C-2	C-3
<b>APPENDIX D ACRONYMS GLOSSARY</b>		
<b>APPENDIX E FLEXIBLE RCM METHODOLOGY EXAMPLE.....</b>	<b>E-1</b>	<b>E-1</b>

**LIST OF TABLES**

<i>Number</i>	<i>Title</i>	<i>Page</i>
1-1	Cost benefits of using RCM for developing PM program .....	1-4
2-1	Data sources for the RCM analysis.....	2-4
2-2	Non-destructive inspection (NDI) techniques, briefly .....	2-6
2-3	Examples of failure mechanisms and modes .....	2-6
2-4	Examples of failure effect categorization .....	2-8
3-1	Examples of tasks under two categories of preventive maintenance .....	3-3
4-1	Examples of effects of operational failures.....	4-3
4-2	Methods for modeling reliability .....	4-4
4-3	Key features of the GO method .....	4-6
5-1	Criteria for applying RCM to products .....	5-1
5-2	Types of mechanical systems typical for a C4ISR facility .....	5-1
5-3	Typical components comprising the C4ISR facility electrical system .....	5-2
5-4	Typical components for a SCADA system .....	5-2
5-5	General data sources for the RCM analysis .....	5-3
5-6	Potential sources of C4ISR maintainability data .....	5-3
5-7	Understanding and using different sources of data .....	5-4
5-8	NDI techniques .....	5-9
5-9	Information needed for RCM.....	5-11
5-10	Example of identified tasks.....	5-26
5-11	Packaging the tasks from table 5-4 .....	5-26
5-12	Typical questions addressed by a reliability assessment.....	5-27
5-13	Steps in design trades .....	5-30
5-14	Typical costs considered in cost-benefit analysis .....	5-31
6-1	Examples of positive incentives.....	6-4

**CONTENTS**

**LIST OF FIGURES**

<i>Number</i>	<i>Title</i>	<i>Page</i>
2-1	The RCM process starts in the design phase and continues for the life of the system.....	2-1
2-2	Applicability of age limit depending on failure pattern .....	2-7
3-1	Major categories of maintenance by when performed .....	3-1
3-2	Typical approach to categorizing maintenance by where it is performed..	3-2
3-3	An example of packaging PM tasks.....	3-6
3-4	Example of how PM cards can be used to document required PM tasks...	3-7
4-1	Block diagram of a simple redundant system .....	4-2
4-2	Example of a reliability block diagram.....	4-4
4-3	Example of a fault tree (from RAC Fault Tree Analysis Application Guide) .....	4-5
4-4	Example of a single line diagram (from IEEE Gold Book Standard Network) .....	4-7
5-1	Data elements from FMEA that are applicable to RCM analysis .....	5-12
5-1a	Example of Failure Modes and Effects Analysis worksheet; DA Form 7610	5-12
5-2	RCM decision logic tree (adapted from MSG-3).....	5-14
5-3	Evident failure – hazardous effects .....	5-17
5-4	Evident failure – operational effects .....	5-19
5-5	Evident failure – economic effects.....	5-21
5-6	Hidden failure – hazardous effects.....	5-23
5-7	Hidden failure – non-hazardous effects .....	5-25

# CHAPTER 1

## INTRODUCTION TO RELIABILITY-CENTERED MAINTENANCE

---

### 1-1. Purpose

The purpose of this technical manual is provide facility managers with the information and procedures necessary to develop and update a preventive maintenance (PM) program for their facilities that is based on the reliability characteristics of equipment and components and cost. Such a PM program will help to achieve the highest possible level of facility availability at the minimum cost.

### 1-2. Scope

The information in this manual reflects the commercial practices and lessons learned over many years of developing cost-effective preventive maintenance programs for a wide variety of systems and equipment. It specifically focuses on developing PM programs for electrical and mechanical systems used in command, control, communications, computer, intelligence, surveillance, and reconnaissance (C4ISR) facilities based on the reliability characteristics of those systems and economic considerations, while ensuring that safety is not compromised. The process for developing such a PM program is called Reliability-Centered Maintenance, or RCM. Two appendices develop key topics more deeply: appendix B, statistical distribution; and appendix C, availability.

### 1-3. References

Appendix A contains a complete list of references used in this manual.

### 1-4. Availability, maintenance, and reliability

In addition to the following key terms, the glossary lists acronyms, abbreviations, and additional definitions for terms used in this document. Additional terms are included to help the reader better understand the concepts presented herein.

a. *Availability*. (Also see appendix C). Availability is defined as the instantaneous probability that a system or component will be available to perform its intended mission or function when called upon to do so at any point in time. It can be measured in one of several ways.

(1) *Operational availability*( $A_o$ ). Another equation for availability directly uses parameters related to the reliability and maintainability characteristics of the item as well as the support system. Equation 1 reflects this measure.

$$A_o = \frac{\text{Mean Time Between Maintenance (MTBM)}}{\text{Mean Downtime} + \text{MTBM}} \quad \text{Equation 1}$$

(2) *Inherent availability*( $A_i$ ). In equation 1, MTBM includes all maintenance required for any reason, including repairs of actual design failures, repairs of induced failures, cases where a failure cannot be confirmed, and preventive maintenance. When only maintenance required to correct design failures are counted and the effects of the support system are ignored, the result is *inherent availability*, which is given by equation 2.

$$A_i = \frac{\text{Mean Time Between Failure (MTBF)}}{\text{Mean Time to Repair} + \text{MTBF}} \quad \text{Equation 2}$$

b. *Maintenance*. Maintenance is defined as those activities and actions that directly retain the proper operation of an item or restore that operation when it is interrupted by failure or some other anomaly. (Within the context of RCM, proper operation of an item means that the item can perform its intended function.) These activities and actions include removal and replacement of failed items, repair of failed items, lubrication, servicing (includes replenishment of consumables such as fuel), and calibrations. Other activities and resources are needed to support maintenance. These include spares, procedures, labor, training, transportation, facilities, and test equipment. These activities and resources are usually referred to as logistics. Although some organizations may define maintenance to include logistics, it will be used in this TM in the more limited sense and will not include logistics.

(1) *Corrective maintenance*. Corrective maintenance is maintenance required to restore a failed item to a specified condition. Restoration is accomplished by removing the failed item and replacing it with a new item, or by fixing the item by removing and replacing internal components or by some other repair action.

(2) *Preventive maintenance*. Scheduled maintenance or maintenance performed based on the condition of an item conducted to ensure safety, reduce the likelihood of operational failures, and obtain as much useful life as possible from an item.

(3) *Condition-based maintenance*. Condition-based maintenance can be performed on the basis of observed wear or on predicting when the risk of failure is excessive.

(a) Some items exhibit wear as they are used. If the probability of failure can be related to a measurable amount of wear, it may be possible to prescribe how much wear can be tolerated before the probability of failure reaches some unacceptable level. If so, then this point becomes the criterion for removal or overhaul. Measurement can be done using a variety of techniques depending on the characteristic being measured. The length of cracks in structures, for example, can be measured using x-ray and ultrasound.

(b) In predictive maintenance, a given operating characteristic of the item, vibration or temperature, for example, is trended and compared with the known "normal" operating levels. An acceptable range is established with either upper and lower limits, or some maximum or minimum level. As long as the trend data remain inside the acceptable level, any variation is considered to be normal variation due to variances in materials, operating environment, and so forth. When the trend line intersects the "unacceptable" limit line, preventive maintenance is required to prevent a failure in the future. The limits are based on knowledge of the normal operating characteristics and the level of risk of failure we are willing to accept.

c. *Reliability*. Reliability is defined as the probability that a component can perform its intended function for a specified time interval (t) under stated conditions.

d. *Reliability-centered maintenance (RCM)*. RCM is a logical, structured framework for determining the optimum mix of applicable and effective maintenance activities needed to sustain the operational reliability of systems and equipment while ensuring their safe and economical operation and support. Although RCM focuses on identifying preventive maintenance actions, corrective actions are identified by default. That is, when no preventive action is effective or applicable for a given item, that item is run

to failure (assuming safety is not at issue). From that perspective, RCM identifies all maintenance. RCM is focused on optimizing readiness, availability, and sustainment through effective and economical maintenance.

### 1-5. The reliability-centered maintenance concept

Prior to the development of the RCM methodology, it was widely believed that everything had a "right" time for some form of preventive maintenance (PM), usually replacement or overhaul. A widespread belief among many maintenance personnel was that by replacing parts of a product or overhauling the product (or repairable portions thereof), that the frequency of failures during operation could be reduced. Despite this previous commonly held view, the results seemed to tell a different story. In far too many instances, PM seemed to have no beneficial effects. Indeed, in many cases, PM actually made things worse by providing more opportunity for maintenance-induced failures.

a. *Airline study.* When the airline companies in the United States observed that PM did not always reduce the probability of failure and that some items did not seem to benefit in any way from PM, they formed a task force with the Federal Aviation Administration (FAA) to study the subject of preventive maintenance. The results of the study confirmed that PM was effective only for items having a certain pattern of failures. The study also concluded that PM should be required only when required to assure safe operation. Otherwise, the decision to do or not do PM should be based on economics.

b. *RCM approach.* The RCM approach provides a logical way of determining if PM makes sense for a given item and, if so, selecting the appropriate type of PM. The approach is based on the following precepts.

(1) *The objective of maintenance is to preserve an item's function(s).* RCM seeks to preserve system or equipment function, not just operability for operability's sake. Redundancy improves functional reliability but increases life cycle cost in terms of procurement and life cycle cost.

(2) *RCM focuses on the end system.* RCM is more concerned on maintaining system function than individual component function.

(3) *Reliability is the basis for decisions.* The failure characteristics of the item in question must be understood to determine the efficacy of preventive maintenance. RCM is not overly concerned with simple failure rate; it seeks to know the conditional probability of failure at specific ages (the probability that failure will occur in each given operating age bracket).

(4) *RCM is driven first by safety and then economics.* Safety must always be preserved. When safety is not an issue, preventive maintenance must be justified on economic grounds.

(5) *RCM acknowledges design limitations.* Maintenance cannot improve the inherent reliability – it is dictated by design. Maintenance, at best, can sustain the design level of reliability over the life of an item.

(6) *RCM is a continuing process.* The difference between the perceived and actual design life and failure characteristics is addressed through age (or life) exploration.

c. *RCM concept.* The RCM concept has completely changed the way in which PM is viewed. It is now a widely accepted fact that not all items benefit from PM. Moreover, even when PM would be effective, it is often less expensive (in all senses of that word) to allow an item to "run to failure" rather than to do PM. In the succeeding discussions, we will examine the RCM concept in more detail. We will



explore the meaning of terms that are central to the RCM approach. These terms include failure characteristics, efficiency, run to failure, cost, and function.

**1-6. Benefits of RCM**

a. *Reduced costs.* A significant reason for creating the aforementioned joint airline/FAA task force was the new Boeing 747 (B747) jumbo jet. Boeing and United Airlines, the initial buyer of the aircraft, were already considering the development of the PM program for the B747. This new airliner was vastly larger and more complex than any ever built. Given the cost of maintenance on smaller aircraft already in service, the maintenance costs for the B747, using the traditional approach to PM, would have threatened the profitability, and hence the viability, of operating the new aircraft. Examples of the ultimate savings achieved in using RCM to develop the PM program for the B747 and other aircraft are shown in table 1-1. Similar savings have been achieved by other industries for other equipment when going from a traditional to an RCM-based PM program. It is important to note that these costs savings are achieved with no reduction in safety, an obvious requirement in the airline industry.

*Table 1-1. Cost benefits of using RCM for developing PM program*

Type of PM	Required Using Traditional Approach	Required Using RCM
Structural inspections	4,000,000 hours for DC-8	66,000 hours for B747
Overhaul	339 items for DC-8	7 items for DC-10
Overhaul of turbine engine	Scheduled	On-condition (cut shop maintenance costs by 50% compared with DC-8)

b. *Increased availability.* For many systems, including C4ISR facilities, availability is of primary importance. Availability was defined in paragraph 1-4. As indicated in the definition, the level of availability achieved in actual use of a product is a function of how often it fails and how quickly it can be restored to operation. The latter, in turn, is a function of how well the product was designed to be maintainable, the amount of PM required, and the logistics resources and infrastructure that have been put in place to support the product. RCM directly contributes to availability by reducing PM to that which is essential and economic.

**1-7. Origins of RCM**

a. *Airlines.* As stated earlier, RCM had its origins with the airline industry. Nowhere had the then-prevailing philosophy of maintenance been challenged more. By the late 1950's, maintenance costs in the industry had increased to a point where they had become intolerable. Meanwhile, the Federal Aviation Agency (FAA) had learned through experience that the failure rate of certain types of engines could not be controlled by changing either the frequency or the content of scheduled fixed-interval overhauls. As a result of these two factors, a task force consisting of representatives of the airlines and aircraft manufacturers was formed in 1960 to study the effectiveness of PM as being implemented within the airline industry.

(1) *The task force.* The task force developed a rudimentary technique for developing a PM program. Subsequently, a maintenance steering group (MSG) was formed to manage the development of the PM program for the new Boeing 747 (B747) jumbo jet. This new airliner was vastly larger and more complex than any ever built. Given the cost of maintenance on smaller aircraft already in service, the maintenance

costs for the B747, using the traditional approach to PM, would have threatened the profitability, and hence the viability, of operating the new aircraft.

(2) *MSG-1*. The PM program developed by the steering group, documented in a report known as MSG-1, was very successful. That is, it resulted in an affordable PM program that ensured the safe and profitable operation of the aircraft.

(3) *MSG-2*. The FAA was so impressed with MSG-1 that they requested that the logic of the new approach be generalized, so that it could be applied to other aircraft. So in 1970, MSG-2, Airline Manufacturer Maintenance Program Planning Document, was issued. MSG-2 defined and standardized the logic for developing an effective and economical maintenance program. MSG-2 was first used on the L1011, DC10, and MD80 aircraft. In 1972, the European aviation industries issued EMSG (European Maintenance System Guide), which improved on MSG-2 in the structures and zonal analysis. EMSG was used on the Concorde and A300 Airbus.

b. *Adoption by military*. The problems that the airlines and FAA had experienced with the traditional approach to maintenance were also affecting the military. Although profit was not an objective common to both the airlines and military, controlling costs and maximizing the availability of their aircraft were. Consequently, in 1978, the DOD contracted with United Airlines to conduct a study into efficient maintenance programs. The study supplemented MSG-2 by emphasizing the detection of hidden failures and moved from a process-oriented concept to a task-oriented concept. The product of the study was MSG-3, a decision logic that was called Reliability-Centered Maintenance (RCM).

c. *Use for facilities and other industries*. Although created by the aviation industry, RCM quickly found applications in many other industries. RCM is used to develop PM programs for public utility plants, especially nuclear power plants, railroads, processing plants, and manufacturing plants. It is no overstatement to say that RCM is now the pre-eminent method for evaluating and developing a comprehensive maintenance program for an item. Today, a variety of documents are available on RCM. A listing of some of the more prominent documents is included in appendix A.

## 1-8. Relationship of RCM to other disciplines

a. *Reliability*. It is obvious why the first word in the title of the MSG-3 approach is reliability. Much of the analysis needed for reliability provides inputs necessary for performing an RCM analysis, as will be seen in succeeding sections. The fundamental requirement of the RCM approach is to understand the failure characteristics of an item. As used herein, failure characteristics include the underlying failure rate, the consequences of failure, and whether or not the failure manifests itself and, if it does, how. Reliability is measured in different ways, depending on one's perspective: inherent reliability, operational reliability, mission (or functional) reliability, and basic (or logistics) reliability. RCM is related to operational reliability.

(1) *Inherent versus operational reliability*. From a designer's perspective, reliability is measured by "counting" only those failures that are design-related. When measured in this way, reliability is referred to as "inherent reliability." From a user's or operator's perspective, all events that cause the system to stop performing its intended function is a failure event. These events certainly include all design-related failures that affect the systems' function. Also included are maintenance-induced failures, no-defect found events, and other anomalies that may have been outside the designer's contractual responsibility or technical control. This type of reliability is called "operational reliability."

(2) *Mission or functional reliability versus basic or logistics reliability*. Any failure that causes the product to fail to perform its function or mission is counted in "mission reliability." Redundancy

improves mission reliability. Consider a case where one part of a product has two elements in parallel where only one is needed (redundant). If a failure of one element of the redundant part of the product fails, the other continues to function allowing the product to do its job. Only if both elements fail will a mission failure occur. In "basic" reliability, all failures are counted, whether or not a mission or functional failure has occurred. This measure of reliability reflects the total demand that will eventually be placed on maintenance and logistics.

b. *Safety*. Earlier, it was stated that one of the precepts on which the RCM approach is that safety must always be preserved. Given that the RCM concept came out of the airline industry, this emphasis on ensuring safety should come as no surprise. In later sections, the manner in which the RCM logic ensures that safety is ensured will be discussed. For now, it is sufficient to note that the RCM specifically addresses safety and is intended to ensure that safety is never compromised. In the past several years, environmental concerns and issues involving regulatory bodies have been accorded an importance in the RCM approach for some items that is equal (or nearly so) to safety. Failures of an item that can cause damage to the environment or which result in some Federal or state law being violated can pose serious consequences for the operator of the item. So the RCM logic is often modified, as it is in this TM, to specifically address environmental, mission, or other concerns.

c. *Maintainability*. RCM is a method for prescribing PM that is effective and economical. Whether or not a given PM task is effective depends on the reliability characteristics of the item in question. Whether or not a task is economical depends on many factors, including how easily the PM tasks can be performed. Ease of maintenance, corrective or preventive, is a function of how well the system has been designed to be maintainable. This aspect of design is called maintainability. Providing ease of access, placing items requiring PM where they can be easily removed, providing means of inspection, designing to reduce the possibility of maintenance-induced failures, and other design criteria determine the maintainability of a system.

## CHAPTER 2

### ESSENTIAL ELEMENTS OF A SUCCESSFUL RCM PROGRAM

---

#### 2-1. RCM implementation plan

An overview of steps of the RCM process is shown in figure 2-1.

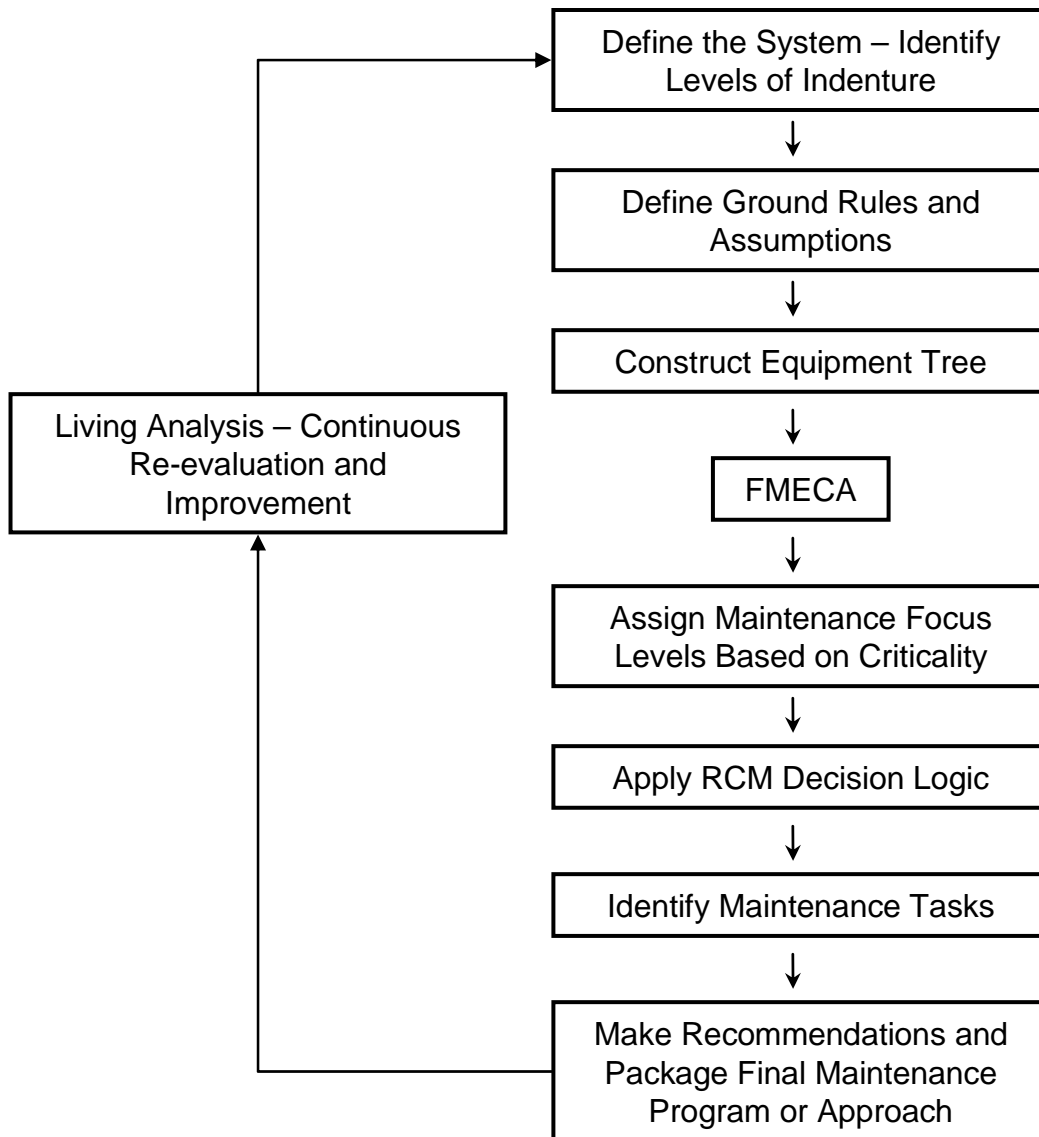

Figure 2-1. The RCM process starts in the design phase and continues for the life of the system.

a. *Major tasks.* As shown in figure 2-1, several major tasks are required to implement the RCM concept.

- **Define the System** – Identify and document the boundaries of the analysis
  - Identify and document equipment included in the analysis
  - Identify and document the indenture level the analysis is intended to extend to
- **Define Ground Rules and Assumptions** – Identify and document ground rules and assumptions used to conduct the analysis
- **Construct Equipment Tree** – Construct equipment block diagrams to indicate equipment configuration, down to the lowest indenture level intended to be covered by the analysis
- **Conduct FMECA** – Analyze failure modes, effects and criticality
- **Assign Maintenance Focus Levels** – Classify maintenance focus levels based on criticality rankings
- **Apply RCM Decision Logic** – Apply RCM logic trees for items, especially those identified as being critical (see figure 5-2)
- **Identify Maintenance Tasks** – Identify maintenance tasks to be performed on the given item
- **Package Maintenance Program** – Develop a maintenance tasking schedule for the analyzed equipment

Note: RCM Analysis is intended to be a living analysis. Effort should be made to continue to collect more complete information and add it to the analysis, to continue to provide a foundation for effective continuous improvement. Results and recommendations should be periodically reviewed and re-evaluated, taking into consideration additional information of any kind.

(1) *Conduct supporting analyses.* RCM is a relatively information-intensive process. To provide the information needed to conduct the RCM analysis, several supporting analyses are either required, often as prerequisites to beginning the RCM analysis, or desirable. These supporting analyses include the Failure Modes and Effects Analysis, Fault Tree Analysis, functional analysis, and others.

(2) *Conduct the RCM analysis.* The RCM analysis consists of using a logic tree (see figure 5-2) to identify effective, economical, and, when safety is concerned, required PM. (As will be seen, PM is required when safety is involved; if no PM is effective, then redesign is mandatory).

b. *The implementation plan.* Planning to implement an RCM approach to defining the PM for a system or product must address each of the tasks noted in the preceding paragraph. The plan must address the supporting design phase analyses needed to conduct an RCM analysis. Based on the analysis, an initial maintenance plan, consisting of the identified PM with all other maintenance being corrective, by default, is developed. This initial plan should be updated through Life Exploration during which initial analytical results concerning frequency of failure occurrence, effects of failure, costs of repair, etc. are modified based on actual operating and maintenance experience. Thus, the RCM process is iterative, with field experience being used to improve upon analytical projections.

## 2-2. Data collection requirements

a. *Required data.* Since conducting an RCM analysis requires an extensive amount of information, and much of this information is not available early in the design phase, RCM analysis for a new product cannot be completed until just prior to production. The data falls into four categories: failure characteristics, failure effects, costs, and maintenance capabilities and procedures.

(1) *Failure characteristics.* Studies conducted by the MSGs and confirmed by later studies showed that PM was effective only for certain underlying probability distributions. Components and items, for example, for which a constant failure rate applies (e.g., the underlying probability distribution is the exponential) do not benefit from PM. Only when there is an increasing probability of failure should PM be considered.

(2) *Failure effects.* The effects of failure of some items are minor or even insignificant. The decision whether or not to use PM for such items is based purely on costs. If it is less expensive to allow the item to fail, and to perform CM, than it is to perform PM, then the item is allowed to fail. As stated earlier, allowing an item to fail is called run to failure.

(3) *Costs.* The costs that must be considered are the costs of performing a PM task(s) for a given item, the cost of performing CM for that item, and the economic penalties, if any, when an operational failure occurs.

(4) *Maintenance capabilities and procedures.* Before selecting certain maintenance tasks, the analyst needs to understand what the capabilities are, or are planned, for the system. In other words, what is or will be the available skill levels, what maintenance tools are available or are planned, and what are the diagnostics being designed into or for the system.

b. *Sources of data.* Table 2-1 lists some of the sources of data for the RCM analysis. The data elements from the Failure Modes and Effects Analysis (FMEA) that are applicable to RCM analysis are highlighted in paragraph 5-5b. Note that when RCM is being applied to a product already in use, or when a maintenance program is updated during Life Exploration, historical maintenance and failure data will be inputs for the analysis. An effective Failure Reporting and Corrective Action System (FRACAS) is an invaluable source of data.

Table 2-1. Data sources for the RCM analysis

Data Source	Comment
Lubrication requirements	Determined by designer. For off-the-shelf items being integrated into the product, lubrication requirements and instructions may be available.
Repair manuals	For off-the-shelf items being integrated into the product.
Engineering drawings	For new and off-the-shelf items being integrated into the product.
Repair parts lists	
Quality deficiency reports	For off-the-shelf items being integrated into the product.
Other technical documentation	For new and off-the-shelf items being integrated into the product.
PREP Database	For new and off-the-shelf items being integrated into the product.
Recorded observations	From test of new items and field use of off-the-shelf items being integrated into the product.
Hardware block diagrams	For new and off-the-shelf items being integrated into the product.
Bill of Materials	For new and off-the-shelf items being integrated into the product.
Functional block diagrams	For new and off-the-shelf items being integrated into the product.
Existing maintenance plans	For off-the-shelf items being integrated into the product. Also may be useful if the new product is a small evolutionary improvement of a previous product.
Maintenance technical orders/manuals	For off-the-shelf items being integrated into the product.
Discussions with maintenance personnel and field operators	For off-the-shelf items being integrated into the product. Also may be useful if the new product is a small evolutionary improvement of a previous product.
Results of FMEA, FTA, and other reliability analyses	For new and off-the-shelf items being integrated into the product. Results may not be readily available for the latter.
Results of Maintenance task analysis	For new and off-the-shelf items being integrated into the product. Results may not be readily available for the latter.

### 2-3. Data analysis

Data can be considered the lifeblood of RCM. The data from the sources listed in table 2-1 is used in several ways. Data provides the basis for determining the failure characteristics of items. It is also used to evaluate the effectiveness of specific PM tasks used on past systems. Economic data provides the basis for determining whether PM is more economical than running an item to failure (only done when safety is not affected).

### 2-4. Commitment to life cycle support of the program

*a. The Process Perspective.* As will be shown in this section, RCM must be viewed as a continuing process, rather than an event that occurs once. Although a maintenance program based on RCM should be developed during design, it should be refined throughout the operational life of the system. In addition, RCM can be used to develop a maintenance program for an existing system for which the initial maintenance program was not based on RCM

*b. Learning from Experience.* Much of the information used to develop an RCM program, either during design for a new system or after fielding for an existing system will be based on estimates, may change over time, or be subject to some combination of these two factors. Consequently, it is essential to use experiential data to update the maintenance program.

## 2-5. RCM as a part of design

It is ideal to implement an RCM approach during the design and development of a new system to develop a maintenance program. The reasons will be briefly discussed here but will become clearer as the reader proceeds through the remaining sections of this TM.

a. *Effective use of analyses.* During design and development, numerous analyses are performed. Many of these analyses directly support an RCM analysis. In turn, the results of going through the RCM process of developing a maintenance program can affect and contribute to these analyses. Obviously, implementing RCM during design and development makes very effective use of analyses that are usually performed.

b. *Impact on design.* As will be seen when the RCM logic diagrams are discussed, redesign is either mandatory or desirable in many cases. The cost and level of effort of design changes made during the design and development phase of a system are much less than if they were made after the system was fielded. Additionally, the effectiveness of design changes is higher when made during the design and development phase. Of course, RCM can and is used to develop maintenance programs for fielded systems, for which RCM was not applied during design and development. However, it is always best to implement RCM during design and development.

## 2-6. Focus on the four Ws

Discussion of the four Ws: what can fail, why does it fail, when will it fail, and what are the consequences of failures.

a. *What can fail?* In determining required maintenance, the first and most fundamental question that must be answered is what can fail. A variety of methods can be used to answer this question.

(1) *Analytical methods.* Failure Modes and Effects Analysis, Fault Tree Analysis, and relayed analyses address, among other issues, what can fail that will prevent a system, subsystem, or component from performing its function(s).

(2) *Test.* Analytical methods are not infallible and a particular failure may be overlooked or cannot be anticipated by analysis. Testing often reveals these failures. Testing can, of course, also be used to confirm or validate the results of analytical methods.

(3) *Field experience.* Often, the same type of component, assembly, or even subsystem that is already used in one system may be used in a new system. If data is collected on field performance of these components, assemblies, and subsystems, it can be used to help answer the question, what can fail. Obviously, field experience is equally applicable to RCM when applied to an already fielded system.

b. *Why does an item fail?* To determine which, if any preventive maintenance tasks are appropriate, the reason for failure must be known. Insights into the modes and mechanisms of failure can be gained through analysis, test, and past experience. Some of the analytical methods are the same as those used to determine What Can Fail. The methods include the FMEA and FTA. Others include root cause analysis, destructive physical analysis, and non-destructive inspection techniques. Table 2-2 lists some non-destructive inspection (NDI) techniques and table 2-3 lists some of the modes and mechanisms of failure.



Table 2-2. Non-destructive inspection (NDI) techniques, briefly

Acoustic emission	Magnetic particle examination
Dye penetrant	Radiography
Eddy current	Spectrometric oil analysis
Emission spectroscopy	Stroboscopy
Ferrography	Thermography
Leak testing	Ultrasonics

Table 2-3. Examples of failure mechanisms and modes

<b>Modes</b>		
Stuck open (valve)	Fractured (shaft)	Wear (bearing)
Shorted (connector)	Leakage (seal)	Slippage (belt drive)
Low torque (motor)	Excessive friction (shaft journal)	Short (resistor)
<b>Mechanisms</b>		
Brinelling (bearing ring)	Spalling (concrete)	Elongation/yielding (structure)
Fretting (pump shaft)	Condensation (circuit board)	Freezing (battery)
Ionization (microcircuit)	Glazing (clutch plate)	Fatigue (springs)
Plastic deformation (springs)	Wear (clutch plate)	Galvanic corrosion (structure)

c. *When will an item fail? (Occurrence)* If the underlying time to failure distribution is known for a part or assembly, then the probability of failure at any point in time can be predicted. For some items, the underlying distribution is exponential and the item exhibits a constant failure rate. In such cases, a new item used to replace an old item has exactly the same probability of failing in the next instant of time as did the old item. Consequently, changing such an item at some prescribed interval has no effect on the probability of failure. It makes more sense to run the item to failure. If that is not possible, if safety is involved for example, then redesign is necessary. As shown in figure 2-2, only a small percentage of items can benefit from PM. Knowing the underlying distribution of times to failure is essential in determining if PM is applicable.

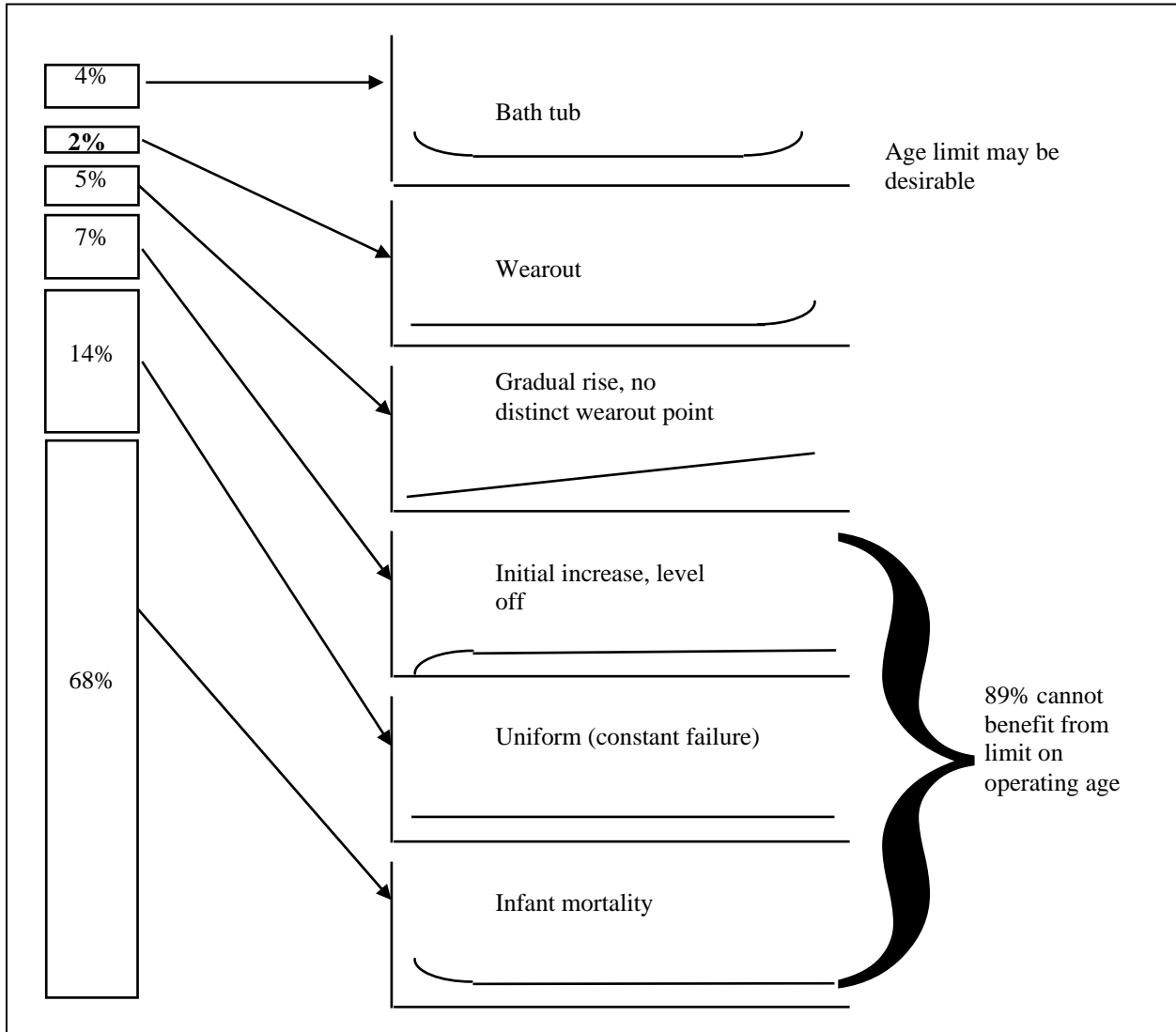

Figure 2-2. Applicability of age limit depending on failure pattern

d. *What are the consequences of the item failing? (Severity)* Not all failures are equal in their effect on the system. Obviously, any failures that can cause death or injury to system operators or maintainers, or others who may be served by the system (e.g., airline passengers) or are nearby are the most serious. Very close in seriousness are failures that can result in compromised mission requirements, pollution to the environment, or a violation of government statutes. At the bottom of the list are failures such as cosmetic damage and other problems that have no effect on system operation. Knowing the effect of a failure helps prioritize decisions. Serious failures usually demand some form of PM or redesign is necessary. Minor failures usually do not lead to redesign and PM is performed only if it is less expensive than running the item to failure. Table 2-4, on the following page, lists some examples of failure effect categorization used in FMEAs and in the RCM process. The manner in which failure effects are categorized for C4ISR facilities should be based on the functions of the facility. Obviously, any failure that could kill or injure personnel or cause loss of the C4ISR mission would have to be categorized as the most serious. The criteria shown in table 2-4 or some combination could be the basis for a C4ISR facility-specific categorization approach. Note that in using the RCM approach to developing a PM

program, all failure must be put into one of three categories (Preventative Maintenance, Predictive Maintenance, Corrective Maintenance). These categories are used in the logic trees.

Table 2-4. Examples of failure effect categorization

<b>AIAG Standard (Automobile Industry Standard)</b>		
<b>Effect</b>	<b>Severity of Effect</b>	<b>Ranking</b>
Hazardous without warning	Very high severity ranking when a potential failure mode affects safe system operation and/or involves non compliance with federal safety regulation without warning	10
Hazardous with warning	Very high severity ranking when a potential failure mode affects safe system operation and/or involves non compliance with federal safety regulation warning	9
Very High	System/item inoperable with loss of primary function	8
High	System/item operable, but at reduced performance level. User dissatisfied	7
Moderate	System/item operable, but comfort/convenience item inoperable	6
Low	System/item operable, but comfort/convenience item operable at reduced level	5
Very Low	Defect noticed by most customers	4
Minor	Defect noticed by average customer	3
Very Minor	Defect notice by discriminating customer	2
None	No effect	1
<b>Example of a Simplified Categorization</b>		
Critical	Death, loss of system, violation of governmental statute	
High	Injury, loss of some system functions, very high economic loss	
Moderate	Damage to system requiring maintenance at first opportunity, economic loss	
Low	Minor damage to system, low economic loss	
Negligible	Cosmetic damage, no economic loss	
<b>RCM Analysis</b>		
Safety	Directly and adversely affects on operating safety	
Operational	Prevents the end system from completing a mission	
Economic	Does not adversely affect safety and does not adversely affect operations - the only effect is the cost to repair the failure	

# CHAPTER 3

## MAINTENANCE OF SYSTEMS

### 3-1. Introduction

Maintenance is defined as those activities and actions that directly retain the proper operation of an item or restore that operation when it is interrupted by failure or some other anomaly. (Within the context of RCM, proper operation of an item means that the item can perform its intended function). These activities and actions include fault detection, fault isolation, removal and replacement of failed items, repair of failed items, lubrication, servicing (includes replenishment of consumables such as fuel), and calibrations. Other activities and resources are needed to support maintenance. These include spares, procedures, labor, training, transportation, facilities, and test equipment. These activities and resources are usually referred to as logistics. Although some organizations may define maintenance to include logistics, it will be used in this document in the more limited sense and will not include logistics.

### 3-2. Categories of maintenance

Maintenance is usually categorized by either when the work is performed or where the work is performed.

a. *Categorizing by when maintenance is performed.* In this case, maintenance is divided into two major categories: preventive and corrective. Figure 3-1 illustrates how these two categories are further broken down into specific tasks. These categories of maintenance, corrective and preventive, are further subdivided in some references into reactive, preventive, predictive, and proactive maintenance.

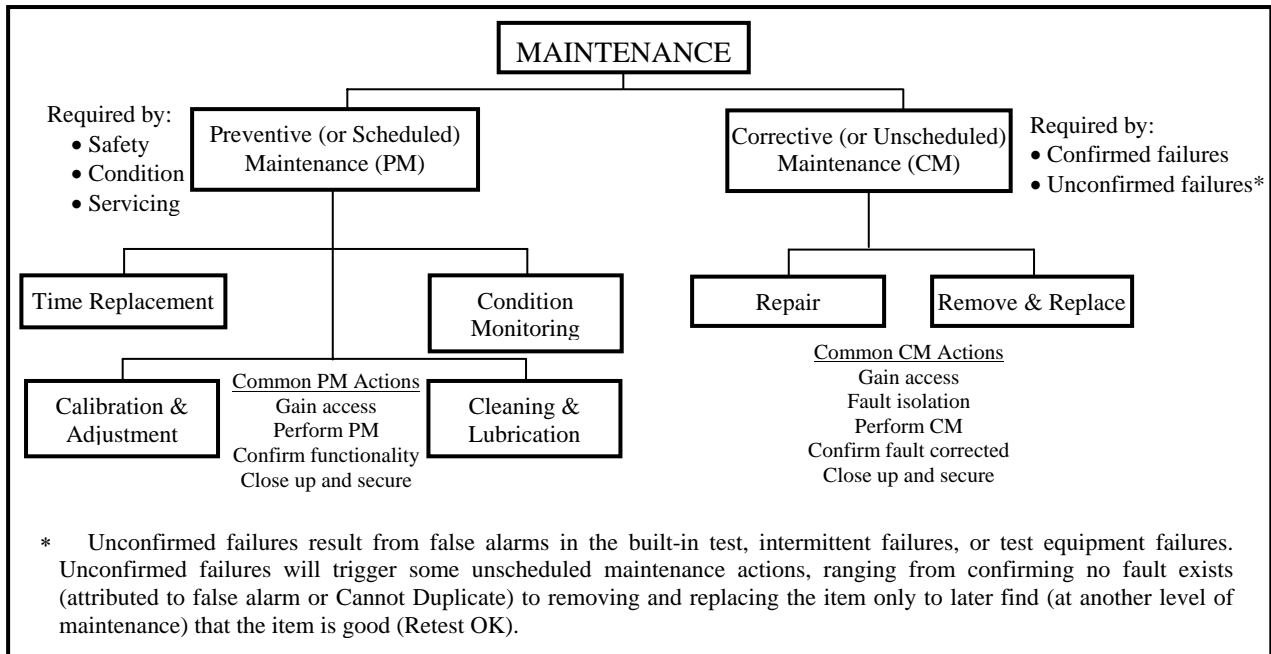

Figure 3-1. Major categories of maintenance by when performed.

(1) *Reactive maintenance.* This term is equivalent to corrective maintenance and both are also referred to as breakdown, repair, fix-when-fail, or run-to-failure maintenance.

(2) *Proactive maintenance.* Includes actions intended to extend useful life, such as root-cause failure analysis, continual improvement, and age exploration. Proactive and predictive are treated herein as categories of preventive maintenance, with proactive included under Scheduled, predictive under Condition-based (see paragraph 3-1), and age exploration as a separate step in the RCM process.

b. *Categorizing by where maintenance is performed.* Maintenance can also be categorized by where the work is performed. These categories are referred to as levels of maintenance. The categories most often used are shown in figure 3-2.

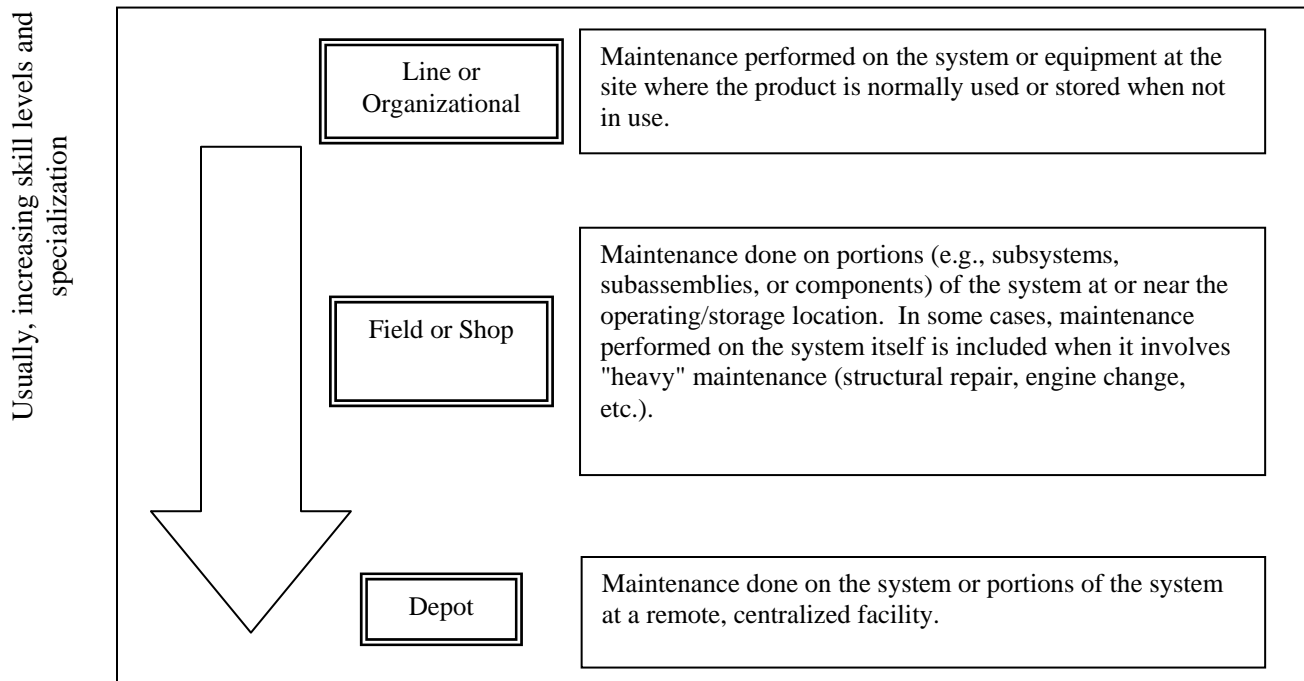

Figure 3-2. Typical approach to categorizing maintenance by where it is performed.

### 3-3. Categorization by when maintenance is performed

a. *Preventive maintenance.* Preventive maintenance (PM) is usually self-imposed downtime (although it can be done while corrective maintenance is being performed and it may even be possible to perform some PM while the product is operating). PM consists of actions intended to prolong the operational life of the equipment and keep the product safe to operate. This manual defines two types of PM: Scheduled and Condition-based. In both cases, the objectives of PM are to ensure safety, reduce the likelihood of operational failures, and obtain as much useful life as possible from an item. Table 3-1 has examples of each type of PM.

Table 3-1. Examples of tasks under two categories of preventive maintenance

Category	Tasks	Examples	Notes
Scheduled <sup>1</sup>	Remove and replace (R&R)	R&R batteries in smoke alarm twice annually	Maintenance is performed without regard to actual condition of item. Interval based on useful life and other factors. Includes all lubrication and servicing.
		R&R gun barrel after 5,000 rounds have been fired	
		Change oil every 3,000 miles	
		Lubricate bearings every 25,000 shaft revolutions	
	Overhaul or recondition	Overhaul transmission every 100,000 miles	Item is overhauled or reconditioned without regard to actual condition. Interval based on useful life and other factors.
		Refinish blades every 2,000 operating hours	
Recalibrate	Recalibrate depth setting on drill press daily	Compensate for changes in calibration due to vibration and other conditions of use.	
	Recalibrate gage against standard at beginning of each shift		
Condition <sup>2</sup>	Inspect item or area	Visually inspect belts and pulleys for excessive wear prior to starting machine	Inspections can be performed using human senses (e.g., visually check belts for wear), using non-destructive inspection (NDI) techniques (e.g., inspect for corrosion using dye penetrant), or special measuring equipment (check tread depth using gage). Can also include functional check to determine proper operation.
		Inspect for corrosion every 2 weeks	
		Inspect for delamination or disbond weekly	
		Inspect tires for cuts and proper tread depth before and after each flight	
		Inspect for hidden failure of redundant item	
	Monitor condition	Continuously monitor vibration profile and R&R bearing when limits reached	Objective is to take action before useful life has been reached or a functional failure has occurred. Parameter limits and profiles based on analysis, test, and field experience. Monitoring can but does not need to be continuous.
		Check sample of oil every 50 operating hours for presence of wear metals and overhaul engine when limits reached	

1. Based on time.
2. Based on observed or measured condition.

(1) *Scheduled maintenance.* When a specified interval between maintenance is required, the maintenance is referred to as scheduled preventive maintenance. The interval may be in terms of hours, cycles, rounds fired, or other measure meaningful to the manner in which the item is operated. Note that with scheduled PM, no attempt is made to ascertain the condition of the item. Scheduled maintenance may also consist of recalibrations or adjustments made at regular intervals. Some texts categorize inspections as scheduled PM. Certainly, inspections are based on some periodic interval or event (e.g., inspection of an aircraft prior to and after each flight). However, since the purpose of an inspection is to ascertain the condition of the item, we have chosen to include it under the next category of PM, Condition-based.

(2) *Condition-based maintenance.* Preventive maintenance performed to ascertain the condition of an item, detect or forecast an impending failure, or performed as a result of such actions is referred to as Condition-based PM.

(a) A hidden failure of an item is one that has already occurred, has not affected performance of the end system, but will if another item fails. Ideally, through some form of warnings or monitoring device, no failure will be "hidden." In reality, it is impractical and not always feasible to detect every failure of every item in a system and alert the operator or maintainer that the failure has occurred.

Inspections are therefore needed to detect such failures. See chapter 4-3a(3) for a more complete discussion of hidden failures. Maintenance that is required to correct a hidden failure condition is, of course, corrective maintenance.

(b) Some texts use terms such as predictive maintenance and on-condition. The definition of condition-based PM used herein includes these concepts. In summary, the objectives of condition-based PM are to first evaluate the condition of an item, then, based on the condition, either determine if a hidden failure has occurred or a failure is imminent, and then take appropriate action.

*b. Corrective maintenance and run-to-failure.* As already alluded to, corrective maintenance (CM) is required to restore a failed item to proper operation.

(1) *Restoration.* Restoration is accomplished by removing the failed item and replacing it with a new item, or by fixing the item by removing and replacing internal components or by some other repair action.

(2) *When CM is required.* CM can result from system failures or from condition-based PM.

(a) When system operation is impaired by the failure of one or more items, the operator is usually and immediately alerted to the problem. This alert may come from obvious visual or sensory signals (i.e., the operator can see, hear, or feel that a problem has occurred) or from monitoring equipment (indicators, built-in diagnostics, annunciator lights, etc.). When the alert comes from the latter, it is possible that a system failure has in fact not occurred. That is, the detecting equipment itself has failed or a transient condition has occurred resulting in an indication of system failure that is false or cannot be duplicated. Whether or not an actual system failure has occurred, any indication that one has will necessitate CM. The CM may result in a Cannot Duplicate (CND) or Retest OK (RTOK), in-place repair, or replacement. CNDs and RTOKs are serious problems in very complex systems for two reasons. First, they consume maintenance time and can cause unnecessary loss of system availability. Second, without in-depth test and analysis, one cannot be certain whether the detecting equipment failed, the system did fail, or transients caused the failure (and is not evident except under those transient conditions).

(b) When inspection or condition monitoring detects a hidden or failure, then some form of corrective maintenance is required.

(c) If the only concern were to obtain the greatest possible amount of life from an item, it would be allowed to run-to-failure. Under a run-to-failure approach, only CM would be required. No PM would be performed. However, the consequences on economics, safety, and mission requirements of some failures make a run-to-failure approach untenable. Consequently, most practical maintenance programs consist of a combination of PM and CM. Determining what combination is "right" for an item is one of the objectives of the RCM process.

### **3-4. Maintenance concepts**

*a. Levels of maintenance.* In considering how maintenance can be categorized, the idea of levels of maintenance was introduced. The term "levels of maintenance" has traditionally been used by the military services, although its use is not unknown in commercial industry. Within the services, the norm was once three levels of maintenance (line or organizational, field or shop, and depot). Under a 3-level concept, items are either repaired while installed on the end product or are removed and replaced. Various terms are used to refer to an item that is removed and replaced and include Line Replaceable Unit (LRU) and Weapon Replaceable Assembly (WRA). For convenience, LRU will be used in this document to refer to items that are normally removed from and replaced on the end product.

(1) *The benefits of a 2-level maintenance concept.* In an effort to reduce costs and increase availability, the services have been working for several years to implement a 2-level maintenance concept. Under this concept, repairs made on the system are kept to a minimum and, whenever possible, consist of remove and replace (R&R) actions. The idea is that by making R&R the preferred maintenance on the product, the downtime of the system can be kept to a minimum. Failed items are then sent back to the second level of maintenance, usually a depot or original equipment manufacturer (OEM).

(2) *Making a 2-level concept work.* A 2-level maintenance concept will only be affordable and practical if three criteria are met. First, each LRU's reliability must be "sufficiently high" given the item's cost. If not, availability will suffer, due to an excessive number of high-cost spares failing, and the supply "pipeline" will be expensive. Second, the integrated diagnostic capability (Built-in Test, Automatic Test Equipment, manual methods, etc.) must be very accurate and reliable. Otherwise, the supply pipeline to the second level of maintenance will be filled with good LRUs mistakenly being sent for repair – CNDs and RTOKs are a serious problem under any maintenance concept but spell disaster for a 2-level maintenance concept. Finally, a responsive and cost-effective means of transporting LRUs between the field and the depot must be available.

b. *Centralized versus de-centralized.* When maintenance at a given level is performed at several locations located relatively close to the end user, a decentralized maintenance concept is being implemented. For example, suppose a 3-level maintenance concept is being used. When an LRU fails at an operating location, it is removed and replaced with a good LRU. The operating location sends the failed LRU to a co-located field repair activity (FRA) where it is repaired. Such repair can consist of either in-place repair or R&R of constituent components often called Shop Replaceable Units (SRUs). Under a centralized concept, each operating location would not have a co-located FRA. Instead, one or more centralized FRAs would be strategically located throughout the geographic operating area (i.e., country, continent, hemisphere, etc.). Each operating location would ship its failed LRUs to the nearest centralized FRA. Such a concept is most effective when the LRUs are highly reliable. If the reliability is high, then few failures will occur at any given operating location making it difficult to keep the technicians proficient in repairing the LRUs. Also, with few failures, the technicians and any support equipment (e.g., automatic test equipment) will be under utilized. Under such conditions, it is difficult to justify a co-located FRA.

### **3-5. Packaging a maintenance program**

The total maintenance requirements for a product will dictate a set of preventive maintenance (PM) tasks and a set of corrective maintenance (CM) tasks. The latter tasks are essentially "maintenance on demand" and by definition cannot be predicted. PM, as discussed previously, will consist of on-condition and scheduled maintenance. Once all PM tasks have been identified, they must be grouped, or packaged. By packaging PM tasks, we can use our maintenance resources more effectively and minimize the number of times that the system will be out of service for PM.

a. *Packaging example.* An example is shown in figure 3-3. We could have conducted the pump inspection at 28 hours, the panel inspection at 22 hours, and lubricated the gearbox at 25 hours. But it is much more efficient to "package" the tasks as shown in the example.



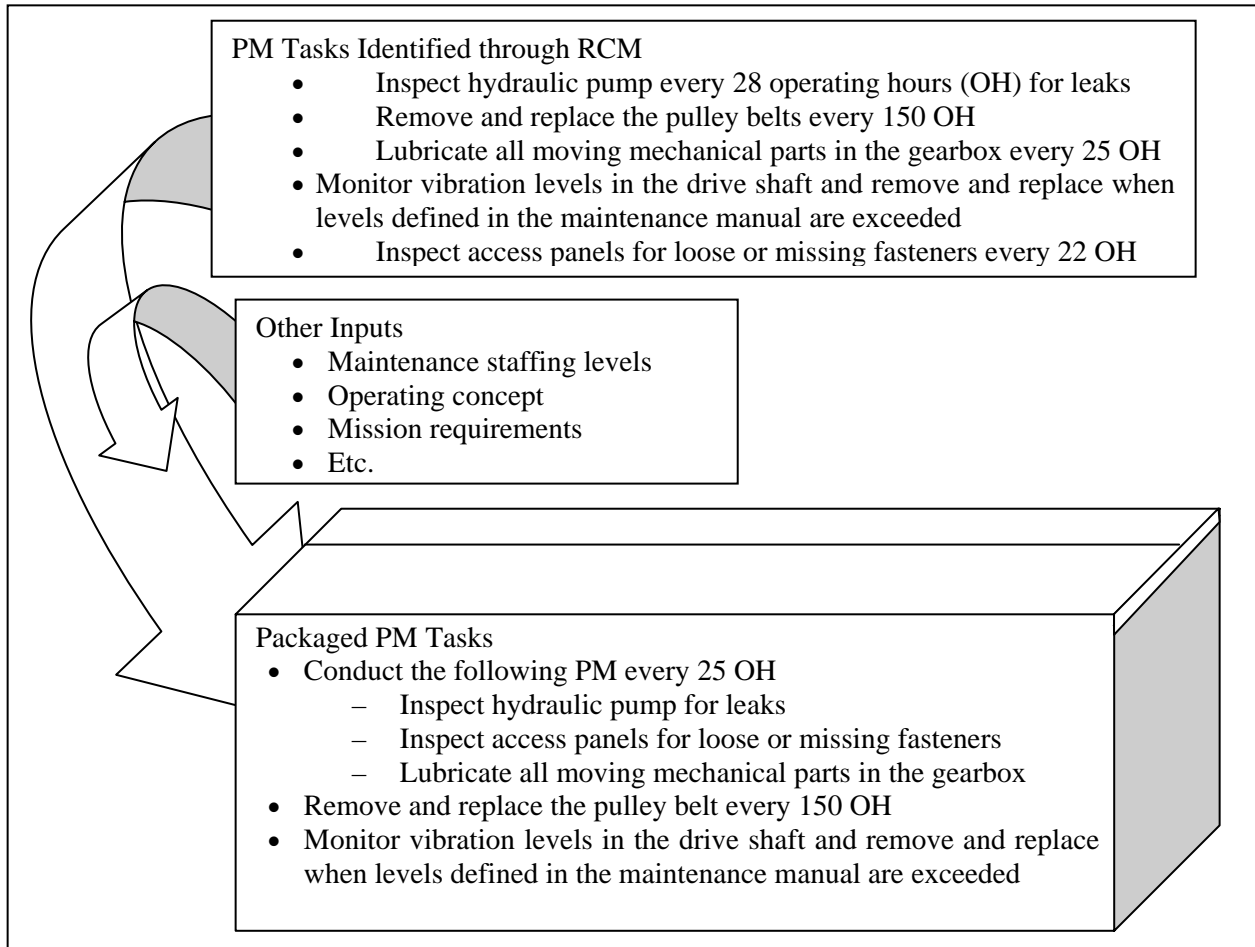

Figure 3-3. An example of packaging PM tasks.

b. *Document the packaging for maintenance personnel.* One method of documenting the packaging of PM tasks is to create inspection cards. For a given point in time (calendar time, number of operating hours, etc.), a set of cards defines the PM tasks to be performed. Figure 3-4 illustrates this approach.

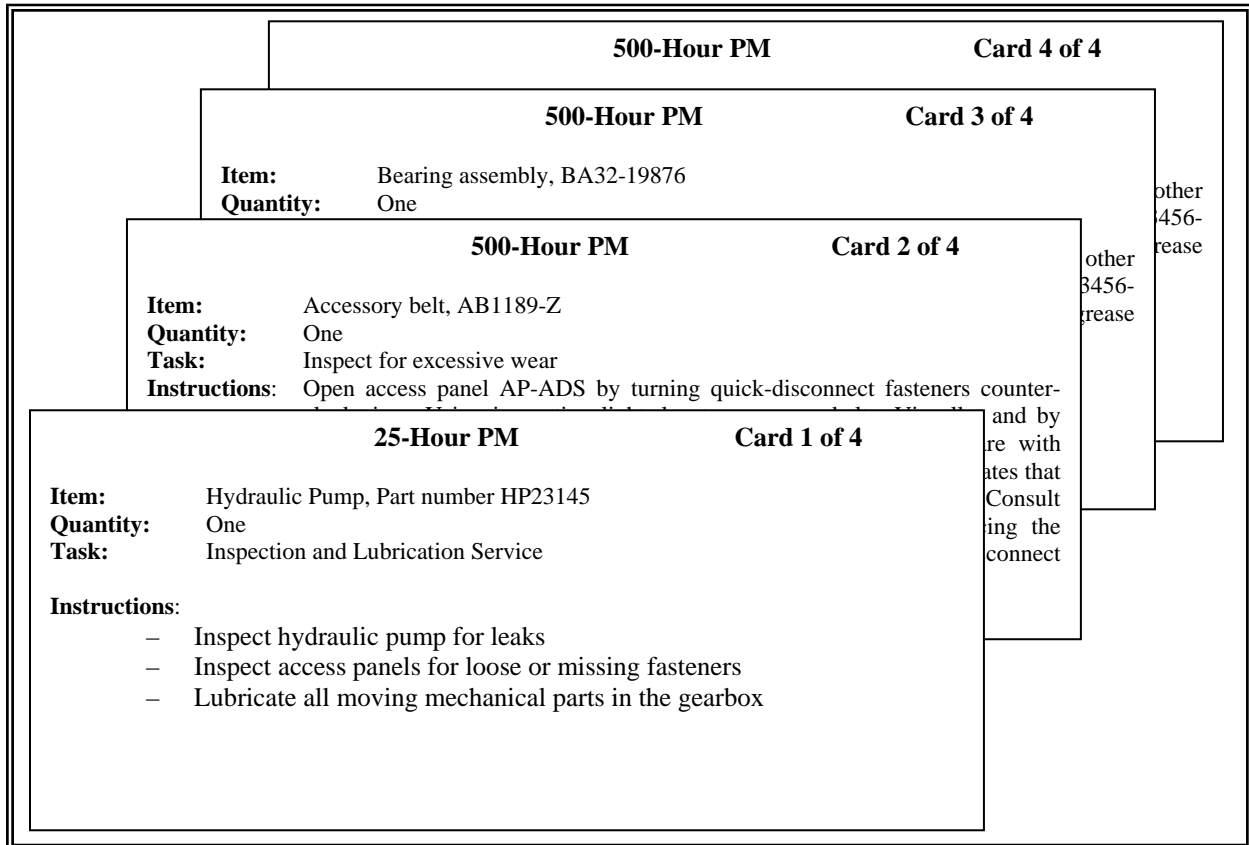

Figure 3-4. Example of how PM cards can be used to document required PM tasks.

## CHAPTER 4

# FUNDAMENTAL CONCEPTS OF A RELIABILITY-CENTERED MAINTENANCE PROGRAM

---

### 4-1. Objectives of RCM

This chapter provides a discussion of the two primary objectives of RCM: Ensure safety through preventive maintenance actions, and, when safety is not a concern, preserve functionality in the most economical manner. For C4ISR facilities, mission should be considered at the same level as safety.

### 4-2. Applicability of preventive maintenance

a. *Effectiveness.* PM can be effective only when there is a quantitative indication of an impending functional failure or indication of a hidden failure. That is, if reduced resistance to failure can be detected (potential failure) and there is a consistent or predictable interval between potential failure and functional failure, then PM is applicable. Condition monitoring has long been used to monitor operating parameters that have been shown to be dependable predictors of an impending failure. Age limit information can also be utilized to determine effectiveness of preventative maintenance efforts (see figure 2-2). Preventive maintenance (PM) is effective if a potential failure condition is definable or there is a quantitative indication of an impending failure. PM is generally effective only for items that wearout. It has no benefit for items that have a purely random pattern of failure (i.e., failures are exponentially distributed and the failure rate is constant – see appendix B for a discussion of statistical distributions). Consequently, we rarely, if ever, use a PM action for electronics, since electronics exhibit a random pattern of failures. Mechanical items, on the other hand, usually have a limited useful period of life and then begin to wearout.

b. *Economic viability.* The costs incurred with any PM being considered for an item must be less than for running the item to failure. The failure may have operational or non-operational consequences. The costs to be included in such a comparison for these two failure consequences are Operational and Non-operational.

(1) *Operational.* The cost of repair is defined in (2) following. The operational cost is defined as the indirect economic loss as a result of failure plus the direct cost of repair. An example of an operational cost is the revenue lost by an airline when a flight must be canceled and passengers booked another airline. For military organizations where profit is not an objective, an operational cost might be the cost of a second flight or mission. Sometimes, it may be difficult for a military organization to quantify an operational cost in terms of dollars and a subjective evaluation may be needed.

(2) *Non-operational.* The non-operational cost is defined as the direct cost of repair. The direct cost of repair is the cost of labor, spare parts, and any other direct costs incurred as a result of repairing the failure (by removing and replacing the failed item or performing in-place repair of the item).

c. *Preservation of function.* The purpose of RCM is not to prevent failures but to preserve functions. Many maintenance people who are unfamiliar with RCM initially find this idea difficult to accept. As was discussed in paragraph 1-4, for many years prior to and following World War II, the "modern" view within the maintenance community was that every effort should be made to prevent all failures. Preventing failure was the focus of every maintenance technician. But products became increasingly

complex and maintenance costs increased both in absolute terms and as a percentage of a product's total life cycle costs. It was soon clear that preventing all failures was technically and economically impractical. Instead, attention was turned to preserving all of the essential functions of a product. This shift from preventing failures to preserving function was fundamental to the development of the RCM approach to defining a maintenance program.

### 4-3. Failure

For RCM purposes, three types of failures are defined: functional, evident, and hidden.

#### a. Types of failures.

(1) *Functional failure.* A functional failure is one in which a function of the item is lost. A functional failure directly affects the mission of the system. To be able to determine that a functional failure has occurred, the required function(s) must be fully understood. As part of a Failure Modes and Effects Analysis (FMEA), all functions have been defined. This definition can be very complex for products that have varying levels of performance (e.g., full, degraded, and loss of function).

(2) *Evident failures.* When the loss of a function can be observed or is made evident to the operator, the failure is said to be evident. In the latter case, dials or displays, audible or visual alarms, or other forms of instrumentation alert the operator to the failure.

(3) *Hidden failures.* A hidden failure is a functional failure of an item that has occurred, has not affected performance of the end system, and is not evident to the operator, but will cause a functional failure of the end system if another item fails. In other words, because of redundancy or the nature of the item's function in the system, no single-point failure of the end system has occurred. If, on the other hand, multiple failures occur, then the system will fail to perform its function. A simple example is the system shown in figure 4-1. Either of the two redundant items, A and B, can perform a critical function. Redundancy was used because the function is critical and a single point failure was unacceptable. If either item A or B can fail without the knowledge of the operator, it is considered a hidden failure. The system would now be subject to a single point failure (i.e., the function can be lost by one more failure – the failure of the other redundant component). Hidden failures must be found by maintenance personnel.

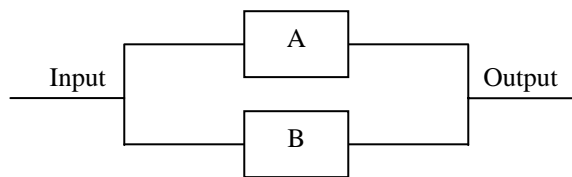

Figure 4-1. Block diagram of a simple redundant system.

b. *Failure consequences.* A basic objective of the RCM analysis is to make decisions regarding the selection of a maintenance action for a specific functional failure of a specific item based on the consequence of the failure. Three categories of failure consequences are generally used. They are safety, operational (mission), and economic.

(1) *Safety.* If a functional failure directly has an adverse affect on operating safety, the failure effect is categorized as Safety. The functional failure must cause the effect by itself and not in combination with other failures. That is, the failure must be a single-point failure. (Note that a hidden failure for which no preventive maintenance is effective and which, in combination with another failure, would

adversely affect safety must be treated as a safety-related failure. The methodology is designed to address this situation).

(2) *Operational*. When the failure does not adversely affect safety but prevents the end system from completing a mission, the failure is categorized as an Operational failure. For many end systems, operational failure results in loss of revenue. In other cases, a critical objective cannot be met. See table 4-1 for examples.

(a) An adverse effect on safety means that the result of the failure is extremely serious or catastrophic. Results can include property damage, injury to operators or other personnel, death, or some combination of these.

(b) In some industries, this category is expanded to include failures that result in a federal statute being violated. An industry such as the petroleum or power industry often includes failures that would result in violations of the Environmental Protection Act. Other industries may include failures with other effects in this category.

Table 4-1. Examples of effects of operational failures

End System	Effect of Operational Failure
Airliner	Airline must cancel flight and either send passengers to another airline or add a flight. In either case, revenue is adversely affected.
Manufacturing equipment	Production must be halted until repairs are made adversely affecting sales. Some orders may be canceled because delivery dates cannot be met (unless no other sources can provide the product to the customers – in that case, loss of customer confidence may result affecting future sales).
Military aircraft	Prolonged or lost conflict, inability to respond to a political crisis in a timely manner, or exposure to a period of vulnerability.
Financial information system	Loss of revenue due to an inability to make timely investments, penalties due to late payments, etc.
C4ISR Facility	Facility can not provide necessary electrical power to support an assigned mission.

(3) *Economic*. When a functional failure does not adversely affect safety and does not adversely affect operations, then the failure is said to have an Economic effect. The only penalty of such a failure is the cost to repair the failure.

**4-4. Reliability modeling and analysis**

The following is a brief discussion of reliability modeling in general and the GO method, used for facilities such as C4ISR facilities. For an in-depth discussion, see TM 5-698-1.

a. *Reliability modeling*. To evaluate the reliability characteristics of a system, and its constituent elements, a model is needed. Table 4-2 lists some of the methods most often used to model reliability.

Table 4-2. Methods for modeling reliability

Method	Comment
Reliability Block Diagram	A method of modeling that uses series and parallel connections to represent a system. The series connections represent opportunities for single point failures. Parallel connections represent redundancy.
Fault Tree	A top-down analysis useful for identifying multiple failure conditions, and the effect of human operation and maintenance on system failure. Useful for developing trouble-shooting procedures.
Single Line Diagram	Used for GO analysis (see paragraph 4-4b).

(1) *Reliability block diagram (RBD)*. Figure 4-2 is an example of an RBD. The system consists of five subsystems. Subsystems B, D, and E are all instances where one failure can cause the system to fail; i.e., each of these subsystems is like the link in a chain and if one fails, the "chain" fails. Subsystems A and C have redundancy. Subsystem A will fail to perform its system function only if both item 1 and 1A fail. Likewise, subsystem C will fail to perform its system function only if both item 3 and 3A fail. If the reliabilities of items 1, 1A, 2, 3, 3A, 4, and 5 are known, the reliability of the system can be calculated (see TM5-698-1).

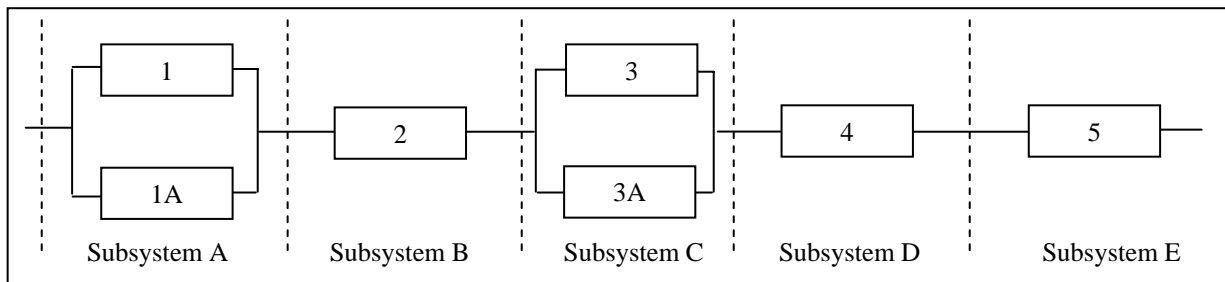

Figure 4-2. Example of a reliability block diagram.

(2) *Fault tree*. Figure 4-3 is an example of a fault tree developed for one type of failure in an elevator (passenger box falls free).

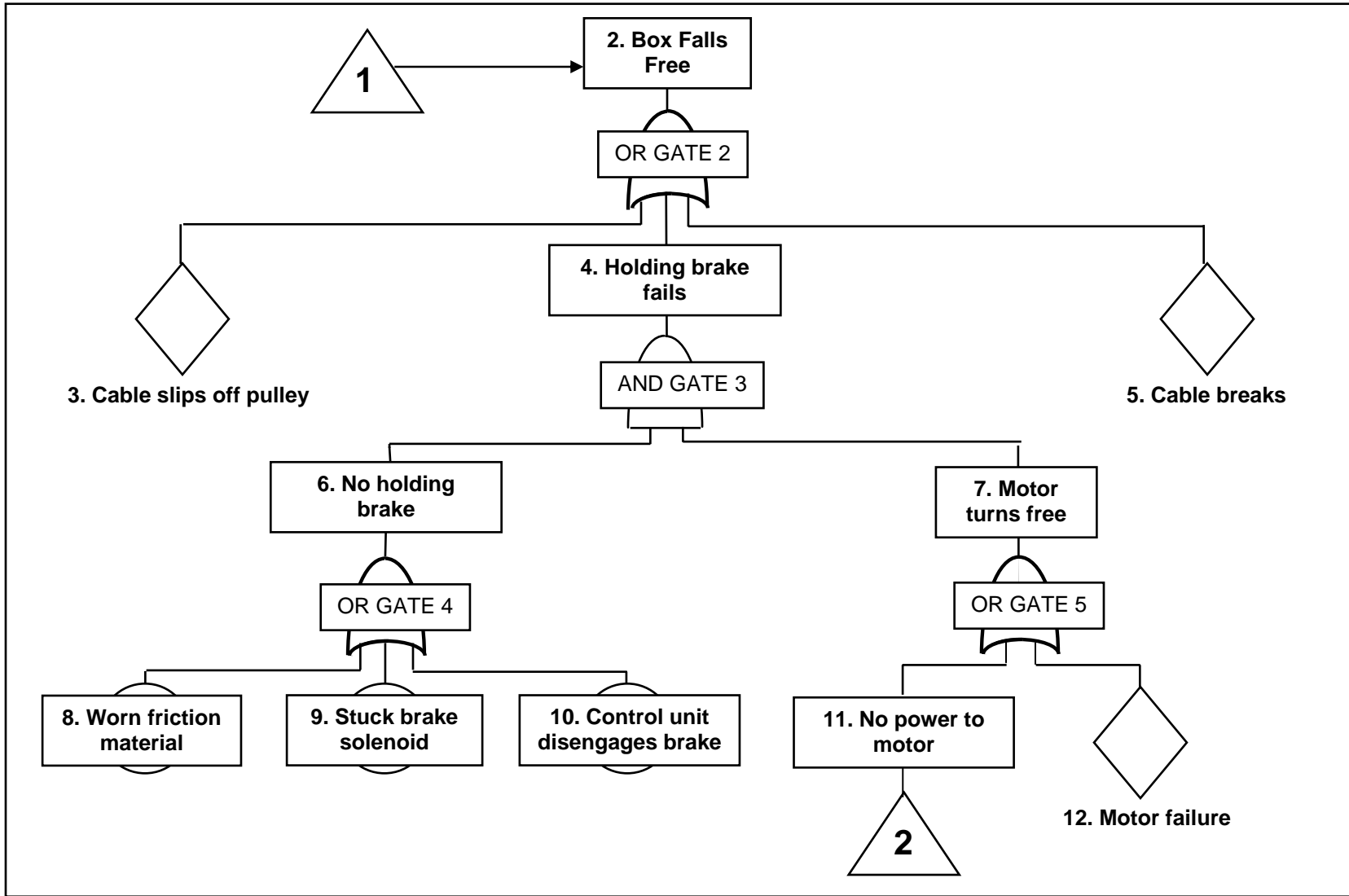

Figure 4-3. Example of a fault tree (from RAC Fault Tree Analysis Application Guide.)

b. *The GO method.* The GO software was originally designed to address the need of availability of nuclear facilities. The GO method, unlike fault tree analysis which focuses on a single system event and uses good/bad elements, is a comprehensive system analysis technique that addresses all system operational modes and is not restricted to two-state elements. GO is not a simulation package but a tool that utilizes the point estimates of component reliabilities to calculate desired system metrics. The GO procedure has been enhanced over the years to incorporate some special modeling considerations, such as system interactions and dependencies, as well as man-machine interactions. Key features of the GO method are listed in table 4-3.

*Table 4-3. Key features of the GO method*

- |                                                                                                                                                                                                                                                                                                                                                                                                                                                                                                                                                                                                                                                                   |
|-------------------------------------------------------------------------------------------------------------------------------------------------------------------------------------------------------------------------------------------------------------------------------------------------------------------------------------------------------------------------------------------------------------------------------------------------------------------------------------------------------------------------------------------------------------------------------------------------------------------------------------------------------------------|
| <ul style="list-style-type: none"> <li>• Models follow the normal process flow;</li> <li>• Most model elements have one-to-one correspondence with system elements;</li> <li>• Models accommodate component and system interactions and dependencies;</li> <li>• Models are compact and easy to validate;</li> <li>• Outputs represent all system success and failure states;</li> <li>• Models can be easily altered and updated;</li> <li>• Fault sets can be generated without altering the basic model;</li> <li>• System operational aspects can be incorporated; and</li> <li>• Numerical errors due to pruning are known and can be controlled.</li> </ul> |
|-------------------------------------------------------------------------------------------------------------------------------------------------------------------------------------------------------------------------------------------------------------------------------------------------------------------------------------------------------------------------------------------------------------------------------------------------------------------------------------------------------------------------------------------------------------------------------------------------------------------------------------------------------------------|

c. *Single line diagram.* The first step to performing an analysis with GO is to develop the one line drawing that represents the system. The single line diagram provides the analyst the path that must be modeled by GO to accurately represent the physical and logical equipment of the system. Figure 4-4 represents a single line diagram of the IEEE Gold Book Standard Network System.



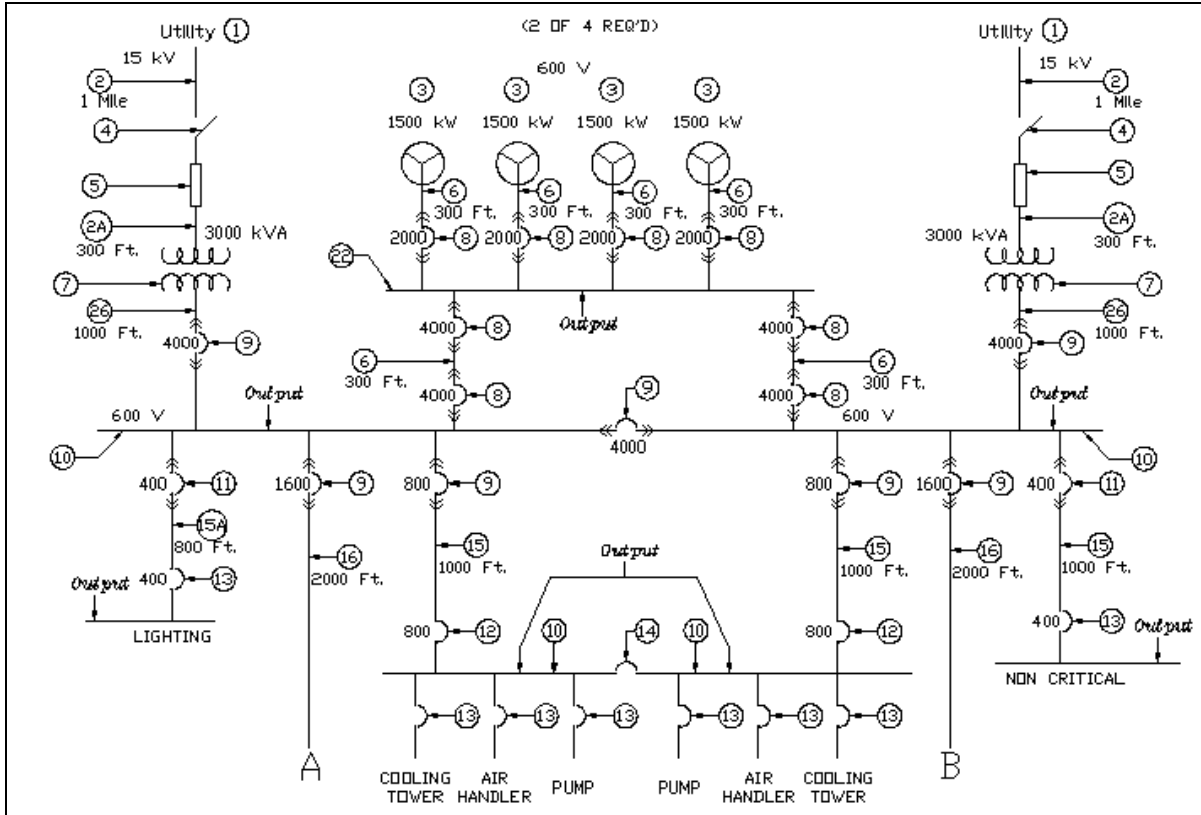

Figure 4-4. Example of a single line diagram (from IEEE Gold Book Standard Network).

## CHAPTER 5

### THE RELIABILITY-CENTERED MAINTENANCE PROCESS

---

#### 5-1. Overview

The overall RCM process was introduced in chapter 2 and is depicted in the process flow chart, figure 2-1. This chapter will describe in more detail how the process is implemented.

#### 5-2. C4ISR candidates for RCM analysis

Is important to note from the onset that an RCM analysis is not beneficial for all products. The criteria listed in table 5-1 will help the analyst determine if an RCM analysis is potentially of value. There are three major systems comprising C4ISR facilities that are candidates for RCM analysis, mechanical systems, electrical systems, and control systems. All three combine to support the facilities mission and provide the necessary environmental conditions to maintain operation of critical equipment and personnel. All of the components shown in paragraph 5-2 are candidates for RCM optimization and require a maintenance program geared toward the mission requirement of the facility.

*Table 5-1. Criteria for applying RCM to products*

Criteria	Comment
Product has or is projected to have a large number of PM tasks.	Existing product already in service or new system for which the PM tasks were identified using an approach other than RCM.
Product maintenance costs are or are projected to be very high.	Existing product already in service. PM tasks either identified using an approach other than RCM or RCM requires updating. New system for which maintenance tasks were identified using an approach other than RCM.
Product requires or is projected to require frequent corrective maintenance.	Existing product already in service. PM program may be inadequate; either identified using an approach other than RCM or RCM requires updating. New system for which maintenance tasks were identified using an approach other than RCM.
Hazardous conditions could result from failure.	New product, or existing product for which the PM tasks were identified using an approach other than RCM.

a. *Mechanical systems.* The types of mechanical systems typical for a C4ISR facility include those shown in table 5-2.

*Table 5-2. Types of mechanical systems typical for a C4ISR facility*

<ul style="list-style-type: none"> <li>• Chillers</li> <li>• Cooling towers</li> <li>• Valves</li> <li>• Piping</li> </ul>	<ul style="list-style-type: none"> <li>• Boilers</li> <li>• HVAC distribution equipment including Fan Coil Units</li> </ul>
----------------------------------------------------------------------------------------------------------------------------	-----------------------------------------------------------------------------------------------------------------------------

(1) *Other systems.* Mechanical systems also include generators, fuel oil delivery systems and storage and pumping components. These are critical to the mission of the facility but are frequently neglected.

(2) *Temperatures.* Mechanical systems not only maintain a comfortable environment for the occupants but are also designed to maintain optimal equipment operating temperatures.

b. *Electrical systems.* Electrical systems begin at the transformer feeding the building or the 13.8 v feeder and continue through the entire distribution system generally to the panels containing the 208 or 220/120-volt distribution. Some facility mission requirements require solutions all the way to the operating equipment at the wall outlet. Typical components comprising the electrical system include those shown in table 5-3.

*Table 5-3. Typical components comprising the C4ISR facility electrical system*

<ul style="list-style-type: none"> <li>• Transformers, liquid filled and air cooled</li> <li>• Connections</li> <li>• Cables</li> <li>• Switch Gear</li> <li>• Circuit Breakers</li> </ul>	<ul style="list-style-type: none"> <li>• Motor Control Centers</li> <li>• Motors</li> <li>• Cable Connections</li> <li>• UPS systems including Gel and Wet Cell Lead Acid Batteries</li> </ul>
--------------------------------------------------------------------------------------------------------------------------------------------------------------------------------------------	------------------------------------------------------------------------------------------------------------------------------------------------------------------------------------------------

c. *Control systems.* Control systems are the third major component making a C4ISR facility as reliable as possible. Control systems are the brains behind the operational characteristics during normal and abnormal conditions. Control systems are commonly identified as Supervisory Control and Data Acquisition (SCADA) systems and are designed to monitor conditions and react in a manner to maintain a set point. Typical SCADA systems are comprised of a series of sensors sending signals to a central command center where the signals are interpreted. Signals are sent from the command center to actuators to throttle input conditions and provide the necessary environmental condition required for the mission operations. Typical components for a SCADA system are shown in table 5-4.

*Table 5-4. Typical components for a SCADA system*

<ul style="list-style-type: none"> <li>• Computer access panel</li> <li>• Digital drivers</li> <li>• Power Supplies</li> <li>• PLC</li> <li>• Interface devices such as control panels or flying circuit breakers.</li> </ul>
-------------------------------------------------------------------------------------------------------------------------------------------------------------------------------------------------------------------------------

**5-3. RCM data sources**

Conducting an RCM analysis requires an extensive amount of information. Since much of this information is not available early in the design phase, RCM analysis for a new product cannot be completed until just prior to production. Table 5-5 lists some general sources of data for the RCM analysis. The data elements from the Failure Modes and Effects Analysis (FMEA) that are applicable to RCM analysis are highlighted in paragraph 5-5b. Note that when RCM is being applied to a product already in use, or when a maintenance program is updated during Life Exploration, historical maintenance and failure data will be inputs for the analysis.

Table 5-5. General data sources for the RCM analysis

Data Source	Comment
Lubrication requirements	Determined by designer. For off-the-shelf items being integrated into the product, lubrication requirements and instructions may be available.
Repair manuals	For off-the-shelf items being integrated into the product.
Engineering drawings	For new and off-the-shelf items being integrated into the product.
Repair parts lists	
Quality deficiency reports	For off-the-shelf items being integrated into the product.
Other technical documentation	For new and off-the-shelf items being integrated into the product.
Recorded observations	From test of new items and field use of off-the-shelf items being integrated into the product.
Hardware block diagrams	For new and off-the-shelf items being integrated into the product.
Bill of Materials	For new and off-the-shelf items being integrated into the product.
Functional block diagrams	For new and off-the-shelf items being integrated into the product.
Existing maintenance plans	For off-the-shelf items being integrated into the product. Also may be useful if the new product is a small evolutionary improvement of a previous product.
Maintenance technical orders/manuals	For off-the-shelf items being integrated into the product.
Discussions with maintenance personnel and field operators	For off-the-shelf items being integrated into the product. Also may be useful if the new product is a small evolutionary improvement of a previous product.
Results of FMEA, FTA, and other reliability analyses	For new and off-the-shelf items being integrated into the product. Results may not be readily available for the latter.
Results of Maintenance task analysis	For new and off-the-shelf items being integrated into the product. Results may not be readily available for the latter.

a. *C4ISR data sources.* RCM related data may be obtained from several different types of sources. Some potential sources of maintainability data include those shown in table 5-6.

Table 5-6. Potential sources of C4ISR maintainability data

- |                                                                                                                                                                                                                                                                                      |
|--------------------------------------------------------------------------------------------------------------------------------------------------------------------------------------------------------------------------------------------------------------------------------------|
| <ul style="list-style-type: none"> <li>• Historical data from similar products used in similar conditions (PREP Database, IEEE Gold Book)</li> <li>• Product design or manufacturing data</li> <li>• Test data recoded during demonstration testing</li> <li>• Field data</li> </ul> |
|--------------------------------------------------------------------------------------------------------------------------------------------------------------------------------------------------------------------------------------------------------------------------------------|

(1) *Expressing data.* The data maybe expressed in a variety of terms. These include observed values or modified values (true, predicted, estimated, extrapolated, etc.) of the various maintainability measures. Some precautions are therefore necessary regarding the understanding and use of such data as shown in table 5-7.

Table 5-7. Understanding and using different sources of data

- Historical – Used primarily during the concept definition phase to generate specifications requirements. In latter phases historical data may be compared with actual data obtained for the product. They can also serve as additional sources of information for maintainability verification.
- Product Design and Manufacturing – Data obtained through the use of design analysis or prediction, or from data generated during the design phase or the manufacturing phase. Design data may be used as the basis for product qualification and acceptance, review and assessment of historical data relevancy and the validity or previous assessments. Before this type of data is used in your analysis you must understand the data collection and analysis methodology, why the specific method was chosen, and any possible limitations.
- Product Demonstration and Field – These data are essential for sustaining engineering activities during the in-service phase of the system life cycle. They include maintainability related data obtained from formal or informal demonstration test on mock-ups, prototypes or production equipment in either a true or simulated environment or data generated during actual item use.

(2) *Other data categories.* Other categories of data that would be beneficial to collect include information on the maintenance support conditions. Operational maintainability may not be determined solely by inherent maintainability, but by logistical factors. Therefore information to be collected should include shortages in spares (due to inadequate initial provisioning, long pipeline times, etc.), test resources, and human resources. Such data are important to determine why a system's maintainability as measured in the field, may not be meeting the values expected based on the design data.

(3) *SCADA systems.* SCADA systems are excellent data collection mechanisms, providing the system is initially design to capture critical information. It can also be utilized to monitor trends of component operational conditions to provide information on proactive logistics supplies.

#### 5-4. PM tasks under RCM

a. *Lubrication and servicing task.* Many mechanical items in which movement occurs require lubrication. Examples include internal combustion engines that require oil and periodic replacement of that oil (and associated filters). Lubrication and servicing tasks are sometimes overlooked due their relative simplicity and because they are "obvious." Prior to the latest version of the airline's RCM approach, lubrication and servicing tasks were often omitted from the decision logic tree, with the understanding that such tasks cannot be ignored. In the current MSG-3, these tasks are explicitly included in the decision logic, as they are in this document.

b. *Inspection or functional check task.* Inspections normally refer to examinations of items to ensure that no damage, failure, or other anomalies exist. Inspections can be made of: an entire area (e.g., the body or "under the hood"), a subsystem (e.g., the engine, controls, or feed mechanism), and a specific item, installation, or assembly (e.g., the battery, shaft, or flywheel).

(1) *Visual inspections or checks.* These are checks conducted to determine that an item is performing its intended function. The check may be performed by physically operating the item and observing parameters on displays or gauges, or by visually looking to see if the function is being performed properly. In neither case are quantitative tolerances required. A functional check consists of operating an item and comparing its operation with some pre-established standard. Functional checks often involve checking the output of an item (e.g., pressure, torque, voltage, or power) and checking to determine if the output is acceptable (i.e., within a pre-established range, greater than a pre-established

minimum value, or less than a pre-established maximum value). These checks are conducted as failure-finding tasks.

(2) *Use of NDI.* Inspections may consist of purely visual examinations or be made using special techniques or equipment. Many inspections require the special capability of non-destructive inspection (NDI) techniques. Table 5-8 lists some of the NDI methods available to maintenance personnel.

c. *Restoration task.* Many items, primarily mechanical, wear out as they are used. At some point, it may be necessary, and possible, to restore the item to "like new" condition. Examples include internal combustion engines, electric motors, and pumps.

d. *Discard task.* Some items upon failure or after their useful life has been reached (i.e., they are worn out), cannot be repaired or restored. These items must be discarded and replaced with a new item identical in function. Examples include seals, fan belts, gaskets, screws (stripped threads), and oil filters.

### **5-5. The RCM process**

The objective of conducting an RCM analysis is to rank all included equipment and systems by their relative importance, and risk, to the overall facility mission, and to prescribe PM tasks based on subsystem and system ranking. The RCM process is outlined below, by an expanded figure 2.1, and following text.

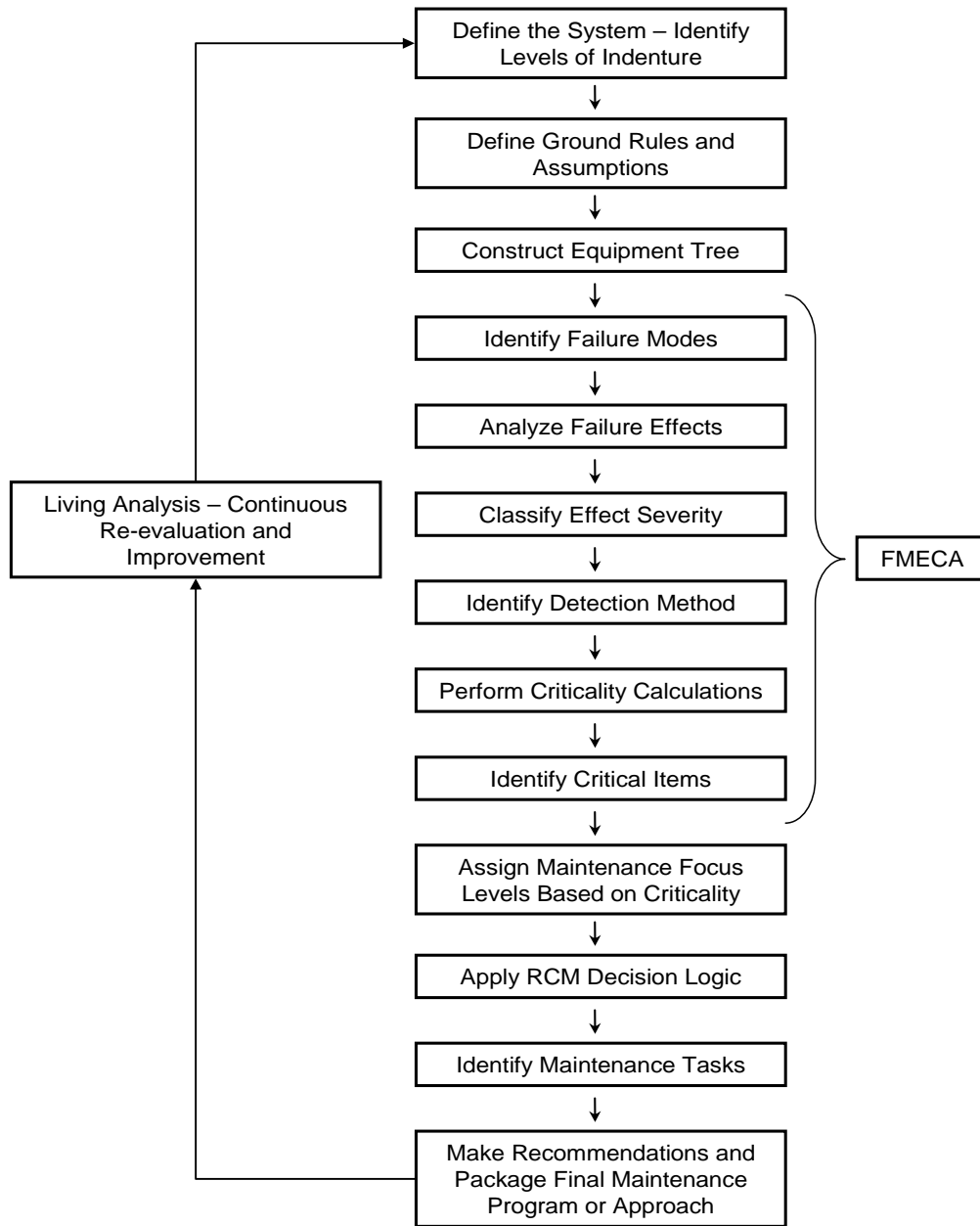

- **Define the System** – Identify and document the boundaries of the analysis
  - Identify and document equipment included in the analysis
  - Identify and document the indenture level the analysis is intended to extend to
- **Define Ground Rules and Assumptions** – Identify and document ground rules and assumptions used to conduct the analysis
- **Construct Equipment Tree** – Construct equipment block diagrams to indicate equipment configuration, down to the lowest indenture level intended to be covered by the analysis
- **Identify Failure Modes** – Identify the potential failure modes for the analyzed equipment at the indenture levels covered by the analysis

- **Analyze Failure Effects** – Analyze the effects of the identified failure modes on the lowest levels of indenture and above
- **Classify Effect Severity** – Classify the effects of the identified failure modes on the lowest levels of indenture and above
- **Identify Detection Method** – Identify and classify the methods, in place, by which potential failures may be detected or avoided
- **Perform Criticality Calculations** – Perform Criticality Analysis
- **Identify Critical Items** – Identify items within the analysis that ranked highly critical
- **Assign Maintenance Focus Levels** – Classify maintenance focus levels based on criticality rankings
- **Apply RCM Decision Logic** – Apply RCM logic trees for items, especially those identified as being critical (see figure 5-2)
- **Identify Maintenance Tasks** – Identify maintenance tasks to be performed on the given item
- **Package Maintenance Program** – Develop a maintenance tasking schedule for the analyzed equipment

Note: RCM Analysis is intended to be a living analysis. Effort should be made to continue to collect more complete information and add it to the analysis, to continue to provide a foundation for effective continuous improvement. Results and recommendations should be periodically reviewed and re-evaluated, taking into consideration additional information of any kind.

*a. Identify the system configuration.* Since the RCM analysis usually begins before the final design has been completed, the system configuration is changing. Even when the design is complete, model changes can be made. The configuration, of course, determines how functions are performed, the relationship of items within a product, and so forth. Consequently it is important that the precise configuration of the product or system for which the RCM analysis is being conducted be documented as part of the analysis. It is also important that the analysis be updated to account for any changes in the configuration (some of which may be required as a direct result of the RCM analysis itself).

*b. Perform an FMEA and other analyses.* To perform the RCM analysis, many pieces of information are needed. These include the information shown in table 5-9. Obviously, such information will probably not be known or be very shaky early in design. For that reason, the RCM analysis should not be started until sufficient and reasonably stable information is available. Of course, the objective is to develop and complete the initial maintenance program prior to the product being transferred to the customer.



RCM Analysis can be conducted using a traditional quantitative, qualitative, or flexible approach.

- Traditional quantitative approach can be used when there is sufficient failure rate data available to calculate criticality numbers. A quantitative approach is the preferred analysis method. However, to be effective, high levels of failure specific data must be available. When specific failure rates for specific failure modes and failure mechanisms are unavailable, analysis must be conducted qualitatively.
- Qualitative analysis must be used when specific part or item failure rates are not available. Therefore, failure mode ratio and failure mode probability are not used in this analysis. Instead, the equipment is ranked in terms of discrete occurrence levels. Under traditional qualitative analysis severity, occurrence, and detection method levels are determined subjectively and utilized to produce a component risk assessment.
- The flexible technique is born of traditional qualitative analysis. Under this approach, RPN calculations will be generated by the same formulas as given by traditional qualitative approach. However, the arguments of the component level RPN calculation (O, S, D) will be defined differently.

$$RPN = O \times S \times D$$

Where:

- RPN = Risk associated with failure mode (Risk Priority Number)
- S = Severity level for failure mode (subjective)
- O = Occurrence level for failure mode (Reliability Data)
- D = Detection method level (Subjective)

(1) *Other inputs.* When FTAs are needed to understand the effects of, for example, multiple failures, the information derived from these analyses can also be valuable inputs to the RCM analysis.

Table 5-8. NDI techniques

Main Application / NDE Method		C	W	F	CR	E	L	MA	MC	S	D	MT	DT	PR	OTHER	Remarks
1	Acoustic cross correlation						X									Locating buried pipes
2	Acoustic emission	X		X			X		X		X				X	Internal structural noise
3	Coating thickness												X		X	Magnetic methods and eddy currents. Ferrite content of ferritic-austenitic steels
4	Dye penetrant	X		X			X									Including the chalk, water, alcohol methods
5	Eddy current testing	X	X	X	X	X	X				X	X			X	Heat exchanger tubes, wire rope, surface checks, sorting
6	Emission spectroscopy (Metascope)							X								Low and high alloy steels. Including X-ray fluorescence
7	Endoscopy	X	X	X	X	X	X						X	X		Inspection of internal surface
8	ER-probe				X											Average corrosion rates
9	Ferrography		X													Lubricated mechanical systems
10	Hardness testing								X							Brinell, Vickers, Rockwell B, C&N, Rockwell superficial, Knoop, Shore, Scleroscope, Equotip, UCI
11	Hydrogen cell				X											Average corrosion rates
12	Isotope techniques		X				X		X			X	X	X	X	Tracer tech., ball test, radiometry, collim. Photon
13	Laser distance measurements (optocator)		X									X			X	Topography, symmetry
14	Leak testing resistance						X								X	Liquid penetrant, ultrasonics, pressure change, foam, tracers, sulphur diffusion, ozalide paper, halogen
15	LPR-probe, polarization				X											Instantaneous corrosion rate
16	Magnetic plugs		X													Lubricated mechanical systems
17	Magnetic particle examination	X													X	Weld defects, laminations – only ferromagnetic materials
18	Mechanical calibration		X		X	X						X	X		X	Physical dimensions
19	NDE method combination	X	X	X	X	X	X	X	X	X	X	X	X	X	X	Check of entire component condition. Predictive programs
20	NDE meth. under. dev.	(X)						(X)	(X)	(X)					(X)	
	20.1 SPAT									X						Stress pattern analysis by thermal emission
	20.2 Pulsed video thermography (PVT)							X							X	Composite materials. Glued metals, delamination, and coatings.

Table 5-8. NDI techniques (Cont'd)

Main Application NDE Method		C	W	F	CR	E	L	MA	MC	S	D	MT	DT	PR	OTHER	Legend: C = Cracks; W = Wear; F = Fractures; CR = Corrosion; E = Erosion; L = Leaks; MA = Material Analysis; MC = Material Conditions; S = Stress; D = Deformation; MT = Material Thickness; DT = Deposit Thickness; PR = Physical Restrictions Remarks
		Remarks														
20.3	Moire contour										X				X	Topography
20.4	Holographic interferometry (HI)									X					X	Lack of adhesion, material defects, thin samples
20.5	Computerized tomography (CT)	X													X	Annual rings, knots, moisture, concrete column cross sections
20.6	Positron annihilation								X						X	Voids in metals. Fatigue in titanium
21	Noise measurements														X	Noise level, bearing checks
22	Pattern recognition	X	X	X	X	X					X	X	X	X		
23	P-scan	X	X	X	X	X						X			X	Weld inspection, stress corrosion, corrosion topography, creep defects. Full documentation
24	Pinhole														X	Coatings, high/low voltage
25	Pressure testing	X		X			X				X					Including vacuum testing. See also leak
26	Radiography	X	X	X	X	X	X					X	X	X	X	Check of joints, geometry, laminations, reinforced concrete and corrosion/erosion
27	Replica technique	X	X	X					X		X				X	Surface microstructure, crack type, wear grooves, topography
28	Spectrometric oil analysis program		X													Lubricated mechanical systems
29	Strain gauge technique									X	X					Weight, pressure, oscillation
30	Stroboscopy	X	X	X											X	Visual condition monitoring, rotation direction and rate
31	Test coupons				X	X										Average corrosion rate
32	Thermography	X			X		X						X		X	Surface temp., bearing pressure, moisture, energy loss
33	Ultrasonic lea, detection						X								X	Electrical discharge, flow
34	Ultrasonics	X	X	X	X	X	X		X	X	X	X				Including sound attenuation
35	Vibration monitoring	X	X	X											X	Machinery include bearings, gears, turbines, centrifuges, etc.
36	Visual inspection	X	X	X	X	X	X	X			X		X	X		Spark pattern & chemical analysis
37	X-ray crawlers														X	Checking welds inside pipes
38	X-ray diffraction									X						Measurement residual stresses

Table 5-9. Information needed for RCM

<p>The types of failures that can occur in the product</p> <p>The failure characteristics of the items that make up the product being analyzed</p> <p>The nature of the failures (hidden, evident, safety, operational, etc.)</p> <p>The capabilities of the maintenance organization</p> <p>The maintenance concept</p> <p>A thorough understanding of operation</p>
-----------------------------------------------------------------------------------------------------------------------------------------------------------------------------------------------------------------------------------------------------------------------------------------------------------------------------------------------------------------------

(2) *Other information.* Other important sources of information for the RCM analysis include Reliability Block Diagrams (RBDs), Functional Block Diagrams, system requirements documents, descriptions of system applications, technical manuals/drawings/layouts, and indenture level identification system.

(3) *Sources.* To provide the needed information, various sources must be exploited. One of the most obvious sources is the body of analyses conducted as part of the design process. These include the Failure Mode and Effects Analysis (FMEA) or Failure Modes, Effects, and Criticality Analysis (FMECA), Fault Tree Analysis (FTA), maintainability analysis, and so forth.

(4) *FMEA.* The FMEA can be a primary source of much of the information needed for the RCM analysis. Figure 5-1 shows excerpts of the form prescribed in the Automotive Industry Group standard on FMEA/FMECA. Upon examining figure 5-1, it is obvious that the data in many of the columns can be directly used for the RCM analysis. The columns having data most applicable for the RCM analysis are shaded. In addition to those shown, columns can be added for functions, functional failure, compensating provisions, and three columns for failure effects: local effects, next higher level, and end effects. Other chart examples for recording FMECA data can be used as shown in figure 5-1a. Further information is available in TM 5-698-4, Failure Modes, Effects and Criticality Analysis (FMECA) for C4ISR Facilities.

Form from the Automotive Industry Group Standard on FMEA

Item/Function	Potential Failure Mode(s)	Potential Effect(s) of Failure	SEV	CLASS	Potential Cause(s)/Mechanisms of Failure	OCC	Current Design Controls	DET	RPN	Recommended Action(s)	Responsibility & Target Completion Date	Action Results				
												Action Taken	New Sev	New Occ	New Det	New RPN

Figure 5-1. Data elements from FMEA that are applicable to RCM analysis.

- Legend: SEV – Severity of failure effect  
 OCC – Probability of occurrence  
 DET – Method of detection  
 RPN – Risk Priority Number

A completed chart may be similar to the following example:

ITEM NUMBER	ITEM/FUNCTIONAL ID	POTENTIAL FAILURE MODES	FAILURE MECHANISM (CAUSE)	SEVERITY	FAILURE RATE $\lambda_p$ (SOURCE)	DETECTION METHOD	CRITICALITY NUMBER ( $C_M$ )
130.2	Cooling Tower #1/ maintain a water temp of 75°F.	Fan failure	Motor winding open, Loss of power to motor	3	$10.0518 \times 10^{-6}$	3	$99.05 \times 10^{-5}$
310.1	Air Handler/ Provide 3200cfm of air to room, maintain room at 72°F,	Provide airflow at a rate less than 3200cfm	reduced motor output – winding degradation, belt slippage- belt too loose, loose sheave, Dirty intake filter	3	$1.7657 \times 10^{-6}$	2	$1.06 \times 10^{-5}$
310.0	Air Handler/ Provide 3200cfm of air to room, maintain room at 72°F,	Maintain air at a temp higher than 72°F	Dirty coils	3	$1.7657 \times 10^{-6}$	7	$3.7 \times 10^{-5}$

DA FORM 7610 AUG 2006

Figure 5-1a. Example of Failure Modes and Effects Analysis worksheet; DA Form 7610.

Where:

- Failure modes are the generic manner in which an item failed
- Failure mechanisms are the specific circumstances that allowed the given failure mode to occur
- Severity is the assessment of the consequence of a given failure
- Occurrence is the probability of the failure occurring (failure rate)

c. *Apply RCM decision logic.* The overall decision logic for applying the RCM methodology is depicted in figure 5-2. The decision logic represented in this figure is adapted from that used in the Reliability Analysis Center's Master Steering Group -3 (MSG-3). The most significant difference is in the portions of the tree labeled ②, ④, ⑦, and ⑧. MSG-1 through MSG-3 (see paragraph 1-6) used the term "safety" for these portions of the tree.

(1) *Safety.* Obviously, safety is of paramount importance to the airline industry, as it is in other industries, such as the nuclear power industry.

(2) *Other Critical Considerations.* Many industries have concerns that are as important, or nearly so, as safety considerations. The petroleum and chemical industries, for example, are subject to severe economic and even criminal penalties under Federal statutes for events in which the environment is polluted. For other industries, failures that result in the violation of other Federal, state, or local statutes, or in other unacceptable consequences may be treated as seriously as safety-related failures are in the airline industry. For that reason, in the portions of the tree labeled ②, ④, ⑦, and ⑧, the term "hazardous effects" is used rather than "safety effects". (The circled numbers in this and following discussions refer to a corresponding numbered portion of the referenced figures.) When applying RCM decision logic, it is important to consider the criticality of the current item. Highly critical items have the direct potential to compromise mission goals, and risk should be heavily mitigated. It is important to recognize single point failures, as well as their functional contribution to critical and non-critical systems, and to prescribe maintenance approaches accordingly. Conversely, some items recognized as being very non-critical may be allowed to run to failure, especially non-critical items that are inherently very reliable. This viewpoint should also be incorporated into the use of RCM decision logic to build an intelligent, and cost effective, maintenance strategy.

d. *Use of Logic Tree.* As can be seen from figure 5-2, the decision logic tree consists of a series of Yes-No questions. The answers to these questions lead to a specific path through the tree. The questions are structured to meet the objectives of the RCM analysis: ensure the safe (non-hazardous) and economical operation and support of a product while maximizing the availability of that product. This objective is met by selecting preventive maintenance (PM) tasks when appropriate, redesign, some combination of PM and redesign, and by corrective maintenance (CM) when PM is either applicable or effective.

(1) The first question asked is "Is the occurrence of a functional failure evident to the operator (or user) during normal use?" A "No" answer means that the failure is hidden, and the analyst is directed to ⑦ in the tree. The portion of the tree below ⑦ is discussed under paragraphs 5-5h and 5-5i. A "Yes" answer means that the failure can be observed or is made known to the operator/user, in which case, the analyst is directed to ②.

(2) At ②, the question is "Does the (evident) functional failure or secondary damage resulting from the functional failure have a direct and hazardous effect?" A "Yes" answer directs the analyst to ④. The portion of the tree below ④ is discussed under paragraph 5-5e. A "No" answer directs the analyst to ③. The portion of the tree below ③ is discussed under paragraphs 5-5f and 5-5g.

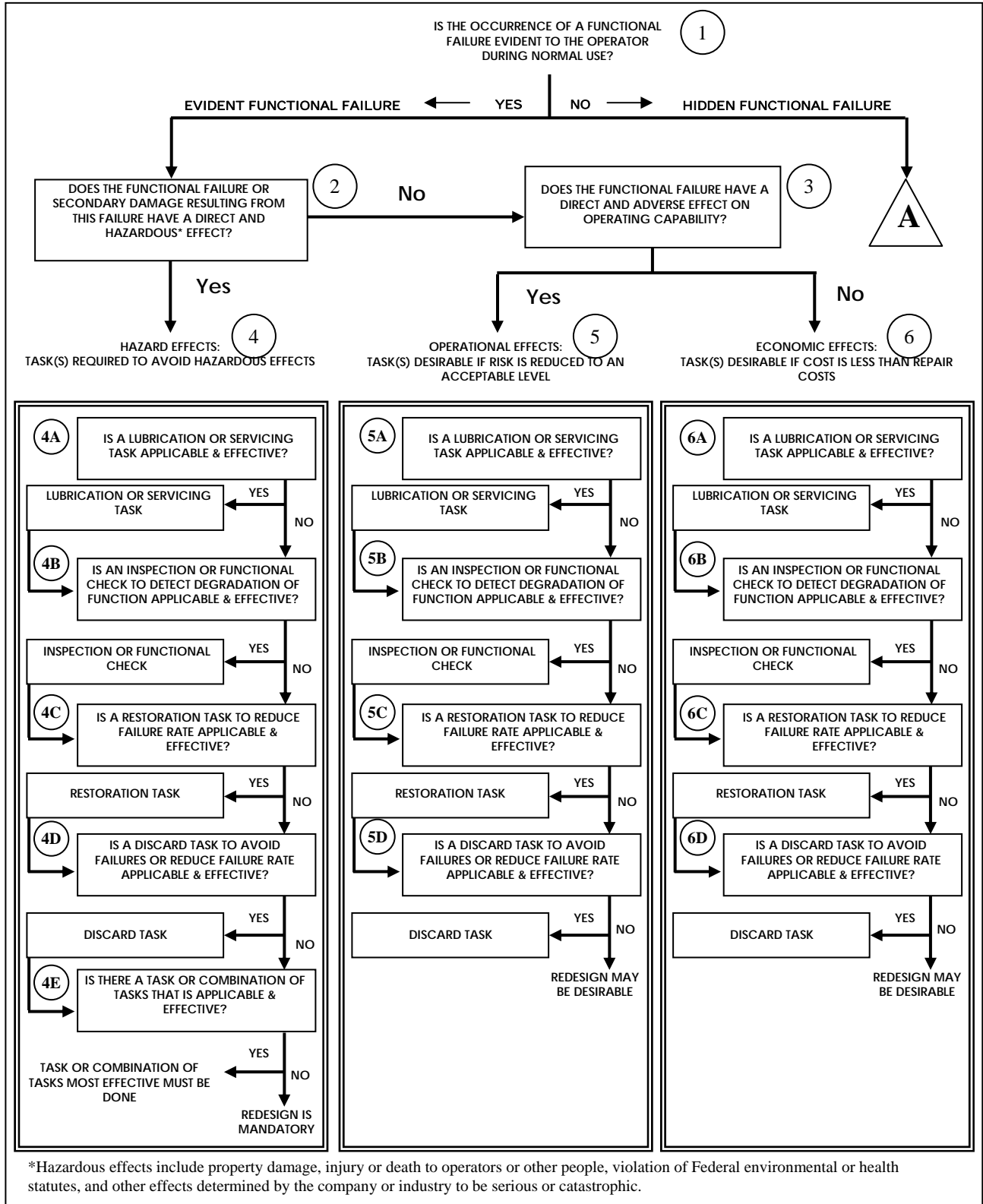

Figure 5-2. RCM decision logic tree (adapted from MSG-3).

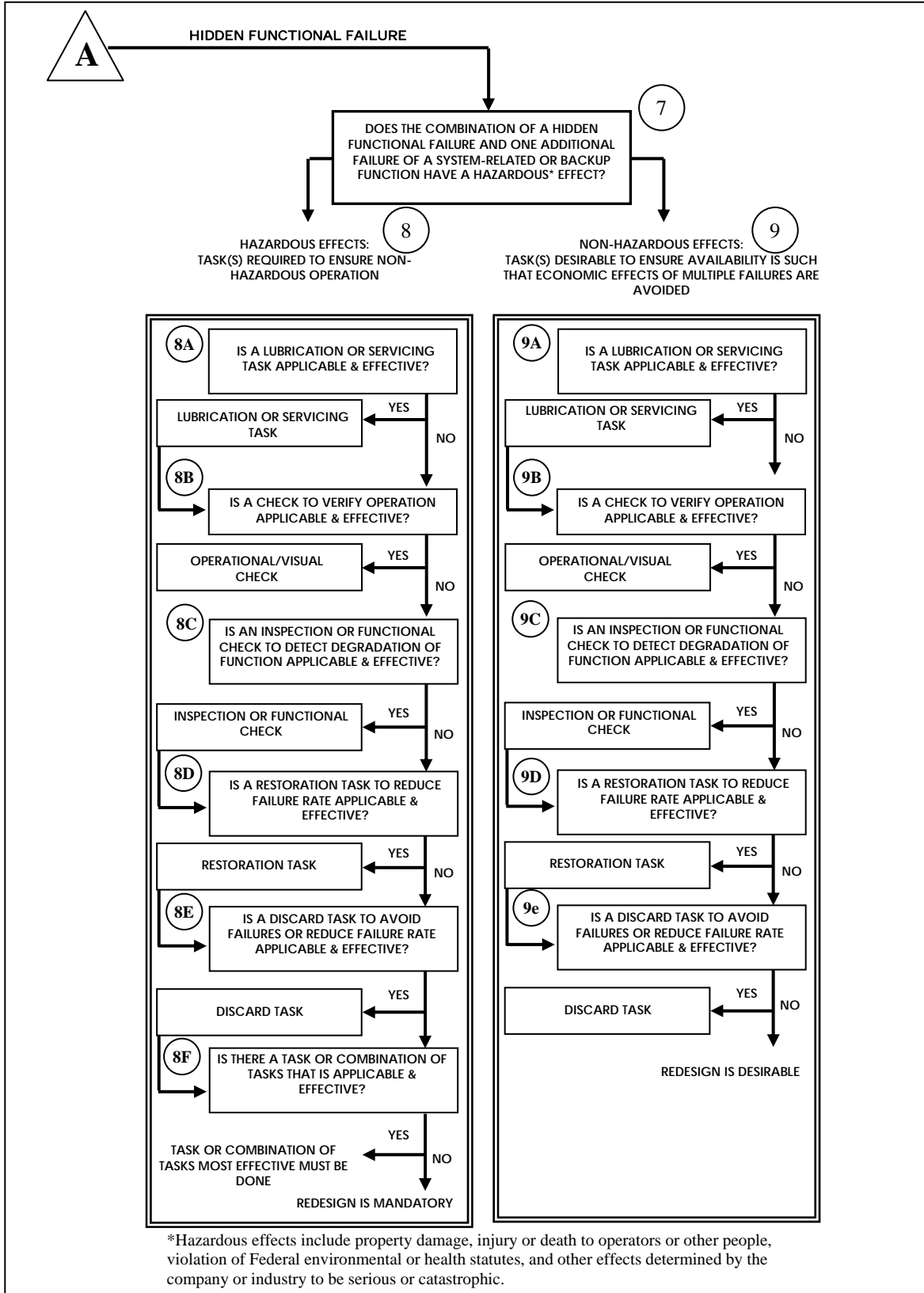

Figure 5-2. RCM decision logic tree (adapted from MSG-3) (Cont'd).



*e. Evident Failure – Hazardous Effects.* The portion of the decision logic tree that deals with situations where an evident functional failure has hazardous effects is shown in figure 5-3.

(1) This portion of the tree steps the analyst through a series of questions intended to identify any and all PM tasks that will reduce to an acceptable level the probability of occurrence of the functional failure that results in the effects, reduce the effects to purely operational or economic effects, or result in a combination of these two improvements.

(2) If none of the PM tasks listed is either applicable or effective, then redesign is mandatory. The reason for making redesign mandatory is obvious. The effects categorized as "hazardous" are unacceptable. Consequently, when PM cannot fulfill any of the objectives listed, we must redesign the product to eliminate the mode of failure that causes the hazardous effects, reduce to an acceptable level the probability of occurrence of the functional failure that results in the effects, or result in a combination of these two improvements.

2  
 ↓  
**HAZARDOUS EFFECTS:** 4  
**TASK(S) REQUIRED TO ENSURE NON-HAZARDOUS OPERATION**

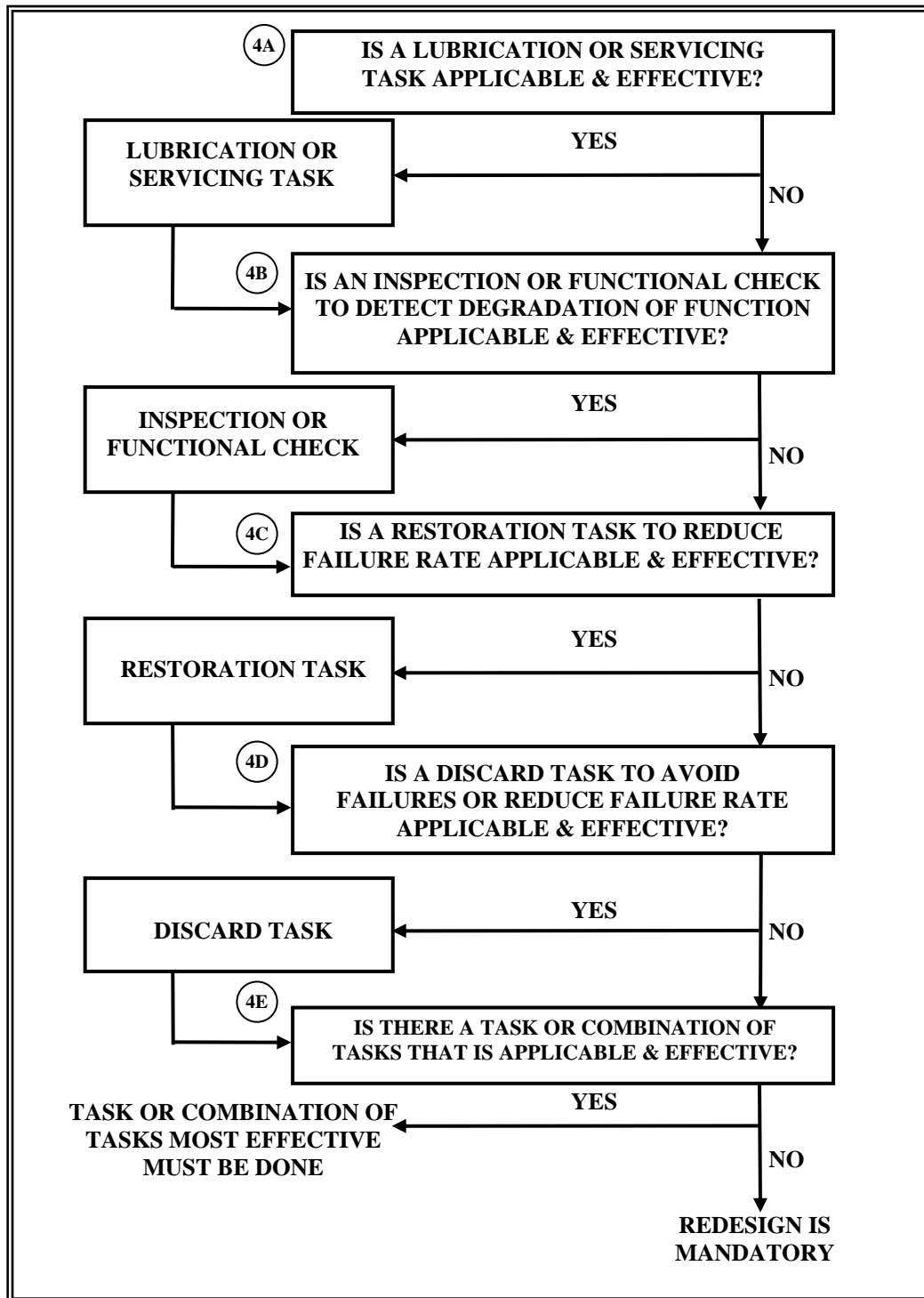

Figure 5-3. Evident failure – hazardous effects.

f. *Evident Failure – Operational Effects.* The portion of the decision logic tree that deals with situations where an evident functional failure has a direct and adverse effect on operating capability is shown in figure 5-4. This portion of the tree steps the analyst through a series of questions intended to identify any and all PM tasks that will reduce the risk of failure to an acceptable level. If none of the PM tasks listed is either applicable or effective, then redesign may be desirable. The cost of a functional failure that results in operational effects includes both the cost of the PM and the economic cost incurred as a result of the end system not completing a mission or being able to perform its function(s).

(1) If the costs exceed the cost to redesign the product, redesign is economically justified. The purpose of the redesign would be to eliminate the mode of failure that causes the operational effects, reduce to an acceptable level the probability of occurrence of the functional failure that results in the effects, or some combination of these.

(2) Even if redesign is economically justified, other considerations, such as schedule, may outweigh the advantages gained.

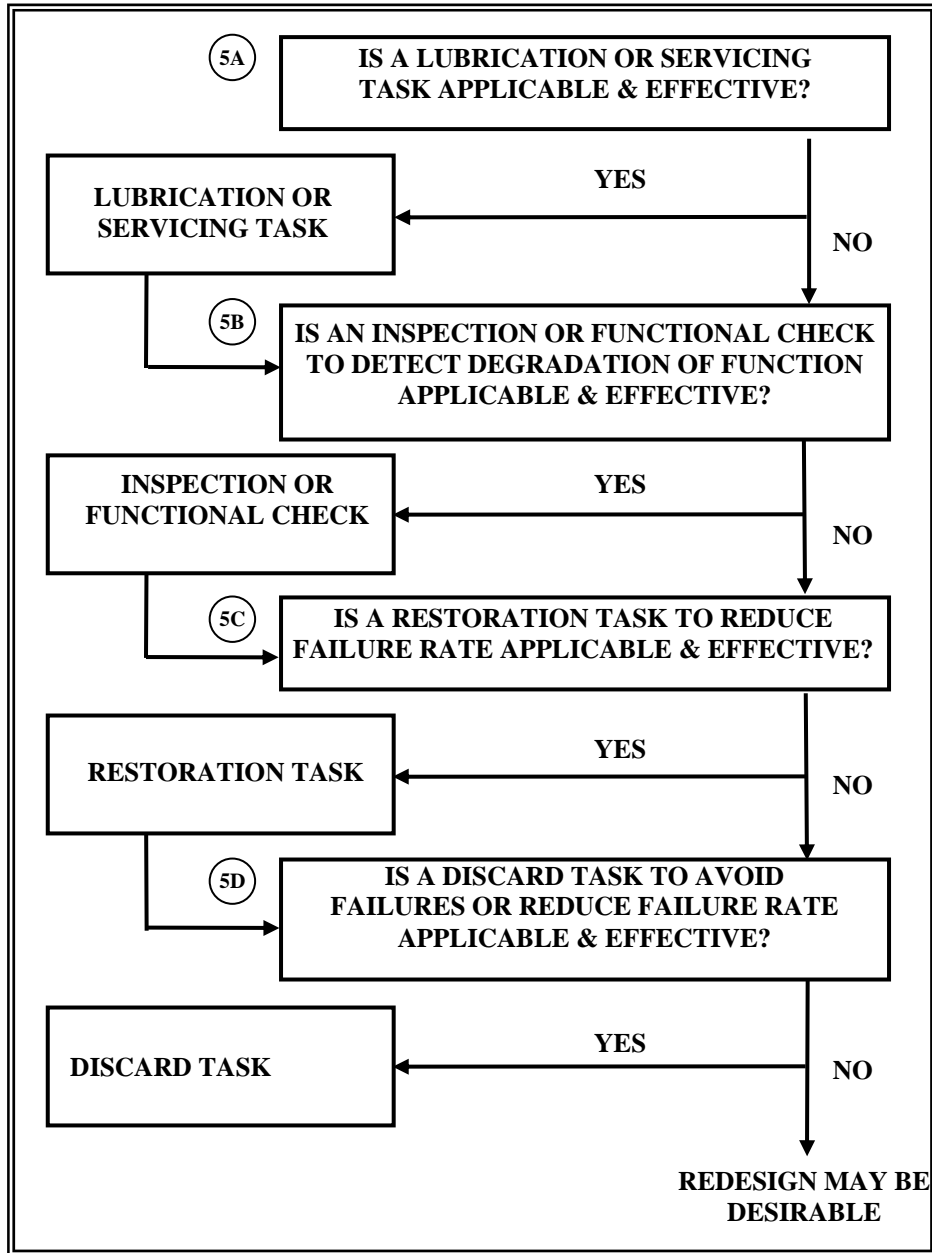
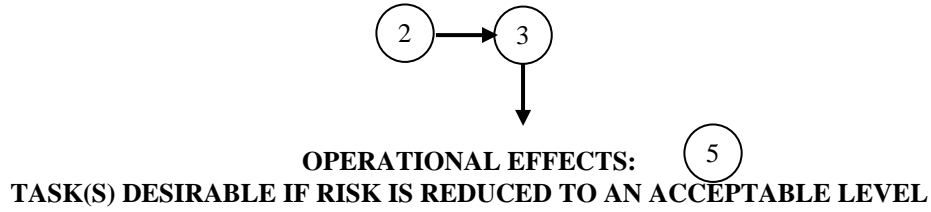

Figure 5-4. Evident failure – operational effects.

g. *Evident Failure – Economic Effects.* The portion of the decision logic tree that deals with situations where an evident functional failure has only an economic effect is shown in figure 5-5. This portion of the tree steps the analyst through a series of questions intended to identify any and all PM tasks that are desirable if their costs are less than the cost of repair. If none of the PM tasks listed is either applicable or effective, then redesign may be desirable. Again, the decision to redesign or not redesign is one of economics. If redesign is less than the economic effects of the failure, then it may be desirable. Otherwise, redesign is not justified.

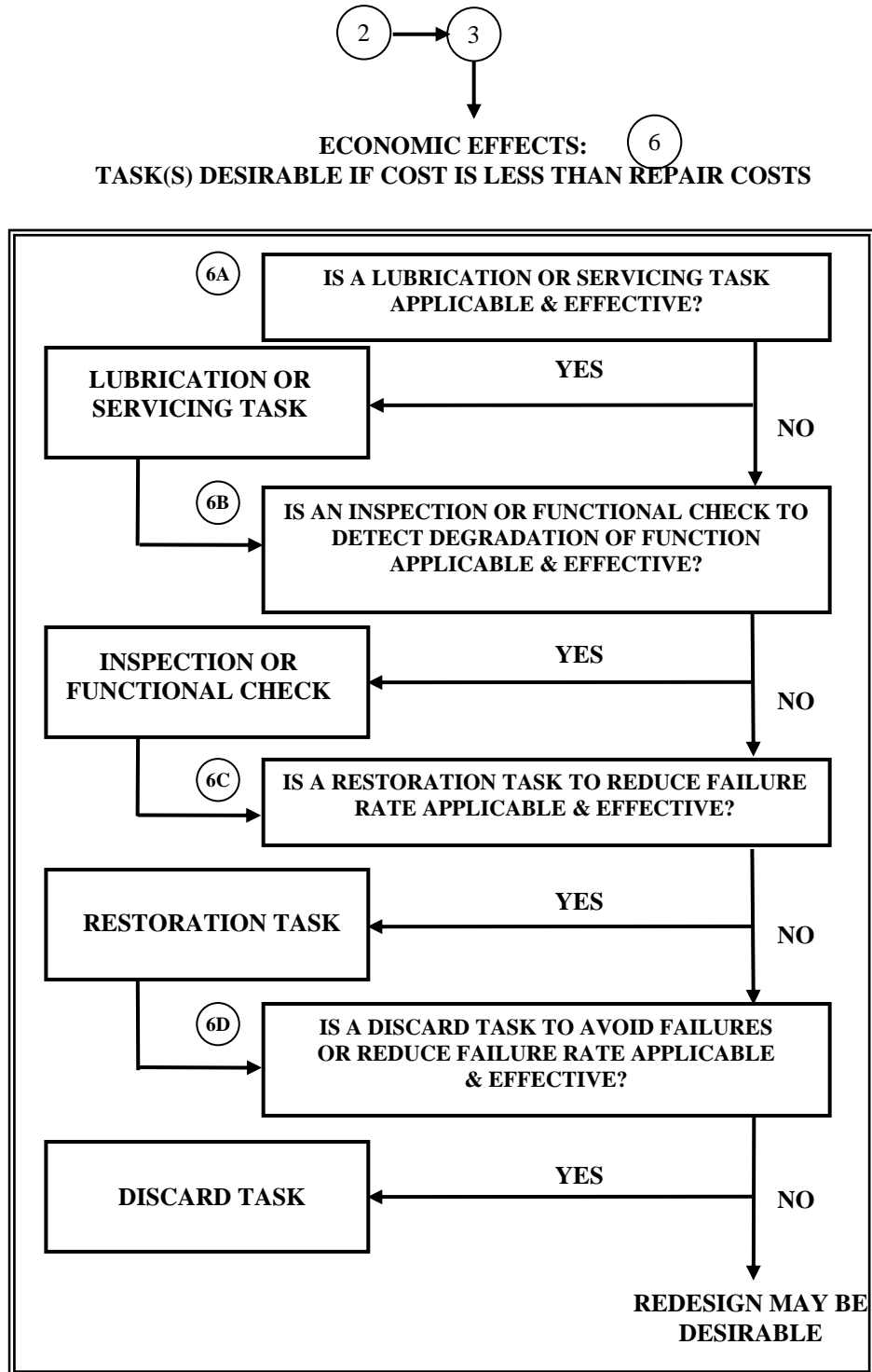

Figure 5-5. Evident failure – economic effects.

h. *Hidden Failure – Hazardous Effects.* The portion of the decision logic tree that deals with situations where a hidden functional failure has a hazardous effect in combination with another failure is shown in figure 5-6. This portion of the tree steps the analyst through a series of questions intended to identify any and all PM tasks that are required to ensure non-hazardous operation. The tasks are effective if they reduce to an acceptable level the probability of occurrence of the functional failure that results in the effects, reduce the effects to purely operational or economic effects, or result in a combination of these.

(1) If none of the PM tasks listed is either applicable or effective, then redesign is mandatory. The reason for making redesign mandatory is obvious. The effects categorized as "hazardous" are unacceptable. Consequently, when PM cannot fulfill any of the objectives listed, we must redesign the product to eliminate the mode of failure that causes the hazardous effects, reduce to an acceptable level the probability of occurrence of the functional failure that results in the effects, or result in a combination of these.

(2) Note that by redesigning to make the failure evident, the effects might be reduced to purely economic or operational.

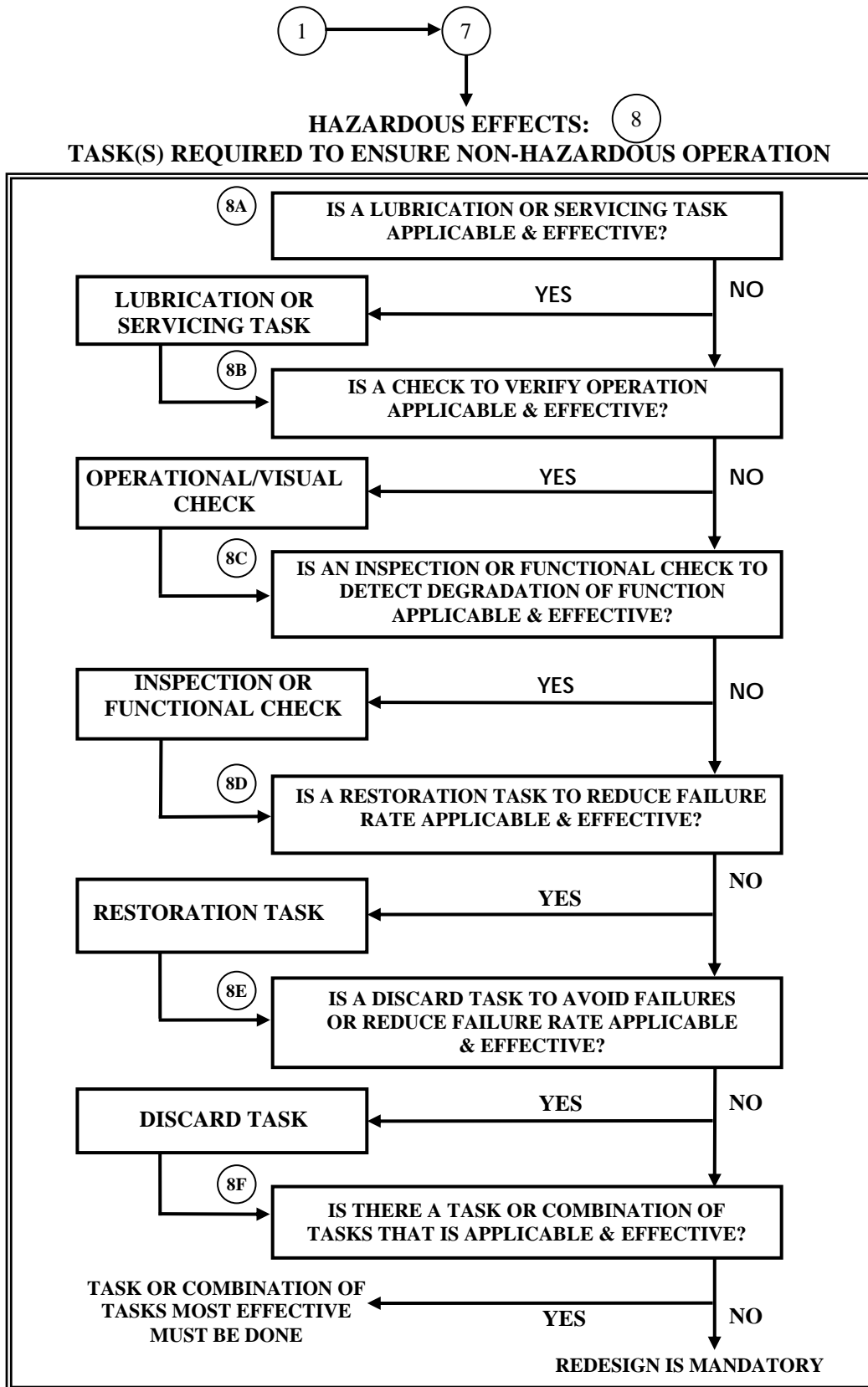
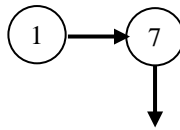

Figure 5-6. Hidden failure – hazardous effects.



i. *Hidden Failure – Non-hazardous Effects.* The portion of the decision logic tree that deals with situations where a hidden functional failure has a non-hazardous effect is shown in figure 5-7. This portion of the tree steps the analyst through a series of questions intended to identify any and all PM tasks that are desirable to ensure availability is sufficiently high to avoid the economic effects of multiple failures. If none of the PM tasks listed is either applicable or effective, then redesign is desirable.



**NON-HAZARDOUS EFFECTS:** (9)  
**TASK(S) DESIRABLE TO ENSURE AVAILABILITY IS SUCH THAT ECONOMIC EFFECTS OF MULTIPLE FAILURES ARE AVOIDED**

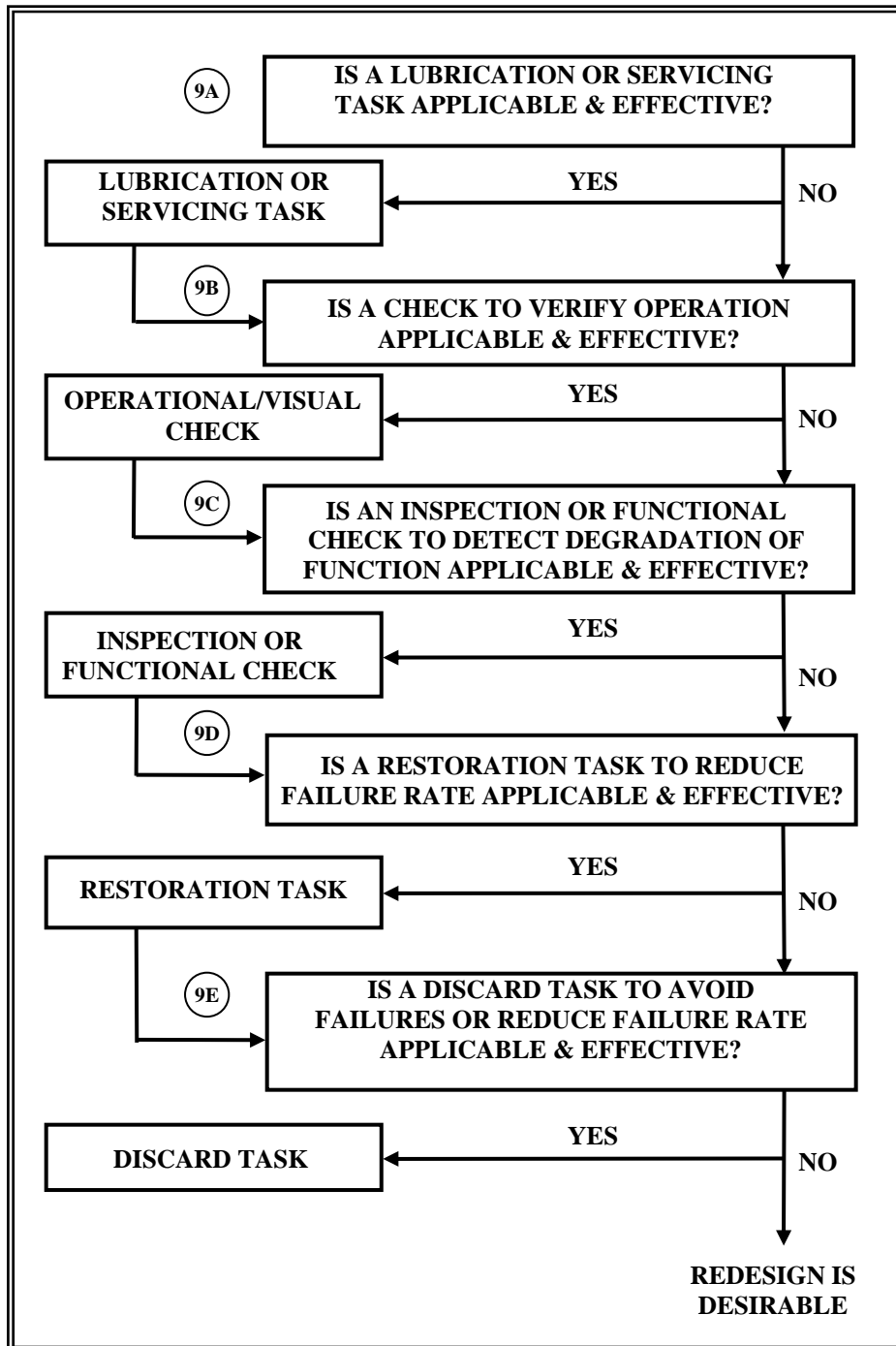

Figure 5-7. Hidden failure – non-hazardous effects.

j. *Package final maintenance program.* The result of the RCM analysis will be a set of preventive maintenance (PM) tasks and, by default, a set of corrective maintenance (CM) tasks. PM will consist of on-condition and scheduled maintenance.

(1) *Frequency of tasks.* The frequency with which each of the scheduled PM tasks must be performed will no doubt vary from item to item. It is also probable that many of these tasks may be grouped and performed together at some calendar or operating time interval. The process of grouping the scheduled tasks into sets of tasks to be performed at some prescribed time is called "packaging" the maintenance program.

(2) *Example of packaging.* For example, it may be that for a given product that the scheduled tasks shown in table 5-10 were identified. One way to package these tasks is shown in table 5-11. Note that at the 100, 200, 300, etc. hour points, all of the tasks except the overhaul task are performed. This example is purposely over-simplified and many other factors may (and probably will) have to be considered when packaging the tasks. The point is that by packaging PM tasks, we use our maintenance resources as effectively as possible and minimize the downtime of the product for PM.

Table 5-10. Example of identified tasks

- Three visual inspections: A to be conducted every 45 hours of operation, B to be conducted every 52 hours of operation, and C to be conducted every 105 hours of operation
- A lubrication performed every 55 hours of operation
- A non-destructive inspection every 100 hours of operation
- An overhaul task performed when a stated operating characteristic is out of limits
- A hard-time replacement task every 60 hours of operation

Table 5-11. Packaging the tasks from table 5-4

- Conduct the following PM every 50 operating hours (i.e., at 50, 100, 150, 200, etc.)
  - Visual inspections A and B
  - Lubrication
  - Hard-time replacement
- Conduct the following PM every 100 operating hours (i.e., at 100, 200, 300, etc.)
  - Visual inspection C
- Perform overhaul task whenever the operating characteristic goes out of limits

k. *Continuously improve the maintenance program.* Given the possibility for errors in the initial maintenance program, it is prudent to implement the RCM process as an on-going effort, one requiring perpetual evaluation and adjustment, as depicted in figure 2-1. The process for continuously improving the RCM-based maintenance program consists of Maintenance Audit, Trend Analysis, and Life Exploration. The purpose of this process is to continuously improve the initial maintenance program developed using the RCM concept.

(1) *The initial maintenance program.* The maintenance program that is developed based on the RCM analysis done prior to the first product being delivered to the customer is the *initial* maintenance program. This initial program will have been based on the best information that was available at the time the analysis was performed. One of the critical pieces of information is the underlying failure distribution

for each item. The information used in the initial RCM analysis was based on a mix of analysis and test results. When "off-the-shelf" items are used in the product, the information can include actual field experience. It must be recognized, however, that some of the information will not be 100% "accurate."

(2) *Maintenance audit.* Auditing the maintenance performed in actual service provides the data needed to refine and improve the maintenance program. In analyzing the data, the maintenance analysts and planners attempt to address the technical content of the program, intervals for performing tasks, packaging of tasks, training, the maintenance concept, and the support infrastructure.

(a) In addressing technical content, analysts and planners must determine if the current maintenance tasks cover all identified failure modes and result in the desired/required level of reliability. Failure modes may have been missed or the current maintenance tasks may not be effectively addressing identified failure modes. The latter may result from incorrectly identifying the underlying failure probability distribution function. Much of this information can be confirmed or updated through a reliability assessment. Table 5-12 lists the type of questions that can be answered by such an assessment.

*Table 5-12. Typical questions addressed by a reliability assessment*

- |                                                                                                                                                                                                                                                                                                                                                                                                                                                                                                                                                                                                                                                                                                                                                                                                                                                                                 |
|---------------------------------------------------------------------------------------------------------------------------------------------------------------------------------------------------------------------------------------------------------------------------------------------------------------------------------------------------------------------------------------------------------------------------------------------------------------------------------------------------------------------------------------------------------------------------------------------------------------------------------------------------------------------------------------------------------------------------------------------------------------------------------------------------------------------------------------------------------------------------------|
| <ul style="list-style-type: none"> <li>• Were assessments of useful life too conservative?</li> <li>• Have replacement intervals been made too short?</li> <li>• Is wearout occurring later or earlier than anticipated?</li> <li>• Have the operating conditions or concept changed?</li> <li>• Has the reliability performance been as expected?</li> <li>• Have any new failure modes been uncovered?</li> <li>• Are failure modes identified in development occurring with the expected frequency and pattern (i.e., underlying pdf of failures)?</li> <li>• Have any modifications to the product been made or are any planned that would add or delete failure modes, change the effects of a given failure mode, or require additional or different PM tasks?</li> <li>• Were the consequences of failures forecast during development adequately identified?</li> </ul> |
|---------------------------------------------------------------------------------------------------------------------------------------------------------------------------------------------------------------------------------------------------------------------------------------------------------------------------------------------------------------------------------------------------------------------------------------------------------------------------------------------------------------------------------------------------------------------------------------------------------------------------------------------------------------------------------------------------------------------------------------------------------------------------------------------------------------------------------------------------------------------------------|

(b) In addressing performance interval, analysts and planners must determine if the intervals for PM tasks result in decreased resistance to failure. Most often, the objective is to extend the interval as much as possible, without compromising safety, when doing so will reduce costs. Initial intervals are frequently set at conservative levels.

(c) In addressing task packaging, analysts and planners must determine if like tasks with similar periodicity are or can be grouped together to minimize downtime and maximize effectiveness. Lessons learned during actual operation and maintenance may make it necessary to revise the initial packaging.

(d) The analysts and planners should evaluate if available personnel, as currently being trained and using available tools and data, are effectively performing the identified PM tasks. If not, changes to training, procedures, tools, and so forth should be considered.

(e) The analysts and planners should determine if the maintenance concept for the product is effective or should be revised.

(f) The analysts and planners should address the adequacy and responsiveness of the support infrastructure. If the performance of the infrastructure is not as anticipated, recommendations regarding policy, spares levels, and other factors should be considered.

(3) *Trend analysis.* By collecting data on failures, time to failure, effectiveness of maintenance tasks, and costs of maintenance, trends can be identified. The objective of trend analysis is to anticipate problems and adjust the maintenance program to prevent their occurrence. For the RCM effort, two factors typically addressed by trend analysis are the rate of occurrence of failures and maintenance costs.

(a) For trending purposes, at least three data points are needed. The first two establish the trend (positive or negative) and the third serves as confirmation. (In control charting used for quality control, a trend is said to exist when 7 consecutive points continue to rise or fall). However, when measurements are based upon sample surveys over time, data at different points in time may vary because the underlying phenomenon has changed (i.e., a trend exists) or due to sampling error (i.e., the underlying phenomenon has not changed at all). It is not an easy task to sought out the one from the other.

(b) Statistical methods can be used to determine if a trend actually exists. For example, if a system failure rate is actually changing (i.e., it is not constant), the Laplace Statistic will show that a trend exists at a certain level of confidence.

(c) In addition to trend analysis, impending failures can be detected using pattern recognition, data comparison, tests against limits and ranges, correlation, and statistical process analysis.

(4) *Life exploration.* The process of collecting and analyzing in-service or operational reliability data to update the maintenance program is called Life (or Age) Exploration. The data that should be collected during Life Exploration includes historical field service data. Historical field service data typically describes three kinds of maintenance activities: corrective maintenance actions, preventive maintenance action, and service maintenance action.

(a) Historical corrective maintenance data. Corrective maintenance actions occur in response to an operational failure of the system. Corrective maintenance actions are always unscheduled, unwanted, inconvenient, and random.

(b) Historical preventive maintenance data. Preventive maintenance actions occur in accordance with a schedule and are intended to minimize the need for corrective maintenance actions.

(c) Historical service maintenance data. Service maintenance actions are those tasks performed to replenish expended parts and supplies required to operate a system. Many assets require adjustment, replenishment of supplies, lubrication, and cleaning.

## **5-6. Specific considerations for implementing RCM for C4ISR facilities**

a. *Current versus new facilities.* Many C4ISR facilities were built and the mechanical and electrical equipment developed and installed without an RCM analysis having been conducted. Implementing RCM for an existing C4ISR facility, when the current PM program was not based on RCM, is different from implementing it on a facility, new or old, for which the PM program was based on RCM.

(1) *Current PM program in place.* Of course, a program of preventive maintenance will already be in place for an existing facility. Without an RCM analysis, the PM program was probably based on past programs. Indications that the PM program is inefficient or ineffective are an excessive number of corrective maintenance actions (with an associated low facility availability), or an extremely large number of required PM actions that are imposing a very heavy economical penalty. Attempts to change the existing PM program may meet with some resistance (see paragraph 5-6c(3)).

(2) *Need for supporting analyses.* If an RCM analysis was not originally performed for the facility, its systems and equipment, much of the supporting analysis may also have been omitted. If such analyses, such as an FMEA, were not conducted, they must be conducted before an RCM-based PM program can be developed. For many of the installed systems and equipment, performing an FMEA or other analysis may be quite difficult because much of the data may not be available. Either the data was not acquired with the systems and equipment (i.e., data rights were not procured), or the data is missing. In such cases, engineers will have to use engineering judgment and require more time to adequately analyze the systems and equipment.

(3) *Feasibility of redesign.* If following the RCM logic, it is possible that the path may lead to a "Redesign is mandatory" or "redesign may be desirable" outcome. Redesign during initial development is in itself a sometimes-difficult task. Once a system or piece of equipment is in operation, redesign is even more difficult. However, an advantage of a facility is that adding redundancy is less constrained, in terms of space and weight, than for other systems.

b. *Training.* The RCM process is very disciplined and logical. It involves the integration of many different analytical tools, data, experience, and a decision logic tree. Without proper training, those assigned the responsibility of implementing RCM will find it difficult to succeed. Training in the RCM methodology and the related disciplines must be an essential element of an organization's plan for implementing RCM. For C4ISR facilities, especially when maintenance is outsourced (see chapter 6), funding must be provided for training to ensure that an RCM analysis is properly performed. Of course, training to ensure maintenance is properly performed is also essential.

c. *Pitfalls.* In implementing an RCM program in organizations where the concept is new, pitfalls can make implementation ineffective.

(1) *Run to failure shock.* For many maintenance managers and technicians, allowing an item to run to failure runs counter to "conventional wisdom". It is important that they understand the concepts of reliability and turn their focus from preventing failures to preserving function.

(2) *Failure to accept the "Preserve Function" principle.* Most maintenance personnel traditionally have viewed their role as one of preventing failures. To effectively implement an RCM program, it is essential that maintenance personnel focus on preserving the function or functions of an item, not preventing failures.

(3) *Challenging the Past.* Tradition and conventional wisdom remain the principal guidance for many maintenance organizations. Challenging past practices almost always invokes strong resistance, especially if the new practices are not fully understood. Education is the best way to deal with cultural resistance.

(4) *Organization structure.* The RCM process requires close coordination and cooperation among several groups of people, including but not limited to designers, maintainers, and logistic planners. Organizational structures can impede or even prevent the level of cooperation and coordination needed to make RCM a success. The concept of integrated process/product teams (IPPTs) is one that facilitates and encourages cross-discipline cooperation.

(5) *Threat of reduction in staff.* When RCM was first implemented within the airline industry, drastic reductions in scheduled maintenance tasks were made possible. Consequently, the number labor hours and people required to, for example, conduct structural inspections of an aircraft were significantly reduced. When a segment of an organization perceives that a new policy or procedure will eliminate their jobs, the natural reaction is to fight against the new policy or procedure. However, with vision and

planning, management can find ways to effectively use the resources freed up by implementing RCM and minimize the impact on jobs by using normal attrition, cross training, etc.

(6) *Inadequate buy-in.* All too often, management implements a new policy or procedure without fully supporting that policy or procedure. If either resources or management interest is insufficient, the new policy or procedure will probably fall short of expectations. This is especially true for RCM, an approach that is often met with skepticism and resistance by the very same people who must help implement it.

(7) *Informal procedures.* RCM is a very structured, disciplined method of developing a comprehensive and effective maintenance program. It cannot be effectively implemented on an informal or ad hoc basis. The procedures for implementing an RCM approach within an organization must be formal, documented, and managed.

(8) *Inadequate data collection.* If the underlying pattern of failures for a given item is unknown, one cannot objectively determine if PM should be considered. Without adequate information regarding the frequency of failure or the parameters of the failure probability density function, one cannot objectively determine when a PM task should be performed. Data that is adequate in both quantity and type (e.g., time to failure) is essential to the RCM process.

## 5-7. Evaluation of alternatives

As a result of performing an RCM analysis, alternatives will present themselves. These alternatives fall into two categories: Maintenance Tasks and Designs. Both categories are a natural result of the RCM analysis. In examining the logic trees in paragraph 5-5, it is obvious that more than one type of maintenance task may be applicable and effective for a given failure. Also, in some cases, for example where the effects of a failure are hazardous or a hidden failure can occur, redesign is mandatory or desirable. How do we determine which tasks to perform? How do we select the "best" design change (e.g., in the case of failures with hazardous effects) or determine if a design change is cost-effective (e.g., in the case of a hidden failure). We can address these questions using Trade-off Studies, Operational Analysis, and Cost-Benefit Analysis.

a. *Trade-off studies.* Designing a new system or a change to an existing one, even a moderately complex one, requires a series of compromises. These compromises are inevitable, given the fact that requirements often conflict. Design decisions necessary to meet one requirement may result in another requirement not being met. For example, strength and fatigue life requirements drive the selection of materials and the size (bulk) of structures in one direction. The maximum weight requirement drives these same factors in the opposite direction. Systems engineering is the process of selecting design solutions that balance the requirements and provide an optimized system. Usually, this balance means that some requirements may not be fully met. The process of selecting one design solution over another is often referred to as design trade-offs. Trade-off studies consist of the steps shown in table 5-13.

Table 5-13. Steps in design trades

- |                                                                                                                                                                                                                                                                                                                                                                                                                                                                                                |
|------------------------------------------------------------------------------------------------------------------------------------------------------------------------------------------------------------------------------------------------------------------------------------------------------------------------------------------------------------------------------------------------------------------------------------------------------------------------------------------------|
| <ul style="list-style-type: none"> <li>• Compare two or more design solutions</li> <li>• Determine which provides the best results given cost and schedule constraints</li> <li>• Determine if the system requirements can be met with the selected design solution</li> <li>• If the system requirements cannot be met, determine the budget and schedule required to support a design solution that does allow the system requirements to be met, or re-evaluate the requirements</li> </ul> |
|------------------------------------------------------------------------------------------------------------------------------------------------------------------------------------------------------------------------------------------------------------------------------------------------------------------------------------------------------------------------------------------------------------------------------------------------------------------------------------------------|

(1) *RCM and desired design changes.* An RCM analysis may indicate that a change to the design is required or desirable. In such cases, trade-off studies will probably be needed to determine if a solution can be found that is effective (affordability is addressed in a cost-benefit analysis – see paragraph 5-7c).

(2) *RCM and mandatory design changes.* When the RCM analysis shows that two or more PM tasks are applicable, trade-off studies will be needed to determine which task(s) is (are) most effective. Of course, when a specific failure has hazardous effects, redesign is mandatory if no PM tasks are effective and applicable.

b. *Operational analysis.* To determine if a specific failure has operational effects (but no hazardous effects), an analysis of the operational concept is necessary. This analysis addresses the impact of a given failure on measures of operational performance. The measures are a function of the type of product and how that product is used. For the airline industry, for example, the cost of an operational failure includes lost revenue, potential penalties (in the form of compensation to passengers), loss of customer confidence and loyalty, and the cost of fixing the failure. For a military organization that operates aircraft, the costs might include a decrease in readiness, the inability to fulfill a mission, the cost of reassigning another aircraft to replace the original aircraft, and the cost to fix the failure. For a commercial company, the cost of an operational failure of a product could include the loss of customer confidence and loyalty, the cost of repair under warranty, and possible claims by the customer for lost revenue or other non-hazardous effects of the failure.

c. *Cost-benefit analysis.* Another type of analysis frequently used whenever one of two or more alternatives (design A vs. design B, task 1 vs. task 2, process I vs. process II, etc.) must be selected is a cost-benefit analysis (CBA).

(1) *Potential benefits.* In a CBA, the potential life-cycle benefits of and life-cycle costs to implement a given alternative are compared with those of the other alternatives. One of the most difficult steps in a CBA is finding a common basis for comparison. That basis is almost always dollars, since the costs of implementing a choice can almost always be directly measured in terms of dollars. Some of the benefits of an alternative may be intangible. However, it may be possible to attach a dollar value to even these benefits. Benefits to which a dollar value cannot be assigned should be evaluated and assigned relative numeric values for comparison purposes. For example, a maximum benefit could be assigned a value of 5, an average benefit a value of 3, and a minimum benefit a value of 1. Evaluating and comparing benefits that have both dollar values and relative numeric values requires extra effort, but it allows all benefits to be considered in the analysis.

(2) *Costs.* In a simple CBA, the annual costs of implementing each alternative design change, for example, are estimated. For this purpose, the analyst would sum up the estimates of the costs shown in table 5-14. The analyst would estimate the annual benefits of the first alternative and then repeat this process for each of the other alternative design.

*Table 5-14. Typical costs considered in cost-benefit analysis*

- |                                                                                                                                                                                                                                                                                                                                           |
|-------------------------------------------------------------------------------------------------------------------------------------------------------------------------------------------------------------------------------------------------------------------------------------------------------------------------------------------|
| <ul style="list-style-type: none"> <li>• The cost of the labor hours needed to develop the design</li> <li>• The cost of any additional testing required</li> <li>• Any differences in materials costs</li> <li>• Changes in manufacturing costs</li> <li>• Additional costs due to changes in schedule</li> <li>• Other costs</li> </ul> |
|-------------------------------------------------------------------------------------------------------------------------------------------------------------------------------------------------------------------------------------------------------------------------------------------------------------------------------------------|



(3) *Conversion.* The analyst must convert the annual estimates to a common unit of measurement to properly compare competing alternatives. This conversion is done by discounting future dollar values, which transforms future benefits and costs to their "present value." The present value (also referred to as the discounted value) of a future amount is calculated using equation 4.

$$PV = FV/(1 + i)^n \qquad \text{Equation 4}$$

where:

- PV = Present Value
- FV = Future Value
- i = Interest rate per period
- n = Number of compounding periods

(4) *Comparison.* When the costs and benefits for each competing alternative have been discounted, the analyst compares and ranks the discounted net value (discounted benefit minus discounted cost) of the competing alternatives. In the ideal case one alternative will have the lowest discounted cost and provide the highest discounted benefits – it clearly would be the best alternative. More often, however, the choice is not so clear-cut, and other techniques must be used to determine which alternative is best.

(5) *Dollar values.* Earlier, it was mentioned that some benefits may not quantifiable in terms of dollars and may have relative numeric values assigned for comparison purposes. In those cases, these numeric values can be used as tie breakers if the cost figures do not show a clear winner among the competing alternatives, and if the non-quantifiable benefits are not key factors. If they are key factors, the quantified benefits can be converted to scaled numeric values consistent with the non-quantifiable benefits. The evaluation then consists of comparing the discounted costs and the relative values of the benefits for each alternative. When the alternative with the lowest discounted cost provides the highest relative benefits, it is clearly the best alternative (the same basic rule used when you have discounted benefits). If that is not the case, the evaluation is more complex.

(6) *Numerical values.* Finally, if no benefits have dollar values, numerical values can be assigned (using some relative scale) to each benefit for each competing alternative. The evaluation and ranking are then completed in the manner described in the previous paragraph.

(7) *Sensitivity analysis.* Sensitivity analysis can be used to test the sensitivity and reliability of the results obtained from a CBA. For more information on conducting a CBA and related analysis, see the references in appendix A.

## CHAPTER 6

# CONTRACTING FOR MAINTENANCE

---

### 6-1. Introduction to maintenance contracting

Over the past several years, the Department of Defense and the Military Services have made a concerted effort to outsource functions that are not inherently governmental. These functions are referred to as commercial activities. Although disagreements arise in defining what is not inherently a government function, most agree that there are difficulties and challenges in successfully outsourcing any function traditionally performed by the military. Among these are determining the approach for C4ISR facilities, how best to measure contractor performance, how best to monitor performance, the scope of the contract, and the benefits of including contractual incentives.

a. *Background.* In the federal government, outsourcing refers to the policy of the government not to compete for work that can be performed by the private sector, unless the government performed the work previously and the government has proven to be the more economical provider. Work that can be performed by the private sector is commonly referred to as a commercial activity. In the federal government, outsourcing decisions are made based on inventories of people who perform commercial activities. In that respect, the competition between government and the private sector for commercial activities, or outsourcing, is not a new concept; it has been around for well over 30 years.

b. *The Reason for outsourcing.* In light of declining defense budgets, efforts have been made to decrease funds supporting infrastructure and to increase budgetary support for acquisition and maintenance of the fleet. This has been referred to as increasing the "Tooth to Tail Ratio." Studies by the Center for Naval Analysis and the Defense Science Board suggest that cost savings of 30 percent should be possible by outsourcing. Dr. Paul G. Kaminski, former Under Secretary of Defense for Acquisition and Technology, described outsourcing as having four distinct benefits.

(1) *Fosters competition.* Outsourcing can introduce competitive forces, which drive organizations to improve quality, increase efficiency, reduce costs, and better focus on their customer's needs over time. For DoD, competition can lead to more rapid delivery of better products and services to the warfighter, thereby increasing readiness.

(2) *Can enhance management flexibility.* Outsourcing provides commanders with the flexibility to determine the appropriate size and composition of the resources needed to complete tasks over time as the situation changes.

(3) *Outsourcing takes advantage of economies of scale and specialization.* Organizations that specialize in specific services generate a relatively larger business volume, which allows them to take advantage of scale economies. Often, these economies of scale mean that specialized service firms can operate and maintain state-of-the-art systems more cost-effectively than other firms or the government. Outsourcing to such firms provides a means for the government to take advantage of technologies and systems that the government itself cannot acquire or operate economically.

(4) *Fosters better management focus.* In recent years, the nation's most successful companies have focused intensively on their core competencies -- those activities that give them a competitive edge—and outsourced support activities. The activities that have been outsourced remain important to success, but

are not at the heart of the organization's mission. Business analysts frequently highlight the fact that the attention of an organization's leaders is a scarce resource that should be allocated wisely. This observation is equally true for the Department of Defense and the military services.

*c. Inherently governmental function.* A function so intimately related to the public interest as to mandate performance by Government employees. Consistent with the definitions provided in the Federal Activities Inventory Reform Act of 1998 and OFPP Policy Letter 92-1, these functions include those activities that require either the exercise of discretion in applying Government authority or the use of value judgment in making decisions for the Government. Services or products in support of inherently Governmental functions. Inherently Governmental functions normally fall into two categories: The act of governing; i.e., the discretionary exercise of Government authority, and monetary transactions and entitlements. (Excerpted from OMB Circular A-76).

*d. OMB Circular A-76.* Office of Management and Budget (OMB) Circular A-76, an executive order referred to as A-76, directs the Executive Branch of the government to inventory and schedule for competition all commercial activities. By 1989, the process, which frequently took up to five years to complete and contributed little to overall savings, fell out of practice. In January 1997, facing a declining budget, CNO identified 10,665 in-house positions and 146 in-house activities that would be required to compete with the private sector. In January 1998 another 7,227 positions and 137 activities were announced, with the total for the fiscal year expected to reach 15,000 positions.

## 6-2. Approach for C4ISR facilities

Before committing to outsourcing C4ISR facility maintenance, the responsible manager must make the following determinations.

*a. Determine private sector capability.* Determine if private sector firms are able to perform the maintenance and meet the C4ISR facility mission. DoD will not consider outsourcing activities that constitute its core capabilities (i.e., those considered by DoD and military leaders as essential to being prepared to carry out the Department's warfighting mission).

*b. Determine competitive environment.* Determine if a competitive commercial market exists for the C4ISR facility maintenance. DoD will gain from outsourcing and competition when there is an incentive for continuous service improvement.

*c. Determine economic benefit.* Determine if outsourcing the facility maintenance results in best value for the government and therefore the US taxpayer. Activities will be considered for outsourcing only when the private sector can improve performance or lower costs in the context of long-term competition.

## 6-3. Measures of performance

When maintenance is outsourced, the first question is how to measure performance. To determine the "best" measure, one must first determine the requirements of the system in question. In the case of C4ISR facilities, providing power and environmental control for mission-critical equipment is the primary requirement. Furthermore, C4ISR facilities must provide these functions, for the most part, on a 24 hour per day, 365 day per year basis. That is, high availability is absolutely essential. Given that essential requirement, one of the measures for contractor maintenance should be derived from availability. The other should be based on economic considerations.

*a. Availability-related requirement.* Even with adequate redundancy, system failures will occur. The number of system failures will, of course, be determined by the reliability of all components and

equipment, use of redundancy, effectiveness of maintenance, and so forth. When a failure does occur, the job of maintenance is to restore the system to full operation as quickly as possible. Three such measures are maximum downtime, maximum time to restore system, and turn around time.

(1) *Maximum downtime.* Specifying the maximum downtime (MDT) is specifically intended to limit the periods of non-operation. A stated period of operation must be stipulated for a MDT requirement. For facilities, the requirement would normally be stated for each year of operation (i.e., MDT shall not exceed 150 hours in any year).

(2) *Maximum time to restore system.* Related to MDT is Mean Time to Restore (MTTRS). MTTRS relates to the maximum time it will take to restore the system from any one failure event. In other words, although the previously stated example of a 150-hour MDT requirement limits the downtime over a one-year period, it is statistically possible for one failure event to take 50, 75, or even 100 hours to correct. Such a long downtime, even though it may occur only once or twice a year, is usually unacceptable. MTTRS limits the downtime that results from any single system failure.

(3) *Turn around time.* Only a limited number of spares can be bought, especially at the equipment or "box" level. Consequently, when a failed piece of equipment must be removed and replaced at the facility (organizational) level and repaired at a field or depot level, the length of time it takes to return the equipment to the spares supply is important. The shorter the turn around time (TAT), the fewer the number of spares that need be purchased, all other factors remaining constant. Usually we are concerned about the average and maximum TAT.

b. *Economic requirement.* Given fiscal realities and limited funding, economic considerations are also important. It is assumed that the contractor who can demonstrate in the proposal that they can provide the stipulated maintenance at the required level of performance at the lowest cost will be awarded the contract. "Cost" should be more than the price of the contract. The overall life cycle costs that will be incurred over the life of the contract should be considered.

#### **6-4. Scope of the contract**

Providing maintenance support requires labor, parts, spare units, consumables (such as lubrication oil and hydraulic fluid, clean-up materials such as rags and absorbent materials to soak up oil spills), test and diagnostics equipment, maintenance manuals, and much more. In developing the statement of work for outsourcing maintenance of a C4ISR facility, decisions must be made as to what the contractor will furnish and what the government will furnish. This process of allocation must be done with care to avoid unpleasant surprises after contract signing. An example of the level of detail required for this allocation is ordering of national stock numbered items. Will the contractor directly order these parts from DLA and, if so, will the contractor be given the necessary authority to do so? On the other hand, the contractor may be required to order such parts through a local government supply office. Whichever approach is taken, it must be reflected in the scope of the contract.

#### **6-5. Monitoring performance**

Once a contract for contractor maintenance support is awarded, it is essential that responsible government managers provide adequate level of technical oversight over the contractor's performance in executing the contract. Tracking the administrative details of the contract is not included – the contracts office that issued the contract is responsible for this tracking. Instead, technical oversight ensures that the end customer and the customer's mission are being adequately served, within the scope of the contract. Trending is important in this regard, so that potential problems are addressed before the customer and mission are negatively affected.

**6-6. Incentives**

Incentives are often used to motivate contractors to achieve some level of performance above the contractually required minimum. Such incentives are often used on construction projects to keep the construction time to a minimum. Incentives can be positive or negative.

a. *Positive incentives.* A positive incentive is one involving rewards. If the contractor exceeds the minimum levels of performance, a monetary reward is paid. Examples of exceeding the minimum level of performance are listed in table 6-1.

*Table 6-1. Examples of positive incentives.*

<b>Minimum Level of Performance</b>	<b>Reward Level</b>	<b>Typical Reward</b>
Complete construction within 16 weeks	Complete construction in 15 months or less	Bonus of x% of contract value for each week early up to a maximum of y%
Maximum downtime of 150 hours in any 1-year period	Downtime does not exceed 140 hours*	Bonus of x% of one year contract value for each 15-hour reduction in downtime below 140 hours
Maximum TAT $\leq 30$ calendar days	Maximum TAT $< 25$ calendar days*	Bonus of x% for each day reduction in maximum TAT achieved over a six month period

\*Allows for normal statistical variation in downtime.

b. *Negative incentives.* A negative incentive is a penalty imposed for failing to meet a contractual requirement. It is rare that some kind of penalty is not imposed whenever a contractual requirement is not met. However, the type of negative incentive intended here is one related to a specific performance requirement, such as availability. The objective of a negative incentive is similar to that of a positive incentive, in that both will hopefully ensure that the performance requirements in question are met. However, the negative incentive provides no motivation for exceeding the requirement. Moreover, experts debate whether or not a negative incentive is as effective as a positive one.

## APPENDIX A

### REFERENCES

---

#### Required Publications

##### Government Publications

*Department of the Army*

TM 5-698-4

*Failure Modes, Effects and Criticality Analysis (FMECA) for Command, Control, Communications, Computer, Intelligence, Surveillance and Reconnaissance (C4ISR) Facilities* (Cited in paragraph 5-5b (4))

#### Related Publications

##### Government Publications

*Department of the Army*

*Guide to Reliability-Centered Maintenance (RCM) for Fielded Equipment*, Pamphlet 750-40, 15 May 1982.

*Department of the Navy*

*Condition Based Maintenance*, OPNAVINST 4790.16, 6 May 1998.

*Reliability-Centered Maintenance Program*, NAVARINST 4790.20, 3 May 1999.

*Guidelines for the Naval Aviation Reliability-Centered Maintenance Process*, NAVAIR 00-25-403, 1 February 2001.

MIL-STD-2173 (AS), *Reliability-Centered Maintenance Requirements for Naval Aircraft, Weapons Systems and Support Equipment*, 21 January 1986.

*National Aeronautics and Space Agency*

*Preventive Maintenance Strategies Using Reliability-Centered Maintenance (RCM)*, Technique PM-4, Johnson Space Flight Center.

*Reliability-Centered Maintenance Guide for Facilities and Collateral Equipment*, December 1996.

##### Non-Government Publications

Abernethy, Dr. R.B., "The New Weibull Handbook," Gulf Publishing Co., Houston, TX, 1994.

Air Transport Association, "Maintenance Steering Group Report (MSG) 3, Revision 2," Washington, DC, 1993.

Baguley, Phil, "Condition-based maintenance," *Chemical Engineer*, No. 427, July-August 1986, p 38-40.

Baillie, D.C. and J. Mathew, "A Comparison of Autoregressive Modeling Techniques for Fault Diagnosis of Rolling Element Bearings," *Mechanical Systems and Signal Processing*, Vol. 10, No. 1, 1996, p. 1-17.

- Barbera, F., "A condition based maintenance model with exponential failures and fixed inspection intervals," *Operational Research Society. Journal*, Vol. 47, No. 8, August 1996, p. 1037.
- Bland, R.J., "Practical application of a new method for condition-based maintenance," *Maintenance Management International*, Vol. 7, No. 1, August 1987, p. 31-35.
- Campbell, John Dixon, "Uptime: Strategies for Excellence in Maintenance Management," Productivity Press, Portland, OR, January 1995.
- Cheng, Anha, "Advances and trends in mechanical fault diagnosis," *Journal of Xiangtan Mining Institute*, Vol. 11, No. 1, March 1996, p. 20-24.
- Doyle, Donna J., "Monitoring Machines for Maintenance, Performance," *Hydro Review*, Vol. 13, No. 4, June 1994, p. 10.
- Fang, Zenan, "Condition monitoring and fault diagnosis system for combined large scale turbines and generator sets," *Journal of Tsinghua University*, Vol. 36, No. 7, July 1996, p. 79-85.
- IEC 60300, PT 3-11, "Dependability Management - Part 3: Application Guide – Section 11: Reliability-Centered Maintenance, First Edition, 1999.
- Eisenmann, Robert C., "Machinery Malfunction Diagnosis and Correction; Vibration Analysis and Troubleshooting for the Process Industries," Prentice Hall, A Pearson Education Company, Upper Saddle River, New Jersey, November 1997.
- Moubray, John, Reliability-Centered Maintenance II, Industrial Press, New York, NY, April 1997.
- Nowlan, F.S. and H.F. Heap, "Reliability-Centered Maintenance," DoD, 1978, available from Maintenance Quality Systems, LLC, 1127-F Benfield Blvd, Suite F, Millersville, MD 21108-2540, <http://mqslc.com>.
- PEM* - Plant Engineering and Maintenance, Clifford/Elliot Publishing Ltd., Toronto, Canada.
- Reliability Analysis Center, "Reliability Toolkit: Commercial Practices Edition," Rome, NY, 1994.
- Smith, Anthony M., Reliability-Centered Maintenance, McGraw Hill, New York, NY, September 1992.
- Society of Automotive Engineers, "Evaluation Criteria for Reliability-Centered Maintenance (RCM) Processes," JA1011, August 1999.
- Society of Automotive Engineers, "A Guide to the Reliability-Centered Maintenance (RCM) Standard," JA1012, Draft, June 2001.
- Wei, Wu, "New method for fault diagnosis and performance monitoring of machinery," American Society of Mechanical Engineers (Paper), 1995.

## APPENDIX B

# STATISTICAL DISTRIBUTION USED IN RELIABILITY AND MAINTAINABILITY

### B-1. Introduction to statistical distribution

Many statistical distributions are used to model various reliability and maintainability parameters. The particular distribution used depends on the nature of the data being analyzed.

a. *Exponential and Weibull.* These two distributions are commonly used for reliability modeling – the exponential is used because of its simplicity and because it has been shown in many cases to fit electronic equipment failure data, and the Weibull because it consists of a family of different distributions that can be used to fit a wide variety of data and it models wearout (i.e., an increasing hazard function).

b. *Normal and lognormal.* Although also used to model reliability, the normal and lognormal distributions are more often used to model repair times. In this application, the normal is most applicable to simple maintenance tasks that consistently require a fixed amount of time to complete with little variation. The lognormal is applicable to maintenance tasks where the task time and frequency vary, which is often the case for complex systems and products.

### B-2. The exponential distribution

The exponential distribution is widely used to model electronic reliability failures in the operating domain that tend to exhibit a constant failure rate. To fail exponentially means that the distribution of failure times fits the exponential distribution as shown in table B-1. The characteristics of the exponential distribution are listed in table B-2. figure B-1 shows the exponential pdf for varying values of  $\lambda$ .

*Table B-1. Summary of the exponential distribution*

Probability Density Function	Reliability Function	Hazard Function
		<p style="text-align: center;"><math>h(t) = f(t)/R(t) = \lambda e^{-\lambda t} / e^{-\lambda t} = \lambda</math></p> 



Table B-2. Characteristics of the exponential distribution

- It has a single parameter,  $\lambda$ , which is the mean. For reliability applications,  $\lambda$  called the failure rate.
- $\lambda$ , the failure rate, is a constant. If an item has survived for  $t$  hours, the chance of it failing during the next hour is the same as if it had just been placed in service.
- The mean-time-between-failure (MTBF) =  $1/\lambda$ .
- The mean of the distribution occurs at about the 63<sup>rd</sup> percentile. Thus, if an item with a 1000-hour MTBF had to operate continuously for 1000 hours, the probability of success (survival) would be only 37%.

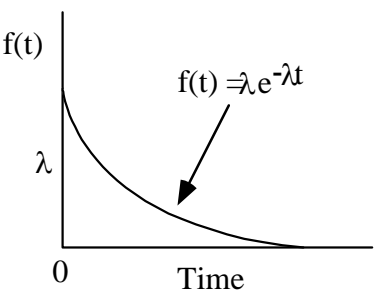
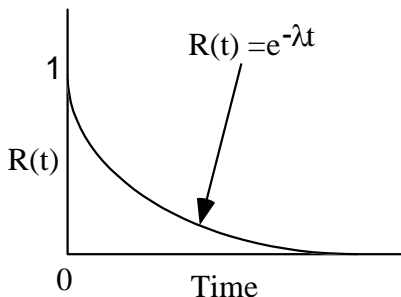
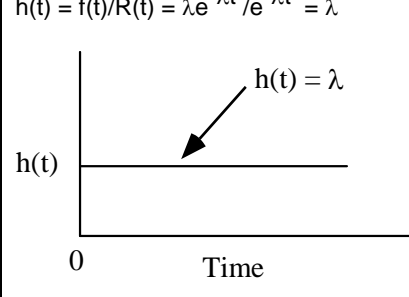
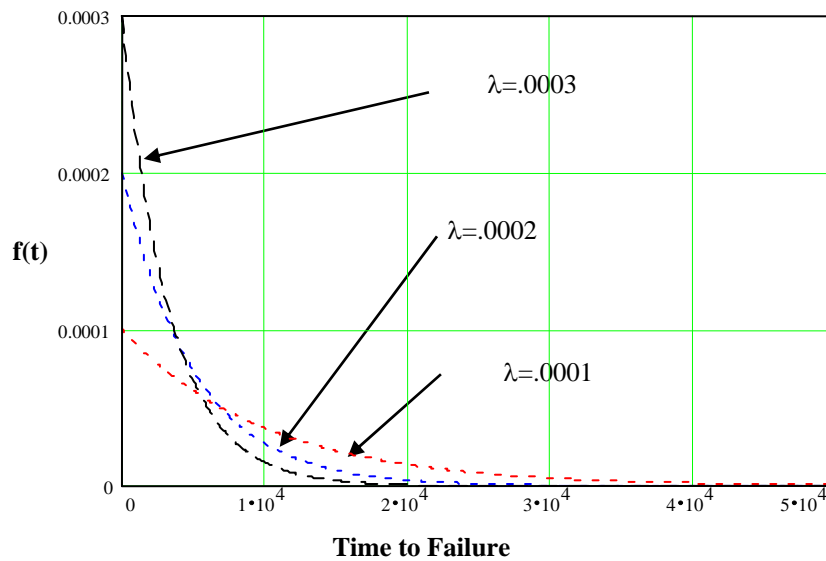

Figure B-1. The exponential pdf for varying values of  $\lambda$ .

### B-3. The Weibull distribution

The Weibull distribution is an important distribution because it can be used to represent many different pdfs; therefore, it has many applications. The characteristics of the Weibull are shown in table B-3. The distribution is described in table B-4. Figure B-2 shows the 2-parameter Weibull pdf for different values of  $\beta$  and a given value of  $\eta$ .

Table B-3. Characteristics of the Weibull distribution

- It has 2 ( $\beta$  and  $\eta$ ) or 3 ( $\beta$ ,  $\eta$ , and  $\gamma$ ) parameters.
  - The shape parameter,  $\beta$ , describes the shape of the pdf.
  - The scale parameter,  $\eta$ , is the 63<sup>rd</sup> percentile value of the distribution and is called the characteristic life. In some texts,  $\theta$  is used as the symbol for the characteristic life.
  - The location parameter,  $\gamma$ , is the value that represents a failure-free or prior use period for the item. If there is no prior use or period where the probability of failure is zero, then  $\gamma = 0$  and the Weibull distribution becomes 2-parameter distribution.
- $\beta$ ,  $\eta$ , and  $\gamma$  can be estimated using Weibull probability paper or software programs.
- When  $\beta = 1$  and  $\gamma = 0$ , the Weibull is exactly equivalent to the exponential distribution.
- When  $\beta = 3.44$ , the Weibull closely approximates the normal distribution.

Table B-4. Summary of the Weibull distribution

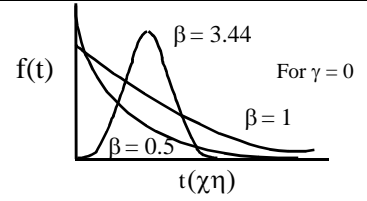
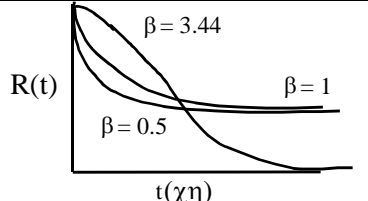
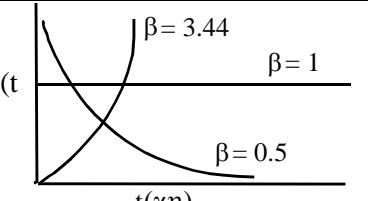
Probability Density Function	Reliability Function	Hazard Function
 <p style="text-align: center;">For <math>\gamma = 0</math></p> $f(t) = \frac{\beta}{\eta} \left( \frac{t - \gamma}{\eta} \right)^{\beta-1} \exp \left[ - \frac{(t - \gamma)^\beta}{\eta} \right]$	 $R(t) = \exp \left[ - \frac{(t - \gamma)^\beta}{\eta} \right]$	 $h(t) = \frac{\beta}{\eta} \left( \frac{t - \gamma}{\eta} \right)^{\beta-1}$

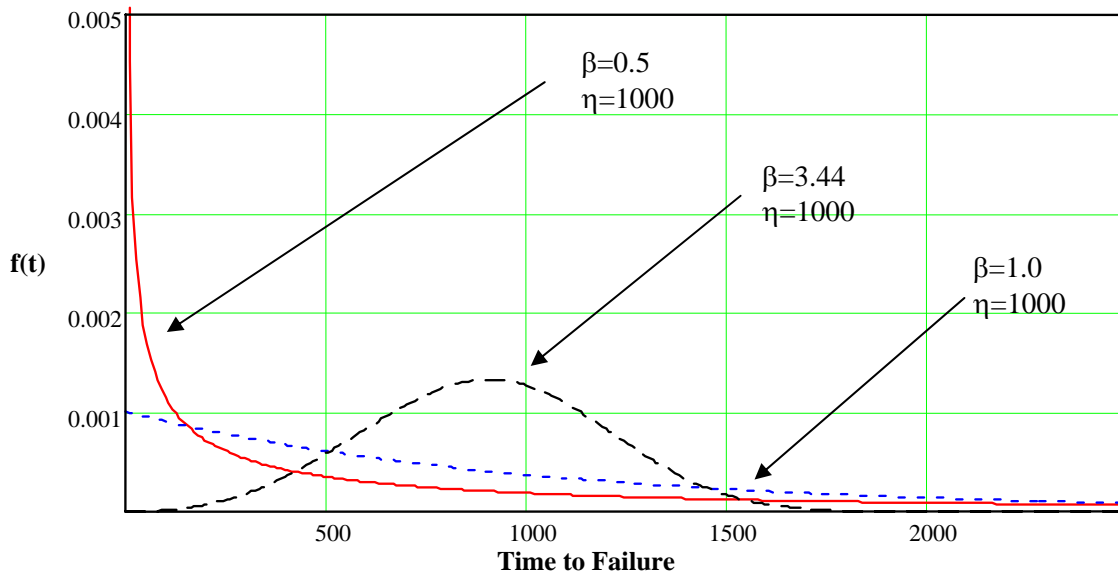

Figure B-2. The two-parameter Weibull pdf for different values of  $\beta$  and a given value of  $\eta$ .

**B-4. The normal distribution**

The pdf of the Normal distribution is often called the bell curve because of its distinctive shape. The Normal distribution is described in table B-5. The characteristics of the Normal distribution are shown in table B-6. Figure B-3 shows the normal pdf for different values of  $\sigma$  and a fixed value of  $\mu$ .

*Table B-5. Summary of the normal distribution*

Probability Density Function	Reliability Function	Hazard Function
$f(t) = \frac{1}{\sigma\sqrt{2\pi}} e^{-\frac{(t-\mu)^2}{2\sigma^2}}$	$R(t) = \int_t^{\infty} f(t) dt$	$h(t) = \frac{f(t)}{R(t)}$

*Table B-6. Characteristics of the normal distribution*

- It has two parameters:
  - The mean,  $\mu$ , is the 50<sup>th</sup> percentile of the distribution. The distribution is symmetrical around the mean.
  - The standard deviation,  $\sigma$ , is a measure of the amount of spread in the distribution.
- If  $t$  has the pdf defined in figure B-5 and  $\mu = 0$  and  $\sigma = 1$ , then  $t$  is said to have a standardized normal distribution.
- The integral of a distribution's pdf is its cumulative distribution function, used to derive the reliability function. The integral of the normal pdf cannot be evaluated using the Fundamental Theorem of Calculus because we cannot find a function for which the derivative equals  $\exp(-x^2/2)$ . However, numerical integration methods have been used to evaluate the integral and tabulate values for the standard normal distribution.

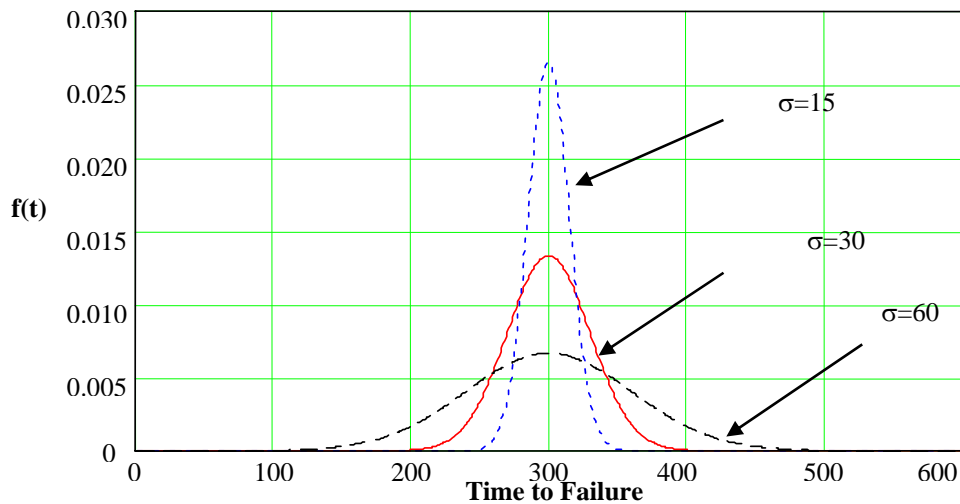

*Figure B-3. The normal pdf for varying values of  $\sigma$  and a fixed  $\mu$ .*

**B-5. The lognormal distribution**

The lognormal distribution is summarized in table B-7. The characteristics of the lognormal distribution are shown in table B-8. Figure B-4 shows the distribution for different values of  $\mu$  and  $\sigma$ .

Table B-7. Summary of the lognormal distribution

Probability Density Function	Reliability Function	Hazard Function
$f(t) = \frac{1}{\sigma t \sqrt{2\pi}} e^{-\frac{(\ln t - \mu)^2}{2\sigma^2}}$	$R(t) = \int_t^{\infty} f(t) dt$	$h(t) = \frac{f(t)}{R(t)}$

Table B-8. Characteristics of the lognormal distribution

- It has two parameters:
  - The mean,  $\mu$ . Unlike the mean of the Normal distribution, the mean of the lognormal is not the 50<sup>th</sup> percentile of the distribution and the distribution is not symmetrical around the mean.
  - The standard deviation,  $\sigma$ .
- The logarithms of the measurements of the parameter of interest (e.g., time to failure, time to repair) are normally distributed.

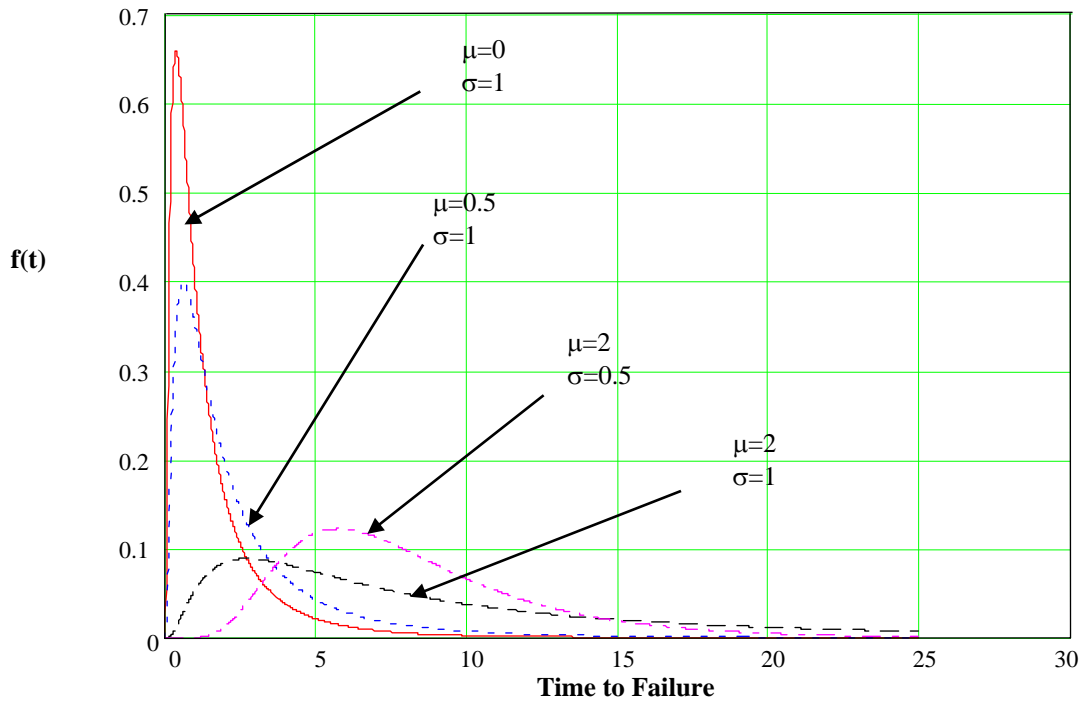

Figure B-4. The lognormal pdf for different values of  $\mu$  and  $\sigma$ .

## APPENDIX C

### AVAILABILITY AND OPERATIONAL READINESS

#### C-1. Availability

In general, availability is the ability of a product or service to be ready for use when a customer wants to use it. That is, it is available if it is in the customer's possession and works when it's turned on or used. A product that's "in the shop" or is in the customer's possession but doesn't work is not available. Measures of availability are shown in table C-1.

*Table C-1. Quantitative measures of availability*

Measure	Equation	Description
Inherent Availability: $A_i$	$\frac{MTBF}{MTBF + MTTR}$	<ul style="list-style-type: none"> <li>Where MTBF is the mean time between failure and MTTR is the mean time to repair</li> <li>A probabilistic measure</li> <li>Reflects the instantaneous probability that a component will be up. <math>A_i</math> considers only downtime for repair due to failures. No logistics delay time, preventative maintenance, etc. is included.</li> </ul>
Operational Availability: $A_o$	$\frac{MTBM}{MTBM + MDT}$	<ul style="list-style-type: none"> <li>Where MTBM is the mean time between maintenance (preventive and corrective) and MDT is the mean downtime, which includes MTTR and all other time involved with downtime such as logistic delays</li> <li>A probabilistic measure</li> <li>Similar to inherent availability but includes ALL downtime. Included is downtime for corrective maintenance and preventative maintenance, including any logistics delay time.</li> </ul>

MTBF = Mean Time Between Failure  
MDT = Mean Downtime

MTBM = Mean Time Between Maintenance  
MTTR = Mean Time to Repair (corrective only)

a. *Nature of the equations.* Note that the equations are time independent and probabilistic in nature. The value of availability yielded by each equation is the same whether the period of performance being considered is 1 hour or a year.

b. *Derivation of steady state equation for availability.* The equations in table C-1 are steady state equations. The equation for inherent availability (equation C-1), for example, is the steady state equation derived from equation C-2, as time approaches infinity:

$$A_i = \frac{MTBF}{MTBF + MTTR} \tag{Equation C-1}$$

$$A_i = \frac{MTBF}{MTBF + MTTR} + \frac{MTTR}{MTBF + MTTR} e^{-\left(\frac{1}{MTBF} + \frac{1}{MTTR}\right)t} \tag{Equation C-2}$$

1. Equation C-1 represents a limit for inherent availability. It represents the long-term proportion of time that a system will be operational.

2. Assuming that the times to failure and time to repair are both exponentially distributed, with rates  $\lambda$  and  $\mu$ , respectively, equation C-1 can be expressed as:

$$A_i = \frac{\frac{1}{\lambda}}{\frac{1}{\lambda} + \frac{1}{\mu}} = \frac{\mu}{\mu + \lambda} \quad \text{Equation C-3}$$

3. The derivation of equation C-1 now follows. A simple Markov model is used to evaluate availability. The probabilities of being in either the up state or the down state are determined using the Laplace transform. The model and equations are:

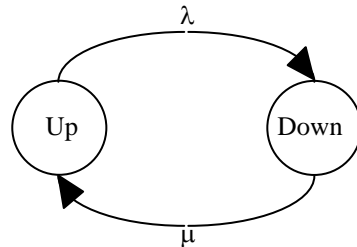

$$\frac{dP_{Up}(t)}{dt} = -\lambda P_{Up}(t) + \mu P_{Down}(t) \quad \text{Equation C-4}$$

$$sL_{Up}(s) - P_{Up}(0) = sL_{Up}(s) - 1 = -\lambda L_{Up}(s) + \mu L_{Down}(s) \quad \text{Equation C-5}$$

$$1 - sL_{Up}(s) = sL_{Down}(s) = \lambda L_{Up}(s) - \mu L_{Down}(s) \quad \text{Equation C-6}$$

$$\text{From equation C-4, } L_{Up}(s) = \frac{1 + \mu L_{Down}(s)}{s + \lambda} \quad \text{Equation C-7}$$

$$\text{From equation C-5, } L_{Down}(s) = \frac{\lambda L_{Up}(s)}{s + \mu} \quad \text{Equation C-8}$$

4. Substituting the expression for  $L_{Down}(s)$  into equation C-7,

$$L_{Up}(s) = \frac{1}{s + \mu + \lambda} + \frac{\mu}{s(s + \lambda + \mu)} \quad \text{Equation C-9}$$

5. Then, availability = the inverse of the Laplace transform for  $L_{Up}(s)$ . To obtain the inverse,

$$\begin{aligned}
 \frac{1}{s + \mu + \lambda} + \frac{\mu}{s(s + \lambda + \mu)} &= \frac{1}{\lambda + \mu} \left( \frac{\mu(s + \mu + \lambda) + \lambda s}{s(s + \mu + \lambda)} \right) \\
 &= \frac{1}{\lambda + \mu} \left( \frac{\mu}{s} + \frac{\lambda}{s + \mu + \lambda} \right) \\
 &= \frac{\mu}{\lambda + \mu} \frac{1}{s} + \frac{\lambda}{\mu + \lambda} \frac{1}{s + \mu + \lambda} \\
 &= \frac{1}{\lambda + \mu} \left( \frac{\mu}{s} + \frac{\lambda}{s + \mu + \lambda} \right) \\
 &= \frac{\mu}{\lambda + \mu} \times \frac{1}{s} + \frac{\lambda}{\mu + \lambda} \times \frac{1}{s + \mu + \lambda} \\
 &= \frac{\mu}{\lambda + \mu} \int_0^{\infty} e^{-st} dt + \frac{\lambda}{\mu + \lambda} \int_0^{\infty} e^{-(s + \mu + \lambda)t} dt \\
 &= \int_0^{\infty} \frac{\mu}{\lambda + \mu} e^{-st} + \frac{\lambda}{\mu + \lambda} e^{-(s + \mu + \lambda)t} dt \\
 &= \int_0^{\infty} e^{-st} \left( \frac{\mu}{\lambda + \mu} + \frac{\lambda}{\mu + \lambda} e^{-(\mu + \lambda)t} \right) dt \\
 &= L \left[ \frac{\mu}{\lambda + \mu} + \frac{\lambda}{\mu + \lambda} e^{-(\mu + \lambda)t} \right] \\
 \therefore A &= \frac{\mu}{\mu + \lambda} + \frac{\lambda}{\lambda + \mu} e^{-(\lambda + \mu)t}
 \end{aligned}$$

Equation C-10

6. Taking the limit of equation C-10 as t approaches infinity,

$$\begin{aligned}
 A_i &= \frac{\mu}{\mu + \lambda} + \frac{\lambda}{\lambda + \mu} \times 0 = \frac{\mu}{\lambda + \mu} \\
 A_i &= \frac{MTBF}{MTBF + MTTR}
 \end{aligned}$$

Q.E.D.

## C-2. Operational readiness

Closely related to the concept of operational availability but broader in scope is operational readiness. Operational readiness is defined as the ability of a military unit to respond to its operational plans upon

receipt of an operations order. It is, therefore, a function not only of the product availability, but also of assigned numbers of operating and maintenance personnel, the supply, the adequacy of training, and so forth.

a. *Readiness in the commercial world.* Although operational readiness has traditionally been a military term, it is equally applicable in the commercial world. For example, a manufacturer may have designed and is capable of making very reliable, maintainable products. What if he has a poor distribution and transportation system or does not provide the service or stock the parts needed by customers to effectively use the product? Then, the readiness of this manufacturer to go to market with the product is low.

b. *Relationship of availability and operational readiness.* The concepts of availability and operational readiness are obviously related. Important to note, however, is that while the inherent design characteristics of a product totally determine inherent availability, other factors influence operational availability and operational readiness. The reliability and maintainability engineers directly influence the design of the product. Together, they can affect other factors by providing logistics planners with the information needed to identify required personnel, spares, and other resources. This information includes the identification of maintenance tasks, repair procedures, and needed support equipment.



## APPENDIX D

### ACRONYMS

---

#### D-1. ACRONYMS

$A_i$	-	Availability, Inherent
$A_o$	-	Availability, Operational
CBM	-	Condition-based Maintenance
CM	-	Corrective Maintenance
CND	-	Cannot Duplicate
FEA	-	Finite Element Analysis
FMEA	-	Failure Modes and Effects Analysis
FMECA	-	Failure Modes, Effects, and Criticality Analysis
FD	-	Fault Detection
FI	-	Fault Isolation
FTA	-	Fault Tree Analysis
LCC	-	Life Cycle Cost
LRU	-	Line Replaceable Unit
MA	-	Maintenance Action
MTBF	-	Mean Time Between Failure
MTBM	-	Mean Time Between Maintenance
MTTR	-	Mean Time To Repair
NDE	-	Nondestructive Evaluation
NDI	-	Nondestructive Inspection
O&S	-	Operating and Support
PM	-	Preventive Maintenance

**TM 5-698-2**

pdf	-	Probability Density Function
R&R	-	Remove and Replace
RBD	-	Reliability Block Diagram
RCM	-	Reliability-Centered Maintenance
RTOK	-	Retest OK
R&M	-	Reliability and Maintainability
TAT	-	Turn Around Time

## APPENDIX E

### Flexible Methodology Example

---

#### **Definition of Detection Method, Failure Occurrence, and Severity Levels for Flexible RCM Analysis**

It should be understood that, from an overall perspective, flexible analysis approach focuses on subsystem and system level function loss. This is different from traditional analysis techniques, which focus on specific failure modes for specific components. Focus on the subsystem and system level allows RCM analysis to be conducted despite the absence of complete component level information.

#### **Detection Method**

As stated in the Ground Rules and Assumptions section, when system controls, automation configurations, and system safeguards are unknown, Detection Method Level can be assumed to be 1. This assumes and stresses that, for a mission critical facility, all item and system level function losses should and will be apparent.

Although this is an acceptable approach for initial analysis, and demonstration purposes, it should be understood that the presence, or absence, of detection method in a systems has a direct effect on the risk associated with the operation of that system. Therefore, consideration of detection method will provide more accurate and resolute analysis results and recommendations. Furthermore, an understanding of current detection method provisions, along with results of an analysis which considered detection method and component level failure modes, can and should be utilized to make recommendations on future detection method provisions.

#### **Occurrence**

Equipment specific PREP database availability numbers will provide indication of failure frequency. These metrics will help to provide less subjective item and system risk assessments. However, they must be adjusted to account for system redundancy, and ranked into discrete occurrence levels to be used in qualitative equipment criticality calculations.

By design and purpose, a redundant system is more reliable and less vulnerable than a single point, with respect to system function and mission requirements. Therefore, the occurrence level for a single point function must be weighted to reflect the operation, presumed reliability, and severity of loss of function of the redundant component system as accurately as possible.

The following formula is used to calculate the adjusted availability of a given subsystem due to a level of component or subsystem redundancy.

$$A_i^1 = \sum_{k=m}^n \frac{n!}{k!(n-k)!} (A_i)^k (1 - A_i)^{(n-k)}$$

Where:

- $A_i$  = Initial inherent component availability
- $A_i^1$  = Adjusted redundant component availability level
- m = Minimum number of components needed
- n = Number of components available
- k = Current component in redundant system being analyzed

With availability metrics representative of system configuration now available, component availability is ranked to provide discrete subsystem occurrence levels, as follows:

Availability (nines)	Occurrence Rank	Occurrence Description
≥ 0.999999999	1	Almost Never
0.999999999	2	Remote
0.9999999	3	Very Slight
0.9999999	4	Slight
0.999999	5	Low
0.99999	6	Medium
0.999	7	Moderately High
0.99	8	High
0.9	9	Very High
0	10	Almost Certain

### Severity

It is also important to consider the concept of failure severity. Severity pertains to and ranks the consequences of system level failure mode effects. For example, a highly probable failure may occur for a subsystem of a piece of critical equipment without severe consequences.

Severity rankings used are as follows:

Ranking	Effect	Comment
1	None	No reason to expect failure to have any effect on Safety, Health, Environment or Mission
2	Very Low	Minor disruption to mission.
3	Low	Minor disruption to mission.
4	Low to Moderate	Moderate disruption to mission.
5	Moderate	Moderate disruption to mission.
6	Moderate to High	Moderate disruption to mission.
7	High	High disruption to mission.
8	Very High	High disruption to mission.
9	Hazard	Extremely high disruption to mission
10	Hazard	Extremely high disruption to mission.

**RPN Calculations and Ranking Methods for Flexible Analysis**

Severity, occurrence, and detection method levels are then utilized to produce a subsystem risk assessment as follows:

$$RPN = O \times S \times D$$

Where:

- RPN = Risk associated with failure mode (Risk Priority Number)
- S = Severity level for failure mode
- O = Occurrence level for failure mode
- D = Detection method level (1)

This calculation will be performed for every subsystem item in the master equipment listing. With this information, Risk Priority Numbers for sub-systems and systems can be obtained as follows:

$$RPN_s = \sum_{n=1}^j (RPN_c)_n$$

Facility Identifier	Equipment Type	Parent System	M	N	PREPID	A	A'	O' Rank	S	RPN
A-1	A	X	1	2	13	0.999988924	0.9999999999	1	9	9
A-2	A	X	1	2	13	0.999988924	0.9999999999	1	9	9
B-1	B	X	1	4	163	0.999993654	1.0000000000	1	9	9
B-2	B	X	1	4	163	0.999993654	1.0000000000	1	9	9
B-3	B	X	1	4	163	0.999993654	1.0000000000	1	9	9
B-4	B	X	1	4	163	0.999993654	1.0000000000	1	9	9

**System RPN 54**

Where:

- RPN<sub>s</sub> = Risk Priority Number for the current system being analyzed
- RPN<sub>c</sub> = Risk Priority Number for the current subsystem
- n = The current subsystem being analyzed
- j = Total number of components in the sub-system or system

**Results – System X**

Item and system risk assessments can now be utilized to apply RCM decision logic (see figure 5.2), and to build maintenance tasking program. Items and systems assessed to be of high operational risk should, especially, be applied to the decision logic and should receive high levels of maintenance focus. Items having extremely low operation risk will receive low levels of maintenance focus, and may be allowed to run to failure.

## GLOSSARY

---

### -A-

**ACTIVE TIME:** That time during which an item is in an operational inventory.

**AFFORDABILITY:** Affordability is a measure of how well customers can afford to purchase, operate, and maintain a product over its planned service life. Affordability is a function of product value and product costs. It is the result of a balanced design in which long-term support costs are considered equally with near-term development and manufacturing costs.

**ALIGNMENT:** Performing the adjustments that are necessary to return an item to specified operation.

**AVAILABILITY:** The instantaneous probability that a component will be up.

**AVAILABILITY, INHERENT ( $A_i$ ):** The instantaneous probability that a component will be up.  $A_i$  considers only downtime for repair due to failures. No logistics delay time, preventative maintenance, etc. is included.

**AVAILABILITY, OPERATIONAL ( $A_o$ ):**  $A_o$  is the instantaneous probability that a component will be up but differs from inherent availability in that it includes ALL downtime. Included is downtime for both corrective maintenance and preventative maintenance, including any logistics delay time..

### -C-

**CALIBRATION:** A comparison of a measuring device with a known standard and a subsequent adjustment to eliminate any differences. Not to be confused with alignment.

**CANNOT DUPLICATE (CND):** A situation when a failure has been noted by the operator but cannot be duplicated by maintenance personnel attempting to correct the problem. Also see Retest OK.

**CHECKOUT:** Tests or observations of an item to determine its condition or status.

**COMPONENT.** A piece of electrical or mechanical equipment viewed as an entity for the purpose of reliability evaluation

**CONDITION-BASED PM:** Maintenance performed to assess an item's condition and performed as a result of that assessment. Some texts use terms such as predictive maintenance and on-condition. The definition of condition-based PM used herein includes these concepts. In summary, the objectives of condition-based PM are to first evaluate the condition of an item, then, based on the condition, either determine if a hidden failure has occurred or determine if a failure is imminent, and then take appropriate action. Maintenance that is required to correct a hidden failure is, of course, corrective maintenance.

**CORRECTIVE ACTION:** A documented design, process, procedure, or materials change implemented and validated to correct the cause of failure or design deficiency.

**CORRECTIVE MAINTENANCE (CM):** All actions performed as a result of failure, to restore an item to a specified condition. Corrective maintenance can include any or all of the following steps: Localization, Isolation, Disassembly, Interchange, Reassembly, Alignment and Checkout.

**COST:** The expenditure of resources (usually expressed in monetary units) necessary to develop, acquire, or use a product over some defined period of time.

**-D-**

**DEPENDABILITY:** A measure of the degree to which an item is operable and capable of performing its required function at any (random) time during a specified mission profile, given item availability at the start of the mission. (Item state during a mission includes the combined effects of the mission-related system R&M parameters but excludes non-mission time; see availability).

**DETECTABLE FAILURE:** Failures at the component, equipment, subsystem, or system (product) level that can be identified through periodic testing or revealed by an alarm or an indication of an anomaly.

**DIAGNOSTICS:** The hardware, software, or other documented means used to determine that a malfunction has occurred and to isolate the cause of the malfunction. Also refers to "the action of detecting and isolating failures or faults."

**DOWNTIME:** That element of time during which an item is in an operational inventory but is not in condition to perform its required function.

**-E-**

**EFFECTIVENESS:** The degree to which PM can provide a quantitative indication of an impending functional failure, reduce the frequency with which a functional failure occurs, or prevent a functional failure.

**EQUIPMENT:** A general term designating an item or group of items capable of performing a complete function.

**-F-**

**FAILURE (f).** The termination of the ability of a component or system to perform a required function.

**FAILURE, CATASTROPHIC:** A failure that causes loss of the item, human life, or serious collateral damage to property.

**FAILURE, HIDDEN:** A failure that is not evident to the operator; that is, it is not a functional failure. A hidden failure may occur in two different ways. In the first, the item that has failed is one of two or more redundant items performing a given function. The loss of one or more of these items does not result in a loss of the function. The second way in which a hidden failure can occur is when the function performed by the item is normally inactive. Only when the function is eventually required will the failure become evident to the operator. Hidden failures must be detected by maintenance personnel.

**FAILURE, INTERMITTENT:** Failure for a limited period of time, followed by the item's recovery of its ability to perform within specified limits without any remedial action.



**FAILURE, RANDOM:** A failure, the occurrence of which cannot be predicted except in a probabilistic or statistical sense.

**FAILURE ANALYSIS:** Subsequent to a failure, the logical systematic examination of an item, its construction, application, and documentation to identify the failure mode and determine the failure mechanism and its basic course.

**FAILURE EFFECT:** The consequence(s) a failure mode has on the operation, function, or status of an item. Failure effects are typically classified as local, next higher level, and end.

**FAILURE MECHANISM:** The physical, chemical, electrical, thermal or other process which results in failure.

**FAILURE MODE:** The way in which a failure is observed, describes the way the failure occurs, ie., short, open, fracture and excessive wear..

**FAILURE MODE AND EFFECTS ANALYSIS (FMEA):** A procedure by which each potential failure mode in a product (system) is analyzed to determine the results or effects thereof on the product and to classify each potential failure mode according to its severity or risk probability number.

**FAILURE MODES, EFFECTS, AND CRITICALITY ANALYSIS (FMECA):** The term is used to emphasize the classifying of failure modes as to their severity (criticality).

**FAILURE RATE ( $\lambda$ ):** The mean (arithmetic average, also known as the forced outage rate) number of failures of a component and/or system per unit exposure time. The most common unit in reliability analyses is hours (h). However, some industries use failures per year (f/y) which is denoted by the symbol ( $\lambda y$ ).

**FAILURE REPORTING AND CORRECTIVE ACTION SYSTEM (FRACAS):** A closed-loop system for collecting, analyzing, and documenting failures and recording any corrective action taken to eliminate or reduce the probability of future such failures.

**FALSE ALARM:** A fault indicated by BIT or other monitoring circuitry where no fault can be found or confirmed.

**FAULT:** Immediate cause of failure (e.g., maladjustment, misalignment, defect, etc.).

**FAULT DETECTION (FD):** A process that discovers the existence of faults.

**FAULT ISOLATION (FI):** The process of determining the location of a fault to the indenture level necessary to affect repair.

**FAULT TREE ANALYSIS:** An analysis approach in which each potential system failure is traced back to all faults that could cause the failure. It is a top-down approach, whereas the FMEA is a bottom-up approach.

**FINITE ELEMENT ANALYSIS (FEA):** A modeling technique (normally a computer simulation) used to predict the material response or behavior of the device or item being modeled. FEA can describe material stresses and temperatures throughout the modeled device by simulating thermal or dynamic loading conditions. It can be used to assess mechanical failure mechanisms such as fatigue, rupture, creep, and buckling.

**FUNCTIONAL TEST:** An evaluation of a product or item while it is being operated and checked under limited conditions without the aid of its associated equipment in order to determine its fitness for use.

-H-

**HIDDEN FAILURE:** See Failure, Hidden.

-I-

**ISOLATION:** Determining the location of a failure to the extent possible, by the use of accessory equipment.

-L-

**LEVELS OF MAINTENANCE:** The division of maintenance, based on different and requisite technical skill, which jobs are allocated to organizations in accordance with the availability of personnel, tools, supplies, and the time within the organization. Typical maintenance levels are organizational, intermediate, and depot.

**LIFE CYCLE COST (LCC):** The sum of acquisition, logistics support, operating, and retirement and phase-out expenses.

**LIFE CYCLE PHASES:** Identifiable stages in the life of a product from the development of the first concept to removing the product from service and disposing of it. Within the Department of Defense, four phases are formally defined: Concept Exploration; Program Definition and Risk Reduction; Engineering and Manufacturing Development; and Production, Deployment, and Operational Support. Although not defined as a phase, demilitarization and disposal is defined as those activities conducted at the end of a product's useful life. Within the commercial sector, various ways of dividing the life cycle into phases are used. One way of doing this is as follows: Customer Need Analysis, Design and Development, Production and Construction, Operation and Maintenance, and Retirement and Phase-out.

**LINE REPLACEABLE UNIT (LRU):** A unit designed to be removed upon failure from a larger entity (product or item) in the operational environment, normally at the organizational level.

**LOCALIZATION:** Determining the location of a failure to the extent possible, without using accessory test equipment.

**LOGISTIC DELAY TIME:** That element of downtime during which no maintenance is being accomplished on the item because of either supply or administrative delay.

**LOGISTICS SUPPORT:** The materials and services required to enable the operating forces to operate, maintain, and repair the end item within the maintenance concept defined for that end item.

-M-

**MAINTAINABILITY:** The relative ease and economy of time and resources with which an item can be retained in, or restored to, a specified condition when maintenance is performed by personnel having specified skill levels, using prescribed procedures and resources, at each prescribed level of maintenance and repair. Also, the probability that an item can be retained in, or restored to, a specified condition when maintenance is performed by personnel having specified skill levels, using prescribed procedures and resources, at each prescribed level of maintenance and repair.

**MAINTENANCE:** All actions necessary for retaining an item in or restoring it to a specified condition.

**MAINTENANCE ACTION:** An element of a maintenance event. One or more tasks (i.e., fault localization, fault isolation, servicing and inspection) necessary to retain an item's condition or restore it to a specified condition.

**MAINTENANCE CONCEPT:** A description of the planned general scheme for maintenance and support of an item in the operational environment. It provides a practical basis for design, layout, and packaging of the system and its test equipment. It establishes the scope of maintenance responsibility for each level of maintenance and the personnel resources required to maintain the system.

**MAINTENANCE EVENT:** One or more maintenance actions required to effect corrective and preventive maintenance due to any type of failure or malfunction, false alarm or scheduled maintenance plan.

**MAINTENANCE TASK:** The maintenance effort necessary for retaining an item in, or changing/restoring it to a specified condition.

**MAINTENANCE TIME:** An element of downtime that excludes modification and delay time.

**MEAN DOWNTIME (MDT).** The average downtime caused by preventative and corrective maintenance, including any logistics delay time. This is synonymous with mean time to restore system (MTTRS) as found in some publications.

**MEAN TIME BETWEEN FAILURES (MTBF).** The mean exposure time between consecutive failures of a component. MTBF is a require measurement used for calculating inherent availability. It can be estimated by dividing the exposure time by the number of failures in that period.

**MEAN TIME BETWEEN MAINTENANCE (MTBM).** The average time between all maintenance events that cause downtime, both preventative and corrective maintenance, and also includes any associated logistics delay time.

**MEAN TIME TO REPAIR (MTTR).** The mean time to replace or repair a failed component. Logistics time associated with the repair, such as parts acquisitions, crew mobilization, are not included. It can be estimated by dividing the summation of repair times by the number of repairs and, therefore, is practically the average repair time. The most common unit in reliability analyses is hours (h/f).

**MISSION TIME:** That element of up time required to perform a stated mission profile.

-N-

**NON-DESTRUCTIVE EVALUATION:** A collective term referring to a wide range of technologies and methods used for nondestructive inspection, evaluation, or testing.

**NON-DESTRUCTIVE INSPECTION (NDI):** Any method used for inspecting an item without physically, chemically, or otherwise destroying or changing the design characteristics of the item. However, it may be necessary to remove paint or other external coatings to use the NDI method. A wide range of technology and methods are usually described as nondestructive inspection, evaluation, or testing (collectively referred to as non-destructive evaluation or NDE). The core of NDE is commonly thought to contain ultrasonic, visual, radiographic, eddy current, liquid penetrant, and magnetic particle inspection methods. Other methodologies include acoustic emission, use of laser interference, microwaves, NMR and MRI, thermal imaging, and so forth.

**NON-DETECTABLE FAILURE:** Failures at the component, equipment, subsystem, or system (product) level that are identifiable by analysis but cannot be identified through periodic testing or revealed by an alarm or an indication of an anomaly.

-O-

**ON-CONDITION MAINTENANCE:** See Condition-based PM.

**OPERATING AND SUPPORT (O&S) COSTS:** Those costs associated with operating and supporting (i.e., using) a product after it is purchased or fielded.

**OPERATIONAL READINESS:** The ability of a military unit to respond to its operation plan(s) upon receipt of an operations order. (A function of assigned strength, item availability, status, or supply, training, etc.).

-P-

**PREDICTED:** That which is expected at some future time, postulated on analysis of past experience and tests.

**PREDICTIVE MAINTENANCE:** See Condition-based PM.

**PREVENTATIVE MAINTENANCE (PM):** All actions performed in an attempt to retain an item in a specified condition. These actions may or may not result in downtime for the component, and may or may not be performed on a fixed interval.

-R-

**REASSEMBLY:** Assembling the items that were removed during disassembly and closing the reassembled items.

**REDUNDANCY:** The existence of more than one means for accomplishing a given function. Each means of accomplishing the function need not necessarily be identical.

**RELIABILITY (R(t)).** The probability that a component can perform its intended function for a specified time interval (t) under stated conditions. This calculation is based on the exponential distribution.

**RELIABILITY-CENTERED MAINTENANCE (RCM):** A disciplined logic or methodology used to identify preventive and corrective maintenance tasks to realize the inherent reliability of equipment at a minimum expenditure of resources, while ensuring safe operation and use.

**RETEST OK (RTOK):** A situation where a failure was detected on the system, either through inspection or testing, but no fault can be found in the item that was eventually removed for repair at a field or depot location. Also see Cannot Duplicate.

-S-

**SCHEDULED MAINTENANCE:** Periodic prescribed inspection and/or servicing of products or items accomplished on a calendar, mileage or hours of operation basis. Included in Preventive Maintenance.

**SERVICING:** The performance of any act needed to keep an item in operating condition, (i.e. lubricating, fueling, oiling, cleaning, etc.), but not including preventive maintenance of parts or corrective maintenance tasks.

**SINGLE-POINT FAILURE:** A failure of an item that causes the system to fail and for which no redundancy or alternative operational procedure exists.

**SUBSYSTEM:** A combination of sets, groups, etc. that performs an operational function within a product (system) and is a major subdivision of the product. (Example: Data processing subsystem, guidance subsystem).

**SYSTEM DOWNTIME:** The time interval between the commencement of work on a system (product) malfunction and the time when the system has been repaired and/or checked by the maintenance person, and no further maintenance activity is executed.

**SYSTEM:** General – A composite of equipment and skills, and techniques capable of performing or supporting an operational role, or both. A complete system includes all equipment, related facilities, material, software, services, and personnel required for its operation and support to the degree that it can be considered self-sufficient in its intended operational environment.

-T-

**TESTABILITY:** A design characteristic that allows status (operable, inoperable, or degraded) of an item to be determined and the isolation of faults within the item to be performed in a timely manner.

**TOTAL SYSTEM DOWNTIME:** The time interval between the reporting of a system (product) malfunction and the time when the system has been repaired and/or checked by the maintenance person, and no further maintenance activity is executed.

-U-

**UNSCHEDULED MAINTENANCE:** Corrective maintenance performed in response to a suspected failure.

**UPTIME:** That element of ACTIVE TIME during which an item is in condition to perform its required functions. (Increases availability and dependability).

**USEFUL LIFE:** The number of life units from manufacture to when the item has an unreparable failure or unacceptable failure rate. Also, the period of time before the failure rate increases due to wearout.

-W-

**WEAROUT:** The process that results in an increase of the failure rate or probability of failure as the number of life units increases.

The proponent agency of this publication is the Chief of Engineers, United States Army. Users are invited to send comments and suggested improvements on DA Form 2028 (Recommended Changes to Publications and Blank Forms) directly to HQUSACE, (ATTN: CEMP-OS-P), Washington, DC 20314-1000.

By Order of the Secretary of the Army:

Official:



JOYCE E. MORROW  
*Administrative Assistant to the  
Secretary of the Army*

PETER J. SCHOOMAKER  
*General, United States Army  
Chief of Staff*

Distribution:

To be distributed in accordance with Initial Distribution Number (IDN) 344774, requirements for non-equipment TM 5-698-2.

