

Michigan Demonstration Project: Performance Contracting for Construction on M-115 in Clare County, MI

FINAL REPORT
JUNE 2013

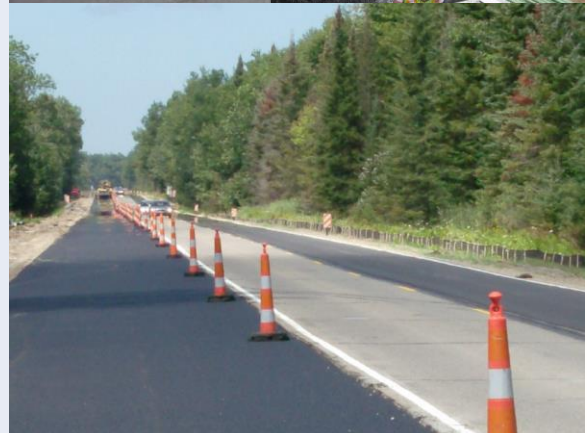

U.S. Department of Transportation
Federal Highway Administration

FOREWORD

The purpose of the Highways for LIFE (HfL) pilot program is to accelerate the use of innovations that improve highway safety and quality while reducing congestion caused by construction. **LIFE** is an acronym for **L**onger-lasting highway infrastructure using **I**nnovations to accomplish the **F**ast construction of **E**fficient and safe highways and bridges.

Specifically, HfL focuses on speeding up the widespread adoption of proven innovations in the highway community. “Innovations” is an inclusive term used by HfL to encompass technologies, materials, tools, equipment, procedures, specifications, methodologies, processes, and practices used to finance, design, or construct highways. HfL is based on the recognition that innovations are available that, if widely and rapidly implemented, would result in significant benefits to road users and highway agencies.

Although innovations themselves are important, HfL is as much about changing the highway community’s culture from one that considers innovation something that only adds to the workload, delays projects, raises costs, or increases risk to one that sees it as an opportunity to provide better highway transportation service. HfL is also an effort to change the way highway community decisionmakers and participants perceive their jobs and the service they provide.

The HfL pilot program, described in Safe, Accountable, Flexible, Efficient Transportation Equity Act: A Legacy for Users (SAFETEA-LU) Section 1502, includes funding for demonstration construction projects. By providing incentives for projects, HfL promotes improvements in safety, construction-related congestion, and quality that can be achieved through the use of performance goals and innovations. This report documents one such HfL demonstration project.

Additional information on the HfL program is at www.fhwa.dot.gov/hfl.

NOTICE

This document is disseminated under the sponsorship of the U.S. Department of Transportation in the interest of information exchange. The U.S. Government assumes no liability for its contents or use thereof. This report does not constitute a standard, specification, or regulation.

The U.S. Government does not endorse products or manufacturers. Trade and manufacturers’ names appear in this report only because they are considered essential to the object of the document.

1. Report No.	2. Government Accession No	3. Recipient's Catalog No	
3. Title and Subtitle Michigan Demonstration Project: Performance Contracting for Construction on M-115 in Clare County, MI		5. Report Date June 2013	6. Performing Organization Code
7. Authors Shreenath Rao, Ph.D., P.E., Jagannath Mallela, Gary Hoffman, P.E., R.L.S.		8. Performing Organization Report No.	
9. Performing Organization Name and Address Applied Research Associates, Inc. 100 Trade Centre Drive, Suite 200 Champaign, IL 61820		10. Work Unit No. (TRAIS) C6B	11. Contract or Grant No.
12. Sponsoring Agency Name and Address Office of Infrastructure Federal Highway Administration 1200 New Jersey Avenue, SE Washington, DC 20590		12. Type of Report and Period Covered Final Report	14. Sponsoring Agency Code
15. Supplementary Notes Contracting Officers Technical Representatives: Byron Lord, Mary Huie			
16. Abstract As part of a national initiative sponsored by the Federal Highway Administration under the Highways for LIFE program, the Michigan Department of Transportation (MDOT) was awarded a \$1 million grant to demonstrate the use of innovative technologies for construction contracting using performance contracting for construction (PCfC). This report documents the contracting methods used to encourage and reward contractor innovation on construction of M-115, a two-lane rural highway in Clare County near Mt. Pleasant, MI. This report includes contracting details of the construction project with specifics on the incentives and disincentives MDOT offered to encourage the contractor to meet or exceed MDOT requirements for performance measures such as early opening to traffic, early construction and cleanup completion, pavement performance, ride quality, worker safety during construction, reduced work zone crashes, and reduced motorist delays. The report also describes the project construction and steps the contractor took to earn incentives. Details of the experiences of MDOT and the contractor are also included. MDOT's overall conclusion was that the project was successful and the agency would use performance-based contracting on future projects when appropriate. The as-constructed roadway added \$1,369,072 to the initial cost of the project. The incremental initial costs after considered user-costs was \$690,226. However, the warranty resulted in the contractor constructing a roadway with potentially improved long-term performance as compared to that specified in the request for proposal (RFP). The life-cycle cost analysis (LCCA) showed that the baseline project will cost MDOT and the users of the roadway \$7,801,876 in terms of net present value (NPV) based on a 20-year analysis period. By comparison, the as-constructed project will cost \$6,150,201 in terms of NPV, for a total savings of \$1,651,675. Through the use of PCfC, the project was completed with minimal disruption to the traveling public, and provided MDOT with a safer, smoother pavement with a 5-year warranty, and lower life-cycle costs.			
17. Key Words disincentives, economic analysis, goal-oriented contracting, Highways for LIFE, incentives, innovation deployment, performance contracting, performance metrics, result-oriented contracting		18. Distribution Statement No restriction. This document is available to the public through the Highways for Life website: http://www.fhwa.dot.gov/hfl/	
Security Classif.(of this report) Unclassified	19. Security Classif. (of this page) Unclassified	20. No. of Pages 66	21. Price

SI* (MODERN METRIC) CONVERSION FACTORS

APPROXIMATE CONVERSIONS TO SI UNITS					APPROXIMATE CONVERSIONS FROM SI UNITS				
Symbol	When You Know	Multiply By	To Find	Symbol	Symbol	When You Know	Multiply By	To Find	Symbol
LENGTH					LENGTH				
(none)	mil	25.4	micrometers	μm	μm	micrometers	0.039	mil	(none)
in	inches	25.4	millimeters	mm	mm	millimeters	0.039	inches	in
ft	feet	0.305	meters	m	m	meters	3.28	feet	ft
yd	yards	0.914	meters	m	m	meters	1.09	yards	yd
mi	miles	1.61	kilometers	km	km	kilometers	0.621	miles	mi
AREA					AREA				
in^2	square inches	645.2	square millimeters	mm^2	mm^2	square millimeters	0.0016	square inches	in^2
ft^2	square feet	0.093	square meters	m^2	m^2	square meters	10.764	square feet	ft^2
yd^2	square yard	0.836	square meters	m^2	m^2	square meters	1.195	square yards	yd^2
ac	acres	0.405	hectares	ha	ha	hectares	2.47	acres	ac
mi^2	square miles	2.59	square kilometers	km^2	km^2	square kilometers	0.386	square miles	mi^2
VOLUME					VOLUME				
fl oz	fluid ounces	29.57	milliliters	mL	mL	milliliters	0.034	fluid ounces	fl oz
gal	gallons	3.785	liters	L	L	liters	0.264	gallons	gal
ft^3	cubic feet	0.028	cubic meters	m^3	m^3	cubic meters	35.71	cubic feet	ft^3
yd^3	cubic yards	0.765	cubic meters	m^3	m^3	cubic meters	1.307	cubic yards	yd^3
NOTE: volumes greater than 1000 shall be shown in m^3									
MASS					MASS				
oz	ounces	28.35	grams	g	g	grams	0.035	ounces	oz
lb	pounds	0.454	kilograms	kg	kg	kilograms	2.202	pounds	lb
T	short tons (2000 lb)	0.907	megagrams (metric tons)	Mg (or t)	Mg (or t)	megagrams (metric tons)	1.103	short tons (2000 lb)	T
TEMPERATURE (exact degrees)					TEMPERATURE (exact degrees)				
$^{\circ}\text{F}$	Fahrenheit	$5(F-32)/9$ or $(F-32)/1.8$	Celsius	$^{\circ}\text{C}$	$^{\circ}\text{C}$	Celsius	$1.8C+32$	Fahrenheit	$^{\circ}\text{F}$
ILLUMINATION					ILLUMINATION				
fc	foot-candles	10.76	lux	lx	lx	lux	0.0929	foot-candles	fc
fl	foot-Lamberts	3.426	candela/ m^2	cd/m^2	cd/m^2	candela/ m^2	0.2919	foot-Lamberts	fl
FORCE and PRESSURE or STRESS					FORCE and PRESSURE or STRESS				
lb	pounds	4.45	Newtons	N	N	Newtons	0.225	pounds	lb
lb/in^2 (psi)	pounds per square inch	6.89	kiloPascals	kPa	kPa	kiloPascals	0.145	pounds per square inch	lb/in^2 (psi)
k/in^2 (ksi)	kips per square inch	6.89	megaPascals	MPa	MPa	megaPascals	0.145	kips per square inch	k/in^2 (ksi)
DENSITY					DENSITY				
lb/ft^3 (pcf)	pounds per cubic foot	16.02	kilograms per cubic meter	kg/m^3	kg/m^3	pounds per cubic foot	0.062	kilograms per cubic meter	lb/ft^3 (pcf)

*SI is the symbol for the International System of Units. Appropriate rounding should be made to comply with Section 4 of ASTM E380.

(Revised September 1993)

ACKNOWLEDGMENTS

The project team would like to acknowledge the invaluable insights and guidance of Federal Highway Administration (FHWA) Highways for LIFE Team Leader Byron Lord and Program Coordinators Mary Huie and Kathleen Bergeron, who served as the technical panel on this demonstration project. Their vast knowledge and experience with the various aspects of construction, technology deployment, and technology transfer helped immensely in developing both the approach and the technical matter for this document. The team is also indebted to Michigan Department of Transportation Engineers Jack Hofweber, Bill Mayhew, and Tony Kratofil and FHWA Division Administrator Jim Steele and Engineering and Operations Manager Tom Fudaly for their advice, assistance, and coordination during this project.

TABLE OF CONTENTS

INTRODUCTION	1
HIGHWAYS FOR LIFE DEMONSTRATION PROJECTS	1
<i>Project Solicitation, Evaluation, and Selection</i>	1
<i>HfL Project Performance Goals</i>	2
REPORT SCOPE AND ORGANIZATION	3
PROJECT OVERVIEW AND LESSONS LEARNED	4
PROJECT OVERVIEW	4
DATA COLLECTION.....	5
ECONOMIC ANALYSIS.....	6
LESSONS LEARNED.....	6
CONCLUSIONS	8
PROJECT DETAILS.....	9
BACKGROUND	9
PROJECT DESCRIPTION	12
<i>M-115 Request for Proposal and Project Goals</i>	13
<i>Best-Value Contractor Selection</i>	18
<i>Construction</i>	21
<i>Contractor Performance and Awarded Incentives/Disincentives</i>	28
DATA ACQUISITION AND ANALYSIS.....	31
SAFETY	31
CONSTRUCTION CONGESTION.....	33
QUALITY.....	34
<i>Sound Intensity Testing</i>	34
<i>Smoothness Measurement</i>	40
USER SATISFACTION.....	41
TECHNOLOGY TRANSFER.....	47
ECONOMIC ANALYSIS	50
CONSTRUCTION TIME	50
DETOUR.....	50
CONSTRUCTION COSTS	50
USER COSTS	51
INITIAL COST SUMMARY	52
LIFE-CYCLE COST ANALYSIS	52
APPENDIX A: SHOWCASE AGENDA	55
APPENDIX B: CONSTRUCTION CONGESTION COST (CO3) OUTPUT FOR M-115 CONSTRUCTION BASED ON TRADITIONAL CONSTRUCTION METHODS.....	56

FIGURES

Figure 1. Existing typical section.	9
Figure 2. Overview of deteriorated pavement.	10
Figure 3. Small bridge over Norway Creek.	10
Figure 4. Typical deteriorated PCC joint reflecting through the HMA overlay.	10
Figure 5. Deteriorated bridge approach joint over Doc and Tom Creek.	11
Figure 6. Typical delamination of HMA overlay.	11
Figure 7. Deteriorated bridge leave joint over Doc and Tom Creek.	11
Figure 8. Proposed typical section.	12
Figure 9. Proposed staging of bridge superstructure replacement over Doc and Tom Creek and Norway Creek.	13
Figure 10. Removal of part of the old bridge with one-lane traffic on the rest of the bridge.	22
Figure 11. Controlling one-lane traffic using temporary traffic signals.	22
Figure 12. Transporting and unloading the bridge elements.	23
Figure 13. Moving the bridge element into place.	23
Figure 14. Adjusting the placement of the bridge element.	23
Figure 15. Final placement of a bridge element.	24
Figure 16. Bridge elements set to grade.	24
Figure 17. Grading the bridge elements in preparation for placing the HMA layers.	24
Figure 18. Completed placement of the bridge with AC shoulder before application of the HMA surface layers over the bridge.	25
Figure 19. Widening of shoulders to provide two-way temporary lanes.	25
Figure 20. Fully open roadway with two lanes open to traffic.	26
Figure 21. Sign directing traffic to emergency pull-off areas.	26
Figure 22. Milling the existing HMA.	26
Figure 23. Rubblization of PCC pavement.	27
Figure 24. Seating the rubblized pavement.	27
Figure 25. ASCRL application.	27
Figure 26. 4E3 leveling application.	28
Figure 27. Final pavement surface following application of 5E3 top course.	28
Figure 28. Distribution of delay time measurements.	33
Figure 29. OBSI dual probe system and the SRTT.	34
Figure 30. Tread of the SRTT.	35
Figure 31. Mean preconstruction A-weighted sound intensity one-third octave frequency spectra for road sections.	36
Figure 32. Mean preconstruction A-weighted sound intensity one-third octave frequency spectra for bridge sections.	36
Figure 33. Resulting preconstruction mean A-weighted sound intensity one-third octave frequency spectra for bridge and road sections.	37
Figure 34. Mean postconstruction A-weighted sound intensity one-third octave frequency spectra for road sections.	38
Figure 35. Mean postconstruction A-weighted sound intensity one-third octave frequency spectra for bridge sections.	38
Figure 36. Resulting postconstruction mean A-weighted sound intensity one-third octave frequency spectra for bridge and road sections.	39

FIGURES, CONTINUED

Figure 37. Auburn University ARAN van.	41
Figure 38. Preconstruction user satisfaction survey results on construction timeline.	42
Figure 39. Preconstruction user satisfaction survey results on daytime construction.	43
Figure 40. Preconstruction user satisfaction survey results on pavement and ride quality condition.	43
Figure 41. Preconstruction user satisfaction survey results on time delays when traveling through construction zones.	44
Figure 42. Postconstruction user satisfaction survey results on project results.	45
Figure 43. Postconstruction user satisfaction survey results on traffic maintenance.	45
Figure 44. Postconstruction user satisfaction results on pavement and ride quality.	46
Figure 45. Postconstruction user satisfaction results on delay time traveling through construction zone.	46
Figure 46. Doherty Hotel in Clare, MI.	47
Figure 47. Showcase participants.	48
Figure 48. FHWA Division Administrator Jim Steele presenting HfL program overview.	48
Figure 49. MDOT Delivery Engineer Bill Mayhew presenting MDOT's experiences with PCfC on M-115.	49
Figure 50. Central Asphalt Inc. Vice President Aaron White presenting contractor experiences with PCfC on M-115.	49
Figure 51. Visit to M-115 project site.	49

TABLES

Table 1. Warranty thresholds and requirements.	15
Table 2. Recommended corrective actions.	16
Table 3. Ride quality requirements.	17
Table 4. Evaluation factors and sample score sheet.	19
Table 5. Results of the best-value selection process.	20
Table 6. Preconstruction crash data.	32
Table 7. Post construction crash data.	32
Table 8. Pre and post construction crash rates.	32
Table 9. Global preconstruction SI levels of bridge and road sections and related statistics.	37
Table 10. Global postconstruction SI levels of bridge and road sections and related statistics.	39
Table 11. Preconstruction ARAN data collected on M-115.	41
Table 12. Postconstruction ARAN data collected on M-115.	41
Table 13. M-115 capital costs calculations.	50
Table 14. Summary of LCCA cost computations (20-year analysis period).	54

ABBREVIATIONS AND SYMBOLS

AASHTO	American Association of State Highway and Transportation Officials
AC	asphalt cement
ADT	average daily traffic
ASCRL	asphalt stabilized crack relief layer
dB(A)	A-weighted decibel
DOT	department of transportation
FHWA	Federal Highway Administration
FY	fiscal year
HfL	Highways for LIFE
HMA	hot-mix asphalt
IRI	International Roughness Index
LCCA	life-cycle cost analysis
MDOT	Michigan Department of Transportation
NPV	net present value
OBSI	on-board sound intensity
OSHA	Occupational Safety and Health Administration
PASER	Pavement Surface and Evaluation Rating
PCC	portland cement concrete
PCfC	performance contracting for construction
RFP	request for proposal
RQI	ride quality index
RSL	remaining service life
SAFETEA-LU	Safe, Accountable, Flexible, Efficient Transportation Equity Act: A Legacy for Users
SI	sound intensity
SR	sufficiency rating
SRTT	standard reference test tire
VOC	vehicle operating costs

INTRODUCTION

HIGHWAYS FOR LIFE DEMONSTRATION PROJECTS

The Highways for LIFE (HfL) pilot program, the Federal Highway Administration (FHWA) initiative to accelerate innovation in the highway community, provides incentive funding for demonstration construction projects. Through these projects, the HfL program promotes and documents improvements in safety, construction-related congestion, and quality that can be achieved by setting performance goals and adopting innovations.

The HfL program—described in the Safe, Accountable, Flexible, Efficient Transportation Equity Act: A Legacy for Users (SAFETEA-LU)—may provide incentives to a maximum of 15 demonstration projects a year. The funding amount may total up to 20 percent of the project cost, but not more than \$5 million. Also, the Federal share for an HfL project may be up to 100 percent, thus waiving the typical State-match portion. At the State's request, a combination of funding and waived match may be applied to a project.

To be considered for HfL funding, a project must involve constructing, reconstructing, or rehabilitating a route or connection on an eligible Federal-aid highway. It must use innovative technologies, manufacturing processes, financing, or contracting methods that improve safety, reduce construction congestion, and enhance quality and user satisfaction. To provide a target for each of these areas, HfL has established demonstration project performance goals.

The performance goals emphasize the needs of highway users and reinforce the importance of addressing safety, congestion, user satisfaction, and quality in every project. The goals define the desired result while encouraging innovative solutions, raising the bar in highway transportation service and safety. User-based performance goals also serve as a new business model for how highway agencies can manage the highway project delivery process.

HfL project promotion involves showing the highway community and the public how demonstration projects are designed and built and how they perform. Broadly promoting successes encourages more widespread application of performance goals and innovations in the future.

Project Solicitation, Evaluation, and Selection

FHWA issued open solicitations for HfL project applications in fiscal years 2006, 2007, 2008, and 2009. State highway agencies submitted applications through FHWA Divisions. The HfL team reviewed each application for completeness and clarity, and contacted applicants to discuss technical issues and obtain commitments on project issues. Documentation of these questions and comments was sent to applicants, who responded in writing.

The project selection panel consisted of representatives of the FHWA offices of Infrastructure, Safety, and Operations; the Resource Center Construction and Project Management Team; the Division offices; and the HfL team. After evaluating and rating the applications and

supplemental information, panel members convened to reach a consensus on the projects to recommend for approval. The panel gave priority to projects that accomplish the following:

- Address the HfL performance goals for safety, construction congestion, quality, and user satisfaction.
- Use innovative technologies, manufacturing processes, financing, contracting practices, and performance measures that demonstrate substantial improvements in safety, congestion, quality, and cost-effectiveness. An innovation must be one the applicant State has never or rarely used, even if it is standard practice in other States.
- Include innovations that will change administration of the State's highway program to more quickly build long-lasting, high-quality, cost-effective projects that improve safety and reduce congestion.
- Will be ready for construction within one year of approval of the project application. For the HfL program, FHWA considers a project ready for construction when the FHWA Division authorizes it.
- Demonstrate the willingness of the applicant department of transportation (DOT) to participate in technology transfer and information dissemination activities associated with the project.

HfL Project Performance Goals

The HfL performance goals focus on the expressed needs and wants of highway users. They are set at a level that represents the best of what the highway community can do, not just the average of what has been done. States are encouraged to use all applicable goals on a project:

- **Safety**
 - Work zone safety during construction—Work zone crash rate equal to or less than the preconstruction rate at the project location.
 - Worker safety during construction—Incident rate for worker injuries of less than 4.0, based on incidents reported via Occupational Safety and Health Administration (OSHA) Form 300.
 - Facility safety after construction—Twenty percent reduction in fatalities and injuries in 3-year average crash rates, using preconstruction rates as the baseline.
- **Construction Congestion**
 - Faster construction—Fifty percent reduction in the time highway users are impacted, compared to traditional methods.
 - Trip time during construction—Less than 10 percent increase in trip time compared to the average preconstruction speed, using 100 percent sampling.
 - Queue length during construction—A moving queue length of less than 0.5 mile (mi) (0.8 kilometer (km)) in a rural area or less than 1.5 mi (2.4 km) in an urban area (in both cases at a travel speed 20 percent less than the posted speed).
- **Quality**
 - Smoothness—International Roughness Index (IRI) measurement of less than 48 inches per mile.

- Noise—Tire-pavement noise measurement of less than 96.0 A-weighted decibels (dB(A)), using the onboard sound intensity (OBSI) test method.
- User satisfaction—An assessment of how satisfied users are with the new facility compared to its previous condition and with the approach used to minimize disruption during construction. The goal is a measurement of 4-plus on a 7-point Likert scale.

REPORT SCOPE AND ORGANIZATION

This report documents the Michigan Department of Transportation's (MDOT) HfL demonstration project, which involved performance contracting for construction (PCfC) on M-115, a two-lane rural highway in Clare County, MI. The report presents project details relevant to the HfL program, including innovative contracting techniques, MDOT performance measures and goals, contractor innovations to meet or exceed MDOT measures and goals, HfL performance metrics measurement, and economic analysis. Technology transfer activities that took place during the project and lessons learned are also discussed.

PROJECT OVERVIEW AND LESSONS LEARNED

PROJECT OVERVIEW

This rural two-lane project is located on M-115 from the Osceola–Clare County line to Lake Station Avenue in Clare County. Within the 5.56 mi (8.95 km) length of this project are two small bridges over two creeks (Doc and Tom Creek and Norway Creek). This roadway is the primary connection for summer tourists and cottage owners traveling over the weekends from the Detroit metropolitan region to northwest Michigan. The pavement was in poor condition, with a 2006 remaining service life (RSL) of 1 year, a Pavement Surface Evaluation and Rating (PASER) system rating of 3 (needs structural improvement), and a sufficiency rating (SR) of 4.5 (very poor). The two bridges were also in extremely poor condition and needed significant rehabilitation.

The key innovation on this project was the use of performance contracting for construction (PCfC). PCfC is an innovative contracting technique in which the contract between the highway agency and the paving contractor defines **what** to achieve through a set of performance goals, but not necessarily **how** to achieve it. The key to PCfC is the flexibility it provides the contractor to innovate and take some control of the construction process, but also to bear some of the associated risks through incentives and disincentives. In PCfC, the agency specifies performance goals rather than construction methods, and it awards the contract on the basis of best value considering price, goals, and disincentives rather than the lowest cost bid.

Special provisions related to the minimum performance goals were established for this project. The performance goals focused on what the agency wanted the project to achieve and were established with stakeholder group input. Each goal included a measurement method and incentive and/or disincentive. Each goal was scored as part of the prescribed best-value factor in the overall selection of the contractor:

1. Date open to traffic
2. Construction and cleanup completion
3. Pavement performance
4. Worker safety during construction
5. Work zone crashes
6. Motorist delay

Phase I of the project, which included bridgework and the corresponding approach and leave areas, began May 27, 2008, and was completed July 1, 2008. Phase II, which included the road and shoulder work, began August 18, 2008, and all work including cleanup was completed on October 16, 2008. Because of the flexibility provided through the PCfC process, the prime contractor, Central Asphalt Inc., used a number of innovations throughout the construction process:

- Bridge construction using Hyspan-type design
- Elimination of joint repairs by rubblizing the underlying concrete pavement
- Drainage improvements

- Hot-mix asphalt (HMA) transfer and placement
- Minimal impact on traffic (widening of existing shoulder to provide two-way traffic, traffic pulloff areas, 24-hour motorist assistance services)
- Alternates routes posting to help the public find alternate routes and provide advance notice about the road work area, resulting in few minor traffic delays
- Polymer-modified asphalt concrete (AC) in the top course to provide a greater chance of meeting the warranty requirements for the 5-year warranty

Central Asphalt Inc. earned the maximum incentives for date open to traffic, construction and cleanup completion, pavement performance, worker safety during construction, and work zone safety. Central Asphalt Inc. also earned the maximum motorist delay payments, but missed the bonus payment for user delay because one measurement was longer than 15 minutes. Incentives awarded to Central Asphalt Inc. totaled \$340,100, which was more than 7 percent of the bid price of \$4.44 million.

DATA COLLECTION

Safety, construction congestion, quality, and user satisfaction data were collected before, during, and after construction to demonstrate that PCfC can be used to achieve the HfL performance goals in these areas.

The HfL performance goals for safety include meeting both worker and motorist safety goals during construction. During the construction of the M-115 project, no workers were injured, so the contractor exceeded the HfL goal for worker safety (incident rate of less than 4.0 based on the OSHA 300 rate). MDOT had set a goal of less than 1.0 crash per month (excluding animal crashes) during construction, based on three other projects constructed between 2004 and 2006. Only two motorist incidents involving crashes with deer were reported over the 3.5-month construction period, resulting in a crash rate (excluding animal crashes) of 0.0 crashes per month. The post construction crash statistics indicate that the safety performance of the facility after construction exceeded the HfL goal of twenty percent reduction in injuries and fatalities.

The performance goal on motorist delay was that no vehicle should be delayed by contractor operations more than 10 minutes beyond its normal travel time. To attain the maximum incentives, Central Asphalt Inc. chose several innovations that were not part of MDOT's original plans, including precast bridge construction, self-adjusting temporary signals to control single-lane traffic during precast bridge construction, 24-hour roadside patrol within the construction zone to minimize any delays caused by breakdowns, and 11-foot (ft) wide (3.3-meter (m) wide) temporary traffic lanes during major construction stages to provide two-way traffic. As a result of these innovations, the average delay was 2 minutes and 16 seconds.

Quality was measured in terms of noise (OBSI) and smoothness (IRI), both before and after construction. The average preconstruction OBSI level was 99.4 dB(A), while the average postconstruction OBSI level was 95.2 dB(A), resulting in a substantial reduction of 4.2 dB(A).

The preconstruction average IRI was 115.5 inches per mile (in/mi), while the postconstruction IRI was 37.8 in/mi, resulting in a dramatic improvement in the pavement ride quality. Based on

the field data collected following construction, the M-115 project exceeds both the HfL goals of IRI less than 48 in/mi and tire-pavement noise less than 96.0 dB(A) using the OBSI test method.

User satisfaction surveys were conducted both before and after construction. The preconstruction survey results indicated a high level of dissatisfaction with the pavement condition and ride quality. A majority of those surveyed also indicated a high level of satisfaction with the proposed construction schedule and the daytime construction plan. The postconstruction survey results indicated that a majority of the respondents were very satisfied with the pavement condition and ride quality. The postconstruction survey also showed that more than half of the respondents were somewhat to totally dissatisfied with delays experienced in the work zone. This was a surprising find to MDOT because the average measured delay was 2 minutes and 16 seconds beyond the normal travel time and only one delay measured was beyond the 10 minute performance goal established for the project.

ECONOMIC ANALYSIS

The benefits and costs of this innovative project approach were compared with those of a project of similar size and scope with a more traditional delivery approach. MDOT supplied most of the cost figures for the as-built project, and the cost assumptions for the traditional approach were determined from discussions with MDOT and MDOT's preconstruction estimates. The economic analysis revealed that the as-constructed roadway resulted in net higher costs of \$690,226 over conventional construction practices, after considering the reduced user delay costs. However, the higher initial costs were more than offset by the lower life-cycle costs.

A life-cycle cost analysis (LCCA) was performed to compare the conventionally-constructed roadway with the as-constructed roadway. The 5-year warranty term and the flexibility provided to the contractor as a result of PCfC, resulted in the contractor opting to mill the existing HMA overlays, rubblize the underlying portland cement concrete (PCC) pavement, and place an asphalt stabilized crack relief layer (ASCRL), prior to placing the HMA overlays. The MDOT design included in the original request for proposal (RFP) only required the contractor to perform full-depth repairs of deteriorated areas prior to placing the HMA overlays. Because of this difference, the as-constructed pavement is expected to perform better and last longer than the baseline pavement, which is reflected in the LCCA. The LCCA shows that the baseline project will cost MDOT and the users of the roadway \$7,801,876 in terms of net present value (NPV) based on a 20-year analysis period. By comparison, the as-constructed project will cost \$6,150,201 in terms of NPV, for a total savings of \$1,651,675.

LESSONS LEARNED

MDOT learned many valuable lessons through its first PCfC project. These lessons are summarized in MDOT's Special Experimental Project No. 14 (SEP-14) report and include the following:

- **Pavement warranty**—The original contractor selected submitted a 6-year pavement warranty that it could not obtain. Long-term warranties may be difficult for smaller

companies to obtain, depending on the economic climate. One possible solution is to allow multiterm bonds.

- **Provisions for site change**—During development of the project, MDOT assumed the contractor would follow the agency’s normal process for site changes by using the claim procedures. However, the process to follow was unclear to the contractor. For example, the existing bridge’s as-built plans had inaccurate dimensions and caused additional work. Although MDOT eventually paid for this additional work through the normal claim process, the contractor was not always sure if these site changes were warranted for payment because MDOT paid for the project in a lump sum. The contractor recommended that MDOT provide clearer direction on future projects.
- **Proposal innovations in violation**—One bidding contractor proposed a narrow bridge width of 40 ft (12.1 m). Although this width met American Association of State Highway and Transportation Officials (AASHTO) minimum width standards, it did not meet MDOT’s minimum width of 44 ft (13.4 m), an additional 2 ft (0.6 m) beyond the shoulders. While this contractor was not selected for other reasons based on best value, future contracts need to state that design standards must meet both AASHTO and MDOT standards. Another bidding contractor proposed to eliminate slope restoration adjacent to the aggregate shoulder. This proposal was in clear violation of project requirements for slope seeding. The PCfC process undertaken as part of this project did not address how to handle situations in which a contract is accepted that proposes innovations that violate project requirements. Future contracts should allow for conditions of acceptances in addition to the PCfC requirements.
- **Temporary object markers**—These devices were set up along the edge of the temporary lane just outside the shoulder. Historically this roadway experienced high recreational vehicle runoffs beyond the shoulder and into the ditches, which these signs helped eliminate.
- **Precast bridge construction**—The two smaller bridges were constructed using Hispan-type design. This allowed the contractor to reduce the time needed for construction and for single-lane traffic compared to cast-in-place construction.
- **Rubblizing existing underlying concrete pavement**—The contractor chose to substitute all joint repairs and HMA overlay with milling of the existing hot-mix asphalt (HMA) layer and “rubblizing” of the underlying concrete pavement. A structural HMA pavement was then placed over the “rubblized” concrete. The method reduced the contractor’s risk on the 5-year pavement warranty while providing MDOT with a superior pavement compared to a pavement with an overlay over repaired joints.
- **24-hour roadside patrol**—The contractor provided 24-hour roadside service in the construction zone. This helped minimize delays from vehicle breakdowns.

- **Temporary traffic lane**—During the major construction stages, the contractor used an 11-ft-wide (3.3-m-wide) temporary traffic lane. This provided two-way traffic, which reduced delays and flag control-type crashes while increasing speed of construction work.

CONCLUSIONS

From the standpoint of speed of construction, motorist and user safety and delay, cost, and quality, this project was an unqualified success and embodied the ideals of the HfL program. MDOT learned many valuable lessons through the PCfC process. Because of the success of this project, MDOT would use performance-based contracting on future projects when appropriate. Currently, MDOT is working on similar projects that use design-build contracting in conjunction with industry to incorporate the lessons learned from this project in the projects under development.

PROJECT DETAILS

BACKGROUND

This rural two-lane project is located on M-115 from the Osceola–Clare County line to Lake Station Avenue in Clare County. The original roadway was a 22-ft-wide (6.7-m-wide) concrete pavement placed in 1940. The concrete pavement was overlaid with hot-mix asphalt (HMA) in 1957. In 1976, the HMA was milled and the concrete was cracked and seated, followed by a 5.5-inch (in) (140-millimeter (mm)) HMA overlay and construction of 3-ft-wide (0.9-m-wide), 2.5-in-thick (64-mm-thick) HMA shoulders. In 1999, as part of a capital preventive maintenance project, about 1.5 in (38 mm) of old pavement was cold milled and replaced with an HMA overlay. Crack sealing was performed on the pavement in 2000. Within the 5.56-mi (8.95-km) length of this project are two small bridges over two creeks (Doc and Tom Creek and Norway Creek). A typical cross-section of the existing pavement section is shown in figure 1.

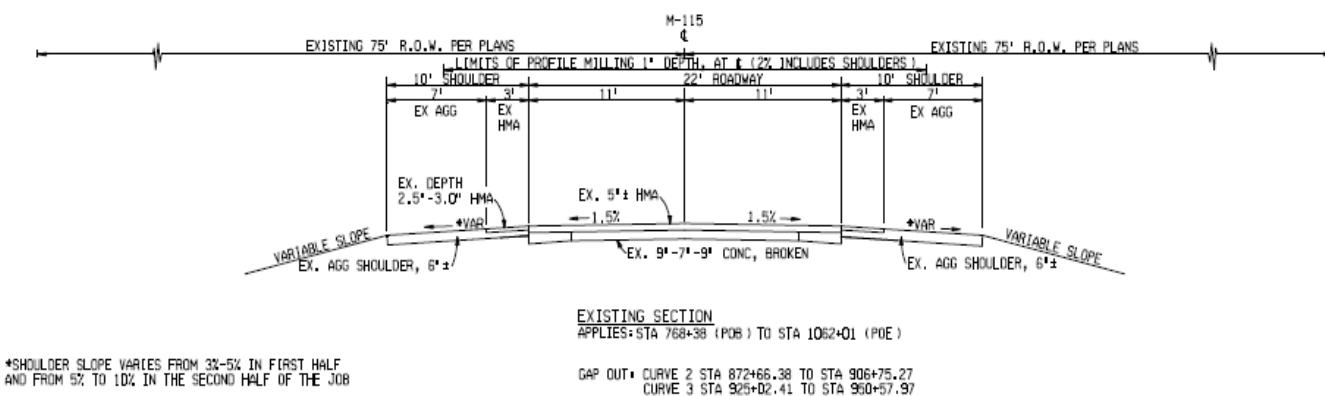

Figure 1. Existing typical section.

The 2005 average daily traffic (ADT) for this section was 5,940 with 14 percent commercial traffic. The 200 High Hour Report showed peak traffic on the northwest-bound lane on Fridays and Saturdays and on the southeast-bound lane on Sundays and Mondays, mostly during the summer and fall. This roadway is the primary connection for summer tourists and cottage owners traveling over the weekends from the Detroit metropolitan region to northwest Michigan.

The pavement was in poor condition, with a 2006 RSL of 1 year, a PASER rating of 3 (needs structural improvement), and an SR of 4.5 (very poor). The two bridges were also in extremely poor condition and needed significant rehabilitation. Figures 2 through 7 show the condition of the pavement and bridges in October 2007.



Figure 2. Overview of deteriorated pavement showing structural distress in the wheelpath.



Figure 3. Small bridge over Norway Creek.



Figure 4. Typical deteriorated PCC joint reflecting through the HMA overlay.



Figure 5. Deteriorated bridge approach joint over Doc and Tom Creek.



Figure 6. Typical delamination of HMA overlay.



Figure 7. Deteriorated bridge leave joint over Doc and Tom Creek.

PROJECT DESCRIPTION

The M-115 construction project included profile cold-milling, substructure repair, HMA resurfacing, joint repair, intersection improvements, bridge approach work, bridge superstructure replacement, drainage installation, and upgrading of all guardrails. The pavement mix design for this section consisted of 1.5 in (38 mm) of 5E3 (top course), 2 in (51 mm) of 4E3 (leveling course), and 3 in (76 mm) of ASCRL. The traffic was to be maintained at all times during the project using lane and shoulder closures as described in the Special Provision for Maintaining Traffic. A typical cross-section of the existing pavement section is shown in figure 8. The proposed staging of the bridge superstructure replacement is shown in figure 9.

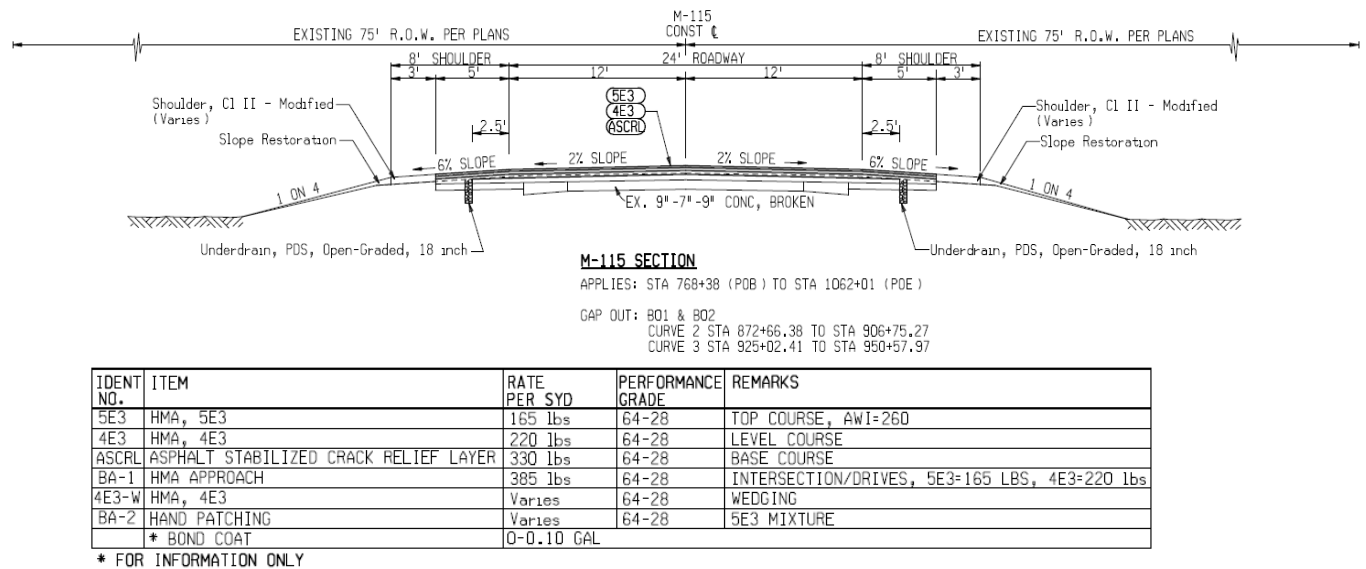

Figure 8. Proposed typical section.

The key innovation on this project was the use of performance contracting for construction (PCfC). PCfC is an innovative contracting technique in which the contract between an agency and the paving contractor defines **what** to achieve through a set of performance goals, but not necessarily **how** to achieve it. The key to PCfC is the flexibility it provides the paving contractor to innovate and take some control of the construction process, but also to bear some of the associated risks through incentives and disincentives. In PCfC, the highway agency specifies performance goals rather than construction methods and awards the contract on the basis of best value rather than the lowest cost bid.

The pros of PCfC are that it encourages contractors to innovate and defines the outcomes expected from the contractor. This results in contractor flexibility and a sharing of the risks and rewards between the agency and contractor. The cons of PCfC are that it is a new approach to contracting and requires a cultural shift for both the agency and the contractor. The agency has to give up some control over the construction process while the contractor has to take on some additional responsibility and risk, which means PCfC may not be applicable to all projects.

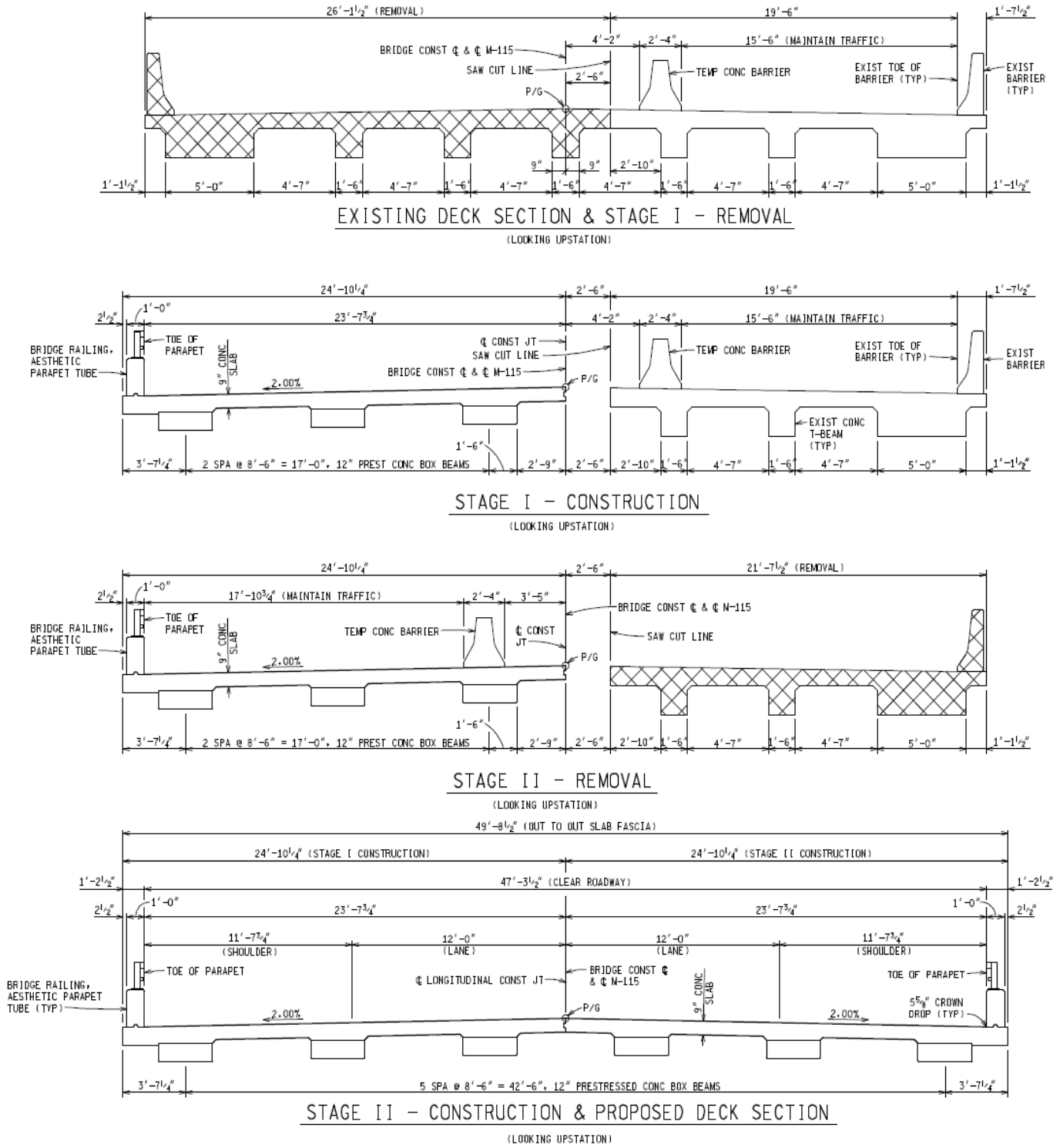

Figure 9. Proposed staging of bridge superstructure replacement over Doc and Tom Creek and Norway Creek.

M-115 Request for Proposal and Project Goals

The construction project was advertised in October 2007 and a mandatory prebid meeting was held November 5, 2007, at MDOT's Mt. Pleasant Transportation Service Center. All prospective bidders had to attend the prebid meeting to be considered eligible to bid. Contractor proposal and bid sheets were due December 14, 2007, and the contract would be awarded to the contractor whose proposal represented the best value to MDOT based on price, goals, and disincentives.

Special provisions related to PCfC were included in the request for proposal (RFP). The special provisions related to the minimum performance goals established for this project. The performance goals focused on what the agency wanted the project to achieve and were established with stakeholder group input. Each goal included a measurement method and incentive and/or disincentive. Each goal was scored as part of the prescribed best-value factor in the overall selection of the contractor:

1. Date open to traffic
2. Construction and cleanup completion
3. Pavement performance
4. Worker safety during construction
5. Work zone crashes
6. Motorist delay

The RFP stated a set baseline for some goals. A contractor could elect to either meet or exceed the set baseline, in which case the baseline submitted in the contractor's proposal would become the baseline.

Open to Traffic

The set baseline date was August 2, 2008, for full opening of all travel lanes to traffic (no flag control, lane closures, or signal operations). Pavement-marking operations and daytime shoulder closures would be allowed after the open-to-traffic date. The measurement for pay purposes would be the actual open-to-traffic date.

The incentive to open to traffic before the baseline date would be \$7,000 per calendar day, and the disincentive to open to traffic after the baseline date would be \$7,000 per calendar day. The maximum incentive would be \$98,000 (14 calendar days), and the maximum disincentive would be unlimited.

Construction and Cleanup Completion

All construction and cleanup of roadway and bridges was to be completed on or before the set baseline of 15 calendar days after the actual open-to-traffic date. The measurement for pay would be the actual final acceptance date as defined in the Definitions and Project Requirements section of the RFP.

The incentive for construction and cleanup before the baseline number of calendar days would be \$2,650 per calendar day, and the disincentive for construction and cleanup after the baseline

number of calendar days would be \$2,650 per calendar day. The maximum incentive would be \$37,100 (14 calendar days) and the maximum disincentive would be unlimited.

Pavement Performance

Meeting the goal of pavement performance was divided into three areas:

- Initial pavement acceptance
- Pavement performance warranty
- Ride quality

The initial pavement acceptance criteria were specified in the special provisions included in the RFP.

As part of this special provision, bidders were to provide a pavement performance warranty that consisted of a warranty bond defined by the terms of the special provision. The contractor would be required to warrant the HMA pavement for performance deficiencies for the duration of the warranty period. The minimum baseline warranty period was 5 years, beginning on the construction acceptance date. The contractor's maximum cumulative liability for warranty work would be 80 percent of the project pavement cost. The maximum liability would be reduced over the warranty period if no previous performance deficiencies had occurred for which the contractor was responsible. The length of the performance warranty period proposed by a bidder would be one of the criteria used to determine the best-value bid for the project, so contractors were encouraged to offer longer warranty periods.

MDOT would conduct pavement evaluations by dividing the project into 528-ft (0.1-mi or 161-m) lane segments for measuring and quantifying the condition parameters. Warranty work would be required when the threshold limit for a condition parameter was exceeded and the maximum allowable number of defective segments was exceeded for one or more condition parameters of a driving lane. These criteria, defined in the RFP for individual performance-related distresses and the corresponding recommended warranty corrective actions, are shown in tables 1 and 2.

Following construction of the entire length of the project, ride quality measurements would be calculated and reported as a ride quality index (RQI) in accordance with Michigan Test Method (MTM) 726 for each 0.5-mi (0.8-km) segment and for the entire length of each lane. Reported values would be the average of the left and right wheel path values and rounded to the nearest whole number following ASTM E 29. Segments less than 0.5-mi (0.8-km) long would be reported as partial segments and the RQI calculation would account for the shorter length by using weighted averaging. The required ride quality values as defined in the RFP are shown in table 3.

Table 1. Warranty thresholds and requirements.

CONDITION PARAMETER	THRESHOLD LIMITS PER SEGMENT (Length = 528 feet)	MAX. DEFECTIVE SEGMENTS PER DRIVING LANE-MILE (a)
Longitudinal Crack	30 percent of segment length	1
Longitudinal Joint Crack	10 percent of segment length	1
De-bonding	5 percent of segment length	1
Raveling	8 percent of segment length	1
Flushing	4 percent of segment length	1
Rutting (c)	ave. rut depth = 0.25 inch (b)	1
CONDITION PARAMETER	THRESHOLD LIMITS PER SEGMENT (Length = 1 mile)	MAX. DEFECTIVE SEGMENTS PER DRIVING LANE-MILE
Transverse Crack	15 Cracks	1
<p>a. The maximum allowable number of defective segments per driving lane is determined by multiplying by the length of the specific driving lane in miles.</p> <p>b. The rut depth threshold applies to each wheel path independently.</p> <p>c. The pavement surface will be evaluated for the presence of rutting on each driving lane throughout the warranty period. The pavement surface will be measured beginning at the POB and every 132 feet thereafter to determine average rut depth to quantify rutting for a particular segment. Rut measurements will be done using a straight rigid device that is a minimum of 7 feet long and of sufficient stiffness that it will not deflect from its own weight, or a wire under sufficient tension to prevent sag when extended 7 feet. Measurements will be taken by placing this "straightedge" across the pavement surface perpendicular to the direction of travel. The straightedge shall contact the surface on at least two bearing points with one located on either side of the rut. The straightedge is properly located when sliding the straightedge along its axis does not change the location of the contact points. Rut depth is then measured at the point of greatest perpendicular distance from the bottom of the straightedge to the pavement surface.</p>		

Table 2. Recommended corrective actions.

CONDITION PARAMETER	RECOMMENDED ACTION
Longitudinal Joint Crack	Cut and Seal
Longitudinal Crack	Cut and Seal
Transverse Crack	Mill and Resurface (b)
De-bonding	Mill and Resurface
Raveling	Mill and Resurface
Flushing	Mill and Resurface
Rutting	Mill & Resurface (a)
<p>a. Recommended action is dependent on the depth of the rut susceptible material.</p> <p>b. Mill and resurface limits shall be such that the transverse cracks within the segment are removed.</p>	

Table 3. Ride quality requirements.

	For Total Length of Lane		For Each Half-Mile Segment		Surface Irregularities Subject to Correction
	Acceptable Range (RQI)	Correction Limit (RQI)	Acceptable Range (RQI)	Correction Limit (RQI)	
HMA - Surface	0-30	>30	0-30	>30	>0.3 inch in 25 feet

The contractor would be eligible for an incentive for each 0.5-mi (0.8-km) segment and for a separate incentive for the entire project as shown below:

ROI Range

20–30

0–20

≤ 30 for all segments

Incentive Amount

\$2,500 per 0.5-mi (0.8-km) segment

\$5,000 per 0.5-mi (0.8-km) segment

\$25,000 for entire project.

To receive the incentive for the entire project, the contractor had to be in the incentive range for all individual segments and would not be allowed to grind the pavement to obtain the incentive except in specified areas. There were no ride quality disincentives because the measured ride had to meet an RQI of 30 or less for the total length of the lane and for each 0.5-mi (0.8-km) segment.

Worker Safety During Construction

A worker injury rate (total recordable case rate) less than the rate of 4.0 based on the OSHA 300 rate was the specified goal for this project. The measurement method was use of the OSHA 300A form. An incentive of \$5,000 was specified if the actual rate was less than the goal for the duration of the project, and a disincentive of \$5,000 was specified if the actual rate was greater than the goal.

Work Zone Crashes

The stated goal was to maintain the preconstruction crash rate of no more than 1.0 crash per month on the entire length of the roadway for the duration of the project. The measurement method would be the Transportation Management System crash data from the statewide database of actual police crash reports. The data used for measurement would be from the period between actual construction start date and project final acceptance date, and all crashes during this period would be used regardless of whether there was active construction. An incentive of \$20,000 was specified if the actual rate was equal to or less than 1.0 crash per month, and a disincentive of \$5,000 was specified if the actual rate was equal to or greater than 2.0 crashes per month.

Motorist Delay

The performance goal related to motorist delay was that no vehicle should be delayed by contractor operations more than 10 minutes beyond its normal travel time. The method of evaluation was to perform onsite total travel time measurements from Dover Road to 13 Mile Road. The random onsite delay measurements would be taken four times per week, twice during the weekdays (Monday through Thursday) and twice on the weekend (Friday through Sunday). Each measurement would include both directions of travel. The measurement for the direction with the highest delay would be used for determining the incentive or disincentive. The measurement would occur from 10 a.m. to 1 p.m. and 3 p.m. to 6 p.m., with a variance of plus or minus 30 minutes. The normal travel time at 55 miles per hour (mi/h) (88.5 kilometers per hour (km/h)) for 11 mi (17.7 km) was estimated at 12 minutes. The following are the incentives/disincentives per measurement:

<u>Measured Delay</u>	<u>Incentive/Disincentive</u>
0-5 min	+\$1,000
6 min	+\$800
7 min	+\$600
8 min	+\$400
9 min	+\$200
10 min	0
11 min	-\$200
12 min	-\$400
13 min	-\$600
14 min	-\$800
15–20 min	-\$1,000
+ 20 min	-\$5,000 (Contractor’s operation may be shut down.)

The maximum total or overall incentive would be \$50,000. In addition, if there were no more than three measured occurrences exceeding 10 minutes and less than or equal to 15 minutes’ delay for the duration of the project, the contractor would be eligible for the overall incentive of \$50,000. Any one measurement exceeding 15 minutes would void the overall incentive.

Best-Value Contractor Selection

The best-value contractor selection was done by a team of MDOT engineers, including two members from the Mt. Pleasant Transportation Service Center, one from the Bay Region Office, one from the Lansing Central Office, one from the Central Selection Review Team, and one bridge engineer. The contractors submitted technical proposals and lump-sum bids in separate sealed envelopes. After the letting date, the selection team evaluated each contractor’s technical proposal package in accordance with the selection criteria, but the team members did not see the contractor’s lump-sum bid. The prescribed evaluation process had potential scores for various evaluation factors that ranged from 5 to 50, with a total possible score of 150. The evaluation factors and a sample score sheet are shown in Table 4.

Table 4. Evaluation factors and sample score sheet.

	CONTRACTORS NAME:	Total Possible	Rater's Score
		Best Value	Best Value
A. Factors			
1.) Open to Traffic <ul style="list-style-type: none"> ➢ 0 points: August 2nd, 2008 (Baseline) ➢ 1-5 points: August 1st - July 15th, 2008 ➢ 6-20 points: July 14th - July 2nd, 2008 	Reviewer's Comments:	20	
2.) Construction and Cleanup Completion <ul style="list-style-type: none"> ➢ 0 points: 15 days after open to traffic (Baseline) ➢ 1-5 points: 14 - 5 days after open to traffic 	Reviewer's Comments	5	
3.) Pavement Performance Goal <ul style="list-style-type: none"> ➢ 0 points: 5 year pavement warranty (Baseline) ➢ 15 points: 6 year pavement warranty ➢ 30 points: 7 year pavement warranty ➢ 50 points: 8 year pavement warranty 	Reviewer's Comments	50	
4.) Develop and provide a "Worker Safety Plan" as it relates to the goal of Worker Safety During Construction <ul style="list-style-type: none"> ➢ 0 points: A generic "Worker Safety Plan" is provided with no/few specifics on how the plan will be followed to achieve the goal. ➢ 1-2 points: An adequate general "Worker Safety Plan" is provided with some specifics on how the plan will be followed to achieve the goal. ➢ 3-5 points: A clearly defined "Worker Safety Plan" is provided with a detailed description of how the plan will be followed to achieve the goal. 	Reviewer's Comments	5	
5.) Develop and provide a "Work Zone Safety Plan" as it relates to the goal of Work Zone Crashes <ul style="list-style-type: none"> ➢ 0 points: A generic "Work Zone Safety Plan" is provided with no/few specifics on how the plan will be followed to achieve the goal. ➢ 1-5 points: An adequate general "Work Zone Safety Plan" is provided with some specifics on how the plan will be followed to achieve the goal. ➢ 6-10 points: A clearly defined "Work Zone Safety Plan" is provided with a detailed description of how the plan will be followed to achieve the goal. 	Reviewer's Comments	10	
6.) Develop and provide a "Reducing Motorist Delay Plan" as it relates to the goal of Motorist Delay <ul style="list-style-type: none"> ➢ 0 points: A generic "Reducing Motorist Delay Plan" 	Reviewer's Comments	30	
<ul style="list-style-type: none"> ➢ is provided with no/few specifics on how the plan will be followed to achieve the goal. ➢ 1-15 points: An adequate general "Reducing Motorist Delay Plan" is provided with some specifics on how the plan will be followed to achieve the goal. ➢ 16-30 points: A clearly defined "Reducing Motorist Delay Plan" is provided with a detailed description of how the plan will be followed to achieve the goal including proven traffic engineering tools and analysis to manage motorist delay. 			
B. Innovations			
1.) Describe innovations that will be incorporated into the project including, but not limited to, Road Construction, Bridge Construction, Delay Reduction, and Materials. <ul style="list-style-type: none"> ➢ 0 points: Innovations that most likely can't be used and provide no value. ➢ 1-15 points: Innovations that could be used in the project and provide some value. ➢ 16-30 points: Innovations that are usable in the project and provide significant value. 	Reviewer's Comments:	30	
	Maximum Total	150	
SELECTION TEAM NAME	SELECTION TEAM MEMBER SIGNATURE		DATE
SELECTION TEAM NAME	SELECTION TEAM MEMBER SIGNATURE		DATE
SELECTION TEAM NAME	SELECTION TEAM MEMBER SIGNATURE		DATE
SELECTION TEAM NAME	SELECTION TEAM MEMBER SIGNATURE		DATE
SELECTION TEAM NAME	SELECTION TEAM MEMBER SIGNATURE		DATE
SELECTION TEAM NAME	SELECTION TEAM MEMBER SIGNATURE		DATE

The selection team members individually determined each contractor’s total score from the information the contractor provided in its technical proposal package and completed the score sheet in table 4. Based on the total score computed, a cost multiplier was calculated for each contractor. The cost multiplier, ranging from 0.80 to 1.00, was computed through linear interpolation of the contractor score between the maximum score of 150 and the minimum score of 0, with 150 points corresponding to a cost multiplier of 0.80 and 0 points corresponding to a cost multiplier of 1.00.

The selection team provided scores and the sealed bid from each contractor along with its associated cost multiplier to MDOT’s Bureau of Finance and Administration, which applied each contractor’s cost multiplier to each contractor’s respective bid to determine the best value. Three bids were received for the M-115 construction, with bid amounts ranging from \$4.19 million to \$5.76 million. The contractor scores, cost multipliers, bid amounts, and best values are shown in table 5. The best value was proposed by Pyramid Paving and Contracting Company Inc. However, the company was unable to secure the single-term 6-year warranty bond it had proposed, so it withdrew its bid. The contract was awarded to the second-ranked contractor, Central Asphalt Inc.

Table 5. Results of the best-value selection process.

Contractor Name	Contractor Score	Cost Multiplier	Contractor Bid	Best Value
Rieth-Riley Construction Company, Inc.	111	0.8520	\$5,755,413.00	\$4,903,611.87
Central Asphalt, Inc. (Awarded)	80	0.8933	\$4,477,777.77	\$3,999,998.88
Pyramid Paving and Contracting Company, Inc. (Unable to secure a single term, six-year warranty)	62	0.9173	\$4,190,777.00	\$3,844,199.74

The following summarizes the evaluations of the three bids received and the innovations proposed by the contractors:

- Two of the three contractors (including Central Asphalt Inc.) provided an early open-to-traffic date in their proposals, and both proposed rapid bridge construction techniques.
- Two contractors (including Central Asphalt Inc.) provided a construction and cleanup time of less than the project goal of 15 days after the open-to-traffic date.

- Pyramid Paving Company Inc. proposed a 6-year warranty, Central Asphalt Inc. submitted a 5-year warranty, and Reith Riley Construction Company Inc. submitted an 8-year bond.
- Central Asphalt Inc. proposed changing MDOT’s pavement design cross-section from transverse joint repair and placing an HMA overlay on existing composite concrete pavement to removing the existing HMA, “rubblizing” the existing concrete, and placing the HMA structural layers.
- All three contractors provided an adequate worker safety plan. One contractor proposed giving workers lighted flashing arm bands for night work.
- Central Asphalt Inc. proposed widening the existing shoulder to provide two-way traffic for most of the construction stages and eliminate most flagging operations, and also proposed emergency traffic pulloff areas and 24-hour motorist assistance services. This innovation had the most benefits to the traveling public.
- All contractors proposed fully opening the roadway during historic peak travel times and designating alternate routes.
- Other innovations proposed included radar speed signs, additional police surveillance, pilot cars, and self-adjusting temporary traffic signals at the two bridges.

Construction

The construction was originally scheduled to start April 1, 2008, and end August 15, 2008. However, the withdrawal of the bid by Pyramid Paving and Contracting Company Inc. resulted in a delay in awarding the contract to Central Asphalt Inc. A new schedule was developed in which all bridgework had to be completed by July 12, 2008. No construction was to be done between July 12 and August 18, 2008, the peak tourist season. Roadwork could begin on August 18 and paving had to be completed on the open-to-traffic date of November 3, 2008. Cleanup was to be completed by November 18, 2008.

Because of the flexibility provided to the contractor through the PCfC process, Central Asphalt Inc. used a number of innovations throughout the construction process. These innovations include the following:

- Bridge construction using Hyspan-type design
- Elimination of joint repairs by rubblizing the underlying concrete pavement
- Drainage improvements
- HMA transfer and placement
- Minimal impact on traffic (widening of existing shoulder to provide two-way traffic, traffic pulloff areas, 24-hour motorist assistance services)
- Alternate routes posting to help the public find alternate routes and provide advance notice on the road work area, resulting in few minor traffic delays
- Use of polymer-modified AC in the top course to provide a greater chance of meeting the warranty requirements for the 5-year warranty

While the original RFP specified only replacing the bridge superstructure as shown in figure 9, Central Asphalt Inc. proposed rapid bridge construction using Hyspan-type design. The first step was removal of a portion of the old bridge (figure 10), allowing for one-lane traffic on the

remaining portion of the bridge. The one-lane traffic was controlled using temporary traffic signals as shown in figure 11. Following the removal of the old bridge, prefabricated bridge elements (Hyspan-type design) were placed over the creek as shown in figures 12 through 15. The bridge was set to grade (figure 16) and covered with subbase material in preparation for HMA overlay (figure 17). This process was repeated for the other half of the bridge and was performed for the bridges over both the Doc and Tom Creek and the Norway Creek. The completed bridge with AC shoulder before application of HMA surface layers is shown in figure 18.



Figure 10. Removal of part of the old bridge with one-lane traffic on the rest of the bridge.



Figure 11. Controlling one-lane traffic using self-adjusting temporary traffic signals.



Figure 12. Transporting and unloading the precast bridge elements.



Figure 13. Moving the precast bridge element into place.



Figure 14. Adjusting the placement of the precast bridge element.



Figure 15. Final placement of a precast bridge element.



Figure 16. Bridge elements set to grade.



Figure 17. Grading the bridge elements in preparation for placing the HMA layers.



Figure 18. Completed placement of the bridge with AC shoulder before application of the HMA surface layers over the bridge.

Following installation of the bridges, which was completed in July 2008, no work was performed until August 18, 2008, as specified by MDOT. For the paving portion of the contract, Central Asphalt Inc. widened the existing shoulder (figure 19) to provide two-way temporary traffic lanes (figure 20), eliminating most flagging operations and reducing delay times. Central Asphalt Inc. also provided emergency traffic pulloff areas (figure 21) to improve worker safety, reduce crash rates, and reduce delay times resulting from disabled vehicles. The existing HMA overlay was milled (figure 22) and the portland cement concrete (PCC) pavement was rubblized (figure 23). This was another innovation proposed by the contractor to eliminate joint repair work, improve performance, and reduce construction time. The rubblized pavement was seated (figure 24) before the application of the 3-in (76-mm) ASCRL (figure 25). This was followed by the application of the 2-in (51-mm) 4E3 leveling course (figure 26). The final HMA application was the 1.5-in (38-mm) 5E3 top course.



Figure 19. Widening of shoulders to provide two-way temporary lanes.



Figure 20. Fully open roadway with two lanes open to traffic.



Figure 21. Sign directing traffic to emergency pulloff areas.



Figure 22. Milling the existing HMA.



Figure 23. Rubblization of PCC pavement.



Figure 24. Seating the rubblized pavement.



Figure 25. ASCRL application.



Figure 26. 4E3 leveling application.



Figure 27. Final pavement surface following application of 5E3 top course.

Contractor Performance and Awarded Incentives/Disincentives

Open to Traffic

The original open-to-traffic date proposed by Central Asphalt Inc. was July 2, 2008. However, as described earlier, because of the delay in awarding the contract, the adjusted baseline open-to-traffic date was set as November 3, 2008. The actual open-to-traffic date was October 14, 2008, 20 days ahead of schedule. The incentive to open before the baseline date was \$7,000 per calendar day with a maximum incentive of \$98,000 (14 calendar days). The total incentive granted to Central Asphalt Inc. was \$98,000.

Construction and Cleanup Completion

All construction and cleanup of roadway and bridges was to be completed on or before the set baseline of 15 calendar days after the actual open-to-traffic date. The punch list was issued and

completed on October 16, 2008. The incentive for construction and cleanup before the baseline number of calendar days was \$2,650 per calendar day with a maximum incentive of \$37,100 (14 calendar days). Although cleanup completion was only 13 days ahead of schedule (compared to the new baseline), Central Asphalt Inc. asked the Mt. Pleasant Transportation Service Center to consider that the open-to-traffic date was 20 days early and it could have delayed this for 6 days and still received the full open-to-traffic incentive. Central Asphalt Inc. opened the roadway early, which provided a great benefit to the traveling public. The Center agreed that Central Asphalt Inc. should not be penalized and was granted the full incentive of \$37,100.

Pavement Performance

Central Asphalt Inc. was eligible for an incentive for each 0.5-mi (0.8-km) segment and a separate incentive for the entire project as shown below:

<u>RQI Range</u>	<u>Incentive Amount</u>
20–30	\$2,500 per 0.5-mi (0.8-km) segment
0–20	\$5,000 per 0.5-mi (0.8-km) segment
≤ 30 for all segments	\$25,000 for entire project.

Central Asphalt Inc. had to be in the incentive range for all individual segments to receive the incentive for the entire project and would not be allowed to grind the pavement to obtain the incentive except in specified areas. Twenty units measured in the RQI range of 0 to 20, resulting in an incentive of \$100,000. Two units measured in the RQI range of 20 to 30, resulting in an incentive of \$5,000. All segments on the project measured an RQI of less than 30, resulting in the bonus incentive of \$25,000, so Central Asphalt Inc. received the maximum ride quality bonus of \$130,000.

Worker Safety During Construction

An incentive of \$5,000 was specified if the actual worker injury rate was less than the goal (4.0 based on the OSHA 300 rate) for the duration of the project. No workers were injured during construction, so Central Asphalt Inc. received the maximum incentive of \$5,000.

Work Zone Crashes

An incentive of \$20,000 was specified if the actual work zone crash rate was equal to or less than 1.0 crash per month. Only two animal crashes were recorded during the 3.5-month project, so Central Asphalt Inc. received the maximum incentive of \$20,000.

Motorist Delay

As described earlier, random onsite delay measurements were taken four times per week, twice during the weekdays (Monday through Thursday) and twice on the weekend (Friday through Sunday). Fifty-two measurements were under 5 minutes, which earned Central Asphalt Inc. the \$50,000 maximum incentive for motorist delay. However, one measurement on October 6, 2008, was over 15 minutes and, based on a mutual group agreement, there was no factual evidence that

the delay was completely outside of Central Asphalt Inc. control. This resulted in Central Asphalt Inc. not being awarded the \$50,000 overall incentive. Central Asphalt Inc. requested a MDOT region-level claim meeting on the overall incentive decision by the Mt. Pleasant Transportation Service Center. The region's decision was to support the Center's outcome.

Therefore, Central Asphalt Inc. received incentives totaling \$340,100 out of a possible total of \$390,000.

DATA ACQUISITION AND ANALYSIS

Data collection on the MDOT HfL project consisted of acquiring and comparing data on safety, construction congestion, quality, and user satisfaction before, during, and after construction. The primary objective of acquiring these types of data was to provide HfL with sufficient performance information to support the feasibility of the proposed innovations and to demonstrate that PCfC can be used to do the following:

- Achieve a safer environment for the traveling public and workers.
- Reduce construction time and minimize traffic interruptions.
- Deliver better quality because of incentives and flexibility offered to the contractor.
- Produce greater user satisfaction.

This section discusses how well MDOT project met the specific HfL performance goals in these areas.

SAFETY

The HfL performance goals for safety include meeting both worker and motorist safety goals during construction. No workers were injured during the construction of the M-115 project, so the contractor exceeded the HfL goal for worker safety (an incident rate of less than 4.0 based on the OSHA 300 rate).

MDOT set a goal of less than 1.0 crash per month (excluding animal crashes) during construction, based on three other projects constructed between 2004 and 2006 on M-115 and US-10 in Clare County and M-115 in Osceola County. The crash rates (excluding animal crashes) for these three construction projects adjusted for project length were 1.24, 0.33, and 0.99 per month, respectively. Two motorist incidents involving crashes with deer were reported over the 3.5-month construction period, resulting in a crash rate (excluding animal crashes) of 0.0 crashes per month.

From the Crash Analysis and Safety Review, dated March 22, 2006, this M-115 roadway segment experienced a total of 58 crashes, including 11 injuries and no fatalities, from 2000 to 2002. The majority of the crashes consisted of 38 (66 percent) animal crashes, seven (12 percent) fixed-object crashes, six (10 percent) miscellaneous single-vehicle crashes, and three (5 percent) overturn-type collisions. The remainder included the following crash types: one head-on, one rear-end, one side-swipe, and one head-on left-turn crash. No section of this roadway appeared on MDOT's 2000–2002 Bay Region Surveillance Report. A review of the fixed-object crashes indicated that the objects struck were four trees, two ditches, and one mailbox. Of the seven fixed-object crashes, five (71 percent) occurred during wet conditions: two icy/snowy conditions and three roadway conditions.

As part of this HfL M-115 construction project, rumble strips were constructed on the shoulder to alert animals to approaching vehicles, minimizing animal crashes and improving safety. An improvement in the pavement surface characteristics is expected to reduce wet condition crashes. These measures taken to improve long-term safety will be tracked for several years.

The preconstruction and post construction crash data obtained from MDOT has been provided below in table 6 and table 7.

Table 6. Preconstruction crash data

Period	Fatalities	Injuries	PDO	ADT
2004	0	1	16	6108
2005	0	6	12	5940
2006	0	5	18	5814
2007	0	0	15	5855
Total	0	12	61	

Table 7. Post construction crash data

Period	Fatalities	Injuries	PDO	ADT
2009	0	2	9	5450
2010	0	0	9	5721
2011	0	2	9	5671
2012	0	2	13	5636
Total	0	6	40	

Based on the pre and post construction crash data the crash rates were computed for this project. The crash rates by severity type have been provided in table 8.

Table 8. Pre and post construction crash rates

	Pre-construction	Post-Construction	Difference
Days of Coverage	1460	1460	
Average ADT	5929	5620	
Section Length	5.71	5.71	
Million Vehicle Miles Travelled	49.4	46.8	
Total Crashes	1.48	0.98	-50.4%
Fatalities	0.00	0.00	-
Injuries	0.24	0.13	-89.6%
PDO	1.23	0.85	-44.5%

As indicated in table 8, there is a 50 percent reduction in total crashes after construction, the injury rates by almost 90 percent and property damage rates by 44.5 percent. No fatal event occurred after construction. The post construction safety performance exceeds the HfL goal of twenty percent reduction in fatalities and injuries.

CONSTRUCTION CONGESTION

The performance goal on motorist delay was that no vehicle should be delayed by contractor operations more than 10 minutes beyond its normal travel time. The normal travel time at 55 mi/h (88.5 km/h) for 11 mi (17.7 km) was estimated at 12 minutes. The method of evaluation was to perform onsite total travel time measurements four times per week, twice during the weekdays (Monday through Thursday) and twice on the weekend (Friday through Sunday). Each measurement would include both directions of travel and the measurement for the direction with the highest delay would be recorded as the delay time. Incentives and disincentives were awarded based on this travel time.

To attain the maximum incentives, Central Asphalt Inc. chose several innovations that were not part of MDOT's original plans, including precast bridge construction, self-adjusting temporary signals to control single-lane traffic during precast bridge construction, 24-hour roadside patrol within the construction zone to minimize delays caused by breakdowns, and 11-ft-wide (3.3-m-wide) temporary traffic lanes during major construction stages to provide two-way traffic. As a result of these innovations, the average delay based on 54 measurements was 2 minutes and 16 seconds. The distribution of these measurements is shown in figure 28.

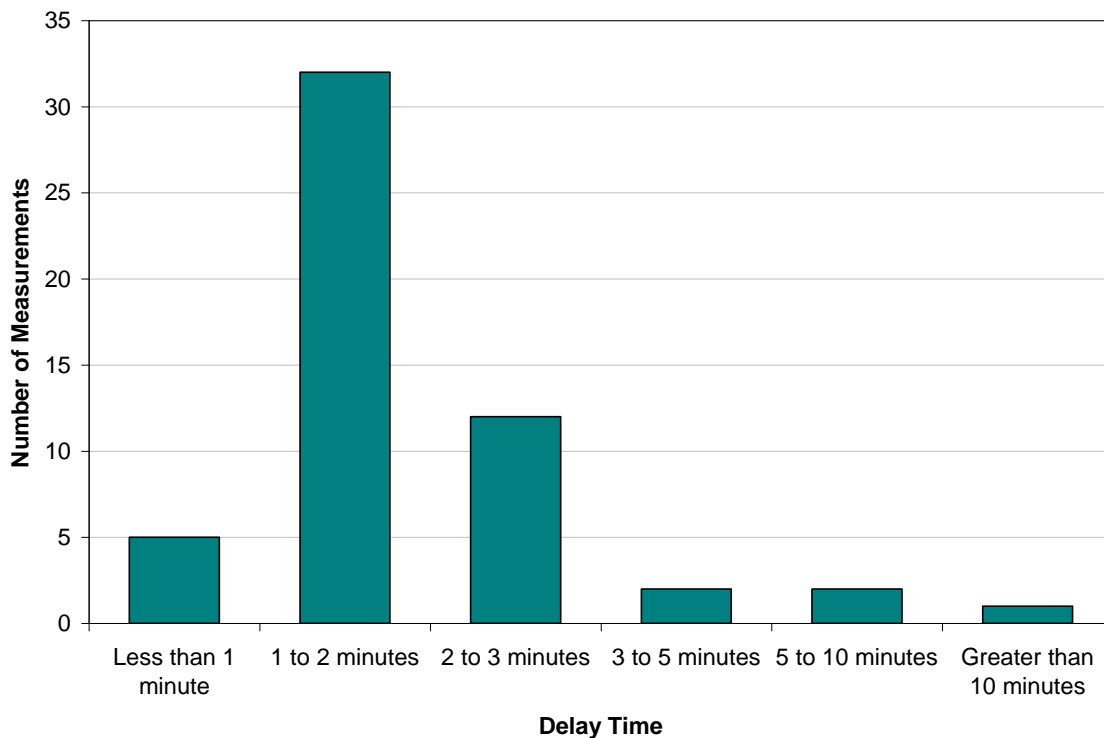

Figure 28. Distribution of delay time measurements.

QUALITY

Sound Intensity Testing

Sound intensity (SI) measurements were taken on November 15, 2007, before reconstruction, using the latest industry standard onboard sound intensity (OBSI) equipment. The measuring device was the OR25 OROS (www.oros.com) analyzer with four GRAS (www.gras.com) 0.5-in (12.7-mm) microphones. The OROS NVGATE software processed the recorded data. The recorded data were analyzed with the third octave band approach and averaged logarithmically over the three runs and between leading and trailing edges.

The OBSI measurements were executed using two pairs of phase-matched sound intensity microphones attached to a bracket and adjacent respectively to the trailing and leading edges of the test vehicle rear wheel (figure 29). The microphones were set 4 in (101 mm) from the edge of the tire wall and 3 in (76 mm) off the ground, and the distance between the two pairs of microphones was 8 in (203 mm). The measurements consisted of three runs in each direction at a constant speed of 45 mi/h (72 km/h) using the standard reference test tire (SRTT), inflated at a pressure of 35 pounds per square inch (psi) (241 kilopascals (kPa)). Figure 30 shows the tread of the SRTT.

The system was calibrated before the OBSI measurements. After the SRTT was mounted on the vehicle, it was warmed up as the vehicle was driven for about 30 miles (48 km). The tire pressure was checked to verify the pressure of 35 psi \pm 0.1 psi (241 kPa \pm 0.7 kPa). The microphones were also calibrated using a Larson Davis signal generator and mounted on the bracket. After the OBSI measurements, another recording with the Larson Davis signal generator and data analysis confirmed that the microphone calibration was within tolerance.



Figure 29. OBSI dual probe system and the SRTT.



Figure 30. Tread of the SRTT.

The dual sound intensity probes simultaneously collect noise data from the leading and trailing tire-pavement contact areas, and the software uses Fourier transform to analyze the raw data signals over the full length of each test run to produce SI values. The values are normalized for environmental effects such as ambient air temperature and barometric pressure at the time of testing. The resulting A-weighted mean SI levels are filtered to produce the noise-frequency spectra in one-third octave bands, as shown in figures 31 and 32, for road and bridge sections.

The global noise levels for the northbound and southbound lanes are computed using a logarithmic addition of the intensity level corresponding to each frequency of the spectrum. Figure 33 shows the resulting spectra among the road and bridge sections. Table 9 includes the preconstruction global noise level measured at each bridge and road section and related statistics over three measurement runs for the northbound and southbound lanes.

The onboard preconstruction SI levels on M-115 in each direction of travel were as follows:

- Northbound SI = 99.3 dB(A)
- Southbound SI = 99.5 dB(A)

The average preconstruction SI level determined as described above was 99.4 dB(A).

On October 30, 2008, the postconstruction SI levels were acquired at 45 mi/h (72 km/h). The resulting A-weighted mean SI levels are filtered to produce the noise-frequency spectra in one-third octave bands, as shown in figures 34 and 35, for road and bridge sections. Figure 36 shows the resulting spectra among the road and bridge sections. Table 10 includes the postconstruction global noise level measured at each bridge and road section and related statistics over three measurement runs for the northbound and southbound lanes.

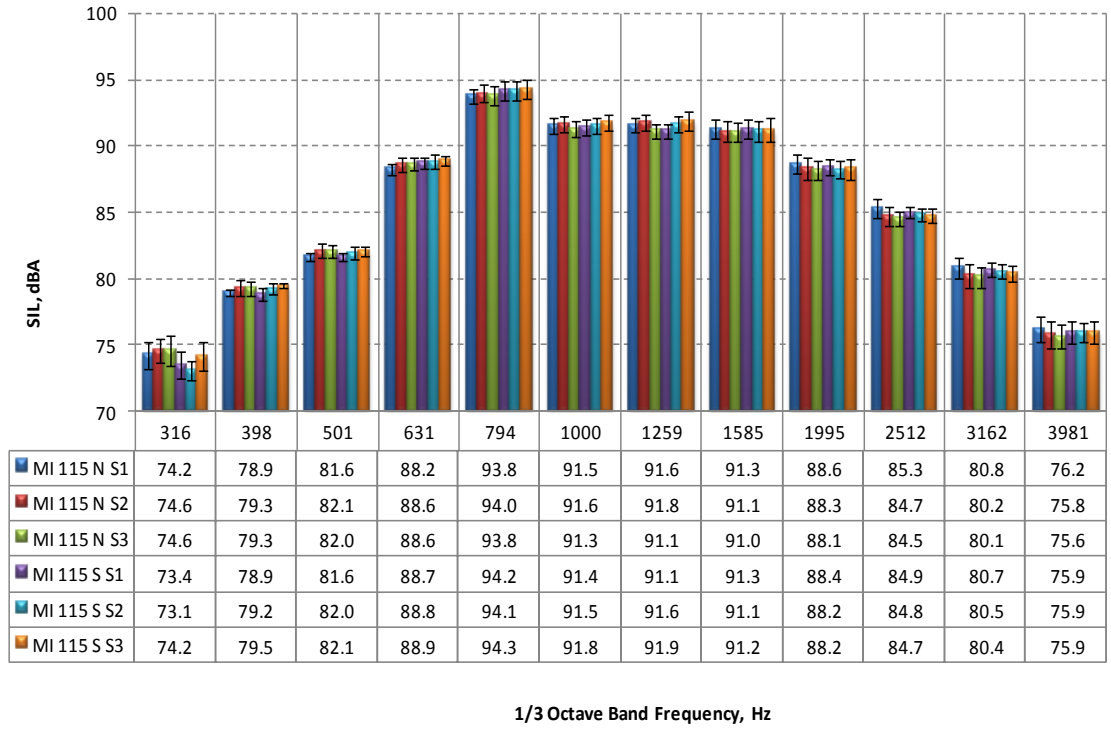

Figure 31. Mean preconstruction A-weighted sound intensity one-third octave frequency spectra for road sections.

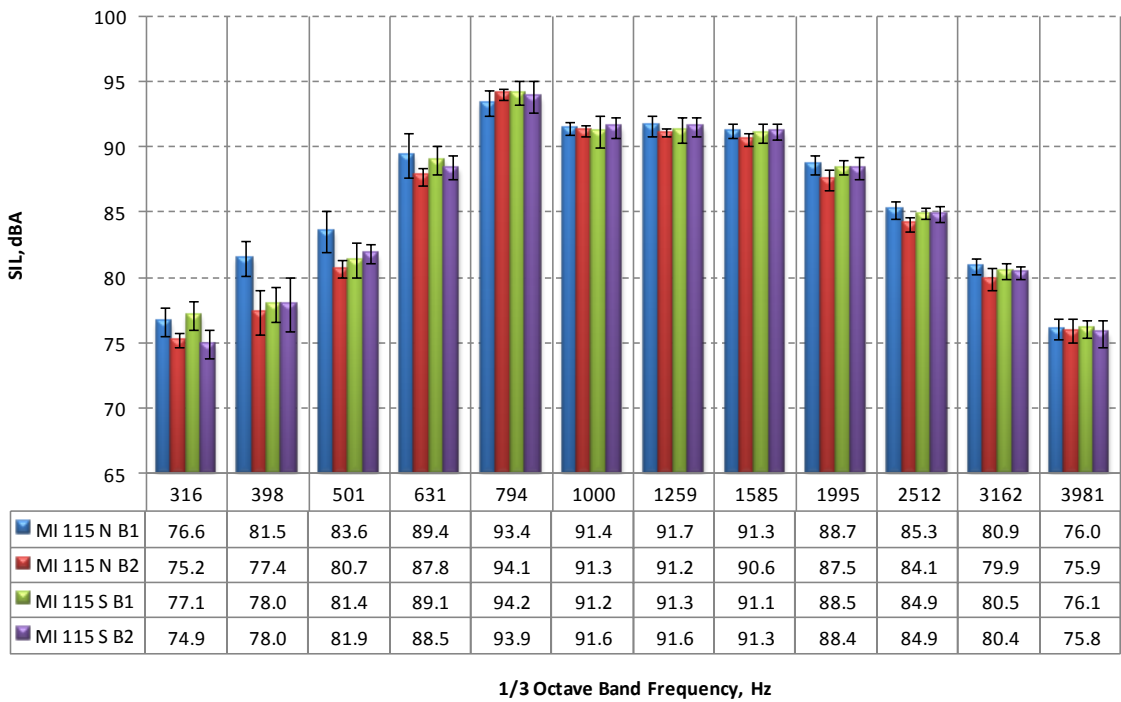

Figure 32. Mean preconstruction A-weighted sound intensity one-third octave frequency spectra for bridge sections.

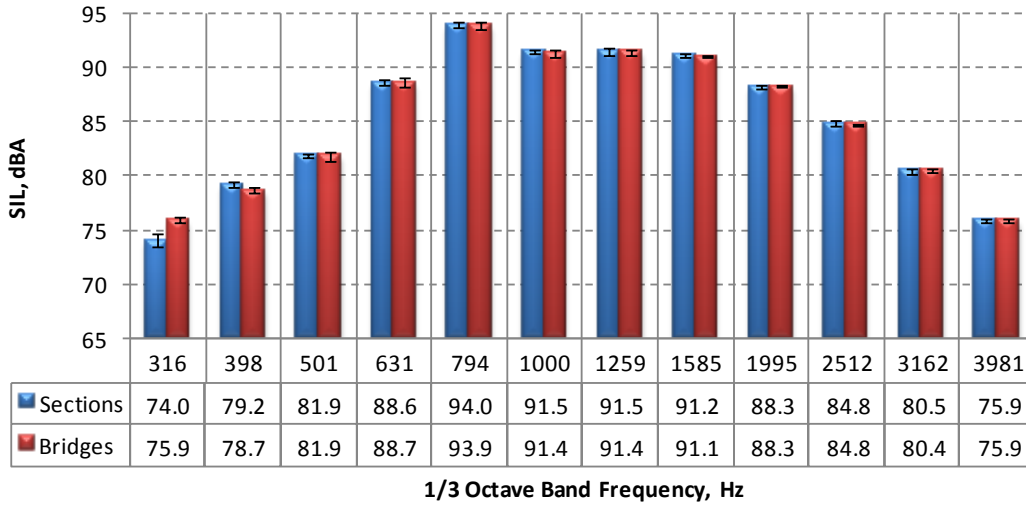

Figure 33. Resulting preconstruction mean A-weighted sound intensity one-third octave frequency spectra for bridge and road sections.

Table 9. Global preconstruction SI levels of bridge and road sections and related statistics.

Direction	Structure	Section	Mean (dB(A))	Std. Deviation (dB(A))
North	Road	S1	99.4	0.6
		S2	99.5	0.7
		S3	99.2	0.6
	Resulting SIL		99.4	0.6
	Bridge	B1	99.5	0.8
		B2	99.1	0.4
	Resulting SIL		99.3	0.6
Average North Resulting SIL			99.3	0.6
South	Road	S1	99.4	0.6
		S2	99.5	0.6
		S3	99.6	0.7
	Resulting SIL		99.5	0.6
	Bridge	B1	99.5	0.9
		B2	99.4	0.9
	Resulting SIL		99.4	0.8
Average South Resulting SIL			99.5	0.6
Overall SIL (entire surveyed path)			99.4	0.6

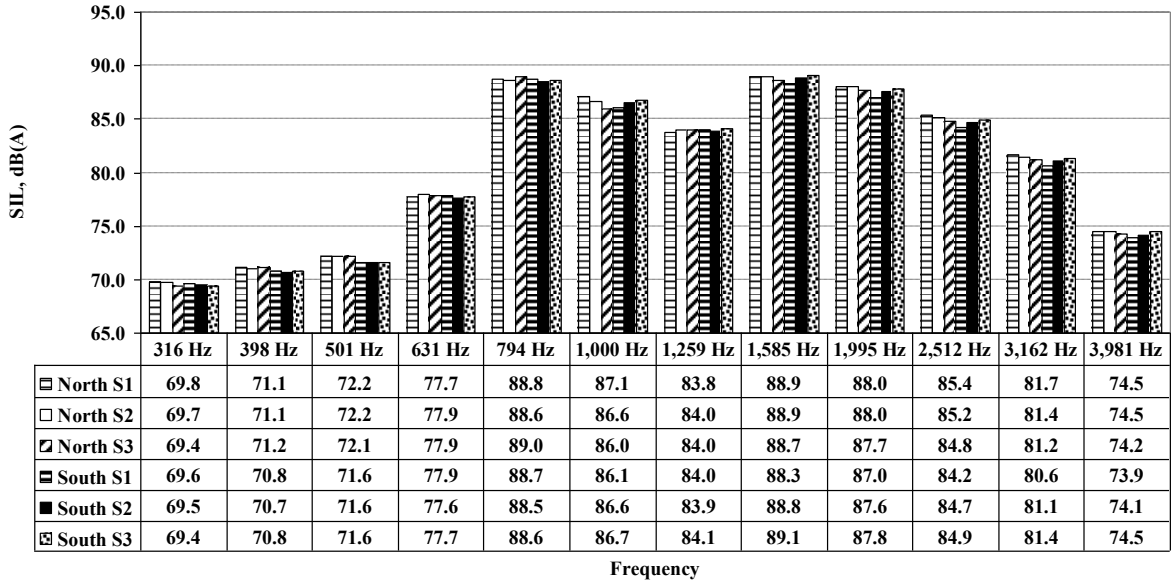

Figure 34. Mean postconstruction A-weighted sound intensity one-third octave frequency spectra for road sections.

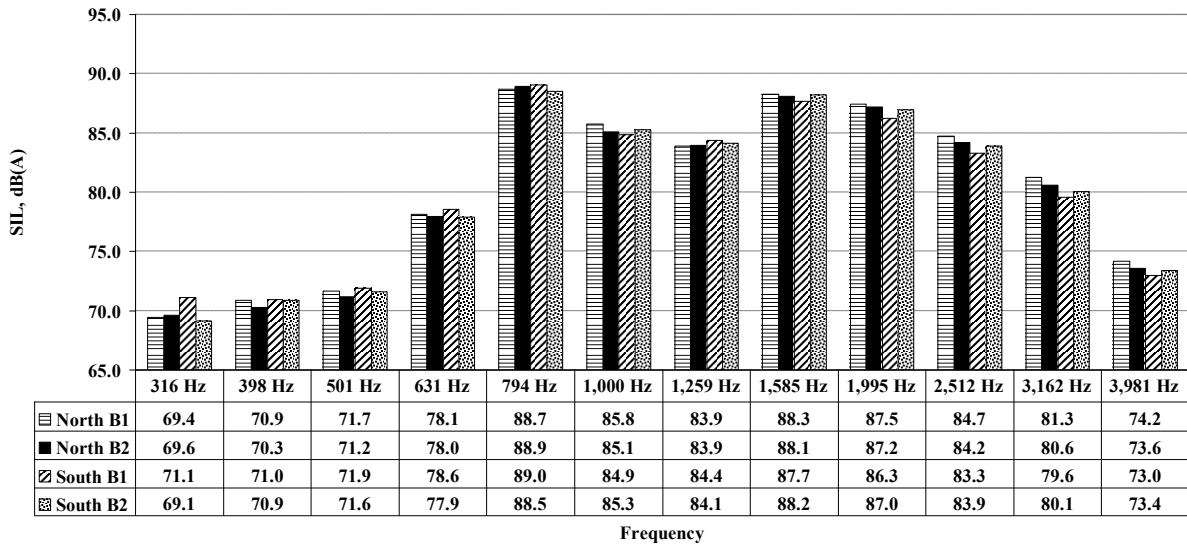

Figure 35. Mean postconstruction A-weighted sound intensity one-third octave frequency spectra for bridge sections.

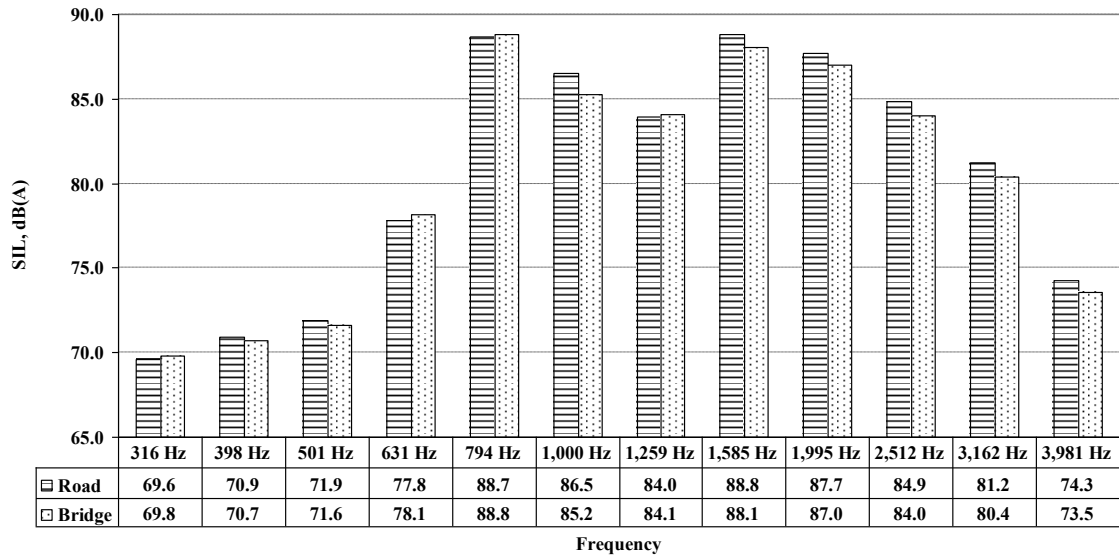

Figure 36. Resulting postconstruction mean A-weighted sound intensity one-third octave frequency spectra for bridge and road sections.

Table 10. Global postconstruction SI levels of bridge and road sections and related statistics.

Direction	Structure	Section	Mean (dB(A))	Std. Deviation (dB(A))	
North	Road	S1	95.6	0.2	
		S2	95.5	0.2	
		S3	95.3	0.2	
	Resulting SIL			95.5	0.2
	Bridge	B1	95.1	0.2	
		B2	94.9	0.3	
	Resulting SIL			95.0	0.3
Average North Resulting SIL			95.3	0.3	
South	Road	S1	95.0	0.3	
		S2	95.3	0.2	
		S3	95.5	0.1	
	Resulting SIL			95.3	0.2
	Bridge	B1	94.6	0.3	
		B2	94.8	0.2	
	Resulting SIL			94.7	0.3
Average South Resulting SIL			95.0	0.3	
Overall SIL (entire surveyed path)			95.2	0.3	

The onboard postconstruction SI levels on M-115 in each direction of travel were as follows:

- Northbound SI = 95.3 dB(A)
- Southbound SI = 95.0 dB(A)

The average preconstruction SI level determined as described above was 99.4 dB(A). These data suggest that the difference between pre- and postconstruction SI levels was significant and dropped from 99.4 dB(A) to 95.2 dB(A).

Smoothness Measurement

Smoothness measurements on the sections were collected by the Auburn University Automatic Road Analyzer (ARAN) van (figure 37) on the same days as the preconstruction and postconstruction OBSI measurements. The ARAN is a high-speed inertial profiler able to perform smoothness measurements of the pavement surface in both wheel paths. Smoothness is reported in in/mi (mm/km) as measured by the International Roughness Index (IRI). The latter consists of a mathematical assessment of the section profile aimed to quantify quality of the ride on a passenger car—the higher the IRI, the rougher the pavement, and the lower the IRI, the smoother the pavement. The ARAN van system provides data summarized every 25 ft (7.6 m) along the measured section.

The ARAN van performed three runs in each direction at a speed of 45 mi/h (72 km/h) and collected IRI data of the left wheel path (L-IRI), and right wheel path (R-IRI). The average of the two (A-IRI) was then calculated. Tables 11 and 12 show the preconstruction and postconstruction mean IRI of 115.5 and 37.8 in/mi, respectively. An analysis of the roughness data on the road and bridge sections indicated no significant differences. Table 11 shows that the southbound lane is rougher than the northbound lane before construction. Table 12 shows that following construction, there was no significant difference between the southbound and northbound lanes. Table 12 shows a dramatic improvement in smoothness and reduction in IRI following construction. Based on the field data collected after construction, the M-115 project exceeds both the HfL goals of IRI less than 48 in/mi and tire-pavement noise less than 96.0 dB(A) using the OBSI test method.



Figure 37. Auburn University ARAN van.

Table 11. Preconstruction ARAN data collected on M-115.

Lane	L-IRI (in/mi)	R-IRI (in/mi)	A-IRI (in/mi)
Northbound	112.2	108.3	110.3
Southbound	118.6	122.9	120.8

Table 12. Postconstruction ARAN data collected on M-115.

Lane	L-IRI (in/mi)	R-IRI (in/mi)	A-IRI (in/mi)
Northbound	34.6	41.0	37.8
Southbound	33.9	41.9	37.9

USER SATISFACTION

User satisfaction surveys were conducted before and after construction. This survey was difficult to sample because the users were seasonal tourists and MDOT had to substitute the major stakeholders to include businesses and homeowners. The following questions were included in the preconstruction survey:

1. Construction is expected to take place from April to June and from August to November 2008. How satisfied are you with the timeline for completing this project?
2. For this project, construction will be completed primarily during daytime hours to maximize work zone safety. How satisfied are you that this approach to constructing the new facility will improve work zone safety?

3. How satisfied are you with current pavement condition and ride quality?
4. Based on your experiences traveling through other MDOT construction zones, how satisfied do you think you will be with time delays experienced when traveling through this construction zone?

A total of 46 responses were collected during the preconstruction survey. The results of the preconstruction survey, shown in figures 38 through 41, indicate a high level of dissatisfaction with the pavement condition and ride quality. A majority of those surveyed also indicated a high level of satisfaction with the proposed construction schedule and the daytime construction plan.

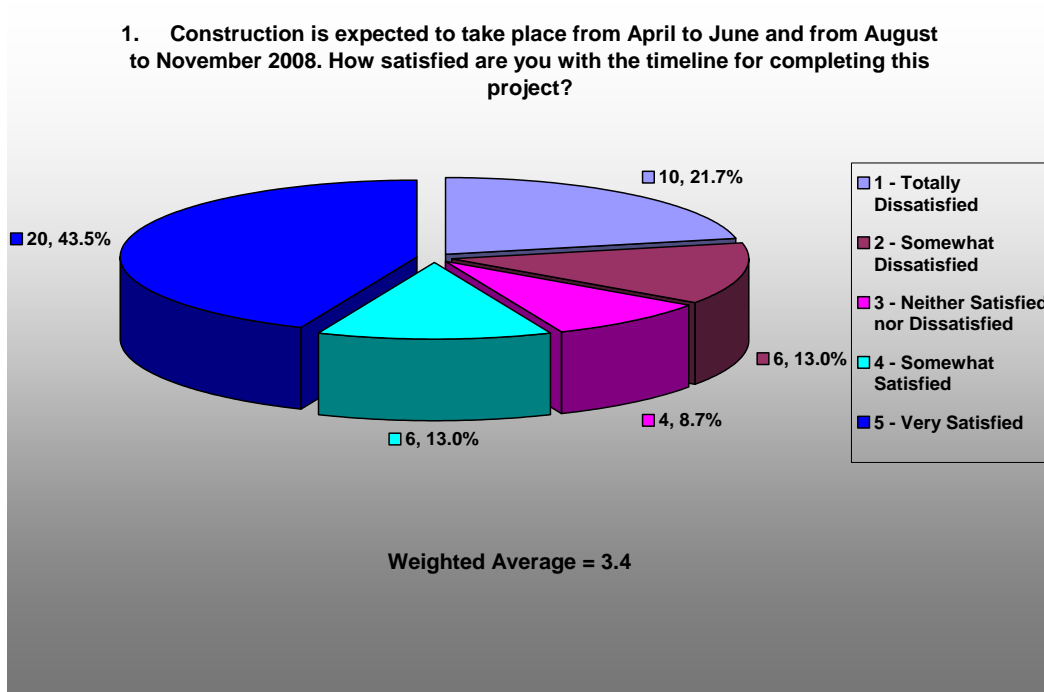

Figure 38. Preconstruction user satisfaction survey results on construction timeline.

2. For this project, construction will be completed primarily during daytime hours to maximize work zone safety. How satisfied are you that this approach to constructing the new facility will improve work zone safety?

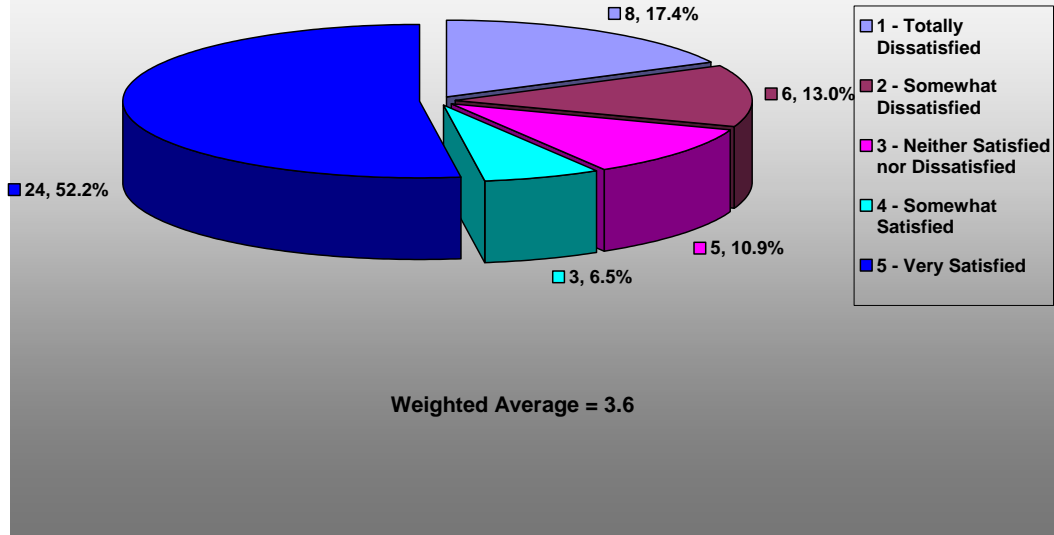

Figure 39. Preconstruction user satisfaction survey results on daytime construction.

3. How satisfied are you with current pavement and ride quality condition?

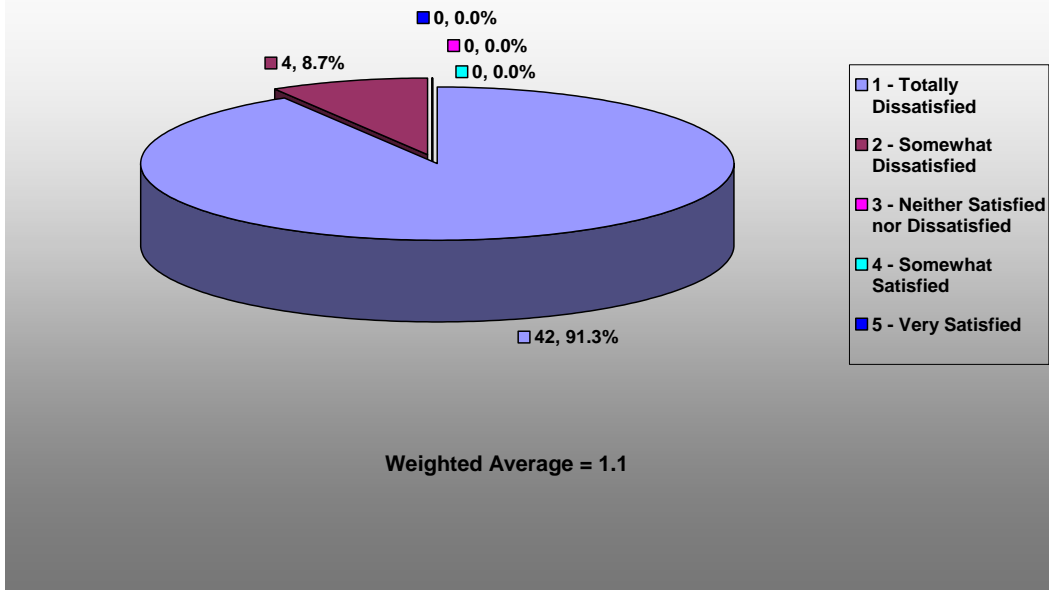

Figure 40. Preconstruction user satisfaction survey results on pavement and ride quality condition.

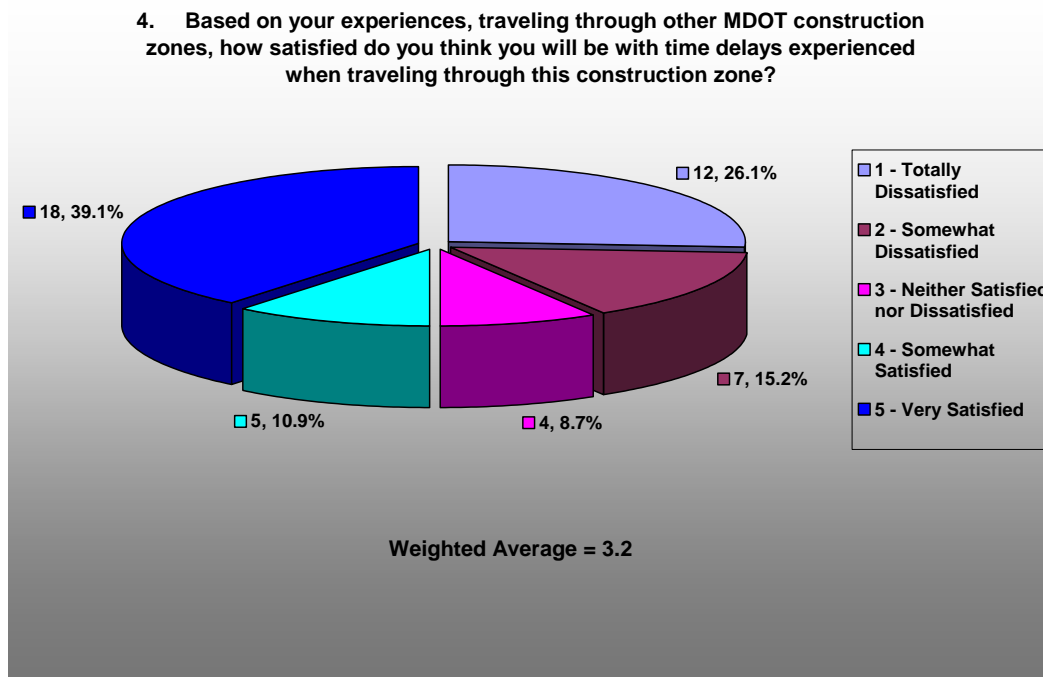

Figure 41. Preconstruction user satisfaction survey results on time delays when traveling through construction zones.

The following questions were included in the postconstruction survey:

1. How satisfied are you with the results of the project, compared with its previous condition?
2. For this project, traffic was maintained by alternating traffic, using single-lane closures along with flag control, and providing a temporary traffic lane. How satisfied are you with the maintenance of traffic during construction in terms of alleviating congestion?
3. How satisfied are you with the improvements to pavement and ride quality compared to the roadway's previous ride quality?
4. How satisfied are you with the delay time experienced by motorists traveling through this construction zone?

A total of 43 responses were collected during the postconstruction survey. The results of the postconstruction survey, shown in figures 42 through 45, indicate that a majority of the respondents were very satisfied with the pavement condition and ride quality. The postconstruction survey also showed that more than half the respondents were somewhat dissatisfied or totally dissatisfied with the delays experienced in the work zone. This was a surprising find to MDOT because the average measured delay was 2 minutes and 16 seconds beyond the normal travel time and only one delay measured was beyond 10 minute maximum delay goal that was established for this project.. MDOT should evaluate the factors causing this apparent anomaly and adjust future goals and actions based on their findings.

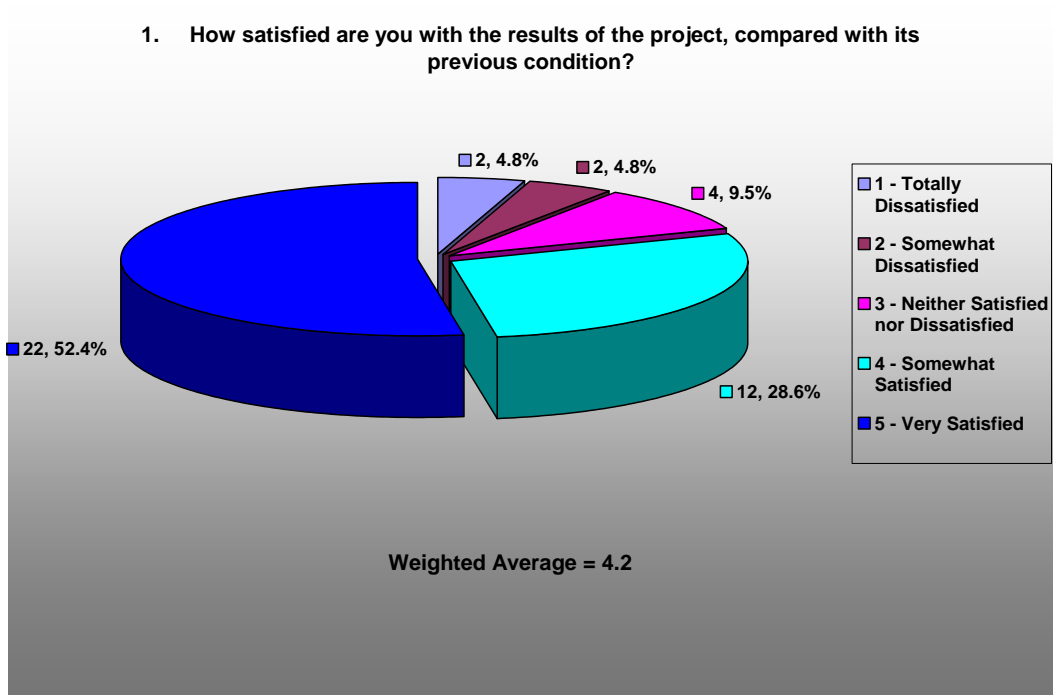

Figure 42. Postconstruction user satisfaction survey results on project results.

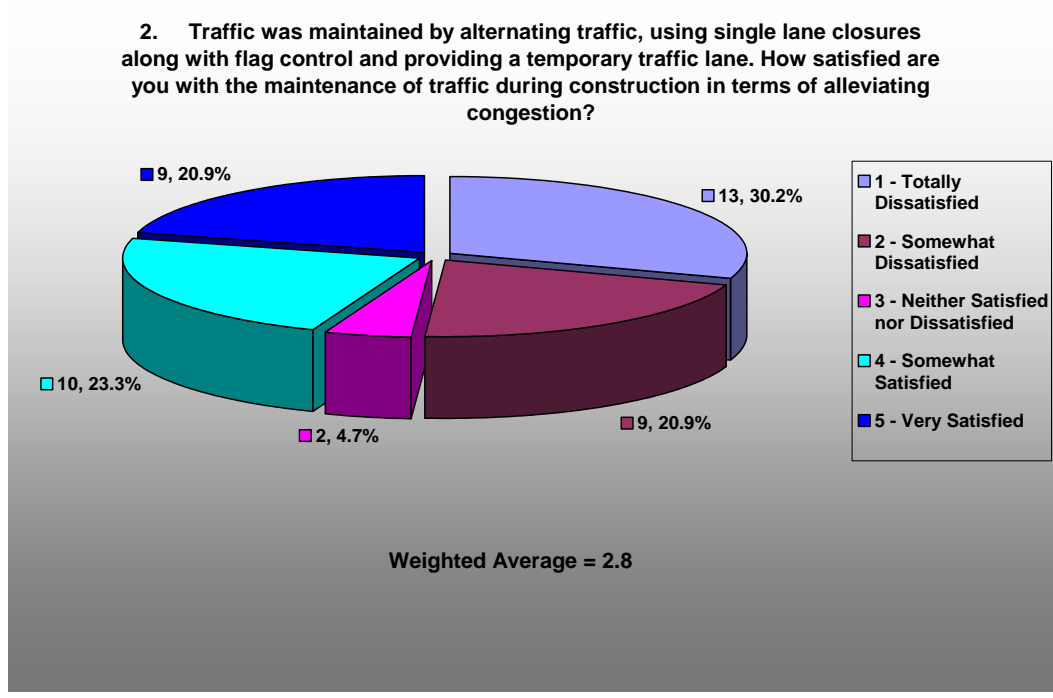

Figure 43. Postconstruction user satisfaction survey results on traffic maintenance.

3. How satisfied are you with the improvements to pavement and ride quality, when compared to the roadways previous ride quality?

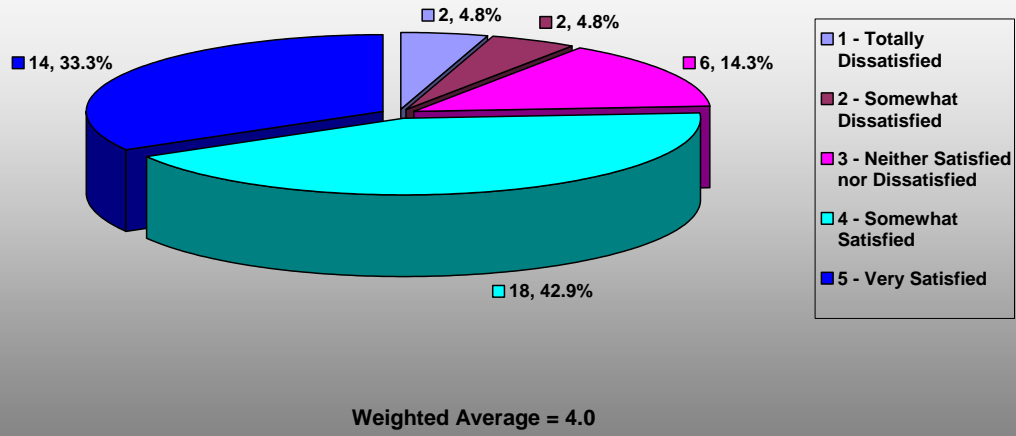

Figure 44. Postconstruction user satisfaction results on pavement and ride quality.

4. How satisfied are you with the delay time experienced by motorists traveling through this construction zone?

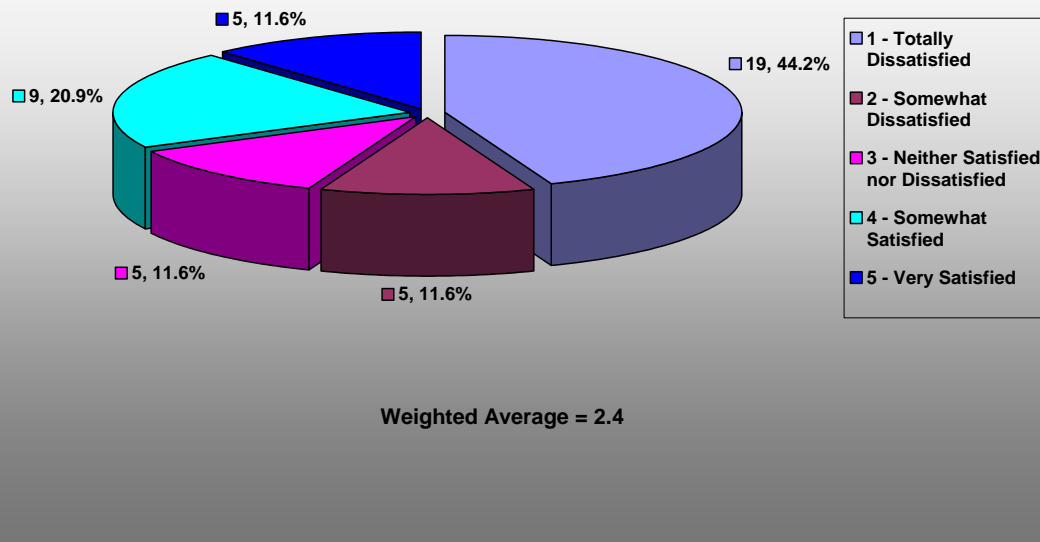

Figure 45. Postconstruction user satisfaction results on delay time traveling through construction zone.

TECHNOLOGY TRANSFER

MDOT was interested in using performance contracting to accomplish roadwork cost effectively and with minimum disruption to travelers and maximum safety for workers and travelers. FHWA sent a team of subject matter experts, including Dr. Mark Robinson, Sid Scott, Mary Huie, and Chris Schneider, to Michigan for a 3-day, hands-on workshop to acquaint contractors and government officials with PCfC and FHWA's Performance Contracting Framework. Contractors and government officials discussed the opportunities and challenges this approach offers. Top opportunities government officials cited included improved quality of workmanship, the potential for reducing resource and administrative burdens while improving cost-effectiveness, and the public benefits of reduced delay coupled with faster project completion. Top opportunities from the contractors' perspective included the ability to analyze cost and time benefits or savings, the elimination of acceptance testing with the use of performance warranties, and the opportunity for collaborative design efforts with the best-value approach.

Robinson and Scott led the group through an examination of the challenges and ways to address them through the PCfC approach. Perceived challenges included contractors' concerns about having enough project control to offset their risks and the need for MDOT to establish performance measures that are both clear and reasonable. Challenges identified by the government included concerns about whether this process would be more or less susceptible to claims and determining the types of innovations that should be encouraged and at what stages of the work process they should be permitted. By the end of the workshop, both government officials and contractors were comfortable with the approach and had a shared understanding of what to expect in using it.

As a result of the PCfC workshop, MDOT selected the planned project to reconstruct the roadway and replace bridges on M-115 from Lake Station Avenue to the Clare–Osceola County line as its pilot to implement PCfC. This project was awarded a grant under the HfL program. On September 30, 2008, following completion of most of the construction activities, a showcase was held at the Doherty Hotel (figure 46) in Clare, MI, to disseminate knowledge and experiences gained through the PCfC process to others in the highway community.



Figure 46. Doherty Hotel in Clare, MI.

The showcase was attended by 36 participants (figure 47) representing MDOT, FHWA, consultants, paving contractors, and other highway agencies, including the Colorado Department of Transportation. The agenda for the showcase is included in appendix A. MDOT Bay Region Engineer Tony Kratofil introduced showcase participants to the project. FHWA Michigan Division Administrator Jim Steele presented an overview of the HfL program (figure 48). Mark Robinson, senior engineer at SAIC, presented background on PCfC. Tom Fudaly, engineering and operations manager from the FHWA Michigan Division, detailed the award process. MDOT Delivery Engineer Bill Mayhew discussed the agency’s experiences with the PCfC process (figure 49). Operations Vice President Aaron White represented Central Asphalt Inc. (figure 50).

The showcase concluded with a site visit to the M-115 project site (figure 51), followed by a panel discussion. The showcase was a successful demonstration of the adaptation and implementation of PCfC on M-115 in Michigan.



Figure 47. Showcase participants.



Figure 48. FHWA Division Administrator Jim Steele presenting HfL program overview.



Figure 49. MDOT Delivery Engineer Bill Mayhew presenting MDOT’s experiences with PCfC on M-115.



Figure 50. Central Asphalt Inc. Vice President Aaron White presenting contractor experiences with PCfC on M-115.



Figure 51. Visit to M-115 project site.

ECONOMIC ANALYSIS

A key aspect of HfL demonstration projects is quantifying, as much as possible, the value of the innovations deployed. This entails comparing the benefits and costs associated with the innovative project delivery approach adopted on an HfL project with those from a more traditional delivery approach on a project of similar size and scope. The latter type of project is referred to as a baseline case and is an important component of the economic analysis.

For this economic analysis, MDOT supplied most of the cost figures for the as-built project. The assumptions for the baseline case costs were determined from discussions with MDOT.

CONSTRUCTION TIME

Using conventional methods, MDOT estimated the construction time for this project as 127 calendar days. One of the proposal evaluation criteria under the PCfC best-value selection process was the baseline open-to-traffic date with incentives for early opening to traffic and construction cleanup and removal compared to this baseline. The actual construction on this project was completed in two phases. Phase I, which included placement of the two precast bridges, started on May 27, 2008 and was completed on July 1, 2008. Phase II included drainage work, milling, rubblizing, curb and gutter work, HMA paving, shoulder work, plantings, slope restoration, corrugations, and pavement markings. Phase II started on August 18, 2008, and was completed on October 16, 2008. Total actual construction time was 94 calendar days.

DETOUR

No traffic was detoured for this construction. During installation of the two precast bridges, self-adjusting temporary signals were used to control single-lane traffic. During construction of the rest of the project, 11-ft-wide (3.3-m-wide) temporary traffic lanes were used by the contractor to provide two-way traffic. As a result of these innovations, the average delay time experienced on the project was 2 minutes and 16 seconds, compared to a delay time of 10 minutes for conventional construction.

CONSTRUCTION COSTS

Table 13 presents the differences in construction costs between the baseline and as-built alternatives. All as-built costs were obtained from MDOT's Web site at <http://mdotwas1.mdot.state.mi.us/public/trnsport> (project number 84169). The baseline cost was determined from the engineering estimates for the construction project. These engineering estimates were based on a nearly identical project constructed on M-115 in 2007. Because the baseline cost estimate is inexact, the information presented is a subjective analysis of the likely cost differential rather than a rigorous computation of a cost differential. Other assumptions were made in selecting significant cost factors and determining some unit costs, as noted in table 13.

Table 13. M-115 capital costs calculations.

Cost Category	Baseline	As Built (PCfC)
Preliminary Design and Engineering¹		
Bridge ⁵		\$ 28,156
Roadway	\$ 102,043 ²	\$ 102,299
Construction		
June 2008 Bridge		\$ 725,400
June 2008 Roadway		\$ 501,511
July 2008 Bridge		\$ 170,156
July 2008 Roadway		\$ 179,111
August 2008 Roadway*		\$1,038,844
September 2008 Roadway*		\$1,110,489
October 2008 Roadway**		\$ 716,444
Pay Item Total Roadway ⁴	\$2,551,065	
Mobilization (5%) Roadway ⁴	\$ 127,553	
Traffic Control (7%) Roadway ⁴	\$ 178,575	
Contingencies (3%) Roadway ⁴	\$ 76,532	
Bridgework ⁴	\$ 590,470	
Construction Engineering¹		
Bridge ⁵		\$ 73,248
Roadway	\$ 165,819 ³	\$ 175,370
Incentives		
Open to Traffic		\$ 98,000
Construction and Cleanup Completion		\$ 37,100
Pavement Ride Quality		\$ 130,000
Worker Safety During Construction		\$ 5,000
Work Zone Crashes		\$ 20,000
Motorist Delay		\$ 50,000
Total Cost	\$3,792,057	\$5,161,128
Notes:		
¹ Estimates of as-built values provided by MDOT.		
² MDOT estimate for preliminary design and engineering.		
³ MDOT estimate for construction engineering.		
⁴ MDOT project estimates.		
⁵ Baseline engineering estimates not applicable for bridge because they were not expected to be replaced, only repaired.		
* Drain work, milling, rubblizing, curb and gutter, HMA leveling, shoulders, plantings, slope restoration.		
** HMA top, shoulders, corrugation, pavement markings.		

USER COSTS

Generally, three categories of user costs are used in an economic life-cycle cost analysis: vehicle operating costs (VOC), delay costs, and crash- and safety-related costs. The cost differential in delay costs was included in this analysis to identify the differences in costs between the baseline and as-built alternatives. Since no detours were included in this project, VOC is not applicable for this analysis.

The following baseline information was available for M-115:

- Based on the data provided by MDOT, the ADT on M-115 was 5,940 with 14 percent commercial traffic.
- The average delay time on this project was 2 minutes and 16 seconds (2.27 minutes).
- MDOT estimates delay costs of \$15.31 per hour for automobiles and \$27.02 per hour for commercial trucks, which are the numbers used with the Construction Congestion Cost (CO3) software program for this project.
- MDOT CO3 output for this project using traditional construction methods yielded a weekday delay cost of \$6,810 per day and a weekend delay cost of \$9,686 per day (information provided by MDOT and shown in appendix B).

Assuming that traditional construction would have impacted traffic for an estimated 127 days, this results in a user delay cost differential of $\$969,228 - \$358,050 = \$611,178$, as shown below:

- **Traditional construction:** $[6,810 \times 5 \text{ weekdays/week} + 9,686 \times 2 \text{ weekend days per week}] \times (1/7) \text{ days/week} \times 127 \text{ days} = \$969,228$.
- **PCfC construction:** $5,940 \times [0.86 \text{ passenger cars/day} \times 15.31 \text{ delay cost/hour} + 0.14 \text{ commercial trucks/day} \times 27.02 \text{ delay costs/hour}] \times 2.27/60 \text{ hours delay} \times 94 \text{ days} = \$358,050$.

Three other comparable projects were constructed between 2004 and 2006 on M-115 and US-10 in Clare County and M-115 in Osceola County. Sixteen crashes (excluding animal crashes) were recorded during construction on these three projects. Two crashes were disabling injury crashes, while 14 were property damage or minor injury crashes. Based on 2004 National Safety Council values, disabling injury crashes are valued at \$49,700 per crash while property damage and minor injury crashes are valued at \$7,400 per crash. Thus the crash-related cost on these three projects was estimated as $\$49,700 \times 2 + \$7,400 \times 14 = \$203,000$, resulting in an average of \$67,667 for traditional construction. Since no crashes (excluding animal crashes) were reported on this project, this results in a crash-related cost differential of \$67,667.

INITIAL COST SUMMARY

From a construction cost standpoint, traditional construction methods would have cost MDOT about \$1,369,071 less than PCfC construction. However, the PCfC techniques saved \$611,178 in user costs related to traffic delays and \$67,667 in user costs related to crashes, for a total savings of \$678,845 in user costs. In this construction project, the initial construction costs of the PCfC construction was \$690,226 higher than that of traditional construction methods. The higher initial cost is more than offset by the lower life-cycle costs as shown below.

LIFE-CYCLE COST ANALYSIS

As part of the PCfC, the contractor was required to provide a minimum warranty of five years. Due to the flexibility provided to the contractor under the PCfC, the contractor chose to mill the existing HMA layers and rubblize the PCC beneath the HMA layers and placed an ASCRL prior to placement of the new HMA overlay. This procedure is expected to result in improved performance and service life of the pavement as compared to traditional construction methods.

The RFP only required the contractor to perform full-depth repairs at the deteriorated areas prior to placing the HMA overlay. To quantify the benefits of the improved performance and service life of the as-constructed pavement versus the baseline pavement, LCCA was performed using a deterministic approach (i.e., no variability in costs, ages, etc. was considered). Life-cycle costs were computed in the form of NPV which is defined as follows:

where:

$$NPV = Initial\ Cost + \sum Future\ Cost * \left[\frac{1}{(1+i)^n} \right]$$

NPV = net present value, \$.
 i = discount rate, percent.
 n = time of future cost, years.

A summary of the various costs and the applicable timeline is shown in table 14. MDOT’s Pavement Design and Selection Manual, downloaded from MDOT’s website http://www.michigan.gov/documents/mdot/MDOT_Pavement_Design_and_Selection_Manual_257723_7.pdf was used. For the as-built project, the facility type chosen was “Low Volume” and the fix type chosen was “HMA Overlay on Rubblized Concrete.”

For the baseline pavement, the age of the first preventive maintenance treatment was reduced from 6 years to 5 years as compared to the as-built pavement to account for the difference in expected performance. The service lives of 11 years and 20 years for the baseline pavement and the as-built pavement are from page 7 of the MDOT Manual for “Repair and HMA Resurface on Composite or Concrete” and “HMA over Rubblized Concrete,” respectively. For the reconstruction or HMA overlay at age 11 of the baseline pavement, the estimated costs of the current construction project (without including bridge costs) were used. As far as the bridges are concerned, MDOT considers the baseline and as-built projects to have an equivalent service life, and were not considered in the LCCA. A discount rate of 3.1% was used based on 2005 MDOT data as specified in the MDOT manual.

The LCCA analysis, summarized in table 14, shows that the baseline project will cost MDOT and the users of the roadway \$7,801,876 in terms of NPV based on a 20-year analysis period. By comparison, the as-constructed project will cost \$6,150,201 in terms of NPV, for a total savings of \$1,651,675. Additional safety features such as rumble strips are expected to reduce crashes over the life of the pavement, making this innovative contracting approach even more significant over the long term.

Table 14. Summary of LCCA cost computations (20-year analysis period).

Cost Category	Age (yrs)	Baseline Pavement Service Life (11 years)	As Built (PCfC) Pavement Service Life (20 years)
Preliminary Design and Engineering, Construction, Construction Engineering, and Incentives	0	\$3,792,057	\$5,161,128
Delay-Related User Costs		\$ 969,228	\$ 358,050
Crash-Related User Costs		\$ 67,667	\$ 0
Preventive Maintenance (MDOT Manual) 11.12 lane-mile @ \$27,192 per lane-mile	5 (baseline) 6 (as-built)	\$ 302,375	\$ 302,375
Preventive Maintenance (MDOT Manual) 11.12 lane-mile @ \$44,891 per lane-mile	9 (as-built)		\$ 499,188
Reconstruction or HMA Overlay (Preliminary Design and Engineering, Construction [Roadway Pay Item, Mobilization, Traffic Control, Contingencies], Construction Engineering)	11 (baseline)	\$ 102,043 \$2,551,065 \$ 127,553 \$ 178,575 \$ 76,532 \$ 165,819	
Delay-Related User Costs		\$ 969,228	
Crash-Related User Costs		\$ 67,667	
Salvage Value (2 of 11 years remaining life for baseline pavement)	20	- \$ 582,107	\$ 0
Net Present Value of All Costs		\$ 7,801,876	\$ 6,150,201

APPENDIX A: SHOWCASE AGENDA

Michigan Department of Transportation/Federal Highway Administration Performance Contracting for Construction Showcase September 30, 2008

1. Welcome and Introductions—Tony Kratofil, Bay Region Engineer, MDOT
2. Highways for LIFE Overview—Jim Steele, Division Administrator, Federal Highway Administration (FHWA) MI Division
3. What is PCfC—Mark Robinson, Senior Transportation Engineer, SAIC
4. Award Process—Tom Fudaly, Engineering and Operations Manager, FHWA MI Division

Break

5. MDOT Presentation—Bill Mayhew, Delivery Engineer, MDOT
6. Contractor Presentation—Aaron White, Vice President of Operations, Central Asphalt Inc.

Lunch

7. Site Visit to M-115
8. Open Panel Discussion—All Speakers
9. Evaluations and Adjournment

APPENDIX B: CONSTRUCTION CONGESTION COST (CO3) OUTPUT FOR M-115 CONSTRUCTION BASED ON TRADITIONAL CONSTRUCTION METHODS

The CO3 output was developed by MDOT assuming a 24-hour flagging operation. In the output, the project length modeled is shorter than the project length for the M-115 project, because MDOT has maximum lengths that can be flagged at one time. Therefore, multiple stages would be needed to perform the work over the entire project.

SummaryView - Flagging Operation

period length (min)			PROJECT INFORMATION			REPORT INFORMATION						
annual traffic growth (%)			PROJECT	M-115 Rehab Osceola/Clare COL		REPORT	DETAILED USER COST REPORT					
years of growth			TITLE	to Lake Station Avenue		TITLE	SUMMARY VIEW					
VEHICLE INPUT			C.S. 18011			DIVISION C&T						
cars trucks			JOB # 84169			REPORT BY BK						
design demand (%)			START DATE			REPORT DATE 7/26/2007						
user cost per hour (\$/V hr)			NOTES:									
user cost per mile, (\$/V mi)												
user cost per cancellation, (\$/V)												
METHOD INPUT			METHOD 1		METHOD 2		METHOD 3		METHOD 4			
method title			Weekday Flag Control									
DISTANCE AND SPEED INPUTS			distance	speed	distance	speed	distance	speed	distance	speed		
work zone			1.85	45								
normal travel			1.85	55								
diversion												
method travel												
normal travel												
FLAG OPERATION INPUTS												
vehicle headway at gate (sec)			3		3		3		3			
dead time at gate when direction changes (sec)			15		15		15		15			
allowable gate closed time (min.)			10									
DECREASE TO DEMAND												
canceled cars (with no delay) (%)												
canceled trucks (with no delay) (%)												
canceled cars (with delay) (%/min)												
canceled trucks (with delay) (%/min)												
diverted cars (with no delay) (%)												
diverted trucks (with no delay) (%)												
diverted cars (with delay) (%/min)												
diverted trucks (with delay) (%/min)												
OTHER USER COST INPUT			cars	trucks	cars	trucks	cars	trucks	cars	trucks		
other user cost per actual demand (\$/V)			\$0.00	\$0.00	\$0.00	\$0.00	\$0.00	\$0.00	\$0.00	\$0.00		
user cost per diversion (\$/V)			\$0.00	\$0.00	\$0.00	\$0.00	\$0.00	\$0.00	\$0.00	\$0.00		
PERIOD INPUT (V/period)			(Backup at Start of Flagging) Flag Periods (Capacity at End of Flagging) Demand									
direction:			Both Directions		(Bsof) Flag	demand	(Bsof) Flag	demand	(Bsof) Flag	demand	(Bsof) Flag	demand
period	historical	design	(Ceof)	actual	(Ceof)	actual	(Ceof)	actual	(Ceof)	actual	(Ceof)	actual
12 A	25	25	51	58	Flag	58						
1 A	14	14	28	32	Flag	32						
2 A	14	14	28	32	Flag	32						
3 A	14	14	28	32	Flag	32						
4 A	25	25	51	58	Flag	58						
5 A	65	65	130	147	Flag	147						
6 A	139	139	277	314	Flag	314						
7 A	175	175	351	397	Flag	397						
8 A	156	156	311	352	Flag	352						
9 A	150	150	300	339	Flag	339						
10 A	153	153	306	346	Flag	346						
11 A	158	158	317	359	Flag	359						
12 P	161	161	323	365	Flag	365						
1 P	167	167	334	378	Flag	378						
2 P	187	187	373	423	Flag	423						
3 P	218	218	436	493	Flag	493						
4 P	226	226	453	512	Flag	512						
5 P	209	209	419	474	Flag	474						
6 P	156	156	311	352	Flag	352						
7 P	122	122	243	275	Flag	275						
8 P	102	102	204	230	Flag	230						
9 P	85	85	170	192	Flag	192						
10 P	65	65	130	147	Flag	147						
11 P	42	42	85	96	Flag	96						
Total	2829	2829	5658	6402	0	6402	0	0	0	0	0	0
SUMMARY OUTPUT			traffic method		Weekday Flag Control		Flagging		Flagging		Flagging	
total user cost					\$6,810		\$0		\$0		\$0	
user cost of delays					\$6,810		\$0		\$0		\$0	
user cost of decreases					\$0		\$0		\$0		\$0	
maximum backup (V)					0		0		0		0	
maximum backup length (lane mi)					0.0		0.0		0.0		0.0	
maximum delay (min.)					7.9		0.0		0.0		0.0	
average delay, except diversions (min)					3.8		0.0		0.0		0.0	
total delay, except diversions (V hr)					402		0		0		0	
total vehicles canceled(V)					0		0		0		0	
total vehicles diverted (V)					0		0		0		0	
total decrease in demand (V)					0		0		0		0	
% decrease in demand					0%		0%		0%		0%	
delay per diverted vehicle (min)					0.0		0.0		0.0		0.0	
total diversion delay (V hr)					0		0		0		0	
average delay, including diversions (min)					3.8		0.0		0.0		0.0	
total delay, including diversions (V hr)					402		0		0		0	
user cost / design demand					\$1.06		\$0.00		\$0.00		\$0.00	
delay cost / actual demand					\$1.06		\$0.00		\$0.00		\$0.00	
work zone method travel time (min.)					2.5		0.0		0.0		0.0	
speed delay (min.)					0.4		0.0		0.0		0.0	
maximum capacity (V/hr)					752		2400		2400		2400	
gate delay at maximum capacity (min.)					5.0		0.0		0.0		0.0	
maximum gate and speed delay (min.)					7.9		0.0		0.0		0.0	
maximum backup delay (min.)					0.0		0.0		0.0		0.0	
Aut(ON	Print(ON	Nov(OK	validity of output		VALID		NOT VALID		NOT VALID		NOT VALID	

SummaryView - Flagging Operation

period length (min)			60			PROJECT INFORMATION				REPORT INFORMATION				
annual traffic growth (%)			2.50%			PROJECT TITLE	M-115 Rehab Osceola/Clare COL to Lake Station Avenue			REPORT TITLE	DETAILED USER COST REPORT SUMMARY VIEW			
years of growth			5			C.S.		18011		DIVISION		C&T		
VEHICLE INPUT			cars		trucks		JOB #		84169		REPORT BY		BK	
design demand (%)			86.2%		13.8%		START DATE				REPORT DATE		7/26/2007	
user cost per hour (\$/V hr)			\$15.31		\$27.02		NOTES:							
user cost per mile, (\$/V mi)			\$0.45		\$1.59									
user cost per cancellation, (\$/V)														
METHOD INPUT					METHOD 1		METHOD 2		METHOD 3		METHOD 4			
method title					Weekend Flag Control									
DISTANCE AND SPEED INPUTS					distance		speed		distance		speed			
work zone					method travel		1.85 45							
					normal travel		1.85 55							
diversion					method travel									
					normal travel									
FLAG OPERATION INPUTS														
vehicle headway at gate (sec)					3		3		3		3			
dead time at gate when direction changes (sec)					15		15		15		15			
allowable gate closed time (min.)					10									
DECREASE TO DEMAND														
canceled cars (with no delay) (%)														
canceled trucks (with no delay) (%)														
canceled cars (with delay) (%/min)														
canceled trucks (with delay) (%/min)														
diverted cars (with no delay) (%)														
diverted trucks (with no delay) (%)														
diverted cars (with delay) (%/min)														
diverted trucks (with delay) (%/min)														
OTHER USER COST INPUT					cars		trucks		cars		trucks			
other user cost per actual demand (\$/V)					\$0.00		\$0.00		\$0.00		\$0.00			
user cost per diversion (\$/V)					\$0.00		\$0.00		\$0.00		\$0.00			
PERIOD INPUT (V/period)					(Backup at Start of Flagging) Flag Periods (Capacity at End of Flagging) Demand									
direction:			Both Directions		(Bsof) Flag	demand	(Bsof) Flag	demand	(Bsof) Flag	demand	(Bsof) Flag	demand		
period	historical	design	historical	design	(Ceof)	actual	(Ceof)	actual	(Ceof)	actual	(Ceof)	actual		
12 A	33	33	66	75	Flag	75								
1 A	18	18	37	42	Flag	42								
2 A	18	18	37	42	Flag	42								
3 A	18	18	37	42	Flag	42								
4 A	33	33	66	75	Flag	75								
5 A	85	85	170	192	Flag	192								
6 A	181	181	362	410	Flag	410								
7 A	229	229	458	518	Flag	518								
8 A	203	203	406	460	Flag	460								
9 A	196	196	392	443	Flag	443								
10 A	199	199	399	451	Flag	451								
11 A	207	207	414	468	Flag	468								
12 P	211	211	421	476	Flag	476								
1 P	218	218	436	493	Flag	493								
2 P	244	244	488	552	Flag	552								
3 P	284	284	569	644	Flag	644								
4 P	295	295	591	669	Flag	669								
5 P	273	273	547	619	Flag	619								
6 P	203	203	406	460	Flag	460								
7 P	159	159	318	359	Flag	359								
8 P	133	133	266	301	Flag	301								
9 P	111	111	222	251	Flag	251								
10 P	85	85	170	192	Flag	192								
11 P	55	55	111	125	Flag	125								
Total	3694	3694	7387	8358	0	8358	0	0	0	0	0	0		
SUMMARY OUTPUT					Weekend Flag Control		Flagging		Flagging		Flagging			
traffic method					Flagging		Flagging		Flagging		Flagging			
total user cost					\$9,686		\$0		\$0		\$0			
user cost of delays					\$9,686		\$0		\$0		\$0			
user cost of decreases					\$0		\$0		\$0		\$0			
maximum backup (V)					0		0		0		0			
maximum backup length (lane mi)					0.0		0.0		0.0		0.0			
maximum delay (min.)					9.3		0.0		0.0		0.0			
average delay, except diversions (min)					4.1		0.0		0.0		0.0			
total delay, except diversions (V hr)					572		0		0		0			
total vehicles canceled(V)					0		0		0		0			
total vehicles diverted (V)					0		0		0		0			
total decrease in demand (V)					0		0		0		0			
% decrease in demand					0%		0%		0%		0%			
delay per diverted vehicle (min)					0.0		0.0		0.0		0.0			
total diversion delay (V hr)					0		0		0		0			
average delay, including diversions (min)					4.1		0.0		0.0		0.0			
total delay, including diversions (V hr)					572		0		0		0			
user cost / design demand					\$1.16		\$0.00		\$0.00		\$0.00			
delay cost / actual demand					\$1.16		\$0.00		\$0.00		\$0.00			
work zone method travel time (min.)					2.5		0.0		0.0		0.0			
speed delay (min.)					0.4		0.0		0.0		0.0			
maximum capacity (V/hr)					752		2400		2400		2400			
gate delay at maximum capacity (min.)					5.0		0.0		0.0		0.0			
maximum gate and speed delay (min.)					9.3		0.0		0.0		0.0			
maximum backup delay (min.)					0.0		0.0		0.0		0.0			
Aut(ON) Print(ON) No(OK) validity of output					VALID		NOT VALID		NOT VALID		NOT VALID			