



U.S. Department
of Transportation
**Federal Highway
Administration**

Recording and Coding Guide for the Structure Inventory and Appraisal of the Nation's Bridges

Report No. FHWA-PD-96-001



Office of Engineering
Bridge Division

December 1995

FOREWORD

The Recording and Coding Guide for the Structure Inventory and Appraisal of the Nation's Bridges (Guide) has been revised several times in the past. This latest edition revises the Guide to convert all of the units of measurement to the International System of Units. This revised Guide represents several years of effort by the Federal Highway Administration with the States' cooperation and comments, both individually and through the AASHTO Subcommittee on Bridges and Structures.

Initial distribution of the Guide is being made directly to each FHWA field office for distribution to the States. Additional copies are available from the Bridge Management Branch (HNG-33) of the FHWA Bridge Division.

William A. Weseman, Director
Office of Engineering

Under the Paper Work Reduction Act and CFR 1320 the Structure Inventory and Appraisal Sheet reporting requirements have been cleared by OMB under 2125-0501.

RECORDING AND CODING GUIDE
FOR THE STRUCTURE INVENTORY AND APPRAISAL OF THE NATION'S BRIDGES

Report No. FHWA-PD-96-001



U.S. Department
of Transportation

**Federal Highway
Administration**



Prepared by

Office of Engineering
Bridge Division
Bridge Management Branch
Washington, D. C. 20590

December 1995

TABLE OF CONTENTS

	Page
INTRODUCTION	vi
DEFINITION OF TERMS	viii
DATA ITEMS	
1 State Code	1
2 Highway Agency District	1
3 County (Parish) Code	1
4 Place Code	2
5 Inventory Route	2
6 Features Intersected	5
7 Facility Carried by Structure	5
8 Structure Number	6
9 Location	6
10 Inventory Route, Minimum Vertical Clearance	6
11 Kilometer Point	7
12 Base Highway Network	7
13 LRS Inventory Route, Subroute Number	8
14 (Reserved)	8
15 (Reserved)	8
16 Latitude	8
17 Longitude	9
18 (Reserved)	9
19 Bypass, Detour Length	10
20 Toll	11
21 Maintenance Responsibility	12
22 Owner	12
23 (Reserved)	12
24 (Reserved)	12
25 (Reserved)	12
26 Functional Classification of Inventory Route	13
27 Year Built	13
28 Lanes On and Under the Structure	14
29 Average Daily Traffic	15
30 Year of Average Daily Traffic	16
31 Design Load	16
32 Approach Roadway Width	16
33 Bridge Median	18
34 Skew	19
35 Structure Flared	19
36 Traffic Safety Features	19
37 Historical Significance	21
38 Navigation Control	21
39 Navigation Vertical Clearance	22
40 Navigation Horizontal Clearance	22
41 Structure Open, Posted, or Closed to Traffic	22
42 Type of Service	23
43 Structure Type, Main	24
44 Structure Type, Approach Spans	25

Item	Page
45 Number of Spans in Main Unit	26
46 Number of Approach Spans	26
47 Inventory Route, Total Horizontal Clearance	26
48 Length of Maximum Span	28
49 Structure Length	28
50 Curb or Sidewalk Widths	30
51 Bridge Roadway Width, Curb-to-Curb	32
52 Deck Width, Out-to-Out	33
53 Minimum Vertical Clearance Over Bridge Roadway	33
54 Minimum Vertical Underclearance	33
55 Minimum Lateral Underclearance on Right	35
56 Minimum Lateral Underclearance on Left	37
57 (Reserved)	37
-- Condition Ratings	37
58 Deck	38
59 Superstructure	39
60 Substructure	39
61 Channel and Channel Protection	40
62 Culverts	41
63 Method Used to Determine Operating Rating	42
64 Operating Rating	43
65 Method Used to Determine Inventory Rating	44
66 Inventory Rating	44
-- Appraisal Ratings	45
67 Structural Evaluation	46
68 Deck Geometry	48
69 Underclearances, Vertical and Horizontal	52
70 Bridge Posting	55
71 Waterway Adequacy	56
72 Approach Roadway Alignment	57
73 (Reserved)	58
74 (Reserved)	58
75 Type of Work	58
76 Length of Structure Improvement	60
77 (Reserved)	62
78 (Reserved)	62
79 (Reserved)	62
80 (Reserved)	62
81 (Reserved)	62
82 (Reserved)	62
83 (Reserved)	62
84 (Reserved)	62
85 (Reserved)	62
86 (Reserved)	62
87 (Reserved)	62
88 (Reserved)	62
89 (Reserved)	62
90 Inspection Date	62
91 Designated Inspection Frequency	62

Item	Page
92 Critical Feature Inspection	63
93 Critical Feature Inspection Date	64
94 Bridge Improvement Cost	64
95 Roadway Improvement Cost	65
96 Total Project Cost	65
97 Year of Improvement Cost Estimate	66
98 Border Bridge	66
99 Border Bridge Structure Number	66
100 STRAHNET Highway Designation	67
101 Parallel Structure Designation	67
102 Direction of Traffic	68
103 Temporary Structure Designation	68
104 Highway System of the Inventory Route	69
105 Federal Lands Highways	69
106 Year Reconstructed	69
107 Deck Structure Type	70
108 Wearing Surface/Protective System	70
109 Average Daily Truck Traffic	71
110 Designated National Network	72
111 Pier or Abutment Protection (for Navigation)	72
112 NBIS Bridge Length	73
113 Scour Critical Bridges	75
114 Future Average Daily Traffic	77
115 Year of Future Average Daily Traffic	77
116 Minimum Navigation Vertical Clearance Vertical Lift Bridge	77
GENERAL	78
APPENDIX A	Structure Inventory and Appraisal Sheet
APPENDIX B	Sufficiency Rating Formula and Example
APPENDIX C	National Bridge Inspection Standards
APPENDIX D	Commentary
APPENDIX E	NBI Record Format

INTRODUCTION

The Recording and Coding Guide for the Structure Inventory and Appraisal of the Nation's Bridges, hereafter referred to as the Guide, has been revised several times in the past. This latest edition revises the Guide to convert all of the units of measurement to the International System of Units (SI). It also provides more thorough and detailed guidance in evaluating and coding specific bridge data. New items have been added to include the reporting of Federal Lands Highway Systems, each State's existing linear referencing system (LRS), and the method used to determine the load ratings. Some items in the Guide have also been expanded to provide more definitive and explicit explanations and instructions for coding. Further, more basic definitions applicable to the instructions in the Guide are provided. The changes are based on comments received on the previous Guide and the metric version (January 1994) draft Guide. This revised Guide should be thoroughly reviewed by each individual involved with the National Bridge Inspection Program.

This Guide has been prepared for use by the States, Federal and other agencies in recording and coding the data elements that will comprise the National Bridge Inventory data base. By having a complete and thorough inventory, an accurate report can be made to the Congress on the number and state of the Nation's bridges. The Guide also provides the data necessary for the Federal Highway Administration (FHWA) and the Military Traffic Management Command to identify and classify the Strategic Highway Corridor Network and its connectors for defense purposes.

The coded items in this Guide are considered to be an integral part of the data base that can be used to meet several Federal reporting requirements, as well as part of the States' needs. These requirements are set forth in the National Bridge Inspection Standards (23 CFR 650.3) which are included as Appendix C. A complete, thorough, accurate, and compatible data base is the foundation of an effective bridge management system. Reports submitted in connection with the Highway Bridge Replacement and Rehabilitation Program and the National Bridge Inspection Program also are related to this Guide.

The AASHTO Manual for Condition Evaluation of Bridges discusses the various items of information that are to be recorded as part of original bridge reports. That manual and the Bridge Inspector's Training Manual/90, with supplements, discuss inspection procedures and the preparation of detailed reports about the structure components. These reports will be the basis for recording values for many of the data elements shown in the Guide, particularly those having to do with the condition or the appraisal ratings.

Some bridge owners are collecting bridge condition ratings for items included in this Guide (Items 58-Deck, 59-Superstructure, 60-Substructure, and 62-Culvere) using the American Association of

Highway and Transportation Officials' (AASHTO) Guide for Commonly Recognized (CoRe) Structural Elements. CoRe element inspection ratings provide detailed condition assessments that can serve as input into a comprehensive bridge management system (BMS). The FHWA has provided bridge owners with a computer program for translating bridge condition data in the CoRe element format to National Bridge Inventory (NBI) condition ratings for the purpose of NBI data submittal to FHWA. The purpose of the program is to permit bridge inspectors to record condition information in a format that satisfies both BMS and NBI data collection requirements.

The Structure Inventory and Appraisal (SI&A) Sheet and the sufficiency rating formula, with examples, are included as Appendices A and B, respectively. The SI&A sheet is intended to be a tabulation of the pertinent elements of information about an individual structure. Its use is optional, subject to the statements in the preceding paragraph of this Introduction. It is important to note that the SI&A Sheet is not an inspection form but merely a summary sheet of bridge data required by the FHWA to effectively monitor and manage a National bridge program.

States, Federal and other agencies are encouraged to use the codes and instructions in this Guide. However, its direct use is optional; each agency may use its own code scheme provided that the data are directly translatable into the Guide format. When data are requested by FHWA, the format will be based on the codes and instructions in this Guide. An agency choosing to use its own codes shall provide for translation or conversion of its own codes into those used in the Guide. In other words, agencies are responsible for having the capability to obtain, store, and report certain information about bridges whether or not this Guide or the SI&A Sheet is used. Any requests by the FHWA for submittals of these data will be based on the definitions, explanations, and codes supplied in the Guide, the AASHTO Manual for Condition Evaluation of Bridges and the Bridge Inspector's Training Manual/90 plus supplements.

The values provided in the tables or otherwise listed in this Guide are for rating purposes only. Current design standards must be used for structure design or rehabilitation. All possible combinations of actual site characteristics are not provided in this Guide. If a special situation not listed in the Guide is encountered, the evaluation criteria closest to the actual site situation should be used.

The implementation of this Guide may require some restructuring of an agency's data base and support software. If so, it is suggested that the agency consider the additional enhancements that would be necessary to support a bridge management system.

Appendix D is a Commentary that compares, item by item, the 1988 Guide to this Guide. The Commentary will provide a ready reference for item changes.

DEFINITION OF TERMS

The definitions of terms used in the Guide are provided below.

- (1) Bridge. The National Bridge Inspection Standards published in the Code of Federal Regulations (23 CFR 650.3) give the following definition:

A structure including supports erected over a depression or an obstruction, such as water, highway, or railway, and having a track or passageway for carrying traffic or other moving loads, and having an opening measured along the center of the roadway of more than 20 feet* between undercopings of abutments or spring lines of arches, or extreme ends of openings for multiple boxes; it may also include multiple pipes, where the clear distance between openings is less than half of the smaller contiguous opening.

* (6.1 meters)

- (b) Culvert. A structure designed hydraulically to take advantage of submergence to increase hydraulic capacity. Culverts, as distinguished from bridges, are usually covered with embankment and are composed of structural material around the entire perimeter, although some are supported on spread footings with the streambed serving as the bottom of the culvert. Culverts may qualify to be considered "bridge" length.
- (c) Inventory Route. The route for which the applicable inventory data is to be recorded. The inventory route may be on the structure or under the structure. Generally inventories along a route are made from west to east and south to north.
- (d) National Bridge Inventory (NBI). The aggregation of structure inventory and appraisal data collected to fulfill the requirements of the National Bridge Inspection Standards. Each State shall prepare and maintain an inventory of all bridges subject to the NBIS.
- (e) National Bridge Inventory (NBI) Record. Data which has been coded according to the Guide for each structure carrying highway traffic or each inventory route which goes under a structure. These data are furnished and stored in a compact alphanumeric format on magnetic tapes or disks suitable for electronic data processing.
- (f) National Bridge Inspection Standards (NBIS). Federal regulations establishing requirements for inspection procedures, frequency of inspections, qualifications of personnel, inspection reports, and preparation and maintenance of a State bridge inventory. The NBIS apply to all structures defined as bridges located on all public roads.
- (g) Public Road. Any road under the jurisdiction of and maintained by a public authority and open to public travel.

- (h) Structure Inventory and Appraisal (SI&A) Sheet. The graphic representation of the data recorded and stored for each NBI record in accordance with this Guide.
- (i) Strategic Highway Corridor Network (STRAHNET). A system of highways which are strategically important to the defense of the United States. It includes the Interstate Highways and 25,215 kilometers of other non-interstate highways. The Military Traffic Management Command Report SE 89-4b-27, Strategic Highway Corridor Network, January 1991, contains additional information on STRAHNET.
- (j) STRAHNET Connectors are roads that connect military installations and ports of embarkation to the STRAHNET. The connector routes represent about 3,042 kilometers of roads that complement STRAHNET.
- (k) Indian Reservation Road (IRR). A public road that is located within or provides access to an Indian reservation as described in Title 23, U. S. C., Sect. 101. The terminus of a road providing access to an Indian reservation or other Indian land is defined as the point at which the road intersects with a road functionally classified as a collector or higher classification (outside the reservation boundary) in both urban and rural areas. In the case of access from an Interstate Highway, the terminus is the first interchange outside the reservation.
- (l) Land Management Highway System (LMHS). Consists of adjoining state and local public roads that provide major public access to Bureau of Land Management administered public lands, resources, and facilities.
- (m) Forest Highway (FH). A road, under the jurisdiction of, and maintained by, a public authority and open to public travel; wholly or partly within, or adjacent to, and serving the National Forest System (NFS) and which is necessary for the protection, administration, and utilization of the NFS and the use and development of its resources. (23 CFR 660).
- (n) Forest Service Development Road. A forest road wholly under the jurisdiction of the Forest Service, which may be "open to public travel". Bridges on Forest Service Development Roads which are "open to public travel" are subject to the NBIS.

- (o) Base Highway Network. The Base Highway Network includes the through lane (mainline) portions of the NHS, rural/urban principal arterial system and rural minor arterial system. Ramps, frontage roads and other roadways are not included in the Base Network.
- (p) Highway Performance Monitoring System. The Highway Performance Monitoring System (HPMS) is a database of universe and sample data that describes the nation's public road mileage. The data are annually updated and submitted to FHWA by the State Highway Agencies, Puerto Rico and the District of Columbia. The universe data provides some basic characteristics of all public road mileage while the sample of the arterial and collector systems allows for assessment of the condition, performance, usage and additional characteristics of the nation's major highway systems.
- (q) Conversion of Numerical Data. Throughout this Guide the following conversion factors are used:
Convert - foot to meter multiply by 0.3048
 - mile to kilometer multiply by 1.609
 - english ton to metric ton multiply by .9
- (r) Rounding and Truncating of Numerical Data. All numeral values in this Guide, except as specifically noted, will follow standard rounding criteria, that is, 5 and above will be rounded up to the next higher unit and 4 and below will be rounded down to the next lower unit. This is applicable to all decimal roundings. In certain items where rounding may cause a safety hazard for clearance, the numeric measurements will be truncated at the appropriate decimal place. This means that a fractional portion less than a whole unit will be dropped to the lower whole number, for example 2.88 would be truncated to 2.8 when using tenth of a meter accuracy. All decimal points are assumed in the locations as specified in the Guide.
- (s) Commonly Recognized (CoRe) Structural Elements). A group of structural elements endorsed by AASHTO as a means of providing a uniform basis for data collection for any bridge management system, to enable the sharing of data between States, and to allow for a uniform translation of data to NBI Items 58, 59, 60 and 62.
- (t) Bridge management System (BMS). A system designed to optimize the use of available resources for the inspection, maintenance, rehabilitation and replacement of bridges.

DATA ITEMS

Item 1 - State Code

3 digits

The first 2 digits are the Federal Information Processing Standards (FIPS) code for States, and the third digit is the FHWA region code. (New Jersey and New York will retain an FHWA region code of 2.)

<u>Code</u>	<u>State</u>	<u>Code</u>	<u>State</u>
014	Alabama	308	Montana
020	Alaska	317	Nebraska
049	Arizona	329	Nevada
056	Arkansas	331	New Hampshire
069	California	342	New Jersey
088	Colorado	356	New Mexico
091	Connecticut	362	New York
103	Delaware	374	North Carolina
113	District of Columbia	388	North Dakota
124	Florida	395	Ohio
134	Georgia	406	Oklahoma
159	Hawaii	410	Oregon
160	Idaho	423	Pennsylvania
175	Illinois	441	Rhode Island
185	Indiana	454	South Carolina
197	Iowa	468	South Dakota
207	Kansas	474	Tennessee
214	Kentucky	486	Texas
226	Louisiana	498	Utah
231	Maine	501	Vermont
243	Maryland	513	Virginia
251	Massachusetts	530	Washington
265	Michigan	543	West Virginia
275	Minnesota	555	Wisconsin
284	Mississippi	568	Wyoming
297	Missouri	721	Puerto Rico

Item 2 - Highway Agency District

2 digits

The highway agency district (State or Federal) in which the bridge is located shall be represented by a 2-digit code. Existing district numbers shall be used where districts are identified by number. Where districts are identified by name, a code number shall be assigned based on an alphabetical or organizational listing of the districts.

Item 3 - County (Parish) Code

3 digits

Counties shall be identified using the Federal Information Processing Standards (FIPS) codes given in the current version of the Census of Population and Housing - Geographic Identification Code Scheme.

Item 4 - Place Code

5 digits

Cities, towns, townships, villages, and other census-designated places shall be identified using the Federal Information Processing Standards (FIPS) codes given in the current version of the Census of Population and Housing - Geographic Identification Code Scheme. If there is no FIPS place code, then code all zeros.

Item 5 - Inventory Route

9 digits

The inventory route is a 9-digit code composed of 5 segments.

<u>Segment</u>	<u>Description</u>	<u>Length</u>
5A	Record Type	1 digit
5B	Route Signing Prefix	1 digit
5C	Designated Level of Service	1 digit
5D	Route Number	5 digits
5E	Directional Suffix	1 digit

Item 5A - Record Type

1 digit

There are two types of National Bridge Inventory records: "on" and "under". Code the first digit (leftmost) using one of the following codes:

<u>Code</u>	<u>Description</u>
1	Route carried "on" the structure
2	Single route goes "under" the structure
A through Z	Multiple routes go "under" the structure

- A signifies the first of multiple routes under the structure.
- B signifies the second of multiple routes under the structure.
- Z signifies 26 routes under the structure.

"On" signifies that the inventory route is carried "on" the structure. Each bridge structure carrying highway traffic must have a record identified with a type code = 1 (numeric). All of the NBI data items must be coded, unless specifically excepted, with respect to the structure and the inventory route "on" it.

"Under" signifies that the inventory route goes "under" the structure. If an inventory route beneath the structure is a Federal-aid highway, is a STRAHNET route or connector or is otherwise important, a record must be coded to identify it. The type code must be 2 or an alphabetic letter A through Z. Code 2 for a single route under the structure. If 2 or more routes go under a structure on separate roadways, the code of 2 shall not be used. Code A, B, C, D, etc. consecutively for multiple routes on separate roadways under the same structure. STRAHNET routes shall be listed first. When this item is coded 2 or A through Z, only the following items must be coded: Items 1, 3-13, 16, 17, 19, 20, 26-30, 42, 43, 47-49, 100-104, 109 and 110. All other items may remain blank.

Item 5A - Record Type (cont' d)

It cannot be overemphasized that all route-oriented data must agree with the coding as to whether the inventory route is "on" or "under" the structure.

Tunnels shall be coded only as an "under" record; that is, they shall not be coded as a structure carrying highway traffic.

There are situations of a route "under" a structure, where the structure does not carry a highway, but may carry a railroad, pedestrian traffic, or even a building. These are coded the same as any other "under" record and no "on" record shall be coded.

Item 5B - Route Signing Prefix

1 digit

In the second position, identify the route signing prefix for the inventory route using one of the following codes:

<u>Code</u>	<u>Description</u>
1	Interstate highway
2	U. S. numbered highway
3	State highway
4	County highway
5	City street
6	Federal lands road
7	State lands road
8	Other (include toll roads not otherwise indicated or identified above)

When 2 or more routes are concurrent, the highest class of route will be used. The hierarchy is in the order listed above.

Item 5C - Designated Level of Service

1 digit

In the third position, identify the designated level of service for the inventory route using one of the following codes:

<u>Code</u>	<u>Description</u>
0	None of the below
1	Mainline
2	Alternate
3	Bypass
4	Spur
6	Business
7	Ramp, Wye, Connector, etc.
8	Service and/or unclassified frontage road

Item 5D - Route Number

5 digits

Code the route number of the inventory route in the next 5 positions. This value shall be right justified in the field with leading zeros filled in. (See examples below.)

If concurrent routes are of the same hierarchy level, denoted by the route signing prefix, the lowest numbered route shall be coded. Code 00000 for bridges on roads without route numbers.

Item 5E - Directional Suffix

1 digit

In the last position, code the directional suffix to the route number of the inventory route when it is part of the route number, using one of the following codes:

<u>Code</u>	<u>Description</u>
0	Not applicable
1	North
2	East
3	South
4	West

In some cases, letters may be used with route numbers and as part of the route numbers and not to indicate direction. In such cases, the letter should be included in the 5-position route number field.

EXAMPLES:

	<u>Record</u>	<u>Code</u>
Interstate 95, on	1 1 1 00095 0	111000950
Interstate 70S, under	2 1 1 00070 3	211000703
State Highway 104, Spur, under	2 3 4 00104 0	234001040
U. S. 30E Bypass, on	1 2 3 00030 2	123000302
City street, on	1 5 0 00000 0	150000000
Ramp from I-81, under	2 1 7 00081 0	217000810
County Highway 173 on	1 4 1 00173 0	141001730
Interstate 84 under	2 1 1 00084 0	211000840
Interstate 495 on	1 1 1 00495 0	111004950
State Hwy 120 (STRAHNET Rte) under	A 3 1 00120 0	A31001200
Alternate State Hwy 130 under	B 3 2 00130 0	B32001300
Tunnel on Interstate 70	2 1 1 00070 0	211000700

Item 6 - Features Intersected

25 digits

This item contains a description of the features intersected by the structure and a critical facility indicator. When Item 5A indicates an "under" record, this item describes the inventory route and/or features under the structure. There are 25 digits divided into 2 segments.

<u>Segment</u>	<u>Description</u>	<u>Length</u>
6A	Features Intersected	24 digits
6B	No Longer Coded (Blank)	1 digit

The information to be recorded for this item in the first 24 digits shall be the name or names of the features intersected by the structure.

When one of the features intersected is another highway, the signed number or name of the highway shall appear first (leftmost) in the field. The names of any other features shall follow, separated by a semicolon or a comma. Parentheses shall be used to provide a second identification of the same feature (see third example). Abbreviations may be used where necessary, but an effort shall be made to keep them meaningful. The data in this segment shall be left justified in the first 24 positions without trailing zeros.

EXAMPLES:

I 81, US 51, MILL ROAD
MISSISSIPPI RIVER
SR 42 (POND ROAD)

Item 7 - Facility Carried by Structure

18 digits

The facility being carried by the structure shall be recorded and coded. In all situations this item describes the use "on" the structure. This item shall be left justified without trailing zeros.

EXAMPLES:

US 66
MAIN STREET
COUNTY ROAD 450
C & O RAILROAD (appropriate for "under" record only)
PEDESTRIAN BRIDGE (appropriate for "under" record only)

Item 8 - Structure Number

15 digits

It is required that the official structure number be recorded. It is not necessary to code this number according to an arbitrary national standard. Each agency should code the structure number according to its own internal processing procedures. When recording and coding for this item and following items, any structure or structures with a closed median should be considered as one structure, not two. Closed medians may have either mountable or non-mountable curbs or barriers.

The structure number must be unique for each bridge within the State, and once established should preferably never change for the life of the bridge. If it is essential that structure number(s) must be changed, all 15 digits are to be filled. For any structure number changes, a complete cross reference of corresponding "old" and "new" numbers must be provided to the FHWA Bridge Division. The cross reference shall include both a computer tape or diskette and a printed listing in the FHWA required format.

The identical structure number must appear on the "on" and all "under" records associated with a particular structure. (Refer to Item 5 - Inventory Route).

Item 9 - Location

25 digits

This item contains a narrative description of the bridge location. It is recommended that the location be keyed to a distinguishable feature on an official highway department map such as road junctions and topographical features. This item shall be left justified without trailing zeros.

EXAMPLES:

6 km SW. OF RICHMOND
3.5 km S. OF JCT. SR 69

Item 10 - Inventory Route, Minimum Vertical Clearance
(XX.XX meters)

4 digits

Code the minimum vertical clearance over the inventory route identified in Item 5, whether the route is "on" the structure or "under" the structure. The minimum clearance for a 3-meter width of the pavement or traveled part of the roadway where the clearance is the greatest shall be recorded and coded as a 4-digit number truncated to the hundredth of a meter (with an assumed decimal point). For structures having multiple openings, clearance for each opening shall be recorded, but only the greatest of the "minimum clearances" for the two or more openings shall be coded regardless of the direction of travel. This would be the practical maximum clearance. When no restriction exists or when the restriction is 30 meters or greater, code 9999. Coding of actual clearances between 30.0 and 99.99 meters to an exact measurement is optional.

Item 11 - Kilometerpoint (XXXX.XXX)

7 digits

The linear referencing system (LRS) kilometerpoint is used to establish the location of the bridge on the Base Highway Network (see Item 12). It must be from the same LRS Inventory Route and kilometerpoint system as reported in the Highway Performance Monitoring System (HPMS). The kilometerpoint coded in this item directly relates to Item 13 - LRS Inventory Route, Subroute Number.

This item must be coded for all structures located on or overpassing the Base Highway Network. Code a 7-digit number to represent the LRS kilometer-point distance in kilometers to the nearest thousandth (with an assumed decimal point). For structures carrying the LRS Inventory Route, code the kilometerpoint at the beginning of the structure (i.e. the lowest kilometer-point on the bridge). When the LRS Inventory Route goes under the structure (Item 5A coded 2 or A-Z), then code the kilometerpoint on the underpassing route where the structure is first encountered.

Code all zeros in this field for all records where kilometerpoints are not provided. Kilometerpoints may be coded for bridges that are not located on the Base Highway Network, however Item 12 - Base Highway Network shall be coded 0 for these records.

The kilometerpoint is coded aligned to the assumed decimal point and zero filled where needed to fill the 7 digits.

EXAMPLES:

Code

Kilometerpoint is 130.34	0130340
Kilometerpoint is 9.60	0009600

Item 12 - Base Highway Network

1 digit

This item is to be coded for all records in the inventory. The Base Highway Network includes the through lane (mainline) portions of the NHS, rural/urban principal arterial system and rural minor arterial system. Ramps, frontage roads and other roadways are not included in the Base Network. For the inventory route identified in Item 5 - Inventory Route, indicate whether the inventory route is on the Base Highway Network or not on that network. Use one of the following codes:

<u>Code</u>	<u>Description</u>
0	Inventory Route <u>is not</u> on the Base Network
1	Inventory Route <u>is</u> on the Base Network

Item 13 - LRS Inventory Route, Subroute Number

12 digits

If Item 12 - Base Highway Network has been coded 1, the information to be recorded for this item is inventory route for the State's linear referencing system (LRS). If Item 12 has been coded 0, this entire item should be left blank. This item is a 12-digit code composed of 2 segments.

<u>Segment</u>	<u>Description</u>	<u>Length</u>
13A	LRS Inventory Route	10 digits
13B	Subroute Number	2 digits

The LRS inventory route and subroute numbers to be reported in this item must correspond to the LRS inventory route and subroute numbers reported by the State for the HPMS. The LRS inventory route number is coded in the ten positions of segment 13A, right justified and zero filled. The subroute number, if it exists, is coded in the two positions of segment 13B, right justified and zero filled.

The LRS inventory route number can be alphanumeric, but must not contain blanks. The LRS inventory route number is not necessarily the same as that posted along the roadway, but is a number used to uniquely identify a route within at least a county and perhaps throughout the State.

The subroute number is a number that uniquely identifies portions of an inventory route sections where duplicate kilometerpoints occur. These subroute numbers, if they exist, are identified in the State's HPMS-LRS records. If there is no subroute number, code 00 in this segment.

EXAMPLES:

	<u>Code</u>
Inventory Route 2775, Subroute Number 0	000000277500
Inventory Route 2775, Subroute Number 3	000000277503

Item 14 and Item 15

(Reserved)

Item 16 - Latitude

(XX degrees XX minutes XX.XX seconds)

8 digits

For bridges on STRAHNET and STRAHNET Connector highways and on the NHS, record and code the latitude of each in degrees, minutes and seconds to the nearest hundredth of a second (with an assumed decimal point). The point of the coordinate may be the beginning of the bridge in the direction of the inventory or any other consistent point of reference on the bridge which is compatible with the LRS. If the bridge is not on a STRAHNET highway or the NHS, a code of all zeros is acceptable, but it is preferable to code the latitude if available.

Item 16 - Latitude (cont' d)

The reason for the increased precision is to facilitate the use of Global Positioning System (GPS) data directly into this item. The increased precision is not currently mandatory and, if GPS readings are not available, the current measuring methods and level of precision may continue to be used. The minimum precision should be to the nearest minute, but the preferred precision is to the nearest hundredth of a second using GPS methods.

EXAMPLE:		<u>Code</u>
Latitude is 35°27.3'	(current precision)	35271800
	(acceptable coding)	35270000
35°27' 18.55"	(GPS reading)	35271855

Item 17 - Longitude (XXX degrees XX minutes XX.XX seconds) 9 digits

For bridges on STRAHNET and STRAHNET Connector highways and on the NHS, record and code the longitude of each in degrees, minutes and seconds to the nearest hundredth of a second (with an assumed decimal point). A leading zero shall be coded where needed. The point of the coordinate may be the beginning of the bridge in the direction of the inventory or any other consistent point of reference on the bridge which is compatible with the LRS. If the bridge is not on a STRAHNET highway or the NHS, a code of all zeros is acceptable, but it is preferable to code the longitude if available.

The reason for the increased precision is to facilitate the use of Global Positioning System (GPS) data directly into this item. The increased precision is not currently mandatory and, if GPS readings are not available, the current measuring methods and level of precision may continue to be used. The minimum precision should be to the nearest minute, but the preferred precision is to the nearest hundredth of a second using GPS methods.

EXAMPLE:		<u>Code</u>
Longitude is 81°5.8'	(current precision)	081054800
	(acceptable coding)	081060000
81°5' 50.65"	(GPS reading)	081055065

Item 18

(reserved)

Item 19 - Bypass, Detour Length (XXX kilometers)

3 digits

Indicate the actual length to the nearest kilometer of the detour length. The detour length should represent the total additional travel for a vehicle which would result from closing of the bridge. The factor to consider when determining if a bypass is available at the site is the potential for moving vehicles, including military vehicles, around the structure. This is particularly true when the structure is in an interchange. For instance, a bypass likely would be available in the case of diamond interchanges, interchanges where there are service roads available, or other interchanges where the positioning and layout of the ramps is such that they could be used without difficulty to get around the structure. If a ground level bypass is available at the structure site for the inventory route, record and code the detour length as 000.

If the bridge is one of twin bridges and is not at an interchange, code 001 where the other twin bridge can be used as a temporary bypass with a reasonable amount of crossover grading. The detour route will be established following allowable criteria determined by the governing authority. (Some authorities will not allow a designated detour over a road or bridge of lesser "quality.") Code 199 for 199 kilometers or more.

EXAMPLES:

	<u>Code</u>
Diamond interchange, structure bypassable	000
Cloverleaf, not bypassable; 18-kilometer detour	018
Structure over river; 121-kilometer detour	121
Structure over highway, no interchange,	
bypassable at ground level	000
Structure on dead end road	199

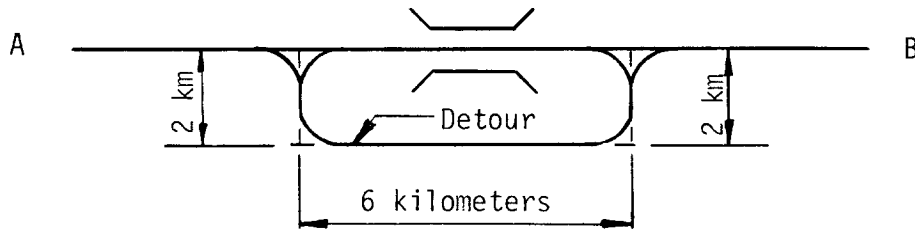

Bypass, Detour Length A to B = 4 kilometers

Item 19 - Bypass, Detour Length (cont' d)

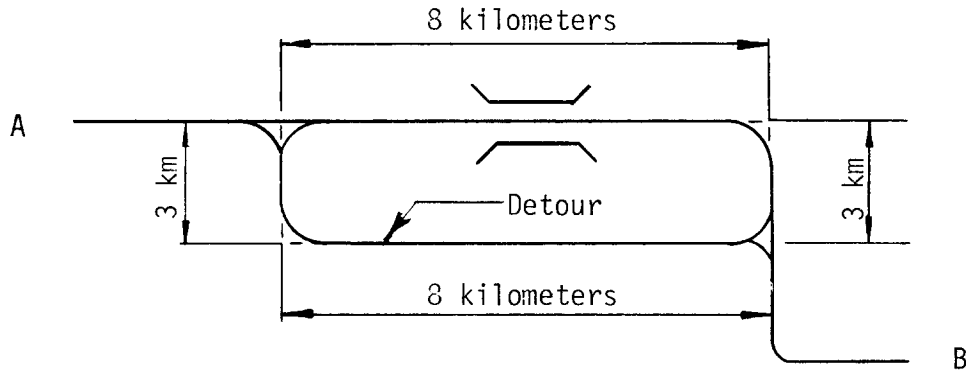

Bypass, Detour Length A to B = 0 kilometers

Item 20 - Toll

1 digit

The toll status of the structure is indicated by this item. Interstate toll segments under Secretarial Agreement (Title 23 - United States Code - Highways Section 129 as amended by 1991 ISTEA and prior legislation) shall be identified separately. Use one of the following codes:

<u>Code</u>	<u>Description</u>
1	Toll bridge. Tolls are paid specifically to use the structure.
2	On toll road. The structure carries a toll road, that is, tolls are paid to use the facility, which includes both the highway and the structure.
3	On free road. The structure is toll-free and carries a toll-free highway.
4	On Interstate toll segment under Secretarial Agreement. Structure functions as a part of the toll segment.
5	Toll bridge is a segment under Secretarial Agreement. Structure is separate agreement from highway segment.

Item 21 - Maintenance Responsibility

2 digits

The actual name(s) of the agency(s) responsible for the maintenance of the structure shall be recorded on the inspection form. The codes below shall be used to represent the type of agency that has primary responsibility for maintaining the structure. If more than one agency has equal maintenance responsibility, code one agency in the hierarchy of State, Federal, county, city, railroad, and other private.

<u>Code</u>	<u>Description</u>
01	State Highway Agency
02	County Highway Agency
03	Town or Township Highway Agency
04	City or Municipal Highway Agency
11	State Park, Forest, or Reservation Agency
12	Local Park, Forest, or Reservation Agency
21	Other State Agencies
25	Other Local Agencies
26	Private (other than railroad)
27	Railroad
31	State Toll Authority
32	Local Toll Authority
60	Other Federal Agencies (not listed below)
61	Indian Tribal Government
62	Bureau of Indian Affairs
63	Bureau of Fish and Wildlife
64	U. S. Forest Service
66	National Park Service
67	Tennessee Valley Authority
68	Bureau of Land Management
69	Bureau of Reclamation
70	Corps of Engineers (Civil)
71	Corps of Engineers (Military)
72	Air Force
73	Navy/Marines
74	Army
75	NASA
76	Metropolitan Washington Airports Service
80	Unknown

Item 22 - Owner

2 digits

The actual name(s) of the owner(s) of the bridge shall be recorded on the inspection form. The codes used in Item 21 - Maintenance Responsibility shall be used to represent the type of agency that is the primary owner of the structure. If more than one agency has equal ownership, code one agency in the hierarchy of State, Federal, county, city, railroad, and other private.

Item 23 through Item 25

(Reserved)

Item 26 - Functional Classification of Inventory Route 2 digits

For the inventory route, code the functional classification using one of the following codes:

<u>Code</u>		<u>Description</u>
	<u>Rural</u>	
01		Principal Arterial - Interstate
02		Principal Arterial - Other
06		Minor Arterial
07		Major Collector
08		Minor Collector
09		Local
	<u>Urban</u>	
11		Principal Arterial - Interstate
12		Principal Arterial - Other Freeways or Expressways
14		Other Principal Arterial
16		Minor Arterial
17		Collector
19		Local

The bridge shall be coded rural if not inside a designated urban area. The urban or rural designation shall be determined by the bridge location and not the character of the roadway.

Item 27 - Year Built 4 digits

Record and code the year of construction of the structure. Code all 4 digits of the year in which construction of the structure was completed. If the year built is unknown, provide a best estimate. See also Item 106 - Year Reconstructed.

<u>EXAMPLES:</u>		<u>Code</u>
Construction completed	1956	1956
	1892	1892

Item 28 - Lanes On and Under the Structure

4 digits

Record and code the number of lanes being carried by the structure and being crossed over by the structure as a 4-digit number composed of 2 segments. The number of lanes should be right justified in each segment with leading zero(s) coded as required.

<u>Segment</u>	<u>Description</u>	<u>Length</u>
28A	Lanes on the structure	2 digits
28B	Lanes under the structure	2 digits

Include all lanes carrying highway traffic (i.e., cars, trucks, buses) which are striped or otherwise operated as a full width traffic lane for the entire length of the structure or under the structure by the owning/maintaining authority. This shall include any full width merge lanes and ramp lanes, and shall be independent of directionality of usage (i.e., a 1-lane bridge carrying 2-directional traffic is still considered to carry only one lane on the structure). It should be noted here that for the purpose of evaluating the Deck Geometry - Item 68, any "1-lane" bridge, not coded as a ramp (Item 5C = 7), which has a Bridge Roadway Width, Curb-to-Curb - Item 51 coded 4.9 meters or greater shall be evaluated as 2 lanes.

When the inventory route is "on" the bridge (the first digit of Item 5 - Inventory Route is coded 1), the sum of the total number of lanes on all inventoried routes under the bridge shall be coded. When the inventory route is "under" the bridge (the first digit of Item 5 - Inventory Route is coded 2 or A through Z), only the number of lanes being identified by that "under" record shall be coded in Item 28B.

When the inventory route is "under" the structure, the obstruction over the inventory route may be other than a highway bridge (railroad, pedestrian, pipeline, etc.). Code 00 for these cases if there are no highway lanes on the obstructing structure.

Double deck bridges may be coded as 1 or 2 structures as noted in the examples on the next page. Either method is acceptable, however, all related data must be compatible with the method selected.

Item 28 - Lanes On and Under the Structure (cont' d)

EXAMPLES*:

	<u>Code</u>
1 lane on, 0 lanes under	0100
3 lanes on, 1 lane under	0301
8 lanes on 2-way, 12 lanes under **	0812
5 lanes on double deck each direction, 2 lanes under	1002***
5 lanes on double deck each direction, 2 lanes under	0502****
Railroad and pedestrian on, 4 lanes under	0004

* For the inventory route on the bridge, the first digit of Item 5 - Inventory Route is coded 1.

** This example has 3 inventory routes under the bridge of 6, 4, and 2 lanes of 2-way traffic respectively. When coding an "under" record for each of these inventory routes, the first digit of Item 5 - Inventory Route is coded A, B, and C, and Item 28 is coded 0806, 0804, and 0802 respectively for the 3 required records.

***Acceptable if coded as 1 bridge. However, other data such as ADT, curb- to-curb width, etc., must be for both decks (preferred method).

****Acceptable if coded as 2 separate bridges. However, other data such as ADT, curb-to-curb width, etc., must be for a single deck.

Item 29 - Average Daily Traffic

6 digits

Code a 6-digit number that shows the average daily traffic volume for the inventory route identified in Item 5. Make certain the unit's position is coded even if estimates of ADT are determined to tens or hundreds of vehicles; that is, appropriate trailing zeros shall be coded. The ADT coded should be the most recent ADT counts available. Included in this item are the trucks referred to in Item 109 - Average Daily Truck Traffic. If the bridge is closed, code the actual ADT from before the closure occurred.

The ADT must be compatible with the other items coded for the bridge. For example, parallel bridges with an open median are coded as follows: if Item 28 - Lanes On and Under the Structure and Item 51 - Bridge Roadway Width, Curb-to-Curb are coded for each bridge separately, then the ADT must be coded for each bridge separately (not the total ADT for the route).

EXAMPLES:

	<u>Code</u>
Average Daily Traffic 540	000540
15,600	015600
24,000	024000

Item 30 - Year of Average Daily Traffic

4 digits

Record the year represented by the ADT in Item 29. Code all four digits of the year so recorded.

EXAMPLE:

Code

Year of ADT is 1994

1994

Item 31 - Design Load

1 digit

Use the codes below to indicate the live load for which the structure was designed. The numerical value of the railroad loading should be recorded on the form. Classify any other loading, when feasible, using the nearest equivalent of the loadings given below.

<u>Code</u>	<u>Metric Description</u>		<u>English Description</u>
1	M 9	or	H 10
2	M 13.5		H 15
3	MS 13.5		HS 15
4	M 18		H 20
5	MS 18		HS 20
6	MS 18+Mod		HS 20+Mod
7	Pedestrian		Pedestrian
8	Railroad		Railroad
9	MS 22.5		HS 25
0	Other or Unknown (describe on inspection reporting form)		

Item 32 - Approach Roadway Width (XXX.X meters)

4 digits

Code a 4-digit number to represent the normal width of usable roadway approaching the structure measured to the nearest tenth of a meter (with an assumed decimal point). Usable roadway width will include the width of traffic lanes and the widths of shoulders where shoulders are defined as follows:

Shoulders **must** be constructed and normally maintained flush with the adjacent traffic lane, and **must** be structurally adequate for all weather and traffic conditions consistent with the facility carried.

Unstabilized grass or dirt, with no base course, flush with and beside the traffic lane is not to be considered a shoulder for this item.

For structures with medians of any type and double-decked structures, this item should be coded as the sum of the usable roadway widths for the approach roadways (i.e., all median widths which do not qualify as shoulders should not be included in this dimension). When there is a variation between the approaches at either end of the structure, record and code the most restrictive of the approach conditions.

Item 32 - Approach Roadway Width (cont' d)

EXAMPLES:

<u>Left Shoulder</u>	<u>Left Roadway</u>	<u>Median Shoulders</u>	<u>Right Roadway</u>	<u>Right Shoulder</u>	<u>Code</u>
1.2	-	-	4.8	1.8	0078
1.8	-	-	10.8	3.6	0162
3.6	14.4	9.0	14.4	3.6	0450
3.0	7.2	4.8	10.8	3.0	0288

The last example above represents the coding method for a structure in which the most restrictive approach has the cross-section shown below:

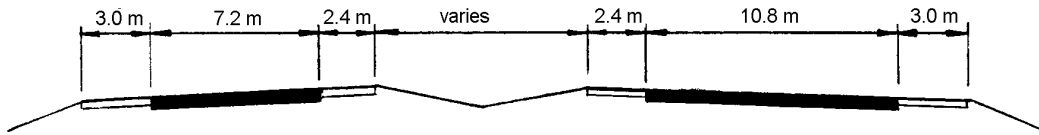

Regardless of whether the median is open or closed, the data coded must be compatible with the other related route and bridge data (i.e., if Item 51 - Bridge Roadway Width, Curb-to-Curb is for traffic in one direction only, then Items 28, 29, 32, etc. must be for traffic in one direction only).

If a ramp is adjacent to the through lanes approaching the structure, it shall be included in the approach roadway width. The total approach roadway width for the example below is 29.2 meters (a code of 292).

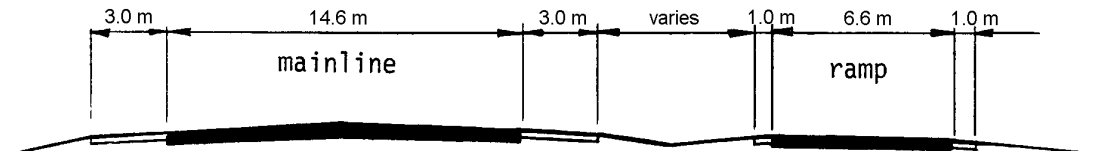

Item 33 - Bridge Median

1 digit

Indicate with a 1-digit code if the median is non-existent, open or closed. The median is closed when the area between the 2 roadways at the structure is bridged over and is capable of supporting traffic. All bridges that carry either 1-way traffic or 2-way traffic separated only by a centerline will be coded 0 for no median.

<u>Code</u>	<u>Description</u>
0	No median
1	Open median
2	Closed median (no barrier)
3	Closed median with non-mountable barriers

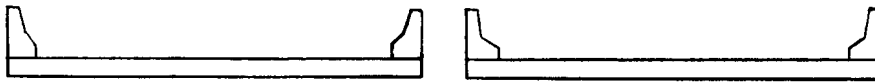

Open Median



Closed Median



Closed Median with Non-mountable Barrier

Item 34 - Skew (XX degrees)

2 digits

The skew angle is the angle between the centerline of a pier and a line normal to the roadway centerline. When plans are available, the skew angle can be taken directly from the plans. If no plans are available, the angle is to be field measured if possible. Record the skew angle to the nearest degree. If the skew angle is 0E, it should be so coded. When the structure is on a curve or if the skew varies for some other reason, the average skew should be recorded, if reasonable. Otherwise, record 99 to indicate a major variation in skews of substructure units. A 2-digit number should be coded.

EXAMPLES:

		<u>Code</u>
Skew angle	0°	00
	10°	10
	8°	08
	29°	29

Item 35 - Structure Flared

1 digit

Code this item to indicate if the structure is flared (i.e., the width of the structure varies). Generally, such variance will result from ramps converging with or diverging from the through lanes on the structure, but there may be other causes. Minor flares at ends of structures should be ignored.

<u>Code</u>	<u>Description</u>
0	No flare
1	Yes, flared

Item 36 - Traffic Safety Features

4 digits

Bridge inspection shall include the recording of information on the following traffic safety features so that the evaluation of their adequacy can be made.

- (A) Bridge railings: Some factors that affect the proper functioning of bridge railing are height, material, strength, and geometric features. Railings must be capable of smoothly redirecting an impacting vehicle. Bridge railings should be evaluated using the current AASHTO Standard Specifications for Highway Bridges, which calls for railings to meet specific geometric criteria and to resist specified static loads without exceeding the allowable stresses in their elements. Bridge railing should be crash tested per FHWA policy. Railings that meet these criteria and loading conditions are considered acceptable. Other railings that have been successfully crash tested are considered acceptable even though they may not meet the static loading analysis and geometric requirements. Acceptable guidelines for bridge railing design and testing are also found in the AASHTO Guide Specifications for Bridge Railings 1989. Additional guidance for testing is found in National Cooperative Highway Research Program - Report 350 Recommended Procedures for the Safety Performance Evaluation of Highway Features 1993.

Item 36 - Traffic Safety Features (cont' d)

- (B) Transitions: The transition from approach guardrail to bridge railing requires that the approach guardrail be firmly attached to the bridge railing. It also requires that the approach guardrail be gradually stiffened as it comes closer to the bridge railing. The ends of curbs and safety walks need to be gradually tapered out or shielded.
- (C) Approach guardrail: The structural adequacy and compatibility of approach guardrail with transition designs should be determined. Rarely does the need for a barrier stop at the end of a bridge. Thus, an approach guardrail with adequate length and structural qualities to shield motorists from the hazards at the bridge site needs to be installed. In addition to being capable of safely redirecting an impacting vehicle, the approach guardrail must also facilitate a transition to the bridge railing that will not cause snagging or pocketing of an impacting vehicle. Acceptable guardrail design suggestions are contained in the AASHTO Roadside Design Guide and subsequent FHWA or AASHTO guidelines.
- (D) Approach guardrail ends: As with guardrail ends in general, the ends of approach guardrails to bridges should be flared, buried, made breakaway, or shielded. Design treatment of guardrail ends is given in the AASHTO Roadside Design Guide.

The data collected shall apply only to the route on the bridge. Collision damage or deterioration of the elements are not considered when coding this item. Traffic safety features is a 4-digit code composed of 4 segments.

<u>Segment</u>	<u>Description</u>	<u>Length</u>
36A	Bridge railings	1 digit
36B	Transitions	1 digit
36C	Approach guardrail	1 digit
36D	Approach guardrail ends	1 digit

The reporting of these features shall be as follows:

<u>Code</u>	<u>Description</u>
0	Inspected feature does not meet currently acceptable standards or a safety feature is required and none is provided. *
1	Inspected feature meets currently acceptable standards. *
N	Not applicable or a safety feature is not required. *

* For structures on the NHS, national standards are set by regulation. For those not on the NHS, it shall be the responsibility of the highway agency (state, county, local or federal) to set standards.

Item 36 - Traffic Safety Features (cont' d)

EXAMPLE:	<u>Code</u>
All features meet currently acceptable standards except transition	1011

Item 37 - Historical Significance 1 digit

The historical significance of a bridge involves a variety of characteristics: the bridge may be a particularly unique example of the history of engineering; the crossing itself might be significant; the bridge might be associated with a historical property or area; or historical significance could be derived from the fact the bridge was associated with significant events or circumstances. Use one of the following codes:

<u>Code</u>	<u>Description</u>
1	Bridge is on the National Register of Historic Places.
2	Bridge is eligible for the National Register of Historic Places.
3	Bridge is possibly eligible for the National Register of Historic Places (requires further investigation before determination can be made) or bridge is on a State or local historic register.
4	Historical significance is not determinable at this time.
5	Bridge is not eligible for the National Register of Historic Places.

Item 38 - Navigation Control 1 digit

Indicate for this item whether or not navigation control (a bridge permit for navigation) is required. Use one of the following codes:

<u>Code</u>	<u>Description</u>
N	Not applicable, no waterway.
0	No navigation control on waterway (bridge permit not required).
1	Navigation control on waterway (bridge permit required).

Item 39 - Navigation Vertical Clearance (XXX.X meters) 4 digits

If Item 38 - Navigation Control has been coded 1, record the minimum vertical clearance imposed at the site as measured above a datum that is specified on a navigation permit issued by a control agency. The measurement shall be coded as a 4-digit number truncated to the tenth of a meter (with an assumed decimal point). This measurement will show the clearance that is allowable for navigational purposes. In the case of a swing or bascule bridge, the vertical clearance shall be measured with the bridge in the closed position (i.e., open to vehicular traffic). The vertical clearance of a vertical lift bridge shall be measured with the bridge in the raised or open position. Also, Item 116 - Minimum Navigation Vertical Clearance Vertical Lift Bridge shall be coded to provide clearance in a closed position. If Item 38 - Navigation Control has been coded 0 or N, code 000 to indicate not applicable.

EXAMPLES:

		<u>Code</u>
Measured Vertical Clearance	50.00 meters	0500
	20.65 meters	0206
	24.28 meters	0242

Item 40 - Navigation Horizontal Clearance (XXXX.X meters) 5 digits

If Item 38 - Navigation Control has been coded 1, record the horizontal clearance measurement imposed at the site that is shown on the navigation permit. This may be less than the structure geometry allows. If a navigation permit is required but not available, use the minimum horizontal clearance between fenders, if any, or the clear distance between piers or bents. Code the clearance as a 5-digit number truncated to the tenth of a meter (with an assumed decimal point). If Item 38 - Navigation Control has been coded 0 or N, code 0000 to indicate not applicable.

EXAMPLES:

		<u>Code</u>
Horizontal Clearance	53.57 meters	00535
	95.00 meters	00950
	202.09 meters	02020

Item 41 - Structure Open, Posted, or Closed to Traffic 1 digit

This item provides information about the actual operational status of a structure. The field review could show that a structure is posted, but Item 70 - Bridge Posting may indicate that posting is not required. This is possible and acceptable coding since Item 70 is based on the operating stress level and the governing agency's posting procedures may specify posting at some stress level less than the operating rating. One of the following codes shall be used:

Item 41 - Structure Open, Posted, or Closed to Traffic (cont'd)

<u>Code</u>	<u>Description</u>
A	Open, no restriction
B	Open, posting recommended but not legally implemented (all signs not in place or not correctly implemented)
D	Open, would be posted or closed except for temporary shoring, etc. to allow for unrestricted traffic
E	Open, temporary structure in place to carry legal loads while original structure is closed and awaiting replacement or rehabilitation
G	New structure not yet open to traffic
K	Bridge closed to all traffic
P	Posted for load (may include other restrictions such as temporary bridges which are load posted)
R	Posted for other load-capacity restriction (speed, number of vehicles on bridge, etc.)

Item 42 - Type of Service 2 digits

The type of service on the bridge and under the bridge is indicated by a 2-digit code composed of 2 segments.

<u>Segment</u>	<u>Description</u>	<u>Length</u>
42A	Type of service on bridge	1 digit
42B	Type of service under bridge	1 digit

The first digit indicates the type of service "on" the bridge and shall be coded using one of the following codes:

<u>Code</u>	<u>Description</u>
1	Highway
2	Railroad
3	Pedestrian-bicycle
4	Highway-railroad
5	Highway-pedestrian
6	Overpass structure at an interchange or second level of a multilevel interchange
7	Third level (Interchange)
8	Fourth level (Interchange)
9	Building or plaza
0	Other

Item 42 - Type of Service (cont' d)

The second digit indicates the type of service "under" the bridge and shall be coded using one of the following codes:

<u>Code</u>	<u>Description</u>
1	Highway, with or without pedestrian
2	Railroad
3	Pedestrian-bicycle
4	Highway-railroad
5	Waterway
6	Highway-waterway
7	Railroad-waterway
8	Highway-waterway-railroad
9	Relief for waterway
0	Other

Item 43 - Structure Type, Main

3 digits

Record the description on the inspection form and indicate the type of structure for the main span(s) with a 3-digit code composed of 2 segments.

<u>Segment</u>	<u>Description</u>	<u>Length</u>
43A	Kind of material and/or design	1 digit
43B	Type of design and/or construction	2 digits

The first digit indicates the kind of material and/or design and shall be coded using one of the following codes:

<u>Code</u>	<u>Description</u>
1	Concrete
2	Concrete continuous
3	Steel
4	Steel continuous
5	Prestressed concrete *
6	Prestressed concrete continuous *
7	Wood or Timber
8	Masonry
9	Aluminum, Wrought Iron, or Cast Iron
0	Other

* Post-tensioned concrete should be coded as prestressed concrete.

Item 43 - Structure Type, Main (cont' d)

The second and third digits indicate the predominant type of design and/or type of construction and shall be coded using one of the following codes:

<u>Code</u>	<u>Description</u>
01	Slab
02	Stringer/Multi-beam or Girder
03	Girder and Floorbeam System
04	Tee Beam
05	Box Beam or Girders - Multiple
06	Box Beam or Girders - Single or Spread
07	Frame (except frame culverts)
08	Orthotropic
09	Truss - Deck
10	Truss - Thru
11	Arch - Deck
12	Arch - Thru
13	Suspension
14	Stayed Girder
15	Movable - Lift
16	Movable - Bascule
17	Movable - Swing
18	Tunnel
19	Culvert (includes frame culverts)
20 *	Mixed types
21	Segmental Box Girder
22	Channel Beam
00	Other

* Applicable only to approach spans - Item 44

EXAMPLES:

	<u>Code</u>
Wood or Timber Through Truss	710
Masonry Culvert	819
Steel Suspension	313
Continuous Concrete Multiple Box Girders	205
Simple Span Concrete Slab	101
Tunnel in Rock	018

Item 44 - Structure Type, Approach Spans

3 digits

Indicate with a 3-digit code composed of 2 segments, the type of structure for the approach spans to a major bridge or for the spans where the structural material is different. The codes are the same as for Item 43 preceding. However, code 000 if this item is not applicable. Use code 20 (Item 44B) when no one type of design and/or construction is predominate for the approach units. If the kind of material (Item 44A) is varied, code the most predominant.

Item 44 - Structure Type, Approach Spans (cont' d)

<u>Segment</u>	<u>Description</u>	<u>Length</u>
44A	Kind of material and/or design	1 digit
44B	Type of design and/or construction	2 digits

EXAMPLES:

	<u>Code</u>
Simple prestressed concrete I-beam	502
Continuous concrete T-beam	204
Continuous steel deck truss	409

Item 45 - Number of Spans in Main Unit 3 digits

Record the number and indicate with a 3-digit number the number of spans in the main or major unit. This item will include all spans of most bridges, the major unit only of a sizable structure, or a unit of material or design different from that of the approach spans.

Item 46 - Number of Approach Spans 4 digits

Record the number and indicate with a 4-digit number the number of spans in the approach spans to the major bridge, or the number of spans of material different from that of the major bridge.

Item 47 - Inventory Route, Total Horizontal Clearance 3 digits
(XX.X meters)

The total horizontal clearance for the inventory route identified in Item 5 should be measured and recorded. The clearance should be the available clearance measured between the restrictive features -- curbs, rails, walls, piers or other structural features limiting the roadway (surface and shoulders). The measurement should be recorded and coded as a 3-digit number truncated to the nearest tenth of a meter (with an assumed decimal point). When the restriction is 100 meters or greater, code 999.

The purpose of this item is to give the largest available clearance for the movement of wide loads. Flush and mountable medians are not considered to be restrictions. This clearance is defined in 2 ways; use the most applicable:

1. Clear distance between restrictions of the inventory route either "on" or "under" the structure.
2. Roadway surface and shoulders - when there are no restrictions.

For a divided facility with a raised or non-mountable median, or an "under" route divided by piers, record the greater of the restricted widths in either direction, not both directions.

Item 47 - Inventory Route, Total Horizontal Clearance (cont' d)

EXAMPLES:

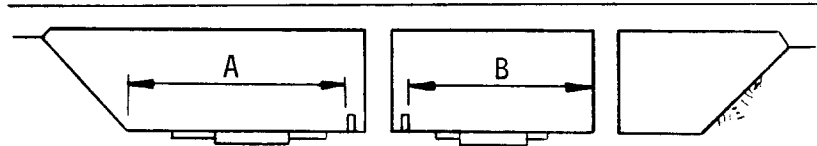

Clearance A > B Item 47 = A

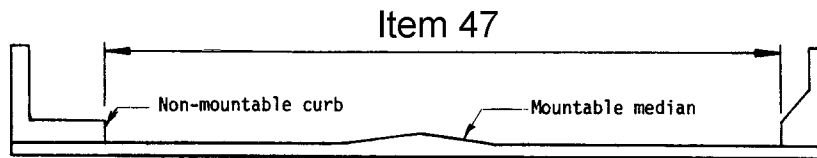

No Median or Flush or Mountable Median

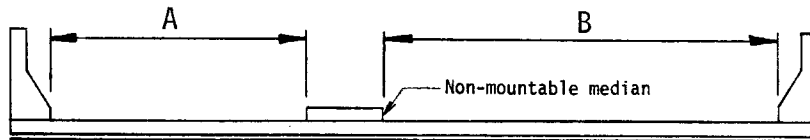

Raised Median or Non-mountable Median

B > A Item 47 = B

Item 48 - Length of Maximum Span (XXXX. X meters)

5 digits

The length of the maximum span shall be recorded. It shall be noted whether the measurement is center to center of bearing points or clear open distance between piers, bents, or abutments. The measurement shall be along the centerline of the bridge. For this item, code a 5-digit number to represent the measurement to the nearest tenth of a meter (with an assumed decimal point).

EXAMPLES:

		<u>Code</u>
Length of Maximum Span	35.5 meters	00355
	117.0 meters	01170
	1219.2 meters	12192

Item 49 - Structure Length (XXXXX.X meters)

6 digits

Record and code a 6-digit number to represent the length of the structure to the nearest tenth of a meter (with an assumed decimal point). This shall be the length of roadway which is supported on the bridge structure. The length should be measured back to back of backwalls of abutments or from paving notch to paving notch.

Culvert lengths should be measured along the center line of roadway regardless of their depth below grade. Measurement should be made between inside faces of exterior walls. Tunnel length should be measured along the centerline of the roadway. Be sure to code Item 5A = 2 for all tunnels.

EXAMPLES:

		<u>Code</u>
Structure Length	35.5 meters	000355
	542.1 meters	005421
	333.0 meters	003330
	10 123.5 meters	101235

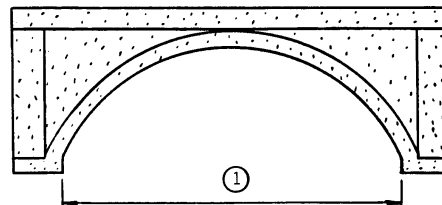
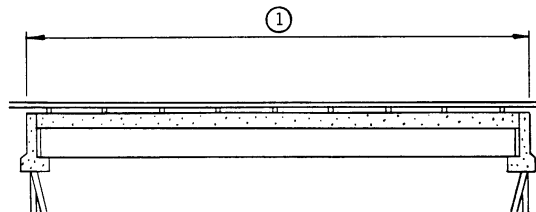
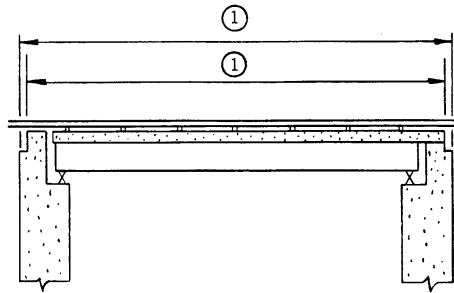

(1) Item 49 - Structure Length

Item 49 - Structure Length (cont' d)

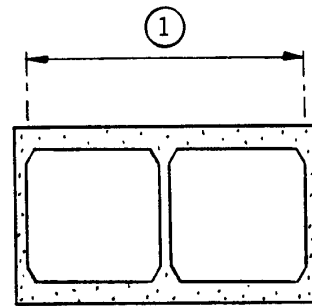
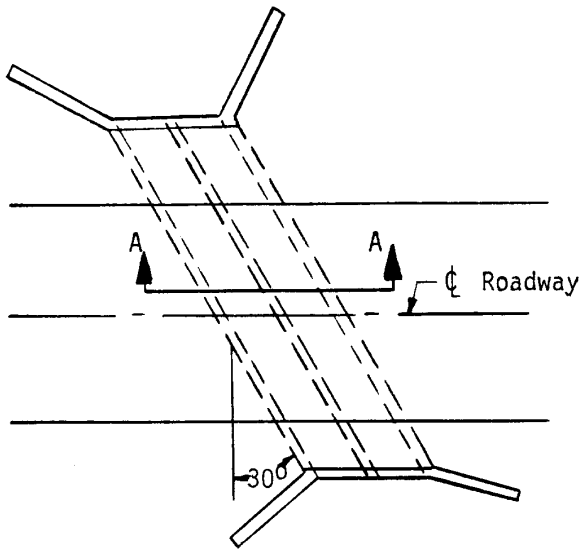

SECTION A-A

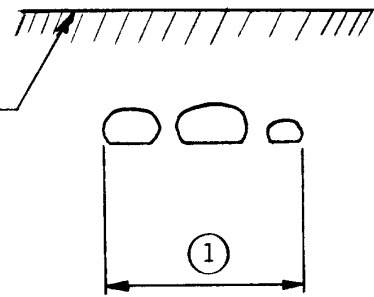
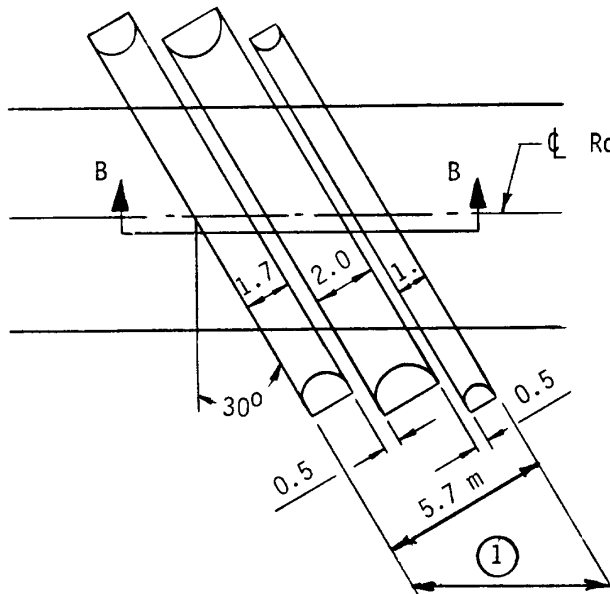

SECTION B-B

(1) Item 49 - Structure Length = $\frac{5.7 \text{ m}}{\cos 30^\circ} = 6.58 \text{ m}$

Code
000066

Item 50 - Curb or Sidewalk Widths (XX.X meters, XX.X meters) 6 digits

Record and code two contiguous 3-digit numbers to represent the widths of the left and right curbs or sidewalks to nearest tenth of a meter (with assumed decimal points). This is a 6-digit number composed of 2 segments, with the leftmost 3 digits representing the left curb or sidewalk and the rightmost 3 digits representing the right curb or sidewalk. "Left" and "Right" should be determined on the basis of direction of the inventory.

<u>Segment</u>	<u>Description</u>	<u>Length</u>
50A	Left curb or sidewalk width	3 digits
50B	Right curb or sidewalk width	3 digits

<u>EXAMPLES:</u>	<u>Left Side</u>	<u>Right Side</u>	<u>Code</u>
Curb or sidewalk	None	2.3 meters	000023
	3.0 meters	4.1 meters	030041
	3.3 meters	None	033000
	12.1 meters	11.5 meters	121115
	None	None	000000
	0.6 meters	1.5 meters	006015

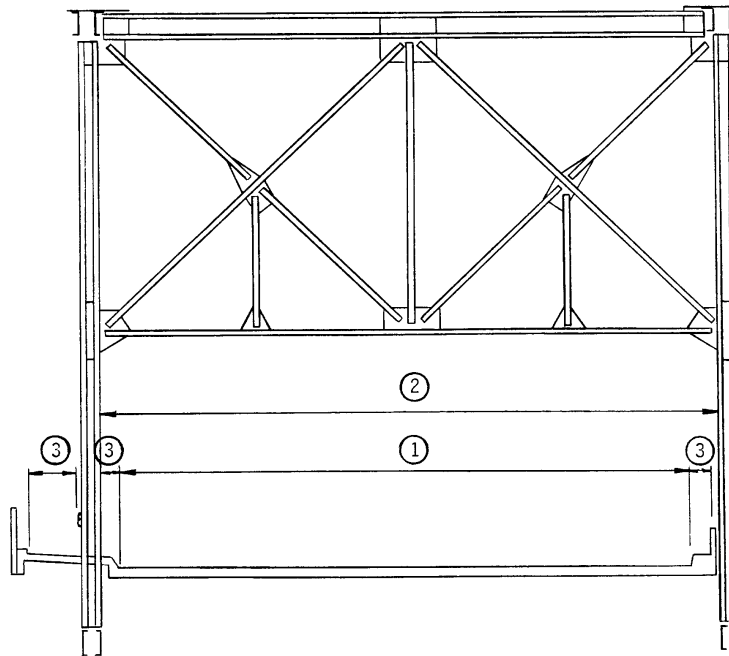

- (1) Item 51 - Bridge Roadway Width, Curb-to-Curb
- (2) Item 52 - Deck Width, Out-to-Out
- (3) Item 50 - Curb or Sidewalk Width

Item 50 - Curb or Sidewalk Widths (cont' d)

EXAMPLES:

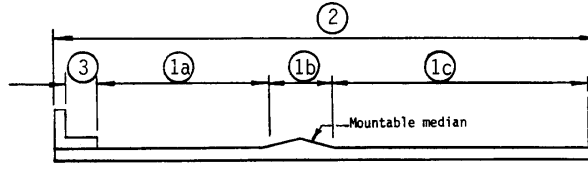
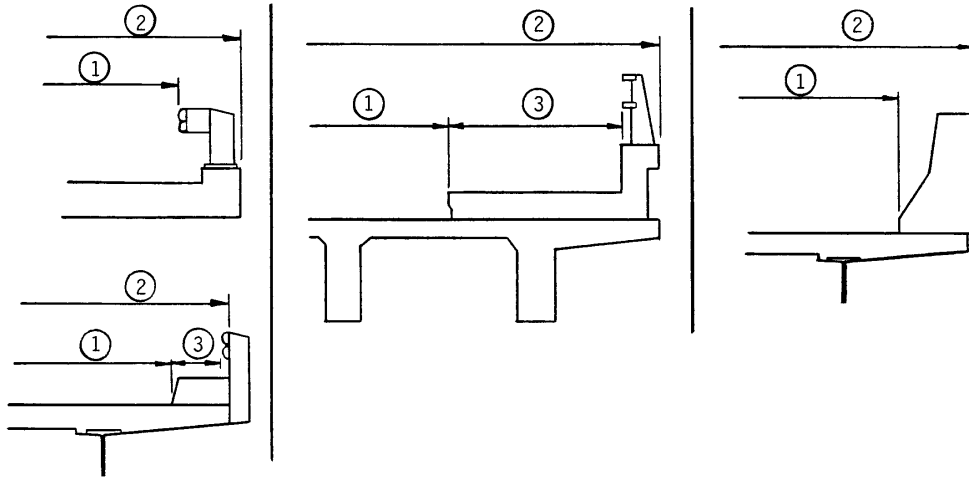

$$\textcircled{1} = \textcircled{1a} + \textcircled{1b} + \textcircled{1c}$$

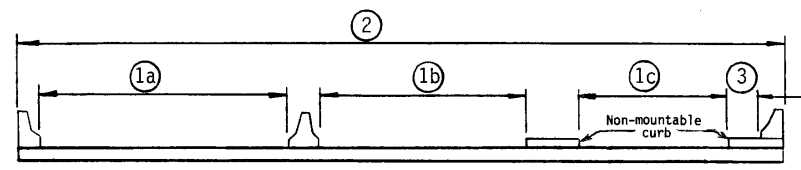

$$\textcircled{1} = \textcircled{1a} + \textcircled{1b} + \textcircled{1c}$$

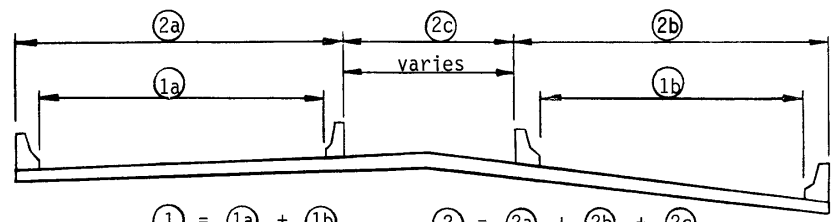

$$\textcircled{1} = \textcircled{1a} + \textcircled{1b} \quad \textcircled{2} = \textcircled{2a} + \textcircled{2b} + \textcircled{2c}$$

- (1) Item 51 - Bridge Roadway Width, Curb-to-Curb
- (2) Item 52 - Deck Width, Out-to-Out
- (3) Item 50 - Curb or Sidewalk Width

Item 51 - Bridge Roadway Width, Curb-to-Curb (XXX.X meters) 4 digits

The information to be recorded is the most restrictive minimum distance between curbs or rails on the structure roadway. For structures with closed medians and usually for double decked structures, coded data will be the sum of the most restrictive minimum distances for all roadways carried by the structure*. The data recorded for this item must be compatible with other related route and bridge data (i.e., Items 28, 29, 32, etc.). The measurement should be exclusive of flared areas for ramps. A 4-digit number should be used to represent the distance to the nearest tenth of a meter (with an assumed decimal point). See examples on pages 30 and 31.

Where traffic runs directly on the top slab (or wearing surface) of a culvert-type structure, e.g. an R/C box without fill, code the actual roadway width (curb-to-curb or rail-to-rail). This will also apply where the fill is minimal and headwalls or parapets affect the flow of traffic.

Where the roadway is on fill carried across a structure and the headwalls or parapets do not affect the flow of traffic, code 0000. This is considered proper inasmuch as a filled section simply maintains the roadway cross-section. However, for sidehill viaduct structures code the actual full curb-to-curb roadway width. See figure in the Commentary Appendix D.

* Raised or non-mountable medians, open medians, and barrier widths are to be excluded from the summation along with barrier-protected bicycle and equestrian lanes.

EXAMPLES:

	<u>Code</u>
Bridge Roadway Width 16.00 meters wide	0160
21.43 meters wide	0214
33.07 meters wide	0331

The last example above would be the coded value for the deck section shown below.

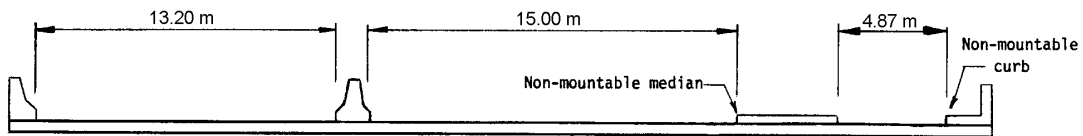

Item 52 - Deck Width, Out-to-Out (XXX.X meters) 4 digits

Record and code a 4-digit number to show the out-to-out width to the nearest tenth of a meter (with an assumed decimal point). If the structure is a through structure, the number to be coded will represent the lateral clearance between superstructure members. The measurement should be exclusive of flared areas for ramps. See examples on pages 30 and 31.

Where traffic runs directly on the top slab (or wearing surface) of the culvert (e.g., an R/C box without fill) code the actual width (out-to-out). This will also apply where the fill is minimal and the culvert headwalls affect the flow of traffic. However, for sidehill viaduct structures code the actual out-to-out structure width. See figure in the Commentary Appendix D.

Where the roadway is on a fill carried across a pipe or box culvert and the culvert headwalls do not affect the flow of traffic, code 0000. This is considered proper inasmuch as a filled section over a culvert simply maintains the roadway cross-section.

Item 53 - Minimum Vertical Clearance Over Bridge Roadway 4 digits
(XX.XX meters)

The information to be recorded for this item is the actual minimum vertical clearance over the bridge roadway, including shoulders, to any superstructure restriction, rounded down to the nearest hundredth of a meter. For double decked structures code the minimum, regardless whether it is pertaining to the top or bottom deck. When no superstructure restriction exists above the bridge roadway, or when a restriction is 30 meters or greater, code 9999. Coding of actual clearances between 30 meters and 99.99 meters to an exact measurement is optional. A 4-digit number should be coded to represent the clearance to the nearest hundredth of a meter (with an assumed decimal point).

EXAMPLES:

<u>Minimum Vertical Clearance</u>	<u>Code</u>
No restriction	9999
5.25 meters	0525
23.00 meters	2300
38.50 meters	9999

Item 54 - Minimum Vertical Underclearance 5 digits
(X code, XX.XX meters)

Using a 1-digit code and a 4-digit number, record and code the minimum vertical clearance from the roadway (travel lanes only) or railroad track beneath the structure to the underside of the superstructure. (When both a railroad and highway are under the structure, code the most critical dimension.)

<u>Segment</u>	<u>Description</u>	<u>Length</u>
54A	Reference feature	1 digit
54B	Minimum Vertical Underclearance	4 digits

Item 54 - Minimum Vertical Underclearance (cont'd)

Using one of the codes below, code in the first position, the reference feature from which the clearance measurement is taken:

<u>Code</u>	<u>Description</u>
H	Highway beneath structure
R	Railroad beneath structure
N	Feature not a highway or railroad

In the next 4 positions, code a 4-digit number to represent the minimum vertical clearance from that feature to the structure, truncated to the hundredth of a meter (with an assumed decimal point). When a restriction is 30 meters or greater, code 9999. Coding of actual clearances between 30 meters and 99.99 meters to an exact measurement is optional. If the feature is not a highway or railroad, code the minimum vertical clearance 0000.

EXAMPLES:

River beneath structure

CODE
N0000

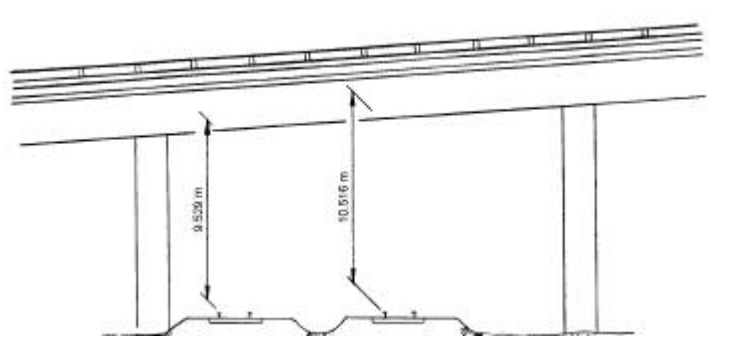

Railroad 9.529 meters beneath structure

R0952

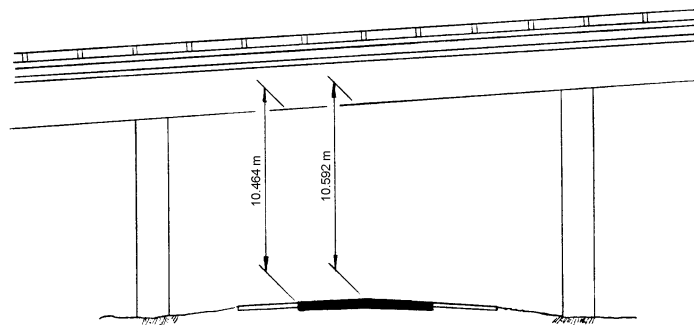

Highway 10.464 meters beneath structure

H1046

Item 55 - Minimum Lateral Underclearance on Right
(X code, XX.X meters)

4 digits

Using a 1-digit code and a 3-digit number, record and code the minimum lateral underclearance on the right to the nearest tenth of a meter (with an assumed decimal point). When both a railroad and highway are under the structure, code the most critical dimension (Refer to Item 69 - Underclearances, Horizontal - Table 3B).

<u>Segment</u>	<u>Description</u>	<u>Length</u>
55A	Reference feature	1 digit
55B	Minimum Lateral Underclearance	3 digits

Using one of the codes below, code in the first position the reference feature from which the clearance measurement is taken:

<u>Code</u>	<u>Description</u>
H	Highway beneath structure
R	Railroad beneath structure
N	Feature not a highway or railroad

In the next 3 positions, code a 3-digit number to represent the minimum lateral underclearance on the right. The lateral clearance should be measured from the right edge of the roadway (excluding shoulders) or from the centerline (between rails) of the right-hand track of a railroad to the nearest substructure unit (pier, abutment, etc.), to a rigid barrier (concrete bridge rail, etc.), or to the toe of slope steeper than 1 to 3, e.g. 1 to 1 or 2 to 1. The clearance measurements to be recorded will be the minimum after measuring the clearance in both directions of travel. In the case of a dual highway this would mean the outside clearances of both roadways should be measured and the smaller distance recorded and coded.

If two related features are below the bridge, measure both and record the lesser of the 2. An explanation should be written on the inspection form as to what was recorded. When the clearance is 30 meters or greater, code 999. Coding of actual clearances between 30 meters and 99.9 meters to an exact measurement is optional.

If the feature beneath the structure is not a railroad or highway, code N000 to indicate not applicable.

The presence of ramps and acceleration or turning lanes is not considered in this item; therefore, the minimum lateral clearance on the right should be measured from the right edge of the through roadway.

EXAMPLES:

	<u>Code</u>
Railroad 6.22 meters centerline to pier	R062
Highway 6.16 meters edge of pavement to pier	H062
Creek beneath structure	N000

Item 55 – Minimum Lateral Underclearance on Right (cont' d)
EXAMPLES:

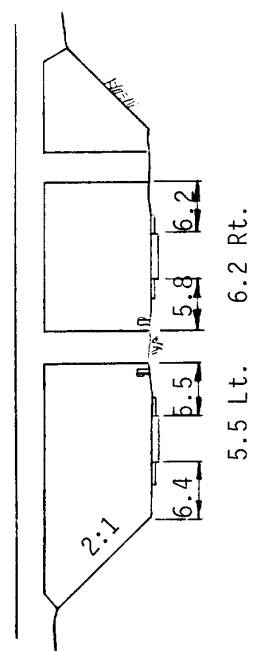
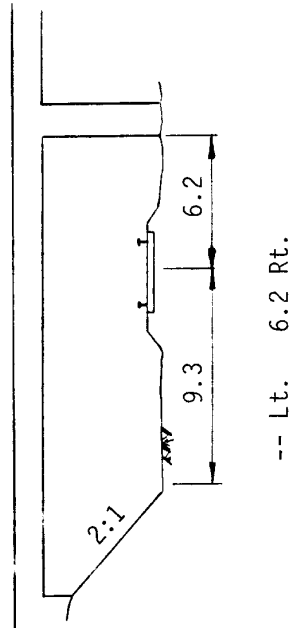
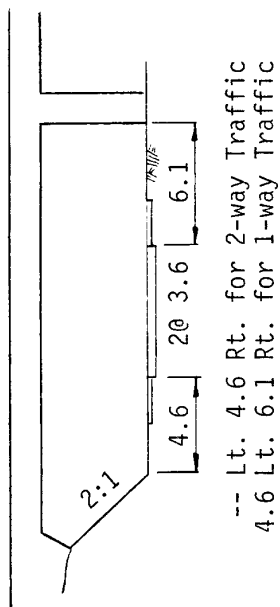
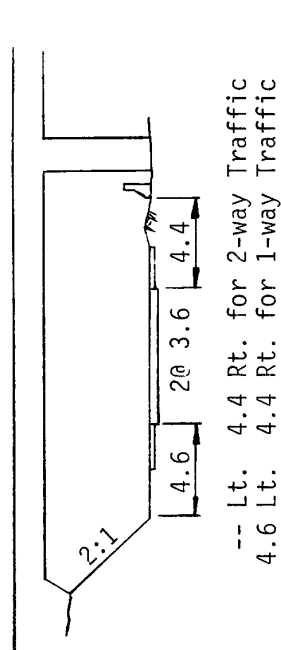
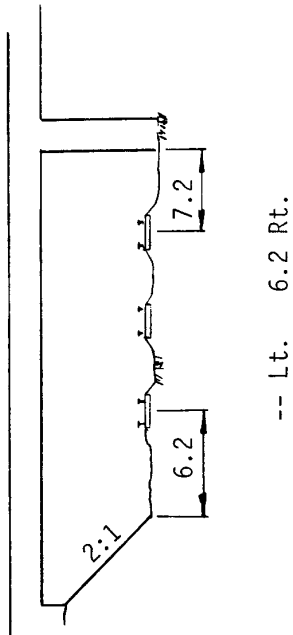
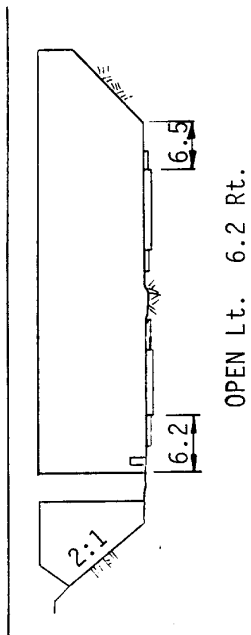

Item 56 - Minimum Lateral Underclearance on Left 3 digits
(XX.X meters) (code only for divided highways, 1-way streets, and ramps; not applicable to railroads)

Using a 3-digit number, record and code the minimum lateral underclearance on the left (median side for divided highways) to the nearest tenth of a meter (with an assumed decimal point). The lateral clearance should be measured from the left edge of the roadway (excluding shoulders) to the nearest substructure unit, to a rigid barrier, or to the toe of slope steeper than 1 to 3. Refer to examples on page 34 under Item 55 - Minimum Lateral Underclearance on Right.

In the case of a dual highway, the median side clearances of both roadways should be measured and the smaller distance recorded and coded. If there is no obstruction in the median area, a notation of "open" should be recorded and 999 should be coded. For clearances greater than 30 meters, code 998. Coding of actual clearances greater than 30 meters to an exact measurement is optional. Code 000 to indicate not applicable.

Item 57

(Reserved)

Items 58 through 62 - Indicate the Condition Ratings

In order to promote uniformity between bridge inspectors, these guidelines will be used to rate and code Items 58, 59, 60, 61, and 62. The use of the AASHTO Guide for Commonly Recognized (CoRe) Structural Elements is an acceptable alternative to using these rating guidelines for Items 58, 59, 60, and 62, provided the FHWA translator computer program is used to convert the inspection data to NBI condition ratings for NBI data submittal.

Condition ratings are used to describe the existing, in-place bridge as compared to the as-built condition. Evaluation is for the materials related, physical condition of the deck, superstructure, and substructure components of a bridge. The condition evaluation of channels and channel protection and culverts is also included. Condition codes are properly used when they provide an overall characterization of the general condition of the entire component being rated. Conversely, they are improperly used if they attempt to describe localized or nominally occurring instances of deterioration or disrepair. Correct assignment of a condition code must, therefore, consider both the severity of the deterioration or disrepair and the extent to which it is widespread throughout the component being rated.

The load-carrying capacity will not be used in evaluating condition items. The fact that a bridge was designed for less than current legal loads and may be posted shall have no influence upon condition ratings.

Portions of bridges that are being supported or strengthened by temporary members will be rated based on their actual condition; that is, the temporary members are not considered in the rating of the item. (See Item 103 - Temporary Structure Designation for the definition of a temporary bridge.)

Completed bridges not yet opened to traffic, if rated, shall be coded as if open to traffic

Condition Ratings (cont' d)

The following general condition ratings shall be used as a guide in evaluating Items 58, 59, and 60:

<u>Code</u>	<u>Description</u>
N	NOT APPLICABLE
9	EXCELLENT CONDITION
8	VERY GOOD CONDITION - no problems noted.
7	GOOD CONDITION - some minor problems.
6	SATISFACTORY CONDITION - structural elements show some minor deterioration.
5	FAIR CONDITION - all primary structural elements are sound but may have minor section loss, cracking, spalling or scour.
4	POOR CONDITION - advanced section loss, deterioration, spalling or scour.
3	SERIOUS CONDITION - loss of section, deterioration, spalling or scour have seriously affected primary structural components. Local failures are possible. Fatigue cracks in steel or shear cracks in concrete may be present.
2	CRITICAL CONDITION - advanced deterioration of primary structural elements. Fatigue cracks in steel or shear cracks in concrete may be present or scour may have removed substructure support. Unless closely monitored it may be necessary to close the bridge until corrective action is taken.
1	"IMMINENT" FAILURE CONDITION - major deterioration or section loss present in critical structural components or obvious vertical or horizontal movement affecting structure stability. Bridge is closed to traffic but corrective action may put back in light service.
0	FAILED CONDITION - out of service - beyond corrective action.

Item 58 - Deck

1 digit

This item describes the overall condition rating of the deck. Rate and code the condition in accordance with the above general condition ratings. Code N for culverts and other structures without decks e.g., filled arch bridge.

Concrete decks should be inspected for cracking, scaling, spalling, leaching, chloride contamination, potholing, delamination, and full or partial depth failures. Steel grid decks should be inspected for broken welds, broken grids, section loss, and growth of filled grids from corrosion. Timber decks should be inspected for splitting, crushing, fastener failure, and deterioration from rot.

The condition of the wearing surface/protective system, joints, expansion devices, curbs, sidewalks, parapets, fascias, bridge rail, and scuppers shall not be considered in the overall deck evaluation. However, their condition should be noted on the inspection form

Item 58 - Deck (cont' d)

Decks integral with the superstructure will be rated as a deck only and not how they may influence the superstructure rating (for example, rigid frame, slab, deckgirder or T-beam, voided slab, box girder, etc.). Similarly, the superstructure of an integral deck-type bridge will not influence the deck rating.

Item 59 - Superstructure

1 digit

This item describes the physical condition of all structural members. Rate and code the condition in accordance with the previously described general condition ratings. Code N for all culverts.

The structural members should be inspected for signs of distress which may include cracking, deterioration, section loss, and malfunction and misalignment of bearings.

The condition of bearings, joints, paint system, etc. shall not be included in this rating, except in extreme situations, but should be noted on the inspection form.

On bridges where the deck is integral with the superstructure, the superstructure condition rating may be affected by the deck condition. The resultant superstructure condition rating may be lower than the deck condition rating where the girders have deteriorated or been damaged.

Fracture critical components should receive careful attention because failure could lead to collapse of a span or the bridge.

Item 60 - Substructure

1 digit

This item describes the physical condition of piers, abutments, piles, fenders, footings, or other components. Rate and code the condition in accordance with the previously described general condition ratings. Code N for all culverts.

All substructure elements should be inspected for visible signs of distress including evidence of cracking, section loss, settlement, misalignment, scour, collision damage, and corrosion. The rating given by Item 113 - Scour Critical Bridges, may have a significant effect on Item 60 if scour has substantially affected the overall condition of the substructure.

The substructure condition rating shall be made independent of the deck and superstructure.

Integral-abutment wingwalls to the first construction or expansion joint shall be included in the evaluation. For non-integral superstructure and substructure units, the substructure shall be considered as the portion below the bearings. For structures where the substructure and superstructure are integral, the substructure shall be considered as the portion below the superstructure.

Item 61 - Channel and Channel Protection

1 digit

This item describes the physical conditions associated with the flow of water through the bridge such as stream stability and the condition of the channel, riprap, slope protection, or stream control devices including spur dikes. The inspector should be particularly concerned with visible signs of excessive water velocity which may affect undermining of slope protection, erosion of banks, and realignment of the stream which may result in immediate or potential problems. Accumulation of drift and debris on the superstructure and substructure should be noted on the inspection form but not included in the condition rating.

Rate and code the condition in accordance with the previously described general condition ratings and the following descriptive codes:

<u>Code</u>	<u>Description</u>
N	Not applicable. Use when bridge is not over a waterway (channel).
9	There are no noticeable or noteworthy deficiencies which affect the condition of the channel.
8	Banks are protected or well vegetated. River control devices such as spur dikes and embankment protection are not required or are in a stable condition.
7	Bank protection is in need of minor repairs. River control devices and embankment protection have a little minor damage. Banks and/or channel have minor amounts of drift.
6	Bank is beginning to slump. River control devices and embankment protection have widespread minor damage. There is minor stream bed movement evident. Debris is restricting the channel slightly.
5	Bank protection is being eroded. River control devices and/or embankment have major damage. Trees and brush restrict the channel.
4	Bank and embankment protection is severely undermined. River control devices have severe damage. Large deposits of debris are in the channel.
3	Bank protection has failed. River control devices have been destroyed. Stream bed aggradation, degradation or lateral movement has changed the channel to now threaten the bridge and/or approach roadway.
2	The channel has changed to the extent the bridge is near a state of collapse.
1	Bridge closed because of channel failure. Corrective action may put back in light service.
0	Bridge closed because of channel failure. Replacement necessary.

Item 62 - Culverts

1 digit

This item evaluates the alignment, settlement, joints, structural condition, scour, and other items associated with culverts. The rating code is intended to be an overall condition evaluation of the culvert. Integral wingwalls to the first construction or expansion joint shall be included in the evaluation. For a detailed discussion regarding the inspection and rating of culverts, consult Report No. FHWA-IP-86-2, Culvert Inspection Manual, July 1986.

Item 58 - Deck, Item 59 - Superstructure, and Item 60 - Substructure shall be coded N for all culverts.

Rate and code the condition in accordance with the previously described general condition ratings and the following descriptive codes:

<u>Code</u>	<u>Description</u>
N	Not applicable. Use if structure is not a culvert.
9	No deficiencies.
8	No noticeable or noteworthy deficiencies which affect the condition of the culvert. Insignificant scrape marks caused by drift.
7	Shrinkage cracks, light scaling, and insignificant spalling which does not expose reinforcing steel. Insignificant damage caused by drift with no misalignment and not requiring corrective action. Some minor scouring has occurred near curtain walls, wingwalls, or pipes. Metal culverts have a smooth symmetrical curvature with superficial corrosion and no pitting.
6	Deterioration or initial disintegration, minor chloride contamination, cracking with some leaching, or spalls on concrete or masonry walls and slabs. Local minor scouring at curtain walls, wingwalls, or pipes. Metal culverts have a smooth curvature, non-symmetrical shape, significant corrosion or moderate pitting.
5	Moderate to major deterioration or disintegration, extensive cracking and leaching, or spalls on concrete or masonry walls and slabs. Minor settlement or misalignment. Noticeable scouring or erosion at curtain walls, wingwalls, or pipes. Metal culverts have significant distortion and deflection in one section, significant corrosion or deep pitting.
4	Large spalls, heavy scaling, wide cracks, considerable efflorescence, or opened construction joint permitting loss of backfill. Considerable settlement or misalignment. Considerable scouring or erosion at curtain walls, wingwalls or pipes. Metal culverts have significant distortion and deflection throughout, extensive corrosion or deep pitting.

(codes continued on the next page)

Item 62 - Culverts (cont' d)

- 3 Any condition described in Code 4 but which is excessive in scope. Severe movement or differential settlement of the segments, or loss of fill. Holes may exist in walls or slabs. Integral wingwalls nearly severed from culvert. Severe scour or erosion at curtain walls, wingwalls or pipes. Metal culverts have extreme distortion and deflection in one section, extensive corrosion, or deep pitting with scattered perforations.
- 2 Integral wingwalls collapsed, severe settlement of roadway due to loss of fill. Section of culvert may have failed and can no longer support embankment. Complete undermining at curtain walls and pipes. Corrective action required to maintain traffic. Metal culverts have extreme distortion and deflection throughout with extensive perforations due to corrosion.
- 1 Bridge closed. Corrective action may put back in light service.
- 0 Bridge closed. Replacement necessary.

Item 63 - Method Used to Determine Operating Rating

1 digit

Use one of the codes below to indicate which load rating method was used to determine the Operating Rating coded in Item 64 for this structure.

<u>Code</u>	<u>Description</u>
1	Load Factor (LF)
2	Allowable Stress (AS)
3	Load and Resistance Factor (LRFR)
4	Load Testing
5	No rating analysis performed

Item 64 - Operating Rating (XX.X metric tons)

3 digits

This capacity rating, referred to as the operating rating, will result in the absolute maximum permissible load level to which the structure may be subjected for the vehicle type used in the rating. Code the operating rating as a 3-digit number to represent the total mass in metric tons of the entire vehicle measured to the nearest tenth of a metric ton (with an assumed decimal point).

It should be emphasized that only MS loading shall be used to determine the operating rating. This is the metric equivalent of an HS loading. The total mass in tons of the entire vehicle should be coded; that is, MS18 which has a mass of 32.4 metric tons shall be coded '324', and likewise, a MS13.5 shall be coded '243'.

The AASHTO Manual for Condition Evaluation of Bridges provides a choice of load rating methods, such as the new load and resistance factor (LRFR) rating method, in addition to the traditional allowable stress (AS) and load factor (LF) methods. Of the three rating methods, the LF method is the most suitable for use as a national standard, therefore the FHWA has chosen the LF method as the standard for computing inventory and operating ratings reported to the NBI. The highway agencies may, however, elect to use LF, AS or LRF to establish load limits for purposes of load posting.

If the bridge will not carry a minimum of 2.7 metric tons of live load, the operating rating shall be coded '000'; and consistent with the direction of the AASHTO Manual, it shall be closed.

The use or presence of a temporary bridge requires special consideration in coding. In such cases, since there is no permanent bridge, Items 64 and 66 should be coded as 000 even though the temporary structure is rated for as much as full legal load.

A bridge shored up or repaired on a temporary basis is considered a temporary bridge and the inventory and operating rating shall be coded as if the temporary shoring were not in place. See Item 103 - Temporary Structure Designation for definition of a temporary bridge.

Code 999 for a structure under sufficient fill such that, according to AASHTO design, the live load is insignificant in the structure load capacity.

EXAMPLES:

	<u>Code</u>
MS27	486
Temporary bridge	000
Shored-up bridge	030*
Structure under fill (not affected by live load)	999

* load capacity without shoring.

Item 65 - Method Used to Determine Inventory Rating

1 digit

Use one of the codes below to indicate which load rating method was used to determine the Inventory Rating coded in Item 66 for this structure.

<u>Code</u>	<u>Description</u>
1	Load Factor (LF)
2	Allowable Stress (AS)
3	Load and Resistance Factor (LRFR)
4	Load Testing
5	No rating analysis performed

Item 66 - Inventory Rating (XX.X metric tons)

3 digits

This capacity rating, referred to as the inventory rating, will result in a load level which can safely utilize an existing structure for an indefinite period of time. Only the MS loading shall be used to determine the inventory rating. Code the Inventory Rating as a 3-digit number to represent the total mass in metric tons of the entire vehicle measured to the nearest tenth of a metric ton (with an assumed decimal point). The statements in Item 64 - Operating Rating apply to this item also.

Code 999 for a structure under sufficient fill such that, according to AASHTO design, the live load is insignificant in the structure load capacity.

Items 67, 68, 69, 71, and 72 - Indicate the Appraisal Ratings

The items in the Appraisal Section are used to evaluate a bridge in relation to the level of service which it provides on the highway system of which it is a part. The structure will be compared to a new one which is built to current standards for that particular type of road as further defined in this section except for Item 72 - Approach Roadway Alignment. See Item 72 for special criteria for rating that item.

Items 67, 68, 69, 71, and 72 will be coded with a 1-digit code that indicates the appraisal rating for the item. The ratings and codes are as follows:

<u>Code</u>	<u>Description</u>
N	Not applicable
9	Superior to present desirable criteria
8	Equal to present desirable criteria
7	Better than present minimum criteria
6	Equal to present minimum criteria
5	Somewhat better than minimum adequacy to tolerate being left in place as is
4	Meets minimum tolerable limits to be left in place as is
3	Basically intolerable requiring high priority of corrective action
2	Basically intolerable requiring high priority of replacement
1	This value of rating code not used
0	Bridge closed

The FHWA Edit/Update computer program calculates values for Items 67, 68 and 69 according to the tables provided in this manual. These tables and the table for Item 71 shall be used by all evaluators to rate these items. They have been developed to closely match the descriptions for the appraisal evaluation codes of 0 to 9. The tables shall be used in all instances to evaluate the item based on the designated data in the inventory, even if a table value does not appear to match the descriptive codes. For unusual cases where the site data does not exactly agree with the table criteria, use the most appropriate table to evaluate the item. The code of N is not valid for use with Items 67 and 72.

Completed bridges not yet opened to traffic, if rated, shall be appraised as if open to traffic. Design values, for example ADT, shall be used for the evaluation. The data provided will include a code of G for Item 41 - Structure Open, Posted, or Closed to Traffic.

Item 67 - Structural Evaluation

1 digit

This item is calculated by the Edit/Update Program based on Table 1, and need not be coded by the bridge inspector. The following specifications are used by the Edit/Update Program:

- ! For structures other than culverts, the lowest of the codes obtained from Item 59 - Superstructure, Item 60 - Substructure, or Table 1 is used.
- ! For culverts, the lowest of the codes obtained from Item 62 - Culverts, or Table 1 is used.
- ! If Item 59, Item 60 or Item 62 is coded 1, then Item 67 is equal to zero (0), regardless of whether the structure is actually closed. However, if the structure is closed, it does not mean that this value is zero (0) unless the overall condition and appraisal ratings indicate that a code of 0 is appropriate.

Table 1 Notes:

1. Use the lower rating code for values between those listed in the table.
2. Inventory Ratings are shown in metric tons with decimal point.
3. To use Table 1, the Inventory Rating must be the coded MS rating or its equivalent. If the comparable MS equivalent is not calculated for the controlling rating, using a factor to determine the MS equivalent is acceptable even though converting other rating loads to an MS equivalent is not a constant.
4. All bridges with Item 26 - Functional Class coded Interstate, Freeway or Expressway shall be evaluated using the ADT column of >5000 regardless of the actual ADT on the bridge.

Item 67 - Structural Evaluation (cont' d)

Table 1. Rating by Comparison of ADT - Item 29 and Inventory Rating - Item 66

Structural Evaluation Rating Code	Inventory Rating		
	Average Daily Traffic (ADT)		
	0- 500	501- 5000	>5000
9	>32.4 (MS18) *	>32.4 (MS18)	>32.4 (MS18)
8	32.4 (MS18)	32.4 (MS18)	32.4 (MS18)
7	27.9 (MS15.5)	27.9 (MS15.5)	27.9 (MS15.5)
6	20.7 (MS11.5)	22.5 (MS12.5)	24.3 (MS13.5)
5	16.2 (MS9)	18.0 (MS10)	19.8 (MS11)
4	10.8 (MS6)	12.6 (MS7)	16.2 (MS9)
3	Inventory rating less than value in rating code of 4 and requiring corrective action.		
2	Inventory rating less than value in rating code of 4 and requiring replacement.		
0	Bridge closed due to structural condition.		

*MS Designation (typical)

Item 68 - Deck Geometry

1 digit

This item is calculated by the Edit/Update Program and need not be coded by the bridge inspector.

The overall rating for deck geometry includes two evaluations: (a) the curb-to-curb or face-to-face of rail bridge width using Table 2A, B, C or D and (b) the minimum vertical clearance over the bridge roadway using Table 2E. The lower of the codes obtained from these tables is used by the Edit/Update Program. When an individual table lists several deck geometry rating codes for the same roadway width under a specific ADT, the lower code is used. (For example, Table 2A lists deck geometry rating codes of 6, 7 and 8 for a 13.4 meter roadway width and an ADT of >5000. Use the code of 6.) For values between those listed in the tables, the lower code is used.

The curb-to-curb or face-to-face of rail dimension shall be taken from Item 51 - Bridge Roadway Width, Curb-to-curb. Item 53 - Minimum Vertical Clearance Over Bridge Roadway is used to evaluate the vertical clearance.

For culverts which have Item 51 - Bridge Roadway Width coded 0000, the Deck Geometry code will be equal to N.

The values provided in the tables are for rating purposes only. Current design standards must be used for structure design or rehabilitation.

Item 68 - Deck Geometry (cont' d)

Table 2A & 2B. Rating by Comparison of ADT - Item 29 and Bridge Roadway Width, Curb-to-Curb - Item 51

TABLE 2A							TABLE 2B	
Deck Geometry Rating Code	Bridge Roadway Width 2 Lanes; 2 Way Traffic						Bridge Roadway Width 1 Lane; 2-Way Traffic	
	ADT (Both Directions)						ADT (Both Directions)	
	0-100	101-400	401-1000	1001-2000	2001-5000	>5000	0-100	>100
9	>9.8	>11.0	>12.2	>13.4	>13.4	>13.4	-	-
8	9.8	11.0	12.2	13.4	13.4	13.4	<4.9	-
7	8.5	9.8	11.0	12.2	13.4	13.4	4.6	-
6	7.3	8.5	9.1	10.4	12.2	13.4	4.3	-
5	6.1	7.3	7.9	8.5	10.4	11.6	4.0	-
4	5.5	6.1	6.7	7.3	8.5	9.8 (8.5)*	3.7	-
3	4.9	5.5	6.1	6.7	7.9	9.1 (7.9)*	3.4	<4.9
2	Any width less than required for a rating code of 3 and structure is open.							
0	Bridge Closed							

* Use value in parentheses for bridges longer than 60 meters.

Notes:

1. Use the lower rating code for values between those listed in the table.
2. Dimensions are in meters.
3. For 1 lane of one-way traffic Table 2A is used.
4. For 3 or more undivided lanes of 2-way traffic, use Table 2C, Other Multilane Divided Facilities.
5. Do not use Table 2B for code 9 and for codes 8 through 4 inclusive when the ADT >100. Single lane bridges less than 4.9 meters wide carrying 2-way traffic are always appraised at 3 or below if they carry more than an ADT of 100.
6. One-lane bridges 4.90 meters and greater in roadway width, which are not ramps, are evaluated as a 2-lane bridge using Table 2A.

Item 68 - Deck Geometry (cont' d)

Table 2C & 2D. Rating by Comparison of Number of Lanes - Item 28 and Bridge Roadway Width, Curb-to-Curb - Item 51

TABLE 2C					TABLE 2D	
Deck Geometry Rating Code	Bridge Roadway Width 2 or More Lanes				Bridge Roadway Width 1-Way Traffic	
	Interstate and Other Divided Freeways		Other Multilane Divided Facilities		Ramps Only (Item 5C = 7)	
	2 Lanes 1-way	3 or more Lanes	2 Lanes 1-way	3 or more Lanes	1 Lane	2 or more Lanes
9	>12.8	>3.7N+7.3	>12.8	>3.7N+5.5	>7.9	>3.7N+3.7
8	12.8	3.7N+7.3	12.8	3.7N+5.5	7.9	3.7N+3.7
7	12.2	3.7N+6.1	11.6	3.7N+4.6	7.3	3.7N+3.0
6	11.6	3.7N+4.9	11.0	3.7N+3.7	6.7	3.7N+2.4
5	11.0	3.7N+4.3	10.1	3.4N+3.0	6.1	3.7N+1.8
4	10.4	3.4N+3.7	9.1	3.4N+1.8	5.5	3.7N+1.2
4	(8.8)*	(3.4N+2.1) *	9.1	3.4N+1.8	5.5	3.7N+1.2
3	10.1	3.4N+3.4	8.2	3.4N+1.5	4.9	3.7N+0.6
3	(8.5)*	(3.4N+1.8) *	8.2	3.4N+1.5	4.9	3.7N+0.6
2	Any width less than required for a rating code of 3 and structure is open.					
0	Bridge Closed					

* Use value in parentheses for bridges longer than 60 meters.
N = Total number of lanes of traffic on the structure.

Notes

1. Use the lower rating code for values between those listed in the tables.
2. Dimensions are in meters.
3. Use Table 2C, Other Multilane Divided Facilities, for 3 or more undivided lanes of 2-way traffic.

Item 68 - Deck Geometry (cont' d)

Table 2E. Rating by Comparison of Minimum Vertical Clearance over Bridge Roadway - Item 53 and Functional Classification - Item 26

Deck Geometry Rating Code	Minimum Vertical Clearance		
	Functional Class		
	Interstate and Other Freeway	Other Principal and Minor Arterial	Major and Minor Collectors and Locals
9	>5.18	>5.02	>5.02
8	5.18	5.02	5.02
7	5.10	4.72	4.72
6	5.02	4.41	4.41
5	4.80	4.34	4.34
4	4.57	4.26	4.26
3	Vertical clearance less than value in rating code of 4 and requiring corrective action.		
2	Vertical clearance less than value in rating code of 4 and requiring replacement.		
0	Bridge Closed.		

Notes

1. Use the lower rating code for values between those listed in the table.
2. Dimensions are in meters.

Item 69 - Underclearances, Vertical and Horizontal

1 digit

This item is calculated by the Edit/Update Program and need not be coded by the bridge inspector.

Vertical and horizontal underclearances are measured from the through roadway to the superstructure or substructure units, respectively. Code "N" is used unless the bridge is over a highway or railroad.

The vertical underclearance is evaluated using Table 3A. The horizontal underclearance is evaluated using Table 3B. The lower of the codes obtained from Table 3A and Table 3B is used by the Edit/Update Program.

Bridges seldom are closed due to deficient underclearances, however, these bridges may be good candidates for rehabilitation or replacement.

Item 54 - Minimum Vertical Underclearance, Item 55 - Minimum Lateral Underclearance on Right, and Item 56 - Minimum Lateral Underclearance on Left are used to evaluate this item.

The functional classification used in the table is for the underpassing route. Therefore, the functional classification is obtained from the record for the route "under" the bridge (see Item 5 - Inventory Route).

If the underpassing route is not on a Federal-aid system, is not a defense route, or is not otherwise important, an "under" record may not be available. If no "under" record exists, it is assumed that the route under the bridge is a major or minor collector or a local road for the purpose of using Tables 3A and 3B.

Item 69 - Underclearances, Vertical and Horizontal (cont'd)

Table 3A. Rating by Comparison of Minimum Vertical Underclearance - Item 54 and Functional Classification of Underpassing Route - Item 26

Under-clearance Rating Code	Minimum Vertical Underclearance			
	Functional Class			Railroad
	Interstate and Other Freeway	Other Principal and Minor Arterial	Major and minor Collectors and Locals	
9	>5.18	>5.02	>5.02	>7.01
8	5.18	5.02	5.02	7.01
7	5.10	4.72	4.72	6.85
6	5.02	4.41	4.41	6.70
5	4.80	4.34	4.34	6.40
4	4.57	4.26	4.26	6.09
3	Underclearance less than value in rating code of 4 and requiring corrective action.			
2	Underclearance less than value in rating code of 4 and requiring replacement.			
0	Bridge closed.			

Notes

1. Use the lower rating code for values between those listed in the tables.
2. Dimensions are in meters.
3. The functional classification of the underpassing route shall be used in the evaluation. If an "under" record is not coded, the underpassing route shall be considered a major or minor collector or a local road.

Item 69 - Underclearances, Vertical and Horizontal (cont'd)

Table 3B. Rating by Comparison of Minimum Lateral Underclearances Right & Left - Items 55 & 56 and Functional Classification of Underpassing Route - Item 26

Under-clearance Rating Code	Minimum Lateral Underclearance							Railroad
	Functional Class							
	1-Way Traffic				2-Way Traffic			
	Principal Arterial- Interstate, Freeways or Expressways				Other Principal and Minor Arterial	Major and Minor Collectors and Locals		
	Main Line		Ramp					
	Left	Right	Left	Right				
9	>9.1	>9.1	>1.2	>3.0	>9.1	>3.7	>6.1	
8	9.1	9.1	1.2	3.0	9.1	3.7	6.1	
7	5.5	6.4	0.9	2.7	6.4	3.4	5.2	
6	1.8	3.7	0.6	2.4	3.7	3.0	4.3	
5	1.5	3.4	0.6	1.8	3.0	2.4	3.4	
4	1.2	3.0	0.6	1.2	1.8	1.2	2.4	
3	Underclearance less than value in rating code of 4 and requiring corrective action.							
2	Underclearance less than value in rating code of 4 and requiring replacement.							
0	Bridge closed.							

Notes:

1. Use the lower rating code for values between those listed in the tables.
2. Dimensions are in meters.
3. When acceleration or deceleration lanes or ramps are provided under 2-way traffic, use the value from the right ramp column to determine code.
4. The functional classification of the underpassing route shall be used in the evaluation. If an "under" record is not coded, the underpassing route shall be considered a major or minor collector or a local road.

Item 70 - Bridge Posting

1 digit

The National Bridge Inspection Standards require the posting of load limits only if the maximum legal load configurations in the State exceeds the load permitted under the operating rating. If the load capacity at the operating rating is such that posting is required, this item shall be coded 4 or less. If no posting is required at the operating rating, this item shall be coded 5.

This item evaluates the load capacity of a bridge in comparison to the State legal load. It differs from Item 67 - Structural Evaluation in that Item 67 uses Item 66 - Inventory Rating, while the bridge posting requirement is based on Item 64 - Operating Rating.

Although posting a bridge for load-carrying capacity is required only when the maximum legal load exceeds the operating rating, highway agencies may choose to post at a lower level. This posting practice may appear to produce conflicting coding when Item 41 - Structure Open, Posted or Closed to Traffic is coded to show the bridge as actually posted at the site and Item 70 - Bridge Posting is coded as bridge posting is not required. Since different criteria are used for coding these 2 items, this coding is acceptable and correct when the highway agency elects to post at less than the operating rating. Item 70 shall be coded 4 or less only if the legal load of the State exceeds that permitted under the operating rating.

The use or presence of a temporary bridge affects the coding. The actual operating rating of the temporary bridge should be used to determine this item. However the highway agency may choose to post at a lower level. This also applies to bridges shored up or repaired on a temporary basis.

<u>Code</u>	<u>Description</u>
4 or less	Posting required
5	No posting required

The degree that the operating rating is less than the maximum legal load level may be used to differentiate between codes. As a guide and for coding purposes only, the following values may be used to code this item:

<u>Code</u>	<u>Relationship of Operating Rating to Maximum Legal Load</u>
5	Equal to or above legal loads
4	0.1 - 9.9% below
3	10.0 - 19.9% below
2	20.0 - 29.9% below
1	30.0 - 39.9% below
0	> 39.9% below

Item 71 - Waterway Adequacy

1 digit

This item appraises the waterway opening with respect to passage of flow through the bridge. The following codes shall be used in evaluating waterway adequacy (interpolate where appropriate). Site conditions may warrant somewhat higher or lower ratings than indicated by the table (e.g., flooding of an urban area due to a restricted bridge opening).

Where overtopping frequency information is available, the descriptions given in the table for chance of overtopping mean the following:

- Remote - greater than 100 years
- Slight - 11 to 100 years
- Occasional - 3 to 10 years
- Frequent - less than 3 years

Adjectives describing traffic delays mean the following:

- Insignificant - Minor inconvenience. Highway passable in a matter of hours.
- Significant - Traffic delays of up to several days.
- Severe - Long term delays to traffic with resulting hardship.

Functional Classification

Principal Arterials - Interstates, Freeways, or Expressways	Other Principal and Minor Arterials and Major Collectors	Minor Collectors, Locals	Description Code
N	N	N	Bridge not over a waterway.
9	9	9	Bridge deck and roadway approaches above flood water elevations (high water). Chance of overtopping is remote.
8	8	8	Bridge deck above roadway approaches. Slight chance of overtopping roadway approaches.
6	6	7	Slight chance of overtopping bridge deck and roadway approaches.
4	5	6	Bridge deck above roadway approaches. Occasional overtopping of roadway approaches with insignificant traffic delays.

(codes continued on the next page)

Item 71 - Waterway Adequacy (cont'd)

Functional Classification

Principal Arterials - Interstates, Freeways, or Expressways	Other Principal and Minor Arterials and Major Collectors	Minor Collectors, Locals	Description Code
3	4	5	Bridge deck above roadway approaches. Occasional overtopping of roadway approaches with significant traffic delays.
2	3	4	Occasional overtopping of bridge deck and roadway approaches with significant traffic delays.
2	2	3	Frequent overtopping of bridge deck and roadway approaches with significant traffic delays.
2	2	2	Occasional or frequent overtopping of bridge deck and roadway approaches with severe traffic delays.
0	0	0	Bridge closed.

Item 72 - Approach Roadway Alignment

1 digit

Code the rating based on the adequacy of the approach roadway alignment. This item identifies those bridges which do not function properly or adequately due to the alignment of the approaches. It is not intended that the approach roadway alignment be compared to current standards but rather to the existing highway alignment. This concept differs from other appraisal evaluations. The establishment of set criteria to be used at all bridge sites is not appropriate for this item. The basic criteria is how the alignment of the roadway approaches to the bridge relate to the general highway alignment for the section of highway the bridge is on.

The individual structure shall be rated in accordance with the general appraisal rating guide described on page 453 in lieu of specific design values. The approach roadway alignment will be rated intolerable (a code of 3 or less) only if the horizontal or vertical curvature requires a substantial reduction in the vehicle operating speed from that on the highway section. A very minor speed reduction will be rated a 6, and when a speed reduction is not required, the appraisal code will be an 8. Additional codes may be selected between these general values.

Item 72 - Approach Roadway Alignment (cont' d)

For example, if the highway section requires a substantial speed reduction due to vertical or horizontal alignment, and the roadway approach to the bridge requires only a very minor additional speed reduction at the bridge, the appropriate code would be a 6. This concept shall be used at each bridge site.

Speed reductions necessary because of structure width and not alignment shall not be considered in evaluating this item.

Item 73 and Item 74

(Reserved)

Item 75 - Type of Work

3 digits

The information to be recorded for this item will be the type of work proposed to be accomplished on the structure to improve it to the point that it will provide the type of service needed and whether the proposed work is to be done by contract or force account. Code a 3-digit number composed of 2 segments.

<u>Segment</u>	<u>Description</u>	<u>Length</u>
75A	Type of Work Proposed	2 digits
75B	Work Done by	1 digit

This item must be coded for bridges eligible for the Highway Bridge Replacement and Rehabilitation Program. To be eligible, a bridge must carry highway traffic, be deficient and have a sufficiency rating of 80.0 or less. This item may be coded for other bridges at the option of the highway agency. Use one of the following codes to represent the proposed work type, otherwise leave blank:

<u>Code</u>	<u>Description</u>
31	Replacement of bridge or other structure because of substandard load carrying capacity or substandard bridge roadway geometry.
32	Replacement of bridge or other structure because of relocation of road.
33	Widening of existing bridge or other major structure without deck rehabilitation or replacement; includes culvert lengthening.
34	Widening of existing bridge with deck rehabilitation or replacement.

(codes continued on the next page)

Item 75 - Type of Work (cont' d)

- | | |
|----|--|
| 35 | Bridge rehabilitation because of general structure deterioration or inadequate strength. |
| 36 | Bridge deck rehabilitation with only incidental widening. |
| 37 | Bridge deck replacement with only incidental widening. |
| 38 | Other structural work, including hydraulic replacements. |

If segment A is blank, leave segment B blank. Otherwise, the third digit shall be coded using one of the following codes to indicate whether the proposed work is to be done by contract or by force account:

<u>Code</u>	<u>Description</u>
1	Work to be done by contract
2	Work to be done by owner's forces

EXAMPLES:

	<u>Code</u>
A bridge is to be replaced by contract because it has deteriorated to the point that it can no longer carry legal loads. The same code should be used if the bridge is replaced because it is now too narrow or the original design was too light to accommodate today's legal loads.	311
A bridge is to be replaced because the roadway must be straightened to eliminate a dangerous curve. The work will be done by contract.	321
A bridge is to be widened to increase shoulder width or the number of traffic lanes. The existing deck is in good condition and will be incorporated as is into the new structure. The work is to be done by contract.	331
A culvert is to be extended by contract to accommodate additional roadway width as part of a reconstruction contract to improve the safety of the adjacent slopes.	331
A deck is to be rehabilitated and the bridge widened to provide a full 3.6 meter shoulder. The existing shoulder is only .2 meters wide and an extra line of girders with appropriate substructure widening must be added. The work will be done by contract.	341
A bridge superstructure and substructure are to be rehabilitated by State forces to increase the bridge's load capacity.	352

Item 75 - Type of Work (cont' d)

EXAMPLES:

	<u>Code</u>
A bridge deck is to be rehabilitated by contract and a safety curb to be removed which results in incidental widening of 0.6 meters.	361
A bridge deck is to be replaced by contract and the deck cantilever overhang extended 0.6 meters, which is the maximum that can be done without adding another line of stringers or girders to the superstructure.	371
A bridge which is no longer needed is to be demolished and an at-grade crossing built by State forces. (This code could also be used to designate incidental safety work on a bridge such as bridge-rail upgrading or replacement.)	382

Item 76 - Length of Structure Improvement (XXXXX.X meters) 6 digits

Code a 6-digit number that represents the length of the proposed bridge improvement to the nearest tenth of a meter (with an assumed decimal point). For replacement or rehabilitation of the entire bridge, the length should be back to back of backwalls of abutments or from pavement notch to pavement notch. For replacement or rehabilitation of only part of the structure, use the length of the portion to be improved.

This item must be coded for bridges eligible for the Highway Bridge Replacement and Rehabilitation Program. It may be coded for other bridges at the option of the highway agency.

For culvert improvements, use the proposed length measured along the centerline of the barrel regardless of the depth below grade. The measurement should be made between the inside faces of the top parapet or edge-stiffening beam of the top slab.

EXAMPLES:

		<u>Code</u>
Length of Structure Improvement	76.2 meters	000762
	1200 meters	012000
	12,345 meters	123450

For substructure or channel work only, code the length of superstructure over, or supported by, the substructure or channel.

Typically, a replacement bridge is longer than the existing bridge. Nationwide averages for the increase in bridge length with replacement as a function of the existing length are given in the following figures. The length-expansion factors represent data for the years 1981 to 1985. Where site-specific data is lacking, these factors are suggested for estimating the length of replacement bridges. For exceedingly long bridges (i.e., 300 meters or more) the length-expansion factor approaches 1.0.

Item 76 - Length of Structure Improvement (cont' d)

INCREASED LENGTH OF REPLACEMENT BRIDGES

**X = EXISTING BRIDGE LENGTH
Y = LENGTH EXPANSION FACTOR**

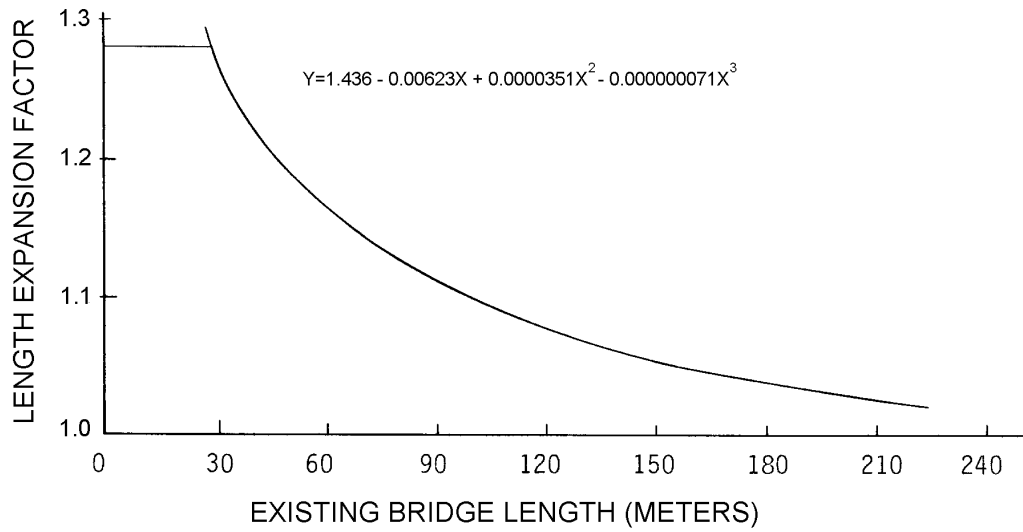
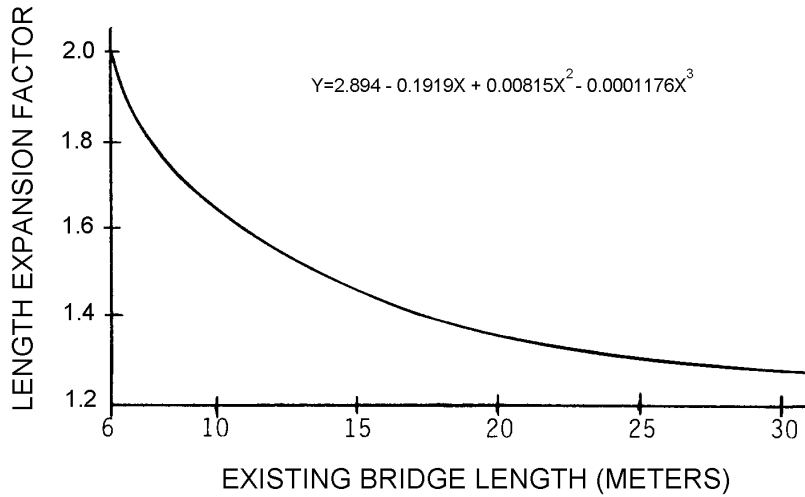

REPLACEMENT BRIDGE LENGTH = EXISTING BRIDGE LENGTH x LENGTH EXPANSION FACTOR

Item 77 through Item 89

(Reserved)

Item 90 - Inspection Date

4 digits

Record the month and year that the last routine inspection of the structure was performed. This inspection date may be different from those recorded in Item 93 - Critical Feature Inspection Date. Code a 4-digit number to represent the month and year. The number of the month should be coded in the first 2 digits with a leading zero as required and the last 2 digits of the year coded as the third and fourth digits of the field.

EXAMPLES:

Code

Inspection date November 1992
March 1994

1192
0394

Item 91 - Designated Inspection Frequency

2 digits

Code 2 digits to represent the number of months between designated inspections of the structure. A leading zero shall be coded as required. This interval is usually determined by the individual in charge of the inspection program. For posted, understrength bridges, this interval should be substantially less than the 24-month standard. The designated inspection interval could vary from inspection to inspection depending on the condition of the bridge at the time of inspection.

EXAMPLES:

Code

Posted bridge with heavy truck traffic and questionable structural details which is designated to be inspected each month

01

Bridge is scheduled to be inspected every 24 months

24

It should be noted that bridges will also require special non-scheduled inspections after unusual physical traumas such as floods, earthquakes, fires or collisions. These special inspections may range from a very brief visual examination to a detailed in-depth evaluation depending upon the nature of the trauma. For example, when a substructure pier or abutment is struck by an errant vehicle, in most cases only a visual examination of the bridge is necessary. After major collisions or earthquakes, in-depth inspections may be warranted as directed by the engineer in overall charge of the program. After and during severe floods, the stability of the substructure of bridges may have to be determined by probing, underwater sensors or other appropriate measures. Underwater inspection by divers may be required for some scour critical bridges immediately after floods. See Item 113 - Scour Critical Bridges.

Item 92 - Critical Feature Inspection

9 digits

Using a series of 3-digit code segments, denote critical features that need special inspections or special emphasis during inspections and the designated inspection interval in months as determined by the individual in charge of the inspection program. The designated inspection interval could vary from inspection to inspection depending on the condition of the bridge at the time of inspection.

<u>Segment</u>	<u>Description</u>	<u>Length</u>
92A	Fracture Critical Details	3 digits
92B	Underwater Inspection	3 digits
92C	Other Special Inspection	3 digits

For each segment of Item 92A, B, and C, code the first digit Y for special inspection or emphasis needed and code N for not needed. The first digit of Item 92A, B, and C must be coded for all structures to designate either a yes or no answer. Those bridges coded with a Y in Item 92A or B should be the same bridges contained in the Master Lists of fracture critical and special underwater inspection bridges. In the second and third digits of each segment, code a 2-digit number to indicate the number of months between inspections only if the first digit is coded Y. If the first digit is coded N, the second and third digits are left blank.

Current guidelines for the maximum allowable interval between inspections can be summarized as follows:

Fracture Critical Details	24 months
Underwater Inspection	60 months
Other Special Inspections	60 months

EXAMPLES:

	<u>Item</u>	<u>Code</u>
A 2-girder system structure which is being inspected yearly and no other special inspections are required.	92A	Y12
	92B	N__
	92C	N__
A structure where both fracture critical and underwater inspection are being performed on a 1-year interval. Other special inspections are not required.	92A	Y12
	92B	Y12
	92C	N__
A structure has been temporarily shored and is being inspected on a 6-month interval. Other special inspections are not required.	92A	N__
	92B	N__
	92C	Y06

Item 93 - Critical Feature Inspection Date

12 digits

Code only if the first digit of Item 92A, B, or C is coded Y for yes. Record as a series of 4-digit code segments, the month and year that the last inspection of the denoted critical feature was performed.

<u>Segment</u>	<u>Description</u>	<u>Length</u>
93A	Fracture Critical Details	4 digits
93B	Underwater Inspection	4 digits
93C	Other Special Inspection	4 digits

For each segment of this item, when applicable, code a 4-digit number to represent the month and year. The number of the month should be coded in the first 2 digits with a leading zero as required and the last 2 digits of the year coded as the third and fourth digits of the field. If the first digit of any part of Item 92 is coded N, then the corresponding part of this item shall be blank.

EXAMPLES:

	<u>Item</u>	<u>Code</u>
A structure has fracture critical members which were last inspected in March 1986. It does not require underwater or other special feature inspections.	93A	0386
	93B	(blank)
	93C	(blank)

A structure has no fracture critical details, but requires underwater inspection and has other special features (for example, a temporary support) for which the State requires special inspection. The last underwater inspection was done in April 1986 and the last special feature inspection was done in November 1985.	93A	(blank)
	93B	0486
	93C	1185

Item 94 - Bridge Improvement Cost

6 digits

Code a 6-digit number to represent the estimated cost of the proposed bridge or major structure improvements in thousands of dollars. This cost shall include only bridge construction costs, excluding roadway, right of way, detour, demolition, preliminary engineering, etc. Code the base year for the cost in Item 97 - Year of Improvement Cost Estimate. Do not use this item for estimating maintenance costs.

This item must be coded for bridges eligible for the Highway Bridge Replacement and Rehabilitation Program. It may be coded for other bridges at the option of the highway agency.

EXAMPLES:

		<u>Code</u>
Bridge Improvement Cost	\$ 55,850	000056
	250,000	000250
	7,451,233	007451

Item 94 - Bridge Improvement Cost (cont' d)

Nationally, the deck area of replaced bridges is averaging 2.2 times the deck area before replacement. The deck area of rehabilitated bridges is averaging 1.5 times the deck area before rehabilitation. Widening square meter costs are typically 1.8 times the square meter cost of new bridges with similar spans. For example, if the average cost of a new bridge is \$500 per square meter, the average cost of the widened area would be \$900 per square meter.

Each highway agency is encouraged to use its best available information and established procedures to determine bridge improvement costs. In the absence of these procedures, the highway agency may wish to use the following procedure as a guide in preparing bridge improvement cost estimates.

Apply a construction unit cost to the proposed bridge area developed by using (1) current State deck geometry design standards and (2) proposed bridge length from Item 76 - Length of Structure Improvement.

Item 95 - Roadway Improvement Cost

6 digits

Code a 6-digit number to represent the cost of the proposed roadway improvement in thousands of dollars. This shall include only roadway construction costs, excluding bridge, right-of-way, detour, extensive roadway realignment costs, preliminary engineering, etc. Code the base year for the cost in Item 97 - Year of Improvement Cost Estimate. Do not use this item for estimating maintenance costs.

This item must be coded for bridges eligible for the Highway Bridge Replacement and Rehabilitation Program. It may be coded for other bridges at the option of the highway agency.

In the absence of a procedure for estimating roadway improvement costs, a guide of 10 percent of the bridge costs is suggested.

Item 96 - Total Project Cost

6 digits

Code a 6-digit number to represent the total project cost in thousands of dollars, including incidental costs not included in Items 94 and 95. This item should include all costs normally associated with the proposed bridge improvement project. The Total Project Cost will therefore usually be greater than the sum of Items 94 and 95. Code the base year for the cost in Item 97 - Year of Improvement Cost Estimate. Do not use this item for coding maintenance costs.

This item must be coded for bridges eligible for the Highway Bridge Replacement and Rehabilitation Program. It may be coded for other bridges at the option of the highway agency.

In the absence of a procedure for estimating the total project cost, a guide of 150 percent of the bridge cost is suggested.

Item 97 - Year of Improvement Cost Estimate

4 digits

Record and code the year that the costs of work estimated in Item 94 - Bridge Improvement Cost, Item 95 - Roadway Improvement Cost, and Item 96 - Total Project Cost were based upon. This date and the data provided for Item 94 through Item 96 must be current; that is, Item 97 shall be no more than 8 years old.

EXAMPLES:

Year of Cost Estimate	1994 costs	<u>Code</u> 1994
	2000 costs	2000

Item 98 - Border Bridge

5 digits

Use this item to indicate structures crossing borders of States. Code a 5-digit number composed of 2 segments specifying the percent responsibility for improvements to the existing structure when it is on a border with a neighboring State. Code the first 3 digits with the neighboring State code using State codes listed in Item 1 - State Code. Code the fourth and fifth digits with the percentage of total deck area of the existing bridge that the neighboring State is responsible for funding.

<u>Segment</u>	<u>Description</u>	<u>Length</u>
98A	Neighboring State Code	3 digits
98B	Percent Responsibility	2 digits

If a neighboring State codes the structure and accepts 100% of the responsibility, but your State still codes a record for the structure, then Item 98B in your State's record should be coded 99 to represent that your State has no responsibility for the structure.

For the special case of a structure on the border with Canada or Mexico, code the State code value = CAN or MEX respectively. If structure is not on a border, leave blank.

EXAMPLES:

A structure connects your State with New Jersey and New Jersey is responsible for funding 45 percent of future improvement costs.	<u>Code</u> 34245
A structure connects your State with Mexico and Mexico is not responsible for any funding of future improvement costs.	MEX00

Item 99 - Border Bridge Structure Number

15 digits

Code the neighboring State's 15-digit National Bridge Inventory structure number for any structure noted in Item 98 - Border Bridge. This number must match exactly the neighboring State's submitted NBI structure number. The entire 15-digit field must be accounted for including zeros and blank spaces whether they are leading, trailing, or embedded in the 15-digit field. If Item 98 is blank, this item is blank.

In the above example where Mexico (or a neighboring State) has 00% responsibility, and, if there is no NBI Structure Number in that State's inventory file, then the entire 15-digit field shall be coded zeroes.

Item 100 - STRAHNET Highway Designation

1 digit

This item shall be coded for all records in the inventory. For the purposes of this item, the STRAHNET Connectors are considered included in the term STRAHNET. For the inventory route identified in Item 5, indicate STRAHNET highway conditions using one of the following codes:

<u>Code</u>	<u>Description</u>
0	The inventory route is not a STRAHNET route.
1	The inventory route is on a Interstate STRAHNET route.
2	The inventory route is on a Non-Interstate STRAHNET route.
3	The inventory route is on a STRAHNET connector route.

Item 101 - Parallel Structure Designation

1 digit

Code this item to indicate situations where separate structures carry the inventory route in opposite directions of travel over the same feature. The lateral distance between structures has no bearing on the coding of this item. One of the following codes shall be used:

<u>Code</u>	<u>Description</u>
R	The right structure of parallel bridges carrying the roadway in the direction of the inventory. (For a STRAHNET highway, this is west to east and south to north.)
L	The left structure of parallel bridges. This structure carries traffic in the opposite direction.
N	No parallel structure exists.

EXAMPLE:

	<u>Code</u>
Structure #1	R
Structure #2	L

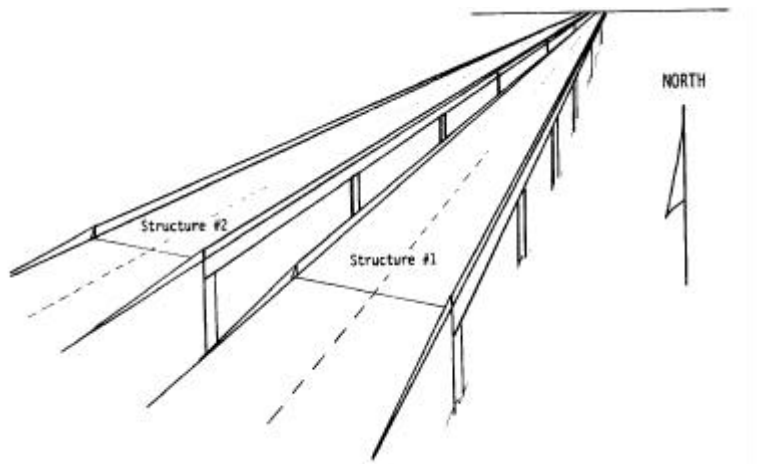

Item 102 - Direction of Traffic

1 digit

Code the direction of traffic of the inventory route identified in Item 5 as a 1-digit number using one of the codes below. This item must be compatible with other traffic-related items such as Item 28A Lanes on the Structure, Item 29 - Average Daily Traffic, Item 47 - Total Horizontal Clearance and Item 51 - Bridge Roadway Width, Curb-to-Curb.

<u>Code</u>	<u>Description</u>
0	Highway traffic not carried
1	1-way traffic
2	2-way traffic
3	One lane bridge for 2-way traffic

Item 103 - Temporary Structure Designation

1 digit

Code this item to indicate situations where temporary structures or conditions exist. This item should be blank if not applicable.

<u>Code</u>	<u>Description</u>
T	Temporary structure(s) or conditions exist.

Temporary structure(s) or conditions are those which are required to facilitate traffic flow. This may occur either before or during the modification or replacement of a structure found to be deficient. Such conditions include the following:

- ! Bridges shored up, including additional temporary supports.
- ! Temporary repairs made to keep a bridge open.
- ! Temporary structures, temporary runarounds or bypasses.
- ! Other temporary measures, such as barricaded traffic lanes to keep the bridge open.

Any repaired structure or replacement structure which is expected to remain in place without further project activity, other than maintenance, for a significant period of time shall not be considered temporary. Under such conditions, that structure, regardless of its type, shall be considered the minimum adequate to remain in place and evaluated accordingly.

If this item is coded T, then all data recorded for the structure shall be for the condition of the structure without temporary measures, except for the following items which shall be for the temporary structure:

- Item 10 - Inventory Route, Minimum Vertical Clearance
- 41 - Structure Open, Posted, or Closed to Traffic
- 47 - Inventory Route, Total Horizontal Clearance
- 53 - Minimum Vertical Clearance Over Bridge Roadway
- 54 - Minimum Vertical Underclearance
- 55 - Minimum Lateral Underclearance on Right
- 56 - Minimum Lateral Underclearance on Left
- 70 - Bridge Posting

Item 104 - Highway System of the Inventory Route

1 digit

This item is to be coded for all records in the inventory. For the inventory route identified in Item 5, indicate whether the inventory route is on the National Highway System (NHS) or not on that system. Initially, this code shall reflect an inventory route on the NHS "Interim System" description in Section 1006(a) of the 1991 ISTEA. Upon approval of the NHS by Congress, the coding is to reflect the approved NHS. Use one of the following codes:

<u>Code</u>	<u>Description</u>
0	Inventory Route <u>is not</u> on the NHS
1	Inventory Route <u>is</u> on the NHS

Item 105 - Federal Lands Highways

1 digit

Structures owned by State and local jurisdictions on roads which lead to and traverse through federal lands sometimes require special coded unique identification because they are eligible to receive funding from the Federal Lands Highway Program. One of the following codes shall be used:

<u>Code</u>	<u>Description</u>
0	Not applicable
1	Indian Reservation Road (IRR)
2	Forest Highway (FH)
3	Land Management Highway System (LMHS)
4	Both IRR and FH
5	Both IRR and LMHS
6	Both FH and LMHS
9	Combined IRR, FH and LMHS

Item 106 - Year Reconstructed

4 digits

Record and code the year of most recent reconstruction of the structure. Code all 4 digits of the latest year in which reconstruction of the structure was completed. If there has been no reconstruction code 0000.

For a bridge to be defined as reconstructed, the type of work performed, whether or not it meets current minimum standards, must have been eligible for funding under any of the Federal-aid funding categories. The eligibility criteria would apply to the work performed regardless of whether all State or local funds or Federal-aid funds were used.

Some types of eligible work not to be considered as reconstruction are listed:

- Safety feature replacement or upgrading (for example, bridge rail, approach guardrail or impact attenuators).
- Painting of structural steel.

Item 106 - Year Reconstructed (cont' d)

- Overlay of bridge deck as part of a larger highway surfacing project (for example, overlay carried across bridge deck for surface uniformity without additional bridge work).
- Utility work.
- Emergency repair to restore structural integrity to the previous status following an accident.
- Retrofitting to correct a deficiency which does not substantially alter physical geometry or increase the load-carrying capacity.
- Work performed to keep a bridge operational while plans for complete rehabilitation or replacement are under preparation (for example, adding a substructure element or extra girder).

EXAMPLE:	<u>Code</u>
Reconstruction completed 1970	1970

Item 107 - Deck Structure Type 1 digit

Record the type of deck system on the bridge. If more than one type of deck system is on the bridge, code the most predominant. Code N for a filled culvert or arch with the approach roadway section carried across the structure. Use one of the following codes:

<u>Code</u>	<u>Description</u>
1	Concrete Cast-in-Place
2	Concrete Precast Panels
3	Open Grating
4	Closed Grating
5	Steel plate (includes orthotropic)
6	Corrugated Steel
7	Aluminum
8	Wood or Timber
9	Other
N	Not applicable

Item 108 - Wearing Surface/Protective System 3 digits

Information on the wearing surface and protective system of the bridge deck shall be coded using a 3-digit code composed of 3 segments.

<u>Segment</u>	<u>Description</u>	<u>Length</u>
108A	Type of Wearing Surface	1 digit
108B	Type of Membrane	1 digit
108C	Deck Protection	1 digit

Item 108 - Wearing Surface/Protective System (cont' d)

1st Digit - Type of Wearing Surface (Item 108A):

<u>Code</u>	<u>Description</u>
1	Monolithic Concrete (concurrently placed with structural deck)
2	Integral Concrete (separate non-modified layer of concrete added to structural deck)
3	Latex Concrete or similar additive
4	Low Slump Concrete
5	Epoxy Overlay
6	Bituminous
7	Wood or Timber
8	Gravel
9	Other
0	None (no additional concrete thickness or wearing surface is included in the bridge deck)
N	Not Applicable (applies only to structures with no deck)

2nd Digit - Type of Membrane (Item 108B):

<u>Code</u>	<u>Description</u>
1	Built-up
2	Preformed Fabric
3	Epoxy
8	Unknown
9	Other
0	None
N	Not Applicable (applies only to structures with no deck)

3rd Digit - Deck Protection (Item 108C):

<u>Code</u>	<u>Description</u>
1	Epoxy Coated Reinforcing
2	Galvanized Reinforcing
3	Other Coated Reinforcing
4	Cathodic Protection
6	Polymer Impregnated
7	Internally Sealed
8	Unknown
9	Other
0	None
N	Not Applicable (applies only to structures with no deck)

Item 109 - Average Daily Truck Traffic (XX percent) 2 digits

Code a 2-digit percentage that shows the percentage of Item 29 - Average Daily Traffic that is truck traffic. Do not include vans, pickup trucks and other light delivery trucks in this percentage.

If this information is not available, an estimate which represents the average percentage for the category of road carried by the bridge may be used. May be left blank if Item 29 - Average Daily Traffic is not greater than 100.

EXAMPLES:

	<u>Code</u>
Average Daily Traffic 7% trucks	07
12% trucks	12

Item 110 - Designated National Network 1 digit

The national network for trucks includes most of the Interstate System and those portions of Federal-Aid highways identified in the Code of Federal Regulations (23 CFR 658). The national network for trucks is available for use by commercial motor vehicles of the dimensions and configurations described in these regulations. For the inventory route identified in Item 5, indicate conditions using one of the following codes:

<u>Code</u>	<u>Description</u>
0	The inventory route is not part of the national network for trucks.
1	The inventory route is part of the national network for trucks.

Item 111 - Pier or Abutment Protection (for Navigation) 1 digit

If Item 38 - Navigation Control has been coded 1, use the codes below to indicate the presence and adequacy of pier or abutment protection features such as fenders, dolphins, etc. The condition of the protection devices may be a factor in the overall evaluation of Item 60 - Substructure. If Item 38 - Navigation Control has been coded 0 or N, leave blank to indicate not applicable.

<u>Code</u>	<u>Description</u>
1	Navigation protection not required
2	In place and functioning
3	In place but in a deteriorated condition
4	In place but reevaluation of design suggested
5	None present but reevaluation suggested

Item 112 - NBIS Bridge Length

1 digit

Does this structure meet or exceed the minimum length specified to be designated as a bridge for National Bridge Inspection Standards purposes? The following definition of a bridge is to be used:

A structure including supports erected over a depression or an obstruction, such as water, highway, or railway, and having a track or passageway for carrying traffic or other moving loads, and having an opening measured along the center of the roadway of more than 20 feet* between undercopings of abutments or spring lines of arches, or extreme ends of openings for multiple boxes; it may also include multiple pipes, where the clear distance between openings is less than half of the smaller contiguous opening.
* (6.1 meters).

<u>Code</u>	<u>Description</u>
Y	Yes
N	No

EXAMPLES:

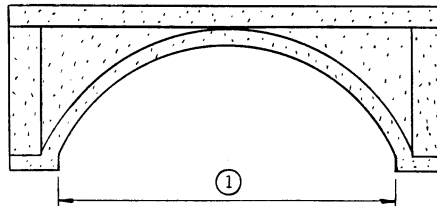
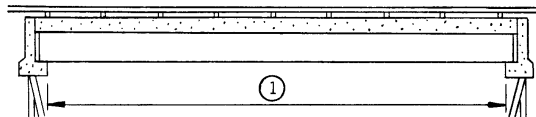
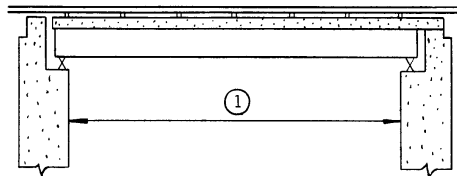

(1) Item 112 - NBIS Bridge Length

Item 112 - NBIS Bridge Length (cont' d)
EXAMPLES:

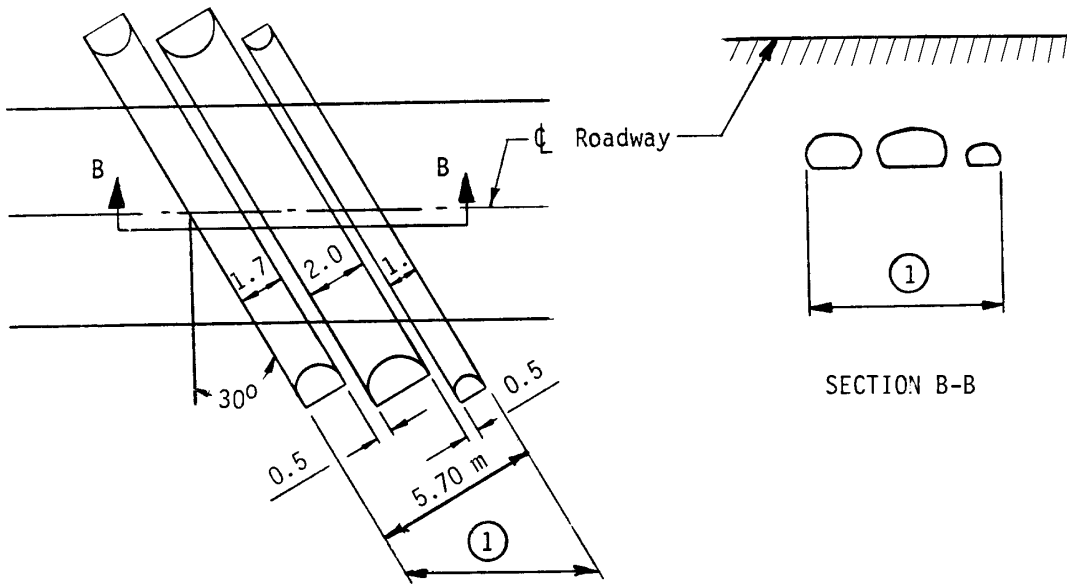
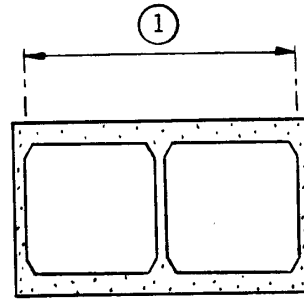
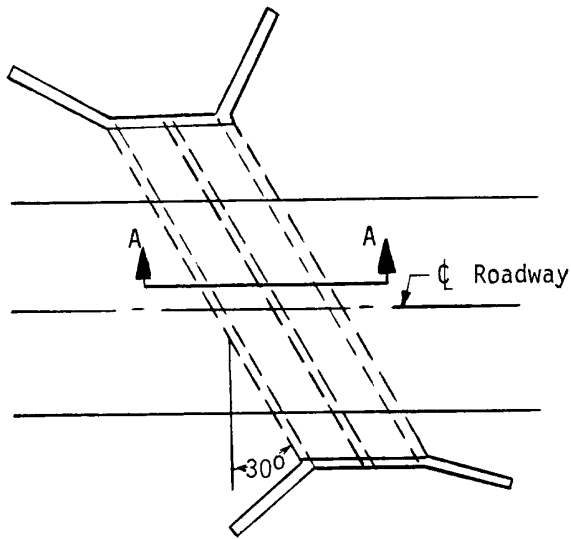

(1) Item 112 - NBIS Bridge Length

Item 113 - Scour Critical Bridges

1 digit

Use a single-digit code as indicated below to identify the current status of the bridge regarding its vulnerability to scour. Scour analyses shall be made by hydraulic/geotechnical/structural engineers. Details on conducting a scour analysis are included in the FHWA Technical Advisory 5140.23 titled, "Evaluating Scour at Bridges." Whenever a rating factor of 4 or below is determined for this item, the rating factor for Item 60 - Substructure may need to be revised to reflect the severity of actual scour and resultant damage to the bridge. A scour critical bridge is one with abutment or pier foundations which are rated as unstable due to (1) observed scour at the bridge site or (2) a scour potential as determined from a scour evaluation study.

Code Description

- N Bridge not over waterway.
- U Bridge with "unknown" foundation that has not been evaluated for scour. Since risk cannot be determined, flag for monitoring during flood events and, if appropriate, closure.
- T Bridge over "tidal" waters that has not been evaluated for scour, but considered low risk. Bridge will be monitored with regular inspection cycle and with appropriate underwater inspections. ("Unknown" foundations in "tidal" waters should be coded U.)
- 9 Bridge foundations (including piles) on dry land well above flood water elevations.
- 8 Bridge foundations determined to be stable for assessed or calculated scour conditions; calculated scour is above top of footing. (Example A)
- 7 Countermeasures have been installed to correct a previously existing problem with scour. Bridge is no longer scour critical.
- 6 Scour calculation/evaluation has not been made. (Use only to describe case where bridge has not yet been evaluated for scour potential.)
- 5 Bridge foundations determined to be stable for calculated scour conditions; scour within limits of footing or piles. (Example B)
- 4 Bridge foundations determined to be stable for calculated scour conditions; field review indicates action is required to protect exposed foundations from effects of additional erosion and corrosion.
- 3 Bridge is scour critical; bridge foundations determined to be unstable for calculated scour conditions:
 - Scour within limits of footing or piles. (Example B)
 - Scour below spread-footing base or pile tips. (Example C)

(codes continued on the next page)

Item 113 - Scour Critical Bridges (cont' d)

Code Description

- 2 Bridge is scour critical; field review indicates that extensive scour has occurred at bridge foundations. Immediate action is required to provide scour countermeasures.
- 1 Bridge is scour critical; field review indicates that failure of piers/abutments is imminent. Bridge is closed to traffic.
- 0 Bridge is scour critical. Bridge has failed and is closed to traffic.

EXAMPLES:

CALCULATED SCOUR DEPTH

ACTION NEEDED

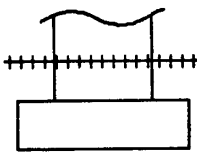
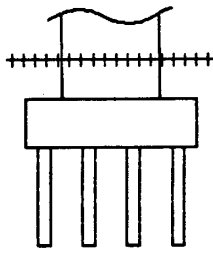
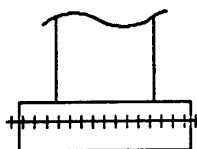
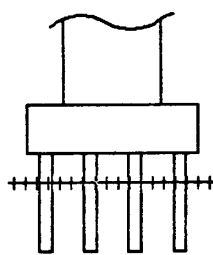
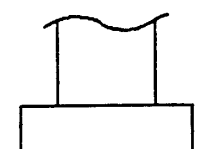
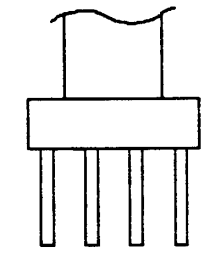
A.	Above top of footing			None - indicate rating of 8 for this item
B.	Within limits of footing or piles			Conduct foundation structural analysis
C.	Below pile tips or spread-footing base			Provide for monitoring and scour countermeasures as necessary
		SPREAD FOOTING (NOT FOUNDED IN ROCK)	PILE FOOTING	

+++++ = Calculated scour depth

Item 114 - Future Average Daily Traffic

6 digits

Code for all bridges the forecasted average daily traffic (ADT) for the inventory route identified in Item 5. This shall be projected at least 17 years but no more than 22 years from the year of inspection. The intent is to provide a basis for a 20-year forecast. This item may be updated anytime, but must be updated when the forecast falls below the 17-year limit. If planning data is not available, use the best estimate based on site familiarity.

The future ADT must be compatible with the other items coded for the bridge. For example, parallel bridges with an open median are coded as follows: if Item 28 - Lanes On and Under the Structure and Item 51 - Bridge Roadway Width, Curb-to-Curb are coded for each bridge separately, then the future ADT must be coded for each bridge separately (not the total for the route).

EXAMPLES:

		<u>Code</u>
Future ADT	540	000540
	15,600	015600
	240,000	240000

Item 115 - Year of Future Average Daily Traffic

4 digits

Record and code the year represented by the future ADT in Item 114. The projected year of future ADT shall be at least 17 years but no more than 22 years from the year of inspection.

EXAMPLE:

		<u>Code</u>
Year of Future ADT is	2014	2014

Item 116 - Minimum Navigation Vertical Clearance.
Vertical Lift Bridge (XXX.X meters)

4 digits

Record and code as a 4-digit number truncated to the tenth of a meter (with an assumed decimal point), the minimum vertical clearance imposed at the site as measured above a datum that is specified on a navigation permit issued by a control agency. Code this item only for vertical lift bridges in the dropped or closed position, otherwise leave blank.

EXAMPLES:

		<u>Code</u>
Vertical Clearance	10.67 meters	0106
	24.22 meters	0242

GENERAL

Inspection reports should generally include the following:

1. A statement of action taken, if any, pursuant to findings of inspection.
2. Any special findings stemming from the inspection and evaluation of fracture critical members, underwater inspections, and special feature inspection.
3. Any features which should be monitored closely during subsequent inspections as should any specific descriptions, instructions, or concerns.

Measurements, sketches, diagrams, test results, or calculations should generally be included on separate sheets.

APPENDIX A

Structure Inventory and Appraisal Sheet

Appendix A

OMB No. 2125-0501

Structure Inventory and Appraisal Sheet

NATIONAL BRIDGE INVENTORY - - - - - STRUCTURE INVENTORY AND APPRAISAL 10/15/94

***** IDENTIFICATION *****

(1) STATE NAME - _____ CODE _____

(8) STRUCTURE NUMBER _____ # _____

(5) INVENTORY ROUTE (ON/UNDER) - _____ = _____

(2) HIGHWAY AGENCY DISTRICT _____

(3) COUNTY CODE _____ (4) PLACE CODE _____

(6) FEATURES INTERSECTED - _____

(7) FACILITY CARRIED - _____

(9) LOCATION - _____

(11) MILEPOINT/KILOMETERPOINT _____

(12) BASE HIGHWAY NETWORK - _____ CODE _____

(13) LRS INVENTORY ROUTE & SUBROUTE # _____

(16) LATITUDE _____ DEG _____ MIN _____ SEC

(17) LONGITUDE _____ DEG _____ MIN _____ SEC

(98) BORDER BRIDGE STATE CODE _____ % SHARE _____ %

(99) BORDER BRIDGE STRUCTURE NO. # _____

***** STRUCTURE TYPE AND MATERIAL *****

(43) STRUCTURE TYPE MAIN: MATERIAL - _____

TYPE - _____ CODE _____

(44) STRUCTURE TYPE APPR: MATERIAL - _____

TYPE - _____ CODE _____

(45) NUMBER OF SPANS IN MAIN UNIT _____

(46) NUMBER OF APPROACH SPANS _____

(107) DECK STRUCTURE TYPE - _____ CODE _____

(108) WEARING SURFACE / PROTECTIVE SYSTEM:

A) TYPE OF WEARING SURFACE - _____ CODE _____

B) TYPE OF MEMBRANE - _____ CODE _____

C) TYPE OF DECK PROTECTION - _____ CODE _____

***** AGE AND SERVICE *****

(27) YEAR BUILT _____

(106) YEAR RECONSTRUCTED _____

(42) TYPE OF SERVICE: ON - _____

UNDER - _____ CODE _____

(28) LANES: ON STRUCTURE _____ UNDER STRUCTURE _____

(29) AVERAGE DAILY TRAFFIC _____

(30) YEAR OF ADT _____ (109) TRUCK ADT _____ %

(19) BYPASS, DETOUR LENGTH _____ KM

***** GEOMETRIC DATA *****

(48) LENGTH OF MAXIMUM SPAN _____ M

(49) STRUCTURE LENGTH _____ M

(50) CURB OR SIDEWALK: LEFT _____ M RIGHT _____ M

(51) BRIDGE ROADWAY WIDTH CURB TO CURB _____ M

(52) DECK WIDTH OUT TO OUT _____ M

(32) APPROACH ROADWAY WIDTH (W/SHOULDERS) _____ M

(33) BRIDGE MEDIAN - _____ CODE _____

(34) SKEW _____ DEG (35) STRUCTURE FLARED _____

(10) INVENTORY ROUTE MIN VERT CLEAR _____ M

(47) INVENTORY ROUTE TOTAL HORIZ CLEAR _____ M

(53) MIN VERT CLEAR OVER BRIDGE RDWY _____ M

(54) MIN VERT UNDERCLEAR REF - _____ M

(55) MIN LAT UNDERCLEAR RT REF - _____ M

(56) MIN LAT UNDERCLEAR LT _____ M

***** NAVIGATION DATA *****

(38) NAVIGATION CONTROL - _____ CODE _____

(111) PIER PROTECTION - _____ CODE _____

(39) NAVIGATION VERTICAL CLEARANCE _____ M

(116) VERT-LIFT BRIDGE NAV MIN VERT CLEAR _____ M

(40) NAVIGATION HORIZONTAL CLEARANCE _____ M

***** CLASSIFICATION *****

(112) NBIS BRIDGE LENGTH - _____

(104) HIGHWAY SYSTEM - _____

(26) FUNCTIONAL CLASS - _____

(100) DEFENSE HIGHWAY - _____

(101) PARALLEL STRUCTURE - _____

(102) DIRECTION OF TRAFFIC - _____

(103) TEMPORARY STRUCTURE - _____

(105) FEDERAL LANDS HIGHWAYS - _____

(110) DESIGNATED NATIONAL NETWORK - _____

(20) TOLL - _____

(21) MAINTAIN - _____

(22) OWNER - _____

(37) HISTORICAL SIGNIFICANCE - _____

***** CONDITION *****

(58) DECK _____

(59) SUPERSTRUCTURE _____

(60) SUBSTRUCTURE _____

(61) CHANNEL & CHANNEL PROTECTION _____

(62) CULVERTS _____

***** LOAD RATING AND POSTING *****

(31) DESIGN LOAD - _____ OR _____

(63) OPERATING RATING METHOD - _____

(64) OPERATING RATING - _____

(65) INVENTORY RATING METHOD - _____

(66) INVENTORY RATING - _____

(70) BRIDGE POSTING - _____

(41) STRUCTURE OPEN, POSTED OR CLOSED - _____

DESCRIPTION - _____

***** APPRAISAL *****

(67) STRUCTURAL EVALUATION _____

(68) DECK GEOMETRY _____

(69) UNDERCLEARANCES, VERTICAL & HORIZONTAL _____

(71) WATERWAY ADEQUACY _____

(72) APPROACH ROADWAY ALIGNMENT _____

(36) TRAFFIC SAFETY FEATURES _____

(113) SCOUR CRITICAL BRIDGES _____

***** PROPOSED IMPROVEMENTS *****

(75) TYPE OF WORK - _____ CODE _____

(76) LENGTH OF STRUCTURE IMPROVEMENT _____ M

(94) BRIDGE IMPROVEMENT COST \$ _____,000

(95) ROADWAY IMPROVEMENT COST \$ _____,000

(96) TOTAL PROJECT COST \$ _____,000

(97) YEAR OF IMPROVEMENT COST ESTIMATE _____

(114) FUTURE ADT _____

(115) YEAR OF FUTURE ADT _____

***** INSPECTIONS *****

(90) INSPECTION DATE ____/____/____ (91) FREQUENCY ____ MO

(92) CRITICAL FEATURE INSPECTION: (93) CFI DATE

A) FRACTURE CRIT DETAIL - ____ - ____ MO A) ____/____

B) UNDERWATER INSP - ____ - ____ MO B) ____/____

C) OTHER SPECIAL INSP - ____ - ____ MO C) ____/____

APPENDIX B

Sufficiency Rating Formula and Example

Appendix B

Sufficiency Rating Formula and Example

The sufficiency rating formula described herein is a method of evaluating highway bridge data by calculating four separate factors to obtain a numeric value which is indicative of bridge sufficiency to remain in service. The result of this method is a percentage in which 100 percent would represent an entirely sufficient bridge and zero percent would represent an entirely insufficient or deficient bridge.

An asterisk prefix is used to identify a sufficiency rating that was calculated even though some essential data was missing or coded incorrectly. The Edit/Update Program will substitute a value for the unusable data (which will not lower the rating) and calculate the sufficiency rating. The asterisk is dropped when the unusable data is corrected. It is normal that all culverts with Bridge Roadway Width, Curb-to-Curb - Item 51 coded '0000' will have an asterisk prefixed sufficiency.

Figure 1. Summary of Sufficiency Rating Factors

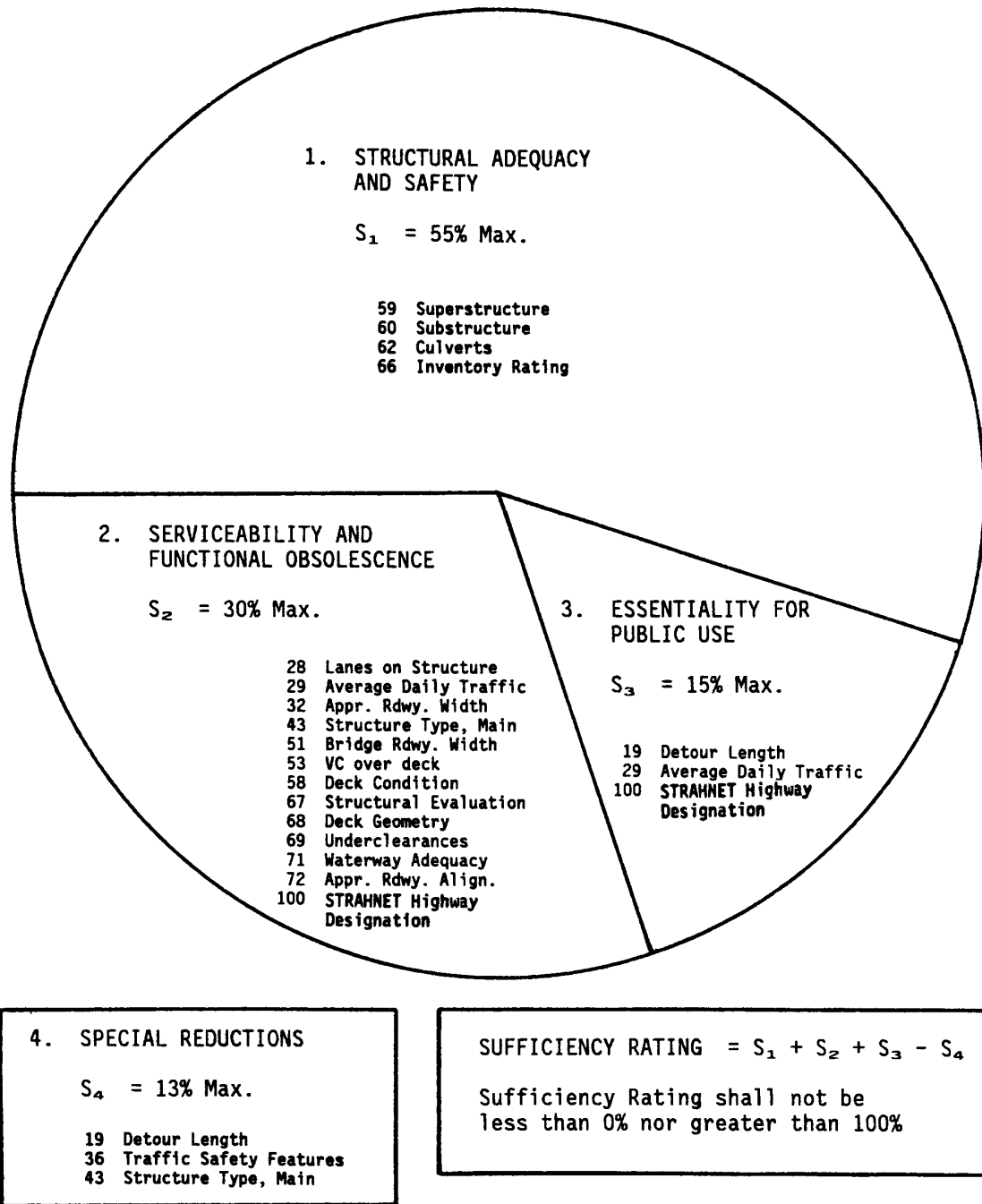

Sufficiency Rating Formula

1. Structural Adequacy and Safety (55% maximum)

- a. Only the lowest rating code of Item 59, 60, or 62 applies.

If Item 59 (Superstructure Rating) or
Item 60 (Substructure Rating) is

≤ 2	then	A = 55%
= 3		A = 40%
= 4		A = 25%
= 5		A = 10%

If Item 59 and Item 60 = N and
Item 62 (Culvert Rating) is

≤ 2	then	A = 55%
= 3		A = 40%
= 4		A = 25%
= 5		A = 10%

- b. Reduction for Load Capacity:

Calculate using the following formulas where
IR is the Inventory Rating (MS Loading) in tons
or use Figure 2:

$$B = (32.4 - IR)^{1.5} \times 0.3254$$

or

$$\text{If } (32.4 - IR) \leq 0, \text{ then } B = 0$$

"B" shall not be less than 0% nor greater than 55%.

$$S_1 = 55 - (A + B)$$

S_1 shall not be less than 0% nor greater than 55%.

FIGURE 2. Reduction for Load Capacity

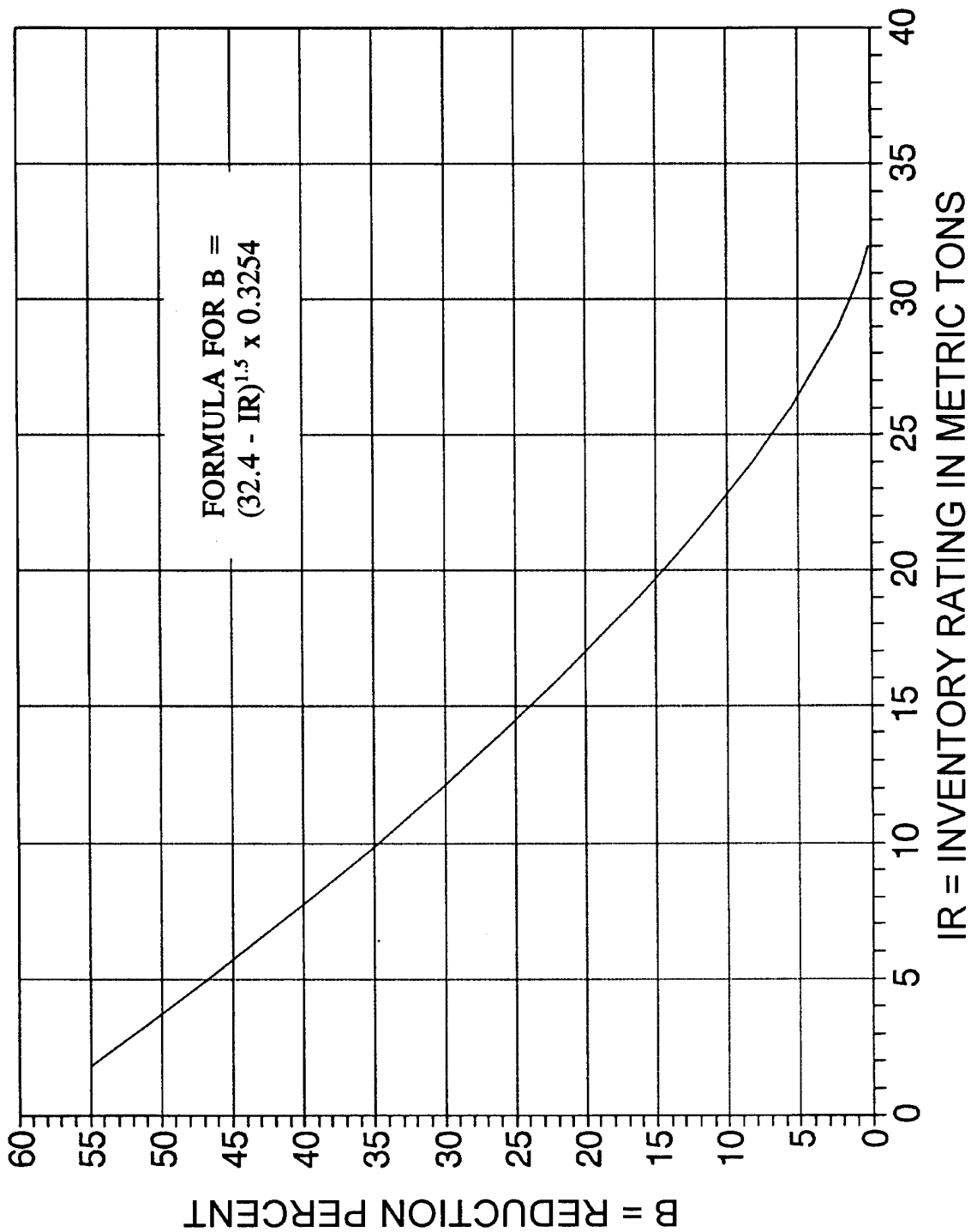

2. Serviceability and Functional Obsolescence (30% maximum)

a. Rating Reductions (13% maximum)

If #58 (Deck Condition) is ≤ 3 then A = 5%
 $= 4$ A = 3%
 $= 5$ A = 1%

If #67 (Structural Evaluation) is ≤ 3 then B = 4%
 $= 4$ B = 2%
 $= 5$ B = 1%

If #68 (Deck Geometry) is ≤ 3 then C = 4%
 $= 4$ C = 2%
 $= 5$ C = 1%

If #69 (Underclearances) is ≤ 3 then D = 4%
 $= 4$ D = 2%
 $= 5$ D = 1%

If #71 (Waterway Adequacy) is ≤ 3 then E = 4%
 $= 4$ E = 2%
 $= 5$ E = 1%

If #72 (Approach Road Alignment) is ≤ 3 then F = 4%
 $= 4$ F = 2%
 $= 5$ F = 1%

$$J = (A + B + C + D + E + F)$$

J shall not be less than 0% nor greater than 13%.

b. Width of Roadway Insufficiency (15% maximum)

Use the sections that apply:

- (1) applies to all bridges;
- (2) applies to 1-lane bridges only;
- (3) applies to 2 or more lane bridges;
- (4) applies to all except 1-lane bridges.

Also determine X and Y:

$$X \text{ (ADT/Lane)} = \frac{\text{Item 29 (ADT)}}{\text{first 2 digits of \#28 (Lanes)}}$$

$$Y \text{ (Width/Lane)}^* = \frac{\text{Item 51 (Bridge Rdwy. Width)}}{\text{first 2 digits of \#28 (Lanes)}}$$

*A value of 10.9 Meters will be substituted when item 51 is coded 0000 or not numeric.

- (1) Use when the last 2 digits of #43 (Structure Type) are not equal to 19 (Culvert):

$$\text{If } (\#51 + 0.6 \text{ meters}) < \#32 \text{ (Approach Roadway Width)} \quad G = 5\%$$

- (2) For 1-lane bridges only, use Figure 3 or the following:

If the first 2 digits of #28 (Lanes) are equal to 01 and

$$Y < 4.3 \quad \text{then} \quad H = 15\%$$

$$Y \geq 4.3 < 5.5 \quad H = 15 \left[\frac{5.5 - Y}{1.2} \right] \%$$

$$Y \geq 5.5 \quad H = 0\%$$

- (3) For 2 or more lane bridges. If these limits apply, do not continue on to (4) as no lane width reductions are allowed.

$$\text{If the first 2 digits of } \#28 = 02 \text{ and } Y \geq 4.9, \quad H = 0\%$$

$$\text{If the first 2 digits of } \#28 = 03 \text{ and } Y \geq 4.6, \quad H = 0\%$$

$$\text{If the first 2 digits of } \#28 = 04 \text{ and } Y \geq 4.3, \quad H = 0\%$$

$$\text{If the first 2 digits of } \#28 \geq 05 \text{ and } Y \geq 3.7 \quad H = 0\%$$

- (4) For all except 1-lane bridges, use Figure 3 or the following:

$$\text{If } Y < 2.7 \text{ and } X > 50 \quad \text{then } H = 15\%$$

$$Y < 2.7 \text{ and } X \leq 50 \quad H = 7.5\%$$

$$Y \geq 2.7 \text{ and } X \leq 50 \quad H = 0\%$$

If $X > 50$ but ≤ 125 and

$$Y < 3.0 \quad \text{then} \quad H = 15\%$$

$$Y \geq 3.0 < 4.0 \quad H = 15(4 - Y)\%$$

$$Y \geq 4.0 \quad H = 0\%$$

If $X > 125$ but ≤ 375 and

$$Y < 3.4 \quad \text{then} \quad H = 15\%$$

$$Y \geq 3.4 < 4.3 \quad H = 15(4.3 - Y)\%$$

$$Y \geq 4.3 \quad H = 0\%$$

Figure 3. Width of Roadway Insufficiency

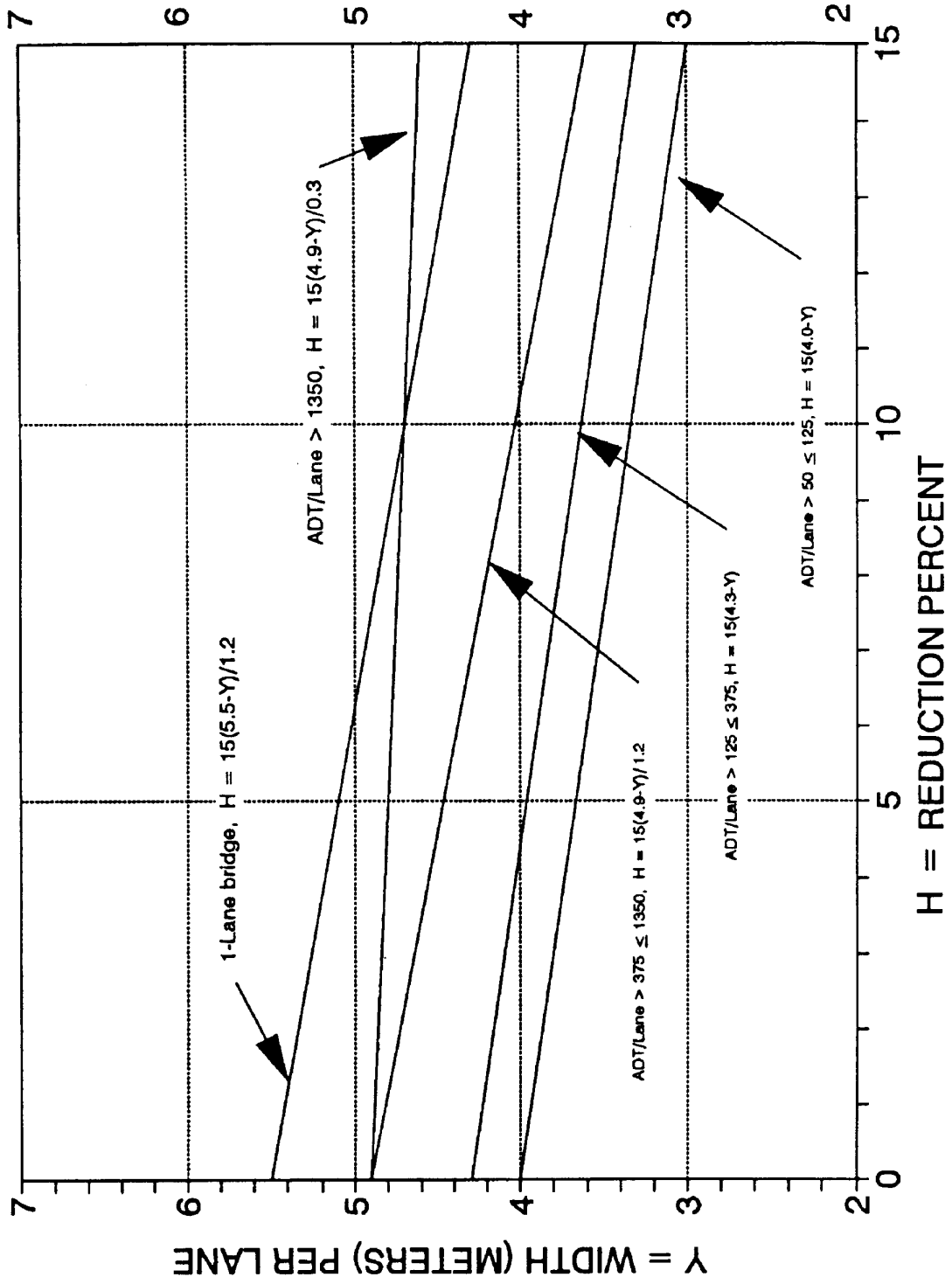

If $X > 375$ but ≤ 1350 and

$Y < 3.7$ then $H = 15\%$

$Y \geq 3.7 < 4.9$ $H = 15 \left[\frac{4.9 - Y}{1.2} \right] \%$

$Y \geq 4.9$ $H = 0\%$

If $X > 1350$ and

$Y < 4.6$ then $H = 15\%$

$Y \geq 4.6 < 4.9$ $H = 15 \left[\frac{4.9 - Y}{1.2} \right] \%$

$Y \geq 4.9$ $H = 0\%$

$G + H$ shall not be less than 0% nor greater than 15%.

c. Vertical Clearance Insufficiency - (2% maximum)

If #100 (STRAHNET Highway Designation) > 0 and

#53 (VC over Deck) ≥ 4.87 then $I = 0\%$

#53 < 4.87 $I = 2\%$

If #100 = 0 and

#53 ≥ 4.26 then $I = 0\%$

#53 < 4.26 $I = 2\%$

$$S_2 = 30 - [J + (G + H) + I]$$

S_2 shall not be less than 0% nor greater than 30%.

3. Essentiality for Public Use (15% maximum)

a. Determine:

$$K = \frac{S_1 + S_2}{85}$$

b. Calculate:

$$A = 15 \left[\frac{\#29(ADT) \times \#19(DetourLength)}{320,000 \times K} \right]$$

"A" shall not be less than 0% nor greater than 15%.

c. STRAHNET Highway Designation:

If #100 is > 0 then B = 2%

If #100 = 0 then B = 0%

$$S_3 = 15 - (A + B)$$

S₃ shall not be less than 0% nor greater than 15%.

4. Special Reductions (Use only when S₁ + S₂ + S₃ ≥ 50)

a. Detour Length Reduction, use Figure 4 or the following:

$$A = (\#19)^4 \times (7.9 \times 10^{-9})$$

"A" shall not be less than 0% nor greater than 5%.

b. If the 2nd and 3rd digits of #43 (Structure Type, Main) are equal to 10, 12, 13, 14, 15, 16, or 17; then

$$B = 5\%$$

c. If 2 digits of #36 (Traffic Safety Features) = 0 C = 1%
If 3 digits of #36 = 0 C = 2%
If 4 digits of #36 = 0 C = 3%

$$S_4 = A + B + C$$

S₄ shall not be less than 0% nor greater than 13%.

$$\text{Sufficiency Rating} = S_1 + S_2 + S_3 - S_4$$

The Rating shall not be less than 0% nor greater than 100%.

Figure 4. Special Reduction for Detour Length

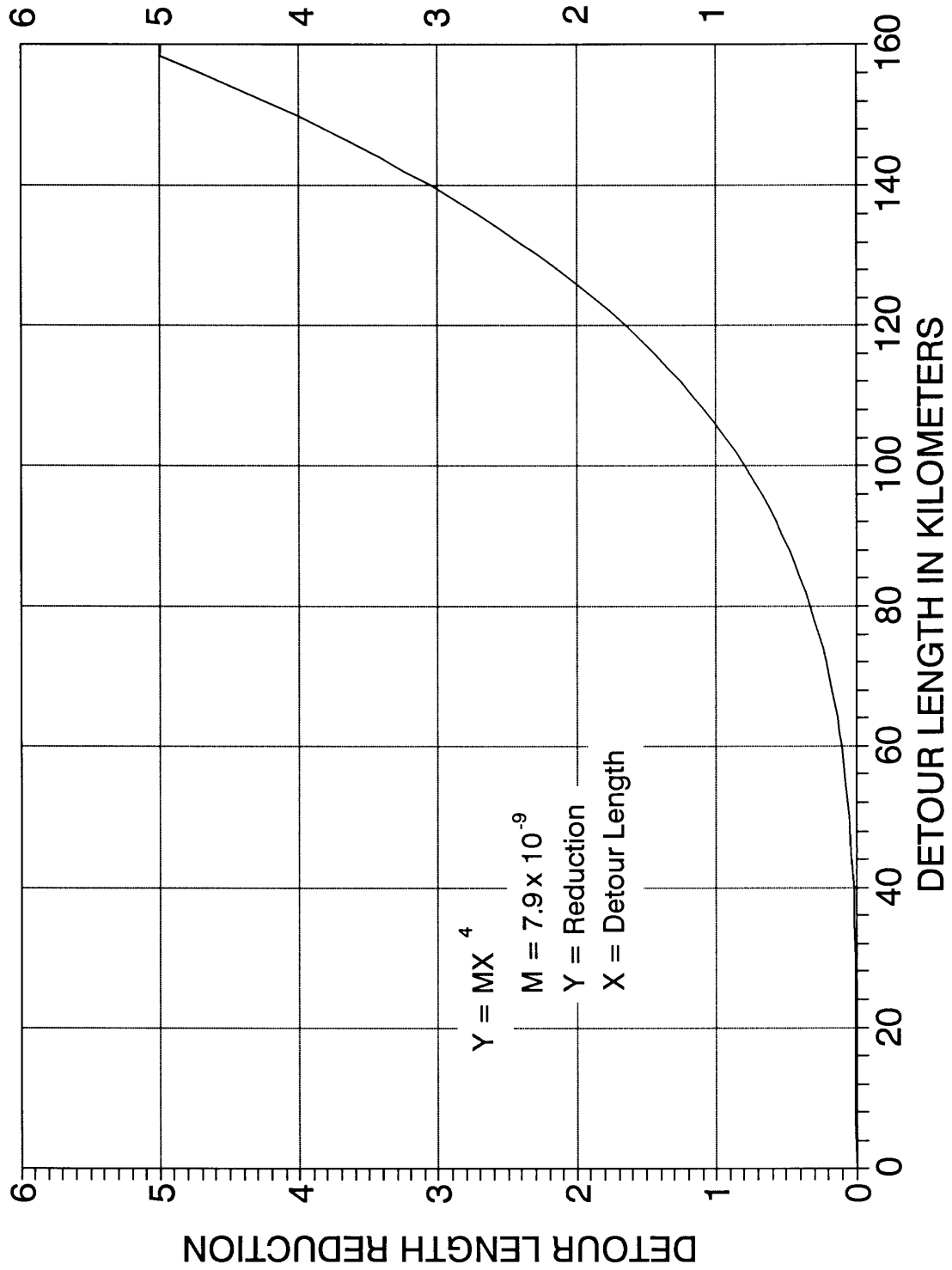

EXAMPLE

Calculation of Sufficiency Rating

1. Structural Adequacy and Safety

$$A = 10\%$$

$$B = [32.4 - (19.8 \text{ metric tons})]^{1.5} \times 0.3254 = 14.6$$

$$S_1 = 55 - (10 + 14.6) = 30.4$$

2. Serviceability and Functional Obsolescence

$$A = 3\%, \quad B = 1\%, \quad C = 4\%, \quad D = \text{NA}, \quad E = \text{NA}, \quad F = \text{NA}$$

$$J = (3 + 1 + 4) = 8\%$$

$$X = \frac{18500}{2} = 9250 \quad Y = \frac{7.9 \text{ m}}{2} = 3.95$$

(1) If $(7.9 + 0.6) < 12.2$ then $G = 5$

(2) Not Applicable

(3) Not Applicable

(4) If $X = 9250$ and $Y = 3.95$ then $H = 15$

$$G + H = 5 + 15 = 20 \text{ (however, maximum allowable} = 15)$$

$$I = 0$$

$$S_2 = 30 - [8 + (15) + 0] = 7.0$$

3. Essentiality For Public Use

$$K = \frac{30.4 + 7.0}{85} = 0.44$$

$$A = 15 \left[\frac{18,500 \times 12.8 \text{ Km}}{320,000 \times 0.44} \right] = 25.2 \text{ (however, max .allowable} = 15)$$

$$B = 0$$

$$S_3 = 15 - (15 + 0) = 0$$

4. Special Reductions

$$S_1 + S_2 + S_3 = (30.4 + 7.0 + 0.0) = 37.4 < 50$$

$$S_4 = \text{NA}$$

$$\text{SUFFICIENCY RATING} = 30.4 + 7.0 + 0.0 = 37.4$$

EXAMPLE DATA

OMB No. 2125-0501
10/15/94

NATIONAL BRIDGE INVENTORY - - - - - STRUCTURE INVENTORY AND APPRAISAL

```

***** IDENTIFICATION *****
(1) STATE NAME - YOUR STATE NAME          CODE 999
(8) STRUCTURE NUMBER
(5) INVENTORY ROUTE (ON/UNDER) - ON      = 131000440
(2) HIGHWAY AGENCY DISTRICT              03
(3) COUNTY CODE 075 (4) PLACE CODE 59767
(6) FEATURES INTERSECTED - SR 772, ROARING LION R. *
(7) FACILITY CARRIED - STATE ROUTE 44
(9) LOCATION - 9.7 KM SW. OF RICHMOND
(11) MILEPOINT/KILOMETERPOINT            0036.008
(12) BASE HIGHWAY NETWORK - PART OF NET  CODE 1
(13) LRS INVENTORY ROUTE & SUBROUTE      #000000277503
(16) LATITUDE 35 DEG 27 MIN 18.55 SEC
(17) LONGITUDE 081 DEG 05 MIN 50.65 SEC
(98) BORDER BRIDGE STATE CODE 888 % SHARE 40 %
(99) BORDER BRIDGE STRUCTURE NO. #ABC003790243009

***** STRUCTURE TYPE AND MATERIAL *****
(43) STRUCTURE TYPE MAIN: MATERIAL - STEEL
      TYPE - DECK TRUSS CODE 309
(44) STRUCTURE TYPE APPR: MATERIAL - STEEL
      TYPE - GIRDER & FLOORBEAM SYSTEM CODE 303
(45) NUMBER OF SPANS IN MAIN UNIT 002
(46) NUMBER OF APPROACH SPANS 0004
(107) DECK STRUCTURE TYPE - CONCRETE C-I-P CODE 1
(108) WEARING SURFACE / PROTECTIVE SYSTEM:
      A) TYPE OF WEARING SURFACE - CONCRETE CODE 1
      B) TYPE OF MEMBRANE - NONE CODE 0
      C) TYPE OF DECK PROTECTION - UNKNOWN CODE 8

***** AGE AND SERVICE *****
(27) YEAR BUILT 1948
(106) YEAR RECONSTRUCTED 0000
(42) TYPE OF SERVICE: ON - HIGHWAY-PEDESTRIAN
      UNDER - HIGHWAY-WATERWAY CODE 56
(28) LANES: ON STRUCTURE 02 UNDER STRUCTURE 02
(29) AVERAGE DAILY TRAFFIC 019500
(30) YEAR OF ADT 1993 (109) TRUCK ADT 05 %
(19) BYPASS, DETOUR LENGTH 013 KM

***** GEOMETRIC DATA *****
(48) LENGTH OF MAXIMUM SPAN 0097.5 M
(49) STRUCTURE LENGTH 00312.0 M
(50) CURB OR SIDEWALK: LEFT 00.0 M RIGHT 02.5 M
(51) BRIDGE ROADWAY WIDTH CURB TO CURB 007.9 M
(52) DECK WIDTH OUT TO OUT 011.8 M
(32) APPROACH ROADWAY WIDTH (W/SHOULDERS) 12.2 M
(33) BRIDGE MEDIAN - NO MEDIAN CODE 0
(34) SKEW 00 DEG (35) STRUCTURE FLARED NO
(10) INVENTORY ROUTE MIN VERT CLEAR 99.99 M
(47) INVENTORY ROUTE TOTAL HORIZ CLEAR 07.9 M
(53) MIN VERT CLEAR OVER BRIDGE RDWY 99.99 M
(54) MIN VERT UNDERCLEAR REF - HIGHWAY 10.46 M
(55) MIN LAT UNDERCLEAR RT REF - HIGHWAY 06.2 M
(56) MIN LAT UNDERCLEAR LT 00.0 M

***** NAVIGATION DATA *****
(38) NAVIGATION CONTROL - BR PERMIT REQ CODE 1
(111) PIER PROTECTION - FUNCTIONING CODE 2
(39) NAVIGATION VERTICAL CLEARANCE 18.3 M
(116) VERT-LIFT BRIDGE NAV MIN VERT CLEAR . M
(40) NAVIGATION HORIZONTAL CLEARANCE 047.2 M

***** CLASSIFICATION *****
(112) NBIS BRIDGE LENGTH - YES
(104) HIGHWAY SYSTEM - ROUTE ON NHS 1
(26) FUNCTIONAL CLASS - OTHER PRIN ART URBAN 14
(100) DEFENSE HIGHWAY - NOT DEFENSE 0
(101) PARALLEL STRUCTURE - NONE EXISTS N
(102) DIRECTION OF TRAFFIC - 2 WAY 2
(103) TEMPORARY STRUCTURE - NOT TEMPORARY -
(105) FEDERAL LANDS HIGHWAYS - NOT APPLICABLE 0
(110) DESIGNATED NATIONAL NETWORK - PART OF NET 1
(20) TOLL - ON FREE ROAD 3
(21) MAINTAIN - STATE HIGHWAY AGENCY 01
(22) OWNER - STATE HIGHWAY AGENCY 01
(37) HISTORICAL SIGNIFICANCE - NOT ELIGIBLE 5

***** CONDITION *****
(58) DECK 4
(59) SUPERSTRUCTURE 5
(60) SUBSTRUCTURE 6
(61) CHANNEL & CHANNEL PROTECTION 8
(62) CULVERTS N

***** LOAD RATING AND POSTING *****
(31) DESIGN LOAD - H-15 OR M-13.5 2
(63) OPERATING RATING METHOD - LOAD FACTOR 1
(64) OPERATING RATING - MS-14 25.2
(65) INVENTORY RATING METHOD - LOAD FACTOR 1
(66) INVENTORY RATING - MS-11 19.8
(70) BRIDGE POSTING - POSTING REQUIRED 2
(41) STRUCTURE OPEN, POSTED OR CLOSED - P
      DESCRIPTION - POSTED FOR LOAD

***** APPRAISAL *****
(67) STRUCTURAL EVALUATION 5
(68) DECK GEOMETRY 3
(69) UNDERCLEARANCES, VERTICAL & HORIZONTAL 6
(71) WATERWAY ADEQUACY 8
(72) APPROACH ROADWAY ALIGNMENT 8
(36) TRAFFIC SAFETY FEATURES 1100
(113) SCOUR CRITICAL BRIDGES 8

***** PROPOSED IMPROVEMENTS *****
(75) TYPE OF WORK - REPLACE FOR DEFICIENCY CODE 311
(76) LENGTH OF STRUCTURE IMPROVEMENT 00317.0 M
(94) BRIDGE IMPROVEMENT COST $ 4,200,000
(95) ROADWAY IMPROVEMENT COST $ 300,000
(96) TOTAL PROJECT COST $ 5,000,000
(97) YEAR OF IMPROVEMENT COST ESTIMATE 1995
(114) FUTURE ADT 025600
(115) YEAR OF FUTURE ADT 2014

***** INSPECTIONS *****
(90) INSPECTION DATE 03/94 (91) FREQUENCY 12 MO
(92) CRITICAL FEATURE INSPECTION: (93) CFI DATE
      A) FRACTURE CRIT DETAIL - YES - 06 MO A) 09/94
      B) UNDERWATER INSP - NO - MO B) /-
      C) OTHER SPECIAL INSP - NO - MO C) /-

```

APPENDIX C

National Bridge Inspection Standards

Section 650.311 - The January 1979 Coding Guide has been superseded by a December 1988 Guide, which is superseded by this metric version of the Coding Guide.

National Bridge Inspection Standards

CODE OF FEDERAL REGULATIONS

23 HIGHWAYS - PART 650

Subpart C - National Bridge Inspection Standards

'650.301 Application of standards.

The National Bridge Inspection Standards in this part apply to all structures defined as bridges located on all public roads. In accordance with the AASHTO (American Association of State Highway and Transportation Officials) Transportation Glossary, a "bridge" is defined as a structure including supports erected over a depression or an obstruction, such as water, highway, or railway, and having a track or passageway for carrying traffic or other moving loads, and having an opening measured along the center of the roadway of more than 20 feet between undercopings of abutments or spring lines of arches, or extreme ends of openings for multiple boxes; it may also include multiple pipes, where the clear distance between openings is less than half of the smaller contiguous opening.

'650.303 Inspection procedures.

(a) Each highway department shall include a bridge inspection organization capable of performing inspections, preparing reports, and determining ratings in accordance with the provisions of the AASHTO Manual¹ and the Standards contained herein.

(b) Bridge inspectors shall meet the minimum qualifications stated in '650.307.

(c) Each structure required to be inspected under the Standards shall be rated as to its safe load carrying capacity in accordance with Section 4 of the AASHTO Manual. If it is determined under this rating procedure that the maximum legal load under State law exceeds the load permitted under the Operating Rating, the bridge must be posted in conformity with the AASHTO Manual or in accordance with State law.

(d) Inspection records and bridge inventories shall be prepared and maintained in accordance with the Standards.

(e) The individual in charge of the organizational unit that has been delegated the responsibilities for bridge inspection, reporting and inventory shall determine and designate on the individual inspection and inventory records and maintain a master list of the following:

(1) Those bridges which contain fracture critical members, the location and description of such members on the bridge and the inspection frequency and procedures for inspection of such members. (Fracture critical members are tension members of a bridge whose failure will probably cause a portion of or the entire bridge to collapse.)

(2) Those bridges with underwater members which cannot be visually evaluated during periods of low flow or examined by feel for condition, integrity and safe load capacity due to excessive water depth or turbidity. These members shall be described, the inspection frequency stated not to exceed five years, and the inspection procedure specified.

(3) Those bridges which contain unique or special features requiring additional attention during inspection to ensure the safety of such bridges and the inspection frequency and procedure for inspection of each such feature.

(4) The date of last inspection of the features designated in paragraphs (e)(1) through (e)(3) of this section and a description of the findings and follow-up actions, if necessary, resulting from the most recent inspection of fracture critical details, underwater members or special features of each so designated bridge.

'650.305 Frequency of inspections.

(a) Each bridge is to be inspected at regular intervals not to exceed 2 years in accordance with Sect. 2.3 of the AASHTO Manual.

¹ The "AASHTO Manual" referred to in this part is the "Manual for Maintenance Inspection of Bridges 1983" together with subsequent interim changes or the most recent version of the AASHTO manual published by the American Association of State Highway and Transportation Officials. A copy of the Manual may be examined during normal business hours at the office of each Division Administrator of the Federal Highway Administration, at the office of each Regional Federal Highway Administrator, and at the Washington Headquarters of the Federal Highway Administration. The addresses of those document inspection facilities are set forth in Appendix D to Part 7 of the regulations of the Office of the Secretary (40 CFR Part 7). In addition, a copy of the Manual may be secured upon payment in advance by writing to the American Association of State

Highway and Transportation Officials, 444 N. Capitol Street, N.W., Suite 225, Washington, D.C. 20001.

(b) Certain types or groups of bridges will require inspection at less than 2-year intervals. The depth and frequency to which bridges are to be inspected will depend on such factors as age, traffic characteristics, state of maintenance, and known deficiencies. The evaluation of these factors will be the responsibility of the individual in charge of the inspection program.

(c) The maximum inspection interval may be increased for certain types or groups of bridges where past inspection reports and favorable experience and analysis justifies the increased interval of inspection. If a State proposes to inspect some bridges at greater than the specified 2-year interval, the State shall submit a detailed proposal and supporting data to the Federal Highway Administrator for approval.

' 650. 307 Qualifications of personnel.

(a) The individual in charge of the organizational unit that has been delegated the responsibilities for bridge inspection, reporting, and inventory shall possess the following minimum qualifications:

(1) Be a registered professional engineer; or

(2) Be qualified for registration as a professional engineer under the laws of the State; or

(3) Have a minimum of 10 years experience in bridge inspection assignments in a responsible capacity and have completed a comprehensive training course based on the, "Bridge Inspector's Training Manual"², which has been developed by a joint Federal-State task force, and subsequent additions to the manual.³

(b) An individual in charge of a bridge inspection team shall possess the following minimum qualifications:

(1) Have the qualifications specified in paragraph (a) of this section; or

(2) Have a minimum of 5 years experience in bridge inspection assignments in a responsible capacity and have completed a comprehensive training course based on the "Bridge Inspector's Training Manual", which has been developed by a joint Federal-State task force.

(3) Current certification as a Level III or IV Bridge Safety Inspector under the National Society of Professional Engineer's program for National Certification in Engineering Technologies (NICET)⁴ is an alternative acceptable means for establishing that a bridge inspection team leader is qualified.

' 650. 309 Inspection report.

The findings and results of bridge inspections shall be recorded on standard forms. The data required to complete the forms and the functions which must be performed to compile the data are contained in Section 3 of the AASHTO Manual

²The "Bridge Inspector's Training Manual" may be purchased from the Superintendent of Documents, U.S. Government Printing Office, Washington, D.C. 20402.

³The following publications are supplements to the "Bridge Inspector's Training Manual": "Bridge Inspector's Manual for Movable Bridges," 1977, GPO Stock No. 050-00200103-5; "Culvert Inspector's Training Manual," July 1986, GPO Stock No. 050-001-0030-7; and "Inspection of Fracture Critical Bridge Members," 1986, GPO Stock No. 050-00100302-3.

' 650. 311 Inventory.

(a) Each State shall prepare and maintain an inventory of all bridge structures subject to the Standards. Under these Standards, certain structure inventory and appraisal data must be collected and retained within the various departments of the State organization for collection by the Federal Highway Administration as needed. A tabulation of this data is contained in the structure inventory and appraisal sheet distributed by the Federal Highway Administration as part of the Recording and Coding Guide for the Structure Inventory and Appraisal of the Nation's Bridges (Coding Guide) in January of 1979. Reporting procedures have been developed by the Federal Highway Administration.

(b) Newly completed structures, modification of existing structures which would alter previously recorded data on the inventory forms or placement of load restriction signs on the approaches to or at the structure itself shall be entered in the State's inspection reports and the computer inventory file as promptly as practical, but no later than 90 days after the change in the status of the structure for bridges directly under the State's jurisdiction and no later than 180 days after the change in status of the structure for all other bridges on public roads within the State.

⁴For information on NICET program certification contact: National Institute for Certification in Engineering Technologies 1420 King Street, Alexandria, Virginia 22314. Attention: John D. Antrim, P.E., Phone (703) 684-2835.

APPENDIX D

Commentary

The 22 page commentary contained in the 1988 Coding Guide has not been included in this document. The following pages of commentary, however, show item by item changes caused by this revision.

Appendix D

December 1994 Commentary

This commentary provides a ready reference for item by item changes between the 1988 Coding Guide and this proposed revision. Items not specifically mentioned here are essentially unchanged except for SI metric conversion.

Introduction

- ! Mentions new items and their use.
- ! References to Defense Bridges removed and STRAHNET added.
- ! Federal agencies specifically included in this Guide.
- ! Minor editorial changes and reference revisions have been made to bring the text up to date.

Definition of Terms

- ! The order of the definitions has changed and the following added or modified:
 - (a) Bridge length has been converted to metric.
The length of 20 feet has been changed to 6.1 meters.
 - (b) Culvert.
 - (i) Strategic Highway Corridor Network (STRAHNET). Replaces Defense Items, which were dropped.
 - (j) STRAHNET Connectors.
 - (k) Indian Reservation Road definition has been added.
 - (l) Land Management Highway System (LMHS)
 - (m) Forest Highway (FH)
 - (n) Forest Service Development Road.
 - (o) Base Highway Network.
 - (p) Highway Performance Monitoring System.
 - (q) Conversion of Numerical Data
 - (r) Rounding and Truncating of Numerical Data.

Item 2 - Highway Agency District

- ! Name of item changed to reflect inclusion of federal bridges.

Item 5A - Record Type

- ! Clarification has been made for the case of 2 or more routes passing under a structure.
- ! Items 30, and 109 have been added to the list of items required to be coded for "under" records.

Item 6 - Features Intersected

- ! Item coding requirements have been clarified for "under" records.
- ! References to defense highway and FHPM 6-10-2 have been eliminated.
- ! Critical facilities are now STRAHNET and STRAHNET Connectors.

Item 7 - Facility Carried by Structure

- ! Item coding requirements have been clarified for "under" records.
- ! Temporary use of this item for coding IRR has been changed to Item 105.

Item 8 - Structure Number

- ! Closed median has been described.
- ! Additional emphasis has been given to the need to have all 15 digits filled.

Item 10 - Inventory Route, Minimum Vertical Clearance

- ! Units of measurement have been converted to metric, using a 3-meter width of pavement.
- ! Vertical restrictions 30 meters or greater may now be coded 9999, with exact actual clearances in this range optional.

Item 11 - Kilometer Point

- ! Units of measurement and the description of the item have been converted to metric.
- ! Seven digits will be coded instead of six.

Item 12 - Base Highway Network

- ! New item added for use in identifying Linear Referencing System (LRS).

Item 13 - LRS Inventory Route, Subroute Number

- ! New item added for identifying LRS.

Item 16 - Latitude and Item 17 - Longitude

- ! Number of digits have been expanded to 8 and 9 digits, respectively.
- ! The format of the item allows an increased precision of measurement (not mandatory) to accommodate the use of the Global Positioning System (GPS). Current measuring methods and level of precision may continue to be used.

References to defense highways changed to STRAHNET.

! Location where measurement is taken must be compatible with the LRS.

Item 19 - Bypass, Detour Length

! Number of digits has been expanded to three to accommodate metric.

Item 20 - Toll

! Reference to Secretarial Agreement updated.

Item 21 - Maintenance Responsibility and Item 22 - Owner

! Several federal agencies have been added.

Item 26 - Functional Classification of Inventory Route

! This item is no longer compatible with Item 104 and appropriate revisions have been made.

Item 28 - Lanes On and Under the Structure

! Text clarified for "under" records.

! Text has been added advising that any "1-lane" bridge 4.9 meters or greater in curb-to curb width is evaluated as 2 lanes or more in Item 68 - Deck Geometry.

Item 29 - Average Daily Traffic

! Text has been added explaining that if the bridge is closed, the coding is to be the actual ADT from the period before the closure occurred.

Item 30 - Year of Average Daily Traffic

! Field expanded to four digits to allow coding of complete year.

Item 31 - Design Load

! Codes have been converted from the H and HS loadings to metric M and MS loadings.

Item 32 - Approach Roadway Width

! A hard conversion of the units of measure has been used to match the metric standards of AASHTO.

Item 36 - Traffic Safety Features

! Add and update reference publications.

! Segment A has been updated to include the latest FHWA policy on crash testing and other recommended barrier specifications.

! Note on national set of standards updated.

Item 38 - Navigation Control

Term bridge permit clarified.

Item 41 - Structure Open, Posted or Closed to Traffic

Code B has been clarified concerning signs not correctly implemented. An example of "not correctly implemented" is existing posting signs not changed to indicate a lower load posting calculated for more recent inspection conditions.

Code P expanded to include temporary bridges which are load posted.

Item 43 - Structure Type, Main

Segment A codes 5 and 6 have been noted to include post-tensioned concrete.

Segment B code 07 has been noted that frame culverts are excluded. Code 19 has been noted that frame culverts are included.

Item 47 - Inventory Route, Total Horizontal Clearance

FHPM reference has been eliminated.

In addition to the metric changes and editorial clarifications, the definition for clearance has been modified.

Item 48 - Length of Maximum Span

The units of measurement have been converted to metric and the number of digits expanded to 5 digits to accommodate the metric values.

Center to center measurements specified to be center of bearing points.

Item 49 - Structure Length

In addition to the metric changes, an explanation has been added concerning the measuring and coding of tunnels.

Item 50 - Curb or Sidewalk Widths

Example figure modified to accentuate the mountable median.

Item 51 - Bridge Roadway Width, Curb-to-Curb

In addition to the metric changes, a reference has been added for the case of sidehill viaducts. A sidehill viaduct has a portion of its width on embankment and a portion on structure. The problem arises in calculating Item 68, the sufficiency rating and the deck area of the bridge. Commentary Figure 1 illustrates the coding of sidehill viaducts.

Commentary Figure 1
FIGURE ILLUSTRATING CODING
OF SIDEHILL VIADUCTS

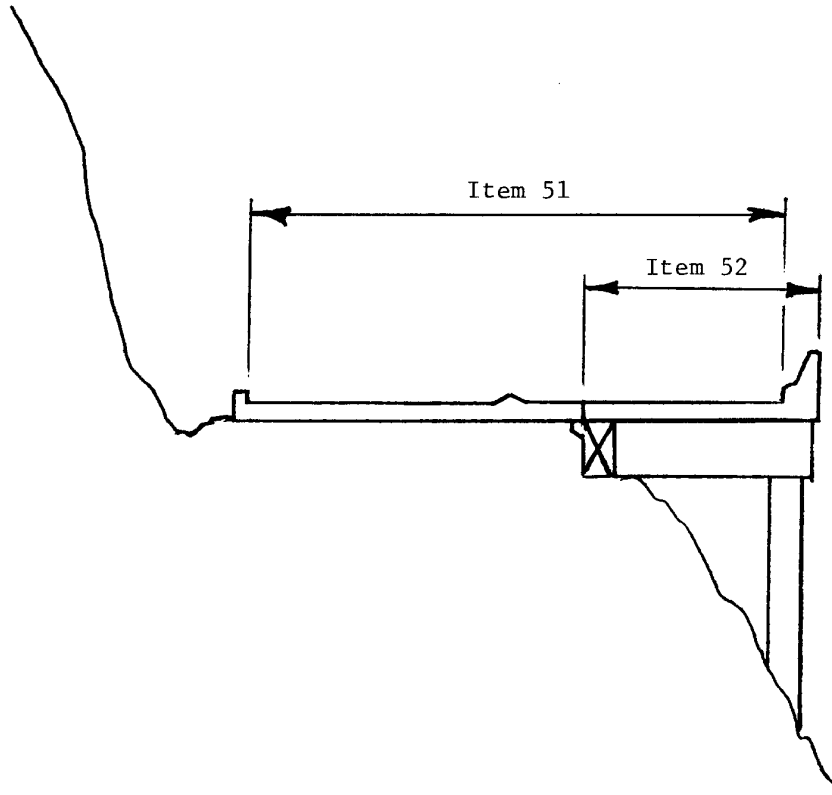

Associated Items:

- Item 28A - Lanes On Structure
- Item 29 - ADT = Total for entire structure
- Item 32 - Approach Roadway Width
- Item 102 - Direction of Traffic = 2 for 2-way

Item 53 - Minimum Vertical Clearance Over Bridge Roadway

- ! Units of measurement have been converted to metric.
- ! Clarification has been added for recording the minimum vertical clearance for double decked structures.
- ! Restrictions of 30 meters or greater or no superstructure restriction are now both to be coded 9999. However coding of actual clearances between 30 and 99.99 meters to an exact measurement is optional.

Item 54 - Minimum Vertical Underclearance

- ! In addition to metric changes, instructions have been given to code restrictions of 30 meters or greater as code 9999. However coding of actual clearances between 30 and 99.99 meters to an exact measurement is optional.

Item 55 - Minimum Lateral Underclearance on Right

- ! In addition to metric changes, instructions have been given for the coding of restrictions 30 meters or greater. The numeric value in segment B is to be coded 999 for restrictions of 30 meters or greater. However coding of actual clearances between 30 and 99.9 meters to an exact measurement is optional.
- ! If the feature beneath the structure is not a railroad or highway, the code 000 in the numeric value for segment B is to indicate that the item is not applicable. This replaces the previous code of 999 to indicate that the item is not applicable.

Item 56 - Minimum Lateral Underclearance on Left.

- ! Care should be used in coding bridges with "open" medians, they should be coded 999. Those with clearances greater than 30 meters may be coded 998. However coding of actual clearances between 30 and 99.8 meters to an exact measurement is optional. When indicating that the item is not applicable code 000.

Item 58 - Deck

- ! Clarification has been added for "structures without decks".

Item 61 - Channel and Channel Protection

- ! The word channel is now consistently used in this item.

Item 63 - Method Used to Determine Operating Rating.

- ! New item added for use with Operating Rating.

Item 64 - Operating Rating

- ! The entire item has been redefined using the MS rating system instead of the previous HS vehicle ratings. Instructions have been given to code a 3 digit number representing the total weight in metric tons of the entire vehicle (maximum load).
- ! A description has been added indicating that the load factor (LF) method is to be used for determining operating ratings and inventory ratings.
- ! A change has been made to advise that with the coding for metric tonnage, the codes 200 or 900 are not appropriate for temporary bridges. Code 000 is to be used.
- ! Instructions have been given to use code 999 for a structure under a fill where live load is insignificant in the structure load capacity.

Item 65 - Method Used to Determine Inventory Rating

- ! New item added for use with Inventory Rating.

Item 66 - Inventory Rating

- ! See commentary for Item 64 - Operating Rating.

Items 67, 68, 69, 71, and 72 - Indicate the Appraisal Ratings

- ! Information has been provided advising that the Edit/Update computer calculates the codes for Items 67, 68 and 69, based on the Coding Guide tables for these items. Values entered by bridge owners or inspectors are not used.
- ! Because the level of service concept is no longer being considered, all reference to level of service has been eliminated.

Item 67 - Structural Evaluation

- ! This item is calculated by the Edit/Update program and need not be coded in the field. The reference to how the item was to be coded by bridge inspectors has been eliminated. Editorial changes have also been made to indicate the specifications on which the Edit/Update program is based.
- ! The load rating vehicle conversion factors have been eliminated as only MS (previously HS) ratings are to be coded into the inventory rating item.
- ! Table 1 has been converted to metric values for the MS inventory ratings. Note that the inventory ratings have been shown in total metric tons with the decimal point included instead of assumed. The MS equivalent values have been included in the table.

Item 68 - Deck Geometry

- ! This item is calculated by the Edit/Update program and need not be coded in the field. Editorial changes have also been made to indicate the specifications on which the Edit/Update program is based.
- ! A statement has been added to advise that culverts coded 0000 for roadway width will be given the coding of N for this item.
- ! All tables have been converted to metric units of measurement. Where appropriate, a hard conversion has been used to match the metric standards of AASHTO.
- ! A note has been added to advise that one-lane bridges 4.90 meters and greater in deck width are evaluated as a 2-lane bridge using Table 2A.

Item 69 - Underclearances, Vertical Horizontal

- ! This item is calculated by the Edit/Update program and need not be coded in the field. Editorial changes have also been made to indicate the specifications on which the Edit/Update program is based.
- ! All tables have been converted to metric units of measurement. Where appropriate, a hard conversion has been used to match the metric standards of AASHTO.

Item 75 - Type of Work

- ! Segment A code "38" has been expanded to include hydraulic replacements.
- ! In addition to metric changes, editorial additions have been made, such as that this item may be left blank if not required.

Item 76 - Length of Structure Improvement

- ! Formulae for graphs have been added.

Item 92 - Critical Feature Inspection

- ! Text has been added to give the current guidelines on maximum allowable inspection intervals.

Item 94 - Bridge Improvement Cost.

- ! The examples showing average cost per unit of area have been changed to reflect in metric units. The value used is for example only.

Item 97 - Year of Improvement Cost Estimate

- !Field expanded to four digits to allow coding of complete year.

Item 99 - Border Bridge Structure Number

! Text has been added to clarify the coding.

Item 101 - Parallel Structure Designation

! Clarification of distance between structures coding.

Item 102 - Direction of Traffic

! Text has been added to clarify the coding.

Item 104 - Highway System of the Inventory Route

! With the passage of the 1991 ISTEA, the previous designation of highway systems has been eliminated. This item has been changed to identify structures that are on inventory routes that are on the National Highway System.

Item 105 - Federal Lands Highways

! New item used to indicate special federal lands highways.

Item 108 - Wearing Surface/Protective System

! Wearing surface type code 3 or latex concrete has been modified to include "similar" types of additive enhanced concrete, i.e. silica fume.

! A note has been added to the code 0 description of Segment A to make it clear that code 0 is to be used if no additional concrete thickness or thickness of a wearing surface is included in the bridge deck.

Item 110 - Designated National Network

! Consistent with the changes caused by the 1991 ISTEA, the reference to the Primary System has been changed to Federal-aid highways.

Item 112 - NBIS Bridge Length

! Bridge length has been defined in metric terms to be structures greater than 6.1 meters.

Item 113 - Scour Critical Bridges

- ! Two new codes have been added. These are for bridges over "tidal" waters and bridges with unknown foundations.
- ! Text has been added to update guidance and instructions on the scour critical coding of bridges over waterways to be in line with an October 6, 1993 memorandum on the coding of this item. The subject of the memorandum is "NBIS Clarification of Recording and Coding Guide - Item 113." The memorandum advises that structures such as culverts which have a low risk of scour damage and accordingly assessed as stable, are exempt from a scour analysis. Culverts which are assessed as low risk may be coded 8, and this includes open bottom culverts on competent rock or piles. Open bottom culverts with footings on soil should be coded 6 until they have been analyzed. The memorandum further states that in considering if a bridge is eligible for a code 8, the State shall have completed an analysis of a similar bridge with comparable conditions. It is recommended that the memorandum be reviewed for more detail.

Item 115 - Year of Future Average Daily Traffic

- ! Field expanded to four digits to allow coding of complete year.
- ! Editorial change made to clarify the coding instructions.

APPENDIX E

National Bridge Inventory Record Layout

Appendix E

National Bridge Inventory Record Format

With the conversion to metric and the addition of new items it is required to expand the size of the NBI record to 432 characters. The following format will be use to submit data to the FHWA.

<u>ITEM NO</u>	<u>ITEM NAME</u>	<u>ITEM POSITION</u>	<u>ITEM LENGTH/TYPE</u>
1	State Code	1 - 3	3/N
8	Structure Number	4 - 18	15/AN
5	Inventory Route	19 - 27	9/AN
5A	Record Type	19	1/AN
5B	Route Signing Prefix	20	1/N
5C	Designated Level of Service	21	1/N
5D	Route Number	22 - 26	5/AN
5E	Directional Suffix	27	1/N
2	Highway Agency District	28 - 29	2/AN
3	County (Parish) Code	30 - 32	3/N
4	Place Code	33 - 37	5/N
6	Features Intersected	38 - 62	25/AN
6A	Features Intersected	38 - 61	24/AN
6B	Critical Facility Indicator	62	1/AN
7	Facility Carried By Structure	63 - 80	18/AN
9	Location	81 - 105	25/AN
10	Inventory Rte, Min Vert Clearance	106 - 109	4/N
11	Kilometerpoint	110 - 116	7/N
12	Base Highway Network	117	1/N
13	Inventory Route, Subroute Number	118 - 129	12/AN
13A	LRS Inventory Route	118 - 127	10/AN
13B	Subroute Number	128 - 129	2/N
16	Latitude	130 - 137	8/N
17	Longitude	138 - 146	9/N
19	Bypass/Detour Length	147 - 149	3/N
20	Toll	150	1/N
21	Maintenance Responsibility	151 - 152	2/N
22	Owner	153 - 154	2/N
26	Functional Class Of Inventory Rte.	155 - 156	2/N
27	Year Built	157 - 160	4/N
28	Lanes On/Under Structure	161 - 164	4/N
28A	Lanes On Structure	161 - 162	2/N
28B	Lanes Under Structure	163 - 164	2/N
29	Average Daily Traffic	165 - 170	6/N
30	Year Of Average Daily Traffic	171 - 174	4/N
31	Design Load	175	1/N
32	Approach Roadway Width	176 - 179	4/N
33	Bridge Median	180	1/N
34	Skew	181 - 182	2/N
35	Structure Flared	183	1/N

<u>ITEM NO</u>	<u>ITEM NAME</u>	<u>ITEM POSITION</u>	<u>ITEM LENGTH/TYPE</u>
36	Traffic Safety Features	184 - 187	4/AN
36A	Bridge Railings	184	1/AN
36B	Transitions	185	1/AN
36C	Approach Guardrail	186	1/AN
36D	Approach Guardrail Ends	187	1/AN
37	Historical significance	188	1/N
38	Navigation Control	189	1/AN
39	Navigation Vertical Clearance	190 - 193	4/N
40	Navigation Horizontal Clearance	194 - 198	5/N
41	Structure Open/Posted/Closed	199	1/AN
42	Type Of Service	200 - 201	2/N
42A	Type of Service On Bridge	200	1/N
42B	Type of Service Under Bridge	201	1/N
43	Structure Type, Main	202 - 204	3/N
43A	Kind of Material/Design	202	1/N
43B	Type of Design/Construction	203 - 204	2/N
44	Structure Type, Approach Spans	205 - 207	3/N
44A	Kind of Material/Design	205	1/N
44B	Type of Design/Construction	206 - 207	2/N
45	Number Of Spans In Main Unit	208 - 210	3/N
46	Number Of Approach Spans	211 - 214	4/N
47	Inventory Rte Total Horz Clearance	215 - 217	3/N
48	Length Of Maximum Span	218 - 222	5/N
49	Structure Length	223 - 228	6/N
50	Curb/Sidewalk Widths	229 - 234	6/N
50A	Left Curb/Sidewalk Width	229 - 231	3/N
50B	Right Curb/Sidewalk Width	232 - 234	3/N
51	Bridge Roadway Width Curb-To-Curb	235 - 238	4/N
52	Deck Width, Out-To-Out	239 - 242	4/N
53	Min Vert Clear Over Bridge Roadway	243 - 246	4/N
54	Minimum Vertical Underclearance	247 - 251	5/AN
54A	Reference Feature	247	1/AN
54B	Minimum Vertical Underclearance	248 - 251	4/N
55	Min Lateral Underclear On Right	252 - 255	4/AN
55A	Reference Feature	252	1/AN
55B	Minimum Lateral Underclearance	253 - 255	3/N
56	Min Lateral Underclear On Left	256 - 258	3/N
58	Deck	259	1/AN
59	Superstructure	260	1/AN
60	Substructure	261	1/AN
61	Channel/Channel Protection	262	1/AN
62	Culverts	263	1/AN

<u>ITEM NO</u>	<u>ITEM NAME</u>	<u>ITEM POSITION</u>	<u>ITEM LENGTH/TYPE</u>
63	Method Used To Determine Operating Rating	264	1/N
64	Operating Rating	265 - 267	3/N
65	Method Used To Determine Inventory Rating	268	1/N
66	Inventory Rating	269 - 271	3/N
67	Structural Evaluation	272	1/AN
68	Deck Geometry	273	1/AN
69	Underclear, Vertical & Horizontal	274	1/AN
70	Bridge Posting	275	1/N
71	Waterway Adequacy	276	1/AN
72	Approach Roadway Alignment	277	1/AN
75	Type of Work	278 - 280	3/N
75A	Type of Work Proposed	278 - 279	2/N
75B	Work Done By	280	1/AN
76	Length Of Structure Improvement	281 - 286	6/N
90	Inspection Date	287 - 290	4/N
91	Designated Inspection Frequency	291 - 292	2/N
92	Critical Feature Inspection	293 - 301	9/AN
92A	Fracture Critical Details	293 - 295	3/AN
92B	Underwater Inspection	296 - 298	3/AN
92C	Other Special Inspection	299 - 301	3/AN
93	Critical Feature Inspection Dates	302 - 313	12/AN
93A	Fracture Critical Details Date	302 - 305	4/AN
93B	Underwater Inspection Date	306 - 309	4/AN
93C	Other Special Inspection Date	310 - 313	4/AN
94	Bridge Improvement Cost	314 - 319	6/N
95	Roadway Improvement Cost	320 - 325	6/N
96	Total Project Cost	326 - 331	6/N
97	Year Of Improvement Cost Estimate	332 - 335	4/N
98	Border Bridge	336 - 340	5/AN
98A	Neighboring State Code	336 - 338	3/AN
98B	Percent Responsibility	339 - 340	2/N
99	Border Bridge Structure Number	341 - 355	15/AN
100	STRAHNET Highway Designation	356	1/N
101	Parallel Structure Designation	357	1/AN
102	Direction Of Traffic	358	1/N
103	Temporary Structure Designation	359	1/AN
104	Highway System Of Inventory Route	360	1/N
105	Federal Lands Highways	361	1/N
106	Year Reconstructed	362 - 365	4/N
107	Deck Structure Type	366	1/AN
108	Wearing Surface/Protective System	367 - 369	3/AN
108A	Type of Wearing Surface	367	1/AN
108B	Type of Membrane	368	1/AN
108C	Deck Protection	369	1/AN

<u>ITEM NO</u>	<u>ITEM NAME</u>	<u>ITEM POSITION</u>	<u>ITEM LENGTH/TYPE</u>
109	AVERAGE DAILY TRUCK TRAFFIC	370 - 371	2/N
110	DESIGNATED NATIONAL NETWORK	372	1/N
111	PIER/ABUTMENT PROTECTION	373	1/N
112	NBIS BRIDGE LENGTH	374	1/AN
113	SCOUR CRITICAL BRIDGES	375	1/AN
114	FUTURE AVERAGE DAILY TRAFFIC	376 - 381	6/N
115	YEAR OF FUTURE AVG DAILY TRAFFIC	382 - 385	4/N
116	MINIMUM NAVIGATION VERTICAL CLEARANCE VERTICAL LIFT BRIDGE	386 - 389	4/N
---	Washington Headquarters Use	392 - 426	
	STATUS	427	
n/a	Asterisk Field in SR	428	1/AN
SR	SUFFICIENCY RATING (select from last 4 positions only)	429 - 432	4/N

Status field: 1=Structurally Deficient; 2=Functionally Obsolete; 0=Not Deficient; N=Not Applicable